

Popular Electronics

INCLUDING **Electronics World**

**Design your own
CLOSED BOX SPEAKER SYSTEM**

**CHROMIUM DIOXIDE vs FERRIC OXIDE
CASSETTE TAPES --a Hirsch-Houck Test Report**

HOW TO BUILD:

- The COSMOS Die
- Carrier Current AM Transmitter

**Selecting an
ELECTRONIC ORGAN**

MODEL ROCKETS for the EXPERIMENTER

TEST REPORTS:

- Heath AD-1530 Cassette Tape Deck
- Marantz 2440 Quadraphonic Adaptor/Amp
- Lafayette SSB-50 CB Transceiver
- Electrosonics EM-S
- Williams Model A Tra

561256 DLS B0245M97 NOV73 6 1D
 M DELSCHLAGER
 BX 245
 BROWNS MILLS NJ 08015
 4
 06

Kit for kit, text for text, dollar for dollar, your best home training buy is NRI

NRI "hands on" method gives you as much as 2 years of on-the-job experience. Pick your field and enroll now!

After over 55 years of training men for Electronics in their homes, NRI knows that theory alone is not enough. That's why NRI concentrates so heavily in the development of special training equipment. Your hands must be trained as well as your head, and NRI gives you both kinds of training in a manner no other school can match.

You get your hands on professional parts and demonstrate theory you read in NRI's unique "bite-size" texts. You build designed-for-learning Electronic circuits and complete, operating equipment. You use what you build to prove out what you read. Electronics comes alive in the most valuable, practical manner. You experiment with the same kinds of solid-state and transistorized and tube circuits you'll find on the job—not hardware or breadboard hobby kits.

NRI prepares you for your choice of careers in Color TV Servicing, Communications, Industrial Electronics and the growing field of Computer Electronics. Many NRI graduates start earning \$5 to \$7 an hour extra soon after they enroll, fixing home Electronic equipment for friends and neighbors in spare time. NRI's remarkable teaching method simplifies, organ-

izes, dramatizes subject matter so that any ambitious man, regardless of his education, can effectively learn and profit from the Electronics course of his choice—and NRI gives you 15 training plans to choose from.

Over three-quarters of a million men have enrolled with NRI since 1914. Proof of the value and experience you get when you choose NRI for your Electronics training . . . proof of why NRI continues to be the country's largest Electronics home-study school. Discover for yourself how easy it is to move into Electronics and move up in a rewarding career. Mail the postage-free card for the new NRI Catalog. There is no obligation. No salesman will call on you because NRI does not employ salesmen. NATIONAL RADIO INSTITUTE, Washington, D.C. 20016.



If postage-free card is missing, write to:
NATIONAL RADIO INSTITUTE
Washington, D.C. 20016

GET FACTS ABOUT GI BILL

If you have served since January 31, 1955, or are in service now, check GI line on postage-free card.



...first and only school to include training equipment designed from chassis up for your education

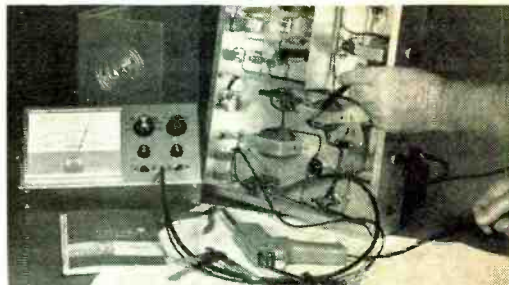
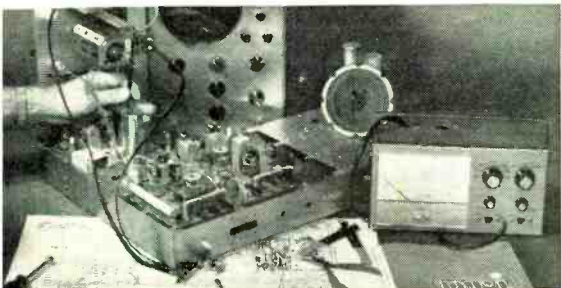

Earn \$5 to \$7 an hour spare or full time in COLOR TV SERVICING

It's easy to learn as you build, stage-by-stage, the only custom designed Color TV receiver engineered specifically for training purposes. You grasp a professional understanding of all color circuits through logical demonstrations never before presented. The end product is a superb Color TV set that will give you and your family years of viewing pleasure. NRI gives you the option of selecting either Color or black-and-white training equipment.

There's glamour, success awaiting Technicians in COMMUNICATIONS

NRI gives you the experience you need to qualify for jobs in TV broadcasting stations, or operating and servicing mobile, marine, aviation communications equipment. You build and use a solid-state voltohmmeter; perform experiments on transmission lines and antenna systems, even build your own 25-watt, phone-cw amateur transmitter band. In all NRI Communications courses, *you must pass your FCC exams—or you get your money back.*



Fill technical jobs without a degree in INDUSTRIAL ELECTRONICS

NRI's Electronics Technology course gives you completely specialized training kits engineered for business, industrial and military Electronics fields. On completing this training, competent technical ability can be instantly demonstrated by you. As you learn, you actually build and use your own training center in solid-state motor control and analog computer servo-mechanisms. Telemetering circuits, solid-state multi-vibrators, even the latest integrated circuits are included in your home training program.

Prepare quickly for a high pay career in COMPUTER ELECTRONICS

This may well be the most unique and exciting educational aid ever developed for home training—a digital computer *with memory* you build and use to learn organization, trouble shooting, operation and programming. It performs the same functions as commercial computers you encounter on the job. Lessons stress computer repair. You perform a hundred experiments, build hundreds of circuits. Your own solid-state voltohmmeter is included among the ten training kits you receive.

OVER 50 YEARS OF LEADERSHIP IN ELECTRONICS TRAINING

Popular Electronics

WORLD'S
LARGEST-SELLING
ELECTRONICS MAGAZINE

INCLUDING **Electronics World**

FEATURE ARTICLES

- 26** MODEL ROCKETRY FOR THE ELECTRONICS EXPERIMENTER *Forrest Mims*
An exciting and interesting hobby.
- 31** MOVE UP TO BUSINESS RADIO BAND *William I. Thomas*
Higher power and less interference.
- 41** CLOSED BOX SPEAKER SYSTEM DESIGN, PART 1 *David B. Weems*
- 45** HOW TO SELECT AN ELECTRONIC ORGAN *L. George Lawrence*
- 50** TEST REPORT ON CHROMIUM DIOXIDE VS FERRIC OXIDE CASSETTE TAPES *Julian D. Hirsch*
- 61** CDA—THE NEW CURRENT DIFFERENCING AMPLIFIER *Walter G. Jung*
The latest in integrated circuits.
- 84** AN ELECTRONIC COUNTER FOR THE TECHNICIAN *John T. Frye*
- 88** HOW DO SERIES-CONNECTED CONSTANT CURRENT SOURCES OPERATE? *John T. Bailey*
- 90** DO YOU KNOW YOUR DC CIRCUITS? PART 2 *Arthur H. Seidman*
- 98** THE NEW 4-CHANNEL RECORDS *Harry Maynard*
- 102** THE SURFACE CHARGE TRANSISTOR *David L. Heiserman*
- 112** VIDEO COLOR PICTURE PLAYER USES STANDARD AUDIO CASSETTES

CONSTRUCTION STORIES

- 34** A 5-WATT CARRIER-CURRENT TRANSMITTER *Jim S. Harmon*
An inexpensive radio system.
- 40** LIGHT-ACTIVATED SLAVE STROBE TRIGGER *Adolph A. Mangieri*
- 58** BUILD A COSMOS DIE *Michael S. Robbins*
An interesting and entertaining IC project.

ZIFF-DAVIS PUBLISHING COMPANY
Editorial and Executive Offices
One Park Avenue, New York, New York 10016
212 679-7200

William Ziff, President
W. Bradford Briggs, Executive Vice President
Hershel B. Sarbin, Senior Vice President and Secretary
Philip Sine, Financial Vice President and Treasurer
Phillip T. Heffernan, Vice President, Marketing
Frank Pomerantz, Vice President, Creative Services
Arthur W. Butzow, Vice President, Production
Edward D. Muhlfeld, Vice President, Aviation Division
Irwin Robinson, Vice President, Travel Division
George Morrissey, Vice President
Sydney H. Rogers, Vice President
Sidney Holtz, Vice President
Lawrence Sporn, Vice President, Circulation

POPULAR ELECTRONICS Including ELECTRONICS WORLD, June, 1973, Volume 3, Number 6. Published monthly at One Park Ave., New York, NY 10016. One year subscription rate for U.S., U.S. Possessions and Canada, \$6.00; all other countries, \$7.00. Second class postage paid at New York, N.Y. and at additional mailing offices. Authorized as second class mail by the Post Office Department, Ottawa, Canada and for payment of postage in cash. Subscription service and Forms 3579: P.O. Box 2774, Boulder, CO 80302. Editorial offices for manuscript contributions, reader inquiries, etc.: One Park Ave., New York, NY 10016.

POPULAR ELECTRONICS Including ELECTRONICS WORLD is indexed in the Reader's Guide to Periodical Literature.

Copyright © 1973 by ZIFF-DAVIS PUBLISHING COMPANY. All rights reserved.

EDGAR W. HOPPER

Publisher

WM. A. STOCKLIN

Editorial Director

MILTON S. SNITZER

Editor

LESLIE SOLOMON

Technical Editor

JOHN R. RIGGS

Managing Editor

EDWARD I. BUXBAUM

Art Director

ALEXANDER W. BURAWA

Associate Editor

ANDRE DUZANT

Technical Illustrator

JOHN T. FRYE

J. GORDON HOLT

RICHARD HUMPHREY

WALTER G. JUNG

MATT P. SPINELLO

Contributing Editors

JOSEPH E. HALLORAN

Advertising Director

JOHN J. CORTON

Advertising Sales

MADELEINE LITTMAN

Advertising Service Manager

STANLEY NEUFELD

Associate Publisher

FURMAN H. HEBB

*Group Vice President
Electronics and Photographic*

THE SCENES

- 12 STEREO SCENE** *J. Gordon Holt*
- 68 SOLID-STATE SCENE** *Walter G. Jung*
- 94 HOBBY SCENE**
- 96 CB SCENE** *Matt P. Spinello*
- 100 TEST EQUIPMENT SCENE** *Leslie Solomon*
- 113 SURPLUS SCENE** *Alexander W. Burawa*

PRODUCT TEST REPORTS

- 76 HEATH MODEL AD-1530 STEREO CASSETTE DECK**
- 78 MARANTZ MODEL 2440 QUADRADIAL 4 ADAPTOR-AMPLIFIER**
- 80 LAFAYETTE RADIO TELSAT SSB-50 CB TRANSCEIVER**
- 82 ELECTROSONICS INTERNATIONAL EM-S MONITOR RECEIVER**
- 83 JUD WILLIAMS MODEL A TRANSISTOR CURVE TRACER**

DEPARTMENTS

- 6 EDITORIAL** *Milton S. Snitzer
Electronics Helps Fight Crime*
- 8 LETTERS**
- 22 NEWS HIGHLIGHTS**
- 104 NEW PRODUCTS**
- 109 ELECTRONICS LIBRARY**
- 110 NEW LITERATURE**

COMING NEXT MONTH

- Build an SQ Four-Channel Decoder*
- Cassette Noise Reducing Systems*
- Electronics and Brain Control*
- How to Become a Radio Amateur*

Midwestern Office
The Patis Group, 4761 West Touhy Ave.,
Lincolnwood, Illinois 60644, 312 679-1100
GERALD E. WOLFE, DICK POWELL
DICK GOVATSKI, MANLEY LUDWIG

Western Office
9025 Wilshire Boulevard, Beverly Hills, California 90211
213 273-8050; BRadshaw 2-1161
Western Advertising Manager, BUD DEAN

Japan: James Yagi
Oji Palace Aoyama; 6-25, Minami Aoyama
6 Chome, Minato-Ku, Tokyo 407-1930/6821

Ziff-Davis also publishes Boating, Car and Driver, Cycle, Flying, Modern Bride, Popular Photography, Skiing, and Stereo Review.

Forms 3579 and all subscription correspondence should be addressed to POPULAR ELECTRONICS Including ELECTRONICS WORLD, Circulation Department, P.O. Box 2774, Boulder, CO 80302. Please allow at least eight weeks for change of address. Include your old address, as well as new—enclosing, if possible, an address label from a recent issue.

Editorial contributions must be accompanied by return postage and will be handled with reasonable care; however, publisher assumes no responsibility for return or safety of art work, photographs or manuscripts.



Member Audit Bureau of Circulations



Editorial

By Milton S. Snitzer, Editor

ELECTRONICS HELPS FIGHT CRIME

We are all familiar with the use of two-way radio in police cars to dispatch them to the scene of a crime quickly and efficiently. We have also seen closed-circuit television cameras used in banks and stores for surveillance purposes. But there are also some behind-the-scenes applications of electronics that we may not be aware of.

One of these is a computerized criminal identification system that has been in use in New York State. This system provides information to some 3600 law enforcement agencies throughout the state. Crime data is supplied in response to one-third of a million requests a year from criminal justice agencies. The databank contains about four million sets of fingerprints and over five million names which are used to check if suspects have a previous criminal record.

Some 26 facsimile transmitters across the state—including one in each of New York City's five boroughs—are now used to transmit fingerprints and suspects' names to the databank in the state capital at Albany. Unfortunately however, the facsimile machines are slow—requiring almost 15 minutes to transmit a single standard 8" fingerprint card—and copies are often not legible enough.

The other day we went up to Albany to see a demonstration of a new electronic system that does the same job more quickly and more accurately. The system, called Intravision by its developer Data-Plex Systems, Inc. (Greenwich, Conn.), transmits the card in less than a minute and with a high resolution of 400 to 2000 lines. Intravision is now being studied and evaluated by N.Y.'s State Division of Criminal Justice Service, which maintains the central crime databank.

The very high speed of transmission is obtained because the data is scanned by a TV camera whose video output rides piggyback on television programs being carried by the state's educational TV network. This is done by replacing one of the TV picture frames, transmitted at the usual 30 frames per second, with a frame containing the special information, such as a fingerprint card. We were barely able to see on TV line monitors the special information flashing on the screen. To prevent the special information from being seen at all on the home receiver, this frame is removed at the network receiving end. The special information is then displayed on a storage cathode ray tube and photographed to obtain one or more hard copies of the data. In the meantime the video information on the previous frame of the TV program is recorded on a video disc memory and inserted where the special frame was removed. The reconstituted TV picture as sent out over the air is then completely free of flashing or flickering.

The system could also be used by libraries, business organizations and other government agencies. It can transmit high resolution material at the rate of portions of a page in a minute and low resolution documents at one page per second.

With our present high crime rate being a major national problem, we are glad to see that electronics is lending a hand to our law enforcement agencies. They need all the help they can get.

Explore the big-pay world of Electronics.

It's easy as 1-2-3

1. Print your name here Age
2. Print your address Apt. No.
City State Zip
3. MAIL THIS COUPON FOR FREE INFORMATION

We will rush you, without obligation, a FREE sample lesson in Electronics to demonstrate LaSalle's home study method — plus 2 illus-

trated booklets, "Your Place in the World of Electronics" and "How to Obtain Your Commercial FCC License."

LASALLE EXTENSION UNIVERSITY

A Correspondence Institution • 417 S. Dearborn Street, Dept. 90-070, Chicago, Illinois 60605

05B

© 1973 LaSalle Extension University.

Find out how to take the important step from a low-pay, dead-end job to an exciting future in electronics. LaSalle's free sample electronics lesson demonstrates how you can learn at home to earn big money as an electronics technician. Send for this free lesson. There's no obligation.

Thousands of technicians in demand!

Each year the electronics field continues to grow, revolutionizing industry and communications, developing new applications that reshape our lives. "The world of tomorrow" is here . . . with electronic crime detectors, electronic traffic control, electronic factory automation, electronic medicine . . . and with TV-radio broadcasting reaching new peaks of development. No wonder the electronics technician is the man of the hour — with thousands of high-pay opportunities to choose from! Why don't you get started in this rewarding field?

Let LaSalle teach you at home

You don't need previous experience for LaSalle training. You learn the basic principles of electronics under the guidance of experienced instructors. Lessons in this up-to-date course are simply presented, easy to

understand. You are led step-by-step into practical applications — *with emphasis on modern techniques*. You actually build your own electronic equipment with parts supplied to you. You receive individual attention and you can have additional help by mail whenever you need it. When your studies are completed, you are awarded the LaSalle diploma, a respected credential.

Training for FCC License included

If your goal is in the field of communications you will need the Government FCC (Federal Communications Commission) License. LaSalle training in communications fully prepares you to pass the FCC's first class radio-telephone operator license exam.

LaSalle has enrolled more than 2,000,000 men and women in its many career programs. It gives you a great feeling of confidence to know that your training is in the hands of a leader in home study.

Here's your big chance to break into an electronics career, with all the opportunities that it offers for interesting work and high pay. Mail the big Opportunity Coupon today for free sample lesson and free booklets. There's no obligation. LaSalle, 417 S. Dearborn Street, Chicago, Illinois 60605.

ALL 3 FREE!

Sample Lesson in Electronics, "Your Place in the World of Electronics," "How to Obtain Your Commercial FCC License."

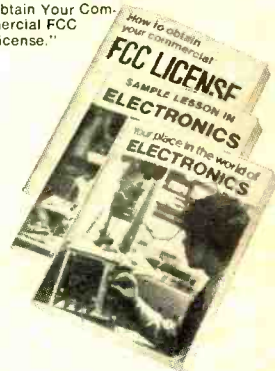

CIRCLE NO. 18 ON READER SERVICE CARD

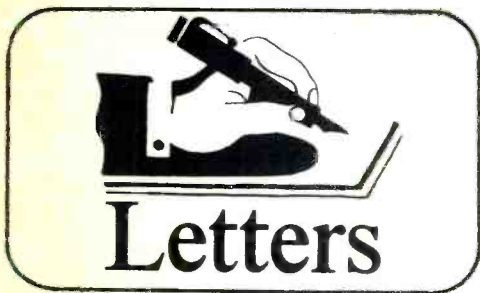

COBALT-DOPED TAPES TAKE THE BRUNT

J. Gordon Holt's "Cassettes For Perfectionists" (March 1973) was generally well done, but it contained information that I feel does an injustice to a large segment of the blank tape industry. In his discussion of the relative signal retention of the three main types of tape formulations used in the manufacture of cassettes, Mr. Holt gives the brunt of the punishment to cobalt-doped tapes. We are aware that, when the first such tape appeared on the market more than 12 years ago (not ours, however), there was a very real problem with high-frequency signal loss after several plays. Though this particular product was on the market only a short time, the studies relating to its limitations continue to live on.

3M has a cobalt-energized cassette tape that we introduced in 1971 under the title "High

Energy" as our top-of-the-line cassette tape. While CrO₂ tape is said (in the story) to be down 1 to 1.5 dB at 15,000 Hz after 30 plays, our technical people found that High Energy tapes exhibit an average loss of only 2 dB after 100 plays—a far cry from the 8-dB figure stated. I think you will agree that great strides have been made in 12 years.

RICHARD ZIEFF
Senior Publicist
3M Company
New York, N.Y.

SHADES OF DR. FRANKENSTEIN!

I've decided to build a 3-4-million-volt Tesla coil. In looking through back issues of POPULAR ELECTRONICS, I noticed that you published construction articles like "Big TC" and "Li'l TC" (July 1964) and several letters from readers who have built Tesla coils. I am interested in hearing from any readers who have built TC's with outputs of 1 million or more volts. I would specifically like to know the input voltages they used.

DALE PFAFFLE
3890 Yolo Dr.
San Jose, CA 95136

A 3-4-million-volt TC? You must have enough money to bankroll the federal defense budget. Well, if you're really serious about this (we'd like to dissuade you), we've given your

If what you don't know about converting stereo to 4-channel sound would fill a book... write for the book.

Quadrasonic. Quadrosonic. Matrix. Discrete. SQ. QS. EV-4. CD-4. Logic. Demodulator. Decoder. Ambience Recovery. Derived. Synthesized.

Confused? We can't blame you.

We can help you.

4-channel is great to listen to, but murder to talk about.

There's a new vocabulary to learn. And new kinds of components.

New ways to use old components. New places to put speakers. Complex wiring. And more.

BSR-Metrotec makes equipment to convert your stereo

system to 4-channel, at minimum cost, and without replacing any of your present components.

We think you'll like 4-channel. And if you'll spend a few minutes with our free booklet, you'll understand it, and be better able to decide if it's for you.

BSR

METROTEC

BSR (USA) Ltd.,
Blauvelt, N.Y. 10913

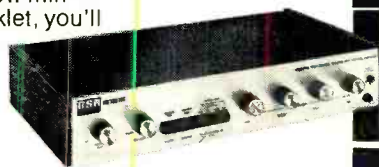

Name _____
Address _____
City _____
State _____ Zip _____

CIRCLE NO. 2 ON READER SERVICE CARD

POPULAR ELECTRONICS Including Electronics World

complete address so that interested readers can tell their "hair-raising" stories directly to you.

ANOTHER DIRE NEED . . .

I am in dire need of a single-trace 19-in. rack-type oscilloscope for audio purposes. I'm looking for something the "average" hi-fi buff can afford, not something a well-endowed scientific laboratory would buy. Can you or any of your readers help?

ROBERT HARRIS
14047 Roblar Rd.
Therman Oaks, CA 91403

Ever hear of surplus dealers? They might have what you're looking for. You might try first R.E. Goodheart Co., Inc., P.O. Box 1220, Beverly Hills, CA 90213, then work around to other dealers (see this month's "Surplus Scene") if Goodheart doesn't have what you need. In the unlikely event that none of the dealers can supply you with your needs, any reader who can help can write directly to you.

CUSTOMER RELATIONS AND ALL THAT

Since November 21, 1972, I have had occasion to purchase about \$430 worth of IC's from Solid State Systems, Inc. ("Surplus Scene," March 1973). The orders have covered about 90 percent of all IC's offered by SSSI to the tune of about 1000 devices. To date, all IC's delivered have been operational, pins clean, properly identified, and about 40 percent were of the higher quality ceramic package variety rather than the plastic type advertised.

I conducted all my business with SSSI via air mail. The average turnaround for my orders has been eight days. Everything you say about Solid State Systems, Inc., is correct.

THOMAS P. VAN WORMER, JR.
El Cajon, Calif.

Nice to hear that you're doing business instead of getting the business.

"DEAR ALPHA WAVERS"

We would like to inform the many people who ordered the Alpha Brain-Wave Monitor Kit in your January 1973 issue that we are sending out kits as fast as we can. Due to the very large number of orders received, there may be some delay before all are filled.

We have sent a post card to all those whose orders we received. If they have not heard from us, please have them write again to find out what happened.

Orders can still be placed for the complete Alpha Brain-Wave Feedback Monitor Kit at \$58.95, postpaid (kit PE-1) from Extended Digital Concepts, P.O. Box 9161, Berkeley, CA 94709.

BISHOP ROGERS
Head of Operations
Extended Digital Concepts

The "GREATEST" Sound in the World...



- The powerful new Altec 411-8A low frequency loudspeaker
- 15 inch Dynamic Force Acoustic Suspension design
- 4 inch edge-wound copper ribbon voice coil with aluminum support
- 18 pound magnet structure
- High power handling and house shaking bass
- Build your own box
- Add the Altec high frequency system and matching attenuator/equalizer circuits

This is the why . . . and Altec provides the how . . . Write for your free copy of the 411-8A instruction sheet. Altec, 1515 S. Manchester Ave., Anaheim, California 92803.

ALTEC
A DIVISION OF ALTEC CORPORATION

CIRCLE NO. 36 ON READER SERVICE CARD

ANYTHING

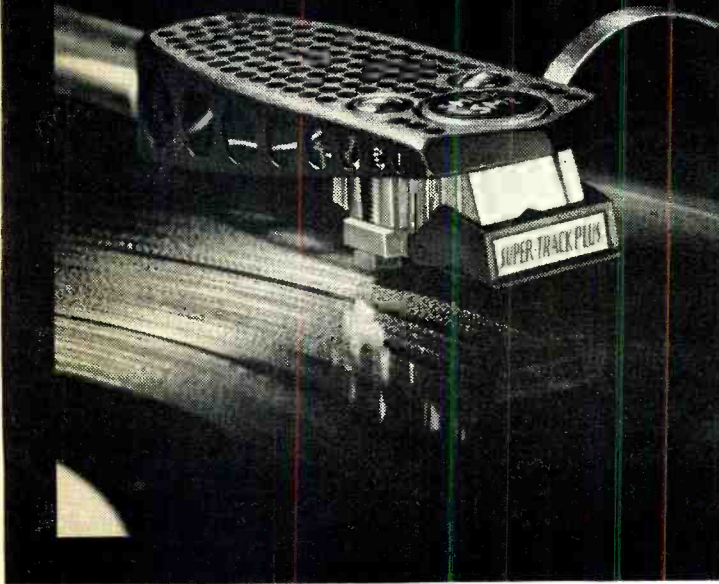

II COULD DO III CAN DO BETTER!

Several years ago, we decided that our next challenge would be to go beyond the best there was. Our computers told us we had taken the existing cartridge structure and stylus assembly of the V-15 Type II Improved as far as we could, and that hereafter, any improvement in one performance parameter would be at the expense of performance in some other parameter.

Therefore, over the past several years, a wholly new *laminated* cartridge structure has been developed, as was an entirely new stylus assembly with a 25% reduction in effective stylus mass! These developments have resulted in optimum trackability at light tracking forces ($\frac{1}{4}$ - $1\frac{1}{4}$ grams), a truly flat, unaccented frequency response, and more extended dynamic range than was possible even with the Type II Improved, without sacrificing output level!

Further, because these factors are held in perfect equilibrium, wherein each design parameter enhances every other parameter, the total audio effect is greater than the sum of its individual engineering achievements. Engineers call this effect a Synergistic Reaction; ergo, we call the Type III the Synergistic Cartridge.

If you like its sound today, you will like it even more as time goes on. In fact, to go back to any other cartridge after living with the Type III for a short while is simply unthinkable, so notable is its neutral, uncolored sound. You must hear it \$72.50.

INTRODUCING THE NEW



V-15 TYPE III Super-Track "Plus" Phono Cartridge

Shure Brothers Inc. • 222 Hartrey Ave. • Evanston, Ill. 60204

In Canada: A. C. Simmonds & Sons Ltd.

CIRCLE NO. 30 ON READER SERVICE CARD



Stereo Scene

By J. Gordon Holt

THE STATE of indecision and vacillation that has characterized the audio industry's initial plunge into 4-channel sound may have dismayed a lot of consumers, but most of the writers for the audio press will admit privately that they've had rather a lot of fun with it. A good writer prides himself on the breadth of his vocabulary, and the 4-channel situation has provided him a golden opportunity to dig deeply into his bag of synonyms for the word "confusion." Hence, we have had the 4-channel scene described as "chaotic," "muddled," "disordered," "messy" and "turbid," to name only a few. But the party's over, fellas. The period of anarchy is passing. Order is emerging from the chaos, and it is now possible to sit down, survey the situation calmly, and say "This is where we're going, and those were dead ends."

The early 4-channel years have left their mark, though, in a small legacy of arcane terminology which was intended originally to clarify the situation by pegging each variation on the 4-channel theme with a clear identification, but which now serves only to confuse—terms like Hafler, Scheiber, SQ, QS, E-V I, E-V II, Sansui, CD-4, and so on. We will attempt to bring order to *that* chaos.

It may come as a surprise, but all of those terms really do mean something. Hafler and Scheiber are people, whose "systems" were named after them. Sansui, of course, is a Japanese electronics manufacturer, which

put its name to *its* system. The others are abbreviations which we'll investigate.

The whole mess started when the word got around that the only way to record and reproduce 4-channel sound was via four separate tape tracks. This was the kind of arrogant proclamation that challenges the American inventive urge, particularly when the consequences of its being true would be that 4-channel sound would halve a tape's playing time and be impossible to record on a disc or reproduce via FM. The industry's reaction was, "Dammit, there *must* be a way of squeezing two more channels into a disc groove or an FM transmission."

One of the first ideas to be demonstrated was promoted by Dynaco founder David Hafler. It was not intended to be a way of recording and reproducing 4 channels via two, but as a way of extracting rear-channel ambience information from conventional two-channel stereo recordings. Its most attractive feature, apart from the fact that it did a passable job with many recordings, was that it required no additional amplifying channels; just two more loudspeakers and a variable resistor. Subsequently, a few experimental recordings were made to place *instrumental* sounds at the rear via Hafler "decoding," but none have been made for several years now, and the Hafler system is used only for ambience extraction.

Most so-called "universal" 4-channel decoders have a selector setting for ambience extraction, but as usual, there is no agreement as to what to call it. Electro-Voice calls it Dyna, Eico calls it Background, JVC calls it SFCS (Simulated Four-Channel System), while Lafayette calls it Composer A or Composer B. The two "Composers" are identical except that one drops the level of the rear-channel signals by several dB. (The choice depends on the program material.)

The Logical Scheiber. The first system

CIRCLE NO. 6 ON READER SERVICE CARD →

What's in a 4-Channel Name

Now there's a CB radio with too much talk power.



Put punch in your voice, from a block away to the fringes of your range. New Dyna-Mike gain control puts out absolute modulation. So much talk power you'll have to turn it down.

An important feature, but only one that makes this fantastically low-priced CB radio the best CB value on today's market.

The Cobra 21 with crystal filter, dual conversion receiver; transmits and receives on all 23 AM channels.

Features 60 dB adjacent channel rejection that completely eliminates bleedover.

Extra large Power S Meter let's you monitor your set's performance easily even when it's tucked under the dashboard.

And you get switchable automatic noise limiter, P.A./external speaker jack, large built-in speaker and detachable mike.

It's all wrapped up in a beautiful, compact cabinet only 6" wide x 2½" wide x 7½" deep. Meets FCC requirements.

Ask your CB Dealer for the Cobra 21. The radio with too much talk power for not much money.



\$119.95
with mike

COBRA 21
WITH EXCLUSIVE DYNA-MIKE

Product of DYNASCAN CORPORATION • 1801 W. Belle Plaine • Chicago, Illinois 60613

specifically intended for the encoding and decoding of four channels down to two and back to four was Peter Scheiber's proposal to use what was (and is) termed a matrixing arrangement, whereby the four channels undergo adjustments in relative phase (time coincidence) and intensity before they are combined into two channels. The resulting relationships are used later to "matrix out" the original four signals. This did indeed recreate four separate signals, but the isolation between adjacent channels was very poor. So, Mr. Scheiber devised a little black box containing "logic" circuitry, which compared the signals in each channel with the signals appearing in the adjacent and diagonal ones, "decided" which channel was trying to reproduce its own signal, and shut down the adjacent channels. The "enhancing" action was done almost instantaneously, according to the signal waveform at each given moment, so it was possible, within certain limits, to give the impression of a different sound source coming from each of the four channels, *as long as they weren't playing simultaneously*. When they were, the logic circuits became confused and separation went to pieces. Mr. Scheiber took it back to the drawing board, and later joined forces with Electro-Voice, Inc. to develop the system further.

The result of their collaboration was the EVX-4 decoder, which used refined matrixing techniques but no logic circuitry, so separation between some channels was rather poor. The E-V matrix was used for a number of popular releases on 4-channel discs, but now there were other systems appearing.

All matrix systems are basically the same. They differ only in the proportions and the phase relationships by which the four signals are mixed down to two and then subsequently matrixed out to four again, and in the nature of the "enhancement" that is used to overcome the inevitable losses of channel separation. Thus, there have been proposed matrix systems such as the "New-Orleans" matrices (so-called because that's where they originated) which differed one from the other by nothing more than 45 degrees of phase shift. None of the New Orleans matrices were adopted by or used by any American manufacturer, but one of them—the so-called 90-degree-rotation matrix—was developed independently by a Japanese (R. Itoh) and became the basis of the original Sansui "QS" (Quadra Sonic) system.

Then in mid-1972, the Engineering Committee of the Record Association of Japan (the equivalent of our RIAA) proposed as a "standard" matrix the so-called Regular Matrix, or RM. On paper, this looks very much like the original Sansui matrix, as indeed both of them resemble the matrix that would have been used to encode four channels via the Dynaco/Hafler "system." And all three share a certain functional incompatibility in that any sounds intended for rear reproduction in four channels are almost entirely lost in monophonic reproduction—a situation which is hardly desirable in view of the fact that the statistical majority of persons still listen via one channel.

Perhaps the major difference between the RM and the original Sansui and Hafler matrices, though, is that the definitions of the directional modulations in an RM-encoded groove are such that they could be met only by monophonic signal sources "matrixed" via panning controls. A typical multi-channel master tape could supply the necessary signals, but the less-coherent outputs from the four microphones of a true 4-channel recording could not.

Columbia Records, in the U.S., wanted a matrix system that was compatible with both mono reproduction and true 4-channel recording, and their answer—which they named, rather perversely it seemed, "SQ" (Stereo Quadraphonic)—was the first to differ in some important respects from all other matrix systems. Mono compatibility was obtained by prohibiting, by definition, the recording of any signal for rear-center location in mono. The matrixing could be achieved either by panning from mono signals or via the outputs from four mikes in a 4-channel setup.

SQ for America. Most of the 4-channel discs released in the US have been encoded for Columbia SQ playback, while Japan, to date, seems to favor Sansui encoding. Officially, Columbia's view is that the Sansui matrix has little to recommend it, for Sansui's QS encoding yields a disc with poor separation when played back via two channels, and with badly upset instrumental balances when reproduced monophonically. But QS just won't go away.

A main reason for this is that, while both systems are intended to be reproduced via separation-enhancing circuits similar in action to those of the original Scheiber decoder, the inexpensive decoders—which most peo-

Don't let the handy size fool you.

The Serviset E/C is a complete, self contained versatile field test instrument. A precision-built, reliable, much-used instrument to compliment your VOM, scope or other equipment, too.

The Serviset E/C is great for servicing all sorts of electronics in the field and on the bench. Whether you're a professional engineer working on communications or EDP devices. An electronics or appliance technician working in radio, television, hi-fi audio or appliance repair. Or an amateur electronics enthusiast, ham radio operator or student.

Checks you'll make with the Serviset E/C include: sync, sweep, video, audio circuits; high or low DC, RF, or pulse voltage supplies; coils, capacitors, resistors, tubes, transistors, diodes, transformers, speakers--whatever you're trouble-shooting from stage to stage, or discrete components. What's more, your Serviset E/C is safe: whatever you check, you won't blow it.

The Serviset E/C. The \$35. Electronic Test Lab (almost) that will follow you anywhere. One of an advanced line of guaranteed electronic test devices from Lee that will save you time and effort. Including our CT-1 Condenser Tester and Leakage Indicator.

*send check or money order. C.O.D., send \$2. deposit.

Serviset E/C, \$34.95 postpaid *from Lee Electronic Labs.
Available also at electronic dealers and all Olson Stores, nationwide.

The \$35. Electronic Test Lab (almost) that will follow you anywhere: Serviset E/C



Lee Electronic Labs, Inc.

BOX 78, WATERTOWN, MASS. 02172 (617) 891-8686

ple are buying—do not have any enhancement at all, and without it, the Sansui discs give better front-to-rear separation than SQ. On the other hand, the SQ discs *are* noticeably less degraded by 2-channel playback than Sansui. So, bit by bit, and with a minimum of public announcement, Columbia has been modifying their matrix parameters to approach those of Sansui's, while it appears that Sansui has been approaching the SQ matrix. The systems are still not compatible—Sansui decoding yields poor 4-channel performance from SQ discs, and vice versa. But the differences are dwindling, and it is possible that, within a year, they may be virtually interchangeable.

In other words, it is misleading to speak of "the SQ matrix" or "the QS matrix," for there have been several versions of each to date. And the more nearly compatible the two systems become, the poorer the results are likely to be when early discs encoded for each system are played back on the ultimate-compromise decoder.

As a matter of fact, we can't accurately speak of "the Electro-Voice matrix," either, because that has changed, too. E-V's EVX-4 decoder has been superseded by a model EVX-44, with "partial" (i.e., not full) logic enhancement, which comes close to matching the latest SQ matrix but will of course not do as good a job of decoding discs made for E-V's earlier matrix. Confusion compounded!

There are other indications of this state of flux. Sansui has recently unveiled another enhancing technique which they call Vario-Matrix. This actually changes the matrixing of the signals from moment to moment, according to what the control circuits sense to be the *intent* of the signal at any given instant, in order to place the signal's direction more accurately and more specifically. CBS is working on what they call "paramatrix logic decoding," which would employ every enhancement technique known in an effort to provide theoretically infinite channel separation in every direction. The best that either SQ or QS can achieve right now is 20 dB in all directions, and neither system can yet reproduce different sounds from all four channels simultaneously.

The Discrete Approach. Until recently, the only 4-channel recording medium that could reproduce different sounds from all directions at once was tape, with four separate, parallel tracks.

Some open-reel four-channel tapes have been (and still are being) issued, but discrete 4-channel didn't really take off until it became available on 8-track cartridges. RCA was the first to start releasing these, under the name "Quad-8," until they ran into trademark problems with an English manufacturer of amplifiers, tuners, and a full-range electrostatic speaker. As a compromise solution, the 4-channel cartridges are now known as Q-8's.

Late in 1972, RCA dropped the other shoe, introducing the Japanese-developed "CD-4" (Compatible Discrete 4-Channel) *disc* system. Instead of trying to wedge additional signal information into the usual two disc channels, the CD-4 system extends the disc's information capacity by carrying the recorded range up to around 50,000 Hz. The range up to 15,000 Hz carries the *combined* front and rear signals for right and left channels, and the ultrasonic signals carry only information pertaining to the *difference* between the front and rear signals. Thus, when the disc is played through two channels, front and rear sounds are all reproduced through the front speakers. Total compatibility! For 4-channel playback, the difference signals are recovered in a manner similar to FM reception, and are used to separate out the front and rear channels.

Obviously, it takes something special in the way of a pickup to reproduce the 50,000-Hz signals, and JVC and Panasonic are making the pickups available along with the necessary decoders. RCA, meanwhile, is pressing the discs on a new record material which they claim to be 10 times as wear-resistant as vinyl, in order to minimize erasure of the ultrasonic signals by the conventional pickups with which many people will be playing the discs. (All of RCA's releases are now in CD-4.)

RCA calls their new discs "Quadra-discs," to the horror of language purists. (There is no such prefix as "quadra.") Columbia calls theirs "Quadrasonic" discs, which is equally ungrammatical. Then there are "Quadrasonic," discs, "Tetrasonic" discs. "Tetraphonic" discs, and the gamut of correct but awkward-looking spellings like "Quadriphonic," "Quadrasonic," and so on. That's not a bit confusing, though; they all mean the same thing. Which is more than can be said for SQ, QS, Dyna, Regular, Scheiber, New Orleans 1, New Orleans 2 and New Orleans 3. ♦



Everything you need to know to service practically everything electronic

1-2-3-4 SERVING STEREO AMPS

by Forest H. Belt

A complete guide to servicing the latest transistor audio circuits. It follows the logical 1-2-3-4 step-by-step procedure that avoids false starts and "blind alleys" in searching out defects in performance. 240 pages.

No. 20912 \$4.95

1-2-3-4 SERVING TRANSISTOR COLOR TV

by Forest H. Belt

Follow the 1-2-3-4 method outlined in this guide and get the repair job done easily and right the first time. Covers latest circuitry circuitry from problem diagnosis to repair. 264 pages.

No. 20777 \$4.95

1-2-3-4 SERVING AUTOMOBILE STEREO

by Forest H. Belt

Explains and shows how to apply the easy 1-2-3-4 method to auto stereo equipment. Use it to locate and solve auto stereo problems and troubles with minimum waste effort. 192 pages.

No. 20737 \$3.95

1-2-3-4 SERVING CASSETTES

by Forest H. Belt

The 1-2-3-4 system makes it a simple matter to trace, pinpoint and correctly service cassette problems. This newest addition to the 1-2-3-4 library is a "must" for service technicians in the fast-growing cassette market. 240 pages.

No. 20922 \$5.25

AUTO RADIO SERVICING MADE EASY

(Second Edition)

by Wayne Lemons

A clear detailing of auto-radio circuits, from antenna to speaker. Shows how to eliminate noise and interference, determine the correct bias, handle AVC trouble. Also covers fm auto radio, multi-plex, and stereo tape players. 168 pages.

No. 20719 \$3.95

CB RADIO SERVICING GUIDE

(Second Edition)

by Leo G. Sands

Complete and practical directions for troubleshooting, servicing, tuning, and testing all types of Citizens Band radio equipment. Includes FCC regulations on equipment performance and maintenance. 160 pages.

No. 20722 \$3.95

COLOR-TV SERVICING GUIDE

by Robert G. Middleton

Using full color tube-face illustrations of color-tv trouble symptoms as clues, it details possible causes of the problems, analyzes them, and gives procedures necessary to effect a cure. A quick, effective servicing guide. 112 pages.

No. 20358 \$4.25

AUTOMOBILE ELECTRONICS

SERVICING GUIDE

by Joseph J. Carr

Auto electronics equipment has come far since the push-button a-m auto radio, and this new guide covers every advance in detail. It explains how to troubleshoot and service a-m and fm car radios, cassettes, and eight-track cartridges. 128 pages.

No. 20927 \$4.95

SOLID-STATE SERVICING

by William Sliot

Explains semiconductor theory as it applies to

The Sams Technical Library contains many other helpful books in the electronics servicing field. Send for our free Catalog.

servicing solid-state electronics, and covers the functions of circuits used in home entertainment electronic products. This format allows development of techniques that apply to all solid-state servicing problems. 160 pages.

No. 20888 \$4.95

TAPE RECORDER SERVICING GUIDE

by Robert G. Middleton

Gives full coverage and explanation of servicing techniques and problems encountered in the fast-growing field of tape cartridges, tape cassettes and stereo tape players. Covers both electronic circuitry and mechanical aspects. 96 pages.

No. 20748 \$3.95

HI-FI STEREO SERVICING GUIDE

by Robert G. Middleton

Shows how to localize troubles and repair a-m tuners, fm tuners, stereo-multi-plex units, and audio amplifiers. Explains use of audio test and measurement equipment to achieve best results. 112 pages.

No. 20785 \$3.95

RECORD CHANGER SERVICING GUIDE

by Robert G. Middleton

Fully analyzes the working parts of record changer mechanisms, points up possible defects, adjustments and corrective measures. Many illustrations and exploded views to make the service technician familiar with all working parts. 96 pages.

No. 20730 \$3.95

 HOWARD W. SAM'S & CO., INC. 4300 West 62nd Street, Indianapolis, Indiana 46268		PE 063	
		<input type="checkbox"/> 20912	<input type="checkbox"/> 20358
Order from your Electronics Parts Distributor, or mail to Howard W. Sams & Co. Inc. Send books checked at right. \$_____ enclosed. Please include sales tax where applicable. <input type="checkbox"/> Send FREE 1973 Sams Book Catalog.		<input type="checkbox"/> 20777	<input type="checkbox"/> 20927
		<input type="checkbox"/> 20737	<input type="checkbox"/> 20888
Name _____ (Please Print)		<input type="checkbox"/> 20922	<input type="checkbox"/> 20748
		<input type="checkbox"/> 20719	<input type="checkbox"/> 20785
Address _____ City _____ State _____ Zip _____		<input type="checkbox"/> 20722	<input type="checkbox"/> 20730

CIRCLE NO. 27 ON READER SERVICE CARD

Great careers

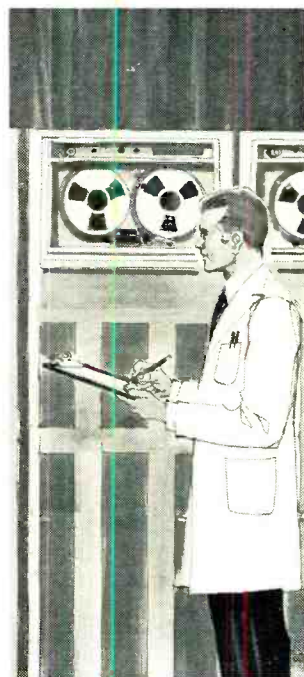
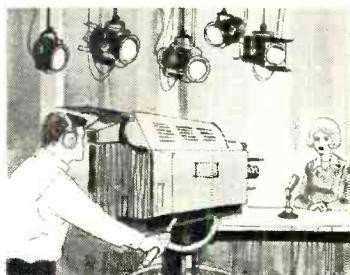

Join the high-paid electronics technicians who got their start through NTS Home Training.

Your home can become your own private classroom-workshop. NTS sends you everything you need to learn valuable technical skills in electronics. You get easy-to-grasp lessons, comprehensive kit manuals, large fold-out charts, and more. Plus the finest professional equipment available today. It's all included in your tuition, yours to keep.

You'll work with commercially-designed equipment, and school training material. Cash in on the tremendous opportunities in the expanding, exciting world of electronics.

If your field is television, you might decide to join a first-class TV repair center. Or start a shop of your own. Or specialize in industrial applications of television. Once you master an area of electronics, the direction you take is really up to you. And you'll be able to use the test instruments you built yourself.

It all begins at home, with NTS Project Method Training. Check card or coupon today for free full-color NTS Catalog and complete details. No obligation. No salesman will call.

NTS COLOR AND B&W TV SERVICING

Build the largest most advanced color TV made! It's a Heath! Over-all solid-state design. 315 sq. in. ultra-rectangular screen. 24 channel detent UHF/VHF power tuning, matrix picture tube, built-in self-servicing features. "Instant On," A.F.T., solid-state VHF tuner, and much more! This is a commercial set, the kind you'll encounter in the field — and not for training purposes only. Also build and keep AM-SW Radio, Solid-State Radio, FET Volt-Ohmmeter, and Electronic Tube Tester. Learn trouble-shooting, stereo multiplex systems, radio, color and B&W TV servicing.

Solid-state B&W TV 74 sq. in. picture (cabinet included)

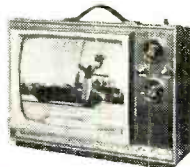

Learn advanced solid-state circuitry as you build this B&W TV receiver. Course covers the full range of home entertainment electronics.

NTS AUDIO ELECTRONICS SERVICING



Solid-state Heath Stereo Receiver and Speakers

Learn sound theory — how it works in home radio, 4-channel, and more! Set up a spectacular music system. Learn about sound distortion, amplification and control, loud-speaker baffles, problems of system installation, etc. Included is Volt-Ohmmeter, In-Circuit Transistor Tester and solid-state Radio. Prepare yourself for great opportunities in the Home Entertainment Industry!

begin at home.



**New solid-state
315 sq. in. color TV**



**The exclusive
NTS Compu-Trainer**

NTS COMPUTER ELECTRONICS

Build and operate the exclusive NTS Compu-Trainer! Loaded with integrated circuits, it teaches you the how, what, and why of computers — faster, more thoroughly. You perform all wiring and patch-cording. No shortcuts! No pre-wired circuit boards. Also receive an FET Volt-Ohmmeter and a 5" wide-band Solid State Oscilloscope.

NTS ELECTRONIC COMMUNICATIONS

Gain the prestige and earning power of owning an FCC First Class Radio Telephone License! Two exciting courses in the fields of transmitting and receiving. Experiment with an amateur phone 6-meter VHF transmitter, NTS exclusive 6-transistor solid-state radio and a fully transistorized volt-ohmmeter.

5-watt AM transmitter/receiver.



NTS AUTOMATIC/ INDUSTRIAL ELECTRONICS

Systems automation is the future of the industry — and you can play an important role! Enter the age of electronic controls by training on the NTS Electro-Lab — a complete workshop. Also receive a Solid State 5" wide-band professionally rated Oscilloscope. Build five industrial controls to regulate motor speed, temperatures, pressure, liquid level and much more.

5" Solid State Oscilloscope

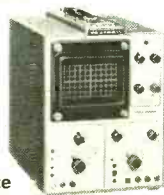

CLASSROOM TRAINING AT LOS ANGELES

You can take classroom training at Los Angeles in sunny Southern California. NTS occupies a city block with over a million dollars in facilities devoted exclusively to technical training. Check box in coupon.

APPROVED FOR VETERANS

Accredited Member, National Association of Trade and Technical Schools; National Home Study Council.

NATIONAL TECHNICAL SCHOOLS

Resident & Home Study Schools
World-Wide Training Since 1905
4000 S. Figueroa St., Los Angeles, CA 90037

Please rush Free Color Catalog and Sample Lesson, plus information on course checked below. No obligation. No salesman will call.



National Technical Schools

Resident & Home Study Schools
World-Wide Training Since 1905
4000 S. Figueroa St., Los Angeles, CA 90037

- Master Course in Color TV Servicing (For Advanced Technicians)
- Master Course in B&W TV & Radio Servicing
- Master Course in Electronic Communications
- Practical Radio Servicing
- FCC License Course
- Master Course in Electronics Technology
- Automation & Industrial Electronics Computer Electronics
- Basic Electronics
- Audio Electronics Servicing Dept. 295-063

Name: _____ Age _____

Address _____

City _____ State _____ Zip _____

- Check if interested in Veteran Training under new G.I. bill.
- Check if interested ONLY in Classroom Training at Los Angeles.



News Highlights

Consumer Electronics on the Rise

Total U.S. market figures for consumer electronics, reflecting U.S. produced and imported products, were released recently by the Electronic Industries Association. Total U.S. color television 1972 volume, a record 8,843,547 sets, exceeded 1971 figures by 21.6 percent. Total TV, radio, phonograph, and tape recorder markets also posted all-time records, making 1972 one of the best years in consumer electronics history.

Radar Probes Saturn's Rings

Saturn's rings appear to be made of solid chunks—perhaps rough and rocky—rather than made of gas, ice or dust. This is the finding of two Jet Propulsion Laboratory radar astronomers after the first successful radar probing of the huge planet some 700 million miles away. Using NASA's 210-foot antenna at Goldstone Station in the Mojave Desert in California, scientists directed the 400-kilowatt radar beams at Saturn and its rings a dozen times before reporting their results. Much stronger bounceback signals were received than were expected from such a distance. The radar echoes indicate rough, jagged surfaces, with solid material 3 feet in diameter or possibly much larger.

Patents Granted for Printed Circuit TV Antenna

U.S. patents have been granted to JFD Electronics Corp. for its Stellar 2001 82-channel solid-state printed circuit TV antenna. The antenna derives its advantages of high gain and directivity through use of miniaturized passive and active antenna assemblies. Heart of the antenna is a planar printed circuit vhf/uhf antenna whose elements are etched from copper on a Mylar substrate. The outputs of the antenna sections are fed to filter networks which act as combiners as well as isolators. The outputs of both vhf and uhf networks are applied to the inputs of low noise solid-state amplifiers. The outputs are fed by a combining network to coaxial cable downlead.

JVC Signs up 4-Channel Licensees

Practically all of Japan's hi-fi manufacturers have signed a licensing agreement with JVC (Victor Co. of Japan) for equipment that uses the company's compatible discrete 4-channel (CD-4) system for quadraphonic records. The signers are: Akai, Brothers Industries, Cynrbet, Hitachi, Japan Columbia, Matsushita (Panasonic), Mitsubishi, Onkyo, Pioneer, Sansui, Sanyo, Sharp, Toshiba, and Trio-Kenwood.

Computerized Parking Garage

Construction of the first of a series of fully automated, computerized parking garages has been scheduled by Budget Parking Methods, Inc. The garage will be located in Westwood, Calif. near the UCLA campus. The \$5 million, 12-story facility will also house a 185-room hotel. The new system uses a patented computerized method of programming car

movement in and out of parking structures at high speed. Vertical high-rise stacking of cars is done by machines which lift and store the vehicle. The average return time is said to be 20 seconds. The parking facility will have 357 stalls. The automatic equipment will be installed, maintained and serviced under contract to Westinghouse.

X-ray Screening for Airline Passengers

A new x-ray system, designed to tighten airport security while speeding anti-highjack screening, has been purchased by Eastern Airlines from Bendix. The equipment, used to inspect luggage, carry-on bags and parcels, is part of the airline's program which includes 100 percent inspection of passenger carry-on luggage. The radiographic system uses an extremely low-dose, short-pulse x-ray to detect illegal objects. The device produces an x-ray image of a suitcase and its contents on a television screen. Radiation dose is so low that luggage containing photographic film, magnetic recording tapes or pharmaceuticals can be inspected without damage to them.

FM Signals to Transmit Still TV Pictures

A Michigan school system is using an FM radio subcarrier to transmit instructional television pictures. Station WFBE-FM, owned and operated by the Flint Public School System, is beaming learning information to selected classrooms through a new audio-visual method that promises tremendous savings over conventional TV costs. The unique program employs the unused subcarrier band of the station's assigned FM frequency to "build" still pictures on standard TV sets by means of slow or controlled scan projection. Regular TV sets, equipped with a converter, can display a picture after about six seconds of "build-up" time, while the audio portion of the program is carried simultaneously. High quality pictures have been transmitted with very little deterioration.

New High-Voltage Power Transistor

A new power transistor rated at a 2200-volt peak collector-emitter voltage has been announced by Texas Instruments. The device, designated the BUY71, is designed primarily for black and white TV horizontal deflection circuits. It was developed mainly for use in European 220-volt line operated sets, but can also be a cost effective solution with lower line voltages. Featuring a continuous collector current of two amperes, the new transistor frees TV set designers from the problems posed by lower voltage power transistors. The transistor has a fast switching time of 0.7 microsecond and a total power dissipation of 40 watts at a case temperature of 25 degrees C. Price in 100-piece quantities is \$12.35.

Tenth Anniversary of COMSAT

The Communications Satellite Corporation (COMSAT) is marking its tenth anniversary this year. In this brief period, the international satellite system has changed world communications. It has also pioneered the way for U.S. domestic, as well as aeronautical and maritime satellite communications services. Starting with no money and no employees in 1963, COMSAT now employs more than 1100 people at eleven locations. The Corporation operates the satellites in the global system for its INTELSAT partners, the seven U.S. earth stations for international satellite communications, the COMSAT Laboratories, and a wide range of related technical activities.

**A. Build your own Heathkit
25V Color TV...599.95*** less cabinet

The GR-900 is the most advanced TV you can build. Yet everything goes together with traditional Heathkit simplicity. And the built-in convergence board and test meter for at-home maintenance add further savings over the life of the set. You preset any 12 UHF channels for positive pushbutton power tuning, and you can scan both UHF and VHF channels in either direction. An ultra-rectangular black matrix tube, voltage controlled varactor UHF tuner, MOSFET VHF tuner, and an exclusive angular tint control for better flesh tones combine to produce an absolutely brilliant color picture.
Mailing weight, 125 lbs.

**B. Heathkit 18V
Color TV...349.95*** less cabinet

Solid-state modular circuitry spells reliable operation and easy assembly. And the GR-269 comes with a full complement of alignment and self-service equipment — dot generator, convergence board, test meter and troubleshooting book. Factory assembled and aligned AFT module for perfect picture & sound at a touch. VHF tuner with MOSFET circuitry

and UHF tuner with hot-carrier diode design for low noise, high sensitivity. Both tuners & IF assembly factory assembled & aligned "Instant-on", switch-controlled degaussing, hi-fi sound output; 75 & 300 ohm antenna inputs; exclusive Heath Magna-Shield, standard.
Mailing weight, 100 lbs.

**C. Heathkit 14V
Color TV...299.95*** includes cabinet

Set aside about a dozen evenings. Build up 10 circuit boards, prepare the chassis. Install the wiring harness. Result: the Heathkit GR-169, with picture purity at the top of its class. And you keep it that way — with plug-in modular circuit boards, troubleshooting meter and data book to help you fix it right at home. A "big" little TV, the GR-169 has all the secondary controls found in our larger models —

color, tint, contrast, horizontal & vertical hold, height, AGC, color killer, switch-controlled degaussing. Carry it room to room or across the country — this is the portable that bounces back with console-like performance. Mailing weight, 69 lbs.

**D. NEW Heathkit 19V B&W
Portable TV...179.95*** includes cabinet

The new GR-1900 is like no other B&W portable! With advanced solid-state "modular" design — most circuitry mounts on just 4 plug-in boards. Just 2 tubes; picture & high voltage. Total detent tuning on all 70 UHF channels as well as VHF. "Instant-on." Front panel controls of VHF/UHF fine tuning; brightness; contrast, master on/off; vert. hold; AGC & height. New ultrarectangular tube for a full 184 sq. in. view. Other

Start a Heathkit hobby...

It's fun, easy, and it
saves you money.

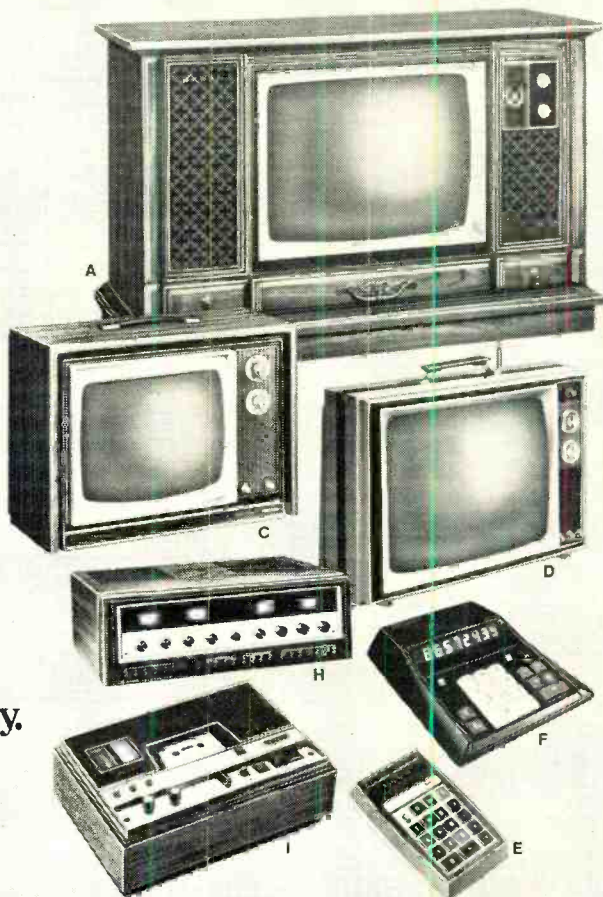

"big" set features are Automatic Vertical Linearity; dual-controlled AGC; extra-wide Video Bandwidth; 4-circuit grounded-base VHF tuner. A kit even the novice can build; both tuners come preassembled & aligned; transistors & ICs plug into sockets; and all chassis wiring is color coded. Mailing weight, 56 lbs.

E. New Heathkit Pocket Calculator... 92.50*

The new Heathkit IC-2009 is a fully portable calculator with rechargeable nickel-cadmium battery. Or you can leave it connected to the plug-in charger for permanent desk-top use. Weighs just 12 oz. And check over these features: 8-digit capacity. Four arithmetic function. Floating decimal. Constant key. Chain calculation capability. Clear-entry key. Entry & total overflow indicators. Low battery indicator. Battery-saver circuitry. And you can build it in three evenings. Mailing weight, 3 lbs.

F. New Heathkit Desk-top Calculator... 79.95*

The Heathkit IC-2108 — a great looking full-function electronic calculator for home or office. You can assemble it in two spare evenings. Features

include: Addition, subtraction, multiplication and division functions. Floating and fixed decimal. Constant key. Chain calculation capability. Clear display key. Entry and result overflow indicators. Negative answer indicator. 120 or 240 Volt operation. Mailing weight, 4 lbs.

G. New Heathkit Small-engine Tune-up Meter... 39.95*

Kit CM-1045 — for all 2- and 4-cycle engines, 1 to 4 cylinders, with conventional, CD, or transistorized ignitions. Great for motorcycles, snowmobiles, outboard marine engines, etc. Clip-on leads let you check dwell, volts, ohms and continuity without tearing down the engine to get at systems buried beneath the flywheel. A built-in inductive-pickup tachometer works with any number of cylinders. Blue high-impact plastic case stores leads and three "C" batteries for ultimate portability. Mailing weight, 5 lbs.

H. Heathkit 4-Channel Amplifier with decoder... 359.95* less cabinet

You select discrete 4-channel, or switch-in the "Universal" decoder for reproduction of all the matrixed 4-channel discs now on the market, plus "derived" 4-channel from conventional stereo. Four solid-state amplifiers produce 200 watts (4x50 IHF) into 8 ohms, with power bandwidth on all channels from less than 5 Hz to greater than 45 kHz at 0.25% distortion.

Kit AA-2010, mailing weight, 37 lbs. AAA-2004-1, pecan cabinet 24.95* Mailing weight, 7 lbs.

I. Heathkit Cassette Deck with Dolby circuitry... 249.95* less cabinet

The Heathkit AD-1530 is a kit-form cassette deck utilizing the famous Dolby™ noise reduction system. Accommodates the greater fidelity and dynamic range of chromium dioxide cassettes. Independent switches provide Dolby on/off and regular or CrO₂ bias control. Domestic-make tape transport comes preassembled for easy kit building. Mailing weight, 20 lbs.

J. New Heathkit AM Radio... 14.95*

The Heathkit GR-1008 is a smartly styled, great sounding solid-state radio that makes a great introduction to Heathkit building. Eight-transistor circuitry mounts on one printed board, big 3½" speaker mounts in high impact plastic case. If you've never built a kit before you can probably have this one together in one fun evening. Uses 9-volt battery (not supplied). Order the Heathkit GR-1008 for yourself or the kids. Mailing weight, 2 lbs.

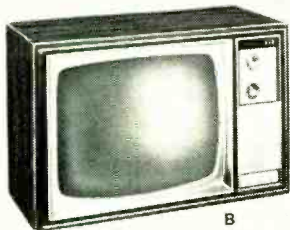

B



G



OVER 350 KITS TO CHOOSE FROM IN THIS NEW FREE CATALOG



SEND FOR YOUR FREE

1973 HEATHKIT CATALOG

— it describes more than

350 Heathkit projects

HEATH COMPANY, Dept. 10-6
Benton Harbor, Michigan 49022

HEATH
Schlumberger

Please send FREE Heathkit Catalog.
Enclosed is \$ _____, plus shipping

Please send model(s) _____

Name _____

Address _____

City _____ State _____ Zip _____

*Mail order prices; F.O.B. factory CL-469R

CIRCLE NO. 16 ON READER SERVICE CARD

MODEL rocketry is currently one of the fastest growing of hobbies. Unlike slot-car racing and other fads that have come and gone in the recent past, model rocketry promises the hobbyist the type of permanence that has continued to draw new adherents to airplane modeling for decades. And it holds the key to new areas for experimentation for the electronics enthusiast.

With today's micro-technology and light-weight components, quite a sophisticated electronics package can be put together to make up the useful payload (weighing only a few ounces) of a typical model rocket. Enterprising electronics/rocket hobbyists are lofting (jargon for launching) live mice thousands of feet into the air and telemetering back to earth their temperatures, pulse rates, and breathing rates via tiny radio transmitters. Other experimenters are using similar transmitters to conduct meteorological (weather) studies, and still others are studying the performance of the rocket itself by means of simple accelerometers and sensors designed to monitor velocity and roll rate.

Getting Started in Rocketry. Model rocketry demands only a small cash outlay to get into the hobby. Simple kits for assembling a rocket, sans engine, are available for less than \$1, while rocket engines can be obtained for as little as 25¢ or less.

The beginner to model rocketry is advised to confine his first effort to a kit-built rocket to learn what goes into the design and fabrication of a rocket. As he gains experience, he can graduate to designing and building his own creations, making use of sturdy paper tubes, balsa and plastic nose cones and fins, and other accessories available from hobby shops. Most manufacturers of items for rocketry publish booklets and other literature detailing how to design rockets from scratch. Books on the subject often go into greater detail.

A typical home-made rocket consists of a 12-in. (or longer) paper tube that is 1 in. in diameter and is fitted with three $\frac{1}{4}$ -in. thick balsa stabilizer fins and a commercial balsa nose cone. A plastic dry-cleaning bag and some cord are often used to make a parachute, while an engine restraining block can be made from a sawed-off section of used rocket engine. The total cost for the materials might average about 75¢, depending on how much use can be made of make-do or salvage items.

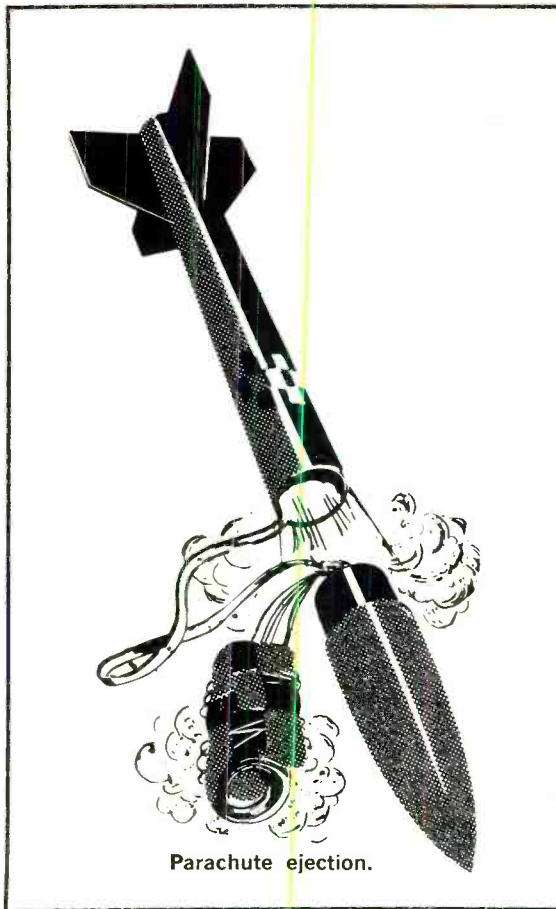

Parachute ejection.

A simple launch stand made from a 36-in. length of stiff piano wire, a metal flame deflector, and a base plate are used for lofting model rockets. One or two lugs cut from a plastic drinking straw and glued to the side of the rocket can be slipped over the piano wire to guide the rocket until its velocity is sufficient to provide aerodynamic stabilization from the fins.

For safety and efficiency, the rocket engine is ignited electrically from a remote location. The igniter is usually made from a 2-3-in. strand of Nichrome wire coated with a flammable plastic. The wire is inserted into the engine's throat and held in place with tape or wadded tissue. The free ends of the ignition wire go to a pair of clip leads that trail off to a spring-loaded normally open switch and 6-volt automotive or lantern battery.

When switch contact is made, the Nichrome wire heats rapidly, igniting the plastic which, in turn, ignites the engine

MODEL ROCKETRY for the Electronics Experimenter

*An exciting hobby and
an interesting
application of electronics*

BY FORREST MIMS

almost instantly. At lift-off, the rocket takes only a few seconds to attain a velocity of several hundred miles/hour. The engine burns out quickly, and the rocket coasts for most of its flight toward apogee (maximum altitude). Most engines have a slow-burning powder charge that produces a trail of white smoke. After this tracking charge burns out, a small explosive charge blows off the nose cone and ejects the parachute that returns the rocket back to earth.

Most hobbyists limit rocket lengths to 18 in., but more advanced hobbyists build rockets that sometimes exceed 36 in., weigh up to 1 pound, and use power plants capable of more than 20 pounds of peak thrust. There are dozens of types of rocket engines from which to choose, ranging from miniature ones for ultra-small rockets to brute-power ones for "muscle" rockets. The most popular engines provide an average thrust of about 1 pound for a burn time of 0.24 to 1.70 seconds. Engines are also available

without the parachute-eject capability for use in multi-stage rockets.

The most powerful rocket engines available are made by Century Engineering (see box) under the name Enerjet. While most engines employ a low-impulse compressed black powder charge, the Enerjet uses a high-impulse composite propellant (fuel-and-oxidizer mixture). These core-burning engines provide an average thrust of about 15.1 pounds for 1.2 seconds, enough to send a 1-pound rocket and payload to an altitude well in excess of 1000 ft. Truly professional engines, the Enerjets have epoxy casings and machined graphite nozzles.

Enter Electronics. The launch of a "bare-bones" rocket provides little scientific data. The real fun comes when a rocket is equipped with instrumentation, telemetry, live payloads, and rocket cameras. Estes was one of the first and is currently the largest of the manufacturers of model rocket supplies and engines. Their Transroc transmitter weighs only 1.3 ounces, including battery, but it can be used in a wide variety of applications.

The Transroc transmitter can be used to telemeter temperature or roll-rate information or as a homing-signal beeper for locating downed rockets. It can also be used with a crystal microphone to send back to earth such sounds as the roar of the engine, the rush of air past the fuselage during the coasting phase, the noise of the chute's ejection, and the sound of the chute cords' rubbing against each other on the way down. Other transmitters and modules are available from Astro-Communications, Prime Recovery Systems, and Microdyne Electronics.

Besides telemetry, a simple transmitter system can be quite useful as a tracking beacon (also helps locate lost kids!) for downed rockets. A rocket only a few feet long and 1 in. in diameter can get lost fairly easily during launch, especially on a windy day. The optimum recovery system consists

Warning: Before launching rockets, check your local authorities for maximum altitudes permitted in your area and any other safety conditions that may apply. Also, remember that a rocket engine is potentially very dangerous and extreme care must be used when storing, transporting, setting up, and igniting.

of a miniature transmitter (in the rocket), a receiver, and a loop antenna.

Tracking is the basic application of the telemetry transmitter. Roll rate, for example, can be measured by connecting a photocell to a transmitter so that variations in its resistance cause an audio tone to vary in frequency. The photocell is mounted in the payload section in a manner that permits light to enter from only one side so that each revolution results in the transmission of a complete tone cycle to a ground receiver as the cell alternately faces toward and away from the sun. A tape recorder can be



A wide variety of rocket engines are available for model rockets. Larger ones shown here are capable of supplying more than 20 pounds of thrust, while smaller ones have thrust of a few pounds. All engines are equipped with an exploding powder charge for parachute ejection. The larger units have machined graphite nozzles; smaller ones have ceramic or clay nozzles.

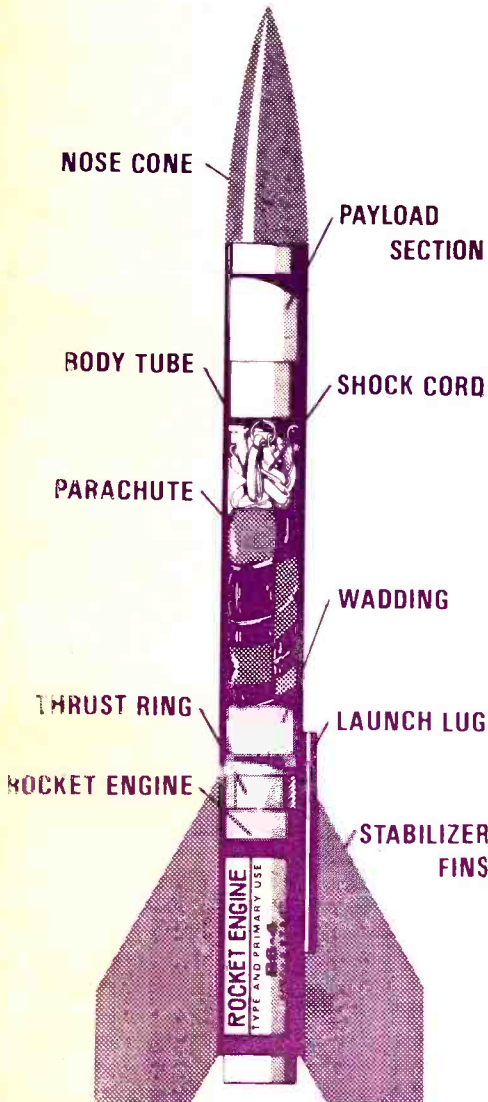

A model rocket is a real flying model of a research or space booster rocket.

used to record the signal for later study.

A slide-type potentiometer with its wiper attached to a spring or rubber band and a small weight can be used to measure acceleration. As the rocket accelerates, the wiper contact slides back and changes the modulation of the transmitter. As the rocket slows down, the spring or rubber band returns the wiper to the neutral position. To calibrate the accelerometer potentiometer, a number of small weights are hung from it to pull against the spring; with each weight addition, a frequency measurement is made and logged.

Velocity can also be measured if care is used in designing an appropriate sensor. One technique you might want to try is a pressure-sensitive device that consists of two thermistors in a bridge circuit (one inside the rocket, the other outside). Another is a small propeller that sends back one pulse for each revolution made. Velocity sensors are calibrated in homemade wind tunnels or are mounted on the outside of a car and monitored at a range of highway speeds for the results yielded. If acceleration is known with respect to time, velocity can be calculated and used to calibrate or check a velocity sensor.

Sensors can also be used to monitor the pulse and breathing rates of animal payloads. For example, a roll-rate sensor that employs a photocell can be arranged so that

it responds to variations in light intensity effected by the moving thorax of a breathing mouse. Light can be supplied by a small lamp mounted on the side of the mouse opposite the photocell. A similar technique can be used to monitor pulse, the photocell and light source being placed on opposite sides of the mouse's tail or ear. Blood flow variations during each heartbeat attenuate the light getting through and modulate the transmitter.

Transmitters are not the only electronic payloads that can be launched in a model rocket. Perhaps the simplest of all payloads is the solid-state light flasher that permits a rocket to be launched at night for a very unusual and spectacular sight. A night launch provides an inexpensive, yet reliable, method of obtaining useful scientific data about the flight characteristics of a model rocket. The usual technique is to photograph the rocket's flaming trail with a camera set for time exposure so that the trail leaves a distinct track across the film. When the engine burns out, the light flasher can be seen and recorded on the film. Also, if the flash rate is known, it is possible to measure the rocket's velocity by counting the number of flashes during a given portion of the flight.

Even the flame trail can be used to obtain velocity and acceleration data. To do this, a strobe disc is placed in front of the camera's lens so that, when the disc is rotated at a fixed speed, the flame trail's track on the film is divided into a series of

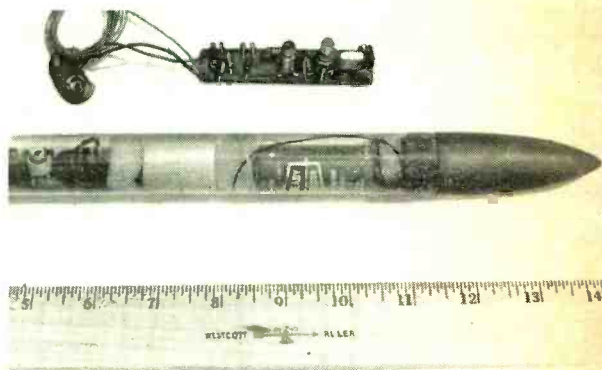

Here are two telemetry transmitters marketed by Micro Instrumentation and Telemetry Systems, Inc. (MITS). Unit above rocket payload capsule is a relatively inexpensive kit, while the one mounted in capsule is a factory-built unit. Both operate in Citizens Band.

streaks. By using simple photometrics and knowing the time duration of each streak, it is possible to measure velocity, acceleration, and altitude at various points along the flame trail.

The flasher also facilitates rapid recovery of the rocket during night launches. The darker the night, the faster the recovery.

Photography In Rocketry. Of equal importance with instrumentation in model rocketry is photography. Simple single-frame still cameras, activated by the force of the parachute-ejection charge, were developed in the late 1950's. Several years ago, Estes Industries introduced the Camroc, a single-shot plastic camera. This simple but sturdy camera has since been used to take high-altitude photos of landscapes, housing developments, agricultural areas, etc., and in a lot of serious amateur scientific work.

An even more exciting development came in 1970 when Estes introduced their Cineroc super-8 color movie camera. This 3-ounce camera is powered by two miniature pen-light cells and accepts a cassette of color film made especially for the camera. A moving picture taken from a model rocket in flight is truly spectacular.

The film begins with an out-of-focus hand that moves off the screen. A few seconds later, a puff of smoke below the fins signals ignition. A moment later, a large cloud of smoke and a tinge of flame signal lift-off. The rocket rises with startling speed; the launch rod is gone in an instant, and



Several companies produce telemetry equipment for model rockets. Shown is Transroc, a kit operating on the Citizens Band with range of several miles paired with superhet receiver.

then the launch crew and spectators come into view, only to rapidly disappear from the screen as the rocket zooms up to apogee. The most exciting part of the flight occurs when a two-stage rocket is used to loft the Cineroc. The first stage can be seen in intimate detail as it separates from the second stage in a burst of smoke and flame. The drifting, tumbling first stage, its top spouting orange and yellow fire, is reminiscent of NASA film clips that show stage separation of full-size rockets.

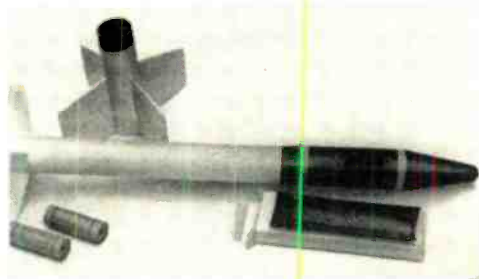

One of the most spectacular developments in model rocketry is the Cineroc movie camera shown here. Constructed of sturdy black plastic, camera has enough 8-mm color film to record over 20 seconds of high-speed rocket flight. Camera shown here is mounted on a carrier rocket. The stubby, four-finned section to the rear is rocket's first stage booster. In front are two engines and plastic encased film holder.

MODEL ROCKET MANUFACTURERS

Below are some of the larger companies that make model rockets, engines, and electronic telemetry and photographic equipment. On request, they will forward information about their products and general literature on rocketry.

Astro-Communications
3 Coleridge Place
Pittsburgh, PA 15201

Century Engineering Co.
Box 1988
Phoenix, AZ 85001

Estes Industries, Inc.
Box 227
Penrose, CO 81240

Microdyne Electronics
P. O. Box 477
Bozeman, MT 59714

Prime Recovery Systems
P. O. Box 84
Lansing, MI 48901

The National Association of Rocketry offers membership to anyone interested in model rocketry. The association sponsors a variety of conventions and launches. Model rocketeers compete in contests similar to those held for model aircraft hobbyists. The association also sponsors competition in research and development. For more information, write to:

National Association of Rocketry
Box 178
McLean, VA 22101

The Southwest Research Association (SRA) sponsors an annual conference with emphasis on model rocket telemetry, electronics, aerodynamics, and math. This year's meeting will be in Albuquerque, NM, July 15-18. For more information, write to:

James P. Miller, Chairman SRA
Math Department
University of New Mexico
Albuquerque, NM 87106

The camera can be rigged to its parachute so that it points upward, downward, or at any intermediate angle. The upward shot is an interesting sequence of the parachute unfurling, popping open, and slowly oscillating back and forth on the way down. Downward shots produce dramatic views of the earth as the natural oscillations of the chute continuously change the view. Some downward shots have even been known to produce a touch of nausea for the ground-bound observers when the film was shown.

Model rockets, engines, and launch stands are relatively inexpensive. Rockets can be assembled from raw materials, purchased as kits, or bought ready to fly. Instrumentation costs can range from a few dollars for a light flasher to about \$20 for the Cineroc color movie camera. A low-cost walkie-talkie receiver can be used to pick up the signals from most commercial model rocket telemetry transmitters (a few operating outside the CB channels, but most on the CB band); and any portable tape recorder will enable the experimenter to preserve the telemetry signals. An inexpensive Polaroid camera can be used to photograph night-time launches.

You can find out more about model rocketry by writing to some of the manufacturers listed in the box or by visiting a hobby shop that caters to rocketry enthusiasts. After you have launched a few rockets of your own, you will almost certainly want to go on to instrumentation and photography. Good luck and safe flying. ♦

MOVE
UP
TO

BUSINESS RADIO BAND

HIGHER POWER AND LESS INTERFERENCE
ARE THE MAIN ADVANTAGES

BY WILLIAM I. THOMAS, Pace Div., Pathcom Inc.

NO QUESTION about it, the Class D Citizens Band is overcrowded—especially if you have to use the band for business purposes. A large number of people are using those 23 channels every day, mainly because almost any U.S. citizen with the \$20 license fee can get on the air. But if you have a legitimate need for two-way radio communication in your business, you can get away from the congestion. All it takes is to move up to the relatively uncluttered Business Radio Service band set aside by the Federal Communications Commission.

The Business Radio band is designed for short-range communication (5-15 miles) between any two transceivers, whether mobile or base station. Located in the 27-MHz band, use of the Business Radio Service is restricted to individuals and organizations who have a *legitimate* need for radio communication for business purposes. This means that only organizations like truck fleets, delivery services, and large farms, and individuals like doctors and salesmen can qualify for a business-band license—and only if the primary use of the service is for conducting business.

Legal Requirements. To get on the 27-MHz AM Business Band, you must be involved in a commercial or business activity that requires the use of two-way radio communication. This does not, however, pre-

clude the use of the band for personal messages. You must also have read and be familiar with the applicable portion of Part 91 of the FCC Rules and Regulations.

In making the application for a license to operate on the 27-MHz Business Radio band, you must fill out FCC license form 400 and mail it with a \$20 remittance to the FCC. By return mail, you will receive a five-year license that permits you to operate on a channel frequency specifically requested by you.

When applying for the license, you will have to supply certain pertinent data. For example, one of the most important things you will have to do is accurately define the geographic location of your planned base station antenna installation. The FAA requires this information to insure against your erecting a 100-ft antenna directly in an airplane landing pattern. If you do not know how to go about determining the exact geographical location of your proposed antenna site, you can ask assistance from your local FAA office.

Channel selection is a matter of choice, to be made by the applicant. When operating on the Business Radio band, you are assigned just one channel (instead of having license to hunt among the 23 channels available on CB to find a "free" one). So, it pays to check out the channel-utilization situation in your area before submitting your request to the



Pace 2000-35 Business Radio transceiver.

FCC because you will be sharing your channel with everyone else who has the same assignment.

A good way to find out the channel-utilization situation in the area in which you plan to operate is to ask the people who sell two-way Business Radio equipment. They will be glad to answer your questions. One company, Pace Inc., recommends that their dealers sell a single Model 2000-35 mobile

unit with up to six receive crystals temporarily installed to permit the buyer to listen for himself in his primary area of operations so that he can select the channel that best suits his needs.

There is one other factor that must be taken into consideration when making a channel selection: channels are assigned according to power limitations as well as type of business. A partial listing of your choices is given in the table. For a complete listing, you can check Part 91 of the FCC Rules and Regulations.

Recommendations on how to go about selecting a channel and operational power vary all over the ballpark. Some people state that you should select the channel (frequency) with a maximum power limitation sufficient for your job needs. They reason that you can be certain that no higher-powered station will come on to interfere at a later date. Others feel that you should select the frequency whose maximum power is enough to permit you to expand your range when needed.

BUSINESS RADIO SERVICE FREQUENCY GUIDE

LOW BAND—SPECIAL CATEGORIES

MHz	Power	Use
26.620	By area	Civil Air Patrol
27.575	5 W	Special Gov't Services

LOW BAND—INDUSTRIAL CATEGORY

Agriculture, Construction,
Mining, Industrial

MHz	Power	MHz	Power
27.235	30 W	27.290	500 W
27.245	30 W	27.310	500 W
27.255	30 W	27.330	500 W
27.265	30 W	27.350	500 W
27.275	30 W	27.370	500 W

LOW BAND—BUSINESS CATEGORY

Commercial, Educational,
Clergy, Medical Activity

MHz	Power	MHz	Power
27.235	30 W	27.430	180 W
27.245	30 W	27.450	180 W
27.255	30 W	27.470	180 W
27.265	30 W	27.490	180 W
27.275	30 W	27.510	3 W
27.390	500 W	27.530	3 W
27.410	500 W		

Note: Power is stated in watts (W).

Equipment Requirements. Business Radio transmitters can use as much power as needed to do the job effectively, up to the maximum permitted on the band selected. The greatest maximum power permitted is 500 watts; the least maximum is 3 watts.

Graph relates effective radiated power to communication range and height of antenna.

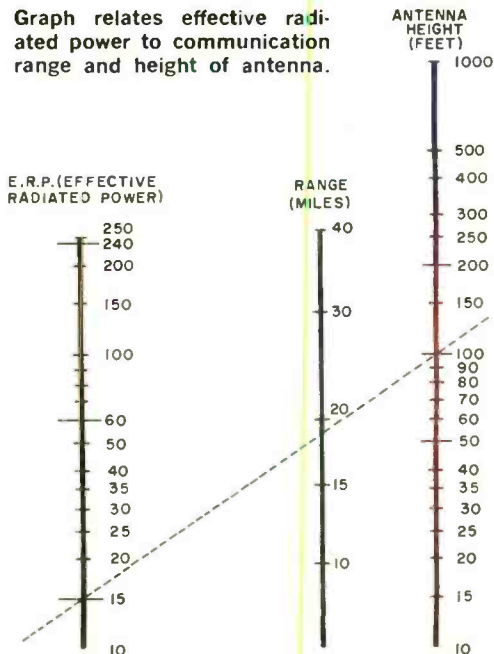

Multiple-channel operation is permitted, provided you have a separate license for *each* channel you use. Extra channels can be obtained if there is a legitimate need for them, such as in construction where a company has two or more projects under way at the same time.

Antenna height is not restricted, except that any tower that exceeds 100 ft must have tower lights.

A communications equipment installer makes use of charts and other guides to provide you with the best system per dollar spent. He takes into account such factors as effective radiated power (erp), antenna height above ground, and receiver sensitivity. (Erp is the result obtained when transmitter power is multiplied by the *true* gain of the antenna.)

More than anything else in a Business Radio system, the height of the antenna above ground has the most significant effect on the communication range. This can more readily be seen in the graph. Note here that the RANGE scale is much closer to the ANTENNA HEIGHT scale than to the ERP scale. The diagonal line shows a representative plot. Receiver sensitivity is assumed to be 1 μ V at 27 MHz. The transmitter has a 15-watt erp, and the antenna height is 100 ft. Under these conditions, the communication range would be about 19 miles. Now, if the erp remained the same but the antenna height was increased to 150 ft, the range would be about 22 miles. Conversely, if antenna height remained the same but the erp was increased to 20 watts, the range would be increased by only a mile or so. The change ratio is clearly in favor of the antenna height adjustment.

10-CODE DEFINITIONS

10-1	Unable to copy
10-2	Signals good
10-3	Stop transmitting
10-4	Acknowledgement
10-5	Relay
10-6	Busy—Stand by unless urgent
10-7	Out of service
10-8	In service
10-9	Repeat
10-10	Transmission completed
10-12	Stand by (stop)
10-13	Weather and road report
10-16	Make pick up at —
10-18	Completed assignments at —
10-19	Return to —
10-20	Location
10-21	Call — by telephone
10-22	Disregard
10-24	Assignment completed
10-25	Report in person to (meet) —
10-27	I am moving to channel —
10-28	Identify your station
10-30	Unnecessary use of radio
10-33	EMERGENCY
10-36	Correct time
10-43	Information
10-46	Assist motorist
10-47	Emergency road repairs needed
10-50	Accident
10-51	Wrecker needed
10-52	Ambulance needed
10-63	Prepare to make written copy
10-69	Message received
10-70	Fire alarm
10-74	Negative
10-77	E T A (Estimated time of arrival)
10-85	Delayed due to —
10-97	Check (test) signal

Operational Rules. Common sense and courtesy govern, or should govern, all radio communication operations. As with CB, the Business Radio operator should never interrupt when a channel is in use, except in the event of a real emergency. Call letters must be given at the start and finish of each message transmitted. Conversations should be limited to five minutes or less. Additionally, a simple log of conversations should be kept, listing date and time and the unit with which communicated (particularly important in multi-unit systems). And frequency checks of the equipment must be made at least once a year.

Not required by any written rule but a highly efficient way of communicating is the use of the 10-Code (see box). While this is the code of the public-safety radio service, it works equally well on the Business Radio band. ◆

Johnson 210-T Business Radio transceiver.

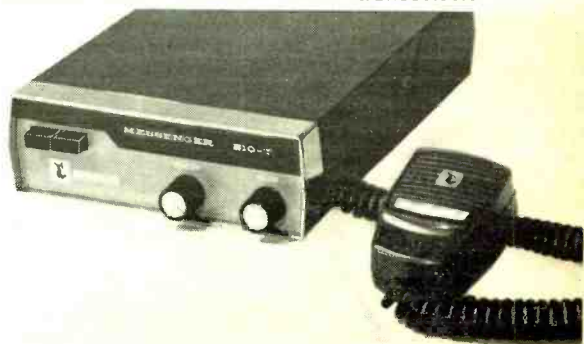

A 5-WATT CARRIER-CURRENT TRANSMITTER

*Build this license-free AM transmitter
that operates into the power line.*

BY DR. JIM S. HARMON

WOULD you like to operate, legally, your own five-watt unlicensed AM broadcast transmitter? It is possible.

Everyone seems to know that the FCC controls restrict the operation of non-licensed transmitters. A close look at the regulations, however, indicates a greater concern for antennas than for actual transmitter power. One interesting regulation is that, while a conventional antenna is generally forbidden, one is permitted limited use of the 117-volt ac power line within a building as a low-frequency, carrier-current "antenna." All radios plugged into the 117-volt antenna circuit receive the signal and communication is usually limited to the utility transformer for the building.

Several wireless intercoms operate on this principle and at least one commercial unlicensed 50-watt output, carrier-current AM transmitter is manufactured for use on broadcast frequencies. Although the price of that transmitter is over \$800, it's range is probably not much more than that of the transmitter described here.

How It Works. A schematic of the transmitter is shown in Fig. 1. Tube *V1* is used as a crystal-controlled oscillator operating at a quiet spot in the local broadcast band. The r-f signal is then amplified by *V2* and coupled to the power line through capacitors *C7* and *C8*. The audio section starts with *V3*, connected as a conventional voltage amplifier which drives modulator *V4*.

The modulator supplies dc power to the r-f amplifier through an arrangement known as Heising modulation. The dc power to *V2* goes through the primary of *T1* (whose secondary is not used) and is modulated by the output of *V4*. Thus, as the audio content varies, the amount of power applied to the r-f amplifier is varied.

For safety, be sure to use high-quality, high-voltage (about 400 V) disc capacitors

for *C7* and *C8*. These capacitors are coupled directly to the power line.

Construction. Since this is an r-f circuit, the parts should be laid out so that there are short leads in the r-f section. Inductors *L1* and *L2* should be at least five inches apart and preferably at right angles to each other. These two coils are conventional loopstick antenna coils such as Radio Shack 270-376. For a crystal frequency between 1000 and 1100 kHz, remove the slug from *L1* and unwind 55 turns from *L2* (leaving the slug in the coil form). Should another type of loopstick be used, it may be necessary to use a grid-dip meter to set them to resonance. The output coupling coil of *L2* consists of 21 turns of wire, such as that removed previously. Coils *L3* and *L4* are plain loopsticks.

After choosing a suitable chassis, mount all components so that lead lengths are minimum, using terminal strips for *L3* and *L4*. The other two loopsticks can be mounted on the chassis using the mounting spring locks on the coil forms.

Tune Up. Start by adjusting *C1* for maximum transmitter output. A simple tune-up device can be made from a one-turn loop coupled near *L1* and connected to an oscilloscope (that will respond to about 2 or 3 MHz) or a suitable field strength meter. A conventional BCB receiver can also be used if it is equipped with a signal strength meter.

Once *C1* has been set for maximum output, adjust the slug of *L2* for maximum output in a similar manner. The slug in *L2* should be approximately half way into the coil. If maximum output occurs when the slug is removed from the coil form, add a few turns to *L2* and repeat the tune-up. Similarly, if maximum output occurs when the slug is completely within the coil, remove a few turns and repeat the tune-up.

Once the r-f portion has been adjusted,

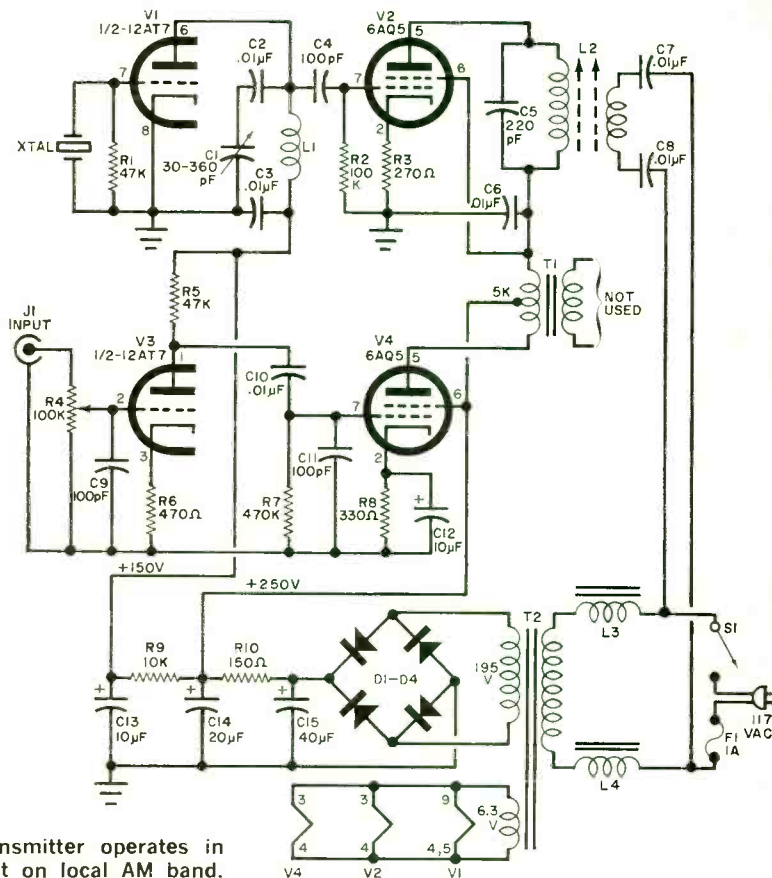

Fig. 1. Transmitter operates in a quiet spot on local AM band.

PARTS LIST

- | | |
|---|--|
| <p>C1—30-360-pF variable capacitor
 C2, C3, C6, C7, C8, C10—0.01-μF disc capacitor (see text for C7 and C8)
 C4, C9, C11—100-pF capacitor
 C5—220-pF capacitor
 C12, C13—10-μF, 400-volt electrolytic capacitor
 C14—20-μF, 400-volt electrolytic capacitor
 C15—40-μF, 400-volt electrolytic capacitor
 D1-D4—600-PRV, 1-A silicon diode
 F1—1-A fuse and holder
 J1—Phono connector
 L1-L4—Loopstick antenna (see text)
 R1, R5—47,000-ohm, $\frac{1}{2}$-watt resistor
 R2—100,000-ohm, $\frac{1}{2}$-watt resistor
 R3—270-ohm, 1-watt resistor</p> | <p>R4—100,000-ohm potentiometer
 R6—470-ohm, 1-watt resistor
 R7—170,000-ohm, $\frac{1}{2}$-watt resistor
 R8—330-ohm, 1-watt resistor
 R9—10,000-ohm, 2-watt resistor
 R10—150-ohm, 2-watt resistor
 S1—Spst switch
 T1—Push-pull, 10-watt audio output transformer (BA 13A862 or similar)
 T2—Power transformer: secondaries: 195 V rms and 6.3 V (McGee TR²5 or similar)
 XTAL—1050-Hz crystal (JAN Crystals 2400 Crystal Drive, Ft. Meyers, Fla.)
 Misc.—Suitable chassis, crystal microphone, line cord, terminal strips, mounting hardware, etc.</p> |
|---|--|

the carrier can be tuned in on a CBB radio set to the crystal frequency. The audio signal required for modulation can be from almost any source that can deliver 1 volt. For low-output microphones or a turntable, a preamplifier is required.

With both the transmitter and receiver operating and an audio signal applied to J1, turn up gain control R1 for maximum signal before noticeable distortion occurs.

This final measurement should be made with the receiver plugged in at least 50 feet from the transmitter. A lesser distance may result in receiver overloading.

Be sure that all radiation from the transmitter is confined to the power line. The FCC Rules covering this type of operation are covered in Manuals OCE-11 and OCE-12. They are free and perhaps should be investigated before starting on this project. ♦



USMC C-119
MILITARY TRANP
TO STEVENSON
TO WASH DC
TOWN 180 11 20
12 WASH 13 10
AND 14 11

TRIP NUMBER DATE
0000

48,000		
85	102	127
108	105	120
107	127	
101	103	
	92	

Modern aircraft are loaded with vital electronic equipment. There is equipment for communications, direction finding, instrument landing and for many other functions to insure safe operation of the aircraft.

The man who checks out this equipment has to be an expert. Many lives depend on his specialized knowledge as an engineering technician. His work is interesting and exciting and he enjoys top pay in his field.

Consider a career In advanced electronics

Aeronautical and Navigational Electronics is just *one* of the advanced electronics programs CREI offers. There are *seventeen* others. All of the programs, except a brief introductory course, are college-level. The programs cover every major field of electronics today.

If you want to qualify for the highest paying level of technical employment in electronics, we invite you to consider the unique home study programs of CREI. Here is a list of just some of the CREI programs: *Communications Engineering • Computer Engineering • Missile & Spacecraft Guidance • Radar & Sonar • Television Engineering • Nuclear Instrumentation & Control • Digital Communications • Industrial Electronics • Electronic Systems Engineering • Microwave Communications • Satellite Communications • Cable Television Engineering*

For over 45 years, CREI programs have been recognized by industry and government as effective home study training in advanced electronics.

Qualifications to enroll. To qualify for enrollment in a CREI program, you must be a high school graduate (or equivalent). You should also be working in electronics or have previous training in this field.

Send for FREE book. If you are qualified, send for CREI's newly published book describing your career opportunities in advanced electronics. This full color book is filled with facts about career opportunities for you.

Capitol Radio Engineering Institute
A Division of McGraw-Hill Continuing Education Co.
3939 Wisconsin Avenue, Washington, D. C. 20016



Accredited Member, National Home Study Council

CREI Dept. E1206D
3939 Wisconsin Avenue
Washington, D. C. 20016

Rush me your FREE book describing my opportunities in advanced electronics. I am a high school graduate.

Name _____ Age _____

Address _____

City _____ State _____ ZIP _____

If you have previous training in electronics, check here

Employed by _____

Type of Present Work _____

Veterans and servicemen, check here for G. I. Bill information

CREI
**CAPITOL
RADIO
ENGINEERING
INSTITUTE**

WASHINGTON, D.C.

LIGHT-ACTIVATED SLAVE STROBE TRIGGER

BY ADOLPH A. MANGIERI

MANY photo enthusiasts have several strobe lights, which they often want to operate at the same time. The trigger circuit described here uses a light-activated SCR to trip a slave strobe when a master strobe is fired.

The trigger circuit, consisting of the light-activated SCR (*LASCRI*) and resistor *R1*, is shown in the schematic the way it should be connected to the standard commercial slave strobe. When used by itself with a camera, the commercial strobe is fired when an external switch (usually on the camera) is closed to discharge *C1* through the primary of *T1* and apply a surge of voltage to the flash tube.

With the slave strobe trigger, *LASCRI* acts as the switch since it starts to conduct when the light from a master strobe strikes it. (Under normal light conditions, *LASCRI* is turned off.) When *C1* and *C2* are discharged by the firing of the flash tube, *LASCRI* returns to the off state. Resistor *R1* bypasses the slight internal leakage, which may otherwise cause self turn-on of *LASCRI*.

Construction. As shown in Fig. 2, *LASCRI* and *R1* are mounted on a small piece of perf board with the sensitive end of *LASCRI* at the end of the board. Do not solder *R1* permanently into place at this time. The case is made of any opaque tubing, such as a pill container painted black, with a small hole in the closed end to accept the face of *LASCRI*. The *LASCRI* sensitive surface should be about $\frac{3}{8}$ " from the end of the container. A short length of two-conductor cable, terminated with a suitable connector, is used to connect the trigger to the strobe.

Using a VTVM, check the voltage level and polarity at the strobe PC cord plug or socket. This may range up to 200 volts.

Checkout. Connect the trigger to the slave strobe. Aim the slave trigger at the main strobe, turn the main strobe on and depress the test button. If the slave strobe does not fire, use the VTVM to measure the voltage across *LASCRI* anode and cathode. If this voltage is about 1 volt, *LASCRI* is already on. Replace *R1* with a smaller

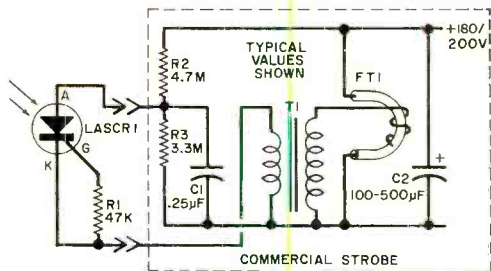

PARTS LIST

LASCRI—1-ampere, 300-PIV light-activated SCR*

R1—47,000-ohm, $\frac{1}{2}$ -watt resistor (see text)

Misc.—Perf board, opaque container, two-conductor cable with suitable connector.

*Available from Delta Electronics, P.O. Box 1, Lynn, MA 01903 (Part No. P4119).

Fig. 1. *LASCRI* replaces switch in strobe.

ohmic value until the VTVM indicates the previously measured PC cord voltage with *LASCRI* off. Make *R1* as high a value as possible for maximum sensitivity of *LASCRI*.

If *LASCRI* cannot be made to fire, the strobe may have unusually high resistance values as *R2* and *R3*. (Typical values are shown in Fig. 1.) In such cases, a slight leakage current may be pulling down the triggering voltage across *C1*. This can be checked by measuring the PC cord voltage with *LASCRI* connected and disconnected.

Always test-fire the master-slave strobe combination a few times before actual use, making sure that you aim *LASCRI* toward the main strobe. For use in a slightly high light level, a neutral density filter may be placed in front of *LASCRI* so that ambient light will not cause it to operate, but the much brighter flash from the main strobe will cause operation. ♦

Fig. 2. Photo of the prototype assembly.

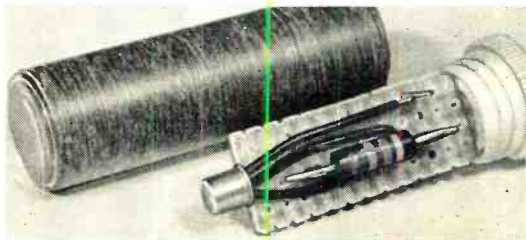

Some of the types of high compliance speakers tested to aid speaker system builder in determining enclosure size.

PART 1



Closed Box Speaker System Design

HERE'S HOW TO MATCH SPEAKER TO ENCLOSURE

BY DAVID B. WEEMS

ANYONE who has listened for more than ten seconds to an unmounted speaker knows that some type of enclosure is necessary. Comparing a speaker in a suitable enclosure with the same speaker in a mismatched box will also demonstrate what a bad combination can do to a speaker. In fact, choosing a box size that is right for a given woofer is the most critical decision to be made in designing a closed-box system because once construction is under way, little can be done to change it.

The fact that deciding on the speaker box design is critical to the building of a speaker system is no reason for the prospective builder to abandon his project. To be sure, some test equipment is needed to insure optimum performance; but predictable results can be realized by following generalized design charts. One virtue of the closed box is that design problems are straightforward.

The Infinite Baffle. Closed-box speaker systems were once referred to as "infinite baffles." The name was adopted from the type of baffle that many audio men consider ideal: a flat baffle so large that the out-of-phase back wave from the speaker cone would never reach the front of the cone. Such a baffle would present equal air load-

ing on both sides of the cone. The practical equivalent of a true infinite baffle is a speaker mounted in a room wall which acts as a barrier down to the frequency for which the path from the rear to the front of the cone is equal to one-half the wavelength of the sound. For a distance of 30 ft, the wall acts as an infinite baffle down to below 20 Hz. The frequency response of a speaker in an infinite baffle extends down to its resonant frequency, below which it rolls off at 12 dB/octave.

Chopping holes in walls for speakers has never been popular among home owners and landlords; so, the closed box came into being. The closed box is infinite in the sense that the back wave is completely isolated from the front. But there is one significant difference between the performance of a speaker in a true infinite baffle and the same speaker in a closed box. This is that the trapped air in the box acts as an added compliance, the acoustical equivalent of a capacitance.

In the mechanical circuit shown in Fig. 1, the box compliance (capacitance) is in series with the resonant circuit of the speaker, raising the frequency of resonance. This is similar to a capacitance in series with a resonant electrical circuit where it reduces the total capacitance and shifts the resonant

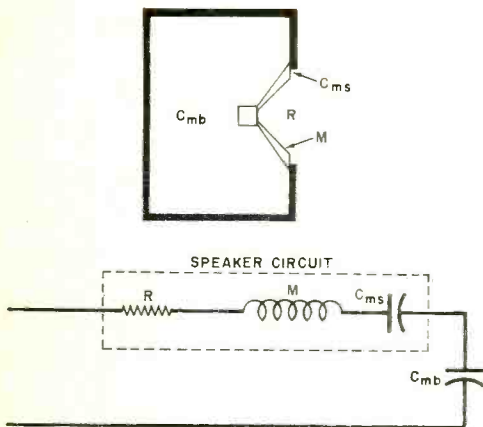

Fig. 1. This electrical schematic is the equivalent of a speaker in a closed box.

frequency upward. In mechanical terms, the box stiffness is added to that of the speaker's suspension. To modify this effect, the early closed-box systems were made extremely large to provide high compliance (low stiffness). A typical optimum volume for a 12-in. speaker was 12 cu ft.

To counter the large-box problem, manufacturers began making speakers with high-compliance suspensions and heavy cones. These low-resonance speakers have a much greater cone compliance (C_{ms}) than do conventional speakers. This means that they can be used with a lower box compliance (C_{mb}) and still produce a system resonance equal to the larger system. But there is a limit to how far C_{mb} can be reduced.

When two capacitors are connected in series, the smaller capacitance limits total capacitance no matter how much the value of the other capacitance is increased. The same principle is true for high-compliance-speaker/low-compliance-box combinations. And in addition to the theoretical limit of total compliance due to the series circuit,

ENCLOSURE SIZE/SPEAKER SIZE DESIGN TABLE	
Recommended Box Volume (cu ft)	Nominal Speaker Size (in. dia.)
Less than 0.2	4
0.2-0.25	5
0.25-0.5	6
0.5-1.5	8
1.5-2.0	10
2.0 and larger	12
4.0 and larger	15

there is a practical limit to how much we can increase the compliance of a speaker cone. A useful compromise between the goals of space saving and high fidelity sound is to accept a system resonance of 50 Hz as a practical lower limit for large woofers in enclosures of moderate size and 70-100 Hz for smaller speakers in bookshelf size cabinets.

Cabinet Size. Most published instructions for designing a speaker system begin with measurements on the woofer. If space is strictly limited, there is another design decision that should be considered first. This is the choice of permissible cabinet volume. Unless this step is completed first, the builder might find that he is attempting to do the acoustical equivalent of fitting a size 10 foot into a size 9 shoe. The size of the box determines how large a woofer should be used.

To better appreciate the import of this statement, refer to Fig. 2. Notice that although each of the three speakers has the same resonant frequency (50 Hz), system resonance for any given interior volume varies greatly, especially at lower volumes. The differences are due to changing values of box compliance for the various piston

Fig. 2. System resonance vs enclosure volume for 3 woofers of different sizes but having the same resonant frequency.

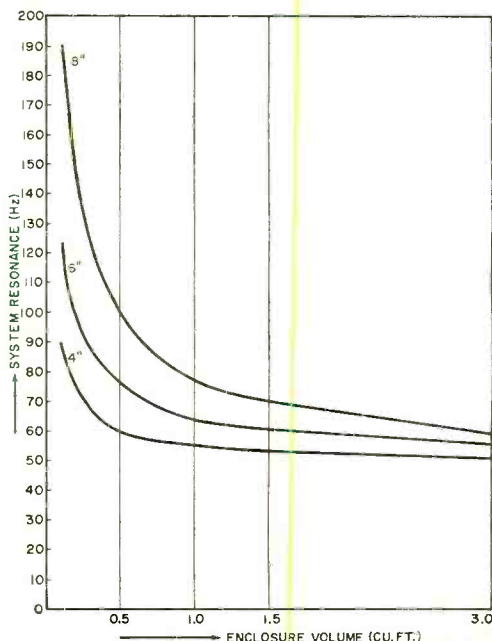

areas of the speakers. The formula for box compliance is

$$C_{mb} = V/dc^2A^2 \text{ (cm/dyne)}$$

where V is the volume of the box; d is the density of air (usually expressed as Greek

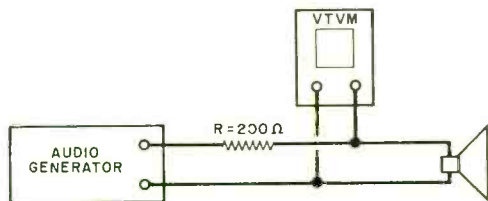

Fig. 3. Test setup for determining free air resonance using an audio generator.

letter rho); c is the speed of sound; and A is the effective cone area. All values are expressed in metric units (cgs).

Note that C_{mb} varies inversely with the square of the cone area. The air in the box acts with much more stiffness against a large piston than against a small one. This decreases the effective cone compliance of large speakers and raises their resonant frequency.

The exact enclosure volume for a woofer can be decided only after performing some tests on the woofer. However, the woofer size must still roughly match the available space from the outset. Some suggested limits for various size woofers are given in the table. These recommendations are based on more than 200 tests with many high-compliance woofers of various sizes. In choosing an enclosure size, volume calculations are based on *internal* dimensions.

There is one case in which a larger-than-normal woofer might be acceptable for a given enclosure size. This choice can be made if higher-than-normal power handling capability is desired at the expense of the low-frequency range. Small woofer cones must move much farther than large cones to deliver equal acoustical power at low frequencies. Also, small cones typically have a lower permissible range of movement before succumbing to sound distortion or serious mechanical damage. The power-handling ability of any woofer varies inversely with C_{mb} . So, for high-power operation, a compromise must be reached between the low-frequency range and the low-power-handling ability of the system by choosing a smaller-than-normal box. In addition to limiting the low-frequency response, a problem in reducing box volume below the

optimum value is that Q , or resonance magnification, is increased. This factor can produce a nasty boom at resonance that is difficult to control.

Woofer Testing. Accurate enclosure plans require knowledge of the woofer's free-air resonance, mass and compliance. For some reason, this information—except for free-air resonance—is almost never available from the speaker manufacturer. But anyone with access to an audio generator and a VTVM can obtain this information through a few simple tests.

The first step is to find the free-air resonance. To do this, follow the hookup shown in Fig. 3. Hold the woofer in mid-air and sweep the audio generator down from about 200 Hz, noting carefully the frequency at which the voltage across the voice-coil rises to a peak. This frequency is the free-air resonance (f_r).

Next, add a small known (non-magnetic) mass to the woofer cone. Modeling clay will stick to most cones. Select enough clay to equal the mass of a nickel (5 grams), a penny (3 grams), or a dime (2.5 grams). A simple balance made from a ruler and a pencil can be used to determine how much clay you will need in each case. Press the blob



Modeling clay is pressed against the speaker cone to change mass of speaker.

of clay over the point on the front surface of the cone where the voice coil leads protrude, providing a firm footing, until it firmly adheres. Do this carefully, supporting the lower surface of the cone with your fingers and using only enough pressure to seat the clay. The clay, incidentally, must be of the non-drying variety.

When the added mass (M') is snug against the cone, measure the cone's

resonance again. Record the new frequency as f_r . It will be lower in frequency than the first resonance. The mass of the cone can now be calculated as follows

$$M = \frac{M'}{(f_r/f_r')^2 - 1} \quad (\text{grams}).$$

When the mass is known, the compliance (C_{ms}) can be calculated from the formula

ance, $f_r = 1/(2\pi\sqrt{M C_{ms}})$, is halved, the resultant resonance is equal to the square-root of 2, or 1.41, times the original resonance. The same is true for closed-box speaker systems in which $C_{ms} = C_{mb}$. For large speakers, this ratio of box compliance to speaker compliance will result in enclosures that are rather large. For these speak-

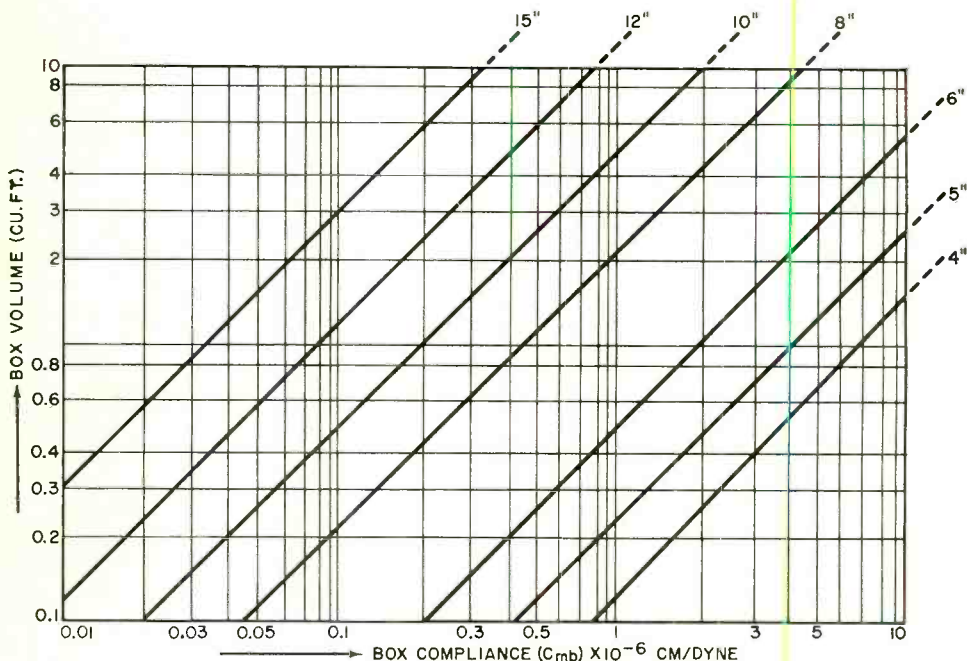

Fig. 4. Box compliance for speakers of various sizes. Sizes are nominal diameters.

$$C_{ms} = \frac{1}{(2\pi f_r)^2 M} \quad (\text{cm/dyne}).$$

As an example of how to put these equations to work, let us assume that a 6-in. speaker is found to have a free-air resonance of 50 Hz; a 5-gram mass is added and the new resonance is found to be 41 Hz:

$$M = \frac{5}{(50/41)^2 - 1} = \frac{5}{1.5 - 1} = 10 \text{ grams.}$$

Substituting the figure 10 for M in the formula for compliance, we have

$$C_{ms} = \frac{1}{(2\pi \cdot 50)^2 \cdot 10} = \frac{1}{1 \times 10^6} = 1 \times 10^{-6} \text{ cm/dyne.}$$

For speakers up to about 8 in. in diameter, it is practical to set the box compliance equal to that of the speaker. Two equal capacitances in series produce a new capacitance equal to half the value of one of the capacitances. When the value of the compliance in the formula for speaker resonance,

it is more practical to choose a box volume that will produce a 50-Hz system resonance.

When the compliance is known, we can find the equal box compliance from Fig. 4. To do this, extend the vertical line at 1×10^{-6} cm/dyne until it touches the diagonal line for 6-in. speakers. Then move horizontally to the left side of the chart where you will find that a box of approximately 0.5 cu ft is about right. At this volume, you can expect the system resonance to be 1.41 times 50 Hz, or 70 Hz.

More To Come. This ends Part I of our article devoted to speaker system design. Next month, in the conclusion, we will be discussing such topics as enclosure design without test equipment, enclosure details, and the characteristics of high-compliance woofers. ♦



HOW TO SELECT AN ELECTRONIC ORGAN

IMPORTANT FEATURES TO LOOK FOR IN MAKING YOUR CHOICE

BY L. GEORGE LAWRENCE

THE MOST prominent feature of today's electronic organ market is its abundance of offerings. Some elaborate modern organs rival computers in design sophistication and complexity, with sound synthesized and augmented by special effects to give the spectral brilliance of massive pipe instruments. All of these considerations make electronic organ selection and purchase a fine art. Selections are based on the buyer's preference in the electrical and mechanical considerations peculiar to the 15 or so brands available. In this article, we will be profiling several leading electronic organ models.

Typically, most electronics-oriented people who buy organs acquire them for one or more of the following reasons: good spectral excellence or sound coupled with reverberation; quality woodwork and the good acoustical integrity it ensures with no unpleasant self-resonances; and ease of maintenance. The latter ties in nicely with

modern module-type printed circuit board assemblies.

Organ Features. Another consideration in choosing an organ is whether or not it is to be used as a learning instrument. For example, the four electronic organs made by Optigan of California meet the "two-finger" requirements of both adult and child learners. With one finger of the right hand playing the keyboard, one finger of the left hand can be used to depress the chord buttons located to the left of the keyboard. Chord-type accompaniment is provided by means of prerecorded rhythm-disc albums. About the size of a phonograph record, the transparent rhythm discs have photo-electric tracks that resemble the sound tracks on motion picture film. A given disc is inserted into a slot beneath the organ's chord section, after which discrete tracks are selected, according to the programs being played on



Fig. 1. The keyboard of the Wurlitzer 4037 organ, designed for the advanced amateur or the professional. Special modulator/attack keyboard is shown at upper right while the built-in cassette tape recorder is at the lower right.

the main keyboard, by depressing one of 21 chord buttons. Special effects (drums, maracas, etc.) can be injected; and simple one-finger doodles are made pleasant by melodious rhythms of banjo, classical guitar, bossa nova, and other selections.

Virtually all professional and advanced amateur artistic needs are met by such modern—and popular—multi-keyboard organs as the Wurlitzer Model 4037. Easy to learn to play and great for listening, the 4037 provides instrumental and percussion presets, sine wave timbre, “delta pitch,” and other features. Delta pitch allows notes played on the keyboard to begin below pitch and rise to the actual pitch, rendering electronic effects not related to traditional musical instruments. A built-in cassette recorder permits direct taping, a great convenience for learners. (The keyboard of the 4037 is shown in Fig. 1.)

Reverberation adds dynamic depth to all organs. Employing artificial time-delay tech-

niques, effects can be achieved that resemble the acoustical effects encountered in large concert halls and churches. Some reverb techniques are better than others. In Fig. 2 are shown three of the most popular techniques used by organ manufacturers.

Acoustical delay (Fig. 2A) can be found in some older imported organ models. The delay element might consist of spiral-wound tubing to the ends of which are fastened a miniature loudspeaker driver and a microphone receiver. Sound waves are held captive within the tube and travel at a constant 300-meter/second velocity so delay is determined by the length of the tube. A 150-meter-long tube, then would produce an acoustical delay of 0.5 second for a quite pleasant effect. The switch and potentiometer comprise the electronic shunt across the driver and receiver to attenuate the delay effect when the resistance is decreased.

The electromechanical delay/reverb technique shown in Fig. 2B employs one or more

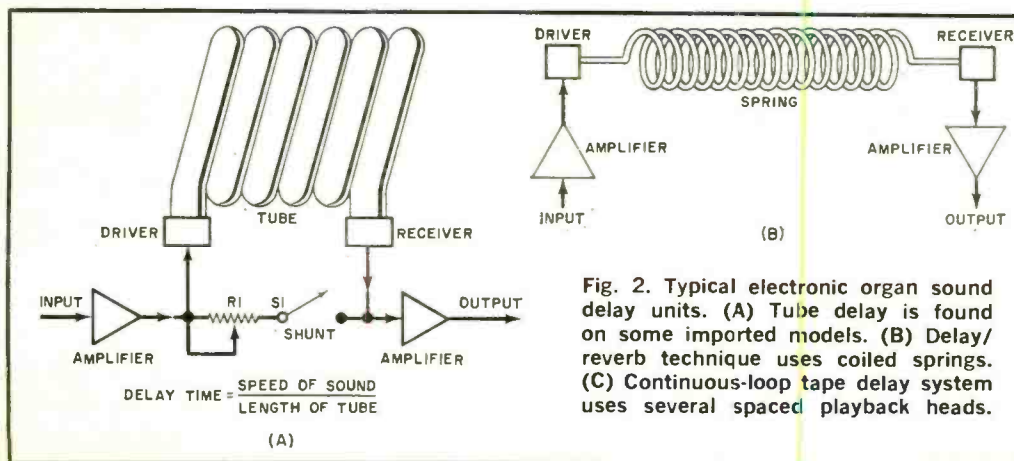

Fig. 2. Typical electronic organ sound delay units. (A) Tube delay is found on some imported models. (B) Delay/reverb technique uses coiled springs. (C) Continuous-loop tape delay system uses several spaced playback heads.

coiled springs. Functional and reliable, the driver injects a vibrational sound replica into the springs with pickup being provided by an electromagnetic or piezoelectric receiver. This setup is somewhat frequency selective, but the overall effect is most agreeable.

Electromechanical delay effects accomplished with the aid of a tape recorder (Fig. 2C) work very well. The "Reverbatape" system made by Schober and shown in Fig. 3 employs an endless tape loop that moves past heads that are separated by fixed distances from each other. The first head on the right completely erases the tape as it passes over it. The next head records the organ sounds onto the tape. The final three heads play back the sounds on the tape, each adding a slight delay between themselves and the record head. The constants are the speed of the tape and the spacing between the heads. The success of the kit-type Schober Recital Organ (Fig. 4) is partly due to its reverb/delay system.

Most of the more elaborate organs (such as those made by Thomas, Minshall, Lowery, Baldwin, Allen, Conn, etc.) are designed to accommodate the addition of special-effects units, including reed instruments equipped with air blowers. Generally, a very broad, deep, and melodious sound spectrum is sought. This is accomplished by holding down selected keys on the special-effects keyboards, while the main organ provides superimposed "fill."

A simple studio setup is shown in Fig. 5. Designed for electronic music compositions for motion-picture and film use, it employs key clamp-down with the aid of clips and rubber bands that are fastened to the lower frame of the organ. The modified

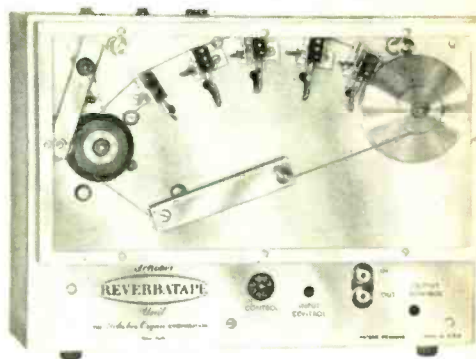

Fig. 3. This Schober Reverbatape unit employs a number of playback heads.

Eico Model 377 audio signal generator produces discrete harmonics that "paint out" portions of the organ's spectrum. Rapid cadence sounds are obtained from the cadence timer unit whose controls are at the left. The microphone and simple mixer shown to the left combine the generator's and organ's sounds with each other.

Servicing Electronic Organs. One thing that characterizes modern electronic organs is their relative ease of servicing by the knowledgeable technician. The basic service instruments needed are no different from those that would be found in a radio-TV or hi-fi service shop or on the workbench of a serious electronics experimenter. They include a vacuum-tube or transistor multimeter, an audio signal tracer, small hand tools, etc.

One specialized instrument is needed, however. It is an organ tuner. Among those offered, three examples are Conn's "Strobconn" and "Strobotuner" and Schober's "Autotuner" (Model AT-1). To a novice organ owner, though he may be highly skilled in other areas of electronics, the way musical pitches and frequencies are determined can become a formidable puzzle without the help of an organ tuner.

Shown in Fig. 6 is the Schober Model AT-1 organ tuner. It features a motor-driven stroboscope disc that rotates at precisely one revolution per second. Notes that correspond to an organ's 12 tones in one octave are printed on the tuner's panel and Plexiglass window. The motor-driven disc is imprinted with precisely spaced dark and white markers. There are 98 radial marks on the outermost band, each equally spaced with an accuracy of 5 minutes of arc.

When the Autotuner is used for tuning

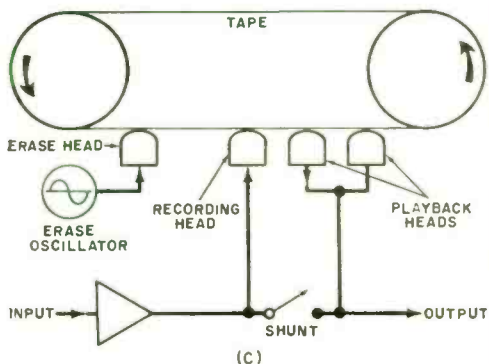



Fig. 4. Kit-type Schober Recital Organ.

an organ, the latter's output is fed into the tuner via an input jack located on the front panel. The signals from the organ cause neon lamps located behind the stroboscopic disc to fire. Then, for example, as the organ's oscillators are being tuned to their proper frequencies, the second G below middle C is tuned until the marks on the outer band appear to be stationary, and so on down the line.

Another useful "tool" that every organ owner and serviceman should have is a keyboard chart that shows the frequency in hertz for every note on the keyboard. Such a chart is shown in Fig. 7. It can be used with both organs and pianos. This chart can be used by the professional organ tuner who has at his disposal a good digital frequency counter.

(Editor's Note: Organ tuning can also be accomplished "by ear." This can be done with a "pitch reference" generator, a digital example of which was presented as a construction project in the article "Build A Musical Pitch Reference" by Don Lancaster in the September 1968 issue of POPULAR ELECTRONICS. This frequency synthesizer instrument generates 12 of the middle notes of the equally tempered musical scale to an accuracy better than the best ear can determine and with a stability unattainable by the finest set of tuning forks. With this instrument, the person doing the tuning listens only for fundamental unison beats that even an untrained ear can easily detect. Unfortunately, this back issue is no longer available from us.)

Kit-Type Organs. Electronic organs are fairly expensive instruments, running into the thousands of dollars for an elaborate full-size system with multiple voicing. Consequently the question of the relative value of building an electronic organ from a kit compared to buying a completed organ arises. Taken from a strictly monetary point, kit organs offer the buyer a substantial saving when compared to factory-wired instruments. However, the benefits go beyond just cost saving.

The person who assembles his own electronic organ from a kit absorbs a great deal of information about its mechanical and electrical layout, which can be a great aid when it comes to servicing the instrument. A great deal of the electronics theory that goes into the making of an organ can also be learned if the builder takes the time and effort to read and study the theory-of-operation material generally supplied with the assembly manuals that accompany organ kits.

Thousands of kit-type electronic organs are assembled every year, frequently by individuals who have never before held a soldering iron. Today's kit organs are next to foolproof. Instruction manuals and illustrations are extremely easy to understand and follow. Each step of assembly, no matter how simple, is given separate attention and is presented in its proper logical order. In addition, preparatory instructions on soldering procedures and techniques for both printed circuit boards and chassis wiring accompany electronic kits.

Fig. 5. Special effects setup for an electronic organ. Audio generator and keyboard at right; controls for cadence timer, mixer and mike at left.

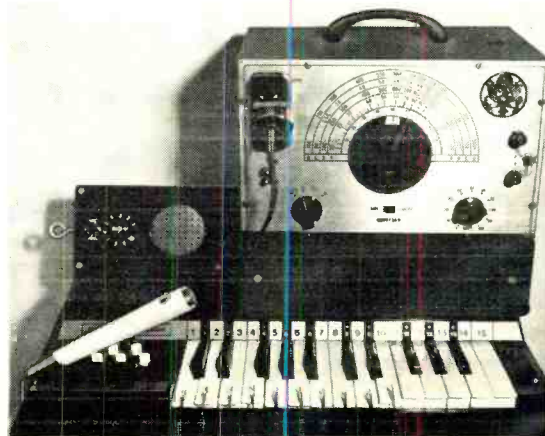



Fig. 6. Organ tuner has stroboscopic disc.

The mechanics of assembling a kit organ generally consumes a lot of time. The average runs somewhere in the neighborhood of 55 to 80 hours for a top-quality organ, depending on the model selected and the working pace. Making the assembly a project for the family can provide an enjoyable pastime in which everyone pitches in to reduce the number of individual man hours.

Two outstanding examples of kit-type electronic organs are the Schober Recital Organ that sells for \$1850 and the Heathkit "Legato" 25-pedal organ that sells for \$1495. (Simpler kits are available at \$500 to \$700.) A factory-wired organ, such as the Wurlitzer Model 4573, for example, retails for roughly \$2850. Practically all good multi-keyboard organs not in kit form are in the \$2000-plus league. So, you can readily see that kit-type organs really do offer a sizable monetary saving.

Summing Up. It is prudent to state that modern electronic organs offer enough of a variety at a wide range of prices to meet just about every requirement a beginner or professional musician might demand. Making a selection among the various organ models available is not easy; each has attractions and features that draw the buyer to it. Of all the factors to be singled out in organ selection, however, ample reverberation and amplifier power-handling capacity

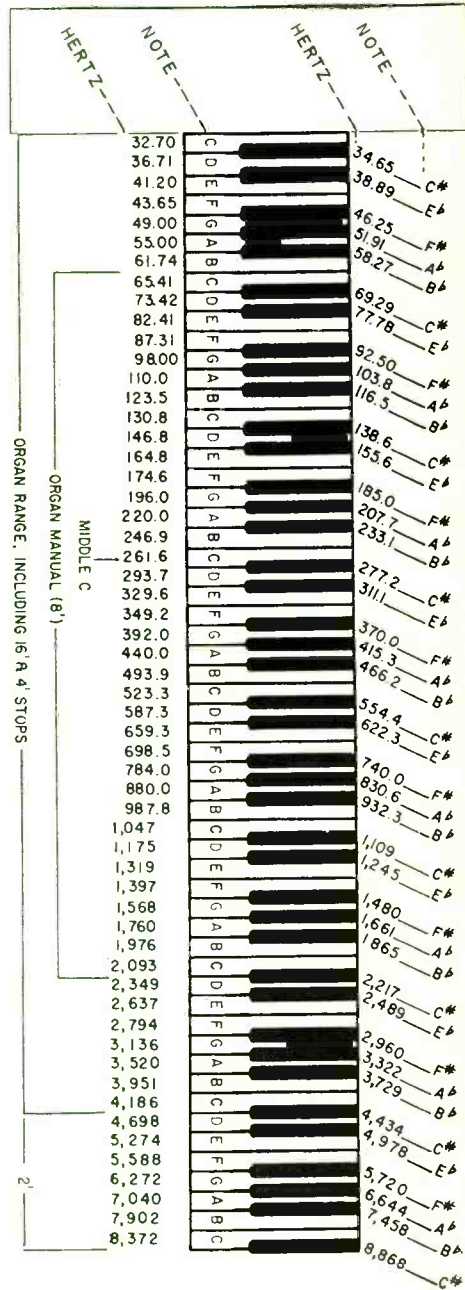

Fig. 7. Chart of organ keyboard shows frequencies and notes. It can be used to tune electronic organs or pianos.

are probably the most important points to ponder. Attach all this to a good special effects speaker system and you have an electronic enchanter that both you and your family will treasure for many years to come.

TEST REPORT ON CHROMIUM DIOXIDE vs FERRIC OXIDE CASSETTE TAPES

*Although higher in cost,
CrO₂ tape provides slightly
better performance.*

BY JULIAN D. HIRSCH
Hirsch-Houck Laboratories

A LARGE share of the credit for the acceptance of the cassette as a true high-fidelity medium goes to the special tape coatings developed to complement the unique characteristics of the cassette recorders. In recent years, chromium dioxide (CrO₂) tapes, for example, have received a great deal of attention with the advertising media claiming for them such advantages as extended high-frequency response and better signal-to-noise (S/N) ratio as compared to the more common ferric oxide (Fe₂O₃) tape. Nothing is perfect, however, not even the chromium dioxide formulation whose major disadvantage is its need for higher record bias and erase currents, as well as the need for special equalization to realize its full potential.

The chromium dioxide tape can be used effectively only with specially designed decks. Fortunately, most high-quality decks contain a switch that allows their performance to be optimized for chromium dioxide and ferric oxide formulations (and sometimes for more than one grade of ferric oxide tape). Chromium dioxide cassettes are slightly more expensive than ferric oxide. But the premium price is not much of a disadvantage for the listener who wants the best from his hi-fi equipment.

Electrical Considerations. During the recording process, certain criteria must be met if the best possible performance is to be obtained from both the recorder and the tape. As the ultrasonic bias signal, combined with the audio signal in the recording head, is increased from a low level, an increase in playback output and a reduction in distortion occur. The residual noise level, or hiss, remains relatively constant, yielding a net improvement in the S/N ratio. Simultaneously, however, the higher audio frequencies are partially erased by the stronger bias signal as they are recorded. The result is a loss of high-frequency response which, at optimum bias (from distortion and output considerations), is usually excessive. To counteract this, a lower bias is used.

In all cases, treble boost is used during recording to obtain a "flat" response with standard playback equalization. It might appear, then, that by increasing the recording high-frequency boost, a flat frequency response would be achieved with maximum output and minimum distortion. In reality, however, this would saturate the tape with low-level, high-frequency signals.

The concentration, therefore, has been on developing magnetic coatings capable of storing higher energy levels without succumbing to bias-flux demagnetization. With the better ferric oxide tapes, this is partially accomplished with smaller magnetic particles and tape surface polishing to assure better contact with the record/playback head. Such tapes usually go by such names as "Low Noise," "Super Dynamic," "Ultra Dynamic," "Extended Range," "High Energy," etc. As compared with standard ferric oxide tapes, these special tapes can provide significantly better S/N ratios and high-frequency responses, especially where the recorder is properly set.

Going a step beyond the best ferric oxide tapes, chromium dioxide cassettes have a greater capacity to store energy, particularly at high frequencies, and to resist bias demagnetization. They are designed to be operated at a higher bias level and recorded at a higher level; and because they resist erasure, a higher erase current is required. Their improved treble response can be put to use in several ways. By using more treble cut in the playback equalization, an improved S/N is obtained. On the other hand, with standard playback equalization, high-frequency response can be extended and the higher bias and recording levels still give

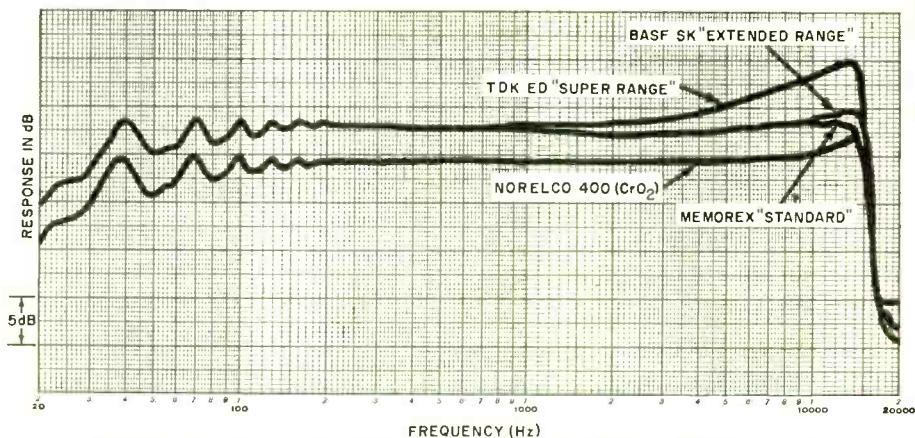

Typical frequency response curves of four distinctly different tapes.

S/N ratios at least the equal of ferric oxide tape. (Each recorder manufacturer selects the operating conditions he considers to be the optimum.)

The overall performance of any cassette recorder depends on the properties of the tape, recording bias and equalization, recording level, and playback equalization. Obviously, other factors like head design enter the picture if a really thorough discussion of the mechanics and electronics were to take place. These, however, are beyond the scope of this article.

There are industry-accepted standards for playback equalization, a necessity for playing commercially recorded tapes. But each manufacturer is free to choose his own combination of the other factors involved. In the case of chromium dioxide tape, there is not yet a universally accepted playback equalization characteristic, a situation that has a great deal of potential for chaos.

Our Test Results. The goal in our tape tests was to measure what were the actual differences among a number of cassettes when used in a single high-quality cassette recorder. We used as our test deck the Advent Model 201 which has bias and playback equalization for both ferric oxide and chromium dioxide tape formulations. Since we had determined that it gave the flattest frequency response, we used the factory-set chromium dioxide bias. However, for our tests with ferric oxide tapes, we adjusted the bias for the flattest overall frequency response with typical "standard" tapes, such as the Memorex and the Scotch HE brands.

We measured the performance of each cassette under identical conditions, not al-

tering any control settings or operating levels (except to switch between chromium dioxide and ferric oxide as needed). We measured the playback output level with a 1000-Hz signal recorded at 0 dB. A section of tape that had been recorded with no signal input was used to measure noise levels. These were essentially unweighted measurements, although we attenuated frequencies below 250 Hz to prevent hum and low-frequency disturbances from influencing our results since our only concern was "hiss."

To determine at what point the recorder's level meter corresponded to a standard 3-percent THD in playback, the playback distortion (THD) was measured at a number of recording levels. For our output S/N ratio, we took the difference in decibels (dB) between the output at 3 percent THD and the playback noise with no recorded signal. With each tape, the overall record/playback frequency response was measured using a level of -30 dB to prevent tape saturation at the higher frequencies.

Fluctuating output level caused by tape imperfections or mechanical faults in the cassette is a common problem with cassettes. To evaluate this, we recorded a 10,000-Hz signal and played it back onto a graphic-level recorder over a three-minute period. An ideal tape would produce a straight horizontal line on the chart; generally though, cassettes always reveal some irregularity or thickening of the line as the output varies. The graph also allows us to identify the nature of the problem, random coating variations, occasional "drop-outs," or periodic "cogging" effects due to uneven friction in the cassette hubs.

Listening comparisons were also conduct-

ed among the cassettes, both to check the similarities of some cassettes we tested out as being identical to each other and to hear how much difference in sound resulted from some of the measured differences.

The cassettes we tested were representative of the current offerings of several leading manufacturers. Whenever possible, we chose manufacturers who produced both ferric oxide and chromium dioxide cassettes. In a couple of cases, where the line did not include both types of tape, we tested the best ferric oxide tape offered.

Our test cassettes included: BASF SK (Low Noise/Extended Range), LH and Chromdioxid; Capitol 2; Memorex and Memorex CrO₂; Norelco 300 (High Output/Low Noise) and 400 (CrO₂); Scotch HE (High Energy); TDK LN (Low Noise), SD (Super Dynamic), ED (Extra Dynamic) and KR (CrO₂). Many of these cassettes are available in different playing times, but we restricted our tests to only the popular C-60 length. Note, however, that since the longer playing cassettes use thinner tapes and coatings, they do not necessarily yield the same performance as a C-60 cassette of the same type and formulation.

Listed in the table are the results of our measurements. The "output" figures are purely relative, but they do reveal a "spread" of almost 5 dB among the tapes tested. Similarly, the 3-percent THD figures apply only to the particular Advent cassette deck we were using and the bias settings we made. The actual numbers could be quite different when using another recorder, but we expect that the relative standings of the tapes would be about the same in any case. The S/N figures have been rounded off to the nearest decibel since the method we

used in our measurements does not warrant greater precision.

Instead of showing actual tape output variations, we have interpreted them according to our experience with this test and assigned relative rankings to the various cassettes. Higher numbers indicate more variation in output, and cassettes with the same number had essentially the same performance.

The frequency-response charts were all alike (except for level) up to about 1000 Hz. At higher frequencies, some tapes had a rising characteristic; most had a slight peak at 14,000 or 15,000 Hz (a characteristic of the recorder) and fell off rapidly at higher frequencies. Some typical curves are shown in the figure. Since most of the differences were at higher frequencies, we have tabulated the outputs at 4000 and 12,000 Hz, relative to the 400-Hz level for each tape.

The final S/N figures fell into fairly well defined categories, in spite of the considerable "spread" in output, noise and maximum recording levels among our test tapes. The "standard" tapes are those that operated best (exhibited the flattest frequency response) on the Advent 201 recorder with the bias we used. These included Memorex, Scotch HE, and TDK LN cassettes. Designed to operate with "standard" bias recorders, Scotch's HE cassettes have a higher output level that extends their dynamic range.

A second group, which for want of a better name we will call "extended range," had a slightly rising high-end response (up about 2-2.5 dB at 12,000 Hz) which would have been reduced by a slight increase in bias. However, these tapes (BASF SK, BASF LH, Norelco 300 and TDK SD) are very

Results of measurements show variation among different cassette tapes tested.

TAPE	OUTPUT dB	REC. LEVEL dB @ 3% THD	S/N re 3% THD dB	OUTPUT FLUCTUATION*	FREQ. RESP. re 400 Hz 4 kHz	12 kHz	PRICE
BASF SK	+0.8	+1	57	1	-0.6 dB	+1.8 dB	\$1.75
BASF LH	-0.2	+1.5	55	1	-1.0 dB	+0.7 dB	\$2.65
BASF CrO ₂	-2.3	+2	58	2	0.0 dB	+2.0 dB	\$3.89
Capitol 2	+0.9	-1	54	2	+2.2 dB	+5.3 dB	\$2.98
Memorex	+1.4	0	56	3	0.0 dB	+1.0 dB	\$1.99
Memorex CrO ₂	-1.3	+3.5	60	2	+0.3 dB	+1.8 dB	\$2.99
Norelco 300	+0.5	+1.5	57	2	0.0 dB	+2.6 dB	\$2.95
Norelco 400 CrO ₂	-2.3	+2	58	1	0.0 dB	+1.5 dB	\$3.49
Scotch HE	+2.1	-1	56	4	-2.0 dB	-0.8 dB	\$2.80
TDK LN	+1.6	+1.5	55	1	-0.7 dB	+0.5 dB	\$1.49
TDK SD	+1.5	+1	57	1	-0.4 dB	+2.2 dB	\$2.29
TDK ED	+2.2	0	55	2**	+1.5 dB	+6.4 dB	\$3.00
TDK KR CrO ₂	-1.5	+3	59	1	0.0 dB	+1.0 dB	\$3.00

*Number rankings increase with greater fluctuation

**Largely due to internal cassette mechanical friction; otherwise would rank 1.

satisfactory performers with the standard bias level. The third category might be termed "super range" (everyone else uses superlatives; so, why not us too). These have a strongly accentuated high end with an appreciable rise at 4000 Hz and really require a higher-than-standard bias for satisfactory performance. In the "super" category were the Capitol 2 and TDK ED tapes. Finally, of course, there were the CrO₂ cassettes—BASF Chromdioxid, Memorex Chromium Dioxide, Norelco 400, and TDK Krom-O₂ (KR).

In general, as we progressed from "standard" to "extended range" to chromium dioxide tapes, the S/N ratio figures improved. They were typically 55 to 56 dB for "standard" cassettes, 57 dB for the "extended range" category, and 58 to 60 dB for chromium dioxide tapes. Operating with standard bias, the "super range" cassettes had the poorest S/N ratios at 54 or 55 dB. Obviously, an increase in bias would flatten out the high-end response and allow the use of higher recording levels. Almost certainly, their S/N ratios under optimum conditions would have been slightly better than those of the other ferric oxide tapes tested. However, the point of this investigation was to demonstrate comparative performance under *real*, not necessarily *optimum*, conditions. If your recorder is biased for these "super" tapes, they will outperform the others. Few, if any, cassette decks are so adjusted at the factory, and only the Advent 201 (to our knowledge) even provides access to bias adjustments for the benefit of the knowledgeable user.

The Scotch HE tape also reached 3 percent THD at a lower recording level, although its output was higher than other standard bias tapes. The net result was a 56-dB S/N ratio which is high for this group but not quite as high as that of the "extended range" cassettes.

An improvement of 3 dB in S/N ratio is always welcome to a recordist, even if it does not look impressive in print. Our measurements indicate that 3 dB is the actual S/N advantage of chromium dioxide over the best ferric oxide cassette tapes. The chromium dioxide tapes can be recorded at a 2-3-dB higher level without exceeding the 3-percent THD mark. But their output levels, to our surprise, were also about 2 or 3 dB lower than those of the ferric oxide tapes. The net improvement in S/N ratio is evidently due to the added roll-off in the

playback equalization of the Advent 201 recorder. This was confirmed by our experience with other cassette recorders that use the same playback equalization for all tapes. With these machines, the S/N is no better with chromium dioxide tape than it is with any good ferric oxide tape, although the high-frequency response is usually considerably extended.

Most chromium dioxide cassettes employ DuPont's "Crolyn" tape and, therefore, have identical magnetic properties. An exception is the BASF Chromdioxid that is made in West Germany by a BASF process. In our tests, it reached 3 percent THD at a slightly lower recording level than did the Crolyn tapes. As a result, it did not have quite as good a S/N figure (the difference, although measurable, was slight). The Norelco 400 tape appeared to be identical to the BASF Chromdioxid in its properties.

Does Chromium Dioxide Tape Sound Better? Little in our tests suggest that chromium dioxide cassettes would be audibly superior to high-grade ferric oxide tapes. They are obviously "better," but it is not so easy to judge whether or not the benefits are worth the higher tape cost. We could not fully resolve this question during our listening tests, either.

In general, chromium dioxide cassettes sounded more "open," with less apparent compression of dynamics, particularly at high frequencies, that one sometimes hears in cassette recordings. But we must also take into consideration that we always knew which of the cassettes was in use at any given moment during the tests, which could conceivably have affected the objectivity of our judgment. A test of this sort should really be made before a panel of listeners who are unaware of the products being judged.

Our conclusion is that for the very finest cassette recordings, chromium dioxide tape is indicated. Its use may prove uneconomical to the average recordist/listener, since the price of these cassettes is beyond the point of diminishing returns for most people. For 99 percent of home cassette recording needs, a good grade of "extended range" ferric oxide tape will do about as well at an appreciable saving in cost. The "super range" tapes—Capitol 2 and TDK ED—rival chromium dioxide tapes in most respects, including price, but will require a bias adjustment on most tape recorders. ♦

If you like to work with your hands...

... you're a special breed. Always taking things apart to find out how they work. Always wanting to know why they work the way they do. The kind of guy who uses his head and his hands.

If that sounds like you, you've got a head start on an exciting future. You already have skills you could turn into a profitable career in two-way radio electronics communications.

And this Bell & Howell Schools learn-at-home program can give you the know-how you need to make it happen.

Get the facts.
Mail the postage-free card now!

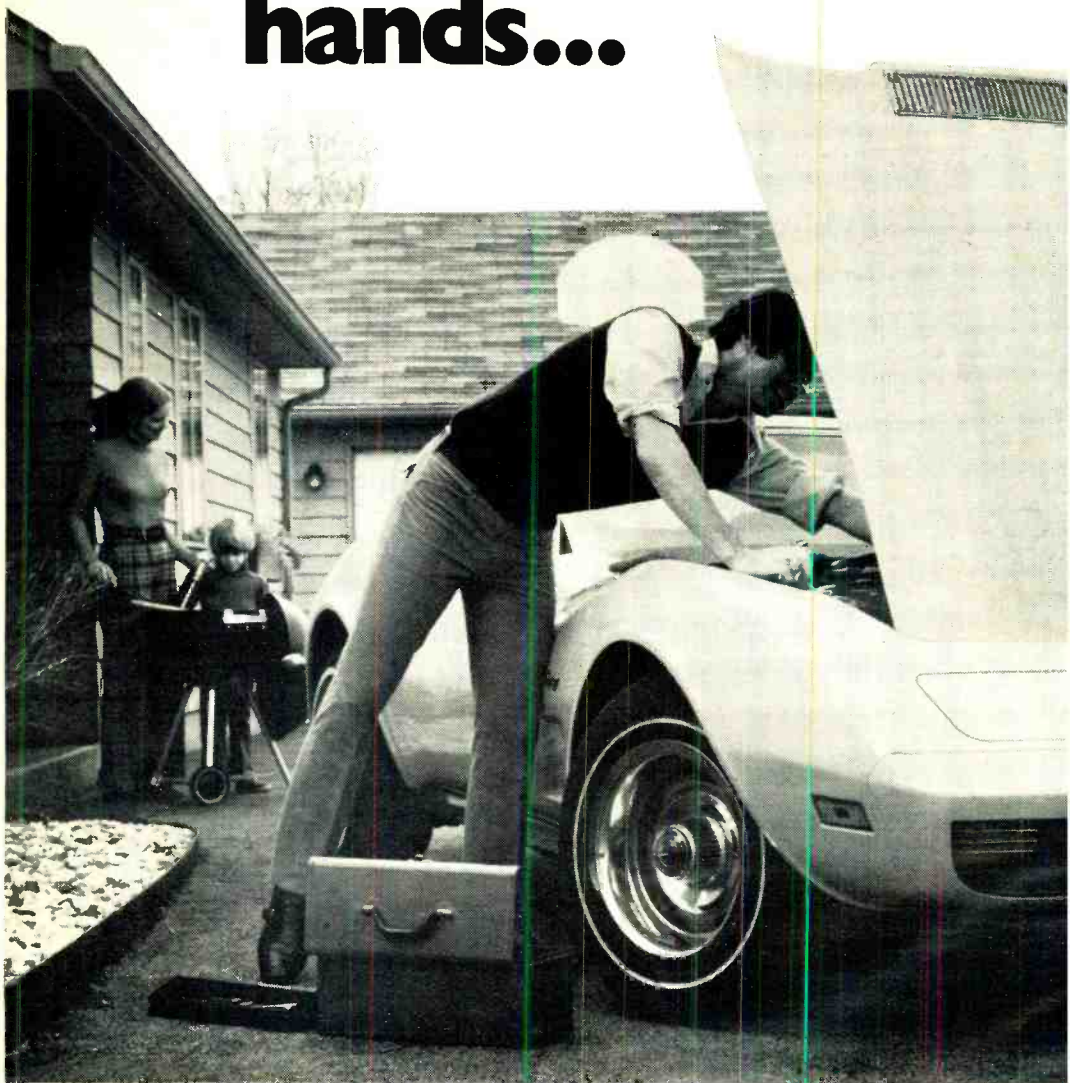

You're a pretty lucky guy. You know what you like to do in your spare time. How would you like being able to do it *all* the time — in a rewarding new career or maybe even a business of your own?

This unique Bell & Howell Schools learn-at-home program in two-way radio electronics communications will give you the "tools" you need to have the career you want — thorough knowledge of electronics, plus "hands on" experience with \$1,500.00 worth of commercial-grade equipment.

You'll need *both* to take full advantage of growing opportunities in two-way radio electronics communications. Two-way radio communications is a vital growth area in the electronics industry.

And it's lucrative. Almost two million commercial two-way radio systems now serve as vital communications links for trucks, planes, boats and taxis. The FCC requires each system to have its equipment serviced regularly by a licensed technician.

That adds up to at least two million service calls a year for licensed technicians. Maybe *you*. But you need career-oriented training — and that's where we come in.

FCC Regulations are your key to a rewarding new career... or a profitable business of your own!

It's almost like having a ready-made market for your skills. As a Bell & Howell Schools graduate, you'll have the technical know-how you need to take advantage of it.

With your FCC license, you could eventually build your own business, or work for a top corporation that needs full-time on-the-spot

troubleshooters and licensed technicians for its massive two-way communications system.

Or service equipment in your spare time for extra cash. FCC regulations could mean security and regular income for you!

But first you'll need practical, career-oriented training.

To get ready for your new career in two-way radio, you need: 1) Career-oriented training; 2) FCC License; 3) "Hands on" experience with commercial-grade equipment.

Bell & Howell Schools now offers this unique at-home training program that helps you get all three. (See FCC License Warranty on attached card.)

You're probably already skilled with the tools you'll use in your new career. Bell & Howell Schools provides the theory and practical know-how you'll need.

You build your knowledge one step at a time. And you practice your new skills in experiments you perform in your own home — with Bell & Howell Schools exclusive Electro-Lab[®] electronics training system!

NEW! With your first lesson you get...

... the brand-new Laboratory Starter Kit! A volt-ohm-meter (VOM) with design panels, modular connectors, experimental parts, battery power source. Gives you "hands on" experience with your very first lesson.

You also build the improved Bell & Howell Schools Electro-Lab[®] electronics training system...

... Gives you troubleshooting experience with precision instruments you assemble and use in your new career:

Design Console

"Breadboard" circuits without soldering for both solid state and vacuum tube experiments.

Oscilloscope

Professional technician's diagnostic instrument.

Transistorized Voltmeter

Measures current, voltage, and resistance.

Put your new skills to work on the real thing — \$1,500.00 worth of commercial-grade equipment!

When you're servicing two-way radio systems for aircraft or advising trucking companies about their mobile

communications system, you'll need troubleshooting experience with the real McCoy. This unique new Bell & Howell Schools learn-at-home program includes "firing line" experience with professional, commercial-grade equipment.

You can work with the equipment by attending one of our special "help sessions" or by dropping by one of the Bell & Howell resident schools. If neither of these plans is convenient, you can have the equipment shipped to your home in return for a \$100 deposit, which is refundable when you return it.

This is the equipment you'll work with during your Bell & Howell Schools training program!

Commercial-Band FM Transceiver

... exactly the kind of two-way radio you'll be servicing in your new career.

Deviation Meter... model favored by many working technicians to check modulation of transmitted signal.

Frequency Meter... highly sensitive instrument used to check signal frequency within precise tolerances established by government standards.

Power Output Meter... meter used almost universally by trained and licensed technicians to check power output — or wattage — of signal.

Alignment Generator... a custom-designed unit you use to generate test signals for transceiver alignment.

Bell & Howell Schools offers you these special advantages:

Help Sessions Scheduled regularly at the Bell & Howell Schools and in many other cities throughout the U.S. and Canada.

National Career Placement Center Helps you locate a job that fits your background and interests any time after you complete your program.

Veterans' Benefits We are approved by the state approval agency for Veterans' Benefits.

Student Financial Aid We are an eligible institution under the Federally Insured Student Loan Program.



Mail the postage-free card today!

If card has been removed, write:

An Electronics Home Study School

DeVRY INSTITUTE OF TECHNOLOGY

ONE OF THE



BELL & HOWELL SCHOOLS

4141 Belmont, Chicago, Illinois 60641

507

"Electro-Lab" is a registered trademark of the Bell & Howell Company.

BUILD A COSMOS DIE



BY MICHAEL S. ROBBINS

Learn to use this latest extremely low-power logic

WHERE power supply requirements are concerned, today's digital integrated circuits are amazingly economical. For example, RTL gates use 3.6 volts with each gate requiring about 13 mA; DTL gates use a 5-volt supply and require about 4 mA per gate; and TTL uses 5 volts at 5 mA per gate. The new COSMOS gates, however, require only 0.02 microampere at 5 volts and can operate between 3 and 15 volts.

COSMOS is an acronym for complementary-symmetry metal-oxide semiconductor. RCA actually calls their units COS/MOS, while Motorola calls theirs MCMOS. The technology involved is an outgrowth of that used to produce the more familiar metal-oxide field-effect transistor (MOSFET).

Besides taking very little power, the individual COSMOS elements are so small that more of these devices can be packed on a single chip than conventional bipolar devices. As an example, consider the complexity of a whole calculator on one chip or a complete clock on a single chip. One standard COSMOS device, the RCA CD4020AE, contains 14 flip-flops and, with a 16.384-kHz input, will divide down to 1 Hz. Power consumption of this chip is less than 0.5 mA at 5 volts.

Electronic experimenters will want to work with COSMOS units to get to know how they operate and learn some of their many uses. One way to get started is to build the random-digit generator shown in Fig. 1. To make the project more interesting, this circuit forms the equivalent of a six-sided die by randomly displaying digits 1 through 6 on a small seven-segment LED readout. Two COSMOS IC's and a single bipolar transistor are the only active elements.

Circuit Operation. The 15-kHz oscillator drives a single-chip counter-driver which ordinarily would indicate from 0 to 9. However, at the seventh input pulse (which would attempt to cause the LED readout to go from 6 to 7), a reset pulse is gener-

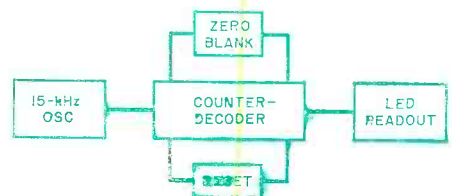

Fig. 1. Circuit includes a 15-kHz oscillator driving a counter-decoder.

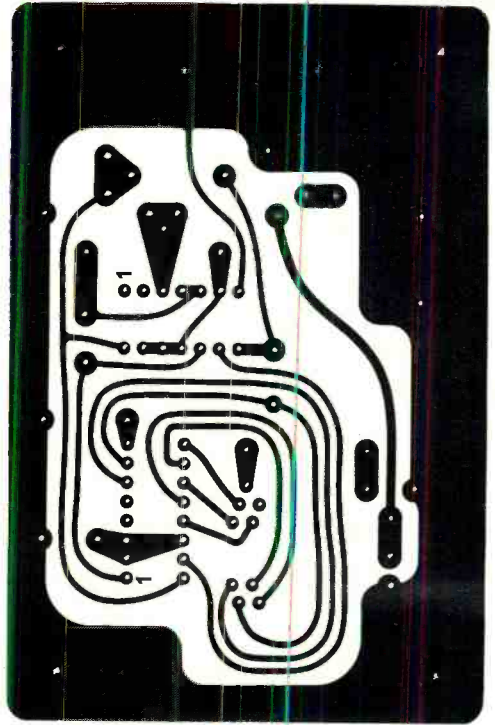
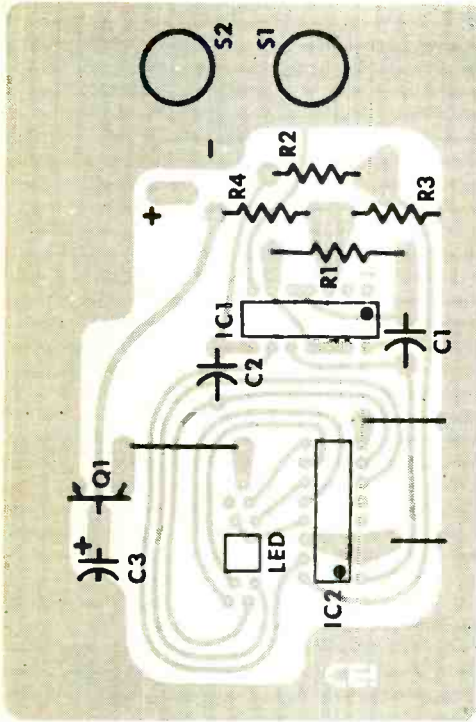

Fig. 3. Actual size foil pattern for a single die and the component installation. Take care in handling COSMOS IC's. They can be damaged by static electricity.

Construction. The components for a single die can be mounted on a PC board such as that shown in Fig. 3. Sockets may be used for the IC's, and Molex pins for the LED, though they can be soldered in place. Care should be used when handling the IC's. Although they have built-in diode protection, the oxide gate-insulating layer can be destroyed by static electricity. Contact with the foam plastic conventionally used to

package transistors should be avoided. The black foam used to pack MOS devices is conductive and will not cause any harm. It is suggested that the soldering iron used have a three-wire line cord and a grounded tip. The plastic housing the LED readout has a low melting temperature, so take care if soldering this component in place.

The completed board, or pair of boards if you want a set of two dice, can be mounted in any suitable chassis, with only the LED readout exposed through a cut-out and the pushbutton switches mounted on the front panel. If you are making a pair of dice, a single switch can be used for S1. Any 9-to-12-volt battery may be used as the power source.

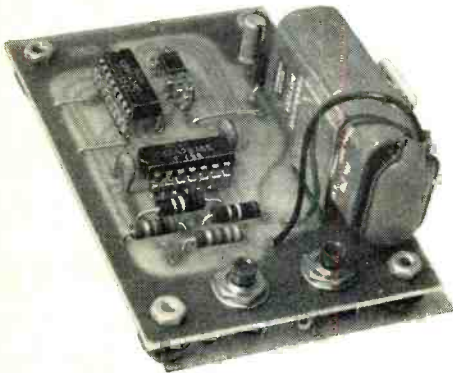

Photo shows how components, including battery and switches, mount on board.

Operation. Depressing S1 starts the oscillator and counter and should be kept depressed during the entire operation. When S2 is depressed, the oscillator stops and the LED will indicate the random digit. Due to the reset system used, on occasion the LED will not display a digit. This is a "no dice" condition and if it occurs, S2 should be released, left open for as long as desired, and then depressed again. ♦

CDA-

THE NEW CURRENT DIFFERENCING AMPLIFIER

This IC can be used in either linear or digital circuits and will operate from a single 4-to-36-volt power supply.

THE UBIQUITOUS integrated circuit operational amplifier has been with us for some time—especially in such popular types as the 709, 741, and 301A. Since, with the addition of a few resistors and capacitors, these familiar devices can be used in so many applications, we are tempted to ask, Do we really need another general-purpose op amp? When a handful of 741's can be bought for a couple of bucks, is another type necessary?

However, innovation and technological ingenuity on the part of manufacturers never cease to expand; and if there is a possibility of one untapped market area, they will soon come up with the product to fill the gap—and probably supply the answer to somebody's needs. Consider, for instance, the following questions: Have you ever been frustrated by the necessity of having two power supplies for a simple op amp circuit? Ever wished for an op amp functional equivalent of the popular quad gate? Do you need an amplifier that will operate from your 5-volt "digital type" power supply? Or, better yet, how about an op amp which could be used for both linear and digital applications?

Well, don't worry about these problems any more. There is a new family of op amps on the scene and they provide the answers to all of these questions—and at a price per amplifier of about one half that of a 741! The performance is not exactly that of a 741 or 301A; sometimes it is more modest, sometimes it is better. These op amps are not just a repackaging of older devices. They are Current Differencing Amplifiers (CDA) and the part numbers to watch for are the MC3301P and MC3401P by Motorola and the LM2900N and LM3900N by National. You'll be hearing about them because they are both inexpensive and useful, and, at the

same time, a little different. This difference requires some "re-thinking" about how to use op amps.

What Makes It Tick? The current-input op amp can be more easily understood if approached from the standpoint of how it evolved. Suppose you were designing a new amplifier from the ground up. Using a single supply voltage, the one-transistor common-emitter stage of Fig. 1A can be designed to have quite a high gain if certain precautions are taken. To obtain high gain, the collector impedance is raised to maximum, allowing a gain of 60 dB or better (more than 1000/1). Then, to drive a low-impedance load, a buffer stage (Q2) is added as shown in Fig. 1B. Now we have high gain and enough drive for low-impedance loads. However, with a single supply voltage, the "pulldown" action of R_e limits the output voltage swing.

The solution is to add an active transistor (Q3) as shown in Fig. 1C. Now we have a high-gain amplifier which can swing nearly the full supply voltage at its output; and it will work well using a single supply voltage. To increase the gain and also make it stable over a wide range of supply voltages, we add a further refinement—a constant-current biasing transistor (Q4) as the load resistor of Q1 (Fig. 1D). And there it is, the complete idea behind what is basically a single-stage amplifier designed for a single, wide-range power supply, with low-impedance output. The only thing needed before it can be wrapped up into a neat little op amp package is a second input so that it can handle differential signals. But how do you make a differential amplifier from what is basically a souped-up, single-stage, common-emitter amplifier? Here is the really unique

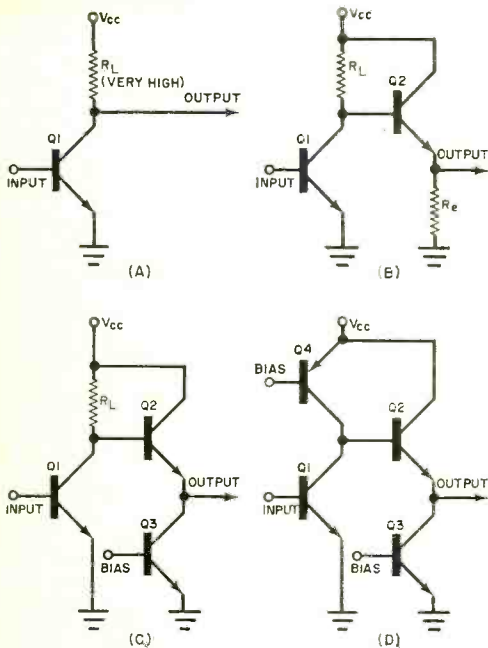

Fig. 1. These diagrams show the evolution of a high-quality amplifier. At (A) is a common emitter with high gain. Circuit (B) has a buffer stage. Active pulldown is shown at (C); and (D) includes constant-current biasing.

difference—from which the device gets its name.

Adding an inverting transistor (Q_m) across $Q1$'s input will allow non-inverting inputs, as shown in Fig. 2. Although Q_m is a signal inverting stage, it is not an ordinary common-emitter amplifier like $Q1$. The connection of Q_m with $D1$ across its base forms a *current-mirror* stage. The diode in parallel with Q_m is matched to Q_m 's characteristics in such a way that Q_m will conduct the same current as that applied to the (+) input terminal. The input current actually flows through the diode, but since Q_m is matched and in parallel with the diode, it duplicates the input current, with an inversion. In this way, a current at the (+) input terminal is made to appear with equal amplitude, but inverted, at the original input terminal, the base of $Q1$.

If differential operation is required, both inputs are used. If only single-ended operation is desired, Q_m can be biased off by grounding the (+) input and $Q1$ is used as a high-gain, buffered gain stage.

One thing which should be noted from this discussion is that we are now talking in terms of input *currents*, not voltage inputs as in a standard op amp. What this means is that the two inputs work together as a pair of current differencing inputs. Standard op amp theory works on differential input volt-

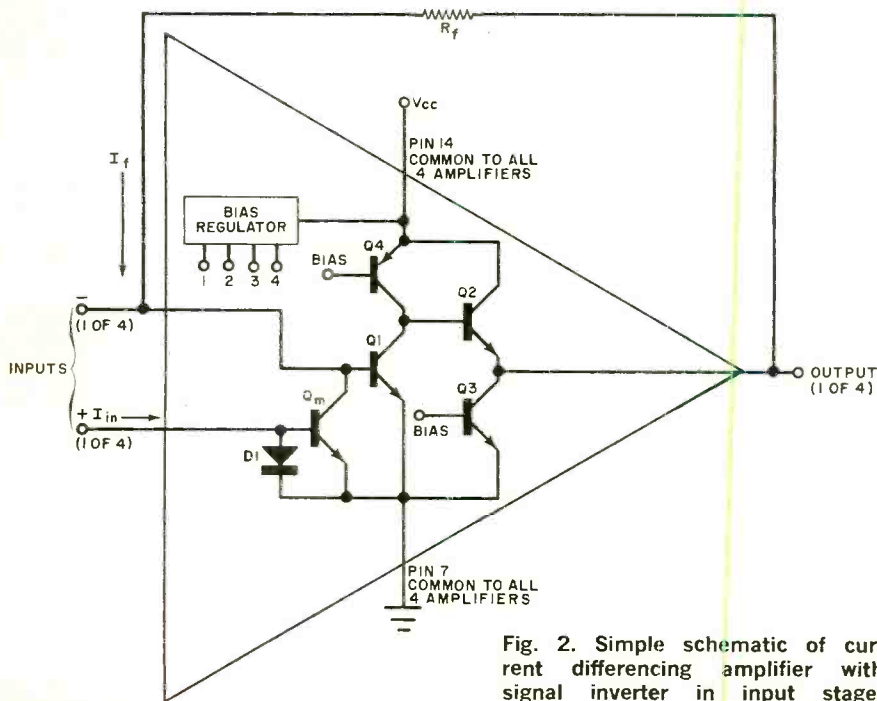

Fig. 2. Simple schematic of current differencing amplifier with signal inverter in input stage.

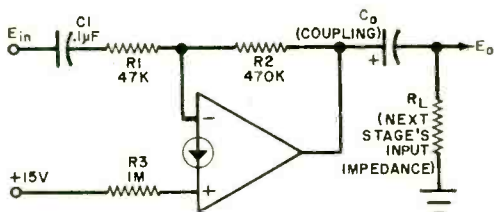

Fig. 3. This inverting amplifier uses the current-mirror biasing technique.

ages. By contrast, this stage works to keep the current difference between the two inputs to a minimum. As a result of the current mirror's unity gain, the current I_{in} appears at the collector of Q_m and must flow also in the external feedback resistor R_f as I_f . Once the difference of this biasing is understood, setting the stage up is rather simple, as will be seen shortly.

Currently available types provide four of these op amp circuits in a single 14-pin dual-inline package. All amplifiers are identical and share a common biasing network which removes the effects of supply variations and temperature. There are slight differences in the key specs, the most notable being a wider range of supply voltage for the LM2900N and LM3900N, which use +4 to +36V.

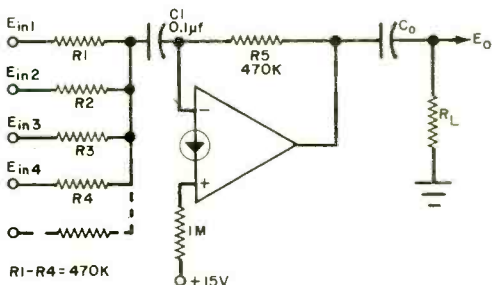

Fig. 4. Mixing amplifier using CDA.

Inverting Amplifier. As a first example of uses of the CDA, we will consider an ac voltage amplifier. Many different amplifier configurations are possible using CDA's, with individual stage gains of up to 1000. Even higher gain can be obtained merely by cascading 2 or more stages. Due to the high bandwidth of CDA's, they often outperform 741's in terms of frequency response.

Figure 3 illustrates an inverting CDA amplifier using current mirror biasing. Gain and low-frequency cutoff are changed by changing the values of R_1 and C_1 . Capacitor C_o is an output coupling capacitor which feeds the next stage, represented here by R_L . The value of C_o is chosen in a manner similar to C_1 .

Mixing Amplifier. A very useful circuit is the mixing amplifier shown in Fig. 4. It is a variation of the basic inverter. This circuit can mix virtually any number of inputs (4 is not the limit) into a common signal for tape recording, public address systems, etc. The gain of each channel is unity, and R_1 - R_4 should be equal values for matched input sensitivities. Coupling capacitors are chosen as in the inverter.

Non-Inverting Amplifier. Figure 5 shows a non-inverting amplifier using a CDA. This is

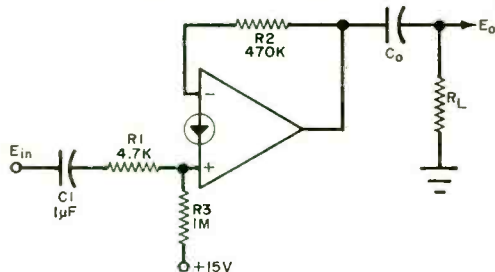

Fig. 5. Non-inverting CDA amplifier.

no more complicated than transferring R_1 - C_1 from the negative input (in the inverter) to the positive input. With the example shown, the gain is 100. There will be some deviation from precise accuracy of the gains due to the current mirror, but this is negligible at all but the higher gain settings. Coupling capacitors are chosen as previously.

Differential Amplifier. Using both inputs results in a differential amplifier (Fig. 6), known for its ability to reject noise such as hum, pickup, etc. As shown, the circuit is suited for a balanced line, low-impedance source such as a microphone. Input capacitors may be eliminated in this circuit if there is no dc voltage across the input terminals, which is true in the case of the microphone. Two-conductor shielded cable, grounded as shown, should be used to minimize noise

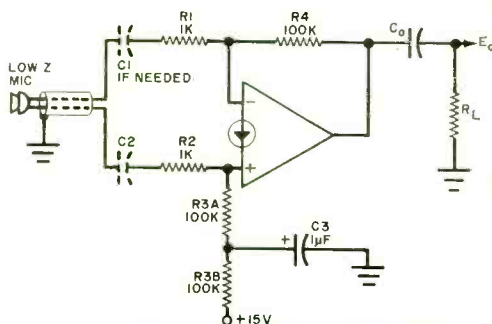

Fig. 6. Inverting amplifier using CDA.

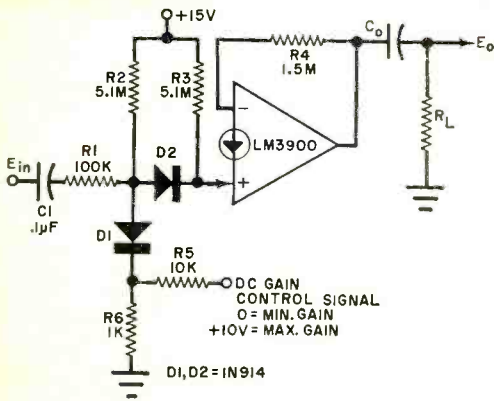

Fig. 7. CDA can be used as a gain-controlled amplifier with dc signal.

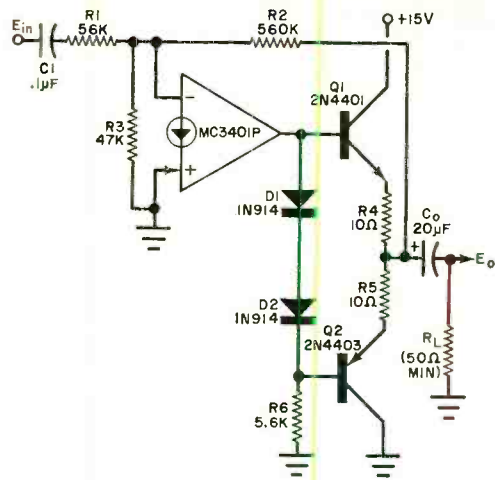

Fig. 8. A 50-ohm line driver amplifier.

pickup. Stage gain is 100, but this may be varied by adjusting R_1 and R_2 . Resistor R_3 is split by filtering capacitor C_3 if supply noise is a problem; otherwise make R_3 220,000 ohms.

Gain Controlled Amplifier. Ever have a need for a circuit with a remotely or electronically adjustable gain? Figure 7 is such a circuit, National Semiconductor's recommendation for gain controlling one section of an LM3900.

The circuit works basically by varying the diode impedance of D_2 , which passes the

signal current into the current mirror input. With a control signal of +10 V, D_1 is off and full gain of approximately 15 is obtained. As the control voltage is lowered, current is diverted from D_2 by D_1 , reducing the gain.

Line Driver Stage. Generally the output current of a CDA should be limited to 10 mA or less, which does not allow loads with very low impedances (such as 50 ohms). A simple booster stage can be used to overcome this (Fig. 8).

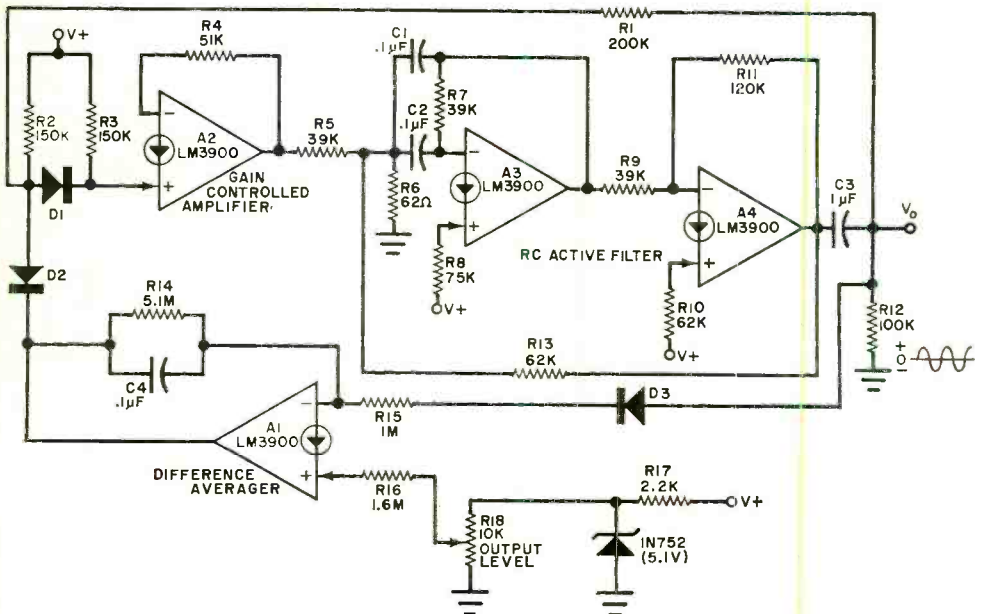

Fig. 9. This low-distortion, amplitude-regulated, sine wave oscillator uses four CDA sections.

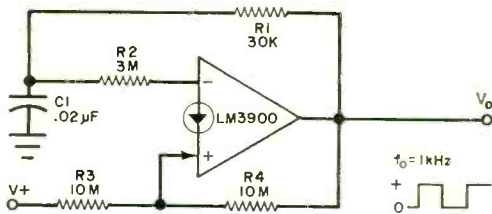

Fig. 10. Square wave generator using CDA.

This output stage is Motorola's circuit for driving a 50-ohm load at voltages up to 6 V peak-to-peak. Transistors *Q1* and *Q2* form a class B emitter follower with bias supplied by *D1* and *D2*. As shown, it is an inverting stage with a gain of 10. This circuit also illustrates the use of *V_{be}* multiplication biasing. This output buffer is applicable to any of the amplifier stages described previously.

Oscillators. Like conventional op amps, CDA's are very useful in oscillator circuits for generating sinusoidal, pulse, and rectangular waveforms. Taking full advantage of all four amplifiers of a single CDA package and a combination of different circuit sections, National Semiconductor's sine wave oscillator (Fig. 9) produces a 1-kHz output with a total harmonic distortion of 0.1%, regulated in amplitude.

Sections A2 through A4 form the oscillator, with gain being controlled by A2. This section is a gain controlled amplifier similar to Fig. 7. Stage A1 senses the output level through rectifier D3 and develops a control voltage to drive D2. Amplitude is adjustable by varying the voltage applied to R16 with output level control R18.

This circuit is useful in tone signalling systems as it produces a predictable low-distortion sine wave; and, more important, the same RC active filter used in the oscillator can be used as the bandpass filter for the tone receiver. This guarantees frequency tracking between the transmitter and the

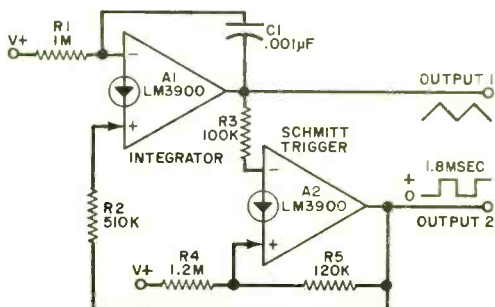

Fig. 11. A CDA triangle wave generator.

receiver since the frequency determining circuit is exactly the same for both.

A CDA square wave generator is shown in Fig. 10, where *R1* and *C1* are the frequency determining components and *R2*, *R3* and *R4* determine the voltages at which the amplifier switches states. The values shown give a frequency of 1 kHz. For variable frequency operation, use different values for *C1* and make *R1* a pot plus a fixed resistor, with total maximum value close to 30,000 ohms and a 10/1 spread.

Triangle waveforms are very useful for test purposes, and a handy circuit to produce them is shown in Fig. 11. In this cir-

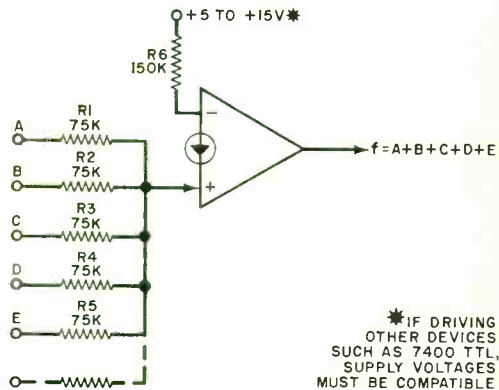

Fig. 12. The CDA as a multi-input OR gate.

cuit, A1 is a dual slope ramp generator, charging and discharging *C1* to form the triangle wave. The wave's amplitude is sensed by A2, a Schmitt trigger which controls the peak-to-peak amplitude of the triangle. The state of the ramp generator (up or down) is controlled by the switched current at the (+) input, developed by R2. Both square and triangle waveforms are available from the circuit.

Digital and Switching Circuits. Since CDA's operate from single power supplies as low as 4 volts, they naturally work well with logic devices (the popular 7400 series, for example). However, they can also be used as logic elements themselves. An all CDA logic system can be operated at any voltage within the range of the particular devices used—not just the conventional +5 volts. The circuits shown here will work with any CDA if supplies are between +5 and +15 V. If interfaced with other logic elements, of course, a mutually compatible voltage is needed (+5 V for the 7400, for instance).

Most digital logic families have an input gate characteristic which is inherently either OR or AND. Examples are RTL (OR structure) and TTL (AND structure). CDA logic is inherently neither and can be used with equal facility either way. It has the added capability of inversion to NOR or NAND by merely interchanging the positive and negative inputs.

A CDA OR gate is shown in Fig. 12. It works as follows: $R6$, connected to the (-) input holds the output low if all inputs are low. If any single input goes high, it overcomes the bias current from $R6$, since $R1$ to

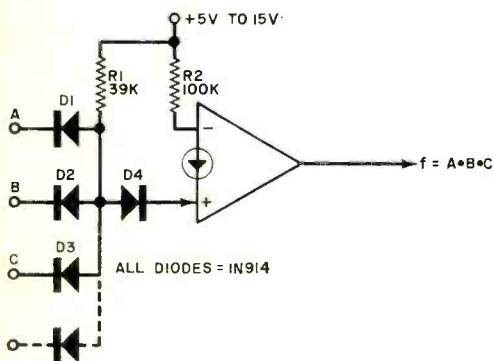

Fig. 13. Circuit for a CDA AND gate.

$R5$ are half the value of $R6$. This drives the output high, performing the OR function. Additional inputs are possible.

If the inversion of this OR function is required, a NOR gate results from interchanging the (+) and (-) inputs on the CDA. Additional inputs are possible in this configuration also.

A CDA AND gate is shown in Fig. 13, where $R2$ supplies a constant bias current to the (-) input, holding the output low if any input is low. If all inputs are high, the current through $R1$ diverts from the input diodes into the (+) input, overriding the current from $R2$ and driving the output

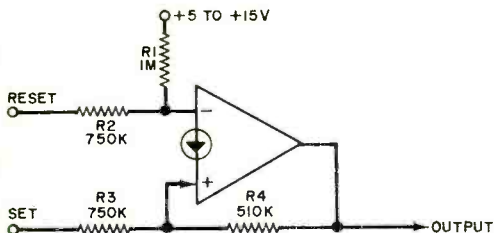

Fig. 14. The CDA can also be used as an RS flip-flop or as digital latch.

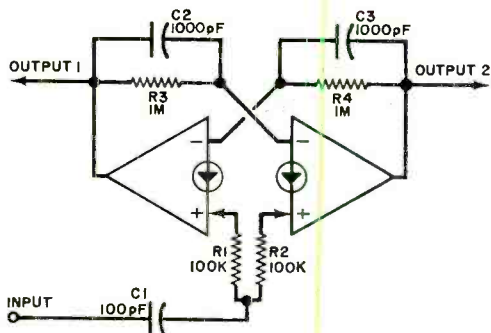

Fig. 15. Toggle flip-flop uses two CDA's.

high. As many additional inputs as desired may be connected through additional diodes.

The NAND function is implemented by interchanging the inputs to the CDA, which inverts the output response. Again additional inputs are possible by adding diodes.

An RS flip-flop may be made with a CDA as shown in Fig. 14. This circuit will remain in the state commanded by the last high input pulse and has a single output.

A toggle flip-flop is one that divides its input by two, changing output state with each application of an input pulse. Such a circuit is shown in Fig. 15, with two CDA sections cross-coupled. This flip-flop by nature has complementary outputs.

Very often in a digital system, the complement of a signal is required, necessitating an inverter. Or, just to drive additional loads, a non-inverting buffer may be useful. The latter is illustrated in Fig. 16. This circuit will drive 10 loads assuming a 75,000-ohm input resistance. An inverting buffer results when the two inputs are interchanged.

What we've tried to do in this look at a unique new amplifier is expose its workings

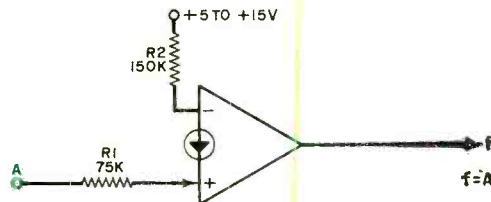

Fig. 16. Simple non-inverting buffer.

and illustrate some applications. We look for the CDA to be a hot item and expect it to be popping up from additional sources in the very near future. Our thanks to Motorola and National Semiconductor, whose application literature formed the basis for portions of the article. ♦

Walkin' But Not Talkin'? Better Get REALISTIC®



1395
TRC-3

1795
TRC-4

2195
TRC-25A

Realistic Walkie-Talkies have what it takes to keep you in touch while hunting, hiking, working—you name it! Each is built rugged with a die-cast case and packed with solid-state reliability. They'll get your message through where others might fail.

TRC-3 Our lowest-priced one-channel superhet has push-pull audio for extra listening power, 100 mW "no license operation", front facing speaker/mike, more. With Channel 11 crystal, 9 volt battery, carry strap.

TRC-4 Our lowest priced 2-channel model. 100 mW power, speaker/mike combination with push-to-talk button, "beep" tone alert, sidemounted on/off volume control. With hand-strap, battery, crystals.

TRC-25A A "hot" superhet. Our best 100mW model. It has separate speaker and mike for maximum modulation and reception. "Beep" tone signal, battery condition meter, push-pull audio. With 9 volt battery, crystals.

TRC-35C Crystal-controlled transmit & receive on up to 3 channels. 1.5 watts power. RF & IF stages, squelch, noise limiter, battery meter with instant check button, carrying strap, Ch. 11 crystals. FCC TYPE ACCEPTED.

TRC-99C 3 channels, 3 watts. Extra convenient, top-mounted squelch and volume controls. RF amplifier, noise limiter, automatic gain control, battery/RF meter, carrying case, more. Ch. 11 crystals. FCC TYPE ACCEPTED.

Rush me _____ Realistic® Walkie-Talkies at 185
\$ _____ each (plus applicable sales tax).
Check or money order for \$ _____ is enclosed.
Please PRINT CLEARLY Send FREE Catalog
Name _____ Apt. # _____
Street _____
City _____ State _____ Zip _____



3995
TRC-35C

5995
TRC-99C

Over 2000 Stores In All 50 States

Radio Shack®

and ALLIED RADIO STORES
A TANDY CORPORATION COMPANY

2611 WEST SEVENTH STREET FORT WORTH, TEXAS 76107

CIRCLE NO. 26 ON READER SERVICE CARD

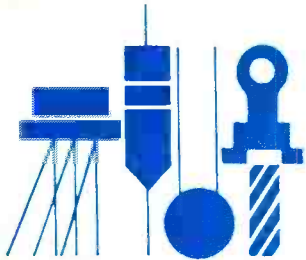

Solid-State Scene

By Walter G. Jung

THERE is virtually a bewildering variety of different logic family types, packaging styles, temperature ranges, and operating speed options from which to choose. It really takes some homework to select a good device for a particular application. This month's Solid-State Scene focuses on the big three currently popular logic families: the present champion TTL (and its many derivatives), the challenger CMOS, and the speedy ECL. We will take a look at the basic features of each.

TTL Family. By far the most widely used digital logic family today is TTL (transistor-transistor logic), familiar to us in the form of the 7400 series devices. The basic 7400 series encompasses just about all levels of integration—SSI (small scale integration) gates, expanders, flip-flops; MSI (medium scale integration) counters, registers, decoders; and, to an extent, LSI (large scale integration) in some of the memory circuits. Pioneered by Texas Instruments, the 7400 TTL line is now available from virtually all manufacturers of digital logic.

The list of available functions numbers about 300 and is still expanding. This is perhaps the biggest virtue of 7400 logic—the large number of functions available. A second virtue is the fact that a great many

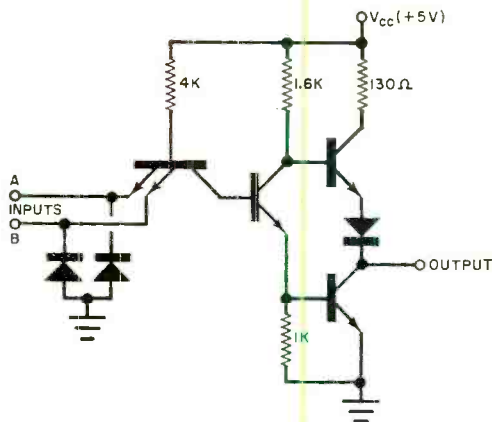

Fig. 1. Basic 7400 TTL gate circuit.

of them are also available in low power, high speed, the super high speed Schottky, and low power Schottky versions. This allows one to optimize a particular performance parameter with a minimum of change merely by substituting an equivalent device for higher speed or lower power. All 7400 family members can be intermixed if loading considerations are taken into account.

The basic TTL gate structure (Fig. 1) is probably familiar to us by now, but it is appropriate to note what changes allow low power or super speed performance.

Going from the basic gate to a low power version, a general increase in resistance values allows a decrease in power consumption by a factor of 10. To go for high speed, the change is the other way around—a lowering of resistances. This provides an increase in speed of nearly 2/1 in the 74H, but at the expense of power. However, a dramatic improvement in performance is obtained with Schottky (74S) TTL.

TTL is a saturated form of logic; that is, the transistors are driven into their saturated

Meet the IC Logic Families

states. This slows on-off response since they require a finite length of time to come out of saturation. The 74S series avoids this problem by integrating a Schottky clamping diode across each transistor base-collector junction. These diodes prevent saturation, thus avoiding excessive delay. The results are speeds of nearly 100 MHz and delays of only 3 ns and a 2/1 increase in power over the standard 7400. A further option is also available: low power Schottky TTL, which offers a good combination of speed and low power.

It is difficult to sum up the possible uses of TTL, since the devices have such a wide range of versatility and performance capability. TTL is limited, however, to a relatively fixed power supply (5 V) making it best suited for stationary systems operating up to 100 MHz.

CMOS Family. Although it is the latest arrival on the IC logic scene, CMOS (complementary metal oxide semiconductor) is right now making more noise than any of its brethren. This is because it has some highly attractive distinguishing characteristics. The outstanding feature of CMOS is its very low power requirement, coupled with the ability to operate over a very wide range of supply voltages, with but little effect on performance. This permits its use with battery

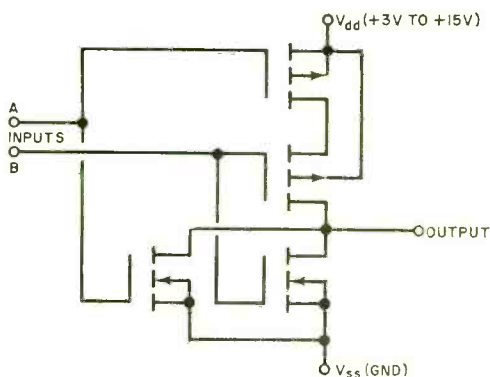

Fig. 2. Basic 4000A CMOS gate circuit.

power and systems where the supply voltage varies over a wide range. Special selections of CMOS devices can even be operated at as low as 1.3 V, making all-electronic watches a reality today.

As far as circuit goes, the CMOS is simplicity itself, as can be seen from the NOR gate schematic in Fig. 2. Note that there are no resistors—only transistors. The NOR

function is performed by the parallel-connected n-channel devices (bottom). These are inverters so that if either input is high, the output is low. Conversely, to obtain a high output, both inputs must be low to turn on the series-connected p-channel devices (top). Hence, only 4 transistors perform the NOR logic function.

The characteristics of CMOS are nearly ideal for a digital logic element. The only drawback is the relatively low speed capability, but even 10 MHz is fast enough for most experiments.

Although CMOS is not yet as mature a logic family as TTL, many MSI functions are already available. High-density functions, such as MSI and LSI, are the real forte of CMOS. It can be expected that CMOS will fill a very large percentage of future LSI requirements—particularly where low power operation is a must; and, in fact, CMOS may gradually nudge out TTL as the standard.

ECL Family. The epitome of high speed logic is ECL (emitter coupled logic). Although ECL has been with us for a number of years, it has recently begun to take on importance with the emergence of a standard: Motorola's MC10,000 series.

ECL is a nonsaturated logic family (as opposed to standard TTL, which is saturated) so that it is inherently capable of high speed and low delay. ECL is based on the differential amplifier (Fig. 3) which works as follows. Fixed bias is applied to the right side of the differential pair, $Q1$ and $Q2$. This bias establishes the input voltage threshold at $Q1$. Emitter current for the pair is fixed by R_{E1} . If inputs A through D are low, this current flows through $Q2$, pulling its collector and the OR output down. If any of the four inputs is high, the current flows through $Q1A$ (or $Q1B, C, \text{ or } D$) pulling down the $Q1$ side and making the NOR output low. External resistors, R_o , serve to reduce the outputs for logic zero output signals. ECL uses a 5.2-volt power supply with a positive ground.

ECL performs an OR function for high inputs since a one at any of the four inputs creates a one at the OR output. A side benefit of the emitter coupled operation is that the complementary NOR output is available. The 10,000 series has two subsets which differ slightly in speed.

This form of logic finds applications in very high speed computers (above 100



“If music be the food of love, play on.”

TWELFTH NIGHT, Act I, Scene i, Line 1

In past articles we have discussed the research and the technology behind the Bose Direct/Reflecting® speakers. It would indeed be misleading for us to imply that the unprecedented series of rave reviews and the worldwide acceptance of these speakers is the result of only the research and technology that gave birth to their new design! While these factors are absolutely necessary, they are far from sufficient to provide the performance for which these speakers are famous.

The more accurate the performance of any instrument or loudspeaker, the more apparent are small imperfections. Variation in the responses of individual speaker drivers, that might be masked by performance limitations inherent in the basic design of conventional speakers, can become annoyingly apparent with the accuracy of music reproduction associated with Direct/Reflecting speakers. The realization of this fact has led us to develop *quality control* measures that we think have no close second anywhere in our industry.

Here are some of the items we check:

1. Acoustical properties of the cone material
2. Annulus material and doping
3. Thickness and bond of the critical glue joints where the cone joins the voice coil bobbin. Errors in either direction can cause audible coloration
4. Density of voice coil winding
5. Flux density in the magnetic circuit
6. Sixteen mechanical parameters are checked ranging from the length of the flexible voice coil leads to the centering tolerance of the voice coil
7. Power tests to check for possible thermal problems
8. Accelerated humidity tests
9. Power sweeps after complete assembly in cabinet to check for any extraneous noises
10. Extensive computer checking of all parameters in the 901 active equalizer

Some of the items in this list cannot be directly tested after the speaker is assembled. For example, we can't see the glue joints or the voice coil. These tests and many others are made by our newly developed Syncom™ speaker testing computer. In addition, this computer selects matched drivers for each 901; and it matches the woofers and tweeters in each 501. One of the significant achievements of this computer is that its measurements are directly related to audible effects rather than to typical specifications whose correlation to audible performance has not been established. When the Syncom computer rejects a speaker, it means that a critical listener could hear the difference between that particular speaker and our standard of quality – more on this in a later issue.

When you couple this unique *quality control* system with all the technology behind the Direct/Reflecting speaker systems, you can appreciate our confidence in asking you to A-B the 901 with any speaker regardless of size or price. And while you're at it, audition the 501 against direct radiating speakers costing several times as much.

*Photograph of Shakespeare First Folio
courtesy of Harvard College Library*

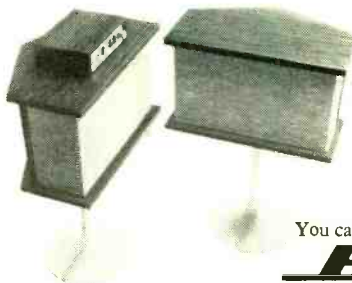

¹For copies of the reviews, circle our number(s) on your reader service card.
²Copies of the Audio Engineering Society paper, ON THE DESIGN, MEASUREMENT AND EVALUATION OF LOUSPEAKERS, by Dr. A. G. Bose, are available from the Bose Corporation for fifty cents.

You can hear the difference now.

BOSE
Framingham, Massachusetts 01701

CIRCLE NO. 4 ON READER SERVICE CARD

A Government FCC License can help you qualify for an exciting, rewarding career in ELECTRONICS, the Science of the Seventies. Read how you can prepare for the license exam at home in your spare time — with a passing grade assured or your money back.

IF YOU'RE OUT TO BAG A BETTER JOB in Electronics, you'd better have a Government FCC License. It will help you track down the choicest, best-paying jobs in the growing field of Electronics.

Demand for people with technical skills is growing twice as fast as any other group, while jobs for the untrained are rapidly disappearing. Right now there are thousands of new openings every year for electronics specialists. And you don't need a college education to qualify!

But you *do* need knowledge, knowledge of electronics fundamentals. And there is only one nationally accepted method of measuring this knowledge . . . the licensing program of the FCC (Federal Communications Commission).

Why a license is important

An FCC License is a legal requirement if you want to become a Broadcast Engineer, or get into servicing any other kind of transmitting equipment — two-way mobile radios, microwave relay links, radar, etc. And even when it's not legally required, a license proves to the world that you understand the principles involved in *any* electronic device. Thus, an FCC "ticket" can open the doors to thousands of exciting, high-paying jobs in communications, radio and TV broadcasting, the aerospace program, industrial automation, and many other areas.

So why doesn't everyone who wants a good job in Electronics get an FCC License?

It's not that simple. You must pass a Government licensing exam. A good way to prepare for your FCC exam is to take a licensing course from Cleveland Institute of Electronics.

Our training is so effective that, in a recent survey of 787 CIE graduates, better than 9 out of 10 CIE grads passed the Government FCC License exam. That's why we can offer this famous Money-Back Warranty: when you complete any CIE licensing course, you'll be able to pass your FCC exam or be entitled to a full refund of all tuition paid. This warranty is valid during the completion time allowed for your course. You get your FCC License — or your money back!

And with CIE, you learn at home in your spare time. With AUTO-PROGRAMMED® Lessons, you'll pick up the facts, figures and electronics theories you

CIE HAS CAREER COURSES TO FIT YOUR BACKGROUND

ELECTRONICS TECHNOLOGY with LABORATORY . . . teaches you the fundamentals. With a 161-piece laboratory you apply the principles you learn by analyzing and trouble-shooting electronics equipment.

ELECTRONICS ENGINEERING . . . A college-level course for men already working in Electronics. Covers steady-state and transient network theory, solid-state physics and circuitry, pulse techniques, computer logic and mathematics through calculus.

may have considered "complicated" . . . even if you've had trouble studying in the past.

CIE Grads get licenses . . . better jobs

The value of CIE training has been demonstrated time and again by the achievements of our thousands of successful students and graduates.

An outstanding example is Ed Dulaney of Scotts-bluff, Nebraska. He passed his 1st Class FCC License exam soon after completing his CIE course. Today, he owns two companies . . . one to manufacture and distribute two-way radio equipment, the other to maintain and repair such equipment along with home radio, TV and stereo sets. He says: "In the last three years we sold more than \$1,500,000 worth of equipment through dealers in every state plus Canada, South America and Europe."

Richard Kihn, Anahuac, Texas, worked in the engine room of a tugboat when he started his CIE training. He reports, "Before finishing, I got my FCC License and landed a job as broadcast engineer at KFDM-TV in Beaumont, Texas. I was able to work, complete my CIE course and get two raises . . . all in the first year of my new career in broadcasting."

Send for FREE books

If you'd like a chance to succeed like these men, send for our FREE book, "How To Get A Commercial FCC License." It tells you all about the FCC License . . . requirements for getting one . . . types of licenses available . . . how the exams are organized and what kind of questions are asked . . . where and when the exams are held, and more.

With it, you will also receive a second FREE book, "Succeed in Electronics." For your convenience, we will try to have a representative call. Send for both books today.

APPROVED UNDER G. I. BILL

All CIE career courses are approved for educational benefits under the G.I. Bill. If you are a Veteran or in service now, check box for G.I. Bill information.

CIE Cleveland Institute of Electronics, Inc.

1776 East 17th Street, Cleveland, Ohio 44114
Accredited Member National Home Study Council

Cleveland Institute of Electronics, Inc.

1776 East 17th Street, Cleveland, Ohio 44114

Please send me your two FREE books:

1. Your book on "How To Get A Commercial FCC License."
2. Your school catalog, "Succeed in Electronics."

I am especially interested in:

- | | |
|---|--|
| <input type="checkbox"/> Electronics Technology | <input type="checkbox"/> Electronic Communications |
| <input type="checkbox"/> Broadcast Engineering | <input type="checkbox"/> Industrial Electronics |
| <input type="checkbox"/> First Class FCC License | <input type="checkbox"/> Electronics Engineering |
| <input type="checkbox"/> Electronics Technology with Laboratory | |

Name _____ (PLEASE PRINT)

Address _____

City _____

State _____ Zip _____ Age _____

Veterans and Servicemen:

Check here for G.I. Bill information.

PE-47

CIRCLE NO. 5 ON READER SERVICE CARD



Product Test Reports

HEATH MODEL AD-1530 STEREO CASSETTE DECK (A Hirsch-Houck Labs Report)

THE Dolby-equipped Model AD-1530 cassette deck continues Heath's expansion of their line of sophisticated hi-fi components. This is the company's most advanced model, meeting the highest current quality standards for cassette decks. Available only in kit form, the AD-1530 lists for \$250.

The deck employs the well-known Wollensak transport mechanism used in some of the finest cassette machines. This somewhat unconventional American-made transport is operated by controls that are distinctly shaped and grouped according to function, making it nearly impossible to mistake one control for another, even in the dark.

Kit Features. Although the electronic portions of the AD-1530 deck are in kit form, the mechanical transport is supplied completely assembled. A large master circuit board that occupies most of the deck's interior volume contains the power supply and bias oscillator circuits, a number of calibration controls, and switches for the built-in test oscillator and metering circuits. Four smaller boards that plug into the main board contain the amplifiers and Dolby noise reduction circuits for the individual channels.

In addition to the usual recording level bias adjustments that must be made, the Dolby system requires precise gain and operating-level settings to yield proper operation of the system. As with other kits by Heath, the AD-1530 has built into it the necessary facilities for testing and calibration, obviating the need for external test instruments.

A built-in phase-shift oscillator supplies either a 5000-Hz signal for calibrating the meters and setting various circuit gains or a 400-Hz signal for finalizing the Dolby level adjustments. The right-channel meter can be switched into a stable feedback amplifier

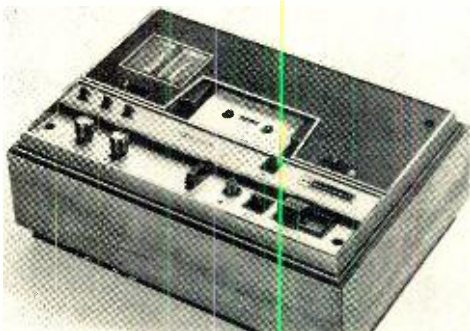

circuit to form an accurately calibrated ac voltmeter. (This meter is also used as a dc voltmeter during the initial power supply adjustments.) The comprehensive manual supplied with the kit includes a complete adjustment and check-out procedure, giving the correct meter indications for each step.

After initial calibration has been performed, a special test cassette supplied with the kit is used to provide a standard-level Dolby calibration signal. The PLAY CAL controls on each amplifier board are adjusted for a 0-dB meter indication to complete internal calibration.

A blank cassette, also supplied, is used for calibrating the recording levels with the aid of the internal 400-Hz test signal. Adjustments are made until the playback levels are 0 dB, at which point the recorder is ready to use with regular tape.

Optimum performance with chromium-dioxide tape is obtained by changing three operating parameters when the TAPE selector switch is set to CrO₂. The bias is increased, the recording level is increased, and playback equalization is altered to improve the signal-to-noise ratio. It is necessary to set the Dolby recording levels for CrO₂ tape (not supplied), again using the 400-Hz test

signal. The four REC CAL (for both channels and both kinds of tape) are accessible through holes in the rear of the transport's base and are normally covered by plastic buttons.

Laboratory Tests. The AD-1530 tape deck easily surpassed all of its published specifications. However, the playback response (not specifically defined by Heath) had a rising low-frequency characteristic that attained a maximum of +7.9 dB at 40 Hz. From 100 to 10,000 Hz, using a Nortronics AT200 test cassette, it was within ± 1.5 dB.

The overall record/playback response, using the tape supplied with the kit, was within ± 1.5 dB from 100 Hz to 16,000 Hz. At low frequencies, beginning at about 300 Hz, the response curve exhibited cyclic variations caused by the design of the record/playback head. This is a common effect in cassette recorders that use a single head for both recording and playing back. The average low-frequency response fell off smoothly to -8 dB at 30 Hz.

The frequency response with other "standard" tapes should be quite similar to the curve we obtained. Memorex tape, for example, gave almost identical results. The Dolby circuits, at a -30-dB level, had only a minor effect on the frequency response above 8000 Hz. The response never deviated by more than 2 dB from the curve obtained without the Dolby system switched in.

With TDK KR (CrO₂) tape, the response above 11,000 Hz was slightly improved, with an overall variation of ± 2.5 dB from 70 Hz to 17,000 Hz. It fell off to -8 dB at 30 Hz.

For a 0-dB recording level, an input of

38 mV on AUX and 0.23 mV on MIC was required. The fixed playback level was 0.58 V, while the reference distortion level of 3 percent was reached with a +1-dB recorded signal on regular tape and +2 dB on CrO₂ tape. The S/N ratio, unweighted except for the attenuation of frequencies below 250 Hz, was 52.2 dB with regular and 56.5 dB with CrO₂ tape, referred to 3 percent THD. With the Dolby system on, the corresponding figures were 56.5 and 60.0 dB. When the MIC inputs were used, at maximum gain the S/N figures were reduced by 3 dB.

Wow and flutter, unweighted, were 0.03 and 0.17 percent, respectively, typical of today's high-quality cassette transports. Using a timing signal supplied on the test tape, we found that the operating speed was slow by about 0.5 sec/min of playing time. This is an acceptable speed error for cassette recorders. In the fast speed modes, a C-60 cartridge went from end to end in 44 seconds.

User Comments. The Heath AD-1530 deck represents an impressive achievement primarily because of its complete self-testing and alignment facilities. Although an external VTVM adjustment procedure is given, the precision resistors and feedback stabilization in the deck's metering system probably make it more accurate than any but a laboratory-grade voltmeter. In any event, our kit-built unit performed so well after "no-instrument" setup that no improvement would have been possible with external meters.

Assembly time for the kit was about 12½ hours, plus 2 hours for set-up. The manual explains in detail the function of each stage,

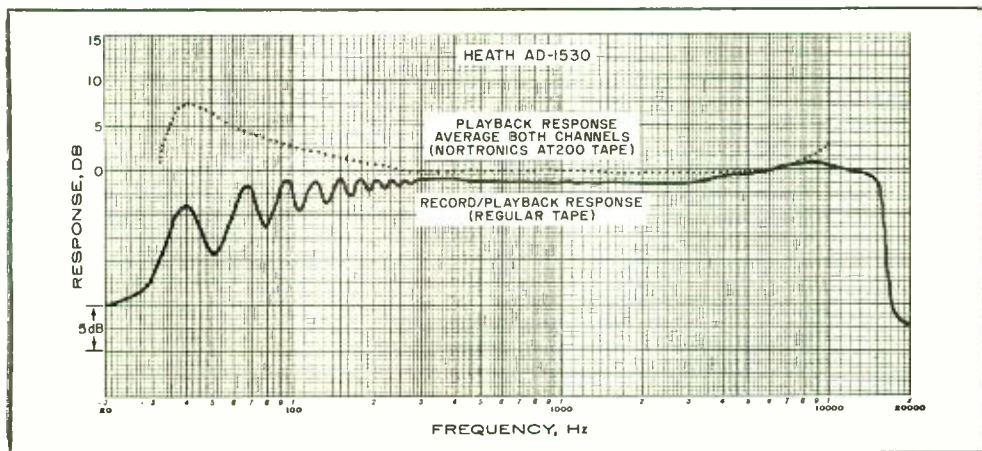

It includes the first complete explanation we have seen of the operation of Dolby circuits, not just the basic principles of the Dolby system.

A legitimate question can be raised on the economics of assembling a \$250 kit recorder when other manufactured machines are available for not many more dollars. On a

strict dollars-and-cents basis, it might be difficult to justify, but the knowledge the builder gains of the mechanical and electronic operation, plus the ability to periodically optimize performance, add up to a good investment. Add to this the fact that the AD-1530 is the equal in performance of any cassette deck we have used.

Circle No. 65 on Reader Service Card

MARANTZ MODEL 2440 QUADRADIAL 4 ADAPTOR-AMPLIFIER (A Hirsch-Houck Labs Report)



THE Marantz Model 2440 Quadradial amplifier is designed to provide up-to-date program formats in mono, stereo, and 4-channel sound. Built into the amplifier are a matrix decoder and facilities for plugging in an SQ decoder module. With the 2440 connected to a good stereo amplifier or receiver and the addition of an extra pair of speaker systems, the Quadradial transforms a 2-channel system into a high-quality 4-channel system for \$300.

A "Vari-Matrix" circuit built into the 2440 is used to create synthetic rear-channel signals from 2-channel programs and to decode (at least approximately) many currently available quadrasonic records. Like most synthesizers, the Vari-Matrix drives the rear speakers with an L - R difference signal to add a sense of ambience to stereo programs. In addition, the phase of the rear channels is shifted, relative to the front channels, in a manner that varies with frequency. A DIMENSION control is provided for adjusting the degree to which L + R front-center or mono signals are suppressed in the rear speakers.

The five-position MODE switch offers operational modes for MONO to all four channels; STEREO to the front and rear channels; DISCRETE 4-channel; VARI-MATRIX synthesized 4-channel or enhanced stereo; and SQ matrixed 4-channel sound. A socket is provided inside the 2440 for the user to plug in Marantz's optional Model SQA-1 decoder module. This module accurately decodes

SQ-encoded records. If Marantz chooses in the future to make available other decoders for the QS matrix or possibly the CD-4 discrete disc, the modules would presumably plug into the SQ socket.

A REMOTE CONTROL switch allows the user to operate the 2440 via its front-panel controls when in the OUT position. Set to the IN position, the REMOTE switch allows 4-channel balance and overall volume adjustments to be made from any point in the listening room via the optional Model RC-4 remote control accessory that plugs into a socket on the rear apron.

Three other knobs on the front panel are used to control rear-channel bass and treble response and volume for all four channels. Slide-type controls are used to adjust separately the left-to-right balance in the front and the rear channels and the overall front-to-rear balance.

Once the 2440 is connected into a sound system, the main amplifier's tape monitoring inputs and outputs are no longer available. So, to regain the monitoring facilities, the 2440 has appropriate jacks on its rear apron, switchable in and out of the circuit by a front-panel pushbutton switch. Another pushbutton, labeled AUX, is used to select a second high-level source. Two more

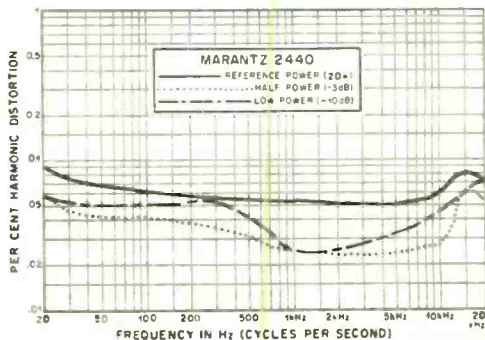

pushbutton switches activate the two pairs of speaker output terminals.

When the Model 2440 is turned on, four illuminated meters monitor the outputs of the four channels. Either a 2 or a 4 to the left of the meters lights up, depending on the position in which the MODE switch is set.

On the rear apron are all input and output jacks, a level switch for high- and low-level input signals, and two ac outlets (one of which is switched). The speaker connectors are insulated spring-loaded push types.

The rated output of the 2440's amplifier section is 20 watts/channel into 4 or 8 ohms with both channels driven over a frequency range of 20 to 20,000 Hz at less than 0.3 percent harmonic and IM distortion. The front-channel output (which returns to the front-channel tape inputs) is a maximum of 1 volt at 1 percent distortion. At a nominal 150-mV operating level, its distortion is less than 0.1 percent.

The Quadradial 4 measures 17 $\frac{3}{4}$ " \times 14 $\frac{3}{4}$ " \times 5 $\frac{3}{4}$ " and weighs slightly more than 24 pounds. In appearance, it matches other Marantz components with its walnut wrap-around cabinet, brushed gold panel, and large-size control knobs.

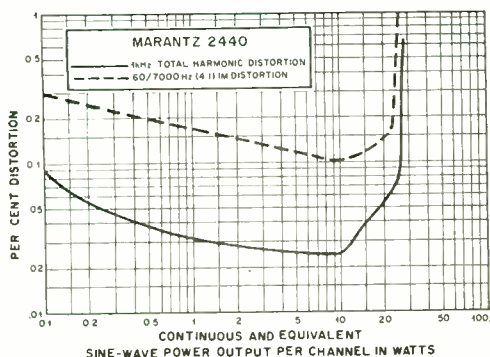

Laboratory Measurements. The outputs of the Model 2440 amplifier clipped at 25.6 watts/channel into 8-ohm loads, 27 watts into 4-ohm loads, and 15.6 watts into 16-ohm loads, at 1000 Hz with both channels driven. At these levels, the front-channel return signal was 178 mV with about 0.05 percent distortion. At the rated front-channel maximum output of 1 volt, distortion was 0.6 percent.

The amplifiers were of a quality we have come to expect from Marantz, with the 1000-Hz distortion typically about 0.03 percent and less than 0.1 percent from 0.1 watt

CONTROLLED
QUALITY
CRYSTALS by



The "On-Channel" Crystals

FOR
CITIZEN BAND
23 Channels and "Mars"
HAM OPERATORS
Commercial 2-Way

Marine-Monitor
See your Distributor for Speedy
"Zip Certificates"



formerly Texas Crystals
Div. of Whitehall Electronics Corp.
1000 Crystal Drive 4117 W. Jefferson Blvd
Fort Myers, Florida 33901 Los Angeles, California 90016

CIRCLE NO. 8 ON READER SERVICE CARD

TV TUNER SERVICE

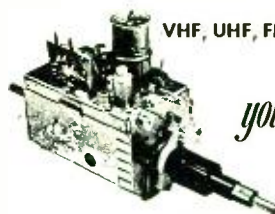

VHF, UHF, FM or IF-Subchassis...
... All Makes

you get...

Fast 8 hr. Service!

You owe it to yourself

to try P.T.S. We are the fastest growing, oldest and now the largest tuner service company in the world. Here is what you get:

1. Fastest Service—8 hr.—in and out the same day. Overnight transit to one of our six plants, for parts, tuners or IF modules.
2. All tuners cleaned inside and out, repaired, retuned and air tested.
3. On IF-modules all stages checked, all traps set with high capacity test equipment.
4. Fine Quality! Your customers are satisfied and you are not bothered with returned your units for repairs!
5. Lower Cost! Up to \$3.50 less than other tuner companies!
6. Friendly, helpful personalized service!

**NEW SERVICE CENTER
PHILADELPHIA, PA.**
P.O. BOX 16855
Phila. Pa. 19142

LINE TO DO IT YOURSELF!

PTS makes all tuner parts available to you.
Send one dollar (refundable) for our TUNER RE-PLACEMENT GUIDE AND PARTS CATALOG.

60 pages of top information • Blow-up of all tuners • Largest exact tuner replacement guide • Antenna Coil Replacement Guide • Multi-Kit Replacement Tuner Sheet Guide

We offer you finer, faster...

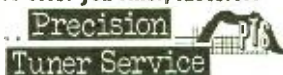

VHF-UHF-FM \$ 9.95
UV-COMBO \$16.95
IF-MODULE \$12.50

Major Parts charged at Net Price
CUSTOMIZED REPLACEMENTS AVAILABLE
FOR 417-95 GP (INVA OR RFRSULT)

For fastest service, send clearly cut with faces, shields and all broken parts to:

PTS ELECTRONICS, INC.

HOME OFFICE— P.O. Box 272—Bloomington, Ind. 47401
SOUTHWEST— P.O. Box 8771—Jacksonville, Fla. 32205
WEST COAST— P.O. Box 41354—Sacramento, Calif. 95841
EAST— P.O. Box 2138—Springfield, Mass. 01103
SOUTHWEST— P.O. Box 7322—Longview, Tex. 75601
MOUNTAIN— P.O. Box 4145—Denver, Colo. 80206

Tel. 812/854-8331
Tel. 904/329-9952
Tel. 916/482-8270
Tel. 417/324-2137
Tel. 214/753-4334
Tel. 303/244-2818

CIRCLE NO. 23 ON READER SERVICE CARD

to more than 25 watts/channel. The IM distortion was less than 0.3 percent over the same power range, typically between 0.1 and 0.2 percent. At the rated 20-watt/channel output, harmonic distortion was about 0.5 percent at most frequencies and did not exceed 0.09 percent from 20 Hz to 20,000 Hz. At reduced power, the distortion was even lower, averaging between 0.02 and 0.05 percent. The front panel output meters indicated 0 dB with about 8.5 watts output into 8-ohm loads

Input sensitivity was 97 mV (low) and 55 mV (high) for 10 watts output with an

83-dB signal-to-noise ratio. The inputs could not be overloaded by levels as high as 10 volts. At a maximum volume control setting, the front-channel input/output gain was unity. The bass tone control varied the turnover frequency from less than 100 Hz to about 500 Hz, while the treble control operated above 2000 Hz.

Our test unit did not contain the optional SQ decoder, but we found the Vari-Matrix to be effective with most quadrasonic records, regardless of the recording matrix used. It also did a fine job of synthesizing the rear channels from 2-channel material.

Circle No. 66 on Reader Service Card

LAFAYETTE RADIO TELSAT SSB-50 CB TRANSCEIVER

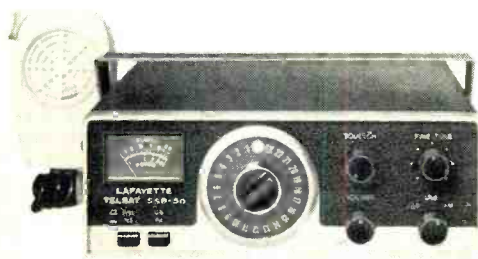

SINGLE sideband is the most modern and efficient method of voice communication by radio. Consequently, CB transceivers with ssb facilities are appearing in increasing numbers. Among the newest such rigs is the Lafayette Radio Electronics Telsat Model SSB-50 AM/ssb transceiver. This rig provides the CB'er with 23 crystal-synthesized frequencies that yield a total of 69 possible channels of operation (23 each on AM, upper-sideband, and lower-sideband modes).

Designed primarily as a mobile rig, the SSB-50 can also double as a full-facility base station when used with Lafayette's optional Model PS-50 ac power supply. When used in mobile service, it will operate from any 11.5-14.5-volt dc negative- or positive-ground electrical system.

For its selling price of \$290, the buyer gets a lot from his SSB-50. The list of features leads off with "range boost," automatic modulation control, and adjustable squelch for both AM and ssb. These are backed up with a full-time anl, switchable noise silencer, fine tuning, PA facilities, receiver recorder output, a-f input for tape or record playback through the receiver, and a theft alarm system. A built-in meter indicates re-

ceiver S units and *actual* transmitter output power. The rig operates at 5 watts input on AM and 10 watts p.e.p. on ssb.

Technical Data. The receiver has a common "front end" for both AM and ssb operation. The 11,275-kHz i-f output is obtained by mixing the CB signals with a crystal frequency synthesizer. For AM, a second conversion is made to 455 kHz by combining the 11,275-kHz i-f with an 11,730-kHz crystal frequency at a balanced-diode second mixer. Selectivity is obtained with a mechanical filter that precedes two i-f stages. The detector and agc are conventional, as is the a-f section.

Single conversion is used for ssb, directly to an 11,275-kHz crystal-lattice filter whereby sideband selection is obtained. The proper bfo signal for the desired sideband is obtained from individual 11,275-kHz or 11,272-kHz crystal oscillators.

Squelch is triggered by separate AM and ssb agc systems. The ssb agc is amplified, eliminating the need for an r-f gain control to minimize strong-signal overload.

A conventional full-time anl is set up for AM. A noise silencer (blanker) can be switched in for AM and ssb. This is handled by a high-gain IC pulse amplifier and transistor pulse-shaping and amplifying chain that gates the diodes at the AM second mixer or a diode switch at the input to the 11,275-kHz ssb filter. This action momentarily cuts off the signal paths during each impulse-noise peak.

On transmit, the AM signal is generated in the usual manner, with the synthesizer output applied to the driver and, hence, to the power amplifier where a dual-pi output cir-

cuit provides antenna matching and harmonic reduction. An adjustable TVI trap is included. Modulating power is obtained from the a-f section of the receiver, as usual. The "range boost" is a compression system that feeds back a rectified sample of the modulating voltage to the microphone amplifier, thus providing age.

For transmitting ssb, the receiver product detector is used as a balanced modulator to which the speech-input signal is applied. It is followed by the same crystal filter and first i-f stage used for receiving ssb. This 11,275-kHz signal is mixed with the synthesizer signals for an on-channel signal that goes to the driver and output amplifier.

An automatic-modulation system (usually referred to as alc) controls the gain of the i-f stage for maintaining high modulating levels without power amplifier overload in much the same way as does the range boost in AM.

The theft alarm consists of an internal switch that has leads for connecting to a car's horn. When one of the thumbwheel fastening screws at the mounting bracket is removed, the switch closes and automatically causes the horn to sound.

Test Results. Receiver sensitivity was found to be 0.5 μV on AM and 0.16 μV on ssb for 10 dB (S+N)/N. Selectivity allowed excellent voice intelligibility while maintaining an adjacent-channel rejection of 60 dB. Unwanted-sideband suppression on ssb was 60 dB at 1000 Hz. Image rejection was more than 80 dB. The exceptionally smooth squeelch had a threshold sensitivity that could be set for signals as low as 0.2 μV on AM and 0.16 μV on ssb. The age was quite flat with an a-f output change of 4-5 dB with an input signal change of 80 dB (1-10,000 μV).

In either mode, 100 μV of signal was required to produce an S-9 meter reading. However, some difference in linearity of the age and metering circuits for each mode during lower signal levels was evidenced by an S-5 reading on AM and S-1 on ssb with at 1- μV signal.

The normal anl is quite effective with AM signals; but where extra suppression is needed for different type noises, the noise silencer comes in handy. The normal anl does not function on ssb; in which case, use of the silencer is a must for mobile service, where it does a terrific job, attenuating impulse noise by at least 25 dB.

SAVE MONEY!

A Delta Mark Ten Capacitive Discharge Ignition (CDI) System On Your Car Slashes Maintenance Costs And Increases Performance.

Put a Mark Ten on your car and save by eliminating 3 out of 4 tune-ups. Save as gasoline mileage increases (up to 20%). The Mark Ten CDI system also extends spark plug life, promotes more complete combustion and assures instant starts in all weather. It operates on any 6 or 12 volt negative or positive ground system.

The Mark Ten B affords additional money saving advantages by drastically reducing combustion contaminants and restoring power lost by the use of smog control devices. Equipped with handy switch for instant return to standard ignition, the Mark Ten B works with ANY 12 volt negative ground engine. Both systems install in ten minutes without rewiring.

Order your Mark Ten or Mark Ten B today. Save money while you enjoy low maintenance and increased performance.

Mark Ten (Assembled) \$44.95 ppd.

Mark Ten (Deltakit) \$29.95 ppd.
(Kits available in 12 volt only,
positive or negative ground)

Mark Ten B \$59.95 ppd.
(12 volt negative ground only)

Superior Products at Sensible Prices
Mfg. in U.S.A.



Dept. PE
DELTA PRODUCTS, INC.
P.O. BOX 1147 • GRAND JUNCTION, COLORADO 81501
PHONE (303) 242-9000

Please send me literature immediately:
Enclosed is \$ _____
 Ship ppd. Ship C.O.D.

Please send: _____ Mark Ten B @ \$59.95 ppd.
 ___ Standard Mark Ten (Assembled) @ \$44.95 ppd.
 ___ 6 Volt: Neg. Ground Only ___ Positive Ground
 ___ 12 Volt: Specify _____ Negative Ground
 ___ Standard Mark Ten (Deltakit™) @ \$29.95 ppd.
 (12 Volt Positive Or Negative Ground Only)

Car Year _____ Make _____
 Name _____
 Address _____
 City/State _____ Zip _____

CIRCLE NO. 10 ON READER SERVICE CARD

Using a 13.8-volt dc source, we measured 4 watts of transmitter carrier output on AM with up to 100 percent modulation, while the range boost held a high level or relatively good waveform without high distortion otherwise experienced with clipping systems. On ssb, the p.e.p. output was 6.5 watts with third- and fifth-order distortion products down 19 dB and 35 dB at the ale

threshold. At an 80° F ambient temperature, the frequency accuracy was ± 120 Hz or less.

Fine tune provided a frequency variation of ± 2000 Hz on receive only. It does not alter the transmitter frequency as is the case with most other ssb CB gear. Power drain was 230 mA on receive, 1-1.3 A on AM transmit, and 0.5-1.1 A on ssb transmit.

Circle No. 67 on Reader Service Card

ELECTROSONICS INTERNATIONAL EM-S MONITOR RECEIVER (A Hirsch-Houck Labs Report)



USERS of the mobile radio services must often monitor a number of channels at the same time. This, plus the fact that much narrow-band FM mobile communication is conducted on the 25-50-MHz and 152-174-MHz low and high bands, has caused manufacturers to develop and market multi-channel receivers. Some of these receivers permit monitoring several channels in either band, while others offer monitoring facilities for several channels in both bands, though the latter require separate low- and high-band "front ends." Crystal-controlled local oscillators are used, with separate crystals switched into the circuit for each channel.

Automatic scanning has become popular in several models of multi-channel monitor receivers. In such setups, the receiver is electronically tuned in sequence through a number of channels, stopping the scan whenever a signal is detected and moving on when the message is completed. Automatic scanning works well—up to a point. During the scanning and "listen" sequences, important messages on other channels can go by unheard.

A different approach has been taken by Electrosonics International, Inc., in their "Simo" receivers. Instead of scanning, these receivers monitor several channels continuously and simultaneously through separate front ends whose outputs drive a common i-f amplifier, discriminator, and audio amplifier system. In addition to simpler circuitry, this approach allows one channel to

"break in" on another during a transmission, a feature not possible with scanners.

The Electrosonics International Model EM-S Simo monitor receiver is designed to keep tabs on two frequencies simultaneously. One signal can be in the low band and the other in the high band, or both signals can be in the same band as long as their frequency difference does not exceed 1 percent. (The high selectivity of the front end makes this necessary.) Separate antenna connectors are provided for the two bands.

The EM-S monitor contains a built-in power supply for operation from household ac power sources and a connector that allows operation from a 12-volt mobile source. An optional nickel-cadmium battery pack that charges from the power line when the receiver is line-operated is also available. Power consumption is 2.5 watts on ac and 0.8 watt on dc.

Behind the front panel of the EM-S is a small speaker. Also on the panel is a red pilot lamp that operates only when ac power is supplied, a volume control/power switch, and three pushbutton channel selectors. Along the lower edge of the front panel is a thumbwheel-type squelch threshold control. Wire and whip antennas are supplied for the channel frequencies in use.

Laboratory Tests. Our test receiver came equipped with crystals for approximately 46 MHz in the low band and 159 MHz in the high band. The 20-dB quieting sensitivity tested out at $0.9 \mu\text{V}$ on 46 MHz and $0.8 \mu\text{V}$ on 159 MHz. The latter was reduced slightly to $1.25 \mu\text{V}$ in the Simo operating mode.

With a 5-kHz deviation at 400 Hz, a 20-dB (S + N)/N ratio was obtained at $0.75 \mu\text{V}$ on 46 MHz and $0.5 \mu\text{V}$ on 159 MHz. Again, simultaneous operation reduced the high-band sensitivity, this time to $0.8 \mu\text{V}$.

Performance on the low band was independent of the mode used.

The squeelch could be adjusted to open up completely with inputs of $5 \mu\text{V}$ or less. Its action was gradual rather than a sudden transition from silence to full signal output. A low audio output remained, even with the volume control set to minimum. The maximum audio output at the external speaker jack (on the rear apron) was 2.3 volts. Assuming that the same voltage was applied to the internal speaker which is always in op-

eration, this corresponds to an output of 1.35 watts into 4 ohms and 0.67 watt into 8 ohms.

The selectivity met or surpassed the published specification. At -6 dB , it was $\pm 15 \text{ kHz}$, and at -60 dB , it was $\pm 30 \text{ kHz}$. The latter indicates good skirt selectivity.

Electrosonics makes a number of monitor receivers, for various groupings of channels, both with and without the Simo feature. The EM-S Simo, priced at \$150, is approximately midway in their product line.

Circle No. 68 on Reader Service Card

JUD WILLIAMS MODEL A TRANSISTOR CURVE TRACER



TESTING transistors can be quite a chore, especially when the transistors to be tested run into the dozens and are crowded like cord wood on a small PC board assembly. Of course, there are a number of excellent in-circuit transistor testers that can be used, but we have always felt that a good dynamic curve tracer gives more satisfactory results. Most in-circuit testers are limited in the number of tests they can perform, leaving the user with the feeling that he has not been told the whole story. In the hands of a person who knows what he is doing and how to interpret CRT waveforms, on the other hand, the curve tracer removes such doubts.

Lately, we have been using the "signature" approach to testing and servicing solid-state equipment. With this method, the curve tracer is connected to a transistor on a PC board and all associated resistors, capacitors, inductors, etc., are left hooked up; the power to the circuit under test is turned off. The resulting family of curves not only includes the semiconductor but the effects the various components have on it under actual circuit conditions. The curves are recorded, along with a listing of the various control settings of the test equipment. The next time a similar circuit comes under inspection, all

that has to be done is to compare the known good signature pattern with the circuit under test. If there is a difference, it will be obvious.

The latest transistor curve tracer—actually, it is an adaptor designed to be used in conjunction with an oscilloscope—we have been using is the Model A made by Jud Williams and selling for \$135. It displays on the CRT screen six curves that can be swept from 0 to 80 volts peak. The applied base current can be varied between $1 \mu\text{A}$ and 5 mA. Five steps of gate voltage ranging from 0.2 volt to 10 volts are available for testing FET's.

A pair of test sockets is provided for comparing and matching two transistors at a time. In addition to the sockets, a three-tipped probe on the end of a cable that connects to a control-panel jack is provided for performing in-circuit tests.

Besides testing conventional bipolar transistors, the Model A can also be used to check junction and insulated-gate FET's (JFET's and IGFET's or MOSFET's) in either the depletion or enhancement modes; rectifier, signal, zener, and tunnel diodes; some types of IC's; and several other types of semiconductors.

The family of transistor characteristics that can be checked includes gain, saturation voltage, polarity, linearity, dynamic collector impedance, leakage, breakdown voltage, and type identification.

We have been using the Model A curve tracer for several weeks now with different types of scopes and on all different types of transistors. It lives up to every one of its published specifications. The tracer is especially handy in finding low-cost replacement transistors for strangely marked imported units.

Circle No. 69 on Reader Service Card



An Electronic Counter For the Technician

By John T. Frye, W9EGV, KHD4167

"IT'S Regency's new six-digit Model EC-175 electronic counter." Mac was explaining to Barney as he affectionately patted a device about the size of a solid-state mobile CB transceiver that was resting on the bench on its combination tilt stand and carrying handle.

"Did you buy it?"

"Not yet. When I was at Center City last Friday, a dealer-friend suggested I bring it home for a few days and see what technician uses I can find for it inasmuch as it is specifically designed for service work. He says he plans to use any information I collect in his sales pitch to technicians, but I'm suspicious that he believes I'll not be able to part with it after I learn what it will do. When you get used to working with something, you don't want to give it up so quickly."

"What will it do?"

"Count and display the cycles per second of any regularly recurring phenomenon with a frequency of 5 Hz to 175 MHz. This covers the great majority of frequencies we encounter in our work."

"How come it's reading 100.000?" Barney asked, pointing to the display panel showing this number in bright red 5/16" high numerals.

"It's displaying the frequency of our 100-kHz crystal oscillator frequency standard. Since the five-position switch on the right is set to a kHz position, that means the number to the left of the decimal indicates kilohertz."

"You mean that thing is actually counting, one by one, the whole hundred thousand cycles that take place in a second?"

"That's right, and it's recounting about forty-five times a minute just to make sure the frequency has not changed since the last count."

"Want to give me a quick-and-dirty explanation of how it does it?"

How It Works. "That's asking a lot. A 'simplified' explanation of anything as complicated as an electronic counter is bound to produce over-simplification and incomplete descriptions, but I'll try to sketch the basics for you:

"A frequency to be measured with a minimum amplitude of 100 millivolts is fed through that BNC connector at the lower left of the panel to a broadband dual-gate MOSFET amplifier-shaper whose gain is controlled by the sensitivity knob at the upper left. The reshaped cycles are fed to a count gate between the amplifier and six decade counter assemblies (DCA's). Each of these provides an output count of one for an input count of ten. Since they are connected in series and the signal is fed to the one on the right, this means the six of them can absorb up to a million counts; and when the count is stopped, the number of counts each DCA contains and its position properly reflect the correct digits of the total count.

If we open the count gate for just one second, the DCA's will count and store the number of cycles occurring in that second, and when the count in each DCA is moved to its associated 7-segment LED (light emitting diode) display, we have a direct readout of the frequency without any need for critical adjustment, computation, interpolation, or decimal positioning."

"Yeah, but how can you keep that gate open for precisely one second?"

"Now you're getting to the nitty-gritty. It's done with a self-contained highly accurate 'clock' consisting of an oven-controlled crystal oscillator operating at 3 MHz. TTL logic circuitry divides this frequency

1440



4½ POUNDS 8" X 12" X 4"

**up-date
YOUR
ABACUS!**

TRADE THE BEADS FOR KEYS...THE MITS 1440 SPACE AGE CALCULATOR!

- 14 DIGIT LED DISPLAY READ-OUT
- + MOS-LSI CIRCUITRY
- MEMORY CLEARANCE AND CLEAR KEY
- x CONSTANT DATA MEMORY
- ÷ DECIMAL POINT LOCATION SELECTOR
- √ AUTOMATIC SQUARE ROOT SELECTOR
- AUTOMATIC² SQUARING SELECTOR
(MEMORY + OR - KEYS)

- 1440 KIT \$199.95
- 1440 ASSEMBLED \$249.95

USE YOUR MASTER CHARGE OR BANKAMERICARD

WRITE OR MAIL COUPON FOR ADDITIONAL INFORMATION:

MITS[®] Micro Instrumentation & Telemetry Systems, Inc.

5404 Coal Ave., S. E., Albuquerque, New Mexico 87108
505/265-7553

ENCLOSED IS CHECK	<input type="checkbox"/> KIT
FOR MODEL = _____	<input type="checkbox"/> ASSEMBLED
AMOUNT OF CHECK \$ _____	PB-73
Include \$5.00 for postage and handling.	
<input type="checkbox"/> Please send information on entire MITS line.	
NAME _____	
ADDRESS _____	
CITY _____	
STATE & ZIP _____	

CIRCLE NO. 21 ON READER SERVICE CARD

into submultiples and uses them to form highly accurate pulses with widths of 1 ms, 10 ms, 100 ms, 1 s, and 10 s. When one of these pulses is fed to the count gate, its width determines how long the gate is held open."

"What happens if the gate is held open for ten seconds right now?"

Mac reached over and switched from the second to the first kHz position. A little red LED that had been flashing about 45 times a minute behind a panel opening labelled "Gate" stayed lighted for ten seconds at a time. When it blinked out briefly for the second time, the display changed to read 00.0001.

"Note the right-hand digit is now reading tenths of a cycle," Mac said, "and the LED behind the over range opening in the panel has lighted. That means the most significant digit—in this case a 1—is not visible. If we go to the first MHz position, like so, the reading becomes 0.10000; in the second MHz position, 0.1000; and in the third position, 0.101. In this last case, remember, we're only counting for 1 ms."

"Why, in every case, does the last digit keep switching from a 0 to a 1 and back every now and then? Surely the frequency isn't changing that much."

"No; you're observing the plus-or-minus-one-count ambiguity inherent in all conventional counters. It results from the fact that the counted frequency and the gate-controlling clock are not synchronized; so the first cycle entering the gate may be going either positive or negative at the time of its entry. Since only one-directional slopes are counted, this can make a difference of one count in any given gate period. But by increasing the gate time we can reduce this ambiguity error from one kHz at a 1-ms count to .1 Hz with a ten-second count."

"Are there other possible sources of error?"

"Another important one is the accuracy of the time base reference that opens and closes the gate. In this counter the claimed time-base stability after a 24-hour warmup is specified as 2 parts in 10^8 over 24 hours and 1 part in 10^6 over six months. This is accomplished by having the crystal oven temperature maintained as long as the counter is plugged in, whether it is turned on or not, and by having the power supply, whether it's operating on 120 volts ac or 12 volts dc, both current and temperature regulated. The 100-kHz sub-multiple of the

clock frequency is brought out through a harmonic generator to a jack on the rear so the clock can be reset in the field by zero beating harmonics of this submultiple against WWV."

"Is that all that's in the thing?"

"Oh no. There's a sample rate generator controlled by the logic circuitry that determines when the counting gate pulse is fed to the counting chain, that sets the length of time between pulses, and that resets all DCA's to zero and resets the time base dividers for an immediate restart of counting. Then there's a strobe pulse that initiates the transfer of the count held in storage to the readout LED's. Incidentally, the previous count is displayed while the updating count is taking place. You must keep this in mind when using the ten-second gate and wait long enough to be sure you have a full count."

"What uses have you found for it?"

Some Practical Uses. "Lots. For one thing, it makes all our signal generators super-accurate. When the output frequen-



cies of our r-f, sine wave, square wave, and marker generators are monitored by the counter, we can set these generators exactly to the frequency we want. Even our grid-dip oscillator, which is not designed for great accuracy, can be set precisely on any desired frequency up to 175 MHz by means of a pickup loop from the counter held near the GDO inductor."

"Hey, that's neat! A technician need not spend hundreds of dollars for hair-splitting dial-setting accuracy in signal generating equipment. He can buy low-cost generators and put them right on frequency with the counter."

"You've got the idea. Furthermore, in working with CB, amateur, and other communications equipment, the transmitting fre-

quencies can be read directly by feeding the transmitter into a dummy antenna and by holding the proper pickup loop—sold as an accessory by Regency—near the output section of the transmitter. Alternatively, the frequency of any crystal, receiving or transmitting, can be checked by holding the proper pickup loop near the coil associated with the crystal. In the Owner's Manual of the EC-175, Regency lists hundreds of crystal frequencies for their own equipment, together with the proper pickup loop to use, the upper and lower frequency limits for each crystal frequency, and diagrams showing the locations of the coils associated with each crystal. But the procedure described in the manual can be used to check the important frequencies in any type of CB, ham, mobile, marine, or vhf monitoring equipment.

"In addition to the harmonic-rich 100-kHz frequency brought through a jack, which provides the owner with a very accurate 100-kHz frequency standard, the counter also contains a 10.7-MHz crystal oscillator with the output brought out to another jack at the rear. This furnishes an excellent signal source for aligning 10.7 i-f strips and for setting the automatic frequency control in Regency's uhf Monitor-radios or other similar equipment."

"Let's take it apart and see what's on the inside."

"Not on your life! Remember it's not mine. Anyway, I know there are 11 diodes, 21 transistors, and 24 IC's, not to mention all the supporting passive components for these active devices. I might add it weighs 4.5 pounds and takes 30 watts (max.) from a 110-130-V ac line or draws 2.2 A (max) from an 11-15-V dc source."

"You're avoiding the big question: How much does it cost?"

"Four hundred and forty-nine dollars, which the manufacturer claims makes it the lowest priced, high-stability counter on the market today. I do not know if this is true or not, but I do know some other counters with the frequency range of this one sell for over two thousand dollars—some of them *well* over. On the other hand, Heath sells an 8-digit model in kit form with a range of 1 Hz to 120 MHz that sells for just under \$300. But it is very difficult to compare counters because there are so many features besides price to consider: number of digits, frequency range, sensitivity, stability, maximum resolution, type of readout, range of gate times, etc. I just hope I've given you enough explanation of how counters work so that you can better understand descriptions and specifications of these instruments."

"You sound as though you expect me to be working with the things."

"If you stay in electronics, I know you'll be. Digital equipment is coming on fast, and we're going to be servicing more and more of it. Don't forget even clocks and watches are going down the "digitalized" road. Either we're going to become jewelers or jewelers are going to be studying digital logic instead of miniature lathe operation! I'm certain that automobiles of the future will be using a great deal of digital sensors and logic circuitry for measurement and control."

"And anywhere things are being counted a frequency counter is a basic service instrument; right?"

"Right. That's why I want you to become familiar with the use of instruments like this one—starting right now."

"Aye, aye, sir," Barney said, snapping a smart salute to his employer and picking up the Owner's Manual of the EC-175. ♦

FREE McIntosh CATALOG and FM DIRECTORY

McIntosh Laboratory, Inc.
East Side Station P.O. Box 96
Binghamton, N.Y. 13904
Dept. 16-5

**SEND
TODAY!**

NAME _____

ADDRESS _____

CITY _____ STATE _____ ZIP _____

Get all the news and latest information on the new McIntosh Solid State equipment in the McIntosh catalog. In addition you will receive an FM station directory that covers all of North America.



MX 113

AM FM/FM STEREO TUNER PREAMPLIFIER

CIRCLE NO. 20 ON READER SERVICE CARD

HOW DO SERIES-CONNECTED CONSTANT CURRENT SOURCES OPERATE?

WITH TWO SUCH DIFFERENT SOURCES, HOW DOES THE CIRCUIT WORK?

BY JOHN T. BAILEY

"OH, SLIM, I have a surprise for you," called Joe, the shop owner, to his technician. "It's another brain teaser. Do you want to tackle it?"

"Well, I have to admit I learned something when you sprung that last one on me about whether an amplifier tube can have zero transconductance," Slim responded cautiously. "I don't think it was too complimentary to me when you wrote that incident up and submitted it to POPULAR ELECTRONICS. They published it in their November 1971 issue and I still get kidded about it from my friends. You wouldn't do that to me again would you?"

Joe's face took on a sympathetic expression. "Slim, I must admit this one is a little tougher so last night I breadboarded it just to confirm the answer to myself. To make amends with you, I will perform the experiment in silence and I want you to narrate what I am doing and why. In this way you will get credit for your knowledge of con-

stant current circuitry. Your friends will be proud of you when they read about your performance."

"Well OK," Slim sighed. "I see you are determined. What is the puzzle?"

Joe grinned. "Here it is. You know, Slim, in solid-state circuits, constant current sources are very important. And you know that such a source in its simplest form can consist of no more than one transistor with an emitter resistor and a base voltage obtained from a divider, zener, or other low-impedance voltage source. Within certain limits the collector current will be relatively constant regardless of the value of the load resistance and, in some designs, regardless of the supply voltage. Now, suppose you have two constant current sources, A and B, each designed for a different constant current. Connect them in series and apply a supply voltage to the series combination. What will happen? Will the constant current of A or B prevail? Or maybe an average of the two will flow. Maybe no current at all will pass. Whatever you think now, just keep it to yourself and start describing what I'm doing."

"Ok," agreed Slim with relief. "Here goes. My boss, who has a weakness for puzzles, has just sketched a constant current circuit in which an npn transistor has a resistor between its emitter and ground, a battery between base and ground, and a power supply between collector and ground. Now he is rummaging around in the stock bins for a couple of transistors making sure that his right profile with his best sideburn is toward the camera."

"All right! Knock it off. We are not on television," exclaimed Joe. "I just want you

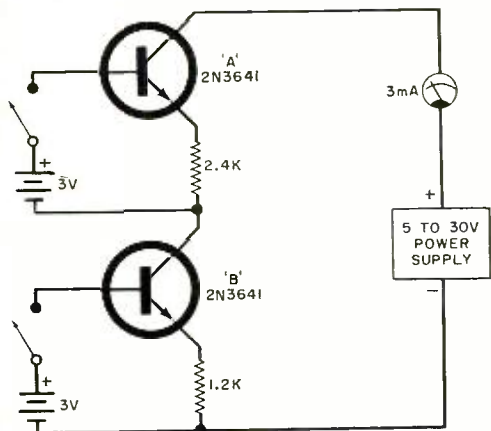

to display your know-how by a technical narration of what I am doing. Now, why did I use a battery for the base voltage? On second thought, I had better tell you because we haven't reached the point yet where the reason would be obvious. If I had used a divider or zener to establish the base voltage source there would be a divider current or zener bias current involved. That would not be a problem with the single constant current source; but when two constant current sources are connected in series, the extra currents complicate matters. With battery sources we have floating voltage sources and the currents from them don't get added into the collector current flowing from the power supply through the two transistors.

"I see," said Slim. "You want true two-terminal operation of the constant-current sources when they are in series."

Slim continued in a more serious vein. "I see you have added a 3-mA meter in the collector leg in your schematic and a switch between the battery and the transistor base. You have also marked the battery terminal that goes to the switch with a plus, and a plus has been added to the power supply lead going to the milliammeter in the collector leg. You have labelled the transistor as a 2N3641, which I recall is a general purpose npn silicon transistor. Now you have marked the emitter resistor as 2400 ohms. Hold it a minute while I calculate the constant current value."

Slim calculated audibly, "Subtracting 0.7 volts for the base-to-emitter voltage from the battery voltage, I get 2.3 volts across the emitter resistor so dividing this by 2400 ohms, I get almost 1 mA for the collector current."

"Now Joe is trying the circuit out. He has closed the switch in the base circuit and turned on the power supply which he adjusted to about 30 volts. Sure enough! The milliammeter reads nearly 1 mA and, as Joe varies the power supply voltage from 30 volts down to 5 volts, the milliammeter reading doesn't budge.

"Joe has now put together another constant current source exactly like the first except he has used a 1200-ohm resistor in the emitter leg. Give me a second first, Joe, to figure the current. Three volts minus 0.7 volts is 2.3 volts as before. When divided by 1200 ohms, that gives nearly

2 mA. OK, go ahead. Right again! The milliammeter reads just about 2 mA and is rock steady.

"With pencil in hand, Joe sketches the two transistor circuits in series and labels the 1-mA one 'A' and the 2-mA one 'B'. Now he is connecting them in series on the bench and has attached them to the power supply through the milliammeter. Now for the moment of truth. Joe adjusts the power supply to 30 volts and turns it on. No reading on the milliammeter. Now he closes the base voltage switch of transistor 'A'. Still no milliammeter reading. Finally, he closes the base voltage switch of transistor 'B' and quickly puts his hand over the face of the meter and flashes a mean grin."

"Do you want to guess?," asked Joe. "What does it read?"

"But Joe, you said all I had to do was narrate, and I did that. Besides you admitted you weren't sure what would happen. However, if it would impress you, I would like to point out that, if there is a reading, either 1 mA or 2 mA or something else, this circuit behaves like an AND logic gate where no output is obtained unless both inputs are ON."

"Slim, that's an astute observation. It shows you are on the digital ball. So I'll let you see the meter. Look!"

"1 mA!" exclaimed Slim. "The lower current transistor won the fight! "Now that I know the answer the analysis isn't too hard. The 'B' transistor can't pass the 2-mA collector current that its base-emitter circuit design calls for because transistor 'A', which is in series, has limited the series current to 1 mA. Therefore the base-emitter circuit of 'B' simply forward biases its base-emitter junction with about 1 mA of base current. Transistor action of 'B' ceases and the whole circuit acts as if 'B' didn't exist.

"Joe," added Slim, "you have my permission to write this one up and have it published. I'm not ashamed of my analysis. You know it wasn't too easy a puzzle."

"Good boy, Slim. I knew you would come through with flying colors. I'm proud of you. Now check out the first vertical stage of our scope. It has poor common mode rejection so maybe the long-tailed portion, which is a constant current circuit, is haywire." ♦

DO YOU KNOW YOUR DC CIRCUITS?

PART 2 OF A 3-PART SERIES
COVERING DC CIRCUIT ANALYSIS

BY ARTHUR H. SEIDMAN
Prof. of Elec. Eng., Pratt Institute

9. Equilibrium Equations.

A. Mesh (Loop) Equations. For an n -mesh circuit with independent sources, assuming clockwise flow of current in each mesh, one may write, in general, the following mesh equations:

$$V_1 = R_{11}I_1 - R_{12}I_2 - \dots - R_{1n}I_n$$

$$V_2 = -R_{21}I_1 + R_{22}I_2 - \dots - R_{2n}I_n$$

$$\dots$$

$$V_n = -R_{n1}I_1 - R_{n2}I_2 - \dots + R_{nn}I_n$$

where, for example, V_1 is the voltage source present in mesh 1, I_1 is the current in mesh 1, R_{11} is the self resistance of mesh 1, and R_{12} is the mutual resistance linking meshes 1 and 2. For a given circuit, some of the terms in the mesh equations may be equal to zero.

B. Nodal Equations. For a circuit containing n nodes and independent current sources, assuming that currents at each node are taken as flowing from left to right and from top to bottom,

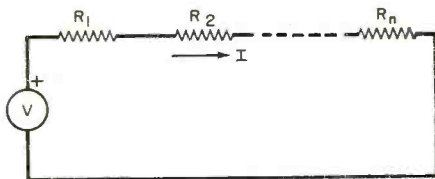

Fig. 12

one may write, in general, the following nodal equations:

$$I_1 = G_{11}V_1 - G_{12}V_2 - \dots - G_{1n}V_n$$

$$I_2 = -G_{21}V_1 + G_{22}V_2 - \dots - G_{2n}V_n$$

$$\dots$$

$$I_n = G_{n1}V_1 - G_{n2}V_2 - \dots + G_{nn}V_n$$

where, for example, I_1 is the current source connected to node 1, V_1 is the voltage across node 1 and the common node, G_{11} is the self conductance of

node 1, and G_{12} is the mutual conductance between nodes 1 and 2. For a given circuit, some of the terms in the nodal equations may be zero.

10. Equivalent Resistance.

A. Resistors in Series. Consider n resistors connected in series (Fig. 12). Applying Kirchhoff's voltage law, $V = I(R_1 + R_2 + \dots + R_n) = IR_{eq}$, where $R_{eq} = R_1 + R_2 + \dots + R_n$ is the equivalent resistance. The equivalent resistance of a number of resistors in series is equal to the sum of the individual resistors.

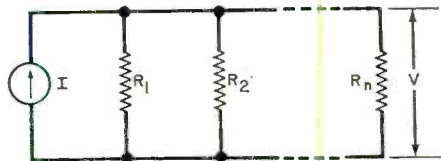

Fig. 13

Ex. 13. What single equivalent resistor can replace a 3-ohm, a 5-ohm, and a 12-ohm resistor connected in series? *Sol.* $R_{eq} = 3 + 5 + 12 = 20$ ohms.

B. Resistors in Parallel. Consider n resistors connected in parallel (Fig. 13). Applying Kirchhoff's current law, $I = V(1/R_1 + 1/R_2 + \dots + 1/R_n) = V(G_1 + G_2 + \dots + G_n) = VG_{eq}$, where $G_{eq} = G_1 + G_2 + \dots + G_n$ is the equivalent conductance of the

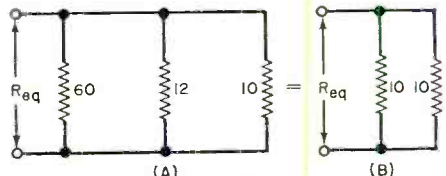

Fig. 14

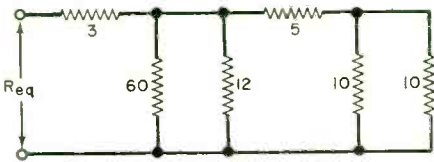

Fig. 15

parallel network. In words, the equivalent conductance of a number of resistors in parallel is equal to the sum of the conductance of each resistor.

(1) In terms of resistance, $R_{eq} = 1/G_{eq} = 1/(G_1 + G_2 + \dots + G_n) = 1/(1/R_1 + 1/R_2 + \dots + 1/R_n)$. In words, the equivalent resistance of a number of resistors in parallel is equal to the reciprocal of the sum of their conductances. (2) For two resistors in parallel ($n = 2$), we have a simple expression: $R_{eq} = 1/(1/R_1 + 1/R_2)$

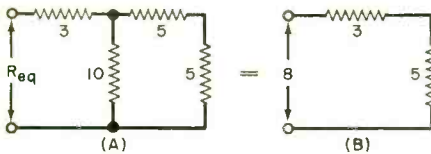

Fig. 16

$= R_1 R_2 / (R_1 + R_2)$ (Eq 13). (3) Where more than two resistors are in parallel, it is convenient to find the equivalent resistance of two resistors at a time.

Note: For parallel combinations of resistors, we use a double slash, //, to indicate "in parallel with."

Ex. 14. Find the equivalent resistance of the parallel network in Fig. 14A. *Sol.* From Eq (13), $60//12 = (60 \times 12)/(60 + 12) = 10$ ohms. This is shown in parallel with the 10-ohm resistor in Fig. 14B. Thus, $R_{eq} = 10//10 = (10 \times 10)/(10 + 10) = 5$ ohms.

C. Equal Resistors in Parallel. The equivalent resistance of n equal resistors in parallel is equal to the resistance of one of the resistors divided by n : $R_{eq} = R/n$.

Ex. 15. Find the equivalent resistance

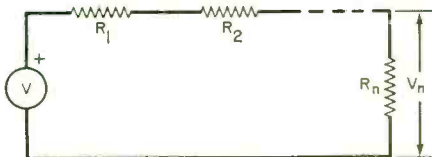

Fig. 17

of four 60-ohm resistors connected in parallel. *Sol.* $R_{eq} = R/n = 60/4 = 15$ ohms.

D. Resistors in Series and Parallel.

In a circuit containing combinations of resistors in parallel connected in series with other resistors, the parallel combinations are reduced to their equivalent

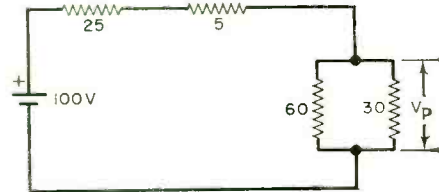

Fig. 18

values until the resultant circuit is composed only of a series of resistors.

Ex. 16. Determine the equivalent resistance of Fig. 15. *Sol.* $60//12 = 10$ and $10//10 = 5$. Thus, Fig. 15 is reduced to Fig. 16A. $5 + 5 = 10$ and $10//10 = 5$. From Fig. 16B, $R_{eq} = 3 + 5 = 8$ ohms.

11. Voltage and Current Dividers.

A. Voltage Divider. An example of a voltage divider is shown in Fig. 17. Since the resistors are connected in series and the same current flows in each, the voltage, V_n , across resistor, R_n , is: $V_n = R_n V / (R_1 + R_2 + \dots + R_n)$. For a series circuit, the voltage

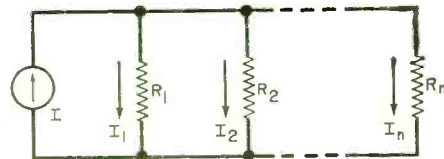

Fig. 19

across a resistor is proportional to the value of the resistor.

Ex. 17. Find the voltage across the parallel resistors in Fig. 18. *Sol.* $60//30 = 20$ ohms. Hence, $V_p = 20 \times 100 / (25 + 5 + 20) = 40$ V.

B. Current Divider. An example of a current divider is shown in Fig. 19. Since the resistors are connected in parallel and the same voltage is across each, the current in R_n is: $I_n = G_n I / (G_1 + G_2 + \dots + G_n)$. For two resistors, R_1 and R_2 , in parallel: $I_1 = G_1 I / (G_1 + G_2) = R_2 I / (R_1 + R_2)$

and $I_2 = G_2 I / (G_1 + G_2) = R_1 I / (R_1 + R_2)$. The current varies inversely with the resistance in a parallel circuit.

Ex. 18. In Fig. 19, assume $n = 2$, $R_1 = 15$ ohms, $R_2 = 10$ ohms, and $I = 10$ A. Find the currents in R_1 and R_2 . **Sol.** $I_1 = R_2 I / (R_1 + R_2) = 10 \times 10 / (15 + 10) = 4$ A. $I_2 = R_1 I / (R_1 + R_2) = 15 \times 10 / (15 + 10) = 6$ A.

12. Modeling.

A. Independent Sources. The ideal voltage and current sources we have been using can be termed independent sources. The value of an independent current or voltage source is specified and is independent of the circuit to which it is connected. By combining independent ideal sources and resistors,

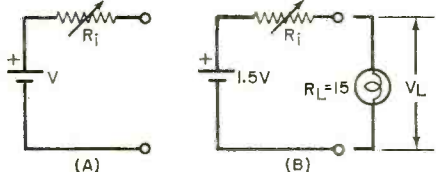

Fig. 20

models may be developed for many physical devices. With continuous use, for instance, the voltage of a battery decreases. A model of a battery can be developed to reflect this behavior by connecting an ideal independent voltage source in series with a resistor, R_1 , as in Fig. 20A. Resistor R_1 is called the internal resistance of the source. It is shown as a variable resistor in Fig. 20A because, for a battery, its value increases with use and age.

Ex. 19. A 1.5-volt battery, which is represented by the model in Fig. 20A, is connected to a lamp as shown in Fig. 20B. The lamp's resistance, R_L , is 15 ohms. When the battery is "fresh," R_1 is approximately 0 ohms. With use, assume that R_1 increases to 15 ohms. Determine the voltage across the lamp for

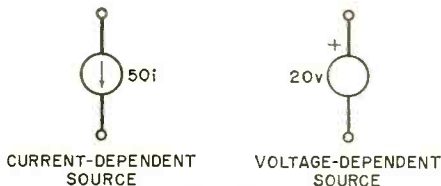

Fig. 21

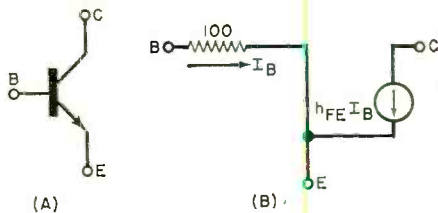

Fig. 22

these two conditions. **Sol.** For $R_1 = 0$, $V_L = 1.5$ V. For $R_1 = 15$ ohms, $V_L = 1.5 \times 15 / (15 + 15) = 0.75$ V.

B. Dependent (Controlled) Sources.

A dependent, or controlled, source is one whose value is not specified, but depends on a current (or voltage) in the circuit. (Fig. 21) The bipolar junction transistor (BJT) of Fig. 22A can be represented, under certain operating conditions, by the simple model of Fig. 22B. Note that the value of the dependent current source, $h_{FE} I_B$, depends on the value of the base current, I_B .

Ex. 20. If, in Fig. 22B, $h_{FE} = 50$, $I_B = 1$ mA, and a 1000-ohm resistor is connected between terminals C and E, find the voltage at C with respect to E. **Sol.** For $I_B = 1$ mA, $h_{FE} I_B = 50 \times 10^{-3}$ A. Then, $V_{CE} = -50 \times 10^{-3} \times 1000 = -50$ V. The reason for the minus sign is that the 50-mA current flows out from C and the voltage is taken at C with respect to E.

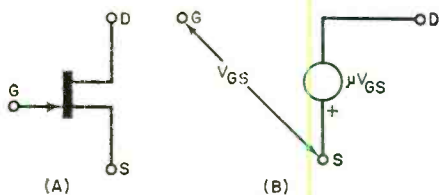

Fig. 23

The field effect transistor (FET) in Fig. 23A may be represented, under certain operating conditions, by the simple model of Fig. 23B. Note that the value of the dependent voltage source, μV_{gs} , depends on the voltage between gate G and source S of the device.

Ex. 21. If, in Fig. 23B, $\mu = 20$, and $V_{gs} = 1$ V, find the voltage at D with respect to S. **Sol.** The voltage at terminal D with respect to terminal S is: $V_{DS} = -20 \times 1 = -20$ V.

(To be concluded)

Here's everything you'd expect from a high-priced portable multimeter.

Except a high price.

The B & K Solid-State Electronic Multimeter (Model 277) has 8 important features that you can get on most other quality-made units, but not at prices like ours.

You'd expect to pay quite a lot for a multimeter featuring both high and low power ohms ranges. Both are critically necessary. The B & K 277, with its .068 V power source on low power ohms, will always read the true value of a resistor | shunted by a semi-conductor without concern for the semi-conductor's presence. A con-

ventional ohmmeter with a 1.5 volt supply could cause a shunt semi-conductor to conduct, giving a false resistance reading.

The 277's high-power resistance ranges are useful in determining whether transistors are good or bad simply by first forward biasing them to make them conduct and then reversing the leads to qualify the front-to-back ratio.

The B & K 277 has so many features you wouldn't expect at the price: like a .1 V low-voltage scale for both AC and DC; a DC current range of

1 μ A full-scale for testing sensitive semi-conductor leakage; the unit is fully protected from overloads by fuse; input impedance of 15 M Ω on DC; 1% precision resistors; a 4 1/2 inch, 50 μ A mirrored scale meter; frequency response to 150 KHz and 59 individual ranges.

Our price alone doesn't make it a value, but our features at our price make it a fantastic value

\$99⁹⁵



B&K Very good equipment at a very good price.

Product of Dynascan Corporation/1801 W. Belle Plaine Ave., Chicago, Ill. 60613

CIRCLE NO. 7 ON READER SERVICE CARD

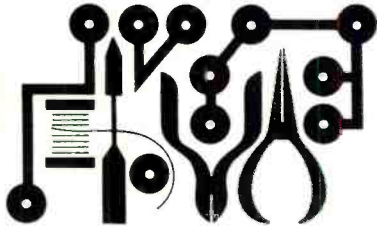

Hobby Scene

Field-Strength Meter

Q. I am an electronics experimenter and active CB'er. Can you show me a simple field-strength meter that I can use to evaluate antennas and different transmitters?

A. The "minimum-parts" field-strength meter shown here should do the job. The basic circuit is shown at the left and is used with high field strength. For more distant testing, add the dc amplifier as shown. The coil consists of 12 turns of #16 wire wound closely on a 3/8" wood dowel and tapped at four turns. The antenna can be any telescopic type salvaged from an old portable radio or CB walkie-talkie. Tuning is by the small trimmer capacitor. The dc amplifier version uses a zero set control for meter zero with no signal input.

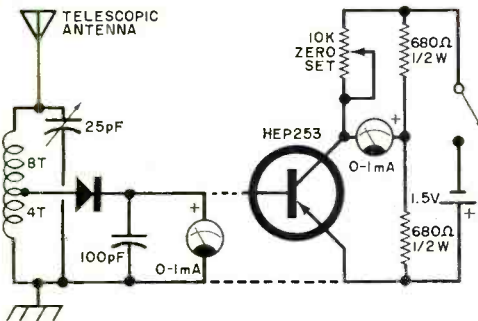

When Is It Raining?

Q. Is there any way (electronically) that I can tell when it starts to rain? Seriously, if my mother is doing the laundry and can't see outside, how could I warn her about the rain?

A. Build your mother a device using the circuit shown below. With silicon transistors, the standby power drain is negligible. The switch is used to stop the alarm. The

rain probe is made of several lengths of bare wire (or a printed circuit board) placed next to each other as shown, with just enough spacing to provide contact when a raindrop strikes them. Readily available transistors can be used.

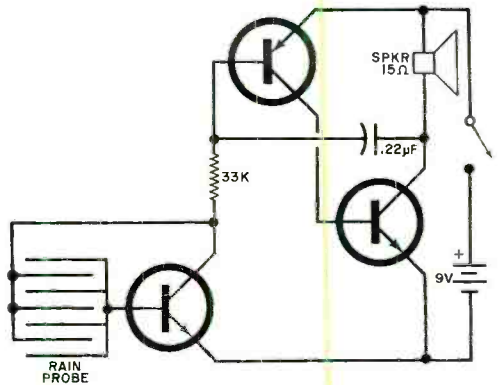

Timing for a Musician

Q. What's a good circuit for an electronic metronome for a budding musician?

A. Try the one below. It can be set for a beat of about one every four seconds to four per second, adjusted by the potentiometer. Just about any available unijunction and npn transistors can be used.

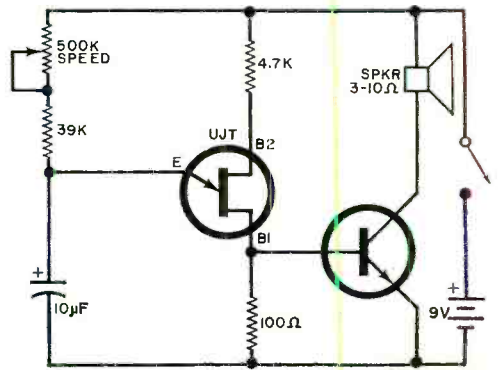

All quadraphonic systems are not created equal... Sansui has created the QS vario matrix.

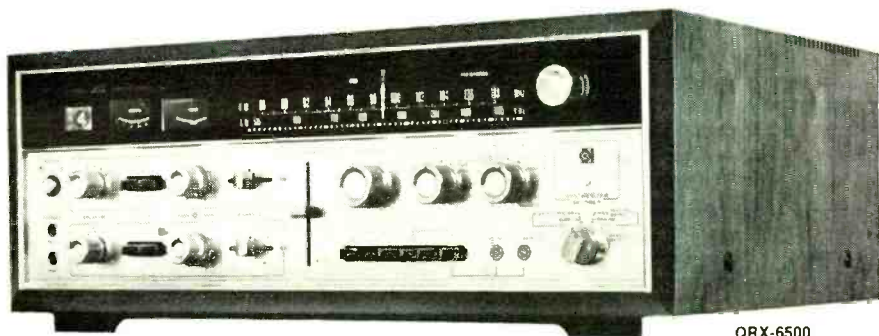

QRX-6500

Here at last is the development that once and for all will lay to rest the dispute over discrete vs. encoded recordings. The Sansui vario matrix—a technological extension of the QS Regular Matrix—provides unbelievable front-to-back separation, to a degree never before possible with matrix recordings—separation so great that engineers have hailed it the "discrete matrix."

Two new units in the Sansui four-channel lineup—the QRX-6500 and the QRX-3500 contain this outstanding new decoder. These full-featured four-channel receivers have high power output (280 watts and 180 watts IHF), superb FM sensitivity, and are loaded with special features to make quad listening a totally trouble-free and fulfilling experience.

The new decoder includes a position for Phase Matrix recordings, and both "Hali" and "Surround" positions for the QS Regular Matrix and for the synthesizer section, for accurate decoding of any current matrix as well as creating enhanced 4-channel sound from two-channel recordings.

Other special features include a sound-field rotation switch, linear balance controls for front/rear and left/right, and the capability to drive up to 10 speakers—all front-panel switch-selected.

Treat your ears to a demonstration today at your nearest Sansui dealer. Your listening will never be the same again.



QRX-3500



SANSUI ELECTRONICS CORP.

Woodside, New York 11377 • Gardena, California 90247

ELECTRONIC DISTRIBUTORS Canada

SANSUI ELECTRIC CO., LTD. Tokyo, Japan • Sansui Audio Europe S. A., Antwerp, Belgium

CIRCLE NO. 28 ON READER SERVICE CARD

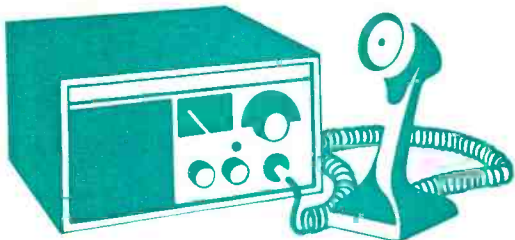

CB Scene

By Matt P. Spinello, KHC2060

Just 30 minutes after the shocking news of the March 2 disaster in Virginia, where a flying boom crane dropped through 24 floors of a high-rise apartment building under construction, Tom Rabbitt, KCI8528, Communications Officer for Fairco REACT, Springfield, Virginia, was on the scene. In less than an hour, he and Community Emergency Coordinator Larry Green, KBU-0573, had established a CB emergency network between the accident site, the Calvary Baptist Church several blocks away and a number of Fairco REACT members who remained on standby, monitoring their base stations around the clock from 2:00 p.m. Friday through 1:30 p.m. Sunday.

First reports from the scene at the Skyline Center complex at Bailey's Crossroads, located within the Washington, D.C. metropolitan area near the boundaries of Alexandria, Arlington, and Fairfax Counties, indicated that there were 5 workmen dead, 15 missing, and 34 injured. (*Subsequently, the death toll rose above the figure indicated.—Ed.*)

Citizens radio was immediately put into service by searchers. Fairco REACT's camper-type bus was set up in the parking

REACT Aids In High-Rise Disaster



Fairco REACT Vice President Chuck Brown dictates notes into cassette recorder for club records while Emergency Coordinator Larry Green looks on during the long rescue operation.

lot of a McDonalds hamburger stand to establish a communication link between the searchers, the American Red Cross, area police, the fire department, and Fairfax County Medical Aid Station personnel who were located at the site and at REACT's second communications control point.

The Calvary Baptist Church made its facilities available to the Red Cross, local authorities, and the families of workers who were still unaccounted for. Messages of importance were relayed from the accident site to the church basement, where REACT's emergency unit #2 was located. Messages handled during the first evening included requests for doctors, inquiries from families attempting to establish the whereabouts of relatives who were awaiting word of the workers from within the church, and information as to the types of supplies needed at the disaster site.

Friday evening, the Chesapeake and Potomac Telephone Company of Virginia

installed a telephone line directly to the REACT mobile communications center and verbally opened its doors to all volunteers by offering the use of its facilities, telephones, and Xerox machines. From then on, communications became more frequent as telephone messages had to be relayed via CB radio to various areas around the accident site.

By Saturday morning, REACT had established shifts of 6 to 8 hours at both communications points. REACT members paired off in teams at each site. Over the 48-hour period, 17 Fairco REACT members participated. Among them were two XYL's: Tom Rabbitt's wife, Clair, and Mrs. Edan Green, KQI2431. The same morning, an unidentified gentleman offered REACT personnel the use of his camper in place of the VW camper bus. The unit was installed and was supplied with ac power which was being generated by the fire department to serve a mobile hospital and medical aid center that was also located next to the CB van.

Chuck Brown, KQI2103, Fairco REACT Vice President, told us that the Red Cross Duty Officer, George Collier, made extensive use of the Fairco communications facility and that he commended highly the efforts of REACT's volunteers. Chuck praised McDonalds Hamburgers for keeping emergency food service available around the clock for rescue workers, authorities, and volunteer personnel.

Chuck Brown also commended the National Capitol REACT Team, KMI1207, another large emergency CB team in the

Washington, D.C. area, for offering its assistance and remaining on standby in the event they were needed at any time during the emergency.

CB Jamboree. The 6th National Air Capital CB Club Jamboree, sponsored by the Wichita (Kansas) Air Capital CB Radio Club, Inc., will be held at the 4-H Building, Central and Tyler Rds., June 29 through July 1. Free camper and trailer parking on jamboree grounds; monitoring on channels 9 and 11; REACT, KDO8333, will assist motorists on channel 9. Main door prizes include a Yamaha motorcycle, a Toshiba color TV, a Cobra 132 CB rig, and an Audiovox stereo tape player. For more information, CB'ers located in the area can contact Dave Good, P.O. Box 1427, Wichita, Kansas 67201.

EIA CB Promotion Thrust. A major innovation of the Citizens Radio Section, Electronic Industries Association, is the recognition of CB clubs as significant community activities which help to influence the greater use of Citizens 2-way radio to benefit everyone. The CB Section Committee has prepared a free information kit to assist local CB clubs in telling the community about their organizations and how they use 2-way radios. Citizens Radio clubs interested in more information should contact Citizens Radio Section, Communications and Industrial Electronics Division, Electronic Industries Association, 2001 Eye Street, NW, Washington, DC 20006.

I'll CB'ing you. ◆



This is the site of the high-rise disaster, where a crane fell and brought down a whole section in the middle of the building under construction. Scene is Bailey's Crossroads in Virginia. Rescue operation was speeded by Fairco REACT.

The New 4-Channel Records

*Producers of
4-channel discs
give their views*

BY HARRY MAYNARD

THERE ARE approximately 1000 4-channel recordings currently available on the market in various formats. Soon there will be more, probably an avalanche, including traditional disc pressings, tape cartridges, and—to a lesser extent—open-reel tapes.

It has taken 19 years (since 1954) to fully develop the 2-channel stereo recording medium to its present state of the art. But there is every evidence that 4-channel stereo will develop and mature much faster. The market is growing at a phenomenal rate and with it has come the demand for more diversity in programs, ranging from classical works to hard rock.

Two Approaches. Two-channel stereo gave us left-to-right directionality. It had breadth but lacked depth. Then about three years ago, 4-channel sound appeared on the scene, offering the listener the full ambience of the concert hall with a “you are there” quality to the sound. The addition of “ambience” to

the reproduced sound was the first thing done to distinguish the new 4-channel from the traditional 2-channel stereo medium.

Max Wilcox, producer of RCA's first commercially available 4-channel recordings with Eugene Ormandy and the Philadelphia Orchestra, believes in the traditional approach of putting ambience in the rear channels. RCA's new “Quadradisc,” using the CD-4 system, of the Shostakovich Symphony No. 15 is a dramatic example of the state-of-the-art of 4-channel recording (ARD1-0014). Wilcox believes that the medium should not overpower the message. Other than allowing a little of the extreme left and right sides of the orchestra to drop into the rear channels, he followed a traditional approach to these recordings.

The second approach to 4-channel reproduction is more unconventional and controversial. Sometimes called “surround sound” by its proponents, it will be debated for years to come, especially by those used to a proscenium orientation in listening to recorded sound. Surround sound immerses the listener in sound coming from all directions to create new listening experiences that cannot be easily duplicated in most conventional live musical encounters.

In the beginning Columbia Masterwork's Executive Producer Tom Frost leaned toward the traditional approach to the 4-channel recording of classical music: orchestra up front and concert-hall ambience in the rear channels. Now he believes that you *can* tamper with the traditional arrangement of the orchestra and microphone . . . “if you do it judiciously and with good taste.” What convinced him was the extraordinarily successful Columbia 4-channel recording of Stravinsky's “Le Sacre du Printemps” with Leonard Bernstein and the London Symphony (MQ-31520). Here, John McClure, Bernstein's personal record producer, has arranged the orchestra *around* the conductor. Strings and woodwinds are up front, French horns on the left, brass on the right, and percussion in the rear. The recording has earned wide critical acclaim.

RCA Executive Producer Jack Pfeiffer, creator of some of the company's first 4-channel recordings, believes that the listener “wants not only the music of his choice, but wants a vivid illusion of the event happening in an optimum live surrounding, plus the intimacy which reveals the detail, separation, clarity, and balance which (are) virtually impossible to obtain in the live encounter.”

Pfeiffer sees the essential case for 4-channel sound as an illusion that transcends the concert hall, where there are no bad seats, no poor acoustics, and everyone programs his nervous system with repertoire of his own choice.

Enoch Light is all for the innovative approach. "We arranged the orchestra for recording. Why can't we arrange the musical elements for listening in the home? . . . I'm not talking of putting the violin in the rear, but of clarifying musical line and compositional texture. Composers don't hear their compositions in a concert hall, but in their heads. With 4-channel recording, we can enhance the original intent of the composer."

Making 4-Channel Recordings. Most 4-channel record producers mix down from a multi-channel master tape containing 8 or 16 tracks. They mix for whatever sounds exciting, gives a sense of immediacy, and is involving. After all, no recording can ever be more than a simulation of reality with speaker listening in the home.

John Woram, formerly Chief Engineer of Vanguard Records, which released the first commercially available 4-channel recording, believes that a quadraphonic recording can be a creative medium in itself for some types of material and provides the artist, composer, and engineer with new flexibilities, just as the multi-track tape recorder has given them new sonic capabilities for introducing all sorts of "electronic additives."

John McClure reports that when he set up for his unorthodox recording of "Le Sacre," the artists and conductor had trouble hearing one another and at first were upset by the small changes in the placement of the artists, instruments, and microphones. The musicians found it difficult to blend with each other. Bernstein, although skeptical, was pleased with what he later heard in playback. McClure found E. Power Biggs an instant champion of 4-channel recording because he had heard some experimental "takes" and was amazed at the advantages of 4-channel over 2-channel stereo in capturing the huge reverberant sound of an organ in a church or large recording area.

Anthony Newman, the harpsichordist who has made several 4-channel recordings for Columbia, sees 4-channel sound as creating a new problem for the artist, namely the invidious comparison between the superior close-mike 4-channel sound and the often poor sound characteristics of many

concert halls. "The concert hall demands the same acoustically supplemented sound as the recording," says he.

Hugo Montenegro, who with Jack Pfeiffer produced one of RCA's first 4-channel records (Love Theme from "The Godfather"—APDI-0001), believes that there must be joint experimentation among artists, recording engineer, and, whenever possible, composer. "We'll make mistakes just as we did in stereo, but we'll come out on a higher plateau knowing what we can or can't do with 4-channel recordings. Successful recordings don't just happen—you have to plan for them."

Max Wilcox who produces only classical records for RCA represents the more conservative point of view: He says we should do what we have always done, but do it better by adding ambient information in the rear speaker systems. But classical music represents less than 5 percent of total record sales. It is in the area of non-classical recordings that recorded sound has long since departed from the goal of replicating a live musical encounter, and the non-classical record has clearly established itself as a creative medium in its own right.

Other than avant-garde electronic compositions like "Touch," especially commissioned as a 4-channel composition by Columbia from Morton Subotnik, the future for quadraphonic records seems to lie in the non-classical field. Here, the recording has very little connection with reality and it is possible to employ the echo chamber, tape delay, equalization, and other electronic manipulations.

But if 4-channel sound has a justification, traditional or not, it is because it can bring new and positive values to recorded music and to the trans-action between humans and music. This calls for full exploitation of our binaural listening abilities endowed upon us by nature. Research has disclosed that, if our binaural listening capabilities are to be fully exploited, both direct and reflected sound must reach our ears from different directions.

At the level of recording—before the listener trans-action takes place—many current 4-channel recordings have shown that it is possible to bring new excitement to home listening—and more involvement by the listener. Perhaps the criticism of 4-channel sound voiced most often is that it is "too involving." But involvement is an essential part of *any* art form. ♦

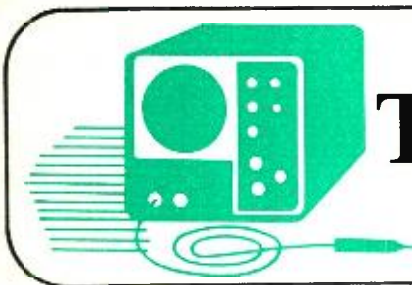

Test Equipment Scene

By Leslie Solomon, Technical Editor

IN AN electronics world of rigidly prescribed bandwidths, a sweep generator and an oscilloscope are indispensable aids for the service technician or serious hobbyist who wants to get the most out of expensive receiving equipment, be it a hi-fi tuner or a color TV receiver. When properly operated, these two instruments show clearly the bandwidths and characteristics of the equipment under test. The displays can then be checked against the manual accompanying the receiver, or the service manual, which gives the details of all of these specifications showing the proper response curves from the r-f amplifier stage through to the final output stage.

We all know what a scope is, but just what is a sweep generator and what are the factors to be considered in selecting one? Up to now, the name "sweep generator" has implied an r-f device, since audio sweep generators have not yet become widely available.

A typical sweep generator consists of an r-f source whose output frequency can be swept over some predetermined frequency range. The actual sweep techniques used vary from manufacturer to manufacturer, but the end result—a swept frequency—is usually the same. In most cases, the swept frequency is accompanied by markers ("birdies" as some old-timers call them) to indicate important frequencies along the sweep. The display is made on the oscilloscope whose horizontal sweep is generated within or synchronized with the r-f sweep generator (usually at 60 Hz) and whose

vertical signal is the demodulated frequency response of the circuit under test.

Important Characteristics. There are several important characteristics to look for in a sweep generator. One is the flatness of the r-f output over the swept frequency range. This is critical because the amplitude response of the detected signal is what you are looking for and it should not be affected by a varying r-f input.

To check the sweep generator's output flatness, connect the r-f output directly to a demodulator probe, which in turn is connected to the scope, using the r-f generator to supply the scope horizontal sweep. The display should be a flat line—or two flat lines if the sweep generator is provided with a zero reference. Any excessive peaks or valleys mean that there is a variation in the generator output within the frequency range under inspection. Avoid generators that do not have a relatively flat output.

A second important characteristic is the range of frequency coverage. An ideal sweep generator should be capable of covering all r-f bands used; but in the interests of usefulness (and to keep the cost down), the real-life generator should cover all of the currently used TV and FM channels, plus the various "internal" frequencies used for i-f strips and chroma sections.

Some of these internal frequencies are the conventional 40-MHz TV i-f band, 4.5-MHz sound i-f, 10.7-MHz FM i-f, 21 MHz used as i-f in some imported or older TV receivers, and 3.58 MHz used in chroma sections. You should also be able to cover those oddball frequencies used in communication systems—if you do much work in those areas.

There is also the question of just how wide a sweep should be. If you have a sweep just wide enough to span the frequency range of interest, you may be harm-

R-F Sweep Generators

ing yourself unwittingly. Keep in mind that responses outside of the band of interest can represent trouble. For example, assume that you have accurately set the adjacent channel traps on a TV i-f strip, and everything looks just like the manual says it should. Unknown to you, however, there is a "hump" in the response curve near the adjacent channel sound or video. This hump may or may not bother you in conventional reception; but if you are on a cable system where the channels are adjacent to each other (as opposed to the alternate channel spacing used on the air in any given area of the country), then prepare for the herringbones as the out-of-band signal gets into your carefully aligned i-f strip. Even with on-the-air reception, herringbones can appear if there is any chance of adjacent channel reception in your area.

How much sweep width is enough? You should be able to "see" well into the next channel on each side of the one you are aligning.

Frequency Markers. Now, what about those frequency markers? The best bet here is to look for a crystal-controlled marker at each frequency of interest. There are several excellent multiple marker devices on the market—made by Heath, B & K, RCA and others. The Heath IG-57 uses 15 crystal-controlled markers covering just about all service areas. The B & K Model 415 uses the novel approach of having an actual alignment waveform etched on the front panel with small lamps placed properly on the curve, which come on as the various markers are selected. Of course, you could use a variable frequency marker, but make sure that there are provisions for calibrating it to keep all frequencies "on the head." In most cases, a crystal marker is supplied along with a variable marker to permit easy calibration.

The way in which the markers are injected is also important. Some of the older sweep generators inject the marker right along with the swept signal into the i-f strip. Although this approach does work, it may also produce problems, as the composite r-f level may produce overloading and severe distortion of the displayed curve. Also, in this approach, the marker will disappear when tuning into a trap. Most modern generators use "post injection" type markers to avoid these problems. Some even include an optional audio modulation for

greater ease of trap alignment, or for location of a particular marker.

Impedance Matching and AGC. One usually overlooked, self-generated problem involves the connection between the sweep generator and the equipment being tested. A conventional test lead, or a length of ordinary wire lying around the workbench, is definitely out. The name of the game is impedance matching because any changes in the impedances between the generator and cable and between the cable and the receiver under test can produce standing wave variations on the cable, causing the displayed response to shift all over the ballpark. It is always best to look for a generator having a properly terminated cable to keep out the unwanted responses. A simple test you can make is to couple your generator to a receiver, obtain a proper response, then slide your hand up and down the cable—keeping an eye on the displayed curve. If there is an impedance change, you will see the curve move about. If this happens, then get the proper cable for the generator and make sure it is terminated with the correct impedance device.

There is one more little thing—called agc. If you try an alignment of a receiver where the agc is operating, the display will be altered (and useless), since the agc system within the receiver will try to compensate for the variations in the curve. This sometimes takes on the appearance of a droop at one end of the curve, and a peak at the other. Any alignment made under these conditions is a waste of time. The answer is to use an agc voltage box or, even better, to look for a sweep generator having a built-in, variable-polarity agc voltage source—sometimes called a bias supply.

When you buy your new sweep generator, please take the time to read completely the manual that comes with it. If you're not buying a new one and have a perfectly good one on hand, sit down now and read the manual that came with it. It is amazing how many people buy a piece of expensive equipment, unpack it, and put it to work immediately without reading the manual—simply because they think they are already familiar with this kind of equipment. New design approaches and new component availability often make each new model more versatile than its predecessors, and most companies cover these changes in their manuals. ♦

THE SURFACE CHARGE TRANSISTOR

May be used in TV camera tubes or to store a million bits of data per cubic inch

BY DAVID L. HEISERMAN

EVERY time we think semiconductor packaging techniques (such as LSI—large scale integration) have provided the ultimate in compactness, something new is bound to come along. Now it is the surface charge transistor (SCT)—a semiconductor so small that several hundred of them can fit into the period at the end of a sentence.

In pre-transistor days, vacuum-tube digital computers had a maximum information handling density of about $\frac{1}{4}$ binary bit per cubic inch. Transistors pushed the figure to 10 bits/cu in.; and IC's increased it to 100. Recent MOS devices provide densities of 10,000 bits/cu in.; and how about the surface charge transistor? Would you believe 1,000,000 bits/cu in.?

Just how soon the SCT will appear in practical circuits depends largely on how rapidly development engineers can exploit the SCT's special operating characteristics.

Unusual Characteristics. Unlike other types of transistors, the switching and amplifying of an SCT do not rely on the flow of carriers through a substrate material. SCT's are purely electrostatic devices that use electrical charges on thin metallic electrodes to control the motion of other charges along the surface of a substrate material.

Existing MOSFET's (metal oxide silicon field-effect transistors) have an electrically charged metal gate which controls the flow of carrier current between the source and drain electrodes. An SCT has a metal gate connection (Fig. 1); but, unlike the source and drain connections of a FET, the SCT's *source* and *receiver* connections are also metal electrodes. All three electrodes are insulated from the substrate by a thin layer of silicon dioxide; and the only mechanism for passing information from the source to the receiver is that of electrostatic charge transfer.

Surface charge transistors must be "primed" before they can work, the priming consisting of applying a sub-microsecond voltage spike to the receiver. This spike must have the same polarity as the majority carriers in the substrate material. The priming pulse for a typical p-type SCT, for example, would be a 20-volt positive pulse with a duration of about 0.1 microsecond. This pulse sweeps most majority carriers out of the region around the receiver electrode, creating an unstable depletion region. Although carriers tend to drift back into the depletion region and eventually refill it, the region remains intact for several

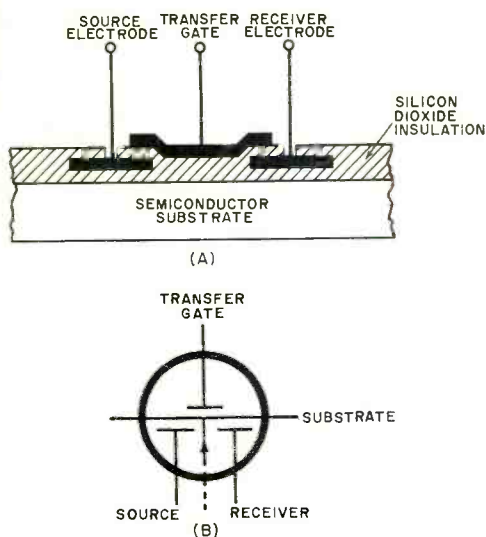

Fig. 1. Physical construction of an SCT is shown at (A). Substrate may be either p or n type. Proposed symbol for the transistor is shown at (B).

milliseconds—long enough to carry out thousands of high-speed computer operations.

Most of the charges that refill the depletion region move along the surface between the substrate and the silicon-dioxide insulation, and it is possible to control the rate of refilling by placing a positive charge (in the case of p-type substrates) on the transfer gate electrode. The greater the charge

of the electrodes, it is possible to control most of the charge transfer between the source and receiver using only a small charge on the transfer gate.

Applications. The most promising computer application of the SCT appears to be in large-scale shift registers (Fig. 2). By connecting a number of SCT devices in series and applying a fixed depletion bias to alternate electrodes, it is possible to shift combinations of high and low depletion regions one step along the register each time the transfer gates are "opened."

The SCT is also light sensitive. Light falling on the device tends to hasten the disappearance of the depletion region, the charge remaining over the depletion region being inversely proportional to time and the amount of incident light.

Coupling this optical effect with the shift-register approach may make it possible to create a solid-state TV camera consisting of 252 horizontal rows of closely spaced, series-connected SCT's electronically scanned. Any optical image focussed on the SCT matrix creates a depletion region replica of the scene. To retrieve this information, digital logic circuits can be used to shift the depletion regions to the right, one step at a time, one row at a time, at a rate corresponding to conventional TV techniques. The signal then emerging from the solid-state camera is a stream of video information, fully compatible with present TV systems. ♦

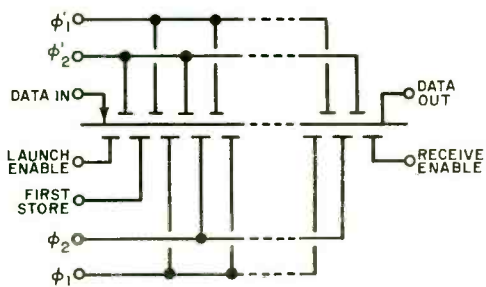
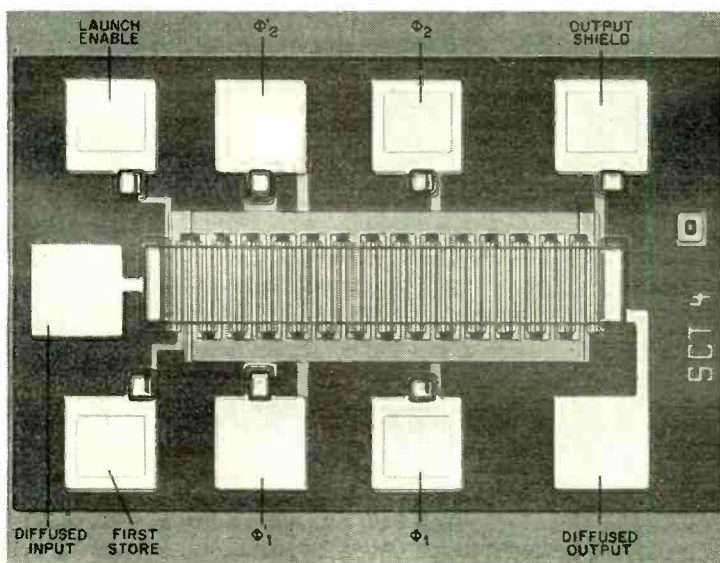

Fig. 2. SCT serial shift register can accumulate and shift any combination of high and low depletion regions through substrate from left to right.

on the transfer gate, the more slowly the receiver depletion region fills. Thus, the transfer gate acts as the controlling element in the SCT.

An electrical charge on the source electrode tends to hasten the refilling process; but, again, the gate potential controls the charge transfer rate and can even stop it altogether. By controlling the relative sizes



This 14-bit 5-MHz SCT shift register made by GE is only little bigger than the head of a pin.



New Products

SHURE V-15 TYPE III CARTRIDGE

Shure Brothers' announcement of the availability of all their all-new V-15 III stereo phono cartridge signals a major step forward in pickup design. Two new design features are the

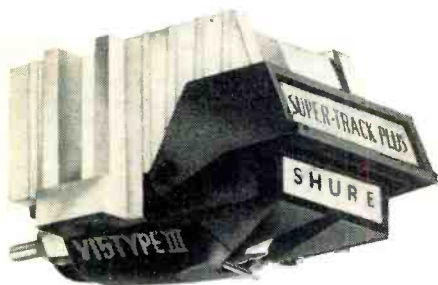

major contributors to the unique performance characteristics of the top-of-the-line Type III. One is an entirely new laminated magnetic core structure; the other is a new stylus assembly with a 25-percent reduction in effective stylus mass. The result is higher trackability at tracking forces in the range of $\frac{3}{4}$ to $1\frac{1}{4}$ grams, a virtually flat frequency response with no noticeable emphasis or de-emphasis at any frequency, and a significantly extended dynamic range—beyond that of even the V-15 Type II Improved.

Circle No. 70 on Reader Service Card

MITS DIGITAL CLOCK KITS

Two new digital electronic clocks have recently been introduced by MITS, Inc. One clock displays the time in hours, minutes, and seconds, while the other displays it in hours and minutes with an LED colon flashing the seconds. Both clocks are designed to operate on a 12/24-hour display and either 50- or 60-Hz power line frequencies. The readout displays are 7-segment LED units that can easily be read at distances up to 20 ft. The clocks are available in both wired and kit forms.

Circle No. 71 on Reader Service Card

HIGH-STYLE CABINETS FROM VECTOR

The clever use of standard parts, optional accessories, and modern finishes combines high styling with functional beauty in Vector's new line of card cases. Called Multi Mod, the system

104

provides 27 basic models with interior sizes ranging from 2 to 207 cu in. Sleek aluminum extrusions ranging in width from 1.6 to 4.5 in. provide the package foundation. The dominant functional feature of all cases is the four internal surfaces which have parallel 0.075-in. grooves for positioning, and holding PC boards, mounting, and shielding plates. Circuit boards mounted in the grooves need no additional fastening devices so that case exteriors can be unflawed by screws or bracket mounting holes.

Circle No. 72 on Reader Service Card

PIONEER BOOKSHELF SPEAKER SYSTEM

Project 100, a versatile bookshelf speaker system from U.S. Pioneer Electronics Corp., features a hemispherical dome tweeter for better transients and wider dispersion. Using an air-suspension type of enclosure that houses a 10-in. woofer and a 1½-in. hemispherical dome combination midrange and tweeter, the system is capable of handling a maximum power input of 35 watts. Because of its extreme rigidity, the cone of the woofer is not subject to breakup even with maximum inputs. The woofer has a long-throw voice coil and a neoprene half-roll surround that ensure clear bass response down to 30 Hz. The midrange/tweeter is peripherally driven, rather than at the apex, a feature that provides good transient response.

Circle No. 73 on Reader Service Card

PAGE 250-WATT 2-WAY RADIO TEST METER

Pace Communications has introduced a new Model P5425 2-way radio test meter with a 250-watt capacity. The tester features a 0-25-watt scale for use on CB and low-power business radio equipment and an accurately



calibrated 250-watt scale for checking medium- and high-powered business radio transceivers in the 25-50 MHz band. Crystal activity and a complete range of transmitter and receiver functions can be checked with the tester. On the 25-watt range, there is a built-in dummy load, while on the 250-watt range, through-line power measurements with the antenna in the

POPULAR ELECTRONICS Including Electronics World

circuit can be made, or an accurate dummy load can be connected.

Circle No. 74 on Reader Service Card

KENWOOD INTRODUCES LUXURY AMPLIFIER

A new 300-watt (1HF) direct-coupled stereo amplifier, the Model KA-8004, is the top-of-the-line unit in Kenwood Electronics' products. The new amplifier employs a combination of differential amplifier and 20 transistors in the preamp stage with complementary-symmetry and direct-coupled circuitry in the main amp stage for maximum stability, superior tonal quality, and the widest dynamic range. It boasts a maximum input level of 250 mV, with 15 volts of equalizer output. The main amplifier section delivers 55 watts/channel rms continuous power into 8 ohms at any frequency from 20 Hz to 20,000 Hz with 0.2 percent maximum THD. Two large filter capacitors eliminate transient distortion at very low frequencies and offer distortion-free reproduction even at low output levels.

Circle No. 75 on Reader Service Card

TV SERVICE AID TRIO FROM RCA

Three new test instruments recently released by RCA can make the TV serviceman's job much simpler. The Model WC-528B Quicktracer permits the technician to quickly check transistors and diodes in or out of the circuit. The Model WV-529A Service Special VOM was designed for rugged use, with a taut-band

meter movement, high-impact plastic case with recessed controls, and input polarity reversal switch. The Model WR-525A Marker-Signalyst can be used as an aid in checking vhf and uhf tuners as well as r-f/i-f receiver alignment when used with a sweep alignment generator; used as a Signalyst, it can reproduce video information on all vhf and many uhf channels.

Circle No. 76 on Reader Service Card

HIGH-ACCURACY DMM FROM WESTON

Weston Instruments' new Model 442 DMM is a low-cost, high-accuracy 3½-digit portable

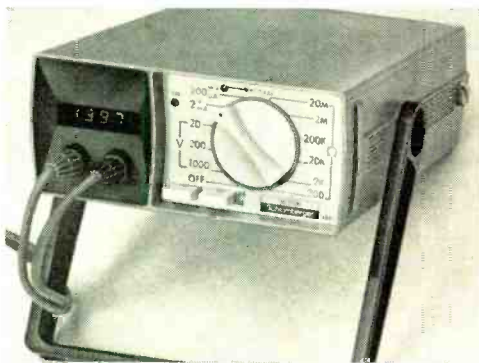

multimeter that is small enough to be carried in a standard attache case. Designed specifically

avanti's Astroplane gives CBer's Performance to brag about.

The unique construction features are exceptional.

4.46 db gain over isotropic is, and provides, a stronger transmit and a stronger receive.

To make use of the better signal, the Astroplane radiates the signal from higher up than other CB antennas and at a better angle. According to Dr. Alva Todd of the Midwest College of Engineering, "it possesses an unusually low angle of maximum radiation." This low angle of radiation means that your power is radiated at the horizon and not up into the clouds.

You'll also get long lasting, trouble-free performance because it is compact in design —without long drooping radials, without coils to burn or

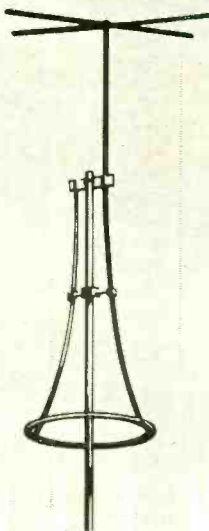

short out, and with direct ground construction for positive lightning protection and static dissipation.

\$29.95 Sugg. Retail

Gain 4.46 over isotropic
Power Capacity 2KW
Lightning protection D.C.
Ground

V.S.W.R. 1.2:1
Length 12 Ft.
Diameter 30 In.

Free 16 page color catalog

Write: Avanti, R & D, Inc.
35 W. Fullerton
Addison, Illinois 60101

avanti
RESEARCH AND DEVELOPMENT, INC.

creators of the
famous

MOONRAKER

CIRCLE NO. 1 ON READER SERVICE CARD

for field use, the 4442 is lightweight and shock-proof. A self-contained battery pack provides up to 12 hours of continuous operation. Twenty ranges cover 200 mV (100- μ V resolution) to 1000 volts ac and dc, 200 ohms (0.1-ohm resolution) to 20 megohms, and ac and dc current measurement capability. It has LED readouts, Dual Slope high-impedance bipolar A/D converter for excellent accuracy (0.05 percent) and long-term stability, a single MOS LSI chip for all logic circuitry, automatic polarity indication, automatic blanking of unused digits to conserve battery power, and overload protection.

Circle No. 77 on Reader Service Card

CHANNEL MASTER "SPORTENNA" SYSTEM

Channel Master's "Sportenna" system makes it possible for sport fans to obtain long-distance TV reception of locally blacked-out football, basketball, and hockey games while eliminating interference commonly experienced in such installations. Each Sportenna consists of an outdoor TV antenna and selected components specifically designed and engineered for a particular reception area. The key accessory is a new trap that blocks out adjacent-channel interference. In most areas, one trap is sufficient, but a second trap may be needed in certain areas. Local conditions determine the particular model antenna in the custom-designed installation kit.

Circle No. 78 on Reader Service Card

SAE STEREO PREAMPLIFIER

Scientific Audio Electronics are marketing their Mark XXX stereo preamplifier as the newest product in their component stereo line. The Mark XXX has tone and balance controls with

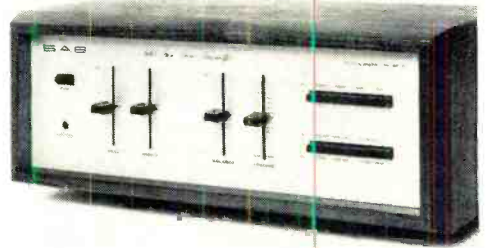

a center detent position; pushbutton program and mode selection; a tone defeat switch that electrically removes the tone amplifier from the circuit; one switched and one unswitched accessory ac outlets; and a stereo headphone jack. Low distortion and outstanding reproduction of all input signals are characteristic of the preamp. The Mark XXX complements the company's product line of preamplifiers, power amplifiers, digital FM tuners, equalizers, and loudspeaker systems.

Circle No. 79 on Reader Service Card

The Electronic Ignition that turns on Tom McCahill.

When Tom McCahill tested Gaylord's CompuSparkTM Capacitive Discharge Ignition, he said it flat out; "For my money, CompuSpark's a steal. Under 50 bucks. No moving parts. Fully electronic. Solid-state. And CD, too! "It's built like a brick out-house. They tried to wear one out and stopped at 270,000 miles when the car fell apart.

"What's in it for you? It virtually does away with point wear. Ends plug fouling hassles and puts plug wear way down the road. Often cuts your gas consumption by 20% and makes your engine run clean.

"The reasons for all this are as obvious as warts on a snake. A 60,000 volt spark is a helluva lot hotter than a stock ignition. CompuSpark -- 'The Ignition System with a Brain'TM actually computes spark characteristics to engine RPM. You get the right spark at the right time and the right place. Darned things run great in Alaska or the tropics. Why not? All Silicon, y' know. And the anti-theft lock really works!

"Another thing: CompuSpark is guaranteed one month longer than a Rolls-Royce. 37 months free repair or replacement. 30 day money back guarantee, too!

"Think of it this way: One skipped tune-up and CompuSpark has paid for itself. Two and you're money ahead. Plenty more where that came from -- you're in clover, right? **You bet.**

"Order your CompuSpark now. It turned me on. I'm sure it'll turn you on, too!"

© 1973 CD Systems Division
Gaylord Electronics Inc. Dept. 24JN.
2314 Fourth St. Berkeley, Calif. 94710
415/849-0300

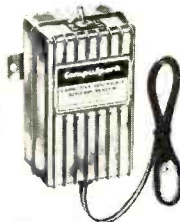

Installs in 15 minutes.

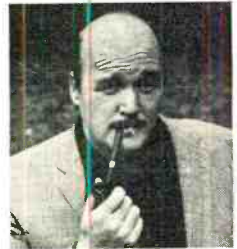

Rush me: CompuSpark ready to install. \$49.95
 Kit \$39.95
 CompuSpark brochure. free.

Car Year & Make _____

Name _____

Address _____

City, State, Zip _____

Enclosed: \$ _____ Ship ppd _____ Ship C.O.D. _____

Charge to my:
 Master Charge BankAmericard American Express
For Credit Card orders supply all card information.
California residents, please include sales tax.

CIRCLE NO. 14 ON READER SERVICE CARD

REALISTIC 4/2-CHANNEL TAPE DECK

Radio Shack's Model 494 4/2-channel, three-head tape deck records and plays four discrete channels for true quadraphonic performance and is fully compatible with conventional 2-channel stereo equipment. The deck features four recording level meters with individual controls, as well as a master recording level control, separate 4- and 2-channel record buttons, and three-speed operation. Three heads and a tape monitor switch allow instant comparison of source material with the recorded tape. A tape bias switch can be used for standard and low-noise tape, while preamp level controls allow adjustment of output levels to match other components in a hi-fi system without having to adjust the system volume when switching between program sources.

Circle No. 80 on Reader Service Card

CROWN'S NEW "AURALINEAR" SPEAKER LINE

Crown International moves into the loudspeaker market with the introduction of a line of four "Auralinear" speaker systems that unite electrostatic radiators with special acoustic suspension woofers. Radically new ultra-wideband electrostatic radiators have thinner membranes that deliver greater efficiency and acoustic output for realistic sound pressure levels. Dispersion has been improved with multi-element arrays set at precise angles. The Model ES 224 contains two 10" woofers and 24 electrostatic radiators. The Models ES 212, ES 26 and ES 14 also have 10" woofers but reduce the numbers of electrostatic radiators to 12, 6, and 4, respectively.

Circle No. 81 on Reader Service Card

ECONOMY-PRICED RECORD PLAYER FROM DUAL

The Model 1214 is both the newest and lowest priced record player in Dual's current line. Distributed by United Audio, the 1214 offers many features of the higher priced Duals: high-



torque constant-speed motor, 6 percent pitch control, silicone-damped cue control, and elevator-action changer spindle. The low-mass counterbalanced tonearm has low-friction pivot bearings for tracking as low as 1 1/4 grams. A built-in adjustable antiskating system is preset at the factory for optimum compensation with modern cartridges. Three-speed operation is



12 REASONS YOUR CAR NEEDS TIGER CDI

Instant starting in any weather - Eliminates tune-ups - Increases gas mileage - Increases horsepower 15% - Improves acceleration and performance - Spark plugs last up to 70,000 miles - Reduces engine maintenance expense - Amplifies spark plug voltage to 45,000 volts - Maintains spark plug voltage to 10,000 RPM - Reduces exhaust emissions - Dual ignition switch - An Unconditional LIFETIME GUARANTEE - Installs in 10 minutes on any car with 12 volt negative ground - No rewiring - Most powerful, efficient and reliable Solid State Ignition made.

SATISFACTION GUARANTEED or money back.

TIGER 500 assembled \$49.95

TIGER SST assembled 39.95

TIGER SST Simpli-Kit 29.95

Post Paid in U.S.A.

Send check or money order with order to:

Tri-Star Corporation

Dept. W, P. O. Box 1946
Grand Junction, Colorado 81501

DEALER INQUIRIES INVITED

CIRCLE NO. 34 ON READER SERVICE CARD



FREE

1973 LAFAYETTE CATALOG 730

Ready Now!

Your Complete Electronics Buying Guide

- Stereo/Hi-Fi Components • CB Transceivers & Walkie-talkies • PA Systems • Tools & Test Equipment
- Police/Fire Monitor Receivers • Antennas • Photography Equipment • Ham Gear • Books, Parts, and More!

Send Today!

Lafayette Radio Electronics
P.O. Box 10, Dept. 35063
Syosset, L.I., N.Y. 11791

35063

NAME _____

ADDRESS _____

CITY _____

STATE _____ ZIP _____

CIRCLE NO. 17 ON READER SERVICE CARD

AT LAST! PROFESSIONAL HOME PROTECTION EVERYONE CAN INSTALL AND AFFORD.

Model FC-100
\$69.95
WIRED



- Start your custom Burglar/Hold-up/Fire Alarm System with the FC-100. Add on Sensors, Alarms and Accessories to suit your own needs.
- "Do-it-Yourself" Installers Handbook included. No technical knowledge needed — No soldering.
- 100% Professional in Design, Reliability, Performance.



'Fail Safe'-SYSTEM BY EICO

A New Concept in "Do-it-Yourself" Home Protection

FREE 32 PAGE EICO CATALOG

For latest catalog on EICO Test Instruments, Stereo, EICOCRAFT Projects, Environmental Lighting, Burglar/Fire Alarm Systems, and name of nearest EICO Distributor, check Reader Service Card or send 25¢ for First Class mail service.

EICO, 283 Malta Street, Brooklyn, N.Y. 11207



CIRCLE NO. 11 ON READER SERVICE CARD

Midwest Hifi

WHOLESALE & MAIL ORDER DIVISION

Protect your wallet.

Don't pay retail prices. Choose from over 100 name brands, and save on freight charges by ordering from the location nearest you.

Write today for our free catalog!
Midwest Hifi Wholesale & Mail Order Div.,
2455b Wisconsin Ave.,
Downers Grove, Ill. 60515 (Attn Peter Eckart)
3309 E. J W Carpenter Frwy.,
Irving, Tex. 75062 (Attn Paul Eisner)

CIRCLE NO. 22 ON READER SERVICE CARD

featured, and a molded plastic or oiled walnut base and separate dust cover are available.

Circle No. 82 on Reader Service Card

ARCHERKIT AUTO/MARINE TACHOMETER

Radio Shack's new Archerkit auto/marine tachometer kit indicates engine speed from 0 to 8000 rpm on any 4-, 6-, or 8-cylinder engine with a 12-volt electrical system. The unit can be mounted in any position and the rotatable bezel adjusted for best visibility of the 3¼-in. lighted dial. An all-metal case and ruggedly constructed meter movement make the tachometer highly resistant to shock and vibration. The all-electronic circuit design compensates for normal changes in voltage and temperature for readings with ± 2 percent accuracy.

Circle No. 83 on Reader Service Card

HEATH R-F ABSORPTION WATTMETER KIT

An r-f absorption wattmeter for the ham who wants to tune up his transmitter off the air is available in kit form from the Heath Company as their Model HM-2103. It uses a 50-ohm noninductive load resistor and has a less than 1.2:1 SWR for measuring 1.8-30-MHz



r-f. The built-in wattmeter offers 0-200 and 0-1000 ranges with a ± 10 percent accuracy (full-scale). Power rating is 175 watts continuous, 1000 watts maximum. The rugged air-cooled resistor eliminates the need for oil coolant. An overload indicator lamp, coupled through a thermal switch and a 9-volt battery, uses a back-up circuit to permit testing both lamp and battery conditions.

Circle No. 84 on Reader Service Card

SUPERSCOPE STEREO AMPLIFIER

Superscope Inc., has introduced the Model A-240 solid-state integrated stereo amplifier to their initial product line. The amplifier delivers 30 watts of IHF power into 8-ohm loads. It features tape monitoring capability, main and remote speaker switching, direct-coupled two-stage phono preamplifier, stereo headphone jack, and a signal source selector for tuner, phono, tape, and auxiliary inputs. Also featured are a loudness control, a stereo balance control, separate bass and treble controls, and a switched ac outlet.

Circle No. 85 on Reader Service Card

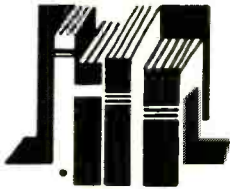

Electronics Library

VIDEO RECORDING

by Gordon White

This book describes the principles of video recording and discusses the various systems that are now on the market or will soon make an appearance. The book is technical, but it is written so that people who have an interest in the subject will find no difficulty in understanding the principles, advantages, and disadvantages of the various systems. As every manufacturer uses different circuitry, detailed circuits are not described. Instead, the text provides detailed descriptions of the techniques that all manufacturers employ when designing video equipment.

Published by Crane, Russak & Co., Inc., 52 Vanderbilt Ave., New York, NY 10017. Hard cover. 208 pages. \$10.75.

SHORTWAVE LISTENER'S GUIDE, Fifth Edition

by H. Charles Woodruff

This enlarged and fully revised guide was written for the millions of hobbyists known to have shortwave receivers in the U.S. It is arranged in an easy-to-use format so that the reader can gain maximum enjoyment from his hobby. The book is divided into four sections. The first consists of an alphabetical listing of worldwide SW broadcasting stations. Section two lists stations by frequency and country. The third section divides the day into six 4-hour periods and lists stations by the times they broadcast within their respective time periods. The last section lists known clandestine stations. At the back of the book is a handy 6-page log for recording stations heard.

Published by Howard W. Sams & Co., Inc., 4300 West 62 St., Indianapolis, IN 46268. Soft cover. 128 pages. \$2.95.

SOLID STATE SERVICING

This book is intended to be the extra tool on the technician's workbench that will simplify and cut the time required to make repairs, with greater assurance of customer satisfaction. It explains how to deal with troubleshooting problems in a direct, logical manner on color and monochrome TV receivers, AM and stereo and mono FM receivers, and hi-fi and tape-

recorder amplifiers. The text describes actual in-circuit test equipment hookups and typical field alignment and adjustment procedures. The professional service technician will find this manual a valuable training and reference tool in his shop, and the amateur or neophyte will benefit from it by learning how to repair his own equipment.

Published by RCA Commercial Engineering, Harrison, NJ 07029. Soft cover. 352 pages. \$3.95.

RECENT TITLES FROM TAB BOOKS

(Blue Ridge Summit, PA 17214)

HOW TO SOLVE SOLID-STATE CIRCUIT TROUBLES

by Wayne Lemons

This book contains 161 circuit descriptions and step-by-step troubleshooting procedures for analyzing and repairing any type of solid-state entertainment equipment.

304 pages. \$8.95 hard cover; \$5.95 soft cover.

ALL-IN-ONE TV ALIGNMENT HANDBOOK

by Jay Shane

This book discusses how to recognize some of the classical TV misalignment symptoms that can steer the technician to a speedy repair of even the toughest of tough dogs. Also discussed in detail are the basic alignment instruments needed and the tests and measurements to be performed prior to making an all-out alignment.

304 pages. \$8.95 hard cover; \$5.95 soft cover.

NEW TITLES FROM HOWARD W. SAMS & CO., INC.

(4300 West 62 St., Indianapolis, IN 46268)

HOW TO WIRE HI-FI EXTENSION SPEAKERS

by Len Buckwalter

This book tells you what the manufacturers don't about the job of wiring extension loud-speaker systems into an audio system.

Soft cover. 96 pages. \$3.95.

FROM CB TO HAM BEGINNER

by J.A. Stanley

CB'ers, do you want to be able to DX and rag-chew and still stay on the right side of the law? If you do, this book was written for you; it tells how to make the transition from CB to amateur radio operator.

Soft cover. 144 pages. \$4.25.

TUBE SUBSTITUTION HANDBOOK, Sixteenth Edition

There is no real need to describe this book except to say that it contains a cross-index of more than 12,000 receiving and picture tube substitutions.

Soft cover. 96 pages. \$1.75.

Planning to move?

Let us know **6 to 8 weeks in advance** so that you won't miss a single issue of **POPULAR ELECTRONICS INCLUDING ELECTRONICS WORLD**

Attach old label where indicated and print new address in space provided. Also include your mailing label whenever you write concerning your subscription. It helps us serve you promptly.

Write to: P.O. Box 2774, Boulder, Colo., 80302 giving the following information.

If you have no label handy, print OLD address here.

name	please print
address	
city	
state	zip-code

AFIX LABEL

Change address only.

Extend subscription. Enter new subscription.

(1) 5 yrs. \$21 (2) 3 yrs. \$15. (3) 1 year \$6

Payment enclosed (1 extra issue per yr. as a BONUS)

Bill me later.

0777

name please print

address

city state zip

Add'l postage: \$1 per year outside U.S., its possessions & Canada.

ABOUT YOUR SUBSCRIPTION

Your subscription to POPULAR ELECTRONICS is maintained on one of the world's most modern, efficient computer systems, and if you're like 99% of our subscribers, you'll never have any reason to complain about your subscription service.

We have found that when complaints do arise, the majority of them occur because people have written their names or addresses differently at different times. For example, if your subscription were listed under "William Jones, Cedar Lane, Middletown, Arizona," and you were to renew it as "Bill Jones, Cedar Lane, Middletown, Arizona," our computer would think that two separate subscriptions were involved, and it would start sending you two copies of POPULAR ELECTRONICS each month. Other examples of combinations of names that would confuse the computer would include: John Henry Smith and Henry Smith; and Mrs. Joseph Jones and Mary Jones. Minor differences in addresses can also lead to difficulties. For example, to the computer, 100 Second St. is not the same as 100 2nd St.

So, please, when you write us about your subscription, be sure to enclose the mailing label from the cover of the magazine—or else copy your name and address exactly as they appear on the mailing label. This will greatly reduce any chance of error, and we will be able to service your request much more quickly.

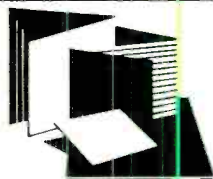

New Literature

SCINTREX STEREOPHONES BROCHURE

A 4-page brochure in which are listed and described five models of stereo headphones is available from Scintrex. Among the listings are phones for every budget and audiophile demand. The entire specification lineups for the various models are given. Address: Scintrex Audio Div., Scintrex Inc., 400 Creekside Dr., Amherst Industrial Park, Tonawanda, NY 14150.

UNIVERSITY MIKES SPECIFICATION SHEETS

Specification sheets for three new University Sound microphones in the professional category are available for the asking. Described in detail on separate sheets are the Models 1656G and 1656 cardioid and 1655 omnidirectional microphones. All are professional mikes, designed for faithful reproduction of sound. Address: University Sound, 1515 S. Manchester Ave., Anaheim, CA 92803.

XCELITE ATTACHE TOOL CASE BULLETIN

New Product Bulletin No. N273, just issued by Xcelite, contains complete information, including prices, on the company's new attache-style tool case, Model TC-200/ST and its companion Model TC-100/ST. Described and illustrated are the cases and tool assortments. Detailed are dimensions and design features, including removable tool pallet and tray, plus suggested uses for the pockets and extra tool space provided in each case. A description and model number for each tool furnished with the tool kits is in tabular form. Address: Xcelite Inc., 344 Delaware Ave., Buffalo, NY 14202.

JERROLD 2-WAY TV SYSTEMS BROCHURE

A new 12-page brochure explaining the patented J-Jacks system that provides unusual flexibility and ruggedness to educational and medical TV systems is available from Jerrold. The text covers design and installation procedures, from basic distribution systems to sophisticated automatic two-way systems. Architect specifications are included. Address: Jerrold Electronics Corp., 401 Walnut St., Philadelphia, PA 19105.

VECTOR SHORT-FORM CATALOG

Packaging products from A (aluminum rails)

to V (Vectorbord) are described in a new short-form catalog, No. 23, issued by Vector Electronic Co. Specifications, features, and prices are given for terminals, patchboards, card cases, sockets, Vectorbord, and Micro-Vectorbord. Fourteen types of circuit boards, including the new factory-applied, direct, and positive photo resist boards are described. Also included is a listing of a wide variety of IC sockets, receptacles for PC cards, card cases, as well as the Vector-Pak System and Multi-Mod cases. Address: Vector Electronic Co., Inc., 12460 Gladstone Ave., Sylmar, CA 91342.

EDC SOLDERING IRON BULLETIN

The all-new Endeca dual-heat pencil soldering iron with an exclusive built-in power indicating light is described in Bulletin No. 540 available from Enterprise Development Corp. The Bulletin describes and illustrates the various irons offered, types of iron-clad soldering tips, and a desoldering head. Address: Enterprise Development Corp., 5127 E. 65 St., Indianapolis, IN 46220.

SOLA ELECTRIC POWER SUPPLY CATALOG

Sola Electric has just published a new power supply catalog, No. 617, that describes, in its six fold-out pages, four different standard de power supplies. Among the listings are a rack-mounted supply, an open-frame regulated supply series, a premium IC-regulated supply, and a constant voltage supply. Address: Sola Electric, 1717 Busse Rd., Elk Grove, IL 60007.

RCA LINEAR IC PRODUCT GUIDE

A new 48-page product guide (Catalog No. CDL-820E) that provides quick-reference information on linear IC's is available from RCA Solid State Division. The catalog provides easy-to-read information that gives ready access to schematics and block diagrams, charts, general applications notes, features, and comparisons between types. Also included are an industry cross-reference guide to RCA linear IC's and applications notes and technical papers. Address: RCA Solid State Div., Route 202, Somerville, NJ 08876.

SILICONIX FET APPLICATION NOTE

A 16-page application note that deals with the techniques to use in applying FET's as voltage-controlled resistors (vcr's) is available from Siliconix. It discusses the characteristics of JFET's as vcr's and draws performance comparisons between the JFET vcr and conventional fixed-value resistors. Numerous circuit applications are presented, in addition to means of reducing signal distortion via feedback techniques and an analytical approximation of predicting FET vcr behavior. Address: Siliconix Inc., 2201 Laurelwood Rd., Santa Clara, CA 95054.

Now... the most enjoyable, do-it-yourself project of your life—a Schober Electronic Organ!



You'll never reap greater reward, more fun and proud accomplishment, more benefit for the whole family than by assembling your own Schober Electronic Organ.

You need no knowledge of electronics, woodwork or music. Schober's complete kits and crystal-clear instructions show you — whoever you are, whatever your skill (or lack of it) — how to turn the hundreds of quality parts into one of the world's most beautiful, most musical organs, worth up to twice the cost of the kit.

Five superb models, with kit prices from \$500 to around \$2,000, each an authentic musical instrument actually superior to most you see in stores.

Get the full story FREE by mailing the coupon TODAY for the big Schober color catalog, with all the fascinating details!

The *Schober* Organ Corp., Dept. PE-50
43 West 61st Street, New York, N. Y. 10023
 Please send me Schober Organ Catalog.
 Enclosed please find \$1.00 for 12-inch L.P. record of Schober Organ music.

NAME _____
ADDRESS _____
CITY _____ STATE _____ ZIP _____

CIRCLE NO. 29 ON READER SERVICE CARD

POLY-PLANAR IS WEATHERPROOF SOUND.

Put a Poly-Planar speaker anyplace you listen to music out-of-doors. Hang them, mount them, stand them anywhere—from your favorite tree, under an eave, on the patio, beach, fence, diving board... Send for detailed specifications



THE SPEAKER YOU DON'T HAVE TO SEE TO HEAR.

The Magitran Company
311 East Park Street • Moonachie, New Jersey 07074
CIRCLE NO. 39 ON READER SERVICE CARD

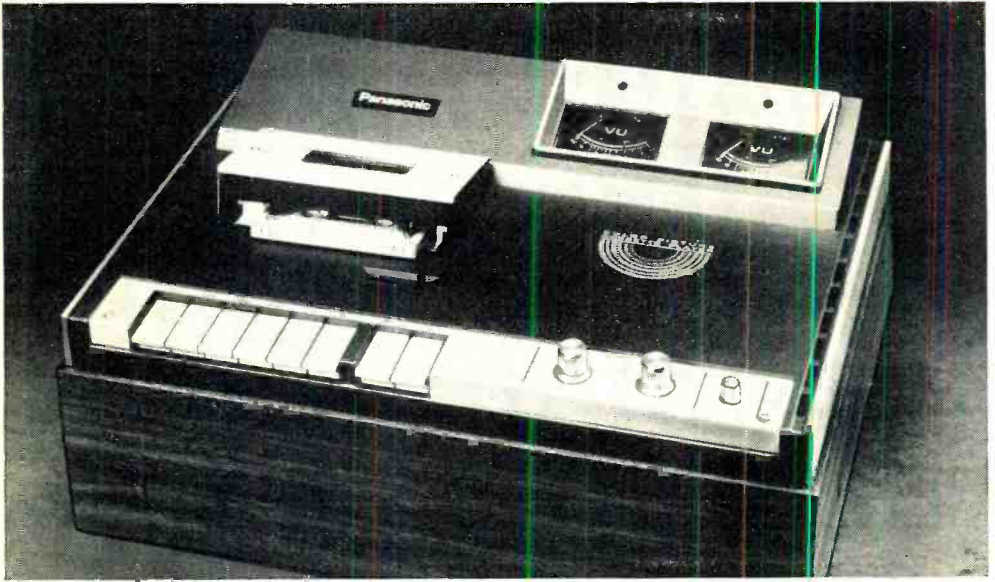

VIDEO COLOR PICTURE PLAYER USES STANDARD AUDIO CASSETTES

THIS past March at the annual IEEE Intercon show held in New York's Coliseum, Matsushita Electric Industrial Co., Ltd., unveiled a new concept in audio/video tape playback systems. Representing a major breakthrough in the art of audio/visual presentation, their Panasonic Color Picture Cassette Player displays a sequence of high-quality still pictures on a standard color TV receiver screen.

The Color Picture Cassette Player plays back pictures recorded on standard, inexpensive Philips-type audio cassettes. What is more, the cassettes can be used on both sides while retaining their stereo sound capability and compatibility with any audio cassette player.

Rotating magnetic heads in the Color Picture Cassette Player scan the cassette tape in the longitudinal direction. Video information is stored in two narrow bands near the center of the tape *between* the audio bands.

The cassette tape when played through the new player travels at the standard speed of 1-7/8 ips, allowing complete audio compatibility. Still color pictures are shown for an interval of approximately 3.6 seconds.

However, any single picture can be displayed for any multiple of 3.6 seconds. The video information on the cassette displays a high-resolution color picture when the player is connected to any conventional color TV receiver. The low-distortion video signal is accompanied by full stereo sound that can be played through a conventional stereo amplifier.

A standard C-60 audio cassette can record and store more than 1000 images in addition to its stereo soundtrack. By contrast, 16-mm film cartridges or even bulkier and shorter 35-mm filmstrips accommodate a maximum of 300 frames.

Operating the Color Picture Cassette Player is not very different from operating a conventional audio cassette deck. Once the cassette is inserted into its slot, a push-button switch is depressed. All other operations are automatic, including tape motion shutoff when play is finished. Individual controls are provided for adjusting the volume of the audio tracks, while a pair of VU meters monitor the audio playback level. Piano-key controls are used for operating the loading, play, pause, fast-forward, rewind, stop, and eject functions. ♦



Surplus Scene

By Alexander W. Burawa, Associate Editor

QUICK-REFERENCE DEALER GUIDE—Part I

FOR THOSE of you who keep asking for the addresses of this dealer and that and where to get what, we have decided to devote as many columns as it takes to compile a quick-reference guide to the dealers doing business on the Surplus Scene. Here is the first installment.

Poly Paks, P.O. Box 942, South Lynnfield, MA 01940. Transistors, diodes, triacs, digital and linear IC's; resistors, capacitors, controls, switches, transformers; fibre optics kits; digital electronic clock kit; assorted parts specials.

Edmund Scientific Co., 380 Edscorp Bldg., Barrington, NJ 08007. Something for everyone: lasers, calculators, intercoms, parabolic microphones, optics, microscopes, telescopes, light-show equipment, scientific items and games, ecology kits.

Solid State Systems, Inc., P.O. Box 773, Columbia, MO 65201. Not really a "surplus" dealer, but great prices on digital and linear IC's and numeric readouts; universal decade counting units in various configurations; voltage regulators; resistors, capacitors, transformers, and Molex IC socket pins.

Delta Electronics Co., P.O. Box 1, Lynn, MA 01903. IC's, SCR's, UJT's, FET's, bipolar transistors, diodes; resistors, capacitors, switches, controls, transformers; surplus computer boards, power supplies; push-button switch assemblies.

Star-Tronics, P.O. Box 17127, Portland, OR 97217. Resistors, capacitors, transformers, switches, controls; military surplus test equipment; panel meters, motors, cables, connectors.

KA Sales, 1312 Slocum St., Dallas, TX 75207. Digital and linear IC's, transistors, diodes; numeric readouts; resistors, capacitors, pots, lamps, sockets, switches, etc.

Solid State Sales, P.O. Box 74A, Somerville, MA 02143. IC's, transistors, SCR's, triacs, LED's, power rectifiers and bridges, diodes; gas-discharge and LED numeric readouts; tantalum capacitors; 10-turn trim pots; IC designer PC boards; decade counter kit.

R.E. Goodheart Co., Inc., P.O. Box 1220, Beverly Hills, CA 90213. Everything in military and commercial/industrial surplus test and measurement equipment, communications gear, etc. (When writing for catalog, specify type of equipment that interests you.)

Fair Radio Sales Co., P.O. Box 1105, Lima, OH 45802. Military surplus equipment: transmitters, receivers, transceivers, amplifiers; test equipment: test sets, scopes, carrier monitors, summation bridges, power supplies; headphones, antennas, microphones.

Cortlandt Electronics, Inc., 16 Hudson St., New York, NY 10013. Kits; old-type vacuum tubes; motors, stepping switches, relays; transformers, resistors, capacitors, switches, controls; panel meters, barrier blocks, enamel paints, hardware; semiconductors; numeric and alpha-numeric read-out devices.

John Meshna Jr. Electronics, P.O. Box 62, E. Lynn, MA 01904. Small parts, transistors, IC's; radiation survey meters; ASCII alpha-numeric keyboards with and without encoders; motors, nickel-cadmium cells, underwater microphones.

Circuit Specialists Co., P.O. Box 3047, Scottsdale, AZ 85257. All sorts of small parts; 7-segment numeric displays; transistors, diodes, electronic attenuators, digital and linear IC's (wide range of Motorola HEP devices); Circuit-Stik etchless PC materials; capacitors, chokes, transformers, LMB cabinets. ♦

ELECTRONICS MARKET PLACE

NON-DISPLAY CLASSIFIED: COMMERCIAL RATE: For firms or individuals offering commercial products or services, \$1.60 per word (including name and address). Minimum order \$16.00. Payment must accompany copy except when ads are placed by accredited advertising agencies. Frequency discount: 5% for 6 months; 10% for 12 months paid in advance. **READER RATE:** For individuals with a personal item to buy or sell, \$1.00 per word (including name and address.) No minimum! Payment must accompany copy. **DISPLAY CLASSIFIED:** 1" by 1 column (2 3/8" wide), \$200.00. 2" by 1 column, \$400.00. 3" by 1 column, \$600.00. Advertiser to supply cuts. For frequency rates, please inquire.

GENERAL INFORMATION: First word in all ads set in bold caps at no extra charge. All copy subject to publisher's approval. All advertisers using Post Office Boxes in their addresses **MUST** supply publisher with permanent address and telephone number before ad can be run. Advertisements will not be published which advertise or promote the use of devices for the surreptitious interception of communications. Closing Date: 1st of the 2nd month preceding cover date (for example, March issue closes January 1st. Send order and remittance to Hal Cymes. **POPULAR ELECTRONICS** Including **ELECTRONICS WORLD**, One Park Avenue, New York, New York 10016.

FOR SALE

FREE! bargain catalog. Fiber optics. LED's, transistors, diodes, rectifiers, SCR's, triacs, parts. Poly Paks, Box 942, Lynnfield, Mass. 01940.

GOVERNMENT Surplus Receivers. Transmitters, Sniperscopes, Radios, Parts, Picture Catalog 25c. Meshna, Nahant, Mass. 01908.

LOWEST Prices Electronic Parts. Confidential Catalog Free. KNAPP, 3174 8TH Ave. S.W., Largo, Fla. 33540.

ELECTRONIC PARTS, semiconductors, kits. FREE FLYER. Large catalog \$1.00 deposit. BIGELOW ELECTRONICS, Bluffton, Ohio 45817.

CONVERT any television to sensitive, big-screen oscilloscope. Only minor changes required. No electronic experience necessary. Illustrated plans. \$2.00. Relco-A33, Box 10563, Houston, Texas 77018.

WE SELL CONSTRUCTION PLANS. TELEPHONE: Answering Machine, Speakerphone, Carphone, Phonevision, Auto Dialer, Touch Button Dialer, Central Dial System. **TELEVISION:** \$35.00 Color Converter, Video Tape Recorder. \$25.00 Camera. **HOBBYIST:** Electron Microscope, 96 Hour Tape Music System, Ultrasonic Dishwasher, Radar-Oven. Plans \$4.95 each. **NEW ITEM:** \$75 Electronic Pocket Calculator, \$7.50. **COURSES:** Telephone Engineering \$39.50. Detective Electronics \$22.50. Integrated Circuit Engineering, \$49.50. **NEW SUPER HOBBY CATALOG** plus year's subscription to Electronic New Letter **AIRMAILED \$1.00.** Don Britton Enterprises, 6200 Wilshire Blvd., Los Angeles, Calif. 90048.

RAIO—T.V. Tubes—36¢ each. Send for free catalog. Cornell, 4213 University, San Diego, Calif. 92105.

SENCORE, B&K Test Equipment Unbelievable Prices. Free Catalog and Price Sheet. Fordham Radio, 265 East 149th Street, Bronx, N.Y. 10451.

METERS—Surplus, new, used, panel or portable. Send for list. Hanchett, Box 5577, Riverside, CA 92507.

PYROTECHNICAL chemicals, casings, tools, supplies, fuse, literature. Giant, illustrated catalogue/handbook includes formulas. instructions—50¢, with samples—\$1.00. Westech, Box 593, Logan, Utah 84321.

ELECTRONIC COMPONENTS—Distributor prices, Free catalog. Box 2581, El Cajon, California 92021.

ANTIGRAVITY, experiment and theory, Rushed—\$2.00. U.S. Inquiries. Intertech 7AB, Box 5373, Station-F, Ottawa, Canada.

JAPAN HONG KONG DIRECTORY. World products information. \$1.00 today. Sekai Shogyo Annai. Hillyard, Washington 99207.

TEST EQUIPMENT, Aerospace-Laboratory Grade. Request your needs; will mail appropriate catalogs (we have 24 catalog categories). Only for Engineers, Businesses, Schools and advanced Technicians. Goodheart, Box 1220PE, Beverly Hills, Calif. 90213.

CONSTRUCTION PLANS: Laser . . . \$2.00. Missile Tracker . . . \$2.00. Catalog 25c. ESP Experimenters Kit . . . \$2.00. Howard, P.O. Box 35271, Detroit, Michigan 48235.

GREGORY ELECTRONICS
Reconditioned & Used
FM 2-WAY RADIO ASSETS
Partial List—Send for New Catalog

MOTOROLA

U51GGT

40-50 MHz

12 volts, 60 watts.

Transistorized power supply. Narrow band complete with accessories

Private line (if available) add \$35.



\$188

Just Arrived! G.-E. "Message Mates"
High Band Receivers with Sel-Call

G.E. PROGRESS LINE STRIPS, physically complete, AS IS!	LOW BAND	VHF	UHF
Power supply, 30 watts, less vibrator	MA E13 MA E16 MA E33 MA E36 MA E42		
Power supply, 60 watts, less vibrator			
TX narrow band less final tubes			
Note: MA/E42 wide band	\$18	\$25	\$25
FX wide band			
less ovens	\$18	\$18	\$12
1 1/2" Progress Line Case, consisting of front basket and front plate with lock			\$5
Low band dual front end, 2 freq. strip			\$15

GREGORY ELECTRONICS CORP.
249-F Rt. 46, Saddle Brook, N.J. 07662
Phone: (201) 489-9000

BUILD YOUR OWN SPACE-AGE TV CAMERA



ONLY KNOWN SOLIDSTATE CAMERA KIT! Ideal for experimenters, students, education, industry, etc. * High quality * Backed by over six years of lab & field testing * Fully Guaranteed * Connects to any TV set without modification * Step-by-step construction manual * Model KIT-10, Series D Complete kit includes \$115.00 postage anywhere in US & Canada (first vidicon kit \$115.00)

PHONE OR WRITE FOR CATALOG.
800-462-987-2773

Many other kits, parts assemblies available including starter kits, focus-defl. coils, vidicon tubes, const. plans, audio subcarrier kit, etc.

3001 BROADWAY **ATV Research** DAKOTA CITY, NEBR. 68731

AMATEUR SCIENTISTS, Electronics Experimenters, Science Fair Students . . . Construction Plans—Complete, including drawings, schematics, parts list with prices and sources . . . Robot Man — Psychedelic shows — Lasers — Emotion/Lie Detector — Touch-Tone Dial—Quadrasonic Adapter—Transistorized Ignition —Burglar Alarm—Sound Meter . . . over 60 items. Send 25¢ coin (no stamps) for complete catalog. Technical Writers Group, Box 5994, State College Station, Raleigh, N.C. 27607.

SCOPES, meters, test equipment, military and industrial surplus. Write for free "Bargain Bulletins". Lawrence Instruments, P.O. Box 744, Sunbury, Pa. 17801.

MECHANICAL, ELECTRONIC devices catalog 10¢. Greatest Values—Lowest Prices. Fertik's, 5249 "D", Philadelphia, Pa. 19120.

DIGITAL ELECTRONICS! Complete schematics, parts lists, theories—Discrete Component Digital Clock, \$3.00—Sound Sensitive Switch, \$1.50. Increase technical competence, hobby skills—Complete Course in Digital Electronics is highly effective, \$10.00. Free literature. DYNASIGN, Box 60A7, Wayland, Mass. 01778.

SURPLUS electronics for everyone. Free catalog. U.S. inquiries. ETCO, 464 McGill, Montreal, Canada.

FREE Catalog lists resistors, tubes, transistors, rectifiers, condensers, tools, tuners, etc. Hytron Hudson, Dept. PE, 2201 Bergenline Ave., Union City, N.J. 07087.

ELECTROENCEPHALOPHONE: brainwave monitor. Professional biofeedback instruments. J&J, 8102-E, Bainbridge, Wash. 98110.

OSCILLOSCOPE improvement. Add trigger sweep and dual trace to any scope using low cost kits. HTP, Box 901, Cupertino, Calif. 95014.

FREE CATALOG
UP TO 50% OFF COMPARABLE KITS*
•BUY DIRECT •SAVE \$\$\$

FREE Catalog—Electronic Kits—Amplifiers—Preamps—Psychedelic Strobes—Burglar Alarms—Digital Tachometer—More: Free Catalog. SWTPC, Box A32040, San Antonio, Tex. 78284.

IGNITION SYSTEMS: Capacitor, Transistor. Information 10¢. Anderson Engineering, Epsom, N.H. 03239.

AUTHENTIC, INSTRUMENTED, FLYING ROCKETS for casual or serious experimenters. Over 80 scale, original, multi-stage or ready-to-fly models. Solid-propellant engines for safe, electric launch system liftoffs up to 2,500 feet. Measure altitude, temp. inversions, more. Real telemetry, electronic tracking, aerial still and movie photography with super-miniaturized equipment. New, detailed tech manual and full-color catalog, 25¢ from ESTES INDUSTRIES, Dept. 18K, Penrose, Colo. 81240.

SHARE my Electronic Profits, your area! Free details! Hutson 23S, 1425 E. Madison, El Cajon, CA 92021.

WHOLESALE C.B., multiband receivers. Lowest prices. Catalog 25¢. G-Enterprises, Box 14P, O'Fallon, Ill. 62269.

ALPHA/THETA feedback instruments—\$25. Sensitive circuit of \$75 unit. Ultimate ease of use. Inner Space Electronics, Box 308PE, Berkeley, CA 94701.

ELECTRONIC CDI Ignitions, VHF/UHF monitors, CB radios. Wholesale. Southland, Box 3591, Baytown, Texas 77520.

EXPERIMENTER and audiophile-test cables, chemicals, useful items—Free catalog. Technical Services, Box 687, Arlington, MN 55307.

1973 HOBBY ELECTRONICS DIRECTORY. \$1.50, Newcal, Box 323A, El Segundo, Cal. 90245.

SURPLUS and **NEW** electronics for pros and serious amateurs. Computer memories, boards, I.C.S., semi-conductors. 2N2222, eight for \$1. Miniature 4V 40MA Lamp, eleven for \$1. Fifteen magnetic reeds on board, \$1. Tri-Tek, Inc., P.O. Box 14206, Phoenix, Arizona 85063.

BRAIN WAVE CONTROL Biosone BF-2 Alpha Training Instrument. \$34.95 complete. Not a Kit. Fully Guaranteed. For information write. BIO-LOGIC DEVICES, Dept. A, Box 308, Stewartstown, Pa. 17363.

FREE CATALOG. Parts, circuit boards for Popular Electronics projects. PAIA Electronics, Box C14359, Oklahoma City, OK 73114.

BURGLAR-FIRE alarm supplies and information. Free catalog. Protecto Alarm Sales, Box 357-G, Birch Run, Michigan 48415.

Special New
Digital Multimeter
Kit 3½ Digits
—Volts—Ohms
—Current—Capacity
\$99.95 in Kit Form
\$149.95 Pre-Wired

Send For Free Flyers On Linears, PC Kits, Readouts, Resistors & Other Bargains

DIODES	
1N4148	100 for 3.00
1N4001	60 for 3.00
1N4004	40 for 3.00
1N4007	20 for 3.00
1N4729A	15 for 3.00
1N4734A	15 for 3.00

Min. order \$3.00. On orders less than \$10.00 enclose .50 for postage and handling. Send check or M.O.

EDWARDS ELECTRONICS

The John Edwards Electronics Co.
P.O. Box 465, Glen Ellyn, Ill. 60137

CIRCLE NO. 35 ON READER SERVICE CARD

DIGITAL MUSIC COMPOSER KIT

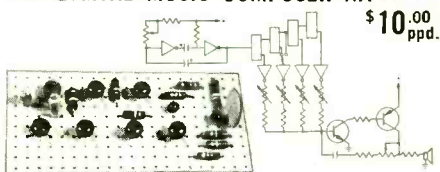

Fully described in our new catalog. This "Tune Computer" uses a 7-IC digital circuit to make its own melodies. You can adjust the **SEQUENCE** of notes, the **TEMPO**, the **VOLUME**, and on a "pseudo-random" basis, the **FREQUENCY** of the notes. By varying the 6 switches and 6 controls provided for these functions, you can set the unit to "compose" an infinite variety of 1-15 note melodies. Our complete **CONSTRUCTION INSTRUCTION GUIDE** makes this kit fast & easy to assemble. All parts including speaker supplied.

SCA ADAPTOR KIT

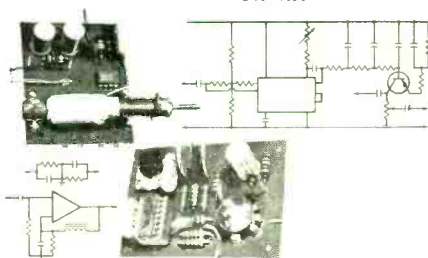

Fully described in our new catalog. This SCA adaptor makes it possible to listen in on **\$10.15** "background music" programs offered by many FM **ppd.** Broadcasting Stations. Two P.C. boards, and a pre-tuned coil & capacitor, make assembling, wiring & installation easy. Requires only 10 to 24 VDC. Our illustrative & descriptive **CONSTRUCTION INSTRUCTION GUIDE** simplifies assembly & explains how to connect the KIT to any FM radio. For commercial use, a subscription to the FM Station is required.

Send check or M.O. 10-day money-back guarantee. Ask for free catalog.

CORTLANOT ELECTRONICS, Inc.
16 Hudson St. NYC 10013, 212-964-0044

CIRCLE NO. 37 ON READER SERVICE CARD

CASSETTES—18,000 good quality C-O Lubricated Pin and Roller, Graphite Washer, Windows 12¢. Frank Pensado, VULCAN CORP., 6 E. 4th St., Cincinnati, Ohio 45202.

DIGITAL voltmeter, frequency counter, time modules and main-frame—assembled. Low cost—Free brochure. Farrell' Research Corporation, P.O. Box 386, Elizabeth, Pa. 15037.

WHOLESALE burglar alarm supplies. Catalog \$1.00 (refundable). Ellin, 161 Bonad. Chestnut Hill, Mass. 02167.

FREE Parts Flyer! Phase Seventy, Box 475P Marysville, Washington 98270.

LASER parts catalog, 60¢. Moynihan, 107 North Brighton, Atlantic City, New Jersey 08401.

DIGITAL and analog computer modules. LED numeric display kits. **FREE LITERATURE.** Scientific Measurements, 2945 Central, Wilmette, Illinois 60091.

ELECTRONIC ORGAN KITS, KEYBOARDS, Independent and divider tone generators. All diode keying. I.C. circuitry. Many components. With our kits you can build any type or size organ desired. 25¢ for catalog. **DEVTRONIX ORGAN PRODUCTS,** Dept. C, 5872 Amapola Dr., San Jose, Calif. 95129.

POLICE—FIRE Frequency Directories \$2.00. Monitor Crystals \$4.95. 25¢ extra for airmail. Crystal Service, P.O. Box 612, East Moline, Illinois 61244.

BRAIN WAVE Interpretation Manual, Rushed—\$2.00. Intertech-7L1, Box 5373, Station F, Ottawa, Canada. U. S. Inquiries.

EPCO TELEPHONE DIALERS for burglary protection. 1600 Milwaukee St., Delafield, Wisconsin 53018.

EXCESS INVENTORY—Integrated Circuits, Transistors, Components, Production and Test Equipment at a fraction of their original cost. All listed in a new publication **ELECTRONIC BROKERS NEWS.** Subscription rates: \$8.00/1 year; \$14.00/2 years; \$18.00/3 years. Electronic Brokers News, 1001 Grand Ave., Glenwood Springs, Colorado 81601.

PRINTED circuits made. Free Details. Reed Engineering, 1140-C, N. Lemon, Orange, Calif. 92667.

PRODUCE Quality Circuit Boards by our easy step by step photo process. Details Free. Western Photo Etch, Box 2086, Renton, Washington 98055.

EXPERIMENTERS—Circuits, V/F converters \$2.00. Others, list 25¢. Yeager, P.O. Box 2213, Olympia, Washington 98507.

CITIZENS BAND EQUIPMENT Discount Prices on name brand equipment. Write for price list. CRS Communications, 2271 Morris Avenue, New York, N.Y. 10453.

UNIFIED Science—God Theory, Finally Discovered; Proven Experiments. Manual Rushed—\$2.00. Intertech-7T1, Box 5373, Station F, Ottawa, Canada. U.S. Inquiries.

FREE BARGAIN CATALOG. Transistors, Computer Boards, Diodes, Thermocouples, parts. Chaney, Box 15431, Lakewood, Colorado 80215.

FREE Catalog LED's, I.C.'s parts. Coronet Electronics, 720 Notre Dame W., Montreal, Canada. U.S. Inquiries.

TUNNEL diode oscillators, amplifiers, transmitter plans. Proven miniature circuits \$1. ESR, 312 Gordon, Thomasville, Georgia 31792.

FIREWORKS NEWS—Monthly magazine covering Fireworks, Construction, Literature, Sources of Supplies, New Firms Products. Free Fireworks Catalogs With Subscriptions! \$9.00 per calendar year. Pyro Press, Box 1202N6, Lexington, Kentucky 40501.

SOUND SYNTHESIZER KITS—Surf \$11.95, Wind \$11.95, Wind Chimes \$16.95, Electronic Songbird \$6.95, Musical Accessories, many more. Catalog free. PAIA Electronics, Box J14359, Oklahoma City, OK 73114

WAVEFORM Generator Kit \$10.00. Stereo Multiplex Kit \$19.95. Free Kit Catalog. Photolume Corp., Box 139, N.Y., N.Y. 10016.

WANTED

QUICKSILVER, Platinum, Silver, Gold, Ores Analyzed. Free Circular. Mercury Terminal, Norwood, Mass. 02062.

MILITARY SURPLUS EQUIPMENT WANTED. ARC-34C, ARC-51BX, ARC-73, ARC-102, ARC-109, ARC-131, ARC-134, ARN-21C, ARN-52, ARN-65, GRC-106, VRC-12, URC-24, 618T, Also Bendix, Collins GR, HP, Tektronix needed, plus military test sets. We Buy or Trade. Slep Electronics, 2412 Highway 301, Ellenton, Florida 33532.

PLANS AND KITS

ANTIGRAVITY DEVICE. Brochure rushed free. AGD, Box 3062-ZD, Bartlesville, Oklahoma 74003.

CDI PLANS—Proven design \$2.00. General Analog, 3014F S. Halladay, Santa Ana, Calif. 92705.

FREE KIT CATALOG

Why does every major College, University, Technical School, Research & Development Center buy from us? Because we have the highest quality and lowest prices. Free Catalog. SWTPC, Box H32040, San Antonio, Tex. 78284.

LASER kit for the amateur scientist—complete optics, mirrors, crystal, tubing—write for instructions and free literature, Esco Products, 167 Oak Ridge Road, Oak Ridge, New Jersey 07438.

TESLA COIL—40" SPARKS! Plans! \$7.50. Information 75¢. Huntington Electronics, Box 2009-P, Huntington, Conn. 06484.

KIRLIAN Electric Field Photography apparatus, plans, instructions, 25pp, \$10. H.S. Dakin, 300 Broadway #39, San Francisco, CA 94133.

WALL-SIZED TV . . . Build a 72 INCH TV PROJECTOR for under \$15.00. Free Details: MACROCOMA, Dept. PE-G, Washington Crossing, Pennsylvania 18977.

LATEST vista digital, linear IC, PC Board Kits. Free Flyer. Photolume Corp., Dept. A, Box 139, N.Y., N.Y. 10016.

INVENTIONS WANTED

CASH-ROYALTIES for patented, unpatented inventions. Global Marketing Service, 2420-P 77th, Oakland, California 94605.

PATENT Searches including Maximum speed, full airmail report and closest patent copies. Quality searches expertly administered. Complete secrecy guaranteed. Free Invention Protection forms and "Patent Information," Write Dept. 9, Washington Patent Office Search Bureau, Benjamin Franklin Substation, P.O. Box 7167, Washington, D.C. 20044.

FREE "Directory of 500 Corporations Seeking New Products." For information regarding development, sale, licensing of your patented/unpatented invention. Write: Raymond Lee Organization, 230-GR Park Avenue, New York City 10017.

INVENTORS: Protect your ideas! Free "Recommended Procedure". Washington Inventors Service, 422T Washington Building, Washington, D.C. 20005.

INVENTORS! Either I will sell your invention before you do, (either through your own efforts or those of another firm) or I will pay you a cash bonus. For Free Invention Evaluation and information, write Gilbert Adams, Invention Broker, Dept. 20, 81 Wall St., New York, N.Y. 10005.

NEW PRODUCTS—INVENTIONS—IDEAS Developed/Marketed by professional organization. **FREE INFORMATION** "How to Market Inventions To Industry". Lawrence Peska Associates, 500-PE Fifth Avenue, New York City 10036.

FREE PAMPHLET: "Tips on Safeguarding Your Invention." Write: United States Inventors Service Company, 708-T Carry Building, Washington, D.C. 20005.

HIGH FIDELITY

DIAMOND NEEDLES and Stereo Cartridges at Discount prices for Shure, Pickering, Stanton, Empire, Grado and ADC. Send for free catalog. All merchandise brand new and factory sealed. **LYLE CARTRIDGES,** Dept. P, Box 69, Kensington Station, Brooklyn, New York 11218.

LIGHT EMITTING DIODES	
FLV 100 VIS. LED	\$.65
MT2 Photo Transistor	\$.90
MCT-2 Opto. Isolator	\$1.49
MCD-2 Opto. Isolator	\$1.49
MCA-2.30 Photo Relay	\$1.95
MY5026 VIS LED	\$.65
M64 IR LED's	.65
MRD 14B Photo darlington's	.65

7400	.30	7472	.50
7401	.30	7473	1.00
7402	.30	7474	.60
7403	.30	7475	1.00
7404	.35	7476	.75
7405	.35	7480	.65
7410	.30	7481	1.25
7411	.35	7483	1.25
7420	.30	7493	.70
7422	.35	7490	1.30
7426	.45	7492	1.00
7430	.30	7494	1.10
7440	.30	7495	1.10
7441	1.50	74107	.75
7442	1.50	74123	1.20
7445	1.50	74153	1.50
7446	1.50	74154	.95
7447	1.50	74161	1.79
7448	1.50	74192	1.25
7450	.30	74193	.95
7451	.30	74194	2.35
7452	.30	8570	1.95
7453	.30	8590	1.95
7454	.30	9309	1.95
7460	.30	9312	1.95
7465	.35	9322	1.95

VERIPAX PC BOARD

This board is a 1/16" single sided paper epoxy board 4 1/2" x 6 1/2" (standard veripax) DRILLED and etched, which will hold 21 single 14 pin IC's, or 8.16 or LSI DIP IC's with busses for power supply connections. It is also etched for a 22 pin connector. \$4.50

Send \$.20 for our latest catalog featuring Transistors and Rectifiers

TRANSISTOR SPECIALS										
2N3638	PNP	Si	TO-5	3W	25V	5A	10	63	5	\$1.00
2N3584	NPN	Si	TO-66	35W	250V	2A	10MHz	100Hfe		\$1.50
2N965	PNP	Ge	TO-18	15W	7V	1A	300	40		/ \$1.00
2N1605	NPN	Ge	TO-5	15W	24V	1A	14	125	5	\$1.00
2N5324	PNP	Ge	TO-3	60W	250V	10A	20	35		\$1.50
2N1015D	NPN	Si	TO-82	150W	200V	7.5A	025	10		\$1.45
2N3724	NPN	Si	TO-5	.8W	30V	1A	250	60	3	\$1.00
2N3772	NPN	Si	TO-3	150W	60V	30A	2	30		\$1.25
2N6109	PNP	Si	TO-220	36W	40V	4A	8	60		50c
2N5296	NPN	Si	TO-220	36W	40V	4A	8	60		55c
2N4898	PNP	Si	TO-66	25W	40V	4A	40	46		5.60
MJ2251	NPN	Si	TO-66	10W	225V	.5A	10	40		5.70
2N3055	NPN	Si	TO-3	115W	100V	15A	2	44		\$1.00

NIXIE TUBE RAYTHEON 8754 WITH SOCKET AND DATA SHEET \$2.25 3/\$6.00

Printed circuit board 4 1/2" x 6 1/2" double sided fiber glass board 1/16" thick, unetched. \$.60 ea. 5 \$2.50

MAN-4 LED READOUT \$4.50

MAN-3 LED READOUT \$2.95

SV 1 Amp. regulated power supplies. These units are similar to analog devices encapsulated. SE905 power supplies \$34.95

8223 Field Prog ROM	\$8.00
1101 256 Bit RAM	\$4.00
8225 64 BIT MEMORY	\$4.00

TRIACS

PRV	1A	10A	15A	20A*
100	.40	.70	1.00	1.20
200	.70	1.10	1.50	1.60
300	.90	1.35	1.90	2.00
400	1.10	1.60	2.30	2.40
500	1.50	2.00	2.70	2.80

*Press Fit

FULL WAVE BRIDGES

PRV	2A	6A
200	.95	1.25
400	1.15	1.50
600	1.35	1.75

Silicon Power Rectifiers

PRV	1A	3A	12A	50A
100	.06	.09	.30	.85
200	.07	.16	.35	1.25
400	.09	.20	.45	1.50
600	.11	.30	.70	1.30
800	.15	.40	.85	2.30
1000	.20	.55	1.10	2.75

Silicon Control Rectifiers

PRV	6A	10A	20A	70A
100	.30	.45	1.00	3.50
200	.50	.75	1.25	6.50
300	.60	.90	1.50	
400	.70	1.10	1.75	9.50
500	.80	1.25	2.00	
600	.90	1.40	2.25	11.00

T1543 UJT's .50
2N3819 N Channel FET's .50
D13T PROG. UJT's .60
ER 900 Trigger Diodes 4/\$1.00

8000 SERIES IC'S			
8234	1.75	8271	1.95
8267	1.75	8275	.90
8269	1.00	8280	1.75
8273	1.75	8284	1.95
8230	1.75	8T13	1.75
8233	1.75	8T14	1.95
8242	1.00	8T16	1.95
8250	1.95	8T22	1.75
8252	1.95	8T24	1.75
8262	1.95	8T80	1.10
8270	1.95	8T90	1.10

DECADE COUNTER KIT
Consisting of:
1-Nixie tube & socket (8754)
1-7490
1-7475
1-7441
\$5.95

PA234 1 Watt Audio Amps	\$1.25
LM 309K 5V 1 Amp Regulator	\$2.25
741 OPER AMP	5.50
Dual 709	.95
723 Regulator	\$.75
TVR-2002 high power 723	\$1.00
703RF IF Amp	\$.80
CA3065 FM TV Amp	\$1.35
565 Phase Lock Loop	\$3.25
566 Function Gen.	\$3.25
567 Tone Decoder	\$3.25
560 Phase Lock Loop	\$3.25
561 Phase Lock Loop	\$3.25
555 2US to 1 Hour Timer	\$1.19
558 Dual 741 (Mini Dip)	.85
531 High Slew Oper Amp	\$2.50
536 FET Input Oper Amp	\$3.25
537 Precision 741	\$2.50
540 70W Power Driver	\$2.04
747 Dual 741	\$1.25
1N4208 Oper Amp	\$1.95
5556 Oper Amp	\$.75
101 Oper Amp	\$.75
7410V Oper Amp	\$.55
320-5V Reg.	\$1.75
320-15V Reg.	\$1.75
424-Zero Voltage Switch	\$1.25

Terms: FOB Cambridge, Mass. Send check or Money Order. Include postage. Average Wt. per package 1/2 lb. No C.O.D.'s. Minimum Order \$3.00 Rated companies 30 days net

SOLID STATE SALES

Post Office Box 74A Somerville, Mass. 02143 Tel. (617) 547-4005

CIRCLE NO. 31 ON READER SERVICE CARD

INSTRUCTION

LEARN ELECTRONIC ORGAN SERVICING at home all makes including transistor. Experimental kit—trouble-shooting. Accredited NHSC, Free Booklet. NILES BRYANT SCHOOL, 3631 Stockton, Dept. A, Sacramento, Calif. 95820.

LEARN WHILE ASLEEP, Hypnotize! Strange catalog free. Auto-suggestion, Box 24-ZD, Olympia, Washington 98501.

ASSOCIATE D.E.I. IN ELECTRONICS through correspondence instruction. G.I. Bill approved. Free catalog. Grantham, 1509 N. Western, Hollywood, California 90027.

FCC First and Second Tests. \$8.95. Electronic Tutoring, Box 24190, Cleveland, Ohio 44124.

HIGHLY effective college-level home study programs in Electronics Engineering and Engineering Mathematics. (Our 27th Year). Free Literature. Cook's Institute, Dept. 15, Box 10634, Jackson, Miss. 39209.

F.C.C. Type Exams Guaranteed to prepare you for F.C.C.'s 3rd., (\$7.00). 2nd., (\$12.00), 1st., (\$16.00), phone exams; Complete package. \$25.00. Research Company, Dept. A, Rt. 2, Box 448, Calera, Alabama 35040.

ON THE AIR announcer training at R.E.I. features individual realistic preparation for your Radio/TV career. R.E.I.'s engineering course features intensive training for the FCC First Phone! Complete either course in just five (5) weeks! Call 1-800-237-2251 toll free for brochure. Write: R.E.I., 1336 Main Street, Sarasota, Florida 33577.

SHORTCUTS To Success! Highly Effective, Profitable Short Courses. (75 Choices). Study At Home. Diploma Awarded. Our 27th Year. Free Literature. CIEE-D, Box 10634, Jackson, Miss. 39209.

TAPE RECORDING COURSE: Taught by studio engineers. Free information. NNA, Box 721R, Rye, New York 10580.

JUNE 1973

AVIATION ELECTRONICS TECHNICIAN—Prepare for exciting career in new field of "Avionics." Train at nation's largest aeronautical school. Indicate if eligible for G.I. Benefits. Spartan Airschool, International Airport, Dept. MMW, Tulsa, Oklahoma 74151.

F.C.C. EXAM MANUAL

PASS FCC EXAMS! Memorize, study —1973 Tests—Answers* for FCC First and Second class Radio-telephone licenses. Newly revised multiple-choice questions and diagrams cover all areas tested in FCC exams... plus... "Self-Study Ability Test." \$9.95 postpaid.

Tests—Answers for
FCC First and
Second Class
Commercial
License

**COMMAND PRODUCTIONS P.O. BOX 26348-P
RADIO ENGINEERING DIVISION SAN FRANCISCO, CALIF. 94126**

FCC FIRST CLASS LICENSE through tape recorded lessons with one week personal instruction. Radio License Training, 1060D Duncan, Manhattan Beach, Calif. 90266.

BEST Organ Service Repair Guides—"Servicing Electronic Organs" \$7.95. Free Catalog. TAB BOOKS, B.R.S., Pa. 17214.

LEARN COMPUTER ELECTRONICS Free homestay details. Computers, Box 4192N, Mountain View, Calif. 94040.

EARN COLLEGE DEGREES at home. Many subjects. Florida State Christian University, P.O. Box 1674, Fort Lauderdale, Florida 33302.

DIGITAL:THEORY,DESIGN,
CONSTRUCTION

LOGIC NEWSLETTER

SAMPLE COPY \$1.00
LOGIC NEWSLETTER
POB 252
WALDWICK,N.J. 07463

'CALCULATOR CHIP' SALE

NEW! 12-DIGIT 'CALCULATOR ON A CHIP'
 Similar to Moatck 5001. Outperforms Texas 8-digit TMS1802. A 40-pin DIP. Adds, multiplies, subtracts, and divides. Use with 7-segment readouts, Nixies, and LEDs. We include schematics, instructions to build calculator.



6.95
 □ CT5005 — Same as above with MEMORY — \$12.88

NATIONAL EQUALS ON "DIGITAL CLOCK on a CHIP"

***Money Back Guarantee! Any "Chip" *With Spec Sheet! \$12.88**

Mfrs #	Description	Sale
□ 5311	28-pin, ceramic, any readout.	\$12.88
□ 5312	6-digits: A-B-D	
□ 5312	24-pin, ceramic, any readout.	\$12.88
□ 5313	4-digits: C-D	
□ 5313	28-pin, ceramic, any readout.	\$12.88
□ 5314	6-digits: A-C	
□ 5314	24-pin, plastic, LED and incandescent readouts.	\$12.88

Code: A—Hold Count. C—1 PPS Output.
 B—Output Strobe. D—BCD

LED MITY DIGITS "DCM'S"

9.99

Digital Counting Modules

Will outperform any other DCM on the market today. No fuses, not incandescent, but a device that will READ almost for life. MAN-4, Monsanto equal.

Kit includes: 3 x 2" printed ckt board, with fingers too! Side-mounting socket, MAN-4 resistors. 7418, 7476, 7490, booklet.

Includes P.C. EDGE CONNECTOR — FREE!

LINEAR Op Amps

FACTORY GUARANTEED FACTORY TESTED

Buy 3 Take 10% Discount

□ 531	Hi slow rate op-amp (TO-5)	\$2.50
□ 532	Micro power 741 (TO-5)	2.50
□ 533	Micro power 709 (TO-5)	2.50
□ 536	FET input op amp (TO-5)	3.95
□ 537	Precision 741 (TO-5)	2.50
□ 540	70W pwr driver amp (TO-5)	2.04
□ 550	Precision 723 voltage reg. (DIP)	1.17
□ 556	5 Times faster than 741C (A)	1.00
□ 558	Dual 741 (mini DIP)	.88
□ 560	Phase lock loops (DIP)	3.25
□ 561	Phase lock loops (DIP)	3.25
□ 562	Phase lock loops (DIP)	3.25
□ 563	Phase lock loops (A)	3.25
□ 566	Function Generator (A)	3.25
□ 567	Tone generator (A)	3.25
□ 593	Operational amp (A)	3.10
□ 702C	Hi-grain, DC amp (TO-5)	.44
□ 703C	RF-IF, amp. 14 ckt. (TO-5)	1.00
□ 709CV	Op amp (mini DIP)	.49
□ 710C	Differential amp (A)	.39
□ 711C	Dual diff. amp (A)	.39
□ 723C	Voltage regulator (A)	.95
□ 741C	Frequency compensator 709 (A)	.41
□ 741CV	Freq. comp. 709 (Mini DIP)	1.25
□ 747C	Dual 741C (A)	.49
□ 748C	Freq. adj. 741C (A)	.44
□ 749CV	Freq. adj. 741C (mini DIP)	.49
□ 709-709	Dual 709C (DIP)	1.00
□ 739-739	Dual stereo preamp	1.98
□ 741-741	Dual 741C (A)	1.00
□ 75450	Dual peripheral driver (DIP)	.69

(A) TO-5 or DIP dual in line pak

LED READOUTS \$2.95

Buy 3 Take 10%

This display is excellent for small portable electronics, such as DVM's, calculators, etc. Equivalent to Monsanto MAN-3A. Operates from 5V, 20 milliamperes, with 47 ohm dropping resistor.

Includes: SN7490, decade counter, SN7475, latch, SN7441 BCD de-coder driver, SN7447, Nixie tube, instructions.

Largest Selection TTL IC's

Type	5c	Buy 3 - 10%	Buy 100 - Take 20%
□ SN7400	.30	SN7442 1.25	SN7483 1.50
□ SN7401	.30	SN7443 1.25	SN7484 1.41
□ SN7402	.30	SN7444 1.25	SN7485 .55
□ SN7403	.30	SN7445 1.25	SN7486 55
□ SN7404	.35	SN7446 1.65	SN7489 3.75
□ SN7405	.35	SN7447 1.65	SN7490 1.50
□ SN7406	.55	SN7448 1.50	SN7491 1.10
□ SN7407	.55	SN7449 1.50	SN7492 1.50
□ SN7408	.15	SN7450 .35	SN7493 1.10
□ SN7409	.35	SN7451 .35	SN7494 1.10
□ SN7410	.35	SN7452 .35	SN7495 1.10
□ SN7411	.35	SN7453 .35	SN7496 1.10
□ SN7412	.35	SN7454 .35	SN7497 1.10
□ SN7413	.95	SN7455 .35	SN7498 .55
□ SN7414	.95	SN7456 .35	SN7499 1.45
□ SN7415	.95	SN7457 .35	SN74104 .55
□ SN7416	.55	SN7458 .50	SN74105 .55
□ SN7417	.55	SN7459 .50	SN74106 .55
□ SN7418	.55	SN7460 .50	SN74107 .60
□ SN7419	.30	SN7470 .50	SN74108 .60
□ SN7420	.30	SN7471 .50	SN74109 .60
□ SN7421	.35	SN7472 .50	SN74110 1.25
□ SN7422	.35	SN7473 .50	SN74111 1.25
□ SN7423	.37	SN7474 .65	SN74112 1.25
□ SN7424	.30	SN7475 1.25	SN74121 .70
□ SN7425	.30	SN7476 .75	SN74122 .70
□ SN7426	.30	SN7477 .75	SN74123 1.20
□ SN7427	.60	SN7478 .95	SN74140 .50
□ SN7428	.60	SN7479 .95	SN74145 1.40
□ SN7429	.60	SN7480 .95	SN74145 1.40
□ SN7430	.60	SN7481 1.50	SN74200 3.99
□ SN7431	.60	SN7482 .95	
□ SN7432	.60		
□ SN7433	.60		
□ SN7434	.60		
□ SN7435	.60		
□ SN7436	.60		
□ SN7437	.60		
□ SN7438	.60		
□ SN7439	.60		
□ SN7440	.60		
□ SN7441	1.40		

Best Values for 18 years

Terms: add postage Rates: net 30

Phone Orders: Wakefield, Mass. (617) 245-3829

Retail: 16-18 Del Carmine St. Wakefield, Mass. (off Water Street) C.O.D.'S MAY BE PHONED IN

P.O. BOX 942 E
 Lynnfield, Mass. 01940

MOVIE FILMS

BMM-SUPER 8-16MM MOVIES! Biggest Selection! Lowest Prices!
 Free Catalog! Cinema Eight, Box PE, Chester, Connecticut 06412.

PLASTICS

CASTOLITE pours like water, hardens like glass without heat. Crystal clear, colors. Embed natural flowers, other objects. Make fine gifts. Form flexible molds over any pattern, size. Reproduce your own designs in plastics, candle wax, metal, plaster, cement. Profitable. Illustrated Manual and Catalog Only \$1.00. CASTOLITE, Dept. 73G/PE, Woodstock, Ill. 60098.

HYPNOTISM

"MALE-FEMALE Hypnotism" Exposed. Explained! "Secret Method" — They Never Know! \$2. Rushed. Guaranteed! Isabella Hall, Silver Springs, Florida 32688.

SLEEP learning. Hypnotic method. 92% effective. Details free. ASR Foundation, Box 7566EG, Fort Lauderdale, Florida 33304.

FREE Hypnotism. Self-Hypnosis. Sleep Learning Catalog! Drawer H400, Ruidoso, New Mexico 88345.

BUSINESS OPPORTUNITIES

I MADE \$40,000.00 Year by Mailorder! Helped others make money! Start with \$10.00—Free Prof. Torrey, Box 318-N, Ypsilanti, Michigan 48197.

\$200.00 DAILY In Your Mailbox! Your opportunity to do what mail-order experts do. Free details. Associates, Box 136-J, Holland, Michigan 49423.

FREE CATALOGS. Repair air conditioning, refrigeration. Tools, supplies, full instructions. Doolin, 2016 Canton, Dallas, Texas 75201.

MAILORDER MILLIONAIRE helps beginners make \$500 weekly. Free report reveals secret plan! Executive (1K6), 333 North Michigan, Chicago 60601.

HIGHLY PROFITABLE ONE-MAN ELECTRONIC FACTORY

Investment unnecessary, knowledge not required, sales handled by professionals. Postcard brings facts about this unusual opportunity. Write today! Barta-DEPE, Box 248, Walnut Creek, CA 94597.

PIANO TUNING LEARNED QUICKLY AT HOME! Tremendous field! Musical knowledge unnecessary. GI approved. Information free. Empire School, Box 327, Miami 33145.

GROW RICH DRIVING YOUR CAR. Magnetic signs, Big Money, very, very easy. Copy Sign, 6644 Santa Monica Blvd., L.A., Calif. 90038.

FREE SECRET BOOK "2042 Unique, Proven Enterprises." Beat inflation with fabulous, successful "Little Knowns." Work home! Haylings-BIO, Carlsbad, Calif. 92008.

START SMALL, highly profitable electronic production in your basement. Investment, knowledge unnecessary. Postcard brings facts. Barta-PEM, Box 248, Walnut Creek, California 94597.

\$800.00 Monthly possible addressing envelopes. We can show you how. Details 25¢—stamped envelope. Danzig, Postbox 255A-PEL, Brooklyn 11218.

TRUTH about Mailorder! Report \$2.00. Gerald Stidley, 831 Crane 402F-6 DeKalb, Illinois 60115.

POLICE SCANNERS! Fast sales, big profits. Best Crystal Service, P.O. Box 612, East Moline, Illinois 61244.

GOVERNMENT SURPLUS

GOVERNMENT Surplus. How and Where to Buy in Your Area. Send \$2.00. Surplus Information, Headquarters Bldg., Box 30177-PE, Washington, D.C. 20014.

ELECTRONIC Equipment and Parts. Big 36 page Free Catalog. Send for your copy today! Fair Radio Sales, Box 1105-P, Lima, Ohio 45802.

JEEPS Typically from \$53.90 . . . Trucks from \$78.40 . . . Boats, Typewriters, Knives, Airplanes, Clothing, Multimeters, Oscilloscopes, Transceivers, Photographic. Electronics Equipment. Wide-variety, condition. 100,000 Bid Bargains direct from government nationwide. Complete sales directory and surplus categories catalog \$1.00 (Deductible on orders from separate included catalog). Surplus Service, Box 820-J, Holland, Michigan 49423.

GOVERNMENT SURPLUS. Complete sales directory \$1.00. Surplus Publications, Box 26062Z, Los Angeles, Calif. 90026.

MANUALS for gov't surplus radios, test sets, scopes, teletype. List 50¢. Books, 7218 Roanne Drive, Washington, D.C. 20021.

TAPE AND RECORDERS

RENT 4-Track open reel tapes—all major labels—3,000 different—free brochure. Stereo-Parti, 55 St. James Drive, Santa Rosa, Ca. 95401.

1930-1962 Radio Programs on tape. Huge Catalog! Sample Recordings! \$1.00 refundable!! AM Treasures, Box 192F, Babylon, N.Y. 11702.

SCOTCH MAGNETIC TAPE (USED)

—150, 1800 FT. 7 INCH REEL, 1 MIL POLYESTER, RECORDED ONCE, BULK ERASED (NO BOX), 99¢ PLUS 100% SHIPPING & HANDLING (MIN. ORDER \$10.00); SLIGHTLY USED 10 1/2 INCH FIBERGLASS REELS, 3/8" HOLE, 50¢ EACH, PLUS SHIPPING BY WEIGHT AND ZONE.



SAXITONE TAPE SALES

1776 Columbia Rd., N.W. Washington, D.C. 20009

RECORD 8TRK cartridges with any player. Instructions, \$2.00. C. Faust, Rancocas, New Jersey 08073.

TREASURE FINDERS

FREE—Valuable Treasure Finder catalog sent by return mail. Find Coins, Rings, Gold, Silver, Metals, Relics. Write today. JETCO, Dept. CPE, Box 26669, El Paso, Texas 79926.

DISCOVER AMERICA'S FASTEST GROWING HOBBY. White's Electronics, Inc., would like to send you—absolutely FREE, their 42 page, fact-filled catalog on Mineral and Metal Locating Equipment. Amateurs or Professionals select from the world's largest line of metal detectors, priced as low as \$79.50, up. Detect Gold, Silver, Copper—Nuggets, Coins, Jewelry, etc. Budget terms available. For your convenience we have three major factory locations in the U.S. and Canada, as well as over 1,000 authorized dealers to serve you. See your local Yellow Pages, under "Metal Locating Equipment", or write: White's Electronics Inc., Room No. 391, 1101 Pleasant Valley Road, Sweet Home, Oregon 97386 —Elk-Air Industrial Park, Dexter Drive, East, Elkhart, Indiana 46514—or White's Electronics Ltd., 33784 Hazel Street, Abbotsford, British Columbia, Canada.

FISHER DETECTORS. You deserve the best. Free literature, FR-L, Dept. PE-6, P.O. Box 490, Belmont, CA 94002.

TREASURE FINDER locates buried gold, silver, coins, treasures. 6 powerful models. \$19.95 up. Instant financing available. Write or call for free catalog. Phone (713) 682-2728 day or night. Dealer inquiries invited. Relco, Dept. A-33, Box 10839, Houston, Texas 77018.

JUNE 1973

NATIONAL MOS DYNAMIC shift registers MM502 dual 50 bit 1.25 MM506 dual 100 bit 1.50 MM5006 dual 100 bit 1.50 MM5013 1024 bit 2.00 MM5017 dual 512 DIP 2.00 MM5016 512 bit 1.50 STATIC shift registers MMS04 dual 16 bit 1.50 MMS05 dual 32 bit 1.75 MM550 dual differential analog switch 2.50	CT5005 CALCULATOR ON A CHIP This chip has a full four function memory. Memory is controlled by four keys, MM (adds entry to memory), M (subtract entry from memory), CM (clear memory—without—clearing rest of registers), RM (read memory or use as entry).  *12 DIGIT DISPLAY AND CALC. *FIXED DECIMAL AT 0.1, 2, 3, 4, OR 5 *LEADING ZERO SUPPRESSION *SEVEN SEGMENT MULTIPLEXED OUTPUT *TRUE CREDIT SIGN DISPLAY *SINGLE 28 PIN CHIP Chip and data—\$14.95 Data only—1.00 (refundable) MC1013 ECL 85mc ff 1.00 MC1023 ECL driver 2.00 MC1039 ECL-TTL interface 7486—50 7489—3.00 8850, 9601—one shot multi-vibrator 1.00 8269 Signetic is same as 8200 National 4 bit 1.60 MC853 dual JK DTL .30 LU321 dual JK "Utilogic" .60 SP629 RS/T Signetic .40 SP659 dual 4 input buf. .25	7400 TTL DIP 7400-----\$.35 7401-----" .35 7402-----" .35 7403-----" .35 7404-----" .35 7405-----" .35 7408-----" .40 7410-----" .35 74110-----" .35 74123-----" .35 7430-----" .35 7440-----" .35 7441-----" 1.30 7442-----" 1.00 7446-----" 1.50 7448-----" 1.25 7450-----" .35 7451-----" .35 7453-----" .35 7454-----" .35 7460-----" .35 7472-----" .40 7473-----" .55 7474-----" .40 7476-----" .55 7480-----" .50 7483-----" 1.15 7486-----" .65 7489-----" 3.00 7492-----" .90 7493-----" .90 7495-----" 1.15 74107-----" .55 74154-----" 2.50 74193-----" 2.00 74195-----" 1.00
3 CHIP CALCULATOR SET This calculator set has eight digit floating point with left hand entry. It will add, subtract, multiply, and divide. Overflow and negative signals are provided. Chips and data—\$7.95 Data only—1.00 (refundable)	LED FL 100 special 1.11 .39 each 3.50 for ten 29.95 for 100 MANEM Each \$3.00 Ten or more .2.50	LINEARS LM100-----\$.80 LM309H-----" 1.00 LM309K-----" 2.50 NE555C-----" .75 NE560-----" 3.25 741(MINI DIP)-----" .45 747-----" 1.10 709-----" .30 710-----" .40 723-----" .40 723-----" 1.00 LM380(audio amp) 1.75
MW-50 red emitting 10-40ma @ 2V .39 MV5020 red LED .45 MW-10B visible red 5-70ma @ 2V .45 SCHOTTKY 774 \$3.00 EACH 82530 8 input multiplexer 82533 2 input 4 bit multiplexer 82541 quad EX/OR element 82542 4 bit comparator 82562 9 bit parity gen./checker 82567 2 input 4 bit multiplexer DM8880 (Sperry DD700 202) 7 segment high voltage mixie driver-----\$1.75	All IC's are new and fully tested, leads are plated with gold or solder. Orders for \$5 or more will be shipped prepaid. Add 3% for smaller orders. California residents add sales tax. IC orders are shipped with 24 hrs COD's may be phoned in 510. minimum. Money back guarantee. BABYLON ELECTRONICS P.O. Box J Carmichael, California 95608 (916) 966-2111	CMOS CD4011-----\$.75 CD4002-----" .75 CD4011-----" .75 CD4012-----" .75 CD4023-----" .75

CIRCLE NO. 3 ON READER SERVICE CARD

EMPLOYMENT INFORMATION

EXCITING Overseas jobs. Directory \$1.00. Research Associates, Box 889-E, Belmont, California 94002.

JOBS GALORE for Electronics Men in San Jose, California. Big classified \$2. R. Sims, 525 University, Palo Alto, California W1307, 94301.

TECHNICIANS desperately needed, employers directory, \$2. Calcis, Box 514, Agnew, CA 95054.

EMPLOYMENT OPPORTUNITIES

ELECTRONICS/AVIONICS EMPLOYMENT OPPORTUNITIES. Report on jobs now open. Details FREE. Aviation Employment Information Service, Box 240E, Northport, New York 11768.

ELECTRICAL SUPPLIES AND EQUIPMENT

PLATING Equipment. Portable Platers, Supplies and "Know-How." Build your own tanks for nickel, chrome, etc. Easy-to-install PVC liners. Rectifier components—all sizes. Schematics, parts lists, formulas, operating instructions for all plating. Guaranteed to save you 25%-75%. Some good units for sale. Write for details. Platers Service Company, 1511-PE Esperanza, Los Angeles. Calif. 90023.

REAL ESTATE

FREE . . . BIG 256-page . . . SUMMER CATALOG! Describes and pictures hundreds of farms, ranches, town and country homes, business coast to coast! Specify type property and location preferred. UNITED FARM AGENCY, 612-EP West 47th St., Kansas City, Mo. 64112.

SPORTS ACTION FILMS

SUPER 8 and 8mm Color or B&W Pro Sports Films for sale. Instant replay of '72 NFL, '72 Super Bowls, '72 NHL Stanley Cup, '72 Championship Basketball, World Series Baseball and all Boxing. Write for discount sports films catalog today, 25¢. Elect Dept., SPORTLITE, Box 500, Speedway, Indiana 46244.

BOOKS

FREE catalog aviation/electronic/space books. Aero Publishers, 329PE Aviation Road, Fallbrook, California 92028.

FREE book prophet Elijah coming before Christ. Wonderful bible evidence. Megiddo Mission, Dept. 64, 481 Thurston Rd., Rochester, N.Y. 14619.

UNUSUAL Books! 40 for \$3. Catalog Free! International, Box 7798PE, Atlanta, Georgia 30309.

TUBES

RADIO & T.V. Tubes—36¢ each. Send for free Catalog. Cornell, 4213 University, San Diego, Calif. 92105.

RECEIVING & INDUSTRIAL TUBES, TRANSISTORS. All Brands—Biggest Discounts. Technicians, Hobbyists, Experimenters—Request **FREE** Giant Catalog and **SAVE!** ZALYTRON, 469 Jericho Turnpike, Mineola, N.Y. 11501.

SAVE money on parts and transmitting-receiving tubes, foreign-domestic. Send 25¢ for giant catalog. Refunded first order. United Radio Company, 56-P Perry Street, Newark, N.J. 07105.

HEAVY DUTY MULTIPLE VOLTAGE REGULATED TRANSFORMER

7 voltages, 15 volts @ 10 A., 36 volts @ 5 A., 10 volts @ 5 A., 20 volts @ 2 A., 36 volts @ 5 A., 42 volts @ 5 A., 36 volts @ 4 A. Resonant primary regulated, (no change in output voltages for up to 20% change in primary). 5 1/4" x 4 1/2" x 6". Complete with regulating capacitor and data for many more uses and voltage combinations.



STOCK NO. F9584 20 lbs. 12.50 ea. 2/22.00

G.E. FLUORESCENT READOUT TUBE

G.E. Y4075 7 segment fluorescent vacuum tube. Operates with 1.2 volts AC or DC on filament, 25 to 55 volts on anodes. Flying leads, mounts on PC board, or TO-5 IC socket. All digits and right hand decimal point. .375" dia. x 1 1/2". 10 pages of applications & data. Stock No. F5026 1.95 ea. 6/11.00



COMPUTER GRADE CAPACITORS

J2062 40,000 mfd. 10 volts 3 1/4" x 4 1/4" 1.25 ea. 6/7.00
J2118 70,000 mfd. 10 volts 3 1/4" x 4 1/4" 1.75 ea. 6/9.00
J2220 32,000 mfd. 40 volts 2 3/4" x 5 1/2" 2.00 ea. 5/9.00
J2116 3,750 mfd. 75 volts 2 1/2" x 4 1/4" 1.75 ea. 6/9.00

Send for new 48 page catalog, loaded with new items. Please include sufficient postage. Excess will be refunded. **MINIMUM ORDER \$3.00**



DELTA ELECTRONICS CO.

BOX 1, LYNN, MASSACHUSETTS 01903
617-388-4705

CIRCLE NO. 9 ON READER SERVICE CARD

120

TUBES "Oldies", latest. Lists free. Steinmetz, 7519 Maplewood, Hammond, Indiana 46324.

TUBES receiving, factory boxed, low prices, free price list. Transleteronic, Inc., 1306 40th Street, Brooklyn, N.Y. 11218A, Telephone: 212-633-2800.

REPAIRS AND SERVICES

TV Tuners rebuilt and aligned per manufacturers specification. Only \$9.50. Any make UHF or VHF. Ninety day written guarantee. Ship complete with tubes or write for free mailing kit and dealer brochure. JW Electronics, Box 51C, Bloomington, Indiana 47401.

MULTIMETER repairs—low prices—literature free. Moberly, 25711-C Eshelman, Lomita, Calif. 90717. Telephone (213) 530-4011.

PERSONALS

MAKE FRIENDS WORLDWIDE through international correspondence. Illustrated brochure free. Hermes, Berlin 11, Germany.

WILL pay \$5 for information on how to build very low frequency receiver (1-20 cps). Burrows, 11618 NW 7th Ave., Miami, Fla. 33168.

DO-IT-YOURSELF

PROFESSIONAL ELECTRONIC PROJECTS—\$1.00 up. Catalog 35¢. PARKS, Box 15201A, Seattle, Wash. 98115.

WATERBEDS—Send 50¢ for plans and parts price list. Concord Furniture, P.O. Box 5652, Concord Calif. 94524.

MUSICAL INSTRUMENTS

30% DISCOUNT name brand musical instruments. Free Catalog. Freeport Music, 455N, Route 110, Melville, N.Y. 11746.

WHOLESALE! Professional Guitars, PA Systems, Altec Speakers, 240W RMS Amplifiers. Free Catalog, Carvin, Escondido, Calif. 92028.

MUSIC

SONGS — POEMS

Wanted for publishing and recording consideration.

Accepted songs will be published & recorded at our expense - for information write to Talent, 17-PE Longwood Rd., Quincy, Ma. 02169



SONGWRITERS! POETS!

SPIRITUAL & RELIGIOUS POEMS & SONGS WANTED FOR PUBLISHING AND RECORDING BY CHAPEL ORCHESTRA & CHOIR. WE PAY ALL COSTS ON ACCEPTED SONGS!

Information: Write
CHAPEL RECORDING CO.
BOX 162, Dept. PE
WOLLASTON, MASS. 02170

POPULAR ELECTRONICS Including Electronics World

Popular Electronics

INCLUDING **Electronics World**

JUNE 1973

ADVERTISERS INDEX

READER SERVICE NO.	ADVERTISER	PAGE NO.
56	Altec	9
1	Avanti Research and Development, Inc.	105
7	B & K Division, Dynascan Corporation	93
2	BSR (USA) Ltd.	8
3	Babylon Electronics	119
	Bell & Howell Schools	54, 55, 56, 57
4	Bose	71
	CREI Capitol Radio Engineering Institute	36, 37, 38, 39
5	Cleveland Institute of Electronics, Inc.	72, 73, 74, 75
6	Cobra Communications, Dynascan Corporation	13
37	Cortlandt Electronics, Inc.	115
8	Crystek	79
9	Delta Electronics Co.	120
10	Delta Products, Inc.	81
11	EICO	108
12	Edmund Scientific Co.	122
35	Edwards Electronics	115
14	Gaylord Electronics Inc.	106
15	Gregory Electronics Corp.	114
16	Heath Company	24, 25
CLASSIFIED ADVERTISING		114, 115, 116, 117, 118, 119, 120, 121

READER SERVICE NO.	ADVERTISER	PAGE NO.
13	Johnson	FOURTH COVER
17	Lafayette Radio Electronics	107
18	LaSalle Extension University	7
19	Lee Electronic Labs, Inc.	15
20	McIntosh Laboratory, Inc.	87
21	MITS Micro Instrumentation & Telemetry Systems, Inc.	85
39	Magitran Company, The	111
22	Midwest HiFi Wholesale & Mail Order Division	108
	National Radio Institute	SECOND COVER, 1, 2, 3
	National Technical Schools	18, 19, 20, 21
23	PTS Electronics, Inc.	79
25	Poly Paks	118
26	Radio Shack	67
27	Sams & Co., Inc., Howard W.	17
28	Sansui Electronics Corp.	95
29	Schober Organ Corp., The	111
30	Shure Brothers Inc.	10, 11
31	Solid State Sales	117
34	Tri-Star Corporation	107
		114, 115, 116, 117, 118, 119, 120, 121

RUBBER STAMPS

RUBBER address stamps. Free catalog. 45 type styles. Jackson's, Box 443F, Franklin Park, Ill. 60131.

FREE literature, business cards, letterheads, rubber stamps, social security plates, labels, lifetime medical, pet. identification tags. Geer's, 111 North Drive, Ottawa Ohio 45875.

MISCELLANEOUS

WINEMAKERS: Free illustrated catalog yeasts, equipment. Semplex, Box 12276P, Minneapolis, Minn. 55412.

HOME WATER DISTILLERS. Remove all impurities for pennies a gallon. Portable, no plumbing. Free details. United Vito-Way, Box 2216-V, Everett, Washington 98203.

1973 ELECTRONIC EXPERIMENTER'S HANDBOOK

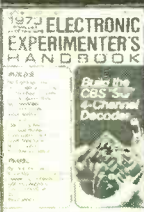

148 pages of the most fascinating and challenging electronics construction projects for hobbyists. Each one lab-tested by the editors, complete with parts list, easy "how-to-do-it, how-it-works" instructions, and many with actual size PC foil patterns and I.C. diagrams!

1973 Spring	\$1.25	#2
1972 Winter	\$1.25	#40
1971 Spring	\$1.50	#26
1971 Winter	\$1.50	#33
1970 Spring	\$1.50	#14

Order by number from

Ziff-Davis Service Div., 595 Broadway • N.Y., N.Y. 10012
Enclose an additional 35¢ per copy for postage and handling.
(Outside U.S.A. all magazines are \$2.50 per copy, postpaid.)

PAYMENT MUST BE ENCLOSED WITH ORDER

LIVE IN THE WORLD OF TOMORROW... TODAY!

A BETTER LIFE STARTS HERE

ASTRONOMICAL TELESCOPE KITS



Grind your own mirror for powerful telescopes. Kit contains fine annealed pyrex mirror blank, tool, abrasives, diagonal mirror, and eyepiece lenses. Instruments you build range in value from \$75.00 to hundreds of dollars.

- Stock No. 70.003AV .4 1/2" diam. 3/8" thick. \$10.75 Ppd.
- Stock No. 70.004AV .6" diam. 1" thick. \$16.95 Ppd.
- Stock No. 70.005AV .8" diam. 1 1/8" thick. \$24.50 Ppd.
- Stock No. 70.006AV .10" diam. 1 3/4" thick. \$44.50 FOB 30 lbs.
- Stock No. 70.007AV .12 1/2" diam. 2 1/8" thick. 46 lbs. \$72.50 FOB

"FISH" WITH A GIANT MAGNET

Go Treasure Hunting On The Bottom!

Fascinating fun, and sometimes very profitable! Tie a line to our 5-pound Magnet—drop it overboard in bay, river, lake or ocean. Trawl it along the bottom. Your "treasured" haul can be outboard motors, anchors, other metal valuables. Five-pound Magnet is war surplus—Alnico V Type that cost the Government \$50. It lifts over 150 pounds on land—much greater weights under water!



- Stock No. 70.571AV \$14.00 Ppd.
- Stock No. 70.570AV 3 1/2 lbs. \$8.75 Ppd.
- Stock No. 85.152AV 15 3/4 lbs. \$33.95 F.O.B.

BIG BOOM & FLASH CANNON



Perfectly safe giant noisemaker for sports, games, the 4th and just plain fun produces brilliant flash and loud bang. Completely harmless—no gun powder, matches or recoil. Easily operated. Beautiful reproduction of regular Army 60

MM cannon in hefty cast iron. "Ammo" is pulverized Bangsite combined with water in cannon producing harmless gas. Can not be ignited by hottest flame or heaviest concussion. Incl. ammo for 200 shots, instr. Wt. 2 1/4 lbs.

- Stock No. 70.898AV \$6.95 Ppd.
- 25" "Big Bertha" Cannon (5 1/2 lbs.)
- Stock No. 71.654AV \$16.50 Ppd.

(And our FREE CATALOG is packed with exciting and unusual ecological & physical science items—plus 4,000 finds for fun, study or profit... for every member of the family.)

KNOW YOUR ALPHA FROM THETA!

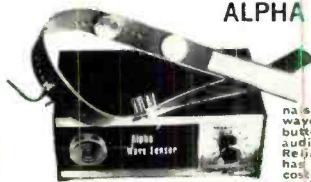

Learn to control your Alpha-Theta brainwaves for relaxation, improved memory, concentration. Electrode headband (w. no messy creams, etc.) attach to amplifier filters brainwaves, signals beep for ea. Alpha or Theta wave passed. Spcl. monitoring button to simulate Alpha sound; audio & visual (L.E.D.) feedback. Reliable, easy-to-use trainer unit has features comparable to many costlier models. Completely safe. Most people can learn in 8-12 hrs w incl instr. (6x3x6", 24 oz.) \$124.50 Ppd.

- No. 1635AV (6x3x6", 24 oz.) \$124.50 Ppd.

3-CHANNEL COLOR ORGAN KIT

Easy to build low-cost kit needs no technical knowledge. Completed unit has 3 bands of audio frequencies to modulate 3 independent strings of colored lamps (i.e. "lows"—reds, "middles"—greens, "highs"—blues. Just connect hi-fi, radio, power lamp etc. & plug ea. lamp string into own channel (max. 300w ea.). Kit features 3 neon indicators, color intensity controls, controlled individ SCR circuits; isolation transformer; custom plastic housing; instr.



- Stock No. 41.831AV \$15.75 Ppd.

SEE THE STARS. MOON, PLANETS CLOSE UP!

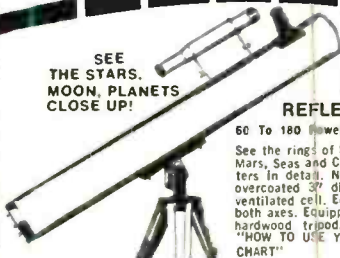

3" ASTRONOMICAL REFLECTING TELESCOPE

60 To 180 Power. Famous Mt. Palomar Type

See the rings of Saturn, the fascinating planet Mars, Seas and Craters of the Moon, Star Clusters in detail. New improved, aluminumized and overcoated 3" diameter f/10 primary mirror, ventilated cell. Equatorial mount with locks on both axes. Equipped with 60x finder telescope, hardwood tripod. Included FREE: VALUABLE "HOW TO USE YOUR TELESCOPE" book; "STAR CHART"

- Deluxe 3" Reflector Telescope Stock No. 85.050AV \$32.95 Ppd.
- Stock No. 80.162AV \$61.50 Ppd
- Stock No. 85.105AV \$99.50 FOB
- 6" Reflector Telescope Stock No. 85.187AV \$199.50 FOB
- 6" Reflector W (Electric) Clock Drive No. 85.086AV \$239.50 FOB

MAIL COUPON FOR GIANT FREE CATALOG!

164 PAGES • MORE THAN 4000 UNUSUAL BARGAINS!

Completely new Catalog. Packed with huge selection of Telescopes, microscopes, binoculars, magnets, magnifiers, prisms, photo components, ecology and Unique Lighting items, parts, kits, accessories — many hard-to-get surplus bargains. 100's of charts, illustrations. For hobbyists, experimenters, schools, industry.

EDMUND SCIENTIFIC CO.
300 Edscorp Building, Barrington, N. J. 08007
Please rush Free Giant Catalog "AV"

Name _____
Address _____
City _____ State _____ Zip _____

COMPLETE & MAIL WITH CHECK OR M.O.

EDMUND SCIENTIFIC CO.
300 Edscorp Building, Barrington, N.J. 08007

How Many	Stock No.	Description	Price Each	Total

PLEASE SEND GIANT FREE CATALOG " " MERCHANDISE Total
 HANDLING CHARGE \$1.00*
TOTAL \$ _____



I enclose check money order for \$ _____

NAME _____
ADDRESS _____
CITY _____ STATE _____ ZIP _____

CIRCLE NO. 12 ON READER SERVICE CARD
Printed in U.S.A.

Popular Electronics

INCLUDING **Electronics World**

READER SERVICE

Here's an easy and convenient way for you to get additional information about products advertised or mentioned editorially (if it has a reader service number) in this issue. Just follow the directions below... and the material will be sent to you promptly and free of charge.

1
In the attached postage-free card, print or type your name and address in the lines indicated.

2
Circle the number (s) that corresponds to the key number (s) at the bottom or next to the advertisement or editorial mention that is of interest to you. (Key numbers for advertised products also appear in the Advertisers' Index.)

3
Simply cut out the card and mail. No postage required.

FREE INFORMATION

a remarkable listening experience for stereo headphone owners!



The phenomenal realism of binaural sound recording is demonstrated by Stereo Review's

AMAZING NEW BINAURAL DEMONSTRATION RECORD

Created specifically for playback through stereo headphones, this unique record presents the listener with sound of unsurpassed realism. It recreates at each of the listener's ears the precise sound that each ear would have heard—independently—at the original scene.

Binaural recording re-creates the directions, distances, and even the elevations of sounds better than any other recording method. The super-realism of binaural recording is accomplished by recording the acoustical input for each ear separately, and then playing it back through stereo headphones. Thus the sound intended for the left ear cannot mix with the sound for the right ear, and vice versa.

Binaural recording offers the listener the identical acoustical perspective and instrument spread of the original. The sound reaching each ear is exactly the same as would have been heard at the live scene.

"MAX"—GENIE OF BINAURAL RECORDING. "Max," a specially constructed dummy head, cast in silicone rubber, duplicates the role of the human head as an acoustical absorber and reflector of sound. Super-precision capacitor microphones were installed in Max's ears so that each microphone would pick up exactly what each human ear would hear. The result is a demonstration of phenomenal recorded sound.

STARTLING REALITY. The Binaural Demonstration Record offers 45 minutes of sound and music of startling reality. You'll marvel at the eerie accuracy with which direction and elevation are re-created as you embark on a street tour in binaural sound—Sounds Of The City... Trains, Planes & Ships... a Basketball Game, a Street Parade, a Street Fabrication Plant, The Bird House at the Zoo—all demonstrating the incredible realism of binaural sound reproduction.

MUSIC IN BINAURAL. The musical performances presented on the Binaural Demonstration Record transport you to the concert hall for a demonstration of a wide variety of music. Selections total 23 minutes, and include examples of jazz, organ, and chamber music.

Although headphones are necessary to appreciate the near-total realism of binaural recording, the record can also be played and enjoyed on conventional stereo systems.

Only \$5.98

HERE'S HOW TO ORDER YOUR BINAURAL DEMONSTRATION RECORD

CASH: Mail your order along with your name, address and remittance in the amount of \$5.98, postpaid.

CHARGE: Your American Express or BankAmericard account! Mail your order, name, address and credit card number. You will be billed at \$5.98, postpaid.

MAIL ALL ORDERS TO: RECORDS, ZIFF-DAVIS SERVICE DIVISION, 595 BROADWAY, NEW YORK, N.Y. 10012
OUTSIDE U.S.A. RECORDS ARE \$8.00, POSTPAID.



He has to hear what you want to hear...

Over a third of the Duo-Scan® FM monitor receivers we make are purchased by police, fire departments, and other professionals... because they can't settle for less than Johnson performance! After all, since we engineer and build professional FM 2-way radios, we just naturally know how to build a better FM scanner: With integrated circuit symmetrical limiting to make it really quiet. Dual ceramic filters to reject interference. Ultra-sensitive "front end" circuitry to pull in the weakest signals. And a true noise-operated squelch that's crisp and clean... just like in a regular police radio. If you want to hear all the action, you want the scanner the professionals use!

Duo-Scan for low and high band VHF \$169.95
Duo-Scan for high band VHF and UHF \$179.95
Mono-Scan for high band VHF \$139.95
Mono-Scan for UHF \$159.95



The professional monitor: Duo-Scan®

EXCELLENCE



THROUGH HALF A CENTURY OF EXPERIENCE

JOHNSON

® Waseca, Minnesota 56093

CIRCLE NO. 13 ON READER SERVICE CARD

www.americanradiohistory.com