

Popular Electronics

INCLUDING **Electronics World**

BASIC HI-FI SPEAKER SYSTEMS

AND HOW THEY WORK

RECOMMENDED TV ANTENNAS

FOR YOUR
LOCATION

USING YOUR CB FOR EMERGENCIES

BUILD:

- Electronic Wind Chimes
- A Simple Compressor/
Expander
- An Accurate Dwell Meter
and Tachometer

TEST REPORTS:

- Heath GC-1005 Digital Clock
- Sharpe Models 7 and 770
Stereo Headphones
- Electro-Voice 4X4 4-Channel
Receiver
- Fanon-Courier Fanfare
CB Transceiver
- RCA WE-130A Sound L...

ELECTRONIC POLLUTION: AN IMPENDING

482452 800 0530F096 NOV73 A 10
E BROOK
530 FRANKLIN ST
GRAND HAVEN MI 49417

**NRI “hands-on” training in
Television, Communications,
Electronics and Computers
can give you as much
as 2 years of on-the-job
experience.**

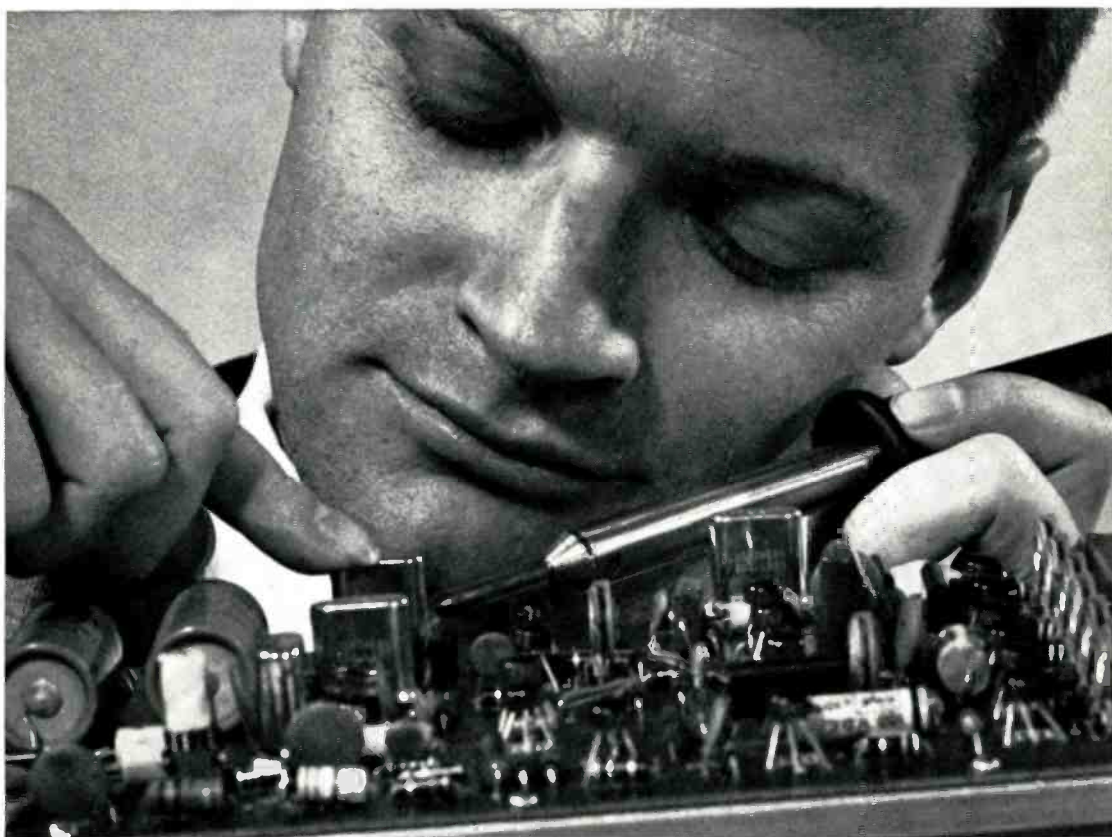

EARN YOUR FCC LICENSE – OR YOUR MONEY BACK

NRI Communications training programs will qualify you for a First Class Commercial Radiotelephone License issued by the FCC. If you fail to pass the FCC examinations for this license after successfully completing an NRI Communications course we will, on request, refund in full the tuition you have paid. This agreement is valid for the period of your active student membership and *for six months* after completion of your training. No school offers a more liberal FCC License agreement.

Experience is still your best teacher



NRI Achievement Kit is educator-acclaimed and the original "starter" kit in home study training. Imitated but never duplicated, this kit is designed and personalized for you and your training objective. It has one purpose — to get you started quickly and easily.



"Bite-Size" Texts average an easily-digested 40 pages of well-illustrated, scientifically prepared subject matter in the course of your choice. Questions in each book are carefully hand-graded and returned to you with helpful instructional notes. You get unlimited personal help from the day you enroll.



Designed-For-Learning Equipment

Like this phone-cw transmitter (Kit #7 in the Communications course) is engineered from chassis up to demonstrate principles you must know. NRI does not use modified hobby kits for training, but the finest parts money can buy, professionally and educationally applied.

...here's how you get it with unique NRI training at home

Ask any teacher, job counselor, engineer, technician or prospective employer about the need for practical application of theory in Electronics. He'll tell you Electronics is as much a "hands-on" profession as dentistry or chemistry. That's how you learn at home with NRI. You prove the theory you read in "bite-size" texts, by actual experimentation with the type of solid-state, transistor and tube circuits you'll find on the job today — *not* hardware or hobby kits. You introduce circuit defects, analyze results, discover quickly the kind of trouble-shooting and design techniques that will make you employable in Electronics.

Train with the leader — NRI

NRI lab equipment is designed from chassis up for effective, fascinating training — not for entertainment. The fact that end results are usable, quality products is a bonus. In Communications, for example, you build and analyze, stage by stage, your own 25-watt phone/cw transmitter. It's suitable for use on the 80-meter amateur band, if you have an interest in ham radio. In TV-Radio Servicing your practical training gives you your choice of monochrome or color TV sets. All training equipment is included in the low tuition — you pay nothing extra. Discover for yourself the ease, excitement and *value* of NRI training. Mail postage-free card today for new NRI Catalog . . . or use the coupon below. No obligation. No salesman will call on you. NATIONAL RADIO INSTITUTE, Washington, D.C. 20016.

APPROVED UNDER NEW GI BILL

If you have served since January 31, 1955, or are in service now, check GI line on postage-free card or in coupon.

MAIL THIS COUPON IF CARD IS GONE



NATIONAL RADIO INSTITUTE

Washington, D.C. 20016

1-043

Please send me your new NRI Catalog. I understand no salesman will call and there is no obligation.

Name _____ Age _____

Address _____

City _____ State _____ Zip _____

Check for facts on new GI Bill

ACCREDITED MEMBER NATIONAL HOME STUDY COUNCIL

Popular Electronics

WORLD'S
LARGEST-SELLING
ELECTRONICS MAGAZINE

INCLUDING **Electronics World**

FEATURE ARTICLES

- 28 UNDERSTANDING THE JUNCTION FIELD EFFECT TRANSISTOR**
Many uses for this versatile device. Adolph A. Mangieri
- 32 ELECTRIC POWER FROM THE EARTH** L. George Lawrence
Continuing the search for natural sources.
- 35 USING YOUR CB SET FOR EMERGENCIES**
- 42 ELECTRONIC POLLUTION—AN IMPENDING CRISIS** Webb Garrison
Some overlooked factors in environmental protection.
- 46 BASIC HI-FI SPEAKER SYSTEMS** Leonard Feldman
- 63 CHOOSING A TV ANTENNA** Harvey F. Swearer
Recommended antennas for your location.
- 76 DESIGN YOUR OWN VOLTAGE REGULATOR** Keith Schuettpeiz
- 93 LEAKAGE CURRENT TESTING AND USING SQUARE WAVES**
John T. Frye
- 112 BATTERY TYPES AND THEIR CHARACTERISTICS** Samuel C. Milbourne
- 118 ELECTRONIC CIRCUIT ANALOGY QUIZ** Robert P. Balin

CONSTRUCTION STORIES

- 50 SIMPLE COMPRESSOR-EXPANDER** Craig Anderton
Improves sound on any program material.
- 51 ELECTRONIC WIND CHIMES** John S. Simanton, Jr.
Natural sounds achieved artificially.
- 56 SHORT 80- THROUGH 10-METER BAND HAM ANTENNA**
Richard A. Yomms
- 62 BUILD A RECHARGEABLE FLASHLIGHT** John McNarney
Use the new battery types.
- 67 BUILD AN ACCURATE DWELL/TACHOMETER INSTRUMENT**
Keep your car in tip-top shape. Edward N. J. Marguerit

ZIFF-DAVIS PUBLISHING COMPANY
Editorial and Executive Offices
One Park Avenue, New York, New York 10016
212 679-7200

William Ziff, President
W. Bradford Briggs, Executive Vice President
Hershel B. Sarbin, Senior Vice President and Secretary
Phillip Sine, Financial Vice President and Treasurer
Phillip T. Heffernan, Vice President, Marketing
Frank Pomerantz, Vice President, Creative Services
Arthur W. Butzow, Vice President, Production
Edward D. Muhlfeld, Vice President, Aviation Division
Irwin Robinson, Vice President, Travel Division
George Morrissey, Vice President
Sydney H. Rogers, Vice President
Sidney Holtz, Vice President
Lawrence Sporn, Circulation Director

POPULAR ELECTRONICS Including ELECTRONICS WORLD, April, 1973, Volume 3, Number 4. Published monthly at One Park Ave., New York, NY 10016. One year subscription rate for U.S., U.S. Possessions and Canada, \$6.00; all other countries, \$7.00. Second class postage paid at New York, N.Y. and at additional mailing offices. Authorized as second class mail by the Post Office Department, Ottawa, Canada and for payment of postage in cash. Subscription service and Forms 3579: P.O. Box 2774, Boulder, CO 80302. Editorial offices for manuscript contributions, reader inquiries, etc.: One Park Ave., New York, NY 10016.

POPULAR ELECTRONICS Including ELECTRONICS WORLD is indexed in the Reader's Guide to Periodical Literature.

Copyright © 1973 by ZIFF DAVIS PUBLISHING COMPANY. All rights reserved.

POPULAR ELECTRONICS Including Electronics World

EDGAR W. HOPPER
Publisher
WM. A. STOCKLIN
Editorial Director
MILTON S. SNITZER
Editor
LESLIE SOLOMON
Technical Editor
JOHN R. RIGGS
Managing Editor
EDWARD I. BUXBAUM
Art Director

ALEXANDER W. BURAWA
Associate Editor
ANDRE DUZANT
Technical Illustrator
JUDITH L. HOGAN
Editorial Assistant
JOHN T. FRYE
J. GORDON HOLT
RICHARD HUMPHREY
WALTER G. JUNG
Contributing Editors

JOSEPH E. HALLORAN
Advertising Director
JOHN J. CORTON
Advertising Sales
MADELEINE LITTMAN
Advertising Service Manager
STANLEY NEUFELD
Associate Publisher
FURMAN H. HEBB
Group Vice President
Electronics and Photographic

THE SCENES

- 12 STEREO SCENE** *J. Gordon Holt*
- 72 TEST EQUIPMENT SCENE** *Leslie Solomon*
- 100 HOBBY SCENE**
- 119 SOLID-STATE SCENE** *Walter G. Jung*
- 122 SURPLUS SCENE** *Alexander W. Burawa*

PRODUCT TEST REPORTS

- 82 ELECTRO-VOICE MODEL 4X4 RECEIVER**
- 85 SHARPE MODELS 7 AND 770 HEADPHONES**
- 88 FANON/COURIER FANFARE 200 CB TRANSCEIVER**
- 90 RCA MODEL WE-130A SOUND LEVEL METER**
- 91 HEATHKIT MODEL GC-1005 DIGITAL ELECTRONIC CLOCK**

DEPARTMENTS

- 6 LETTERS**
- 25 NEWS HIGHLIGHTS**
- 102 NEW PRODUCTS**
- 108 ELECTRONICS LIBRARY**
- 110 NEW LITERATURE**

COMING NEXT MONTH

Electronic Music Synthesizers
Unique Binary Digital Clock
A New Color Organ
Ham 2-Meter FM Repeaters
Electronics in Water Quality Control

Midwestern Office
The Parris Group, 4761 West Touhy Ave.,
Lincolnwood, Illinois 60644, 312 679-1100
GERALD E. WOLFE, DICK POWELL
DICK GOVATSKI, MANLEY LUDWIG

Western Office
9025 Wilshire Boulevard, Beverly Hills, California 90211
213 273-8050; Bradshaw 2-1161
Western Advertising Manager, BUD DEAN

Japan: James Yagi
Oji Palace Aoyama; 6-25, Minami Aoyama
6 Chome, Minato-Ku, Tokyo 407-1930/6821

Ziff-Davis also publishes Boating, Car and Driver, Cycle, Flying, Modern Bride, Popular Photography, Skiing, and Stereo Review.

Forms 3579 and all subscription correspondence should be addressed to POPULAR ELECTRONICS including ELECTRONICS WORLD, Circulation Department, P.O. Box 2774, Boulder, CO 80302, Please allow at least eight weeks for change of address. Include your old address, as well as new—enclosing, if possible, an address label from a recent issue.

Editorial contributions must be accompanied by return postage and will be handled with reasonable care; however, publisher assumes no responsibility for return or safety of art work, photographs or manuscripts.



Member Audit Bureau of Circulations

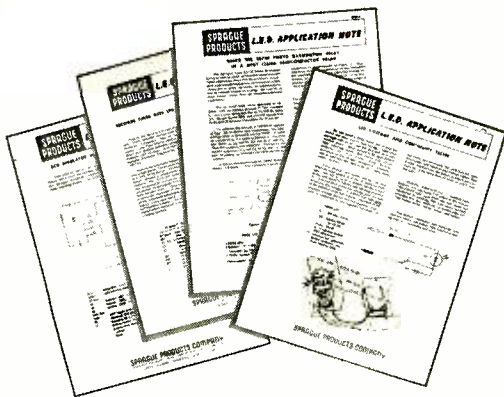

FREE

L.E.D. Application Notes to help you do new things with new circuits!

Now . . . get four **free** Application Notes hot-off-the-press that describe various uses and circuits for Sprague LED devices. Notes cover a BCD simulator, seconds timer, voltage and continuity tester, and an all-solid-state semiconductor relay. They've been prepared specifically to help open up a new world of electronic experimentation for **YOU**.

Ask your distributor for copies, or write our Guy Ezelle at Sprague Products Co. Better yet, fill out and mail coupon today!

Sprague Products Company
395 Marshall St., North Adams, Mass. 01247
Attention: Mr. Guy Ezelle

YES . . . send me free L.E.D. application notes on:

- BCD Simulator Voltage & Continuity Tester
 Seconds Timer Semiconductor Relay

Name

Address

City

State

Zip

SP-213-D



CIRCLE NO. 41 ON READER SERVICE CARD

PERF OR PC BOARDS?

As an old-time electronics experimenter who built one-tube regenerative sets in the early 1920's, I don't understand why experimenters often resort to rather elaborate procedures in devising printed circuit boards for simple projects. What is wrong with mounting components on a piece of unclad perforated boards and running the various interconnecting conductors using ordinary copper wire? After all joints are soldered, the wires could be fastened to the boards with some sort of adhesive. Of course, if dozens of boards had to be duplicated from one master design, the bother of setting up for PC boards would be justified.

LEWIS E. WALKUP
Honolulu, Hawaii

There is nothing wrong with what you suggest. In fact, you would be surprised how many of the projects we have published came from original prototypes wired in this manner—some quite complicated, too. But for the sake of clarity on the printed page and to insure a better finished product in the long run, we don't know of anything better than a PC etching guide.

ONE-UPMANSHIP

I'll bet Bert Wolf ("Multiset Coupling Systems For Your TV antenna," October 1972) would be happy to hear about the Lexan tacks generally available in discount houses. These tacks are the perfect solution for attaching twin-lead to baseboards. Being all plastic, they present no impedance mismatches.

REV. DAVID E. SCHILLING
Kent, Ohio

Thanks for passing on the tip which we now pass on to our readers. The Lexan tacks are indeed an excellent choice for twin-lead tacking.

TECHNICIAN'S HELPMATE

Here's a useful tip for field service technicians: When you go out on a call, carry along a soldering iron handle that uses screw-in type heating elements. On the job, you can screw into the handle a GE 6S6 6-watt, 117-volt indicator lamp and have an instant service light for those dark

areas inside TV and radio receiver chassis. The lamp will also find lots of use on the service bench.

ALBERT V. MANGUM
Ogdensburg, N.Y.

A BETTER WAY TO DO THINGS

While building the Strobe Cube (November 1972), I discovered that a Stancor P-6426 photo-flash trigger coil was superior in performance to the method suggested in the article. The Stancor coil is also more readily available. The circuit layout must be modified slightly (see schematic).

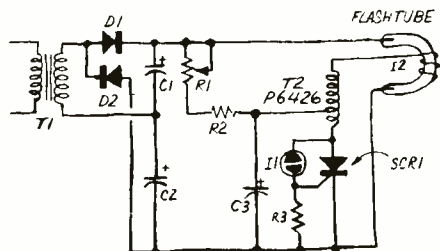

However, all components remain the same, the only difference being the substitution of the trigger coil for T2.

RICK BUCKNER
Hanahan, S.C.

MORE HELP WANTED

I recently obtained a Model TV-7D/U tube tester made by Multi-Amp Electronics Corp. of Cranford, N.J. No tube manual or instructions were supplied with the tester. The manufacturer insists that no manuals are available from them or any other commercial outlet. Can anyone help me?

HARLAN NEFF
Route 1, Box 598
Wilton, CA 95693

There must have been 50,000 TV-7D/U's manufactured for Uncle Sam over the years. Any of you MARS hams who were lucky enough to inherit a TV-7 tube tester and want to be good guys can write directly to Harlan. If you get no answer, Harlan, try writing to Fair Radio Sales Co., 1016 E. Eureka St., Lima, OH 45802, or visit a surplus dealer that handles military gear.

IS 1984 ELEVEN YEARS EARLY?

From Dwain Abell's letter ("Letters," February 1973), it appears that some states are adopting Big Brother tactics in passing unconstitutional laws such as those forbidding us to listen to certain types of communications. In light of the fact that the federal Constitution guarantees the right of free speech and prohibits

SAVE MONEY!

A Delta Mark Ten Capacitive Discharge Ignition (CDI) System On Your Car Slashes Maintenance Costs And Increases Performance.

Put a Mark Ten on your car and save by eliminating 3 out of 4 tune-ups. Save as gasoline mileage increases (up to 20%). The Mark Ten CDI system also extends spark plug life, promotes more complete combustion and assures instant starts in all weather. It operates on any 6 or 12 volt negative or positive ground system.

The Mark Ten B affords additional money saving advantages by drastically reducing combustion contaminants and restoring power lost by the use of smog control devices. Equipped with handy switch for instant return to standard ignition, the Mark Ten B works with ANY 12 volt negative ground engine. Both systems install in ten minutes without rewiring.

Order your Mark Ten or Mark Ten B today. Save money while you enjoy low maintenance and increased performance.

Mark Ten (Assembled) \$44.95 ppd.

Mark Ten (Deltakit) \$29.95 ppd.
(Kits available in 12 volt only,
positive or negative ground)

Mark Ten B \$59.95 ppd.
(12 volt negative ground only)

Superior Products at Sensible Prices
Mfg. in U.S.A.



Dept. PE



DELTA PRODUCTS, INC.

P.O. BOX 1147 • GRAND JUNCTION, COLORADO 81501
PHONE (303) 242 9000

Please send me literature immediately:
Enclosed is \$ _____
 Ship ppd. Ship C.O.D.

Please send: _____ Mark Ten B @ \$59.95 ppd.
 ___ Standard Mark Ten (Assembled) @ \$44.95 ppd.
 ___ 6 Volt: Neg. Ground Only ___ Positive Ground
 ___ 12 Volt: Specify ___ Negative Ground
 ___ Standard Mark Ten (Deltakit*) @ \$29.95 ppd.
 (12 Volt Positive Or Negative Ground Only)

Car Year _____ Make _____
 Name _____
 Address _____
 City/State _____ Zip _____

CIRCLE NO. 11 ON READER SERVICE CARD

NEW!

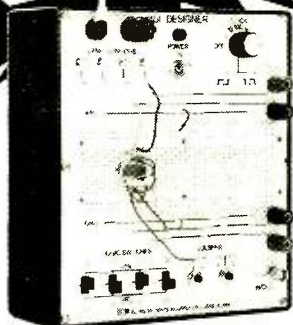

**Build your own
circuit designer, with
all the outstanding features
of expensive models . . .
now at a very low budget price!**

This compact package contains a regulated 5VDC supply, selectable frequency clock, EL-socket, dual bounce-free pushbuttons (pulsers), 4 slide switches for voltage/ground, plus 4 independent "logic lights" for on/off states of various logic circuitry. Exclusive Breadboarding Pins offer input/output connections to socket eliminating all soldering. Use any 22 gage solid wire. **Send check or M.O. today for your choice of two models.**

THE DIGI DESIGNER

DD1-K, Kit Form (incl. p.c. boards, all components, instruction manual) \$49⁹⁵
DD1-A, Assembled ready for use \$95⁰⁰

- Add \$2 postage, handling
- 25% deposit on C.O.D.s



**ASK FOR NEW
FREE
IDEA-PACKED,
ILLUSTRATED
CIRCUIT DESIGN
CATALOG!**



EL INSTRUMENTS, INC.
61 First St., Derby, Conn. 06418
Telephone: 203/735-8774

CIRCLE NO. 16 ON READER SERVICE CARD

any state from abridging that right, how can the states forbid us to listen to police, fire, etc., transmissions?

It was my impression that, when the FCC was established, it was given sole power to regulate communications by radio. Now, it appears, some states are taking upon themselves those regulatory powers.

L.S.S.
Miami, Fla.

Laws that bar the average citizen from listening in on emergency broadcasts have to do with listening—not free speech. It is a fine point that we do not think has been constitutionally tested. But if it were brought to court, the ruling would most likely go against the average citizen on the grounds that emergency broadcasts are for official business and not the entertainment of the general public. Nor are the states actually usurping the powers of the FCC since, in general, the FCC enters the reception picture only when third-party disclosures are involved.

BETTER WATCH ACCURACY FROM QUARTZ?

"Electronic Wrist Watches" (February 1973) left me uncertain as to the obtainable accuracy from these watches. I disagree with the statement: "The greater the number of parts into which a second is split, the greater the obtainable accuracy." According to my calculations, a clock driven from a 60-Hz ± 1 percent source and another driven from a 60,000-Hz ± 1 percent crystal oscillator would both have maximum timing errors of 0.6 sec/min. Hence, it seems that the oscillator's frequency tolerance—not its frequency—determines the accuracy of the time-piece. Any comment?

MARK HEEREMA
Jacksonville, Ark.

True, and we can see how the wording of the quoted statement contributed to a misunderstanding. Actually, the statement would have been more accurate and complete if it finished with ". . . because the frequency tolerances of high-frequency crystals can be more tightly controlled than those of low-frequency crystals." With this in mind and the fact that crystals used in electronic watches are typically cut to 0.001-0.005 percent tolerance, the maximum constant frequency deviation over a 30-day period would be on the order of 25.9-149.6 sec. However, these figures are based on a maximum constant deviation. In reality, the deviation would be all over the ballpark between the plus and minus limits and the average deviation would be much less.

CORRECTION: "Build an Enlarger Timer," February 1973. PCI, the Clairex CdS cell, should read CL705HL, not the CL704IIL specified in the Parts List.

Another introductory offer to new members of the ELECTRONICS AND CONTROL ENGINEERS' BOOK CLUB

 <p>404/445 ELECTRONIC CIRCUITS MANUAL by J. Markus Pub. price, \$19.75 Club price, \$15.75</p>	 <p>637/458 DESIGNING WITH TTL INTEGRATED CIRCUITS by Texas Instruments Inc. Pub. price, \$18.50 Club price, \$13.50</p>	 <p>286/515 INTEGRATED CIRCUITS: A Basic Course for Engineers and Technicians by R. G. Hibberd Pub. price, \$9.95 Club price, \$8.45</p>	 <p>ANY ONE of these great professional books for only \$ 1.00</p> <p>VALUES FROM \$9.95 to \$34.75</p> <p>Special \$1.00 bonus book comes to you with your first club selection</p>
 <p>404/437 SOURCEBOOK OF ELECTRONIC CIRCUITS by J. Markus Pub. price, \$19.75 Club price, \$14.75</p>	 <p>313/059 HANDBOOK OF SEMI-CONDUCTOR ELECTRONICS, 3/e by P. Hunter Pub. price, \$27.50 Club price, \$21.50</p>	 <p>287/341 STANDARD HANDBOOK OF ENGINEERING CALCULATIONS by T. G. Hicks Pub. Price, \$18.50 Club Price, \$14.25</p>	
 <p>259/607 COMMUNICATION SYSTEM ENGINEERING HANDBOOK by D. H. Hamsher Pub. price, \$29.50 Club price, \$22.50</p>	 <p>124/035 HANDBOOK OF PHYSICS, 2/e by Condon and Odishaw Pub. price, \$34.75 Club price, \$14.95</p>	 <p>571/422 ELECTRONIC FUNDAMENTALS FOR TECHNICIANS by R. L. Shradar Pub. price, \$11.95 Club price, \$9.25</p>	
 <p>388/458 MAGNETIC RECORDING by C. E. Lowman Pub. Price, \$14.50 Club Price, \$9.75</p>	 <p>209/731 STANDARD HANDBOOK FOR ELECTRICAL ENGINEERS, 10/e by Fink and Carroll Pub. price, \$32.50 Club price, \$24.95</p>	 <p>649/170 OPERATIONAL AMPLIFIERS by Tobey, Graeme & Huelsman Pub. price, \$15.00 Club price, \$11.50</p>	
 <p>124/035 HANDBOOK OF PHYSICS, 2/e by Condon and Odishaw Pub. price, \$34.75 Club price, \$14.95</p>	 <p>349/428 TRANSISTOR AND INTEGRATED ELECTRONICS, 4/e by M. S. Kiver Pub. Price, \$12.50 Club Price, \$9.75</p>	 <p>209/731 STANDARD HANDBOOK FOR ELECTRICAL ENGINEERS, 10/e by Fink and Carroll Pub. price, \$32.50 Club price, \$24.95</p>	

Save time and money by joining the
Electronics and Control Engineers' Book Club



HERE is a professional club designed specifically to meet your day-to-day engineering needs by providing practical books in your field on a regular basis at below publisher prices.

How the Club operates: Basic to the Club's service is its publication, the *Electronics and Control Engineers' Book Club Bulletin*, which brings you news of books in your field. Sent to members without cost, it announces and describes in detail the Club's featured book of the month as well as alternate selections which are available at special members' prices.

When you want to examine the Club's feature of the month, you do nothing. The book will be mailed to you as a regular part of your Club service. If you prefer one of the alternate selections—or if you want no book at all for that month—you notify the Club by returning the convenient card enclosed with each *Bulletin*.

As a Club member, you agree only to the purchase of four books over a two-year period. Considering the many books published annually in your field, there will surely be at least four that you would want to own anyway. By joining the Club, you save both money and the trouble of searching for the best books.

MAIL THIS COUPON TODAY

ELECTRONICS AND CONTROL ENGINEERS' BOOK CLUB
582 Princeton Road, Hightstown, N.J. 08520

Please enroll me as a member of the Electronics and Control Engineers' Book Club and send me the two books indicated below. I am to receive the bonus for just \$1.00, and my first selection at the special Club price shown. These books are to be shipped on approval, and I may return them both without cost or further obligation. If I decide to keep the books, I agree to purchase as few as four books during the next two years at special Club prices (at least 15% below list).

Write Code No. of
bonus book
here

Write Code No. of
first selection
here

Name

Address

City

State Zip

E33210

CIRCLE NO. 17 ON READER SERVICE CARD

Replacement Parts? You can guess, hope, hunt...

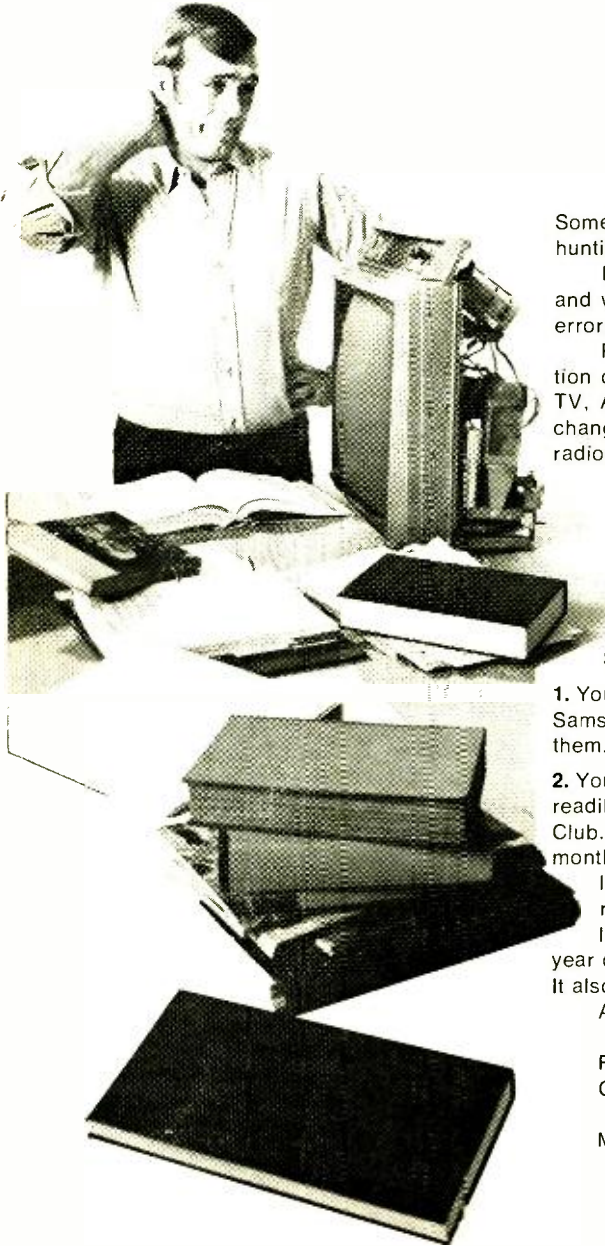

Some folks paw through a mountain of catalogs hunting for the right replacement parts.

Photofact users find what they need, quickly and without frustration, or resorting to trial and error.

Photofact provides detailed circuit information on virtually every model of color and b&w TV, AM and FM radios, stereos and record changers. Plus similar service data on auto radios and tape players, CB radios and tape recorders.

Photofact also lists all parts and replacements by name, number and manufacturer, with standard notation schematics that save loads of time and guesswork in servicing the sets.

Here's how the complete Photofact Servicing System works for you:

1. You can purchase Photofact sets from your Sams distributor from day to day, as you need them.

2. You can have service data on current sets readily at hand by joining Photofact-of-the-Month Club. You'll receive six new Photofact sets every month with detailed, accurate information on at least 50 of the newest TV's, radios, stereos, record changers, etc.

It's only \$13.50 a month. It saves you \$54 a year over individually purchased Photofact sets. It also brings you . . .

Advance schematics and preliminary data on servicing latest equipment

File folder for each Photofact set

Coupons good for permanent Photofact metal file cabinets

Monthly bulletin.

or use the quick, accurate Sams Photofact® System.

3. At any time you can buy Photofact sets to fill-in or expand your servicing library, under four different time payment plans without carrying charge...

Easy Buy Plan

	No. Photofact sets	Down Payment	Balance	
Plan A	60	\$20	\$ 133	Payable without carrying charge
Plan B	180		439	
Plan C	300		745	
Plan D	500		1,275	

4. If your Sams distributor is temporarily out of stock of certain Photofact sets (1-500) that you need right now he will provide you with BLUE STREAK ORDER FORMS. For \$3.75 each including delivery, Sams will rush your Photofact to you via Special Handling Parcel Post.

5. You can get additional help from your Sams distributor's Counter Facts® microfiche file. Replacement parts released after Photofact sets are issued are listed in this file which also provides prices and catalog pages from various manufacturers.

Use the coupon below to improve your service and your profit picture.

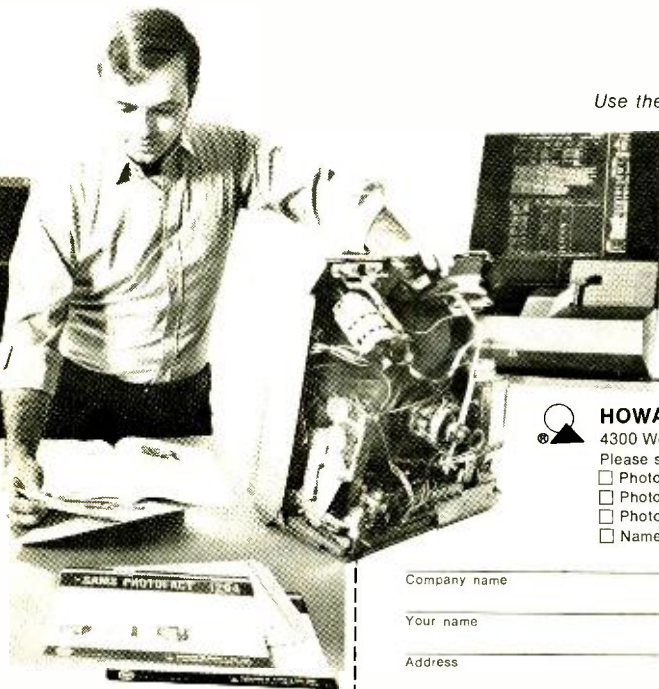

HOWARD W. SAMS & CO., INC.

PX 043

4300 West 62nd Street, Indianapolis, Indiana 46268

Please send me

- Photofact Annual Index
- Photofact Coverage Chart and Easy Buy Contract
- Photofact-of-the-Month information and Contract
- Name of Photofact distributor in my area

Company name _____

My Sams distributor is: _____

Your name _____

Name _____

Address _____

Address _____

City _____

State _____

Zip _____

City _____

State _____

Zip _____

CIRCLE NO. 35 ON READER SERVICE CARD



Stereo Scene

By J. Gordon Holt

"M EASUREMENTS are great and all that, but the ultimate test of any hi-fi component is how it sounds." We've all heard that statement before, and most of us will agree that it is basically true. After all, hi-fi components are intended to be listened to, so no matter what our test instruments tell us, if the thing *sounds* lousy, it's a lousy component.

There is a corollary to the above statement, though, which is not so true, and it states "Since your ears are the ultimate arbiter, the best way to choose a component is to go into a store, listen to what's on display, and pick the one that sounds best." There are, in fact, several fallacies in that advice, most of which we'll let pass for the time being (and take up in a later column). Our primary concern right now is with a particular kind of component which, in a listening test like that, is likely to perform worse than it actually is. I'm speaking of tape recorders.

Everyone is entitled to his personal taste in reproduced sound, as misguided as his taste may be. You may prefer the sound of real, honest-to-goodness live music (if you can remember what it sounds like 24 hours after an exposure to it), which is the ideal situation. After all, high fidelity means re-

alistic reproduction; and, if you don't prefer that, then you don't like high fidelity. Most people, however, when placed in a situation that is a week or so removed from the last contact with live music, will choose reproduced sound that conforms to certain—shall we say—prejudices. Some listeners like big, fat bass, others like it a bit sparse and tightly detailed. Some like razor-sharp highs, for crisp reproduction of high percussion instruments. Others prefer a certain softness for more agreeable reproduction of stringed instruments. And so on. These are the qualities one listens for when choosing a loudspeaker system, a power amplifier or a preamp/control unit. But they are *not* what one listens for when choosing a tape deck.

As far as a tape recorder is concerned, your personal taste in reproduced sound is totally irrelevant. If the rest of your system sounds good to you—if it doesn't, you made a bad choice—then your tape recorder should not *change* the character of the sound at all. Its playback should sound exactly like what you fed into it, and if it doesn't, then the recorder isn't doing the job it's supposed to. But if you'd like a bit of an ear-opener, just stop into your local audio mart and ask to hear some tape recorders in action. That is, ask the salesman to make a tape from an in-house demo disc on each machine and play it back. You'll hear a remarkable variety of sounds.

Not only will some machines sound dull at the high end and others overly bright, but you will also observe that some are noticeably more toppish in one channel than the other. And if you find one whose playback sounds like the original disc, consider yourself lucky. So, are all the other machines poor recorders? In all probability, they are not. They just don't happen to be adjusted to suit the recording tape.

Choosing Your Tape Recorder

1440



**up-date
your
ABACUS!**

4½ POUNDS 8" X 12" X 4"

TRADE THE BEADS FOR KEYS...THE MITS 1440 SPACE AGE CALCULATOR!

- 14 DIGIT LED DISPLAY READ-OUT
- + MOS-LSI CIRCUITRY
- MEMORY CLEARANCE AND CLEAR KEY
- x CONSTANT DATA MEMORY
- ÷ DECIMAL POINT LOCATION SELECTOR
- √ AUTOMATIC SQUARE ROOT SELECTOR
- AUTOMATIC² SQUARING SELECTOR
- (MEMORY + OR - KEYS)

- 1440 KIT \$199.95
- 1440 ASSEMBLED \$249.95

USE YOUR MASTER CHARGE OR BANKAMERICARD

WRITE OR MAIL COUPON FOR ADDITIONAL INFORMATION:

MITS[®] Micro Instrumentation & Telemetry Systems, Inc.

5404 Coal Ave., S. E., Albuquerque, New Mexico 87108
505/265-7553

ENCLOSED IS CHECK	<input type="checkbox"/> KIT
FOR MODEL # _____	<input type="checkbox"/> ASSEMBLED
AMOUNT OF CHECK \$ _____	P. 4-73
Include \$5.00 for postage and handling.	
<input type="checkbox"/> Please send information on entire MITS line.	
NAME _____	
ADDRESS _____	
CITY _____	
STATE & ZIP _____	

CIRCLE NO. 27 ON READER SERVICE CARD

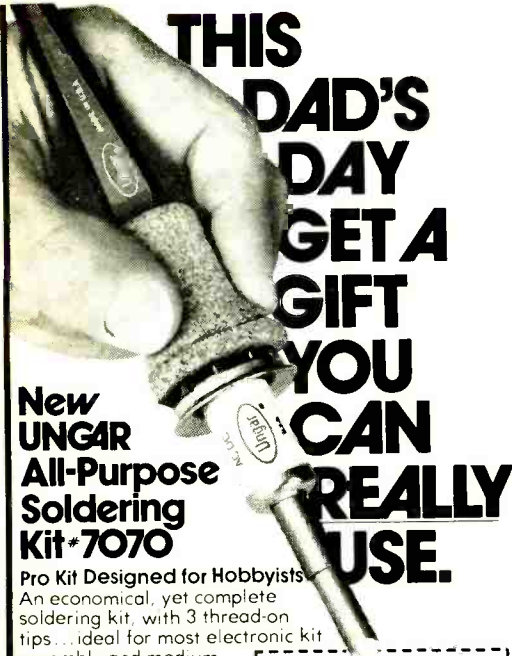

THIS DAD'S DAY GET A GIFT YOU CAN REALLY USE.

New UNGAR All-Purpose Soldering Kit #7070

Pro Kit Designed for Hobbyists
An economical, yet complete soldering kit, with 3 thread-on tips... ideal for most electronic kit assembly and medium duty repair. But that's just the beginning.

Versatility; A Modular System
Only Ungar gives you *Maximized Versatility*. Tips — heater units — even handles are interchangeable and available in an optimum variety of configurations. Custom-make your iron: for PC work simply add a #537 heater to your kit. Tackle virtually every job by simple component change — not the whole tool. (Our brand new catalog has all details plus a handy application guide... at local electronic retailers).

Rugged, Durable Quality Too
Perfectly balanced handle of hi-strength plastic, comfort-cork grip, stainless steel heat deflector and flexible 2 wire, integral cord — all UL listed, backed by Ungar's guarantee of excellence.

Get the Finest Tool Available!
Versatility, high quality, low cost plus a complete selection of accessories and production aids... the reason more pros in service, repair, R&D and production demand Ungar. It's at your local electronic retailer for only about \$6... all accessories and our new catalog is there too. **HAPPY DAD'S DAY!**

Honey, I could sure use a Father's Day gift like the Ungar #7070 Soldering Kit. only about \$6 too!

Hint! Hint!
Argyle socks and wild ties you may still get. This hint coupon may help. Let us know where you put it and what the results were. Ungar



Division of Eldon Industries, Inc.
233 East Manville, Compton, California 90220 (213) 774-5950

CIRCLE NO. 44 ON READER SERVICE CARD

Recorders Vary, Too. This is not to say that all tape machines have identical high-end capability. In fact—particularly among cassette machines—available models may have high-end capabilities varying from 10 kHz in some to beyond 14 kHz in others. This difference is audible under some conditions, but if you notice a conspicuous difference between two machines in the store demo, you can be almost certain that this is *not* because one recorder has better high-end capability than the other, but because at least one of them is improperly ad-

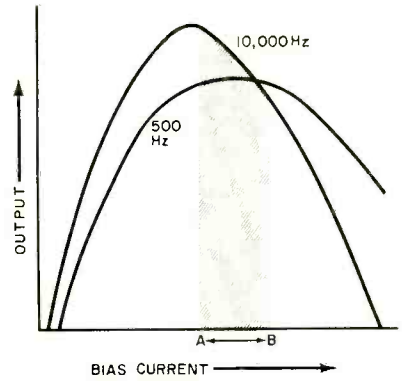

How bias current affects mid- and high-frequency signal output from a cassette tape. Note that, for the current range between A and B, 500-Hz output hardly varies at all, but 10-kHz output varies substantially.

justed for the tape. And if both *were* properly adjusted, it is very possible that the one which previously had less high will end up having a more-extended high end than its competitor.

This is why an in-the-store demonstration of tape equipment will *not* lead you infallibly to the best machine, but merely to the one that provides a better match for the particular kind of tape you use for the tests. It is also why many tape recordists are convinced that only one kind of tape is any good at all and all of the others are terrible, despite published test reports on tapes that indicate that they are not really all that different in treble response. When these people try different tapes, they are not really comparing the tapes' potential qualities. What they are doing is merely finding which one has bias and equalization requirements that happen to coincide with the adjustments of their recorder. If the record-

CIRCLE NO. 22 ON READER SERVICE CARD —>

If you don't happen to live near one of our 603 service centers...

... then it's really important to insist on Johnson quality! Because the proven reliability of Johnson CB radios makes it far less likely that you'll ever need service. Which is why we can confidently back our products with a full 1-year parts and labor warranty, with over 600 authorized service centers nationwide. And besides reliability, Johnson citizens two-way radios have a well earned reputation for truly outstanding performance. Engineered into all our Messenger radios are advanced features like speech compression for greater "talk power" and special selectivity filters to cut adjacent channel interference. And that's why U.S.-made Johnson radios are your best CB value... wherever you live!

Prices start at under \$100. Write for free catalog.



JOHNSON

Waseca, Minnesota 56093

- A** Messenger 120 Built-in Tone Alert selective calling
- B** Messenger 323-M All the features of the Messenger 323 plus Dual Receive Capability
- C** Messenger 125 Full 5-watts, but just 1 3/16" high
- D** Messenger III Rugged, 12-channel mobile
- E** Messenger 223 Powerful hybrid circuitry base station
- F** Messenger 122 New 23-channel mobile with high visibility rotary dial
- G** Messenger 124-M Deluxe 23-channel base station with Dual Receive Capability
- H** Messenger 109 Professional portable with rechargeable batteries
- I** Messenger 121 With PA and fast push-button channel selection
- J** Messenger 325 Ultimate in 23-channel mobile performance
- K** Messenger 123A All 23 channels and new improved circuitry.

Over 100
NAME BRANDS
 QUICK QUOTE SERVICE

**AVOID the HI-FI
 RIP-OFF!**

You'll
SAVE MORE MONEY
 when you BUY DIRECT
 from

**MIDWEST
 Hi-Fi Wholesalers**

Box 567
 Ellsworth Industrial Park
 Downers Grove, Ill. 60515
 (312) 852-5885

Write today for
FREE Catalog!

CIRCLE NO. 29 ON READER SERVICE CARD

**Now... the most enjoyable,
 do-it-yourself project
 of your life—a Schober
 Electronic Organ!**

You'll never reap greater reward, more fun and proud accomplishment, more benefit for the whole family than by assembling your own Schober Electronic Organ.



You need no knowledge of electronics, woodwork or music. Schober's complete kits and crystal-clear instructions show you — whoever you are, whatever your skill (or lack of it) — how to turn the hundreds of quality parts into one of the world's most beautiful, most musical organs, worth up to twice the cost of the kit.

Five superb models, with kit prices from \$500 to around \$2,000, each an authentic musical instrument actually superior to most you see in stores.

Get the full story FREE by mailing the coupon TODAY for the big Schober color catalog, with all the fascinating details!

The Schober Organ Corp., Dept. PE-49
 43 West 61st Street, New York, N. Y. 10023
 Please send me Schober Organ Catalog.
 Enclosed please find \$1.00 for 12-inch L.P. record of Schober Organ music.

NAME _____
 ADDRESS _____
 CITY _____ STATE _____ ZIP _____

CIRCLE NO. 37 ON READER SERVICE CARD

er were individually adjusted for each kind of tape, they would find (as have all professionals) that there is really very little difference between the high-end range and smoothness of the better competing tapes.

The reason for this is that the high frequencies recorded on a tape are rather fragile, and are more easily erased than middle- and low-frequency signals. A tape's ability to retain magnetic fields is profoundly influenced by the amount of ultrasonic bias signal (usually 50 to 100 kHz in frequency) passing through the record

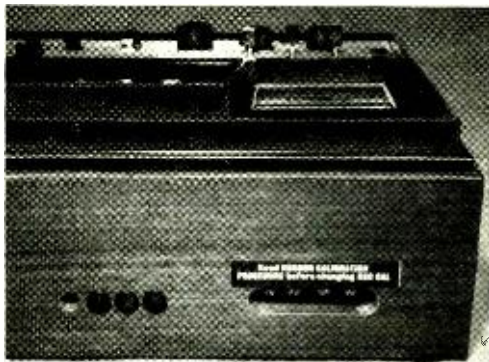

All of the setup adjustments on the Advent 201 cassette recorder are accessible through the case. This happens to be, however, one of the few machines which are usually in proper adjustment as shipped from factory.

head along with the audio signal. With exactly the right bias current (for the tape), the tape will retain the maximum amount of magnetic energy at middle and low frequencies that it is capable of retaining. Any more bias current, or any less, and the retention of signal will diminish (increasing background noise accordingly). The same relationship holds at high frequencies, but here we encounter a complication. Because of their tenuous nature (due to the extremely short recorded wavelengths), treble signals tend to get *erased* by the bias current; and, as the current increases, this erasure causes the highs to diminish much more rapidly than do the lower frequencies, which diminish only because the bias isn't quite optimal. In fact, at low tape speeds (where "self-erasure" of highs is more severe), the effect of bias current on treble response is such that treble output can be adjusted over a wide range without varying

BE AMAZED! ADD STARTLING FOUR-CHANNEL SOUND TO ANY STEREO ... HOME OR CAR ... THE EASY, LOW-COST RADIO SHACK WAY!



Built-In



Hang-On

HOME ADD-ON SYSTEM

Your stereo system is ready and waiting for easy changeover to the "Sound of the Seventies" Our Quatravox four-channel synthesizer and two Solo-103 speakers recover ambient sound previously "hidden" in ordinary stereo records, FM and tapes . . . from right, left, front and rear, just as it's "reflected" in theaters, clubs, concert halls. No internal rewiring. Six audio cables and plugs are included. Save 5%! \$54.95

Realistic Quatravox™ Alone. Add quatravox and two extra speakers to your present system for four-channel enhancement of all stereo. \$24.95

AND "ONE FOR THE ROAD"

If you already have stereo in your car, there's no need to miss out on the joys of four-channel. Our Auto Quatravox, plus two flush-mount speakers, connects easily to your present stereo radio or tape player for startling four-channel enhancement of any program or recording. Listen to front speakers only, rear only, or balance all four. 18-foot cables, hardware included. Save 10%! \$16.11

Above system with "Hang-On" Speakers. Just hang speakers anywhere in car without installation. Save 10%! \$15.21

Realistic Auto Quatravox Alone. Just add two speakers of your choice. Takes minimum space, only 5½ x 2½ x 1-3/4" \$9.95

Exclusive at 1600 Stores in 50 States.

Radio Shack

and ALLIED RADIO STORES

A TANDY CORPORATION COMPANY

P. O. Box 1052, Fort Worth, Texas 76107

FREE '73 CATALOG! AT YOUR		160
NEARBY STORE OR SEND IN THIS COUPON		
180 pages! Stereo Hi-Fi, CB, Ham, Kits, Radios, More!		
Name _____	Apt. # _____	
Street _____		
City _____	State _____	Zip <input type="text"/> <input type="text"/> <input type="text"/>

CIRCLE NO. 33 ON READER SERVICE CARD

the bias enough to have any measurable effect at all on lower frequencies. This is why a cassette recorder seems to be so exceedingly critical of the tape with which it is used. The only oxide-coating formulation that will yield a flat high end from it is the one (if there *was* one) that the machine was adjusted for at the factory.

The Setup Adjustments. Every half-decent tape recorder has a number of internal adjustments for such things as ultrasonic bias current, treble equalization, recording level, VU-meter calibration and so on, and the performance of any given sample of any tape recorder is directly related to how carefully these adjustments are made at the factory. And different manufacturers differ very markedly in the care with which they make these adjustments.

If you expect to get the very best performance from any tape recorder, the only way to ensure this is by assuming that it will be out of adjustment when you buy it, and by having it adjusted after you buy it for the kind of tape you will be using for your most demanding recordings. The adjustment is best done, not by a factory service center (for they aren't likely to be any more careful in doing it than was the factory), but by a crackerjack tape man in the service department of a hi-fi store. Give him a few reels (or cassettes) of the tape you'll be using. Ask him to order a service manual for the machine if necessary (at your expense, probably), and set it up to produce the *flattest* frequency response of which the recorder is capable. (That does not necessarily mean the most-extended high-end response, either. You can extend

highs by introducing a *hump* in the response at around 10,000 Hz, which will be audible as an exaggeration of highs.)

If you demand perfection, which in this case means the absolute best that the recorder can deliver, the only way of being certain of getting it is by availing yourself of a few items of test equipment and the service manual, and doing the job yourself. This is not a terribly difficult task, and will in fact be described in a future "Stereo Scene."

Some recorder manufacturers, though, *are* taking the trouble these days to do an accurate setup job at the factory, so if you'd rather not try customizing your unit, there's a simple in-store test to determine whether a recorder *is* properly set up. Here's how:

First, check the recorder's instruction manual. If any real attempt was made to adjust the machine to a particular tape (or tapes, in the case of models with a tape selector switch), the tape(s) will be recommended for use with the recorder. Obtain a sample of each recommended tape, and use each in turn to record and play back part of a demo disc on the premises. Then play each tape and A-B it with the disc, noting any changes in frequency response and/or channel balance. If the recorder is Dolby-equipped, make your test recordings with the Dolby switched in, as this is the toughest test of a recorder's setup accuracy. Any imperfections here will tend to upset the operation of the Dolby, causing it to dull or exaggerate the highs even more, depending on which way the recorder's inaccuracies go. Few machines will pass this test without customizing. If you find one that does, and also happens to have the features you want in a recorder, buy it. ♦

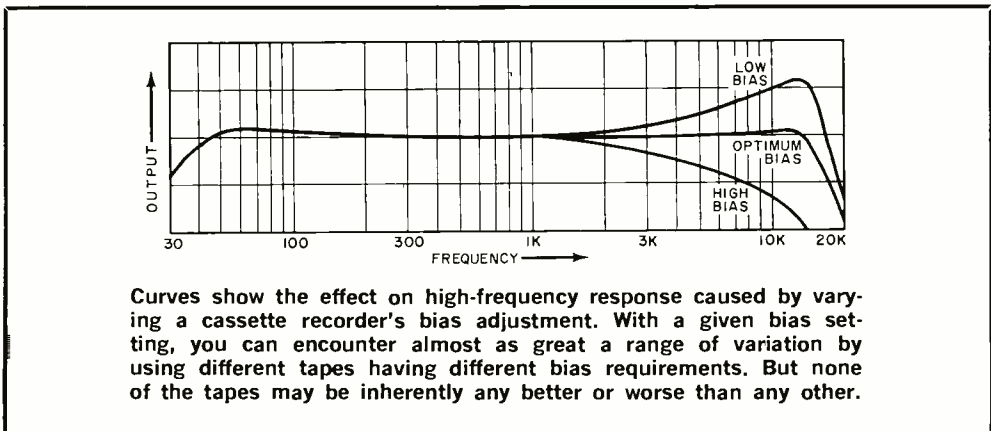



ONLY \$149.95!

NEW! 3 PLUS* NOBEX SUPER METER KIT

Now . . . \$149.95 buys the most accurate *3-plus digit multi-meter kit in the consumer electronics field! Designed and built by the NOBEX DIVISION of Griffith Plastics Corporation, the high-quality components are conveniently packaged in exclusive modular tray for simple, sequential assembly. The precision-engineered 3 PLUS SUPER METER contains over 25 American-made solid-state components, including 15 IC's, and is designed to the same degree of excellence demanded by today's electronics industry . . . the industry to which NOBEX has been a major supplier of quality components for over 10 years.

GUARANTEED RELIABILITY

- 1) All components carry a full 90 day warranty. Replacement parts are readily available.
- 2) FREE-expert technical assistance, by mail.
- 3) Calibration reference sources are supplied.

PLUS FEATURES OF THE NOBEX 3 PLUS . . .

- ALL-AMERICAN MADE
- 3 FULL DIGITS PLUS OVER-RANGE*
- OVEN CONTROL INSURES CONSTANT ACCURACY 0.5%
- 1 ohm to 1 megohm; 1 millivolt to 1,000 volts, AC/DC
- FUSE-FREE PROTECTION TO 300 volts AND OVER-VOLT-AGE LIGHT INDICATOR
- RUGGED, UNBREAKABLE CASE, WITH BAIL
- CONVENIENT CALIBRATION
- COMPREHENSIVE, YET SIMPLE INSTRUCTION MANUAL

Special Introductory Offer!

A set of deluxe test leads included FREE with each purchase. Clip and mail coupon today for your 3 PLUS SUPER METER. Indicate most convenient method of payment. Delivery will be made prepaid if check or money order accompanies order.



The New Generation of Kit Builders

**Nobex Electronics Div.
Griffith Plastics Corporation
1027 California Drive
P.O. Box 4365
Burlingame, California 94010**

Gentlemen:

Please send me _____ NOBEX 3 Plus SUPER METER kit(s) Model 8700K at \$149.95* each, including the FREE deluxe test leads. I have selected the type of payment indicated: check or money order

BankAmericard Master Charge, Include 4 Digit Bank No.

Card No. _____ Expires _____

Print Name _____

Signature _____

Mailing Address _____

City _____ State _____ Zip _____

*Calif. residents add 5% sales tax, 5½% for BART counties

CIRCLE NO. 13 ON READER SERVICE CARD

Changes come fast in electronics.

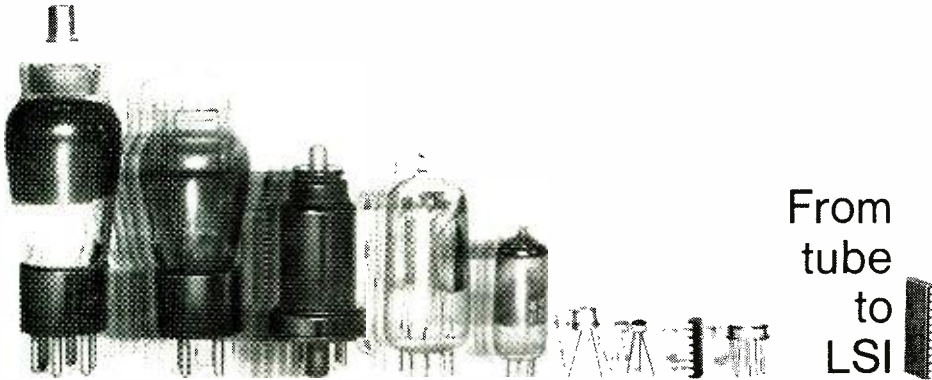

From
tube
to
LSI

Take a look at the race in circuit technology. In the 1960's the tubes at the left made way for the transistors at the right. Today, transistors are surpassed by the large scale integrated circuit (LSI) at the far right. This circuit, less than a quarter inch square, replaces over 6000 transistors!

There's big money to be made by the men who stay ahead of this technology race. Put yourself

ahead with NTS Home Training! You get the latest, most advanced equipment (at no extra cost). More solid-state units, and more advanced technology. Plenty of training with integrated circuits, too! As an NTS graduate, you enter a world of electronics you're familiar with. You have a thorough working knowledge of solid-state circuitry. You're ready to tackle bigger jobs at higher pay!

NTS COLOR AND B & W TV SERVICING

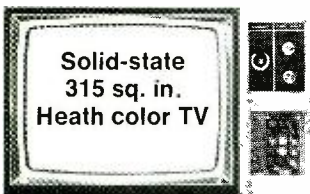

Solid-state
315 sq. in.
Heath color TV

Build and keep the largest, most advanced color TV made! Over-all solid-state design, ultra-rectangular screen, matrix picture tube, built-in self-servicing features. "Instant On," A.F.T., solid-state, 24-channel detent UHF/VHF power tuning, and much more! Also build and keep AM-SW Radio, Solid-State Radio, FET Volt-Ohmmeter, and Electronic Tube Tester. Learn trouble-shooting, hi-fi, stereo, multiplex systems, radio, color and B & W TV servicing.

Learn sophisticated solid-state circuitry as you build this B & W TV receiver. Lo-Silho "Superhet" Radio, FET Volt-Ohmmeter, Solid-State Radio, Electronic Tube Checker, and Signal Generator. TV

and all other equipment are yours to keep.

Solid-state
B & W TV,
74 sq. in.
picture
(cabinet
included)

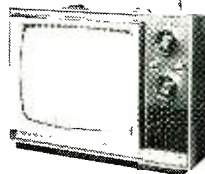

NTS ELECTRONICS & COMPUTER TECHNOLOGY

Build and keep this exclusive NTS Compu-Trainer. It teaches you the

Solid-state
Compu-Trainer
14 integrated
circuits replace
198 transistors!



same principles used in million-dollar systems. Contains 14 inte-

grated circuits! All Solid-State! You perform all wiring and patchcording. No shortcuts. No pre-wired circuit boards. Your training is complete! Also receive an FET Volt-Ohmmeter and a 5" wide-band Solid-State Oscilloscope.

NTS ELECTRONICS COMMUNICATIONS

Gain the prestige and earning power of owning an F.C.C. First Class Radio-Telephone License. Two comprehensive NTS courses cover the big opportunity field of transmitting and receiving.

You build and keep 14 kits, including this amateur phone 6-meter VHF Transceiver. NTS's exclusive 6-transistor Solid-State Radio, and a fully transistorized Volt-Ohmmeter. Also, learn 2-way radio, Citizens Band microwaves, and radar.

5-watt AM
transmitter/
receiver

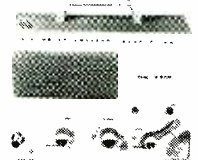

NTS Home Training puts you in the lead.



NTS INDUSTRIAL & AUTOMATION ELECTRONICS

Automation is the future of industry and you can play an important part! Learn industrial controls by training on the NTS Electro-Lab (a complete workshop). You also build and operate this 5" Solid-State oscilloscope. And you perform experiments that involve regulating motor speeds, temperature, pressure, liquid level, and much more. All equipment is yours to keep.



NTS AUDIO ELECTRONICS SERVICING

Learn basic sound theory—how it works in home radio, car tape

decks, stereo multiplex component systems, and more! Set up a spectacular music system. Learn about



Build and keep this famous Heath Stereo Receiver and Speakers.



sound distortion, amplification and control, loud-speaker baffles, problems of system installation, etc. Included is Volt-Ohmmeter, In-Circuit Transistor Tester, and Solid-State

Radio. Prepare yourself for great opportunities in the Home Entertainment Industry!

CLASSROOM TRAINING AT LOS ANGELES

You can take classroom training at Los Angeles in sunny Southern California. NTS occupies a city block with over a million dollars in technical facilities. Check box in coupon below.

NATIONAL TECHNICAL SCHOOLS

WORLD-WIDE TRAINING SINCE 1905
Resident & Home Study Schools
4000 S. Figueroa Street
Los Angeles, California 90037

APPROVED FOR VETERANS

Accredited Member: National Association of Trade and Technical Schools; National Home Study Council.

Big, Colorful NTS Guide to new opportunities in Electronics. Yours FREE!

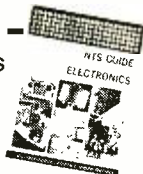

NATIONAL TECHNICAL SCHOOLS
4000 S. Figueroa Street
Los Angeles, California 90037

Please rush me FREE Color NTS Electronics Guide & FREE lesson, plus information on course checked at right. No obligation. No salesman will call.

- MASTER COURSE IN COLOR TV SERVICING
- COLOR TV SERVICING (FOR ADVANCED TECHNICIANS)
- MASTER COURSE IN B&W TV & RADIO SERVICING
- MASTER COURSE IN ELECTRONIC COMMUNICATIONS
- PRACTICAL RADIO SERVICING
- FCC LICENSE COURSE
- MASTER COURSE IN ELECTRONICS TECHNOLOGY
- AUTOMATION & INDUSTRIAL ELECTRONICS
- COMPUTER ELECTRONICS
- BASIC ELECTRONICS
- AUDIO ELECTRONICS SERVICING

Dept. 205-04c

NAME _____ AGE _____

ADDRESS _____

CITY _____

STATE _____ ZIP _____

- Check if interested in Veterans Training under new G. I. Bill.
- Check if interested ONLY in Classroom Training at Los Angeles

FOR INVENTIVE PEOPLE ONLY

If you're the kind of guy who likes to devise his own equipment or the kind who appreciates clever mechanical design. Then Mallory do-your-thing products are for you.

They'll let you invent, create, modify, so things work your way. And of course, you'll get famous Mallory

quality and performance you can count on too. Get them at your nearby Mallory Distributor.



HEADLIGHT OR TURN SIGNAL ALARM
AUTOMOBILE REMINDER ALARM
 Ever leave your lights on? Never again... with solid-state Sonalert®. Its shrill sound warns you, prevents battery drain. Use on turn signals, reverse gear... or any electrical component on your car, truck, boat, tractor. For 6 and 12 volt.



easy time
CONTROL YOUR TIME
 Use "Easy Time" 24-hour timer. Turns anything you plug into it on and off. Appliances, lights, pumps, motors, humidifiers... you name it. Tough enough to handle 12 amps, 1500 watts.

ON-THE-GO GROOMING
 Free yourself from conventional, bulky shaving gear. Handy Shaver... it's about the size of a cigarette pack. Hi-speed, quiet, 3-volt motor for fast, no-pull shaving. Comes with Duracell® batteries, mirror cap and tough carrying case. Also available in new side-burn trimmer model.



HIGH INTENSITY NOISE
Compact, purse-size, big-sound Handy Blast... your personal alarm. Use it for anything... boat horn, emergencies, scare muggers, signals, call kids, scouting, bicycling... even cheer your team.

SILENT PROTECTION
Crime Alert®... uses invisible, silent ultrasonic sound-waves. Anything that moves triggers its piercing alarm. Use anywhere... battery or plug in. Accessories to make it total security system.



MALLORY DISTRIBUTOR PRODUCTS COMPANY
 a division of P. R. MALLORY & CO. INC.
 Box 1284, Indianapolis, Indiana 46206; Telephone: 317-636-5353
CIRCLE NO. 28 ON READER SERVICE CARD



News Highlights

Canada's Domestic Communications Satellite to be Used in U.S.

The first Telesat Canada satellite was launched by NASA on November 9. By the time this item appears, the satellite should already be in full operation. A second identical satellite is to be launched around the middle of April. Not only will the satellite be used in Canada, but it will also be employed in the U.S. The first U.S. company to take advantage of the satellite will be RCA, who recently announced an agreement with Telesat Canada for such use. RCA will install ground stations in the U.S. to relay communications signals through the Canadian satellite.

Lady Services Marine Radio Gear

Talk about Women's Lib, if a boatsman calls on Heine Marine Electronic Sales & Service of East Islip, Long Island, N.Y. to repair his boat radio or depth sounder, he may be surprised to find that the service technician is a woman. Inez Heine took a correspondence course from the National Radio Institute, got an FCC license, and set up a well-equipped shop. Inez has always been interested in boats and radio, so the move was a natural. As far as other qualifications are concerned, how about her previous jobs as society reporter, women's editor, and school teacher?

Would Send Time, Frequency Over TV Networks

Commerce Secretary Peterson has petitioned the Federal Communications Commission to change the television broadcasting rules to permit sending time, frequency, and other information over the nation's TV network services. The "TvTime" system, developed by scientists and engineers at the National Bureau of Standards, generates a signal which can be carried on one line of the blanking interval during broadcast. Special equipment at the broadcast station and on the receiving TV set allow the information to be encoded and decoded to provide a caption on the TV screen. The system could also be used to provide captions for the deaf and in foreign languages.

New Dialing Mechanism Tested at Bell Labs

Seeking to make smaller and simpler the Touch-Tone® dialing system, Bell Labs is testing a technique which uses a paper-thin sheet of electrically charged material, called a foil-electret, to activate the dialing circuits. Instead of mechanical switches which must be operated by pressing, the new system would provide electrical signals at the mere touch of a finger.

New Generation of Gun Detectors Ordered by FAA

Computerized detectors capable of making a head-to-toe, three-dimensional search of passengers for concealed weapons have been installed at eight major airports throughout the nation. The new device is designed to ignore harmless metal objects such as buckles, keys,

etc., but signal an alarm when a passenger is concealing a weapon. Key to the design is an electromagnetic field which works at two frequencies and in three dimensions. The field is generated inside a portal through which passengers pass on the way to the plane.

Video Discs for Home TV Demonstrated

A thin flexible (Mylar) video disc that can be used to show movies on standard home television screens by means of a disc changer/player attachment has been introduced by MCA Disco-Vision®, Inc. The changer permits the user to stack up to 10 discs for a playing time of up to 6½ hours and can play pre-recorded material in either black and white or color. It is expected to retail for under \$500.00. Action can be frozen and held or repeated and short sequences can be selected. A single-disc player is expected to retail under \$400.00. The playback unit uses an optical system with a low-power, helium-neon laser readout to pick up the images and relay them to the screen. Density is 12,500 tracks per radial inch and the disc revolves at 30 rps.

TV, Radio Receiver Sales Up for 1972

Electronic Industries Association reports the sales of color TV sets to dealers for 1972 were 7,555,296—up 22.2% over 1971. Monochrome TV sales were up 10.2% and radio sets were up 0.2%. Phonograph sales were 5,038,442—up 13.5%.

New Nautical Radar Provides Audible Signal

A boon to boatsmen may be the new “Whistler” radar, developed by Kimball Products Co., Inc. The output of the radar unit, which weighs 6 pounds and is carried by a strap around the neck, is an audible signal rather than a picture on a scope. A low, almost rumbling sound indicates that something is ahead no more than 50 ft; while a high note signals a shore line or large ship that is 2 miles away. The system is expected to be of particular value in heavy fog and at night.

Ham Radio Plays Vital Role During Nicaraguan Earthquake

When the series of earthquakes that devastated Managua knocked out power and virtually all regular communications, the first outside contact was made by a Nicaraguan amateur known as “Enrique,” YN1AGL, operating with mobile equipment in his automobile. For the first 20 hours after the disaster, information about what had happened and requests for assistance and emergency supplies reached the world through YN1AGL. General Somoza, former Nicaraguan president and military strongman, is still relying heavily on a portable amateur station established at his home by Benjamin Elizondo, YN1BE.

Fairchild Withdraws from EIA

Fairchild Camera & Instrument Corp. has resigned its membership in the Electronic Industries Association, attributing the withdrawal to “a decline in the value of the association to Fairchild, relative to cost.” Fairchild’s President C. L. Hogan said that EIA has “evolved into an organization representing different segments of electronics, with varying objectives. We therefore feel it does not effectively represent the views and interests of the high-technology industries in the United States, particularly with regard to such issues as free trade.” Other large semiconductor manufacturers have also recently resigned from the organization.

“This pocket-sized masterpiece explains what electronics is all about...a marvelous little book...” **Electronic Buyers' News**

“For \$2.95, it will take a novice from basic electricity through MOS and linear ICs... as good a basic book as we've seen.”

Electronics magazine

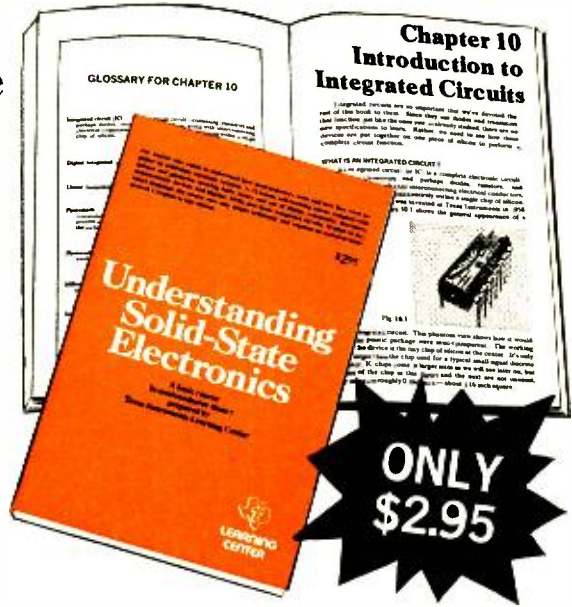

Understanding Solid-State Electronics is a self-teaching text which begins at the beginning and explains every new idea and technical subject in terms you can understand.

This book was created for anyone who wants or needs to understand solid-state electronics, but can't devote years to the study.

Texas Instruments prepared the course for its own non-engineering employees and customers—and thousands have proven its effectiveness.

It's a practical course. Engineering concepts are explained without using mathematics—just a little simple arithmetic. Technical terms are used, but each one is explained—in plain English.

12 lessons plus quizzes, glossaries—250 pages
 The lessons cover: What Electricity Does in Every Electrical System • Basic Circuit Functions • How Circuits Make Decisions • Relating Semiconductors to Systems • Diodes: What They Do and How They Work • Transistors: How They Work, How They Are Made • Transistor Specifications

- Thyristors • Optoelectronics • Introduction to Integrated Circuits • Digital Integrated Circuits • MOS and Linear Integrated Circuits.

Award-winning course

Tens of thousands of readers have followed the serialization of this book in *Electro-Procurement* magazine—for which it won the 1972 Jesse H. Neal Editorial Achievement Award, the “Pulitzer Prize” of the business press.



Send coupon today for your copy

LEARNING CENTER

Texas Instruments Learning Center
 P.O. Box 3640 • Dallas, Texas 75222

Please send _____ copies of **Understanding Solid-State Electronics**. I have enclosed \$2.95 for each copy ordered (check or money order only). Total amount enclosed is \$ _____.

NAME _____

ADDRESS _____

CITY _____ STATE _____ ZIP _____

TEXAS INSTRUMENTS
 INCORPORATED

CIRCLE NO. 42 ON READER SERVICE CARD

11120

UNDERSTANDING THE JUNCTION FIELD EFFECT TRANSISTOR

*Acting like a vacuum tube,
the versatile JFET has many applications*

BY ADOLPH A. MANGIERI

JUNCTION field effect transistors (JFET's) are now available in quantities and prices comparable to those of the bipolar transistor. Although the JFET was developed at about the same time as the bipolar, its appearance on the market was delayed because of the high cost of production, which has now been greatly reduced by advances in manufacturing technology—including the planar process.

The JFET has a transverse conductive channel whose cross section is varied by application of an electric field perpendicular to the current path. The field is applied by gate junctions. The controlled load current consists either of electrons or holes (but not both) and it passes through only one type of semiconductor material—hence, the term unipolar transistor.

Types of construction of the JFET include the n-channel bar (Fig. 1A) and the economically fabricated planar double-diffused unit formed on one side of the silicon substrate as shown in Fig. 1B. Gate regions are heavily doped p regions and channels are lightly doped n regions. This provides considerable “leverage” of control of the depletion zone by relatively small gate voltages.

Channel ends are terminated by source

and drain connections by metalized ohmic contacts (linear, non-rectifying). Source and drain leads are interchangeable in symmetrical JFET's; and, although the gate leads are usually tied together, they may be separated to form a dual-gate JFET.

Figure 1A shows the normal voltage polarities and depletion zones (shaded) for an n-channel JFET. Consider first the effect of varying gate voltage alone at low drain-source voltage. At zero gate voltage, channel height is maximum, and channel resistance is minimum. At an intermediate gate voltage (Fig. 1C) channel height is reduced by penetration of the depletion zone. Channel resistance is higher because the depletion zone is much like a non-conductive insulator. Finally, at a particular gate voltage, usually between one and eight volts, the depletion zones merge, cutting off the current (Fig. 1D). This occurs at gate pinchoff voltage (V_p).

Now, consider the effect of varying the drain voltage with zero gate voltage. As shown in Fig. 2, drain current increases with increasing drain voltage until V_{DS} equals V_p . Channel saturation commences at this point and the depletion zones merge initially at point A in Fig. 1E. With further increase in drain voltage, the drain current

Fig. 1. A bar junction FET is shown at (A), a planar junction FET at (B). At (C), channel height is reduced by increase of depletion zone height. Channel is cut off (D) by merged depletion zones. At (E) is shown onset of saturation region with the drain voltage equal to pinch-off voltage. With high drain voltage, the saturation current remains constant in (F).

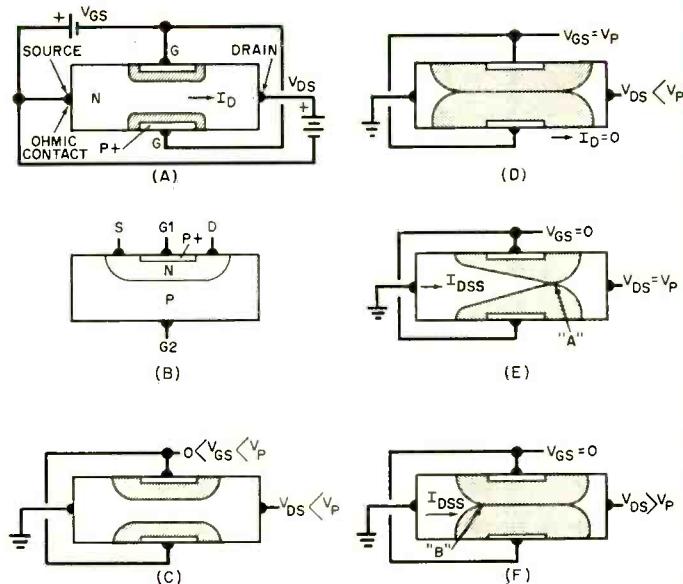

remains constant in the saturation region. Depletion zone merging progresses toward the source, as shown at point B in Fig. 1F. At sufficiently high drain voltage, the gate junction avalanches in the breakdown region.

Although zone merging is shown in Figs. 1E and 1F, current continues to flow by virtue of carrier injection at points A and B, effected by high current concentration and electric fields at these points. In the saturation region, the JFET is a constant-current source with gate voltage control.

At a lower gate voltage (V_1 in Fig. 2) saturation occurs at a lower drain voltage which is equal to $V_P - V_1$ at a lower drain current. Finally, at V_P , the JFET is cut off for all values of drain voltage. The linear region may be termed the triode region and the saturation region the pentode region by analogy to vacuum tube characteristics.

Applications. Frequently used as a low-level preamplifier in the common-source connection (Fig. 3A), the JFET permits direct inputs from a high impedance device

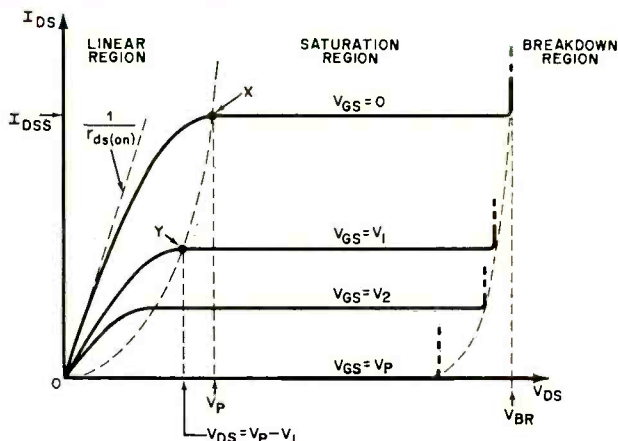

Fig. 2. Static characteristics of the JFET showing the linear, or triode, region and the saturation, or pentode, region of the vacuum tube.

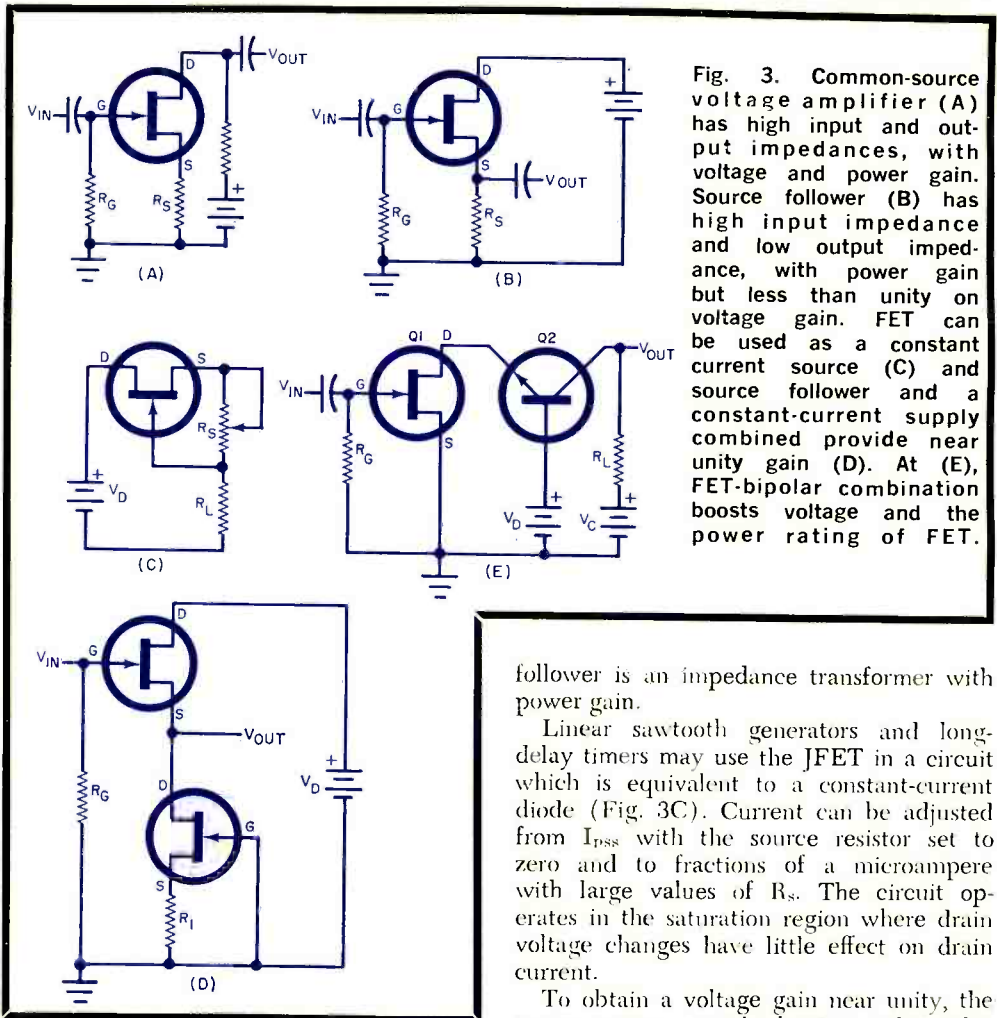

Fig. 3. Common-source voltage amplifier (A) has high input and output impedances, with voltage and power gain. Source follower (B) has high input impedance and low output impedance, with power gain but less than unity on voltage gain. FET can be used as a constant current source (C) and source follower and a constant-current supply combined provide near unity gain (D). At (E), FET-bipolar combination boosts voltage and the power rating of FET.

such as a crystal microphone. Source resistor R_s provides gate bias and also negative feedback which linearizes the input-output characteristics at the expense of voltage gain. For higher ac gain, a capacitor can be connected across the resistor.

The source follower, Fig. 3B, is another common application. Output voltage is across the source resistor. Operationally, the output voltage follows the input but at less than unity gain. In addition, the output impedance is less than the source resistance. This circuit is used to step down impedance levels while preserving bandwidth and linearity. For example, a high-impedance device can be coupled to a low-impedance coaxial cable without sacrificing frequency response. The circuit can be used to step up the input impedance of the bipolar transistor. In effect, the source

follower is an impedance transformer with power gain.

Linear sawtooth generators and long-delay timers may use the JFET in a circuit which is equivalent to a constant-current diode (Fig. 3C). Current can be adjusted from I_{DSS} with the source resistor set to zero and to fractions of a microampere with large values of R_s . The circuit operates in the saturation region where drain voltage changes have little effect on drain current.

To obtain a voltage gain near unity, the source resistor must be large in value. This requires higher supply voltages. By replacing the source resistor with a constant-current source (Fig. 3D), a high equivalent source resistor is achieved with a lower dc drop across the current source.

Present limitations on JFET voltage and power are circumvented by the FET-bipolar cascode circuit shown in Fig. 3E. The drain voltage of Q1, which drives Q2, is about equal to the battery voltage. By using a high-voltage transistor for Q2, V_c can be much larger than V_o , permitting large R_L values and much higher output voltage and power. Cascode circuits inherently have low reverse feedback or coupling. As such, the circuit is particularly suited to high-frequency tuned amplifiers since it eliminates the need for neutralization to prevent oscillations.

Transistorized voltmeters sometimes use

a JFET to provide high input impedances (11 megohms or more) with sensitivities exceeding those of a VTVM. Figure 4A shows the simplest FET voltmeter circuit, a dc bridge with the FET in one leg. The source resistor provides negative feedback to give high linearity in the response. The circuit requires a regulated supply voltage—easily obtained by using a zener diode—and can be used with full-scale dc ranges as low as 200 millivolts.

Higher dc sensitivities are obtained in the differential amplifier dc voltmeter circuit shown in Fig. 4B. The circuit also has high common-mode rejection. Emitter-follower, constant-current source Q3 fixes the drain currents to the zero drift points (or near them) and also reduces effects of supply voltage changes. The source resistors improve stability and linearity. For optimum results, Q1 and Q2 must be closely matched pairs.

The JFET chopper circuit shown in Fig. 4C, when operated with sources having high impedance and amplifiers with high input impedance, is better than a bipolar transistor chopper. A chopper converts low-level dc to low-level ac, which is more

readily amplified. The JFET chopper has an offset voltage near zero. The gates of Q1 and Q2 are driven by square waves 180 degrees out of phase so that one transistor is on while the other is off. Transistor Q2 reduces noise by shorting the amplifier input when Q1 is off or open. Chopper transistors are designed for low on resistance in the linear region. (The on resistance may vary from a low of 10 ohms for low-speed choppers to 150 ohms for higher speeds.)

Other JFET applications include their use in mixers or converters, in which advantage is taken of their nonlinear characteristics. Dual-gate or tetrode JFET's are used in age and other dual-input circuits. Digital circuit logic elements have high fan-out and low power requirements as a result of high input impedances. The relatively high gate voltage swings which change the state from on to off, provide high noise immunity in FET logic elements. The switching speed is inversely related to the operating drain current; but, within the same current range, the switching speed of JFET logic is somewhat comparable to many junction transistors. ♦

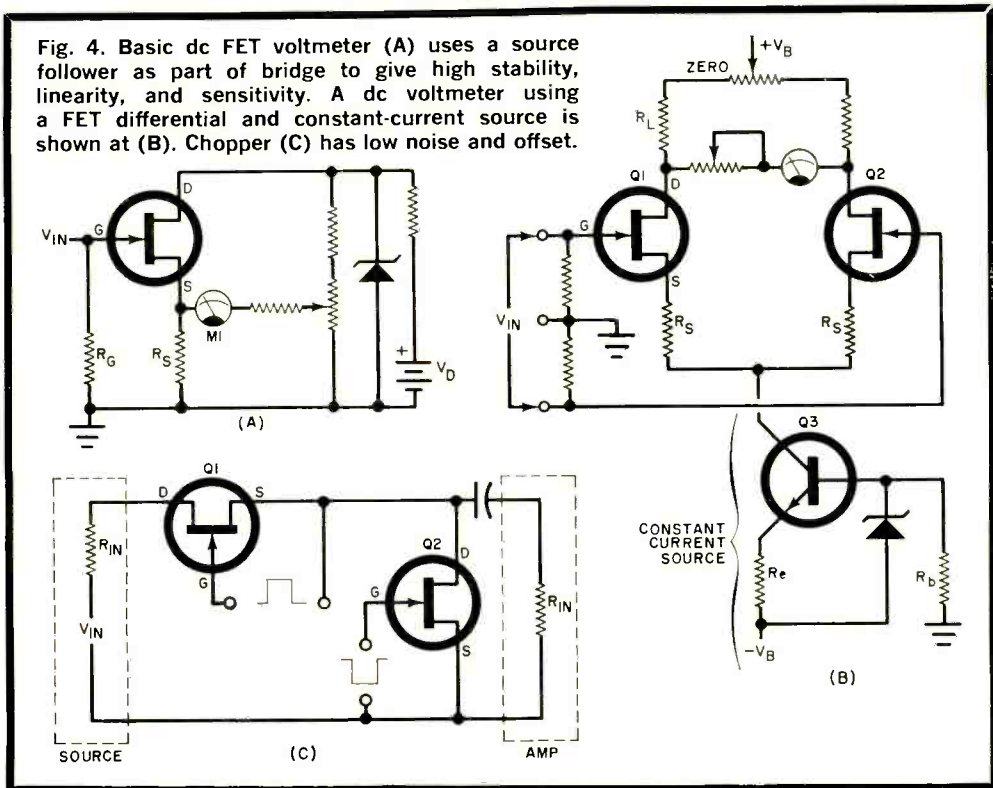
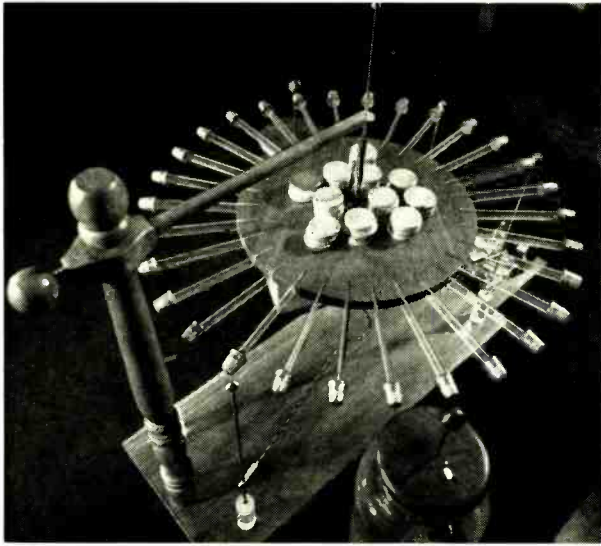

Fig. 1. A replica of Franklin's electrostatic motor. Rotation is achieved by corona discharge.



ELECTRIC POWER FROM THE EARTH

THE SEARCH FOR NATURAL SOURCES OF ENERGY GOES ON

BY L. GEORGE LAWRENCE

MOST economists agree that present standards of living can be maintained only if more electrical power is made available every year. Unfortunately, to obtain power from traditional sources means pollution; getting more power from these sources means more pollution. Consequently, it comes as no surprise that a great deal of effort and capital are being invested in attempts to find "cleaner" sources of electricity than we have been using. Along these lines, we find renewed interest not only in geoelectric phenomena, but also in exotic energy-conversion schemes with excellent promise for the not-too-distant future. So far, everything has been very experimental, but, at last, a beginning has been made.

To geophysicists and electrical engineers, our planet is a powerful generator of dc power in the trillion-kilowatt (10^{12}) range. Its dynamo action is due partially to axial rotation and the magnetic interaction in ionospheric fields and partially to thermo-couple-type phenomena between the hot

magma of the earth's core and the cold crust. The natural earth, or telluric, currents flow in large "sheets." While apparently weak, telluric currents can attain immense magnitudes in submarine telephone cables when certain geoelectric conditions coincide. (Submarine cables between the U.S. and Europe frequently produced terminal voltages up to 2500 volts.)

The question is, how can we harness this power? Studies are currently under way to determine how to increase the current flow in ore-bearing bodies and store the electrical energy potentials in buffers or accumulators for later use. Special provisions must be made for possible telluric polarity changes to safeguard dc-to-ac converter systems.

Another force that is available for immediate use is that of electrostatic energy. Electric fields, currents, and conductivity, as well as positive and negative ions of greatly varying size, constitute the principal electrical properties of the atmosphere in fair weather. In the altitude between 30 and

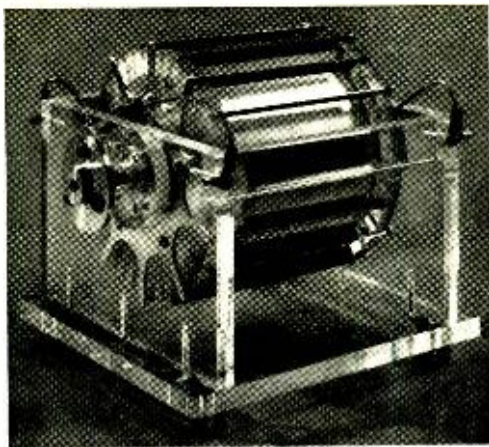

Fig. 2. The electrostatic motor shown here can develop 1/10 horsepower by using an antenna carried by a balloon.

70 kilometers, atmospheric studies of electricity and ionospheric physics merge.

Remarkably enough, Benjamin Franklin was among the very first people to envision the enormous potential of static electricity in industry. An exact replica of his electrostatic corona motor, recreated at West Virginia University by Dr. Oleg Jefimenko and David K. Walker, is shown in Fig. 1. The propulsive force for the motor disk is obtained from discharge electrodes placed at strategic points around the disk's circumference. A Leyden jar (lower right in

photo) serves as the high-voltage storage/discharge component.

The latest version of the WVU electrostatic motor is shown in Fig. 2. Like similar machines, the insulated knife-edge electrodes generate a corona that charges or ionizes air particles floating by. The latter transfer their charge to the nearest part of the plastic rotor and charge it. Now, once a spot on the rotor takes a charge, it will be repelled by simple electrostatic force from the charging electrode. A simultaneous attraction toward the other, oppositely-charged, electrode takes place. So, when the charged portion of the rotor reaches the opposite electrode, another corona discharge takes place, reversing the polarity, and the cycle repeats itself.

The Jefimenko model shown can develop 0.10 horsepower if energized by a 30,000-volt electrostatic generator. Operation by natural electrostatic electricity requires that the feeder antenna be carried aloft by kite or balloon to a height of 200 to 300 ft above ground to obtain an operating potential of about 20,000 volts. Of course, all of this sounds promising, but our society is in a hurry and needs large amounts of power *now*.

More Practical Approaches. Presently, considerable attention and a great deal of money are being used to exploit hot springs and natural geysers as sources of power.

Fig. 3. Direct-conversion geothermal power system.

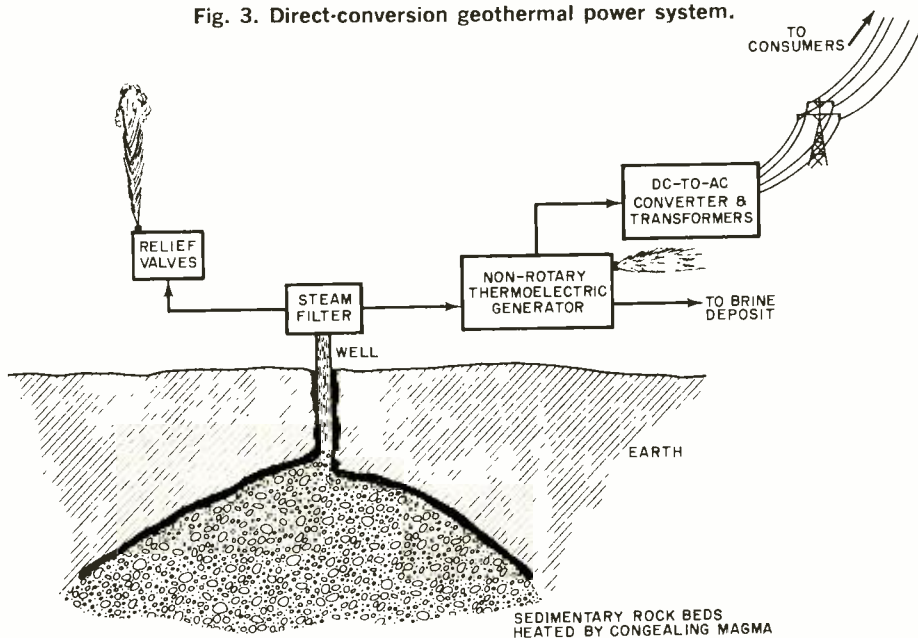

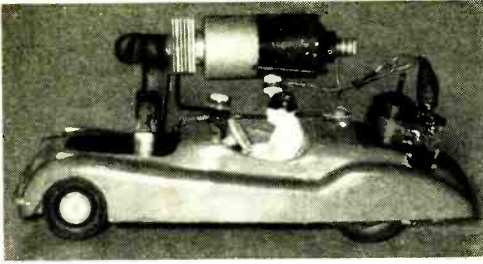

Fig. 4. Model car made by Huffman is powered by a thermotunnel converter.

One promising spring is at Cerro Prieto in northern Mexico, where Toshiba of Japan has installed specially designed turbines to convert escaping steam into electrical power. But the turbine generator conversion process is not ideal; so more direct heat-to-electricity conversion processes are being developed.

Typically, a geothermal spring is made up of a vast underground deposit of spongy sedimentary rock (see Fig. 3) that traps water that has been heated to the boiling point by heat conduction from the solid rock below. The heat is furnished by congealing magma pushed up from the earth's molten core. Geologists have estimated that, in the case of the Mexican and Salton-Sea trough systems, spongy rocks to a depth of 20,000 ft exist, giving an immense energy reservoir. However, in the system concept shown, it is desirable that turbines and the like are avoided altogether either by tapping the heat directly (to avoid turbine contaminations) or by feeding the hot steam into a non-rotary thermoelectric generator as shown. Once fully developed, direct heat-to-electricity converters are cheaper than turbine generators and offer fewer logistical problems in the long run.

Right now, although good progress is being made, problems reside in the area of efficient conversion cells. This field is wide open for new inventions in light of the fact that the need is one of here and now.

A small experimental car, about 8-in. long and containing a small electric motor, is driven by an electronics-based thermotunnel converter invented and patented by F.N. Huffman (Fig. 4). The converter uses 10-40-angstrom-thick oxide spacers between the emitter and collector of the heat-to-electricity conversion assembly. Buffer resistors are inserted in the device to insure an even load balance from all current-generating cells during parallel operation.

While at first glance, Huffman's invention (little more than a sophisticated thermocouple) seems insignificant, it bears great promise for large-scale power plants. What remains is essentially an engineering job of finding a packaging scheme that will permit this type of cell to be directly heated by the earth's magma or steam from hot springs.

Work is also under way in the field of atomic power plants. The specific aim is to bypass the traditional nuclear power plant and its cumbersome reactors, turbines, and the like by realizing the current-generating capacity of the radioactive materials themselves. In Fig. 5 are shown two "classical" nuclear battery types. The design in (A) is a beta-current type in which high-speed electrons emerge from the radioisotope coated on a central emitter electrode and are collected by an outer conducting member. Design (B), coated on one side with Strontium-90, allows the radiation to produce an electron avalanche in one element of the junction diode. These electrons are collected

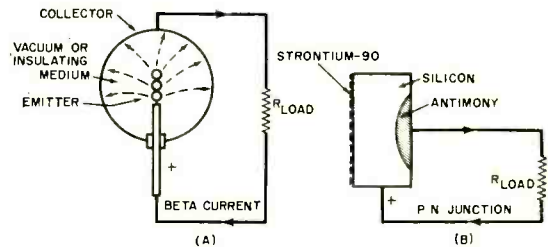

Fig. 5. Schematics of two classical battery types using nuclear energy.

by the "field" across the junction. The field is established by a physical process similar to the collecting field in the contact-potential-difference cell.

Unfortunately, these two and similar types of batteries produce very low output powers, typically in the microwatt range. However, cell (B) continues to be promising because its electromotive force is about 0.2 volt per cell. So, if a large number of radiation-proofed cells can be connected in series-parallel combinations, adequate power outputs might be realized. Current cell failures are due to changes in the crystalline structure of the silicon that are the result of radiation from the radioactive material. But it is this type of solid-state battery that holds the great promise for electric-powered cars, homes, and industrial undertakings. ♦

USING YOUR CB SET FOR EMERGENCIES

*Operating rules and regulations
to make channel 9
a more effective emergency
communications network*

EVERYONE has his own personal reason for getting into CB radio. You may want to use it for business, or just personal communications within your own family. You may want to talk to friends or meet new friends through your radio. Whatever your original purpose, sooner or later, you will find that your personal two-way radio has a great value for emergency communication—your own or someone else's.

Emergency use of your radio will probably first come about when you sight an accident, fire, or traffic hazard while driving. Of course, all you have to do is call on channel 9, the official emergency channel, to report it. Who will respond? Probably a member of a volunteer emergency radio team or a public spirited individual; and, in rare instances, a police department.

According to the Citizens Radio Section, Electronic Industries Association, over 2-000 volunteer groups conduct organized

monitoring of emergency channel 9. In addition, they estimate that 500 police and fire departments are now monitoring CB.

It is important to know how to call for assistance or to report an emergency on channel 9. If you know the call letters of the local channel 9 monitors, it is simply a matter of calling them as you would for any other call, on any other channel.

When you don't have the callsign of an emergency monitor, as is the case when you are traveling, it is another matter. Try, "KZZ-4321 mobile, seeking assistance." Or, "KZZ-4321 mobile with a 10-33 (emergency)." If you are traveling out-of-state, give your home state as, "KZZ-4321, California mobile." Allow time for response before repeating call. However, don't expect an immediate answer the first time. You may have to wait until the monitor hears you repeat before he can identify your signal.

If reporting an accident or other emer-

The EIA highlights emergency uses of CB by means of this public service billboard. It will appear around the country in 1973. Interested CB clubs can get this message posted by having local outdoor advertising firm request material from Citizens Radio Information, 7th Floor, 21 East Hubbard Street, Chicago, Illinois 60611.

No woman should drive alone...

EMERGENCY 9 CHANNEL

**without the safety of
Citizens two-way radio**

CITIZENS RADIO SECTION PUBLIC SAFETY COMMITTEE

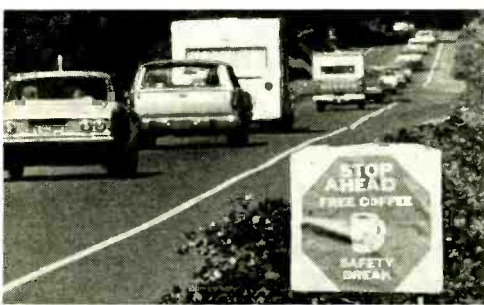

At top, REACT'ers donate their time operating 24-hour coffee stop for motorists tied up in holiday traffic. Ohio State Highway Patrolman directs travelers to stand run by Summit County REACT C-480 (Akron). Sign, at left, welcomes weary travelers—REACT teams hope to reduce accidents in this way.

gency, remain calm and give all necessary details:

1. Your exact 10-20 (location); include city and state as you may be received via "skip."
2. Number of vehicles and people involved.
3. Possibility of injuries.
4. Is traffic blocked?

As an individual, you may find it interesting to monitor channel 9 from your home base station. You can do this at any time. It is one way to determine if an emergency organization is effectively monitoring the channel in your area. You can also provide assistance or answer any emergency call as an individual licensee. For this purpose, you may find one of the new transceivers with dual-channel monitoring capability very useful. You can monitor channel 9 with such a set while you also monitor another channel for personal communications purposes.

It is advisable, however, for individual monitors to act as a backstop to the organized monitoring groups in their area. Let them handle the calls if they are monitoring at the time. If no monitor from an organized group responds, then you, as an individual monitor, can respond and handle the situation.

Encouragement of the emergency group in this way lets the members fill a real need and has a stimulating effect on the organization. "Competition" from individual moni-

tors tends to discourage such organizations.

Once you really become interested in emergency communications, and you probably will once you've been involved, you'll most likely want to consider joining a REACT or ALERT team or other CB organization that monitors channel 9 on a regular basis. In addition to receiving requests for motorist's assistance and accident reports, most of these groups become involved with civil defense and other disaster communications planning.

REACT National Headquarters has a cooperative understanding with the American National Red Cross for both organizations at the local level. The Red Cross is the official national disaster relief organization. This is one means by which REACT teams get programmed into local disaster planning.

Actually, the day-to-day role that REACT, ALERT, and other groups perform for highway communications gives them the experience and organization to do the vital communications job when a true disaster strikes the community, such as the 1972 floods in West Virginia, South Dakota, Pennsylvania, Maryland, Virginia, New York, and California.

By establishing contacts with law enforcement agencies and other authorities, the emergency CB group develops the confidence of public officials in their ability to perform when most needed.

While many so-called CB Clubs are organized primarily for social purposes, even they do try to perform emergency and other communications of benefit to the community. Many emergency and social organizations provide communications for parades; county fairs; boat, auto and motorcycle races; telethons; charity drives; voter registration; etc. The opportunity to perform a service has its own reward, but the recognition to the group and the pure fun of participation makes it all worthwhile.

Of course, affiliation with a specific emergency communications team is the answer if you develop sincere dedication. There are two prominent national organizations devoted to this activity. Following, is a brief description of each. Contact their offices for detailed information about joining your local team or starting a new one.

REACT: (Radio Emergency Associated Citizens Teams) Founded in 1962. 40,000 participants are organized into 1000 local teams throughout the United States and Canada. Membership is only through team membership. The program is sponsored nationally as a safety and community service activity by General Motors Research Laboratories. Write to: REACT National Headquarters, 111 E. Wacker Drive, Chicago, Illinois 60601.

ALERT: (Affiliated League of Emergency Teams) Organized in 1969. ALERT maintains a Washington headquarters office so as to more easily represent its membership in FCC and other governmental issues. Membership is on an individual basis with any group of ten members eligible to form an official ALERT team. Write to: ALERT, 818 National Press Building, Washington, D.C. 20004.

There is still some confusion among CB operators about the channel 9 emergency

rule. It simply restricts communications on channel 9 to genuine emergency situations affecting the safety of life or property and to communications necessary to assist the motorist.

Motorists' assistance includes not only obtaining road service to get a stalled vehicle going again, but to supply information concerning routing and road conditions. Anything that will keep the individual motorist from reaching his destination can be interpreted as qualifying for this purpose.

Another interesting aspect of the channel 9 ruling is that it does not restrict emergency calling solely to channel 9. Any other channel can be used in an emergency. If it is a true emergency affecting the safety of life or property, and you do not get a response on channel 9, switch channels until you hear somebody talking and then ask them to "break for an emergency."

In fact, during recent flood emergencies, many emergency radio teams used a channel other than 9 for their operational working channel and kept channel 9 clear for additional emergencies that might come in. Their use of a secondary channel also prevented blocking channel 9 in other areas due to the "skip" communications phenomenon. FCC regulations do require a report of emergency operations that exceed 12 hours in duration.

The emergency use of CB radio adds greatly to the benefits you get from your equipment. It is satisfying to help others in trouble. It is even more rewarding when you can work with the leaders of your community to prepare to supply disaster communications. When and if you are personally involved in an accident or other emergency, it is even more reassuring to know that help is just waiting for your call. ♦

Mobile emergency communications can be transported wherever needed most. Gateway REACT, Metairie, La., is prepared for the next Gulf-Coast hurricane or any other emergency with its completely equipped van.





TO: ULTRA AM
CF 43743000
Pulse Length 250 Sec
Pulse Rate 2000
Auto Repeat

TIME NUMBER DATE
0800

00.000		
100	101	101
100	100	127
100	107	120
		127
		103
		102

ADVANCED ELECTRONICS CAREER TRAINING AT HOME

Modern aircraft are loaded with vital electronic equipment. There is equipment for communications, direction finding, instrument landing and for many other functions to insure safe operation of the aircraft.

The man who checks out this equipment has to be an expert. Many lives depend on his specialized knowledge as an engineering technician. His work is interesting and exciting and he enjoys top pay in his field.

Consider a career In advanced electronics

Aeronautical and Navigational Electronics is just *one* of the advanced electronics programs CREI offers. There are *seventeen* others. All of the programs, except a brief introductory course, are college-level. The programs cover every major field of electronics today.

If you want to qualify for the highest paying level of technical employment in electronics, we invite you to consider the unique home study programs of CREI. Here is a list of just some of the CREI programs: *Communications Engineering • Computer Engineering • Missile & Spacecraft Guidance • Radar & Sonar • Television Engineering • Nuclear Instrumentation & Control • Digital Communications • Industrial Electronics • Electronic Systems Engineering • Microwave Communications • Satellite Communications • Cable Television Engineering*

For over 45 years, CREI programs have been recognized by industry and government as effective home study training in advanced electronics.

Qualifications to enroll. To qualify for enrollment in a CREI program, you must be a high school graduate (or equivalent). You should also be working in electronics or have previous training in this field.

Send for FREE book. If you are qualified, send for CREI's newly published book describing your career opportunities in advanced electronics. This full color book is filled with facts about career opportunities for you.

Capitol Radio Engineering Institute
A Division of McGraw-Hill Continuing Education Co.
3939 Wisconsin Avenue, Washington, D. C. 20016



Accredited Member, National Home Study Council

CREI, Dept. E1204D
3939 Wisconsin Avenue
Washington, D. C. 20016

Rush me your FREE book describing my opportunities in advanced electronics. I am a high school graduate.

Name _____ Age _____

Address _____

City _____ State _____ ZIP _____

If you have previous training in electronics, check here

Employed by _____

Type of Present Work _____

Veterans and servicemen, check here for G. I. Bill information

CREI
**CAPITOL
RADIO
ENGINEERING
INSTITUTE**

WASHINGTON, D.C.

"THE ELECTROMAGNETIC spectrum is one of our major natural resources. For decades, we have been taking it for granted. We can no longer afford the luxury of such an attitude; there must be a clean-up in spectrum pollution." Environmentalists who did not fully understand what he meant applauded the 1968 address in which FCC Commissioner Robert E. Lee made his plea. Engineers who did understand him agreed that the EM spectrum deserves to be ranked with air, water, and other resources. Most experts, however, took a dim view of the possibilities of a quick cleanup even in the limited part of the spectrum that includes the r-f band.

Today, matters are far worse than they were in 1968. Unexpected effects are becoming increasingly common:

- En route from Miami to San Francisco, a jetliner's navigational system suddenly indicated that the plane was headed for Mexico City.
- A banker wearing an implanted cardiac pacemaker nearly died when he stood close to a commercial microwave oven, and a woman using a similar device was thrown into cardiac crisis by diathermy equipment near her hospital room.
- A Colorado businessman (who should have known better) used properly functioning equipment operating on a licensed frequency to call his office by radio from a construction zone; three members of a work crew narrowly escaped death in the blast and rock slide he triggered.
- Radar systems of a major airport went haywire due to uncontrollable disturbances. The trouble began on Christmas Day. "Now we've learned to expect an annual battle with interference from toy walkie-talkies. Thank God those things break after a few weeks," said an FCC engineer.
- Memory banks of a big Louisiana computer system were crippled when stored information was suddenly erased by radar from a nearby airport.

And so the list goes on and on, pointing up a rapid growth and continued increase in a form of pollution environmentalists often do not even cite. In the U.S. alone, the FCC receives about 1000 complaints per week about interference. Worldwide, the electromagnetic spectrum is becoming unbearably crowded. Simultaneously, proliferation of highly sophisticated electronic devices is multiplying the probability of your receiving unwanted inputs.

ELECTRONIC POLLUTION ...An Impending Crisis

AN ENVIRONMENTAL
FACTOR THAT IS
TOO OFTEN OVERLOOKED

BY WEBB GARRISON

The 1971 international symposium of the Institute of Electrical and Electronics Engineers that was held in Philadelphia zeroed in on this problem. Robert D. Goldblum, a supervising engineer at General Electric's Re-entry and Environmental Systems Division, spoke for 500 scientists and engineers from seven nations when he said: "With thousands of radio, television, and radar transmitters throughout the world beaming electromagnetic radiation through the air almost constantly, we are literally polluting the electromagnetic spectrum."

Noise. During the early days of radio and telephone communication, acoustic filters were numerous and troublesome. It was natural to call such disturbances "noise," and to extend the label to cover electric waves that produced them. Today, interfering waveforms that do not have audible output are encountered in many systems. But "noise" remains the most common name for any kind of interference.

Much noise in a communication system is internal. Some is thermal. Other effects stem from electrons traveling from a heated cathode toward an anode. Such noise is of vital importance in communication, but pollution of the EM spectrum stems from noise caused by radiation external to the systems affected. Much of it is due to natural proc-

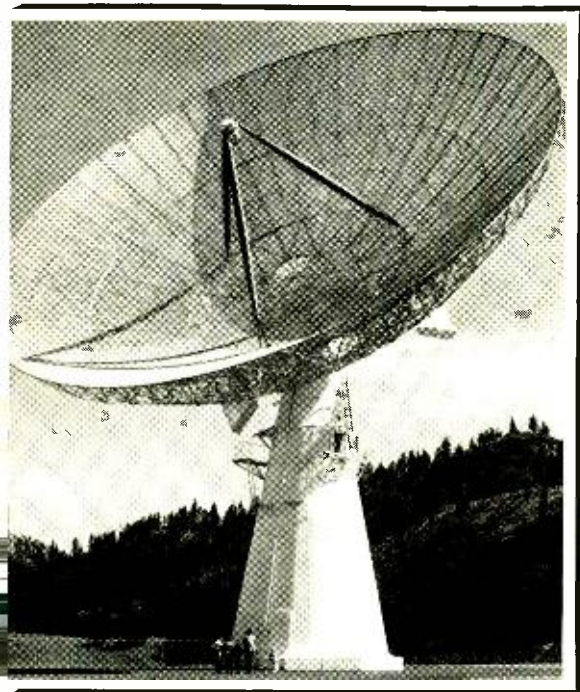

This giant radio telescope had to be moved because of interference problems.

source—it came from the stars. Since then, it has been discovered that various types of celestial bodies emit so many different kinds of radiation that most or all of the EM spectrum is affected.

Man's Contributions. QRM—man-made electrical noise—is often called “grass” by radar operators. TV engineers complain about “birdies” and “glitch.” Along with a bevy of other man-made effects, these constitute electromagnetic junk.

Motors were the first devices to yield radiant trash. Today, a multitude of household and industrial appliances, from electric shavers to arc welders, produce radiant energy as side effects of their operation.

Medical equipment got into the act at least as early as 1905, a decade after Roentgen discovered X-rays. Abundance of X-ray, diathermy, and other machines causes a modern hospital to literally pulsate with radiant energy. Most of it does no harm, but any day, any burst of radiation can create emergency-level noise if it happens to fall upon a system capable of receiving it.

Communication would return to the era of the carrier pigeon if we suddenly stopped using enormous quantities of radiant energy to convey signals. But the proliferation of radio transmitters is a major factor in the production of electronic pollution. In 1949, there were 160,000 transmitters operating in the U.S.; today, there are 36 times as many.

No one knows what happens to individuals whose electrical processes are affected by radio and TV transmissions. But Britain's respected journal *New Scientist* has pointed out that a 1.25-megawatt station dispenses so much radiant energy that the daily bombardment one mile away is sufficient to lift the family car 2 ft off the ground. Irrelevant? Not according to growing evidence. Quotes *New Scientist*, “There is some connection between chronic exposure to certain radio frequencies and a wide range of physical and mental disorders.”

About all we know positively is that some human organs are more susceptible to radiation damage than are others. “Practically speaking,” points out Robert Goldblum in the 1970 edition of *ITEM*, “the human body is a three-dimensional mass having width

esses. But man's additions are constantly growing.

International Q signals used to describe r-f interference label nature's noise QRN. At first considered to be rather simple in nature, QRN is now known to be enormously complex. Beyond both ends of the radio band, waves create effects unknown to early radio pioneers.

Atmospheric static is believed to be linked with electrical discharges that take place between water droplets during turbulence. It is especially strong in the AM broadcast band but also affects the vhf band used for TV and FM. Current tests indicate that rainstorms produce broadband noise that extends deep into the microwave region.

Solar flares sometimes cause widespread disruption of radio service. But many faint signals that reach our planet come from more distant sources. Cosmic rays, X-rays from galactic sources, and infrared light shower down on us from every part of the universe.

Radio astronomy was born as a result of studies aimed at reducing noise in telephone conversations sent across the Atlantic by radio. Karl Guthe Jansky of Bell Telephone Laboratories hooked up a 100-ft antenna to study noise. One night in 1932, he picked up a new sound that was somewhat like a faint hissing. Eventually, he identified the

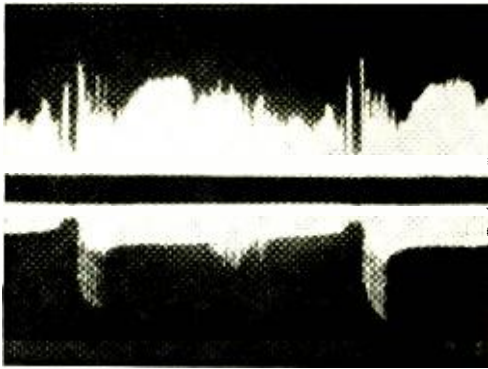

Power-line noise present on visual carrier (TV). (Photo courtesy IEEE)

and depth, as well as height. Therefore, when a man stands erect in an r-f field, he represents an object whose height, width, and depth dimensions can be expressed in terms of wavelength. When the body is so oriented that any of these major dimensions is parallel to the plane of polarization of the r-f energy, the effects are likely to be more pronounced than when the body is oriented to other positions."

Transportation is more obscure than communication in its role as an EM pollutant, but it is highly important because whenever a spark occurs, a radio signal is generated. Many ignition systems radiate staccato-like bursts of noise over a broad range of the r-f band. Radar, now vital to forms of transportation ranging from measurement of highway speeds to observation of aircraft, emits its own kind of radiant energy at constantly increasing levels.

Man's Further Contributions. Lights of various kinds emit enough radiation outside the wavelength of visible light to be considered serious pollutants. Few ordinary sources of electronic noise give TV receivers

more trouble than does a flickering fluorescent tube. Neon advertising signs and other signs that use gases can create a virtual EM blackout for hundreds of yards in every direction.

Nuclear blasts at high altitudes yield radiant energy that interferes with some radar frequencies. Called the "Argus Effect" because it is reminiscent of the Greek creature with 100 eyes, it is being studied as a possible technique for rendering blind enemy radar. And electronic countermeasure (ECM) devices are constantly being developed, adding to the pollution problem.

Microwaves, first put to practical use in World War II radar installations, offer some hope, plus new dangers. Today, microwave relay towers dot the countryside of every advanced nation. With at least 50,000 general-purpose computers operating in the U.S., it is inevitable that microwave transmission of data will show a dramatic increase within this decade. But microwaves are not limited to the field of communication. They do everything from curing plastics and lumber to warming and cooking food. Relatively innocent as sources of noise during the early years of use, microwaves have now been indicted on many counts.

TV Detective. More than any other common electronic device, TV receivers reveal pollution. Much of this noise stems from too strong signals. Such interference is a nuisance, but it is not a hazard. However, it points up the complexity of the problem.

Practically all common sources of EM radiation produce characteristic and readily identifiable patterns of visual disturbance. Mild r-f interference creates a cross-hatched or basket-weave pattern. Diathermy creates moving ripples, herringbones, and similar effects. Power-line noises that can origi-

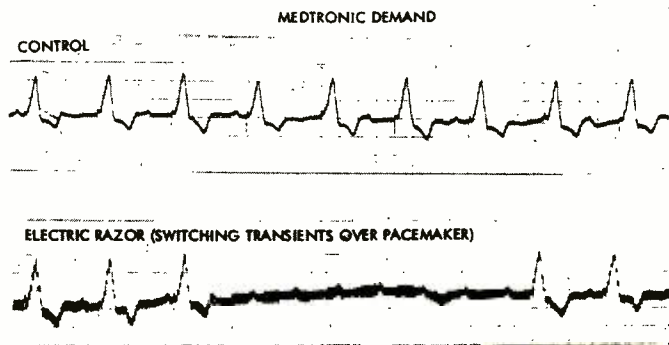

Curve traces show how interference from electric razor affected pacemaker. ("British Heart Journal")

TV receiver tuned to channel 2 (54 to 60 MHz) has potential for picking up noise from four additional bands of frequencies. (Photo: RCA "Consumer Electronics & Commercial Systems")

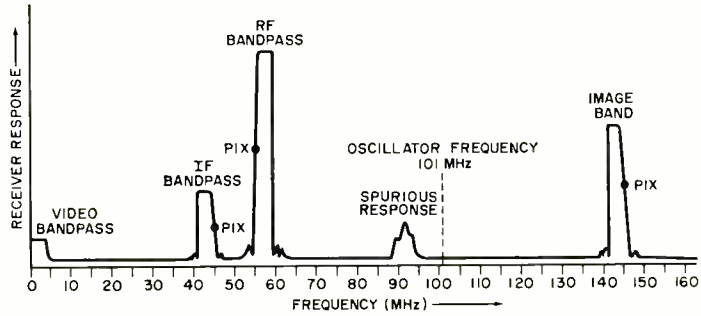

nate at any or all of five sources in normal cable suspension hardware creates pulses that can stop any show. Spark plug interference, usually random, causes fleeting but conspicuous spots. Boats and motorcycles cause much more trouble than do cars since their plugs are less heavily shielded.

Transmitters often radiate energy of several different frequencies with receivers that can frequently pick up two or more frequencies. This factor, coupled with the multiplicity of external sources of noise, makes the chart of sources of TVI too complicated for beginners to read. Every time a TV receiver reveals interference, it can be taken for granted that dozens or hundreds of unseen

Tighter control over manufacturing standards has produced microwave ovens that pose no threat to wearers of cardiac pacemakers—providing that the door seals of the ovens remain factory-fresh.

Passengers on jet airliners are no longer permitted to operate FM radio receivers during flight; they can wreak havoc on navigational equipment. Radio-controlled model airplanes have been outlawed in many cities for obvious and not-so-obvious reasons; one manufacturer, Champion, has spent a fortune developing a resistor spark plug that minimizes noise. Too, the FCC is making a real effort to crack down on broadcasters who do not adhere to assigned frequencies.

Meanwhile, the tide of pollution mounts. Gains are more often than not offset by the continuing upsurge in the number and kinds of equipment transmitting or receiving r-f and microwaves. Deliberate jamming is a growing international problem, as is radio and TV piracy.

Most domestic interference is unintentional, but it may occur whenever the right conditions are found. Every increase in radiated EM energy has potential for creating new problems.

Largely unexplored biological effects of EM radiation are so vast that in some circles there is serious talk of trying to lead-shield homes and offices close to powerful transmitters. With the microwave communications industry already billed as the "next big glamor field on the investment horizon," there is little doubt that radiation will increase faster than protective measures can be taken and applied.

Interference now pollutes the spectrum, so badly that the man on the street faces an impending global crisis. There is no real hope that interference can be eliminated. The best we can do is try to keep it at tolerable levels. ♦

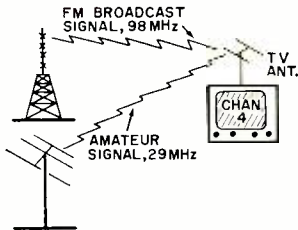

Two signals add or subtract to equal frequency of TV channel (98-29=69).

events are occurring simultaneously. Electromagnetic interference is usually intermittent in a given case. But at any instant, it is taking place wherever electronic devices are being used.

An Uphill Battle. In the war against electronic pollution, progress is being made. But EM interference sits on the shoulders of the electronic age like the Old Man of the Sea on the back of Sinbad the Sailor. With each forward step, the burden becomes heavier.

Upgrading specifications for color-TV receivers has about eliminated excessive X-rays—from properly functioning equipment.

BASIC HI-FI SPEAKER SYSTEMS

FIVE TYPES:

*Infinite baffle, bass reflex,
folded horn, folded
corner horn, and
acoustic suspension*

BY LEONARD FELDMAN

LOUDSPEAKERS are designed to be mounted in an enclosure. Operating a speaker in free air, without the enclosure, causes a notable loss of response in its bass range when compared with its performance in a properly designed enclosure. To understand why this loss in bass response takes place, one must have a passing familiarity with the principles of sound development.

The generation of sound depends upon alternate compressions and rarefactions, or

partial vacuums, of the air projected into the listening environment. Assuming that a "raw" speaker is the sound source, as its cone moves forward, it produces a compression wave in front of it. Simultaneously, the rear surface of the cone is creating an equivalent rarefaction. Compressed air from the front of the speaker rushes around the rim in an attempt to equalize the pressures (see Fig. 1). The net result is a partial or almost total cancellation of the sound you hear, depending upon the frequency.

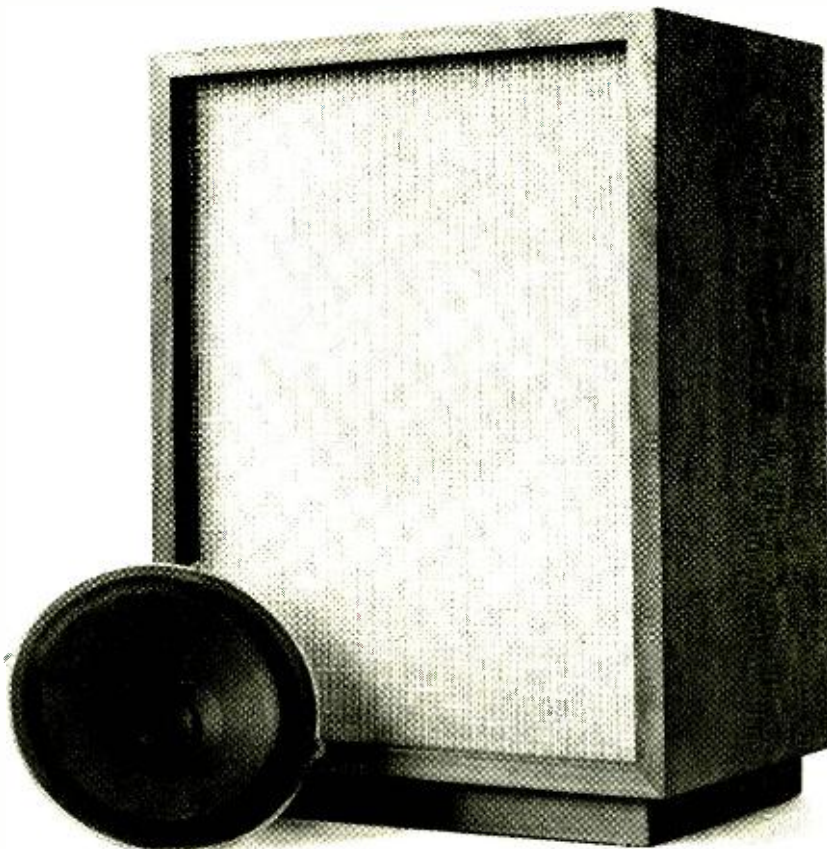

The cancellation effect between the front and rear surfaces of a speaker cone exists at all frequencies to which the speaker can respond. It is particularly severe at the lowest frequencies but diminishes as the frequency is increased. At higher frequencies, the cone moves so fast that the air does not have time to travel between front and rear. So, little or no cancellation takes place. Not so at the low frequencies where cone movement is slow and the air has sufficient time to travel the distance.

Now, if the loudspeaker is mounted on a large rigid baffle, the low-frequency sound waves must travel over a greater distance which, if long enough, can completely negate the cancellation effect. This simple principle is really what is behind the design of the five basic types of enclosures that have been used in hi-fi speaker systems.

Infinite Baffle Systems. Theoretically, if you could make the isolating baffle large enough, you would have an "infinite baffle." If the baffle discussed above were folded in such a manner as to form a closed box of adequate dimensions, the so-called infinite baffle speaker enclosure would be created. This type of enclosure offers smooth response with a minimum of coloration or enclosure resonances, providing that it is solidly built and large enough so that the inside air does not restrict cone travel.

Infinite baffles were among the first popular enclosure designs in the early days of high-fidelity when monophonic sound reigned supreme. Since only a single enclosure was required, size was often not important, and enclosures as big as 10 cu ft were quite common.

Bass-Reflex Systems. At first glance, the bass-reflex enclosure design seems to contradict the rules set forth for isolating the front and rear surfaces of a speaker cone to obtain the best bass response. It deliberately permits the rear sound wave to emerge through a "port" or opening in the front of the enclosure as shown in Fig. 2. However, by properly adjusting the port area and the volume of the enclosure, it is possible to "tune" the opening to provide smooth, extended low-frequency response. In a properly designed system, the sound wave from the rear of the speaker emerges through the port reversed in phase or polarity to reinforce the low-frequency sound.

Normally, a speaker operated in free air

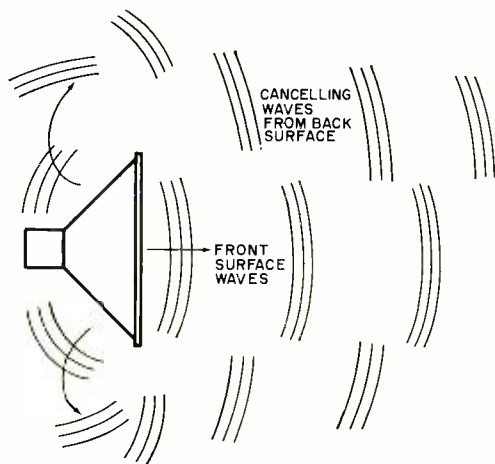

Fig. 1. Front surface waves are cancelled by those from back to reduce bass response of unbaffled speaker.

has a characteristic "self-resonant" frequency that is based upon its cone size and its suspension. Consequently, another advantage of the bass-reflex enclosure design is the fact that the resonant peak associated with a given loudspeaker can often be reduced in amplitude, dividing into two lower amplitude resonances as shown in Fig. 3. In effect, this extends the low-frequency response of the system as it smooths out the overall bass characteristic.

In a variation on the bass reflex principle, a duct or tube is inserted into the simple relief cutout. Because of the geometry of the system, this approach often results in a smaller enclosure than would be possible with a non-ducted design.

Many examples of both forms of bass-reflex enclosures are in popular use today. Rectilinear's Model XI two-way bookshelf system, for example, employs a tube-ducted bass reflex design in an enclosure that measures only 23" by 12" by 10½". Another example is Lafayette Radio Electronics' Criterion VI system (24" by 14½" by 12").

Folded-Horn Systems. Outdoor speaker systems and, for that matter, a great many movie theater sound systems employ speaker coupling systems known as exponential horns. Such horns with their constant rate of flare provide an acoustical match between the cone of the loudspeaker and the air to which sound energy must be coupled.

To be effective, horns must be designed to a length that is determined by the lowest cut-off frequency desired. For example, to be able to use a horn design down to 32

Fig. 2. Port in bass reflex cabinet is cut so that back waves from speaker reinforce front waves at low frequencies.

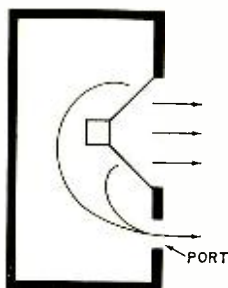

Hz, the horn would have to be nearly 9 ft long! Obviously, the proverbial "average-sized" listening room would not easily accommodate even one of these monsters. Nevertheless, horn designs provide by far the greatest speaker efficiency attainable among the systems we are discussing in this article, and fundamental horns are often used in tweeter or high-frequency arrays in multi-element speaker system designs.

For use at lower frequencies, many manufacturers evolved variations of the horn principle called the "folded horn" designs. The enclosure is first designed as a horn and then folded back on itself to reduce its physical length. A cross-sectional view of such a design is shown in Fig. 4. As you can see, in this folded configuration, the design lends itself to more acceptable "furniture" concepts in speaker enclosures.

An example of a horn-loaded speaker system for the home is the well-known line of "Voice of the Theater" speaker systems manufactured by Altec.

While some experienced listeners maintain that horn designs of this type have a distinctly identifiable quality ("horn" sound), there is no technical reason for this to exist. Well-designed systems based upon the folded-horn principle will always be popular because of the vast amounts of sound they can produce for a given amount of amplifier driving power.

Corner Folded Horn Systems. Shown in Fig. 5 are top and side cross-sectional views of the most enduring horn design of them all—the Klipschorn. Invented and patented by Paul W. Klipsch, the product format has appeared in loudspeakers marketed by Electro-Voice, University, and others, in addition, to being in continuous manufacture by Klipsch's own company.

The enclosure is a low-frequency horn so folded that it can be placed in the corner of a room to utilize reflections from the floor and walls to improve the impedance

match at the mouth of the horn and thereby increase response at the low frequencies. It is as though the walls and floor act as extensions of the horn itself.

A horn of this design offers efficiency that can be 10 to 50 times as great as that offered by an infinite-baffle design; and, therefore, a given amount of acoustic power can be generated with much less excursion of the speaker cone. This often significantly reduces harmonic and intermodulation distortion.

The sound of a Klipschorn is that of low, low bass reproduction that is tight, clean, and very free of distortion. A great many devotees of this design would not part with their corner speaker systems in spite of the sizes—which are rather big.

Acoustic-Suspension Systems. Whether to fill a consumer need or as a mere coincidence, small book-shelf speaker systems employing the acoustic suspension principle hit the market in great numbers at just about the same time that stereo sound posed the problem of having to deal with two speaker systems if the new dimensional sound was to be enjoyed. Fundamentally, the acoustic suspension system really completes the circle; it is a form of infinite baffle, but with a very important difference.

The first type of infinite baffle we discussed involved a completely sealed enclosure, as does the acoustic-suspension system. However, whereas the larger infinite-baffle system required volumes of air so great that they did not influence or impede cone travel, acoustic-suspension enclosures are made small enough so that the air contained within them acts as an integral element of the speaker cone mounting arrangement.

Speakers that are used in such designs have very high compliance cones mounted

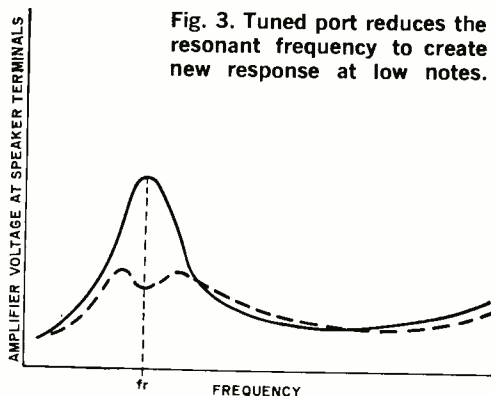

Fig. 3. Tuned port reduces the resonant frequency to create new response at low notes.

by means of a very loose rim suspension so that the entire cone moves easily with very little electrical power applied. Increasing the compliance of a cone mount lowers the free-air resonant frequency of the speaker. However, if carried too far, the speaker can quite easily be driven into distortion. Therefore, such speakers are mounted in airtight enclosures that are usually filled with some type of acoustical absorbing material that back-loads the speaker cone and raises the resonant frequency. The resonant frequency can also be moved up or down by an appropriate change in the interior volume of the enclosure. It is for this reason that an acoustic-suspension design always depends upon the combination of the speaker elements and the enclosure, much more so than is true for other enclosure designs.

Based on this description, one might think that acoustic-suspension designs are the answer to all speaker problems. Actually, the good-bass/small-box combination must give up something as a tradeoff; in this case, it is efficiency. Of all the systems we have so far described, the acoustic-suspension system offers the lowest efficiency, generally ranging between 0.5 and 2.0 percent. In terms of amplifier requirements, this means that if a 20-percent efficient folded-horn enclosure required 5 watts of continuous audio driving power to achieve room-filling sound levels, an acoustic-suspension system with only 1 percent efficiency would require 100 watts of amplifier driving power to achieve the same levels.

For all its inefficiency, however, the acoustic-suspension principle is used in more popular speaker designs than any of the other enclosure styles, largely because the consumer insists upon good sound (especially good bass) from a small enclosure.

Notable examples of acoustic-suspension speaker systems are marketed by Acoustic Research, KLH, Advent, Wharfedale, Recilinear, and just about every other major

Fig. 4. Front-loaded folded horn design gives small cabinet dimensions.

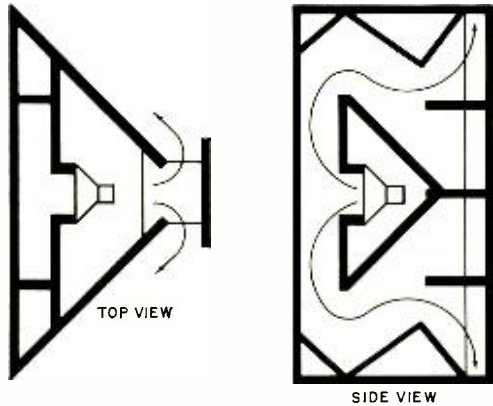
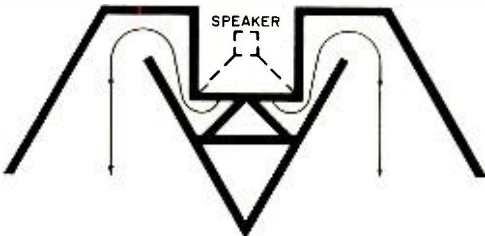

Fig. 5. Top and side views of Klipschorn design. The walls and the floor of the room extend the horn principle.

manufacturer of home-entertainment speaker systems. While some experts maintain that the bass response achieved by the acoustic-suspension principle lacks the "tightness" and clarity obtainable in larger systems, the overwhelming popularity of the "bookshelf" approach testifies to its acceptance by the hi-fi public. Too, the appearance of 4-channel sound in home entertainment insures the acoustic-suspension system's continued popularity since the need for small speaker systems with good sound reproduction is of even greater importance when you are attempting to fit four systems into a listening room.

Aside From Bass Response. We have said nothing so far about midrange and high-frequency considerations in speaker enclosure design. This is because the enclosure style, for the most part, has little to do with how the upper midrange tones will be reproduced and virtually nothing at all to do with the reproduction of the high frequencies.

In the case of horn enclosures, these other driver elements are generally mounted externally to the structure. In acoustic-suspension systems, tweeters and midrange drivers must be isolated (either via closed backs or by being mounted in separate chambers) from the woofer and its specially designed air chamber. If this were not done, the sealed volume of air undergoing compressions and expansions due to woofer cone movement might adversely affect the action of cone-type midrange and tweeter elements. The action in the woofer chamber is quite violent. ♦

SIMPLE COMPRESSOR-EXPANDER

BY CRAIG ANDERTON

"SNAPS UP" ANY PROGRAM MATERIAL

TWO very useful techniques for the audio experimenter are compression and expansion. The compression of the dynamic range of program material (type, records, or off the air), permits maintaining a constantly high modulation level; while expansion, when used with the compressed material, restores the dynamic realism. You can also use the expansion mode in reproducing conventional program material with some surprising results in many cases.

Creating these effects can be costly and complex; but it need not be if the circuit shown here is used. Although simple in form, this circuit works surprisingly well. It gives a slight, though measurable, amount of distortion, a certain amount of loss (since it is a passive circuit), and some (almost unnoticeable) delay. Nevertheless, in all but the most critical audio applications, the circuit will prove very useful.

As shown in the accompanying diagram, an LED is attached to the speaker terminals (via a limiting resistor and volume control) of the audio system to sample the program

material. Diode *D1* and resistor *R1* protect the LED against drawing excessive current. Volume control *R2* is used to vary the sensitivity of the circuit. The exact value of *R1* is determined experimentally—with a high-power audio system, a correspondingly high value of *R1* is required to prevent the LED from burning out.

The audio modulated light from the LED falls on the sensitive surface of a photoresistive cell. *PC1*. To prevent ambient light from becoming a factor, both the LED and *PC1* are enclosed in a light-tight tube.

With *S1* switched to *EXPAND*, *PC1* is connected across the high end of the *R3-R4* voltage divider. The output signal at *J2* is then a function of the resistance ratio of *R3* to *R4*. When audio-modulated light from the LED strikes *PC1*, which is connected in parallel with *R3*, the composite resistance lowers thus increasing the audio output level. With *S1* on *COMPRESS*, *PC1* and *R5* are in parallel with *R4* and when *PC1* is illuminated by the modulated light from the LED, the composite resistance is lowered thus lowering the audio level at *J2*. This, in effect, compresses the signal.

The amount of expansion depends on the resistance values of *R3* and *R4*. A higher value for *R3* means a greater expansion range is possible. Compression depends on the resistance of *R5*. As this value is decreased, the compression effect is increased.

An LED samples audio output of system.

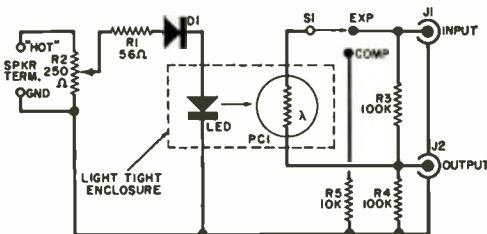

PARTS LIST

- D1*—50PIV, 1A silicon diode
- J1, J2*—Phono connectors
- LED*—Light-emitting diode (Radio Shack 276-026 or similar)
- PC1*—General-purpose cadmium-sulfide cell (Radio Shack 276-116 or similar)
- R1*—56-ohm resistor (see text)
- R2*—250-ohm, 2-watt potentiometer
- R3, R4*—100,000-ohm, ½-watt resistor (see text)
- R5*—10,000-ohm, ½-watt resistor (see text)
- S1*—Spdt switch
- Misc.—Opaque tube for light-tight enclosure, suitable chassis, knob, etc.

Applications. The circuit can be used as the volume control between the preamp and the power amplifier in an audio system, between the tape deck and preamp, etc.

It can also be used in musical instrument amplifiers to extend the signal-to-noise ratio on expansion or prevent speaker blowout on compression; in PA systems; and in making tape recordings so as to add several dB of signal-to-noise improvement.

By using a switch with a neutral center position for *S1*, the signal can be left unaffected. Two of these units can be connected to a stereo system, to put new life into overly-compressed recordings. ♦



ELECTRONIC Wind Chimes

THE TINKLING SOUND OF A SUMMER BREEZE
THROUGH YOUR AMPLIFIER SYSTEM

BY JOHN S. SIMONTON, JR.

WITHOUT stretching a point too much, you could call wind chimes the original background music with no power other than the wind.

Now, you can build a set of electronic wind chimes that doesn't rely on the wind for power so you can use it indoors or out, windy days or still.

How It Works. The operation of the wind chimes as a system can easily be understood by referring to Fig. 1, which shows one of the three identical channels that make up the complete unit. The principal operational divisions are a random voltage generator, a comparator, and a ringing oscillator. The output of the random voltage generator is compared to the voltage developed across C as it charges through R and a pulse is generated at the comparator output whenever the random voltage is within about a half volt of the capacitor voltage. Each pulse from the comparator triggers the associated ringing oscillator and simultaneously discharges C slightly so that the voltage across this capacitor never reaches the supply level.

The complete schematic is shown in Fig. 2. The three random voltage generators are made up from transistors $Q1$ through $Q6$ which are wired to form 3 separate astable

multivibrators. The time constants of these astables have been selected so that their combined periods and duty factors produce a long-duration, pseudo-random pattern. The outputs of these astables are summed by resistive networks ($R13$, $R14$ and $R15$; $R16$, $R17$ and $R18$; $R19$, $R20$ and $R21$) to produce three different randomly varying voltages. Each of these voltages is smoothed by a capacitor ($C10$, $C11$ and $C12$) and applied to the base-2 terminal of a unijunction transistor. The emitter of each UJT connects to a capacitor ($C13$, $C14$ and $C15$) which is charged through a resistor from the supply ($R22$, $R24$ and $R26$).

At some random time the voltage at the emitter gets close enough to the base-2 voltage to allow the UJT to fire. This causes the capacitor to discharge through the emitter/base-1 junction and a pulse to develop across the base-1 resistor ($R37$, $R38$ and $R39$).

The ringing oscillators are parallel-T types consisting of a transistor gain stage ($Q10$, $Q11$ and $Q12$) with a parallel-T notch filter in the feedback loop. A trimmer potentiometer ($R46$, $R47$ and $R48$) in each T adjusts the loss of the network so that the circuit can be set just below the point of oscillation. Each pulse from the UJT kicks the circuit into the rapidly decaying oscillation characteristic of a chime. The outputs of the three individual oscillators are mixed in a resistor matrix ($R49$, $R50$ and $R51$) and capacitively coupled to the output.

Zener diode $D1$ is used to eliminate voltage variations resulting from battery aging which would otherwise change the gain (and consequently sustain) characteristics of the ringing oscillators.

Resistors $R54$, $R55$ and $R56$ couple some

Fig. 1. When random voltage exceeds charge on C , the comparator output triggers the ringing oscillator circuit.

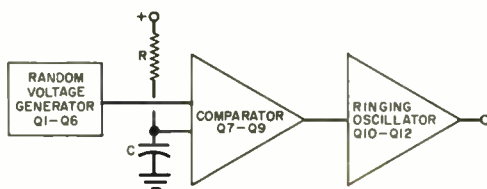

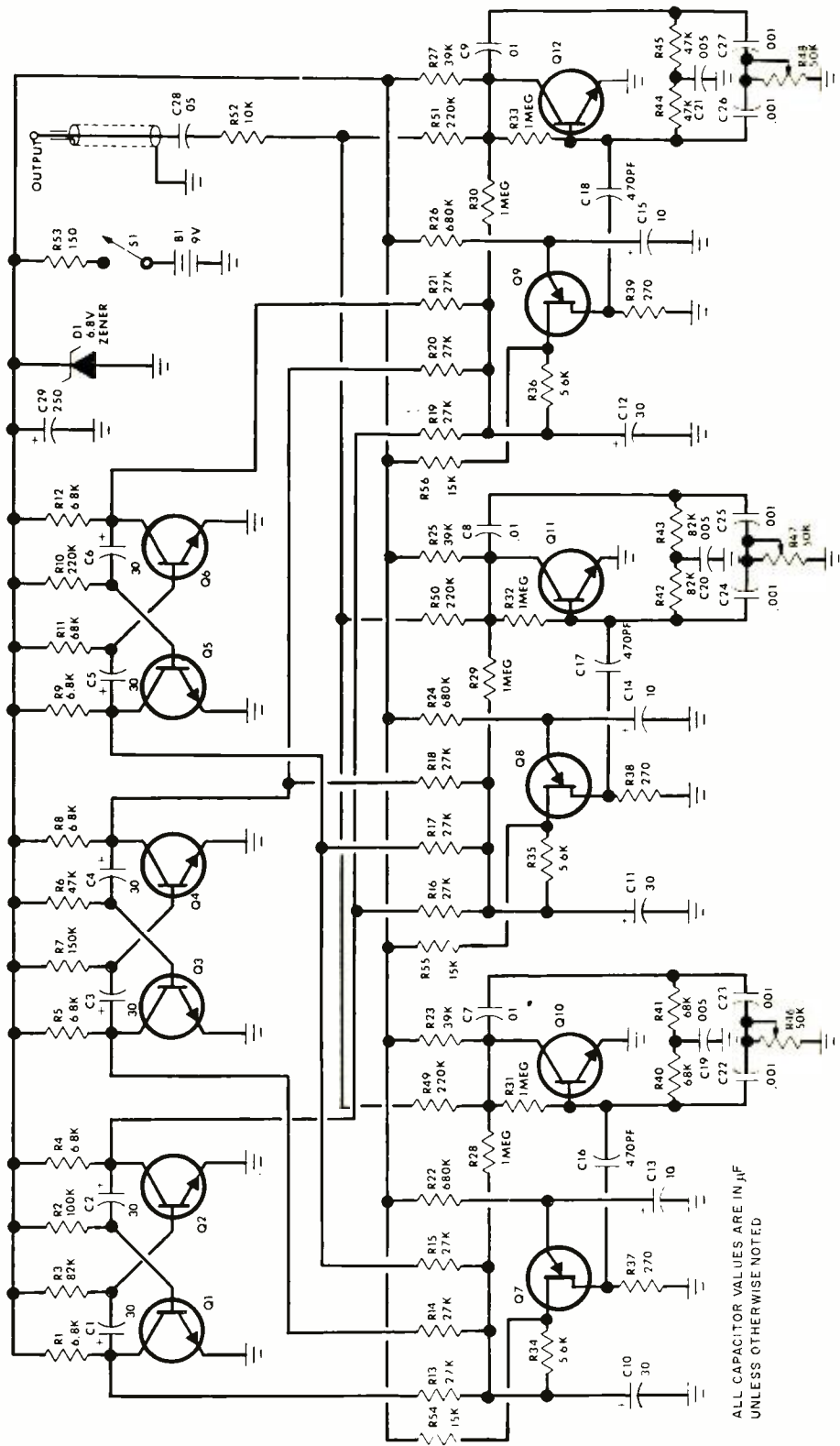

ALL CAPACITOR VALUES ARE IN pF UNLESS OTHERWISE NOTED

Fig. 2. The voltages from the three random-voltage generating multivibrators (Q1-Q6) are compared in the UJT circuits (Q7-Q9). When the UJT fires, it triggers its tone generator. Outputs of three tone generators are mixed in resistors.

of the random voltage generator output directly to the ringing oscillators in such a way that, when the random voltage is high, the gain and sustain duration of the oscillators is increased. This squelching action allows the sustain on some of the strikes to be considerably longer than would otherwise be possible because of the danger of the circuit breaking into continuous oscillation.

Assembly. Any assembly technique from point-to-point wiring to perf-board may be used for the wind chimes but etched circuit boards will produce the most trouble-free and professional looking unit with the

least hassle. Circuit boards may be etched using the full size layouts shown in Fig. 3 or purchased from the source listed. Note that two PC boards are used to keep the project small. One board mounts the three multivibrators, while the other board contains the remainder of the circuit. Spacers are used between the boards.

Assembly of each board is relatively straightforward. Observe the polarity of all electrolytic capacitors and the zener diode, use care in installing the transistors to make sure that they are properly oriented. As with most printed circuit construction, use a small soldering iron rated at no more than 35 watts and just to be on the safe side heat-sink the leads of the transistor and diode while soldering them in place. Some of the pads on the PC board are close together so be particularly careful of solder bridges.

Mount the components on the circuit boards following the parts placement diagrams. Epoxy can be used to fasten a battery clip to the larger board so that it holds the battery in the position indicated. Roughen both mating surfaces with sand paper before gluing and note that the clip must be positioned so that the battery can be inserted from the side. Save the mounting of resistors *R49*, *R50* and *R51* for last and when you get to these parts note that one of the leads of each resistor passes completely through the PC board they mount on and mates with the connecting points marked "X" on the lower board.

For convenience we will at this point designate the smaller of the two boards the tone board and the larger of the two the RVG (random voltage generator) board. Solder lengths of #22 insulated wire to points "A", "B", "C", "D", "E" and "G" on the tone board. Make sure that these wires are long enough to reach to the corresponding points on the RVG board when the two are placed one above the other. Fasten the two circuit boards together (tone board above the RVG board) using 1" stand-offs and 4-40 × 1½" machine screws. Orient the two boards so that the long leads from resistors *R49*-*R51* pass through the "X" holes on the RVG board. Trim the leads from the tone board to proper length and solder them to the corresponding points ("A" through "G") on the RVG board.

Finish assembly by hooking up the battery connector and switch to the "+" and "-" points on the RVG board and using a

PARTS LIST

- B1*—9-volt transistor battery
C1-*C6*, *C10*-*C12*—30-μF, 10-volt electrolytic capacitor
C7-*C9*—0.01-μF disc capacitor
C13-*C15*—10-μF, 10-volt electrolytic capacitor
C16-*C18*—470-pF disc capacitor
C19-*C21*—0.005-μF disc capacitor
C22-*C27*—0.001-μF disc capacitor
C28—0.05-μF disc capacitor
C29—250-μF, 10-volt electrolytic capacitor
D1—6.8-volt zener diode
Q1-*Q6*—2N5129 transistor
Q7-*Q9*—2N4871 UJT
Q10-*Q12*—2N2712 transistor
R1, *R4*, *R5*, *R8*, *R9*, *R12*—6800-ohm, ½W, 10% resistor
R2—100,000-ohm, ½W, 10% resistor
R3, *R42*, *R43*—82,000-ohm, ½W, 10% resistor
R6, *R44*, *R45*—47,000-ohm, ½W, 10% resistor
R7—150,000-ohm, ½W, 10% resistor
R10, *R49*, *R50*, *R51*—220,000-ohm, ½W, 10% resistor
R11, *R40*, *R41*—68,000-ohm, ½W, 10% resistor
R13-*R21*—27,000-ohm, ½W, 10% resistor
R22, *R24*, *R26*—680,000-ohm, ½W, 10% resistor
R23, *R25*, *R27*—39,000-ohm, ½W, 10% resistor
R28-*R33*—1-megohm, ½W, 10% resistor
R34-*R36*—5600-ohm, ½W, 10% resistor
R37-*R39*—270-ohm, ½W, 10% resistor
R46-*R48*—50,000-ohm PC trimmer potentiometer
R52—10,000-ohm, ½W, 10% resistor
R53—150-ohm, ½W, 10% resistor
R54, *R55*, *R56*—15,000-ohm, ½W, 10% resistor
S1—Spst switch
Misc.—Circuit boards, wire, solder, 1" and ¼" standoffs, battery connector and clip, 4-40 hardware, case, phono plug, etc.
Note—The following are available from PAIA Electronics, Inc., Box 14359, Oklahoma City, OK 73114: set of etched and drilled circuit boards (3721pc) at \$5.50 postpaid; complete kit of parts including PC boards but less case (3721K) at \$16.95 postpaid; case as shown (3711c) at \$2.50 plus post-
 age for 1 lb.

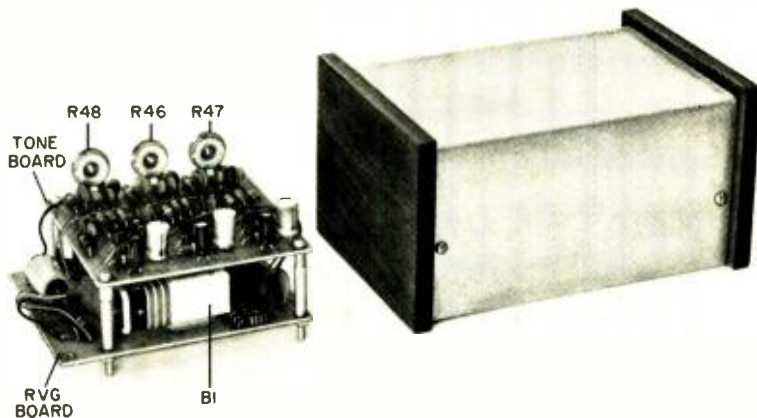

Note how the smaller tone board is mounted over the random voltage generator board. Prototype was mounted in case as shown at the right.

tone should increase in pitch as the control is rotated counterclockwise. At some point before the extreme counterclockwise limit is reached, the tone should cease. After the effect of each trimmer is tested, return it to its clockwise limit. Do not pay any attention to the dull strike tones that you hear at this point.

Once satisfied that all oscillators are operating properly, you can proceed to preliminary adjustments. Beginning with *R46*, advance the trimmer counterclockwise until the point is reached at which the oscillator begins to produce a steady tone and then back off until the tone just stops. At this point you will be listening for two things: a random pattern and the sustain of the oscillator. You will hear a number of dull sounding strikes generated by the other two oscillators which at this stage are detuned but you should also hear a single ringing tone being generated by the oscillator associated with *R46*. Listen to this tone for a few minutes to make sure that the strikes are random. If sustained oscillation occurs while you are listening, back off on the trimmer very slightly.

When satisfied with the setting of *R46* proceed in a like manner to *R47* pausing to assure yourself that the strikes are random and that no sustained oscillation occurs. When satisfied with *R47* proceed to *R48*.

The wind chimes may be mounted in any convenient case. The case illustrated was made of sheet aluminum folded into a U measuring about 5" x 2½" x 3½". The ends of the U were sealed with walnut blocks having a rabbet cut around each edge. The

ends are held in place by #4 wood screws. Holes in the back of the case allow the output coax to pass through and mount the slide switch. When completely assembled, the slide switch is positioned in the open space above *C29*. The circuit board fastens to the flat aluminum base plate with 4-40 hardware and ¼" stand-offs and the bottom plate in turn attaches to the wood ends with #4 wood screws which also hold 4 rubber feet in place.

Modifications. Ringing chime-like tones are not the only possible sound. By turning the sustain trimmers clockwise, tones, resembling the percussive resonance of bamboo rods or solid wood blocks can be produced. Or for really strange sounds, the trimmers can be turned counterclockwise past the range in which continuous oscillation occurs.

After listening to the chimes for a while you may decide that you would like them better if the strikes were closer together or farther apart. This can be achieved without-destroying the random pattern by varying the values of *R22*, *R24* and *R26*. The practical limits for these resistors are from 47,000 ohms to 2.2 megohms with strike being more closely spaced as the resistance decreases.

The pitch of the oscillators may be changed by varying the value of the resistors in the T filter; *R10* and *R11*, for example. Practical limits are from about 47,000 to 150,000 ohms with the pitch increasing as the resistance is lowered. The two resistors need not be identical. ♦

Short 80- through 10-Meter Band Ham Antenna

MULTI-DIPOLE ANTENNA HAS LOW SWR AND USES NO TRAPS

BY RICHARD A. YOMMUS, W2DMK

MANY hams encounter problems in erecting just one antenna, so the thought of needing antennas for five bands seems out of the question. However, with about 70 feet of antenna space (somewhat less if the inverted V configuration is used) a five-band (75, 40, 20, 15, and 10 meters) antenna can be erected. The antenna has a separate dipole for each band and does not use any traps.

As shown in Fig. 1, the antenna is a single-feed, four-band, separate dipole system, using a conventional, commercially available balun transformer (1:1, 75 ohms) for a symmetrical radiated pattern on these bands. The dipoles are individually cut to any given frequency within a band using the equation $L = 468/F$, where L is in feet and F in MHz. For general use, the dipoles should be resonant at the center of each band.

On 40 and 20 meters, the antenna maintains a fairly consistent SWR of less than 2:1 (see Fig. 2), while on 15 meters, the curve is flatter with hardly any change in SWR from the low end to the high end

of the band. On the 10-meter band, the usable bandwidth is about 500 kHz on either side of resonance before the SWR becomes excessive.

Using multiple dipoles with one feedline is a common practice among hams, but the fact still remains that, for 80-meter operation, it takes between 120 and 135 feet of wire to radiate effectively. Using the popular trap-type antenna on 75-80 meters, the overall length usually exceeds 100 feet with an extremely narrow operating frequency range.

The coaxial feedline does not represent a full wavelength electrically on the 40-meter band. At 7.15 MHz, the physical length of the coax is determined by $(492/F)$ times 2 times VF, where F is in MHz and VF is 0.66 when RG-59 or RG-11U, 75-ohm coax is used. For 7.15 MHz, then the length is 90' 6". The flat top overall length at 7.15 MHz is determined from $468/F$ or 65' 6". This is divided by two to give 32' 9". By adding the coax length of 90' 6" to the 32' 9" of the divided flat top, a resonant length of 123' 3" is obtained.

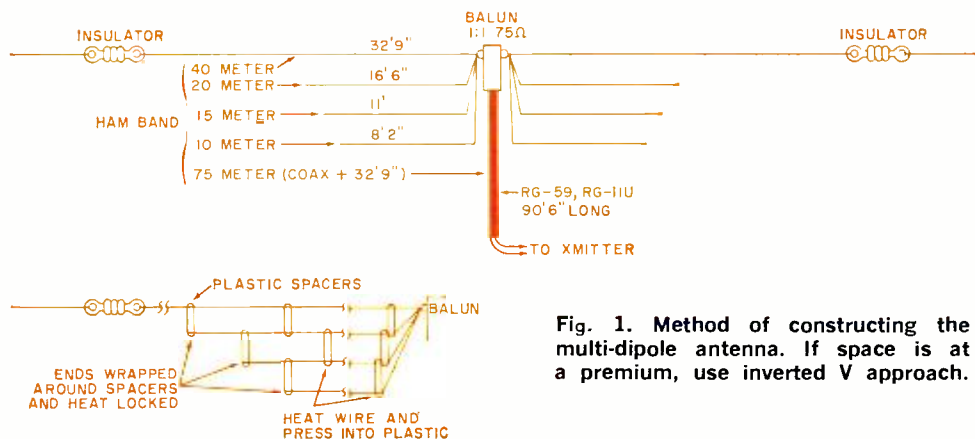

Fig. 1. Method of constructing the multi-dipole antenna. If space is at a premium, use inverted V approach.

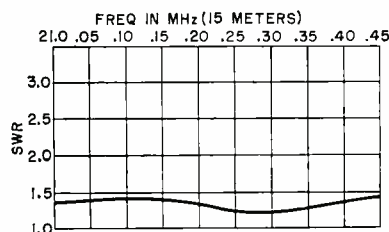
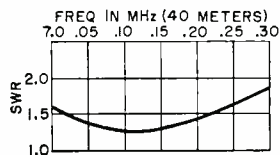
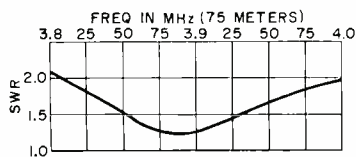
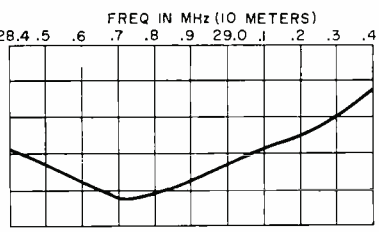
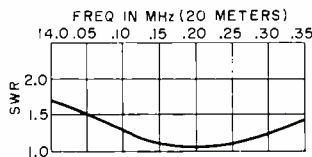

Fig. 2. Standing wave ratios for the antenna on various bands. On 40 and 20 meters, SWR is fairly consistent; but on 15 meters, it is relatively flat.



which represents a half wave of slightly below 3.85 MHz.

The transmission line can be fed from the pi network of a transmitter or transceiver without the aid of an additional antenna coupler, although a coupler could tune out any reactance.

The SWR is excellent for about 200 kHz of the 75-meter phone band, and does not exceed 2:1 at this point. On this band only, the inner and outer conductors of the coax are tied together at the transmitter end. In the event that operation is desired on the low end of 80 meters, a length of wire can be used to resonate at the desired frequency. The wire is then switched out when operation at the high end is desired. This additional length of wire can be simulated in an antenna coupler or by a simple L network. The radiated pattern on 75 meters is essentially omni-directional with both vertical and horizontal polarization.

Construction. The 40-meter antenna should be made of copper-clad steel wire to provide strength. Both the wire and plastic spacers used in the antenna can be obtained from a length of 450-ohm open TV transmission line, or commercially available air dielectric transmission lines. Each end of the 40-meter dipole is connected to an insulator, while the center is tied to the connectors on the balun. The remaining dipoles are suspended from the 40-meter

dipole with the plastic spacers that come with the transmission line. Short lengths of plastic rod may also be used. In most cases, it is sufficient to heat the wire and push it into the plastic, where it will be firmly gripped when the wire cools. The spacers are about 6" apart along the lines. The center of each dipole is connected in parallel with the one above it, to a lug on the balun.

The coax transmission line should be kept away from buildings, trees, power lines, metal surfaces, etc., when being fed as a resonant line. For the same reason, it should also be outdoors as much as possible. Keep the transmission line at right angles to the flat top dipoles if possible.

The balun transformer has no appreciable loss when connected as described here and appears as a small inductance in series with the coax. Since the differential voltage across it is very small, there is no possibility of its burning out.

To experiment with keeping the SWR fairly consistent from one band to another, add about 3' of 75-ohm coax to the 90' 6" length. Before trimming the coax, make sure that all dipoles are resonant at the center of each band. Then, trim off 6" of coax at a time, until the SWR becomes consistent on each band. The extra length of coax will not impair operation on 75 meters; but it will shift the frequency slightly lower than 3.850 MHz. ♦

PREPARE FOR A WHOLE NEW CAREER IN HOME ENTERTAINMENT ELECTRONICS



...AS YOU BUILD YOURSELF A BELL & HOWELL SOLID STATE COLOR TV!

For free information, mail postage-free card today!

A complete at-home learning program in home entertainment electronics!

Send for free information now about this complete, learn-at-home program in home entertainment electronics prepared for you by skilled instructors at Bell & Howell Schools.

Work on this exciting "hands on" project integrated into your learn-at-home program!

As part of your complete electronics education, you build and keep a Bell & Howell solid state color television set. This important project gives you valuable "hands on" experience with solid state circuitry—the kind of *practical* experience you'll need to build a successful career.

Attend special "help sessions" . . . talk to your instructors in person!

If you'd like some personal advice at any point in your program, you can arrange to attend a special "help session" and talk over special problems with a qualified Bell & Howell Schools instructor.

Master the most up-to-date solid-state circuitry

As color TV moves more and more in the direction of *total* solid-state circuitry, you'll be thoroughly familiar with the most advanced "trouble-shooting" techniques for these sophisticated circuits.

Fix stereo systems . . . FM-AM radios . . . phonographs . . . tape recorders

The thorough knowledge of electronics you gain from completing this course and building your own color TV set will be enough to service almost *any* type of home entertainment electronic device—even some that aren't on the market yet!

Earn extra part time income — or start a business of your own!

The skills you acquire through this brand-new program can help you earn extra money—or start a business of your own in color TV servicing. We've helped many thousands of people start new careers or businesses of their own in electronics.

Exclusive Electro-Lab® — yours to keep!

To make sure you get practical experience with instruments used daily by professionals, we've integrated into your program three precision instruments you assemble yourself and keep: a Design Console, an Oscilloscope and a Transistorized Meter. (See details at right.)

For Free Information, Mail Card Today!



25-inch picture (measured diagonally)

Detach postage-paid reply card and mail today for free information about . . .

■ **Bell & Howell Solid State Color TV.** Ultra-rectangular tube . . . 25-inch picture measured diagonally . . . full 315 sq. inch viewing area. Solid state modular circuitry . . . 4 advanced IC's . . . 100 transistors . . . 72 diodes . . . individual plug-in circuit boards. Special UHF/VHF tuning features . . . built-in self-service components.

■ **Design Console** Use this to rapidly "bread-board" circuits without soldering. Equipped with built-in power supply . . . test light . . . speaker . . . patented plug-in modular connectors.

■ **Oscilloscope** Portable 5-inch wide-band oscilloscope offers bright, sharp screen images . . . calibrated for peak-to-peak voltage and time measurements . . . 3-way jacks for leads, plugs, wires.

■ **Transistorized Meter** Combines most desired features of vacuum-tube voltmeter and quality multimeter. Registers current, voltage and resistance measurements on a large, easily-read dial. Features sensitive, 4-inch, jewel bearing d'Arsonval meter movement.

346R3

If card has been removed, write:

An Electronics Home Study School
DeVRY INSTITUTE OF TECHNOLOGY

ONE OF THE
BELL & HOWELL SCHOOLS
4141 Belmont, Chicago, Illinois 60641

Build a RECHARGEABLE FLASHLIGHT

CONVERT YOUR BATTERY-EATING FLASHLIGHT
TO A MODERN RECHARGEABLE

BY JOHN McNARNEY

NOW that you can get low-cost, rechargeable nickel-cadmium batteries (1.25 volts), why not take advantage of them and build a flashlight that can be recharged from either the 117-volt ac power line or a 12-volt vehicle supply? The recharging circuit shown here provides either fast, slow (overnight), or trickle charge.

Provision is made for two power inputs: *J1* for ac and *J2* for dc. In ac charging, connector *P1* is connected to *J1*. In this case, be sure that dc plug *P2* is not connected to *J2*. Transformer *T1* and rectifier diodes *D1* and *D2* provide a dc source of 3 volts. A jumper in *P1* connects the common return line. The charging current applied to the cells is determined by how much of *R1* is in the circuit. When *S2* is in position C, only a few milliamperes flow, providing a trickle charge. In position B, the resistance of *R1* is cut to permit the manufacturer's specified overnight charging current to flow, while position A connects the cells directly to 3 volts. The current flow in the last case is a few hundred milliamperes (must be measured when the circuit is built) and can be used to operate the flashlight from an ac source. The current must not exceed the cell rating.

In dc charging, the 12-volt supply is applied to *J2* through *P2*. In this case, the two cells are connected between one end of *R1* and a slide so that 3 volts is present across the cells. Switch *S2* must be in position C for dc charging.

There are two approaches that can be taken to construction. One is to build the entire flashlight in a small enclosed chassis with a flashlight head (lamp and reflector) on one end and *J1* and *J2* installed and identified on the side of the enclosure.

The second approach is to mount a small two-contact jack on an existing flashlight case (that will hold the nickel-cadmium cells instead of the D cells normally used) and connect the two jack terminals to the cells by soldering. Make sure that this jack is keyed so that its associated plug can be installed in only one way—the nickel-cadmium-cells can be damaged by applica-

tion of reverse polarity. The rest of the components can then be installed in a small enclosure with a cable connected to the flashlight when recharging.

The only component requiring selection and adjustment is *R1*. This resistor can be between 75 and 100 ohms and should be rated at least 10 watts. One slider should be at the 90% point and is connected to position B on *S2*. The other slider should be set at the point where 3 volts is applied to the cells when the dc connector is in place and 12 volts is applied to the circuit.

Using the manufacturer's specifications, select a value for *R1* that will allow a trickle charge to pass through the cells when *S2* is in position C and the charger is on ac. The dc power supply cable can be fabricated from a 12-volt automotive inspection light cable with a 4-pin connector. ♦

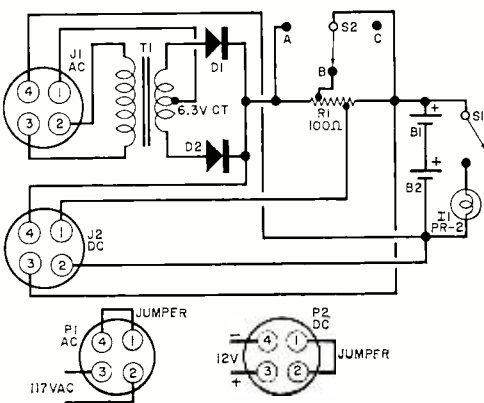

PARTS LIST

- B1, B2*—1.25-volt rechargeable nickel-cadmium cells (Eveready C2T, N56T, Burgess CD7L, Edmund 40,986, or any equivalent that will charge from the available voltage)
- D1, D2*—Silicon rectifier diode
- I1*—2.38-volt flashlight bulb (PR-2)
- J1, J2*—4-pin connector socket
- P1, P2*—4-pin connector plug
- R1*—100-ohm, 10-watt wirewound resistor with two slide contacts
- S1*—Spst slide switch
- S2*—Single-pole, three-position switch
- T1*—6.3-volt CT filament transformer

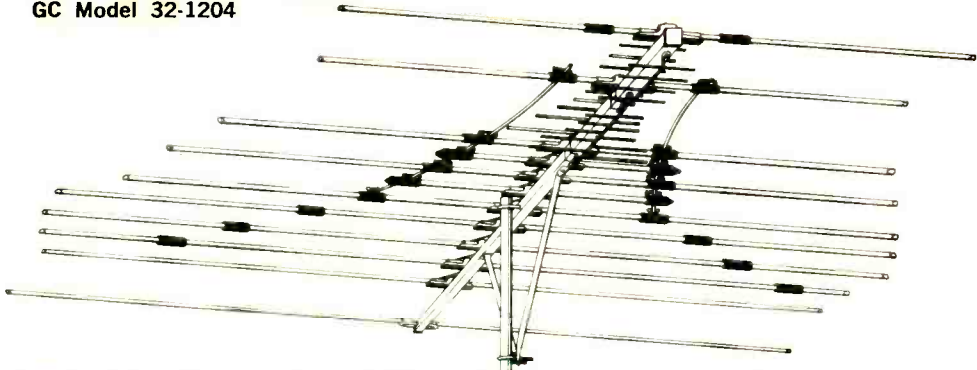

CHOOSING A TV ANTENNA

RECOMMENDED ANTENNAS AND NOTES ON PROPER INSTALLATION

BY HARVEY F. SWEARER

TELEVISION antennas are a matter of prime concern to some 85 percent of the U.S. viewers not on cable or community antenna distribution systems. It is an established fact that the selection of an antenna, especially for color viewing, can mean the difference between good picture and sound quality and a total loss of the investment for the TV receiver. Many of the problems viewers attribute to their TV receivers can be cleared up with the aid of proper selection of an antenna for the local signal conditions and proper antenna connection.

The TV antenna manufacturers recognize that their products must undergo periodic improvement to maximize performance and satisfy consumer demands. Their antennas are continuously redesigned to better cope with all types of electrical noise, the growing numbers of viewers in outer suburban and rural areas where signals are much lower in strength than they are in the urban areas, and "all-color" broadcasting.

When you begin to shop around for a new TV antenna, you are likely to find that the task is not an easy one. Complicating matters is the fact that admen often play the

"numbers game" with specifications, and even true specifications can vary tremendously in the same antenna category from one manufacturer's product to another's. Also, many antennas are known by catchy names that often refer to an entire line instead of a specific antenna model. (Fortunately, the antennas also have model numbers that you can ferret out if you are persistent.) Nor are prices necessarily a good guideline to determining the quality of an antenna. For example, it does not necessarily follow that an antenna selling for \$100 is any better a performer than is an antenna in the same category selling for \$75 by a different manufacturer.

However, you can make use of the published specifications if you know what they mean. This means that you must first know what your local signal conditions demand in the way of gain, directivity, mechanical stability, etc. You must also know whether your viewing area is classed as local, medium-distance, or fringe. Then you have to take into account how much noise immunity your antenna must have to provide a clean signal at the antenna terminals.

RECOMMENDED TV ANTENNAS FOR VARIOUS SIGNAL AREAS

MANUFACTURER	VHF ONLY			UHF ONLY			COMBINATIONS												
	VHF ONLY			UHF ONLY			VHF-UHF			VHF-UHF			VHF-UHF			VHF-UHF			
	Local Signal	Medium Signal	Fringe Signal	Local Signal	Medium Signal	Fringe Signal	UHF Local Signal	UHF Medium Signal	UHF Fringe Signal	VHF Local Signal	VHF Medium Signal	VHF Fringe Signal	UHF Local Signal	UHF Medium Signal	UHF Fringe Signal	VHF Local Signal	VHF Medium Signal	VHF Fringe Signal	
Antenna Corp. of America	AC505 \$10.20	AC511 \$24.55	AC525 \$64.55	AC320 \$8.15	AC310 \$15.35	AC315 \$9.75	AC711 \$11.35	AC712 \$26.15	AC727 \$36.50	AC710 \$21.50	AC717 \$30.70	DC10 \$56.50	AC727 \$36.50	DC10 \$56.50	DC10 \$56.50	AC727 \$36.50	DC10 \$56.50	AC747 \$76.50	
Antennacraft	CS-150 \$12.95	CS-800 \$39.95	CS-1100 \$99.95	Y-11G \$9.95	Y-20G \$14.95	Y-44G \$24.95	BS-8 \$9.95	CDX-650 \$24.95	CDX-750 \$34.95	CDX-850 \$44.95	CDX-750 \$34.95	CDX-850 \$44.95	CDX-950 \$54.95	CDX-950 \$54.95	CDX-1050 \$69.95	CDX-950 \$54.95	CDX-1050 \$69.95	CDX-1150 \$94.95	
Blonder-Tongue Labs	0610 \$24.50	0611 \$32.30	0613 \$48.00	3518 \$8.95	0511 \$17.00	0512 \$28.00	CL-4V5U \$23.30	CL-6V5U \$26.80	CL-8V5U \$31.50	0711 \$39.00	0712 \$49.00	0713 \$51.00	0714 \$63.00	0718 \$75.00	0719 \$85.50				
Channel Master	3615 \$18.75	3612 \$50.75	1111 \$79.50	4305 \$10.25	4304 \$16.50	4310 \$25.65	3644 \$16.40	3646 \$24.19	1167 \$31.50	1164 \$37.50	1164 \$41.50	1165 \$51.50	1162 \$76.50	1161 \$92.50	1160 \$109.50				
Fimney	CS-V5 \$22.35	CS-V10 \$45.85	CS-V18 \$71.80	4BT \$9.85	44BT \$23.15	P-5 \$36.95	CS-A1 \$24.70	CS-A2 \$29.95	CS-A3 \$39.00	CS-B1 \$38.00	CS-B2 \$50.65	CS-B3 \$63.30	CS-C2 \$65.83	CS-D3 \$88.75	CS-D3 \$88.75				
Gavin Electronics	1007 \$20.95	1015 \$36.50	1026 \$69.95	CR-5 \$7.75	CR-10 \$11.95	G4-b \$12.95	1106 \$20.95	1113 \$32.95	1122 \$55.50	1110 \$25.50	1118 \$41.50	1122 \$55.50	1118 \$41.50	1122 \$55.50	1134 \$76.90				
GC Electronics	32-706 \$16.52	32-709 \$24.84	32-719 \$41.49	32-8965 \$3.75	32-8978 \$7.91	32-8978 \$7.91	32-1300 \$8.78	32-507 \$16.52	32-511 \$24.64	32-1302 \$26.30	32-1200 \$27.10	32-519 \$41.49	32-1202 \$49.95	32-524 \$59.94	32-1204 \$74.95				
Jerrold Electronics	VIP-301 \$19.45	VIP-303 \$38.25	VIP-306 \$69.75	PAU-450 \$12.05	CYD \$16.50	PAU-900 \$29.65	VU-9315 \$26.25	VU-9325 \$35.10	PXB-48 \$34.60	VU-9325 \$35.10	VU-9335 \$48.50	PBX-65 \$55.10	VU-9345 \$60.25	VU-9365 \$99.95	VU-937 \$125.00				
JFD Electronics	LPV-TV40 \$17.65	LPV-TV80 \$37.60	LPV-TV190 \$91.95	LPV- \$17.50	LPV- \$23.55	LPV- \$40.10	LPV- \$21.10	LPV- \$28.55	LPV- \$36.20	LPV- \$48.65	LPV- \$61.15	LPV- \$73.00	LPV- \$85.50	LPV- \$98.00	LPV- \$110.00				
Kay-Townes	CP-5G \$11.85	CP-15G \$30.20	CP-36G \$82.75	C-1G \$11.15	UHF-4BT \$20.25	PRO-51UG \$50.25	CPC-9G \$15.25	CPC-12G \$20.25	CT-18G \$30.20	C-21G \$33.57	C-26G \$41.56	CT-30G \$47.65	CT-34G \$56.40	CT-34G \$56.40	CT-34G \$56.40				
Lance Industries	LC-880 \$20.30	LC-881 \$29.90	LC-884 \$59.80	KW4S \$7.95	LU-820 \$13.65	LU-840 \$34.35	LC-30 \$17.20	LC-80 \$19.05	LC-81 \$27.65	LC-37 \$23.00	LC-82 \$32.00	LC-83 \$58.25	LC-38 \$34.95	LC-39 \$44.95	LC-119 \$62.40				
RCA Parts & Acces.	38G09 \$17.30	38G13 \$24.95	38G27 \$66.95	28G04 \$4.85	78140 \$9.45	78141 \$12.45	48G13 \$21.95	48G20 \$31.95	48G20S \$33.95	48G23 \$42.50	48G23 \$42.50	48G30 \$53.25	48G36 \$68.95	48G36 \$68.95	48G69 \$125.00				
RMS Electronics	STP-7 \$15.95	STP-11 \$59.95	STP-28 \$159.95	COR-1 \$8.95	SK-15 \$10.85	SK-19 \$11.95	BJ-8 \$11.95	BJ-12 \$19.95	SK-719 \$50.95	BJ-11 \$51.95	BJ-12 \$51.95	BJ-15 \$62.95	SK-1916 \$71.95	SK-1919 \$77.95	SK-1919 \$77.95				
Winegard	SC-500 \$25.45	SC-520 \$38.20	CW-2002 \$101.25	U-965 \$20.80	U-975 \$28.75	U-995 \$42.15	SC-790 \$30.20	SC-800 \$35.35	SC-820 \$57.80	SC-800 \$35.35	SC-810 \$44.90	SC-820 \$57.80	CW-960 \$61.05	CW-980 \$77.70	CW-1001 \$103.50				
Zenith Sales Co. Div.	973-200 \$19.95	793-201 \$34.95	973-202 \$49.95	973-222 \$7.50	973-221 \$9.00	973-227 \$15.95	973-211 \$15.95	973-212 \$24.95	973-212 \$24.95	973-213 \$34.95	973-213 \$34.95	973-214 \$44.95	973-215 \$54.95	973-216 \$69.95	973-217 \$84.95				

Note: Prices are suggested list, not firm selling prices; they also vary with the locality.

The Current Situation. The current crop of TV/FM antennas have more gain than did their predecessors. They are also less prone to respond to adjacent-channel interference and electrical noise, have better weatherproofing, and a number of other features unavailable to the same degree in previous models. To provide you with a rough guide in selecting a TV antenna, we have compiled a table of recommendations made by the various manufacturers. The

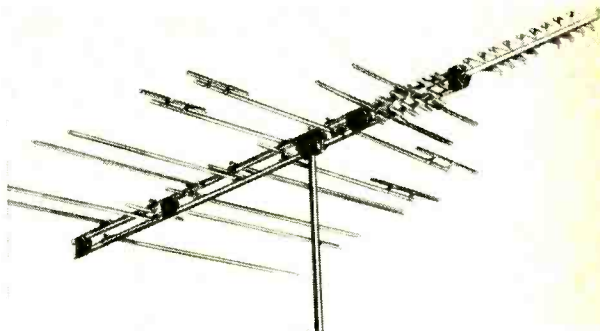

Channel Master Model 1162

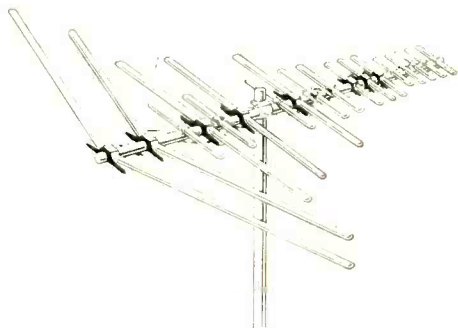

Gavin Model 1118

and FM, multiple tuned elements cut to channel resonance provide optimum coverage.

RCA's Permacolor line features top quality performance. Zenith's Chromatema delivers peak picture performance with 20 different models for color and monochrome on the vhf, FM, and uhf channels. Antennacraft offers their new Colorfinder series along with the regular CDX line in a wide selection of models to meet various conditions, topped by the CDX-1150, as shown in the table.

table, you will note, lists only one model of each antenna in a given category and subgroup. Most companies have more than one antenna model per group; so, it is to your advantage to investigate the other antennas before you buy.

Log-periodic antennas feature low SWR, broadband response, easy impedance matching, and high directivity. Element lengths are far more critical for high front-to-back ratios. Too, close spacing between directors and driven elements is essential. These features are exemplified in JFD's Model CTC-747 antenna.

Let us look at what the various manufacturers are offering. Antenna Corporation of America's deep, deep fringe Model AC-747 provides 100 percent uhf/vhf isolation. The Model SK1919 from RMS features distant station reception to 175 miles on vhf and almost 100 miles on uhf. The design pattern parallels that used in the space program, with corner-reflector/driven-disc directors for total uhf performance. For vhf

Blonder-Tongue's Model 0719 antenna accents interference-reducing directivity, high gain, and flat response with a non-radiating transmission line section that feeds the active dipole elements in a multi-frequency range. The Weingard Color-Wedge emphasizes pull that is exceptional in the vhf/FM/uhf Model CW-980. A corner reflector that offers flat response with a large capture area is the Model VU-937 from Jerrold. It covers the entire uhf band.

Jerrold Model VU-932S

Directivity is an outstanding feature of the new Quantum series of antennas put out by Channel Master, with the 1160 at the top of the line. The Quantum Series is said to eliminate up to 90 percent of electrical interference that plagues reception by virtue of having the highest front-to-back and front-to-side ratios ever attained in a broadband antenna.

Not all manufacturers have made changes in their lines since we last compiled a table (March 1972). GC Electronics (Audio-

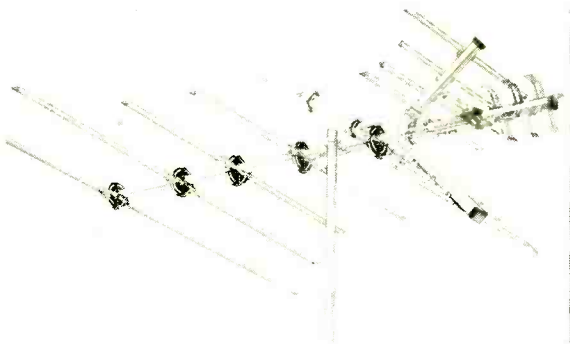

tex brand name) is sticking with a line they feel meets the demand for good reception. The same applies to the entries provided by JFD Electronics, Lance Industries, and RMS Electronics, all of which are exactly the same as they were a year ago. RCA Parts and Accessories' listing has changed by only one entry, from the old Model 4BG30 to the newer Model 4BG20S under the uhf-only fringe signal category.

All of the information given in the table was solicited from the manufacturers represented. Since space was limited, each manufacturer was limited to only one entry per category. The recommended antenna models are the choices of the manufacturers themselves. (We did not test any for this roundup of updated antenna listings.) Obviously, there are some antenna manufacturers who do not appear in our table. Also, those manufacturers who are mentioned in all likelihood have other antenna models in their lines from which you can choose.

Making the Connection. Now that you have chosen an antenna, it is necessary to consider how you hook it up to your set. Overlooking transmission line characteristics is a common mistake and many users do not have enough signal at their receiver terminals to afford throwing away 50% or more. If the antenna does the good job that it was designed to do, a proper leadin must be used to deliver most of that signal to your receiver—under all conditions. Losing half or more on the way is not a good deal; and, furthermore, it is unnecessary.

Old, dirty, brittle, cracked, or improper types of lead wire must be replaced. The 8290 or 9090 (Belden) for shielded 300-ohm line and 8285 or 9085 for unshielded applications offer stable, all-weather replacements (or initial installations). If you

don't have ignition, transmitter, or electrical interference in your locality, the shielded line is not your best bet, unless you have signal to spare. There will be some loss at higher frequencies with shielding, but isolation of all external factors, including the weather, may compensate for part of the loss. As noise pollution is increasing daily, it should be considered carefully when making a perfect installation; and if any doubt exists about the choice between shielded and unshielded, make it the former.

In considering the effects of dirt and weather on the transmission line, note that typical flat twin-lead may show a signal loss exceeding 95% under adverse conditions. Shielded (8290 or 9090) shows no loss under similar conditions.

Ghost effects become more pronounced as the standing wave ratio increases and only by maintaining a figure as close to 1:1 as possible can optimum results be expected. How can this SWR figure be obtained? Only by terminating the line in its characteristic impedance so that no standing waves exist and the line represents a pure resistance with negligible attenuation. If the 300-ohm antenna terminals are connected to a 300-ohm transmission line without bends, punctures, mashing, or external disturbances and the line is connected to the 300-ohm terminals at the receiver, then and only then will standing waves be eliminated, insuring a good, satisfying picture.

Transmitting path reflections result in severe ghosting problems that are only partially corrected with quality, shielded transmission lines. Careful orientation of the antenna array will often be instrumental in reducing ghosts, but in some cases, it may be necessary to have an antenna with exceptionally good front-to-back features or even more directivity. The latter will do much to reduce side-lobe pickup and possible paths for reflected images.

Changes in the electrical field around or between the leadin conductors will alter impedances and may best be avoided by using shielded line. Antenna impedance may be affected by corrosive smoke, fumes, salt, or other airborne materials which build up a resistive coating over a period of time. Bent, missing, or loose elements also alter the output impedance of the antenna; and when using unshielded leadin, avoid metal spouting, flashing, etc. by at least a few inches and do not have any sharp bends or pinching. ♦

Lance Model LC-82

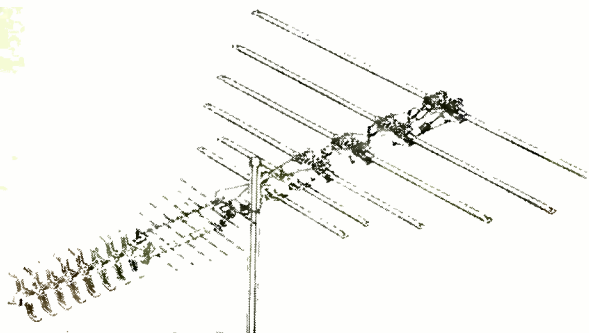

DWELL/TACHOMETER INSTRUMENT

*Tune up your car
the professional way*

TO MAINTAIN the performance and smooth running of an internal combustion engine, it is necessary to recalibrate it or tune it at regular intervals.

One aspect of the tuning procedure requires that the gap between the contact breaker points in the primary circuit be within certain limits. There are two ways of doing this. The first is a static method which simply measures the gap between the points when they are fully opened; the second is a dynamic method and is more accurate since it relates point gap to dwell angle.

The dwell angle is the number of degrees rotated by the distributor rotor with the points closed.

Dwell Angle. A simplified primary ignition circuit for a 4-cylinder engine is shown in Fig. 1. When the contacts (or points) are closed, energy from the battery is stored in the ignition coil primary (in the form of a magnetic field). As the engine rotates, the distributor rotor pushes the contacts apart, thus breaking the circuit. The energy which was stored in the primary is now transferred to the secondary and the large emf produced is used to produce a spark across one of the 4 spark plugs.

A mechanical adjustment provided on the distributor can be used to alter the distance (or gap) between the point contacts when they are fully opened. Hence, the time during which the contacts remain closed will change as the gap is altered. For example, if the gap is increased, the contacts will remain open longer.

A dc voltmeter connected between the fixed contact and ground would indicate the average (area above equals area below) voltage value (e) of the waveform. Thus, the dc voltmeter can give an indication of the gap between the points. However as the gap is directly proportional to the time the points remain closed, the meter scale can also be calibrated to read dwell angle in degrees.

In the case of a 4-cylinder engine, the period is equivalent to one quarter of one complete cycle or 90° . Suppose the points always remained closed. In this case no voltage would be generated and zero deflection of the meter would correspond to 90° of dwell. If the points were closed for half a period, the meter would read $e = E/2$ giving 45° of dwell on the scale. Hence if E is known, the meter scale can be calibrated linearly in degrees of dwell. To obtain consistently accurate readings, it is essential that E remain constant when the instrument is used on different engines. This is obtained by connecting a shaping circuit between the distributor and the voltmeter. The shaping circuit also removes the

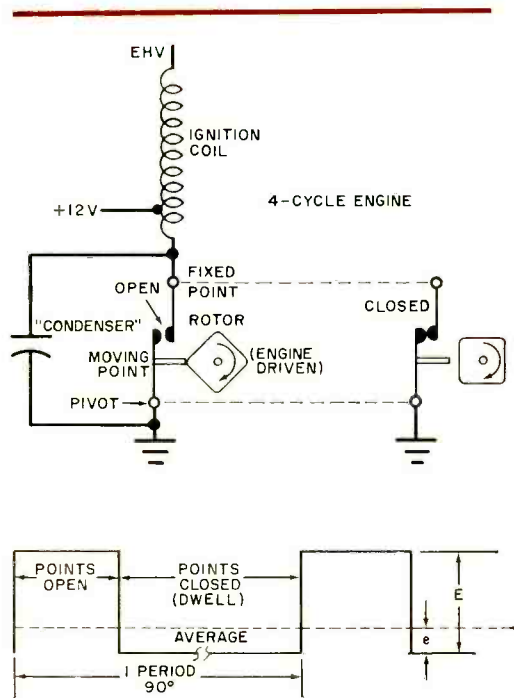

Fig. 1. Simplified ignition circuit and waveforms for a 4-cylinder engine.

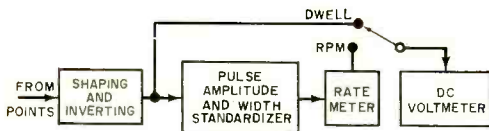

Fig. 2. Block diagram of the dwell-tachometer instrument. The voltmeter is switched to read dwell or rev/min.

large amount of ringing typically found in ignition circuits.

Note that the preceding also applies to 8- and 6-cylinder engines. In the case of an 8-cylinder engine the period would be equivalent to one eighth of one cycle or 45°. Hence if the same scale is used, zero deflection of the needle would indicate a dwell angle of 45°. For a 6-cylinder engine,

zero deflection corresponds to 60°. When the waveform of Fig. 1 is inverted, two advantages are immediately obtained: the meter scale is "reversed" (The 90-, 60-, or 45-degree markings are at full-scale deflection.) This means that a typical dwell indication will be in the upper third of the meter scale instead of in the first, hence greater meter accuracy; and, easier calibration of the instrument.

Engine Revolution. By counting the number of times the voltage E of Fig. 1 is generated per unit time, and taking into consideration the number of cylinders in the engine, the number of revolutions per minute (rpm) can be calculated. For example, in a 4-cylinder, 4-cycle engine, the points

Fig. 3. Schematic of the meter. Designed for negative ground systems, it tests 94% of US cars.

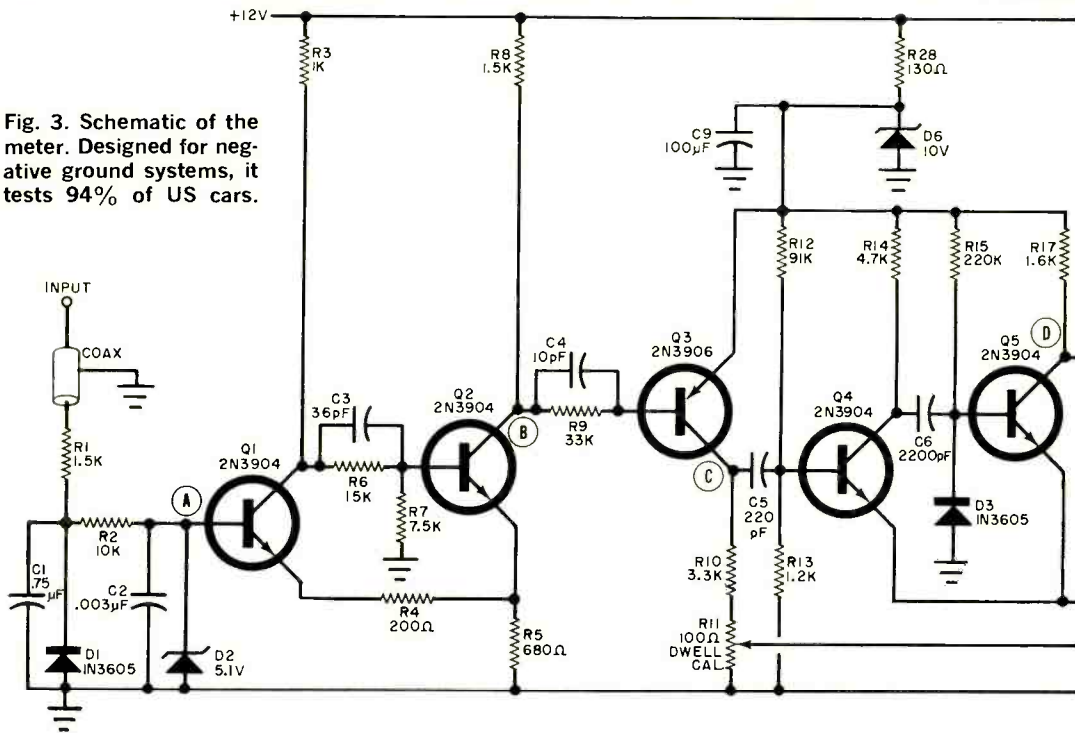

PARTS LIST

C1—0.75- μ F capacitor
 C2—0.003- μ F capacitor
 C3—36-pF capacitor
 C4—10-pF capacitor
 C5—220-pF capacitor
 C6—2200-pF capacitor
 C7—(A) 62 pF, (B) 91 pF, (C) 120 pF (see text)
 C8—1- μ F, 25-volt electrolytic capacitor
 C9, C10—100- μ F, 25-volt electrolytic capacitor
 D1, D3, D4, D5—1N3605 diode

D2—5.1-volt zener diode (1/4M5.1Z or similar)
 D6—10-volt zener diode (1/4M10Z or similar)
 M1—0-1 mA meter
 Q1, Q2, Q4, Q5, Q7, Q8—2N3904 transistor
 Q3—2N3906 transistor
 Q6, Q9—FET (MFE2097 or similar)
 R1, R8—1500-ohm, 1/4-watt resistor
 R2—10,000-ohm, 1/4-watt resistor
 R3—1000-ohm, 1/4-watt resistor
 R4—200-ohm, 1/4-watt resistor
 R5—680-ohm, 1/4-watt resistor
 R6—15,000-ohm, 1/4-watt resistor

open once (and hence produce 1 voltage pulse) for every two revolutions of the crankshaft. The same dc voltmeter can be used to measure engine rpm if a rate meter is connected between the meter and the shaping circuit thus becoming a "tachometer."

The block diagram of a combined dwell angle and tachometer instrument is shown in Fig. 2.

To obtain accurate rpm indications, the input pulses to the rate meter must have constant amplitude and constant width, hence the need for the pulse-width standardizer.

Circuit Details. The instrument to be described, and shown in Fig. 3, is designed

to operate with engines where the negative terminal of the battery is connected to ground. Over 94% of U.S. automobiles manufactured since 1956 fall into this category, while over 60% of imported cars also have negative ground electrical systems.

Converting the complex waveform from the distributor into a relatively clean one is accomplished by processes of limiting, integration and regeneration. Networks *R1C1* and *R2C2* form a pair of integrating networks. Diode *D1* removes most of the negative components of the waveform while zener diode *D2* limits the positive swing to 5.1 volts.

The double integration necessary to remove the ringing from the distributor waveform produces a rather slow-rising and even

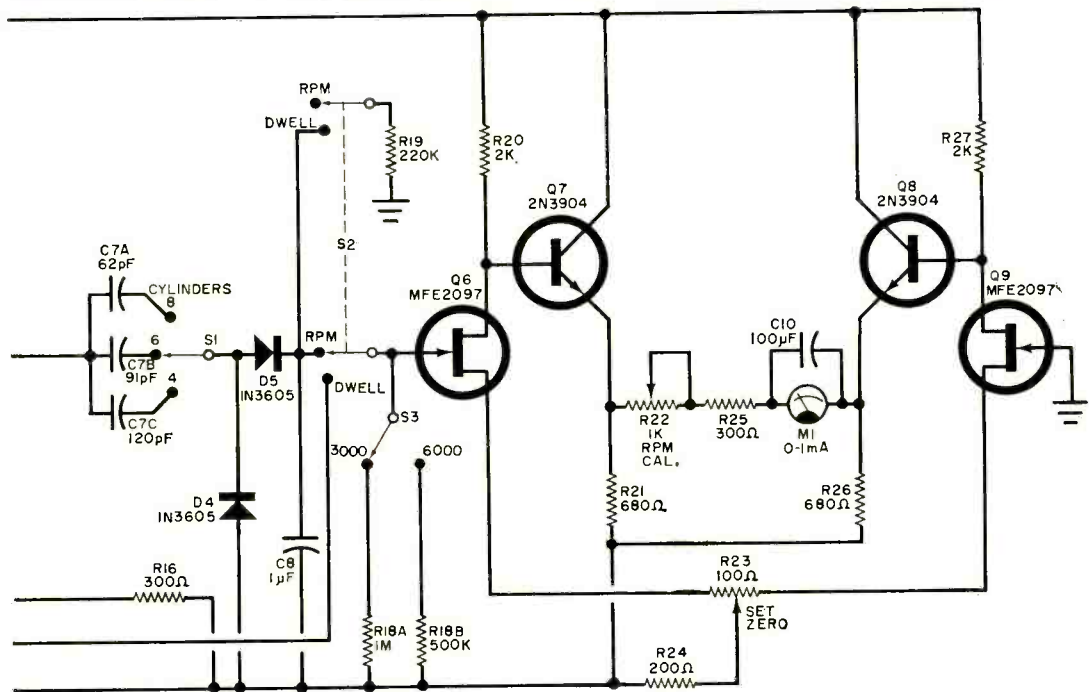

R7—7500-ohm, ¼-watt resistor
R9—33,000-ohm, ¼-watt resistor
R10—3300-ohm, ¼-watt resistor
R11, R23—100-ohm trimmer potentiometer
R12—91,000-ohm, ¼-watt resistor
R13—1200-ohm, ¼-watt resistor
R14—4700-ohm, ¼-watt resistor
R15, R19—220,000-ohm, ¼-watt resistor
R16, R25—300-ohm, ¼-watt resistor
R17—1600-ohm, ¼-watt resistor
R18—(A) 1 megohm, (B) 500,000-ohm, metal film, 1% resistor

R20, R27—2000-ohm, ¼-watt resistor
R21, R26—680-ohm, ¼-watt resistor
R22—1000-ohm trimmer potentiometer
R24—200-ohm, ¼-watt resistor
R28—130-ohm, 5%, ¼-watt resistor
S1—Single-pole, three-position rotary switch (see text)
S2—Dpdt switch
S3—Spdt switch (see text)
 Misc.—Suitable chassis, knobs, mounting hardware, etc.

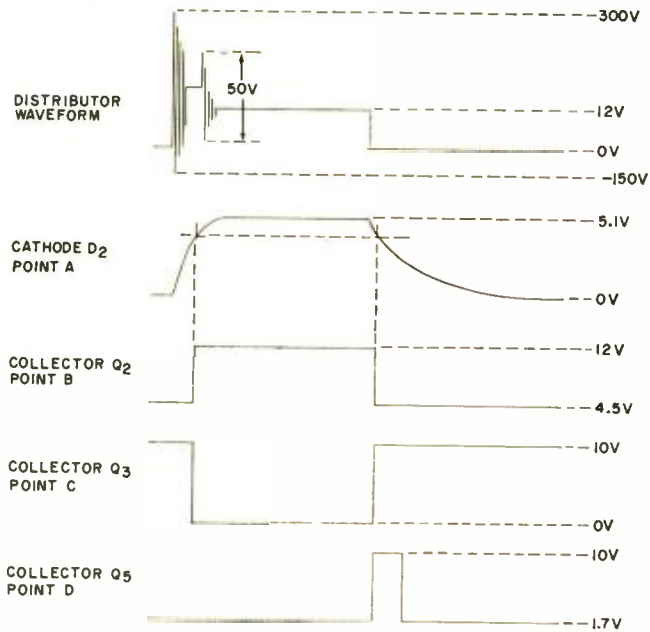

Fig. 4. Typical waveforms found on a 4-cylinder engine. To see ringing and steep rise times, a high-quality scope is needed.

slower-falling waveform as shown in Fig. 4. To overcome this, a waveform regenerator, or Schmitt trigger circuit, consisting of *Q1* and *Q2* and associated components is used; *Q1* is normally off and *Q2* on. The value of *R4* is chosen to reduce the hysteresis gap to 0.4 volt. Transistor *Q1* turns on when the voltage on its base reaches 4.2 volts and turns off again at 3.8 volts. The cut-in and cut-off levels chosen, together with the small hysteresis gap, produce a waveform at the collector of *Q2* with the exact duty cycle of the distributor waveform. The rise time of the waveform at the collector of *Q2* is 100 nanoseconds.

Transistor *Q3* acts as an inverter driven either into saturation or cut off depending on the state of *Q2*, hence the excursions of the collector of *Q3* are well defined. A fraction of the output from *Q3* is tapped off by variable resistor *R11* and sent to the meter circuit for dwell measurements. The full output from *Q3* is differentiated by *C5* and *R13* to provide the trigger signal to switch on *Q4*.

The pulse width standardizer (*Q4* and *Q5*) is a monostable multivibrator energized from a regulated supply.

Normally *Q4* is off and *Q5* conducting, *Q4* being brought into conduction by the trailing edge of the waveform from the collector of *Q3*. The astable time of the

multivibrator is determined by *R15* and *C6*. With the values shown, the output pulse has a width of 90 microseconds and an amplitude of 8.3 volts. Diode *D3* protects the base-emitter junction of *Q5* against reverse breakdown when *Q4* comes into conduction.

The rate meter circuit consists of *C7*, *D4*, *D5*, *C8* and *R18*. Each pulse from the monostable multivibrator dumps some charge into *C8* via *C7* and *D5*, thus a dc voltage builds up on *C8* which is measured by the voltmeter. With the components shown in Fig. 3, a dc voltmeter having a sensitivity of 0.1 volt full scale, connected across *R18*, can be linearly calibrated to indicate RPM with a full-scale deflection of 3000. This assumes that the input resistance of the voltmeter is considerably higher than the value of *R18*. If more than one rpm scale are required, a switch (*S3*) can be connected as shown in the diagram to introduce different values of *R18* into the circuit. Another switch (*S1*) can also be used to select different values of *C7* so that the same rpm scales can be used for 4-, 6-, or 8-cylinder engines.

The dc voltmeter consists of FET differential amplifier *Q6* and *Q9* and provides the necessary high input resistance to avoid loading the rate meter. A pair of emitter followers, *Q7* and *Q8*, provide the low

impedance necessary to drive meter *M1*. The FET's and associated transistors should be placed physically close to each other to achieve optimum temperature compensation. The gain of the differential pair is approximately 10 and *R23* is used to balance the currents in the two halves of the circuit to produce zero meter deflection for zero volts input. Potentiometer *R22* is adjusted to calibrate the rpm scales while *C10* is used to smooth the meter needle fluctuations when measuring dwell angle at low rpm.

The regulated power supply enables the instrument to operate directly from the engine's 12-volt battery. Zener diode *D6* acts as a 10-volt regulating element providing the necessary constant supply voltage for *Q3*, *Q4* and *Q5*, thus making the accuracy of the instrument independent of normal battery voltage fluctuations.

Construction. Almost any type of construction may be used, PC or perf board. Remember that vibration comes into play during automotive use, so take appropriate care in mounting components. In the prototype, a 4" by 2½" board having plated-through holes 0.3" apart was used. All components except the switches and meter were mounted on the single board. The overall size of the project is determined by the meter used.

If the instrument is to be used on only one type of vehicle (say 8 cylinders), then *S1* can be eliminated and the required value of *C7* is used. If only one rpm range is needed, then *S3* can be eliminated after selection of appropriate *R18*. The only switch actually on the front panel will then be rpm/dwell selector *S2*.

The only critical components are the capacitors selected for use as *C7*. These must be of high quality, therefore silver mica or polystyrene capacitors are used.

Another item worth special mention is the meter. Electrically, it must have a full-scale deflection of not more than 1 mA to give the correct indications with the values shown in the diagram. Of course, if a more sensitive meter is available, it can be used provided the values of *R22* and *R25* are changed to match the full-scale deflection. The physical shape and size of the meter are not critical, they depend on individual preference or on what is available. However, because the meter is the bulkiest item in the instrument, it should be chosen

first as it will determine the cabinet size. Always keep in mind that the meter does undergo some physical vibration in use, so a taut-band type is preferred. Another word is in order regarding the meter scales. Preferably there should be two linear scales, say 0-1 and 0-3. The 0-1 scale is used with a $\times 100$ factor to give 0-100 degrees dwell. The 0-3 scale is used with either a $\times 1000$ or $\times 2000$ factor to provide the 0-3000 and 0-6000 rpm readings. Readers with a steady hand may want to open their meters and mark their own scales.

Waveforms. The waveforms shown in Fig. 4 will be found useful when troubleshooting the circuit. They were observed with a 50-MHz oscilloscope using a 10-megohm, 7-pF probe. The amplitudes given for the distributor waveform are approximate since they vary with different types and makes of engines. The distributor ringing waveshape shown is fairly typical for all engines. Note that the amplitude and width of the pulses appearing at the collector of *Q5* are independent of engine characteristics and performance; only the number of these pulses per unit time is significant.

Calibration. Only two adjustments are required to calibrate the instrument after completion. The component values used in Fig. 3 will provide two rpm scales, 0-3000 and 0-6000. Should different full-scale ranges be desired, the values of *R18A* and *R18B* can be determined empirically. A sine wave generator capable of delivering at least 15 volts peak or a square wave generator capable of delivering at least 12 volts peak is necessary. If the frequency of the generator is not known accurately, a frequency counter will also be needed.

Connect the dwell/tach to a source of about 14 volts dc; switch to the rpm mode and connect the output of the audio generator to the input of the instrument. Adjust the audio generator amplitude for either 15 or 12 volts peak and the frequency to 100 Hz. This frequency corresponds to 3000 rpm and, for 4-cylinder engines, is equal to twice the full scale rpm desired divided by 60. Adjust *R23* to obtain full scale deflection.

For dwell calibration, disconnect the audio generator from the instrument, switch *S2* to "dwell" mode. Meter should now indicate full scale. If not, adjust *R11* to obtain an exact full-scale deflection. ♦



Test Equipment Scene

By Leslie Solomon, Technical Editor

CONTINUING in the vein of last month's column, when we answered some important reader questions, there are a couple more that we would like to take a look at. Both have to do with audio: one with test equipment and the other with four-channel sound.

The first question is one I have also asked myself a couple of times: Why doesn't some enterprising manufacturer come up with a reasonably priced audio sweep generator (kit)? Yes, I know that there are a few audio sweepers around, but have you checked the prices lately? We all know how valuable an r-f sweep generator is for front-end and i-f alignments, so why doesn't someone make life easier for the guy who works with audio?

Just think how nice it would be for the audio fan to be able to see the entire response of a speaker, crossover network, preamp, or power amplifier all at once. The ham could check those RTTY and SSTV filters; and the electronics experimenter could look at notch filters and low-, high-, and bandpass filters.

But let's not be too quick to place the blame on somebody else. As we mentioned in this column in January of this year, generating a clean audio sine wave is not the

easiest thing in the world. We said then that it takes a couple of matching conditions to create an oscillator—a frequency determining network and a suitable feedback system. Since both of these conditions are required for stable oscillation, they both have to be “juggled” at the same time. One approach that works well is the use of two r-f oscillators “beating” against each other to produce an audio tone. One oscillator is fixed while the other has its frequency varied sufficiently to produce the resulting audio sweep. A low-pass filter system keeps the r-f out of the audio portion.

Another technique that is finding favor is to use an op amp triangle wave generator and vary its frequency with another op amp oscillator. Although this approach does work, converting the triangle waves to clean sine waves still presents some problems. At present, the triangle is passed through a “soft” amplifier to round off the tips. This produces an “almost, or synthetic, sine wave.”

In some cases, conversion of the triangle to an almost sine is accomplished with a diode-resistor shaping network (see “Test Equipment Scene” for January 1973) which can reconstruct the sine wave segment-by-segment. In another case, the nonlinear drain-to-source current/voltage transfer characteristic of a p-channel junction FET is used to shape the triangle waveform. In still another technique, the nonlinear base-emitter junction characteristic of a differential amplifier is used to do the shaping.

Unfortunately, in both of the latter two cases, just about the best you can do is 2% distortion; and the amplitude of the input triangle waveform is critical and must be carefully adjusted to achieve a low-distortion sine wave output.

Then there is the slight problem of sweep rate. If you take a look at typical audio response graphs, you will note that

Audio Generators and Ceiling Ambience

The research behind the BOSE 901.

By now almost all Hi-Fi enthusiasts know about the performance of the BOSE 901, about its unprecedented series of rave reviews¹ and its unparalleled acceptance by musicians, stereophiles and the public. But few people know how this unconventional speaker was born. In this first article of a series, we would like to share with you the highlights of the twelve years of university research that led to the 901.

The research begins.

In 1956 a basic research program on musical acoustics was started by Professor Bose.² The motivation for this research came from the apparent discrepancy between the acoustical specifications and the audible performance of existing loudspeakers. Musicians were quick to observe the boomy and the shrill sounds produced by loudspeakers for which engineers claimed excellent specifications.



Dr. Bose's research began by making exacting measurements on loudspeakers and setting up experiments to correlate these measurements to aural perception.

By 1959 it was clear that not only were the existing measurement standards (established 30 years before) incomplete, but worse, they were often misleading. For example, measurements of frequency response and distortion made in anechoic chambers not only fail to indicate what a speaker will do in a room, but speakers with better chamber measurements can actually give inferior performance in the home—and vice versa!

Probing psychoacoustics.

By 1960 it became evident that basic psychoacoustic research was necessary to relate the subjective performance of loudspeakers to objective design parameters. This research was launched and the first major results were reported in November 1964 at a joint meeting of the Audio and Computer groups of the Institute of Electrical and Electronic Engineers held at M.I.T. It was this research that established the validity of the then controversial concepts of multiplicity of full range drivers, speaker equalization, and flat "power" response. It was also shown, with the help of computer simulations of ideal acoustical radiators, that

electrostatic, or other types of speakers have no potential performance advantages over properly designed cone speakers—a result that was not known prior to 1964.

Significance of reflected sound established.

At the time of the 1964 meeting, however, little was understood about the spatial properties of speakers. There was some evidence that direct radiating speakers caused shrillness in music but the reasons were not known. From 1964 to 1967 the research concentrated on these spatial problems. With the co-operation of the Boston Symphony Orchestra, measurements were made during live performances to determine characteristics of sound incident upon the listeners. Theoretical studies, verified by experiments, showed that

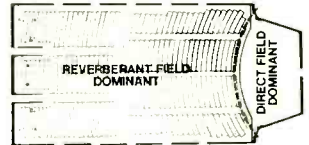

BOSTON SYMPHONY HALL FLOOR PLAN

in live performances sound arriving at the listeners' ears from different directions was much more evenly balanced than was the case for loudspeakers in home environments. Experiments then linked this spatial difference to the strident sounds produced by loudspeakers. Then it was discovered that the desirable spatial characteristics could be produced in the home by directing a large percentage of sound away from the listener at precise angles to the rear wall.

The culmination of 12 years research.

In 1968 we decided to incorporate all the knowledge gained from the years of research into the design of an optimum loudspeaker for the home. The result is the BOSE 901. Perhaps this explains our confidence in asking you to compare it to any other loudspeaker regardless of size or price.

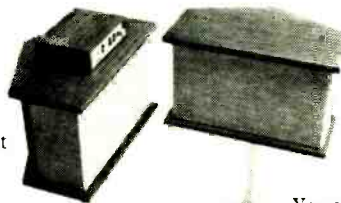

¹For copies of the reviews, circle our number(s) on your reader service card.
²Copies of the Audio Engineering Society paper, ON THE DESIGN, MEASUREMENT AND EVALUATION OF LOUDSPEAKERS, by Dr. A. G. Bose, are available from the Bose Corporation for fifty cents.

You can hear the difference now.

BOSE
Framingham, Massachusetts 01701

CIRCLE NO. 6 ON READER SERVICE CARD



Your Complete Electronics Buying Guide

- Stereo/Hi-Fi Components • CB Transceivers & Walkie-talkies • PA Systems • Tools & Test Equipment
- Police/Fire Monitor Receivers • Antennas • Photography Equipment • Ham Gear • Books, Parts, and More!

Send Today!

Lafayette Radio Electronics
 P.O. Box 10, Dept. 35033
 Syosset, L.I., N.Y. 11791

NAME _____ 35043

ADDRESS _____

CITY _____

STATE _____ ZIP _____

CIRCLE NO. 24 ON READER SERVICE CARD

Planning to move?

Let us know **6 to 8 weeks in advance** so that you won't miss a single issue of **POPULAR ELECTRONICS INCLUDING ELECTRONICS WORLD**

Attach old label where indicated and print new address in space provided. Also include your mailing label whenever you write concerning your subscription. It helps us serve you promptly.

Write to: P.O. Box 2774, Boulder, Colo., 80302 giving the following information.

If you have no label handy, print OLD address here.

name _____ please print

address _____

city _____

state _____ zip-code _____

AFFIX LABEL

- Change address only.
- Extend subscription. Enter new subscription.
- (1) 5 yrs. \$21 (2) 3 yrs. \$15. (3) 1 year \$6
- Payment enclosed (1 extra issue per yr. as a BONUS)
- Bill me later. 0769

name _____ please print

address _____

city _____ state _____ zip _____

Add'l postage: \$1 per year outside U.S., its possessions & Canada.

the horizontal axis is logarithmic and usually spans (at least) the three decades from 20 Hz to 20 kHz. This, of course, requires an accurate logarithmic sweep—not overly difficult if IC's are used. Another necessity is putting "marker birdies" on the displayed sweep to identify various frequencies.

The actual sweep speed also presents a problem. You just have to forget about the good old 60-Hz sweep speed used in r-f sweep generators. If you juggle the math around for a 60-Hz sweep speed in the 20-Hz to 20-kHz audio range, you are in for a rude awakening since you will find that you can't use the power line as a sweep reference. Slow sweep speeds are a necessity for an audio sweeper to prevent display problems.

However, all is not lost. I have heard some rumblings that a couple of outfits are dabbling with op amps and other esoteric IC's with the idea of producing a reasonably priced audio sweep generator.

Four-Channel Sound. The question we received about quadraphonics was interesting because it caused us to think about this latest phenomenon in the audio field in a different light. Here's the question: "Mono is a point source; therefore, theoretically it has no dimensions. Stereo is a line source (between the two speakers), so it has only one dimension (width). Four channel, on the other hand, is two-dimensional because it has width (across the room) and depth (front to back of the room). Now, how can a two-dimensional approach really imitate a real-life three-dimensional performance?"

When you think about it, the use of a present-day, four-channel system imposes an unnatural listening situation since, basically, you are listening to a performance in a room that has four walls, but the ceiling and floor are only vaguely defined—not exactly the kind of listening area that is comfortable. It appears that, although most serious listeners do pay attention to the reflectivity of the walls, they overlook the ceiling and floor.

In a live theater or concert hall, besides the stereo effect coming directly from the stage and the ambience created by reflections from the rear and side walls, there are also reflections from the ceiling. (Consider how many times the ceiling of New York's Philharmonic Hall has been re-

designed in order to improve the acoustics.) The floor can be ignored because carpeting, seats, and people absorb most of the sound from that direction (unless the original production of "The Emperor Jones" is brought back—with speakers in the floor).

If you have ever heard the performance of a piece of music outside and also heard the same music played in a decent hall, you know the importance of the ceiling in creating the overall ambience. At the moment, we can think of this "fifth" channel as a composite of the standard four channels (two front and two rear) as far as phase is concerned.

At the risk of starting a whole new wave of "pentaphonics," let's examine how avid electronics buffs can "play" with the ceiling's contribution to room ambience. One way

is to build the simple op amp summer shown in the schematic. Essentially, this circuit algebraically adds all four channels in one preamplifier. The four inputs can come directly from the four speaker lines since the input impedance of the summer is high enough not to upset impedances. The summed output is used to drive a low-power audio amplifier, which drives a small, but necessarily lightweight, speaker that can be mounted in the center of the room's ceiling.

In our experiments, we used an IC one-watt amplifier driven (through a volume control) from the op-amp summer. The output of the amplifier was coupled through a length of lightweight twin-conductor cable, to a Poly-Planar (lightweight plastic) speaker that was attached to the center of our listening room ceiling with double-sided adhesive tape. Of course, any type of speaker can be used if it is firmly secured to the ceiling.

With the conventional four channels operating normally, slowly turn up the volume of the overhead speaker and listen for the results. In a couple of test cases, the results were quite interesting; in a couple of others, they were only so-so. In any case, it is a fun area in which to experiment. ♦

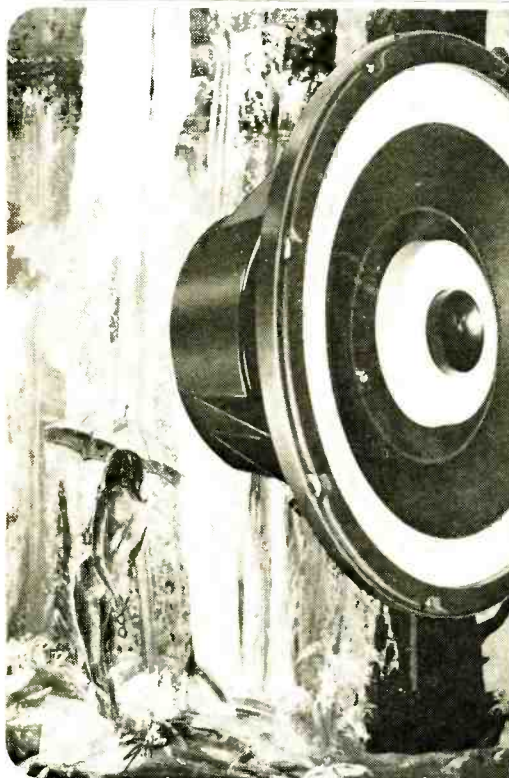
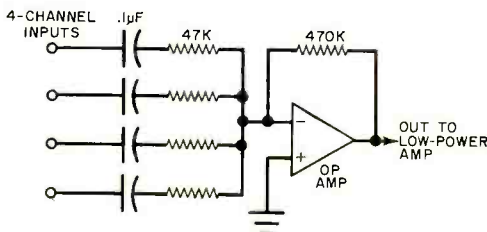

utah PRESENTS

Cascade

MOST POWERFUL, MOST EPIC PRODUCTION EVER!

This is the one you will want to see and hear. It is the most powerful die-cast High Fidelity speaker series ever produced by Utah. Its name is CASCADE... the totally new co-axial speaker line. It has the largest magnets ever and larger voice coils to handle more power for a longer time. Cloth rolls enhance bass performance. The rigid die-cast frame is designed for maximum structural length, and it can be mounted to either the front or rear of the baffle board. Your choice of 2-way or 3-way models in 8" and 12" sizes, some with co-axially mounted compression tweeters. Your ticket to the powerful CASCADE performance can be hurried along by writing us for complete information.



UTAH ELECTRONICS
HUNTINGTON, INDIANA 46750

CIRCLE NO. 45 ON READER SERVICE CARD

DESIGN YOUR OWN VOLTAGE REGULATOR

PUT A ZENER DIODE TO WORK

BY KEITH SCHUETTEL

MOST electronics experimenters have a single power supply that is usually used for all types of projects. The only problem is that the voltage may not be correct for every possible application.

Now, with just a resistor and a zener diode, coupled with a minimum of pencil work, you can make a fixed voltage source that is also well regulated. Of course, the power supply must be capable of delivering slightly more voltage than the expected regulated output level.

Simple Circuit. The circuit to be used is shown in the schematic. Essentially, it consists of a resistor and a zener diode feeding the output load. The zener diode is a semiconductor device that attempts to maintain a constant voltage (V_z) across itself and it accomplishes this by drawing the proper amount of current to maintain the voltage. The maximum current through the zener is determined by the power rating (P_z) of the diode and is calculated from

$$I_{z\max} = (P_z/V_z)(0.9)$$

The 0.9 factor is included as a safety measure to avoid overheating.

Essential circuit is resistor and zener diode.

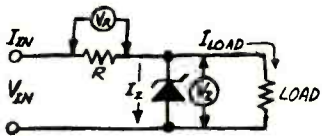

REQUIRED:

$$V_{IN} = 12V$$

$$V_z = V_{OUT} = 9V$$

$$I_{LOAD\ MIN} = 0$$

$$I_{LOAD\ MAX} = 150\ mA$$

$$(0.150\ A)$$

$$P_z = V_z(I_{LOAD\ MAX} - I_{LOAD\ MIN}) 1.25$$

$$= 9(0.150 - 0) 1.25$$

$$= 1.69\ WATTS \quad \text{USE 2-WATT ZENER}$$

$$I_{z\max} = (P_z/V_z) 0.9 = (2/9) 0.9$$

$$= 0.199\ A \quad \text{ASSUME } 200\ mA \ (0.2\ A)$$

$$R = (V_{IN} - V_z) / (I_z + I_{LOAD\ MIN})$$

$$= (12 - 9) / (0.2 + 0) = 15\ \Omega$$

$$P_R = (V_{IN} - V_z)(I_z + I_{LOAD\ MIN})$$

$$= (12 - 9)(0.2 + 0) = 0.6\ WATT \quad \text{USE 1 WATT}$$

The resistor limits the current flow. The voltage drop across the resistor is equal to the difference between the input voltage and the output voltage or $V_{in} - V_z$. If V_z (the output voltage) is to be constant, and V_{in} is constant, then the voltage drop across the resistor must be kept constant. This will occur only if I_{in} is constant or $I_{in} = I_{load} + I_z$. Thus, the function of the zener diode is to control I_z so that $I_z + I_{load}$ remains constant under all load conditions.

The zener will function properly as long as the variation in load current is less than 90% of $I_{z\max}$. When the load current is maximum, the zener current will be minimum and vice versa. It is a good practice to assume a minimum load current of zero if there is any chance that the load will be removed entirely. If this precaution is not taken, the zener diode may be destroyed.

The component values for the zener circuit are determined as follows:

1. Choose a zener diode having the desired voltage.

2. Determine the zener power rating from

$$P_z = V_z(I_{load\ max} - I_{load\ min}) \quad (1.25)$$

The 1.25 protects the zener against overheating and assures a minimum zener current that will be more than 10% of the maximum current needed for proper operation.

3. Maximum zener current is determined from the formula given above.

4. The value for the resistor is determined for the case when zener current is maximum and load current is minimum or

$$R = V_R/I_{in} = (V_{in} - V_z) / (I_{z\max} + I_{load\ min})$$

5. The minimum wattage of the resistor is calculated from

$$P_R = V_R I_{in} = (V_{in} - V_z)(I_{z\max} + I_{load\ min})$$

A typical example is shown worked out in the drawing. Other values can be "plugged in" to achieve various ratings. ♦

The right Pickering cartridge for your equipment is the best cartridge money can buy.

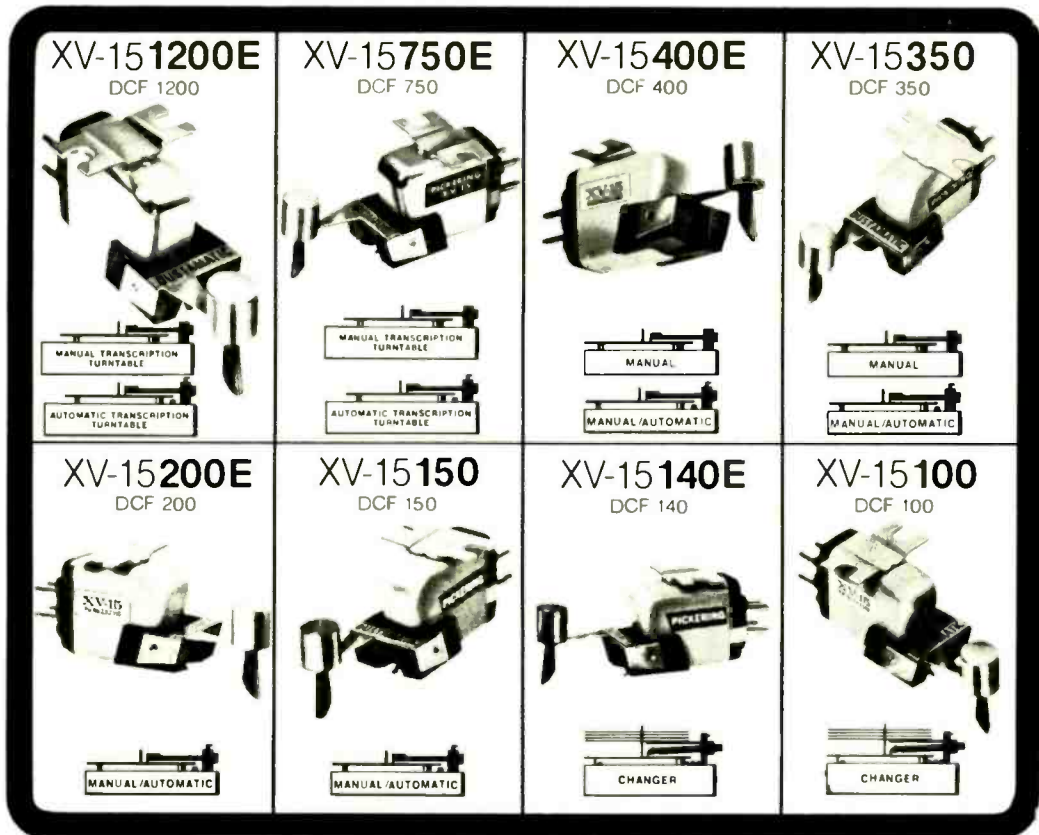

There's a "right" Pickering cartridge for every record player, and only Pickering has developed a way for you to be absolutely certain you select the "right" cartridge for your high fidelity music system.

It is a simple way for you to precisely match one of our XV-15 (100% Music Power) cartridges to whatever kind of record player you have or plan to buy. It's called Dynamic Coupling Factor - DCF for short.

We have taken virtually every record player and pre-analyzed the vital variables affecting cartridge design and those related to the engineering features

of the various turntables and changers. So, no matter what equipment you own or plan to purchase, there is a Pickering XV-15 cartridge exactly "right" for it. The DCF number enables you to select the proper Pickering XV-15 cartridge in relation to a particular type of playback equipment to achieve maximum performance.

If you're ready to buy your next cartridge, be certain you end up with the Pickering XV-15 cartridge that's best for your system. *Have your Pickering high fidelity dealer show you our DCF Chart, or write Pickering & Co., Inc., Dept. E, 101 Sunnyside Boulevard, Plainview, N. Y. 11803.*



PICKERING

"for those who can hear the difference"

The **100%** Music Power Cartridges

All Pickering cartridges are designed for use with all two and four-channel matrix derived compatible systems.

CIRCLE NO. 47 ON READER SERVICE CARD

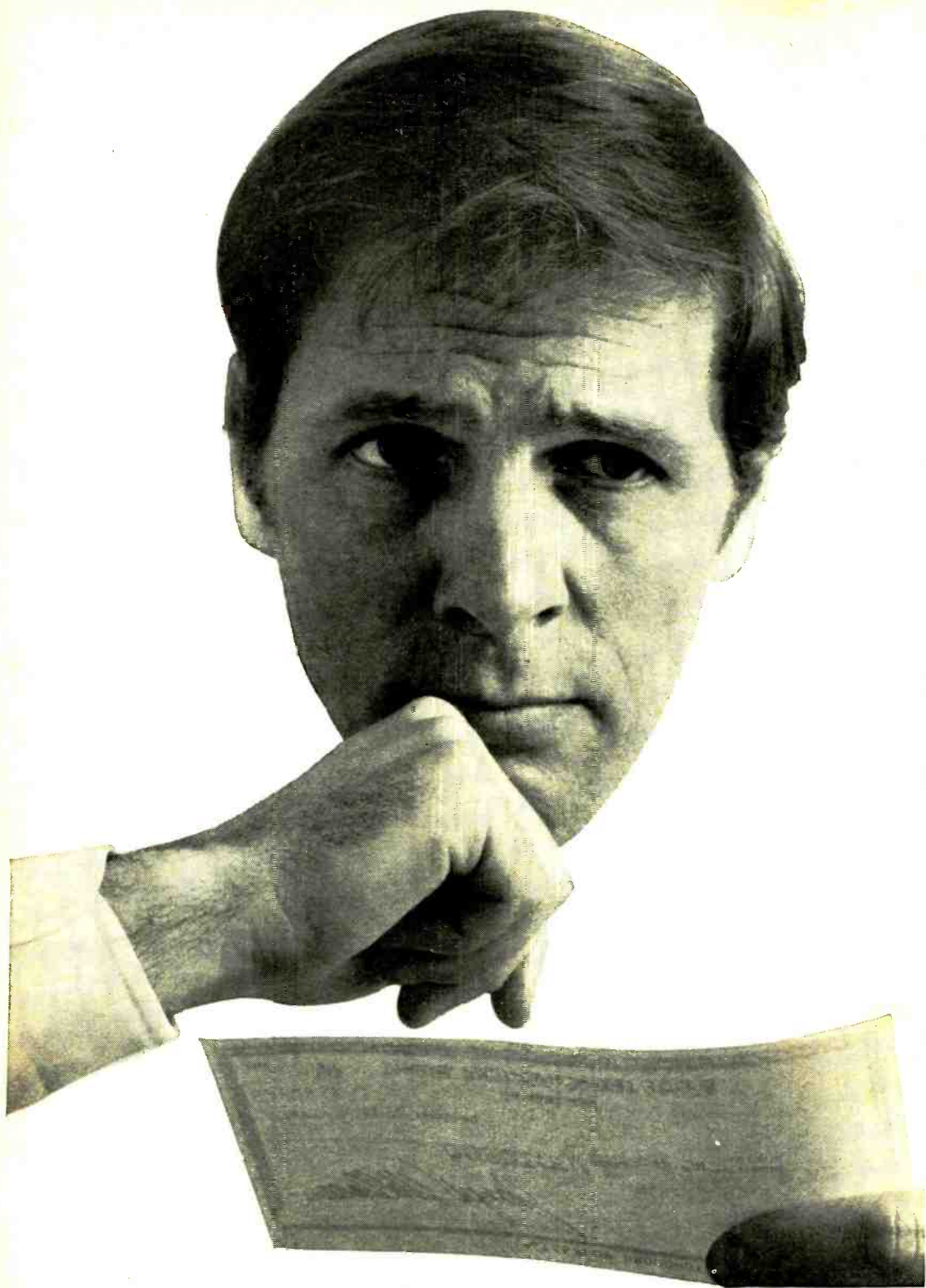

Your paycheck says a lot about you

It tells you more than how much you make. It tells you how far you've come. And if your paycheck looks very much the same as it did last year, or the year before, it simply means that you look very much the same as you did last year and the year before.

But times change, and you should be changing with them. Old dull jobs are disappearing. New exciting ones are being created. There are challenging fields such as computer technology, automation, television, space electronics where the work is interesting and the earnings are good.

RCA Institutes can give you the technical training you need, even if you've had no previous training or experience. RCA Institutes has a faster easy way for you to gain the technical skills and the knowledge required for an electronics career. And you don't have to quit work and go back to school. With RCA Institutes Home Study Plan you can work and study within reasonable limits. You set your own pace depending on your schedule.

Check over these RCA Institutes benefits:

- You get Hands-On Training—as many as 21 kits in RCA's Master TV/Radio Servicing Program.
- You get RCA's unique "Autotext" method of learning—individual programmed instruction, the easy, fast, simplified way to learn!
- You get a wide choice of electronics courses and programs—everything from Basic Electronics right up to Communications and Digital Electronics.
- You get a choice of low-cost tuition plans!

Sounds great, and it is. For complete information, without obligation, send in the attached postage paid card... or return the coupon below. That will say a lot about you.

Veterans: Train under new GI Bill. Accredited Member National Home Study Council. Licensed by N. Y. State Education Dep't — courses of study and instructional facilities approved by the State Education Department. "Eligible Institution" under the Federally insured Student Loan Program.

RCA Institutes, Inc. is a Subsidiary of RCA Corporation

RCA Institutes Home Study Dept. 694-304-0 320 West 31st Street, New York, N. Y. 10001 Please rush me FREE illustrated catalog. I understand that I am under no obligation. Name _____ Age _____ (please print) Address _____ City _____ State _____ Zip _____ Veterans: Check here <input type="checkbox"/>

If reply card is detached—send this coupon today

CIRCLE NO. 32 ON READER SERVICE CARD



Product Test Reports

ELECTRO-VOICE MODEL 4X4 RECEIVER (A Hirsch-Houck Labs Report)



THE NEW Electro-Voice Model 4×4 is a low-priced 4-channel stereo receiver with full control facilities for its internal AM and FM tuners and an external tape recorder and record player. The receiver has a built-in quadraphonic matrix decoder with the new E-V parameters that provide correct decoding for the widely used Columbia SQ records as well as satisfactory results with other recording matrices. It can also enhance ordinary stereo programs, through "ambience recovery," by synthesizing the rear channels.

The amplifiers in the 4×4 are rated at 10 watts per channel at a driving frequency of 1000 Hz, or 70 watts total IIF music power into 8-ohm loads with less than 1 percent distortion. One of the concentric bass tone controls affects both front channels, while the other works on both rear channels. A similar arrangement is used for the treble balance. The balance control is also concentric with one knob controlling the left-to-right balance (both front and rear speakers simultaneously) and the other knob handling the level of both front and both rear speakers simultaneously for front-to-rear balance. The master volume control simultaneously varies all four channels and contains the power switch.

The input selector switch has positions for AUX, FM, AM, and PHONO. Five pushbutton switches control the remaining receiver functions. The DECODE button passes the signals through the decoding matrix which supplies

four program channels to the four amplifiers and speakers. Separate phone jacks for the front and rear channels allow listening through 4-channel phones. The TAPE MONITOR button allows playback from either a 2-channel or a 4-channel tape recorder, and the tape recorder outputs on the rear of the receiver supply a 2-channel signal (not decoded) to an external recorder. These facilities can also be used for other types of quadraphonic decoders such as RCA's "Quadradisc."

The MONO button combines the two stereo channels to produce a monophonic signal at the front channel outputs and the tape outputs. (The rear channels are dead in mono.) The LOUDNESS button introduces bass boost at low volume settings. Finally, the REMOTE SPEAKER button disconnects the four main speakers and switches over to a second set of output terminals; it is not possible to drive both speaker system arrangements at the same time.

The tuning meter gives zero-center readings on FM and relative signal strength readings on AM. Stereo FM switching is automatic, triggering a STEREO lamp on the dial plate when a stereo signal is received. FM interstation noise muting is provided; it can be shut off by a slide switch on the rear of the receiver. Also on the rear are an adjustable AM ferrite rod antenna and a switched ac outlet.

Laboratory Tests. The Electro-Voice 4×4 audio amplifiers clipped at about 8.4 watts per channel during our tests, with all channels driven into 8-ohm loads. With only the front channels operating, the clipping level was 10.1 watts per channel. Slightly more power (14.8 watts) was obtainable with 4-ohm loads, while the maximum output into 16 ohms fell to 6.5 watts per channel.

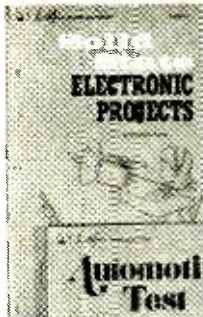
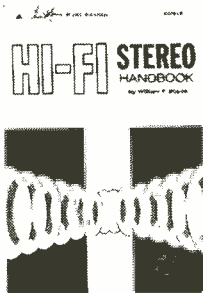
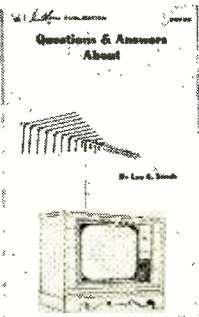
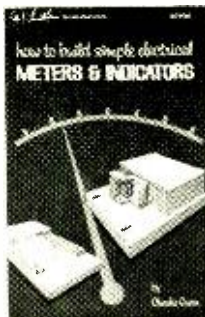

Sams brings you the latest in 10 areas of electronics.

Here are ten new or newly revised books from Sams, dealing with specific areas of electronics. All are informative, instructive, and as current as today. One or more of them may be exactly what you've been looking for.

1-2-3-4 SERVICING CASSETTES

by Forest H. Belt

A complete course in servicing the fast growing cassette market includes all you need to know about the cassette machines, how they work, and the easy 1-2-3-4 method of finding and curing their trouble, made as simple as 1-2-3—hence the name! 240 pages.

No. 20922 \$5.25

ELECTRONICS FOR MEDICAL PERSONNEL

by Edward J. Bukstein

Explains the principles of electrocardiographs, pacemakers, defibrillators, patient-monitoring and telemetry systems used in hospitals. A valuable aid for paramedics and technicians who service this type of equipment. 144 pages.

No. 20931 \$4.95

HOW TO BUILD SIMPLE ELECTRICAL METERS & INDICATORS

by Charles Green

A book for the hobbyist, starting with simple projects and progressing to the more complex. The projects include, among others, a voltaic cell thermocouple galvanometer, magnetometer, polarized-vane meter and moving-coil meter. 128 pages.

No. 20930 \$3.95

AUTOMOTIVE TEST EQUIPMENT YOU CAN BUILD

by A. Edward Evenson

How to build "professional level" instruments for diagnosing and servicing automotive electrical equipment. The first seven chapters describe separate test instruments which are combined into a multifunctional analyzer in chapter eight. 160 pages.

No. 20926 \$4.95

SOLID-STATE ELECTRONIC PROJECTS

by Charles D. Rakes

Shows how to make a wide range of useful projects, such as burglar alarms, metal locators, and a long-range listening device. The use of the transistor—switching mode and unijunction—is emphasized. Circuit descriptions, schematics and pictorial diagrams are all used. 128 pages.

No. 20921 \$3.95

HI-FI STEREO HANDBOOK (Fourth Edition)

by William F. Boyce

A complete and profusely illustrated presentation of all stages of electronic sound reproduction. Covers the three major stages of hi-fi reproduction, and equipment for all modes of four-channel sound. Includes much new material on latest devices, products and equipment in the field. 400 pages.

No. 20918 \$5.95

HI-FI PROJECTS FOR THE HOBBYIST

(Second Edition)

by Leonard Feldman

Detailed instructions for building 19 hi-fi projects all completely practical. Includes how to design a printed circuit, how to etch the boards and mount the components. Projects are progressively more complex throughout the 20 chapters. 144 pages.

No. 20925 \$3.95

QUESTIONS & ANSWERS ABOUT COLOR TV (Second Edition)

by Leo G. Sands

The most important aspects of color TV explained in easy-to-understand question and answer format. Covers theory of operation, insulation, servicing, and modification of equipment. Informative for both beginners and professionals. 96 pages.

No. 20928 \$3.95

TRANSISTOR RADIO SERVICING COURSE

by Wayne Lemons

This complete course covering all aspects of the transistor radio is both a text for beginners and a useful reference for service technicians. It covers all am and fm transistor components and stages and summarizes each chapter with a question and answer review. 191 pages.

No. 20914 \$6.95

PHOTOFACT® GUIDE TO TV TROUBLES (Second Edition)

by Howard W. Sams Editorial Staff

Actual photographs show what you see on a picture tube when any component in the receiver becomes defective. With it as a guide, you'll save valuable time in determining just which part is faulty. 192 pages.

No. 20521 \$4.50



HOWARD W. SAMS & CO., INC.
 4300 West 62nd Street, Indianapolis, Indiana 46268 P.E. 043

Order from your Electronics Parts Distributor or mail to Howard W. Sams & Co. Inc.

Send books checked at right \$_____ enclosed. Please include sales tax where applicable. Canadian prices slightly higher.

20922 20918
 20931 20925
 20930 20928
 20926 20914
 20921 20521

Name _____
 (Please Print)

Address _____

City _____ State _____ Zip _____

CIRCLE NO. 36 ON READER SERVICE CARD

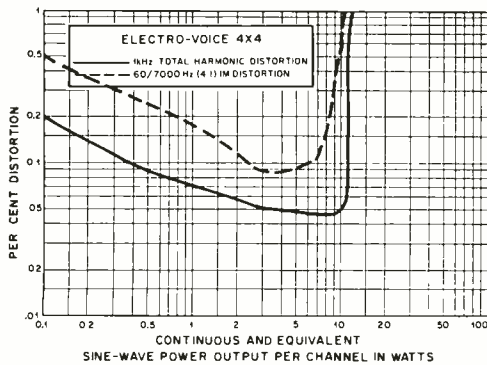

The 1000-Hz harmonic distortion with two channels driven was between 0.1 and 0.2 percent for output powers between 0.4 and 11 watts. The IM distortion varied in the same manner, typical values being 0.1 to 0.2 percent between 1 and 7.5 watts output.

At power levels less than 5 watts per channel, the distortion was 0.05 to 0.2 percent over most of the audio range, increasing at higher frequencies to about 1.0 percent between 15,000 and 20,000 Hz. At the full 10-watt output, the distortion was generally similar, except that it also rose to 1.0 percent at slightly below 40 Hz.

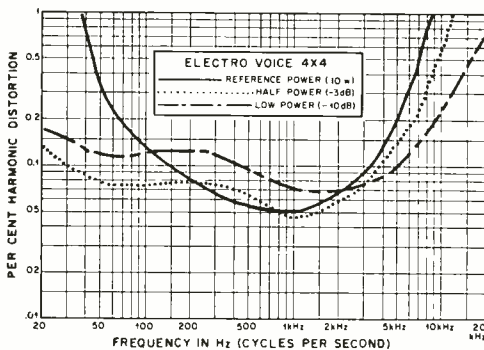

The tone control characteristics were good, with a sliding bass turnover frequency and a wider-than-average control range of ± 20 dB at 20 Hz and ± 17 dB at 20,000 Hz. The loudness compensation's moderate boost action sounded very good. The RIAA phono equalization was accurate within ± 1.5 dB between 30 and 15,000 Hz. The aux inputs required 0.13 volt to produce a 10-watt output with a 71.5-dB signal-to-noise ratio. Phono overload occurred at 38 millivolts.

The 2.9 μ V IHF usable sensitivity of the FM tuner was more than adequate for most reception conditions. A 50-dB S/N ratio was

obtained with less than 7 μ V (point of full limiting) at the input, and the ultimate S/N ratio was 66-67 dB. The stereo FM frequency response was very flat, with no measurable variation between 30 Hz and 15,000 Hz, and exceptionally uniform channel separation of 21-30 dB across that range. The AM tuner had a flat response from 20 to 2000 Hz, falling off to -6 dB at 3300 Hz. The FM capture ratio was 2.6 dB at 1000 μ V, and the image rejection was 51.5 dB. The alternate-channel selectivity was 36 dB, AM rejection was 45.5 dB, and the nonadjustable muting threshold was 40 μ V.

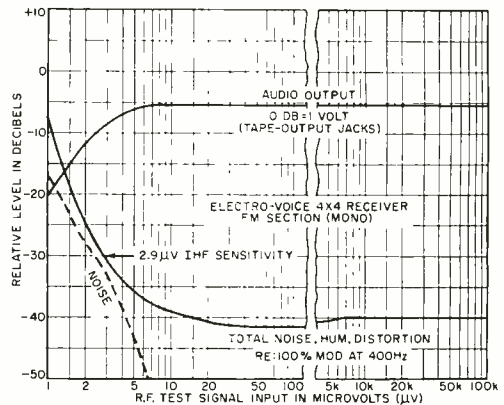

Comments. The Electro-Voice 4×4 , judged as an AM/stereo FM receiver, performed excellently. The FM tuner, in spite of its unimpressive selectivity, gave a good account of itself in our suburban, strong-signal listening area. The audio amplifiers were clean and quiet, though a bit low in power. However, when four speaker systems were connected to the 4×4 , there was no lack of power for ordinary home listening.

The DECODE function provided a satisfying ambience effect in the rear speakers with two-channel programs and did a good job of decoding SQ records. The relatively low phono overload level suggests that only fairly low-level output cartridges, preferably not exceeding 3 to 4 mV at normal program levels, should be used with this receiver. The very low noise level on phono makes it feasible to use the lowest output cartridges available, although some of these are fairly expensive for use with low-priced receivers.

The receiver has a deceptively simple, uncluttered appearance. But it is fully flexible and can function equally well in both its 2-channel and 4-channel modes. Our chief

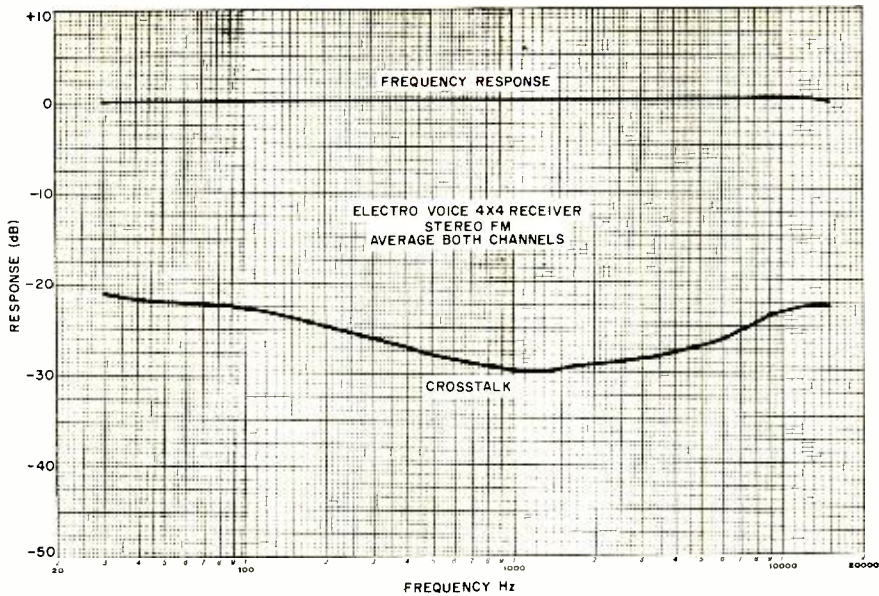

criticism of the receiver's controls was the fact that the gains of all four channels could not be set equal due to the manner in which each balance control affected two speakers. However, the unbalance was never more than a couple of decibels and did not create any audible problems.

Summarizing, the E-V 4×4 receiver is able to hold its own against many comparably priced 2-channel receivers. When the advantages of 4-channel operation are considered, the receiver, selling for \$250 (which includes walnut side plates), becomes an excellent value.

Circle No. 65 on Reader Service Card

SHARPE MODELS 7 AND 770 HEADPHONES (A Hirsch-Houck Labs Report)



THE Sharpe Audio Division of Scintex, Inc., manufactures a line of stereo headphones with a wide range of performance

characteristics at a wide variety of prices. For this report, we selected and tested the company's lowest-priced Model 7 and most expensive Model 770.

The Model 7, unlike most stereo phones, has rather shallow, almost flat, earcups surrounded by liquid-filled plastic cushions. The one-piece molded-plastic headband is adjustable. The attached coiled cord extends to a convenient 14 ft. Weighing 9 ounces, less cord, the Model 7 is relatively light. Electrically, the phones are designed to be driven from any amplifier with a 4-16-ohm output, at a maximum level of 1 watt per phone.

The Model 770 is a more conventional appearing phone that utilizes moderate-sized earcups molded of plastic with a walnut-grain finish. Like the Model 7, the Model 770 features liquid-filled cushions and an integral 14-ft coiled cord. The metal headband is adjustable over a somewhat greater range of sizes than that of the Model 7. The 19-ounce weight of the Model 770 is about

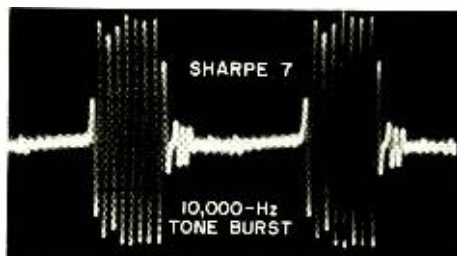
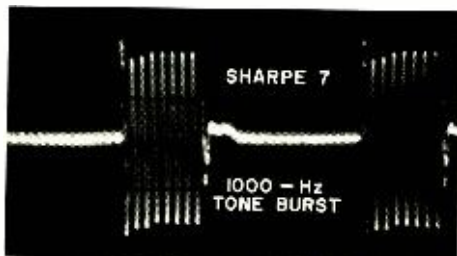
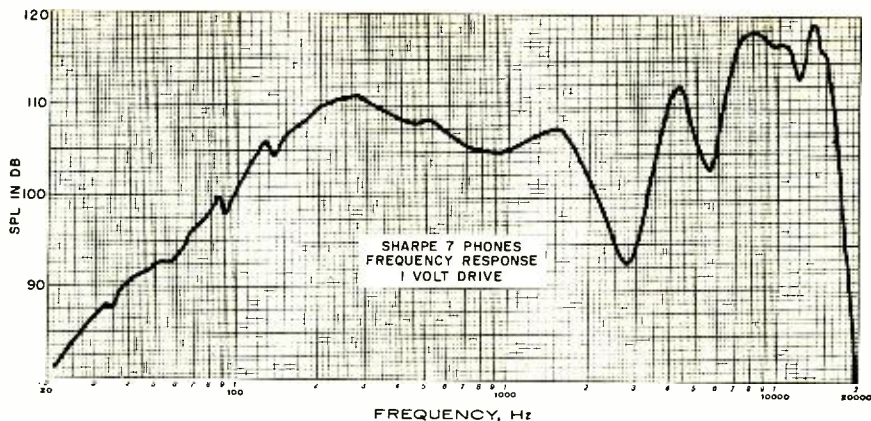

average for dynamic headphones. Each earcup has its own level control and is protected against overload by a 3/10-ampere fuse. While the Model 770 is rated at the same nominal impedance as the Model 7, its efficiency rating is somewhat lower.

Test Results. The frequency response of the phones was measured with a simple coupler arrangement consisting of a flat plate with a calibrated microphone mounted flush with the plate's surface. The earcup of the phone was placed against the plate, centered over the microphone, and weighted with 1 pound.

A sweep-frequency signal was used to drive the phone through an audio amplifier whose output voltage was constantly monitored. The microphone's output was plotted on a synchronized chart recorder. The absolute pressure calibration of the microphone allowed us to determine the actual sound-pressure level (SPL) from the earcups. Tone-burst signals were fed to the phones to check their transient response at various frequencies, and the microphone's output waveform was photographed to show typical tone-burst response. The electrical impedance of the phones was plotted between 20 and 20,000 Hz, while harmonic distortion was measured at 1000 Hz at several SPL's.

The frequency response curves obtained

with the coupler are as irregular as those obtained from most loudspeakers when taken in a normally "live" room—and for the same reason. Internal reflections and resonances in the volume between the ear-piece diaphragms and the microphone affect the response at the higher frequencies. Although a similar effect occurs in the wearer's ear cavity, phones are (or should be) designed to give their best results on a human head, rather than when they are coupled to an "artificial ear." Nevertheless, these measurements do provide some insight into the behavior of the headphone.

Both headphone models had strong, useful outputs up to at least 16,000 Hz. The Model 770's response was smoother above 2000 Hz, but the measured differences were not great. However, its output was quite uniform down to 100 Hz, while the output of the Model 7 began to drop off below 250 Hz. The actual low-frequency response depends on the tightness of the earcup seal, but the Model 770 had typically about 10 dB more output than the Model 7 at all frequencies below 100 Hz, relative to the midrange level.

Both phone models had very uniform impedances across the full frequency range. The impedance of the Model 7 measured 20 ohms, while that of the Model 770 measured 16 ohms. Both models had similar, and good, tone-burst response at all frequencies.

The most obvious difference between the measured performance of the two phone models was in their sensitivities and maximum output levels. With a 1-volt drive signal, the output of the 770 was typically between 80 and 90 dB, a comfortable but not particularly loud level. With the same drive signal applied, the Model 7's output of 100-110 dB was very loud.

This is also reflected in the distortion measurements. The Model 7 had only 1.2 percent distortion at 100 dB SPL, 1.7 percent at 110 dB, and 2.6 percent at an ear-splitting 120 dB level. For the Model 770, the distortion was 2 percent at 90 dB, 2.3 percent at 100 dB, and 4.7 percent at 110 dB.

The fuses in the Model 770 blew at levels only slightly greater than 110 dB. The unprotected Model 7 did not fare as well, and one earpiece element was burned out when we attempted to reach a 130-dB level. Of course, at these extremely high levels, both phone models were being driven beyond their maximum power ratings.



User Comments. The Model 7 was comfortable to wear, but its ear cushions were not very effective in excluding external sounds. On the other hand, the Model 770 has the best sound isolation we have ever observed with a headphone.

Although the Model 7 sounded good (better than average, in fact, when compared with other phones in its price range), the Model 770 was notable for its exceptionally smooth, wide-range sound. Its listening ease and freedom from coloration were instantly apparent. Owing to its low

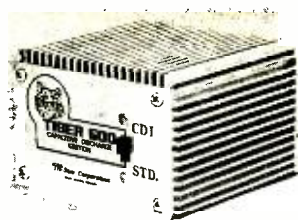

12 REASONS YOUR CAR NEEDS TIGER CDI

Instant starting in any weather - Eliminates tune-ups - Increases gas mileage - Increases horsepower 15% - Improves acceleration and performance - Spark plugs last up to 70,000 miles - Reduces engine maintenance expense - Amplifies spark plug voltage to 45,000 volts - Maintains spark plug voltage to 10,000 RPM - Reduces exhaust emissions - Dual ignition switch - An Unconditional LIFETIME GUARANTEE - Installs in 10 minutes on any car with 12 volt negative ground - No rewiring - Most powerful, efficient and reliable Solid State Ignition made.

SATISFACTION GUARANTEED or money back.
TIGER 500 assembled \$49.95
TIGER SST assembled 39.95
TIGER SST Simpli-Kit 29.95
 Post Paid in U.S.A.

Send check or money order with order to:

Tri-Star Corporation

Dept. W, P. O. Box 1946
 Grand Junction, Colorado 81501

DEALER INQUIRIES INVITED

CIRCLE NO. 43 ON READER SERVICE CARD

TUNER SERVICE

VHF, UHF, FM or IF Modules . . .

. . . All Makes

Fast **8 hr. Service!**

1 YEAR GUARANTEE

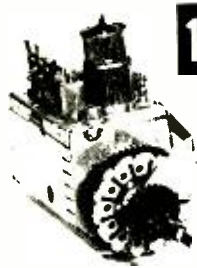

VHF-UHF-FM	\$ 9.95
UV-COMB.	\$16.95
IF-MODULE	\$12.50

Major Parts charged at Net Price
 P.T.S. is overhauling more tuners for more technicians than any other tuner company in the world!

LIKE TO DO IT YOURSELF?
 Send one Dollar (redeemable) for our 60 pages of top information

TUNER REPLACEMENT GUIDE AND PARTS CATALOG

For fastest service, send faulty tuner with tubes, shields and all broken parts to:

PTS ELECTRONICS, INC.

"Precision Tuner Service"



HOME OFFICE—
 Box 272 • Bloomington, Ind. 47101 • Tel. 812. 824-9331
WEST—
 Box 11351 • Sacramento, Calif. 95841 • Tel. 916. 482-6220
SOUTH—
 Box 7332 • Longview, Tex. 75601 • Tel. 214. 753-4334
SOUTHEAST—
 Box 6861 • Jacksonville, Fla. 32205 • Tel. 904. 389-9952
EAST—
 Box 1189 • Springfield, Mass. 01103 • Tel. 413. 734-2737
MOUNTAIN—
 Box 4245 • Denver, Colo. 80204 • Tel. 303. 244-2818

CIRCLE NO. 30 ON READER SERVICE CARD

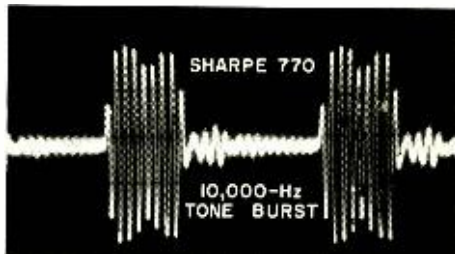
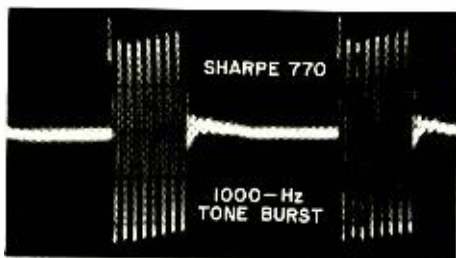
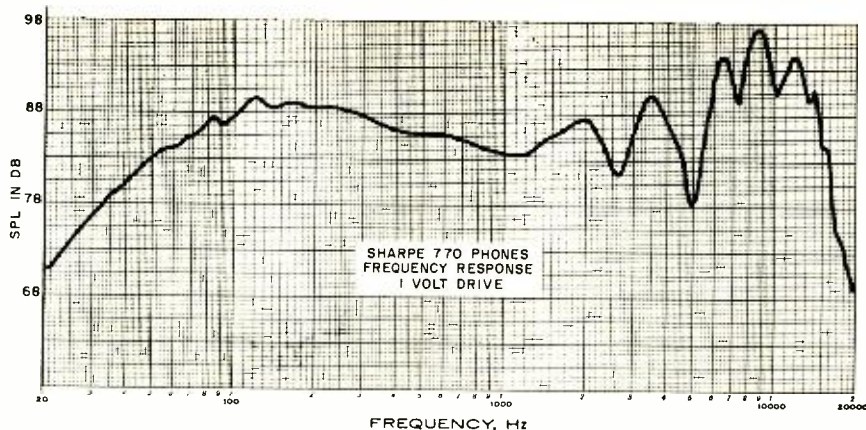

sensitivity, the Model 770 could not be driven to an uncomfortably loud volume level with any amplifier or receiver at our disposal, including some in the 50 to 60-watt per channel class.

Unlike the majority of stereo headphones available, the Sharpe models have the "right" earcup elements connected to the tip of the phone plug; so, with most receivers, this will reverse the left and right channels.

However, the symmetrical design of the phones allows the earcups to be reversed on the user's head to compensate for this.

One would expect the Model 770 to be an outstandingly good headphone, selling as it does for \$100. It certainly is. But the \$19.95 Model 7 also acquitted itself admirably, making it clear that performance in headphones does not necessarily improve in direct proportion to increasing prices.

Circle No. 66 on Reader Service Card

FANON/COURIER FANFARE 200 CB TRANSCEIVER

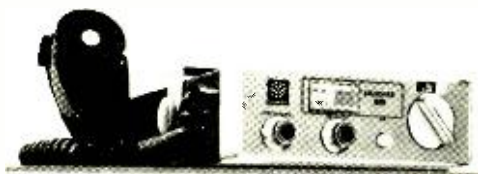

BEING a 23-channel, crystal-synthesized rig, the Fanon/Courier Fanfare 200 is unusual since it is one of the few small CB transceivers available with this coverage feature. Measuring just 8" x 5½" x 1½" and weighing just 3¾ pounds, the transceiver is designed primarily for mobile use. It operates at the maximum legal power from a nominal 13.8-volt dc negative-ground source. In spite of its compact dimensions,

the transceiver will do a job comparable to many of the larger base-station rigs.

Besides the channel selector dial, the front panel of the Fanfare 200 contains the usual volume and adjustable-squelch controls, plus a meter that automatically indicates signal strength in S units on receive or relative output power on transmit. Public address operation is also featured through an external-speaker jack and is put into operation by pushing a button located on the front panel.

The Fanon/Courier Fanfare 200 CB transceiver lists for \$110 and includes a mobile mounting bracket and hardware and a dynamic push-to-talk microphone.

Technical Information. The Transceiver has 20 transistors, one IC, and six diodes.

Double conversion is employed in the receiver section. The first conversion is obtained by heterodyning against the frequency synthesizer's output to produce a frequency of 11,275 kHz that ensures a greater-than-80-dB image signal rejection. The second conversion, down to 455 kHz, is obtained by heterodyning with an 11,730-kHz crystal signal where selectivity is obtained through the use of a mechanical filter to provide the necessary bandpass for good voice intelligibility. At the same time, the adjacent-channel selectivity is rated at 50 dB. However, with our test unit, some asymmetry resulted in a rejection of 30 dB on the low-channel side and more than 60 dB on the high side.

With bipolar transistors used in the r-f and mixer stages and bandpass coupling for uniform gain over the band, the overall sensitivity of the receiver was 0.5 μ V for 10 dB (S+N)/N. This was slightly better than the manufacturer's specified rating of 0.7 μ V. The measurement was made with the signal modulated 30 percent at 1000 Hz, the frequency specified by EIA standards. This makes the receiver look better than when using the older standard test frequency of 400 Hz, particularly in the case where re-

ceiver response falls off 6 dB at 400 Hz. On the other hand, the low-frequency rolloff does provide somewhat better voice readability, thus providing more effective sensitivity.

A single IC after two 455-kHz i-f stages functions as the detector and a series-type full-time limiter. The age also is derived from the IC and is amplified in a setup that holds the a-f output change to 11 dB with an 80-dB r-f input change (1-10,000 μ V), a 5-dB change occurring at an input of 1-10 μ V. A 100- μ V signal was required to produce an S9 meter reading.

Under moderate impulse-noise conditions, the noise limiter was adequate. But where high ignition noise is encountered, we would have liked to have seen more effectiveness from the automatic noise limiter. The squelch, triggered through the age, eases in and out smoothly and could be adjusted for thresholds of 0.3-625 μ V.

The measured audio output power at 1000 Hz into an 8-ohm load was 2 watts with 4 percent distortion (2.5 watts with 10 percent distortion). This power is also available at the external-speaker jack for PA service. A speaker plugged into this jack can

The Greatest Advance In Soldering—The Wahl "Cordless Soldering Iron"!

The Perfect Soldering Tool For The Electronic Enthusiast, The Model Builder, The Home Handyman, and Campers.

- Completely Portable
- 8" Long—Weighs Only 6 Ounces
- Push Button Operation
- Built-In Work Light
- Recharges Automatically
- Heats In 5 Seconds

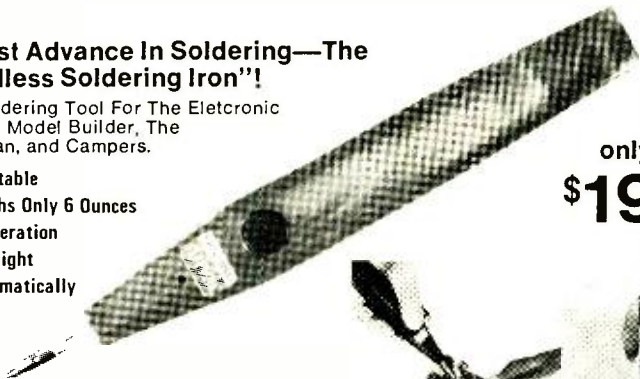

only
\$19.95
plus postage



Complete working freedom for those tough soldering jobs. No cord to get in the way—truly a portable soldering instrument. The Wahl "Iso-Tip" Cordless Soldering Iron is powered by long-life nickel cadmium batteries. Fully charged, unit gives up to 100 solderings at a tip performance of 50 watts. This amazing tool is specially designed for good feel and balance—8" long and only 6 ounces in weight. Just press the button and full soldering heat of 700° F is reached in just 5 seconds. You will gain a new dimension of versatility and precision. **WARRANTY**...Your Wahl Cordless Soldering Iron is of such high quality that the manufacturer will repair or replace this instrument for 1-year from date of purchase if it fails to operate satisfactorily.

Please ship me _____ Cordless Soldering Irons at \$19.95 each plus 75¢ postage and insurance each. (Illinois residents add 5% Sales Tax.) PE 1014
Check or money order enclosed.

NAME _____

ADDRESS _____

CITY _____ STATE _____ ZIP _____

Place in envelope and mail to:
CONTEMPORARY MARKETING, INC.
607A Country Club Drive
 Bensenville, Illinois 60106

CIRCLE NO. 9 ON READER SERVICE CARD

also be used for the receiver output, but only when the PA setup is engaged.

Transmitter. The frequency synthesizer employs various additive combinations of crystals at frequencies in the area of 23,440 and 14,950 kHz. Its output is then mixed with an 11.275-kHz crystal signal for an on-channel signal for the transmitter. Band-pass filters at the synthesizer and mixer outputs minimize spurious responses. The signal then goes to the driver and the r-f power amplifier that has a dual- π 50-ohm output network and a TVI filter.

Powered by a 13.8-volt dc source, the transmitter generated a 3.25-watt carrier output. With the driver and PA collector modulated by the receiver's class-B output stage, the modulation characteristics were among the best we have encountered, as indicated by nice waveforms at full 100 percent modulation with only 4 percent distortion. A modulation-limiting system in a feedback-type compression setup maintains a relatively high signal level without the excessive distortion experienced in many limiting systems. With 10 dB of limiting above the point required for 100-percent modulation, the distortion held to within 10 percent.

We found that the amount of compression

set at the factory was a bit too low to hold the limiting action within the above degree during normal voice operation, in which case, the distortion could rise higher.

The response of the transmitter was -3 dB at 300 Hz and -1 dB at 3000 Hz (referred to 1000 Hz) which, together with the limiting action, maintains a signal of excellent quality. At an 80° ambient temperature, the overall frequency tolerance held within 0.0018 percent on all channels.

General Comments. The Fanfare 200 can be operated from dc sources ranging from a low of 10.8 volts to 15.6 volts. At a nominal 13.8 volts, the current drain on receive is 250 mA, while on transmit, it is 800 mA with unmodulated carrier and 1.1 A with modulation.

The window for the channel-selector dial is quite small. Unless the transceiver is mounted in a sharply tilted upward position, the overhanging lip of the bezel somewhat obscures the numerals, making identification of the channel a bit difficult.

The fine readability of received signals and the excellent modulation characteristics of the transmitter overshadow any minor shortcomings in this transceiver. Add to this the fact that the Fanfare 200 is very low priced for the features it offers.

Circle No. 67 on Reader Service Card

RCA MODEL WE-130A SOUND LEVEL METER



ALTHOUGH you might not consider a sound level meter (SLM) as a piece of test gear, such a device can play an impor-

tant role in your life and in the lives of others around you. One way or another, we are all affected by acoustic noise. In some cases, the noise is almost subliminal and although the effect is not felt at once, it can pile up to reveal itself as nervousness and irritation after a while. In other cases, the noise is of sufficient amplitude and duration to cause emotional damage.

Some published reports claim that as many as 10-million workers may have hearing problems stemming from noisy work areas. Other research has linked noise to such ills as mental distress and heart disease. In Germany, for example, a recent study indicated that workers operating in a high noise environment suffered a higher incidence of heart disorders, circulatory problems, and equilibrium disturbances than workers functioning in a less noisy environment. A number of medical men are almost certain that on-the-job noise is a factor in certain types of neurotic and psychotic behavior.

Standards have been drawn up for human tolerance to noise. Sound amplitudes up to about 80 dB are considered to be in the safe area. Those sounds between 85 and 90 dB are on the borderline of danger. All sound amplitudes of 90 dB and greater represent a definite danger to hearing. Exposure to the latter levels for even a relatively short time can cause loss of hearing and possibly the other problems previously mentioned.

Sound level meters have been available to the professionals for quite some time at prices that the average amateur could not afford. Now, however, several manufacturers are marketing relatively inexpensive SLM's. RCA's new Model WE-130A sound level meter, retailing at \$75, is a good example of a low-cost SLM. Although it measures only 6 $\frac{1}{2}$ " by 3" by 2" and weighs only 1 $\frac{1}{2}$ ounces, this battery-powered (four AA cells) SLM can be used to measure sound intensities ranging from 70 dB through 110 dB on a unique scale. A green area on the scale indicates the 70-85-dB "safe" zone, a yellow area indicates the 85-90-dB borderline danger zone, and a red area indicates the definitely dangerous 90-110-dB zone. Weighted "A" to simulate human hearing, the range of 70 to 110 dB was selected to cover only the range of human tolerance. The colored zones are also marked off in dB for actual measurements.

The WE-130A SLM comes in a heavy-duty case with a shoulder strap. The instrument itself is supplied with a neck lanyard for safety. A Velcro fastener is used to keep the case closed.

To use the SLM, one only has to point the sensitive microphone "front end" in the direction of the sound source and depress a switch. The meter is designed with a slow reaction time to provide an average indication of rapidly fluctuating noises; without this feature, the SLM would be extremely difficult to use if its pointer responded to every peak and null.

The SLM was designed to measure the possible fatigue-producing noise levels of factories, construction sites, heavy traffic areas, schools, and offices. It can also be used to determine the relative amplitudes of PA systems and home audio equipment. Lightweight and compact as it is, the WE-130A is a useful tool to both the professional and amateur for monitoring sounds emanating from lawnmowers, snow blowers, power saws, and marine engines as well as to test the efficiency and effectiveness of sound insulating tiles, pads, baffles, and walls that have been installed to reduce noise levels.

We checked the WE-130A against a laboratory-quality SLM and found it to be well within the manufacturer's specifications. It tracked the lab meter quite well.

Circle No. 68 on Reader Service Card

HEATHKIT MODEL GC-1005 DIGITAL ELECTRONIC CLOCK

ACCORDING to the hands on our old wall clock, it was a "quarter to nine" when we arrived at the office to begin the workday. That is the way most of us "read" time—after interpreting what is meant by the various positions of the hands on the dial face, we put the number of minutes to or after the hour first and follow with the hour, forgetting the seconds altogether. But with the new breed of numeric-readout digital electronic clocks on the market, one is forced to tell time in the proper manner. So, a glance at our Heathkit Model GC-1005 digital clock told us that our actual arrival time was a more precise 8:45:36 a.m.

Telling time by the digital method is actually no more difficult than it was to tell time "by the hands." Once one gets over the initial awkwardness of having the time displayed by hours, minutes, and seconds in



that order, telling the time is easy. It is faster too, because you do not have to interpret what the numbers mean.

Heath's GC-1005 digital clock can be used in any room of a home or office. For those areas where reading time at a distance is the norm, the readouts provided are gas-discharge 7-segment Sperry Rand S $\bar{7}$ -352 units whose extra-large numerals are clearly

legible at distances of 25 ft or more. A unique alarm feature makes the clock ideal for bedroom use.

When assembled, the clock is fully enclosed inside a plastic case with a simulated walnut top and black end panels. The front panel contains a full-width readout filter behind which are an a.m./p.m. indicator and six numeric readouts arranged in pairs for hours, minutes, and seconds.

The case measures 7" × 5" × 2½" in overall dimensions and weighs a mere 3 lb. The retail price of the kit from the factory in Benton Harbor, Michigan, is only \$54.95, making it perhaps the least expensive sophisticated digital electronic clock around.

Technical Details. All of the digital logic functions of the clock are performed inside one of the most complex and sophisticated MOS/LSI clock chips currently available. This single 24-pin IC can be externally pre-programmed to provide either a 12- or a 24-hour time format and to permit the clock to utilize either 50- or 60-Hz line power frequencies, depending upon whether or not certain jumpers are installed on a PC board. Aside from the usual counting and decoding functions performed by all clocks, the LSI chip also has a built-in strobe, or multiplexing, circuit for the display and a programmable alarm circuit.

The alarm circuit is designed to operate on a 24-hour duty cycle (two 12-hour cycles in the event that the board is wired for a 12-hour time format), sounding only once in a given 24-hour period. Unique to this alarm circuit is a "slumber" feature that permits the user to operate a spring-loaded slide switch to disable the alarm's gentle "beep" for 7 minutes, after which the alarm again sounds. The slumber switch can be operated as often as desired for up to one hour after the alarm initially sounds.

The use of a single LSI chip to perform all of the digital logic functions in the clock minimizes the number of discrete components needed to 21 transistors, 12 diodes, a handful of coupling and filtering capacitors, and about six dozen biasing and dropping resistors. Seven of the transistors are used to strobe the segments of all readouts simultaneously. Twelve others strobe the readout stages and provide high-voltage isolation for the LSI chip. Another transistor is used to drive the alarm speaker, and a final one is used in the alarm-set circuit.

Six slide switches are provided for controlling all alarm and time setting functions. On the rear panel are the ALARM ON/OFF and SNOOZE ALARM switches where they are easy to get at. The less used TIME-HOLD, ALARM-SET, MINUTES SET-AHEAD, and HOURS SET-AHEAD switches are all located on the bottom of the cabinet.



General Comments. Our Heathkit Model GC-1005 digital electronic clock arrived in kit form. Having in the past assembled clock kits built around a multitude of IC's and circuit boards, we anticipated a long, tedious time of kit building. However, we were pleasantly surprised to find that this was one of the easier kits in our experience. After flipping through the assembly/operating manual supplied with the kit and noting how few parts were to be mounted onto just two printed circuit boards (one for the readout assembly, the other for the logic and power supply), we were eager to get started. So, in about 4½ hours, we had our clock ready for the acid test. Assembling the kit posed no particular problems except that the MOS/LSI chip required special handling to avoid damaging it through static electricity.

When we first plugged the clock's line cord into the a-c outlet, the display indicated all 8's, the normal condition for a properly operating clock of this type. (All 8's also show up when power has been interrupted to the clock for more than a few seconds to tell the user to reset the time.) Once we knew that the clock had no problems, we quickly set it to the proper time with the aid of the TIME-HOLD, MINUTES SET-AHEAD, and HOURS SET-AHEAD switches. We also set the alarm with the aid of the ALARM-SET switch. Everything worked without a hitch.

Circle No. 69 on Reader Service Card



Leakage Current Testing and Using Square Waves

By John T. Frye, W9EGV, KHD4167

APRIL was never more welcome. The winter had been long and cold and bitter, filled with natural and man-made disasters; but now it was over and spring had returned just as, mercifully, it always does.

Barney came skipping through the front door of the service shop and gently laid a long-stemmed yellow tulip atop Matilda's typewriter; then without a word to the astonished office girl, he went on back to the service department, where he found Mac, his employer, examining two new instruments resting on the service bench.

The larger, at first glance, looked like a conventional bakelite-cased VOM, but lettering on the front revealed it was a "Simpson Model 229 Leakage Current Tester." The range switch had positions designated: OFF, BATT TEST, 150 VAC, SHORT TEST, 10mA, 3mA, 1mA and .3mA. There were matching scales on the meter face.

"What do you do with that odd-ball meter?" Barney asked.

"You measure the amount of 60-Hz current that flows from an electrical line conductor to the metal exterior of an electrical device and thence through an electrical simulation of a human body to an earth ground. Such a dangerous current flows when there is a conductive path, resistive or capacitive, between the hot wire of the device and the case and when the person using the electric drill, hedge-clipper, sander, or what have you simultaneously touches the case and a grounded object.

"This current flows because one side of the 117-volt, single-phase, two-wire line is grounded at the pole transformer and again at the electrical entrance to the building. That means you do not have to touch both wires simultaneously to be shocked. All you have to do is to establish a return circuit between the 'hot' wire and the earth. You

can prove this to yourself by connecting a 117-volt bulb between the hot wire and a water pipe. The bulb will burn almost as brightly as if it were connected across both wires of the line. It will also burn, although usually less brightly, if a poor ground such as a metal stake driven into the earth is used.

"The American National Standards Institute suggests the circuit I've drawn there on the blackboard to test for leakage current. As you can see, one lead of a meter whose characteristics correspond to their specified standards—and this one does—is connected to the grounded neutral conductor. The other meter lead is used to probe the case or any exposed metal parts of the appliance being tested. The ac line is connected to the appliance through switches *S1* and *S2*. All switches on the appliance are turned on.

"With *S1* open, only the hot wire is connected to the electrical circuit, and the return path from the case to the grounded lead is through the meter. With *S1* closed, power is applied normally to the device being tested, but leakage current reaching the case still returns to ground through the meter because the ground pin socket of the 2-pole, 3-wire grounding type socket is left open for these tests; otherwise any leakage current would bypass the meter. *S2* reverses the hot and ground wire connections to the appliance. Motor operated appliances are tested under 'no load' conditions. Heating appliances are tested at maximum heat setting of controls."

"Why reverse the line cord connections?"

"Because, if the leakage path happened to be between the grounded lead and the case, no leakage current would be present; but when the line plug was reversed, the path would be between the hot lead and the case and leakage current would appear. Take that signal tracer of ours. With *S2* in one position,

no leakage current is seen; but in the other position, 2.25 mA of current passes from the case through the meter."

"A partial short from one end of the transformer primary to the core, huh?"

"No, although that could happen. The leakage current path is through an 0.05 capacitor from one side of the line to the chassis, which is bolted to the case. The reactance of this capacitor at 60 Hz is about 53,000 ohms, which will pass almost precisely 2.25 mA of current when subjected to 117 volts, as happens when the side of the line to which the capacitor is connected is hot."

Resistance of Body. "You say that meter simulates the resistance of the human body to electrical current. How does it do that?"

"By presenting a terminal impedance of 1500 ohms noninductive resistance shunted by 0.15 μ F of capacitance. This is the experimentally determined 50 percentile threshold-of-perception-curve value determined by Charles F. Dalziel and others for an average human being in an average environment of temperature, pressure, humidity, etc., when subjected to small ac or dc currents. Remember that name of C.F. Dalziel. You're going to hear much more about him when we talk about the biological effects of electric shock in the near future. But for now, remember the impedance of the human body to electrical current can vary tremendously from this value under non-average conditions. Also health and other conditions can affect the individual's tolerance to electric shock. That's why the maximum leakage current for appliances is set by the ANSI at only 0.5 mA, although most human beings cannot feel even the faintest tingle of electricity until the current is twice this value. The Underwriters' Laboratories feel that this 0.5-mA value of leakage is not likely to produce such adverse effects as ventricular fibrillation, inability to let go of a current-carrying device, or an involuntary reaction which can result in injury from secondary causes (e. g. fall from a ladder, spill hot liquids, etc.)"

"Then why does that meter have all those current ranges?"

"So it can be used to detect everything from a direct conductor-to-case shortcircuit to very small leakage currents produced by damp insulation or carbon dust paths. Note this instrument is designed to perform one specific job: to measure leakage currents of appliances in accordance with American

National Standard specifications. We're going to use it to test all our instruments and electrically operated tools for leakage on a routine basis and to check every set we work on to make sure it is safe for the customer to use. I suggest you take it home with you and check all your tools and all the appliances in your mother's kitchen: refrigerator, dishwasher, toaster, mixer, blender, etc. After you do you'll probably conclude as I have that only a careless idiot employs a cheater plug so he can use his three-wire hedge clipper ungrounded with a two-wire extension cord. He's usually asking for it."

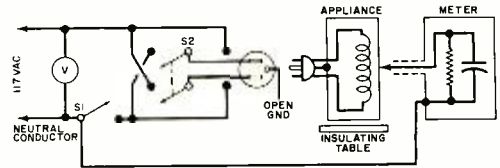

Circuit suggested by American National Standards to check leakage current.

What's a Pippier? Barney didn't answer. He had picked up the other smaller instrument from the bench and was examining it curiously. It was a little tan-colored metal box about 2 $\frac{3}{4}$ " \times 2" \times 1 $\frac{1}{2}$ " with a BNC connector sticking out one end and a control knob and a slide switch on top. One switch position was marked FAST and the other SLOW.

"Who is 'TFE' and what is a 'PP-1A'?" Barney read from the little case.

"TFE is the manufacturer of that little gem. The letters stand for 'Tools for Electronics,' P.O. Box 2232, Denver, Colorado 80201. The PP-1A tells you that is a 1A Model of the *Pocket Pippier*," Mac explained with an anticipatory grin.

"A pocket *what*?" Barney asked incredulously.

"Pippier. Actually it's a miniaturized, sophisticated, battery-powered, fast rise-time step generator that puts out pulses of stepped voltage with repetition rates of either 2 kHz or 200 kHz. Open circuit output voltage is about 500 millivolts, which falls to about $\frac{2}{3}$ this value when working into the output impedance of 50 ohms. But listen to this: the rise time of that stepped voltage is less than 2 ns when working into a 50-ohm load, the following flattop is free of overshoot and ringing, and the fall time is about 5 ns. When working into an open circuit, the rise time

only increases to about 3 ns while the fall time increases to about 20 ns. The open circuit rise and fall times cannot be measured exactly because scopes with sufficient bandwidth to measure them have 50-ohm inputs."

"What on earth is inside that little box?"

"A few ordinary components and some extraordinary ingenuity. Two transistors are used to form a free-running multivibrator. The square wave output at the collector of one of these drives another transistor as an emitter follower. The emitter load of this transistor is a tunnel diode. Now you will recall that a tunnel diode can be biased so that only a very small change in applied voltage will switch it with great rapidity from a high-voltage to a low-voltage state, and vice versa. The control on top of the Pocket Pippin is used to adjust the bias to that condition. Then the square wave from the multivibrator feeding through the emitter follower triggers the tunnel diode back and forth between the high and low voltage states and produces the square-wave-like waveform. But let me show you."

Mac slipped a BNC connector carrying about three inches of coax into the Pocket Pippin connector and clipped the leads of the bench scope to the conductor and shield of the coax. He adjusted the scope sensitivity for 100 millivolts/cm and the sweep for 100 microseconds/cm. With the slide switch of the PP-1A in the SLOW position, he turned the control knob clockwise from the OFF position. A couple of cycles of a square-wave-like trace, about ½ cm high, appeared on the scope. As Mac advanced the control, the trace suddenly jumped up to a height of more than 5 cm. But now only the horizontal lines marking the tops and bottoms of the square waves could be seen clearly. The bottom lines had curious little up-and-to-the-right hooks on their right ends. Only by advancing the brightness away beyond normal could the vertical rise and fall lines be made out dimly.

"Those little hooks on the bottom lines show the increase in the triggering voltage on the tunnel diode just before it switches," Mac explained. They're not involved in the rise time that's defined as the time it takes a stepped voltage to increase from 10% to 90% of the final value. Now let's look at the 200-kHz output." He readjusted the scope sweep to 1 μ s/cm and switched the Pocket Pippin to FAST.

"Oh, oh!" Barney exclaimed. "The waveform's not so good on that speed. Look at

the overshoot and ringing." Sure enough, there was about 7 or 8% overshoot of the leading edges of the square waves and a definite wrinkling of the first part of the horizontal lines.

Scope Makes Difference. "That's what I thought until I got suspicious and had a friend take a look at the output of the PP-1A on his Tektronix 547/1A1 scope," Mac said. "Not a trace of overshoot or ringing appeared on it at the FAST speed. The vertical amplifier of our scope simply isn't up to handling a 200-kHz stepped voltage with that fast a rise time without distorting it."

"Why not? Our scope has a bandwidth out to 5 MHz."

"The trouble lies in how the vertical amplifier response tapers off on the high end. Our vertical amplifier falls off too abruptly because the high end has been overcompensated by propping it up with peaking circuits. Ideally, the response of an amplifier on the high end should follow a gaussian curve in which the response at twice the 3-dB down frequency is only down 12 dB. It's a smoothly tapering curve like this," Mac said, illustrating with a hand wave.

"Why, Mac, I didn't think you'd noticed my figure!" Matilda said from the doorway where she was striking her best starlet pose, leaning back against the jamb, her backflung head cradled in her hand, lips parted, and holding the stem of the yellow tulip between her teeth.

"Back to your typewriter, wench!" Mac said, getting red in the face. "It's getting so a man can't talk sense around here. Anyway, Barney, I've long wanted a really fast rise time generator we can use to test, for example, video amplifiers for bandwidth, rise time, and transient response. Our old square wave generator is perfectly adequate for most of our requirements, but its rise time of 2 microseconds is too slow to trigger transients in extended-range amplifiers. Still I can't afford to put \$500 or so into a fast rise time pulse generator we need only occasionally. But this little gem costs only \$12.95 in kit form and will serve our needs handily. Why are you grinning like a Chessy cat?" he broke off.

"I was just thinking that now you're not going to be happy until you get a scope that can keep pace with that Pippin."

Mac tried to scowl but couldn't quite manage it. "Some people around here are getting just a little too smart," he growled. ♦

One of our most successful students wrote this ad!

Harry Remmert decided he needed more electronics training to get ahead. He carefully "shopped around" for the best training he could find. His detailed report on why he chose CIE and how it worked out makes a better "ad" than anything we could tell you. Here's his story, as he wrote it to us in his own words.

By Harry Remmert

"AFTER SEVEN YEARS in my present position, I was made painfully aware of the fact that I had gotten just about all the on-the-job training available. When I asked my supervisor for an increase in pay, he said, "In what way are you a more valuable employee now than when you received your last raise?" Fortunately, I did receive the raise that time, but I realized that my pay was approaching the maximum for a person with my limited training.

"Education was the obvious answer, but I had enrolled in three different night school courses over the years and had not completed any of them. I'd be tired, or want to do something else on class night, and would miss so many classes that I'd fall behind, lose interest, and drop out.

The Advantages of Home Study

"Therefore, it was easy to decide that home study was the answer for someone like me, who doesn't want to be tied down. With home study there is no schedule. I am the boss and I set the pace. There is no cramming for exams because I decide when I am ready, and only then do I take the exam. I never miss a point in the lecture because it is right there in print for as many re-readings as I find



Harry Remmert gives his CIE Electronics course much of the credit for starting him on a rewarding career. He tells his own story on these pages.

necessary. If I feel tired, stay late at work, or just feel lazy, I can skip school for a night or two and never fall behind. The total absence of all pressure helps me to learn more than I'd be able to grasp if I were just cramming it in to meet an exam deadline schedule. For me, these points give home study courses an overwhelming advantage over scheduled classroom instruction.

"Having decided on home study, why did I choose CIE? I had catalogs from six different schools offering home study courses. The CIE catalog arrived in less than one week (four days before I received any of the other catalogs). This indicated (correctly) that from CIE I could expect fast service on grades, questions, etc. I eliminated those schools which were slow in sending catalogs.

FCC License Warranty Important

"The First Class FCC Warranty* was also an attractive point. I had seen "Q" and "A" manuals for the FCC exams, and the material had always seemed just a little beyond my grasp. Score another point for CIE.

*CIE backs its courses with this famous Money-Back Warranty: when you complete a CIE license preparation course, you'll be able to pass your FCC exam or be entitled to a full refund of all tuition paid. Warranty is valid during completion time allowed for your course.

"Another thing is that CIE offered a complete package: FCC License and technical school diploma. Completion time was reasonably short, and I could attain something definite without dragging it out over an interminable number of years. Here I eliminated those schools which gave college credits instead of graduation diplomas. I work in the R and D department of a large company and it's been my observation that technical school graduates generally hold better positions than men with a few college credits. A college degree is one thing, but I'm 32 years old, and 10 or 15 years of part-time college just isn't for me. No, I wanted to *graduate* in a year or two, not just *start*.

"When a school offers both resident and correspondence training, it's my feeling that the correspondence men are sort of on the outside of things. I wanted to be a full-fledged student instead of just a tag-a-long, so CIE's exclusive home-study program naturally attracted me.

"Then, too, it's the men who know their theory who are moving ahead where I work. They can read schematics and understand circuit operation. I want to be a good theory man.

"From the foregoing, you can see I did not select CIE in any haphazard fashion. I knew what I was looking for, and only CIE had all the things I wanted.

Two Pay Raises in Less Than a Year

"Only eleven months after I enrolled with CIE, I passed the FCC exams for First Class Radiotelephone License with Radar Endorsement. I had a pay increase even before I got my license and *another* only ten months later.

"These are the tangible results. But just as important are the things I've learned. I am smarter now than I had ever thought I would be. It feels good to know that I know what I know now. Schematics that used to confuse me completely are now easy for me to read and interpret. Yes, it is nice to be smarter, and that's probably the most satisfying result of my CIE experience.

Praise for Student Service

"In closing, I'd like to get in a compliment for my Correspondent Counselor who has faithfully seen to it that my supervisor knows I'm studying. I think the monthly reports to my supervisor and generally flattering commentary have been in large part responsible for my pay increases. My Counselor has given me much more student service than "the contract calls for," and I certainly owe him a sincere debt of gratitude.

"And finally, there is Mr. Tom Duffy, my instructor. I don't believe I've ever had the individual attention in any classroom that I've received from Mr. Duffy. He is clear, authoritative, and spared no time or effort to answer my every question. In Mr. Duffy, I've received everything I could have expected from a full-time private tutor.

"I'm very, very satisfied with the whole CIE experience. Every penny I spent for my course was returned many

times over, both in increased wages and in personal satisfaction."

Perhaps you too, like Harry Remmert, have realized that to get ahead in Electronics today, you need to know much more than the "screwdriver mechanics." They're limited to "thinking with their hands" . . . learning by taking things apart and putting them back together . . . soldering connections, testing circuits, and replacing components. Understandably, their pay is limited—and their future, too.

But for men like Harry Remmert, who have gotten the training they need in the fundamentals of Electronics, there are no such limitations. He was recently promoted, with a good increase in income, to the salaried position of Senior Engineering Assistant working in the design of systems to silence submarines. For trained technicians, the future is bright. Thousands of men will be needed in virtually every field of Electronics from two-way mobile radio to computer testing and troubleshooting.

Send for Complete Information — FREE

Many men who are advancing their Electronics career started by reading our illustrated school catalog, "Succeed in Electronics." It tells of the many electronics careers open to men with the proper training. And it tells which courses of study best prepare you for the work you want.

If you're "shopping around" for the training you need to move up in Electronics, this interesting book may have the answers you want. We'll send it to you FREE. With it, we'll also include our other helpful book, "How To Get A Commercial FCC License."

To get both FREE books, just fill out and mail the reply card. For your convenience, we will try to have a representative call. If card is missing, use coupon below.

APPROVED UNDER G.I. BILL

All CIE career courses are approved for educational benefits under the G.I. Bill. If you are a Veteran or in service now, check box for G.I. Bill information.

CIE Cleveland Institute of Electronics, Inc.

1776 East 17th Street, Cleveland, Ohio 44114
Accredited Member National Home Study Council

Cleveland Institute of Electronics, Inc.

1776 East 17th Street, Cleveland, Ohio 44114

Please send me your two FREE books:

1. Your school catalog, "Succeed in Electronics."
2. Your book on "How To Get A Commercial FCC License."

I am especially interested in:

- | | |
|---|--|
| <input type="checkbox"/> Electronics Technology | <input type="checkbox"/> Electronic Communications |
| <input type="checkbox"/> Broadcast Engineering | <input type="checkbox"/> Industrial Electronics |
| <input type="checkbox"/> First Class FCC License | <input type="checkbox"/> Electronics Engineering |
| <input type="checkbox"/> Electronics Technology with Laboratory | |

Name _____ (Please Print)

Address _____

City _____

State _____ Zip _____ Age _____

Veterans & Servicemen: Check here for G. I. Bill information

PE-43

For men with prior electronics training . . . Electronics Engineering Course

. . . Covers steady-state and transient network theory, solid-state physics and circuitry, pulse techniques, computer logic and mathematics through calculus. A college-level course for men already working in Electronics.

CIRCLE NO. 8 ON READER SERVICE CARD

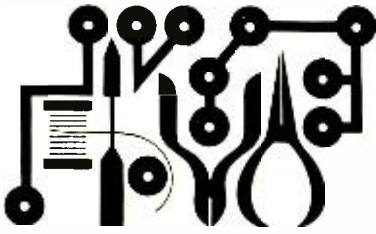

Hobby Scene

SOLVING SOME UNUSUAL PROBLEMS

Q. How can I convert my low-cost cassette tape recorder so that it will accept more than one microphone?

A. Try this circuit. When you build it, check that the collector voltage of the transistor is about half the supply voltage. Current drain is low and the battery should last a long time.

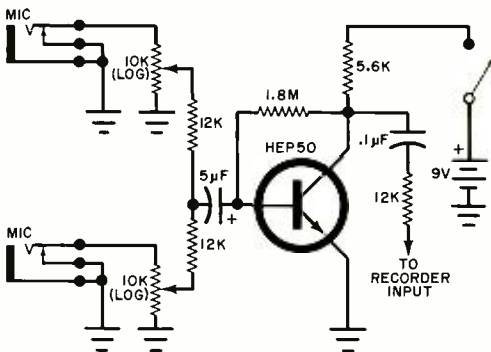

Q. Do you have a simple, low-cost amplifier for general use with a crystal set, phono pickup, etc.?

A. The circuit shown below will deliver about $\frac{1}{4}$ watt into a speaker of 15 ohms or so, and it uses a minimum of parts. If the amplifier shows any signs of high-frequency instability, hook a 500-pF capacitor between pins 1 and 2.

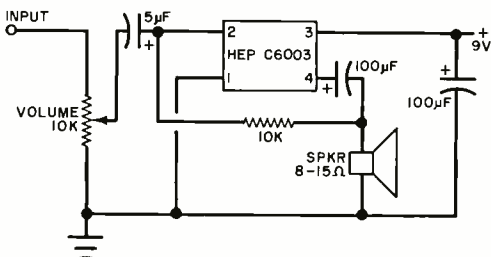

Q. The tuning dial of my shortwave receiver is pretty close, but not really exact. When I set it to WWV, it stays reasonably accurate in that area but gets worse the further from WWV I get. Is there some way to keep my dial calibrated?

A. We get many similar requests about this subject. Probably the best approach here is to build a decent crystal-controlled frequency calibrator such as that shown in the August 1969 issue. The major advantage of this particular calibrator over most others is the tone-modulation that enables locating the generator carrier in a mess of other signals.

Q. I have a speaker out on the patio that I use for background music. Is there any way that I can use this as a microphone so I can hear a baby's cry when the crib is out there?

A. The following basic circuit will allow you to use the speaker as a microphone. The higher the impedance of the speaker, the greater the output from the circuit. You could try using an output transformer to take advantage of the voltage step-up ratio.

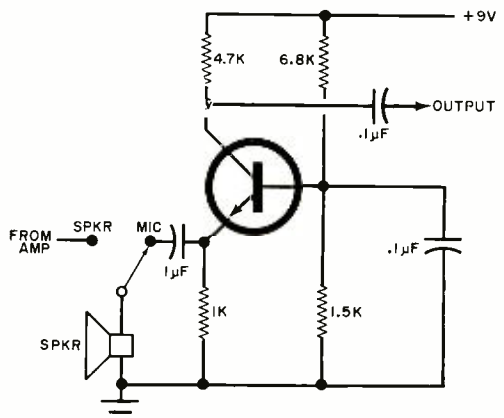

Don't let the handy size fool you.

The Serviset E/C is a complete, self contained versatile field test instrument. A precision-built, reliable, much-used instrument to compliment your VOM, scope or other equipment, too.

The Serviset E/C is great for servicing all sorts of electronics in the field and on the bench. Whether you're a professional engineer working on communications or EDP devices. An electronics or appliance technician working in radio, television, h^f-fi audio or appliance repair. Or an amateur electronics enthusiast, ham radio operator or student.

Checks you'll make with the Serviset E/C include: sync, sweep, video, audio circuits; high or low DC, RF, or pulse voltage supplies; coils, capacitors, resistors, tubes, transistors, diodes, transformers, speakers--whatever you're trouble-shooting from stage to stage, or discrete components. What's more, your Serviset E/C is safe: whatever you check, you won't blow it.

The Serviset E/C. The \$35. Electronic Test Lab (almost) that will follow you anywhere. One of an advanced line of guaranteed electronic test devices from Lee that will save you time and effort. Including our CT-1 Condenser Tester and Leakage Indicator.

*send check or money order. C.O.D., send \$2. deposit.

Serviset E/C, \$34.95 postpaid *from Lee Electronic Labs.
Available also at electronic dealers and all Olson Stores, nationwide.

The \$35. Electronic Test Lab (almost) that will follow you anywhere: Serviset E/C



Lee Electronic Labs, Inc.

BOX 78, WATERTOWN, MASS. 02172 (617) 891-8686



New Products

HEATHKIT 4-CHANNEL INTEGRATED AMPLIFIER

The Heath Company's Model AA-2010 integrated amplifier develops 50 watts from each of its four channels into 8-ohm loads. The amplifier has built-in decoder circuitry that accommodates all currently available matrix-encoded records and enhances recorded stereo and

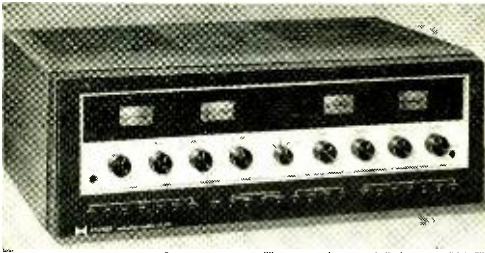

stereo FM programs. Individual amplifier sections are controlled in pairs, providing the user with two complete and independent stereo systems if desired. Pushbutton switches activate speaker pairs in any combination of up to eight speaker systems (or two complete 4-channel systems). Twenty input level controls—enough for up to five 4-channel program sources—can be adjusted from beneath the chassis.

Circle No. 70 on Reader Service Card

AMPEX PREMIUM-QUALITY CASSETTE TAPES

A new premium-quality consumer cassette tape that uses a special magnetic coating developed for professional mastering tape has been placed on the market by Ampex Corp. The new 20/20 + cassette is said to be the highest quality compatible-bias cassette tape on the market. It does not require special electronics or bias adjustment equipment, but it does provide excellent results when used with the new noise-reduction equipment. The high-quality coating used for the cassette produces an extremely smooth playing surface that permits closer head-to-tape contact and fewer dropouts than previously encountered with conventional cassettes.

Circle No. 71 on Reader Service Card

CHANNEL MASTER ANTENNA AMPLIFIERS

The five major causes of poor performance of antenna signal amplifiers have been overcome

in a new line of amplifiers designed by Channel Master Labs. The new "Spartan" amplifiers solve these problems by combining advanced low-noise components with new approaches to circuit design. High-voltage protection is provided by a component layout that prevents static charges from arcing through the circuit and twin-diode energy-absorption circuits that prohibit the flow of static energy into the amplifier. Although the units are high-gain amplifiers featuring flat gain up to 20 dB, they are fully protected against overload (up to 200,000 microvolts in some models). Most of the 11 models that make up the series contain both switchable and tunable traps that eliminate FM interference. Special feedback circuitry permits operation from -22° to $+140^{\circ}$ F.

Circle No. 72 on Reader Service Card

IMPROVED POW'RIVETER TOOL FROM VACO

The introduction of an improved model of the No. 495 Pow'Riveter tool was recently announced by Vaco Products Co. The tool features reversible head operation that permits it to be used with both $\frac{1}{8}$ -in. and $\frac{3}{32}$ -in. blind rivets. An exclusive offset handle arrangement allows the tool to rivet on flat surfaces without running the risk of skinned knuckles. The tool applies rivets to plastics, metals, fiberboard, and other hard material in seconds with exposure to only one side of the work.

Circle No. 73 on Reader Service Card

NEW SSB BASE STATION FROM COURIER

A new SSB base station featuring a digital clock alarm has been added to Courier's line of CB gear. Called the "Centurion," the new base station employs a crystal lattice filter to

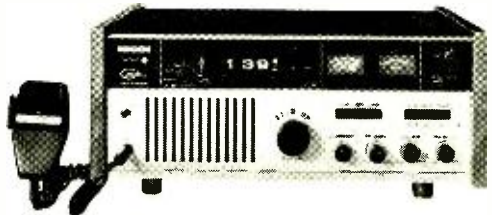

obtain superior adjacent channel rejection and better than 80 dB selectivity at 20 kHz. A mechanical filter is used in the AM mode. Two separate i-f strips, one each for AM and SSB, provide peak performance in each operating mode. Included is a ± 600 -Hz clarifier control that permits adjustment for best voice quality.

Circle No. 74 on Reader Service Card

DUOTONE CARTRIDGE STORAGE CABINET

Looking for an attractive way of storing your 8-track cartridges and cassettes? Then Duotone Co. has just what you're looking for in their book-case storage units. These cabinets have elegant wood-grained side and top panels. Their plush red interiors are designed to protect the

NOT JUST ANOTHER PRETTY FACE.



At 6 lbs., 12 oz., there isn't an ounce of fat on the Cobra 132. It's one of the smallest SSB units ever made.

But with 15-watt P.E.P. input, 100% modulation and Dynaboost voice compression, this AM/SSB two-way radio has what it takes to send a booming signal over land or sea.

You have 23 AM and 46 SSB sending/receiving modes. Two separate

transmitters give you the best of each, with overload protection.

As for reception, this Cobra has the crispest, cleanest sound ever. Over 60 dB cross modulation interference rejection completely eliminates bleedover.

Cobra's drift-free Voice Lock lets you locate and lock-in sideband signals over a wide range. Three filters—one crystal, two

ceramic—keep adjacent channels under wraps.

And when you kick on Cobra's AM/SSB noise blander, noise levels drop unbelievably.

In addition, the Cobra 132 has an adjustable AM/SSB RF gain control. Backlit RF output/S meter. And full-function controls.

Ask your CB dealer for the solid-state Cobra 132. Its beauty is more than skin-deep.

COBRA 132
AM/SSB
\$299⁹⁵

microphone included

Product of Dynascan Corporation, 1801 West Belle Plaine Avenue, Chicago, Illinois 60613

CIRCLE NO. 48 ON READER SERVICE CARD

stored cartridges or cassettes. And the front panels have the look of expensive rare book bindings; they are gold stamped on soft leather-like material. The units are available in brown, black, maroon, and green. The Model BS-C is for cassettes, while the Model BS-T is for 8-track cartridges.

Circle No. 75 on Reader Service Card

AKAI SEMI-PROFESSIONAL TAPE RECORDER

The GX-400D made by Akai is a semi-professional tape recorder that accepts 10½-in. reels and features an exclusive automatic noise reduction system (ADRS) and glass and ferrite heads for both record/play and erase. The three-speed dual-capstan machine is driven by an



ac servo motor, while tape feed and take-up are controlled by another pair of motors. The machine can be used to record and play back in both directions. Built into the GX-400D are a pause control, playback volume control, line/microphone mixer, and sound-on-sound feature, plus automatic shutoff/stop, normal and low-noise equalization selector switch, and headphone jacks.

Circle No. 76 on Reader Service Card

CHRONO-LOG DAY/DATE DIGITAL CLOCK

The new Chrono-Log Series 70,000 digital clock features a 4 x 7 dot-matrix-LED display, a variety of time ranges (including month/day or day-of-the-year calendar), line frequency or crystal time base, and buffered positive or negative BCD logic outputs in parallel and/or serial character format. The circuitry includes a hold capability that stops the clock's readout without introducing a time error, power failure indication and output, and a display freeze circuit that retains the visual display for reading or photographing without affecting the time-keeping circuitry. Controls include time set switches, a stop/run switch, a reset switch, a set/inhibit switch, and a leap-year switch with calendar units. Remote control capability is available as an option.

Circle No. 77 on Reader Service Card

S&A COLOR COMBO TV ANTENNAS

The new line of 82-channel uhf/vhf/FM Target Color Combo antennas from S&A Electronics combines the features of the log-periodic and magnetically driven arrays with an exclusive corner-reflector magnetic wave uhf section for top performance. The unique feature of this system is its ability to discriminate between the desired signal and unwanted noise. The magnetically driven array is said to offer many features not available in other antenna systems. The corner reflector design creates a high front-to-back ratio, very narrow reception patterns, and flat response across the entire band.

Circle No. 78 on Reader Service Card

RCA "END-USE" MULTIMETER DESIGN

RCA's answer to changing service requirements is their new Model WV-529A Service Special VOM. It is designed to meet both the electrical measurement needs of modern servicing and take the rigorous abuse to which a portable instrument is subjected in the field. Representing an "end-use" design approach, the WV-529A 20,000 ohms/volt instrument includes voltage, current, and resistance measurement ranges most suited to modern electronic needs. Included are a 5000-V dc range for servicing TV receivers, a panel-mounted overload fuse, and fullscale ac and dc ranges based on 0.5 and 1.5 factors. Ruggedness is enhanced by the use of a taut-band meter movement.

Circle No. 79 on Reader Service Card

CROWN LABORATORY POWER AMPLIFIER

Recent trends in speaker design demand a new type of output capability in direct-coupled solid-state amplifiers. Highly reactive speaker systems with wide-ranging frequency-dependent imped-



ance curves have created problems for current amplifier design. The Crown Model DC-300A amplifier is said to solve these problems with a unique output protection circuit and built-in features that improve performance and simplify operation. The amplifier will drive any impedance load, including one that is totally reactive, with no adverse effects. Rated at 150 watts/channel into 8 ohm loads, the DC-300A can be set up, with the aid of two plug-in parts, to

SAVE MORE BY MAIL FROM DIXIE!

ON NATIONALLY ADVERTISED STEREO HI-FI COMPONENTS

SAVE ON NATIONALLY ADVERTISED BRANDS!
Write Today for Our FREE 28-page Wholesale Audio Catalog

CHECK THE FACTS: 1. Dixie's Reputation—Over 12 years of great savings & reliable service; 2. Only top brands—Choose the Stereo components & accessories you want; 4. Everything shipped brand new and factory sealed; 5. Quotes answered by return mail; 6. No Membership Fee Required—Write today for FREE Wholesale Catalog.

DIXIE HI-FI WHOLESALE
 Dept. P E-4
 10128/30 Bacon Drive
 Beltsville, Md. 20705
 Phone: 1-301-937-3090

Exclusive!
 Master Charge/
 BankAmericard
 Honored on
 Mail Orders.

BANKAMERICARD

master charge
 THE MTR BANK CARD

CIRCLE NO. 12 ON READER SERVICE CARD

deliver 600 continuous watts into a monophonic 8-ohm load.

Circle No. 80 on Reader Service Card

ECONOPAC REGULATED POWER SUPPLIES

Just introduced by Power Pac Inc. are two new series of "Econopac" power supplies that feature 0.1-percent line and load regulation and 5-mV peak-to-peak ripple. The EP-1 and EP-2 series come in five single-output models of 5, 6, 12, 15, and 24 volts dc (5.0 percent adjustable) at currents to 1 ampere. Featured in the supplies are short-circuit protection with automatic recovery, integrated circuit preamplifiers, and compact design. Each of the five EP-2 models has twice the current output of its corresponding EP-1 model. Both series offer an overvoltage option.

Circle No. 81 on Reader Service Card

BUCKEYE FRONT-LOAD INSTRUMENT CASES

Attractive front-loading cases designed for use with existing test instruments and custom-brewed instrument projects are available from Buckeye Stamping Co. The new cases are specially designed to allow standard panel-size instruments and circuit boards to be slipped easily into place through the front of the case. The sides and trim are composed of decorative anodized aluminum shapes with top and bottom panels of quality aluminum sheets coated with

non-glare paint. While all cases measure 19" wide by 20" deep, heights ranging from 5 3/4" to 12 1/4" are available. The cases are available in a wide variety of colors. An optional feature is a chrome-finished, self-locking tilt stand that can be folded out of the way when not needed.

Circle No. 82 on Reader Service Card

BENJAMIN DOLBY TAPE ADAPTERS

A pair of self-contained adapters designed to add complete Dolby "Type B" record and playback noise suppression facilities to virtually any existing tape system have been announced by

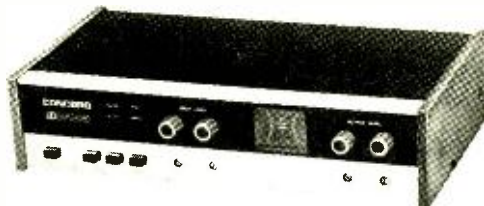

Concord Div. of Benjamin Electronic Sound Co. Offered as the Models DBA-9 and DBA-10 Dolby Tape Adapters, the new Concord Units not only "Dolbyize" cassette and reel-to-reel decks, they also can decode Dolbyized FM broadcasts. The DBA-9 provides 8 dB noise and hiss reduction at 2000 Hz and 10 dB re-

FREE McIntosh CATALOG and FM DIRECTORY

McIntosh Laboratory, Inc.
 East Side Station P.O. Box 96
 Binghamton, N.Y. 13904
 Dept. 16-5

SEND TODAY!

NAME _____

ADDRESS _____

CITY _____ STATE _____ ZIP _____

Get all the news and latest information on the new McIntosh Solid State equipment in the McIntosh catalog. In addition you will receive an FM station directory that covers all of North America.



MX 113

AM FM/FM STEREO TUNER PREAMPLIFIER

CIRCLE NO. 26 ON READER SERVICE CARD

AT LAST! PROFESSIONAL HOME PROTECTION EVERYONE CAN INSTALL AND AFFORD.

Model FC-100
\$69.95
WIRED



- Start your custom Burglar/Hold-up/Fire Alarm System with the FC-100. Add on Sensors, Alarms and Accessories to suit your own needs.
- "Do-it-Yourself" Installers Handbook included. No technical knowledge needed — No soldering.
- 100% Professional in Design, Reliability, Performance.



'Fail Safe'-SYSTEM BY EICO
A New Concept in "Do-it-Yourself" Home Protection

FREE 32 PAGE EICO CATALOG

For latest catalog on EICO Test Instruments, Stereo, EICOCRAFT Projects, Environmental Lighting, Burglar/Fire Alarm Systems, and name of nearest EICO Distributor, check Reader Service Card or send 25c for First Class mail service.

EICO, 283 Malta Street, Brooklyn, N.Y. 11207



CIRCLE NO. 14 ON READER SERVICE CARD

Printed Circuit



FOR THE HOBBYIST & PROFESSIONAL

FREE!
Printed Circuit Handbook
when you take this ad to
your electronic supplier.



GC ELECTRONICS

DIVISION OF HYDROMETALS, INC.
ROCKFORD, ILLINOIS 61101 U.S.A.



CIRCLE NO. 19 ON READER SERVICE CARD

duction from 5000 Hz to 15,000 Hz. The DBA-10 is similar but extends the frequency response to 20,000 Hz.

Circle No. 83 on Reader Service Card

REALISTIC UHF/VHF/AM PORTABLE RADIO

The Realistic Patrolman-3 portable receiver available from Radio Shack tunes the AM band, the 450-470-MHz uhf band, and the 144-174-MHz vhf band for police, fire, public service,



2-meter ham, and business radio services. Separate tuning controls are provided for AM and vhf/uhf. Each band has a window-type rotary dial for accurate frequency selection. An adjustable squelch allows the user to reduce background noise while monitoring on vhf and uhf. Four penlight cells or an optional ac adapter power the receiver.

Circle No. 84 on Reader Service Card

ELECTRONIC ENTERPRISES ELECTRET MIKE

A miniature microphone designed for high-quality reproduction of speech and music is available from Electronic Enterprises as their Model 5333 electret condenser microphone. Measuring only 0.28"-square by 0.16" deep, the new microphone features a smooth frequency response from 50 to 16,000 Hz, very low susceptibility to mechanical shock and vibration, and a built-in self-contained high-voltage electret element and hybrid integrated circuit. The 5333 is recommended for use in audiometers, hearing aids, and sound reinforcement systems but should prove very useful to the hobbyist and experimenter who likes working with microminiature circuits.

Circle No. 85 on Reader Service Card

TI ELECTRONIC "SLIDE RULE" CALCULATOR

Texas Instruments recently announced availability of their Model SR-10 pocket-size electronic "slide rule" calculator to retail at only \$150. The SR-10 performs calculations most frequently done with classical basic slide rules, but with far greater speed and accuracy. In addition to providing the four arithmetic functions, the calculator features reciprocal, square, and square-

root functions. Also, whenever the result of a calculation exceeds the 8-digit display capability of the calculator, the display automatically converts to scientific notation, providing a nearly 200-decade range. Data can be fed into the SR-10 in standard, scientific, or a combination of the two notations.

Circle No. 86 on Reader Service Card

SILTRONIX AM/SSB CB TRANSCEIVER

A new CB transceiver that operates on 23 AM channels plus 46 crystal-controlled SSB channels has been announced by Siltronix, a division of Cubic Corp. Called the SSB-23, the new transceiver can increase performance distance by as much as two-thirds over AM type rigs. Increased clarity of both transmission and reception is built into the SSB-23. Fine tuning and minimum interference are also featured. The transceiver requires 1.2 amperes of power to transmit and 250 milliamps to receive while operating on 13.8 volts dc. Weighing only 5½ pounds, the SSB-23 measures 11" deep by 8" wide by 2½" high, not counting mobile mounting bracket.

Circle No. 87 on Reader Service Card

STANLEY SCREW HOLDING TOOL

The Stanley "Screwstart" is a new tool that firmly holds a screw against its tip and can be

used to locate and start the screw into a threaded hole to a point where a standard screwdriver can take over final tightening. The Screwstart does its work with a unique three-section tip. Two outer sections are stationary. A spring-loaded center section can rotate. When the tip is cocked for use, the three sections are aligned to slip into the screw slot; when the screw is pressed to the tip, the spring-loaded mechanism uncocks, turning the center section of the tip against the sides of the screw slot. As the screw is turned into the threaded hole, increasing pressure on the Screwstart tip again cocks the tool and lets it disengage from the screwhead. The tool is available in both slotted and Phillips-head configurations.

Circle No. 88 on Reader Service Card

EIA TEST TAPE STANDARD

A standard for reproducer test tape (No. RS-400), available from the Electronic Industries Association (2001 Eye St., NW, Washington, DC 20006) for \$4.00, sets the field standard for calibrating the gain, head azimuth, and frequency response of consumer tape recorders and reproducers. Designed for use at 7½ and 3¾ ips, the test tape described in the standard employs a full-track format on ½-in. tape width.

avanti's Astroplane gives CBer's Performance to brag about.

The unique construction features are exceptional.

4.46 db gain over isotropic is, and provides, a stronger transmit and a stronger receive.

To make use of the better signal, the Astroplane radiates the signal from higher up than other CB antennas and at a better angle. According to Dr. Alva Todd of the Midwest College of Engineering, "it possesses an unusually low angle of maximum radiation." This low angle of radiation means that your power is radiated at the horizon and not up into the clouds.

You'll also get long lasting, trouble-free performance because it is compact in design —without long drooping radials, without coils to burn or



short out, and with direct ground construction for positive lightning protection and static dissipation.

\$29.95 Sugg. Retail

Gain 4.46 over isotropic

Power Capacity 2KW

Lightning protection D.C. Ground

V.S.W.R. 1.2:1

Length 12 Ft.

Diameter 30 In.

Free 16 page color catalog

Write: Avanti, R & D, Inc.

35 W. Fullerton

Addison, Illinois 60101

avanti

RESEARCH AND DEVELOPMENT, INC.

CIRCLE NO. 3 ON READER SERVICE CARD

creators of the famous





HI-FI PROJECTS FOR THE HOBBYIST

by Leonard Feldman

For those wanting to improve or upgrade their hi-fi systems by adding worthwhile accessories, this is the book. In clear, easy-to-understand terms the author provides step-by-step instructions for building such useful items as a phono preamp, presence control, a multiple-speaker switch, 4-channel adapter, rumble filter, high-gain antenna, small speaker enclosure, visual FM indicator, aural balancing control, and transistorized mike preamp. All projects have been tested and can be duplicated with a minimum of tools and inexpensive components.

Published by Howard W. Sams & Co., Inc., 4300 W. 62nd St., Indianapolis, Ind. 46268. Soft cover. 139 pages. \$3.95.

HOW TO BUILD SOLID-STATE AUDIO CIRCUITS

by Mannie Horowitz

Written by the Chief Engineer of Eico, this is a practical handbook for those interested in designing and building their own audio equipment. Included are concise instructions for making preamps, multi-stage amplifiers, and power output circuits involving both FET and bipolar audio circuits as well as bipolar power amps. The inclusion of many practical circuits and the elimination of involved mathematical calculations makes this book suitable even for a beginner.

Published by Tab Books, Blue Ridge Summit, Pa. 17214. Hard cover. 320 pages. \$8.95

WORLD RADIO AND TV HANDBOOK

J.M. Frost, Ed.

This is the 27th Edition (1973) of this comprehensive directory of international radio and television. The format is the same as in previous volumes and provides detailed information on all types of broadcasting stations, times on the air, languages and frequencies in use, power, station addresses, etc. Invaluable reference work for the ham and SWL.

Available in U.S. from Gilfer Associates, Inc., P.O. Box 239, Park Ridge, N.J. 07656. Soft cover. 400 pages. \$6.95.

If what you don't know about converting stereo to 4-channel sound would fill a book... write for the book.

Quadraphonic. Quadrosonic. Matrix. Discrete. SQ. QS. EV-4. CD-4. Logic. Demodulator. Decoder. Ambience Recovery. Derived. Synthesized.

Confused? We can't blame you.

We can help you.

4-channel is great to listen to, but murder to talk about.

There's a new vocabulary to learn. And new kinds of components.

New ways to use old components. New places to put speakers. Complex wiring. And more.

BSR-Metrotec makes equipment to convert your stereo

system to 4-channel, at minimum cost, and without replacing any of your present components.

We think you'll like 4-channel.

And if you'll spend a few minutes with our free booklet, you'll understand it, and be better able to decide if it's for you.



BSR (USA) Ltd.,
Blauvelt, N.Y. 10913



Name _____
Address _____
City _____
State _____ Zip _____

CIRCLE NO. 4 ON READER SERVICE CARD

THE TRUE SOUND OF MUSIC

by Hans Fantel

Subtitled "A Practical Guide to Sound Equipment for the Home," this volume is written for the music lover who is not an electronics expert. In non-technical language the author covers mono, stereo, 4-channel; speakers; amplifiers; controls; record players; tuners; tape recorders of all types; hooking up the system; headphones and outdoor speakers; and preserving your records. There is also a glossary of hi-fi terms for reference. The author explains clearly what the various technical specifications mean in terms of personal listening pleasure, making it easier to select the right system for your needs.

Published by E.P. Dutton & Co., Inc., 201 Park Ave. So., New York, N.Y. 10003. Hard cover. 232 pages. \$7.95.

ABC'S OF LASERS & MASERS, Third Edition

by Lytel & Buckmaster

This completely revised and updated book introduces the reader to two devices that play vital roles in science—the laser which produces light radiation, and the maser which produces microwaves. Quantum theory is used to explain the emission of coherent light, without resort to high-level math. Next comes a discussion of a number of emitting materials, followed by descriptions of modulators, detectors, laser frequencies, power supplies, etc. Laser applications discussed include measurements and communications in space, medical surgery and welding of tissue, microwelding and microetching, and radar. Noise-free amplifiers and ultrastable signal sources are but two maser uses discussed.

Published by Howard W. Sams & Co., Inc., 4300 West 62 St., Indianapolis, IN 46268. Soft cover. 128 pages. \$3.50.

TROUBLESHOOTING SOLID-STATE ELECTRONIC POWER SUPPLIES

by Ben W. Gaddis

This practical handbook thoroughly describes both the operation of and the troubleshooting techniques for all types of power supplies. The emphasis is on troubleshooting and repair techniques. Beginning with the very basic types of supplies, the text discusses the progressively more complex systems that employ semiconductor regulators, all without resorting to mathematics. For those interested in communications, radar, and industrial supplies, a complete chapter is devoted to three-phase power supplies and their significance. Throughout the discussions, where appropriate, vacuum-tube equivalent circuits are provided.

Published by Tab Books, Blue Ridge Summit, PA 17214. 208 pages. \$7.95 hard cover; \$4.95 soft cover.

APRIL 1973

Are you missing half the joy of your guitar?

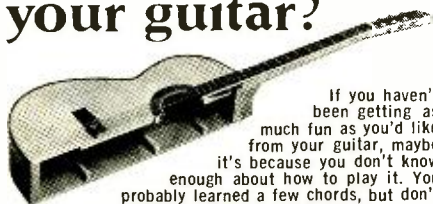

If you haven't been getting as much fun as you'd like from your guitar, maybe it's because you don't know enough about how to play it. You probably learned a few chords, but don't know how to go further. If so, let us help you. We'll teach you to read music and play pick style with both notes and chords—the way a teacher would. The difference is we teach with lessons we send you by mail. You learn at home in spare time and it costs a lot less. Courses in other instruments too—piano, spinet organ (two keyboards), accordion, saxophone, violin. If 17 or over, mail coupon for free booklet. U.S. School of Music. A Home Study School Since 1898.

397 U.S. SCHOOL OF MUSIC

U.S. School of Music, Studio A3734
Port Washington, N.Y. 11050

Please send me your free booklet.
I understand there is no obligation.

MR. _____
MRS. _____ PLEASE PRINT AGE 17 OR OVER

ADDRESS _____

CITY _____ STATE _____ ZIP _____

LIST INSTRUMENT YOU WANT TO LEARN _____
ACCREDITED MEMBER NATIONAL HOME STUDY COUNCIL

The great new
Super Scanner
It scans 360° in milliseconds with 5.75 dB gain. Or beams an 8.75 dB gain signal where and when you want it—instantaneously. (Otherwise, it's just another beautiful base antenna.)

MODEL MS-119 Super Scanner electronic beam, incl. control console—sugg. price, \$99.95

© "Stripes of Quality"

the antenna specialists co.
Division of THE ALLEN GROUP INC,
12435 Euclid Ave., Cleveland, Ohio 44106
Export: 2200 Shames Dr., Westbury, L.I., New York 11590
Canada: A. C. Simmonds & Sons, Ltd.
CIRCLE NO. 1 ON READER SERVICE CARD

109

**THE ONE WORD
FOR PERFORMANCE AND
RELIABILITY IN
ELECTRONIC
IGNITION
JUDSON**

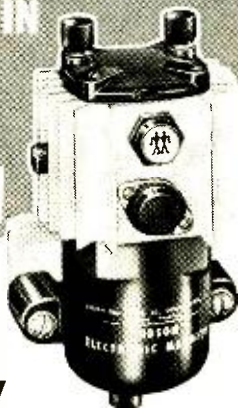

**YOU CAN HAVE
TOMORROW'S
IGNITION ON
YOUR CAR TODAY**

Don't accept "as good as" there are none.

Write Today for Literature

JUDSON
RESEARCH AND MFG. CO
CONSHOHOCKEN PA. 19428



CIRCLE NO. 23 ON READER SERVICE CARD



greatest advance in soldering since electricity!

**WAHL® Cordless
SOLDERING IRON**

Wahl "Iso-Tip" gives soldering heat in 5 seconds. Lets you solder up to 100 joints* unhindered by cord and plug anywhere! Recharger/converter plugs into 12V cigarette lighter. Safe to use on sensitive components. See your dealer or order direct.

7565 Kit with 12V Auto Charger . . . \$18.95
7500 Kit with 120V AC Charger . . . \$19.95

(*Depending upon wire size, temperature and atmospheric conditions.)

WAHL® CLIPPER CORPORATION Dept. 2
2902 Locust St. • Sterling, Ill. 61081 (815) 625-6525
CIRCLE NO. 46 ON READER SERVICE CARD



New Literature

VERO PC AIDS SPEC SHEETS & CATALOG

For those experimenters and hobbyists who like to make their own printed circuit boards, Vero Electronics Inc. has put together a comprehensive package of five specifications sheets, a price listing, and a catalog of PC items offered by them. Some of the items listed and described include PC card pull handles, miniature press-fit board terminals, blank and clad (parallel conductor pattern) perforated boards, tools, and sockets. Address: Vero, 171 Bridge Rd., Hauppauge, NY 11787.

BSR/METROTEC 4-CHANNEL BOOKLET

An informative booklet that contains 20 questions and answers pertaining to 4-channel sound is available from BSR-Metrotec. It covers basic definitions and deals with the somewhat confusing but pertinent subjects of converting stereo systems to 4-channel, matrix versus discrete sound, rear channel speaker and power requirements, quadraphonic tape formats, matrix compatibility, and enhancement of stereo sound sources. Address: Metrotec Division of BSR (USA) Ltd., Route 303, Blauvelt, NY 10913.

ELECTRONIC TOOL CATALOG

Tools for electronics are featured in an illustrated catalog available from Electronic Tool Co. Among the listings are pliers and nippers, tweezers, scissors and shears, pin vises and holders, screwdrivers and nut drivers, etc. All tools listed and described are manufactured to industrial standards by such names as Lindstrom of Sweden, Swiss Dumont, Bausch & Lomb, and other high-quality tool companies. Accompanying catalog No. 171 is a unit-quantity price list for every tool described in the catalog. Address: Electronic Tool Co., 3324 White Plains Rd., Bronx, NY 10467.

SAMS EDUCATIONAL MATERIALS CATALOG

The 1973 Sams Educational Materials Catalog contains 48 pages on which are listed such items as textbooks, student workbooks, instructor guides, lab manuals, supplementary and reference materials, audio-visual aids, and training devices for use in industrial education programs.

Over 300 titles, ranging from automotive electronics to upholstery, are supported by descriptions, illustrations, and prices. Address: Howard W. Sams & Co., Inc., 4300 West 62 St., Indianapolis, IN 46268 (Advertising Coordinator).

R.L. DRAKE RECEIVER BROCHURES

The R.L. Drake Co. is currently offering to interested hams and SWL's two brochures that describe a pair of their latest receivers. One is devoted to the Model SW-4a international short-wave broadcast receiver that tunes from 150 kHz to 260 MHz in 11 bands. The other brochure describes the company's Model DSR-1 receiver with direct digital readout of the 10-kHz to 30-MHz frequency coverage range. Address: R.L. Drake Co., 540 Richard St., Milanisburg, OH 45342.

EL INSTRUMENTS WINTER '72-'73 CATALOG

This catalog put out by EL Instruments is an expanded edition that contains dozens of digital circuit design and bread-boarding aids for the experimenter and the design engineer. Such instruments as a digital circuit designer with built-in power supply and clock generator, professional-quality plug-in socket boards, power supplies, and a pulse generator are fully described. Address: EL Instruments Inc., 61 First St., Derby, CT 06418.

RCA SOLID-STATE PRODUCT GUIDE

A revised Solid-State Product Guide (No. SPG-201J) that describes the commercially available RCA products is available from the RCA Solid State Division. The 36-page guide contains listings and abbreviated data for MOSFET's, power and r-f power transistors, thyristors, rectifiers, dual Darlington's, linear and digital IC's, and linear and digital power transistor and IC chips. Address: RCA Solid State Division, Box 3200, Somerville, NJ 08876.

MOUNTAIN WEST ALARM EQUIPMENT CATALOG

A new intruder/burglar alarm equipment cat-

alog, No. M-73, is available from Mountain West Alarm Supply Co. This 80-page catalog describes more than 400 intrusion and fire alarm products from relatively simple kits through the latest ultrasonic, radar, and infrared intrusion detectors. Major product categories include: intrusion systems, fire systems, fire and intrusion detectors, remote controls, annunciators, telephone dialers, and lock specialties. Also featured in the catalog are eight pages of application notes for alarm equipment. Address: Mountain West Alarm Supply Co., 4215 N. 16 Street, Phoenix, AZ 85016.

ONEIDA ADHESIVES BULLETIN

A new six-page bulletin (IND-3) that describes the company's new line of improved Super Instant-Weld adhesives is available from Oneida. The bulletin gives detailed information on four different types of powerful quick-setting, permanent-bond adhesives that will find wide application in electronics where metal-to-metal, plastic-to-metal, and plastic-to-plastic bonds are required. The bulletin has a two-page chart that lists such specifications as setting time, viscosity, refractive index, flash point, etc., as well as application data as to the best type of adhesive to use for a given job. Address: Oneida Electronic Mfg., Inc., P.O. Box 558, Meadville, PA 16355.

1973 HEATH/SCHLUMBERGER CATALOG

Detailed descriptions and specifications for the complete line of Heath/Schlumberger design and scientific instrumentation are given in the new No. 811/02 catalog. Among the items listed are a new series of vhf counters, oscilloscopes, signal generators, power supplies, and digital voltmeters. The instrumentation items include a mini-computer interfacing system; digital systems for design and research; and individual modules for functions in both digital and analog domains. Finally, the listing includes the famous MalinStadt-Enke Laboratory Stations. Address: Heath/Schlumberger Scientific Instruments, Benton Harbor, MI 49022.

SEE... COMPARE SELECT!!

SBE

Console



SSB/AM BASE STATION
SSB, 15W, p.e.p. input, AM, SW input.
23 channels, no crystals to buy.
115VAC (will operate also from ext. 12V battery).

Catalina



AM MOBILE
23 channels, no crystals to buy.
Supplied w/dynamic mic/coil cord.

Cascade II



5 WATT PORTABLE
6 channels, 5 watts (reducible to 3W).
Battery operated.
All metal case.
Sturdy!

Sidebander II



SSB/AM MOBILE
SSB, 15W, p.e.p. input.
AM, SW input, 23 channels,
no crystals to buy. Supplied
w/dynamic mic

WRITE FOR BROCHURE

SBE 220 Airport Blvd., Watsonville, CA 95076

CIRCLE NO. 34 ON READER SERVICE CARD

Battery Types and Their Characteristics

WHAT'S THAT BATTERY NUMBER THE SAME AS?

BY SAMUEL C. MILBOURNE

A CERTAIN amount of confusion exists with regard to battery types and numbers. Consequently, it is handy to have a chart that gives the specifications of the various batteries commonly used in such consumer equipment as transistor radios, toys, clocks, etc. Our table is limited to listings for 1.5- and 9-volt batteries. Since there are more than 400 battery types and thousands of manufacturers' numbers from which to choose, we make no pretense that the table is complete. However, the listings should cover most needs.

You will note that the batteries are divided into carbon-zinc, alkaline-manganese, and rechargeable alkaline-manganese types.

They are listed in the order of their current delivery capabilities from least to greatest. Too, each common battery type is supplied with such statistics as: size, American National Standards Institute (ANSI) and National Electronic Distributors Association (NEDA) numbers, etc.

In general, batteries of the same physical size and shape with the same voltage output and terminations can be substituted for each other so long as the maximum currents drawn by the circuits can be accommodated by the substitutes. So, you can put an alkaline type in place of a zinc-carbon battery, and a rechargeable alkaline in place of a regular alkaline battery.

Size/Volts	Current (mAh)	DIA X H or L X W X D*	ANSI Desig.	NEDA No.	Manufacturer Numbers				RCA
					Burgess	Eveready	Mallory	Ray-O-Vac	
Carbon-Zinc									
N/1.5	20	0.445 X 1.18	N	910F	NE	904	M904F	716	VS073
AAA/1.5	20	1 ¹ / ₃₂ X 1.75	AAA	24F	7	912	M24F	400	VS074
AA/1.5	25	5/16 X 1 ³ / ₃₂	AA	15F	910	915	M15F	7AA	VS034A
C/1.5	80	1 ¹ / ₃₂ X 1 ¹ / ₁₆	C	14F	1	935	M14F	1C	VS035A
C/1.5	80	1 ¹ / ₃₂ X 1 ¹ / ₁₆	C	14	130	1035	M14R	14	VS335
D/1.5	150	1 ¹ / ₃₂ X 2 ¹ / ₃₂	D	13F	2	950	M13F	2D	VS036
D/1.5	150	1 ¹ / ₃₂ X 2 ¹ / ₃₂	D	13C	210	1150	—	3D	—
109/9	7	3/4 X 2	F17	1611	L6	206	M1611	—	VS327
127/9	9	1 X 1 ¹ / ₁₆	F24	1600	P6	226	M1600	1600	VS300A
—/9	10	3 ³ / ₄ sq X 1 ² / ₃₂	—	1606	Y6	—	—	—	VS309A
117/9	15	1 ¹ / ₃₂ X 2 ¹ / ₃₂ X 1 ² / ₃₂	F22	1604	2U6	216	M1604	1604	VS323
Alkaline-Manganese									
AAA/1.5	100	0.4 X 1.735	L30	24A	AL7	E92	Mn2400	824	VS1074
AA/1.5	150	5/16 X 1 ³ / ₃₂	L40	15A	AL9	E91	Mn1500	815	VS1334
C/1.5	480	1 ¹ / ₃₂ X 1 ¹ / ₁₆	L70	14A	AL1	E93	Mn1400	814	VS1335
D/1.5	650	1 ¹ / ₃₂ X 2 ¹ / ₃₂	L90	13A	AL2	E95	Mn1300	813	VS1336
Rechargeable Alkaline-Manganese									
—/1.5	300	5/16 X 1 ³ / ₃₂	AA	—	—	—	SA15AA	—	—
—/1.5	1000	1 ¹ / ₃₂ X 1 ¹ / ₁₆	C	—	—	—	SA14C	—	—
—/1.5	2000	1 ¹ / ₃₂ X 2 ¹ / ₃₂	D	—	—	—	SA13D	—	—

*DIA X H = diameter X height; L X W X H = length X width X height. All dimensions in inches. Blank entry means no number or designation assigned or manufacturer does not make battery.

It is interesting to note that the current delivery of the more recent alkaline batteries is several times greater than the older carbon-zinc batteries. True, the initial cost of the newer batteries is much greater, but they do not need to be replaced nearly as often as carbon-zinc cells, and if the alkalines are rechargeable types (with higher prices than the regular type alkalines), they can be renewed several dozen times before replacement is needed.

Upon perusing our table, you will note that many categories of batteries are not listed. These include nickel-cadmium, mercuric-oxide, silver-oxide, and lead-acid types. These have not been included in the listing because of their much higher costs and the future likelihood of losing out, at least to some degree, to the rechargeable alkaline types.

We will not go into the subject of recharging batteries here since this topic has been amply covered in other articles. But you should bear in mind the following facts that apply to all types of batteries: First, do not allow batteries to run completely down; test them often under adequate loads. Second, do not attempt to recharge a "leaky" or "rusted" battery; the electrolyte is corrosive and will ruin charger contacts. And, third, do not recharge batteries at abnormally high currents; the batteries will heat up and may explode.

Testing a battery requires a resistive load that reflects the allowable battery discharge current and an accurate dc voltmeter. To illustrate, a Burgess No. 2 or Eveready No. 950 battery can accommodate a 150-mA load across its 1.5-volt poles. By using Ohm's Law ($R = E/I$) you can determine that the proper test load for these batteries would be 10 ohms ($1.5/0.15 = 10$). The resistor selected for the test can be rated at $\frac{1}{2}$ watt. To make the test, place the load resistor across the battery's terminals or poles and connect the meter's leads, in proper polarity, across the resistor. The meter will then indicate between 1.5 and 0.9 volts if the battery's charge has not been irretrievably depleted. If you obtain a meter indication of less than 0.9 volt, discard the battery and replace it with a new unit.

Batteries should be recharged or replaced long before they are completely exhausted. It is not harmful to recharge a 1.5-volt cell before its charge drops to 0.9 volt. In fact, it is beneficial in that it provides longer total life from the battery. ♦

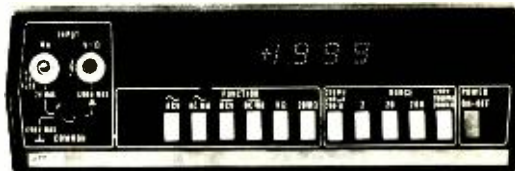

*New low cost digital multimeter \$299

- 26 ranges to measure ac/dc voltages from 100 microvolts to 1200 V, ac/dc currents from 100 nanoamperes to 2 amperes and resistance from 100 milliohms to 20 megohms.
- Guaranteed to stay within specifications for one full year. Fluke gives you the best specs and strongest warranty on the market today for the lowest cost of ownership ever.
- Wide choice of options including rechargeable battery pack, digital printer output, deluxe test leads, high-voltage probe, RF probe, 200-amp ac current probe, carrying case, dust cover and rack mounts.
- Unique self-zero feature eliminates offset errors.
- Rugged high-impact case with securely mounted internal electronics.
- Service centers throughout U. S., Canada, Europe and Far East for 48-hour turnaround repairs.



P. O. Box 7428,
Seattle, Washington 98133.

Get all the details from your nearest Fluke sales office. Dial toll-free 800-426-0361 for address of office nearest you.
CIRCLE NO. 18 ON READER SERVICE CARD

ABOUT YOUR SUBSCRIPTION

Your subscription to POPULAR ELECTRONICS is maintained on one of the world's most modern, efficient computer systems, and if you're like 99% of our subscribers, you'll never have any reason to complain about your subscription service.

We have found that when complaints do arise, the majority of them occur because people have written their names or addresses differently at different times. For example, if your subscription were listed under "William Jones, Cedar Lane, Middletown, Arizona," and you were to renew it as "Bill Jones, Cedar Lane, Middletown, Arizona," our computer would think that two separate subscriptions were involved, and it would start sending you two copies of POPULAR ELECTRONICS each month. Other examples of combinations of names that would confuse the computer would include: John Henry Smith and Henry Smith; and Mrs. Joseph Jones and Mary Jones. Minor differences in addresses can also lead to difficulties. For example, to the computer, 100 Second St. is not the same as 100 2nd St.

So, please, when you write us about your subscription, be sure to enclose the mailing label from the cover of the magazine—or else copy your name and address exactly as they appear on the mailing label. This will greatly reduce any chance of error, and we will be able to service your request much more quickly.

It's fun to build quality. Heathkit Electronics

For full spectrum color, black & white

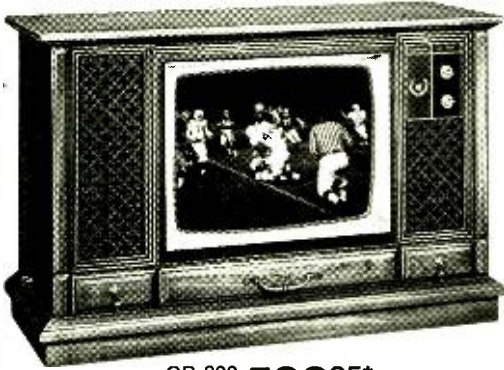

GR-900 **599⁹⁵***
(LESS CABINET)

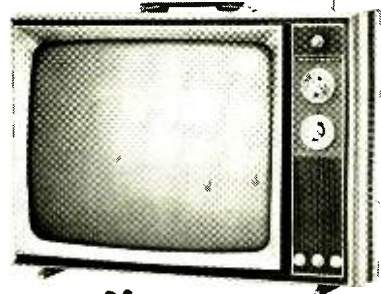

New
GR-1900 **179⁹⁵***
(INCLUDES CABINET)

...and staying out of the red.



New
IC-2108
79⁹⁵*



New
IC-2009
92⁵⁰*

(INCLUDES CHARGER)

See them all at your Heathkit Electronic Center ... or send for Free '73 Heathkit Catalog.

HEATHKIT ELECTRONIC CENTERS

ARIZ.: Phoenix, 2727 W. Indian School Rd.; CALIF.: Anaheim, 330 E. Ball Rd.; El Cerrito, 6000 Potrero Ave.; Los Angeles, 2309 S. Flower St.; Pomona, 1555 Orange Grove Ave. N.; Redwood City, 2001 Middlefield Rd.; San Diego (La Mesa), 3361 Center Dr.; Woodland Hills, 2354 Ventura Blvd.; COLORADO: Denver, 5940 W. 38th Ave.; CONN.: Hartford (Avon), 395 W. Main St. (Rte. 44); FLA.: Miami (Miami), 4705 W. 16th Ave.; GA.: Atlanta, 5285 Roswell Rd.; ILL.: Chicago, 3462-66 W. Devon Ave.; Downers Grove, 224 Ogden Ave.; INDIANAPOLIS, 2112 E. 62nd Ave.; KANSAS: Kansas City (Mission), 59 J. Lamar Ave.; MD.: Baltimore, 1713 E. Joppe Rd.; Rockville, 542 Nicholson Lane; MASS.: Boston (Westley), 155 Worcester St.; MICH.: Detroit, 18645 W. Eight Mile Rd. & 18149 E. Eight Mile Rd.; MINN.: Minneapolis (Hopkins), 101 Shady Oak Rd.; MO.: St. Louis, 9296 Gravois Ave.; N.J.: Fair Lawn, 35-07 Broadway (Rte. 4); N.Y.: Buffalo (Amherst), 3476 Sheridan Dr.; New York City, 35 W. 45th St.; Jericho, L.I., 15 Jericho Turnpike; Rochester, Long Ridge Plaza; OHIO: Cincinnati (Woodlawn), 10133 Springfield Pike; Cleveland, 5644 Pearl Rd.; PA.: Philadelphia, 6318 Roosevelt Blvd.; Pittsburgh, 3482 Wm. Penn Hwy.; TEXAS: Dallas, 2715 Ross Ave.; Houston, 3705 Westheimer; WASH.: Seattle, 221 Third Ave.; WIS.: Milwaukee, 5215 Fond du Lac.

Heathkit GR-900 25V Color TV with total-tuning convenience.

It's the most advanced TV circuitry you can build. Yet everything goes together with traditional Heathkit simplicity. And the built-in convergence board and test meter for at-home maintenance and self-service add further savings over the life of the set. With the GR-900 you pre-set any 12 UHF stations for positive pushbutton power tuning, and you can scan both UHF and VHF channels in either direction. An ultra-rectangular black matrix tube, voltage controlled varactor UHF tuner, MOSFET VHF tuner and an exclusive angular tint control for consistently better flesh tones combine to produce an absolutely brilliant color picture. There are four preassembled and finished cabinets to choose from, plus the Heathkit Wall Mount and wireless remote control option. Any way you look at it, the Heathkit GR-900 is one of the most rewarding kits you can build. Mailing weight, 125 lbs.

New Heathkit Solid-State B&W 19V Portable TV — a truly extraordinary set

The new Heathkit GR-1900 is like no other B&W portable! With advanced solid-state "modular" design — most circuitry mounts on just four plug-in boards. Dependable solid-state circuitry, including 23 transistors, 13 diodes, 2 ICs, and just 2 tubes; picture & high voltage. Total detent tuning on all 70 UHF channels as well as VHF. "Instant-On" for sound and pictures at a touch — plus other "big-set" front panel control features such as VHF/UHF fine tuning; brightness; contrast; master on/off; vertical hold; AGC; and height. New Ultrarectangular picture tube for a full 184 sq. in. viewing area. Automatic Vertical Linearity for rock-steady pictures — a feature usually found only on expensive color sets. Dual-Controlled AGC for improved picture/noise ratio — another "big-set" bonus feature. Extra-wide Video Bandwidth for theater-quality black-and-white pictures. Four circuits (most sets have only 3) in the grounded base VHF tuner for superior cross modulation in dense station areas. With all this, the GR-1900 is a kit even the novice can build. Both tuners come preassembled and aligned, transistors & ICs plug into sockets, and all chassis wiring is color coded. For truly extraordinary performance in B&W TV, you've got it all in the GR-1900. Mailing weight, 56 lbs.

New Heathkit Desk-top Calculator — an outstanding kit-form value.

The Heathkit IC-2108 features a sleek, low-profile case with bright 1/2" readout tubes in an 8-digit display — one of the largest, most legible in the industry. The color-coded keyboard is human engineered to slope down to the desk so you can rest your arm while using. And the IC-2108 is loaded with features: Four arithmetic functions. Floating and fixed decimal. Constant key. Chain calculation capability. Clear display key. Entry and result overflow indicators. Negative number indicator. 120/240 VAC operation. In addition, the IC-2108 is amazingly simple to build. Two spare evenings will do it. Kit IC-2108, 4 lbs.

New Heathkit "Pocketable" Calculator — you can service it yourself

The Heathkit IC-2009 is first a self-contained portable, weighing in at 11 oz. and small enough to fit in your coat pocket, but it's a desk-top calculator too. The internal Nickel-Cadmium battery gives five to eight hours use between charges. Or, the IC-2009 can be left connected to its charger for indefinite operation. And unlike other pocket calculators, the Heathkit IC-2009 is designed to be maintained by you. Plug-in keyboard and display boards, plus a complete troubleshooting section in the manual, make it easy — and economical. Add up the features for yourself: 8-digit capacity. Four arithmetic functions. Full floating decimal. Constant key. Chain calculation capability. Clear entry key. Entry and total overflow indicators. Negative answer indicator. Battery-saver circuitry. Low battery indicator. Tactile-feedback keyboard for positive entry indication. Order your IC-2009 now. You'll have it built in two or three evenings. Mailing weight, 3 lbs.



**Heathkit
4-Channel Amplifier
with Universal Decoder... 359.95***
(488 cabinet)

You select discrete 4-channel, or switch-in the "Universal" decoder for reproduction of all the matrixed 4-channel discs now on the market, plus "derived" 4-channel from conventional stereo. Four solid-state amplifiers produce 200 watts (4x50 IHF) into 8 ohms, with power bandwidth on all channels from less than 5 Hz to greater than 45 kHz at 0.25% distortion. Kit AA5010, 37 lbs. AAA-2004-1, pecan cabinet, 7 lbs. 24.95*



**Heathkit
Universal Decoder for 4-channel
conversion... 89.95***

Reproduces all matrixed discs, plus "derived" 4-channel from conventional stereo materials. Plug it into your receiver's tape monitor circuit, add a second stereo amp and speakers and you're set. Kit AJ-2022, 4 lbs.



**New
Heathkit
Ultrasonic Intrusion
Alarm looks like a book... 49.95***

Disguised as an ordinary library book, this novel device fits unobtrusively anywhere in the home. Transmitter disperses a 41 kHz signal which bounces off walls and returns to the receiver where it's monitored for any change in amplitude. Triggers lights and any conventional alarm device — just plug them into AC outlets on the rear panel. Can be installed anywhere there's a 120 VAC outlet. An enjoyable 2-evening kit. Kit GD-39, 4 lbs.

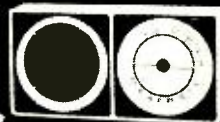

**New
Heathkit
GR-1008 AM Radio can be built in
one evening... 14.95***

A smartly styled, great sounding solid-state radio that makes a great introduction to Heathkit building. Eight-transistor circuitry mounts on one printed board. 8 1/2" 3 1/2" speaker mounts in high impact plastic case. If you've never built a kit before you can probably have this one together in one fun evening. Uses 9-volt battery (not supplied). Order the Heathkit GR-1008 for yourself or the kids. Kit GR-1008, 2 lbs.

HEATH
Schlumberger



**SEND FOR YOUR
FREE
1973 HEATHKIT
CATALOG**
— it describes
more than
350 Heathkit projects

HEATH COMPANY, Dept. 10-4
Benton Harbor, Michigan 49022

Please send FREE Heathkit Catalog.
Enclosed is \$ _____ plus shipping

Please send model(s)

Name _____

Address _____

City _____ State _____ Zip _____

*Mail order prices; F.O.B. factory CL-464R

CIRCLE NO. 21 ON READER SERVICE CARD

Electronic Circuit Analogy Quiz







BY ROBERT P. BALIN

Electronic circuits perform functions that are similar in many respects to those of common mechanical devices. For example, a rectifier circuit produces unidirectional current while a ratchet and pawl produce unidirectional motion. If you can see an analogy between them, you probably have

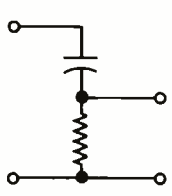
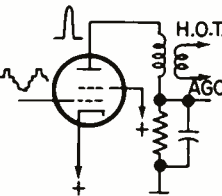
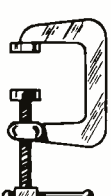
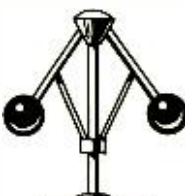
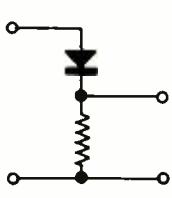
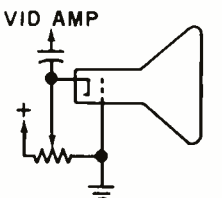
a good understanding of their operating principles.

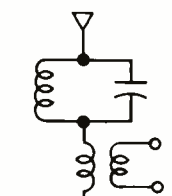
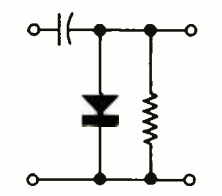
To test your ability to identify analogies, try to match the electronic circuits (1 to 8) on the left below to the related mechanical devices (A to H) which are depicted on the right below.

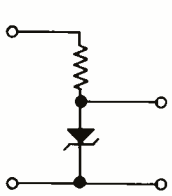
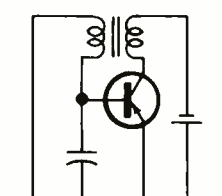
(Answers below. No peeking.)

<p>1</p> 	<p>2</p> 	<p>A</p> 	<p>B</p> 
<p>3</p> 	<p>4</p> 	<p>C</p> 	<p>D</p> 
<p>5</p> 	<p>6</p> 	<p>E</p> 	<p>F</p> 
<p>7</p> 	<p>8</p> 	<p>G</p> 	<p>H</p> 

1. High-pass filter
 2. Agc keyer circuit
 3. Clipper circuit
 4. Brightness control
 5. Wave trap
 6. Regulator circuit
 7. Clamping circuit
 8. Oscillator circuit
 A. C-clamp
 B. Centrifugal governor
 C. Hedge clippers
 D. Drain trap
 E. Lock and key
 F. Metronome
 G. Venetian blinds
 H. Flour sieve

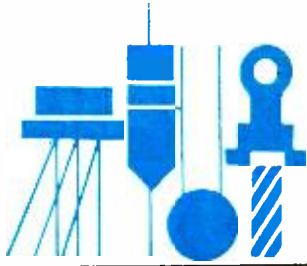

Solid-State Scene

By Walter G. Jung

Devices for Communications

IN OUR fast-paced world of continuing technological innovations, new solid-state devices are announced almost daily. Surprisingly, these new devices (particularly IC's) are not always as high in price as we might expect for new items that are not yet produced in volume. So the devices are here (more on the way) and the question is how to use them.

Not only the numbers of them, but the level of sophistication in IC's has reached a staggering intensity. We now speak of 30-transistor op amps without a second thought—and that's just one example. IC's have now become small electronic systems

capable of performing entire circuit functions—the same operations which might have taken racks of equipment just a few years ago.

At POPULAR ELECTRONICS Including ELECTRONICS WORLD, we feel it is our mandate to fulfill the "how" of applying these exciting new devices. This includes good applications with goals of you the readers in mind. Today's solid-state experimenter has a wealth of devices available to him. It is our aim to help him make a good selection and supply over-all perspective in an area which promises even faster growth in years to come. It'll be fun and we hope you'll be a big part of it.

Devices for Communications. Good examples of "systems" IC's are a couple of devices for use in communications. The first, Lithic System's new LP2000 "Microtransmitter," is just what it says—a single-

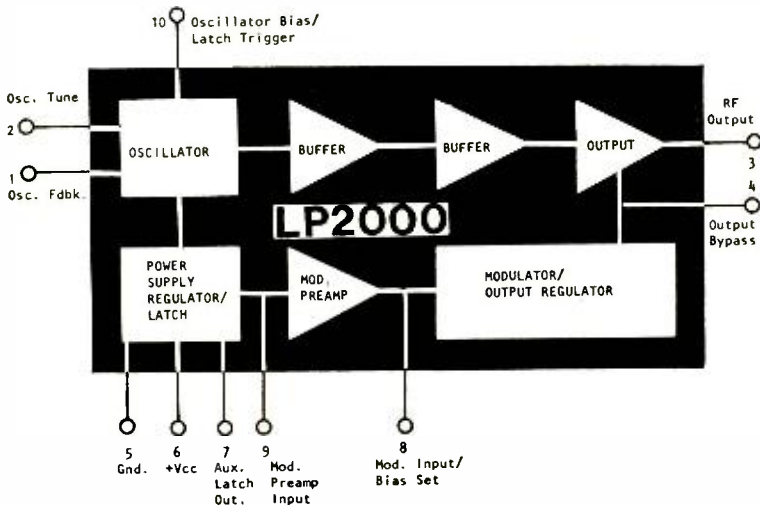

Fig. 1. Functional block diagram of the Lithic LP2000 Microtransmitter.

chip 50-mW transmitter! The LP2000 includes an oscillator, a buffer, a uniquely modulated output stage, and a low-level preamp (Fig. 1). It also has a "zero standby current" latching feature which allows power to be applied without current drain until triggering occurs. Intended for hand-held battery operated communicators, the LP2000 has an internal regulator allowing operation from +3 to +15 volts. Output from a small dynamic speaker (as a mike) is sufficient to modulate the LP2000 transmitter directly.

An LP2000 application note illustrates two possible circuits—a 27-MHz AM transmitter and a 72-MHz pulse modulated transmitter. With the addition of only a mike and an antenna, you have a complete AM transmitter system. This fulfills the transmission function for a low-power walky-talky. Or, using pulse modulation, an LP2000 can provide the transmission end of a remote-controlled model system. The LP2000 Microtransmitter from Lithic Systems is priced at about \$16.00 for small quantities from their distributor:

Circuits Specialists
P.O. Box 3047
Scottsdale, AZ 85237

Communications IC Standard. In each subset of IC technology, there is often a standard device on which a number of related devices are based. In communications IC's the standard building block is a special triplet of differential amplifiers—the balanced modulator/demodulator. First in-

troduced by Motorola as the MC1596 (-55 to 125°C) and MC1496 (0 to 70°C), this IC is now available from many sources—the mark of a standard.

To aid in obtaining the 1496, here is a list of sources and their respective part numbers:

	TO-100 10-pin can	TO-116 14-pin DIP
Fairchild	U5E7796393	U6A7796393
313 Fairchild Dr. Mountain View ($\mu\text{A}796\text{C}$) ($\mu\text{A}796\text{C}$)		
CA 94040		
Lithic Systems, Inc.	LS1496	LS1496
P.O. Box 869 Cupertino CA95014		
Motorola	MC1496G	MC1496L
Tech. Info. Center P.O. Box 20924 Phoenix AZ 85036		
National	LM1496H	LM1496N
2900 Semiconductor Dr. Santa Clara CA 95051		
Signetics	N5596K	N5596A
811 E. Arques Ave. Sunnyvale, CA 94086		
Silicon General	SG1496T	SG1496D
7382 Bolsa Ave. Westminster CA 92683		

The schematic of a 1596/1496 is shown

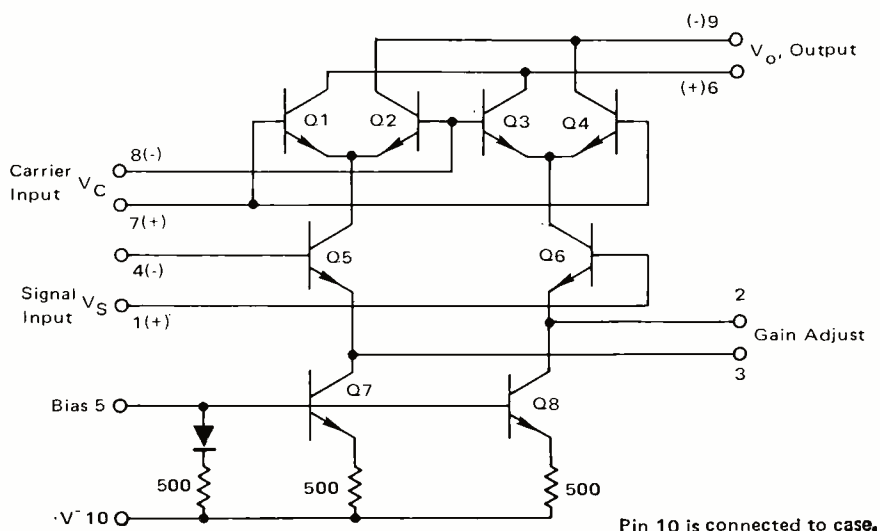

Fig. 2. Schematic of the Motorola MC1596/1496 modulator/demodulator.

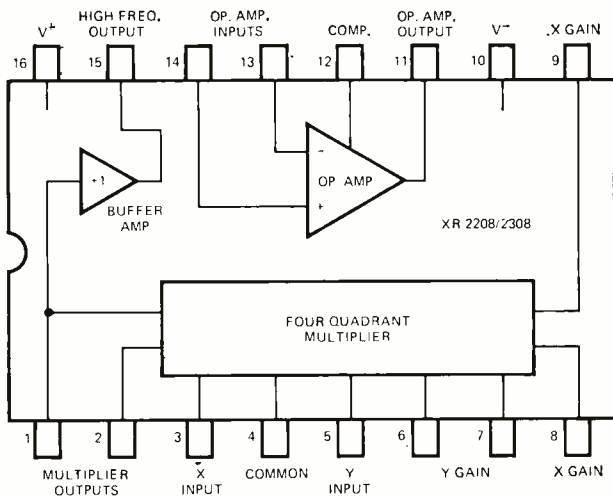

Fig. 3. Functional block diagram of Exar's XR2208/XR2308.

in Fig. 2. Carrier and input signals are applied between pins 7 and 8 and pins 1 and 4 respectively, with output taken from pins 6 and 9. Gain adjustment is by a resistor between 2 and 3, with bias set at pin 5.

This basic circuit element can be used as a mixer, a modulator for either AM or DSSC, a gain control, a two-channel switch or multiplexer, or an AM, DSB, FM and/or PM demodulator. If you look closely at the schematics of popular FM/TV demodulators, PLL's etc., you will see the 1596/1496 often. We recommend Motorola's data sheet and application notes for information.

A new IC is Exar's XR-2208/2308 operational multiplier, which, put simply, multiplies two input signals (in both magnitude and sign). Thus either signal may be used to control the gain and phase of the output signal.

The XR2208/2308 is a very versatile device in that, in addition to the basic multiplier, it also contains an op amp and high-frequency buffer as shown in Fig. 3. The chip has an 8-MHz bandwidth, a 0.3% nonlinearity spec and operation from power supplies of ± 4.5 to ± 16 volts. The applications booklet gives a variety of circuits, including AM modulation and detection, a triangle-to-sine converter, a phase detector, and several PLL circuits. The XR2208 (-55 to 125°C) and XR2308 (0 to 75°C) come in a 16-pin DIP and prices start at \$6.00 each in quantities of 1 to 24 for the XR2308.

While on the subject of versatile communications circuits, we should mention Exar's XR-210 FSK Modulator/Demodulator (MODEM). This one also emphasizes the

systems concept as may be noted from its functional diagram shown in Fig. 4. While basically a PLL, interconnection of the SR-210 in various ways allows different functions to be performed. The oscillator operates from 0.5 Hz to 20 MHz, can be keyed, swept, and digitally programmed and has independently variable mark/space adjustments. Applications include both FSK generation and demodulation, tracking filters, tone decoding, FM detection, and voltage-frequency conversion. The XR-210 is supplied in a 16-pin DIP and price for 1 to 24 is \$10 each. For more information: Exar Integrated Systems, Inc. 750 Palomar Ave. Sunnyvale, CA 94086.

This month we have taken a look at communication devices in both a broad and specialized sense. This area is active and there's more just over the horizon. Make our scene next month for what is happening in solid-state, and how to use it! ♦

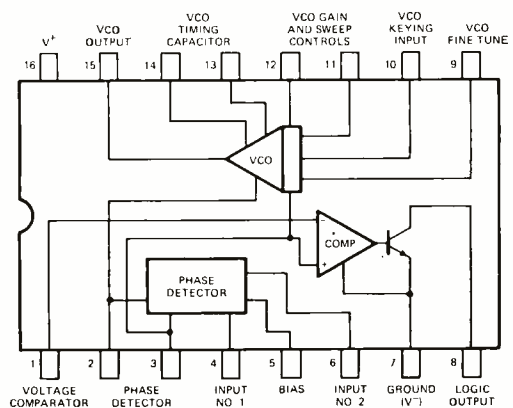

Fig. 4. XR-210 functional diagram.



Surplus Scene

By Alexander W. Burawa, Associate Editor

HOW THE MARKET IS SHAPING UP BEHIND THE SCENES

DURING the past five years or so, electronics experimenters have been reaping a rich harvest through the courtesy of surplus dealers selling at low prices. Now, if rumor is correct, that harvest is likely to become a lot less rich. The rumblings behind the scenes have gradually become articulate and their message is a warning of a tighter future market for items that today appear to be flowing inexhaustibly from a bottomless source.

The first rumblings began to be heard last year when at least two dealers became victims of user/supplier backlash. One company, among the largest of the digital IC suppliers, had their supply of TTL digital IC's cut off; a new supply and supplier had to be found. Fortunately, other suppliers came to the rescue. Not so fortunate was another eastern supplier who was selling one-source calculator chips and had his supply completely dry up.

There is a possibility that the very popular 7400 series of digital IC's may soon become scarce. Logically, this could be expected in light of the fact that the technology is changing and better types of IC's are in the volume-production stage. If the new types of IC's—including ECL (emitter-coupled logic) and CMOS (complementary metal-oxide silicon) devices, to name just two—become available as TTL replacements, we like the idea. Rumor, however, doesn't include replacement lines for the TTL devices we now have. So, all we can really do is sit back and await developments.

Computer Boards. Not in the rumor mill, but something you should take into consideration, is the possibility of a reduction in

the numbers and types of computer boards and assemblies that will show up in surplus dealer bins. If you can remember a couple of years back, you will recall that quite a number of computer engineers were given their walking papers and a number of computer manufacturers went under as the bottom fell out of the industry. The industry is now on the upswing, but it might be a while before it fully recovers from the ravages of its recession. So, don't expect too much from that end.

Where Is Military Gear? Another thing we've noticed over the years is the gradual reduction in the numbers and varieties of military gear getting to the surplus dealers. Why this is so, we haven't been able to pin down. Perhaps the DOD is keeping their gear longer than they used to and what gear they do red-tag is in such bad condition that all it is good for is the scrap heap. This, however, is a bit hard to credit when we consider that we have just ended one of the longest wars in our history. So many advances have taken place in military electronics during the war's duration that a lot of equipment must have been superseded by better gear. So, where is all of the outdated equipment that traditionally gets from DOD salvage yards to surplus dealers? One can only hazard a guess.

The cutbacks imposed by manufacturers will likely take place so gradually that by the time you take notice of the scarcity, they will have been under way for at least a couple of years. By that time, there is little doubt that some of today's "new" items will be abundant on the Surplus Scene, probably in much greater diversity than now. ♦

GREGORY ELECTRONICS
Reconditioned & Used
FM 2-WAY RADIO SAVINGS
Partial List—Send for New Catalog

MOTOROLA
U51GGT
40-50 MHz

12 volts, 60 watts.
Transistorized power supply. Narrow band complete with accessories
Private line (if available) add \$35.

\$188

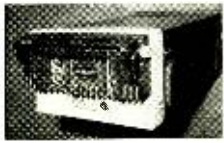

Just Arrived! G.E. "Message Mates"
High Band Receivers with Sel-Call

G.E. PROGRESS LINE STRIPS, physically complete. AS IS!	
Power supply, 30 watts, less vibrator	MA E13 MA E16 MA E33 MA E36 MA E42
Power supply, 60 watts, less vibrator	\$20 \$20 \$20 \$20 \$20
TX narrow band less final tubes	\$25 \$25
Note: MA E12 wide band	\$18 \$25 \$25 \$30 \$12
TX wide band less oven	\$18 \$18 \$18 \$18 \$12
1 1/2" Progress Line Case, consisting of front basket and front plate with lock	\$10
Low band dual front end & freq. strip	\$20

GREGORY ELECTRONICS CORP.
249-F Rt. 46, Saddle Brook, N.J. 07662
Phone: (201) 489-9000

CIRCLE NO. 20 ON READER SERVICE CARD

BURGLAR-FIRE alarm supplies and information. Free catalog. Protecto Alarm Sales, Box 357-G, Birch Run, Michigan 48415.

WHOLESALE C.B., multiband receivers. Lowest prices. Catalog 25¢. G-Enterprises, Box 14P, O'Fallon, Ill. 62269.

HEAR POLICE/FIRE DISPATCHERS! Official Directory shows "confidential" channels your area; receivers. \$3. Communications, Box 56-PE, Commack, NY 11725.

1973 HOBBY ELECTRONICS DIRECTORY. Hundreds of companies, products, and services. Parts, test equipment, surplus, plans, kits, and more. \$1.50, Newcal Enterprises, Box 323-A, El Segundo, Cal., 90245.

ALPHA/THETA feedback instruments—\$25. Sensitive circuit of \$75 unit. Ultimate ease of use. Inner Space Electronics, Box 308PE, Berkeley, CA 94701.

FIREWORKS NEWS—Monthly magazine covering Fireworks, Construction, Sources of Supplies, New Firms-Products. Free Fireworks Catalogs with Subscriptions! \$9.00 per calendar year. Sample-Book 1st \$1.00! Pyro Press, Box 1202N, Lexington, Kentucky 40501.

OSCILLOSCOPE improvement. Add trigger sweep and dual trace to any scope using low cost kits. HTP, Box 901, Cupertino, Calif. 95014.

FREE CATALOG

UP TO 50% OFF COMPARABLE KITS*

• BUY DIRECT • SAVE \$\$\$

FREE Catalog — Electronic Kits — Amplifiers — Preamps — Psychedelic Strokes — Burglar Alarms — Digital Tachometer — More: Free Catalog, SWTPC, Box A32040, San Antonio, Tex. 78284.

MECHANICAL, ELECTRONIC devices catalog 10¢. Greatest Values —Lowest Prices. Fertik's, 5249 "D", Philadelphia, Pa. 19120.

IGNITION SYSTEMS: Capacitor. Transistor. Information 10¢. Anderson Engineering, Epsom, N.H. 03239.

SCOPES, meters, test equipment, military and industrial surplus. Write for free "Bargain Bulletins". Lawrence Instruments, P.O. Box 744, Sunbury, Pa. 17801.

LASER Tube—\$9.50. Bargain Laser-Electronic Catalog—\$1.00 (Refundable). Plasma Systems, Box 3261, San Jose, CA 95116.

AUTHENTIC, INSTRUMENTED, FLYING ROCKETS for casual or serious experimenters. Over 80 scale, original, multi-stage or ready-to-fly models. Solid-propellant engines for safe, electric launch system liftoffs up to 2,500 feet. Measure altitude, temp. inversions, more. Real telemetry, electronic tracking, aerial still and movie photography with super-miniaturized equipment. New, detailed tech manual and full-color catalog, 25¢ from ESTES INDUSTRIES, Dept. 18H, Penrose, Colo. 81240.

FREE catalog. Surplus electronic parts. JK Products, P.O. Box 527-E, Norris, Tenn. 37828.

ELECTRONIC CDI Ignitions, VHF/UHF monitors, CB radios. Wholesale. Southland, Box 3591, Baytown, Texas 77520.

ALPHA/THETA brainwave biofeedback instruments. Unique digital filters for ultimate precision. BioScan, Box 14168E, Houston, Texas 77021.

STROBELIGHT-flashtube, coil, neon, instructions: \$4.95, bakelite cases 4x3x1 1/2: 3/\$2, 10/\$5. Flyer. Mindlight, POB 2846PE, Van Nuys, California 91404.

AMATEUR SCIENTISTS, Electronics Experimenters, Science Fair Students . . . Construction Plans—Complete, including drawings, schematics, parts list with prices and sources . . . Robot Man — Psychedelic shows — Lasers — Emotion/Lie Detector — Touch-Tone Dial—Quadrasonic Adapter—Transistorized Ignition —Burglar Alarm—Sound Meter . . . over 60 items. Send 25¢ coin (no stamps) for complete catalog. Technical Writers Group, Box 5594, State College Station, Raleigh, N.C. 27607.

DIGITAL ELECTRONICS! Complete schematics, parts lists, theories —Discrete Component Digital Clock, \$3.00—Sound Sensitive Switch, \$1.50. Increase technical competence, hobby skills—Complete Course in Digital Electronics is highly effective, \$10.00. Free literature. DYNASIGN, Box 60A7, Wayland, Mass. 01778.

CONSTRUCTION PLANS: Laser . . . \$2.00. Missile Tracker . . . \$2.00. Catalog 25¢. ESP Experimenters Kit . . . \$2.00. Howard, P.O. Box 35271, Detroit, Michigan 48235.

ELECTRONIC IGNITION: Boosts Voltage. Only \$19.95. Box 2002, Huntington Beach, Calif. 92647.

SURPLUS electronics for everyone. Free catalog. U.S. inquiries. ETCO, 464 McGill, Montreal, Canada.

FREE Catalog lists resistors, tubes, transistors, rectifiers, condensers, tools, tuners, etc. Hytron Hudson, Dept. PE, 2201 Bergenline Ave., Union City, N.J. 07087.

ELECTROENCEPHALOPHONE: brainwave monitor. Professional biofeedback instruments. J&J, 8102-E, Bainbridge, Wash. 98110.

SOUND SYNTHESIZER kits—Surf \$11.95, Wind \$11.95, Wind Chimes \$16.95, Electronic Songbird \$6.95, musical accessories, many more. Catalog free. PAIA Electronics, Box J14359, Oklahoma City, OK 73114.

DIGITAL and analog computer modules. LED numeric display kits. FREE LITERATURE. Scientific Measurements, 2945 Central, Wilmette, Illinois 60091.

SHARE my Electronic Profits, your area! Free details! Hutson 23S, 1425 E. Madison, El Cajon, CA 92021.

PARTS! CORNELL TUBES!

FREE Send For FREE

CORNELL'S New Color Catalog

48 Pgs. New Items IN LOTS OF 100

33¢ per tube

36¢ per tube

ORDER FREE IF NOT SHIPPED IN 24 HOURS!

4219 UNIVERSITY AVE. SAN DIEGO, CALIF. 92105

We will equal any quantity discount for any IC or display offered by any surplus dealer advertising in this magazine

LIGHT EMITTING DIODES

MV5026	\$5	65	
ME4 IR LED's	65	
MRD 14B Photo darlings	65	
740025	747660
740125	748065
740225	7481	1.25
740325	7483	1.25
740428	748660
740528	7490	1.00
740828	749279
741025	749379
741648	749579
742025	7494	1.10
743025	7412170
744025	74123	1.05
7441	1.30	74154	1.95
7442	1.30	74161	1.79
7446	1.50	74192	1.75
7447	1.50	74193	1.75
747240	9309	1.95
747375	9312	1.95
7474	1.00	8280	1.40

TANTALUM CAPACITORS

4.7 MFD AT 20V5/\$1.00
 10 MFD AT 20V4/\$1.00
 4.7 MFD AT 100V\$.50
 11 MFD AT 100V\$.75

VERIPAX PC BOARD

This board is a 1/16" single sided paper epoxy board 4 1/2" x 6 1/2" (standard veripax) DRILLED and etched, which will hold 21-14 pin IC's, or 8,16 or LSI DIP IC's with buses for power supply connections. It is also etched for a 22 pin connector.
 \$5.25 3/\$14.50

TRANSISTOR SPECIALS

2N3584 NPN Si	To-66	35W	250V	2A	10MHz	100Hfe	\$1.50
2N965 PNP GE	To-18	.15W	7V	.1A	.300	40	/\$1.00
2N1605 NPN GE	To-5	.15W	24V	.1A	14	125	5/\$1.00
2N5324 PNP GE	To-3	60W	250V	10A	20	35	\$1.50
2N1015DNPN Si	To-82	150W	200V	7.5A	.025	10	\$1.45
2N3724 NPN Si	To-5	.8W	30V	1A	250	60	3/\$1.00
2N3772 NPN Si	To-3	150W	60V	30A	.2	30	\$1.25
2N6109 NPN Si	To-220	36W	40V	4A	.8	60	50¢
2N5296 PNP Si	To-220	36W	40V	4A	.8	60	55¢
2N4898 PNP Si	To-66	25W	40V	4A	40	46	\$.60
MJ2251 NPN Si	To-66	10W	225V	.5A	10	40	\$.70
2N3055 NPN Si	To-3	115W	100V	15A	.2	44	\$1.00

NIXIE TUBE RAYTHEON 8754 WITH SOCKET AND DATA SHEET \$2.25 3/\$6.00

Printed circuit board 4 1/2" x 6 1/2" double sided fiber glass board 1/16" thick, unetched.
 \$.60 ea. 5/\$2.50

MAN-1 LED READOUT ..\$4.50
 MAN-3 LED READOUT ..\$2.95

PRECISION TRIM POTS

500 OHM, 10K, 20K, 25K, 50K\$.75
 or 3 for \$2.00

8223 Field Prog ROM\$8.00
 1101 256 Bit RAM\$4.00
 8225-64 Bit Read Write RAM\$4.95

TRIACS

PRV	1A	10A	15A	20A
100	.30	.60	.85	1.05
200	.65	.85	1.25	1.45
300	.75	1.10	1.45	1.65
400	.90	1.35	1.75	1.90
500	1.20	1.55	2.00	2.20

FULL WAVE BRIDGES

PRV	2A	6A
200	.95	1.25
400	1.15	1.50
600	1.35	1.75

Silicon Power Rectifiers

PRV	1A	3A	12A	50A
100	.06	.09	.30	.85
200	.07	.16	.35	1.25
400	.09	.20	.45	1.50
600	.11	.30	.70	1.30
800	.15	.40	.85	2.30
1000	.20	.55	1.10	2.75

Silicon Control Rectifiers

PRV	6A	10A	20A	70A
100	.30	.45	1.00	3.50
200	.50	.75	1.25	6.50
300	.60	.90	1.50	
400	.70	1.10	1.75	9.50
500	.80	1.25	2.00	
600	.90	1.40	2.25	11.00

T1543 UJT's\$0
 2N3819 N Channel FET's\$0
 D13T PROG. UJT's\$0

SCHOTTKY IC'S

7450099	7455199
7450199	74573	1.75
7450499	74574	1.75
7450599	745107	1.95
7451099	745108	1.95
7451199	745112	1.95
7452099	745113	1.95
7452299	745114	1.95
7454099	745140	1.99
7455199	745153	1.95
			745154	1.95

DECADE COUNTER KIT

Consisting of:
 1-Nixie tube & socket (8754)
 1-7490
 1-7475
 1-7441
\$5.50

PA234 1 Watt Audio Amps

LM 309K SV	\$1.25
1 Amp Regulator	\$2.25
709C OPER. AMP	\$3.25
741 OPER. AMP	\$3.25
748 Adjust 741	\$4.25
Dual 70995
723 Regulator	\$7.75
TVR 002 high power 723	\$1.00
703RF IF Amp	\$1.80
CA3065 FM TV Amp	\$1.35
565 Phase Lock Loop	\$3.25
566 Function Gen.	\$3.25
567 Tone Decoder	\$3.25
560 Phase Lock Loop	\$3.25
561 Phase Lock Loop	\$3.25
555 2US to 1 Hour Timer	\$1.15
5558 Dual 741 (Mini Dip)88
531 High Slew Oper Amp	\$2.50
536 FET Input Oper Amp	\$3.95
537 Precision 741	\$2.50
540 70W Power Driver	\$2.04
747 Dual 741	\$3.95
LM305 Oper Amp	\$2.95
5556 Oper Amp	\$.75
101 Oper Amp	\$.75
741CV Oper Amp	\$.55

Terms: FOB Cambridge, Mass. Send check or Money Order. Include postage. Average Wt. per package 1/2 lb. No C.O.D.'s. Minimum Order \$3.00. Rated companies 30 days net

Send \$.20 for our Spring catalog featuring Transistors and Rectifiers

SOLID STATE SALES

Post Office Box 74A Somerville, Mass. 02143 Tel. (617) 547-4005

CIRCLE NO. 38 ON READER SERVICE CARD

ELECTRONIC components. construction plans, wholesale catalog 25¢. HSC, Box 163, Hazel Park, Mich. 48030.

ELECTRONIC ORGAN KITS, KEYBOARDS, Independent and divider tone generators. All diode keying, I.C. circuitry. Many components. With our kits you can build any type or size organ desired. 25¢ for catalog. **DEVTRONIX ORGAN PRODUCTS**, Dept. C, 5872 Amapola Dr., San Jose, Calif. 95129.

EXPERIMENTER and audiophile-test cables, chemicals, useful items-Free catalog. Technical Services, Box 687, Arlington, MN 55307.

DIAGRAM—Build Fly Back Checker, Condenser Checker, Spark Knocker. All three diagrams only \$3.00. E.P. Electronics Co., Box 489, Colver, Pa. 15927.

AMAZING device converts cassette recorder into telephone message sender. It answers phone, gives caller your recorded message, hangs up. Nothing like it. Solid-state. \$49.95. Satisfaction guaranteed. Includes tape and free voltage adapter. Amplicom, Inc., 11125 Weddington, North Hollywood, California 91601.

FREE 1973 Bargain Catalog of Electronic Components. Chaney, Box 15431, Lakewood, Colorado 80215.

AMAZING! Seventeen different Supreme radio-television diagram manuals, \$40.50 value; only \$14.95. Supreme Publications, 1760 Balsam, Highland Park, Illinois 60035.

DIAGRAMS—Radios \$1.50, Television \$3.00. Give make and model. Diagram Service, Box 1151PE, Manchester, Conn. 06042.

JAPANESE ELECTRONICS DIRECTORY. 350 brands, addresses, tips, \$1.00. Yunyuhin Sankosho, 601 S. Dodson, Urbana, Illinois 61801.

CITIZENS BAND EQUIPMENT. Discount prices on name brand equipment. Write for price list. CRS Communications, 2271 Morris Ave., New York, N.Y. 10453.

ELECTRONIC Fever Thermometer, 30 second reading, kit, \$14.95; Assembled \$19.95; 10 second model \$29.95. ESP, 472 Westover, Stamford, Conn. 06902.

KITS, plans, components. Free Catalog. Krystal Kits, 2202 S.E. 14th, Bentonville, Ark. 72712.

WANTED

QUICKSILVER, Platinum, Silver, Gold, Ores Analyzed. Free Circular. Mercury Terminal, Norwood, Mass. 02062.

UY224S, UY227S, UX245S, UX280S needed. Richard Wolf, 7410 South 127th, Seattle, Washington 98178.

INSTRUCTION

LEARN ELECTRONIC ORGAN SERVICING at home all makes including transistor. Experimental kit—trouble-shooting. Accredited NHSC, Free Booklet. **NILES BRYANT SCHOOL**, 3631 Stockton, Dept. A, Sacramento, Calif. 95820.

LEARN WHILE ASLEEP, Hypnotize! Strange catalog free. Auto-suggestion, Box 24-ZD, Olympia, Washington 98501.

ASSOCIATE DEGREE IN ELECTRONICS through correspondence instruction. G.I. Bill approved. Free catalog. Grantham, 1509 N. Western, Hollywood, California 90027.

FCC First and Second Tests. \$8.95. Electronic Tutoring, Box 24190, Cleveland, Ohio 44124.

HIGHLY effective college-level home study programs in Electronics Engineering and Engineering Mathematics. (Our 27th Year). Free Literature. Cook's Institute, Dept. 15, Box 10634, Jackson, Miss. 39209.

F.C.C. TYPE Exams Guaranteed to prepare you for F.C.C., 3rd., (\$7.00), 2nd., (\$12.00), 1st., (\$16.00), phone exams: Complete package, \$25.00. Research Company, Dept. A, Rt. 2, Box 448, Calera, Alabama 35040.

LOGIC trainers catalogs 50¢. UTI, POB 252, Waldwick, N.J. 07463.

ON THE AIR announcer training at R.E.I. features individual realistic preparation for your Radio/TV career. R.E.I.'s engineering course features intensive training for the FCC First Phone! Complete either course in just five (5) weeks! Call 1-800-237-2251 toll free for brochure. Write: R.E.I., 1336 Main Street, Sarasota, Florida 33577.

SHORTCUTS To Success! Highly Effective, Profitable Short Courses. (75 Choices). Study At Home. Diploma Awarded. Our 27th Year. Free Literature. CIEE-D, Box 10634, Jackson, Miss. 39209.

AVIATION ELECTRONICS TECHNICIAN—Prepare for exciting career in new field of "Avionics." Train at nation's largest aeronautical school. Indicate if eligible for G.I. Benefits. Spartan Airschool, International Airport, Dept. MMW, Tulsa, Oklahoma 74151.

BEST F.C.C. Exam Books! "FCC License Handbook" only \$5.95. Free Catalog. TAB BOOKS, B.R.S., Pa. 17214.

LEARN ADVERTISING. Course like University Extension. AAI-PE, 655 Teresita, San Francisco, CA 94127.

FCC FIRST, SECOND CLASS homestudy answer manual. Enter Electronics. \$9.95. Satisfaction Guaranteed. Pacific, Box 4188C, Mountain View, California 94040.

FCC FIRST CLASS LICENSE through tape recorded lessons with one week personal instruction. Radio License Training, 10600 Duncan, Manhattan Beach, Calif. 90266.

COMPUTER ELECTRONICS! Complete course reveals basics of Logic Design, Digital Electronics, Highly Effective. Free Literature. DYNASIGN, Box 60C1, Wayland, Mass. 01778.

LEARN COMPUTOR ELECTRONICS. Free homestudy details. Compakits, Box 4192A, Mountain View, California 94040.

TAPE RECORDING COURSE: Taught by studio engineers. Free information. NNA, Box 721R, Rye, New York 10580.

PLANS AND KITS

ANTIGRAVITY DEVICE. Brochure rushed free. AGD, Box 3062-ZD, Bartlesville, Oklahoma 74003.

CDI PLANS—Proven design \$2.00. General Analog, 3014F S. Halladay, Santa Ana, Calif. 92705.

FREE KIT CATALOG

Why does every major College, University, Technical School, Research & Development Center buy from us? Because we have the highest quality and lowest prices. Free Catalog. SWTPC, Box H32040, San Antonio, Tex. 78284.

WALL-SIZED TV . . . Build a 72 INCH TV PROJECTOR for under \$15.00. Free Details: MACROCOMA, Dept. PE-4, Washington Crossing, Pennsylvania 18977.

EMPLOYMENT INFORMATION

EXCITING Overseas jobs. Directory \$1.00. Research Associates, Box 889-E, Belmont, California 94002.

EMPLOYMENT OPPORTUNITIES

ELECTRONICS/AVIONICS EMPLOYMENT OPPORTUNITIES. Report on jobs now open. Details FREE. Aviation Employment Information Service, Box 240E, Northport, New York 11768.

CLASSIFIED ADVERTISING ORDER FORM

Please refer to heading on first page of this section for complete data concerning terms, frequency discounts, closing dates, etc.

1	2	3	4	5
6	7	8	9	10
11	12	13	14	15
16	17	18	19	20
21	22	23	24	25
26	27	28	29	30
31	32	33	34	35

_____ Words { @ \$1.00 (Reader Rate) } = \$ _____
 { @ \$1.60 (Commercial Rate) }

Insert _____ time(s) Total Enclosed \$ _____

NAME _____

ADDRESS _____

CITY _____ STATE _____ ZIP _____

Signature _____

WORD COUNT: Include name and address. Name of city (Des Moines) or of state (New York) counts as one word each. Zip Code numbers not counted. (Publisher reserves right to omit Zip Code if space does not permit.) Count each abbreviation, initial, single figure or group of figures or letters as a word. Symbols such as 35mm, COD, PO, AC, etc., count as one word. Hyphenated words count as two words.

PE473

Catalog Number	Inv. (Monthly Per Item) (Qty)			Multiples of 10 Per Item (Qty)			Catalog Number	Inv. (Monthly Per Item) (Qty)			Multiples of 10 Per Item (Qty)		
	1-99	100-999	1000 up	100	1000	9900		1-99	100-999	1000	1000	9900	1000
7100	.26	.25	.23	.22			71176	1.62	1.53	1.45	1.36		
7101	.26	.25	.23	.22			71177	1.62	1.53	1.45	1.36		
7102	.26	.25	.23	.22			71180	1.20	1.13	1.07	1.01		
7103	.26	.25	.23	.22			71181	3.20	1.90	1.59	1.28		
7104	.28	.27	.25	.24			71182	1.20	1.13	1.07	1.01		
7105	.28	.27	.25	.24			71192	1.98	1.87	1.76	1.65		
7106	.52	.50	.47	.44			71193	1.98	1.87	1.76	1.65		
7107	.52	.50	.47	.44			71198	2.81	2.65	2.50	2.34		
7108	.32	.30	.29	.27			71199	2.81	2.65	2.50	2.34		
7109	.32	.30	.29	.27									
7110	.26	.25	.23	.22									
7111	.28	.27	.25	.24			71800	.38	.31	.29	.25		
7113	.58	.55	.52	.49			71801	.38	.31	.29	.25		
7116	.52	.50	.47	.44			71803	.38	.31	.29	.25		
7117	.52	.50	.47	.44			71804	1.00	.95	.90	.85		
7118	.26	.25	.23	.22			71805	1.00	.95	.90	.85		
7120	.26	.25	.23	.22			71809	.38	.31	.29	.25		
7121	.26	.25	.23	.22			71810	.38	.31	.29	.25		
7123	.80	.76	.72	.68			71811	.38	.31	.29	.25		
7125	.50	.48	.45	.43			74820	.38	.31	.29	.25		
7126	.31	.32	.31	.29									
7130	.26	.25	.23	.22			71821	.38	.31	.29	.25		
7137	.50	.53	.50	.48			71822	.38	.31	.29	.25		
7138	.56	.53	.50	.48			71840	1.00	.95	.90	.85		
7110	.26	.25	.23	.22			71850	1.00	.95	.90	.85		
7141	1.73	1.61	1.55	1.46			71851	.38	.31	.29	.25		
7142	1.27	1.21	1.14	1.07			71860	.38	.31	.29	.25		
7143	1.27	1.21	1.14	1.07			71861	.38	.31	.29	.25		
7144	1.27	1.21	1.14	1.07			71865	.38	.31	.29	.25		
7145	1.21	1.62	1.53	1.44			71873	1.82	1.73	1.63	1.51		
7146	1.21	1.17	1.11	1.01			71874	1.82	1.73	1.63	1.51		
7147	1.16	1.10	1.04	.98			71807	1.82	1.73	1.63	1.51		
7148	1.11	1.37	1.29	1.25			71812	1.82	1.73	1.63	1.51		
7149	.26	.25	.23	.22			71814	1.82	1.73	1.63	1.51		
7151	.26	.25	.23	.22			71810	1.00	.95	.90	.85		
7154	.26	.25	.23	.22									
7155	.26	.25	.23	.22									
7159	.26	.25	.23	.22									
7160	.26	.25	.23	.22									
7172	.38	.36	.34	.32			NE501A	2.99	2.82	2.66	2.49		
7173	.50	.48	.45	.43			NE526A	3.59	3.30	3.17	2.95		
7174	.50	.48	.45	.43			NE531A	3.81	3.58	3.36	3.14		
7175	.80	.76	.72	.68			NE533T	3.81	3.58	3.36	3.14		
7176	.56	.53	.50	.48			NE536T	7.31	6.88	6.45	6.02		
7180	.76	.72	.68	.65			NE540T	2.16	2.01	1.92	1.80		
7482	.99	.91	.88	.83			NE540T	1.18	1.20	1.32	1.41		
7483	1.63	1.55	1.46	1.38			NE550A	1.21	1.17	1.11	1.04		
7485	1.43	1.35	1.28	1.20			NE560A	3.57	3.36	3.15	2.91		
7486	.58	.55	.52	.49			NE561B	3.57	3.36	3.15	2.91		
7490	.80	.76	.72	.68			NE566A	3.57	3.36	3.15	2.91		
7491	1.43	1.35	1.28	1.20			NE571A	.90	.86	.81	.77		
7492	.80	.76	.72	.68			NS595	3.40	3.20	3.00	2.80		
7493	.80	.76	.72	.68			NS596A	1.87	.77	1.66	1.56		
7494	1.18	1.12	1.05	.99			709A	.42	.40	.38	.36		
7495	1.18	1.12	1.05	.99			710A	.42	.40	.38	.36		
7496	1.18	1.12	1.05	.99			711A	.41	.42	.40	.37		
71100	1.52	1.41	1.36	1.28			723A	1.00	.95	.90	.85		
71107	.52	.49	.47	.44			733A	1.90	1.80	1.70	1.60		
71121	.56	.53	.50	.48			741F	.41	.42	.40	.37		
71122	.70	.67	.63	.60			717A	1.05	.99	.91	.88		
71123	1.21	1.06	1.00	.91			718A	.48	.46	.43	.41		
71141	1.63	1.55	1.46	1.38			LM335	2.85	2.72	2.61	2.55		
71145	1.11	1.33	1.26	1.18			LM336	3.85	3.66	3.46	3.27		
71150	1.63	1.55	1.46	1.38			LM337	1.05	3.70	3.51	3.31		
71151	1.20	1.13	1.07	1.01									
71153	1.63	1.55	1.46	1.38									
71154	2.13	2.04	2.16	2.03									
71155	1.46	1.39	1.31	1.23			IN270	.15	.14	.13	.12		
71156	1.46	1.39	1.31	1.23			IN911	.10	.09	.08	.07		
71157	1.56	1.48	1.39	1.31			IN4001	.10	.09	.08	.07		
71158	1.56	1.48	1.39	1.31			IN3002	.11	.10	.09	.08		
71160	1.89	1.79	1.68	1.58			IN4003	.13	.12	.11	.10		
71162	1.89	1.79	1.68	1.58			IN4006	.15	.14	.13	.12		
71166	1.98	1.87	1.76	1.65			IN717A thru						
							IN758A	.25	.22	.19	.16		
							2N3860	.25	.23	.21	.19		

LED 7 SEGMENT DISPLAY:
Solid State Systems has now expanded its line of LED Displays and also reduced their cost. The following are now available from us at these prices.

	1-19	50-99	100-199	500-999	1,000 up
SSS-1	1.50	4.25	3.75	3.40	3.00
SSS-1C	1.75	1.50	1.00	3.65	3.25
SSS-2	1.50	1.25	3.75	3.40	3.00
SSS-3	7.75	7.50	7.00	6.75	6.50
SSS-4	7.75	7.50	7.00	6.75	6.50
SSS-7	3.50	4.25	3.00	2.75	2.50
SSS-9	3.50	4.25	3.00	2.75	2.50
Minutrons*	3.00	2.75	2.50	2.25	1.90

The SSS-7 and SSS-9 are the common 3.3 character height 7 segment and overflow display respectively, with decimal point on the left and wide angle viewing. The SSS-1 and SSS-2 have the same physical dimensions as the SSS-7 with increased life and slightly lower current requirement. The SSS-4 is the same as the SSS-1 except it has a colon instead of a decimal point, making it ideal for use in a digital clock. The SSS-3 and SSS-4 are the new giant .75 character height 7 segment and overflow display respectively, with decimal point on the right and readability up to 40 feet. *Also included above is a new reduced price on our Incandescent 7 segment Display.

Package of R, 1/1 watt current limiting resistors..... \$0.30

MOLEX IC SOCKET CONT'S: Use these economical pins instead of ordering you IC's to PC boards. Sold in continuous strips in multiples of 100 pins only.

	100 for \$1.00	200 for \$1.80	300 for \$2.60	400 for \$3.40	500 for \$4.20	600 for \$5.00	700 for \$5.80	800 for \$6.60	900 for \$7.40	1000 for \$8.20	each additional 1,000 \$7.50
--	----------------	----------------	----------------	----------------	----------------	----------------	----------------	----------------	----------------	-----------------	------------------------------

Dual in-line SOCKETS. Brand new with gold plated pins.

	1-19	50-99	100-199	500-999	1,000 up
14 Pin) Solder	.50	.45	.40	.35	.25
16 Pin) Solder	.55	.50	.45	.40	.30
14 Pin) Wire Wrap	.55	.50	.45	.40	.30
16 Pin) Wire Wrap	.60	.55	.50	.45	.35
14 Pin) Closed-Entry Cap	.05	.05	.04	.04	.03
16 Pin) Closed-Entry Cap	.05	.05	.04	.04	.03

STANDARD TRANSFORMERS: Ideal for use with LM series.

PB110, 25.2VCT, 1 amp	\$3.00
PA134, 6.3VCT, 1.2 amp	\$2.75

HEAT SINKS: Wakefield series different board coolers, 1" high with a dissipation up to 20 watts. Designed for use with TO-3 package.

Type	600	1.25A	1.20	1.10	1.00	.90	.80
------	-----	-------	------	------	------	-----	-----

ALLEN-BRADLEY MILIGRAH (5-band) RESISTORS: Any of the R1 STANDARD 10% values from 2.72 to 22M Ω or 5 WATT EACH.....\$0.05

CERAMIC DISC CAPACITORS, Type 50A-1000V D.C.: 5, 7.5, 10, 12, 15, 20, 22, 25, 27, 30, 33, 39, 50, 56, 68, 75, 82, 100, 120, 150, 180, 200, 220, 250, 270, 300, 330, 360, 390, 470, 500, 560, 680, 750, 820, 1000, 1200, 1500, 1800, 2000, 2200, 2500, 2700, 3000, 3300, 3600, 4700, 5000pF. EACH.....\$1.10

0.01uF, EACH.....\$1.11

0.02uF, EACH.....\$1.12

LOW VOLTAGE DISCS, Type 1K:

10uF, 3V	\$2.25	0.47uF, 3V	\$2.25	0.2uF, 10V	\$2.20
1uF, 10V	\$1.12	2.2uF, 3V	\$2.20	0.01uF, 16V	\$1.10

ELECTROLYTIC CAPACITORS: All values are available in both axial or upright (PC Board mount). Please indicate your choice.

10uF, 15V	\$1.00	30uF, 35V	\$2.00	5uF, 50V	\$1.00
30uF, 15V	\$1.00	100uF, 35V	\$2.00	10uF, 50V	\$1.15
50uF, 15V	\$1.00	100uF, 35V	\$2.00	20uF, 50V	\$2.20
100uF, 15V	\$1.10	300uF, 35V	\$1.10	50uF, 50V	\$2.20
220uF, 15V	\$1.15	1000uF, 35V	\$1.15	100uF, 50V	\$2.20
500uF, 15V	\$2.20	1uF, 50V	\$2.20	200uF, 50V	\$1.10
1000uF, 15V	\$3.30	2uF, 50V	\$1.10	500uF, 50V	\$1.10
2uF, 25V	\$1.15	3uF, 50V	\$1.10		

TERMS: Rated firms NET 30 days. Otherwise check or money order with order. Bank American and Mastercard are welcome. All shipping is now done by computer therefore, the following standard charges will automatically be added to your order.

If you need handle total is between:

	SPECIAL CHARGES
\$ 0.00 - \$ 1.99	add \$1.00 COD
\$ 2.00 - \$ 4.99	add \$0.75 Air Mail
\$ 5.00 - \$ 9.99	add \$0.50 Postal Insurance
\$ 10.00 and up	add \$0.25 Special Delivery

With this new system all shipments will be First Class destination, via First Class or UPS (your choice). These charges include shipping, handling and insurance.

MISSOURI RESIDENTS: Please add 1% sales tax.



SOLID STATE SYSTEMS, INC.

P. O. BOX 773 • COLUMBIA, MISSOURI 65201

TWX 910-760-1453 • PHONE 314-443-3673

Your
BANKAMERICARD
welcome here

ORDER DESK
(TOLL FREE)
1-800-325-2595



WHILE THEY LAST

LM101A	5.00	4.50	4.00	3.50
LM201	5.00	2.25	2.00	1.75
LM301	1.15	1.00	.85	.70
LM206	1.60	1.20	3.80	3.40
LM306	2.30	2.10	1.90	1.70
LM207	2.25	2.05	1.85	1.65
LM307	1.10	1.00	.90	.80
LM105	5.00	4.50	4.00	3.50

All IC's are supplied in R, 11, or 21 pin DIP (dual in-line) plastic in ceramic package except for NE536, NE510, ST 540, LM101A, LM201, LM301, LM206, LM306, LM207 and LM105 which come in TO-3 package. Voltage Regulators LM333, LM336 and LM337 are supplied in TO-

"DIGITAL CLOCK ON A CHIP"
Only **\$14.95**

NEW

Buy 3 Take 10%

Similar to Mostek 5012. Outperforms Texas Instruments' 5012. Money saved! Largest in clock design. Features 12 or 24 hr operation, 1 or 2 digits, 10 or 24 hr operation. Internal digital multiplier on the chip. Leads: zero blanking, high output current for simple readout. Features: Single timer, supply operation. High blanking for read and current drain. 11 thru 15 leads. Full MOS LSI. Spec sheets included.

IT'S NEW! 12-DIGIT "CALCULATOR ON A CHIP" 3 for \$35

12.50

Sorry, can't name U.S. maker! Type SD5001. Similar to Mostek 5012. Outperforms Texas Instruments' 5012. Money saved! Largest in clock design. Features: 12 or 24 hr operation, 1 or 2 digits, 10 or 24 hr operation. Internal digital multiplier on the chip. Leads: zero blanking, high output current for simple readout. Features: Single timer, supply operation. High blanking for read and current drain. 11 thru 15 leads. Full MOS LSI. Spec sheets included.

Buy 3 Take 10%

NIXIE LED 7-SEGMENT READOUTS 3 for \$10

MAN-4 EQUAL \$3.95

0.4 plus letters for SN-414. Snaps in 1.1-pin DIP socket. 5V, 10ma, with decimal point. Like MAN-1. Socket for above, 50c

35 WATT AUDIO AMPLIFIER BASIC 2 FOR STEREO 6 \$3.33

For Class AB use. Includes: Signal, 400 ohm resistor, high power driver T-10, with a pair of complementary 35W Class B transistors, 1N270 diode and 2N5610 pnp. With schematics printed circuit and parts board layouts.

Buy 3 Take 10%

8 COUNTING SYSTEM \$4.50

3 for \$12.00

Includes SN7490 decade counter, SN7475 latch, SN7411 BCD decoder, driver, 0 to 9 Nixie tube, instructions.

This display is excellent for small portable electronics, such as DVM's, calculators, etc. Equivalent to Monsanto MAN 3A. Operates from 5V, 20 milliamperes, with 47 ohm dropping resistor.

10 watts peak, with heat sinks, 3/4 x 1/2 x 1/2", 9 to 30V. High sens. 8 to 16 ohms. For mono & stereo

LED READOUTS 3 for \$2.95

Buy 3 Take 10%

GENERAL ELECTRIC 3-WATT AUDIO AMP \$2.95 3 FOR \$6.00

Linear Op Amps

Buy Any 3 PAKS Take 10% Discount

(A) TO-5 TO-9 DIP dial in the pack

FACTORY MARKED GUARANTEED

709-709	1.00
730-739	1.95
741-741	1.00

Best Values for 18 years

Terms: add postage, cod's 25%. Rated: net 30. Phone Orders: Wakefield, Mass. (617) 245-3829. Retail: 16-18 Del Carmine St., Wakefield, Mass. (off Water Street) C.O.D.'S MAY BE PHONED IN.

POLY PAKS P.O. Box 942 E Lynnfield, Mass 01940

ELECTRICAL SUPPLIES AND EQUIPMENT

PLATING Equipment, Portable Platers, Supplies and "Know-How." Build your own tanks for nickel, chrome, etc. Easy-to-install PVC liners. Rectifier components—all sizes. Schematics, parts lists, formulas, operating instructions for all plating. Guaranteed to save you 25%-75%. Some good units for sale. Write for details. Platers Service Company, 1511-PE Esperanza, Los Angeles, Calif. 90023.

TAPE AND RECORDERS

RENT 4-Track open reel tapes—all major labels—3,000 different—free brochure. Stereo-Parci, 55 St. James Drive, Santa Rosa, Ca. 95401.

1930-1962 Radio Programs on tape. Huge Catalog! Sample Recordings! \$1.00 refundable!! AM Treasures, Box 192F, Babylon, N.Y. 11702.

AMPEX MAGNETIC TAPE RECORDING TAPE RIOT! **Scotch MAGNETIC TAPE**

FACTORY FRESH. CHOICE OF SCOTCH #150/ #203. 1800 FOOT 1-MIL POLYESTER, 7" REELS; OR AMPEX #611, —Quantity— 1200 FT. 7" ACETATE. 1-11 12+ 48+ #150-18 Scotch, Polyester, 1800 Ft. 1.95 1.83 1.75 #203-18 Scotch, Low Noise, 1800 Ft. 2.65 2.55 2.45 #611-12 Ampeg, Acetate, 1200 Ft. 1.68 1.50 1.39

Add 10% to above Tape Prices for shipping/hdlg.—5% over \$80.00

SAXITONE, 1776 Columbia Road N.W., Wash., D.C. 20009

SCOTCH 2400' studio tape on 7" reel, degaussed and boxed, 12 for \$11 POSTPAID. Free price list. Wide Response, 2926 Bentley Ave., Los Angeles, Calif. 90064.

HIGH FIDELITY

DIAMOND NEEDLES and Stereo Cartridges at Discount prices for Shure, Pickering, Stanton, Empire, Grado and ADC. Send for free catalog. All merchandise brand new and factory sealed. LYLE CARTRIDGES, Dept. P, Box 69, Kensington Station, Brooklyn, New York 11218.

TUBES

RADIO & T.V. Tubes—36¢ each. Send for free Catalog. Cornell, 4213 University, San Diego, Calif. 92105.

RECEIVING & INDUSTRIAL TUBES, TRANSISTORS. All Brands—Biggest Discounts. Technicians. Hobbyists, Experimenters—Request FREE Giant Catalog and SAVE! ZALYTRON, 469 Jericho Turnpike, Mineola, N.Y. 11501.

SAVE money on parts and transmitting-receiving tubes, foreign-domestic. Send 25¢ for giant catalog. Refunded first order. United Radio Company, 56-P Ferry Street, Newark, N.J. 07105.

TUBES "Oldies", latest. Lists free. Steinmetz, 7519 Maplewood, Hammond, Indiana 46324.

TUBES receiving, factory boxed, low prices, free price list. Translateron, Inc., 1306 40th Street, Brooklyn, N.Y. 11218A, Telephone: 212-633-2800.

TUBES, ANTIQUE—Send list. P.O. Box 5570, Compton, Calif. 90224.

REPAIRS AND SERVICES

TV Tuners rebuilt and aligned per manufacturers specification. Only \$9.50. Any make UHF or VHF Ninety day written guarantee. Ship complete with tubes or write for free mailing kit and dealer brochure. JW Electronics, Box 51C, Bloomington, Indiana 47401.

ELECTRONIC BUILD SERVICE. Experienced with equipment from miniature circuit boards to large control panels. Engineering, consultation, drafting. Multiple Electronics, Post Office Box 2319, Anderson, Indiana 46011. Phone 317-642-4973.

INVENTIONS WANTED

INVENTIONS wanted. Patented; unpatented. Global Marketing Service, 2420-P 77th, Oakland, Calif. 94605.

PATENT Searches including Maximum speed, full airmail report and closest patent copies. Quality searches expertly administered. Complete secrecy guaranteed. Free Invention Protection forms and "Patent Information." Write Dept. 9, Washington Patent Office Search Bureau, Benjamin Franklin Substation, P.O. Box 7167, Washington, D.C. 20044.

FREE "Directory of 500 Corporations Seeking New Products." For information regarding development, sale, licensing of your patented/unpatented invention. Write: Raymond Lee Organization, 230-GR Park Avenue, New York City 10017.

INVENTORS: Protect your ideas! Free "Recommended Procedure". Washington Inventors Service, 422T Washington Building, Washington, D.C. 20005.

INVENTORS! Either I will sell your invention before you do, (either through your own efforts or those of another firm) or I will pay you a cash bonus. For Free Invention Evaluation and information, write Gilbert Adams, Invention Broker, Dept. 20, 81 Wall St., New York, N.Y. 10005.

NEW PRODUCTS—INVENTIONS—IDEAS Developed/Marketed by professional organization. FREE INFORMATION "How to Market Inventions To Industry". Lawrence Peska Associates, 500-PE Fifth Avenue, New York City 10036.

FREE PAMPHLET: "Tips on Safeguarding Your Invention." Write: United States Inventors Service Company, 708-T Carry Building, Washington, D.C. 20005.

PERSONALS

MAKE FRIENDS WORLDWIDE through international correspondence. Illustrated brochure free. Hermes, Berlin 11, Germany.

MOVIE FILMS

8MM-SUPER 8-16MM MOVIES! Biggest Selection! Lowest Prices! Free Catalog! Cinema Eight, Box 245-PE, N.Y.C. 10028.

DO-IT-YOURSELF

PROFESSIONAL ELECTRONIC PROJECTS—\$1.00 up. Catalog 35¢. PARKS, Box 15201A, Seattle, Wash. 98115.

BOOKS

FREE catalog aviation/electronic/space books. Aero Publishers, 329PE Aviation Road, Fallbrook, California 92028.

FREE book prophet Elijah coming before Christ. Wonderful bible evidence. Megiddo Mission, Dept. 64, 481 Thurston Rd., Rochester, N.Y. 14619.

GOVERNMENT SURPLUS

GOVERNMENT Surplus. How and Where to Buy in Your Area. Send \$2.00. Surplus Information, Headquarters Bldg., Box 30177-PE, Washington, D.C. 20014.

ELECTRONIC Equipment and Parts. Big 36 page Free Catalog. Send for your copy today! Fair Radio Sales, Box 1105-P, Lima, Ohio 45802.

APRIL 1973

SEMICONDUCTOR SUPERMART

FREE CATALOG

NAME BRAND—

PRIME QUALITY

SEMICONDUCTORS

- MOTOROLA • RCA •
- FAIRCHILD • HEP •
- NATIONAL • SIGNETICS

Other Parts For
Popular Electronics Projects

CIRCUIT SPECIALISTS CO.

Box 3047 Scottsdale AZ 85257

CIRCLE NO. 7 ON READER SERVICE CARD

JEEPS Typically from \$53.90 . . . Trucks from \$78.40 . . . Boats, Typewriters, Knives, Airplanes, Clothing, Multimeters, Oscilloscopes, Transceivers, Photographic, Electronics Equipment. Wide-variety, condition. 100,000 Bid Bargains direct from government nationwide. Complete sales directory and surplus categories catalog \$1.00 (Deductible on orders from separate included catalog). Surplus Service, Box 820-J, Holland, Michigan 49423.

GOVERNMENT SURPLUS. Complete sales directory \$1.00. Surplus Publications, Box 26062Z, Los Angeles, Calif. 90026.

MANUALS for gov't surplus radios, test sets, scopes. List 50¢. Books, 4905 Roanne Drive, Washington, D.C. 20021.

HYPNOTISM

"MALE-FEMALE Hypnotism" Exposed, Explained! "Secret Method" —They Never Know! \$2, Rushed. Guaranteed! Isabella Hall, Silver Springs, Florida 32688.

SLEEP learning. Hypnotic method. 92% effective. Details free. ASR Foundation, Box 7566EG, Fort Lauderdale, Florida 33304.

FREE Hypnotism. Self-Hypnosis. Sleep Learning Catalog! Drawer H400, Ruidoso, New Mexico 88345.

PLASTICS

CASTOLITE pours like water, hardens like glass without heat. Crystal clear, colors. Embed natural flowers, other objects. Make fine gifts. Form flexible molds over any pattern, size. Reproduce your own designs in plastics, candle wax, metal, plaster, cement. Profitable. Illustrated Manual and Catalog Only \$1.00. CASTOLITE, Dept. 73D/PE, Woodstock, Ill. 60098.

POWER SUPPLY RECTIFIER & FILTER CIRCUIT BOARD.



Rectifier, filter, fuse holder & bleeder resistor, on glass epoxy board, ready to use with any transformer up to 40 volts 2 amps, all for less than the price of the capacitor. Complete data sheet & circuit diagram.

3"x4½"

STOCK NO. J9483 \$2.75 ea. 2/5.00 3/7.00

G.E. AUTO-TRANSFORMER

Ideal transformer for workbench, lab, or experimental work. Over 40 different voltages, from 10 to 250 volts, at currents from 15 to 25 amps. In factory sealed cartons. Data sheet shows how to obtain all voltages.

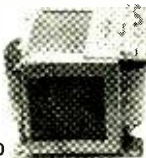

Stk. No. J9467 12.50 ea. 2/22.00

COMPUTER GRADE CAPACITORS

32,000 mfd. 40 V. Stk. F2210, 2.00 ea. 6/11.00
3,750 mfd. 75 V. Stk. F2116, 1.75 ea. 6/9.00

INCLUDE SUFFICIENT POSTAGE Excess refunded. Send for new 48 page catalog, full of circuit boards, transformers, readouts, semi-conductors, capacitors and all kinds of hard to find goodies. Minimum order, \$3.00



DELTA ELECTRONICS CO.

BOX 1, LYNN, MASSACHUSETTS 01903

CIRCLE NO. 10 ON READER SERVICE CARD

BUSINESS OPPORTUNITIES

I MADE \$40,000.00 Year by Mailorder! Helped others make money! Start with \$10.00—Free Proof. Torrey, Box 318-N, Ypsilanti, Michigan 48197.

\$200.00 DAILY In Your Mailbox! Your opportunity to do what mail-order experts do. Free details. Associates, Box 136-J, Holland, Michigan 49423.

FREE CATALOGS. Repair air conditioning, refrigeration. Tools, supplies, full instructions. Doolin, 2016 Canton, Dallas, Texas 75201.

MAILORDER MILLIONAIRE helps beginners make \$500 weekly. Free report reveals secret plan! Executive (1K4), 333 North Michigan, Chicago 60601.

HIGHLY PROFITABLE ONE-MAN ELECTRONIC FACTORY

Investment unnecessary, knowledge not required, sales handled by professionals. Postcard brings facts about this unusual opportunity. Write today! Barta-DEPD, Box 248, Walnut Creek, CA 94597.

PIANO TUNING LEARNED QUICKLY AT HOME! Tremendous field! Musical knowledge unnecessary. GI approved. Information free. Empire School, Box 327, Miami 33145.

MAKE Money at Home as high as \$150.00 per week or more mailing our circulars. Details, 25¢. Cur-Jon Mailing Service, Box 523 PL, Maplecrest Station, Maplewood, N. J. 07040.

GROW RICH DRIVING YOUR CAR. Magnetic signs, Big Money, very, very easy. Copy Sign, 6644 Santa Monica Blvd., L.A., Calif. 90038.

FREE SECRET BOOK "2042 Unique, Proven Enterprises." Beat inflation with fabulous, successful "Little Knowns." Work home! Haylings-B8, Carlsbad, Calif. 92008.

START SMALL, highly profitable electronic production in your basement. Investment, knowledge unnecessary. Postcard brings facts. Barta-PEM, Box 248, Walnut Creek, California 94597.

FREE BOOK "999 Successful, Little-Known Businesses." Work home! Plymouth Q4, Brooklyn, New York 11218.

FREE! FREE! Bargain Book—Central Camera Co., Dept. 1041, 230 S. Wabash, Chicago, Ill. 60604.

SPORTS ACTION FILMS

START a new hobby, collect Pro Sports Action films on Super 8 and Regular 8mm; color or B&W. Write now for 25¢ catalog. Elect. Dept., SPORTLITE, Box 500, Speedway, Indiana 46244.

RUBBER STAMPS

RUBBER address stamps. Free catalog, 45 type styles. Jackson's, Box 443G, Franklin Park, Ill. 60131.

FREE literature, business cards, letterheads, rubber stamps, social security plates, labels, lifetime medical, pet, identification tags. Geer's, 111 North Drive, Ottawa, Ohio 45875.

TREASURE FINDERS

TRANSISTORIZED detectors—\$19.95 to \$79.95. Family fun and fortune. Catalog write: Treasureprobe PE 34, Tennent, N.J. 07763.

FREE—Valuable Treasure Finder catalog sent by return mail. Find Coins, Rings, Gold, Silver, Metals, Relics. Write today. JETCO, Dept. CPE, Box 26669, El Paso, Texas 79926.

TREASURE FINDER locates buried gold, silver, coins, treasures. 5 powerful models. \$19.95 up. Instant financing available. Free catalog. Relco, Dept. A-33, Box 10839, Houston, Texas 77018.

DISCOVER AMERICA'S FASTEST GROWING HOBBY. White's Electronics, Inc., would like to send you—absolutely FREE, their 42 page, fact-filled catalog on Mineral and Metal Locating Equipment. Amateurs or Professionals select from the world's largest line of metal detectors, priced as low as \$79.50, up. Detect Gold, Silver, Copper—Nuggets, Coins, Jewelry, etc. Budget terms available. For your convenience we have three major factory locations in the U.S. and Canada, as well as over 1,000 authorized dealers to serve you. See your local Yellow Pages, under "Metal Locating Equipment", or write: White's Electronics Inc., Room No. 391, 1101 Pleasant Valley Road, Sweet Home, Oregon 97386—Elk-Air Industrial Park, Dexter Drive, East, Elkhart, Indiana 46514—or White's Electronics Ltd., 33784 Hazel Street, Abbotsford, British Columbia, Canada.

FISHER DETECTORS. You deserve the best. Free literature, FR-L, Dept. PE-4, P.O. Box 490, Belmont, CA 94002.

MUSICAL INSTRUMENTS

30% DISCOUNT name brand musical instruments. Free Catalog. Freeport Music, 455N, Route 110, Melville, N.Y. 11746.

WHOLESALE! Professional Guitars, PA Systems, Altec Speakers, 240W RMS Amplifiers. Free Catalog, Carvin, Escondido, Calif. 92028.

YOUR low cost ad in these columns will reach America's largest audience of Electronics Professionals and Electronics Hobbyists. Send copy now for next issue.

Popular Electronics

INCLUDING **Electronics World**

APRIL 1973

ADVERTISERS INDEX

READER SERVICE NO.	ADVERTISER	PAGE NO.	READER SERVICE NO.	ADVERTISER	PAGE NO.
1	Antenna Specialists Co.	109	24	Lafayette Radio Electronics	74
3	Avanti Research and Development, Inc.	107	25	Lee Electronic Labs, Inc.	101
4	BSR (USA) Ltd	108	26	McIntosh Laboratory Inc.	105
5	Babylon Electronics	123	27	MITS Micro Instrumentation & Telemetry Systems, Inc.	13
	Bell & Howell School	58, 59, 60, 61	28	Mallory Distributor Products Company	24
6	Bose	73	29	Midwest Hi-Fi Wholesalers	16
	CREI Capitol Radio Engineering Institute	38, 39, 40, 41		National Radio Institute	SECOND COVER, 1, 2, 3
7	Circuit Specialists Co.	129		National Technical Schools	20, 21, 22, 23
8	Cleveland Institute of Electronics, Inc.	96, 97, 98, 99	30	PTS Electronics, Inc.	87
48	Cobra Communications, Dynascan Corporation	103	47	Pickering & Co., Inc.	77
9	Contemporary Marketing, Inc.	89	31	Poly Paks	128
10	Delta Electronics Co.	130	32	RCA Institutes	78, 79, 80, 81
11	Delta Products, Inc.	7	33	Radio Shack and Allied Radio Stores	17
12	Dixie Hi-Fi Wholesalers	105	34	SBE	111
14	EICO	106	35	Sams & Co., Inc., Howard W.	10, 11
15	Edmund Scientific Co.	132	36	Sams & Co., Inc., Howard W.	83
16	EI Instruments, Inc.	8	37	Schober Organ Corp., The	16
2	Electro-Voice, Inc.	FOURTH COVER	38	Solid State Sales	125
17	Electronics and Control Engineers' Book Club	9	39	Solid State Systems, Inc.	127
18	Fluke	113	41	Sprague Products Company	6
19	GC Electronics	106	42	Texas Instruments Incorporated	27
20	Gregory Electronics Corp.	124	43	Tri-Star Corporation	87
13	Griffith Plastics Corporation	19		U. S. School of Music	109
21	Heath Company	114, 115, 116, 117	44	Ungar	14
22	Johnson	15	45	Utah Electronics	75
23	Judson Research and Mfg. Co.	110	46	Wahl Clipper Corporation	110
CLASSIFIED ADVERTISING		123, 124, 125, 126, 128, 129, 130, 131			

REAL ESTATE

FREE . . . NEW . . . BIG . . . SUMMER CATALOG! Describes and pictures hundreds of farms, ranches, town and country homes, businesses coast to coast! Specify type property and location preferred. UNITED FARM AGENCY, 612-EP, West 47th St., Kansas City, Mo. 64112.

MISCELLANEOUS

WINEMAKERS: Free illustrated catalog yeasts, equipment. Semplex, Box 12276P, Minneapolis, Minn. 55412.

36 AIRMAIL ENVELOPES. Printed with your name and address in corner, \$1.00. Satisfaction Guaranteed. JEANART STUDIOS, Dept. E2, 715 E. 19th St., Brooklyn, N.Y. 11230.

EMERGENCY HORN—Hand-sized, self-powered. Perfect for emergencies. Can be heard up to one mile. Will also repel attackers or animals, without permanent harm. \$3.50 postpaid. J. Ross, Box 223, Jamaica, N. Y. 11431. Dept. PE.

YOUR LOW COST Classified or Display Classified Ad in these columns will be seen, read and responded to regularly by America's largest audience of Electronics Professionals and Hobbyists. For \$1.60 per word (minimum \$16.00) your Classified ad will produce sales results far in excess of the small amount you'll spend on advertising. If your product or service deserves more prominent exposure to this audience, then Display Classified is for you . . . and it's available in units of 1", 2" or 3" by one column at rates of \$200.00, \$400.00 or \$600.00 per insertion (even less if you sign up for a 6 or 12-time contract.) For immediate action send copy and payment NOW to: Hal Cymes, Classified Advertising Manager, POPULAR ELECTRONICS including ELECTRONICS WORLD, One Park Avenue, New York, New York 10016.

Popular Electronics

INCLUDING Electronics World

READER SERVICE

FREE INFORMATION

Here's an easy and convenient way for you to get additional information about products advertised or mentioned editorially (if it has a reader service number) in this issue. Just follow the directions below... and the material will be sent to you promptly and free of charge.

MARCH 1973 FIFTY CENTS

Popular Electronics

INCLUDING Electronics World

UNDERSTANDING NEW FM TUNER SPECS

CRYSTALS FOR CB

BUILD:

- A Low-Cost Digital Clock
- The Light Probe
- Stage Lighting for the Amateur

ROCK MUSIC AND NOISE POLLUTION

HOW WE HEAR THE WAY WE DO

TEST REPORTS:

- Dynaco FM-5 Tuner
- Wharfedale W60E Speaker System
- SSI 4-Channel Adapter
- Courier "Gladiator" CB Transceiver
- B & K 50-A Semiconductor Curve Tracer

18101

1. On the attached postage-free card, print or type your name and address on the lines indicated.

2. Circle the number (s) that corresponds to the key number (s) at the bottom or next to the advertisement or editorial mention that is of interest to you. (Key numbers for advertised products also appear in the Advertisers' Index.)

3. Simply cut out the card and mail. No postage required.



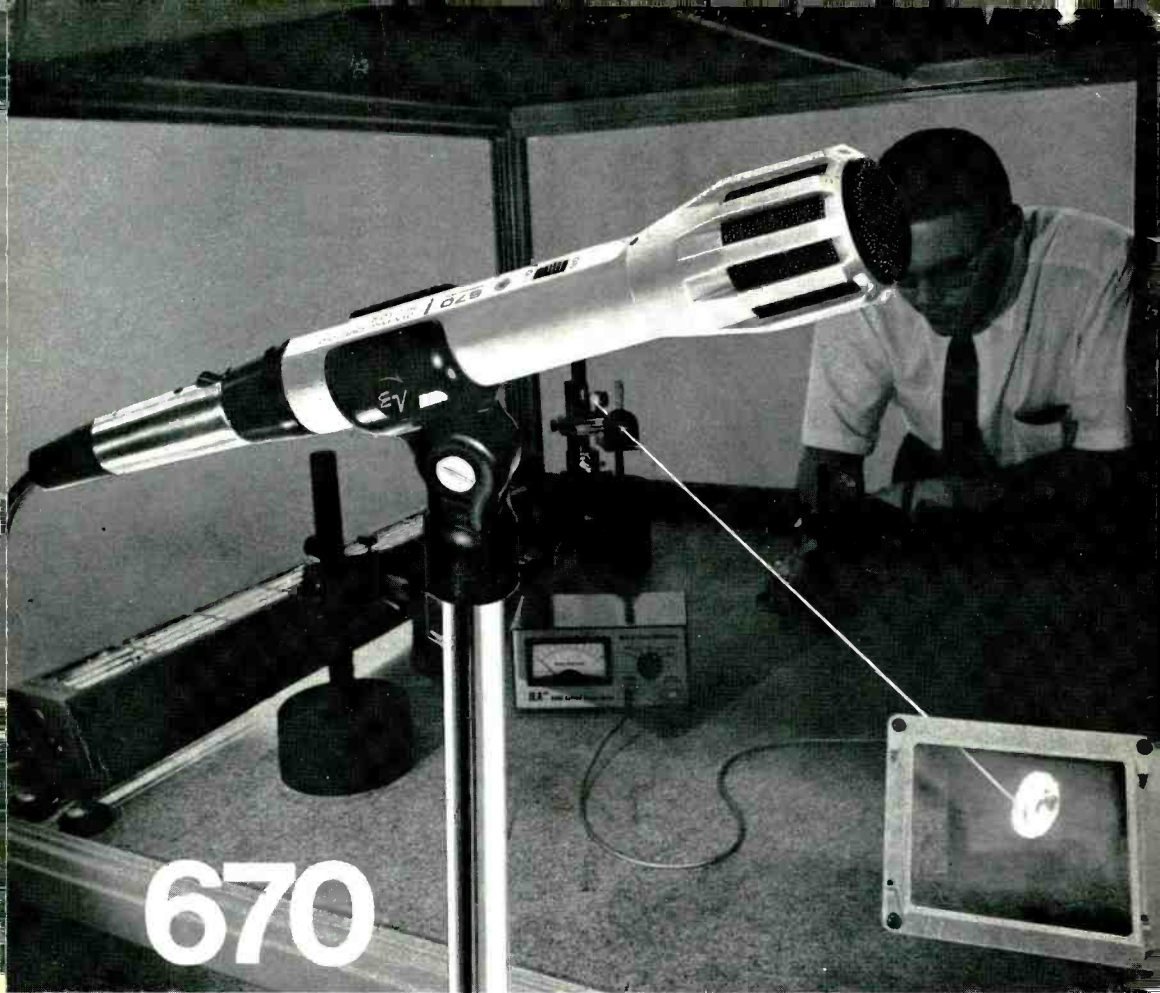

Until we turned on our laser, all Single-D cardioid microphones seemed much alike.

The remarkable Model 670 microphone is the product of exclusive laser holographic research devoted to improving microphone performance. Using a laser beam we are able to measure movement as small as .000005" while studying microphone diaphragms under actual operating conditions.

The results are genuine and impressive. We are able to create a diaphragm that operates closer to the theoretical ideal than any other yet tested. Which brought improvements in frequency response and more uniform rejection of noise and feedback for more useable volume even when acoustics are bad. Improvements that make the 670 uniquely suited for sound reinforcement, tape recording, and contemporary music performances.

The Model 670 has convenience features, too. An integral pop and blast filter. Plus an internal shock absorbing system that soaks up handling noise. And a professional connector. Change impedance from Hi-Z to Lo-Z easily without soldering. Lifetime guarantee against defects in material and workmanship.

Choice of basic Model 670 at \$45.00 suggested net, or Model 670V with handy built-in volume control, \$50.10. Also available with standard phone plug and carrying case optional extra. Try these advanced microphones today at your nearby E-V microphone headquarters.

a **Gulton**
COMPANY

ELECTRO-VOICE, INC., Dept. 432P, 630 Cecil Street, Buchanan, Michigan 49107
In Europe: Electro-Voice, S.A., Römersstrasse 49, 2560 Nidau, Switzerland
In Canada: E-V of Canada, Ltd., Gananoque, Ontario

Electro-Voice[®]

CIRCLE NO. 2 ON READER SERVICE CARD
www.americanradiohistory.com