

Popular Electronics

INCLUDING **Electronics World**

TEST REPORTS:

- Teac AT-100 Stereo FM Tuner
- Superex PEP-77D Electrostatic Phones
- Pearce-Simpson Cougar 23 CB Transceiver
- Lee Model EC Signal-Tracing Probe
- TFE Model PP-1A Step Generator

BUILD:

- Electronic Tag Game on Your TV
- Speed Timer for Model Cars
- The Strobe Cube

Hows & Whys of the SCR

Comeback of the Bass-Reflex Speaker

How Electronics Monitors Hospital Patients

Shortwave Receiver Roundup

with
**Hirsch-Houck
Labs Tests**



712236 010 1FRCHM97 FEB75 R 10
 11
 RICHMOND PUB LIBR
 101 E FRANKLIN ST
 RICHMOND VA 23219

firsts

make learning
Electronics at home
fast and fascinating -
give you priceless
confidence.

Some NRI **firsts** in training equipment



first to give solid state 25" color TV, 5" wide band oscilloscope, color bar generator and other professional equipment engineered specifically for education. You work directly on the receiver as you build it, discovering the practical aspects of TV servicing as you create a handsome new color console. Only NRI includes an attractive woodgrain cabinet without extra charge.



first to give you a unique, exciting digital computer *with memory* built especially for home training. You learn organization, trouble shooting, operation, programming as you build and use it. Performs the same functions as commercial computers. Lessons stress computer repair. You conduct a hundred experiments, build hundreds of circuits. A solid-state VTVM is included among ten training kits.

NRI's "discovery" method is the result of over half a century of leadership simplifying and dramatizing training at home

The FIRSTS described below are typical of NRI's half century of leadership in Electronics home training. When you enroll as an NRI student, you can be sure of gaining the in-demand technical knowledge and the priceless confidence of "hands-on" experience sought by employers in Communications, Television-Radio Servicing and Industrial and Military Electronics. Everything about NRI training is designed for your education . . . from the much-copied, educator-acclaimed Achievement Kit sent the day you enroll, to "bite-size" well-illustrated, easy to read texts programmed with designed-for-learning training equipment.

YOU GET YOUR FCC LICENSE OR YOUR MONEY BACK

There is no end of opportunity for the trained man in Electronics. You can earn \$6 or more an hour in spare time, have a business of your own or qualify quickly for career positions in business, industry, government. And if you enroll for any of five NRI courses in Communications, NRI prepares you for your FCC License exams. *You must pass* or NRI refunds your tuition in full. No school offers a more liberal money-back agreement. The full story about NRI leadership in Electronics training is in the new NRI Catalog. Mail postage-free card today. No salesman is going to call.
NATIONAL RADIO INSTITUTE, Washington, D.C. 20016 (In Canada write: NRI Rep., 330 Progress Ave., Scarborough, Ont.)

APPROVED UNDER NEW GI BILL If you have served since January 31, 1955, or are in service, check GI line on postage-free card.

designed from chassis up for your education

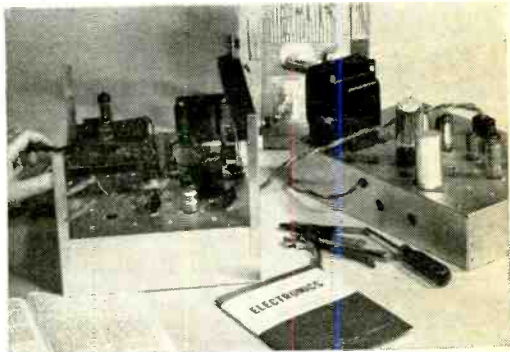
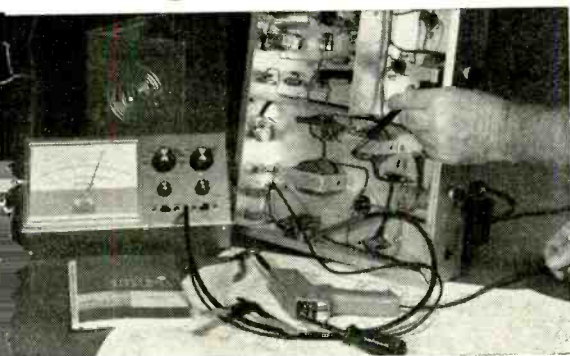

first to give you true-to-life experiences as a communications technician. Every fascinating step you take in NRI Communications training, including circuit analysis of your own 25-watt, phone/cw transmitter, is engineered to help you prove theory and later apply it on the job. Studio equipment operation and troubleshooting become a matter of easily remembered logic.

first to give you completely specialized training kits engineered for business, industrial and military Electronics. Shown above is your own training center in solid state motor control and analog computer servo-mechanisms. Telemetering circuits, solid-state multi-vibrators, and problem-solving digital computer circuits are also included in your course.

Popular Electronics

WORLD'S
LARGEST-SELLING
ELECTRONICS MAGAZINE

INCLUDING **Electronics World**

FEATURE ARTICLES

- 28 RECEIVERS FOR THE SHORTWAVE LISTENER** *Julian D. Hirsch*
Part 1—Features to look for in communications sets
- 34 ELECTRONICS MONITORS HOSPITAL PATIENTS** *Ed Bukstein*
- 48 SELECTAVISION MAGTAPE SYSTEM**
RCA's color video player for consumers
- 49 COMEBACK OF THE BASS REFLEX** *David B. Weems*
- 60 DIGITAL LOGIC TUNES TV RECEIVERS**
- 65 GROWTH OF CBS SQ—A STATUS REPORT**
- 66 NUCLEAR RADIATION & DETECTION** *J. G. Ello*
Part 2—Radioactivity detectors
- 68 SATELLITE PICTURES SHOW EARTH'S RESOURCES**
- 69 THE HOW AND WHY OF THE SCR** *Joseph H. Wujek*
- 88 PHILOSOPHY OF A KIT MANUFACTURER** *John T. Frye*
How kits are designed and tested
- 104 THE RECHARGEABLE ALKALINE BATTERY** *Samuel C. Milbourne*

THE SCENES

- 10 STEREO SCENE** *J. Gordon Holt*
Identifying system interconnections
- 98 TEST EQUIPMENT SCENE** *Leslie Solomon*
Sine waves and scopes
- 102 COMMUNICATIONS SCENE** *Malcolm F. Parrish*
Scanners for monitoring uhf & vhf
- 117 SURPLUS SCENE** *Alexander W. Burawa*

ZIFF-DAVIS PUBLISHING COMPANY
Editorial and Executive Offices
One Park Avenue, New York, New York 10016
212 679-7200

William Ziff, President
W. Bradford Briggs, Executive Vice President
Hershel B. Sarbin, Senior Vice President and Secretary
Phillip Sine, Financial Vice President and Treasurer
Phillip T. Heffernan, Vice President, Marketing
Frank Pomerantz, Vice President, Creative Services
Arthur W. Butzow, Vice President, Production
Edward D. Muhlfeld, Vice President, Aviation Division
Irwin Robinson, Vice President, Travel Division
George Morrissey, Vice President
Sydney H. Rogers, Vice President
Sidney Holtz, Vice President
Lawrence Sporn, Circulation Director

POPULAR ELECTRONICS Including ELECTRONICS WORLD, November, 1972, Volume 2, Number 5. Published monthly at One Park Ave., New York, NY 10016. One year subscription rate for U.S., U.S. Possessions and Canada, \$6.00; all other countries, \$7.00. Second class postage paid at New York, N.Y. and at additional mailing offices. Authorized as second class mail by the Post Office Department, Ottawa, Canada and for payment of postage in cash. Subscription service and Forms 3579: P.O. Box 2774, Boulder, CO 80302. Editorial offices for manuscript contributions, reader inquiries, etc.: One Park Ave., New York, NY 10016.

POPULAR ELECTRONICS Including ELECTRONICS WORLD is indexed in the Reader's Guide to Periodical Literature.

Copyright © 1972 by ZIFF-DAVIS PUBLISHING COMPANY. All rights reserved.

POPULAR ELECTRONICS Including Electronics World

EDGAR W. HOPPER
Publisher
WM. A. STOCKLIN
Editorial Director
MILTON S. SNITZER
Editor
LESLIE SOLOMON
Technical Editor
JOHN R. RIGGS
Managing Editor
EDWARD I. BUXBAUM
Art Director

ALEXANDER W. BURAWA
Associate Editor
ANDRE DUZANT
Technical Illustrator
JUDITH L. HOGAN
Editorial Assistant
FOREST H. BELT
JOHN T. FRYE
DAVID L. HEISERMAN
J. GORDON HOLT
RICHARD HUMPHREY
Contributing Editors

JOSEPH E. HALLORAN
Advertising Director
JOHN J. CORTON
Advertising Sales
MADELEINE LITTMAN
Advertising Service Manager
STANLEY NEUFELD
Associate Publisher
FURMAN H. HEBB
Group Vice President
Electronics and Photographic

CONSTRUCTION STORIES

- 42 TACH-DWELL METER** *Norman J. Olsen*
Checks rpm and dwell angle of engines
- 43 BUILD A SPEED TIMER FOR MODEL CARS** *Philip Harms*
Useful for clocking any kind of race
- 54 BUILD A STROBE CUBE** *Robert Shaw III*
Flasher for pop music or stopping motion
- 61 PLAY ELECTRONIC TAG ON YOUR TV** *Jeffrey W. Anderson*
- 96 BUILD THE DECID-O-TRON** *Lewis J. Newmire*
Let electronics make your decisions

PRODUCT TEST REPORTS

- 78 TEAC MODEL AT-100 STEREO FM TUNER**
- 81 TFE MODEL PP-1A STEP GENERATOR**
- 82 SUPEREX MODEL PEP-77D ELECTROSTATIC HEADPHONES**
- 84 PEARCE-SIMPSON COUGAR 23 CB TRANSCEIVER**
- 86 LEE MODEL EC SIGNAL-TRACING PROBE**

DEPARTMENTS

- 6 EDITORIAL** *Milton S. Snitzer*
Electronics in the Kitchen
- 8 LETTERS**
- 25 NEWS HIGHLIGHTS**
- 106 NEW PRODUCTS**
- 114 ELECTRONICS LIBRARY**
- 116 NEW LITERATURE**
- READER SERVICE CARD ON BACK COVER

COMING NEXT MONTH

All About Alpha Brain Waves
More Shortwave Receiver Tests
Build Universal 4-Channel Decoder
Status of Class E Citizens Band

Midwestern Office
The Pattis Group, 4761 West Touhy Ave.,
Lincolnwood, Illinois 60644, 312 679-1100
GERALD E. WOLFE, DICK POWELL
DICK GOVATSKI, MANLEY LUDWIG

Western Office
9025 Wilshire Boulevard, Beverly Hills, California 90211
213 273-8050; BRadshaw 2-1161
Western Advertising Manager, BUD DEAN

Japan: James Yagi
Oji Palace Aoyama; 6-25, Minami Aoyama
6 Chome, Minato-Ku, Tokyo 407-1930/6821

Ziff-Davis also publishes Boating, Car and Driver, Cycle, Flying, Modern Bride, Popular Photography, Skiing, and Stereo Review.

Forms 3579 and all subscription correspondence should be addressed to POPULAR ELECTRONICS Including ELECTRONICS WORLD, Circulation Department, P.O. Box 2774, Boulder, CO 80302. Please allow at least eight weeks for change of address. Include your old address, as well as new—enclosing, if possible, an address label from a recent issue.

Editorial contributions must be accompanied by return postage and will be handled with reasonable care; however, publisher assumes no responsibility for return or safety of art work, photographs or manuscripts.



Member Audit Bureau
of Circulations



Editorial

By Milton S. Snitzer, Editor

ELECTRONICS IN THE KITCHEN

The other day we attended a press conference at which a new line of microwave ovens was being introduced. Ovens of this type not only cook food very much faster than do regular ovens, they also preserve the nutrients in the food and keep the kitchen cool for the housewife. This new line of ovens, Litton Minutemasters, are able to cook a 20-pound turkey in two hours, a 10-pound roast in one hour, or six hamburgers in seven minutes. An automatic defroster, which turns the oven on and off in 30-second intervals, will thaw a solidly frozen 20-pound turkey with one easy operation in only 90 minutes as compared to about 48 hours by conventional means.

Drawing about 12 amperes from a 120-volt ac circuit, the ovens consume much less electric power because of their high speed than do ordinary electric stove ovens. For example, a microwave oven will use about \$5 worth of electricity in a year as compared to \$60 for a conventional electric oven.

Already widely used in restaurants, vending operations, institutions, school cafeterias, and airlines, Litton is making a strong pitch to get these ovens into home kitchens. The harried housewife is sure to find the time-saving feature and the adaptability of the ovens to off-schedule meals very helpful. Since the temperature inside the oven remains the same as the room temperature, most foods can be cooked right in the container they come in, or even on a paper plate. Also, there is no time-consuming messy oven clean-up required because nothing can bake onto the sides or bottom of the oven.

Priced just below \$400, the electronic oven should be able to take care of about 80 to 90 percent of all oven-use requirements in a typical home kitchen.

About 100,000 consumer microwave ovens were sold by the industry in 1971, and sales are expected to double each year for the next five years. By 1976, it is estimated that one out of four of all ranges sold to consumers in the U.S. will be microwave types, either alone or in combination with a conventional oven. This represents a market of approximately \$600 million.

Heart of the new ovens is a special magnetron tube which is guaranteed for two years and is expected to last for ten years. Replacement of the tube after the two-year warranty expires will cost about \$150.

All through the presentation, references were continually made to the color-TV receiver, which is comparably priced. In the beginning, sales of color-TV sets were very low, but shortly their sales curve shot up to the 6 million unit per year rate they presently enjoy. Microwave ovens should also enjoy a meteoric rise in a few years, and Litton as well as other companies, both domestic and foreign, want to be in on the ground floor.

What all this means to our readers, whether electronics professionals or hobbyists, is that another application of electronics has come really close to them at home. It also means that stove repairmen may have to be electronics technicians in the future.

F.C.C. COMMERCIAL OPERATOR LICENSE

Training

is part of the Grantham

ASSOCIATE DEGREE program IN ELECTRONICS

In today's world of electronics employment, an FCC license is important—sometimes essential—but it's not enough! Without further education, you can't make it to the top. Get your FCC License without fail, but don't stop there. To prepare for the better jobs, continue your electronics education and get your Associate Degree.

This is good common sense for those who want to make more money in electronics. It also makes sense to prepare for your FCC license with the School that gives degree credit for your license training—and with the School that can then take you from the FCC license level to the Degree level.

Grantham School of Engineering (founded in Hollywood, California in 1951) specializes in the teaching of electronics and supporting subjects

This booklet

FREE!

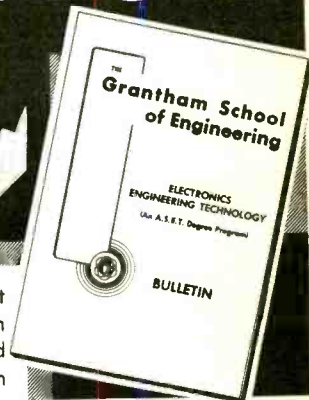

This free booklet explains what an FCC license and ASET degree can do for your future.

mainly by correspondence, is authorized under the laws of the State of California to grant academic degrees, is approved under the G.I. Bill, and is an "eligible institution" under the Federally insured student loan program.

The A.S.E.T. Degree—the Associate in Science in Engineering Technology—with a major in electronics is offered in four "correspondence semesters" plus a two-week residential seminar. Then, for those who wish to continue, the BSEE Degree is obtainable through further residential training in engineering subjects and transfer credits in the humanities.

For our free bulletin, clip and mail the coupon below, or write to GSE, 1505 N. Western Ave., Hollywood, Calif. 90027.



GRANTHAM SCHOOL OF ENGINEERING

ATTENTION, WASHINGTON D.C. AREA

Grantham School of Engineering operates a *resident* technical institute in Falls Church, Va. If you are interested in attending resident classes to earn your FCC license and prepare for a good job as an electronics technician, ask for our free GEI Bulletin. Write, phone, or visit:

GRANTHAM ELECTRONICS INSTITUTE

5884 Leesburg Pike
Falls Church, Virginia 22041
Telephone: (703) 820-4417

Grantham School of Engineering PE-11-72
1505 N. Western Ave., Hollywood, Cal. 90027

Please send me your free Bulletin which explains how the Grantham educational program can prepare me for a degree in electronics.

- I am a beginner in electronics.
- I have a little experience with electronic equipment.
- I am an experienced electronics technician.

Name _____

Address _____

City _____ State _____ Zip _____

CIRCLE NO. 40 ON READER SERVICE CARD

If paging speakers
all seem about alike
to you...wait
'til you get to
the top
of the
ladder
to install
them!



*Electro-Voice
Paging Speakers
... If you pay less
it may cost you more!*

How many trips up the ladder does it take you to finally install a paging speaker? (Be honest and include the times you drop hardware, and the extra trips to change level or positioning). Good news! E-V has made paging speaker installation easier and faster.

Now you need fewer tools and less time to get better sound. Speaker base removes for easy mounting, and it won't fall apart in your hands in the process. There are no screw terminals to short out, pigtailed are already attached, no transformer cover plates to unscrew, and final speaker positioning is simple and positive.

All this and great sound in the bargain. Plus competitive prices on every model. More than a dozen from which to choose. Write today for our catalog or see your nearby Electro-Voice sound merchant.

ELECTRO-VOICE, INC., Dept. 1126P,
630 Cecil Street, Buchanan, Michigan 49107
In Europe: Electro-Voice, S. A., Romerstrasse 49, 2560 Nidau, Switzerland
In Canada: EV of Canada, Ltd., Gananoque, Ontario

Electro-Voice®

a **Gulton**
COMPANY

CIRCLE NO. 12 ON READER SERVICE CARD



Letters

WANTS SOLID-STATE CIRCUITS BOOK

I am interested in obtaining a book of solid-state circuits similar to those which have appeared in the Solid State column in the past. Have these circuits ever been compiled in book form? If not, can you suggest a good book of solid-state circuits?

AARON D. SOLOMON, VE7OC
Dartmouth, Nova Scotia, Canada

The schematic diagrams which have appeared in the Solid State column have never been compiled into book form. Such a book would, of necessity, be large with an attendant price tag. If you are going to get a lot of mileage out of it, we can recommend the \$20 "Circuit Design Manual" by John Markus, McGraw-Hill Book Co., 330 West 42 St., New York, NY 10036.

DISAGREES WITH AUTHOR

I have two comments regarding "Hi-Fi Loudspeakers: Facts & Fallacies" (Part II) in the September issue. First, it was because I agreed with your author on the fallacy of item 40 that I got into trouble. I refused to admit to reality when I started hearing scratching, rasping sounds from an old loudspeaker when played at high volume levels. It was not until the speaker failed due to erosion of a wire in the voice coil that I discovered that the magnet had shifted and was rubbing against the coil.

Secondly, item 50 regarding the reasons why manufacturers do not publish response curves for their speakers would be humorous were it not for the pervasiveness of this very attitude throughout our society. I say, let the public decide on what they should and should not be told about the items they buy. I for one refuse to deal with companies which are unwilling to supply me with this type of information (response curves, for example) on request.

D.L. SCHERMERHORN
Hinsdale, Mass.

Your disagreement with item 40 is interesting in light of the fact that the specific problem referred to was hum in the speaker. In this respect, the author is absolutely correct.

Logically, raspy and scratchy sounds would indicate a mechanical fault with the speaker itself; hum is an amplifier, tuner, recorder, or turntable problem.

Item 50 is, admittedly, a bit controversial. Just where manufacturer disclosures should end is a moot point. But, again, we agree with Mr. Brociner when he states that speaker response curves are very confusing. The average consumer, not to mention many knowledgeable buyers, are not equipped to interpret such curves.

REDESIGNS FET INTERVAL TIMER

After reading "Build The FET Interval Timer" (Sept. 1968), I decided to design my own version using an FET. My results were

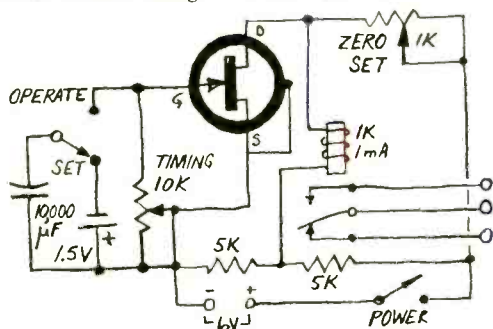

even better than those obtained with the original project. My circuit can be set for from 1 to 101 seconds and has a zero-set for the relay to put in just the right amount of current. I am sending along the schematic diagram of my design, hoping it can be of some use to your readers.

GEORGE BLAKE
Simi Valley, Calif.

REVIEWER CHALLENGED

Your test report on the Heathkit Models IO-103 and IO-105 oscilloscope kits in the Aug. issue (refer to pages 80-82) makes one wonder whether or not you built these scopes at all. Your statement that the checkout and calibration requires the use of only a VTVM or TVM is incorrect (for the IO-103 at least). It is obvious that some calibrated signal source is required to set the sweeps. Line frequency will not do since the high-frequency sweeps have a separate adjustment. It is remarkable that the units met all their specifications, as you "categorically" state, if they were calibrated using nothing but a voltmeter.

R.L. HARRINGTON
San Diego, Calif.

Through an unfortunate editing error, we failed to mention that an accurate time base is indeed needed to set up the sweep in the Heathkit IO-103. The IO-105, however, is set up with its built-in crystal timebase module.



**A Unique
New Concept
in Electronic
Kits!**

BOOK & KIT FOR PRICE OF KIT ALONE:

Yes, for the price of a kit alone, you get a complete kit to help you start building and learning—PLUS a book by an electronics expert, loaded with scores of ideas and plans for projects you will want to build! Each kit contains all the necessary parts to construct the unit.

AUDIO MIXER—Mixes audio from 3 sources!—This FET mixer has a 3-channel input—mixes sound from all three without circuit loading or impedance mismatching. Book is "125 One-Transistor Projects." Order No. K-1 (Total value \$11.90) **\$7.95**

5-WATT HI-FI AMPLIFIER—High power transformerless circuit!—This hi-fi amplifier will provide 5 watts or more of audio into any 3-4 ohm speaker. No preamps or transformers required. Book is "125 One-Transistor Projects." Order No. K-2 (Total value \$13.90) **\$9.95**

ELECTRONIC FORTUNE TELLER—Have fun with the laws of chance!—As a mystery fortune teller, this fun device will answer all yes-no questions at the touch of a button. Book is "104 Easy Projects for the Electronics Gadgeteer." Order No. K-3 (Total value \$8.90) **\$4.95**

AM WIRELESS MIKE—Broadcasts through any AM radio!—This wireless mike will "broadcast" through any AM radio set...from up to 100 ft. away. Book is "Transistor Circuit Guidebook." Order No. K-4 (Total value \$11.90) **\$6.95**

ELECTRONIC TOUCH SWITCH—Touch and light goes on!—This modern device automatically switches on body contact. Lamp automatically comes on when switch is touched, goes off when contact is stopped. Book is "Practical Solid-State Principles and Projects." Order No. K-5 (Total value \$10.90) **\$6.95**

AUTOMATIC LIGHT-SENSITIVE GARAGE LIGHT CONTROL—Unit switches when light hits it—Auto headlights will turn on either inside or outdoor garage lights. Turn them off manually when safely inside. Book is "Practical Solid-State Principles and Projects." Order No. K-6 (Total value \$13.90) **\$9.95**

AUDIO SIGNAL GENERATOR—Use as a tester, audio oscillator, or RF generator!—Makes a precision instrument for checking frequency response of amplifiers and for signal tracing. Can be used as a stable tone oscillator or as an RF signal generator. Book is "Practical Solid-State Principles and Projects." Order No. K-7 (Total value \$9.90) **\$5.95**

LOW-VOLTAGE DC POWER SUPPLY—Well filtered, half-wave miniature circuit—An effective DC power source (10V, 1A) for test bench applications, powering transistor circuits, charging batteries, etc. Book is "104 Easy Projects for the Electronic Gadgeteer." Order No. K-8 (Total value \$8.90) **\$4.95**

DIODE TESTER—Checks diodes in or out of circuit!—This diode tester gives a quick go, no-go test for all types of diodes. Also identifies polarity of unmarked diodes. Book is "104 Easy Transistor Projects." Order No. K-9 (Total value \$9.90) **\$5.95**

HIGH POWER LAMP DIMMER—Replaces wall-mounted light switch—Provides full adjustment of lamp brilliance. Handles any number of lamps up to 1000 watts. Book is "104 Easy Transistor Projects You Can Build." Order No. K-10 (Total value \$8.90) **\$4.95**

Book/Kits available at leading parts distributors or use coupon below.

NO RISK COUPON—MAIL TODAY

TAB BOOKS, Blue Ridge Summit, Pa. 17214

\$ _____ Enclosed (Send postpaid).

Please invoice me plus Shipping.

Please send the Book-Kits checked below:

K-1 _____ K-2 _____ K-3 _____ K-4 _____ K-5 _____
K-6 _____ K-7 _____ K-8 _____ K-9 _____ K-10 _____

Name _____ Phone _____

Address _____

City _____ State _____ Zip _____

Foreign orders must be prepaid. Foreign prices 10% higher than those shown. Pa. residents add 6% sales tax. PE-112

CIRCLE NO. 34 ON READER SERVICE CARD

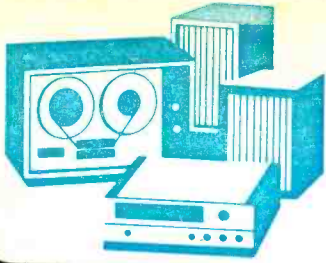

Stereo Scene

By J. Gordon Holt

AN AUDIOPHILE of my acquaintance—a man whose business life is an example of efficiency, organization and exactitude—has one of the most chaotically disorganized hi-fi systems I have ever encountered. To begin with, he is one of those people of more-than-moderate means who is able to indulge his whims quite often when it comes to new equipment purchases.

But what causes the real problem is that he does not like to dispose of old equipment. As long as an amplifier or a preamp or a tape recorder works properly, it not only stays on the premises, it also continues to be a part of the system. Sometimes the old equipment will have suitable wiring and switching to permit it to be selected for use at will; but more often it is left disconnected, with output cables dangling, to be plugged somewhere into the system whenever needed. The rear of his equipment shelves (one of those big gray-painted steel affairs sold for use in industrial stock rooms) is so festooned with dangling cables it looks like badly barbered bangs, and not one of the cables is identified.

Every time he wants to connect a piece of equipment into the system, he must start at the component itself and trace each cable coming from it all the way to the other end, sometimes untangling it from spaghetti-like clumps of other cables on the way. When a piece of equipment in the system malfunctions, or when he can't remember what items he was using last time the system was

fired up, he has been known to spend the better part of a long evening plugging and unplugging cables and doggedly tracing each to its end, muttering darkly under his breath. Meanwhile his guests sit around with their newest records on their laps, drinking beer and talking about the latest super-powered amplifiers or the long-term future, if any, of quadrasonic sound. More often than not, he has ended up just unplugging everything, kicking the tangled mess of loose ends under his work bench, and using four or six more cables from his seemingly limitless supply to wire together the components we all came over to hear.

It isn't that he doesn't know what to do about the situation. In fact, every time I visited him, he explained that he hadn't gotten around yet to labeling his cables, but would as soon as he had time. But if you pursued the question a bit, the thing that might *really* be his problem started to emerge: "How," he would ask, "could I possibly label a pair of plugs that will go into TAPE IN sockets on some occasions, AUX sockets on other occasions, and LINE IN sockets on others?" How indeed?

Cable identification is an unnecessary affectation when a system consists of only three or four components, all of which are in plain sight on a shelf, for you can see where any one wire goes just by glancing at it. But when a system gets more complex, and/or when the components are cabinet-mounted, with interconnecting wires disap-

Connections & Interconnections— Keeping Things Straight



8 Sams Books to update and broaden your Electronics Skills

Three are newly revised editions . . . 5 are brand new this fall . . . all will be valuable additions to your library.

ABC'S OF LASERS AND MASERS (3rd Edition)

By Allan Lytel and Lawrence Buckmaster
The completely updated explanation and review of the development and applications of lasers and masers in measurements, communications, medical surgery, and industrial usages. 126 pages; 5½" x 8½"; softbound.
No. 20863 \$3.50

99 WAYS TO IMPROVE YOUR SHORTWAVE LISTENING (NEW)

By Len Buckwalter
A valuable source of information for both hobbyist and experienced technician. Includes: antennas and installation, receiver improvements, accessories, interference sources, troubleshooting tips, listening techniques. 144 pages; 5½" x 8½"; softbound.
No. 20911 \$3.95

101 QUESTIONS AND ANSWERS ABOUT AM, FM, & SSB (NEW)

By Leo G. Sands
Easy-to-understand information about the three basic modulation techniques and the various types of transmission. Describes best uses, technical aspects and limitations of each in a Q&A format. 96 pages; 5½" x 8½"; softbound.
No. 20919 \$3.95

1-2-3-4 SERVICING STEREO AMPS (NEW)

By Forest H. Belt
Details the "divide and conquer" method of troubleshooting and servicing stereo equipment and shows how to apply the method for best results. Many illustrations and schematics in this clear, easy-to-read manual. 240 pages; 5½" x 8½"; softbound.
No. 20912 \$4.95

NORTH AMERICAN RADIO-TV STATION GUIDE (8th Edition)

by Vane A. Jones
Lists nearly 10,000 a-m, fm and television stations in the U.S., Canada, Mexico, and the West Indies. Includes: power (day and night), antenna height, and time sharing. Arranged by geographical location, frequency (or channel), and call letters. 160 pages; 5½" x 8½"; softbound.
No. 20915 \$3.95

ABC'S OF INDUSTRIAL ELECTRONICS (NEW)

By J. A. Wilson
Covers the circuits and applications of electronics used in manufacturing, together with all types of electronics systems that are not designed for home entertainment. Tells and shows how electronics have improved on old-time methods of machine and process controls. 96 pages; 5½" x 8½"; softbound.
No. 20913 \$3.95

FM MULTIPLEXING FOR STEREO (3rd Edition)

By Leonard Feldman
Analyzes the fm stereo signal; gives requirements for fm stereo receiver; covers multiplex decoder circuit variety and servicing, stereo indicator lights and automatic stereo switching; test equipment and alignment procedures. 176 pages; 5½" x 8½"; softbound.
No. 20910 \$4.95

MARINE SINGLE SIDEBAND (NEW, NOT SHOWN)

By Donald M. Stoner and Pierre B. Goral
Fills a void in published literature on the subject of Marine Single Sideband, the method by which all marine electronic voice communications must soon be carried out. Covers all facets of Single Sideband in marine communications. 192 pages; 5½" x 8½"; softbound.
No. 24029 \$5.95

HOWARD W. SAM'S & CO., INC.
 4300 West 82nd Street, Indianapolis, Indiana 46226

Order from your Electronics Parts Distributor, or mail to Howard W. Sams & Co., Inc.

Send books checked at right, \$_____ enclosed.
 Please include sales tax where applicable.
 Canadian prices slightly higher.

Send Free 1972 Sams Book Catalog.

| | |
|--------------------------------|--------------------------------|
| <input type="checkbox"/> 20f63 | <input type="checkbox"/> 20915 |
| <input type="checkbox"/> 20911 | <input type="checkbox"/> 20913 |
| <input type="checkbox"/> 20919 | <input type="checkbox"/> 20910 |
| <input type="checkbox"/> 20912 | <input type="checkbox"/> 24029 |

Name _____
 Address _____
 City _____ State _____ Zip _____

PE-112

CIRCLE NO. 28 ON READER SERVICE CARD

pearing into and appearing from holes between compartments, cable identification can save considerable time and effort whenever you have to plug something else into the system. And if you ever have to call in a service technician to troubleshoot your system, clear identification of cables can sometimes save money since you won't have to pay the technician's time while he traces each one and hangs his own labelling tags on the ends of them.

What, exactly, should we know about any dangling cable plug? We should know where it comes from, where it goes, and which channel it is supposed to carry from here to there. All this data can be gleaned from a suitably color-coded label. Here's how:

For simplicity's sake, both ends of each cable should carry the same basic color. And since every interconnection in a stereo system involves two cables, it makes sense to make both cables the same color, as long as we have the means for distinguishing left channel from right channel. We have. If each wrapped label carries the base color along only about $\frac{3}{4}$ of its length, we can use the remaining space for a ring of black to indicate left channel or a ring of red to indicate right channel. And if we put the channel-identifying ring on the side of the label towards which the signal is moving, we have an instant indicator as to whether that is the end of the cable that plugs into, say, the TAPE OUTPUT or the AUX INPUT on the recorder.

What to Use. The cheapest and easiest way of applying the color identifications is to use small ($\frac{1}{2}$ by $\frac{3}{4}$ inch) gummed paper labels, wrapped around each cable right behind its plugs, and colored with felt-tipped marking pens. The labels, available from many stationers' stores, should be of the kind that you lick rather than of the self-adhesive variety. The latter tend to unwrap in time, and the adhesive gets gummy and sticky through interaction with plasticizer in the cable insulation. To attach each label, moisten it, wrap it around the cable, and roll it between your fingers until the adhesive sticks. It will then, frequently, be loose to slide along the wire, in which case you slide the label back from the plug, put a dab of contact cement on the cable, slide the label back over this while it's still wet, and roll it between the fingers a few times.

The colors used should be sufficiently different from one another to enable a person with normal color memory to match colors without having to compare them side by side. A suitable spectrum might consist of black, brown, red, orange, yellow, yellowish green, late-summer-grass green, greenish blue, blue, magenta (purple), gray and white. White, of course, means no color on the label, but the other colors should be obtained in the cheapest waterproof-ink marking pens you can buy—preferably ones with a pointed rather than a chisel-shaped tip.

The colors listed will allow you to completely code twelve *pairs* of cables, which should be enough for practically any installation. If it isn't, you can expand the variety by using two wide bands of color around every four labels instead of the single base color, but in this case, the bands should adjoin instead of being separated by a white stripe. Since you may now use reverse combinations of colors (for example: red channel-identifying stripe with green and yellow bands, or red stripe followed by yellow and green bands), there are enough possibilities that you need never again confuse any cable with another.

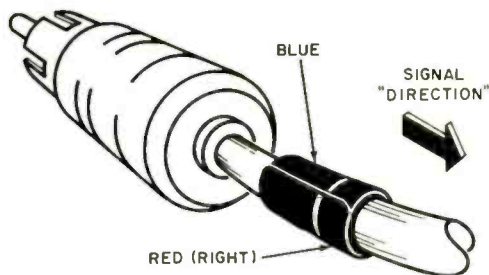

Wide blue band designates signal on color-coded band installed on cable.

It is easier to color the labels before they are put on the wires so the first thing to do is to use each pen to color $\frac{3}{4}$ of each of four labels. Then take the black pen and put the edge stripe on two of the labels, and do the same thing in red on the other two, leaving a small border of white between the colors. Finally, fasten the labels to the wires with both red-striped ones on the same wire and with the stripes toward the left (or the right, but both the same), and both black-striped ones on their wire with their stripes to the same side as before. The diagram on the next page shows how they should be.

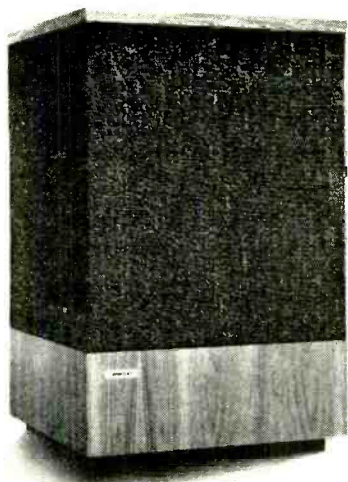

Ask your franchised dealer* to A-B the BOSE 501 with any speaker he carries that uses woofers, tweeters and crossovers.

There is an important reason why we ask you to make this test. There are inherent limitations of performance in the use of a woofer, a tweeter and a crossover—limitations covered in detail in earlier issues. The bypassing of these limitations played a large part in the advances which have made the BOSE 901 the most highly reviewed speaker, regardless of size or price.

We set out to design a lower priced speaker which would preserve as much as possible of the performance of the 901. Most important, we were able to design into the 501 much of the 901's great advance in spatial properties. The BOSE 501 is the second DIRECT/REFLECTING® speaker system.

But it became evident that there was no way to keep the advantages of multiple small full-range drivers and equalization. The cost problem was too great. We were forced to accept the woofer-tweeter-crossover combination as the only feasible compromise and set out to achieve the fullest possible realization of this design approach.

Our engineers designed a unique woofer with an unusually long voice coil which provides tight control of bass transients. They developed a new and different approach to crossing over the outputs of the woofer and the two tweeters. In the process they became convinced that in terms of quality of performance there is no acoustical reason to spend more than \$125 on any speaker containing woofers, tweeters and crossovers.

The design goal of the 501 was to outperform any other woofer-tweeter-crossover speaker. You be the judge. If we have succeeded, the results will be obvious to you when you make the comparison.

*Literature sent in answer to your request will include a list of franchised BOSE dealers in your area who are capable of demonstrating BOSE speakers to their full performance.

Patents applied for.

NATICK, MA. 01760

BOSE®

You can hear the difference now.

CIRCLE NO. 4 ON READER SERVICE CARD

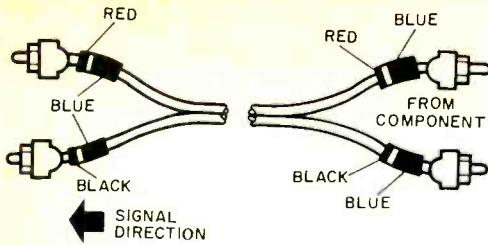

Narrow red and black bands indicate directions on pair of stereo cables.

If there is a "standard" hookup for your components that you return to after each bout with a new piece of equipment, it is helpful to mark the receptacle that each color-coded cable end goes into. For this, you'll need a sheet of *round* self-adhesive labels of between $\frac{3}{8}$ and $\frac{1}{2}$ inch in diameter. Since channels are clearly marked on most components, or are easily determined by position (left is usually the upper receptacle of a pair), the round labels need only bear the base color of the two wires going to those receptacles. If the base "color" is two bands, half of the round label can be each color.

A problem might arise here if you found it necessary to use any reverse combinations of base colors. With half of the circle in each color, there would be nothing to indicate the order of the colors (as the channel-identifying stripe allows us to do on the cable markings). In this case, the simplest thing to do is leave one edge of the round label uncolored, so the white edge can correspond to the white band on the cable label, and the color next to that becomes the "first" color. (But don't use white as a base color.)

Invisible Backs. There is only one thing that can make a shambles of this neat little marking system. If you cannot see the backs of your components without pulling the equipment cabinet away from the wall, those pretty colors on the loose ends of dangling cables won't mean much. You'll still be able to tell which channel is which, and which wires come from outputs and which go to inputs, and this may be all the information you need. Most cabinet systems have only four dangling cables, for the connections to an external tape recorder, and you can make the necessary connections properly with the clues on hand. But what to do if there are more than four? This is easy. You make up round labels with

the base color of the wires coming from each component, and put them in some unobtrusive spot on the *front* of the appropriate components. And in the rare case of a preamplifier that has *two* sets of tape monitor connections, you can cut your colored round label in half (or smaller if necessary) and fasten it to the front panel right next to the markings that say TAPE MON 1 and TAPE MON 2.

What About Speaker Cables? Thus far, we've concentrated on the problem of identifying shielded signal cables. What about loudspeaker cables? The same system applies, except in this case it is necessary to be concerned with the electrical polarity of the connections as well as their continuity. (Cable-plug connections cannot be made the wrong way; loudspeaker connections can.) There are, of course, four connections to each speaker cable—two at each end. What we must do to maintain proper polarity (phasing) is to determine which wire at one end corresponds to which wire at the other end of the cable.

In most cases, this is simply a matter of observation. The molded lamp cord or "zip cord" frequently used for speaker connections nearly always has a molding seam—a

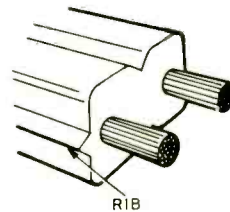

In most cases, zip cord for speakers has a small molding rib on one side.

tiny ridge—running the entire length of one wire. As long as the cable has never been cut and rejoined anywhere along its length, you can be certain that the seamed wire at one end corresponds to the seamed wire at the other end, and these are the wires that should be marked with our twist-around labels.

In rare cases, you may encounter a zip cord that doesn't appear to have a molding seam. Most of these will be found to have different-colored inner conductors, with one copper-colored and the other silver-colored; and this will serve to establish the continuity that is required.

If there is no visible difference at all be-

A NEW STANDARD!... THE 7400 SCIENTIFIC & ENGINEERING CALCULATOR

THE MOST POWERFUL SCIENTIFIC CALCULATOR FOR UNDER \$500.00

The price of the 7400 is low enough to make a desk top computer available to almost anyone.

SIGNIFICANT FEATURES NOT FOUND IN MOST COMPETITIVE MACHINES

- DYNAMIC RANGE: 10⁻⁹⁹ to 10⁹⁹
- DATA STORAGE: 2 Auxiliary Storage Registers plus up to 7 push-up Stack Registers.
- Roll up and roll down keys for complete control of operational stack
- Interfacing provisions for printer and programmer
- Correct X (Allows the operator to correct one digit, without re-entering the whole problem)
- Polar to Rectangular conversion and Retangular to Polar conversion

DISPLAY: Either full floating or scientific notation, 14 large, easy-to-read digits.

SIZE: 8½" x 12" x 3½"

7400A 3 Registers

7400B 5 Registers

7400C 7 Registers

WEIGHT: 4 lbs.

Kit \$299.95

Assembled \$379.95

Kit \$319.95

Assembled \$399.95

Kit \$399.95

Assembled \$419.95

PRICES INCLUDE CARRYING CASE

MITS will repair any 7400 for a fee of \$25.00 for a 5-year period after the normal 1-year warranty has expired.

Use Your BankAmericard or Master Charge



MITS

WRITE OR MAIL COUPON FOR
ADDITIONAL INFORMATION:

**MICRO INSTRUMENTATION
& TELEMETRY SYSTEMS, Inc**

2016 San Mateo NE, Albuquerque, New Mexico 87110 505-266-2330

ENCLOSED IS CHECK FOR MODEL # _____ Kit
 Assembled
 AMOUNT OF CHECK (Include \$5.00 for Postage & Handling) \$ _____
 I am interested in additional information.
 NAME _____
 ADDRESS _____
 CITY _____
 STATE _____ ZIP _____

CIRCLE NO. 21 ON READER SERVICE CARD

tween the wires (as is seldom the case), all is not lost. You can check continuity by using each speaker cable in turn as a jumper to bridge a broken connection to a loudspeaker.

Here's the procedure. Completely disconnect one speaker cable from the loudspeaker.

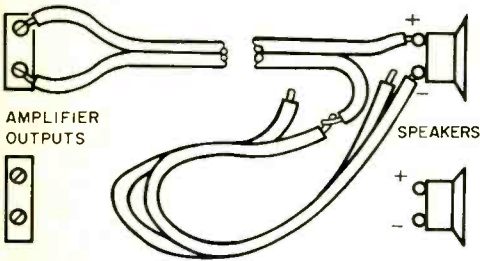

Making continuity test to establish proper phasing for stereo speakers.

er and from the amplifier, and bend it double so that all four wire ends are near each other (but not touching). Disconnect one wire from the other speaker, and join it to any one of the four wires from the disconnected cable. Now, touch each of the remaining three in succession to the previously disconnected speaker terminal. The one that restores the sound is the other end of the wire twisted to the other wire, and these two ends should be marked with an identifying label. Reconnect this cable, using the marked wires for the "hot" connections at both ends, and then completely disconnect the other speaker wire and check it out the same way. (You can also simply tie a knot at both ends of one of the conductors, leaving the other conductor with unknotted ends.)

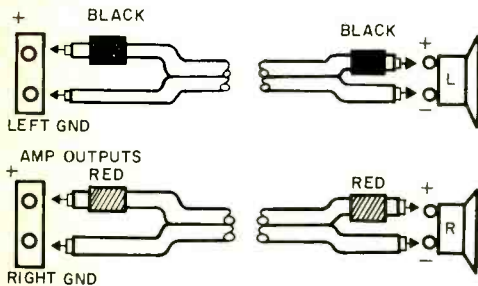

Put markers on the positive leads of cables going to two stereo speakers.

If there are only two speaker cables, logic would dictate that one be color-coded red (for right) and the other black (for

left). The same color would, of course, be used at both ends of each wire. If you need other speaker-wire pairs, start digging into the other colors, but put a red or black stripe at the end of each of these other basic colors to indicate channel orientation.

Are You Color Blind? Finally, since it is known that color-blindness is a common affliction, we come to the problem of identifying cables without using colors. In this case, there is no alternative but to use written identifications, which call for slightly larger gummed labels ($\frac{1}{8}$ by $1\frac{1}{4}$ inch) but only two marking pens—red and black. (Red/black color blindness is exceedingly rare.) Instead of wrapping the label around the cable like a tube, it is sandwiched over the cable, and the identifying legend is written in on both sides of the label in any abbreviation system that makes sense to

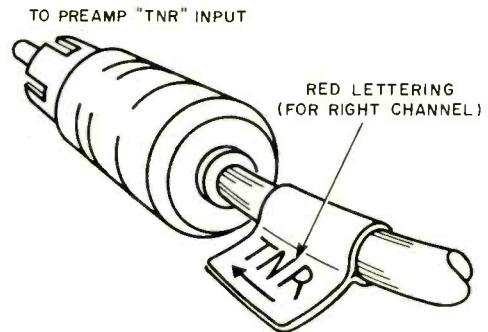

If color coding is out, install this kind of label with simple lettering.

you. For example, a right-channel cable normally used for tuner connections might say TNR at both ends, with arrows to indicate the "flow" of signal. Or, for greater flexibility, you might use identifying numbers instead of specific descriptions, again with arrows indicating which end of each cable goes to, and which from, each component. The latter arrangement would lend itself to the use of round-label markings at the receptacles, but the writing on these would be so small that it would be probably easier in the long run to read the legend right on the back panel of the component.

My audiophile friend, having no trouble with color blindness, was eternally grateful to me for showing him how to organize his system to eliminate all wiring confusion in future. But he has yet to buy his labels or marking pens. ♦

Write for Dixie's Wholesale Stereo Catalog (save on dynaco & everyone else)

**Save More by Mail from Dixie Hi-Fi...
Write Now for Our FREE 36 Pg. Wholesale Catalog**

When you can save over 50% and no less than 20% on the big names in Hi-Fi — it makes good sense to write for our Free 36 page Wholesale catalog.

DIXIE, one of the country's top stereo wholesalers, fills all orders promptly. At prices actually lower than "Discounters".

For over 14 years, we've built our mail-order business with Hi-Fi buffs because

we are actually wholesale. (Incidentally, the new Dixie Catalog is full of the new four channel equipment and software.)

We'll immediately answer mail or phone requests for quotes. All items are shipped factory-sealed and guaranteed.

Write today for your Free Wholesale Catalog!



Convenient! BankAmericard & Master Charge
Honored on Mail Orders!



You can't beat the *dynaco* system

(Especially when it comes from Dixie!)

Dynaco is just one of many brands you'll find in the new Dixie Catalog. And, whether you assemble the superlative new AF-6 AM/FM Stereo Tuner and the Stereo-400 Power Amp by yourself or get it already wired — You're assured of the ultimate in accuracy and power at the lowest possible cost.



DIXIE

**HI-FIDELITY
WHOLESALE**

Dept. PE-11
10140 Bacon Drive
Beltsville, Md. 20705
Phone 301-937-3090

Write Today for FREE Wholesale Catalog

CIRCLE NO. 10 ON READER SERVICE CARD

RCA Institutes Home Training may be
your best investment
for a rewarding
career in electronics

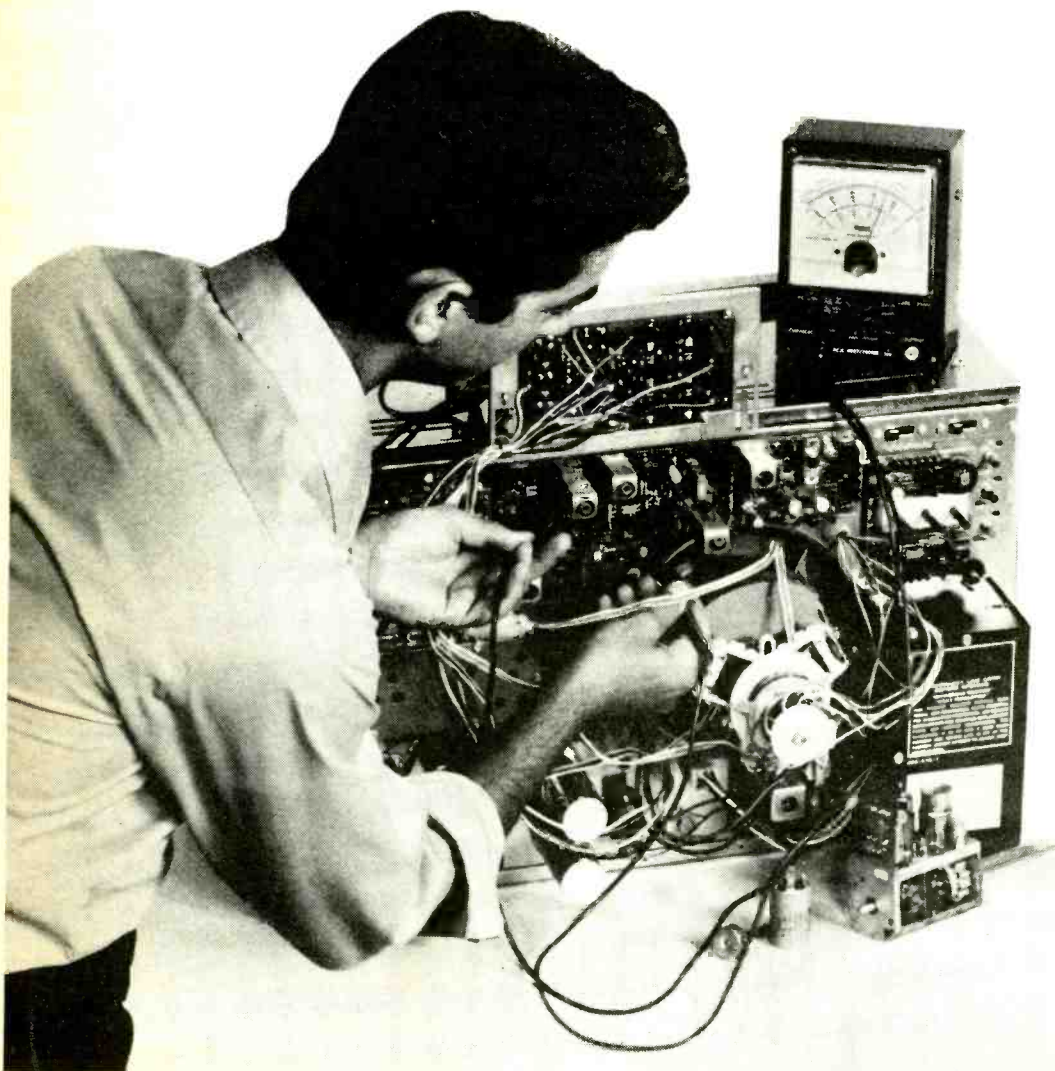

1 LEADER IN ELECTRONICS TRAINING

For over half a century, RCA Institutes, Inc., a subsidiary of RCA, has been a leader in resident school technical training in electronics. For many years, it has offered home study training in electronics.

2 RCA AUTOTEXT TEACHES ELECTRONICS RAPIDLY, EASILY

Beginner or refresher, AUTOTEXT, RCA Institutes' own method of programmed Home Training will help you learn electronics rapidly, easily.

3 WIDE CHOICE OF CAREER PROGRAMS

Start today preparing for an electronics career. On the attached card is a list of "Career Programs," each of which starts with the amazing AUTOTEXT method of programmed instruction. Look the list over, pick the one best suited to you and check it off on the card.

4 SPECIALIZED ADVANCED TRAINING

For those already working in electronics or with previous training, RCA Institutes offers advanced courses. You can start on a higher level without wasting time on work you already know.

5 PERSONAL SUPERVISION THROUGHOUT

All during your program of home study, your exams are reviewed and your questions are answered by RCA Institutes instructors who become per-

sonally involved in your efforts and help you over any "rough spots" that may develop.

6 HANDS-ON TRAINING

To give practical application to your studies, a variety of valuable kits are included in many programs. In RCA's Master TV/Radio Servicing Program, you will actually build and keep an all solid-state black and white TV set, and a color TV set. You also construct an oscilloscope which is yours to keep and use on the job.

7 FCC LICENSE TRAINING - MONEY BACK AGREEMENT

Take RCA's Communications Career Program - or enter with advanced standing and prepare immediately for your 1st, 2nd, or 3rd class FCC Radio Telephone License examinations. RCA Institutes money-back agreement assures you of your money back if you take, and fail to pass, the FCC examination taken within 6 months after completing the course.

8 CONVENIENT PAYMENT PLANS

You get a selection of tuition plans. And, we are an eligible institution under the Federally Insured Student Loan Program.

9 RCA INSTITUTES IS FULLY ACCREDITED

RCA Institutes is licensed by N.Y. State and is accredited by the Accrediting Commission of the National Home Study Council. Its courses of study, faculty and instructional facilities

are approved by the State Education Department. In addition, all RCA Institutes courses and programs require the approval of the RCA Institutes Board of Technical Advisers who represent various technical, research and educational activities of RCA Corporation.

Approved by N.Y. State Education Dept. for the training of veterans.

SEND ATTACHED POSTAGE PAID CARD TODAY! FREE DESCRIPTIVE BOOK YOURS WITHOUT OBLIGATION!

If reply card is detached, send this coupon

RCA INSTITUTES, INC.
DEPT. 694-211-0
320 W. 31 ST.
NEW YORK, N.Y. 10001

Please send me FREE illustrated career catalog. I understand that I am under no obligation.

Name _____

Address _____

City _____

State _____ Zip _____

Age _____

Veterans Check here

RCA



In the Master TV/Radio Servicing Program you build and keep the all solid-state black and white TV set, the color TV set, the oscilloscope and the multi-meter shown above.

CIRCLE NO. 29 ON READER SERVICE CARD



POULTRY

MEATS

MANAGEMENT

Have you had a job interview lately where you really felt needed?

Let's face it. It's tough to get a good job without experience. And how much experience can you have fresh out of high school?

If you'd like a job interview where you'll really feel needed, see your Army Representative.

He's got over 200 job-training courses to choose from. Construction, transportation, computers, you name it. If you're qualified, you'll get it. Guaranteed.

You'll get paid well for it, too. Today's Army starts you at \$288 a month, and that's over and above the free meals, free housing, free medical and dental care, and 30 days paid vacation each year.

Most importantly, the skill you learn in the Army is yours to keep. So even if you don't make the Army a career, you'll have a good start on a career of your own. Including up to 36 months of financial assistance at the college of your choice.

For the location of your nearest Army Representative, call 800-243-6000, toll free. (In Connecticut, call 1-800-822-6500.)

**Today's Army
wants to join you.**

| | |
|---|--------------------------|
| Army Opportunities Dept. 200, Hampton, Va. 23369 | Date _____ 2PE 11-72J |
| I'd like to know more about job-training and promotion in today's Army. | |
| Name _____ | Date of birth _____ |
| Address _____ | |
| City _____ County _____ | |
| State _____ | Zip _____ Phone _____ |
| Education _____ | |

The new Dual 1229.

For those who want nothing less than a full-size professional turntable.

If you now own a 1219, we don't believe you'll want to rush right out and trade it in for its successor, the 1229. But if you have been considering a 1219, we do believe the additional refinements of the 1229 will bring you closer to a decision.

For example, the 1229 has a built-in illuminated strobe for 33-1/3 and 45 rpm. With a typical Dual innovative touch: an adjustable viewing angle that you can set to your own most comfortable position.



Stylus pressure dial calibrated in tenths of a gram from 0 to 1.5 grams; in quarters of a gram from 1.5 to 3.0 grams.

Another refinement is on the stylus pressure dial which is now calibrated in tenths of a gram from 0 to 1.5 grams. This provides finer control in setting optimum stylus pressure for today's finest cartridges, designed for tracking in this range.

Such refinements, while giving you more control over your Dual, don't actually affect its performance. Dual performance is a function of the total precision inherent in the design which has long made Dual's premier model the best-selling "high-end" turntable of them all.

The gyroscope is the best known scientific means for supporting a precision instrument that must remain perfectly balanced in all planes of motion. That is why we selected a true gyroscopic gimbal for the suspension of the 1229 tonearm. This tonearm is centered and balanced within two concentric rings, and pivots around...



The new Dual 1229, \$199.50 less base.

their respective axes. Horizontal bearing friction is specified at less than fifteen thousandths of a gram, and Dual's unerring quality control assures that every 1229 will meet those stringent specifications.

The platter of the 1229 is a full-size twelve inches in diameter, and cast in one piece of non-magnetic zinc alloy. Each platter is individually dynamically balanced. Dual's powerful continuous-pole/synchronous motor easily drives this massive seven pound platter to full speed in one quarter turn.

A turntable of the 1229's caliber is used primarily in its single-play mode. Thus, the tonearm was specifically engineered to perform precisely as a manual tonearm: parallel to the record instead of tilted down. For multiple play, the Mode Selector raises the entire tonearm base to parallel the tonearm to the center of the stack.

All these precision features and refinements don't mean that the Dual 1229 must be handled with undue care. On the contrary, like all Duals, it is quite rugged and virtually foolproof.



Illuminated strobe with adjustable viewing angle: from directly overhead to 20° away.

So we're not being rash when we include a full year guarantee covering both parts and labor. That's up to four times the guarantee

you'll find on other automatic units.

Visit your franchised United Audio dealer and ask for a demonstration.

We believe you will join the other "purists" who prefer Dual.



United Audio Products, Inc., 120 So. Columbus Ave., Mt. Vernon, N.Y. 10553
Exclusive U.S. Distribution Agency for Dual.

CIRCLE NO. 36 ON READER SERVICE CARD



News Highlights

REACT CB'ers Help Out in Flood Disaster

The increasingly important role played by volunteer civilian radio communications groups in responding to emergencies was dramatically—and tragically—underscored during the Rapid City, South Dakota flood disaster. There was remarkable cooperative activity in Rapid City among REACT CB teams, government, radio amateur and Red Cross groups. Among the casualties of that disaster were five REACT team members who gave their lives attempting to help their neighbors.

New In-Line Color TV Picture Tube

A new 19-in. in-line color picture tube will be introduced by GE next spring. The new tube will be up to two inches shorter and four pounds lighter than its predecessors. In addition to the new in-line beam arrangement, the tube will use a slotted mask-screen assembly and a black matrix surround. The new tube requires fewer convergence adjustments—only four compared to twelve in the conventional delta-arranged electron guns.

New Radiation Standards for Diagnostic X-ray Machines

The Food and Drug Administration acted recently to make X-ray examinations safer for millions of Americans by establishing new radiation protection standards for diagnostic X-ray machines and components. The new standard specifies improvements manufacturers must make to reduce X-ray exposures from equipment produced after August 15, 1973. The standard will require that all types of equipment be capable of restricting the beam to the size of the X-ray film or fluoroscope receptor. Under specified conditions, the standard states, the leakage shall not exceed 100 milliroentgens in one hour at a distance of one meter from the X-ray tube assembly.

Student Experiments Selected for Skylab

Experiments proposed by 19 high school students from 16 states have been approved for the earth-orbiting, manned Skylab space station in 1973. The 19 experimenters are from the 25 national winners selected by the National Science Teachers Association earlier this year. The proposals were selected from over 3400 submitted by U.S. secondary school students. Skylab is an experimental space laboratory that will be orbited next year to conduct experiments from the vantage point of space. The first manned mission, with three astronauts, will last up to 28 days; the second and third three-man missions are planned to last up to 56 days.

Another Quartz All-Electronic Watch

Joining the ranks of companies who have offered quartz all-electronic watches is Microma Universal Inc., Mountain View, Cal. Evaluation quantities of the solid-state watch movement are available to the timekeeping industry at \$110 each. Utilizing a quartz crystal as the 32,768-Hz time base, the movement achieves accuracies of better than 5 seconds a month. Time is read by means of a liquid-crystal

digital display, which is composed of four digits showing hours and minutes. Seconds are indicated by a flashing colon between the two pairs of figures.

Minority-Group Research Scientists

A new program designed to find, develop and hire more candidates from minority groups for its research staff has been started by Bell Labs. The program offers outstanding minority-group college graduates a combination of tuition, living expense stipends, and summer employment in a research lab while they study for masters and doctorate degrees. Participants who complete the program and earn the doctorate degree will be reviewed for appointment to a research post in the Labs. Candidates who do not continue in the program may be considered for employment in technical areas other than research.

Institute of High Fidelity Elections

Results of recently held elections for posts in the Institute of High Fidelity (IHF) are as follows: President, Herb Horowitz (Empire Scientific); Vice President, Bernie Mitchell (Pioneer Electronics); Treasurer, Walter Stanton (Pickering/Stanton Magnetics); Secretary, Bill Kasuga (Kenwood Electronics); members of the Board of Directors: Arthur Gasman (British Industries); and Jerry Kaplan (Panasonic). The following members of the Board of Directors are already seated and have one year remaining in their terms: Stan Grossman (Rectilinear Research); Don Palmquist (Altec); and Hiroshi Tada (Sansui Electronics).

Hams Warned by FCC About Commercial Traffic

The FCC has evidence that a number of hams have been using phone-patch and auto-patch repeaters for commercial communications. Both systems permit direct interconnection to the regular telephone system. A ham, for example, operating on vhf in a vehicle may readily trigger a remote repeater which can then be automatically tied in to the phone lines; he may then easily communicate with practically anyone with a telephone. Use of interconnection equipment is not prohibited by the FCC Rules. However the above type of operation encourages commercial or business communications, which are not permissible in the Amateur Service.

Joint Domestic Communications Satellite Program

Fairchild Industries of Germantown, Md. and Western Union International of New York, N.Y. have established jointly a new domestic communications satellite business. The two companies agreed to form a new corporation to be owned equally by the companies involved. This corporation will be headquartered in the Washington, D.C. area and will pursue the obtaining of an FCC license for a domestic satellite.

EIA of Japan Denies Charges of Dumping

The Electronic Industries Association of Japan has formally denied charges that Japanese consumer electronic products manufacturers receive substantial export subsidies. EIA-J also attacked the "hypocrisy" of complainants Zenith and Magnavox who, among others "have themselves benefited from substantial outright subsidies offered by the Government of Taiwan and Mexico to promote exports, to the United States, of television sets and other consumer electronic products produced by their subsidiaries in these countries." In its reply to charges which are being investigated by the Treasury Department, the EIA-J requested the Department to dismiss the complaints.



FREE

send today for the all-new

Olson

1973 CATALOG

NOW the only catalog offering a wide selection of the best of **THE FAMOUS ELECTRONIC BRANDS** plus the exclusive Olson values!

ALL-NEW ANNUAL

save now on everything in electronics

YOUR COMPLETE BUYING GUIDE
Big! Beautiful (many full-color pages!) Value-packed! Your one dependable source for everything in audio and electronics. Enjoy every buying advantage at Olson: low money-saving prices, fastest shipment, personal service, satisfaction guaranteed or money back.

Olson Exclusive Values

Besides the best of the famous brands you'll find 100's of money-saving items sold only by Olson. See our all-new TELEDYNE stereo line, recorders & radios, parts bargains.

more of the best of everything in electronics

Olson Electronics
where the values are!

- Stereo components & the newest in 4-channel
- Tape recorders & recording accessories
- Radios & phonographs of all kinds
- Money-saving do-it-yourself kits
- Auto electronics & accessories
- Citizens Band two-way radios
- VHF & UHF police/fire monitors
- Amateur radio station equipment
- Public address & intercom systems
- Test Gear • Parts bargains
- Electronic security equipment
- TV-FM antennas & accessories
- Books, tools, hardware, parts
- Batteries, transistors, tubes, wire, cable, & more!



MAIL COUPON NOW

OLSON ELECTRONICS Dept. 1Z, 260 S. Forge St., Akron, Ohio 44327

Rush FREE 1973 Olson catalogs to:

Name _____ Apt. _____
 Address _____
 City _____
 State _____ Zip _____

Name _____ Apt. _____
 Address _____
 City _____
 State _____ Zip _____

CIRCLE NO. 22 ON READER SERVICE CARD



RECEIVERS for the SHORTWAVE LISTENER

FEATURES

TO LOOK FOR IN

SELECTING SW RECEIVERS ALONG WITH
LAB TESTS ON 5 TYPICAL COMMUNICATIONS SETS

PART 1

BY JULIAN D. HIRSCH Hirsch-Houck Laboratories

THE thrill of listening to shortwave broadcasts originating in far-off lands has for decades captured the imaginations of people throughout the world. Today's shortwave listener (SWL) can receive clear transmissions from powerful stations in any part of the world with an ease that would have astounded his counterpart of the 1930's. Though loaded with propaganda, there is a wide choice of programs.

When choosing a receiver, the SWL must consider carefully his interests and needs. The extremely powerful transmitters and elaborate antenna systems used by many SW broadcast stations can be heard easily in any part of North America with the simplest of receivers. If the BBC, Radio Moscow, and Voice of America meet your

listening needs, almost any receiver will be adequate.

On the other hand, there are hundreds of SW stations less powerful than those of the major powers. Their weaker signals, interference from adjacent channels, and often irregular operating hours make receiving some of these stations (and obtaining confirmations from them) quite a "feather in the cap" of a serious SWL.

A number of more or less specialized receivers with a wide diversity in features and prices are available to the SWL. Some are essentially portables designed to operate either on batteries or house current. Others are similar to the communications receivers used by amateur and commercial radio stations, but their frequency coverage is

different, and they have certain operating refinements.

To illustrate the choice available to the SWL today, we have evaluated a group of receivers which more or less fall into the above categories. Some share characteristics of both groups: one—essentially a versatile table radio—seems distinct from either. The receivers we tested list from about \$100 to almost \$350, with a corresponding “spread” in features and performance.

Our performance measurements included sensitivity at two or three points in each frequency range provided, dial calibration accuracy, selectivity, and image rejection. Sensitivity was defined as the antenna input in microvolts (μV), modulated 30 percent at 400 Hz, which resulted in a 10-dB ratio of signal-plus-noise to noise.

A frequency counter was used to verify the dial calibration at two or three points on each scale. To determine selectivity (the ability of the receiver to reject interference from a station close in frequency) we measured the i-f bandwidth at four levels relative to the center of its passband (-6 dB, -20 dB, -40 dB, and -60 dB). The image response of a shortwave receiver is very important, since a superheterodyne receiver can receive not only the frequency to which it is tuned, but its “image,” removed by twice the i-f frequency. Many shortwave receivers, especially general coverage types, have poor image rejection, and the “busy” sensation one gets when tuning across their bands is often due to the fact that each station is being received twice!

We listened to each receiver in all its modes, and on all its bands, using the built-in antenna where applicable, as well as appropriate external antennas. Comparisons were made between pairs of receivers under identical conditions to judge their ease of tuning and ability to receive both weak and strong signals. Receivers were physically tapped while receiving SSB or CW stations, to judge mechanical stability.

COMMUNICATIONS RECEIVERS

Lafayette HA-600A.

Apparently designed as a low-cost receiver for the novice ham operator as well as the SWL, the HA-600A is a general-coverage receiver. It tunes the low-fre-

quency band of 150-400 kHz and provides continuous coverage from 550 kHz to 30 MHz in four bands.

The band-spread dial (as large as the main tuning dial) has its own pointer, driven by a separate knob. It has scales for the amateur bands from 10 to 80 meters, keyed to index marks on the main tuning scales. There is also a logging scale, calibrated from 0 to 100, on the band-spread dial.

The HA-600A has a product detector for CW and SSB reception with adjustable bfo frequency for reception of either sideband in the SSB mode. The receiver has a headphone jack, separate audio and r-f gain controls, and an antenna trimmer. The function switch includes a SEND position which silences the receiver during transmissions, and an automatic noise limiter for AM reception.

Good sensitivity and selectivity characterize the HA-600A receiver. The i-f bandwidth was 4 kHz at -6 dB, 9 kHz at -20 dB, 12 kHz at -40 dB, and 14 kHz at -60 dB, largely due to the use of four ceramic filters in the i-f amplifier. The sensitivity was typically between 1.5 and 2.0 μV on the high-frequency bands, 3 μV on the broadcast band, and 8-12 μV on the low-frequency band.

The calibration error on the main tuning dial was 2 to 3 percent. When it was set to the index marks for the various ham bands, the error was usually sufficient to invalidate the calibration of the band-spread dial. However, when the main tuning dial was set for correct band-spread dial readings at the upper end of each band, the calibration error across the band was only 10-20 kHz.

Image rejection was 41 dB at 7 MHz but down to 3 dB at 30 MHz. This is typical of general-coverage, single-conversion super-

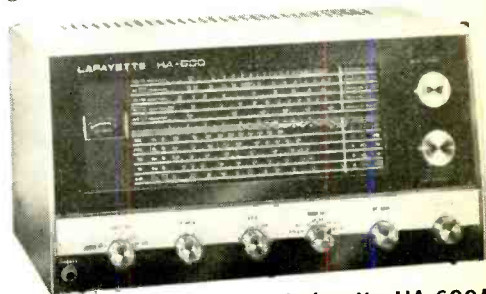

Lafayette HA-600A

heterodyne receivers. The mechanical stability of the higher frequencies was poor, with strong microphonic sounds emitted when the cabinet was lightly tapped. The noise limiter drastically reduced the audio output and was not very effective against impulse noise. The S meter did not respond in the preferable logarithmic manner since a five-fold increase in signal strength produced a change of 9 S units instead of the expected 3 or 4 units.

Although this receiver left something to be desired as a ham receiver, its low price and numerous control functions could make it a good choice for a beginner or casual SWL.

The HA-600A receiver is catalog priced at \$99.95, less speaker.

Realistic DX-150B.

Tuning from 535 kHz to 30 MHz in four bands, the DX-150B is another general-coverage receiver. A separate band-spread dial is calibrated for the 10-80-meter ham bands. The front panel controls include bfo pitch, a-f and r-f gain, band switch, antenna trimmer, and the two tuning knobs. Four slide switches control the automatic noise limiter (anl), AM or CW/SSB operating modes, fast or slow avc time constants, and receive/standby modes of operation. There is also a headphone jack located on the front panel.

The circuits in the DX-150B are simple yet highly effective, using FET's in the r-f, mixer, oscillator, and first i-f stages; ceramic i-f filters; separate AM and product detectors; and an IC audio amplifier.

The receiver had an average measured sensitivity of 1.5-2.5 μV on the high-frequency bands and 7 μV on the broadcast band. Its selectivity was good at -6 dB for a 4.5-kHz bandwidth, -20 dB for 8.3 kHz, -40 dB for 16.3 kHz, and -60 dB for 29.2 kHz bandwidth. Image rejection was 45 dB at 7 MHz and a remarkably good (for a single-conversion receiver) 42 dB at 30 MHz.

The main tuning dial calibration error was very small—between 0.5 and 1.0 percent over its entire range. When it was set for correct band-spread calibration at the high-frequency end of each band, the band-spread calibration was accurate within 15 kHz over each of the ham bands. Tuning was easy and non-critical even on SSB signals. The r-f gain control attenuates sig-



Realistic DX-150B

nals before the r-f amplifier and reduces stage gain which greatly reduces the possibility of front-end overload on strong signals.

The S meter was very optimistic, reading S-9 with only 3.1 μV of signal at 11.5 MHz. With any reasonably good external antenna, the meter will be "pinned" by almost every signal unless the r-f gain is turned down. The automatic noise limiter was fairly effective (on AM reception only).

The receiver was slightly microphonic; placing the speaker on top of it would result in acoustic feedback at moderate listening levels. In general, however, mechanical and electrical stability was compatible with good CW and SSB reception.

We would judge the DX-150B to be an excellent low-cost receiver for the novice ham or beginning SWL. The crowded dial calibration and lack of band-spread scales for the SW bands are its chief drawbacks in SWL service, but the band-spread dial can still be used for easy tuning at any frequency. (This is not really necessary since the main tuning system is smooth and free from backlash.)

The Realistic DX-150B is listed at \$119.95. A matching speaker, the SP-150, is available for \$8.95.

Allied SX-190.

At an appreciable upward step in performance and price (over the previously described receivers) is the Allied SX-190. This is a superhet double-conversion receiver which covers eleven 500-kHz bands between 3.5 MHz and 30 MHz. It is normally supplied with nine crystals (for the first conversion oscillator) for the SW bands at 16, 19, 25, 31, and 49 meters; the 27-MHz Citizens Radio band; and the 20-, 40-, and 80-meter ham bands. (The

40-meter range includes the 41-meter broadcast band.) Additional crystals can be purchased for any one 500-kHz band between 3.5 MHz and 10 MHz, and another band between 10 MHz and 30 MHz.

The first i-f of 2420-2920 kHz is converted to 455 kHz by a highly stable linear vfo. The tuning dial is calibrated from 0 to 500 kHz in 1-kHz steps; its coverage extends for an additional 50 kHz above and below these limits. The dial reading is added to the low-frequency limit of each band to obtain the actual received frequency. A crystal-controlled marker oscillator provides calibration signals at intervals of 100 kHz and 25 kHz over the entire range of the receiver so that the dial calibration can be guaranteed to be better than 500 Hz at any point.

The FET cascode r-f amplifier in the SX-190 is tuned by a separate dial which is calibrated from 3.5 to 30 MHz and can be adjusted for best reception. The i-f amplifier, with two stages of ceramic filters, is followed by separate AM and product detectors. The crystal-controlled bfo has switchable frequencies for reception of USB or LSB.

The r-f and a-f gain controls are concentrically mounted. The r-f control attenuates the signal ahead of the r-f amplifier to prevent overloading on strong signals when the control setting is reduced. An i-f Q multiplier provides a tunable selective peak or notch for interference rejection. On the mode switch are positions for LSB, USB, STANDBY, AM, and ANL. A head-phone jack is located on the front panel.

The receiver's measured sensitivity was 2-3 μ V. Its selectivity was outstanding at -6 dB at 4.1 kHz, -20 dB at 6.5 kHz, -40 dB at 8.7 kHz, and -60 dB at 9.2 kHz. With the Q multiplier, the skirt selectivity was further improved to 4.7 kHz at -20dB,

6.9 kHz at -40 dB, and 7.6 kHz at -60 dB. The double-tuned r-f preselector, plus the use of a high first i-f, resulted in very good image rejection: 77 dB at 7 MHz and 65 dB at 30 MHz.

The S meter readings varied logarithmically at approximately 3 dB/S unit. A 5.5- μ V signal was needed for S-1 at 11.5 MHz and 240 μ V produced an S-9 reading. Dial accuracy, once set with the crystal calibrator at one end of any band, was within 1.3 kHz over the entire band. Resetting the dial to the nearest 25-kHz marker gave a frequency readout accuracy limited only by the visual dial resolution—about 200 Hz.

The receiver was rock-stable, and vigorous pounding on the cabinet produced no effect even when receiving SSB or CW signals. In construction, operation, and electrical performance, this is an outstanding receiver for the serious SWL. Tuning in a station requires no more than setting the dial to its frequency and peaking the pre-selector. When a station is tuned in, its frequency can be resolved to better than 1 kHz directly from the dial.

The noise limiter works quite well (on AM only), and the Q multiplier is able to remove most forms of heterodyne interference.

The Allied SX-190 receiver is list priced at \$249.95. A matching speaker, SP-190, is available for \$19.95.

Drake SW-4A.

The R.L. Drake Co., well known to hams as a leading manufacturer of high-quality receivers and transmitters, has designed a receiver—the SW-4A—specifically for the SWL. This receiver is a double-conversion superhet with eleven 600-kHz ranges which are tuned by a very linear, accurately calibrated oscillator whose dial divisions are at 1-kHz intervals.

The SW-4A covers the 11-, 13-, 16-, 19-, 25-, 31-, 41-, and 49-meter SW bands; a low-frequency band of 150-500 kHz; and the AM broadcast band in 450-1050-kHz and 950-1550-kHz segments. The first conversion, to an i-f of 5645 kHz, uses a combination of crystal and variable frequency oscillators, and crystals are available at nominal cost to cover other bands within the overall tuning range of the receiver, although one of the standard ranges must be sacrificed for each added range.



Allied SX-190

A quartz crystal lattice filter in the first i-f amplifier provides selectivity, and a 5190-kHz crystal oscillator converts to the second i-f of 455 kHz. The r-f amplifier is tuned by a preselector which is calibrated to match the tuning ranges of the receiver.

This is a hybrid receiver, the only one of this group that does not employ a fully solid-state design. The r-f and i-f sections use vacuum tubes, but transistors are used in the audio and age amplifiers and in the tuning oscillator section. The latter is unconventional with a permeability-tuned vfo whose 4.9-5.5-MHz output is heterodyned with the output of a crystal oscillator to produce the required conversion oscillator frequency.

The SW-4A is intended only for AM reception and has no bfo or product detector. Tuning dial calibration accuracy is rated at ± 3 kHz after calibration on any given band. However, there are no built-in markers; so, one must depend on CHU (7335 kHz) or WWV (10 or 15 MHz) for calibration unless another accurate frequency source is available.

The front panel of the receiver reflects exceptional operating simplicity. There is only one band switch, a preselector knob whose calibrations are color-keyed to the band switch markings, a tone control, volume control/power switch, and the tuning knob and dial. There is also a head-phone jack and an illuminated S meter. The dial is calibrated from 0 to 500 and from 500 to 1000. The tuning knob has 25 divisions around its skirt. The sum of the knob and the dial readings, added to the band switch setting, gives the received frequency.



Drake SW-4A

This Drake receiver was one of the most sensitive units in the group, exhibiting a relatively uniform sensitivity of 1.4 to 1.7 μV on all the SW bands. In the broadcast band, the sensitivity was 2.3 to 5.0 μV , and on the low-frequency band, it was 18 to 70 μV . Although we set the dial at only one frequency (15 MHz), calibration was very good throughout, within 1 kHz at almost every point we checked. Since it is not practical to tune an AM signal (as compared to CW and SSB signals) with greater accuracy in any case, the lack of a marker oscillator does not seem to present any problems.

The measured i-f bandwidth agreed almost exactly with the manufacturer's specifications: 5.0 kHz at -6 dB, 7.7 kHz at -20 dB, 10.7 kHz at -40 dB, and 16.2 kHz at -60 dB. The S meter had an accurate logarithmic response, at 6 dB/S unit, over its range. At 11.5 MHz, $6\mu\text{V}$ gave an S-2 reading (the meter gives an S-1 reading with no signal), and $220\mu\text{V}$ corresponded to S-9. The image rejection of the SW-4A was very good: 80 dB at 7 MHz and 64 dB at 25.5 MHz.

The receiver was mechanically and electrically stable, very easy to tune, and gave ample evidence of superior workmanship and quality. For the SWL who is interested only in broadcast reception and has no need for CW or SSB modes, the simplicity and performance of the SW-4A give the receiver a strong advantage over most other receivers. Hunting DX on the lower frequencies (broadcast and low-frequency bands) is aided by an optional accessory loop antenna (AL-4) which mounts directly on top of the receiver cabinet and plugs into a special jack on the rear apron.

Selling price of the Drake SW-4A receiver is \$335. A matching speaker, the MS-4, is available for \$22, and the AL-4 loop antenna is \$22.

Heath SB-313.

The most advanced—and expensive—SWL receiver we tested was the Heath SB-313. Available only in kit form, it is a double-conversion superhet covering nine 500-kHz bands: 3.5-4.0 MHz, 5.7-6.2 MHz, 7.0-7.5 MHz, 9.5-10.0 MHz, 11.5-12.0 MHz, 14.0-14.5 MHz, 15.0-15.5 MHz, 17.5-18.0 MHz, and 21.3-21.8 MHz. The SB-313 is basically the same as the SB-303,

the company's deluxe ham-band model, except for its frequency bands. (Three are common to both models.)

A crystal-controlled oscillator converts the input frequency to an 8.5-9.0 MHz i-f range. The well-known Linear Master Oscillator (LMO) used and proven in Heath's "SB" series of amateur receivers and transmitters operates from 5.0 to 5.5 MHz and converts to the 3395-kHz second i-f. Multi-pole quartz crystal filters (three separate ones for AM, SSB, and CW) provide the receiver's exceptional selectivity in the second i-f amplifier. Both AM and product detectors are used, with switchable crystal-controlled bfo frequencies for USB or LSB and CW reception.

The three-position agc switch has positions for off, fast, and slow; the fast time constant is used for CW, while the slow time constant is preferable for SSB and AM reception. There are separate r-f and a-f gain controls, and a separate r-f attenuator which is adjustable up to about 60 dB. The preselector stage is manually tuned for maximum signal response on each band. A function switch has standby and operate positions plus two positions for the 100-kHz and 25-kHz crystal calibrator frequency markers. A headphone jack is also provided.

The SB-313 tuning dial has two sections—the upper horizontal scale is marked off 0-5, and the circular dial below it has 100 divisions. Each corresponds to 1 kHz, and one rotation of the dial moved the upper pointer from one digit to the next. The direct dial readout in kHz is added to the setting of the band switch to determine the received frequency.

This receiver is all solid-state and is constructed on a number of plug-in printed circuit boards to facilitate easy assembly and servicing. It is a thoroughly professional design, bearing a closer resemblance to quality commercial and military gear than it does to consumer merchandise.

The measured sensitivity was very good, from 1.2 to 2.0 μV across the entire tuning range. The crystal filters provide a near-ideal steep-skirted selectivity characteristic with the AM filter having a 5.4-kHz bandwidth at -6 dB, 8.3 kHz at -20 dB, 12.7 kHz at -40 dB, and 28.2 kHz at -60 dB. Their steep skirts made it difficult to measure the response of the SSB and CW



Heath SB-313

filters which have rated bandwidths of 2.1 kHz and 400 Hz.

When we set the tuning dial calibration at the lower edge of any band, the frequency error was well below 1 kHz across the full 500-kHz tuning range. If the dial is calibrated at the nearest 25-kHz marker frequency, the readout accuracy is limited only by visual resolution (about 150 Hz). Image rejection was by far the best of the receiver group at more than 100 dB at 3.5 MHz and 73 dB at 21.3 MHz. There are a few low-level spurious responses; the worst we found was in the first i-f pass band where, at 8.8 MHz, a 25,000- μV signal produced an S-9 meter reading.

The S meter's response was basically logarithmic with about 3 dB/S unit over most of the meter scale. At 11.5 MHz, a 5- μV signal gave an S-1 reading, and a 280- μV signal produced an S-9 reading.

The SB-313 is for the most advanced SWL. Although the assembly of the kit is not difficult, it is an involved and time-consuming project which we would recommend only for the experienced kit builder. Obviously, many of the features of this receiver would be of little value to a casual listener or to someone interested only in AM SW broadcasts. However, if CW and SSB reception is a significant part of your listening activity, the SB-313 is very close to the ultimate in SWL receivers.

The Heath SB-313 receiver is catalog listed at \$339.95. The matching SB-600 speaker is available at \$19.95.

Next month, in Part 2, we will report on portable receivers and a table model. ♦

IT IS midnight at General Hospital. In the semi-dark coronary care unit (CCU), patients with heart problems requiring close observation sleep in glass-enclosed cubicles within view of a specially trained nurse at the central-station desk.

A new patient arrives, and the CCU nurse promptly tapes three dime-sized discs to his chest. Coated with an electrically conductive paste, these metal discs are connected to a flexible cable which the nurse plugs into a connector on the wall. She reaches up and switches on a bank of instruments mounted on a shelf above the patient's bed. A light begins to flash at a rate of about once a second, each flash triggered by an electrical impulse from the patient's heart.

On another instrument, a meter pointer moves up-scale to indicate the beats/minute. The nurse adjusts two pointers on the face of the meter, setting the low and high alarm limits; if the patient's heart rate should go above or below these limits, an alarm will sound at the central-station desk.

On a bedside monitor oscilloscope, a spot of light traces a series of pulses. Originating in the patient's heart, these pulses are picked up through the metal discs on his chest. The nurse adjusts the scope.

Having attended to the needs of the new patient and adjusted the bedside instruments, the nurse returns to the central-station desk where she glances up at the large eight-trace scope suspended from the ceiling. Here, the heart pulses of all CCU patients, including the new one, are displayed for easy observation.

Seated at the desk, the nurse pushes a numbered button; a desk-mounted instrument unrolls a strip of chart paper on which a pen has traced the voltage waveform generated by the patient's heart. The tracing, an electrocardiogram (ECG), is an important diagnostic indicator of the condition of the heart.

Automatic Alarms. The philosophy and rationale of central monitoring systems is that they call immediate attention to a patient experiencing a cardiac emergency. The sound of an alarm at central station brings immediate medical assistance. It has been estimated that, in cases of cardiac arrest, the probability of survival is 90 percent if the patient is treated within one minute. It decreases to only 10 percent at three minutes.

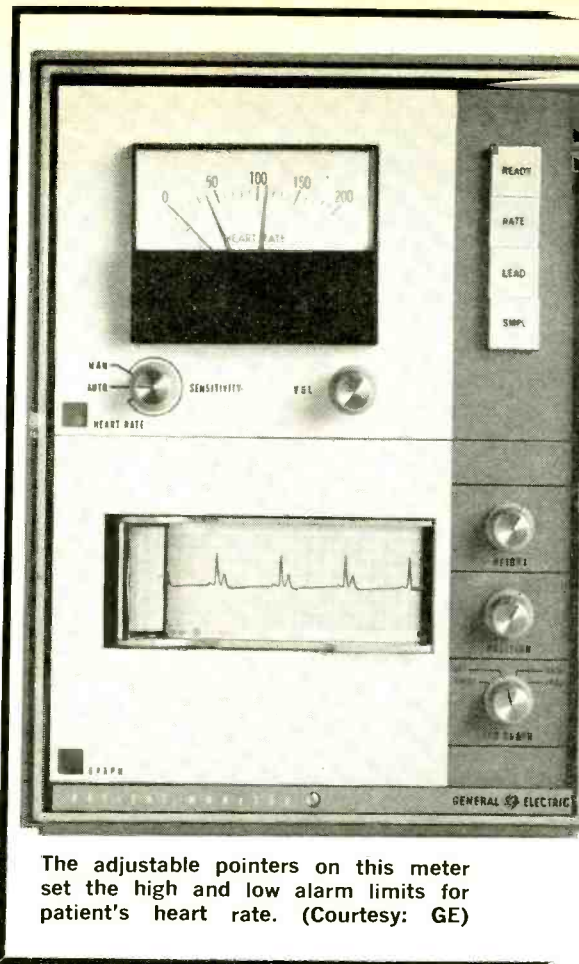

The adjustable pointers on this meter set the high and low alarm limits for patient's heart rate. (Courtesy: GE)

Without central-station monitoring, adequate patient care would require a greater number of nurses. Even with an increased nursing staff, there would still be a significant possibility that a nurse might not be at bedside when an emergency occurs. With an automatic alarm system, the emergency is detected within seconds. An audible alarm sounds and, by means of an illuminated numeral, the CCU nurse knows the bed number of the patient in distress. Furthermore, an electrocardiograph responds to the alarm by producing a strip chart showing the patient's ECG immediately before and after the attack.

A systems diagram of a typical patient monitoring system is shown in Fig. 1. Each bedside installation includes an ECG amplifier, a heart-rate meter, and an oscilloscope. It may also include respiration, temperature, and blood-pressure monitors which communicate with central station and can

Electronics Monitors Hospital Patients

OSCILLOSCOPES, CLOSED-CIRCUIT
TV, COMPUTERS, AND TRANS-
DUCERS ARE USED TO KEEP
TRACK OF PATIENT'S CONDITION

BY ED BUKSTEIN

*Dept. of Bioelectronics, Hennepin County
General Hospital, Minneapolis, Minn.*

trigger the alarm when conditions go beyond preset limits. In Fig. 2 are shown the components of a bedside installation.

One Millivolt Input. The ECG amplifier at bedside receives the heart voltage detected by the electrodes on the patient's chest. This voltage is approximately 1 mV in amplitude. It undergoes a gain of about 1000 in the ECG amplifier to provide an adequate signal for the bedside scope and rate meter and for feeding through cables to central station.

A characteristic ECG waveform is shown in Fig. 3. The P, R, and T waves correspond to electrical events within the heart. The ECG waveform repeats itself during each cycle of heart activity. Typically, this is 60-80 times/minute, or about once a second. Since parts of this cardiac waveform have voltage variations on the order of one hertz or less, the ECG amplifier must

have excellent low-frequency response. High frequency response, on the other hand, is not critical because the ECG waveform contains no significant components above 100 Hz. So, the typical frequency response of an ECG amplifier is 0.05-100 Hz; but many instruments contain a switchable filter which can limit the high end to less than 60 Hz to minimize ac pickup.

Counting Heart Beats. The heart-rate meter counts the R waves of the ECG pattern. (The R waves are greater in amplitude than the P or T waves as shown in Fig. 3.) This instrument is basically a frequency meter designed to respond to pulse rates of 0 to 5 pulses/second. This corresponds to heart rates of up to 300 beats/minute (BPM) for which the meter scale is calibrated accordingly.

The rate meter's high and low alarm limits can be set by means of movable tabs which mechanically position a lamp and photocell inside the meter's case. An opaque vane, moving along with the meter pointer, passes between the lamp and photocell to trigger the alarm. One lamp/photocell assembly is situated upscale for the high-limit alarm and another is located downscale for the low-limit alarm. Excessive heart rates (tachycardia) and insufficient heart rates (bradycardia) trigger the alarms.

Slow Sweep & Long Persistence. The monitor scope is similar to conventional oscilloscopes but has several special features necessitated by the nature of the signals to be displayed. Relatively slow sweep speeds are required so that one or more heartbeat cycles will be displayed during each horizontal sweep. Typical sweep speed is 22 mm/second (about 1 in./second). Some monitor scopes have a front-panel switch which doubles the sweep speed to 50 mm/second, permitting the waveform to be "stretched" horizontally for a closer look.

Designers of medical instrumentation prefer to put as many controls as possible on the rear panel or inside the case. This makes the instruments easier to operate and discourages "knob twisters." Hence, controls for vertical size, vertical positioning, focus, and intensity may be located on the front panel, rear apron, or inside the case.

Another important characteristic of a scope designed for cardiac monitoring is the long persistence of its phosphor screen. This is required so that the left side of the

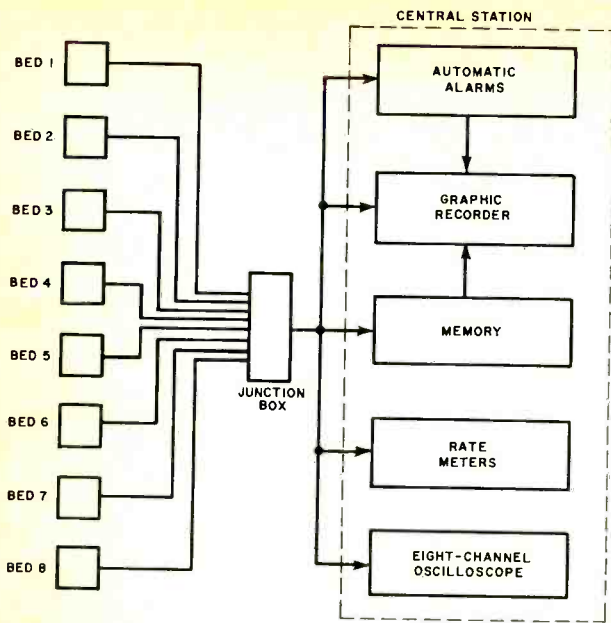

Fig. 1. Block diagram shows how an 8-bed monitoring system with central station control is used.

trace will still be visible as the spot approaches the right side of the screen. Recently, however, several manufacturers of medical electronic equipment have marketed a storage-type scope which can simulate infinite persistence. By pushing a button, the waveform on the screen is "frozen" in place to permit unhurried and detailed examination.

Memory Tape. Monitoring systems also include, either at bedside or at central station, a short-term memory, typically in the form of a 30-second loop of magnetic tape. The patient's ECG is continuously recorded on the tape loop until an alarm condition arises. When this happens, the recording

process ceases, leaving a record on tape of the patient's ECG for the 30-second period preceding the alarm. The tape is then automatically "dumped" into the graphic recorder at central station, producing a graph of the patient's heart action leading up to the attack.

In some of the newer installations, solid-state digital memories are being used in place of magnetic tapes. These no-moving-parts memories eliminate the problems of wear, adjustment, and lubrication associated with mechanical components.

Miscellaneous Parameters. Although ECG and heart rate are parameters of primary interest, additional measurements are often required. Respiration rate, body temperature, and blood pressure are examples of other frequently monitored parameters.

Blood pressure can be monitored via a strain-gauge transducer connected through a fluid-filled tube to a "needle" inserted into an artery or vein, depending on whether arterial or venous pressure is to be monitored. The resistance of the strain gauge changes with pressure variations in the blood stream. The maximum pressure (systolic) occurs when the heart contracts to force blood out into the circulatory system; minimum pressure (diastolic) occurs when the heart relaxes. Systolic and diastolic pressures are indicated on meters at bedside and/or central station. Adjustable alarms can be set for both high and low

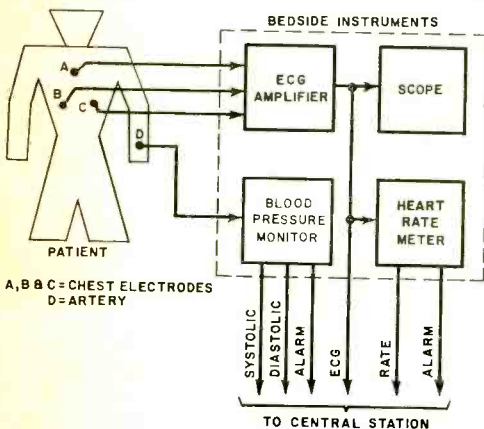

Fig. 2. Basic bedside instrumentation.

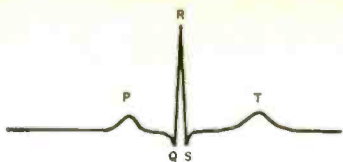

Fig. 3. Typical electrocardiogram wave.



Fig. 4. Example of blood pressure wave.

limits. The pressure waveform shown in Fig. 4 is displayed on either a bedside scope or at central station.

Respiration can be monitored by measuring the changing impedance between a pair of electrodes as the chest expands and contracts. A thermistor can be used to measure temperature rectally or in the armpit.

The Future. The present trend in bioelectronics is toward the use of more instruments to monitor a greater number of patient parameters. Central station monitoring is becoming more commonplace in hospital areas which previously employed only



Bedside instruments monitor the patient's ECG, heart rate, and blood pressure. (Courtesy: Hewlett-Packard)

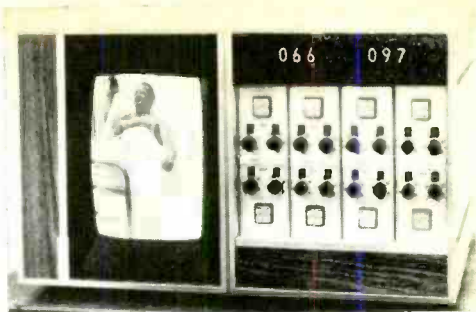

Closed-circuit TV permits observation of patient from central station. Instruments at right monitor heart rate and blood pressure. Digital readout shows parameters for a selected patient. (Courtesy: Smith Kline Insts.)



This central station equipment shows extent to which electronic instrumentation has become a vital part of medicine. (Courtesy: Hewlett-Packard)

bedside instruments or none at all. In many hospitals, central monitoring systems are being tied into digital computers which detect trends and changes in patient parameters and which provide (on command) readout of patient data.

Bioelectronic instruments have followed an evolutionary pattern which is the same as that of equipment designed for other uses. Although many first-generation vacuum-tube instruments are still in use, most modern instruments are of second-generation transistor design. Nor is integrated circuit equipment a rarity.

For the bioelectronics technician, the future is filled with an increasing number of fascinating, sophisticated, life-saving instruments. ♦

You don't have to get a college in electronics.

Next to a willingness to work, nothing will improve your chances of success in electronics more than a college-level education. But family obligations and the demands of your job may make it very difficult for you to attend classes. That doesn't mean you have to forget about getting ahead. CREI makes it possible for you to get the college-level education you need without going back to school.

Learn at home

At your own pace, your own schedule . . . without giving up your present job. CREI lessons are written to be clearly understood without the presence of a teacher. Your problems are anticipated. Your instructors will work with you in a very personal manner and give you all the individual attention you need. Many men learn far more readily through home study than they ever did in the classroom.

Not for beginners

CREI programs are written for men familiar with basic electronics, but who want to

get the advanced, specialized knowledge they must have to move up to engineering-level positions and engineering-level pay. All CREI training material is developed with the help of top engineers and scientists from private industry and government laboratories. Each of these men is an expert in his field of electronics. He knows exactly what level of specialized knowledge a man needs to work successfully in that particular field today. This is your assurance that what you learn from your CREI study can be applied on the job.

You can have confidence in CREI

Since 1927, CREI has helped tens of thousands of men move ahead in every phase of the electronics industry. You'll find CREI graduates and students in key jobs wherever up-to-date knowledge of electronics is demanded. Leading companies recognize the quality of CREI education. Many pay all or part of CREI tuition for their employees.

CREI education is up-to-date education

CREI courses are continually being revised. New developments are included as quickly as they occur. Right

now, CREI students are getting the latest information on cable TV, LSI chips, microminiaturization, lasers and masers, telemetry systems, servomechanisms and data links. If it's new in electronics, CREI—and you—will know about it.

Send for free book with complete information on CREI programs

Use postpaid card—no stamp needed. If card is detached use coupon or write: CREI, Dept. E1211C 3939 Wisconsin Ave., N.W., Washington, D.C. 20016

CREI Founded 1927
Accredited Member of
the National
Home Study Council

Go to college level education

Capitol Radio Engineering Institute



This certifies that
Robert Deany, Jr.
has satisfactorily completed the Course of Study in
Electronic Engineering Technology

Majoring in
Computers

Diploma

and upon the recommendation of the Board of Directors is granted this
In Testimony Whereof, we have affixed our signatures

B. A. Costello

**CREI, A Division of the McGraw-Hill
Continuing Education Company**

Dept. E1211C, 3939 Wisconsin Ave. N.W.,
Washington, D.C. 20016

Please send me free book with full information about
CREI Programs.

Name _____ Age _____

Address _____

City _____ State _____ Zip _____

Employed by _____

Type of Present Work _____

I am interested in: Computers Electronic Engineering
Technology Nuclear Engineering Technology
 Industrial Electronics Electronics Systems
Engineering Television Engineering Non-Technical
Course in Computer Programming New! Cable TV

APPROVED FOR TRAINING UNDER NEW GI BILL



TACH-DWELL METER

ONE LOW-COST IC DOES DOUBLE DUTY

BY NORMAN J. OLSEN

USING only one low-cost digital IC, it is easy to construct a compact instrument that can measure both rpm and dwell angle of an internal combustion engine. Use of a simple equation then permits rpm calibration of almost any type of engine at any rpm.

As shown below, gates A and B are connected as a one-shot multivibrator with R5 and C2 used as the timing elements. As the engine operates, the distributor points open and close, causing the one-shot to generate fixed amplitude pulses with a repetition rate that is a function of the engine rpm. When S1 is in position 2 (tach), these pulses are applied to gate D (the meter driver). The large value of C3 integrates the pulsating voltage so that it is smooth with an amplitude proportional to the pulse frequency—or engine rpm.

When S1 is in position 3 (dwell), gate C is used as a conventional inverter with the pulses passed through S1 to gate D. The pulses are integrated by C3 and the resulting dc is read off on meter M1. The one-shot gates (A and B) are not used in this mode.

Calibration. To calibrate the dwell scale, Set S1 to position 3 and, with the two input leads shorted, adjust R3 for a full-scale deflection. This represents the angular distance between the lobes of the distributor cam shaft; i.e. 45° for an eight-cylinder engine (60° for six cylinders; 90° for four).

For the tachometer scale, determine the desired full-scale (in rpm) indication. By multiplying the rpm by the number of cylinders and dividing by 120, you will find the audio frequency required. For example, assume a speed of 1000 rpm for an 8-cylinder engine. The frequency is 66.67 Hz (about 10 volts output). Select a value for R4 so that, with 66.67 Hz as an input, the meter will indicate at the full-scale mark. The same relationship can be used to determine the audio frequency required for intermediate rpm indications—or for other than 8-cylinder engines.

Installation. Connect the ground lead to a suitable chassis ground on the vehicle. Use a length of insulated wire to connect the "dist" input to the non-grounded connector on the distributor points. Be sure that this lead is kept away from moving or high-temperature engine components. The meter itself can be mounted in any convenient, visible place. ♦

Circuit can be built on PC or perf board and enclosed in a plastic box.

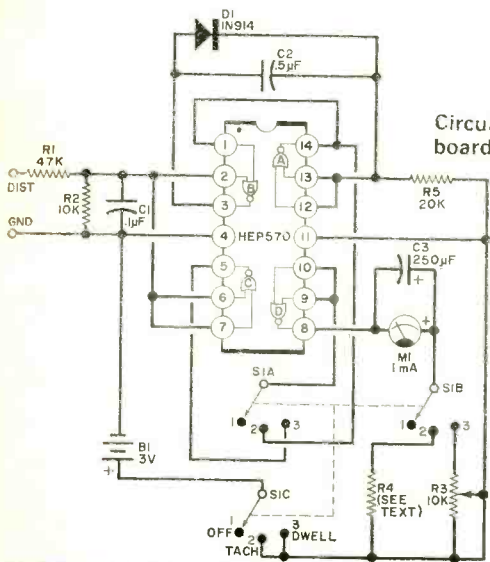

PARTS LIST

- B1—Two 1.5-volt D cells
- C1—0.1- μ F, 400-volt capacitor
- C2—0.5- μ F, 50-volt capacitor
- C3—250- μ F, 10-volt electrolytic capacitor
- D1—Diode (HEP156 or 1N914)
- IC1—Integrated circuit (HEP570 or MC-724P)
- M1—0.1-mA meter
- R1—47,000-ohm, $\frac{1}{2}$ -watt resistor
- R2—10,000-ohm, $\frac{1}{2}$ -watt resistor
- R3—10,000-ohm potentiometer
- R4—See text
- R5—20,000-ohm, $\frac{1}{2}$ -watt resistor
- S1—Three-pole, three-position rotary switch
- Misc.—Suitable enclosure, battery holder, insulated cable for distributor connection.

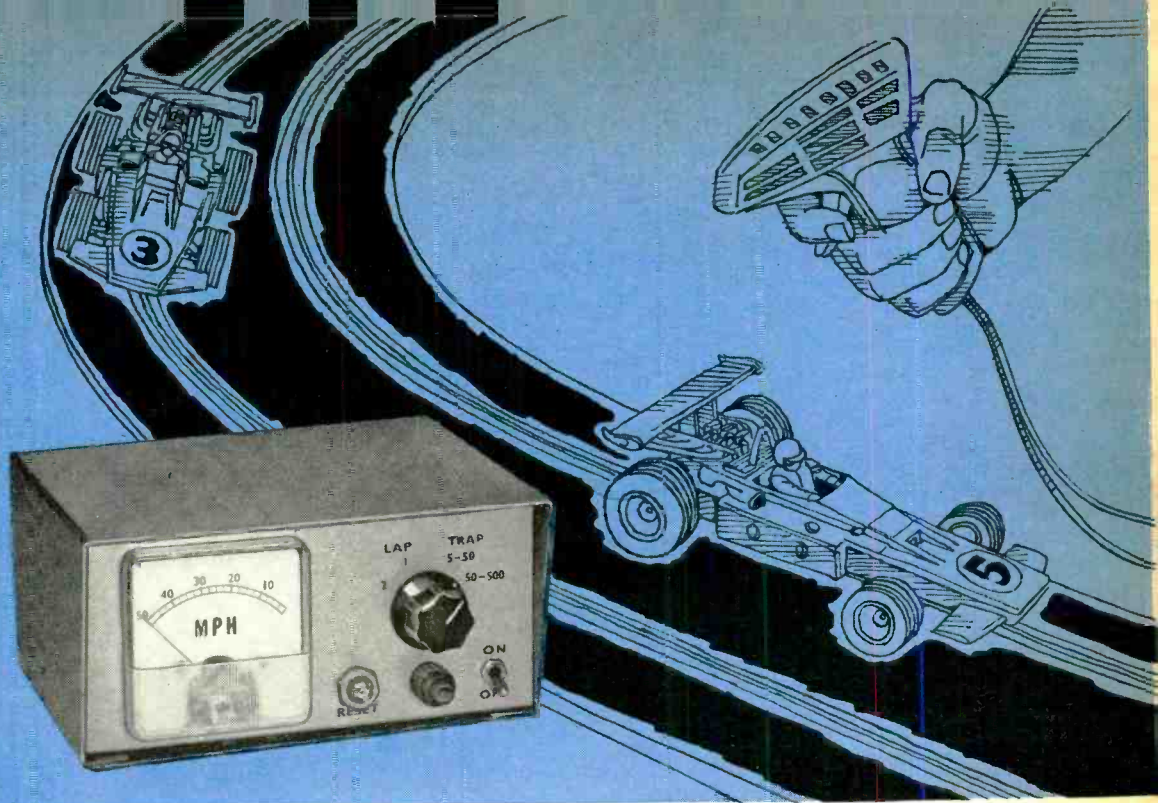

BUILD A Speed Timer for Model Cars

ALSO TIMES BIKES, TRIKES, OR TRACK RUNNERS

BY PHILIP HARMS

IF YOU have a youngster around the house, you know that model auto racing is the "in" thing these days. Although model racing sets come with a variety of accessories, one thing that is usually lacking is a timer to indicate lap speed. The Speed Trap Timer described here is a versatile device that complements any racing set and can also be adapted to time any interval, whether the subject is bicycles, tri-cycles, or track runners.

There are two speeds of interest in racing: lap speed, which can be measured with a stop watch, and instantaneous speed at any point. The Speed Trap Timer measures both with the flick of a switch; and the construction cost is surprisingly low since all of the parts are readily available and many may already be on hand.

How It Works. The heart of the Timer is

a digital-to-analog converter which changes a digital count to an analog current that can be read directly on a panel meter. Figures 1 and 2 show the complete circuit.

Two light beams are formed with phototransistors serving as the light receivers. The beams are placed a known distance apart and the timer begins when the first beam is broken and stops when the second is interrupted. The time interval between the two breaks is equivalent to instantaneous speed. To measure lap time, the timer begins when the first beam is broken and stops when it is broken a second time.

Unijunction transistor $Q3$ serves as a relaxation oscillator frequency source with capacitors $C1$ and $C2$ used for the two trap times and $C3$ and $C4$ for the lap times.

Phototransistors $Q1$ and $Q2$ operate as saturating switches. When light strikes the

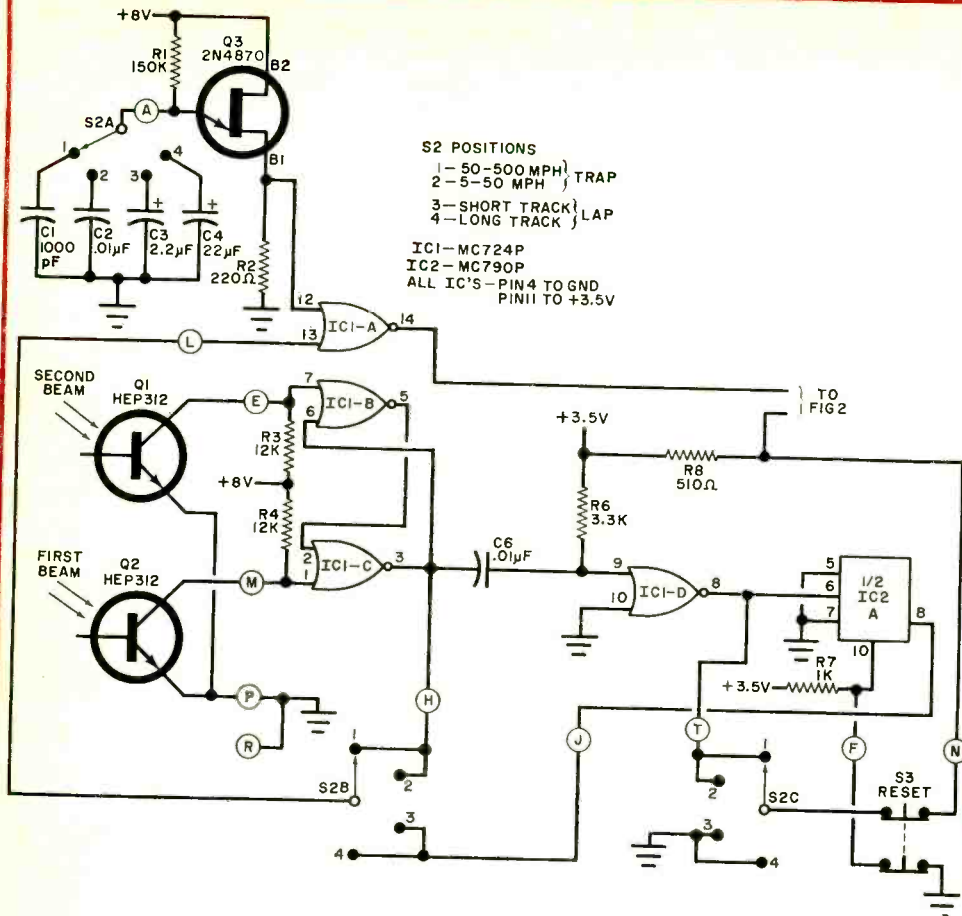

S2 POSITIONS
 1—50-500 MPH } TRAP
 2—5-50 MPH }
 3—SHORT TRACK } LAP
 4—LONG TRACK }
 IC1—MC724P
 IC2—MC790P
 ALL IC'S—PIN4 TO GND
 PIN11 TO +3.5V

PARTS LIST

- C1—1000-pF capacitor
- C2, C6—0.01-μF capacitor
- C3—2.2-μF, 10-volt electrolytic capacitor
- C4—22-μF, 6-volt tantalum capacitor
- C5—4000-μF, 15-volt electrolytic capacitor
- C7—15-μF, 10-volt tantalum capacitor
- Q1—1A, 50V diode (1N4001 or similar)
- Q2—4.3V zener diode (1N749 or similar)
- F1—1/2A fuse and holder
- I1—6.3V lamp and holder (optional)
- I2, I3—#222 lamp (see text)
- IC1—Four-section 2-input NOR gate (MC724P, HEP570)
- IC2—Dual JK flip-flop (MC790P, HEP572)
- M1—0-10-mA dc meter
- Q1, Q2—Phototransistor (HEP312)
- Q3—UJT (2N4870, HEP310)
- Q4—Transistor (2N4921, HEP245)
- Q5-Q9—Transistor (2N4420, 2N4123, 2N5225, HEP724)
- R1—150,000-ohm, 1/4-watt resistor

- R2—220-ohm, 1/4-watt resistor
 - R3, R4—12,000-ohm, 1/4-watt resistor
 - R5—180-ohm, 1/4-watt resistor
 - R6—3300-ohm, 1/4-watt resistor
 - R7—1000-ohm, 1/4-watt resistor
 - R8—510-ohm, 1/4-watt resistor
 - R9-R13—560-ohm, 1/4-watt resistor
 - R14—20,000-ohm, 1/4-watt resistor
 - R15—10,000-ohm, 1/4-watt resistor
 - R16—5100-ohm, 1/4-watt resistor
 - R17—2700-ohm, 1/4-watt resistor
 - R18—1300-ohm, 1/4-watt resistor
 - R19—12-ohm resistor (see text)
 - S1—Spst slide or toggle switch
 - S2—3-pole, 4-position rotary switch
 - S3—2-pole, normally closed pushbutton switch
 - T1—6.3V, 1A filament transformer
 - Misc.—Suitable chassis, knob, candleabra lamp sockets (2), mounting hardware, etc.
- Note—The following are available from Southwest Technical Products, 219 W. Rhapsody, San Antonio, TX 78216: PC board, \$2.34; PC board plus semiconductors, \$14.45.

Fig. 1. Breaking the light beams causes pulses developed in the unijunction transistor to pass to counter circuit.

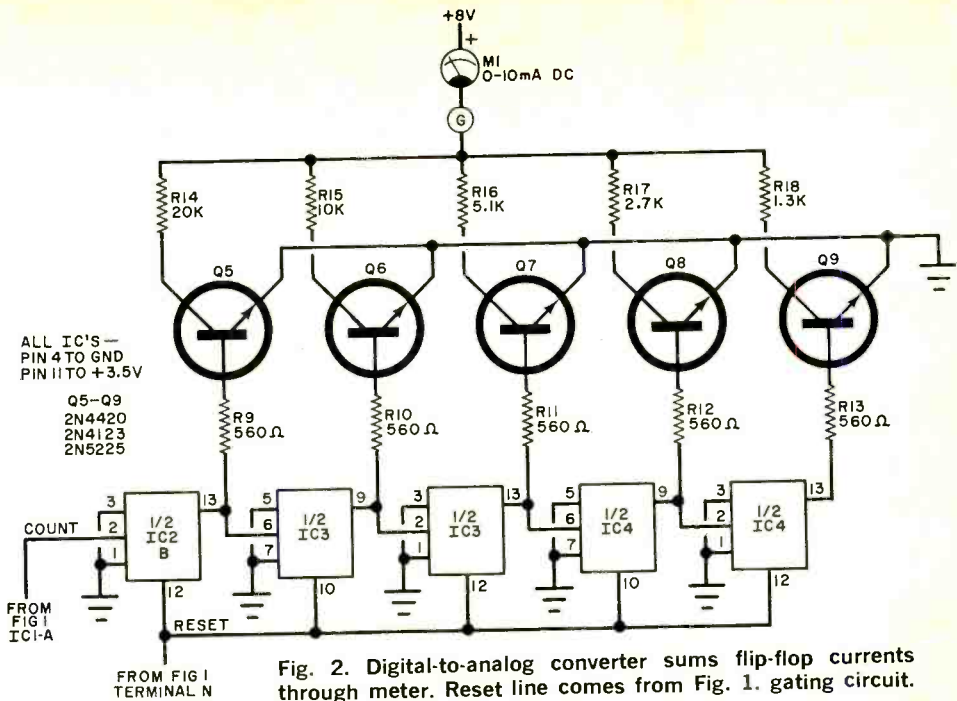

Fig. 2. Digital-to-analog converter sums flip-flop currents through meter. Reset line comes from Fig. 1. gating circuit.

photosensitive base, the transistors saturate and the collector drops to near ground potential. When the light is interrupted, the transistor turns off and the collector voltage rises to that of the supply. NOR gates *IC1-B* and *IC1-C* are connected as a cross-coupled latch and operate in the same manner as a logic switch anti-bounce circuit. The latch is set when the first transistor (*Q1*) is turned off and resets when the second is turned off. To set the latch, *Q1* must turn back on before *Q2* turns off. This will be discussed in more detail later.

If *S2* is in one of the positions to measure trap time, the low output of *IC1-C* is routed to *IC1-A* through *S2B*. This opens the gate and allows the UJT pulses to enter the count-up flip-flops. When the second beam is interrupted, the output of *IC1-C* goes high and turns off the pulses going into the count-up circuit. The totalizer is a five-bit, count-up circuit, giving 32 bits, or increments, of resolution. The outputs of the five flip-flops are routed to *Q5* through *Q9*. The binary sum of the five transistor collector currents determines the total current to the meter. It will be noted that the collector resistors double in value for each transistor. While the resistor values are not exact doubles, this causes little effect in the overall meter reading. The builder can substi-

tute 1% resistors if accuracy has to be improved.

Once the car has passed through the trap, the count is retained and the speed is registered on the meter until reset. The meter can be reset to zero by pressing *S3*, which returns all of the flip-flops to the zero state. The same function is done automatically by gate *IC1-D*. When the first beam is interrupted, a narrow pulse is generated through *C6* and *R6* and shaped by *IC1-D*. This pulse resets the counters to zero automatically before each count-up cycle is begun. Since the pulse is only 5 μs wide, it does not affect the counting cycle.

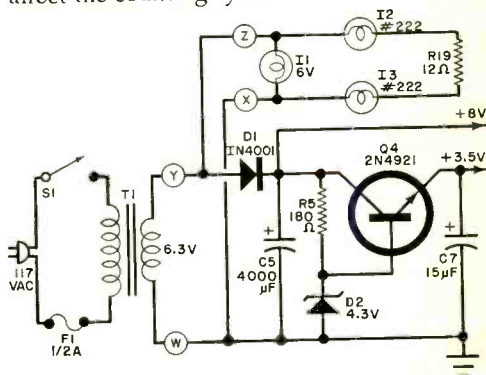

Fig. 3. Circuit for dc supply and ac supply to beam lights.

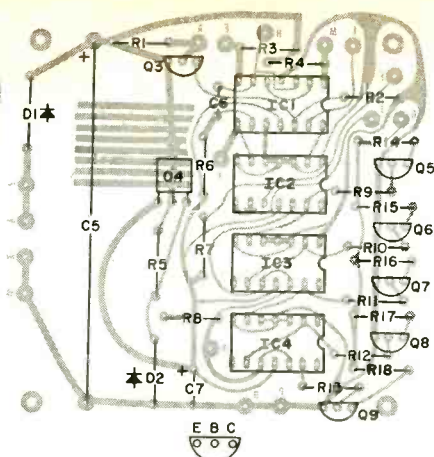
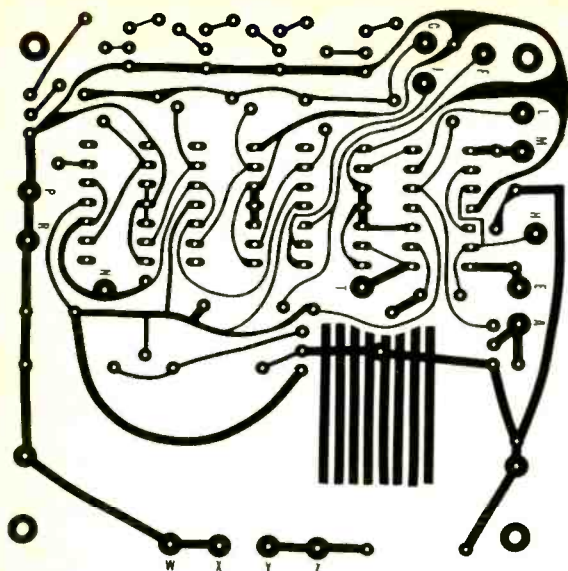

Fig. 4. Actual size foil pattern (at left) and component layout. Foil pattern under Q4 acts as small heat sink.

If lap times are to be measured, the count-up circuit operates in the same way but the input to IC1-A is controlled in a different manner. Flip-flop IC2-A is initially cleared with the reset button and, when the first light beam is broken, pin 8 goes low, allowing the UJT pulses to begin the count-up cycle. When the light beam is interrupted a second time, the flip-flop reverts to the high state, thus halting the count-up cycle. Flip-flop IC2-A must be reset to zero manually since several additional components would be necessary to implement an automatic reset.

The power supply circuit for the Timer is shown in Fig. 3.

Construction. The photograph shows how the prototype was constructed. The circuit was assembled on a printed circuit board (see Fig. 4) though the circuit is not critical and could be built on perf board.

Before beginning construction, decide what you are to time—small cars, bicycles, etc.—since this determines whether you want to mount the phototransistors in the cabinet or outboard. In the prototype, for instance, a 4-inch gap was used between light beams, but a larger gap may be necessary, depending on the light source used. (In the prototype, the author used type 222 lamps, which are 2.2-volt bulbs with integral lenses that help direct the light. However, it was found that bulbs from different manufacturers give different results so it may be necessary to experiment. If bulbs

of a different voltage are used, resistor R19 can be changed. For 6-volt bulbs, connect them in parallel directly to the transformer secondary.)

Install the timing capacitors on S2, tying the ground return to pins 3 and 4 of section C. Be sure all connections are correct or some strange results may occur when you begin testing the unit. It's best to solder wires on all the terminals of the switch and tag them for later connection to other components.

The phototransistors are very fragile and should be mounted only after all other wiring and installations are complete. Since the phototransistors have no mounting support of their own, use two small pieces of perf board with a hole in each that is just large enough to have the phototransistor pressed into it. The emitter and collector leads are wired directly to the PC board. If you are using the phototransistors away from the cabinet, use miniature phone jacks to connect the light receivers to the board.

Use white paint to block out the scale on the meter and black press-on type to put on the speed marks.

Testing. If very accurate timing is required, a digital counter can be used to set the frequency of the UJT oscillator. In most cases, however, this is unnecessary since all times are relative and a faster car will always show up as faster regardless of the frequency.

Adjust the light beams so that they

directly strike the phototransistor lenses. (For a light beam gap of a foot or more and lights a few feet from the phototransistors, high intensity lamps can be used. For timing bicycles or anything else large, flashlights with good reflective lenses work satisfactorily.) The phototransistors have integral lenses which restrict the received light to a beam of approximately 10° . Connect a voltmeter between each collector and emitter (or ground) of the phototransistors and position the light beams for a minimum voltage (about $\frac{1}{10}$ volt). If you are unable to drop the voltage to at least $\frac{2}{10}$ volt, check the phototransistor for correct positioning. If necessary, reduce the resistance of *R19* to increase the lamp brightness. Remember, however, that the lamps should not be operated too brightly or they will burn out too soon. Break the light beam and note that the collector voltage increases to about one volt.

When it has been determined that both phototransistors are operating correctly, set *S2* to position 3 and press the reset button. The meter should indicate zero current (maximum speed) and the reading should remain after the button is released. Break

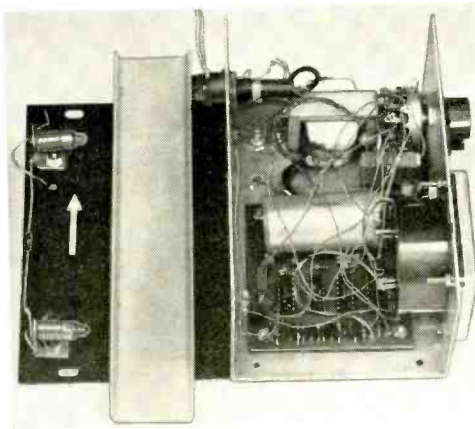

A 4-inch gap between lights was used in prototype (left). Timing capacitors are mounted directly on switch.

the first light beam and observe that the meter pointer moves up in steps toward the right. If you can count the steps, there should be 31, with the 32nd returning the meter to zero. Switch the Timer to position 4 and note that the meter moves up at a much lower pace.

To stop the meter, momentarily break the second beam and then the first. The meter

should freeze until the reset button is pressed. Remember, that when checking the lap timer function, the second beam must be broken before the first beam is broken again—which is what a car does.

With *S2* in position 2, break the first light beam and note that the meter needle oscillates around the midscale mark. Break the second beam and the needle should stop somewhere on the scale. With *S2* in position 1, the meter should be at midscale after the first beam is interrupted; but the frequency is high enough that oscillation should not be noted.

In measuring trap times, always use position 2 of the switch first if readings are near 50 mph. If a slow car is timed on the higher scale, the count-up circuit will “overflow” and an invalid reading will result.

Modifications. The timer can be changed to suit different applications—without changing the PC board circuit.

The values of the timing capacitors (*C1-C4*) can be changed to suit your particular race layout. For instance, a speed of 50 mph is equivalent to 73 ft/s or 876 in./s. Thus, a car traveling 50 mph will cover 0.876 in. in one millisecond. If we start with a four-inch gap between light beams, it will take 4.56 ms to cross the two beams. If the maximum count we can allow before overflow is 31, we can say that 31 counts equals 4.56 ms and one count equals 147 μ s. Therefore, the frequency of the pulses coming from the UJT should have a period of about 147 μ s to give a maximum current reading of 50 mph. Using rough calculations for a UJT oscillator, the oscillation period is equal to emitter resistance times emitter capacitance. The resistance of *R1* is 150,000 ohms so the capacitance is $147/150$ nanofarads or approximately 1000 pF, which is the selected standard value for *C1* in the 50-500 mph range.

A general equation for calculating the value of the UJT timing capacitor is $C = 17.5G/RS$, where *C* is the capacitance in microfarads, *R* is the value of *R1* in kilohms, *G* is the light-beam gap in inches, and *S* is the maximum scale speed in miles per hour. The same equation can be used to determine the lap-time capacitors, using the distance around the track (in inches) for *G*.

When mounting the phototransistors at a distance from the meter, with long leads, it may be necessary to use an emitter fol-

lower buffer circuit to eliminate noise. The phototransistors have high impedance and are rather sensitive to noise. A buffer circuit is shown in Fig. 5, with three-pin microphone connector plugs to connect the circuit to the timer.

The power supply can be replaced by batteries if you want to cut costs or are worried about youngsters using a toy that plugs into the wall. Use a 9-volt battery for the 8-volt source; the voltage difference should have no effect on the operation. The current through the meter may be slightly higher, so a small resistor in series will bring full-scale current back to the end mark. Three D cells can be used to operate the IC's and, although the resultant 4.5 volts

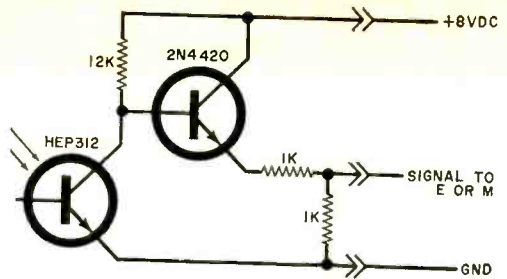

Fig. 5. Use this circuit when wide spacing between beams is required.

will not damage them, a silicon diode in series will drop the voltage to about 3.9, with a resultant lowering of current drain. ♦

SelectaVision MagTape System

RCA TO MARKET COLOR VIDEO PLAYER FOR CONSUMERS

THE latest home video recorder/player, which will be available in 1973, is the all solid-state RCA SelectaVision MagTape unit. Measuring 22" x 17¼" x 5¼", the unit has a front-panel slot to accept a 9" x 6¼" x 1½" molded plastic tape cart-

ridge. A set of piano key switches are used to control the various operations. The only connection between the player/recorder and the TV set is through the antenna terminals. The set is tuned to an unused channel for tape operation.

The player/recorder includes both vhf and uhf tuners so that a monochrome or color recording can be made of one channel while watching another. An automatic timer is also included to turn the recorder on at any desired time. There is provision for using an external black and white camera for the "do-it-yourself" TV producer, at home or at work.

Although the first units will be independent of the TV set, RCA points out that they will be followed by combination models incorporating both color TV receiver and the player/recorder. Final pricing will be determined when the system reaches the selling stage, but it is expected to be under \$700; the cartridges will cost about \$30.

When not in use, the book-size tape cartridge is completely closed so that the tape is never exposed or handled. Chromium dioxide (high energy) tape is used and the approximate 900' of tape in a cartridge permits about one hour of use. When the cartridge is inserted in the slot, an internal lever opens the cartridge to permit the tape to come into contact with the rotating headwheel (four heads). ♦



IT IS likely that hi-fi historians will conclude that the most significant change in loudspeaker design was produced more by revolution than by evolution. The sudden appearance of the high-compliance acoustical-suspension woofer in the 1950's with its ability to provide satisfying bass in a small box put big speaker systems on the defensive. Then the demands of stereo and quadraphonics reversed the rules so that bass output per unit of cabinet volume became more important than conversion efficiency (sound output versus electrical input). Speaker systems became smaller and smaller while amplifier power ratings soared. The bass reflex seemed to be in danger of becoming extinct.

During the past year or two, the first signs of a possible revival for the reflex have become evident. One straw in the wind is the announcement this year of several new reflex speaker systems. Another is the apparent renewed interest in floor model systems even while engineers are coming up with new designs which improve reflex loading in bookshelf cabinets.

Bass reflex enclosures require careful design. But where conversion efficiency is important, the reflex is worth the effort. The typical efficiency of an acoustical suspension speaker is about 1 percent; that of a larger reflex model such as the Electro-Voice monitor systems may be as high as 5 percent. Most reflex systems will deliver room-filling sound in a typical home environment from a 10-watt amplifier. Too, reflex partisans claim it has greater dynamic range, lower distortion, and a more relaxed and smoother bass.

Away from the Boom Box. The fact that anyone would apply the adjective "smooth" to the bass reflex suggests that it has come a long way from the "boom box." One reason for boomy bass from a reflex system was that the builder usually based his dimensions on generalized charts rather than precisely matching the box to his speaker. Manufacturers of commercial enclosures attempted to reduce design complexity—and cost—by approximations which resulted in less than optimum performance. Today, more attention is given to both the tuning and internal damping of the system. For example, some changes were made in the acoustical damping of the E-V Sentry I and Sentry II speaker systems which produce a cleaner low end in the new Sentry IA and Sentry IIA models.

COMEBACK of the BASS REFLEX

THIS HI-FI SPEAKER
ENCLOSURE IS SHOWING
SIGNS OF NEW LIFE

BY DAVID B. WEEMS

Obviously, there is more to a speaker system than enclosure design. The type of box is only one of many factors which contribute to the sound. This brings up a question: Can listeners hear the difference between a typical reflex and a typical sealed box speaker? To find out, Utah—a company that makes both types of systems—set up test demonstrations at several hi-fi shows. A-B comparison tests were made with L-pads in the circuit to equalize volume levels. Says Al Altenhof of Utah, "The visitors seemed to be split 50-50 in their preferences." Nor were the listeners wishy-washy about sound. "There were very few listeners with vague preferences," says Altenhof.

Utah's experience implies that the reflex has a solid future, particularly if it can be made competitive with the sealed box in space requirements. We'll have more to say about some of the new models, but first let's take a look at the history of the reflex.

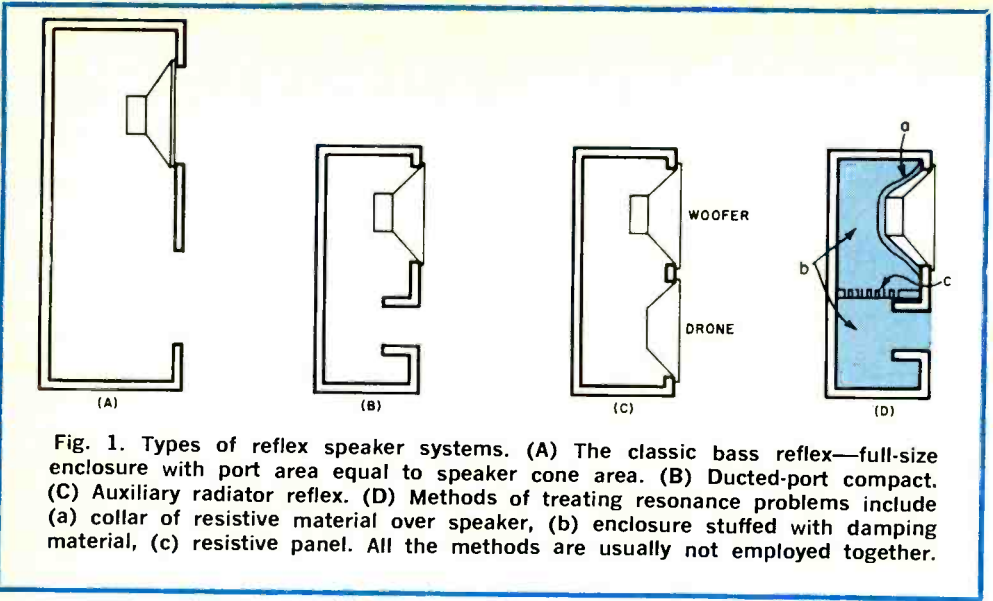

The Classic Bass Reflex. The classic bass reflex consists of a large box tuned, by a simple port, to the speaker's free-air resonance. In the typical old-fashioned reflex, the port area is about equal to that of the woofer cone. The air in the port acts as a second large piston which, like the speaker cone, can compress or expand the air in the box. At system resonance, both the port piston and the speaker cone try to compress the air at the same time. This action damps cone movement at resonance, controlling it and reducing distortion. The speaker's original resonance is replaced by two new resonances, one higher and one lower in frequency than that of the speaker operated in free air. These new resonances are easily identifiable as two peaks in the speaker's impedance curve.

Early experimenters sometimes used compact boxes for reflex operation. But they had to restrict the port area, losing some port radiation and loading effectiveness, in order to maintain proper tuning. Later, they added a duct to the back of the port which increased the mass of air in the port. With the same air volume in the enclosure, and the same compliance of vibrating air, increased mass lowered resonant frequency. This permitted a larger port area or a further reduction in enclosure volume, whichever goal was considered more important. Most of today's designs are based on the ducted port. Regardless of the type of port, all reflexes utilize the same cone damping

principle. James F. Novak, Chief Engineer at Jensen, says, "It really matters very little as to what the shape of the port is or what the duct material is so long as the enclosure is properly tuned."

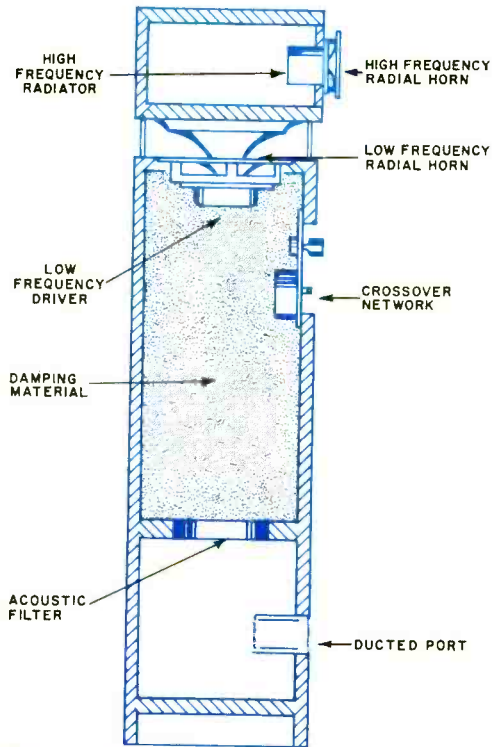
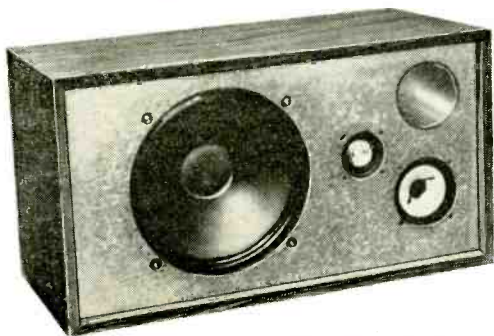

Fig. 2. Internal details of JBL Aquarius 4.

If conventional reflex enclosures are made too small, several problems result. One, mentioned above, is the reduced output from the small port which makes the enclosure act like a leaky box. In extreme cases, the advantages of reflex loading are lost. Another demon of small boxes is the upper resonance which increases in amplitude and frequency as enclosure volume is reduced. When it occurs at about 100 Hz or higher in frequency, it adds an unnatural boom to male speech. Some designers attack this problem by adding an acoustical resistance to the system, usually as a resistive material stretched over the back of the speaker to increase damping. Others put the resistance in a slotted or drilled partition or even stuff the enclosure itself to reduce the resonance. The increased resistance broadens the tuning and makes the box "act" bigger than it really is, but with some loss in efficiency. Each of these design tricks, or variations on them, are being applied today by manufacturers of commercial bass-reflex systems. And they have added a few new ones.

The New Reflexes. Reflex loading is found in speakers at various points along the price scale. It can be used for inexpensive systems because special woofers are not required.

One development of recent years which has enabled the manufacturer to cut the cost of reflex speakers is the type of duct used today. The shelf or slot which was an integral part of the enclosure has been replaced by a low-cost cardboard tube. The tube is also easily installed and tuned. Examples of ducted-port compact systems are the Jensen Model TF-30, Lafayette Radio Electronics Criterion 100B, and the Trusonic Velonte series.



Lafayette Criterion 100B uses tubular ducted port at upper right in photo.

Ducted-port compacts are not always listed at the bottom of a line of speaker systems. The Utah Model HS-4, a three-way system, is considerably more expensive than their Model AS-1 and AS-12 two-way acoustic-suspension models. Also, in the Kenwood line, the two lower priced models are sealed boxes, but their newer more expensive Models KL-5060 and KL-3080 offer reflex loading via a damped pipe. According to Carl K. Uemura, National Service Manager for Kenwood, the damped pipe design was chosen after many experiments and extensive field testing. He says that Kenwood's goal for the new speaker systems was to obtain a well-damped, clean bass with efficient low-end power response.

The "Drone Cone." The simple port has been largely replaced by the duct, particularly in compact enclosures. Another substitute has been employed by some designers who want to obtain full radiation from small boxes and yet achieve correct tuning. This is the "drone cone," sometimes called a passive radiator (PR) or auxiliary bass radiator (ABR). It is simply an extra bass cone with neither voice coil nor magnet assembly. The same laws of physics govern the behavior of the drone as that of any driven cone. This means that its resonant frequency is dependent upon its mass and compliance. It can be tuned by varying its mass, typically by adding or removing cardboard discs from the rear center of the cone.

The drone cone is not a new idea. It was described in 1952 by B.N. Locanthi of JBL. One goal of early advocates of the drone was to improve on open-port performance by insuring uniform particle velocity and in-phase performance across the radiator. An added benefit was a reduction in reflected midrange sound which is sometimes transmitted through an open port. A disadvantage of the drone cone is its cost which is higher than a hole in the baffle. Also, it has no magnet to control it; so, cone damping must be purely mechanical. This requires careful design of the suspension system.

Engineers who choose the drone system contend that with proper suspension design it can yield improved transient response over conventional reflex systems. They base their argument on the use of a small woofer with better inherent transient response. The woofer's effective cone area is doubled by

the matching passive unit. Also, the drone can be tuned to a lower frequency than the woofer itself by adjusting the drone's mass. Because it vibrates in-phase with the woofer cone over its effective operating range, the drone damps the woofer cone at the woofer's resonant frequency, offering the reduced distortion of an open port. Several commercial speaker systems now use the drone principle, notably the JBL Lancer Models 44 and 77 compacts and the new Bang & Olufsen Beovox 5700. The latter is another example of a reflex model which tops a line of sealed-box speaker systems.

In addition to new methods of porting and tuning reflex speaker systems, some engineers are applying imaginative designs to reflex enclosures to obtain special effects. For example, the Tannoy Orbitus I offers 360° radiation of all frequencies by its horizontally mounted 12" dual concentric loudspeaker which faces upward into an orbital deflector. When a conventional large woofer is mounted horizontally, the cone may be deflected by the force of gravity, moving the voice coil into an area of non-uniform magnetic field. Tannoy designed a suspension system for the Orbitus I woofer which maintains cone stability in that position. The Tannoy Monitor line of speakers requires large enclosures if unvented. So, the semi-compact floor model designed for the Orbitus I is ported at the bottom by a duct. This duct on the opposite panel from the speaker is in contrast to the traditional speakers in the Tannoy line which are frontal radiating systems.

Another reflex speaker system with a horizontally mounted woofer is JBL's Aquarius 4. It differs from the Tannoy system in that the JBL system uses reflected sound at the high frequencies produced by a vertically mounted tweeter on the rear panel. With the lows radiating in a horizontal

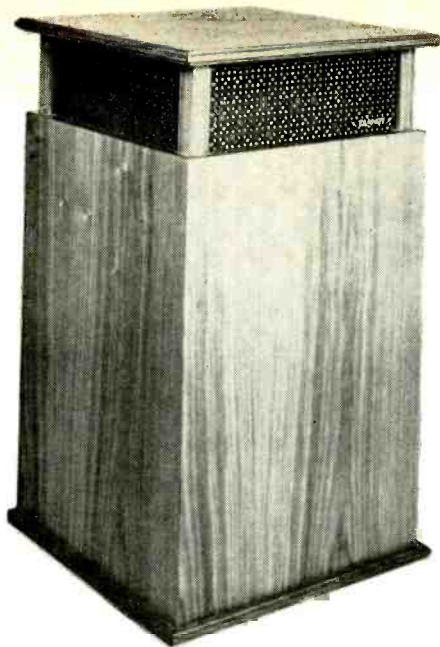

Tannoy Orbitus I is a floor model of medium size with ducted-port reflex.

plane and the highs in a vertical plane, there is interaction between the right angle dispersion patterns which, according to JBL, increases the apparent size of the sound source. At first look, the Aquarius 4 appears to violate an old rule of thumb which states that no enclosure dimension should be more than three times that of another. The Aquarius 4, however, is actually a double-chamber reflex. The upper chamber contains damping material and is terminated in an acoustic filter to prevent its acting as a resonant pipe.

V-M Corporation produces a line of Spiral Reflex speaker systems which are even more subdivided than the Aquarius 4. The number of chambers in the V-M systems varies inversely with the size of the enclosure. The smaller the box, the more chambers contained within it. William Kovach of V-M states that the extra chambers in the smaller boxes serve to delay the low-frequency sound much as it is delayed in large enclosures by the greater distance it must travel. The larger V-M floor models have four chambers, and their shelf speakers have six.

A survey of the new speaker systems discussed above shows some unusual combinations of features making the enclosures

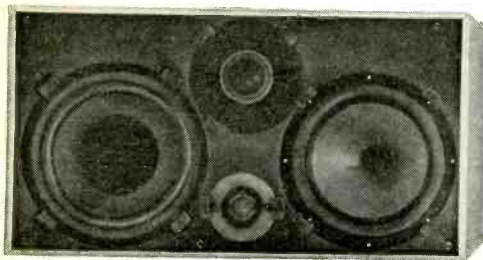

Bang & Olufsen Beovox 5700 employs auxiliary bass radiator at the left.

sometimes resemble sealed boxes or labyrinths. In fact, a strong characteristic of current reflex design seems to be a willingness among engineers to crossbreed between enclosure types. The Aquarius 4, for example, offers horn loading at the front of the woofer cone, while the rear chamber is a broadband tuned pipe. The V-M speakers and the Admiral tunnel reflex systems also appear to be modified labyrinths. And the drone-cone speakers of various manufacturers operate as reflexes, but from a box that is acoustically sealed to middle and high frequencies.

Another reflex-sealed box hybrid is not even listed as a reflex. It is represented by the Dynaco line of speakers which contain a duct stuffed with material to prevent radiation from the duct mouth. The duct is functional in another way: pressure build-up inside the enclosure compresses the material in the duct and slightly alters the volume of the box. This change in volume alters the resonant frequency of the system. The Dynaco cabinets may be regarded as variable-volume enclosures. One advantage of

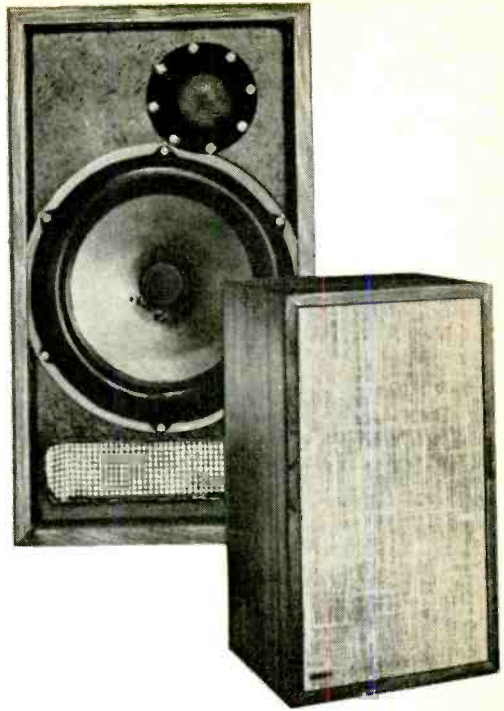

The Dynaco A-25 speaker has a ducted port but is not classified as a reflex since the port does not radiate.

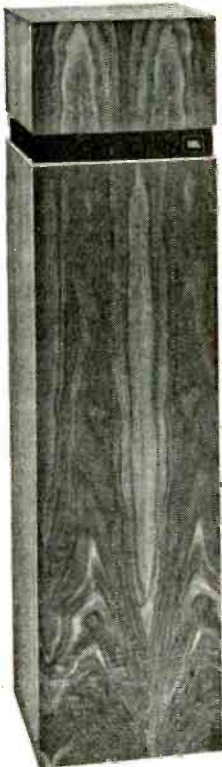

JBL Aquarius 4 ducted reflex uses unusual dual chamber internal design.

the stuffed duct approach is that it produces a smooth speaker impedance curve which permits more efficient power transfer from the amplifier to the speaker.

After looking at the variety of reflex designs available today, it would be foolhardy to attempt to guess what construction details will be adopted in the future. But it is a safe bet that there will always be a demand for more bass from small enclosures. James F. Novak says that the recent trend away from reflex speakers can be explained by the fact that today's cabinets have become acoustically too small for some of today's woofers which would require very large "optimum volume" reflex enclosures. Then he says, "I do, however, see this trend possibly reversing back to the reflex design except that this time the woofers will become smaller."

Al Altenhof also sees a continued trend toward smaller enclosures. He says that they will require smaller woofers with high compliance and refined magnetic circuits.

Whatever the future of reflex speaker systems, there can be little doubt that they are available today in greater variety than ever before. ♦

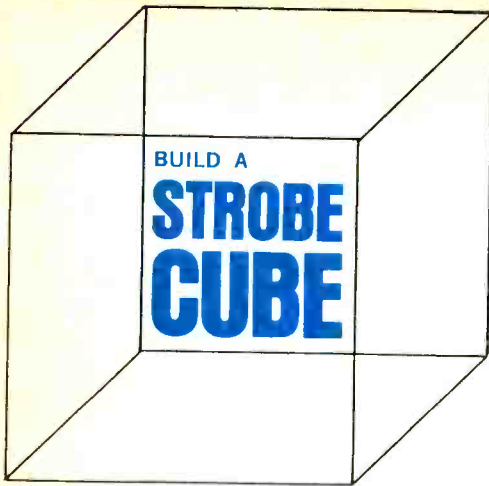

FLASHER FOR POP MUSIC OR MOTION-STOPPING STROBE

BY RICHARD M. FISHER

ALTHOUGH electronic strobes are most often used in industrial and photographic applications, the dramatic effect of a flashing light makes a nice complement to the modern pop-music scene. It also makes a good, hard-to-miss, obstruction warning light.

The Strobe Cube described here can be used for both purposes, and it has a variable flashing rate (with a maximum that does

not do harm to the eye). Any type of container can be used though the kit mentioned in the Parts List includes a square translucent plastic box.

Theory of Operation. The circuit is shown in Fig. 1. Isolation transformer *T1* is optional, but its use is recommended in the interest of safety. When the power is on, capacitor *C3* is charged up through the combination of *R1* and *R2*. The voltage across *R2* is also coupled through *T2* to the anode of *SCR1*. As soon as the voltage reaches the flashover potential of neon lamp *I1*, a positive pulse is applied to the SCR gate. This causes the SCR to turn on and *C3* is discharged through the primary of *T2*. A high-voltage spike is then generated across the secondary of *T2* and is applied to the trigger electrode of the flashtube. The main dc power is also applied across the flashtube, so that as soon as the trigger pulse occurs, the gas in the tube ionizes producing a bright flash of white light. Capacitor *C3* is discharged, and the process repeats. The flash rate is determined by the resistance setting of *R1*.

Construction. A PC board foil pattern and component layout are shown in Fig. 2. Optional transformer *T1* is not on the board. Install all the components except the flashtube, observing the proper polarities.

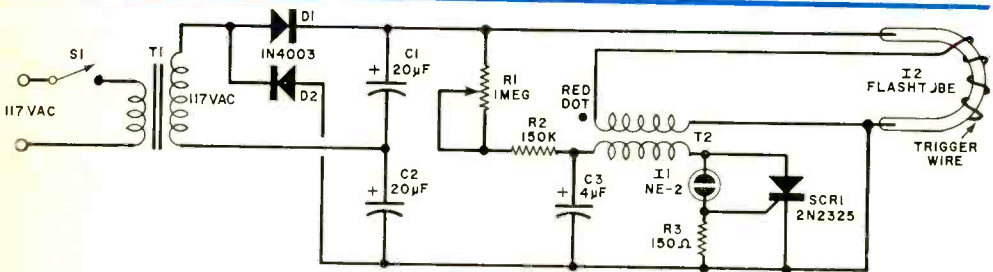

PARTS LIST

- C1, C2*—20- μ F, 250-volt electrolytic capacitor
- C3*—4- μ F, 150-volt electrolytic capacitor
- D1, D2*—Diode (1N4003)
- I1*—NE-2 neon lamp
- I2*—5-watt flashtube (see note)
- R1*—1-megohm linear-taper potentiometer (with integral *S1*)
- R2*—150,000-ohm, $\frac{1}{2}$ -watt resistor
- R3*—150-ohm, $\frac{1}{2}$ -watt resistor
- S1*—Spst switch (on *R1*)
- SCR1*—Silicon controlled rectifier (2N2325)

T1—117V:117V isolation transformer (optional)

T2—Trigger transformer (see note)

Misc.—Suitable translucent plastic cube, mounting brackets, TV cheater assembly, knob, mounting hardware, etc.

Note—The following are available from DEC, 99 E 4th St., New York, NY 10003: 5-watt flashtube (FT-10A), \$3.75; trigger transformer (TR-1A), \$2.00; PC board, \$3.50; PC board and all parts (except *T1*), \$14.95; Plexiglass cube, \$5.95; complete kit, \$19.25. Please add \$1.25 on all orders to cover postage and handling.

Fig. 1. Flashtube is triggered when SCR1 turns on and charge on C3 leaks off through T2.

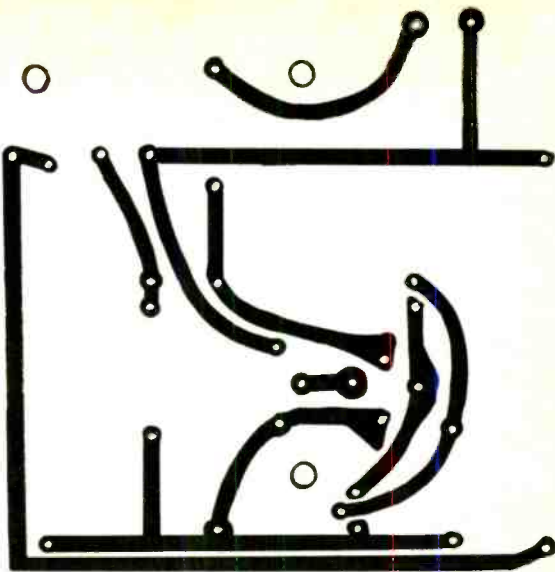
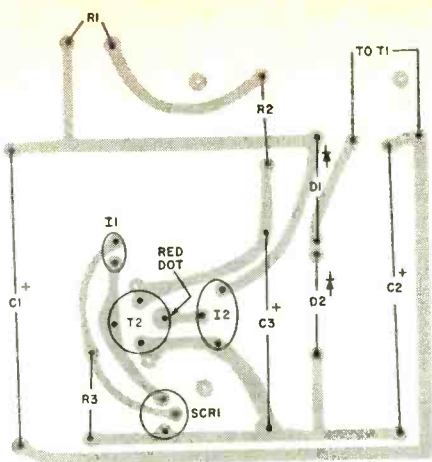

Fig. 2. Actual size foil pattern for the strobe cube is shown at right. Components are mounted as shown above.

The flashtube has three leads, one at each end of the U tube and one connected to a strap around the tube. The latter connection is the trigger electrode. Solder a short length of thin wire to this electrode and wrap it around the tube four times, making sure that the wire does not contact either of the other two leads. Wrapping the wire around the tube increases the trigger lead surface contact. Mount the flashtube in place, noting that the cathode has the large electrode and should be connected to the minus side of the power supply. Trigger transformer *T2* has a red dot at one pin (the high-voltage pulse terminal) and must be connected as shown.

A conventional TV "cheater" connector was used on the prototype to make the ac contacts.

Testing and Installation. Connect the ac cord to the isolation transformer and turn on *S1* (located on *R1*). A 3-ampere fuse may be used to protect the circuit until you are sure that it works properly. Do not touch the circuit until you have made sure that all capacitors have been discharged. Changing the setting of *R1* will cause the strobe to flash at different rates.

If you make the cube, mount the PC board on the bottom plate, remembering that the potentiometer mounting hardware is used to hold the bottom plate to the remainder of the cube. Cut a small hole in the side of the cube where the potentiometer is located. The rest of the cube is cemented together and a small piece of plastic is cemented to the side opposite the potentiometer hole so that a small holding screw can be inserted through the bottom. ♦

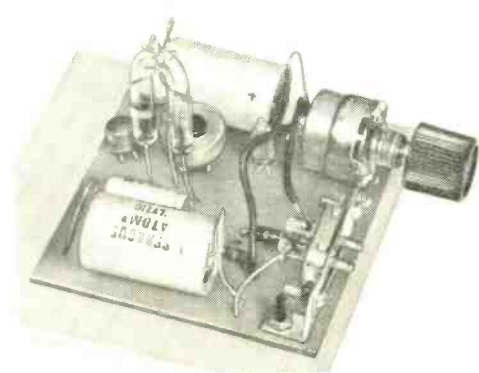

All components except *T1* are mounted on PC board as shown on prototype.

OPERATING CONDITIONS

The equivalent series capacitance of *C1* and *C2* is 10 μF . The energy input to the tube, per flash, is $E = \frac{1}{2}CV^2 = \frac{1}{2}(10 \times 10^{-6})(340)^2 = 0.578$ joule. At six flashes per second, the total power to the tube is 6 times the energy per flash or $3\frac{1}{2}$ watts, which is well within the 5-watt rating of the flashtube. Approximately 9 flashes per second will hit the 5-watt limit. With the circuit enclosed, any heat generated remains in the enclosure. Therefore, if the flasher is to run continuously near its maximum rate, ventilation holes must be used.

10 New Heathkit Projects



499⁹⁵*
less cabinet

NEW Heathkit 21V Color TV — Solid-State Plus Detent UHF Tuning

The new Heathkit GR-271 is the 21-in. (measured diagonally) version of our famous GR-900, the most advanced color TV we've ever offered. The GR-271 has the same state-of-the-art tuning convenience with power detent selection of all VHF and any 12 pre-selected UHF channels; exclusive angular tint control for consistently better flesh tones; voltage controlled varactor UHF tuner & MOSFET VHF tuner for unmatched sensitivity; exclusive MTX-5 matrix tube with etched face plate for increased contrast, less glare. Plus, the GR-271 has built-in dot generator, convergence panel and volt-ohm meter — full remote control options, too. It's Heathkit TV at its finest in a space-saving size.

Kit GR-271, less cabinet, 121 lbs. 499.95*
Assembled GRA-501-21, table model cabinet shown,
tough walnut Marlite® finish, 33 lbs. 54.95*



689⁹⁵*

NEW Heathkit/Thomas Spinet Organ with two 44-note keyboards

A kit for the whole family to build and enjoy. The all-solid-state TO-1160 Heathkit/Thomas Spinet has full 44-note keyboards for Solo and Accompaniment, exclusive Color-Glo keys that light up to indicate notes and chords. With the Color-Glo course included you'll be playing songs almost instantly. There are six solo stops — flute 16', 8' and 4', trumpet 8', oboe 8', and violin 8'. Five accompaniment stops — horn 8', diapason 8', melodia 8', cello 8', and pedal voice with 16' & 8' combined. Plus both regular and a new "light" vibrato effects. Other features include keyboard jacks for private earphone listening or use of a tape cassette deck. The beautiful pecan-veneer cabinet is shipped fully assembled, includes bench. The TO-1160 Spinet organ is one of the most exciting gifts you can give or get for Christmas.

Kit TO-1160, 211 lbs. 689.95*



64⁹⁵*

NEW Heathkit Engine Analyzer

For 3, 4, 6 and 8-cylinder engines. The CM-1050 includes leads and accessories for testing conventional, transistor, and magneto ignition systems, regardless of voltage or grounding. Uses 3 "C" batteries (not included).

Kit CM-1050, 9 lbs. 64.95*



39⁹⁵*

NEW Heathkit C-D Ignition System

This simple, one-evening kit will increase spark-plug and point life up to 50,000 miles on any car or truck using a 12-volt, negative ground system. The Heathkit CP-1060 automatically varies spark duration — longer for low-battery, cold-morning starts, shorter for high-rpm cruising. Screw-on terminals make installation easy; external pushbutton lets you override system without removing leads.

Kit CP-1060, 4 lbs. 39.95*



79⁹⁵*

NEW Heathkit 2 1/2-Digit VOM

A compact, solid-state multimeter with digital readout — at a fantastic kit-form price. The new Heathkit IM-1202 has four overlapping ranges to measure voltages from 10 mV to 1000 V on DC (either polarity), 10 mV to 700 V rms on AC, 10 uA to 2.5 A on AC or DC current. Five resistance ranges measure from 1 ohm to 2 megohms. Front panel polarity switch reverses inputs without changing leads.

Kit IM-1202, 6 lbs. 79.95*



169⁹⁵*

NEW Heathkit 30 MHz Counter

The Heathkit IB-1100 gives 1 Hz to over 30 MHz counting on a full 5-digit readout with 8-digit capability. The lighted overrange indicator makes misreading virtually impossible. Stable time-base circuitry assures accuracy better than ±3 ppm from 22° to 37° C. Diode protected J-FET gives improved triggering over 100 mV to 150 V input range. Solid-state circuitry mounts on one large board.

Kit IB-1100, 6 lbs. \$169.95*

to Brighten Anybody's Christmas!



See them all
in this NEW
FREE CATALOG

Your new Heathkit Catalog is ready and waiting. If you're not already into a Heathkit hobby, what's holding you back? Ask around and you'll find a Heathkit builder who can show you the rewards. You'll pay yourself back for your kitbuilding time with better products. In terms of price, value, performance specifications,

and self-service features. And the Heathkit line-up is bigger and better than ever. Including color TV, stereo/hi-fi, electronic organs, home appliances, engine tune-up tools, radio control, shortwave, marine gear, instruments, hundreds more. They are all in the free '73 Heathkit Catalog. Send for yours now.

NEW Heathkit 6-Digit Electronic Alarm Clock

The exciting Heathkit GC-1005 Digital Clock displays hours, minutes and seconds on highly visible cold-cathode readout tubes. A gentle "beeper" alarm can be set for 24-hour cycle and features a snooze switch that gives you seven more minutes of sleep before the alarm sounds off again. The all-solid-state circuitry is designed to display either conventional 12-hour or 24-hour international time (Manual shows you how to wire it for the readout you prefer). Includes am/pm indicator light to facilitate setting time and alarm. Special fail-safe circuit flashes all "eights" on display if 60-cycle line voltage is interrupted.

Kit GC-1005, 4 lbs. 54.95*



54.95*

NEW Heathkit 8-Channel VHF Band-Scanning Monitor with digital readout

Crystal-controlled monitor tunes any selected 9 MHz segment of the 146 through 174 MHz band — gives you police, fire, marine, ham 2-meter, etc. Features either manual or automatic scanning with numerical readout, channel lock-out buttons. Priority channel "0" takes precedence over all other channels when in the automatic mode. Also has built-in speaker and rear-panel jack for remote speaker; Gimbal bracket and mounting plate for either base-station or mobile use. Operates on either 120/240 VAC or 12 VDC. Includes crystal OSC/Mixer signal source for easy alignment. Order up to eight Crystal Certificates with kit, fill out and return for speedy delivery of the frequencies you need.

Kit GR-110, 9 lbs. 119.95*

GRA-110-1, Crystal Certificate, postpaid each 4.95*



119.95*



NEW Heathkit Dolby® Cassette Deck

A kit-form cassette deck utilizing the famous Dolby® noise reduction system. Accommodates the greater fidelity and dynamic range of chromium dioxide cassettes. Independent switches provide Dolby on/off and regular or CrO₂ bias control. Domestic-make tape transport comes preassembled for easy kit building.

Kit AD-1530, 21 lbs. 249.95*

249.95*

NEW Heathkit Dual-Range Visual/Audible Fish Spotter®

Flasher-type sounder with two ranges reading 0-60° and 0-240°. Audible alarm can be set to sound at any level in between. Super Bright neon light. Runs on 12 VDC ship's power.

Kit MI-1031-1, with thru-hull transducer, 6 lbs. 99.95*

Kit MI-1031-2, with transom transducer, 6 lbs. 99.95*



99.95*

Send For Free '73 Heathkit Catalog!

HEATHKIT ELECTRONIC CENTERS — ARIZ.: Phoenix, 2727 W. Indian School Rd.; CALIF.: Anaheim, 530 E. Ball Rd.; El Cerrito, 6000 Patrero Ave.; Los Angeles, 2309 S. Flower St.; Pomona, 1555 Orange Grove Ave. N.; Redwood City, 2001 Middlefield Rd.; San Diego (La Mesa), 8363 Center Dr.; Woodland Hills, 22504 Ventura Blvd.; COLO.: Denver, 5940 W. 38th Ave.; CONN.: Hartford (Avon), 395 W. Main St. (Rte. 44); FLA.: Miami (Wialeah), 4705 W. 16th Ave.; GA.: Atlanta, 5285 Roswell Rd.; ILL.: Chicago, 3462-66 W. Devon Ave.; W. 16th Ave.; IND.: Indianapolis, 2112 E. 62nd Ave.; KANSAS: Kansas Downers Grove, 224 Ogden Ave.; MD.: Baltimore, 1713 E. Joppa Rd.; Rockville, 5542 City (Mission), 5960 Lamar Ave.; MASS.: Boston (Wellesley), 165 Worcester St.; MICH.: Detroit, 18645 W. Nicholson Lane; MINN.: Minneapolis (Hopkins), 101 Shady Oak Eight Mile Rd. & 18149 E. Eight Mile Rd.; N.J.: Fair Lawn, 35-07 Broadway (Rte. 4); N.Y.: St. Louis, 9296 Gravois Ave.; N.Y.: Buffalo (Amherst), 3476 Sheridan Dr.; OHIO: Cincinnati (Woodlawn), 10133 Spring-Jericho Turnpike; Rochester, Long Ridge Plaza; PA.: Philadelphia, 6318 Roosevelt Blvd.; Pittsburgh, 3482 Wm. Penn Hwy.; TEXAS: Dallas, 2715 Ross Ave.; Houston, 3705 Westheimer; WASH.: Seattle, 221 Third Ave.; WIS.: Milwaukee, 5215 Fond Du Lac.

HEATH COMPANY, Dept. 10-11
Benton Harbor, Michigan 49022

Please send FREE Heathkit Catalog. _____, plus shipping.
 Enclosed is \$ _____
Please send model(s) _____

Name _____
Address _____
City _____ State _____ Zip _____

Prices & specifications subject to change without notice.
*Mail order prices; F.O.B. factory.

CL-443R

CIRCLE NO. 16 ON READER SERVICE CARD

DIGITAL LOGIC TUNES TV RECEIVERS

FLIP-FLOPS AND GATES HAVE ARRIVED FOR TV SETS

Digital logic has, until recently, been the exclusive property of calculators, computers, and the like. However, it now appears that the flip-flops have caught up with TV receivers.

According to a paper published by the Matsushita Electric Industrial Co., TV Products Development Laboratory (the R&D branch of Panasonic), the new system is called "Total Electronic Logic Tuning Systems for TV Receivers".

Two such systems have been proposed, each using IC logic and varactors to replace the mechanical tuner currently used. One approach uses pushbutton switches for tuning, while the other uses a simple 10-button decimal selector switch and gas-discharge readout tubes for channel indication. The logic for this latter system is shown in the accompanying diagram, and shows that the system also works for uhf.

Although varactor devices have been used as afc controllers in FM and TV receivers for many years, this new approach uses digi-

tal logic for controlling the varactors, instead of the usual low-level dc.

The selected channel, via the front-panel pushbuttons, is encoded into a binary number. This signal is then fed to another logic circuit and eventually turns on a particular gate associated with that channel. The gate, in turn, supplies the tuning voltage to its associated varactor. Each varactor is accurately pretuned via a preset potentiometer (called Voltage Memory) for each channel so that when the associated gate operates, the TV set is "on the head".

The selected encoded binary number is also applied to a BCD-to-decimal decoder and used to drive a pair of front-panel gas-discharge readout tubes that indicate the selected channel. The simpler version of the electronic tuner does not have the readouts.

Panasonic feels that the use of this new digital system will eliminate the problems associated with mechanical switching and expects this approach to provide high reliability, small size, and lower cost. ♦

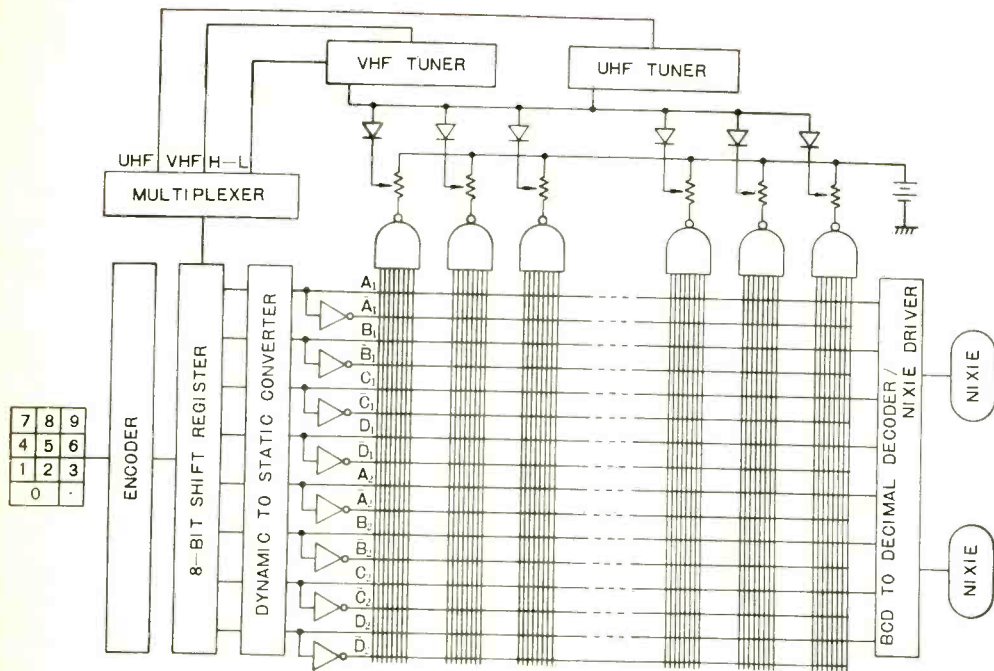

THE children's game of tag has always been good to keep the kids outside and out of mom's way. But sometimes, it rains; and then the kids are inside. When the kids come in, the TV goes on. Now, with "TV Tag," the magic of television can be coupled with the fun of tag; and rain or shine, you and the kids will be happy. On the other hand, TV Tag is fun for adults too—a good conversation piece and a challenge to play.

TV Tag is a two-part system. One part is your ordinary home television receiver; the other is a collection of seven inexpensive integrated circuits, three transistors, a light bulb, and a handful of resistors and capacitors. There are no modifications or connections to be made to the TV set. Any vacant channel from 2 to 6 can be used to receive the video signal from the game.

Two white dots are displayed on the TV screen, one controlled by player A and the other by player B. Each player has two knobs to rotate. One knob moves his dot up or down, the other moves it left or right. A slide switch determines which player is "it" and his dot flashes off and on for easy identification. The player who is it moves his dot into a corner of the screen and begins his count. The other player positions his dot anywhere on the screen. At the count of ten, the it dot begins to stalk the other dot; and with some luck and skill, it eventually tags the other dot. Immediately, the tagged dot disappears from the screen and a lamp on the game begins to flash. Depressing the reset button causes the tagged dot to reappear and the flashing light goes off.

Theory of Operation. As shown in Fig. 1, the circuit can be divided into four basic sections: TV receiver sync generator, player-adjustable delay circuits, logic circuits, and modulated r-f source.

The circuits shown in Fig. 2, generate the necessary horizontal and vertical sync pulses to lock the raster on the TV set. The circuits are similar except for the timing elements. Two inverters are cross-coupled as astable multivibrators (15,750 Hz for horizontal; 60 Hz for vertical) which drive inverters operated as half-shots to generate the required pulses.

The manually controlled delay circuits, shown in Fig. 3, are also similar, except for the time constants. Each section is further divided into similar pairs, one for player A and one for player B. Each circuit

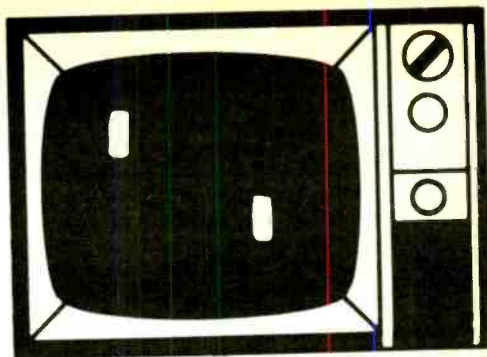

PLAY ELECTRONIC TAG ON YOUR TV

"TV TAG"—UNIQUE GAME
FOR THOSE RAINY
AFTERNOONS

BY JEFFREY W. ANDERSON

takes the H and V syncs, inverts them and uses them to trigger a pair of monostable multivibrators. The amount of delay introduced is determined by the settings of the control potentiometers ($R10$, $R14$, $R18$, and $R22$), operated by the players. The delays determine the positions of the dots on the screen.

The output of each horizontal multivibrator is fed to a half-shot that generates a 600-ns pulse at the end of the adjustable delay time, while each vertical output is fed to a half-shot that produces a 200-300- μ s pulse. The horizontal pulse determines the width of the dot, and the vertical pulse determines its height. An inverter at each output processes the pulse for further use.

If these outputs of the delay circuits were displayed on the TV screen they would appear as a pair of crossed lines, similar to the cross hairs of a rifle scope, except that they would be variable. However, by using

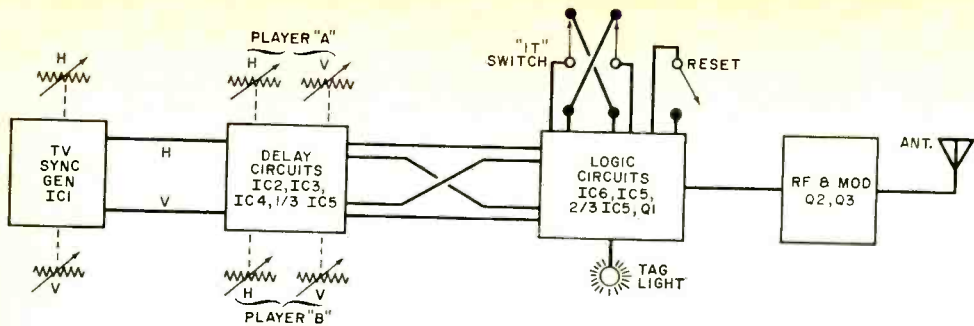

FIG 2

FIG 3

FIG 4

FIG 5

Fig. 1. The circuit of the TV Tag can be divided into four parts: a sync generator (same frequencies as monochrome TV), delay and logic sections, and r-f oscillator.

a coincidence detector, only the line cross, or a small dot, can be passed to the r-f stage. This is the purpose of the three-input gates (IC6) shown in Fig. 4. Pin 3 of IC6 has a narrow pulse output when both horizontal and vertical pulses for player A are present, while pin 9 has the same for player B. The two sets of adjustable-position dots are then mixed in IC7 and passed to another 3-input gate where they are combined with the original H and V sync pulses. The combination of R26 and C17 operates the gate in the linear portion. The output at pin 5 is 1.5 volts dc for a no-signal, no-sync condition. This produces a pedestal for the positive dot video and negative-going sync. That is, all dot video is composed of pulse excursions above the 1.5-volt pedestal; and all sync consists of

PARTS LIST

- C1, C2—0.002- μ F capacitor
- C3, C20—0.001- μ F capacitor
- C4, C6, C11, C13—1- μ F electrolytic capacitor
- C7, C9—0.01- μ F capacitor
- C8, C10—330-pF capacitor
- C12, C14—0.1- μ F capacitor
- C15, C16, C18—5- μ F electrolytic capacitor
- C17—0.05- μ F capacitor
- C19—180-pF capacitor
- C21, C22—24-pF capacitor
- C23—1-pF capacitor
- D1, D2—Diode (1N34)
- I1—Low-voltage lamp (#338,49 or similar)
- IC1-IC3, IC5—Hex inverter (MC789P or HEP573)
- IC4, IC7—Quad 2-input NOR gate (MC724P or HEP 570)
- IC6—Triple 3-input gate (MC792P)*
- I1—Phono Jack
- L1—4 turns of #18 wire, spaced $\frac{3}{8}$ " on $\frac{1}{4}$ " diameter slug-tuned form
- Q1-Q3—Transistor (2N3904 or HEP736)
- R1, R3, R12, R16, R20, R24—11,000-ohm resistor
- R2, R4—3900-ohm resistor
- R5, R6, R10, R14, R18, R22—10,000-ohm potentiometer
- R7—9100-ohm resistor
- R8—1800-ohm resistor
- R9, R13—1000-ohm resistor (see text)
- R11, R15, R19, R23—50,000-ohm potentiometer
- R17, R21—3900-ohm resistor (see text)
- R25, R31, R32—4700-ohm resistor
- R26—68,000-ohm resistor
- R27, R28—33,000-ohm resistor
- R29—2700-ohm resistor
- R30—220-ohm resistor
- R33—33-ohm resistor
- R34—300-ohm resistor
- S1—Normally open pushbutton switch
- S2—Dpdt slide or toggle switch
- Misc.—Suitable enclosure, interconnecting cable, knobs, D cell (2) with holders and connectors, mounting hardware, etc.
- *If you cannot locate an MC792P triple 3-input gate, use two HEP581 dual four-input gates (also RTL) with only three inputs on each gate and the fourth input grounded.

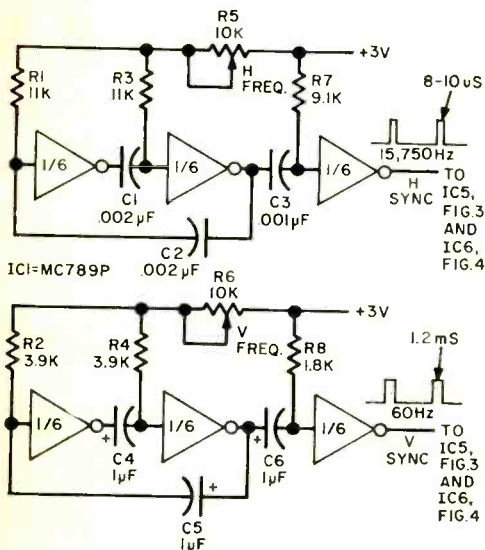

Fig. 2. Sync generators use hex inverters.

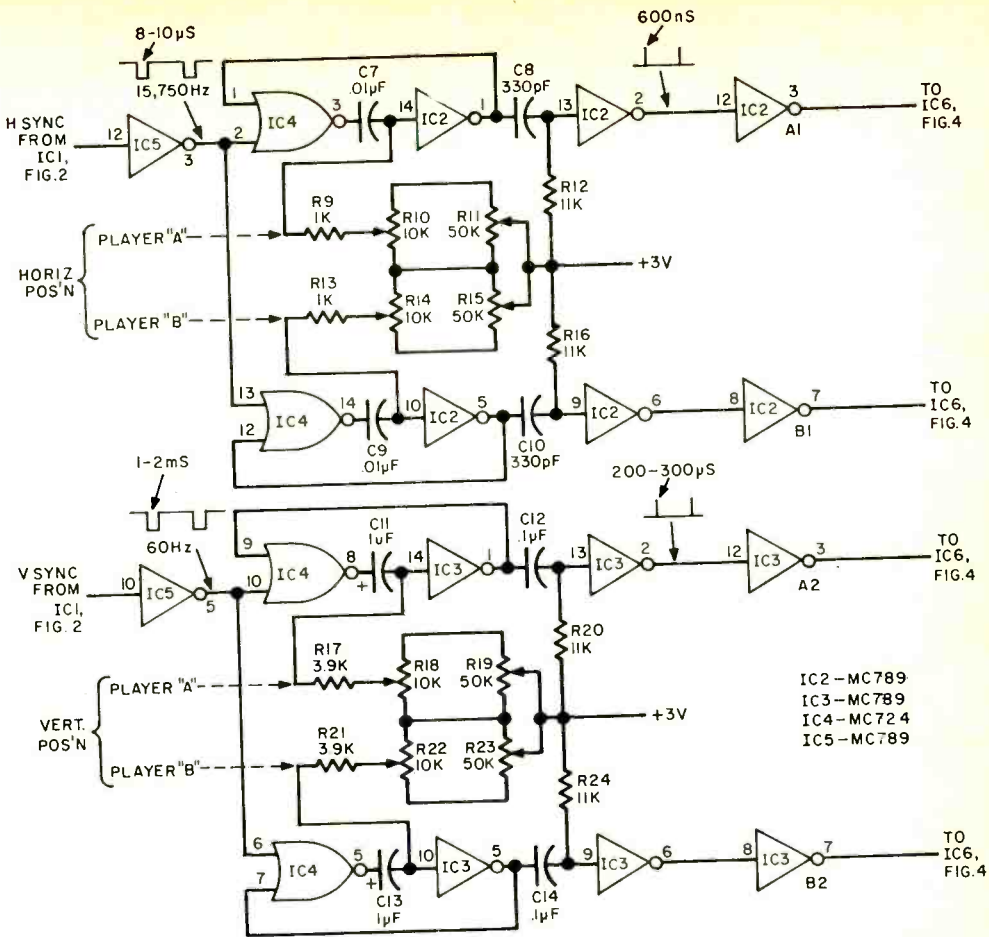

Fig. 3. Delay circuits are multivibrators whose output pulses can be delayed.

excursions below this pedestal. This video signal is fed to the r-f oscillator-modulator.

Two inverters of IC5 are cross-coupled to form the identification multivibrator that is coupled through the it switch to the three-input gate that corresponds to the dot chosen to be it. This causes the selected dot to flash at three cycles per second.

Since the game is won when the pursuing dot catches the other one, a diode gate (D1 and D2) is used to detect the coincidence. The positive-going pulse from this gate causes the tag flip-flop, consisting of a pair of two-input gates of IC7, to change state. The 3-Hz identification signal is then passed to the tag gate consisting of inverters from IC5, which turns on the lamp driver Q1. At the same time, the tag flip-flop inhibits the selected three-input gate (part of IC6), causing the tagged dot to disappear. Depressing pushbutton S1 resets the tag flip-flop enabling the tagged dot to re-appear

(if the coincidence is removed) and turning out the tag lamp.

In the r-f section, shown in Fig. 5, the composite video is impedance matched by Q2 and applied to the base of Q3, the r-f oscillator. A tuned circuit in the collector is set to the desired TV channel, and the modulated r-f is taken from J1.

Initial Adjustment. If your TV set uses an indoor (rabbit ears) antenna, simply connect a short length of wire to output jack J1 and run the wire reasonably close to the antenna. If you have an outdoor TV antenna, connect a length of transmission line from J1 to the antenna terminals on the set.

Set the players' vertical positioning potentiometers (R18, R22) to approximately the middle of their rotation. Set the A horizontal potentiometer ¼ clockwise and B ¾ clockwise. Locate a vacant channel

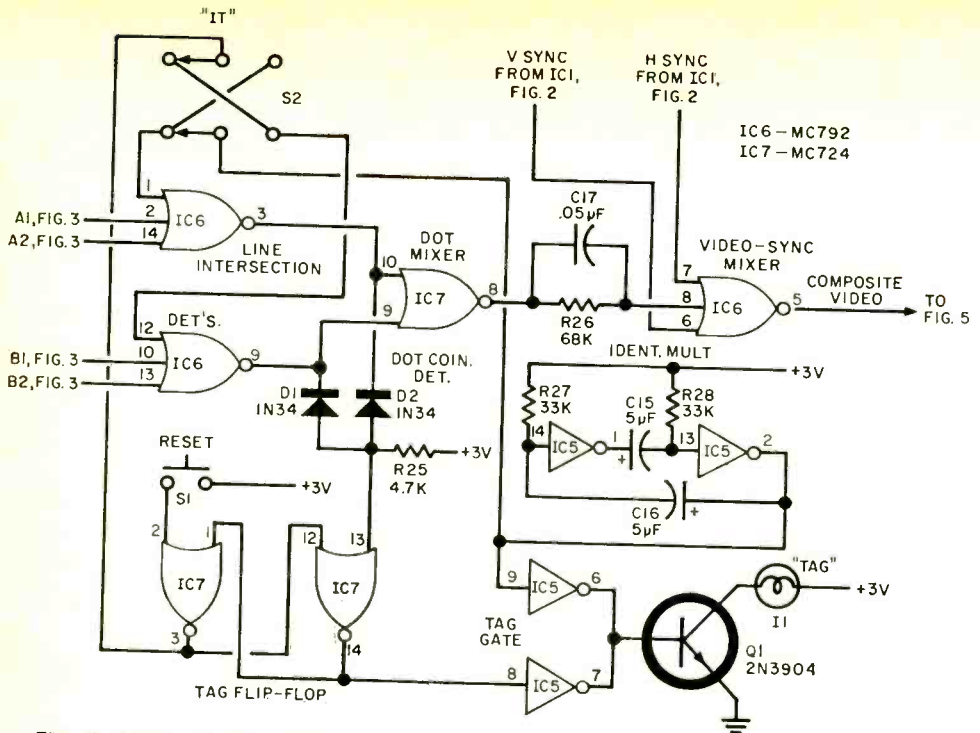

Fig. 4. Logic circuits convert crossed lines into dots and provide tag functions.

(between 2 and 6) on your TV set; turn on the TV Tag; and press the reset button. Spread or compress *LI* (r-f oscillator portion) until a strong signal is seen on the TV screen. (It may or may not be in sync.)

Once a strong signal is obtained, adjust the horizontal and vertical sync controls on the TV Tag (*R5* and *R6*, respectively) until a stable raster is seen. Two dots may

also be visible. Adjust *LI* and the set's fine tuning until the best image is seen. Adjust the set's contrast and brightness control until the two dots stand out very clearly, with one flashing on and off at about 3 Hz.

Operate the B vertical control (*R2*) so that the dot is within 10% of the top and bottom of the screen. Do the same with the B horizontal control. To limit the dot's travel, the trimmer potentiometer in parallel with the player control determines the span of dot movement, while the resistor in series with the player's control potentiometer's rotor adjusts the span centering.

For example, in the horizontal positioning of player A's dot, trimmer *R11* controls the span of dot movement, while *R9* adjusts the span centering. The series value is selected first by setting the horizontal position control (*R10*) to minimum resistance and then adjusting the value of the series resistor (*R9*) until the dot is about 10% from the left of the screen. Then rotate *R10* to its maximum position and adjust *R11* until the dot is about 10% from the right of the screen. Then move player A's vertical control (*R18*) to minimum resistance and adjust *R17* until the dot is about 10% from the top of the screen. Placing *R18* at maximum should cause the dot to go within

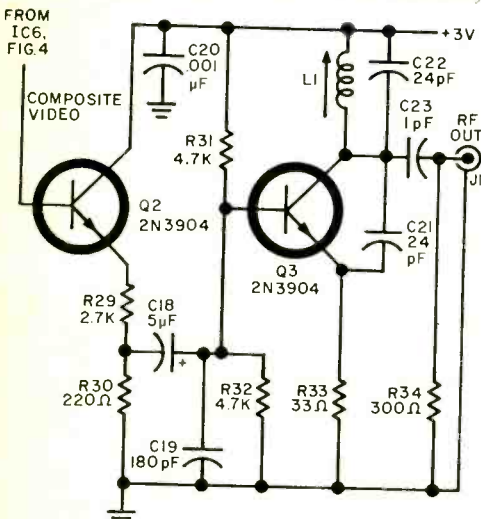

Fig. 5. R-f oscillator and modulator.

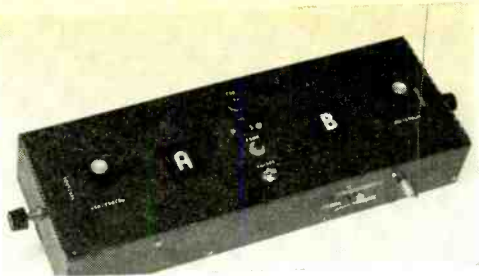

Photo of prototype shows how lights and reset button are mounted on top of chassis with controls on the ends.

10% of the bottom of the screen. If it doesn't, adjust R19.

Repeat this procedure for the horizontal and vertical positioning of player B's dot.

When both dots have been adjusted for span and centering, try to tag one dot with the other. If the proper events having to do with tagging and resetting do not occur, check the circuit wiring.

The TV receiver should be set for maximum contrast with the brightness reduced until the background just disappears. The two dots (one flashing) should then be in high contrast on a dark background. ♦

GROWTH OF CBS SQ—A 4-Channel Status Report

London SQ Convention. Columbia Records' SQ team recently attended and participated in the company's annual convention, held this year in London, where a presentation of future SQ programs and plans were made. At the convention, demonstrations were conducted using the first SQ full logic consumer product, Sony's Model SQD-2000.

Many conferences were held with United Kingdom audio equipment manufacturers whose interest in SQ and quadratics has been awakened by the momentum of the U.S. market. Evidence of this growing European interest is seen in Servo-Sound, a Belgium-Holland based hi-fi manufacturer which has begun marketing SQ decoders. Sonic, a French manufacturer with retail stores in Paris, Audio-Sonic, a Dutch distributor, and Cambridge Audio, a U.K. based hi-fi manufacturer, will also market SQ decoders sometime this fall. SQ hardware licensees can anticipate consumer interest in SQ playback equipment through the growing library of discs from CBS Records and EMI on the European market.

National Quadrasonic Radio Committee Meeting. On July 25, seven proposed multi-channel FM broadcast systems came under study by the National Quadrasonic Radio Committee of the Electronic Industries Association. The proposed systems have been classified into five categories: Category I with Quadracast, RCA, and Motorola, proposes utilization of a 76-kHz subcarrier with double-sideband modulation; Category II (Zenith), also proposes use of a 76-kHz subcarrier, but with single-sideband modulation; Category III (General Electric) also pro-

poses a subcarrier at 76 kHz, but this time with vestigial-sideband modulation; Category IV, suggested by Radio Programming/Management, requires no 76-kHz subcarrier; nor does CBS in Category V, with their matrix system, require the 76-kHz subcarrier.

All systems in Categories I-IV also utilize an additional subcarrier in quadrature with the existing 38-kHz subcarrier. Categories I and II will require abandonment or relocation of present SCA service. Although matrix programs can be broadcast under existing stereo rules, the CBS proposal calls for standardization of SQ encoding and the transmission of an identification signal by modulating the 19-kHz pilot carrier.

SQ Logic IC'S, Customized Discs, New Licensees. Motorola has made excellent progress on the development of the full SQ logic integrated circuit system. It is expected that the logic IC's will be available before January 1973. As more data on the logic IC system become available, CBS promises to keep the interested public informed.

Columbia Special Products is ready to assist in fashioning special SQ discs for promotional purposes. Many SQ licensees have ordered customized discs and are using them as giveaways with the sale of SQ hardware.

Finally, H.H. Scott and Telex Corporation (along with their subsidiary, Waters Conley, Inc.) have joined the growing family of SQ licensees. This raises the total of SQ licensees to 40 brands, and it is estimated that these brands account for more than 60 percent of all stereo equipment that is sold in the United States. ♦



Nuclear Radiation & Detection

Part 2: Radioactivity Detectors

IONIZATION AND HOW IONIZATION CURRENT IS DETECTED

BY J. G. ELLO, Radiation Measurements and Instrumentation
Electronics Division, Argonne National Laboratory

IN PART 1 of this series, the various types of radioactivity and the behavior of each were discussed. Before getting into the details of radiation detection, the topic of Part 2, a review of the characteristics of the three types of radiation is in order.

In Part 1, it was stated that the alpha particle's large mass and high velocity contribute to its good ionizing power. Because its penetrating power is weak, the alpha particle is easily absorbed by a few sheets of newspaper. And, being a particle with a positive charge, it can be deflected in a magnetic field.

The beta particle has more penetrating power and achieves a greater velocity than the alpha particle. Because of its negative charge, it can be deflected in a magnetic field, but in the opposite direction to that of the alpha particle. The beta particle has less ionizing power than the alpha particle, but its penetrating power is greater, a thin sheet of aluminum or Lucite being required to absorb the particle.

Because they are electromagnetic waves—not particles—and without an electrical charge, gamma rays cannot be deflected in a magnetic field. Gamma rays travel at the velocity of light and are highly penetrative. It may take several inches of lead or 3 or 4 ft of concrete to absorb them. Of the three types of radiation, the gamma ray has the least ionizing power.

Ionization. When it passes through matter or gases like air, nuclear radiation produces ion pairs. The manner in which ion pairs are formed by an alpha particle colliding with an oxygen atom is shown in Fig. 1. The electron dislodged by the alpha particle becomes a negative ion, while the remainder of the atom, now minus one electron, becomes a positive ion. Note that the collision forms two oppositely charged ions; hence the term "ion pair."

The alpha particle continues to produce ion pairs until it has lost all its energy through collisions. The process may result in more than 100,000 ion pairs in a cubic centimeter of air. In a similar manner, a beta particle produces ions, but only at a rate of about 300 ion pairs per cubic centimeter of air.

Gamma and X rays which are not particles also produce ion pairs, but in a slightly different manner. Gamma rays can eject electrons from atoms with sufficient velocity to make them collide with other atoms to produce ion pairs. The number of ion pairs thus formed depends on the energy of the freed electrons.

Ion pairs made from neutral atoms move about in random paths until, through recombination, they eventually become neutral atoms again. However, if ions are produced in an electrical field, they are affected by the field.

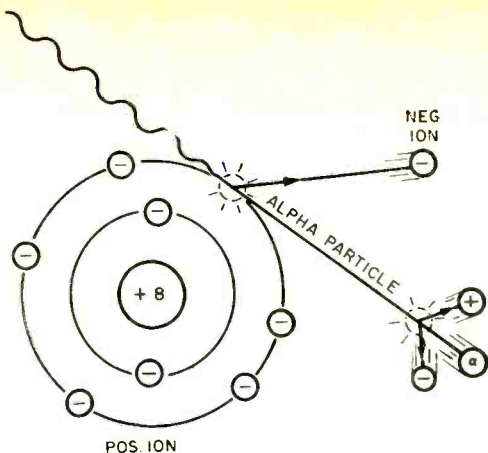

Fig. 1. Ion-pair production is the result of alpha particle striking atom.

Consider a small chamber with one set of parallel plates (electrodes) on the inside. It is being irradiated by a beta ray source as shown in Fig. 2. With the power switch open as in A, no electrical field is applied to the electrodes. In the absence of an electrical field, the ions will recombine to form neutral atoms (as a result of the attraction of opposite charges). However, when the switch is closed as in B, an electrical field is generated between the electrodes. This forces the ions to move in opposite directions, the negative ions to the positive electrode and the positive ions to the negative electrode. Eventually, as shown in C, the ions become neutralized since the positive ions attract negative ions from the negative electrode and the negative ions give up their charge at the positive electrode.

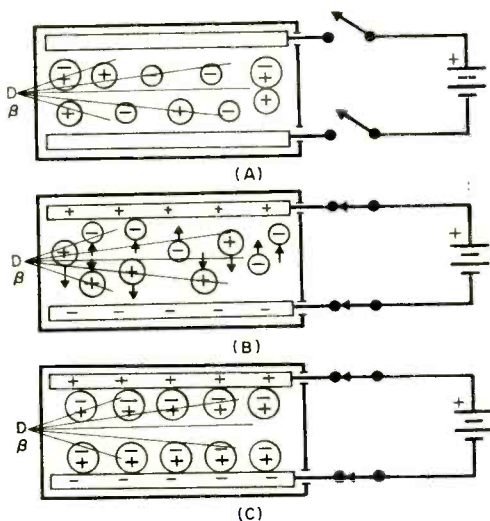

Fig. 2. Neutralization of ions is shown.

Detecting Ionization Current. The basic scheme shown in Fig. 3 is an example of a radiation detector. Attached to the detector, in series with a sensitive ionization pulse current meter, is a power supply which can be varied from zero to some high voltage.

The effect of the detector voltage on neutralizing ion pairs in six different regions is shown in the graph in Fig. 4. The three curves show that an alpha particle ionizes more atoms in its path than do the beta particle and gamma ray.

Assume that the detector chamber which contains a counting gas (Fig. 3) is exposed to a radioactive source with the detector voltage set to zero. There is no electrical field to accelerate the ions which wander about and eventually recombine. Hence, no meter pointer deflection will be observed.

Now, when a low voltage is applied to the detector, creating a weak electrical field between the anode and cathode, a small portion of the negative ions is neutralized or collected at the anode. However, slower moving ions have ample time to recombine before reaching the anode, and the pulse size is smaller. This partial collection of ions takes place in the recombination region on the graph.

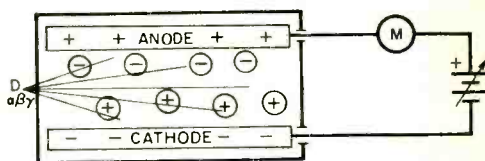

Fig. 3. Ionization current measurement.

Raising the detector voltage increases the electrical field and accelerates the ions, lessening ion recombination and permitting more ions to be collected by the anode. By further increasing the voltage, a point is reached at which the ionization current is proportional to the detector voltage and all ions are collected as fast as they are produced. This occurs at the "saturation point" on the graph and places the detector operating characteristics in the ionization region. Any additional increase in detector voltage in this region will not increase the ionization current because only ions formed by the radioactive particles contribute to the ionization current flow in the detector.

Beyond the ionization region (flat portion of the curve), any additional increase in detector voltage will result in an increase in detector ionization current. This is evi-

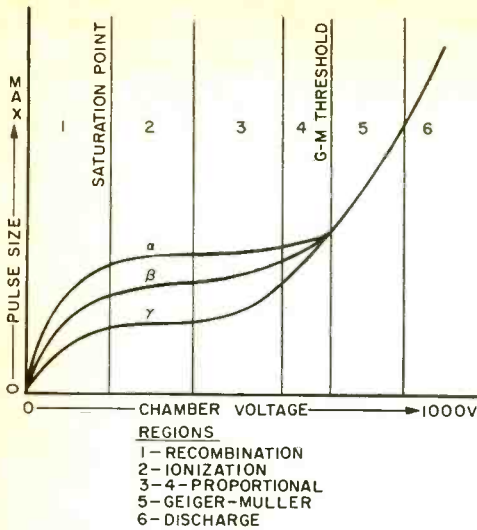

Fig. 4. Chamber voltage vs pulse size.

dence that some new phenomenon is taking place within the detector. Since the voltage has been increased, the electrical field has been increased which accelerates the ions toward the anode at a much greater velocity. The negative ion, or electron, with its higher velocity, has enough energy to dislodge other electrons, creating additional ion pairs which contribute to the total ionization current. This secondary electron region is shown on the curve as the proportional regions.

In the proportional regions, under ideal conditions, it is possible to differentiate between alpha, beta, and gamma ionization current pulses as shown on the graph. Instruments which use this portion of the curves are known as proportional counters.

In the Geiger-Muller region on the graph, the detector's voltage is increased to a level sufficient to cause an avalanche of freed electrons. For example, one alpha or beta particle or gamma ray will ionize an air atom with so much energy that a freed electron is capable of freeing another electron and these, in turn, free other electrons to create an avalanche effect. This electron multiplication reaches a point at which all ionization current pulses are equal in amplitude (G-M threshold point where all curves join to form a single curve on the graph). Radiological instruments operated in this region are known as Geiger-Muller survey meters.

The last section of the graph is the continuous discharge region. Here, the detector's voltage is so high that once an ionization takes place, there is a continuous discharge of electricity like an arc across the gap between the anode and the cathode. Consequently, this region is of no use at all for detection of radioactivity.

Next month in Part 3 in this series, we will discuss the use of the counting regions in various radiological survey meters. ♦

SATELLITE PICTURES SHOW EARTH'S RESOURCES

ONE of the important sources of information obtained from the Earth Resources Technology Satellite (ERTS), launched last July by NASA, is the multitude of photographs of the earth that are transmitted back daily. There are more than 300 prime subscribers for the data and they represent 35 countries. The data is available through negative and positive prints processed with Eastman Kodak Company equipment.

The ERTS photographic system has the capability of churning out as many as 300,000 photos weekly. Since it photographs only a section of the earth each day, it takes the satellite 18 days to cover the entire world. There are seven sensors on the satellite—each relaying separate data back to NASA ground stations located at Goddard Air Force Base; Fairbanks, Alaska; and Goldstone, Calif. Data from the satellite are fed to computers at Goddard and then to a photo laboratory; and a complete set of

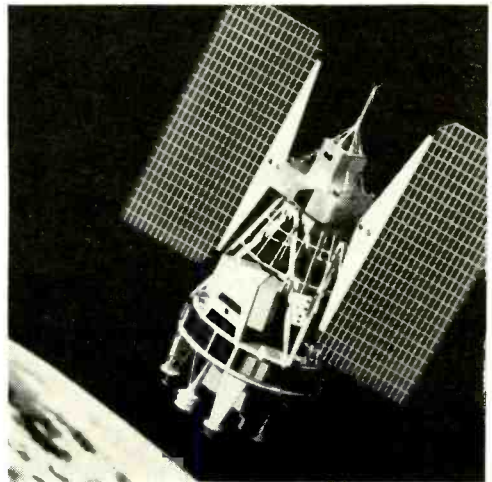

prints is sent each day to Sioux Falls, S.D., where scientists, geologists, etc., can view areas of interest. ♦

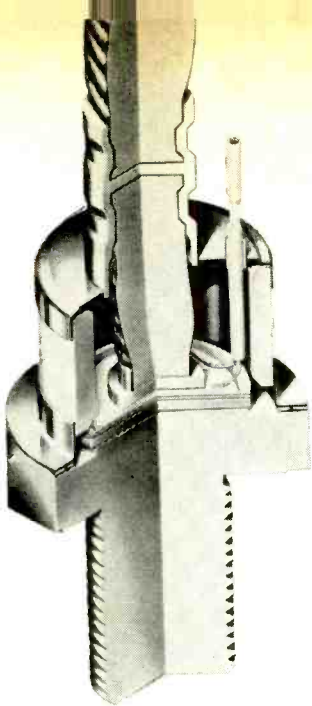

The HOW and WHY of the SCR

PRINCIPLES OF OPERATION AND
APPLICATIONS OF THE
SILICON CONTROLLED RECTIFIER

BY JOSEPH H. WUJEK

WHEN the semiconductor industry began to expand in the 1950's, transistors and solid-state diodes and rectifiers quickly replaced their vacuum-tube counterparts in many applications. Then as now, the *complete* transition from tubes to semiconductors was not possible because of the limitations of the latter. In 1957, however, an important step toward the goal of total replacement by semiconductors was taken when General Electric Co. introduced the silicon controlled rectifier, or SCR.

Briefly, the thyatron permits the control of power in the switching applications with only a small energy loss in the control circuit. By applying a signal to a control grid, the thyatron is made to conduct between a pair of electrodes (anode and cathode) and remains conducting with no further excitation at the control grid. In fact, in normal operation, the grid ceases to control the thyatron once conduction begins. To stop conduction, the anode must go from a high positive potential to near zero as in the phase reversal of a 60-Hz power line.

The SCR performs in an analogous manner; and, in addition to the inherent improvements in reliability and simplicity afforded by semiconductors, some of the kindred devices of the SCR can function as turn-on/off systems to control bidirectional

currents, an impossible task for the thyatron and other vacuum tubes.

How It Works. The operation of the SCR is perhaps best understood by examining the device's pnpn junction, shown in equivalent form by the two transistors in Fig. 1. Assume that the control (gate) electrode is connected so that its voltage is the same as, or slightly negative with respect to, the voltage on the cathode. Transistor Q2 is cut off and only leakage current flows in the circuit. If the gate voltage is made positive with respect to ground, the base-emitter junction of Q2 becomes forward biased and Q2 begins to conduct. Moreover, Q1 also becomes forward biased and conducts. As Q1 starts conducting, its collector current aids in turning on Q2, just as collector current from Q2 assists in turning on Q1.

This mutual aid is a form of regeneration, or positive feedback. A point is reached at which the switching action "runs away" from the control input and becomes self-sustaining. In regeneration, Q1 and Q2 are operated at saturation, and the voltage drop from the collector of Q2 to ground is the sum of the 0.7-volt base-emitter drop of Q1 and the 0.2-volt collector-emitter drop of Q2. (The voltages are for silicon transistors only.) Thus, the switch exhibits a low voltage drop and requires no control input power to sustain conduction.

To turn off the circuit, the current in

Cutaway view above of an SCR courtesy of International Rectifier Corporation.

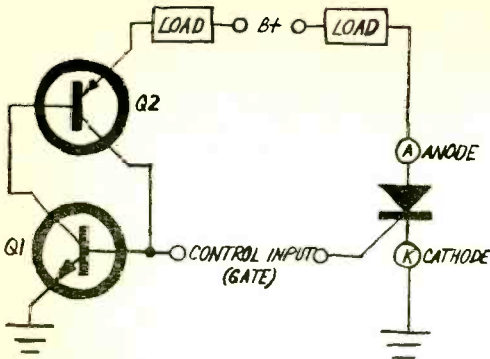

Fig. 1. The transistor circuit at left is equivalent to actual SCR at right.

the transistor bases must be internally reduced to a level at which the current gain of Q1 and Q2 is insufficient to supply the required currents. Since it is not practical to get into the transistor junctions, the current in the emitter-collector branch is reduced. This is accomplished automatically if the supply voltage is derived from an ac

source. (The SCR is primarily an ac device, although in dc applications it will serve as a "latch," or memory switch, and remain conducting until the anode current is reduced or interrupted.)

The point at which the anode current of an SCR is sufficient to keep the device conducting is called the holding current. The peak voltage (anode positive with respect to cathode) at which the SCR does not undergo breakdown for given conditions of bias between the gate and cathode is the the peak forward blocking voltage; this is usually specified with the gate connected to the cathode through a low resistance.

The peak reverse voltage with the anode negative with respect to the cathode is also specified with the gate connected to the cathode through a low resistance.

Leakage currents increase with temperature increases and roughly double for every 10° C rise. In Fig. 1, the transistors cannot distinguish between currents caused by leakage or from a triggering pulse. Hence,

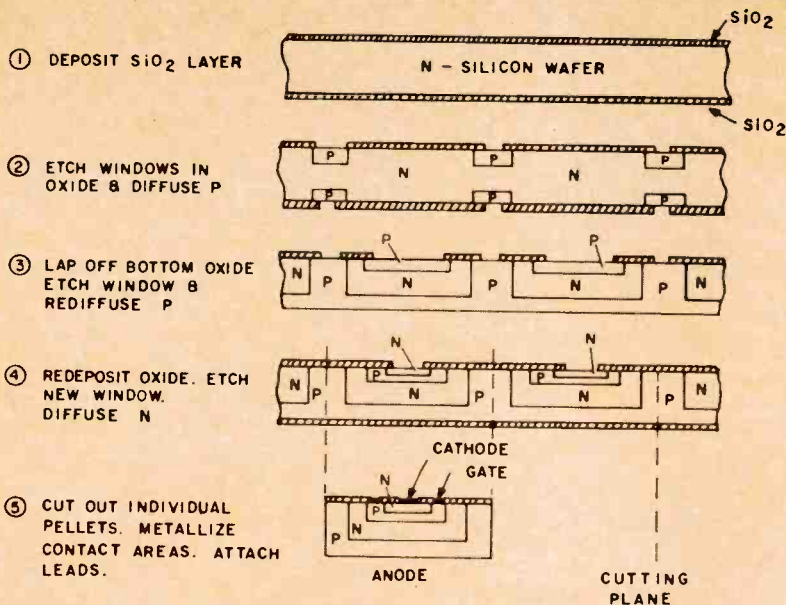

CATHODE LEAD
(ATTACH TO AL.
METALIZED AREA)

GATE LEAD (ATTACH TO AL.
METALIZED AREA)

These diagrams show the steps in the fabrication of a silicon controlled rectifier as made by General Electric.

BOTTOM FACE OF PELLET BECOMES ANODE CONNECTION AFTER MOUNTDOWN

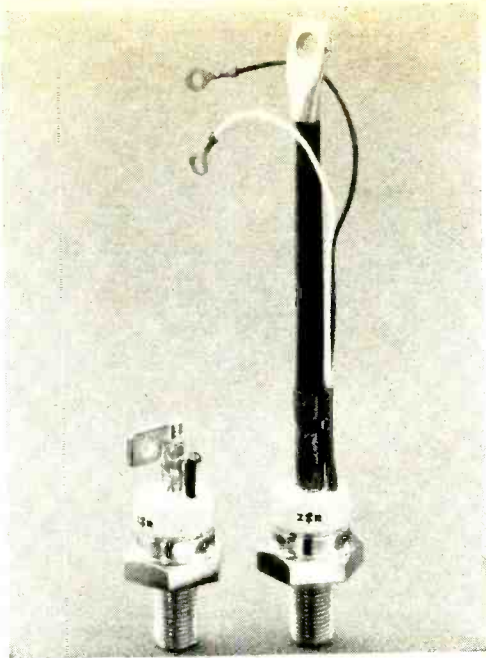

Typical SCR packages for International Rectifier Corp. units which have current ratings from 50 to 100 amps.

care must be exercised in determining the temperature environment and external circuit conditions to prevent thermal turn-on.

Other unwanted turn-on mechanisms are the device's built-in junction capacitances which provide paths for current when the anode-cathode voltage is changing. Current through a capacitor is proportional to the voltage rate of change with time. A fast changing voltage can introduce sufficient current to trigger the SCR. This parameter is specified as the "critical time rise" and usually is given in $V/\mu s$.

The forward and reverse breakdown voltages have already been mentioned. Unless some means of externally limiting the current is used, these breakdown voltages will destroy an SCR. Except where severe transient voltages are present, the breakdown voltages will present no problems if the specified ratings are not exceeded.

Parameters & Characteristics. If the SCR is to be intelligently employed, it is essential that the user be familiar with the device's various parameters and characteristics. These specifications are given in the manufacturer's data sheets. In choosing an SCR, first check the maximum allowable ratings, including the maximum current handling

capacity which may be stated as average current or rms current or both. To use either specification, the current waveform through the SCR must be known.

The peak surge current, usually specified for a 60-Hz half-wave excursion, is the current the SCR can handle on a low duty-cycle basis, permitting the SCR to cool off between surges. These currents can be as much as 10 times greater than the rms current. Such ratings are useful when the SCR is employed in "crowbar" operation to discharge a capacitor bank.

Power ratings for the entire SCR, as well as for the gate circuit are often stated. These ratings depend on ambient and case temperatures. Maximum voltage and current in the gate circuit are sometimes specified.

Finally, temperature limits for storage and operation are given. The low-temperature limit is dictated primarily by the differences in thermal expansion between the chip and surrounding materials. The upper limit is set by considerations of damage to the crystal substrate.

When using the SCR as part of a circuit, the peak reverse and peak forward blocking figures specified are the currents that flow at given sets of bias conditions when the SCR is not conducting. These currents can be viewed as leakage and must be stated for a given temperature or temperature range. An SCR's leakage is on the order of 0.1 percent of its forward current. Hence, an SCR rated at 100 amperes forward current cannot be used to control a 50-mA load since the leakage current will be about the same as the current being controlled.

The gate trigger voltage and current are specified for given anode-to-cathode voltages and gate-to-cathode resistances. They are temperature-dependent and often graphically plotted for SCR's not to trigger. The minimum values for firing at given temperatures also appear on the plots. This information specifies the voltage and current required for triggering the SCR, as well as the bias conditions to be maintained in the blocking state.

The peak on voltage is the drop between the anode and cathode for a given load current and temperature. It is generally in the range of 1 to 2 volts. The holding current specifies the level to maintain to prevent the SCR from turning off.

The turn-on and turn-off times are stated for SCR's intended for high-speed switch-

ing. The operating conditions must be specified if these parameters are to be useful. Some fast SCR's have low-current switching times in tens of nanoseconds.

Design Considerations. Once the SCR is inserted between the power source and the load, a means must be provided for triggering it. When used to control ac, one of the simplest ways of triggering is to use the phase control method. The negative alternation takes care of the turn-off. Then all that is necessary to drive the SCR into conduction is application of a pulse to the gate when the anode is positive with respect to the cathode. A phase control triggering scheme in its simplest form is shown in Fig. 2. By choosing the appropriate resistance and capacitance values for the network, the time, or phase, relationship of the gate with respect to the anode-to-cathode voltage can be determined. Household lamp dimmers often are designed this way and may employ two SCR's back-to-back to control both ac alternations.

Because the phase between the gate and anode-to-cathode voltages determines the time the SCR conducts, the average current

through the SCR is dependent upon this relationship. The firing angle can also be derived from an isolated source like an error signal in a feedback system. When more current is needed, the error signal "tells" the trigger circuit to advance the gate voltage to turn on the SCR earlier in the cycle. This results in an increase in average current flow since the SCR conducts for a longer period of time.

A transformer provides good isolation between the trigger circuit and the load. The control signal might be a dc voltage, such as the on/off conditions of a switch or logic circuit. A simple oscillator can be used to furnish the gate pulses, controlled by a simple AND gate.

If moderate or high currents are to be controlled, the fast turn-on of the SCR can generate high-frequency noise that will be radiated into space and passed along ac power lines. These noise spikes may interfere with radio and TV reception and cause malfunctions in interference-sensitive equipment. Filters can be used in the power line to reduce this noise, but a different means exists for drastically reducing or eliminating the noise.

If the time at which the anode voltage crosses through zero and begins its swing toward positive (with respect to the cathode) can be sensed, a trigger pulse can be provided at that instant. The SCR then starts conducting early in the positive alternation and the current (in a resistive load) follows the sine wave of voltage rather than suddenly jumping from leakage level to a high forward level (see Fig. 2). Several manufacturers offer IC's designed specifically as zero-voltage detectors to use in this application.

Applications. Apart from the familiar lamp dimmer switch and speed controls for certain types of ac motors, the SCR is used in the home to provide continuous (as opposed to stepped) control of heat in electric kitchen ranges. In industry, the SCR is used to control power in battery chargers, power supplies, and machine tools. Welders, power regulators, and temperature control systems have been designed using the SCR as a power control element. Among the most popular of automotive electronic ignition systems available is the SCR-fired system and its variations. And new applications for the SCR are continuously being discovered. ♦

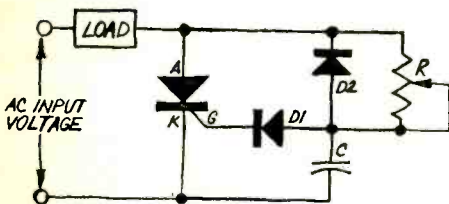

D1 PROTECTS GATE FROM REVERSE-VOLTAGE BREAKDOWN
D2 CHARGES C ON NEGATIVE ALTERNATION
R CONTROLS TRIGGER POINT

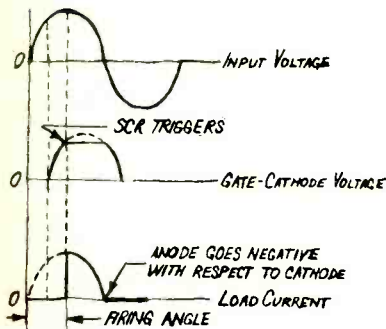

Fig. 2. Schematic of a typical pulse triggering circuit to turn on SCR. Waveforms below show voltages and current and indicate the firing angle.

EVEN IF THEY NEVER SEE YOUR SLEEK NEW COBRA 135, THEY'LL KNOW YOU HAVE THE BEST.



They'll know by listening. Because you'll send with all the power allowed—15 watts P.E.P. input. Plus the extra authority of 100% modulation with Dynabooast speech compression.

You'll transmit on 23 AM and 46 SSB modes. Two separate transmitters give you the best of each, with overload protection.

Your own ears will confirm what we say. This Cobra has the crispest, cleanest

sound ever. Over 60 dB cross modulation interference rejection completely eliminates bleedover.

Cobra's drift-free Voice Lock lets you locate and lock-in sideband signals over a wide range. Three filters—one crystal, two ceramic—keep adjacent channels under wraps.

And Cobra's noise blanker really punches holes in noise, both AM and SSB.

The control console has everything. Adjustable AM/SSB RF gain control. Backlit RF output/SWR/S meter. 24-hour digital-leaf clock. Illuminated mode selector. And full-function controls.

Both talking and listening, it's the first base station to combine all the features you want in one package. And as for looks—wow!

Ask your CB dealer to show you the best. Cobra 135.

COBRA 135 AM/SSB \$419⁹⁵

microphone included

Product of Dynascan Corporation, 1801 West Belle Plaine Avenue, Chicago, Illinois 60613

CIRCLE NO. 2 ON READER SERVICE CARD

**Hunting for
a better job?**

**CIE will
help you get
the license
you need**



A Government FCC License can help you qualify for an exciting, rewarding career in ELECTRONICS, the Science of the Seventies. Read how you can prepare for the license exam at home in your spare time — with a passing grade assured or your money back.

IF YOU'RE OUT TO BAG A BETTER JOB in Electronics, you'd better have a Government FCC License. It will help you track down the choicest, best-paying jobs in the growing field of Electronics.

Demand for people with technical skills is growing twice as fast as any other group, while jobs for the untrained are rapidly disappearing. Right now there are thousands of new openings every year for electronics specialists. And you don't need a college education to qualify!

But you *do* need knowledge, knowledge of electronics fundamentals. And there is only one nationally accepted method of measuring this knowledge... the licensing program of the FCC (Federal Communications Commission).

Why a license is important

An FCC License is a legal requirement if you want to become a Broadcast Engineer, or get into servicing any other kind of transmitting equipment — two-way mobile radios, microwave relay links, radar, etc. And even when it's not legally required, a license proves to the world that you understand the principles involved in *any* electronic device. Thus, an FCC "ticket" can open the doors to thousands of exciting, high-paying jobs in communications, radio and TV broadcasting, the aerospace program, industrial automation, and many other areas.

So why doesn't everyone who wants a good job in Electronics get an FCC License?

It's not that simple. You must pass a Government licensing exam. A good way to prepare for your FCC exam is to take a licensing course from Cleveland Institute of Electronics.

Our training is so effective that, in a recent survey of 787 CIE graduates, better than 9 out of 10 CIE grads passed the Government FCC License exam. That's why we can offer this famous Money-Back Warranty: when you complete any CIE licensing course, you'll be able to pass your FCC exam or be entitled to a full refund of all tuition paid. This warranty is valid during the completion time allowed for your course. You get your FCC License — or your money back!

And with CIE, you learn at home in your spare time. With AUTO-PROGRAMMED* Lessons, you'll pick up the facts, figures and electronics theories you

CIE HAS CAREER COURSES TO FIT YOUR BACKGROUND

ELECTRONICS TECHNOLOGY with LABORATORY ... teaches you the fundamentals. With a 161-piece laboratory you apply the principles you learn by analyzing and trouble-shooting electronics equipment.

ELECTRONICS ENGINEERING ... A college-level course for men already working in Electronics. Covers steady-state and transient network theory, solid-state physics and circuitry, pulse techniques, computer logic and mathematics through calculus.

may have considered "complicated"... even if you've had trouble studying in the past.

CIE Grads get licenses... better jobs

The value of CIE training has been demonstrated time and again by the achievements of our thousands of successful students and graduates.

An outstanding example is Ed Dulaney of Scotts-bluff, Nebraska. He passed his 1st Class FCC License exam soon after completing his CIE course. Today, he owns two companies... one to manufacture and distribute two-way radio equipment, the other to maintain and repair such equipment along with home radio, TV and stereo sets. He says: "In the last three years we sold more than \$1,500,000 worth of equipment through dealers in every state plus Canada, South America and Europe."

Richard Kihn, Anahuac, Texas, worked in the engine room of a tugboat when he started his CIE training. He reports, "Before finishing, I got my FCC License and landed a job as broadcast engineer at KFDM-TV in Beaumont, Texas. I was able to work, complete my CIE course and get two raises... all in the first year of my new career in broadcasting."

Send for FREE books

If you'd like a chance to succeed like these men, send for our FREE book, "How To Get A Commercial FCC License." It tells you all about the FCC License... requirements for getting one... types of licenses available... how the exams are organized and what kind of questions are asked... where and when the exams are held, and more.

With it, you will also receive a second FREE book, "Succeed in Electronics." For your convenience, we will try to have a representative call. Send for both books today.

APPROVED UNDER G. I. BILL

All CIE career courses are approved for educational benefits under the G.I. Bill. If you are a Veteran or in service now, check box for G.I. Bill information.

CIE Cleveland Institute of Electronics, Inc.

1776 East 17th Street, Cleveland, Ohio 44114
Accredited Member National Home Study Council

Cleveland Institute of Electronics, Inc.

1776 East 17th Street, Cleveland, Ohio 44114

Please send me your two FREE books:

1. Your book on "How To Get A Commercial FCC License."
2. Your school catalog, "Succeed in Electronics."

I am especially interested in:

- Electronics Technology Electronic Communications
- Broadcast Engineering Industrial Electronics
- First Class FCC License Electronics Engineering
- Electronics Technology with Laboratory

Name _____ (PLEASE PRINT)

Address _____

City _____

State _____ Zip _____ Age _____

Veterans and Servicemen:

Check here for G.I. Bill information.

PE-36

CIRCLE NO. 5 ON READER SERVICE CARD



Product Test Reports

TEAC MODEL AT-100 STEREO FM TUNER (A Hirsch-Houck Lab Report)

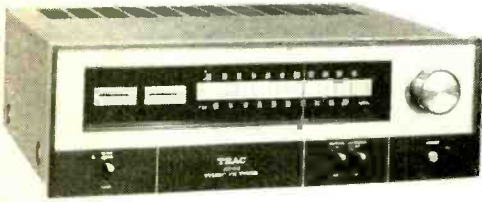

THE Teac Model AT-100 stereo FM tuner is a companion to the company's Model AS-100 integrated stereo amplifier. In fact, the tuner very much resembles the amplifier in size and styling. The lower part of the tuner's front panel, finished in black, contains toggle switch levers for stereo/mono selection, interstation FM muting, and high-frequency channel blending for noise reduction on weak stereo FM signals. The power switch is a pushbutton. The large

slide-rule dial glows a soft blue when the tuner is turned on.

The satin-finished aluminum upper portion of the front panel is largely filled by the dial escutcheon. The dial calibrations are linear, accurate, and well spaced, making it easy to tune to a specific frequency. To the left of the dial are two meters, also illuminated in blue, which indicate relative signal strength and zero-center tuning.

The large tuning knob, located to the right of the dial, drives a silky smooth fly-wheel mechanism that can traverse the full FM band with a single spin of the knob. A tiny orange light to the left of the stereo/mono switch indicates when a stereo broadcast is being received. The switch is normally left in the STEREO position since the tuner automatically switches to mono

Upper curve on graph shows frequency response, while the lower curve is crosstalk over frequency range of 30-15,000 Hz for the Teac AT-100 stereo FM tuner.

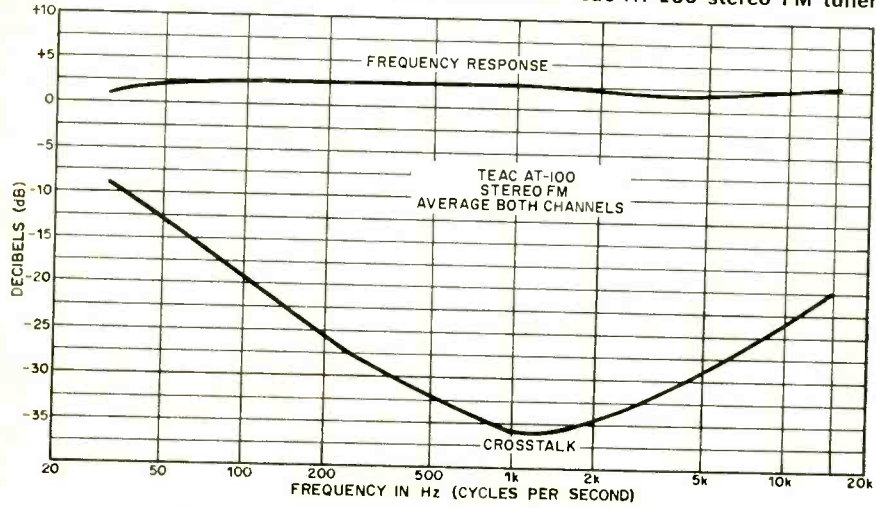

Radio Shack Presents "The Sight of Music"



Five easy-to-build kits that add spectacular "space age" lighting effects to your favorite musical selections. Whether your bag is Bach or Rock, you can fill it with an entire new dimension in sight AND sound experience! See them at any of our over 1500 stores in all 50 states.



Strobe Lite Kit

Strobe Lite Kit makes any party a "now" scene! Stops motion — pulses of blue-white light give a throbbing "far-out" effect. Adjustable to tempo of music from 60 to 600 beats per minute. Has super-bright xenon strobe bulb, woodgrain vinyl case. It's the "with-it" way to add good vibes to any situation! \$29.95

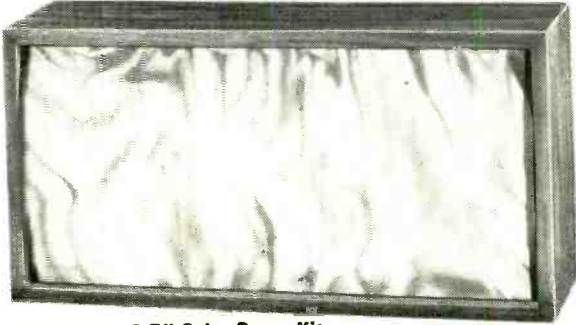

3-Channel "3-D" Color Organ Kit

3-Channel "3D" Color Organ Kit connects to any hi-fi set and makes reds, greens and blues dance to your musical beat! Each color responds to a different frequency, and color brilliance controls let you adjust 'em the way you want! \$29.95

3-Channel Light Control/Color Organ Kit. Here's a two-way fun-maker that guarantees a good time! Use the built-in color organ, or plug in three separate light sources (room lamps, Christmas tree bulbs, etc.) to create a pulsating scene. Handles 900 watts. \$29.95



3-Channel Light Control / Color Organ Kit



Psychostrobe Kit

Psychostrobe Kit. Super-compact — take it along to create an exciting "stop-motion" effect on any party scene. Has 100's of hobby and mechanical uses too! Xenon bulb, intensity switch, and three "freeze-speed" ranges with fine adjustment control. \$19.95

Psycholite Kit attaches to the speaker terminals of your music system, lets you hook up room lights so they pulsate with your music. Also doubles as light dimmer. Handles 600 watts. \$14.95



Dazzling "Psycholite" Kit



FREE 1973 CATALOG
See What's REALLY New in Electronics! Stereo, Communications, Hobby, Parts, Kits, Antennas, Tools, Much More. At Your Nearby Store or Write.

Radio Shack

and ALLIED RADIO STORES
A TANDY CORPORATION COMPANY
P. O. Box 1052, Fort Worth, Texas 76107

CIRCLE NO. 27 ON READER SERVICE CARD

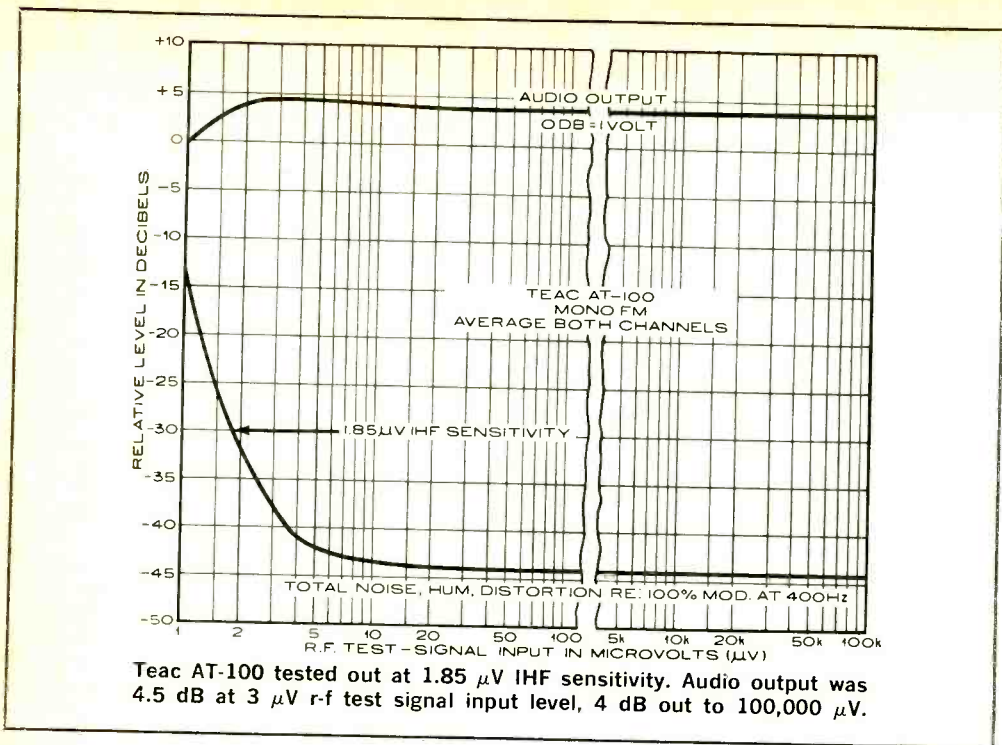

when no pilot carrier is received with the incoming signal.

In the rear of the tuner are inputs for 300-ohm and 75-ohm antennas, an unswitched ac outlet, line fuse, and two pairs of audio outputs. One pair of outputs delivers a fixed level, nominally 1 volt; the level from the other pair of outputs can be varied between 0 and 1 volt via a nearby control.

The AT-100 has FET's in its front end. A four-gang tuning capacitor is used for improved selectivity and rejection of out-of-band signals such as images. The i-f amplifier has six ceramic filter sections as well as a total of ten stages of limiting (six transistors and four sets of diodes). A sophisticated muting circuit is employed. It has a rated threshold of 10 μV, which is also the level for automatic stereo switching so that a weaker signal will be received only in mono. The rated IHF usable sensitivity is 2.0 μV, and the capture ratio is put at better than 1.5 dB.

Laboratory Measurements. We measured the IHF sensitivity of the AT-100 tuner at 1.85 μV, slightly better than specified by Teac. The capture ratio was 1.4 dB, also better than its published specification. The

other key performance aspects of the tuner were, in general, also surpassed in our tests insofar as instrument limitations allowed.

For example, the AM rejection was 52.5 dB (rated 50 dB). Image rejection was 93 dB (rated 90 dB), and alternate channel selectivity was a very impressive 99 dB (rated 65 dB). The distortion at 100 percent modulation was 0.63 percent (rated 0.5 percent), but since our signal generator has about 0.5 percent residual distortion, it seems that the AT-100 easily meets its specifications. The signal-to-noise ratio at 1000 μV input was 72.5 dB (rated 70 dB).

The stereo FM frequency response was well within ±1 dB from 30 Hz to 15,000 Hz as rated. Stereo separation was 38.5 dB at 1000 Hz (rated 40 dB). Our separation figures did not match the manufacturer's specifications at low frequencies, reducing to 11.4 dB at 30 Hz. The published rating claims better than 20 dB separation from 50 Hz to 15,000 Hz; we found it to be better than 20 dB from 85 Hz to 15,000 Hz. Obviously, this difference is of no practical consequence since channel separation in the lowest audible octaves is minimal in any stereo program.

The muting threshold was slightly lower

than claimed. The tuner became activated at $6 \mu\text{V}$, and muting took place when the signal level dropped below $4.5 \mu\text{V}$. The audio output from a 100-percent modulated signal was about 1.5 volts.

Comments. The Teac AT-100 tuner was an outstanding performer. It delivered clean, fully quieted programs from 37 FM stations on one week-day afternoon. This may not sound like a great achievement, but in view of the fact that we used a folded dipole antenna tacked to a basement ceiling at grade level, we think it points up the true quality of this fine tuner.

The muting circuit was one of the best we have used. It was totally free from noise and distorted program sounds, coming on with a barely audible click when the station was tuned dead center. There was a brief time lag, lasting a small fraction of a second, in the muting circuits so that the

tuning could be scanned rapidly across the dial by a twist of the knob without a sound emerging from the speakers. At normal tuning rates, the muting action appeared to be instantaneous.

Every significant specification of the AT-100 was easily met by our test sample. Among them, its capture ratio, image rejection, and alternate channel selectivity were far above the performance of the average good-quality FM tuner. Clearly, this is no "average" tuner. It is a fitting companion to the very fine Teac Model AS-100 integrated stereo amplifier as well as the Teac Models 1230 and 1250 tape recorders, which it matches in styling.

The AT-100 measures $16\frac{1}{2}'' \times 12\frac{5}{16}'' \times 5\frac{5}{16}''$ and weighs 16.5 lb. The black metal cabinet can be decorated, if desired, by using optional teak wood panels. The list price of the Teac AT-100 stereo FM tuner is \$229.50.

Circle No. 65 on Reader Service Card

TFE MODEL PP-1A STEP GENERATOR

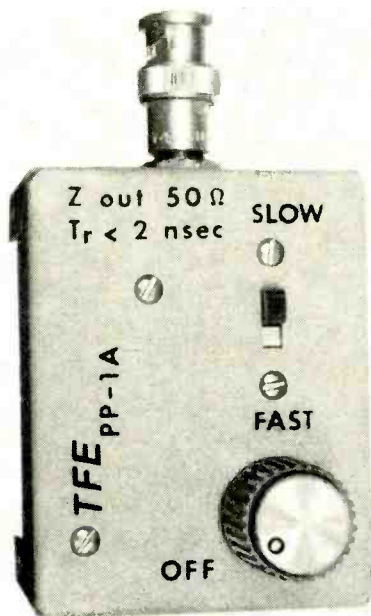

to the high harmonic content of the square wave.

No doubt, many readers already have square-wave generators which they use for a "square" standard. But just how square is your square wave? With the progress in bandwidth extension of modern oscilloscopes, a couple of microseconds rise time just is not fast enough.

The TFE "Pocket Pipper" Model PP-1A (a kit priced at \$19.95) is a small battery-operated square-wave generator that uses a pair of fast switching transistors to generate square waves at either 2 kHz or 200 kHz, front-panel switch selectable, at 50 ohms output. This in itself is not unusual, but the inclusion of an extremely fast acting tunnel diode output stage converts the square wave into a super square wave having a rise time of less than 2 ns—fast enough to check the transient response of a 50-MHz scope or the rise time (bandwidth) of video amplifiers.

A SQUARE-WAVE generator is useful to have around an electronics workshop or on a home workbench for checking rise times of oscilloscopes, calibrating probes, toggling logic circuits, checking audio amplifiers, and the like. Such a generator can also be used by hams and SWL's to provide accurate frequency markers out to 30 MHz or so, due

to the high harmonic content of the square wave. No doubt, many readers already have square-wave generators which they use for a "square" standard. But just how square is your square wave? With the progress in bandwidth extension of modern oscilloscopes, a couple of microseconds rise time just is not fast enough. The TFE "Pocket Pipper" Model PP-1A (a kit priced at \$19.95) is a small battery-operated square-wave generator that uses a pair of fast switching transistors to generate square waves at either 2 kHz or 200 kHz, front-panel switch selectable, at 50 ohms output. This in itself is not unusual, but the inclusion of an extremely fast acting tunnel diode output stage converts the square wave into a super square wave having a rise time of less than 2 ns—fast enough to check the transient response of a 50-MHz scope or the rise time (bandwidth) of video amplifiers. Who needs such high-quality square waves? It is an old maxim that the test equipment used must be at least a decade better than the circuit under test. With the constant upgrading of other test gear, and some of the circuits with which we are presently working, we needed a new standard square wave to make certain that our test equipment was up to snuff. After all,

that is why we upgraded our bench gear in the first place.

Easy Assembly. The PP-1A kit is a relatively simple project to tackle even for a neophyte. At most, assembly time should occupy only a couple of hours of careful work. A small printed circuit board is provided to speed the assembly time along. We found that installing all components within the small metal housing required a bit of dexterity, but the project is not beyond the abilities of anyone who has gotten beyond the "all-thumbs" stage.

After inserting the special 4.5-volt battery called for—another close fit—we tested out the Pocket Peeper on our 25-MHz scope. The CRT trace revealed that the generator was indeed extremely fast. The rise-time trace can barely be seen, attesting to the fast switching action of the tunnel diode.

One thing we did notice about the trace patterns produced by the PP-1A was that the leading edge of the waveform exhibited a slight overshoot. However, this should not impair the usefulness of this handy little instrument since there is absolutely no ringing that we could detect on our lab-type scope.

Circle No. 66 on Reader Service Card

SUPEREX MODEL PEP-77D ELECTROSTATIC HEADPHONES (A Hirsch-Houck Lab Report)

MOST headphones are actually miniature loudspeakers in which a voice coil moves in a magnetic field and drives a diaphragm or cone measuring typically from 2" to 3" in diameter. It has long been known that electrostatic transducers are free from many of the imperfections of dynamic, or moving coil, designs. The large radiating area and peak amplitudes required in full-range electrostatic speakers have made them too bulky and expensive for most people, but their sonic virtues are undisputed.

Since a headphone is a miniature loudspeaker, a logical move would be to use electrostatic elements in the earcups. The sealed air cavity between the diaphragm and the ear drum allows a strong bass response without excessive size or displacement (consider that a 3" dynamic headphone can produce a powerful output at 20 Hz). There are several differences between electrostatic and dynamic phones, however, which affect their installation and operation.

Construction. The Superex Model PEP-77D electrostatic headphone system (\$120) consists of a headset (Model PEP-71) and a small control console. Unlike a dynamic headphone, an electrostatic phone requires a dc polarizing voltage (nearly 300 volts in the PEP-77D) and ac signal voltages of the same order of magnitude. The control console contains two independent step-up transformers, each of which is driven from one of the speaker outputs of a stereo power amplifier. Each earcup contains two closely spaced metal mesh electrodes. Between the electrodes is a very thin metallized Mylar



diaphragm. The diaphragm operates at the dc polarizing voltage, while the electrodes are driven in push-pull, above and below the average level, by the high-voltage ac signal from the coupling transformer.

The electrostatic field between electrodes exerts a force on the Mylar diaphragm which moves under close control of the exciting voltage. Radiation from the rear of the diaphragm is absorbed by padding within the earcup. The front radiation passes through foam plastic damping pads on its way to the listener's ear.

In addition to the step-up transformers, the control console contains a power supply for the dc polarizing voltage. If the unit is plugged into the ac line and turned on by the illuminated rocker switch on the front panel, this voltage is generated by a line-operated voltage multiplier power supply. However, it can also be operated in-

dependently of the ac line as a self-energized system. The voltage multiplier is then driven from the high signal voltage at the secondary of the left-channel transformer. Performance is identical in both modes except that under self-energized operation, it may be necessary to momentarily turn up the volume when starting to listen in order to generate enough dc voltage. No switching is necessary to change from line-energized to self-energized operation.

Although the electrostatic headphones themselves require little audio power, the PEP-77D system does consume some power in its power supply (about 1 watt from the ac line). As a result, these phones cannot be operated from the usual receiver or amplifier headphone jack which is normally driven from the speaker outputs through a resistance on the order of 200 ohms. Terminals on the rear of the console are connected to the amplifier's speaker outputs, and a duplicate set of terminals on the console drive the speakers when a switch on the console's rear panel is set to the SPEAKERS position. Speaker and phones cannot be operated simultaneously. Also on the rear panel of the console are individual level controls for the separate earcup systems, and two sockets for the PEP-71 headphones.

The PEP-71 is a lightweight, conventional-appearing headphone with foam padded vinyl covered ear pads and a comfortable padded headband. The headphone weighs 14 ounces, and the coil cord can be extended to 15 feet. The control console is housed in a wooden walnut-finished cabinet with a sloping front.

Laboratory Measurements. We measured the frequency response of the PEP-77D system with a simple coupler consisting of a flat board into which our calibrated microphone was inserted, flush with its surface. The earcup was centered over the microphone, while a 1-pound weight pressed it to the surface. Although, like most headphones, the frequency response curve measured in this manner was by no means flat, it was considerably better than we have measured in most better grade dynamic phones. A slight loss of low frequencies (below 50 Hz) may have been the result of air leaks around the earpiece and microphone. The response extended well beyond 15,000 Hz, the upper calibration limit of our microphone. It was still strong at 20,000 Hz. The output was somewhat reduced in the

PACE
makes
another
BREAK THROUGH

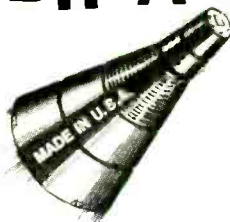

23 CHANNEL CB TRANSCEIVER

- ALL crystals supplied •
- 5 Watts of Transmit •
- Pace plus modulation •
- Ceramic microphone •
- Locking latch rack •

Pace Model 223



\$109.95

From the PACE U. S. Engineering Team that introduced the first all transistor CB transceiver, the Model 223 offers another breakthrough in both Price and Quality. Taking advantage of U. S. mass production techniques and engineering knowhow, the PACE Model 223 provides the truly great bargain for today's CB operator who wants performance and price with the quality guarantee of a U.S. manufacturing firm. With a NO compromise design approach the PACE engineers built a double conversion receiver with a full 6 section tuned filter network for maximum receiver performance even under adverse conditions - we can guarantee performance for 2 years because we shake every one in the roughest QC test procedure ever designed for 2 way radios.

If you compare before you buy you'll join the Proud Pace owner's club!

((P)) PACE COMMUNICATIONS

Division of PATHCOM INC. 24049 South Frampton Ave.
Harbor City, California 90710 • (213) 325-1290
Export: 2200 Shames Drive, Westbury, New York 11590

CIRCLE NO. 24 ON READER SERVICE CARD

2000- to 5000-Hz region and had a broad peak between 10,000 Hz and 17,000 Hz.

The impedance, as seen by the driving amplifier, was between 30 ohms and 50 ohms over much of the audio range. It fell off to about 8 ohms in the 10,000 to 20,000-Hz octave.

The PEP-77D developed a 100-dB sound pressure level—very loud—with about 200 mW of drive, a considerably higher efficiency than we have measured with other electrostatic phones. An acoustic output of 115 dB at 1000 Hz could be obtained with only 1 percent distortion. The distortion was much lower at better listening levels.

As compared to a wide group of phones we have tested, the PEP-77D ranked high in smoothness of frequency response, tone-burst response, and sound isolation from ambient noises. They also were able to deliver at least 10 dB higher sound levels than other electrostatic phones checked, at a

1-percent distortion level; and in this respect, they compared favorably with many good dynamic phones.

Listening Impressions. The Superex PEP-77D had a strikingly smooth, clean, and transparent quality. Not only did they sound better than most dynamic phones we have used, but they outperformed some of the best loudspeaker systems in their clarity and transparency. (This adjective is necessarily overworked when describing the sound of a good electrostatic phone, but only because we do not know a better one!) Of course, it is difficult to compare the sound of a headphone to that of a loudspeaker because of the totally different subjective effects they give. But at least one can be certain that these phones provide a faithful acoustic analog of the electrical input signal, and that is what sound reproduction is all about.

Circle No. 67 on Reader Service Card

PEARCE-SIMPSON COUGAR 23 CB TRANSCEIVER

THE Pearce-Simpson Cougar 23 is a compact, mobile, solid-state CB transceiver designed for AM operation. Special features not usually found in an AM rig of this type include a switchable noise blanker (as well as a full-time conventional noise limiter) and a seven-way metering setup.

The other features of the Cougar 23 often found in mobile CB transceivers include adjustable squelch; external-speaker jacks for receiver output or for the built-in public address system; delta tune; detachable microphone; and operation from a 12-14-volt dc, positive or negative ground, source.

Technical Data. Dual conversion is used on receive. The first i-f is 11.275 MHz, while the second i-f is 455 kHz. A ceramic filter at the second i-f provides a 50-dB adjacent-channel selectivity while maintaining a 5-kHz bandpass for good a-f quality.

Heterodyning-oscillator signals at the first and second mixers are obtained from the company's "HetroSync" system of frequency synthesis. Except for the frequencies involved, this method is like that found in many CB rigs. In principle, two crystal-controlled frequencies are combined with that of the incoming signal at the first mixer to produce a first i-f; a third crystal-controlled frequency at the second mixer



produces the last i-f. Channels are changed by switching in different crystals in proper combination at the first mixer. A delta-tune setup at the second conversion oscillator has three positions which permit the receiver's frequency to be shifted by a given amount around the center frequency.

The i-f stage is a FET for low cross-modulation, while the first mixer is a bipolar transistor. Fine sensitivity is achieved with this front-end arrangement, measuring 0.3 μ V and 0.5 μ V for 10 dB (S + N)/N with 30 percent modulation at 1000 and 400 Hz respectively. Image rejection was found to be 65 dB. The second mixer is unique for a CB rig in that it is a balanced type, using diodes, which also function as gates for the noise blanker. With the bal-

anced arrangement, switching transients at the gates are eliminated for quieter operation.

The noise blanker circuit has a high-gain, integrated circuit r-f amplifier fed from the antenna. This is followed by pulse-detector diodes and transistors as noise-pulse amplifiers for operating the gates. The system is highly effective without distorting the signal. However, quite a loss in overall signal level is experienced with weak signals (less than 10 μV). But with strong signals, there is little audible loss, thanks to the age action.

There are two age systems. One gates the first a-f amplifier which functions as the squelch. The range of the squelch threshold adjustment tested out to be 0.25-10,000 μV . The age characteristic held the a-f output level to within 6 dB with a 20-dB input change of 1-10 μV or 6 dB for a 60-dB input change of 10-10,000 μV .

The a-f system ends up with a class B push-pull power output circuit which also doubles as a PA system rated at 5 watts. The most we could obtain with clean quality on PA was 2.75 watts into an 8-ohm load. The hot side of the 12-volt supply appears on the external-speaker jacks. Therefore, care must be taken not to allow the

speaker leads to come in contact with the ground side of the power source. Otherwise, the supply line will short circuit and the power line fuse will blow.

During Transmission. On transmit, the carrier is generated by combining the crystal frequencies used at the first conversion for the receiver with another crystal-controlled signal at the transmitter mixer. This causes on-channel signals to be produced. Three-section bandpass coupling circuits at the mixers minimize the possibility of undesired spurious responses. The overall frequency tolerance is rated at 0.003 percent (-30° to $+65^\circ$ C). With our test unit operating at a 70° F ambient temperature, two-thirds of the channels were far better, within 0.0005 percent, with the remainder less than 0.0015 percent.

The r-f signal is amplified and applied to a driver for the PA which operates at 5 watts input. A triple-section pi-network provides harmonic filtering and matching to 52-ohm loads or those presenting an SWR of 3:1 or less. With operation from a 13.8-volt source, a carrier of good output at 4 watts is obtainable.

As usual, both the driver and the PA

*the tape that
turned the
cassette into
a high-fidelity
medium*



TDK SUPER DYNAMIC (SD) TAPE



TDK

Until TDK developed *gamma ferric oxide*, cassette recorders were fine for taping lectures, conferences, verbal memos and family fun—but not for serious high fidelity.

Today you can choose among high-quality stereo cassette decks.

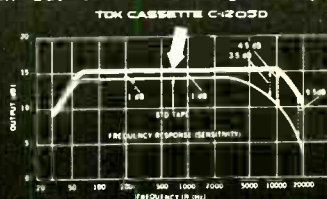

The new magnetic oxide used in TDK Super Dynamic tape distinctly differs from standard formulations in such important properties as coercive force, hysteresis-loop squareness, average particle length (only 0.4 micron!) and particle width/length ratio. These add up to meaningful performance differences: response capability from 30 to 20,000 Hz, drastically reduced background hiss, higher output level, decreased distortion and expanded dynamic range. In response alone, there's about 4 to 10 db more output in the region above 10,000 Hz—and this is immediately evident on any cassette recorder, including older types not designed for high performance. There's a difference in clarity and crispness you can hear.

Available in C30SD, C60SD, C90SD and C120SD length

TDK ELECTRONICS CORP.
LONG ISLAND CITY, NEW YORK 11103

CIRCLE NO. 33 ON READER SERVICE CARD

are modulated by the receiver's power amplifier, in which case an automatic modulation control (AMC) setup is brought into play. This is a compression system that holds the modulation to 100 percent during large variations in speech level inputs. Unlike conventional limiting and clipping affairs which usually introduce considerable distortion during such action, the AMC allows a good a-f waveform to be obtained at all times with little or no distortion, putting out a clean signal and maintaining a high modulating level for a husky signal.

The seven-way metering setup is better defined as an *indicating* system inasmuch as the meter itself is engaged for only four functions: received signal strength in S

units; relative r-f output power; sensitivity calibration for SWR readings; and the magnitude of the SWR. The other functions are indicated by lamps at the meter window: amber on receive; dull red on unmodulated transmit; and bright (varying) red on modulated transmit.

The transceiver, listed at \$189.95, is clean featured, trimmed in chrome. The speaker is bottom-facing. The rig measures $8\frac{1}{2} \times 7\frac{1}{2} \times 2\frac{1}{2}$ and weighs $4\frac{1}{2}$ lb. Power drain on receive is slightly less than 200 mA; on transmit, it is slightly greater than 1 A. A protective measure against application of incorrect power polarity is provided by a diode which short circuits the supply line and blows the fuse.

Circle No. 68 on Reader Service Card

LEE MODEL EC SIGNAL-TRACING PROBE

RECENTLY, we had the opportunity to try out a new concept in basic test gear in the form of the Lee Electronics Lab Model EC Dynamic Serviset. In appearance, this new "gadget" resembles an overgrown test probe measuring 7" long by 1" in diameter. In operation, however, we were surprised at the number of things the Model EC could do.

With a prod on one end and an insulated alligator clip on the other. The probe can be used as an r-f signal tracer, an audio signal tracer, and r-f/a-f signal injector, an ac/dc voltage presence indicator (60-20,000 volts), a low resistance/short circuit indicator, a high-voltage powered leakage checker, a substitute for a low-value capacitor or a high-value electrolytic capacitor, and a substitute for high-, medium-, or low-value resistors. We are not through yet; the instrument will also check speakers and phones for continuity and phasing, and it



can even be used to make some general transistor tests.

The complete package includes the Model EC, a special earphone with extension, a "Klipzon" adapter, high-voltage adapter, kinkless lead for testing, "mini" lead, 1.5-volt AA cell, carrying pouch, and 30-page instruction manual. All of this is supplied

Planning to move?

Let us know 6 to 8 weeks in advance so that you won't miss a single issue of **POPULAR ELECTRONICS INCLUDING ELECTRONICS WORLD**

Attach old label where indicated and print new address in space provided. Also include your mailing label whenever you write concerning your subscription. It helps us serve you promptly.

Write to: P.O. Box 2774, Boulder, Colo., 80302, giving the following information.

Change address only.

Extend subscription. Enter new subscription.
 (1) 5 yrs. \$21 (2) 3 yrs. \$15 (3) 1 year \$6

Payment enclosed (1 extra issue per yr. as a BONUS)

Bill me later.

If you have no label handy, print OLD address here.

name _____ please print _____

address _____

city _____

state _____ zip-code _____

AFFIX LABEL

name _____ please print _____ 0713

address _____

city _____ state _____ zip _____

Add'l postage: \$1 per year outside U.S., its possessions & Canada.

under the basic Model EC price of \$34.95.

The theory behind the Serviset is simple. No matter how complex the apparatus under test, it can be broken down into discrete stages with each performing its own unique function. Each stage can also be broken down into various combinations of capacitors, resistors, inductors, and tube or transistor. If you work on the premise that there is an a-f or r-f input, then this signal can be traced from the input to the output. When you get to the stage that does not operate, the Model EC can be used as a substitute for the various components or be used to bypass this stage, thus helping to further isolate and localize the trouble.

As mentioned earlier, the Model EC uses only one test lead to perform its many functions. Using the instrument is as simple as inserting the test lead prod into one of the 13 receptacles in the upper end of the probe. Each receptacle is clearly identified according to function. The neon lamp high-voltage indicator is visible through a small hole in the probe shell; the low-resistance indicator lamp is readily visible through its hole at the upper end of the probe.

Servicing a Radio. We used the Serviset to check out an inoperative broadcast-band receiver. It was easy to follow the r-f signal from the antenna through the converter and to locate the problem in the i-f stage. Once the trouble was localized, plate voltage checks showed that all appeared to be okay in this area. However, going to the screen grid, we noted that there was no voltage. Further checks, using the Model EC as a substitute resistor, revealed that a resistor was open. Once the receiver was repaired, we again used the instrument as an audio and r-f signal tracer to check it out; the receiver worked fine. And we discovered, by using the Serviset as an electrolytic capacitor substitute, that the small amount of audible hum could be reduced to nil by beefing up the filtering.

Generally, we found that the Model EC Serviset is a handy troubleshooting tool to have around. It can be used in place of much more expensive and specialized equipment when first checking out a set to get a rough idea of why it does not work. On the other hand, the Serviset does not and cannot take the place of a VTVM or an oscilloscope when accuracy is required.

Circle No. 69 on Reader Service Card

ELECTRONICS—NEW TROUBLE-SHOOTER

A compact—complete
circuit analyzer

Model EC
Patented

The SERVISSET

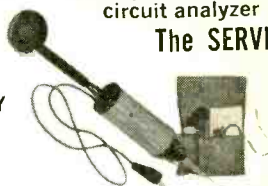

INTRODUCTORY
PRICE
\$34.95
POSTPAID

A precision engineered professional quality electronic test instrument. Ideal for field or bench servicing of all types of Communications gear.

CHECKS: sync, sweep, video, audio circuits, high voltage supplies (DC, RF or Pulse), low voltage supplies, coils, capacitors, resistors, tubes, transistors, diodes, transformers, speakers, etc. Will locate trouble to a particular stage, determine defective component and can actually be clamped in circuit to restore circuit operation temporarily in 80% of component or tube defects. Ideal for locating and confirming intermittents.

SPECIFICATIONS:

RF & AF Signal Tracer, RF & AF Signal Injector, AC & DC Voltage Indicator 0/60/550/20,000 DC Polarity Indicator 60/550/20,000 volts, Lo ohms 0-5. Hi ohms 0-500k-20 megohms. Tests Condensers, .00025-12 mfd., Tests Resistors 2 ohms-20 megohms. 2 Capacitance Sub ranges .01-1 & 4-40 mfd., 3 Resistance Sub ranges 50-500 ohms. 5k-25k. 100k-1 meg.

30 Day Money-Back Guarantee



LEE ELECTRONICS LABS., INC.
88 Evans Street
Watertown, Massachusetts 02172

CIRCLE NO. 18 ON READER SERVICE CARD

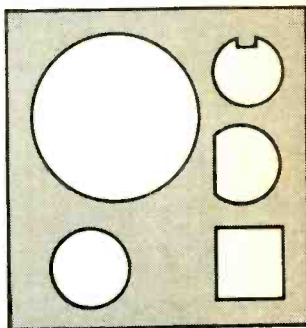

Put more punch in your work.

With a Greenlee Chassis Punch you can punch clean, true holes in seconds. Round, square, key or D. In 16-ga. metal, hard rubber, plastic or epoxy. Available at radio and electronics parts dealers. Write for catalog E-730. Greenlee Tool Co, 1764 Columbia Ave., Rockford, Ill. 61101.

GREENLEE TOOL CO

A Unit of Ex-Cell-O Corporation 

CIRCLE NO. 14 ON READER SERVICE CARD



Philosophy of a Kit Manufacturer

By John T. Frye, W9EGV, KHD4167

WHEN Barney entered the service department, still shivering a bit from the bleak, cold November morning, he found Mac, his employer, thumbing through the pages of a catalog.

"Hey, you've got a new Heathkit catalog!" the youth exclaimed. "How come I don't have mine?"

"Rank has its privileges," Mac replied with a teasing grin. "This came sort of special delivery when Gene, my old friend with the Heath Company, dropped in for a short visit last evening and left it."

"I suppose you two went at it hammer and tongs as usual," Barney said. "I can just hear you nit-picking the assembly instructions for the last kit you put together that didn't work perfectly the first time you turned it on, and I can hear Gene countering with scornful remarks about crusty old service technicians who never really learned how to make a decent solder joint and who stubbornly refuse to follow clear step-by-step instruction in the manual."

"You must have been listening," Mac chuckled reminiscently. "But then we settled down and Gene gave me a lot of information on the painstaking steps that are taken to see to it that a Heathkit is as error-free and fool-proof—both in design and in the instruction manual—as possible before it is put on the market. I think you, or anyone else who ever put a kit together, will find this interesting."

"I'm all ears," Barney invited, settling himself comfortably on the end of the service bench.

"Okay; after an engineering design has been frozen—I hate that barbarism 'finalized'—it is turned over to the Manual Department for publications treatment. The Manual Department gets six sets of parts

and an operating prototype of the kit. Using these, the author of the manual evolves a general building procedure and step-by-step sequence. He strives to simplify wiring, to avoid redundancy of parts, to arrange complex wiring in proper layers, and to avoid more than four soldered connections to a single point. This last, of course, is to avoid rosin joints or the possibility bottom wires will stack up unsoldered because heat from the iron does not reach them. Working in collaboration with the design engineer, the author actually builds the kit, making careful handwritten notes of every procedure. After a preliminary check this written material is turned over to a typist for initial typing.

Pre-proofing and Proof-Building. "Next comes the pre-proof cycle. The design engineer and the author build the kit from the author's notes. This brings to light many obvious errors and spotlights a need for improvement in the sequence of several steps. After these corrections and modifications have been included in the written instructions, the kit is ready for the proof-building stage.

"The instructions are reproduced on a Xerox machine, and a proof-build program is scheduled involving 18 to 20 people, depending on the complexity of the kit. These proof-builders represent a cross-section of capable engineering people, marketing people, customer services people, production and office personnel, and always one or two novices. A novice is defined as someone who has never assembled a kit product before. By necessity these are always Heath employees, and they are issued kits on a Friday afternoon to take home and assemble from the Xerox-prepared instruc-

tions. If the kit is fairly complex, they may be allowed two weekends with the due date on a Monday morning; but quite often the proof-builds are due back on the Monday following the Friday they were issued.

"As these people assemble their kits, they keep track of their time and are encouraged to write their comments directly in the 'manual' at the appropriate place where difficulty was encountered or an error detected. If the kit does not perform correctly when completed, the proof-builder is encouraged to try to locate and correct the trouble himself if he can; but working or not, the proof-builds must be turned over to an evaluation engineering group on the due date. This group is entirely separate from the engineering design group, and their function is to see how well the completed kits perform—if they perform at all—and to determine what is wrong if they will not work. Is the failure due to a defective component? To incorrect assembly or wiring? To a manual error?"

"Finally the proof-builders meet with the engineering evaluation group, and individual experiences and suggestions are gone over in great detail to determine what changes, if any, are needed. Sometimes a different value of component is recommended, or a supplier is required to tighten up his quality control, or holes in the chassis must be changed, or instructions need to be clarified. Out of all this information comes the data that formulates the final pack, parts count, and final manual. Occasionally, however, when the proof-build corrections and changes are excessive, the company may elect to hold a 'post-proof-build.' This is a second proofing stage beyond the proof-build to verify that all the changes and corrections have been caught in the final printing. This post-proof build usually involves only one or two builds."

"Man, they ought to have all the bugs out by that time!" Barney exclaimed.

"They still don't take that for granted. As a final check, the tenth pack of the first production run for the product is pulled off the line by quality control and built again to make sure nothing has happened during the interim between engineering sign-off and the initial production run. And the first production run is not shipped until completion and verification of the production proof by quality control. Formal reports are required at each stage."

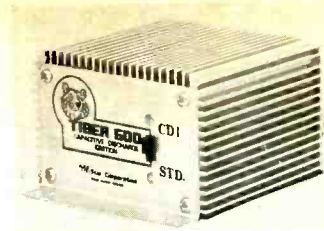

12 REASONS YOUR CAR NEEDS TIGER CDI

Instant starting in any weather - Eliminates tune-ups - Increases gas mileage - Increases horsepower 15% - Improves acceleration and performance - Spark plugs last up to 70,000 miles - Reduces engine maintenance expense - Amplifies spark plug voltage to 45,000 volts - Maintains spark plug voltage to 10,000 RPM - Reduces exhaust emissions - Dual ignition switch - An Unconditional LIFETIME GUARANTEE - Installs in 10 minutes on any car with 12 volt negative ground - No rewiring - Most powerful, efficient and reliable Solid State Ignition made.

SATISFACTION GUARANTEED or money back.

TIGER 500 assembled \$49.95

TIGER SST assembled 39.95

TIGER SST Simpli-Kit 29.95

Post Paid in U.S.A.

Send check or money order with order to:

Tri-Star Corporation

Dept. W, P. O. Box 1946
Grand Junction, Colorado 81501

DEALER INQUIRIES INVITED

CIRCLE NO. 35 ON READER SERVICE CARD

ABOUT YOUR SUBSCRIPTION

Your subscription to POPULAR ELECTRONICS is maintained on one of the world's most modern, efficient computer systems, and if you're like 99% of our subscribers, you'll never have any reason to complain about your subscription service.

We have found that when complaints do arise, the majority of them occur because people have written their names or addresses differently at different times. For example, if your subscription were listed under "William Jones, Cedar Lane, Middletown, Arizona," and you were to renew it as "Bill Jones, Cedar Lane, Middletown, Arizona," our computer would think that two separate subscriptions were involved, and it would start sending you two copies of POPULAR ELECTRONICS each month. Other examples of combinations of names that would confuse the computer would include: John Henry Smith and Henry Smith; and Mrs. Joseph Jones and Mary Jones. Minor differences in addresses can also lead to difficulties. For example, to the computer, 100 Second St. is not the same as 100 2nd St.

So, please, when you write us about your subscription, be sure to enclose the mailing label from the cover of the magazine—or else copy your name and address exactly as they appear on the mailing label. This will greatly reduce any chance of error, and we will be able to service your request much more quickly.

"Well, that explains why I am so often frustrated when I'm building a kit and think I've finally caught them leaving out an essential part or shorting me on hardware or making a goof in the manual. Invariably the missing item shows up tucked away in some obscure corner of the carton or in one of the sacks I've discarded as empty; and the glaring mistake in the manual turns out to be a mistake in my careless reading of it."

"Know what you mean," Mac nodded. "It's sort of like the bitter-sweet feeling you have when your checkbook won't agree with the bank statement and you're practically *sure* the bank has finally made an error; but then, on the tenth review, you discover a subtraction error in your checkbook."

"I'll bet you gave Gene a lot of Why Dontcha's," Barney hazarded.

Kit Philosophy of the Company. "Naturally," Mac said with a grin. "But he knocked them down as fast as I tossed them up. Out of my suggestions and his patient explanations of why the ideas were not practical, I think I acquired some insight into the 'kit philosophy' of the com-

pany. I believe the same philosophy applies to any other kit instrument manufacturer who puts out quality products.

"First is the idea nothing should be done for the builder that he can do well for himself. Doing so increases the cost of the kit and deprives the builder of much of the pride he has in the finished product. If wires are cut to length, sub-assemblies are all put together, and instructions are obviously written for a seven-year-old, the labor involved in doing all this will add very materially to the cost of the kit, since labor is a major item in the cost of any product these days. At the same time, the builder will be made to feel the manufacturer is holding his wrists at every step of the assembly, and this will subtract materially from any feeling of personal accomplishment. Money saved by allowing the builder to furnish as much labor as possible and by assuming he is an intelligent human being can be spent to improve the quality of the kit instrument while still keeping its price below that of an inferior assembled unit."

"Makes sense," Barney agreed. "Sometimes I gripe and growl when I encounter a tedious procedure in a kit assembly (pre-

SAVE MONEY!

A Delta Mark Ten Capacitive Discharge Ignition (CDI) System On Your Car Slashes Maintenance Costs And Increases Performance.

Put a Mark Ten on your car and save by eliminating 3 out of 4 tune-ups. Save as gasoline mileage increases (up to 20%). The Mark Ten CDI system also extends spark plug life, promotes more complete combustion and assures instant starts in all weather. It operates on any 6 or 12 volt negative or positive ground system.

The Mark Ten B affords additional money saving advantages by drastically reducing combustion contaminants and restoring power lost by the use of smog control devices. Equipped with handy switch for instant return to standard ignition, the Mark Ten B works with ANY 12 volt negative ground engine. Both systems install in ten minutes without rewiring.

Order your Mark Ten or Mark Ten B today. Save money while you enjoy low maintenance and increased performance.

Mark Ten (Assembled) \$44.95 ppd.

Mark Ten (Deltakit) \$29.95 ppd.
(Kits available in 12 volt only,
positive or negative ground)

Mark Ten B \$59.95 ppd.
(12 volt negative ground only)

Superior Products at Sensible Prices
Mfg. in U.S.A.



DEPT. PE
DELTA PRODUCTS, INC.

P.O. BOX 1147 • GRAND JUNCTION, COLORADO 81501
PHONE: (303) 242-9000

Please send me literature immediately:

Enclosed is \$ _____

Ship ppd. Ship C.O.D.

Please send: Mark Ten B @ \$59.95 ppd.

___ Standard Mark Ten (Assembled) @ \$44.95 ppd.

___ 6 Volt: Neg. Ground Only ___ Positive Ground

___ 12 Volt: Specity ___ Negative Ground

___ Standard Mark Ten (Deltakit®) @ \$29.95 ppd.

(12 Volt Positive Or Negative Ground Only)

Car Year _____ Make _____

Name _____

Address _____

City/State _____ Zip _____

CIRCLE NO. 9 ON READER SERVICE CARD

POPULAR ELECTRONICS Including Electronics World

paring lengths of coaxial cable, for instance) but I get the job done; and I certainly would not want to pay some high-priced worker to do it for me. After all, the average kit builder is very likely a special breed who really enjoys putting kits together. He doesn't buy a kit instrument just because it costs less than a comparable assembled unit. He savors every moment of the assembly from the time he opens the carton, sniffs that indescribable aroma of new insulation and lacquer, and catches his first peek at the exciting colors and shapes of still-unrecognized items, until he proudly peels the backing from the little blue model label and presses it against the chassis. He has watched something grow entirely under his own hands from a jumbled mess of parts to an attractive, reliable device."

"Spoken like a real *aficionado!*" Mac said. "But whether or not a person assembles or uses kit instruments, I strongly feel he and the entire electronic industry owe a debt to kit manufacturers. They have made it possible for many service technicians, experimenters, and radio amateurs to purchase and become familiar with equipment they could not otherwise afford. Many a small shop opens for business with a service bench full of Heathkit or other manufacturers' kit-type instruments. Then as the business prospers and the technician's time becomes more valuable, he tends to purchase assembled replacement instruments. I'll bet if you could get the figures, you'd find kit instrument manufacturers really have helped the sale of all instrument manufacturers."

"Yeah," Barney agreed. "Many a person enters the electronics field by the act of putting together a simple kit. Once he learns he can wire a bunch of parts together and make an instrument that really works, he is hooked for life. 'Who says electronics is black magic?' he asks himself as he signs up for a correspondence course in electronics or heads for an engineering course in college."

"Speaking of education," Mac concluded, "I've always admired the kit manufacturers' efforts in this area. They try to tell the builder not only *how* to assemble the instrument but also *why* it works as it does. Every manual has a 'Circuit Description' section. Heath's color-TV receiver manuals include what is actually an excellent short course in color-TV theory and practice. I consider this most commendable." ♦

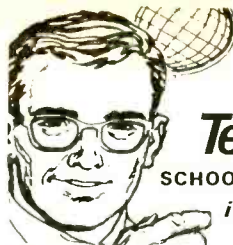

Attention Electronic Technicians!

SCHOOLING OF EXCELLENCE
in ELECTRONICS
ENGINEERING

If you have adequate schooling and experience at the technician level you may be able to qualify to enter our college-level Home Study Program in Electronics Engineering. The CIEE Program is OUTSTANDING, and up-to-date in every respect. CIEE is a forward-looking school, and Engineering is taught on the basis of application and understanding rather than on the basis of memorization. All lesson material and texts are thorough and easy-to-understand. Through this Highly Effective Home Study Program in Electronics Engineering you can raise your status and pay to the Engineering level. No residence classes required for those who qualify. If you are an electronics technician with above-average ambition, and not willing to settle for anything less than the best home study Engineering Schooling available anywhere, then you should write TODAY for our free revealing descriptive literature. There is no obligation, and no salesman will call on you.

**COOK'S
INSTITUTE** of Electronics Engineering



Raymond Road
P. O. Box 10634
Jackson, Miss. 39209

Established 1945
Formerly Cook's School of Electronics

CIRCLE NO. 6 ON READER SERVICE CARD

THE BEER ESSENTIALS

... are easy to come by at Wine-Art, America's leading supplier of home brewing and winemaking equipment and ingredients. Less than \$5 buys the ingredients for a 5 gal. batch of beer. It's easy - and saves you money, too. Send \$2 for "The Art of Making Beer" and the Wine-Art Handbook, a complete catalog of beer, wine, liqueur and soft drink makings. Write: WINE-ART, Dept. PE, 4324 Geary Blvd., San Francisco, Ca. 94118.

WineArt
100 SHOPS COAST TO COAST



CIRCLE NO. 38 ON READER SERVICE CARD

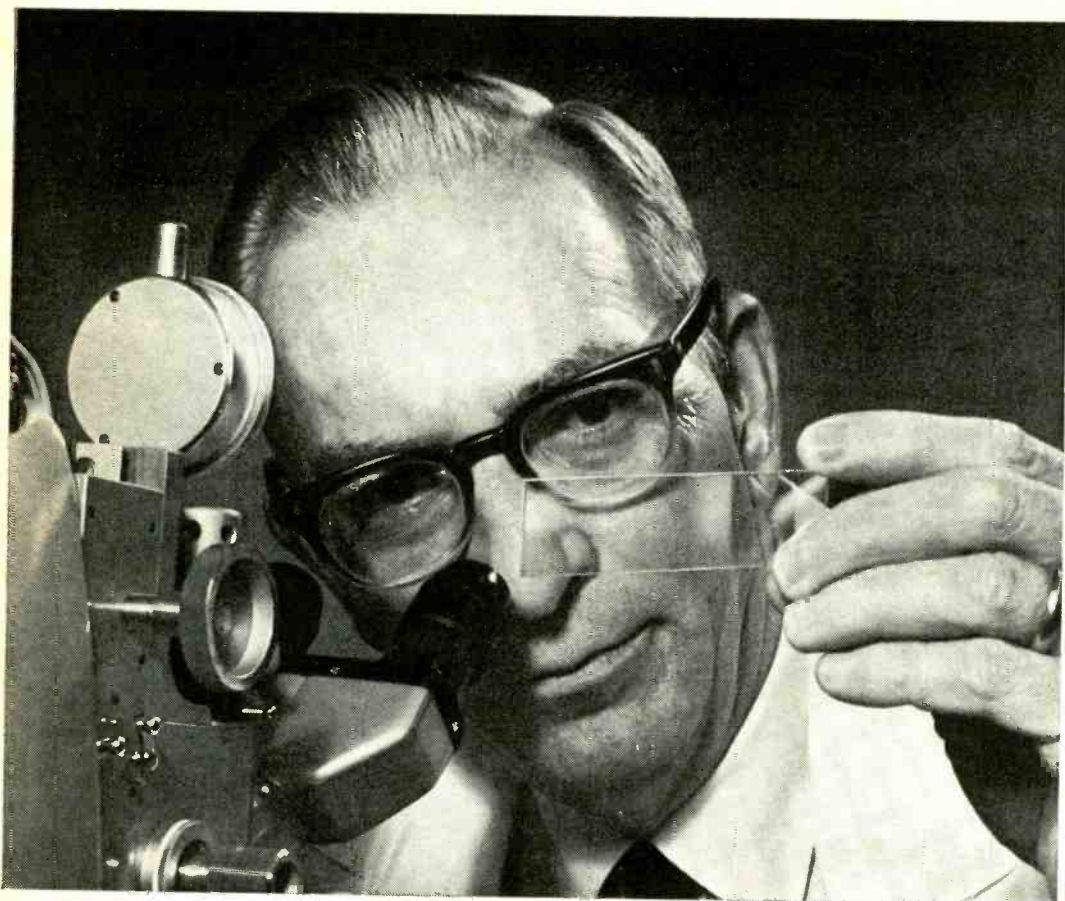

NTS Home-Training in Electronics was the start of something big for James Gupton

An NTS Graduate

James A. Gupton Jr. graduated from National Technical Schools with a diploma in TV & Radio Servicing. Today, he's a mighty important man in the world of Electronics!

Research associate with a major electronics corporation; author of numerous articles in electronics magazines; an inventor with five patent applications to his credit. In the field of electro-optics, he has perfected a revolutionary phosphor deposition technique for cathode ray tubes.

Quite a list of accomplish-

ments for a man who began his career with an NTS diploma and a job in TV & Radio servicing.

Any student can succeed

James Gupton is certainly an exceptional NTS graduate. He proves there's nothing to keep a determined man from becoming a success in Electronics. As he himself says, "Any student, properly motivated, can succeed in Electronics through home-training."

Every NTS Electronics Course is specially designed to keep you motivated from the time you

start building your first test instrument until you're ready to plug-in your solid-state Color TV or other advanced electronics equipment.

Exciting "Project Method" Training

NTS Project Method Training is the best way to learn electronics.

You build advanced equipment while you learn Electronics principles and applications.

Each week brings new excitement when you actually see the progress you've made.

NTS builds self-confidence.

For a man to become successful, like James Gupton, he must have confidence in himself.

As an NTS graduate you have this confidence. Your training is practical and thorough. You know Electronics from the bottom up. You enter a world of Electronics you're familiar with.

And if you have the drive and determination of a man like James Gupton, there are no limits on your success!

(James Gupton's address available upon request).

NTS COLOR TV SERVICING



Solid-state
315 sq. in.
Heath Color TV

Build and keep the largest, most advanced color TV made! Over-all solid-state design, ultra-rectangular screen, matrix picture tube, built-in self-servicing features, "Instant On," A.F.T., solid-state, 24-channel detent UHF/VHF power tuning, and much more! Also build and keep AM-SW Radio, solid-state Radio, FET Volt-Ohmmeter, and Electronic Tube Tester. Learn trouble-shooting, hi-fi, stereo, multiplex systems, radio, color and B&W TV servicing.

NTS B&W TV SERVICING

Learn sophisticated solid-state circuitry as you build this B&W TV Receiver, Lo-Silho "Superhel" Radio, FET Volt-Ohmmeter, solid-state Radio, Electronic Tube

Solid-state
B&W TV,
74 sq. in.
picture
(cabinet
included)



Big, Colorful NTS Guide to new opportunities in Electronics. Yours FREE!

NATIONAL TECHNICAL SCHOOLS
4000 S. Figueroa Street
Los Angeles, California 90037

Please rush me FREE Color NTS Electronics Guide & FREE lesson, plus information on course checked at right. No obligation. No salesman will call.

Checker, and Signal Generator, TV and all other equipment are yours to keep.

NTS ELECTRONIC & COMPUTER TECHNOLOGY

Solid-state
Compu-Trainer
14 integrated
circuits
replace 198
Transistors!

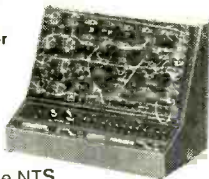

Build and keep this exclusive NTS Compu-Trainer. It teaches you the same principles used in million-dollar systems. Contains 14 integrated circuits! All solid-state! You perform all wiring and patchcording. No shortcuts. No pre-wired circuit boards. Your training is complete! Also receive a FET Volt-Ohmmeter and a 5" wide-band solid-state Oscilloscope.

NTS ELECTRONIC COMMUNICATIONS

Gain the prestige and earning power of owning and F.C.C. First Class Radio-Telephone license. Two comprehensive NTS Courses cover the big opportunity field of transmitting and receiving.



5-watt AM
Transmitter/
Receiver

You build and keep 14 kits, including this amateur phone 6-meter VHF Transceiver, NTS's exclusive 6-transistor solid-state Radio, and a fully transistorized Volt-Ohmmeter. Also, learn 2-way radio, Citizens Band Microwaves, and radar.

NTS INDUSTRIAL & AUTOMATION ELECTRONICS

Automation is the future of industry, and you can play an important part! Learn industrial controls by training on the NTS Electro-Lab (a complete workshop). You also build and operate this 5" solid-state

oscilloscope. And you perform experiments that involve regulating motor speeds, temperature, pressure, liquid level, and much more. All equipment is yours to keep.

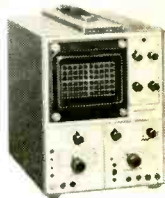

All solid-state!

NTS AUDIO ELECTRONICS SERVICING

Learn sound theory — how it works in home radio, car tape decks, stereo multiplex component systems, and more! Set up a spectacular music system. Learn about sound distortion, amplification and control, loud-speaker baffles, problems of system installation, etc.

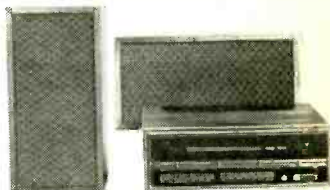

Build and keep this famous Heath Stereo Receiver and Speakers

Included is Volt-Ohmmeter, In-Circuit Transistor Tester and solid-state Radio. Prepare yourself for great opportunities in the Home Entertainment Industry!

CLASSROOM TRAINING AT LOS ANGELES

You can take classroom training at Los Angeles in sunny Southern California. NTS occupies a city block with over a million dollars in technical facilities. Check box in coupon below.

APPROVED FOR VETERANS

Accredited Member: National Association of Trade and Technical Schools; National Home Study Council.

NATIONAL TECHNICAL SCHOOLS

Resident & Home Study Schools
World-Wide Training Since 1905
4000 S. Figueroa St., Los Angeles, Ca. 90037

Dept. 205-112

- MASTER COURSE IN COLOR TV SERVICING
- COLOR TV SERVICING (FOR ADVANCED TECHNICIANS)
- MASTER COURSE IN B&W TV & RADIO SERVICING
- MASTER COURSE IN ELECTRONIC COMMUNICATIONS
- PRACTICAL RADIO SERVICING
- FCC LICENSE COURSE
- MASTER COURSE IN ELECTRONICS TECHNOLOGY
- AUTOMATION & INDUSTRIAL ELECTRONICS
- COMPUTER ELECTRONICS
- BASIC ELECTRONICS
- AUDIO ELECTRONICS SERVICING

NAME _____ AGE _____

ADDRESS _____

CITY _____

STATE _____ ZIP _____

- Check if interested in Veterans Training under new G.I. Bill.
- Check if interested ONLY in Classroom Training at Los Angeles



BY LEWIS J. NEWMIRE

BUILD THE DECID-O-TRON

LET ELECTRONICS HELP YOU MAKE DECISIONS

EVEN top-flight executives sometimes have trouble making decisions. If they don't have a flippable silver dollar handy—or a solid-state Ouija board with alpha-

numeric readout—they just may need a "Decid-O-Tron." This battery-powered device can be used any time or any place to help the undecided take the fatal step.

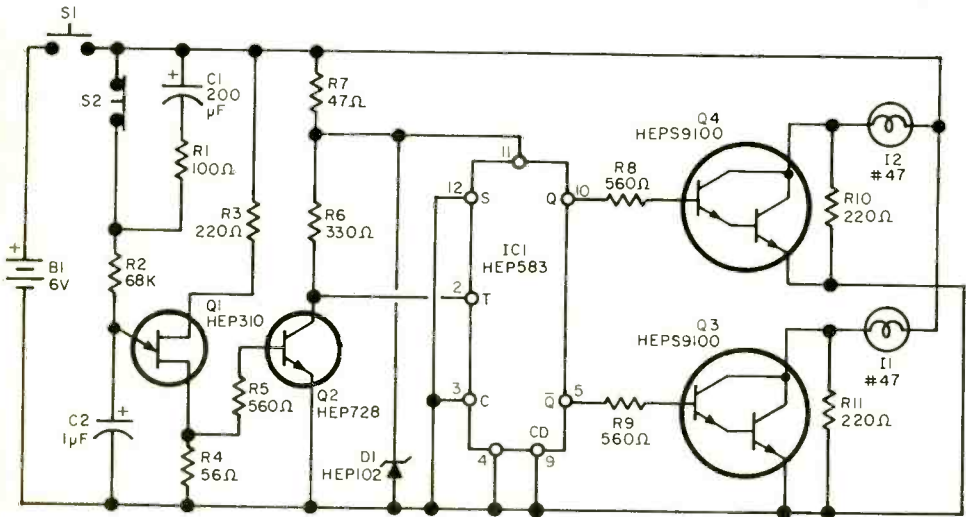

PARTS LIST

- B1—1.5-volt C cell (4 needed)
- C1—200- μ F, 15-volt electrolytic capacitor
- C2—1- μ F, 50-volt electrolytic capacitor
- D1—3.6-volt zener diode (HEP102)
- I1, I2—#47 lamp
- IC1—RTL JK flip-flop (HEP583)
- Q1—Unijunction transistor (HEP310)
- Q2—Transistor (HEP728)
- Q3, Q4—Dual transistor (HEPS9100)
- R1—100-ohm, $\frac{1}{4}$ -watt, 10% resistor
- R2—68,000-ohm, $\frac{1}{4}$ -watt, 10% resistor
- R3, R10, R11—220-ohm, $\frac{1}{4}$ -watt, 10% resistor
- R4—56-ohm, $\frac{1}{4}$ -watt, 10% resistor
- R5, R8, R9—560-ohm, $\frac{1}{4}$ -watt, 10% resistor

- R6—330-ohm, $\frac{1}{4}$ -watt, 10% resistor
 - R7—47-ohm, $\frac{1}{4}$ -watt, 10% resistor
 - S1—Sps normally open pushbutton switch (black)
 - S2—Sps normally closed pushbutton switch (red)
 - Misc.—Suitable chassis (Harry Davis 260) with cover, battery holders, lamp socket with lens (one red, one green,) mounting hardware, etc.
- Note—The following are available from Eljay Electronics, 1437 S. Main St., Tulsa, OK 74119: etched and drilled PC board for \$1.85; front panel cover, with black printing on gold and pressure-sensitive adhesive back for 80¢, postpaid.

Fig. 1. Decisions are made by random toggling of flip-flop through operation of S2.

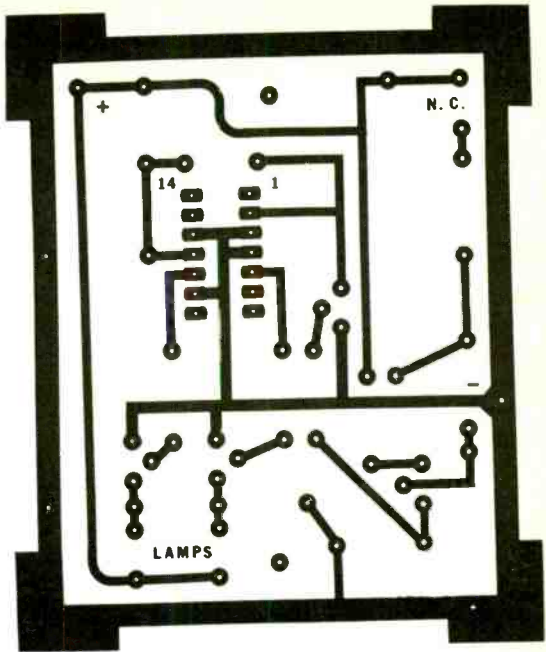
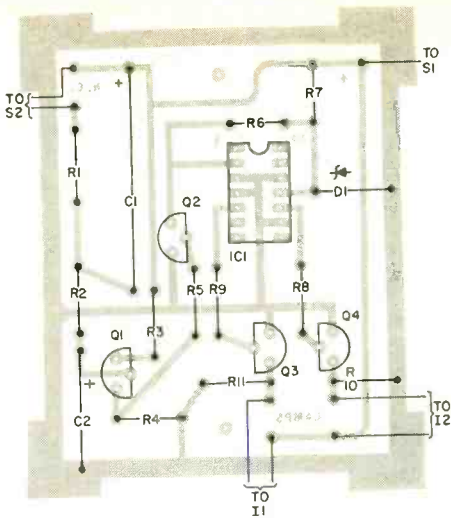

Fig. 2. Actual size foil pattern (at right) and component layout (above). Observe polarities on semiconductors.

How It Works. The heart of the circuit (Fig. 1) is *ICI*, a JK flip-flop whose outputs can be in one of two stable states: high or low. Each output controls a lamp driver (*Q3* or *Q4*) and since only one flip-flop output is positive at any one time, only one lamp can be lit at one time.

With pushbutton switch *S1* closed, UJT *Q1* operates as a conventional relaxation oscillator. This signal drives *Q2* into saturation, causing its collector voltage to drop at each pulse applied to its base. This negative-going pulse is used to toggle the flip-flop.

If *S1* is kept closed, and pushbutton switch *S2* is opened, capacitor *C1* starts to charge up and the voltage across *R2* is reduced. This lowers the charging current for timing capacitor *C2* and reduces the frequency of oscillation to the point where it stops. This is what provides the "decision."

Resistors *R10* and *R11* are used to reduce the stress on *Q3* and *Q4* and the filaments of *I1* and *I2*. This is necessary since the lamps have high inrush currents when cold; the resistors limit the current to about 20 mA.

Construction. Although any type of construction can be used, the best method is to fabricate a PC board using the foil pattern and component layout shown in Fig. 2.

Mount the board in a suitable chassis with the lights and pushbutton switches on the front panel as shown in the photograph of the prototype. Use different colored lenses for the lamps and for the pushbuttons.

The battery holders are mounted in the bottom of the chassis with short lengths of insulated wire to connect the PC board to the other components.

Operation. With *S1* depressed for some short interval of time, the two lamps should alternate. In this mode, the circuit is unable to make a decision. With *S1* still depressed, press *S2*. After a few moments, the two lamps will alternate slower and slower until, finally, only one lamp remains lit.

Is the output random? We asked the Decid-O-Tron that very question; and 50% of the time it said, "Yes." ♦

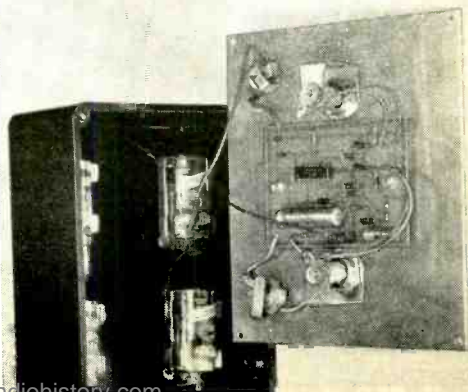

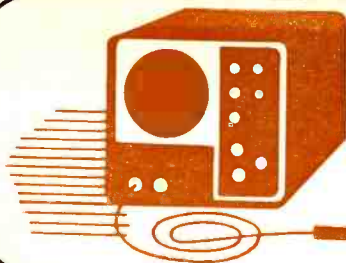

Test Equipment Scene

By Leslie Solomon, Technical Editor

SINE WAVES, and occasionally square waves, are of great use in the testing of audio gear. Having a good audio generator and a respectable scope, one usually assumes that the displayed sine-wave output of the audio generator can be used as a "standard" waveform on which all measurements can be based. But, is this always true?

In professional audio testing and circuit design labs, the distortion inherent in the test gear is usually well noted and accounted for in making analyses. But what of the typical technician who doesn't have the sophisticated gear whose distortion is known? He looks at the sine wave from his audio generator and, if it looks good, assumes that he has a reasonably distortion-free waveform. He may not be aware that the sine wave he is observing can have 2, 3, or even 5% distortion, yet may still look perfect.

How can you determine the quality of your sine wave without resorting to expensive test gear? Build the circuit shown in Fig. 1. You will recognize an op amp inverter with a capacitor input, which forms a differentiator. By differentiating a waveform, any inherent distortion can be seen immediately. Potentiometer *R1* has been added to adjust the high-frequency response, while the optional *R3* and *C3* are used to remove any ac component present in the noninverting input of the op amp. If simplicity is desired (without too much impairment of the results), just ground the

"+" input of the op amp. Optional capacitor *C2* is used if very low noise operation is desired. It can be left out for conventional use. The figure also shows how to calculate the low- and high-frequency cutoff points, if required.

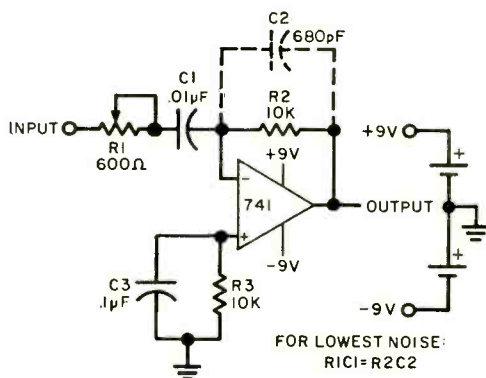

$$\text{HIGH FREQ. CUTOFF: } F_0 = \frac{1}{2\pi R1C1}$$

$$\text{LOW FREQ. CUTOFF: } F_1 = \frac{1}{2\pi R2C2}$$

FOR LOWEST NOISE:
R1C1 = R2C2

Fig. 1. Using op amp as differentiator.

Before trying out the circuit, first set up your audio sine-wave generator and a scope for the best viewable sine-wave display, preferably one or two cycles. If you have dual-trace capability, then use one channel to observe the generator output (differentiator input) directly, and the other channel to observe the output of the differentiator. With power applied to the differentiator and a sine wave input, you should see both sine waves on the scope. There will be some phase shift present, and this is normal.

Take a careful look at the original sine wave from the generator, then look at the differentiated waveform. As is well known, a differentiated sine wave is still a sine wave, but if the waveform is not precisely sine, any minute rate-of-change differences will be "boosted" by the active differenti-

Sine Waves & Scopes

ator. The adjustment of $R1$ will cause the distortion to be emphasized.

If you pass the generator waveform through an audio amplifier, then connect the differentiator between the amplifier output and scope (reducing the amplifier gain to prevent clipping), and compare the input sine wave with the output sine wave. You will see distortions you never thought existed in your amplifier. In some cases, this distortion cannot be detected by conventional means (see Fig. 2).

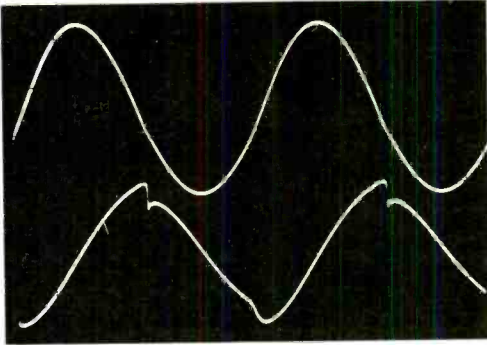

Fig. 2. Although upper waveform looks pretty good, after going through the differentiator, the distortion is accentuated as shown in bottom waveform.

For those who want to “calibrate” the differentiator, a source of approximately 1-kHz triangular waveforms is required as the input to the differentiator. When a triangular wave is differentiated, it results in a square wave. The rising edge of the triangle produces the top edge of the square wave, while the descending edge of the triangular waveform produces the bottom portion of the square wave. Adjust $R1$ for minimum overshoot, as you would a scope probe.

Now, if you use the triangular waveform as the input signal for the audio amplifier under test, couple the output of the amplifier to the differentiator and scope. You will note that any distortions of the input triangular wave produced by the amplifier will result in “notches” on the displayed square wave.

Further Thoughts on Scopes. We have had some mail asking questions about scopes, and this seems as good a time as any to clarify a few points.

The question usually asked is why two scopes with similar specs show somewhat different waveforms. Or, “Why doesn’t my

scope display the same normal waveform that the manufacturer shows in the manual for a particular piece of electronic gear?” Another common question is, “How much bandwidth do I really need in my scope?”

All these questions have to do with the scope’s vertical amplifier response characteristic. Although the specs state that the bandwidth of a particular scope is “dc to X MHz, ± 3 dB”, it doesn’t end there. It is what happens to the vertical amplifier response at its high end that tells the true response story. It is the “rolloff” on the curve that tells whether the scope will display those high-frequency transients properly. (Of course, the vertical amplifier response should not show any excessive bumps or dips.) Many scopes are specified to have their upper 3-dB point as a sine-wave response, but most signals have some steep edges.

The response curves of lab-grade scopes usually have a “Gaussian” rolloff, with the -3 -dB point approximately one-half of the -12 -dB frequency. This means that, if the scope specs show 5 MHz as the upper 3-dB point, the response at -12 dB should be at about the 10-MHz point. The closer you get to the Gaussian rolloff, the better the scope will display the correct waveform with those elusive high-frequency transients.

You can use a signal generator having a flat output to check how your present scope fits in. If you find that your scope has too fast an upper-end rolloff, then it probably uses peaking coils to extend the high end.

Some typical vertical amplifier response curves are shown in Fig. 3, and the effect of the peaking coils can clearly be seen. Just keep that smooth, gentle rolloff in mind, and you can’t go wrong. Note that the curve should have a reasonably flat top, within a couple of dB, to keep some frequencies from being amplified more than others and distorting the waveform.

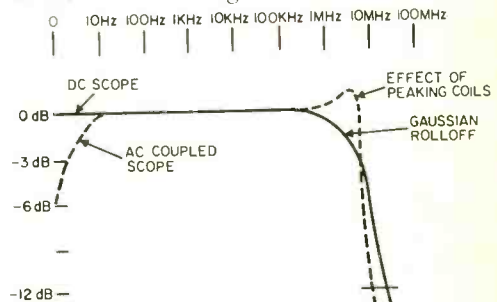

Fig. 3. Typical vertical amp responses.



another great
new idea

reversible ratchet handles

for Xcelite "99" tools



These two unique plastic (UL) handles extend the usefulness of all Xcelite Series "99" tools, make welcome additions to any "99" set.

Both regular (99-1R) and Tee (99-4R) types accept more than 60 individually available nut-driver, screwdriver, and special purpose snap-in blades to speed and simplify assembly and service work.

Fully enclosed ratchet mechanism is built to highest socket wrench quality standards. Recessed reversing shift operates at the flick of a thumb. Patented spring chuck holds blades firmly.

nationwide availability through local distributors

REQUEST BULLETIN N670

Made in U.S.A.

XCELITE

XCELITE, INC. • 20 BANK ST., ORCHARD PARK, N. Y. 14127
Send Bulletin N670 on Series "99" Reversible Ratchet
Handles.

name _____

address _____

city _____

state & zone _____

CIRCLE NO. 39 ON READER SERVICE CARD

There is also a relationship between the vertical amplifier response and the sweep speed. Keep some basic rules-of-thumb in mind. For instance, a 1- μ s period (time) equals a 1-MHz frequency. This means that if you want to display a single 10-MHz waveform on the screen, the sweep must take 0.1 μ s to span the trace. A 10-MHz scope having a 1- μ s maximum sweep speed means that you will see 10 waveforms on the sweep. Most triggered-sweep scopes are calibrated in terms of sweep speeds of so many seconds or microseconds per division of sweep trace. Obviously, the smaller the number (faster sweep), the higher the frequency that can be displayed as a single waveform. Many scopes are also provided with some form of expansion for even faster sweep speeds, making more detailed examination possible.

Another associated topic is that of rise time. The rise time of the vertical amplifier must be better (shorter) than the rise time

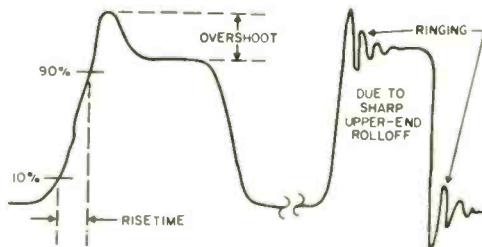

Fig. 4. Nomenclature of pulse parts.

of the signal being displayed. (Rise time, as shown in Fig. 4, is measured from the 10% to the 90% points of the waveform being observed.) For an error of 5% or less, the rise time of the scope should be about one third that of the signal being checked. To calculate your scope's rise time, if you know the high-frequency rolloff, use the equation $Tr = K/B$, where K is a constant (usually .35 for a pulse overshoot of 3% of the pulse peak amplitude), B is the upper-frequency -3-dB point in MHz, and Tr is rise time in microseconds.

Assume a scope response is 10 MHz at the upper -3-dB point. The rise time comes out to $0.35/10$ or 0.035, which is 35 nanoseconds. This then is the best rise time of this scope. With the one-third rule just mentioned, a waveform with a rise time of 105 nanoseconds is the fastest that can be displayed with a rise-time accuracy of 5 percent. ♦



Communications Scene

By Malcolm F. Parrish
Pearce-Simpson

IT WAS a long, hot summer in the city and the unrest in certain neighborhoods was paramount on municipal officials' minds. The mayor cruised in his car every evening so he could quickly arrive at any trouble spot. Fortunately, his rapport with inner city residents was good and he could talk down confrontations between irate street leaders and police before a full-blown riot could develop.

Tonight, the mayor tuned to the weather channel on the receiver in his car. He was hoping for a rain forecast because rain could keep the militants off the streets. But the forecaster was talking only of more sultry heat.

Suddenly, the forecast broke off in mid-sentence. "Signal 99! All units merge at the corner of North and 7th Streets," blared the receiver, "Large crowd. Have riot gear ready."

"Thank God for that priority override," thought the mayor. "I can get there before this situation erupts into something that can't be stopped without violence."

Arriving almost simultaneously at the scene were news media reporters and minority-group community leaders. All had scanners installed in their cars after the previous year's urban problems. All had set their "priority overrides" on the police

EDITOR'S NOTE

A scanner, or scanning receiver, is a fixed-tuned, crystal-controlled receiver that automatically tunes or scans through a number of fixed frequencies until it reaches a channel that is being used. The receiver then remains tuned to that particular channel as long as the transmission continues. Audio squelch is used to eliminate all noise from unused channels. The receiver is, of course, unsquelched when the signal comes in.

channel. Precious time had been gained in correcting a bad situation before the firebombs could be thrown. The press would have the actual story on the air within minutes to dispel the usual false rumors which could lead to trouble in other parts of the city. The false rumors tended to play up quickly broken-up confrontation situations turning them into large-scale riots—so the quick press coverage played a useful role.

This kind of application is only one of the reasons for the boom in scanner use across the country. The uses are tremendously varied. Boatmen find they add greatly, not only to their pleasure, but also to safety. In most boating areas, the National Weather Service transmits continuous marine weather information on a 24-hour-a-day basis on either 162.55 MHz or 162.40 MHz. Boatmen also like to listen to intership conversations (a good way to find out who's catching fish). They can monitor the calling and distress frequency, know if their yacht club is calling them, or listen to the local telephone company station; and do it all at the same time.

Scanners are also being used increasingly by Civil Defense officials, Citizen's Band

Scanners for Monitoring VHF & UHF

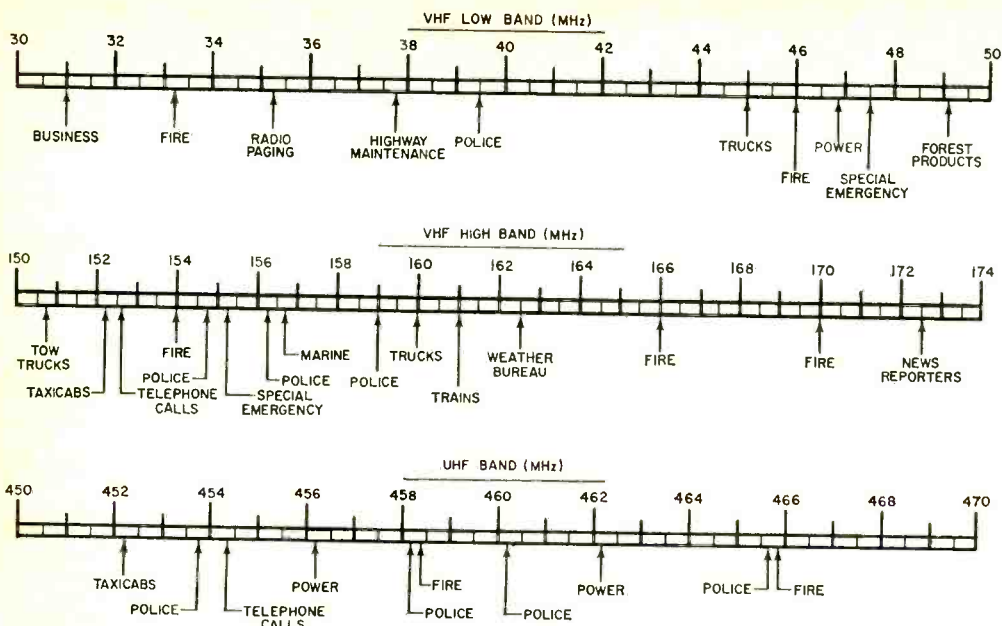

TYPICAL FREQUENCY ALLOCATIONS ON VHF AND UHF BANDS

operators, police and fire buffs, and others. They are a tremendous asset to such organizations as REACT and other public-service-minded groups.

Scanner manufacturers have done a good job in reacting to the requirements of this growing and diverse market. The first scanners to reach the market could cover only one of the three popular bands. The first units were either vhf low band (30 to 50 MHz) or vhf high band (150 to 174 MHz). Uhf (450 to 470 MHz) is getting more popular and so along came equipment to cover this exciting area.

Now, a new generation of scanners is making an appearance, units that cover two or even all three of the bands. The number of channels covered by the receiver is increasing too. For example, recently the Pearce-Simpson Division of the Gladding Corporation introduced a multiband unit with a 16-channel capability. An 8-channel capability is common.

Many New Features. As time has gone by, scanners have become more sophisticated with many more features. Yet, because of the increase in volume, pricing has stayed relatively stable or even gone

down. Single-band equipment is available, less crystals, for around \$125 and the multi-band gear is available for around \$160. Crystals are available for about \$6 each.

Many of the new features are obvious to the prospective user. Look for scanners with a priority channel, one to which the set will automatically return at your direction. For the fireman or policeman who wants to miss nothing on his frequency, yet hear what's going on elsewhere, this feature is a must.

Scanners switch automatically from one channel to another. Some units allow you to set the speed of the scanning as you desire and almost all have manual as well as automatic scanning. Another feature allows you to block out any channel simply by flicking a by-pass switch.

On the multiband gear, the ability to program the units is very important. Suppose you have an eight-channel scanner that covers high band and low band vhf. Obviously, you want to be able to set as many channels on each band as is desirable in your area. On some equipment this can be done by flicking a switch. On others you must move wires and on still others it is preset. Look for easy programming so the

unit you buy will meet your requirement, not someone else's.

Specifications Are Important. The good receivers have crystal filters. The result is that you hear the signal you want, and all the others are rejected. Look for specifications on sensitivity, selectivity, spurious rejection and adjacent-channel rejection. Good specifications mean equipment that does the job right.

When talking about scanners, the subject of antennas is important but often overlooked. Vhf and uhf are line-of-sight frequencies so the higher the antenna, the better performance you can expect. The little antennas that come with the sets do a surprisingly good job; but if you are on the fringe of a channel you want to hear, put an antenna on your roof and the signal will probably come booming in.

Today's scanners are very versatile when it comes to installation. They are all solid-state with very low power consumption. This also keeps down the size. Mounting brackets for installation in car, truck or boat are usually standard. To use at home, just plug into the ac line and away you go. Both ac and dc operation are common.

Perhaps the most common problem regarding scanners is finding out the frequencies to listen to. Your best bet is to ask your local dealer. If he is going to sell this equipment he's got to know what's going on in the area. Give him a chance and he'll put you in the know. ♦

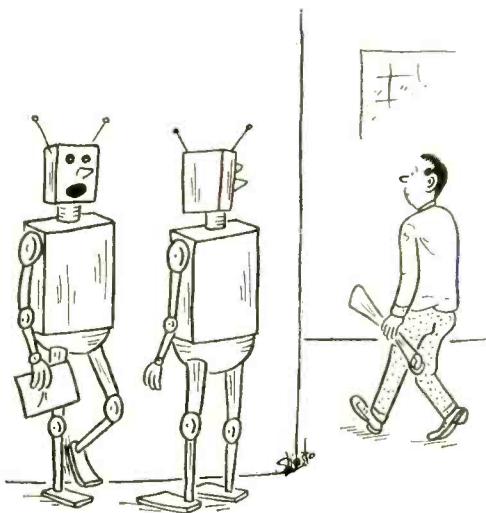

"It's OK, but don't expect too much—it's only made of fat, jelly, and water."

Introducing Pickering Headsets



**They make the difference for
those who can hear it.**

You will hear the difference the moment you put them on. For Pickering has engineered a remarkable difference into these fine headsets.

Their sound is unmistakably natural, imparting a fuller sense of realism to the music. And Pickering's attention to important details goes even beyond the electro-mechanical innovations which result in their extraordinary reproduction performance.

Nothing has been done in a perfunctory manner in the new Pickering headsets. Their matchless styling is the result of tasteful employment of color dynamics, making their appearance as impressive as their sound. They can be comfortably worn over long listening periods. From the natural conforming adjustable headband, to the softly comfortable ear cushions, right on down to the flexible heavy-duty plug—every detail is special with Pickering.

When it comes to headphones, however, words simply can't do it. Demonstration does. Put ours to the test against any other comparable units at your local dealer... you'll hear the difference.

ILLUSTRATED: Pickering Model PH-4955, a true two-way reproduction system with individual woofer and tweeter and L-C crossover network in each ear-piece. Frequency Response: 22-20,000 Hz. Hand-stitched foam-filled headband and ear cushions, coil cord and flexible heavy-duty plug. Only \$59.95. Also available, Model PH-4933, with single full-range speakers. Only \$39.95.

For complete information write Pickering & Co., Inc., Dept. PE, 101 Sunnyside Boulevard, Plainview, New York 11803.



PICKERING

"for those who can hear the difference"

CIRCLE NO. 25 ON READER SERVICE CARD

THE RECHARGEABLE ALKALINE BATTERY

NEW BATTERY OFFERS ECONOMY AND LONG OPERATING LIFE

BY SAMUEL C. MILBOURNE

THE RECHARGEABLE alkaline is a relatively new type of battery. Similar in construction to the regular alkalines (but marked "rechargeable"), these batteries have a potential of 25 or more recharges. They require no added electrolyte or water; and they are available in the conventional 1.5-volt D, C, and AA sizes.

The exclusive product of the Mallory Battery Co., the rechargeable alkaline should not be confused with nor can they be used to replace nickel-cadmium batteries. They can, however, be used for radios, cameras, toys, flashlights, portable TV receivers, record players, tape recorders, etc. Higher priced initially than carbon-zinc types, the rechargeable alkaline's cost, divided by the number of charges it can take, yields excellent overall economy.

Rechargeable alkaline batteries are sold fully charged and have a shelf life of two years or more. Charging should be done at frequent intervals and *always before they discharge below 1.2 volts*. If the output is allowed to drop to 0.9 volt, these batteries may suffer irreparable damage.

The AA, C, and D cells are sold two on a card and list for \$2.00, \$3.00, and \$3.50, respectively, for the pair. (Fortunately, there is usually a substantial trade discount.) The applicable charger lists at \$6.00. Specifications for the 1.5-volt battery types are listed in the Table.

Mallory is also making available a 6-volt version of the alkaline rechargeable battery.

Fig. 1. Simple test circuit for checking rechargeable alkaline batteries.

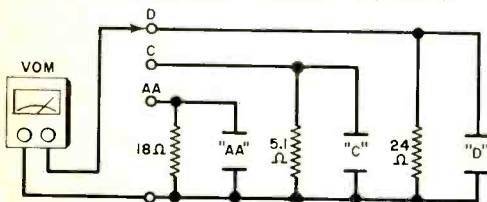

It is roughly 6" high and weighs 3½ pounds. It can furnish 2.5 amperes for 1½ hours. The recharge capacity of this battery is 7 A-hr and a maximum recharge rate of 600 mA. It has an internal 10-ampere fuse; so, use a 5-ampere fuse externally.

The rechargeable 6-volt battery is a natural for any type of portable or mobile application. Two in series can be used as a convenient bench supply for testing 12-volt solid-state mobile equipment.

The charging time for any battery can be estimated from the recharge capacity of the battery in ampere-hours (A-hr) multi-

| Type Number and Size | Recharge Capacity | Charge Rate 36 Hr. Max. | Charge Rate 16 Hr. Max. |
|----------------------|-------------------|-------------------------|-------------------------|
| SA15AA (AA) | 0.3 A-hr | 13.5mA | 27 mA |
| SA14C (C) | 1.0 A-hr | 40 mA | 80 mA |
| SA13D (D) | 2.0 A-hr | 80 mA | 160 mA |

plied by the percentage for recharge losses. For example, the SA15AA battery's recharge capacity is 0.3 A-hr. If this battery is recharged at 13.5 mA for 33 hours, this would result in 0.445 A-hr—or 50 percent extra, which is an average amount.

Charging rates for rechargeable alkaline batteries can be increased, thus decreasing the charging time required, if a voltage-limiting charger circuit is used. This would remove the battery electrically from the charging circuit when the desired voltage level is attained. However, if the previously stated rates and charging times (see Table) are used as a guide, or the maker's relatively simple charger is used, nothing more is needed except patience.

It is recommended that you make up some sort of chart to log all battery recharge times and dates. Make the charts small enough to be rubber-cemented or taped to the equipment in which the rechargeable alkaline batteries are used. Also,

it is a good idea to run periodic voltage checks on the batteries in use. You can assemble a simple battery tester by following the circuit shown in Fig. 1. The indicating device to be used with this test circuit is a simple VOM.

When should a battery be checked to determine if it is in need of a recharge? When the equipment in which it is used begins to malfunction—the receiver to distort, the record player to slow down, etc.—the batteries are ready for recharging. But you will obtain longer life from these batteries if you check them out and charge them more often. (Remember, NEVER recharge a new battery.)

One of the simplest battery chargers is an unregulated type, such as the Mallory Model BC-15 shown in Fig. 2. This unit will accommodate all three 1.5-volt cell sizes and charge them at the proper rates. The charger is very safe to handle. The step-down transformer is located in the line plug housing; so, no lethal or dangerous voltage levels appear in the charger itself.

The stepped-down voltage is supplied to two separate charging circuits through separate diodes, current-limiting lamps and dropping resistors. There are three current controlled circuits available to each of the



Fig. 2. Commercial battery charger accommodates all 1.5-volt cell sizes.

charging troughs. A clever device at the positive ends of the batteries makes contact with one of the three dropping resistors so that the proper charging current is applied to each of the three sizes. The current-limiting lamps are shown to the left of the batteries. One or both lamps lights up according to how the charger is loaded.

Three levels of light are noticeable, one for each battery type. The charging levels are 27 mA, 80 mA, and 160 mA for the AA, C, and D cells, respectively.

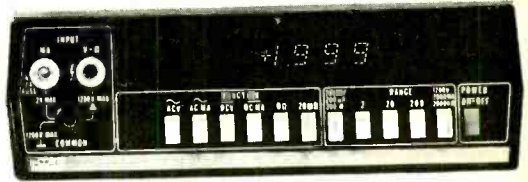

*New low cost digital multimeter \$299

- 26 ranges to measure ac/dc voltages from 100 microvolts to 1200 V, ac/dc currents from 100 nanoamperes to 2 amperes and resistance from 100 milliohms to 20 megohms.
 - Guaranteed to stay within specifications for one full year.
- Fluke gives you the best specs and strongest warranty on the market today for the lowest cost of ownership ever. • Wide choice of options including rechargeable battery pack, digital printer output, deluxe test leads, high-voltage probe, RF probe, 200-amp ac current probe, carrying case, dust cover and rack mounts. • Unique self-zero feature eliminates offset errors. • Rugged high-impact case with securely mounted internal electronics. • Service centers throughout U.S., Canada, Europe and Far East for 48-hour turnaround repairs.



P. O. Box 7428,
Seattle, Washington 98133.

Get all the details from your nearest Fluke sales office. Dial toll-free 800-426-0361 for address of office nearest you.

CIRCLE NO. 13 ON READER SERVICE CARD

AT LAST! PROFESSIONAL HOME PROTECTION EVERYONE CAN INSTALL AND AFFORD.

Model FC-100
\$69.95
WIRED

- Start your custom Burglar/Hold-up/Fire Alarm System with the FC-100. Add on Sensors, Alarms and Accessories to suit your own needs.
- "Do-it-Yourself" Installers Handbook included. No technical knowledge needed — No soldering.
- 100% Professional in Design, Reliability, Performance.



'Fail Safe'-SYSTEM BY EICO

A New Concept in "Do-it-Yourself" Home Protection

FREE 32 PAGE EICO CATALOG

For latest catalog on EICO Test Instruments, Stereo, EICOCRAFT Projects, Environmental Lighting, Burglar/Fire Alarm Systems, and name of nearest EICO Distributor, check Reader Service Card or send 25c for First Class mail service.



EICO, 283 Malta Street, Brooklyn, N.Y. 11207

CIRCLE NO. 41 ON READER SERVICE CARD

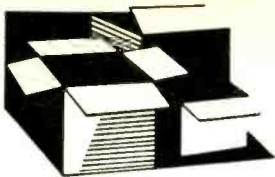

New Products

CEI TRANSISTOR CURVE GENERATOR

The Model TCG-1 transistor curve generator available from *Caringella Electronics Inc.* tests transistors and other semiconductor devices both in and out of circuit. Used with any oscilloscope, it displays the dynamic characteristics of npn and pnp bipolar transistors, FET's, MOSFET's and dual-gate MOSFET's, diodes, zener diodes, tunnel diodes, etc. The instrument contains all the circuits required to generate the base steps and collector sweeps. Unique features include: direct transistor beta readout; capability to consecutively test npn and pnp transistors without changing settings of controls or switches; and simultaneous calibration of the vertical and horizontal scope channels for accurate readings. The TCG-1 is available as a kit or factory wired.

Circle No. 70 on Reader Service Card

LAFAYETTE 4-CHANNEL SQ AMPLIFIER

Lafayette Radio Electronics' Model LA-64 4-channel amplifier features a built-in logical decoder for playing the new SQ discs and SQ FM broadcasts to reproduce encoded 4-channel sound. The SQ decoder section of the LA-64 has advanced logic/age circuitry to provide precise decoding of all SQ program material. The four power amplifiers also repro-



duce discrete 4-channel cartridge and reel-to-reel tape sources. Power output is 37.5 watts per channel, continuous, into 4 ohms. Lafayette's "Composer" circuit is also featured; it provides derived quadraphonic sound from present 2-channel stereo discs, tapes, and FM broadcasts and enhances monophonic material.

Circle No. 71 on Reader Service Card

MURA FET MULTIMETER

The Model FET-200 solid-state multimeter made by *Mura Corp.* has the latest in field-effect transistor circuitry. The outstanding feature of this

instrument is its precision 3 percent accuracy. Compact in size ($5" \times 3\frac{1}{2}" \times 1\frac{1}{4}"$) and weighing only 3 pounds, the FET-200 is battery powered and has all controls and jacks located on the front panel for easy accessibility. Input impedance is 10 megohms on all dc ranges. A new zero centering feature allows positive and negative potential readings without the need for changing test leads. Measuring capability is to 1 megohm in the resistance function, to 600 volts in both ac and dc.

Circle No. 72 on Reader Service Card

PIONEER COMPACT CARTRIDGE PLAYER

Small enough to fit in a glove compartment, Pioneer Electronics of America's Model TR-222 mini-8-track cartridge player features a



unique four-program vertical headshaft mechanism which provides precise tapehead contact and minimizes crosstalk. A shielded capstan provides trouble-free tape feed. Also included are automatic and manual track change; volume, tone, and balance controls; and track indicator lights.

Circle No. 73 on Reader Service Card

PEARCE-SIMPSON SSB CB TRANSCEIVER

Cheetah SSB from *Pearce-Simpson* represents a new plateau in mobile SSB/AM CB radio transceivers. It is the smallest mobile single-sideband unit on the market; yet it features the maximum 15 watts peak-envelope-power output allowed on SSB. Also, Cheetah SSB is the only mobile AM/SSB unit with an SWR bridge for checking antennas. Features include a variable r-f gain that controls both AM and SSB, plug-in microphone and power cords, and an S-unit/RF meter which changes color from transmit to receive.

Circle No. 74 on Reader Service Card

MICRONTA TUNE-UP ANALYZER

Following the trend among economy and ecology minded people for do-it-yourself tuneups, *Radio Shack* is offering a new tune-up analyzer which they say is accurate enough for professional use and easy enough for the home mechanic to handle. The Micronta Tune-Up Analyzer has a 6" color-coded scale for reading engine speed and dwell angle on any 4-, 6-, or 8-cylinder engine. Its voltage and current scales are used for indicating alternator or generator, regulator, diode, and battery conditions and provide a means of good/

bad point checks. The analyzer is designed for use in any 12-volt dc mobile electrical system.

Circle No. 75 on Reader Service Card
UTAH THREE-WAY SPEAKER SYSTEM

A striking appearance and a strong "big system" sound are the major features stressed by Utah Electronics for their new Model MP-3000 three-way speaker system. Finished in genuine walnut on all four sides, the system features a unique sculptured foam grille, acoustically more transparent than cloth, that adds eye appeal. The high-compliance 15" woofer has a 2"-diameter voice-coil and a 6½-pound magnet structure. Cloth edge rolls smooth the response of the 5" midrange speaker. Two dome tweeters with horn amplification assure efficient reproduction of highs over a wide dispersion angle. Separate controls for the midrange and tweeters are provided.

Circle No. 76 on Reader Service Card
LEADER TWO-CHANNEL AC MILLIVOLT METER

Audio signal quality of 4- and 2-channel stereo circuitry can be accurately and rapidly checked with the Model LMV-89 two-channel ac millivoltmeter from Leader Instruments Corp. Measuring range is 100 μ V to 300 V in 12 steps with ± 3 percent full-scale accuracy. Decibel scale readings are at 0 dB = 0.775 V and 1.0 V each over the entire range. The meter has an easy-to-read meter face and two independent scales with separate pointers. Each channel has separate switches and amplifier system to assure operation without crosstalk effect. Both channels operate separately or in common-mode on channel 2.

Circle No. 77 on Reader Service Card
KENWOOD DELUXE TUNER & AMPLIFIER

Kenwood has added a new pair of stereo components to their line of stereo amplifiers and tuners: the Model KA-6004 200-watt (DIF) direct-coupled amplifier and the matching Model KT-6005 AM/stereo FM tuner. Both are



designed for the audiophile who demands top performance. The integrated amplifier's pre-amp employs a new type of transistor for greater resistance to heat and humidity and boasts an excellent signal-to-noise ratio. The

equalizing stage has been designed to obtain an exceptionally wide dynamic range (420 mV peak-to-peak maximum input level at 1000 Hz) to assure that any fortissimo passage will be reproduced without overload distortion. The power amplifier and matching tuner have equally impressive features. Continuous power output is 40 watts per channel into 8 ohms.

Circle No. 78 on Reader Service Card
SANYO 4-CHANNEL MUSIC SYSTEM

Among ten new 4-channel music systems recently introduced by Sanyo Electric, Inc., is the Model DXR-5111 with a built-in decoder matrix circuit and four separate amplifiers. It comes complete with four speaker systems and an AM/stereo FM receiver. Tape recordings made in 2-channel stereo can be reproduced through the system in 4-channel stereo through the built-in 4-channel matrix circuit. The DXR-5111 is attractively priced for those who want to get acquainted with quadraphonic sound without making a large capital investment.

Circle No. 79 on Reader Service Card
CHRISTIANSEN RADIO MINI-MOUNTS

A new breadboarding technique has been developed for high-performance circuitry by Christiansen Radio Co. The new Mini-Mount breadboarding system consists of a variety of

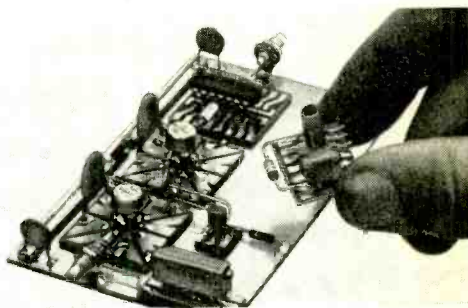

miniature etched patterns, each designed to mount an active or passive electronic component. No holes need be drilled since pressure-sensitive adhesive holds the elements firmly in place yet allows them to be moved or replaced as the circuit develops. Analog, digital, and r-f circuits (dc to the GHz region) can be effectively breadboarded using the Mini-Mounts. The Mini-Mounts are available as kits with a selection of types as used in general breadboarding work or in bulk when a particular type is required in volume.

Circle No. 80 on Reader Service Card
ROBINS 4-CHANNEL SYNTHESIZER

Stereo owners waiting for resolution of the battle of 4-channel systems can try quadraphonic sound with an inexpensive adapter from Robins Industries Corp. The adapter is actually a synthesizer which enables 2-channel material to produce 4-channel effects. It is

TUNER SERVICE

VHF, UHF, FM or IF Modules . . .

. . . All Makes

Fast **8** hr. Service!

1 YEAR GUARANTEE

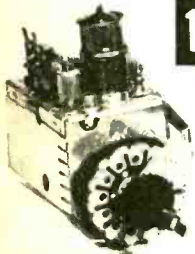

| | |
|------------|---------|
| VHF-UHF-FM | \$ 9.95 |
| UV-COMB. | \$16.95 |
| IF-MODULE | \$12.50 |

Major Parts charged at Net Price
P.T.S. is overhauling more tuners for more technicians than any other tuner company in the world!

LIKE TO DO IT YOURSELF?

Send one Dollar (redeemable) for our 60 Pages of top information

TUNER REPLACEMENT GUIDE AND PARTS CATALOG

For fastest service, send faulty tuner with tubes, shields and all broken parts to:

PTS ELECTRONICS, INC.

"Precision Tuner Service"



HOME OFFICE—
Box 272 • Bloomington, Ind. 47401 • Tel. 812. 824-9331
WEST—
Box 11354 • Sacramento, Calif. 95841 • Tel. 916. 482-6220
SOUTH—
Box 7332 • Longview, Tex. 75601 • Tel. 214. 753-4334
SOUTHEAST—
Box 6881 • Jacksonville, Fla. 32205 • Tel. 904. 389-9952
EAST—
Box 3189 • Springfield, Mass. 01103 • Tel. 413. 734-2737
MOUNTAIN—
Box 4245 • Denver, Colo. 80201 • Tel. 303. 244-2818
CIRCLE NO. 23 ON READER SERVICE CARD

POLY-PLANAR IS Double Knit Speaker Kits

Everything you need to make your own Hi-Fi speaker system. Includes modern-styled double-knit grille cloth, chrome frame, stand and 7/8" thin Poly-Planar



speaker. Ideal for desk top, shelf or floor. A great sounding speaker for 4-channel. Kits for 50 or 25 watts RMS. Send for detailed specifications.

The Speaker You Don't Have To See To Hear!

The Magitran Company

311 East Park Street • Moonachie, N. J. 07074

CIRCLE NO. 20 ON READER SERVICE CARD

a compact "black-box" affair which can be tucked away behind the amplifier or receiver with which it is used. Independent volume controls are provided for setting up left-rear and right-rear levels and balance.

Circle No. 81 on Reader Service Card

ARCHERKIT DELUXE CD IGNITION SYSTEM

Radio Shack recently introduced their Archerkit deluxe capacitive-discharge ignition system kit. The assembled system when properly installed is said to develop 50 percent more

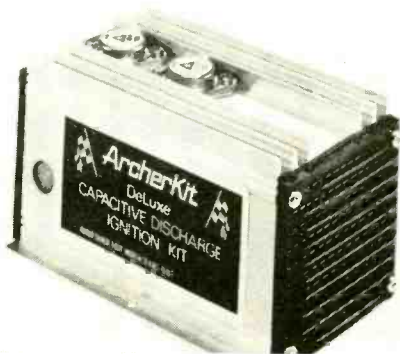

spark energy for more complete fuel combustion and to increase spark magnitude to 3 to 5 times normal for faster acceleration and quicker starts even in subzero weather. This system should reduce the need for tune-ups by increasing point and plug life from three to ten times and provide 10 to 20 percent better gas mileage. The system can be used with any 4-, 6, or 8-cylinder engine employing 12-volt negative ground electrical system.

Circle No. 82 on Reader Service Card

GENERAL RADIO STROBE LIGHT

The Model 1542-B "Strobotac" electronic stroboscope made by General Radio is said to provide 15 times the beam light output of previous models and does so without an increase in price or sacrifice in performance. At \$99, the 1542-B remains the most economical unit in GR's low-cost strobe line and still has the same 180-3800 flashes/minute range, simple operation, and rugged construction as its higher-priced counterparts.

Circle No. 83 on Reader Service Card

CHANNEL MASTER MATV ANTENNA SERIES

Channel Master Antenna Laboratories has announced a new MATV Super Vector Series. The 75-ohm antennas are designed to deliver superior front-to-back ratios, outstanding directivity, and stability. They deliver 25 dB minimum f/b ratios and provide maximum rejection of interference from unwanted channels with narrow beam widths and high directivity. Further, they provide excellent impedance matching as a re-

sult of their low VSWR's. Elements are 50% stronger than those of ordinary antennas, and all fittings and hardware are of stainless steel. Address: Channel Master, Ellenville, NY 12428.

NEW PLIER LINE FROM HUNTER TOOLS

Hunter Tools had announced a completely new plier line titled "Duradium." Duradium is the result of combining the finest quality alloy vanadium tool steel with a special heat treating method. All of the working surfaces are selectively induction hardened. Cutters are available in full flush, semi-flush, and regular styles; wiring pliers are available with finely serrated or smooth jaws with rounded edges. Address: Hunter Tools, 9674 Telstar Ave., El Monte, CA 91731.

CHEMTRONICS TUNER SPRAY KITS

Chemtronics is introducing the "Slim-Jim" Transfer Tuner Spray Kit, the newest innovation in tuner sprays specifically designed to meet the field servicing needs of servicemen. The Slim-Jim features a refillable concept. Bench-size cans of Tun-O-Wash, Tun-O-Brite, and Tun-O-Foam are packaged with a shirt-pocket-size can (the Slim-Jim). The large cans are used to fill the small can in about 30 seconds, providing the serviceman with enough tuner spray for 6-10 tuners, depending on how dirty the tuners are. No special attachments or gadgets are required for transferring chemicals

from the large cans to the Slim-Jim. Address: Chemtronics Inc., 1260 Ralph Ave., Brooklyn, NY 11221.

BITRAN DIGITAL READOUT MOUNTING KIT

The *Bitran Co.* recently introduced their Model R4T kit for mounting RCA "Numitron" digital readouts. The kit comes with a nonreflective front viewing window of red circularly-polarized material made by Polaroid Corp. which improves the appearance of the readout, a flat black bezel, tube sockets (4), chassis, all mounting hardware, and a panel cutout and drilling template. Readout tubes are not included. Address: Bitran, P.O. Box 4921, Columbus, OH 43202.

TESCOM PRECISION WELDING TORCH

A tiny torch which welds wires up to 0.002" and steel up to 16-gauge has been developed by *Tescom Corp.* Called the "Little Torch," it is ideal for heat bonding, welding, and soldering applications in all fields. It uses oxygen and a fuel gas such as acetylene, hydrogen, LPG, or natural gas to produce flame temperatures to 6300° F. Gas consumption rate is 0.023-2.54 cu ft/hr. Five different tips, designed to swivel a full 360° for handling ease, are supplied. The two smallest tips have sapphire jeweled orifices for durability and precision. Address: Instrument Division, Tescom Corp., 2633 S.E. 4th St., Minneapolis, MN 55414.

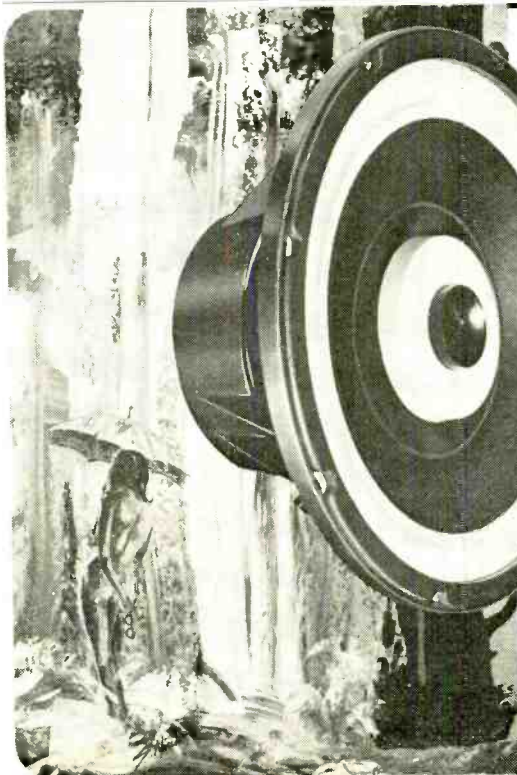

utah PRESENTS

Cascade

**MOST POWERFUL, MOST
EPIC PRODUCTION EVER!**

This is the one you will want to see and hear. It is the most powerful die-cast High Fidelity speaker series ever produced by Utah. Its name is CASCADE... the totally new co-axial speaker line. It has the largest magnets ever and larger voice coils to handle more power for a longer time. Cloth rolls enhance bass performance. The rigid die-cast frame is designed for maximum structural length, and it can be mounted to either the front or rear of the baffle board. Your choice of 2-way or 3-way models in 8" and 12" sizes, some with co-axially mounted compression tweeters. Your ticket to the powerful CASCADE performance can be hurried along by writing us for complete information.

utah

UTAH ELECTRONICS
HUNTINGTON, INDIANA 46750

CIRCLE NO. 37 ON READER SERVICE CARD

HOW WOULD YOU LIKE TO BUILD A BIG, BEAUTIFUL, SOLID STATE BELL & HOWELL 25-INCH COLOR TV YOURSELF...



...and maybe build
a whole new future while
you're at it?

Try it. Build this beaut of a color TV yourself. You'll enjoy the personal satisfaction—especially if you're already handy with a set of tools. And you'll pick up a pretty thorough knowledge of home entertainment electronics along the way.

Who knows? Maybe that's your bag. Maybe you'll find yourself enjoying the process of building your color TV as much as the end result. If you do, you've got a heck of a career opportunity waiting for you in a big, booming industry: home entertainment electronics. You might even end up with a business of your own in color TV servicing.

Fix stereo systems . . . FM-AM radios . . . phonographs . . . tape recorders

Even if you're not interested in a full time electronics career, you can earn extra money part time—or else just enjoy electronics as a hobby. With your new skills, you can build and service stereo hi-fi systems—including FM-AM radios . . . phonographs . . . open reel tape recorders and cassette or cartridge player/recorders. You could even build yourself a complete "home entertainment communications center"—complete with the new gadgetry of cartridge television when it comes out. The skills you build up by following this brand-new program are more than enough to service almost any type of home entertainment electronic device.

Not just a "kit"—a complete at-home learning program in home entertainment electronics systems

Don't confuse this program with an ordinary hobby kit. It's much more than that. It's a complete at-home learning program prepared by skilled instructors at Bell & Howell Schools. You're getting as much as the guy who's planning a lifetime career in electronics—even if you're not planning a career yourself.

Follow simple, step-by-step instructions

It doesn't matter if you've never had any training in electronics before. Nobody's going to start throwing "diodes" and "capacitors" at you right off. You start with the basics. You take it one step at a time. You walk before you run. And you'll be amazed at how quickly you start to feel comfortable with things that seemed complicated at the beginning.

Attend special "help sessions" if you like

In case you should run into a sticky problem or two—one that you can't handle on your own—come in and see us. We've scheduled help sessions every few Saturdays at the Bell & Howell Schools and in many other cities throughout the U.S. and Canada. Drop by. Meet an expert instructor in person. Talk over any rough spots with him—and with other students. You'll enjoy the chance to "talk shop".

Master the most up-to-date solid state circuitry

Solid state is here to stay. Not just color TV but almost every type of electronic device will eventually move farther and farther in the direction of total solid state circuitry. Get to know the most advanced "trouble-shooting" techniques for these sophisticated circuits. You'll find an almost irresistible demand for your skills.

Why you should know electronics

No matter where you look, the amazing technology of electronics is becoming a bigger and bigger part of the picture. More and more automotive parts and diagnostic instruments are electronic. Many large manufacturing plants are controlled almost entirely by electronic systems—in the hands of a few skilled

electronics technicians. The increasing use of two-way radio . . . the huge promise of cable television . . . the astonishing growth of electronic data processing all open doors to exciting new career opportunities for the man with thorough training in electronics. In fact, the day may come when the man who does *not* have electronics skills will be severely handicapped in many industries.

So maybe you're *not* planning a career in electronics. It still makes sense to get the kind of know-how that may turn out to be indispensable in a lot of other career areas—like medical research, broadcasting, engineering, business management, construction and many more.

Why you should get your training from Bell & Howell Schools

Skilled instructors at Bell & Howell Schools—carefully selected for their knowledge, experience and teaching ability—plan each program with the utmost care and attention. Each year, they spend over \$200,000.00 improving programs and materials and keeping them in step with new developments in electronics.

Many thousands of people have used their Bell & Howell Schools training as the foundation for new careers and businesses of their own in electronics. Even if all you want is an interesting hobby, you can hardly help becoming a skilled expert.

You build and keep the exclusive Bell & Howell Schools Electro-Lab®—a complete laboratory-in-the-home

To make sure you get practical experience with instruments used daily by professionals, in addition to the 25-inch color TV, you build and keep a Design Console, an Oscilloscope and a Transistorized Meter (see details at right). These are the three instruments you'll work with constantly—both during your program and thereafter.

CONSIDER THESE ADVANTAGES:

Help Sessions We've scheduled "help sessions" every few Saturdays at the Bell & Howell Schools and in many other cities throughout the U.S. and Canada. Top instructors give you expert guidance and you meet other students, too.

Resident Study After you complete your program, you can transfer to any of the resident schools for more advanced study, if you wish.

Lifetime National Placement Service When you complete your course, we help you locate a position in the field of Electronics that fits your background and interests. This unique service is available at any time after you graduate.

Veterans' Benefits We are approved by the state approval agency for Veterans' Benefits. Check the box for details.

Student Financial Aid We are an eligible institution under the Federally Insured Student Loan Program. Check the box for details.

Build yourself a big, beautiful, solid state Bell & Howell 25-inch color TV. It may be the start of something even bigger.



Detach postage-paid reply card below and mail today for free information about . . .

- **Solid state Bell & Howell 25-inch color TV** Ultra-rectangular 25-inch diagonal with full 315 sq. inch screen. Lets you view more of the transmitted image. 25,000 volts . . . 100 transistors . . . 72 diodes . . . 4 advanced IC's . . . 3-stage solid state IF . . . solid state VHF, UHF tuners . . . automatic fine tuning and many other quality features.
- **Design Console** Use this to rapidly "breadboard" circuits without soldering. Equipped with built-in power supply . . . test light . . . speaker . . . patented plug-in modular connectors.
- **Oscilloscope** Portable 5-inch wide-band oscilloscope offers bright, sharp screen images . . . calibrated for peak-to-peak voltage and time measurements . . . 3-way jacks for leads, plugs, wires.
- **Transistorized Meter** Combines most desired features of vacuum-tube voltmeter and quality multimeter. Registers current, voltage and resistance measurements on a large, easily-read dial. Features sensitive, 4-inch, jewel-bearing d'Arsonval meter movement.

For Free Information, Mail Card Today!

If card has been removed, write:

DEVRY INSTITUTE OF TECHNOLOGY

ONE OF THE



BELL & HOWELL SCHOOLS

4141 Belmont, Chicago, Illinois 60641

332R2

(TV kit not available in Canada)

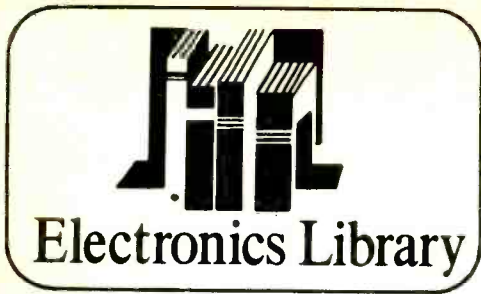

DIGITAL ELECTRONICS: PRINCIPLES AND PRACTICES

by Brice Ward

For those people who like to learn by building, we can recommend this book on digital electronics which treats equally with theory and practice. It is composed of three main sections: theory, experiments, and kits. The chapters on theory are followed by experiments which parallel the explanations, providing a reinforcement pattern which makes for easy learning. In addition to explaining and showing how each digital function and device operates, the text also goes into the various numbering systems, building-block approaches to digital systems, and how to put together various digital elements to obtain counters, encoders and decoders, registers, etc. Three appendices and a glossary are provided.

Published by Tab Books, Blue Ridge Summit, PA 17214. 288 pages. \$8.95 hardbound, \$5.95 softbound.

SOLID-STATE ELECTONICS

by George B. Rutkowski

Today's electronics technician, often called an associate engineer, is expected to assume many responsibilities formerly delegated to engineers. Consequently, he must have more than a passing knowledge of solid-state components and theory. This new book was written to help meet that objective. The author discusses the fundamentals and develops the student's ability to select proper design components for solid-state electronics. A modified programmed style is used, and each point discussed is followed by at least one worked-out example. The problems, with examples, make this book an excellent study guide for both classroom and self-study use.

Published by Howard W. Sams & Co., Inc., 4300 West 62 St., Indianapolis, IN 46268. Hard cover. 616 pages. \$15.50.

RADIO CONTROL FOR MODEL BUILDERS, Revised Second Edition

by F. M. Marks & W. Winter

The text in this book encompasses the latest innovations in the rapidly growing hobby of radio control for modelers. All phases of this

fascinating subject are covered, including transmitters, receivers, and actuators; and the various types of batteries are evaluated. Special emphasis is placed on the most advanced method of radio control which makes use of the digital proportional technique. Helpful features include information on licensing requirements, a list of R/C modeling magazines, and a complete glossary of radio-control terms.

Published by Hayden Book Co., Inc., 116 W. 14 St., New York, NY 10011. Soft cover. 160 pages. \$4.45.

CALCULUS FOR ELECTRONICS, Second Edition

by A. E. Richmond

The elements of differential and integral calculus as applied to electrical and electronic circuits are presented in this textbook. It covers basic calculus, partial derivatives, double integrals, infinite series, and introduces differential equations. Included in the new edition are problems on semiconductor device characteristics. Special features include the reorganization of early chapters to improve the presentation, greatly expanded graphs, and review questions with answers to all odd-numbered problems. The appendix briefly treats trigonometric identities, certain curves from analytic geometry, and determinants.

Published by McGraw-Hill Book Co., 330 West 42 St., New York, NY 10036. Hard cover. 544 pages. \$9.95.

CONFIDENTIAL FREQUENCY LIST

by Robert B. Grove

This first major compilation of AM, CW, SSB, RTTY, and FAX non-broadcast stations made available to the general public is a who's who of unusual radio stations. Frequencies, call-signs, locations, schedules, and radiated power are given for thousands of radio stations operating between the broadcast and ham bands from 12 kHz to 27,240 kHz. Revealed are radio frequency and call-sign information heretofore kept under wraps, such as Interpol, CIA, RTTY Press, USAF Global Aero, Spy and Number stations, radiobeacons, weather broadcasters, AMVER, Flying Doctor Service, foreign embassy networks, hurricane hunters, and many more.

Published by Gilfer Associates, Inc., P.O. Box 239, Park Ridge, NJ 07656.

AUTOMOTIVE ELECTRONICS

by Graf & Whalen

A complete list of all applications of electronics to be found in a modern automobile would surprise the average car owner by its length. The list has grown steadily as car manufacturers continue to add new features and to improve the old. Presented in this book is a complete picture of mobile electronics develop-

DUAL BAND VHF/UHF LF/VHF 10 CHANNEL FM MONITOR RECEIVERS



- ★ Dual Channel non-restrictive programming of channels allows any combination of preselected channels to fit your needs
- ★ Priority channel-locks out all other signals
- ★ Any channel may be switched out of scanning sequence
- ★ Carrier Delay—You may hear mobile callbacks

A sophisticated professional automatic scanning monitor with the most reliable circuitry ever conceived. Has more power, more audio and more features than other monitors. New ceramic filter provides excellent adjacent channel operation in urban areas. All solid state. 2 watts of "Voice Fidelity," easy access plug in crystals. Dual purpose power supply for 117VAC and 12VDC, negative ground only.

designed for:

- Police, Fire and Municipal Depts.
- County, State & Federal agencies
- Commercial & Industrial applications
- Other unlimited uses

FR-2526 VHF/UHF **189⁹⁵**

FR-2528 LF/VHF

FR-2525—UHF only \$179.95

Comes with AC and DC power cables, mounting bracket, less crystals. Crystals \$5.00 ea.

SONAR RADIO CORP., 73 Wortman Ave., Bklyn, N. Y. 11207

Please send information on SONAR-SCAN FM Monitor Receivers.

Name _____ Dept. 800

Address _____

City _____ State _____ Zip _____

CIRCLE NO. 32 ON READER SERVICE CARD

ment, starting with an account of the invention of the "self-starter," progressing through present-day accomplishments, and projecting into the future when computer control of cars and traffic safety features may become commonplace. The book is well illustrated with photos, drawings, and schematics and is quite comprehensive in its coverage.

Published by Howard W. Sams & Co., Inc., 4300 West 62 St., Indianapolis, IN 46268. Soft cover. 320 pages. \$6.95.

UNDERSTANDING AND USING COMMUNICATIONS RECEIVERS

by John Schultz

Professional help on buying, installing, and using communication receivers are offered in this new book. A semi-technical approach is used to help the reader become knowledgeable about receivers so that he can choose equipment best suited to his needs. Included are a study of the electromagnetic spectrum, how radio waves are propagated, and the obstacles and disturbances which affect reception. Various types of receivers are analyzed, including new, kit, and surplus types.

Published by Tab Books, Blue Ridge Summit, PA 17214. 192 pages. \$7.95 hard cover; \$3.95 soft cover.

TRANSISTOR AND INTEGRATED ELECTRONICS, Fourth Edition

by Milton S. Kiver

An extensive revision of the author's earlier "Transistors" book, this new volume covers the theory and application of solid-state devices and integrated circuits. Written expressly for vocational students, it contains a minimum of mathematics at the elementary algebra level. This updated edition contains three totally new chapters on FET's, IC's, and semiconductors used in computers.

Published by McGraw-Hill Book Co., 330 West 42 St., New York, NY 10036. Hard cover. 704 pages. \$12.50.

ABC'S OF INDUSTRIAL ELECTRONICS

by J.A. Wilson

This easy-to-understand book analyzes the field of industrial electronics from a career point of view rather than on a deeply technical level. It explains how industries use electronics to control machines and manufacturing processes, some difficult—if not impossible—to control by old-time manual methods.

Published by Howard W. Sams & Co., Inc., 4300 West 62 St., Indianapolis, IN 46268. Soft cover. 96 pages. \$3.95.

FREE McIntosh CATALOG and FM DIRECTORY

Get all the newest and latest information on the new McIntosh Solid State equipment in the McIntosh catalog. In addition you will receive an FM station directory that covers all of North America.



MX 114 FM/FM STEREO TUNER and STEREO PREAMPLIFIER

CIRCLE NO. 19 ON READER SERVICE CARD

SEND TODAY!

McIntosh Laboratory Inc.
2 Chambers St., Dept. PT-1172
Binghamton, N.Y. 13903

NAME _____

ADDRESS _____

CITY _____ STATE _____ ZIP _____

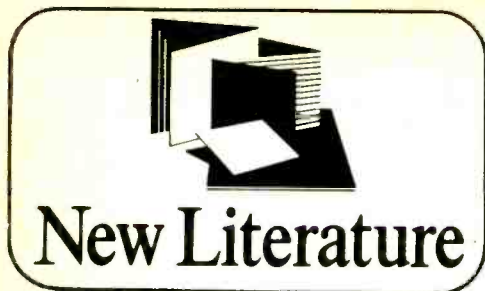

SUPREME PUBLICATIONS MASTER INDEX

Just issued by *Supreme Publications* is their Master Index covering all of the company's existing monochrome and color TV receiver manuals and radio receiver manuals back to the 1926-1938 issue. The index is a great convenience in looking up material in Supreme manuals, determining the year of manufacture of a model, or comparing chassis and model numbers. Hints on the use of diagrams as a service aid are also given. For a copy of the Index, send 50¢ to: Supreme Publications, 1760 Balsam Rd., Highland Park, IL 60035.

CORNELL ELECTRONICS CATALOG

Cornell Electronics Co. has just published a 48-page catalog which lists vacuum tubes, hi-fi equipment and systems, multimeters, etc. All entries are fully described and are accompanied by prices. In a separate 2-page section are listed books devoted to troubleshooting and repair of, radio and color and monochrome TV receivers, appliance repair, and fundamentals of transistors. Address: Cornell Electronics Co., 4217 University Ave., San Diego, CA 92105.

ARCHER TRANSISTOR SUBSTITUTION GUIDE

The new Archer Transistor Substitution Guide available from *Radio Shack* lists 15,000 commercial transistor types which can be directly replaced or substituted for by one of 29 Archer transistors. Detailed specifications and electrical characteristics for each of the 29 transistors are given. The 96-page publication also contains useful information on the care and handling of transistors, details on testing, and important suggestions on the use and replacement of transistors. For a copy of the Guide, send \$1.00 to: Radio Shack, 2617 W. Seventh St., Fort Worth, TX 76107.

SBE CB EQUIPMENT BROCHURE

Available from *SBE* is a fold-up brochure which lists and describes the company's Trinidad, Catalina, Capri, Coronado, and Cascade II base station, mobile, and portable AM CB transceivers; Console, Sidebander II, Superconsole SSB/AM base station and mobile transceivers; and accessories. Accessories listed include an SSB/AM desk-type dynamic microphone, an ac power supply, a power supply/charger, and a voice-

operated relay (VOX). Address: SBE Linear Systems, Inc., 220 Airport Blvd., Watsonville, CA 95076.

BIRD SHORT-FORM CATALOG

The new 4-page short-form catalog (No. SF-72) lists all standard and a dozen new coaxial load resistors, absorption wattmeters, r-f attenuators, and coax switches stocked by *Bird Electronic Corp.* Listed for the first time is the Model 4370 broadband, wide-range Thruline® r-f wattmeter as well as transmitter monitor/alarms and panel-mounted wattmeters. In addition to basic performance specifications and prices, SF-72 also describes custom-built accessories and the new air-cooled r-f systems terminations without fans or water introduced at the IEEE and NAB shows. Address: Bird Electronic Corp., 30303 Aurora Rd., Cleveland (Solon), OH 44139.

EIA CONSUMER ELECTRONICS ANNUAL

The 1972 "Consumer Electronics Annual," detailing facts and figures relating to the production, distribution, and sales of the industry's products has just been published by the Consumer Electronics Group of the *Electronic Industries Association*. In addition to providing factual information on the industry for the past year, this compact booklet describes the development of the industry over its 52-year history. Per-copy price is 50¢; quantity discounts available. Address: Consumer Electronics Group, Electronic Industries Association, 2001 Eye St., N.W., Washington, DC 20006.

BLAKESLEY ELECTRONICS PC BROCHURE

A new service, providing one-of-a-kind and short production runs of printed circuit boards from your own etching guides, is described in a four-page brochure from *Blakesley Electronics*. It also explains how, using artwork supplied by the company, your positive etching guide layout is converted into a semi-finished (undrilled) or finished ready-to-go PC board. Address: Blakesley Electronics, Box 686, Syracuse, IN 46567.

NBS METRIC CONVERSION CHART

The National Bureau of Standards has prepared a handy pocket metric conversion card which contains the minimum data needed for converting from customary to metric units of length, area, volume, mass (weight), and temperature. A centimeter scale is along one edge of the plastic card, an inch scale along the other. A direct readout scale for °C/°F is also given. All numbers are stated to two-place accuracy, sufficient for most needs. Cards are available at 10¢ each (\$6.25 per hundred) as SD Cat. No. C13.10:365 from: Superintendent of Documents, U.S. Government Printing Office, Washington, DC 20402, or from local U.S. Department of Commerce Field Offices.

SALE

Surplus Scene

By Alexander W. Burawa, Associate Editor

A REALISTIC LOOK AT THE MAIL-ORDER BUSINESS

MANY readers doing business on the Surplus Scene for the first time or on very rare occasions have aired peevish in the mail we receive. One of these is the "unusually long" wait that seems to exist between sending in an order and receiving the ordered parts and/or equipment. Another is the dealers' so-called habit of making substitutions for parts ordered.

Let us deal with the lag situation first. When one deals through the mails, it must be expected that there will be a time lag of two or more weeks between the time an order is placed and the receipt of the merchandise ordered. This time lag depends on a number of factors. Beyond the dealers' control are the distance that separates him from the customer, the manner in which the filled order must be shipped, and the class of mail the customer uses when sending in his order. For small parts, regular Parcel Post is most often used by the dealer to ship out orders. For bulk items like transmitters, modulators, and receivers, the dealer usually ships via express or motor freight. The postal priorities for delivery are based on the class of mail used. Express and motor freight companies have similar priorities based on the type of handling specified.

There are some in-company lags with which the customer must contend. Orders are usually processed on a first-come-first-served basis. Should your order arrive at a time when the dealer is deluged with orders, it may take several days before it is processed. Too, if stocks of particular items have been exhausted, the dealer might have to place your order in the back-order file. All told, most reputable dealers make every effort to make the time lag short.

Many surplus dealers still have to guard against deadbeats who send in checks with their orders without having funds in the bank to back up their checks. If the dealer ships merchandise before a check clears the bank, he can be left holding the bag. So, for any order involving about \$25 or more, give the dealer a break by figuring in the time it will take for your check to clear your bank. If you are in a real hurry to obtain your merchandise, pay for your order with a postal or a bank money order, both of which are as good as cash. *Never send cash.*

And now for peeve number two. Be forewarned that most surplus *parts* dealers do ship substitutes for items ordered that are no longer in stock. This is especially true of solid-state components like transistors, diodes, and IC's. In the great majority of cases, however, the substitute parts will be identical or very similar in operating performance to those you specify. If you do not want substitutes, so state on your order form; most dealers will comply with your wishes. The substitution policy, incidentally, does not apply to equipment orders. You either get the VTVM, transmitter, oscilloscope, receiver, or tube tester you order or your money is refunded.

Grab-bag specials on assorted parts can put you way ahead. Bear in mind, however, that these specials are primarily of use only if you are building up a spare parts inventory to use in experimenting. The same applies to those surplus PC board and card assemblies you see offered. Do not rely on a grab-bag special of assorted parts to yield a specific part called for in a project; if you do, you will likely come out the loser. When you need a specific part, order that part. ♦

ELECTRONICS MARKET PLACE

NON-DISPLAY CLASSIFIED: COMMERCIAL RATE: For firms or individuals offering commercial products or services, \$1.50 per word (including name and address). Minimum order \$15.00. Payment must accompany copy except when ads are placed by accredited advertising agencies. Frequency discount: 5% for 6 months; 10% for 12 months paid in advance. **READER RATE:** For individuals with a personal item to buy or sell, \$1.00 per word (including name and address.) No minimum! Payment must accompany copy. **DISPLAY CLASSIFIED:** 1" by 1 column (25 $\frac{5}{8}$ " wide), \$185.00. 2" by 1 column, \$370.00. 3" by 1 column, \$555.00. Advertiser to supply cuts. For frequency rates, please inquire.

GENERAL INFORMATION: First word in all ads set in bold caps at no extra charge. All copy subject to publisher's approval. All advertisers using Post Office Boxes in their addresses **MUST** supply publisher with permanent address and telephone number before ad can be run. Closing Date: 1st of the 2nd month preceding cover date (for example, March issue closes January 1st). Send order and remittance to Hal Cymes, **POPULAR ELECTRONICS** Including **ELECTRONICS WORLD**, One Park Avenue, New York, New York 10016.

FOR SALE

FREE! bargain catalog. Fiber optics. LED's, transistors, diodes, rectifiers. SCR's, triacs, parts. Poly Paks, Box 942, Lynnfield, Mass. 01940.

GOVERNMENT Surplus Receivers, Transmitters, Snooperscopes, Radios, Parts, Picture Catalog 25¢. Meshna, Nahant, Mass. 01908.

ROCKETS: Ideal for miniature transmitter tests. New illustrated catalog. 25¢. Single and multistage kits, cones, engines, launchers, trackers, rocket aerial cameras, technical information. Fast service. Estes Industries, Dept. 18-C, Penrose, Colorado 81240.

LOWEST Prices Electronic Parts. Confidential Catalog Free. **KNAPP**, 3174 8TH Ave. S.W., Largo, Fla. 33540.

ELECTRONIC PARTS, semiconductors, kits. **FREE FLYER**. Large catalog \$1.00 deposit. **BIGELOW ELECTRONICS**, Bluffton, Ohio 45817.

WE SELL CONSTRUCTION PLANS. TELEPHONE: Answering Machine, Speakerphone, Carphone, Phonevision. Auto Dialer, Touch Button Dialer, Central Dial System. **TELEVISION:** \$35.00 Color Converter, Video Tape Recorder. \$25.00 Camera. **HOBBYIST:** Electron Microscope, 96 Hour Tape Music System, Ultrasonic Dishwasher, Radar-Oven. Plans \$4.95 each. **NEW ITEM:** \$75. Electronic Pocket Calculator, \$7.50. **COURSES:** Telephone Engineering \$39.50. Detective Electronics \$22.50, Integrated Circuit Engineering, \$49.50. **NEW SUPER HOBBY CATALOG** plus year's subscription to Electronic New Letter **AIRMAILED \$1.00**. Don Britton Enterprises, 6200 Wilshire Blvd., Los Angeles, Calif. 90048.

RADIO—T.V. Tubes—36¢ each. Send for free catalog. Cornell, 4213 University, San Diego, Calif. 92105.

CONVERT any television to sensitive, big-screen oscilloscope. Only minor changes required. No electronic experience necessary. Illustrated plans. \$2.00. Relco-A33, Box 10563, Houston, Texas 77018.

MECHANICAL, ELECTRONIC devices catalog 10¢. Greatest Values—Lowest Prices. Fertik's, 5249 "D", Philadelphia, Pa. 19120.

SENCORE, B&K Test Equipment Unbelievable Prices. Free Catalog and Price Sheet. Fordham Radio, 265 East 149th Street, Bronx, N.Y. 10451.

ELECTRONIC Ignition. Various Types. Information 10¢. Anderson Engineering, Epsom, N.H. 03239.

METERS—Surplus, new, used, panel or portable. Send for list. Hanchett, Box 5577, Riverside, CA 92507.

PYROTECHNICAL chemicals, casings, tools, supplies, fuse, literature. Giant, illustrated catalogue/handbook includes formulas, instructions—50¢, with samples—\$1.00. Westech, Box 593, Logan, Utah 84321.



GREGORY ELECTRONICS
Reconditioned & Used
FM 2-WAY RADIO SAVINGS
Partial List—Send for New Catalog

GENERAL ELECTRIC Voice Commander III
FULLY SOLID STATE FM
Transmitter-Receiver

132 to 174 MHz
1 WATT OUTPUT
 $\frac{1}{2}$ MICRO-VOLT SENSITIVITY
Size: 9.5" x 5.3" x 1.7"

High performance, completely self-contained two-way FM radio. Compact, lightweight, easily operated and hand-carried. Housed in high-impact 2-section case. All external hardware polished stainless steel.

Proper charges available separately. \$15. each.



\$148.

Lots of 5
less 10% . . . \$133.20
Lots of 10
less 15% . . . \$125.00

Includes rechargeable nickel cadmium battery pack and charger. (Crystals & tuning, add \$50.)

PROGRESS LINE STRIPS
These strips are physically complete, but are sold on an as-is basis only.

| | | | | | |
|--|------------------------------------|-------|-------|-------|-------|
| Power supply, 30 watts, less vibrator | MA E13 MA E16 MA E33 MA E36 MA E42 | \$20. | \$20. | \$20. | \$20. |
| Power supply, 60 watts, less vibrator | | \$25. | \$25. | | |
| TX barrow hand | | | | | |
| 1088 final tubes | | | | | |
| Note: MA E12 wide band | \$18. | \$25. | \$25. | \$30. | \$12. |
| RX wide band | \$18. | \$18. | \$18. | \$18. | \$12. |
| 14" Progress Line Case, consisting of front basket and front plate with lock | | | | | \$10. |
| Low band dual front end, 2 freq. RX strip | | | | | \$20. |

GREGORY ELECTRONICS CORP.
249-F Rt. 46, Saddle Brook, N.J. 07667
Phone: (201) 489-9000

CIRCLE NO. 15 ON READER SERVICE CARD

BUILD YOUR OWN SPACE-AGE TV CAMERA



ONLY KNOWN SOLID-STATE CAMERA KIT! Ideal for experimenters, home, education, industry, etc. * High quality * Backed by over six years of lab & field testing * Fully Guaranteed * Converts to any TV set without modification * Step-by-step construction manual * Model XT-1A, Series D complete with vidicon \$149.50 post-paid anywhere in USA & Canada (less vidicon kit \$110.35pp)

PHONE or WRITE for CATALOG.
DIAL 400-887-9711

Many other kits, parts and plans available including stereo kits, focus-dial, coils, vidicon tubes, conn. plans, audio subcarrier kit, etc.

1301 BROADWAY ATV Research DAKOTA CITY, NEBR. 68731

ELECTRONIC COMPONENTS—Distributor prices, Free catalog. Box 2581, El Cajon, California 92021.

ANTIGRAVITY, experiment and theory, Rushed—\$2.00. U.S. Inquiries. Intertech 7A2, Box 5373, Station-F, Ottawa, Canada.

JAPAN HONG KONG DIRECTORY. World products information. \$1.00 today. Sekai Shogyo Annai, Hillyard, Washington 99207.

EUROPEAN and Japanese bargains catalogs. \$1 each. Dee, P.O. Box 9308, North Hollywood, Calif. 91609.

BURGLAR Alarm Systems equipment, dealers and private. Write: United Security, Box 2428, Dublin, Calif. 94566.

GET "Music Only" FM Programs. SCA Adaptor fits any FM tuner or receiver. Free list of stations with order. Kit \$14.50 (with Squeelch \$19.50) Wired and Tested \$25.00 (with Squeelch \$29.95). All plus postage and insurance. Thousands Sold. SWTPC, Box E32040, San Antonio, Tex. 78284.

FREE Catalog. Parts, circuit boards for Popular Electronics projects. PAIA Electronics, Box C14359, Oklahoma City, OK 73114.

FREE Kit Catalog: Shortproof powersupply \$39.50. Ultrasonic Alarm \$37.25. SWTPC, Box B32040, San Antonio, Tex. 78284.

FIRE & BURGLAR ALARMS

1972 Handbook & Catalog

Save Hundreds of Dollars



Learn the cost of Professional Alarm Equipment. Know how it is installed. Discover how you can save Hundreds-Of-Dollars by installing your own system. See the latest in technology such as **LASER BEAMS, INFRARED BODY HEAT DETECTORS and ELECTRONIC SIRENS.** 1972 "Handbook & Catalog", 84 pages, just \$1.00 postage and handling. \$1.00 is credited to first order.

ALARM COMPONENT DISTRIBUTORS

33 New Haven Ave., Dept. P.E., Milford, Conn. 06460

FREE Kit Catalog: Color Organs \$11.00. Psychedelic Strobes \$17.50. Professional quality-lowest prices. SWTPC, Box F32040, San Antonio, Tex. 78284.

TEST EQUIPMENT, Aerospace-Laboratory Grade. Request your needs; will mail appropriate catalogs (we have 24 catalog categories). Only for Engineers, Businesses, Schools and advanced Technicians. Goodheart, Box 1220PE, Beverly Hills, Calif. 90213.

AMATEUR SCIENTISTS, Electronics Experimenters, Science Fair Students . . . Construction Plans—Complete. including drawings, schematics, parts list with prices and sources . . . Robot Man—Psychedelic shows—Lasers—Emotion/Lie Detector—Touch-Tone Dial—Quadrasonic Adapter—Transistorized Ignition—Burglar Alarm—Sound Meter . . . over 60 items. Send 25¢ coin (no stamps) for complete catalog. Technical Writers Group, Box 5594, State College Station, Raleigh, N.C. 27607.

SURPLUS electronics for everyone. Free catalog. U.S. inquiries. ETCO, 464 McGill, Montreal, Canada.

WRITE for our free 32 page catalog. It lists resistors (14 different types, in kits and singly), 1542 tube types, 3024 different transistor types, many transistor kits, rectifiers in kits and singly, condensers of various types, tools, wire, antennae, phonograph cartridges and needles, speakers, CRT boosters, controls, switches, T.V. tuners, yokes, fly-backs, etc. Hytron Hudson, Dept. PE, 2201 Bergenline Ave., Union City, N. J. 07087.

ELECTROENCEPHALOPHONE: brainwave monitor. Professional biofeedback instruments. J&J, 8102-E, Bainbridge, Wash. 98110.

DIGITAL and analog computer modules. LED numeric display kits. **FREE LITERATURE.** Scientific Measurements, 2945 Central, Wilmette, Illinois 60091.

ELECTRONIC ORGAN KITS, KEYBOARDS for music synthesizers and organs. Every component for organ circuitry. 25¢ for catalog. Devtronix Organ Products, Dept. C, 5872 Amapola Drive, San Jose, Calif. 95129.

LATEST sniping countermeasures: Manual \$10.00. Negeye, Box 1036X, Anderson, Indiana 46015.

WE SELL CONSTRUCTION PLANS—gold recovery unit!—silver recovery unit—infra-red scope—x-ray fluoroscope—alternator adapter—200 watt inverter—electronic insect trap—burglar alarm system—chemical formulary (home products)—electroplater—plans \$5.00—plus many more!—ask for **FREE** catalog—creative products, 1551 east loop 820, Dept. E-1172, fort worth, texas 76112.

Electronics Goodies

The unexpected in high quality and low price. Check KITS on which you want more info:

- | | |
|---|--|
| <input type="checkbox"/> Variable Alternating Lamp Flasher KC16 \$3.25 | <input type="checkbox"/> High-Low Lamp Dimmer KC7 .48 |
| <input type="checkbox"/> Pre-Wired Radio Chassis Plus Parts to Build Telephone AMP, 2-Way Intercom, More KRA1 \$4.88 | <input type="checkbox"/> Semi-Conductor Tester KC6 .75 |
| <input type="checkbox"/> Electronic Coin-Tosser KC38 \$3.25 | <input type="checkbox"/> Lamp Flasher KC5 \$2.35 |
| <input type="checkbox"/> Lamp Dimmer with Triac KC68 \$2.95 | <input type="checkbox"/> Pre-Wired Noise/Disturbance Vibration Detector 2K7 .48 |
| <input type="checkbox"/> Electronic Organ Basic Kit KC4A \$3.35 | <input type="checkbox"/> Precision Time-Interval Kit with IC KC70 \$3.25 |
| <input type="checkbox"/> Vibration Alarm 2K7 .48 | <input type="checkbox"/> Light Activated Relay KC26 \$3.85 |
| <input type="checkbox"/> Electronic Organ with Variable Controls KC4B \$3.99 | <input type="checkbox"/> Light Activated SCR Relay KC51 \$4.05 |
| <input type="checkbox"/> Warning Siren KC62 \$2.65 | <input type="checkbox"/> Electronic Metronome KC2 \$2.65 |
| <input type="checkbox"/> Electric Timer KC31 \$3.25 | <input type="checkbox"/> Tone Generator Probe Kit KC37A \$2.45 |
| <input type="checkbox"/> Code Practice Oscillator KC50 \$1.75 | <input type="checkbox"/> Sound (Noise) Squirter KC37 \$1.98 |
| <input type="checkbox"/> Rectifier Tester for PIV KC63 \$1.25 | <input type="checkbox"/> Reed Switch with Relay KC57 \$2.85 |
| <input type="checkbox"/> Nixie Hi-Voltage Supply KC13 \$1.98 | <input type="checkbox"/> Automobile Alarm KC34A \$1.50 |
| <input type="checkbox"/> Relaxation Oscillator KC58 99¢ | <input type="checkbox"/> Variable Flasher KC69 \$3.25 |
| | <input type="checkbox"/> Diode Switch KC64 \$1.35 |

CORTLANDT ELECTRONICS, INC.

16 Hudson St., New York, N.Y. 10013

- Send me KITS information checked above.
- Send literature on your line of top quality ICs, Transistors, Triacs, Diodes, Capacitors, Resistors, etc. Money Back Guaranteed.

Name _____
Address _____
City _____ State _____ Zip _____

CIRCLE NO. 7 ON READER SERVICE CARD

RESISTORS: Carbon Composition brand new. All standard values stocked. 1/2 Watt 10% 50/\$1.00; 1/4 Watt 10% 40/\$1.00. 10 resistors per value please. Minimum order \$5.00. Postpaid. PACE ELECTRONIC PRODUCTS, Box 161-P, Ontario Center, New York 14520.

DIAGRAMS—TV, Radio, etc. \$2.00. Techservas, Box 1167, Berkeley, Ca. 94701.

CB Radios in quantity direct from Japan at fraction of U.S. prices. Send \$2.00 for information on 30 Japanese companies. K. Englert, 1263 Warner Ave., Los Angeles, Calif. 90024.

BRAINWAVE FEEDBACK—\$25, fully assembled, sensitive, selective, easy to use. Inner Space Electronics, Box 308, Berkeley, Ca. 94701.

IN-PIANO humidity control system. Safe, fully automatic. Stops expensive piano problems. Hughes Electronics, Box 6487, Asheville, N. C. 28806.

AUTON for CHRISTMAS! New Principle Ignition AUTON ONE \$5.00. AUTON TWO \$11.00, AUTON THREE \$17.50. Postpaid, Guarantee, Information: Price Autonics, Box 1581B, National City, California 92050.

AUTOMOBILE BURGLAR SYSTEM with system connected even HOT-WIRING will not start motor, \$7.95 complete. Deluxe-Horn blows when ignition is on or HOT-WIRED \$12.95. VANSONS MFG. & SALES, 10175 Breidt, Tujunga, Calif. 91042.

ELECTRONIC CDI Ignitions. VHF/UHF monitors. Wholesale. Southland, Box 3591, Baytown, Texas 77520.

MICROPHONES, miniature, sensitive, dynamic, used in hearing aids. Weigh less than one gram. \$5.00 postpaid. Rudy Stanowski, Box 2528, La Puente, Calif. 91746.

FREE! Unique component catalog, world's smallest SCR's, LED's, ThermoCouples, parts. Chaney, Box 15431, Lakewood, Colorado 80215.

INTEGRATED CIRCUIT COMPUTER BOARDS

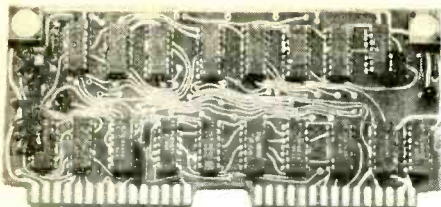

Modern boards, containing from 15 to 19 Fairchild TTL ICs, plus other parts. Catalog value of ICs on each board over \$40.00
STOCK NO. F9407 2.75 ea. 2 diff. boards 5.00, 3 diff. boards 7.00.

VOICE / SOUND OPERATED RELAY
Complete ready to operate PC assembly, includes solid state components and microphone. Ideal for alarms, door openers etc. Circuit diagram and application data.

STOCK NO. F5054 1.25 ea. 6/7.00

COMPUTER GRADE CAPACITORS (BRAND NEW)

40,000 mfd. 10 volts 1.25 ea. 6/7.00 Stk. No. F2026
70,000 mfd. 10 volts 1.75 ea. 6/9.00 Stk. No. F2118
6000 mfd. 55 volts 1.50 ea. 7/9.00 Stk. No. F2117
3,750 mfd. 75 volts 1.75 ea. 6/9.00 Stk. No. F2116

Many other items—send for new 48 page catalog All merchandise guaranteed. Please include postage. Excess will be refunded.



DELTA ELECTRONICS CO.

BOX 1, LYNN, MASSACHUSETTS 01903
617-388-4705

CIRCLE NO. 8 ON READER SERVICE CARD

FREE diodes with free catalog. BDJ Electronics, 11 Revere, Tappan, New York 10983.

"HOW to Make Printed Circuit Boards" Booklet plus complete catalog. Send \$1.50 postage and handling. DEVELOPMENT DESIGN TECHNOLOGY, Dept. PE, 5901 N. Cicero Ave., Chicago, Ill. 60646.

COPPER CLAD, P.C. Board Material. Assorted Sizes and Grades. \$15.00 Value. 2 pounds only \$3.85 including postage. DEVELOPMENT DESIGN TECHNOLOGY, Dept. PE, 5901 N. Cicero Ave., Chicago, Ill. 60646.

XENON StrobeLight Flashtubes FT 106 50W \$2.50, 2/\$4, 10/\$16, 100/\$125. Plans 50¢. Mindlight, POB 2846PE, Van Nuys, California 91404.

DIGITAL ELECTRONICS! Complete schematics, parts lists, theories—Discrete Component Digital Clock, \$3.00—Sound Sensitive Switch, \$1.50. Increase technical competence, hobby skills—Complete Course in Digital Electronics is highly effective, \$10.00. Limited—Clock plans included with Course! Free literature. DYNASIGN, Box 60A4, Wayland, Mass. 01778.

CONVERT any alternator in car or truck to 110 volts at 3,000 watts. Complete kit \$19.95 postpaid. For Delco, Ford Chrysler alternators. CPA RADIO, 2115 Norris Canyon Road, San Ramon, CA 94583.

BURGLAR-FIRE alarm supplies and information. Free catalog. Protecto Alarm Sales, Box 357-G, Birch Run, Michigan 48415.

SWL's FREE antenna info, catalog of insulators, wire, coax, balun. Palomar Engineers, Box 455, Escondido, Calif. 92025.

DIAGRAMS—Radios \$1.50, Television \$3.00. Give make and model. Diagram Service, Box 1151PE, Manchester, Conn. 06042.

FREE catalog of electronic bargain parts. Send to: Kness Electronics, 3236 N. Elston, Chicago, Ill. 60618.

ELECTRONIC IGNITION: Boosts Voltage. Only \$19.95. Box 2002, Huntington Beach, Calif. 92647.

CAPACITIVE DISCHARGE IGNITION IS HERE TO STAY ----- IT'S THE BEST!

Our CAPTRON compares feature by feature with all others. Don't buy a high priced limited production unit when our mass produced design sells for only \$29.95ppd. Completely assembled.

Order Today! from _____ **GENERAL ANALOG**
Your money back within 30 days if not satisfied. | 12 volt negative ground only. 3014F S. HALLADAY ST. Dept C SANTA ANA, CALIF. 92705



ALPHA/THETA feedback instruments—\$25. Sensitive circuit of \$70 unit. Ultimate ease of use. Inner Space Electronics, Box 308PE, Berkeley, CA 94701.

PRINTED CIRCUITS IN 24 HOURS—from magazine page, magic marker layout, etc. Etch & trim \$3. Up. BECO, Box 686, Salem, VA 24153.

A NEW INSTRUMENT TO USE WITH YOUR SCOPE



MULTITRACER

Use with your present Oscilloscope to trace Resistors, Capacitors, Transformers, Diodes, Transistors, Zeners, Triodes, most Semiconductors, IC's, etc. Also shows continuity, in-circuit and going-go checks. Complete with diagrams and instructions. No internal scope connections. For medium or small production runs or for hobbyist, experimenter, engineer, or ham.

ONLY \$19.95—CHECK OR MONEY ORDER
WHY PAY MORE?

BOX 14, LESCO ELECTRONICS, SKOKIE, ILL. 60076

CONSTRUCTION PLANS: Laser . . . \$3.00. Missile Tracker . . . \$3.00. Catalog 25¢. ESP Experimenters Kit . . . \$3.00. Howard, P.O. Box 35271, Detroit, Michigan 48235.

SCOPES, Counters, Meters, Bridges, Precision Instrumentation Components. Industrial and Government Surplus. G-R, Tektronix, H-P, Weston and others. Many "one of a kind" specials. Send name and address for free "Bargain Bulletins" to: Lawrence Instruments, P.O. Box 744, Sunbury, Pa. 17801.

SUPREME twenty different radio-television volumes. \$50 value, only \$19.95, postpaid. Supreme Publications, 1760 Balsam, Highland Park, Illinois 60035.

PLANS AND KITS

FREE Kit Catalog: Why does every major College, University, Technical School, Research & Development Center buy from us? Because we have the highest quality and lowest prices. Free catalog. SWTPC, Box H32040, San Antonio, Tex. 78284.

FREE Kit Catalog: Amazing new Universal Digital Instruments with plug-ins as featured in Popular Electronics. Unbeatable prices. SWTPC, Box D32040, San Antonio, Tex. 78284.

ANTIGRAVITY DEVICE. Brochure rushed free. AGD, Box 3062-ZD, Bartlesville, Oklahoma 74003.

TRIGGERED Sweep conversion kits—EICO 460, Heath 10-102. Details—HW Electronics, RR#2, Bloomfield, Ontario, Canada. U.S. Inquiries.

LOUDSPEAKER cabinet—Attractive, quality design. 25Hx20Wx10D. Easily, economically built. Illustrated plans \$2.00. Christian, Box 19220, Indianapolis, Ind. 46219.

AM CAR RADIO BOOSTER. FET Tuned RF amplifier for car radios or any AM radio. 30 DB gain. Plans \$3.00, Kit \$18.00, Wired \$29.95. Free literature. Check or M.O. R.R. Faulkner, Box 26, Redondo Beach, Calif. 90277.

FREE Kit Catalog: Digital Microlab \$29.95. Also Segmented and Nixie Readouts, Timebases, Scaler, Electronic Digital Clocks (all featured in Popular Electronics) SWTPC, Box C32040, San Antonio, Tex. 78284.

UNIQUE and unusual project plans, send \$1.00 airmailed super hobby catalog. Design Systems, Box 386, Endicott, New York 13760.

PLANS: Profitable electronic devices. Literature free. Barta-PEG, Box 248, Walnut Creek, California 94596.

WANTED

QUICKSILVER, Platinum, Silver, Gold, Ores Analyzed. Free Circular. Mercury Terminal, Norwood, Mass. 02062.

QUICK CASH . . . for Electronic Tubes, Semi-Conductors, Equipment (Receivers, Transmitters, Scopes, Vacuum Variables etc.) Send Lists now! Write: Barry Electronics, 512 Broadway, New York, NY 10012. (212) 925-7000.

SPEAKER, Barker Duode. Write: Robert Perkins, Annvinal Road, Scituate, Mass. 02060.

HIGH FIDELITY

SPEAKER GUARD

PROTECTS SPEAKER AND AMPLIFIER

An overload in wattage of amplifier output activates circuit breaker and prevents damage. Reset circuit breaker and make sure you use correct values of Speaker Guard.

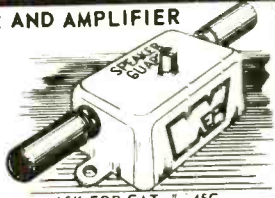

18 DIFFERENT VALUES

ASK FOR CAT. # 45C

MANUFACTURED BY

WORKMAN
Subsidiary of ITP TECHNOLOGY INC.
BOX 3828 SARASOTA FLA 33578

Electronic
PRODUCTS, INC.

DIAMOND NEEDLES and Stereo Cartridges at Discount prices for Shure, Pickering, Stanton, Empire, Grado and ADC. Send for free catalog. All merchandise brand new and factory sealed. **LYLE CARTRIDGES**, Dept. P, Box 69, Kensington Station, Brooklyn, New York 11218.

STEREO Components at lowest prices. Send for free catalog. Carston, Box 1094-A, Danbury, Conn. 06810.

FREE Kit Catalog. Amplifiers: Lil Tiger \$11.10, Universal Tiger \$30.00, Preamp \$44.50 (Featured in Popular Electronics) Mixer-6 Input \$13.75. SWTPC, Box A32040, San Antonio, Tex. 78284.

McGEE RADIO COMPANY

World's Best Selection of Speakers
Almost Every Size From 1 1/2" to 18"
WOOFERS - TWEETERS - CROSSOVERS
MANY HIGH FIDELITY KITS.

McGee's Speaker Catalog
Sent Free Upon Request

NORELCO HI-FI SPEAKERS

An Added Full Line of Norelco Hi-Fi Speakers
For The System Builder

McGEE RADIO COMPANY,
1901 McGee Street PE,
Kansas City, Missouri 64108

**ELECTRICAL SUPPLIES
AND EQUIPMENT**

PLATING Equipment, Portable Platers, Supplies and "Know-How." Build your own tanks for nickel, chrome, etc. Easy-to-install PVC liners. Rectifier components—all sizes. Schematics, parts lists, formulas, operating instructions for all plating. Guaranteed to save you 25%-75%. Some good units for sale. Write for details. Platers Service Company, 1511-PE Esperanza, Los Angeles. Calif. 90023.

**PHILCO 11-TRANSISTOR
AM RADIO CHASSIS**

Originally design for portable phone systems, and tape cassettes! Use as:

- Covers 555 Kcs to 1500 Kcs Broadcast band
- AC or DC
- Mike amplifier
- Phono amplifier
- Tape amplifier

One of the most versatile AM Radio and multi-purpose amplifiers we have seen at Poly Paks for only "Economy" price. Measures only 4 1/2" x 3" x 2" high. With tuning capacitor, IF circuitry, loopstick, ant., volume control with switch, AC and phono-mike jacks. Separate switch for changing from AM radio to amplifier. Uses either 110V plug-in adapter (not with unit) and a 9-volt battery power. Exceptional sensitivity and power. Feeds into 16 ohm speaker. Complete with spec sheets, diagrams, and hookup ideas.

Only **\$5.95**

**8 TRANSISTOR
AMPLIFIER CHASSIS** Only **\$3.95**

Same except minus the radio section of the chassis.
4 1/2" x 4" x 2" high.

\$1.98 MAGIC "SOUND TRIGGER"

Unique Scientific Device, "hand claps", sensitizes crystal mike amplifier, triggers SCR. Needs only 12VDC supply. Can be used for burglar alarm, intrusion detector. Use with photo cell, triggers SCR's, relays, LED's. Even fiber optic light pipe may be used. With hand booklet.

**GENERAL ELECTRIC
3-WATT AUDIO AMP**

Delivers 3 watts continuous, 10 watt peak. With heat sink, micro-mini size, 3 1/2" x 1 1/2" x 1/2". 9 to 30V supply. High sensitivity, 8 to 16 ohms. For mono and stereo systems, tape, FM, AM, TV, servo. **3 FOR \$6.00**
BRAND NEW LOWEST PRICES **\$2.95**



DIGITAL CLOCK KIT

By Scientific Devices
Smaller more compact 8" x 5 1/2" x 3" case

Wattum laminated tapered front cabinet, with gold-line front. Tapered legs for easy viewing. Uses G.E. 7-segment fluorescent "green" polaroid tubes, completely etched and thru plated circuit board, all IC's. Includes HCD outputs for use with timer options. Can be wired for HOURS, MINUTES, SECONDS. 115 VAC 60 cy. Gift packed. Wt. 3 lbs. Buy 3 — Take 10%

Only **\$5.75** WITH CASE

Linear Op Amps

Buy Any 3 PAKS — Take 10% Discount

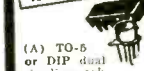

(A) TO-5 or DIP dual in line pkg

- FACTORY MARKED
- FACTORY TESTED
- FACTORY GUARANTEED

| | | |
|---------|-------------------------------|------------|
| 531 | Hi slow rate op-amp | \$2.50 |
| 532 | Micro power 741 TO-5 | 2.50 |
| 533 | Micro power 709 | 2.50 |
| 536 | FET input op amp | 2.50 |
| 537 | Precision 741 TO-5 | 2.50 |
| 540 | 70W pwr driver amp | 2.04 |
| 550 | Precision 723 voltage reg. | 1.17 |
| 555 | Timer 2 uSeconds to 1-hour | 1.19 |
| 558 | Dual 741 (mini DIP) | 3.25 |
| 565 | Phase lock loops (A) | .88 |
| 566 | Function generator (mini DIP) | 3.25 |
| 567 | Tone decoder (mini DIP) | 3.25 |
| 595 | Four quadrant multiplier | 3.10 |
| 702C | Hi-gain, DC amp, TO-5 | 2 for 1.00 |
| 703C | RF-IF, amp, 14 ckts, TO-5 | 1.00 |
| 709C | Operational amp (A) | .39 |
| 710C | Differential amp (A) | .39 |
| 711C | Dual diff. comp. (A) | .39 |
| 723C | Voltage regulator (A) | .95 |
| 741C | Frequency compensator 709 | .41 |
| 747C | Dual 741C, TO-5 | 1.25 |
| 748C | Freq. adj. 741C (A) | .44 |
| 709-709 | Dual 709C (DIP) | 1.00 |
| 739-739 | Dual stereo preamp | 1.98 |
| 741-741 | Dual 741C (mini DIP) | 1.00 |
| 749-749 | Dual channel amp | 1.98 |

• Factory Marked! Factory Guaranteed!

| Type | Quantity | Price |
|--------|----------|--------|
| SN7400 | 2 | \$2.10 |
| SN7401 | 2 | .21 |
| SN7402 | 2 | .21 |
| SN7403 | 2 | .21 |
| SN7404 | 2 | .27 |
| SN7405 | 2 | .27 |
| SN7406 | 2 | .45 |
| SN7407 | 2 | .45 |
| SN7408 | 2 | .45 |
| SN7409 | 2 | .26 |
| SN7410 | 2 | .21 |
| SN7411 | 2 | .26 |
| SN7413 | 2 | .50 |
| SN7416 | 2 | .48 |
| SN7417 | 2 | .48 |
| SN7420 | 2 | .21 |
| SN7421 | 2 | .21 |
| SN7426 | 2 | .32 |
| SN7430 | 2 | .21 |
| SN7437 | 2 | .50 |
| SN7438 | 2 | .51 |
| SN7440 | 2 | .21 |
| SN7441 | 2 | .00 |
| SN7442 | 2 | 1.12 |

Poly Paks Will Never Be Undersold! **LOWEST PRICES ON TTL IC'S** Buy 3 — Take 10% Discount

No gimmicks on Pricing, Deliveries, or Quality! We're "The Only IC Advertiser" with **MONEY BACK GUARANTEE!**

| | | | | | |
|--------|------|---------|------|---------|------|
| SN7443 | 1.21 | SN7481 | 1.10 | SN74150 | 1.25 |
| SN7444 | 1.21 | SN7482 | .88 | SN74151 | 1.13 |
| SN7445 | 1.50 | SN7483 | 1.25 | SN74152 | 1.25 |
| SN7446 | 1.40 | SN7486 | .49 | SN74154 | 1.95 |
| SN7447 | 1.10 | SN7489 | 3.50 | SN74155 | 1.39 |
| SN7448 | 1.25 | SN7490 | .69 | SN74156 | 1.39 |
| SN7450 | .21 | SN7491 | 1.10 | SN74157 | 1.25 |
| SN7451 | .21 | SN7492 | .71 | SN74158 | 1.98 |
| SN7453 | .21 | SN7493 | .71 | SN74160 | 1.79 |
| SN7454 | .21 | SN7494 | 1.10 | SN74161 | 1.79 |
| SN7460 | .21 | SN7495 | .95 | SN74162 | 1.79 |
| SN7470 | .39 | SN7496 | 1.10 | SN74163 | 1.79 |
| SN7472 | .32 | SN74107 | .49 | SN74164 | 1.79 |
| SN7473 | .44 | SN74121 | .49 | SN74180 | 1.10 |
| SN7474 | .39 | SN74122 | .67 | SN74182 | 1.10 |
| SN7475 | .71 | SN74123 | .99 | SN74183 | 1.75 |
| SN7476 | .44 | SN74141 | 1.45 | SN74193 | 1.75 |
| SN7480 | .65 | SN74145 | 1.25 | SN74195 | 1.19 |

Best Values for 18 years **POLY PAKS** L.P. BOX 942 E Lynnfield, Mass. 01940
Terms: add postage. cod's 25%. Rated: net 30
Phone Orders: Wakefield, Mass. (617) 245-3829
Retail: 211 Albion St., Wakefield, Mass. (617) 245-3829
C.O.D.'S MAY BE PHONED IN

CIRCLE NO. 26 ON READER SERVICE CARD

MAGNETS

MAGNETS. All types. Specials—20 disc magnets, or 2 stick magnets, or 10 small bar magnets, or 8 assorted magnets, \$1.00. Maryland Magnet Company, Box 192H, Randallstown, Maryland 21133.

TUBES

RADIO & T.V. Tubes—36¢ each. Send for free Catalog. Cornell, 4213 University, San Diego, Calif. 92105.

ELECTRONIC TUBES. Semiconductors, Equipment, Telephones, Public Address, Intercoms, CB, Walkie-Talkies, etc. Quality Merchandise Only! Servicing Engineers, Purchasing Agents, TV/Hi-Fi Servicemen and Hams for 28 years. Domestic and Export. Write for Catalog or call (212) 925-7000. **BARRY ELECTRONICS**, 512 Broadway, New York, N. Y. 10012.

RECEIVING & INDUSTRIAL TUBES, TRANSISTORS. All Brands—Biggest Discounts, Technicians, Hobbyists, Experimenters—Request **FREE** Giant Catalog and **SAVE!** ZALYTRON, 469 Jericho Turnpike, Mineola, N. Y. 11501.

SAVE money on parts and transmitting-receiving tubes. foreign-domestic. Send 25¢ for giant catalog. Refunded first order. United Radio Company, 56-P Ferry Street, Newark, N.J. 07105.

TUBES "Oldies", latest. Lists free. Steinmetz, 7519 Maplewood, Hammond, Indiana 46324.

TUBES receiving, factory boxed, low prices, free price list. Transleteronic, Inc., 1306 40th Street, Brooklyn, N.Y. 11218A, Telephone: 212-633-2800.

TAPE AND RECORDERS

STEREO TAPE RENTAL for particular people. Free catalog. Gold Coast Tape Library, Box 2262, Palm Village Station, Hialeah, Fla. 33012.

OLD Radio Programs on cassettes or reels. High quality, low prices, thousands to choose from, professional equipment, catalog 50¢. Remember Radio Inc., Box 2513, Norman, Okla. 73069.

RENT 4-Track open reel tapes—all major labels—3,000 different—free brochure. Stereo-Parti, 55 St. James Drive, Santa Rosa, Ca. 95401.

MEMOREX recording tape, audio & video lowest prices, write for free information. Bergetz Systems Co., Box 1181, Melrose Park, Ill. 60161.

8-TR. Blank Cartridges \$1.25 80 minute, Scotch Tape. Atlas Electronics, PO Box 522, Dept. B, Blackwood, N.J. 08012.

SOUNDTRACK Record Albums from Films, Original, Rare, Free List. Whalon, 2321-M Hill, Redondo Beach, Calif. 90278.

1930-1962 Radio Programs on tape. Huge Catalog! Sample Recordings! \$1.00, Refundable! AM Treasures, Box 192F, Babylon, N.Y. 11702.

SCOTCH MAGNETIC TAPE (USED)

#150, 1 mil polyester, 3600 ft. on 10½ in. fiberglass reels, used once, \$1.99; 1800 ft., 7 in. reels, 99¢—guaranteed to perform as good as new or money refunded. (Bulk, no box). Used 10½ in. fiberglass reels (small hole) 50¢. New hinged boxes: 10½ in., 39¢, 7 in., 9¢ (All plus postage by weight & zone)

SAXITONE TAPE SALES

1776 Columbia Rd., N.W. Washington, D.C. 20009



INSTRUCTION

LEARN ELECTRONIC ORGAN SERVICING at home all makes including transistor. Experimental kit—trouble-shooting. Accredited NHSC, Free Booklet. **NILES BRYANT SCHOOL**, 3631 Stockton, Dept. A, Sacramento, Calif. 95820.

LEARN WHILE ASLEEP, Hypnotize! Strange catalog free. Auto-suggestion, Box 24-ZD, Olympia, Washington 98501.

ASSOCIATE DEGREE IN ELECTRONICS through correspondence instruction. G.I. Bill approved. Free catalog. Grantham, 1509 N. Western, Hollywood, California 90027.

FCC First and Second Tests. \$8.95. Electronic Tutoring, Box 24190, Cleveland, Ohio 44124.

LOGIC trainers catalogs 50¢. UTI, POB 252, Waldwick, N.J. 07463.

EARN College Degrees at home. Many Subjects. Florida State Christian College, Post Office Box 1674, Fort Lauderdale, Fla. 33302.

HIGHLY effective college-level home study programs in Electronics Engineering and Engineering Mathematics. (Our 27th Year). Free Literature. Cook's Institute, Dept. 15, Box 10634, Jackson, Miss. 39209.

NEGATIVES FOR ETCHED CIRCUITS from this magazine or your 4x5 drawing \$1.00. C&F, 302 So. 12th, Newark, N.J. 07103.

AVIATION ELECTRONICS TECHNICIAN—Prepare for exciting career in new field of "Avionics". Train at nation's largest aeronautical school. Indicate if eligible for G.I. Benefits. Spartan Airschool, International Airport, MM, Tulsa, Oklahoma 74151.

HIGH SCHOOL DIPLOMA for adults. Earn State Diploma. Accepted by Civil Service, business, colleges. Low cost. No tedious study. Money-back Guarantee. Details: H-S Program, Suite 2504, 1221 Avenue of Americas, New York, N.Y. 10020.

ON THE AIR announcer training at R.E.I. features individual realistic preparation for your Radio/TV career. R.E.I.'s engineering course features intensive training for the FCC First Phone! Complete either course in just five (5) weeks! Call 1-800-237-2251 toll free for brochure. Write: R.E.I., 1336 Main Street, Sarasota, Florida 33577.

F.C.C. TYPE Exams Guaranteed to prepare you for F.C.C., 3rd., (\$7.00), 2nd., (\$12.00), 1st., (\$16.00), phone exams; Complete package, \$25.00. Research Company, Dept. A, Rt. 2, Box 448, Calera, Alabama 35040.

F.C.C. EXAM MANUAL

The Original Test-Answers exam manual that prepares you at home for FCC First and Second class licenses. Includes Updated multiple choice tests and key Schematic diagrams. PLUS - "Self-Study Ability Test." - ONLY: \$9.95 Postpaid

COMMAND PRODUCTIONS P.O. BOX 26348-P
RADIO ENGINEERING DIVISION SAN FRANCISCO, CALIF. 94126

LEARN TAPE RECORDING FROM STUDIO ENGINEERS. Free Literature. Write: NNA, Box 721F, Rye, New York 10580.

SHORTCUTS To Success! Highly Effective, Profitable Short Courses. (75 Choices). Study At Home. Diploma Awarded. Our 27th Year. Free Literature. CIEE-D, Box 10634, Jackson, Miss. 39209.

REPAIRS AND SERVICES

ENTREPRENEURS—Learn to start, build your own manufacturing business professionally. New correspondence course guarantees to teach you. Write for free catalog: NIMS, PE12, 8121 Zimple, New Orleans, Louisiana 70118.

PASS FCC FIRST AND SECOND CLASS EXAMINATIONS

with new 21 lesson, 450 page course. Over 600 FCC-type multiple-choice questions included. Starts with basic electricity. No previous experience required. Commercial Radio Operator Theory Course, Cat. #15-01.

AMECO PUBLISHING only \$5.95
314-P Hillside Ave., Williston Park, N. Y. 11596

Fall 15¢ Gate Sale:

FALL 15¢ GATE SALE

Here's how it works:

For every IC you buy from us at our regular low prices, you get to buy one of the following gates for 15¢ each: 7400, 7401, 7403, 7404, 7405, 7408, 7409, 7410, 7411, 7418, 7420, 7421, 7430, 7440, 7450, 7451, 7453, 7454, and 7460.

THIS OFFER GOOD UNTIL DECEMBER 1, 1972

| Catalog Number | Qty. Quantity | | | | Multiplies of 10 Per Item (Mix) | Catalog Number | Qty. Quantity | | | | Multiplies of 10 Per Item (Mix) | |
|----------------|---------------|-----|------|------|---------------------------------|----------------|---------------|------|------|-------|---------------------------------|------|
| | 1 | 100 | 1000 | 1000 | | | 100 | 1000 | 1000 | 10000 | | |
| 7100 | 26 | 25 | 23 | 22 | 21 | 7460 | 1.89 | 1.79 | 1.68 | 1.58 | 1.47 | 1.37 |
| 7101 | 10 | 15 | 23 | 22 | 21 | 7461 | 1.89 | 1.79 | 1.68 | 1.58 | 1.47 | 1.37 |
| 7102 | 29 | 25 | 23 | 22 | 21 | 7462 | 1.98 | 1.87 | 1.76 | 1.65 | 1.54 | 1.43 |
| 7103 | 29 | 25 | 23 | 22 | 21 | 7463 | 1.62 | 1.52 | 1.45 | 1.36 | 1.28 | 1.19 |
| 7104 | 28 | 27 | 25 | 24 | 22 | 7464 | 1.62 | 1.52 | 1.45 | 1.36 | 1.28 | 1.19 |
| 7105 | 28 | 27 | 25 | 24 | 22 | 7465 | 1.20 | 1.15 | 1.07 | 1.01 | .95 | .88 |
| 7106 | 25 | 20 | 17 | 14 | 12 | 7466 | 1.20 | 1.15 | 1.07 | 1.01 | .95 | .88 |
| 7107 | 25 | 20 | 17 | 14 | 12 | 7467 | 1.98 | 1.87 | 1.76 | 1.65 | 1.54 | 1.43 |
| 7108 | 12 | 10 | 9 | 8 | 7 | 7468 | 1.98 | 1.87 | 1.76 | 1.65 | 1.54 | 1.43 |
| 7109 | 32 | 30 | 29 | 27 | 26 | 7469 | 1.98 | 1.87 | 1.76 | 1.65 | 1.54 | 1.43 |
| 7110 | 26 | 25 | 23 | 22 | 21 | 7190 | 1.98 | 1.87 | 1.76 | 1.65 | 1.54 | 1.43 |
| 7111 | 28 | 27 | 25 | 24 | 22 | 7191 | 1.98 | 1.87 | 1.76 | 1.65 | 1.54 | 1.43 |
| 7112 | 50 | 36 | 34 | 32 | 31 | 7192 | 2.81 | 2.65 | 2.50 | 2.31 | 2.18 | 2.04 |
| 7113 | 52 | 50 | 47 | 44 | 42 | 7193 | 2.81 | 2.65 | 2.50 | 2.31 | 2.18 | 2.04 |
| 7114 | 52 | 50 | 47 | 44 | 42 | 7194 | 2.81 | 2.65 | 2.50 | 2.31 | 2.18 | 2.04 |
| 7115 | 52 | 50 | 47 | 44 | 42 | 7195 | 2.81 | 2.65 | 2.50 | 2.31 | 2.18 | 2.04 |
| 7116 | 52 | 50 | 47 | 44 | 42 | 7196 | 2.81 | 2.65 | 2.50 | 2.31 | 2.18 | 2.04 |
| 7117 | 52 | 50 | 47 | 44 | 42 | 7197 | 2.81 | 2.65 | 2.50 | 2.31 | 2.18 | 2.04 |
| 7118 | 52 | 50 | 47 | 44 | 42 | 7198 | 2.81 | 2.65 | 2.50 | 2.31 | 2.18 | 2.04 |
| 7119 | 52 | 50 | 47 | 44 | 42 | 7199 | 2.81 | 2.65 | 2.50 | 2.31 | 2.18 | 2.04 |
| 7120 | 26 | 25 | 23 | 22 | 21 | 7200 | 1.11 | 1.08 | 1.02 | .96 | .90 | .84 |
| 7121 | 26 | 25 | 23 | 22 | 21 | 7201 | 1.11 | 1.08 | 1.02 | .96 | .90 | .84 |
| 7122 | 80 | 70 | 67 | 64 | 60 | 7202 | 1.11 | 1.08 | 1.02 | .96 | .90 | .84 |
| 7123 | 50 | 48 | 45 | 43 | 40 | 7203 | 1.11 | 1.08 | 1.02 | .96 | .90 | .84 |
| 7124 | 31 | 32 | 31 | 29 | 27 | 7204 | 1.37 | 1.30 | 1.22 | 1.15 | 1.08 | 1.01 |
| 7125 | 50 | 48 | 45 | 43 | 40 | 7205 | 1.11 | 1.08 | 1.02 | .96 | .90 | .84 |
| 7126 | 31 | 32 | 31 | 29 | 27 | 7206 | 1.37 | 1.30 | 1.22 | 1.15 | 1.08 | 1.01 |
| 7127 | 26 | 25 | 23 | 22 | 21 | 7207 | 1.11 | 1.08 | 1.02 | .96 | .90 | .84 |
| 7128 | 26 | 25 | 23 | 22 | 21 | 7208 | 1.11 | 1.08 | 1.02 | .96 | .90 | .84 |
| 7129 | 26 | 25 | 23 | 22 | 21 | 7209 | 1.11 | 1.08 | 1.02 | .96 | .90 | .84 |
| 7130 | 26 | 25 | 23 | 22 | 21 | 7210 | 1.11 | 1.08 | 1.02 | .96 | .90 | .84 |
| 7131 | 26 | 25 | 23 | 22 | 21 | 7211 | 1.11 | 1.08 | 1.02 | .96 | .90 | .84 |
| 7132 | 26 | 25 | 23 | 22 | 21 | 7212 | 1.11 | 1.08 | 1.02 | .96 | .90 | .84 |
| 7133 | 26 | 25 | 23 | 22 | 21 | 7213 | 1.11 | 1.08 | 1.02 | .96 | .90 | .84 |
| 7134 | 26 | 25 | 23 | 22 | 21 | 7214 | 1.11 | 1.08 | 1.02 | .96 | .90 | .84 |
| 7135 | 26 | 25 | 23 | 22 | 21 | 7215 | 1.11 | 1.08 | 1.02 | .96 | .90 | .84 |
| 7136 | 26 | 25 | 23 | 22 | 21 | 7216 | 1.11 | 1.08 | 1.02 | .96 | .90 | .84 |
| 7137 | 26 | 25 | 23 | 22 | 21 | 7217 | 1.11 | 1.08 | 1.02 | .96 | .90 | .84 |
| 7138 | 26 | 25 | 23 | 22 | 21 | 7218 | 1.11 | 1.08 | 1.02 | .96 | .90 | .84 |
| 7139 | 26 | 25 | 23 | 22 | 21 | 7219 | 1.11 | 1.08 | 1.02 | .96 | .90 | .84 |
| 7140 | 26 | 25 | 23 | 22 | 21 | 7220 | 1.11 | 1.08 | 1.02 | .96 | .90 | .84 |
| 7141 | 26 | 25 | 23 | 22 | 21 | 7221 | 1.11 | 1.08 | 1.02 | .96 | .90 | .84 |
| 7142 | 26 | 25 | 23 | 22 | 21 | 7222 | 1.11 | 1.08 | 1.02 | .96 | .90 | .84 |
| 7143 | 26 | 25 | 23 | 22 | 21 | 7223 | 1.11 | 1.08 | 1.02 | .96 | .90 | .84 |
| 7144 | 26 | 25 | 23 | 22 | 21 | 7224 | 1.11 | 1.08 | 1.02 | .96 | .90 | .84 |
| 7145 | 26 | 25 | 23 | 22 | 21 | 7225 | 1.11 | 1.08 | 1.02 | .96 | .90 | .84 |
| 7146 | 26 | 25 | 23 | 22 | 21 | 7226 | 1.11 | 1.08 | 1.02 | .96 | .90 | .84 |
| 7147 | 26 | 25 | 23 | 22 | 21 | 7227 | 1.11 | 1.08 | 1.02 | .96 | .90 | .84 |
| 7148 | 26 | 25 | 23 | 22 | 21 | 7228 | 1.11 | 1.08 | 1.02 | .96 | .90 | .84 |
| 7149 | 26 | 25 | 23 | 22 | 21 | 7229 | 1.11 | 1.08 | 1.02 | .96 | .90 | .84 |
| 7150 | 26 | 25 | 23 | 22 | 21 | 7230 | 1.11 | 1.08 | 1.02 | .96 | .90 | .84 |
| 7151 | 26 | 25 | 23 | 22 | 21 | 7231 | 1.11 | 1.08 | 1.02 | .96 | .90 | .84 |
| 7152 | 26 | 25 | 23 | 22 | 21 | 7232 | 1.11 | 1.08 | 1.02 | .96 | .90 | .84 |
| 7153 | 26 | 25 | 23 | 22 | 21 | 7233 | 1.11 | 1.08 | 1.02 | .96 | .90 | .84 |
| 7154 | 26 | 25 | 23 | 22 | 21 | 7234 | 1.11 | 1.08 | 1.02 | .96 | .90 | .84 |
| 7155 | 26 | 25 | 23 | 22 | 21 | 7235 | 1.11 | 1.08 | 1.02 | .96 | .90 | .84 |
| 7156 | 26 | 25 | 23 | 22 | 21 | 7236 | 1.11 | 1.08 | 1.02 | .96 | .90 | .84 |
| 7157 | 26 | 25 | 23 | 22 | 21 | 7237 | 1.11 | 1.08 | 1.02 | .96 | .90 | .84 |
| 7158 | 26 | 25 | 23 | 22 | 21 | 7238 | 1.11 | 1.08 | 1.02 | .96 | .90 | .84 |
| 7159 | 26 | 25 | 23 | 22 | 21 | 7239 | 1.11 | 1.08 | 1.02 | .96 | .90 | .84 |
| 7160 | 26 | 25 | 23 | 22 | 21 | 7240 | 1.11 | 1.08 | 1.02 | .96 | .90 | .84 |
| 7161 | 26 | 25 | 23 | 22 | 21 | 7241 | 1.11 | 1.08 | 1.02 | .96 | .90 | .84 |
| 7162 | 26 | 25 | 23 | 22 | 21 | 7242 | 1.11 | 1.08 | 1.02 | .96 | .90 | .84 |
| 7163 | 26 | 25 | 23 | 22 | 21 | 7243 | 1.11 | 1.08 | 1.02 | .96 | .90 | .84 |
| 7164 | 26 | 25 | 23 | 22 | 21 | 7244 | 1.11 | 1.08 | 1.02 | .96 | .90 | .84 |
| 7165 | 26 | 25 | 23 | 22 | 21 | 7245 | 1.11 | 1.08 | 1.02 | .96 | .90 | .84 |
| 7166 | 26 | 25 | 23 | 22 | 21 | 7246 | 1.11 | 1.08 | 1.02 | .96 | .90 | .84 |
| 7167 | 26 | 25 | 23 | 22 | 21 | 7247 | 1.11 | 1.08 | 1.02 | .96 | .90 | .84 |
| 7168 | 26 | 25 | 23 | 22 | 21 | 7248 | 1.11 | 1.08 | 1.02 | .96 | .90 | .84 |
| 7169 | 26 | 25 | 23 | 22 | 21 | 7249 | 1.11 | 1.08 | 1.02 | .96 | .90 | .84 |
| 7170 | 26 | 25 | 23 | 22 | 21 | 7250 | 1.11 | 1.08 | 1.02 | .96 | .90 | .84 |
| 7171 | 26 | 25 | 23 | 22 | 21 | 7251 | 1.11 | 1.08 | 1.02 | .96 | .90 | .84 |
| 7172 | 26 | 25 | 23 | 22 | 21 | 7252 | 1.11 | 1.08 | 1.02 | .96 | .90 | .84 |
| 7173 | 26 | 25 | 23 | 22 | 21 | 7253 | 1.11 | 1.08 | 1.02 | .96 | .90 | .84 |
| 7174 | 26 | 25 | 23 | 22 | 21 | 7254 | 1.11 | 1.08 | 1.02 | .96 | .90 | .84 |
| 7175 | 26 | 25 | 23 | 22 | 21 | 7255 | 1.11 | 1.08 | 1.02 | .96 | .90 | .84 |
| 7176 | 26 | 25 | 23 | 22 | 21 | 7256 | 1.11 | 1.08 | 1.02 | .96 | .90 | .84 |
| 7177 | 26 | 25 | 23 | 22 | 21 | 7257 | 1.11 | 1.08 | 1.02 | .96 | .90 | .84 |
| 7178 | 26 | 25 | 23 | 22 | 21 | 7258 | 1.11 | 1.08 | 1.02 | .96 | .90 | .84 |
| 7179 | 26 | 25 | 23 | 22 | 21 | 7259 | 1.11 | 1.08 | 1.02 | .96 | .90 | .84 |
| 7180 | 26 | 25 | 23 | 22 | 21 | 7260 | 1.11 | 1.08 | 1.02 | .96 | .90 | .84 |
| 7181 | 26 | 25 | 23 | 22 | 21 | 7261 | 1.11 | 1.08 | 1.02 | .96 | .90 | .84 |
| 7182 | 26 | 25 | 23 | 22 | 21 | 7262 | 1.11 | 1.08 | 1.02 | .96 | .90 | .84 |
| 7183 | 26 | 25 | 23 | 22 | 21 | 7263 | 1.11 | 1.08 | 1.02 | .96 | .90 | .84 |
| 7184 | 26 | 25 | 23 | 22 | 21 | 7264 | 1.11 | 1.08 | 1.02 | .96 | .90 | .84 |
| 7185 | 26 | 25 | 23 | 22 | 21 | 7265 | 1.11 | 1.08 | 1.02 | .96 | .90 | .84 |
| 7186 | 26 | 25 | 23 | 22 | 21 | 7266 | 1.11 | 1.08 | 1.02 | .96 | .90 | .84 |
| 7187 | 26 | 25 | 23 | 22 | 21 | 7267 | 1.11 | 1.08 | 1.02 | .96 | .90 | .84 |
| 7188 | 26 | 25 | 23 | 22 | 21 | 7268 | 1.11 | 1.08 | 1.02 | .96 | .90 | .84 |
| 7189 | 26 | 25 | 23 | 22 | 21 | 7269 | 1.11 | 1.08 | 1.02 | .96 | .90 | .84 |
| 7190 | 26 | 25 | 23 | 22 | 21 | 7270 | 1.11 | 1.08 | 1.02 | .96 | .90 | .84 |
| 7191 | 26 | 25 | 23 | 22 | 21 | 7271 | 1.11 | 1.08 | 1.02 | .96 | .90 | .84 |
| 7192 | 26 | 25 | 23 | 22 | 21 | 7272 | 1.11 | 1.08 | 1.02 | .96 | .90 | .84 |
| 7193 | 26 | 25 | 23 | 22 | 21 | 7273 | 1.11 | 1.08 | 1.02 | .96 | .90 | .84 |
| 7194 | 26 | 25 | 23 | 22 | 21 | 7274 | 1.11 | 1.08 | 1.02 | .96 | .90 | .84 |
| 7195 | 26 | 25 | 23 | 22 | 21 | 7275 | 1.11 | 1.08 | 1.02 | .96 | .90 | .84 |
| 7196 | 26 | 25 | 23 | 22 | 21 | 727 | | | | | | |

TV Tuners rebuilt and aligned per manufacturers specification. Only \$9.50. Any make UHF or VHF Ninety day written guarantee. Ship complete with tubes or write for free mailing kit and dealer brochure. JW Electronics, Box 51C, Bloomington, Indiana 47401.

PC BOARDS or negatives made from your artwork. HPG, Box 381, Madison, Alabama 35758.

MOVIE FILMS

8MM-SUPER 8-16MM MOVIES! Biggest Selection! Lowest Prices! Free Catalog! Cinema Eight, Box 245-PE, N.Y.C. 10028.

DO-IT-YOURSELF

PROFESSIONAL ELECTRONIC PROJECTS—\$1.00 up. Catalog 35 cents. PARKS, 7544 23rd Ave., N.E., Seattle, Wash. 98115.

PERSONALS

MAKE FRIENDS WORLDWIDE through international correspondence. Illustrated brochure free. Hermes, Berlin 11, Germany.

MAKE friends for travel, matrimony, fishing, etc. Send age and \$1 for bulletin "Introductions." Amity, P.O. Box 2471, Detroit, Michigan 48231.

BUGGED??? . . . Electronic Detector locates hidden transmitters. Literature 25¢. Security Devices, Box 671, Westwood, New Jersey 07675.

RECORD telephone conversations privately—automatically. Leave recorder unattended. Robert's, Box 49PE, Parkridge, Illinois 60068.

INVENTIONS WANTED

INVENTIONS wanted. Patented: unpatented. Global Marketing Service, 2420-P 77th, Oakland, Calif. 94605.

INVENTORS! Don't sell your invention, patented or unpatented, until you receive our offer. Eagle Development Company, Dept. 9, 79 Wall Street, N.Y., N.Y. 10005.

PATENT Searches including Maximum speed, full airmail report and closest patent copies. Quality searches expertly administered. Complete secrecy guaranteed. Free Invention Protection forms and "Patent Information." Write Dept. 9, Washington Patent Office Search Bureau, Benjamin Franklin Substation, P.O. Box 7167, Washington, D.C. 20044.

FREE "Directory of 500 Corporations Seeking New Products." For information regarding development, sale, licensing of your patented/unpatented invention. Write: Raymond Lee Organization, 230-GR Park Avenue, New York City 10017.

INVENTORS: Protect your ideas! Free "Recommended Procedure". Washington Inventors Service, 422T Washington Building, Washington, D.C. 20005.

FREE PAMPHLET: "Tips on Safeguarding Your Invention." Write: United States Inventors Service Company, 708-T Carry Building, Washington, D.C. 20005.

BOOKS

FREE catalog aviation/electronic/space books. Aero Publishers, 329PE Aviation Road, Fallbrook, California 92028.

FREE book prophet Elijah coming before Christ. Wonderful bible evidence. Megiddo Mission, Dept. 64, 481 Thurston Rd., Rochester, N.Y. 14619.

GOVERNMENT SURPLUS

GOVERNMENT Surplus. How and Where to Buy in Your Area. Send \$1.00. Surplus Information, Headquarters Bldg., Box 30177-PE, Washington, D.C. 20014.

ELECTRONIC Equipment and Parts. Big 36 page Free Catalog. Send for your copy today! Fair Radio Sales, Box 1105-P, Lima, Ohio 45802.

JEeps Typically from \$53.90 . . . Trucks from \$78.40 . . . Boats, Typewriters, Knives, Airplanes, Clothing, Multimeters, Oscilloscopes, Transceivers, Photographic, Electronics Equipment. Wide-variety, condition. 100,000 Bid Bargains direct from government nationwide. Complete sales directory and surplus categories catalog \$1.00 (Deductible on orders from separate included catalog). Surplus Service, Box 820-J, Holland, Michigan 49423.

GOVERNMENT SURPLUS. Complete sales directory \$1.00. Surplus Publications, Box 26062Z, Los Angeles, Calif. 90026.

MANUALS for gov't surplus radios, test sets, scopes, teletype. List 25¢. Books, 4905 Roanne Drive, Washington, D.C. 20021.

BUSINESS OPPORTUNITIES

I MADE \$40,000.00 Year by Mailorder! Helped others make money! Start with \$10.00—Free Proof. Torrey, Box 318-N, Ypsilanti, Michigan 48197.

\$200.00 DAILY In Your Mailbox! Your opportunity to do what mail-order experts do. Free details. Associates, Box 136-J, Holland, Michigan 49423.

START small, highly profitable electronic production in your basement. Investment, knowledge unnecessary. Postcard brings facts. Barta-PEB, Box 248, Walnut Creek, California 94597.

FREE CATALOGS. Repair air conditioning, refrigeration. Tools, supplies, full instructions. Doolin, 2016 Canton, Dallas, Texas 75201.

MAILORDER MILLIONAIRE helps beginners make \$500 weekly. Free report reveals secret plan! Executive (1K11), 333 North Michigan, Chicago 60601.

FREE BOOK "999 Successful, Little-Known Businesses." Work home! Plymouth BGL, Brooklyn, New York 11218.

MAKE \$1.00 per sale selling engraved metal Social Security plates. **FREE SALES KIT.** Engravaplates, Box 10460-200, Jacksonville, Florida 32207.

400,000 BARGAINS Below Wholesale! Many free! Liquidations . . . Closeouts . . . Job lots . . . Single Samples. Free details. Bargainhunters Opportunities, Box 730-J, Holland, Michigan 49423.

EARN by placing permanent identification on TV Picture Tubes with wonder metal alloy marking "Lead." Free Details. Cibolabs, Box 1228, Grants, New Mexico 87020.

FREE SECRET BOOK "2042 Unique, Proven Enterprises." Beat inflation with fabulous, successful "Little Knowns." Work home! Haylings-B3, Carlsbad, Calif. 92008.

TV-Tuner Rebuilding Franchise Available. No experience but good Electronics background necessary. Investment required \$6,000—\$10,000 offer open for U.S. and Canada. For free information write: Mr. Leone, 4306 Imperial St., Burnaby 1, B.C., Canada.

EARN \$2,000 monthly!! Easy new business selling mailorder secrets! Hamilton, Box 349-PE2, Flushing, New York 11355.

PIANO TUNING learned quickly at home. Tremendous field! Musical knowledge unnecessary. GI Approved. Information Free. Empire School, Box 327, Miami, Florida 33145.

50 MEGAHERTZ LOW COST COUNTER



Here is a new item, featured because of numerous customer suggestions. We have taken the basic power supply chassis and cover from our clock kit, and by substituting a new front panel and printed circuit board, have made a lowest cost frequency counter. The unbelievable low cost is due to our use of our large stock of unused surplus nixies, the new 74196 50 MHz decade counter, and the commonality of parts with our other kits. Readout is to six decades, time base 1 second, 0.1 seconds, or external. Design is modular, for ease of construction, compactness, and expandability.

- 50 Mhz six digit counter, using line frequency as time base, complete except for cover \$97.50
- Optional crystal controlled time base plug-in conversion \$23.50
- Cover, blue or black anodized \$ 4.50

BUILD YOUR OWN ELECTRONIC CALCULATOR FOR ONLY \$108.00!

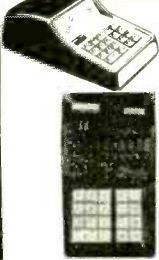

A complete calculator kit, complete with self contained power supply and case, indispensable in the home, office or school. Simple enough for a child to build. Some of the features of the calculator are as follows:

- MOS Integrated circuits (extra large scale integration) reduce the number of components to a minimum, for easy assembly
- Displays eight digits on large size seven segment display
- Full function complement keyboard features addition, subtraction, multiplication, division, alternate display, multiplication by 10
- Sixteen digit entry and sixteen digit results are possible with alternate display key
- Leading zeros suppressed
- Chain operation
- All integrated circuits and displays are socket mounted and replaceable.

So reliable and simple to build, we can make this guarantee: If for any reason you cannot succeed in getting your calculator to function properly after completing construction, for a flat handling fee of \$10.00, B and F will repair and ship back your calculator anywhere in the USA. This applies regardless of the age of the assembler, barring gross negligence or the use of acid core solder in construction.

DIGITAL CLOCK KIT WITH NIXIE DISPLAY

We have well over 20,000 surplus nixies in stock, and because of this bargain purchase we can sell a complete digital clock kit for less than the usual cost of the display tubes only. We provide a complete etched and thru-plated circuit board, all integrated circuits, complete power supply, display tubes, I.C. sockets and a nice front panel with polarized visor. We have never seen anyone offer this kit for less than \$100.00 before. Includes BCD output for use as with timer option. May be wired for 12 or 24 hour display. Indicates hours, minutes, seconds.

- Clock Kit, complete less outside cover \$57.50
 - Aluminum blue or black anodized cover (specify) \$ 4.50
 - SHRINK TUBING SPECIAL. Assortment of 200 pieces of shrink tubing, diameters 1/8" to 1/2", length 1/2" to 2" \$1.25
- Price

KEYBOARDS

- Three keyboards are available: 20 key calculator keyboard, 40 key alphanumeric keyboard, and 12 key touch tone. All have separate contacts carried out to edge connector.
- Touch Tone Keyboard \$ 9.50
 - Calculator Keyboard \$14.50
 - Alphanumeric Keyboard \$29.00

LIGHT EMITTING DIODE NUMERIC DISPLAY

This display is excellent for small portable electronics, such as DVM's, calculators, etc. Equivalent to Monsanto MAN 3A. Operates from 5 volts, 20 milliamperes, with 47 ohm dropping resistor.

- \$3.25 Each
- 10 For \$27.50
- Complete circuit kit, 7490, 7475 latch 7447, printed circuit board, led readout \$9.50

LATEST HARD-TO-GET SEMICONDUCTORS

- MJS 4858 silicon uni-lateral switch. Useful for voltage sensitive switch, sweep generators, etc. \$1.00
- MIS A64 PNP high current Darlington transistor. Super-high gain in small package. 2/81.00
- MPS A14, same as above, NPN. 2/81.00

THIS MONTH'S FEATURE ITEM



POCKET CALCULATOR KIT

This is the kit you have been waiting for. So compact it actually fits in a shirt pocket (3-13/16 x 4-5/8 x 1-1/4). It performs every function you would expect in a desk calculator, including constant and chain operation, and full floating decimal. The unit is powered by self contained batteries, and uses 8 digit LED displays. The calculations are performed by a single 40 pin integrated circuit, which can truly be called large scale integration (LSI). As a student, engineer, salesman, accountant, or anyone who would like fast accurate answers, this calculator fills the bill, and at a price that unquestionably makes this the lowest price high quality calculator available.

- Pocket Calculator Kit \$75.00

RECHARGEABLE BATTERY/CHARGER KIT

This option allows the throw away alkaline battery to be replaced with a nicad battery, and includes a charger to recharge this battery. The unit may be run during the recharge cycle.

- Battery/Charger Kit \$17.50

LOGIC AND OPERATIONAL AMP SUPPLIES

- Figure A, potted logic supply, 5 Volts at 1 Ampere, short circuit proof, ultra high regulation, ultra low ripple \$16.00
- Figure A, potted Op Amp supply, 15 Volts, and 15 Volts at 0.5 Amperes. Mfg. by Analog Devices, similar to their model 902. Short circuit proof, ultra high performance \$29.00
- Figure B, 5 Volts 1Amp supply, regulated by Fairchild 9305, short circuit protected. \$3.75
- Same as above, in kit form \$7.75
- Mating connector for above \$1.00
- 5 Volt 5 Amp regulated supply, by Bullyline (not shown). \$29.00

LIGHT EMITTING DIODES

- Monsanto MV 50 or equivalent LED's. Now less expensive than filamentary bulbs. At this price you can use them in logic circuits as status indicators, build low cost counters or use them as panel lights. Rated at 10 - 40 Ma @2V.
- 10 LED's \$3.00
 - 100 LED's \$20.00
 - 1000 LED's \$200.00

LOUDSPEAKER SYSTEM COMPONENT SPECIAL!!

We have made an excellent purchase of an excess inventory of a local manufacturer's speaker systems although we aren't allowed to mention the manufacturer's name, the specs should make it self evident. The woofers is a 12" free-edge laocoustic suspension unit, with 2" voice coil and a 2 lb. magnet. The mid-range is a 5" unit and the tweeter is of the dome type, for best high frequency dispersion. Crossover between woofer and mid-range is by an R-L network, while high frequency crossover is by an R-C network. Balance controls are provided for both mid-range and tweeter. Plans for a suitable enclosure are provided.

- Speaker System \$29.00 ea./2 for \$55.00

CALCULATOR CHIP SPECIAL

B and F has purchased a quantity of MOS large scale integration chips for calculators. We are not allowed to mention the manufacturer's name, however, the specs should make them self-evident.

- Set "X" - Four 24 pin I.C.'s, BCD output, 16 digit, fixed automatic decimal point, possible memory expansion, constant \$29.00
- Set "Y" - Single 40 pin, 7 segment output, 12 digit, fixed automatic decimal, no constant \$15.00
- Set "Z" - Single 40 pin I.C., 7 segment output, 8 digit, floating point, constant \$19.50

LINEAR DEVICES, OP AMPS, REGULATORS

- 709 High performance Op Amp \$5.00
 - 711 Dual Comparator \$5.50
 - 723 Regulator \$1.25
 - 741 Compensated Op-Amp \$5.00
 - 558 Dual 741 \$1.00
 - LM309 5 Volt 1 amp Regulator, TO-3 \$2.25
- FAIRCHILD VOLTAGE REGULATOR**
- Fairchild UGH7805 5 Volt 1 amp voltage regulator. Perfect for logic supply, very compact. \$1.95

AIRCRAFT/AUTO/BOAT QUARTZ CRYSTAL CHRONOMETER



Revolutionary! was the reaction of our customers when they saw our latest kit. Measuring only 2-1/2" x 2-1/2" x 1", and accurate to 10 seconds a month, this chronometer promises to entirely replace mechanical clocks in cars, boats and airplanes. Fits into a standard 2-1/4" instrument panel cutout. The displays are bright L.E.D. displays that should last a lifetime. Setting controls are recessed and operate from a pointed object such as a pencil point or paper clip, in order to keep non-authorized hands off. The clock should only have to be reset at very great intervals, or in the event of power loss (i.e. replacing battery in car). The clock is wired so that the timing circuits are always running, but the displays are only lit when the ignition is on, resulting in negligible power drain. The low price is only possible because of a new one chip MOS clock circuit, developed for quartz crystal wristwatches.

- Operates from 10-14 Volts D.C. An accessory unit which mounts on the back adapts the unit to 20-28 Volts for twin engine aircraft and larger boats using 24 Volt ignition. Know how disgusted you are with the usual car clock? Order this fine unit now for rallying, sports events, navigation, or just to have a fine chronometer that will give you a lifetime of superbly accurate time.
- Quartz Chronometer, Kit Form \$59.50
 - Quartz Chronometer, Wired \$99.50
 - 24 Volt Adapter \$10.00

HIGH POWER SCR'S

SCR's - invaluable for high power applications, motor speed controls, etc. Never before at this low price. Brand new packaged devices, complete with data sheet and 24 page consumer applications manual.

- 2N5062 Plastic 100V 1 amp \$3.50
- 2N5064 Plastic 200V 1 amp 4.00
- 2N4169 100V/8 amp stud 1.45
- 2N4170 200V/8 amp stud 1.65
- 2N4172 400V/8 amp stud 1.95
- 2N3525 400V/3 amp press fit95
- 2N1772/C15A 100V/8 amp stud 1.75
- 2N1774/C15B 200V/8 amp stud 1.95
- 2N1777/C15D 400V/8 amp stud 2.50
- 2N1844/C20A 100V/12 amp stud 1.75
- 2N1844/C20B 200V/12 amp stud 1.95
- 2N5169 200V/20 amp stud 4.75
- 2N5170 500V/20 amp stud 4.75
- 2N5171 700V/20 amp stud 6.75
- 2N3896/C30A 100V/25 amp stud 2.95
- 2N3897/C30B 200V/25 amp stud 3.95
- 2N3899/C30E 500V/25 amp stud 4.95

SANKEN HIGH POWER, HIGH PERFORMANCE HYBRID VOLTAGE REGULATORS

These hybrid regulators are easy to use, requiring no external components. Excellent for operational amplifier supplies, logic supplies and other high performance applications. All regulators have less than 50 millivolts ripple and better than 1% line and load regulation, some models far exceeding this specification.

- S13120E 12 Volts, 1 Ampere \$2.25
- S1310E 15 Volts, 1 Ampere \$2.25
- S13240E 24 Volts, 1 Ampere \$2.25
- S13050E 5 Volts, 1 Ampere \$2.25
- S1354W 5 Volts, 3 Amperes \$7.00

ALL ITEMS WHERE WEIGHT NOT SPECIFIED

POSTAGE PAID IN THE U. S. A.

Phone in charges to (617) 531-5774 or (617) 532-2323.

BankAmericard - Mastercharge. \$10.00 minimum. No C.O.D.'s please.



B. & F. ENTERPRISES

Phone (617) 532-2323
P. O. Box 44, Hathorne, Massachusetts 01937

CIRCLE NO. 1 ON READER SERVICE CARD

LEDS

| | | |
|----------------------------|-------|--------|
| FLV 100 VIS LED'S | | \$.65 |
| GaAs 1R LED'S | | .65 |
| MRD 148 Photo darlington's | | .65 |

VARIABLE CAPACITANCE DIODES

(Similar to 1N5463A) used to tune VHF, color TV, & FM broadcast sets..... \$.95

| | | | | | |
|------|-------|------|-------|-------|------|
| 7400 | | .25 | 7475 | | .80 |
| 7401 | | .25 | 7476 | | 1.00 |
| 7402 | | .25 | 7480 | | .75 |
| 7404 | | .28 | 7481 | | 1.25 |
| 7410 | | .25 | 7483 | | 1.25 |
| 7413 | | .75 | 7486 | | .57 |
| 7420 | | .25 | 7490 | | .79 |
| 7430 | | .25 | 7492 | | .80 |
| 7440 | | .25 | 7493 | | .75 |
| 7441 | | 1.30 | 7495 | | .75 |
| 7447 | | 1.15 | 74107 | | .85 |
| 7450 | | .25 | 74121 | | .55 |
| 7460 | | .25 | 74192 | | 1.95 |
| 7472 | | .50 | 8570 | | 1.50 |
| 7473 | | .50 | 8590 | | 1.50 |
| 7474 | | .50 | | | |

7 segment 5V, 8 MA, 16 pin DIP readout, 250,000 hrs. lifetime..... \$3.25.

TANTALUM CAPACITORS

| | | |
|-----------------|-------|----------|
| 4.7 MFD AT 20V | | 5 \$1.00 |
| 10 MFD AT 20V | | 4 \$1.00 |
| 4.7 MFD AT 100V | | 5 \$.50 |
| 11 MFD AT 100V | | 5 \$.75 |

2N3055 7 amp NPN Silicon Transistor..... \$1.00

TRANSISTOR SPECIALS

| | | | | | | | |
|----------------|--------|------|------|------|-------|--------|----------|
| 2N3584 NPN Si | TO-66 | 35W | 250V | 2A | 10MHz | 100Hfe | \$1.50 |
| 2N965 PNP GE | TO-18 | .15W | 7V | 1A | 300 | 40 | \$.100 |
| 2N1605 NPN GE | TO-5 | .15W | 24V | 1A | 14MHz | 125 | 5 \$1.00 |
| 2N5324 PNP GE | TO-3 | 60W | 250V | 10A | 2D | 35 | 5 \$1.50 |
| 2N2360 PNP GE | TO-33 | .06W | 20V | .05A | 980 | 32 | 5 \$.50 |
| 2N1015D NPN Si | TO-82 | 150W | 200V | 7.5A | .025 | 10 | \$1.45 |
| 2N2015 NPN Si | TO-36 | 150W | 50V | 10A | .012 | 26 | \$1.45 |
| 2N3724 NPN Si | TO-5 | .8W | 30V | 1A | 250 | 60 | 3 \$1.00 |
| 2N3772 NPN Si | TO-3 | 150W | 60V | 30A | .2 | 30 | \$1.25 |
| 2N6109* PNP Si | TO-220 | 36W | 40V | 4A | .8 | 60 | 50c |
| 2N5296* NPN Si | TO-220 | 36W | 40V | 4A | .8 | 60 | 55c |

*Match pair push pull amplifier

| | | | | | | |
|---------------------------------|-------------|---------|--------------------------|------|------|----|
| REGULATED POWER SUPPLIES | MODEL SE904 | SE902 | FULL WAVE BRIDGES | PRV | 2A | 6A |
| Output Voltage (VDC) | ±15 | ±15 | 200 | .90 | 1.20 | |
| Output Current (MA) | 50 | 100 | 400 | 1.10 | 1.40 | |
| Line (105-125 VAC) | \$18.95 | \$26.95 | 600 | 1.25 | 1.60 | |

NE 565 PHASE LOCK LOOPS..... \$3.50

MINIATURE TRIM POTS

500 OHM, 10K, 20K, 25K, 50K..... \$.75
or 3 for \$2.00

14 Pin Dip Socket..... \$3.10
16 Pin Dip Socket..... \$6.00 ea.

TRIA CS

| | | | | |
|-----|------|------|------|------|
| PRV | 1A | 10A | 15A | 20A* |
| 100 | .40 | .70 | 1.00 | 1.20 |
| 200 | .70 | 1.10 | 1.50 | 1.60 |
| 300 | .90 | 1.35 | 1.90 | 2.00 |
| 400 | 1.10 | 1.60 | 2.70 | 2.40 |
| 500 | 1.50 | 2.00 | 3.20 | 2.80 |

*Press Fit
T1543 UJT's..... \$.50
2N3819 N Channel FET's..... \$.45
D137 PROG. UJT's..... \$.75

Silicon Power Rectifiers

| | | | | |
|------|-----|-----|------|------|
| PRV | 1A | 3A | 12A | 50A |
| 100 | .06 | .09 | .30 | .85 |
| 200 | .07 | .16 | .35 | 1.25 |
| 400 | .09 | .20 | .45 | 1.50 |
| 600 | .11 | .30 | .70 | 1.30 |
| 800 | .15 | .40 | .85 | 2.30 |
| 1000 | .20 | .55 | 1.10 | 2.75 |

Silicon Control Rectifiers

| | | | | |
|-----|-----|------|------|-------|
| PRV | 6A | 10A | 20A | 70A |
| 100 | .30 | .45 | 1.00 | 3.50 |
| 200 | .50 | .75 | 1.25 | 6.50 |
| 300 | .60 | .90 | 1.50 | |
| 400 | .70 | 1.10 | 1.75 | 9.50 |
| 500 | .80 | 1.25 | 2.00 | |
| 600 | .90 | 1.40 | 2.25 | 11.00 |

IN4886 POWER VARIATORS \$4.95

TEST EQUIPMENT SPECIALS

(Used in good condition)
TEKTRONIX 545A with CA plug-in \$800.00
STABILINE 15 KVA 95-135V regulator \$250.00
POWER DESIGN 3240, 1-32V at 4A Power supplies \$95.00
POWER DESIGN 1210, 1-12V at 10A power supplies \$95.00
Dumont 304A scopes \$95.00
Tektronix 531 with B or K plug-in \$475
HP 521C counter \$125
HP 400D voltmeter \$95
Ballantine 314 voltmeter \$95.

DECADE COUNTER KIT

Consisting of:
1-Nixie tube & socket (8754)
1-7490
1-7475
1-7441
\$4.75

709C OPER. AMP..... \$.50
741 OPER. AMP..... \$.50
748 ADJUST 741..... \$.95
Dual 709..... \$1.79
723 Regulator..... \$.75
TVR-2002 high power 723..... \$1.00

NIXIE TUBES

Similar to Raytheon 8650 long-life tubes, with socket & data sheet..... \$2.25

Terms: FOB Cambridge, Mass. Send check or Money Order. Include postage. Average Wt. per package 1/2 lb. No C.O.D.'s.

Minimum Order \$3.00
Rated companies 30 days net

Send \$.20 for our Fall catalog featuring Transistors and Rectifiers: 325 Elm St., Cambridge, Mass.

SOLID STATE SALES

Post Office Box 74A Somerville, Mass. 02143 Tel. (617) 547-4005

CIRCLE NO. 30 ON READER SERVICE CARD

HYPNOTISM

"MALE-FEMALE Hypnotism" Exposed, Explained! "Secret Method" —They Never Know! \$2. Rushed. Guaranteed! Isabella Hall, Silver Springs, Florida 32688.

SLEEP learning. Hypnotic method. 92% effective. Details free. ASR Foundation, Box 7566EG, Fort Lauderdale, Florida 33304.

FREE Hypnotism, Self-Hypnosis, Sleep Learning Catalog! Drawer H400, Ruidoso, New Mexico 88345.

PRINTING

PRINTED Envelopes. Samples, Price List. Anderson Envelope Co., P. O. Box 606A, Anderson, Indiana 46015.

ADDRESS LABELS, gummed, padded, gift boxed, \$1.00. Gifthouse, 102 1/2 East Henry St., Elmira, N.Y. 14904.

EMPLOYMENT INFORMATION

EXCITING Overseas jobs. Directory \$1.00. Research Associates, Box 889-E, Belmont, California 94002.

ELECTRONICS/AVIONICS Employment Opportunities. Report on jobs now open. FREE details. Aviation Employment Information Service, Dept. EW, Box 240, Northport, N.Y. 11768.

YOUR Classified or Display Classified Ad in these columns will be seen, read and regularly responded to by America's largest audience comprising Electronics Professionals and Hobbyists. Cost is low, results high. Send copy and payment now!

ELECTRONIC TECHNICIANS. How to Earn \$15,000—\$20,000 yearly. Not Field Service—Not Overseas—Work in U.S.A. Details \$3.00. W.L.D. Contract Engineering, 8450 Anthony Wayne Ave., Cincinnati, Ohio 45216.

TREASURE FINDERS

FISHER DETECTORS. You deserve the best. Free literature, FRI, Dept. PE-11, P.O. Box 490, Belmont, CA 94002.

TREASURE Hunters! Prospectors! Rockhounds! Hobbyists! Find gold, silver, relics with world famous Detron Metal Detectors. Free information. Delivery immediate. Detron, Dept. 11-PE, Box 243, San Gabriel, Calif. 91778.

TRANSISTORIZED detectors—\$19.95 to \$79.95. Family fun and fortune. Catalog write: Treasureprobe PE 27, Tennent, N.J. 07763.

FREE—Valuable Treasure Finder catalog sent by return mail. Find Coins, Rings, Gold, Silver, Metals, Relics. Write today. JETCO, Dept. CPE, Box 26669, El Paso, Texas 79926.

TREASURE FINOER locates buried gold, silver, coins, treasures. 5 powerful models. \$19.95 up. Instant financing available. Free catalog. Relco, Dept. A-33, Box 10839, Houston, Texas 77018.

DISCOVER AMERICA'S FASTEST GROWING HOBBY. White's Electronics, Inc., would like to send you—absolutely FREE, their 42 page, fact-filled catalog on Mineral and Metal Locating Equipment. Amateurs or Professionals select from the world's largest line of metal detectors, priced as low as \$79.50, up. Detect Gold, Silver, Copper—Nuggets, Coins, Jewelry, etc. Budget terms available. For your convenience we have three major factory locations in the U.S. and Canada, as well as over 1,000 authorized dealers to serve you. See your local Yellow Pages, under "Metal Locating Equipment", or write: White's Electronics Inc., Room No. 391, 1101 Pleasant Valley Road, Sweet Home, Oregon 97386 —Elk-Air Industrial Park, Dexter Drive, East, Elkhart, Indiana 46514—or White's Electronics Ltd., 33784 Hazel Street, Abbotsford, British Columbia, Canada.

SPORTS ACTION FILMS

A TERRIFIC BARGAIN—8mm Pro Sports Films for Instant Replay. '72 NBA; NHL Record Breakers; NFL Football Follies—just out! 8 or Super 8, \$13.95 color; \$6.95 B&W delivered. Free Gift Catalog. SPORTLITE, Elect. Dept., 20 North Wacker Drive, Chicago, IL 60606.

REAL ESTATE

FREE . . . 280-page FALL CATALOG! Describes and pictures hundreds of farms, ranches, town and country homes, businesses coast to coast! Specify type property and location preferred. UNITED FARM AGENCY, 612-EP West 47th St., Kansas City, Mo. 64112.

MUSICAL INSTRUMENTS

30% DISCOUNT name brand musical instruments. Free Catalog. Freeport Music, 455N, Route 110, Melville, N.Y. 11746.

WHOLESALE! Professional Guitars, PA Systems, Aitec Speakers, 240W RMS Amplifiers. Free Catalog. Carvin, Escondido, Calif. 92028.

PLASTICS

CASTOLITE pours like water, hardens like glass without heat. Crystal clear, colors. Embed natural flowers, photos, coins, anything; in paperweights, keytags, desksets; for gifts, profits. Make flexible molds of your own designs over any pattern, any size. Cast reproductions in Castolite, candlewax, plaster, cement. Manual 25¢. CASTOLITE, 72M/PE, Woodstock, Ill. 60098.

MISCELLANEOUS

WINEMAKERS: Free illustrated catalog yeasts, equipment. Semplex, Box 12276P, Minneapolis, Minn. 55412.

POPULAR ELECTRONICS

Including Electronics World

NOVEMBER 1972

| READER SERVICE NO. | ADVERTISER | PAGE NO. |
|-------------------------------|--|--|
| 2 | B&K Division, Dynascan Corporation | 73 |
| 1 | B. & F. Enterprises | 125 |
| | Bell & Howell Schools | 110, 111, 112, 113 |
| 4 | Bose | 13 |
| 5 | Cleveland Institute of Electronics | 74, 75, 76, 77 |
| 6 | Cook's Institute of Electronics Engineering | 91 |
| 7 | Cortlandt Electronics Inc | 119 |
| | CREI, A Division of the McGraw-Hill Continuing Education Company | 38, 39, 40, 41 |
| 8 | Delta Electronics Co | 120 |
| 9 | Delta Products, Inc | 90 |
| 10 | Dixie Hi-Fi Wholesalers | 17 |
| 11 | Edmund Scientific Co | 128 |
| 41 | EICO | 105 |
| 12 | Electro-Voice, Inc | 8 |
| 13 | Fluke | 105 |
| 40 | Grantham School of Engineering | 7 |
| 14 | Greenlee Tool Co | 87 |
| 15 | Gregory Electronics Corp | 118 |
| 16 | Heath Company | 56, 57, 58, 59 |
| 17 | Lafayette Radio Electronics | 129, 130 |
| 18 | Lee Electronics Labs., Inc | 87 |
| 20 | Magitran Company, The | 108 |
| 19 | Meintash Laboratory Inc | 115 |
| 21 | MITS Micro Instrumentation & Telemetry Systems, Inc | 15 |
| | National Radio Institute | SECOND COVER, 1, 2, 3 |
| | National Technical Schools | 92, 93, 94, 95 |
| 22 | Olson Electronics | 27 |
| 24 | Pace Communications | 83 |
| 25 | Pickering & Co., Inc. | 103 |
| 26 | Poly Paks | 121 |
| 23 | PTS Electronics, Inc | 108 |
| 27 | Radio Shack | 79 |
| 29 | RCA Institutes, Inc. | 18, 19, 20, 21 |
| 28 | Sams & Co., Inc., Howard W | 11 |
| 3 | Shure Brothers Inc. | FOURTH COVER |
| 30 | Solid State Sales | 126 |
| 31 | Solid State Systems, Inc | 123 |
| 32 | Sonar Radio Corp | 115 |
| 34 | Tab Books | 9 |
| 33 | TDK Electronics Corp | 65 |
| 35 | Tri-Star Corporation | 89 |
| | U. S. Army | 22, 23 |
| 36 | United Audio | 24 |
| 37 | Utah Electronics | 109 |
| 38 | Wine-Art | 91 |
| 39 | Xcelite, Inc | 100 |
| CLASSIFIED ADVERTISING | | |
| | | 118, 119, 120, 121, 122, 124, 126, 127 |

Guide to Earning EXTRA INCOME

A ZIFF-DAVIS PUBLICATION



Packed with fresh ideas, expert advice and valuable details on money-making ideas — full and part-time — for both men and women. Provides in depth coverage in many important areas of income opportunities — mail order — franchising — vending machines — direct selling — house parties — plus many special features on seasonal business opportunities and money-saving ideas. 1972 Oct./Nov. issue now available. Only 75¢.

Order from the Ziff-Davis Service Division, 595 Broadway, New York, New York 10012. Enclose an additional 25¢ for postage and handling.

YOUR LOW COST Classified or Display Classified Ad in these columns will be seen, read and responded to regularly by America's largest audience of Electronics Professionals and Hobbyists. For \$1.50 per word (minimum \$15.00) your Classified ad will produce sales results far in excess of the small amount you'll spend on advertising. If your product or service deserves more prominent exposure to this audience, then Display Classified is for you . . . and it's available in units of 1", 2" or 3" by one column at rates of \$185.00, \$370.00 or \$555.00 per insertion (even less if you sign up for a 6 or 12-time contract. For immediate action send copy and payment NOW to: Hal Cymes, Classified Advertising Manager, POPULAR ELECTRONICS including ELECTRONICS WORLD, One Park Avenue, New York, New York 10016.

LIVE IN THE WORLD OF TOMORROW... TODAY! NEW PRODUCTS, NEW MATERIALS, NEW IDEAS!

UNUSUAL ECOLOGICAL SCIENCE BOYS

UNIQUE HARD-TO-FIND BARGAINS FOR FUN, STUDY OR PROFIT

SPECIAL VISUAL EFFECTS PROJECTOR SET



Dazzling, avant-garde visual effects. Fantastic variety. Incredibly beautiful. Special package offer contains all necessary apparatus. Create floating, exploding, fiery bursts of color, like "Symphony of Spheres", "Chromatic Starbursts", "Crystal Starburst". Features 15mm 3000 ft. Chromatic Starburst—produces big image at short distance. Accepts two 9" diam. wheels (dry) Kaleidoscope & Hexidoscope) 2 cylindrical accessories (4" colored Cloud & 5" Hexidoscope w/ six internal mirrored walls). Perfect for entertaining. Stock No. 71.212AV \$79.95 Ppd.

"FISH" WITH A MAGNET



Go treasure hunting on the bottom! Fascinating fun & sometimes profitable! Tie a line to our 5 1/2"-th. Magnet—drop it overboard in bay, river, lake or ocean. Troll it along bottom—your "treasured" haul can be ordinary anchors, nails, other metal valuables. 3/4"-th. Magnet is war surplus—Alnico V Type—Gov't. cost \$3.00. Lift over 140 lbs. on land—much greater weights under water. Stock No. 70.571AV . 5 1/2 lbs. \$14.00 Ppd. No. 60.215AV . 1 1/2 lbs. \$5.75 Ppd. 3 1/2 lbs. (40 lbs.) \$8.75 Ppd. 15 3/4 lbs. (350 lbs.) \$33.95 F.O.B.

Stock No. 70.570AV
Stock No. 85.152AV

\$8.95 ELECTRONIC STROBE



Hand-sized solid state electronic strobe light at fantastically low price. Produces bright psychedelic effects like laser, far more expensive Xenon strobes, yet it's just 2 3/4" x 4" x 1 3/8" thick. Adjustable flash rate, approx. 1 to 3-10 flashes per second. Make stop motion effects, hoaxes come alive. Great to take with you to parties, dances, outings, etc. Requires 2 (9v transistor batt. (not incl.)). Instructions. Stock No. 41.443AV \$8.95 Ppd. 4 REPLACEMENT LAMPS 1.00 Ppd.

NEW ELECTRONIC CALCULATOR—\$99.50



Terrific American-made value w/ big machine capabilities. Add, subtract, multiply, divide, do mixed calculations—silent answers in 1/100-seconds. 8 digit entry & readout w/ 14-digit cap. Auto. precise to the decimal. Also features fixed decimal, constant key, underflow, zero suppression, minus sign for true credit balance, error correction, keyboard roll over memory. Solid state; modular constr.; only 3-1/2". Year guarantee (normal use). No. 78.000AV (6 1/2" x 9 1/2" H) \$99.50 Ppd.

PHOTOCELL RELAY SYSTEM BUY! AVAILABLE AGAIN! SURPLUS PRICED!



Self contained unit adapted easily to operate burglar alarms; people, car, conveyor package counters; annunciator; garage door openers; warning systems; assembly-line controls, etc. Originally built for expensive copying machines. Includes cadmium sulfide photocell, single-pole double-throw relay, silicon rectifier, capacitor, resistor, 6.5v lamp, 7.5v 1.25v socket, 1.5sec 110v AC. Metal case (1 1/2 x 3 3/4 x 1 1/2 oz. incl. over memory). Stock No. 60.662AV \$6.95 Ppd.



MAIL COUPON FOR GIANT FREE CATALOG!

164 PAGES • MORE THAN 4000 UNUSUAL BARGAINS!

Completely new Catalog. Packed with huge selection of telescopes, microscopes, binoculars, magnifying prisms, photo components, ecology and Unique Lighting items, parts, kits, accessories—many hard-to-get surplus bargains 100's of charming illustrations. For hobbyists, experimenters, schools, industry.

EDMUND SCIENTIFIC CO.

300 Edscorp Building, Barrington, N.J. 08007
Please rush Free Giant Catalog "AV"

Name _____
Address _____
City _____ State _____ Zip _____

ASTRONOMICAL TELESCOPE KITS

Grind your own mirror for powerful telescopes. Kit contains fine annealed pyrex mirror blank, tool, abrasives, diagonal mirror, and eyepiece lenses. Instruments you build range in value from \$75.00 to hundreds of dollars. Stock No. 70.003AV
4 1/4" dia. x 7" \$10.75 Ppd.
Stock No. 70.004AV 6" dia. x 7" \$16.95 Ppd.
Stock No. 70.005AV 8" dia. x 13" \$24.50 Ppd.
Stock No. 70.006AV 10" dia. x 13" \$44.50 FOB
Stock No. 70.007AV 12 1/2" dia. x 21" \$46 lbs. \$72.50 FOB

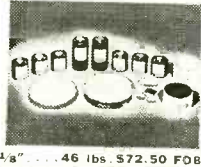

See Moon, planets, orbits, stars, phases of Venus, shutters, close up, 60-180 power, Aluminized, overcoated 3" diam. Equatorial mount with locks on both axes. 60x eyepiece and mounted Barlow. Tripod. FREE: "Star Chart." "How to Use Your Telescope."

Stock No. 85.050AV \$32.95 Ppd.
DELUXE 3" TELESCOPE
Stock No. 80.162AV \$59.50 Ppd.
No. 105.141AV \$96.50 FOB
No. 85.086AV 6" \$239.50 FOB

3" ASTRONOMICAL TELESCOPE



BOXED "LIGHT SHOW"—SAVE \$18!

Terrific price reduction brings you a fabulous Lumina Light Box under \$12! Creates ever-changing out-of-world colored forms & patterns. Hypnotic & relaxing as a glowing fireplace. They merge, turn, dance & spin in soothing, beautiful. Dramatic conversation piece for living room, rec-room, den, bedroom, bookshelf, waiting room. Especially effective amid wall picture group. Handsome 11 1/2" x 8 1/2" x 6 1/2" walnut-finished case, quality low-rpm motor 110-120V AC. Stock No. 71.180AV \$11.95 Ppd.



Solve problems, play games, predict weather with this actual working model of event electronic brains. Amazing new fun way to learn all about computer programming—logic, decimal, binary systems. Laws of Sets even do your own programming after completing simplified 116 page instructive booklet. Includes step-by-step assembly diagrams. Circuit easily changed. Readout from illuminated control panel. Rec. 2 "D" batt. (not incl.). Best model we've seen—for home, school, industry.



NEW! ELECTRONIC DIGITAL COMPUTER KIT!

Stock No. 71.434AV (11" X 12 1/2" X 4") \$31.50 Ppd.

Thrill to the fun of building your own three-through motorized model of revolutionary pistonless type engine, rights for which GM recently paid \$50 million! Only engine experts think Ed-Ed! Only engine experts think Ed-Ed! Only engine experts think Ed-Ed! Only engine experts think Ed-Ed! Only engine experts think Ed-Ed!

AMAZING NEW Wankel Engine KIT

Thrill to the fun of building your own three-through motorized model of revolutionary pistonless type engine, rights for which GM recently paid \$50 million! Only engine experts think Ed-Ed! Only engine experts think Ed-Ed! Only engine experts think Ed-Ed! Only engine experts think Ed-Ed! Only engine experts think Ed-Ed!



"Balls of fun" for kids, traffic stoppers for drivers, favorite for amateur meteorologists. Create a neighborhood sensation. Great backyard fun. Exciting beach attraction. Amateur meteorologists use to measure cloud heights, wind speed and temp. Made of heavy-duty neoprene. Inflates with water, bleach, or auto air hose, or locally available helium for high rise. Stock No. 60.588AV (8' size) \$2.00 Ppd. Stock No. 60.632AV (16' size) \$7.00 Ppd.

GIANT WEATHER BALLOONS



It's two lamps in one! Versatile fixture works with 1 or 18" block stock or fluorescent tubes. Low-cost pkg includes both with slim, flat, white baked-enamel metal case 18x3 3/4 x 1 1/2" (16"); light up posters, displays, achieve magical black-light decor. Use for ceiling, shelves, counters, cabinets. Has modern plastic diffuser (fluo. use only), built-in 110v outlet for accessories or other lamps, push-button switch, side & back mounting holes. Instr. incl. Stock No. P-71.720AV \$12.95 Ppd.

BLACK-LIGHT BARGAIN PACK

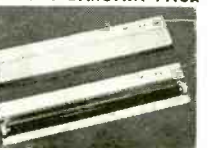

EDMUND SCIENTIFIC CO.
300 EDSCORP BLDG., BARRINGTON, NEW JERSEY 08007
CIRCLE NO. 11 ON READER SERVICE CARD

ORDER BY STOCK NUMBER • SEND CHECK OR MONEY ORDER • MONEY-BACK GUARANTEE
300 EDSCORP BLDG., BARRINGTON, NEW JERSEY 08007
CIRCLE NO. 17 ON READER SERVICE CARD

Mail the Card Today!

FREE

Find All Your Electronic Needs
In One Complete Book



468
PAGES

The World's Largest
Consumer Electronics Catalog

Featuring Everything In Electronics for:

• HOME • INDUSTRY • LABORATORY
All From One Source—All From One Catalog!

- Stereo Hi-Fi • The Latest in 4-Channel Stereo
- CB Equipment • Ham Gear • Test Equipment
- Tools • PA & Intercom Systems • TV • Radios
- Musical Instruments • Cameras • Auto Acces-
- sories • Tape Recorders • Tubes, Books, Parts
- and Much More!

Mail This Card Today for a Friend

STORE LOCATIONS

NEW YORK
NEW JERSEY
CONNECTICUT
MASSACHUSETTS

PENNSYLVANIA
MARYLAND
OHIO
ILLINOIS

GEORGIA
INDIANA
VIRGINIA
MISSOURI

LAFAYETTE RADIO ELECTRONICS
P.O. Box 10
Syosset, L.I., N.Y. 11791

Please Send the FREE CATALOG 730 35112

Name _____

Address _____

City _____ State _____ Zip _____

MAIL THIS
CARD TODAY

1973
CATALOG 730
ALL THE LATEST IN
4 CHANNEL
STEREO

FREE!

LAFAYETTE
CATALOG 730

35112

Name _____

Address _____

City _____

State _____

Zip _____

MAIL THIS
CARD TODAY

1973
CATALOG 730
ALL THE LATEST IN
4 CHANNEL
STEREO

FREE!

LAFAYETTE
CATALOG 730

35112

Name _____

Address _____

City _____

State _____

Zip _____

Mail This Card Today For Your

FREE

1973 LAFAYETTE CATALOG 730



468
Pages

- Stereo Hi-Fi • CB Equipment • Test Equipment • Musical Instruments • Ham Gear • PA Systems • Cameras • Auto Accessories • Tools • Books • Parts • and Much More!

REVOLUTIONARY NEW



Electronic Miracle of the Space Age

LAFAYETTE Leads The Way In 4 CHANNEL STEREO Components



LR-440 AM/FM
4-Channel
Stereo Receiver



Micro 23
CB 2-Way Radio



Dyna-Com
Walkie-Talkies



Musical
Instruments &
Accessories

Do A Friend A Favor . . .

Have a friend interested in hi-fi or electronics? Send us his name and address and we will send him his own personal copy of the 1973 Lafayette Catalog 730.

Mail the Card Today!

LAFAYETTE

RADIO ELECTRONICS

P.O. BOX 10

SYOSSET, L.I., N.Y. 11791

PLACE
STAMP
HERE

LAFAYETTE

RADIO ELECTRONICS

P.O. BOX 10

SYOSSET, L.I., N.Y. 11791

PLACE
STAMP
HERE

Popular Electronics

INCLUDING Electronics World

READER SERVICE

FREE INFORMATION

Here's an easy and convenient way for you to get additional information about products advertised or mentioned editorially (if it has a reader service number) in this issue. Just follow the directions below... and the material will be sent to you promptly and free of charge.

OCTOBER 1972/FIFTY CENTS

Popular Electronics

INCLUDING Electronics World

- Install a HOME TV ANTENNA DISTRIBUTION SYSTEM
- PUBLIC ADDRESS SYSTEMS - Frequently Asked Questions
- ANTI-COLLISION DEVICES FOR CARS
- NUCLEAR RADIATION & DETECTION

BUILD:

- Impedance Meter
- Diode Substitution Box
- Micro-Chemical Hygrometer

Rectilinear III LowBoy Speaker
Heath CO-1015 Ignition Analyzer
Rotel RA-310 Stereo Amplifier
Koss K2+2 Quadraphonic Headphones
Electra Bearcat III Monitor Receiver

1. On the attached postage-free card, print or type your name and address on the lines indicated.

2. Circle the number (s) that corresponds to the key number (s) at the bottom or next to the advertisement or editorial mention that is of interest to you. (Key numbers for advertised products also appear in the Advertisers' Index.)

3. Simply cut out the card and mail. No postage required.



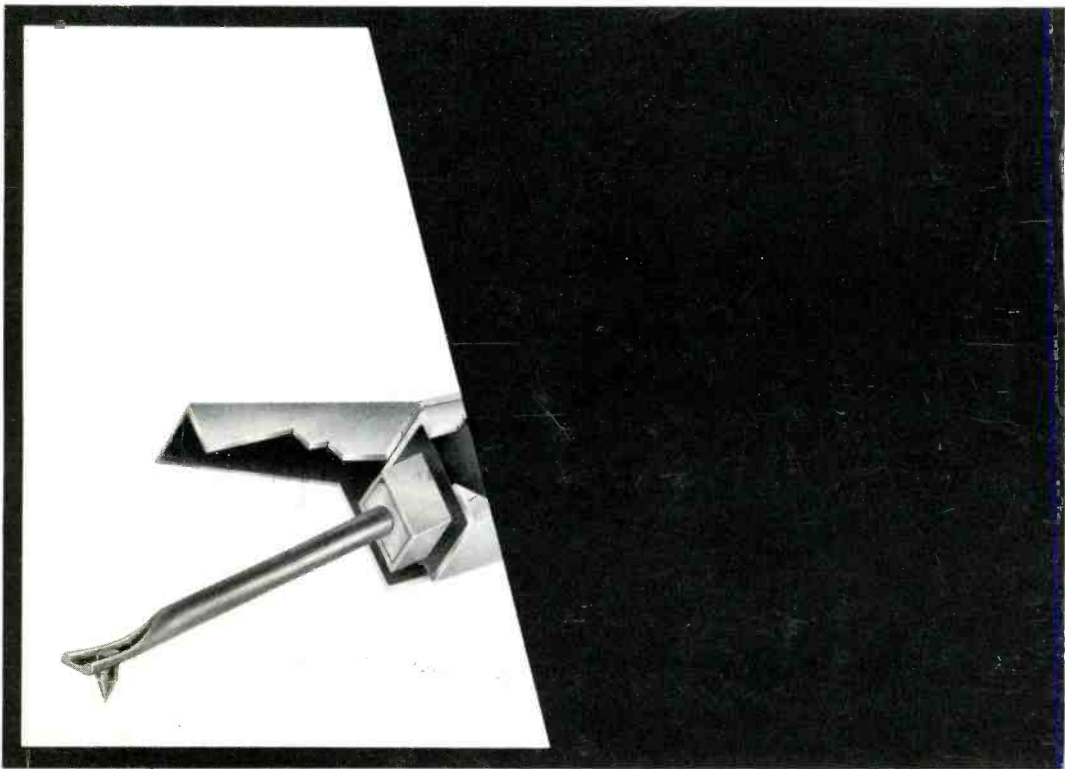

Straight talk about a stylus



Listen carefully and you can still hear some audiophiles refer to the record stylus as... "the needle." Although we are not about to quibble over semantics, we would like to go on record, so to speak, as observing that the stylus of today bears no more resemblance to a needle than it does to a ten-penny nail. In fact, it is probably the most skillfully assembled, critically important component in any high fidelity system. It must maintain flawless contact with the undulating walls of the record groove — at the whisper-weight tracking forces required to preserve the fidelity of your records through repeated playings. We put everything we know into our Shure Stereo Dynetic Stylus Assemblies — and we tell all about it in an informative booklet. "Visit To The Small World Of A Stylus." For your copy, write:

Shure Brothers Inc.
222 Hartrey Ave., Evanston, Ill. 60204



CIRCLE NO. 3 ON READER SERVICE CARD