

Popular Electronics

INCLUDING **Electronics World**



WHICH
TV ANTENNA
FOR YOUR VIEWING AREA

DO YOU
WANT TO BE A
HAM?

REPORT ON
**COMMUNICATIONS
SATELLITES**
FROM ECHO I TO
INTELSAT IV

BUILD:
• A Digital Volt/Ohmmeter
• A Hard-to-fool
Infrared Intrusion Alarm

TEST REPORTS:

- Lafayette LA-44 4-Channel Amp
- Shure V-15 II Phono Cartridge
- Johnson 124 M CB Transceiver
- Kikusui ORC-27A Audio Generator
- Sencore FE160 Field Effect Meter
- Weston 1250 Frequency Counter
- Signal Science Whistle Switch

WHAT YOU
SHOULD KNOW
WHEN BUYING
A
**REEL^{TO} REEL
TAPE
RECORDER**



37C8015 DLCH 245A6C1 C2
REGG8010CC2EC44001AB 012
M DELSCHLAGER
RX 245
BROWNS MILLS NJ 08015

EXPERIENCE IS STILL YOUR BEST TEACHER



NRI designed-for-learning training equipment gives you priceless confidence because your hands are trained as well as your head.

Learning Electronics at home the NRI way is fast and fascinating. Read opposite page.



**OLDEST AND LARGEST
SCHOOL OF ITS KIND**

Accredited by the Accrediting Commission of the National Home Study Council

You get more for your money from NRI

—more value, more solid experience so essential to careers in Electronics. NRI's pioneering "discovery" method is the result of more than half a century of simplifying, organizing, dramatizing subject matter. In each of NRI's major courses you learn by doing. You demonstrate theory you read in "bite-size" texts programmed with NRI designed-for-learning professional lab equipment. Electronics comes alive in a unique, fascinating way. You'll take pleasure in evidence you can feel and touch of increasing skills in Electronics, as you introduce defects into circuits you build, perform experiments, discover the "why" of circuitry and equipment operation.

Almost without realizing it, the NRI discovery method gives you the professional's most valuable tool—practical experience. You learn maintenance, installation, construction and trouble-shooting of Electronic circuits of any description. Whether your chosen field is Industrial Electronics, Communications or TV-Radio Servicing, NRI prepares you quickly to be employable in this booming field or to earn extra money in your spare time or have your own full-time business. And you start out with training equivalent to months—even years—of on-the-job training.

NRI Has Trained More Men for Electronics Than Any Other School

—By actual count, the number of individuals who have enrolled for Electronics with NRI could easily populate a city the size of New Orleans or Indianapolis. Over three-quarters of a million have enrolled with NRI since 1914. How well NRI training has proved its value is evident from the thousands of letters we receive from graduates. Letters like those excerpted below. Take the first step to a rewarding new career today. Mail the postage-free card. No obligation. No salesman will call. NATIONAL RADIO INSTITUTE, Electronics Division, Washington, D.C. 20016.



L. V. Lynch, Louisville, Ky., was a factory worker with American Tobacco Co., now he's an Electronics Technician with the same firm.

"I don't see how the NRI way of teaching could be improved."



G. L. Roberts, Champaign, Ill., is Senior Technician at the U. of Illinois Coordinated Science Laboratory.

In two years he received five pay raises. Says Roberts, "I attribute my present position to NRI training."



Don House, Lubbock, Tex., went into his own Servicing business six months after completing NRI training.

This former clothes salesman just bought a new house and reports, "I look forward to making twice as much money as I would have in my former work."



Ronald L. Ritter of Eatontown, N.J., received a promotion before finishing the NRI Communication course, scoring one of the highest grades in Army proficiency tests.

He works with the U.S. Army Electronics Lab, Ft. Monmouth, N.J. "Through NRI, I know I can handle a job of responsibility."

APPROVED UNDER NEW GI BILL. If you served since January 31, 1955, or are in service, check GI line on postage-free card.

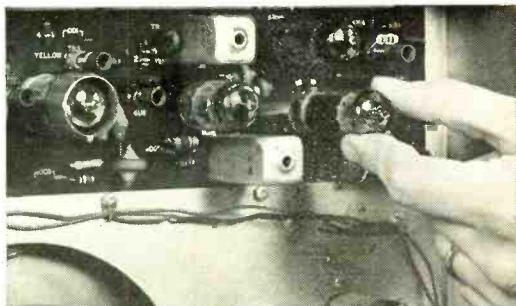

COLOR TV CIRCUITRY COMES ALIVE

as you build, stage-by-stage, the only custom Color-TV engineered for training. You grasp a professional understanding of all color circuits through logical demonstrations never before presented. The TV-Radio Servicing course includes your choice of black and white or color training equipment.



COMMUNICATIONS EXPERIENCE

comparable to many months on the job is yours as you build and use a VTVM with solid-state power supply, perform experiments on transmission line and antenna systems and build and work with an operating, phone-cw, 30-watt transmitter suitable for use on the 80-meter amateur band. Again, no other home-study school offers this equipment. You pass your FCC exams—or get your money back.

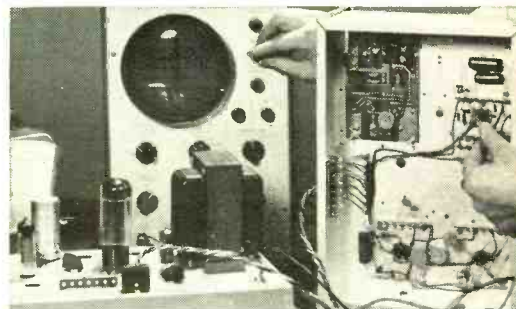

COMPETENT TECHNICAL ABILITY

can be instantly demonstrated by you on completing the NRI course in Industrial Electronics. As you learn, you actually build and use your own motor control circuits, telemetering devices and even digital computer circuits which you program to solve simple problems. All major NRI courses include use of transistors, solid-state devices, printed circuits.

Popular Electronics

WORLD'S
LARGEST-SELLING
ELECTRONICS MAGAZINE

INCLUDING **Electronics World**

FEATURE ARTICLES

16 THE END OF AN ERA

David Sarnoff pioneered in developing radio and TV

28 COMMUNICATIONS SATELLITES *Len Buckwalter*

Radio relays in the sky are helping solve the communications explosion by making more room available for everyone

42 CHOOSING A TV ANTENNA *Forest H. Belt*

A guide to what to, and what not to, look for, including a complete listing by manufacturer of recommended antennas

46 FIRST AMERICAN-MADE QUARTZ WATCH

47 HOW TO SELECT A REEL-TO-REEL TAPE RECORDER *Julian D. Hirsch*

Avoid expensive mistakes and get the right model for you

55 SOLID-STATE TV CAMERA SENSOR

66 WHAT DO HAMS DO? *Don Waters*

70 TVI FROM THE VICTIM'S VIEWPOINT *John T. Frye*

Interference may be due to one of a number of causes

98 NEW IR LASER COMMUNICATOR

CONSTRUCTION STORIES

34 INEXPENSIVE WHEATSTONE BRIDGE *Robert P. West, Jr.*

36 CONTROLLING DC MOTORS *Lawrence Fleming*

51 INFRARED INTRUSION ALARM *Hank Olson*

Modulated beam defies "pooling" or power cutoff

Modulated beam defies "fooling" or power cutoff

60 DIGITAL VOLT-OHMMETER PLUG-IN MODULE *Daniel Meyer*

Measures voltages to 1999; resistances to 199,000 ohms

96 A SIMPLE SW CONVERTER *Larry Lisle*

ZIFF-DAVIS PUBLISHING COMPANY

Editorial and Executive Offices
One Park Avenue, New York, New York 10016
212 679-7200

William Ziff, President

W. Bradford Briggs, Executive Vice President
Hershel B. Sarbin, Senior Vice President and Secretary
Stanley R. Greenfield, Senior Vice President
Philip Sine, Financial Vice President and Treasurer
Phillip T. Heffernan, Vice President, Marketing
Frank Pomerantz, Vice President, Creative Services
Arthur W. Butzow, Vice President, Production
Edward D. Muhlfeld, Vice President, Aviation Division
Irwin Robinson, Vice President, Travel Division
George Morrissey, Vice President
Sydney H. Rogers, Vice President
Lawrence Sporn, Circulation Director

POPULAR ELECTRONICS Including ELECTRONICS WORLD, March 1972, Volume 1, Number 3. Published monthly at One Park Ave., New York, NY 10016. One year subscription rate for U.S., U.S. Possessions and Canada, \$6.00; all other countries, \$7.00. Second class postage paid at New York, N.Y. and at additional mailing offices. Authorized as second class mail by the Post Office Department, Ottawa, Canada and for payment of postage in cash. Subscription service and Forms 3579; P.O. Box 1096, Flushing, NY 11352. Editorial offices for manuscript contributions, reader inquiries, etc.: One Park Ave., New York, NY 10016.

POPULAR ELECTRONICS Including ELECTRONICS WORLD is indexed in the Reader's Guide to Periodical Literature.

Copyright © 1972 by ZIFF-DAVIS PUBLISHING COMPANY. All rights reserved.

EDGAR W. HOPPER
Publisher
WM. A. STOCKLIN
Editorial Director
MILTON S. SNITZER
Editor
LESLIE SOLOMON
Technical Editor
JOHN R. RIGGS
Managing Editor
EDWARD I. BUXBAUM
Art Director

ALEXANDER W. BURAWA
Associate Editor
ANDRE DUZANT
Technical Illustrator
JUDITH L. HOGAN
Editorial Assistant
FOREST H. BELT
JOHN T. FRYE
DAVID L. HEISERMAN
J. GORDON HOLT
RICHARD HUMPHREY
Contributing Editors

JOSEPH E. HALLORAN
Advertising Director
RICHARD J. HALPERN
Advertising Manager
MADELEINE LITTMAN
Advertising Service Manager
STANLEY NEUFELD
Associate Publisher
FURMAN H. HEBB
Group Vice President
Electronics and Photographic

THE SCENES

- 10 STEREO SCENE** *J. Gordon Holt*
What tracking distortion means in phono cartridges
- 100 COMMUNICATIONS SCENE** *Richard Humphrey*
Used marine gear provides a windfall for hams
- 114 TEST EQUIPMENT SCENE** *Leslie Solomon*
What's new in VOM's, VTVM's, and TVM's
- 118 SURPLUS SCENE** *Alexander W. Burawa*
Semiconductors are being offered in quantities

PRODUCT TEST REPORTS

- 78 LAFAYETTE LA-44 FOUR-CHANNEL STEREO AMPLIFIER**
- 80 SHURE V-15 TYPE II (IMPROVED) STEREO PHONO CARTRIDGE**
- 82 E.F. JOHNSON MESSENGER 124-M CB TRANSCEIVER**
- 84 WESTON 1250 DIGITAL FREQUENCY COUNTER**
- 88 KIKUSUI ORC-27A AUDIO SIGNAL GENERATOR**
- 90 SENCORE FE160 SENIOR FIELD EFFECT MULTIMETER**
- 91 SIGNAL SCIENCE WHISTLE SWITCH**

DEPARTMENTS

- 6 EDITORIAL** *Milton S. Snitzer*
- 8 LETTERS**
- 24 NEWS HIGHLIGHTS**
- 99 NEW LITERATURE**
- 104 NEW PRODUCTS**
- 108 ELECTRONICS LIBRARY**

READER SERVICE CARD ON BACK COVER

Midwestern Office
The Pattis Group, 4761 West Touhy Ave.,
Lincolnwood, Illinois 60644, 312 679-1100
GERALD E. WOLFE, DICK POWELL
DICK GOVATSKI, MANLEY LUDWIG

Western Office
9025 Wilshire Boulevard, Beverly Hills, California 90211
213 273-8050; Bradshaw 2-1161
Western Advertising Manager, BUD DEAN

Japan: James Yagi
Oji Palace Aoyama; 6-25, Minami Aoyama
6 Chome, Minato-Ku, Tokyo 407-1930/6821

Ziff-Davis also publishes Boating, Car and Driver, Cycle, Flying, Modern Bride, Popular Photography, Skiing, and Stereo Review.

Forms 3579 and all subscription correspondence should be addressed to POPULAR ELECTRONICS Including ELECTRONICS WORLD, Circulation Department, P.O. Box 1096, Flushing, NY 11352. Please allow at least eight weeks for change of address. Include your old address, as well as new—enclosing, if possible, an address label from a recent issue.

Editorial contributions must be accompanied by return postage and will be handled with reasonable care; however, publisher assumes no responsibility for return or safety of art work, photographs or manuscripts.



MPA
Member Audit Bureau
of Circulations



Editorial

By Milton S. Snitzer, Editor

PARTS FOR CONSTRUCTION PROJECTS

In the Parts Lists for a number of our construction projects, we indicate that the printed circuit board, or the semiconductors, or a complete kit of parts is available from one of a number of suppliers. We do this strictly as a matter of convenience to readers who may have difficulty in obtaining the parts separately for a given project. Even if the parts, especially the semiconductors, are available, they may be quite expensive if bought in single-unit quantities. The kit supplier is able to order a large quantity and pass on his cost savings to you. We have no financial interest or stake in any such offerings and the only reason we continue to list such sources of supply is strictly for the benefit and convenience of our readers.

We sometimes get bitter letters from the very readers we are trying to help. Some of these letters tell us that readers have sent in money orders or checks for kits of parts from one of the suppliers listed and weeks go by without any response. Such readers invariably blame us, the kit supplier, and anyone else within earshot.

While we don't want to make excuses for poor service or unfilled orders, all of these kit suppliers we have talked to are trying to do an honest, conscientious job of supplying their customers' needs. After all, this is where they make their money. In most cases, the problem has been very slow delivery of parts to the kit supplier, especially transistors and IC's from the semiconductor manufacturer. With the general slow-down in the electronics economy, it is natural that some delivery slow-downs occur.

In other cases, our authors may specify a brand-new integrated circuit. There is always the possibility that, as with any new product, unanticipated production problems may crop up. Until these problems are ironed out, delivery of the product is halted. This is another reason for the delay in getting parts to the kit supplier and the delay in getting the parts to you.

Keep in mind that the kit supplier is just as anxious to fill your order as you are to get it. And in most cases, the orders are being filled promptly and to the satisfaction of those receiving the kits or components. In the few cases where there is a delay, all we can ask is that you be a little patient with those suppliers who are biting their fingernails just as you are.

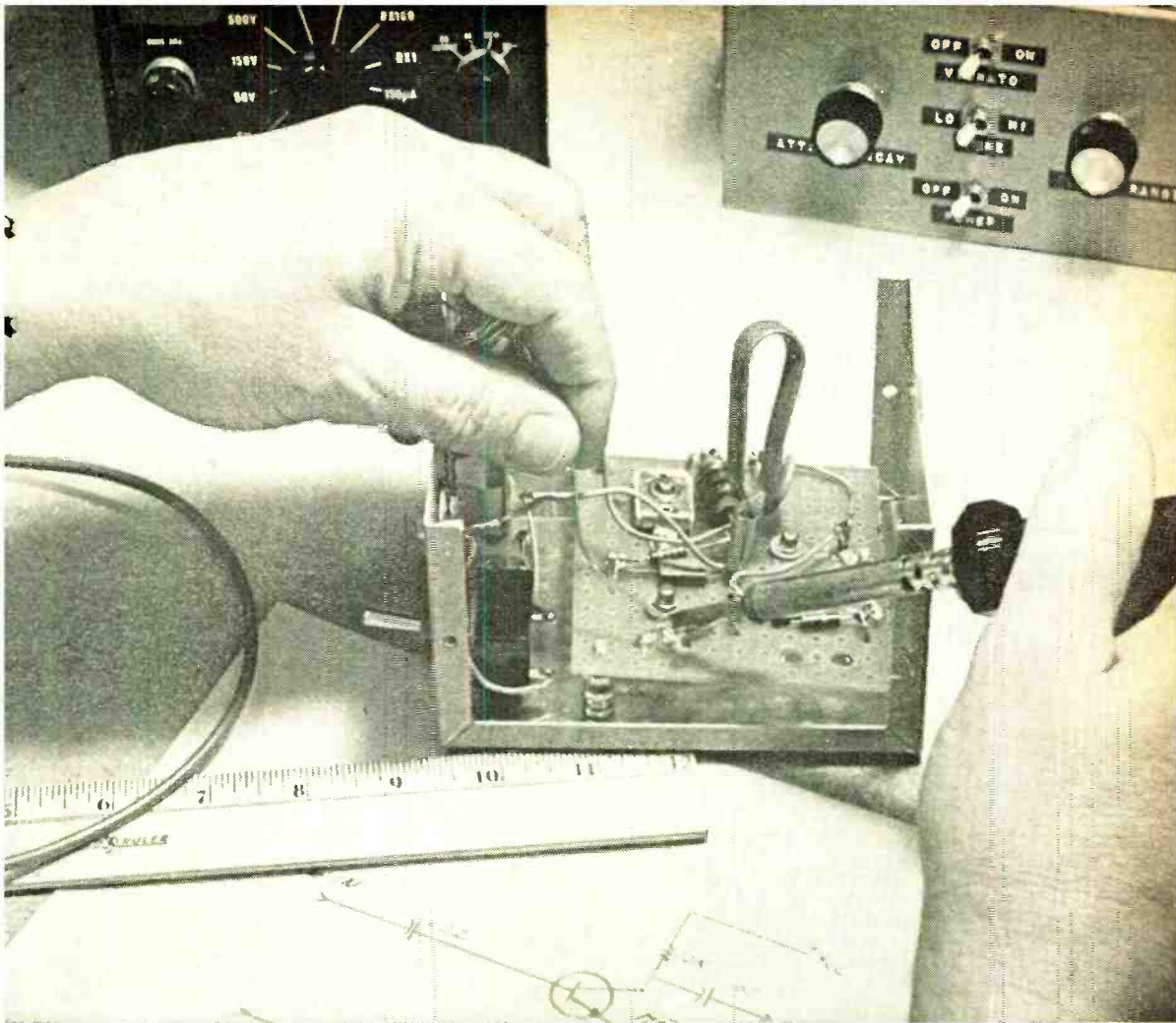

Most electronic hobbyists aren't

Aren't exactly simple hobbyists, that is. They attack most projects with a good deal of professionalism — in knowledge, in experience, in care about components, etc. Small wonder they've contributed so many important discoveries; so frequently "scooped" the pros.

We have a lot of respect for "hobbyists" like that. Enough to segment an entire line of semiconductor just for them. We're talking about our special HEP line: more than 500 ultra-reliable devices (replacing over 30,000 types) of particular interest to hobbyists, offered through distributors they frequent, at prices structured especially for them, coupled with the industry's best collection of project literature and cross-reference material.

No other semiconductor manufacturer has a program anything like it. In fact, many have little interest in this "small numbers" hobbyist business.

Fine. We would like to have it all.



MOTOROLA HEP Semiconductors

P. O. Box 20924, Phoenix, Arizona 85001

CIRCLE NO. 23 ON READER SERVICE CARD

meet the metrics

Xcelite's where the Metrics are!

A great variety of tools and sets to help you turn most any Metric fastener or adjusting screw you're likely to encounter . . . hex socket set screws and cap screws, hex nuts, hex head cap screws, and whatever.

All tools precision made for exact fit. Bright nickel chrome nutdriver shafts and protective black oxide finished hex socket screwdriver blades. Plastic (UL) handles shaped for perfect grip and balance.

FIXED HANDLE NUTDRIVERS



NUTDRIVER SHANKS & HEX SOCKET SCREWDRIVER BLADES for use interchangeably in Series 99 plain and ratchet type handles.

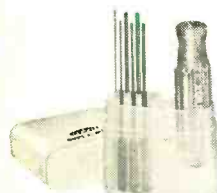

COMPACT SETS
No. 99-PS-41-MM
(7 Metric hex socket blades, extension and handle)



No. 99-PS-51-MM
(10 Metric nutdriver shanks, extension and handle)

nationwide availability through local distributors



XCELITE, INC.,
20 BANK ST., ORCHARD PARK, N. Y. 14127

Send Catalog with information on Xcelite Metric Tools.

name _____

address _____

city _____ state & zip _____

CIRCLE NO. 40 ON READER SERVICE CARD

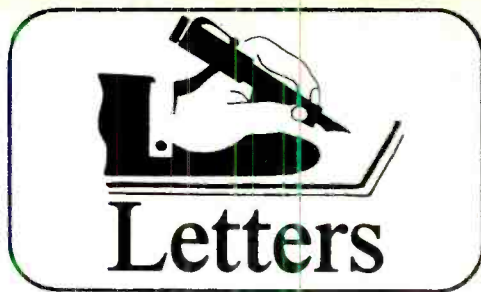

A SUCCESS THE FIRST TIME OUT

For some time, I had been contemplating whether to take the easy way out and bread-board a keyer circuit I had in mind or to try making a printed circuit board for my project. Having never used either technique for building a project, the decision wasn't easy to make. However, when I picked up a copy of the December issue and ran across "Adhesive Stencil Technique For PC Boards," I opted for the PC board.

After buying the materials needed, I carefully followed the published instructions in making my PC board. Now my keyer is a reality. Many thanks for a fine article.

HOWARD S. STERLING, WN2AYE
Lakewood, N.J.

MORE WANTED ON ELECTRONIC MUSIC

Lately, I have been doing a lot of reading about electronic musical instruments and synthesizers. I am really overjoyed when I see articles in POPULAR ELECTRONICS (Including ELECTRONICS WORLD) having to do with electronic musical instruments and accessories. I wish you had more of the same.

In attempting to locate more material on electronic music, and especially synthesizers, I have drawn a blank. Where and how can I obtain literature on this subject?

STEVE GERICK
Florissant, Mo.

We agree with Steve; it is difficult to find material on electronic music. Always attuned to the desires of our readers, we strive to give you what you ask for. A good example is the story on electronic music in our February 1972 issue.

MEDICAL ELECTRONICS COURSE REVISITED

Just a note to tell you of the many inquiries I have received as a result of my letter expressing concern over the lack of interest in a home study medical electronics course. Now might be the time to take another poll. I believe that there is a growing interest by high school graduates to enter the medical electronics field. Many colleges are now offering bio-medical degrees, from the associate through the PhD lev-

els. I believe that a home study course should be made available to those people incapable of attending formal sessions.

BURTON R. KLEIN
Medical Electronics Engr.
Director, Medical Electronics Dept.
New England Medical Center
Boston, Mass.

We'll try again. Anyone who is interested in seeing one or another of the home study schools institute a medical electronics course in their curriculum should address a postcard to this effect to the Letters Editor. If the response is large enough, we will carry the ball from that point on.

ELECTROLUMINESCENT PANEL SUPPLIER FOUND

Your editorial comment in the September 1971 issue indicated that Sylvania gave up the electroluminescent (EL) panel business. But Tau Electronic Products, Inc., Emporium, PA 15834, has recently completed negotiations with Sylvania Electric Products for acquisition of their EL lighting panel operation.

Tau has been a supplier of EL display devices—numeric, alpha-numeric, bar graphs, and random panels—for some time. With our recent acquisition, we can now provide the full range of electroluminescent products, including glass, metal, and plastic panels.

W. PAUL O'HERN
Marketing Manager

OUR DESK CALCULATOR PROJECT

You may be interested to learn that an electronic calculator such as the one described in the November 1971 issue can be obtained for \$169 from a couple of business machine suppliers. I think that people who buy your kit for \$179 may feel bad about it.

C. R. LEWART
Holmdel, N.J.

We, too, have noticed the increased availability of calculators under \$200 with some going as low as \$169 complete and ready to go. People who buy these machines are getting a bargain. But remember that our machine was undergoing design for more than a year when similar-performance calculators were costing in excess of \$400.

Recently, a number of Oriental calculators became "surplus" as the manufacturers began to open their own IC plants and switched away from American supply sources. Many of the units seen around are using the last of the specialized American IC's. Our calculator, on the other hand, employs readily available American IC's and has features not found in the low-priced units. Check the features, and you will readily see that there is a big difference between "theirs" and "ours."

MARCH 1972

CAN YOU QUALIFY

HELP WANTED

CIRCUIT DESIGNERS

Salary:
\$12,000 to \$17,500

Requirements:
BSEE or EQUAL

ANY COMPANY
EVERYWHERE. USA

for a high paying
& secure position
as a...

CIRCUIT DESIGNER?

Chances
are you
can!

DEGREE REQUIREMENT WAIVED!

The need for Circuit Designers is so great that employers will put aside the degree requirement to move up or hire men with these skills. In every industry there are men holding these prestigious positions who do not have a degree in engineering. WHY NOT YOU?

UP-TO-DATE TRAINING!

Our programs are not a rehash of the electronics you already know, but intensive training in the electronics you do not know. They offer you "hands-on" learning of how to design circuits using the latest devices. Included are: transistors, IC's, FET's, IC power supply regulators, UJT's... plus more. ARE YOU READY FOR TODAY'S ELECTRONICS?

LOW COST!

Because these courses are highly specialized, you can choose a curriculum which best suits your needs. And, most important, you can learn at a price you can best afford. CAN YOU AFFORD TO WAIT ANOTHER DAY?

FREE! Send for literature on how you can qualify for training as a CIRCUIT DESIGNER.

NOT FOR
BEGINNERS

The Center For Technical Development, Inc.

517 E. Main St., Louisville, Oh., 44641
PE32

Gentlemen, please send me complete details on your CIRCUIT DESIGN courses.

Name _____ Age _____

Address _____

Zip _____

CIRCLE NO. 47 ON READER SERVICE CARD



Stereo Scene

By J. Gordon Holt

WITH all the excitement these days about magnetic tape and its new high-potency oxide coatings and Dolby B noise reduction, it may come as a surprise that many hi-fi perfectionists prefer to listen to discs. In fact, in this age of electronic everything, it would seem ironic if the best—that is, the highest-fi—medium for home-music reproduction should be mechanical. Yet a surprising number of the most critical listeners maintain that discs have lower noise (if you keep them clean enough), lower electrical distortion and far more transparency (hear-through-ability) than prerecorded tapes.

But if we dig a little deeper into the disc situation, we find there is a fly in the ointment, and even the most loyal discophile will admit that it can be irritating. Discs suffer from tracking or tracing distortion. It may be inaudible much of the time, or it may be a constant source of annoyance, but it is always there to some extent.

A pickup stylus works between a set of conflicting requirements. It must be rugged enough to withstand the rigors of normal handling, yet light enough to be able to change direction (in response to the groove's direction) almost instantly. It

must be stiff enough to move the whole tone arm with it when tracing warps, eccentricities, and the groove's spiral path, yet it must be flexible enough to respond to the groove's undulations without putting destructive pressure on the groove walls. And to complicate matters, the disc's slow rotational speed, the softness of the vinyl, and the very wide dynamic range of some kinds of music dictate that the whole system be operated right on the edge of impracticability, with excessive record wear on one side and mistracking on the other.

Because of the conflicting design requirements, a pickup is always "fighting" the groove, resisting its efforts to flex the stylus by bearing down first on one groove wall and then on the other. As long as these changing inequities of force against the groove wall are reasonably modest, the stylus will continue to touch both walls and the sound will be clean. But the recording industry's thirst for ever-higher recording levels ensures that, at any given state of the art of pickup design, a certain number of discs will always be modulated heavily enough to cause some mistracking with some pickups.

Why Are They Preferred? How then can so many critical hi-fi hobbyists prefer discs to tapes, whether or not discs are better in other ways? Because, even though tracking distortion can't be completely eliminated, it *can* be kept under control to the point where it is no longer a serious consideration from 95 per cent of available discs. This requires doing two things: Using a pickup whose tracking ability is excellent to begin with, and seeing that nothing else in the system makes whatever tracking distortion *does* occur sound any worse than it has to.

In testing labs, it is customary to use harmonic or intermodulation distortion

Tracking Distortion in Phono Cartridges

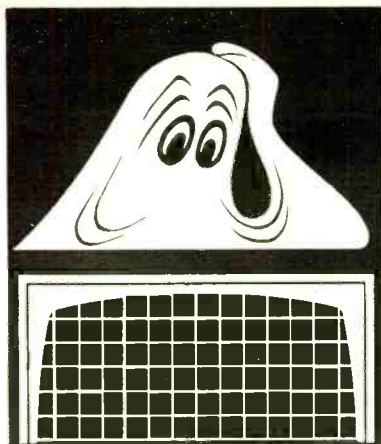

Two new B&K digitals that don't stand a chance of a ghost.

Ghosts, blurs, wiggles, jitters . . . whatever you call them, you won't get them with our two new digital color generators. You can converge, install or trouble-shoot color TV's quickly and accurately. Because these two units employ totally new concepts that take the trouble out of trouble-shooting.

Integrated circuit flip-flops perform all binary counting functions. Just no way they can jump a count. Result: Crisp, clean, stable test patterns.

And all IC's (nine of them) and transistors are silicon devices, which means they can withstand severe weather changes with no effect on performance.

The 1243 is a basic 6 pattern color generator. The deluxe 1246 has nine patterns, three more than the 1243, and

also features a 4½ MHz sound carrier, crystal controlled RF for channels 3 and 4, gun killers, and comes with its own instant-use case.

All the accuracy and reliability of a computer in these compact units, and they're guaranteed to be maintenance free, making your job a lot easier.

So don't get a CBG that may come back to haunt you. Get one of B&K's new digital generators: They don't have a chance of a ghost.



Products of
DYNASCAN CORPORATION
1801 W. Belle Plaine
Chicago, Illinois 60613

The new standard of stability

(Ask your distributor or write us for complete catalog)

1. B&K Model 1246 Color Generator **\$149.95**



2. B&K Model 1243 Color Generator **\$99.95**

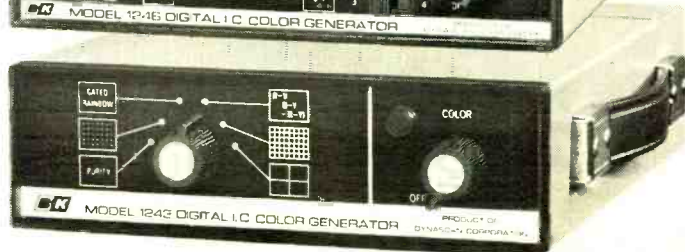

CIRCLE NO. 7 ON READER SERVICE CARD

analyzers for checking a pickup's tracking ability. These devices will show clearly when mistracking sets in, and how severe it is. But the measurements obtained with them are valid only for direct comparisons between different pickups because there is little correlation between the measured distortion and its actual audibility. This is true for two reasons: first, tracking distortion consists of wideband noise impulses rather than harmonics or sum-and-difference tones; and second, its audibility depends almost as much on the associated equipment in the system as it does on the pickup's actual tracking ability.

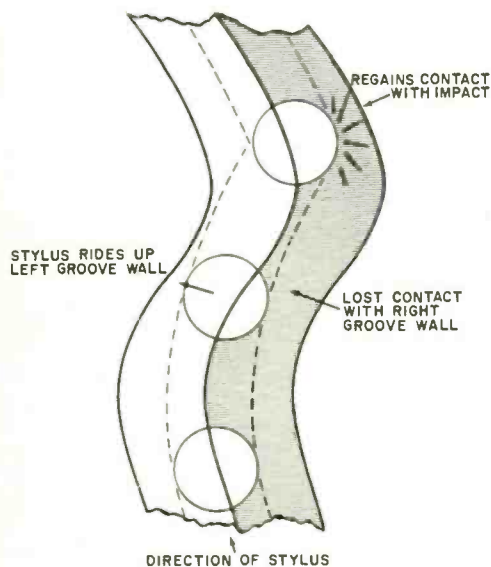

When stylus loses contact with one wall and rides up other, it returns to the first with a noisy impact sound.

Ideally, the rounded tip of a playback stylus maintains constant contact with both of the straight walls of the V-shaped groove. This ideal is realized as long as the stylus is able to respond to the directional urgings of the groove. Once the ability of the stylus to respond is exceeded, though, it will try to ride up over each groove modulation instead of taking the long way around. Each time it does this, it loses contact with one groove wall and then, a fraction of a second later, regains the lost contact with a sharp impact. The impact, of course, causes an audible click through the reproducing system, and it is a whole series of these clicks, strung end to end, that causes the nerve-fraying fuzz.

As mentioned previously, all pickups mistrack to some extent, if subjected to sufficiently high recording levels. But since some do it less than others, the choice of one's pickup will determine at the outset how much tracking distortion goes into the amplifying system. Both compliance and moving mass determine how readily a stylus will follow high modulation levels, but the "trackability" specifications devised by Shure Brothers are among the best indications of a pickup's capabilities in this respect. Some pickups with excellent tracking ability are not rated in this way, perhaps because their manufacturers didn't invent the trackability test, so magazine test reports are probably the best source of information about the relative tracking ability of available pickups.

The Tonearm. Audiophiles know that a tonearm should have low friction and tolerably low mass in order to allow a pickup to be tracked at the lowest possible force. But less well-known is the fact that tiny resonances of the arm and headshell can impair the apparent tracking ability of any pickup. An arm with viscons-damped pivots will often make a cartridge sound cleaner-tracking at a given force than an undamped arm, apparently because its pivots cannot rattle as can undamped ones. Some of the straight-line-tracking tonearms have a reputation for making any given cartridge sound cleaner than a pivoted arm, but whether this is because of the virtually perfect tangency (pivoted arms can be made perfectly tangential to inner grooves too) or because of something else is a matter of conjecture.

Clean tracking is only the first step toward excellent disc sound, though. The noise impulses produced by a mistracking stylus span a wide range of frequencies, but contrary to expectation, the noise is not entirely high-frequency energy. There is some contribution in the over-12-kHz range, but the energy occurs predominantly in the range between 5,000 and 10,000 Hz. Because it is fairly wideband, though, anything which exaggerates the system's output anywhere in the upper-frequency range will also exaggerate tracking distortion. A pickup or speaker system with a rising high end will do this, and sharply resonant peaks do an even better job of it. A sharp resonance causes a clumping of the noise energy

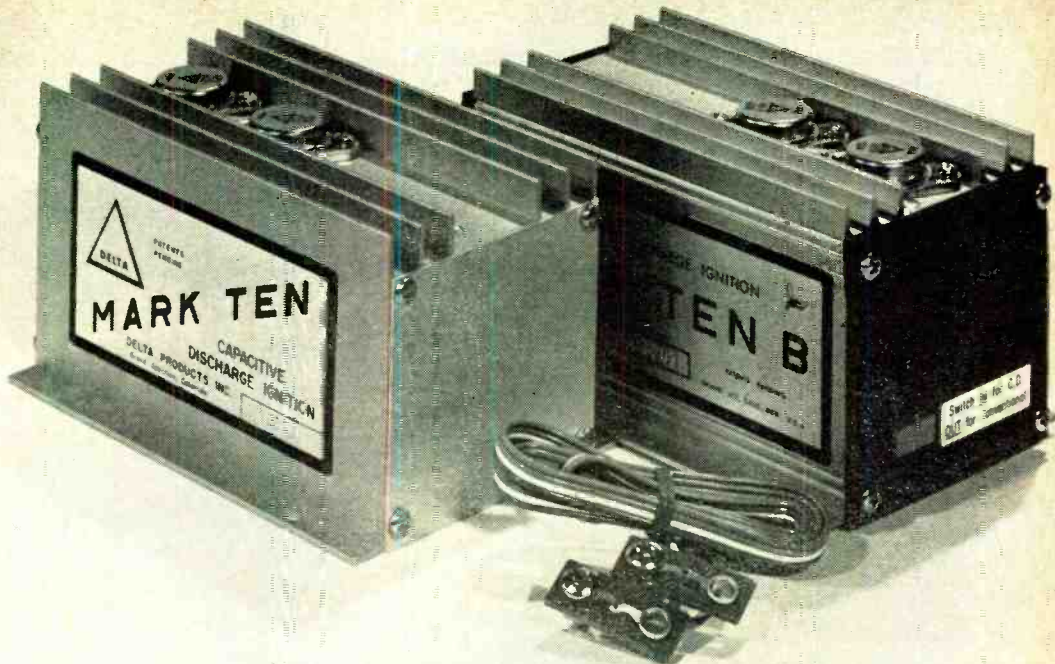

Save money and improve car performance at the same time. Maintenance costs go down and performance increases when you put a Delta Mark Ten Capacitive Discharge Ignition System on your car.

For eight years we've been telling you about the tremendous advantages of CDI systems. We've promised and delivered better performance for cars, boats and trucks. Hundreds of thousands of satisfied customers testify to that fact. However during these eight years, we've been asked over and over again, "If CDI systems are so great, why doesn't Detroit adopt them?" It's taken a long time, but finally Detroit has recognized the value of the CDI system. Chrysler, long noted for excellence in engineering, is now installing CDIs in new cars. Have you seen their ads? Heard their commercials? They're repeating what we've said for eight years. *CDI systems not only improve performance, but eliminate the need for most tune-ups.* If you're not buying a new car, but want new car performance, put a Mark Ten or Mark Ten B on your present automobile. If you're purchasing a new car with no CDI system, install a Mark Ten or Mark Ten B and enjoy the benefits of low maintenance and increased performance.

HERE'S WHAT A MARK TEN WILL DO FOR YOU:

Mark Ten and Mark Ten B—up to 20% increase in gasoline mileage Eliminates 3 out of 4 tune-ups Installs in only 10 minutes Spark plugs last 3 to 10 times longer Dramatic increase in performance Promotes more complete combustion Instant starts in all weather.

Mark Ten B—Improves combustion, reducing contaminants Handy switch with redundant contacts for instant return to standard ignition Applicable to ANY 12 volt negative ground engine Eliminates starting and idle problems Longer spark duration during cranking and idling.

Superior Products at Sensible Prices

Mark Ten (Assembled) \$44.95
ppd

Mark Ten (Deltakit) \$29.95
ppd

Kit available in 12 volt only,
positive or negative ground

Mark Ten B \$59.95 ppd
(12 volt negative ground only)

Order today!



Dept PE
DELTA PRODUCTS, INC.

P.O. Box 1147 / Grand Junction, Colo 81507
(303) 242-9000

Please send me literature immediately:

Enclosed is \$ _____ Ship ppd. Ship C.O.D.

Please send:

___ Mark Ten B @ \$59.95

___ Standard Mark Ten (Assembled) @ \$44.95

___ 6 Volt: Neg. Ground Only ___ Positive Ground

___ 12 Volt: Specify ___ Negative Ground

___ Standard Mark Ten (Deltakit) @ \$29.95
(12 Volt Positive Or Negative Ground Only)

Car Year _____ Make _____

Name _____

Address _____

City/State _____ Zip _____

**CIRCLE NO. 11
ON READER SERVICE CARD**

and, since this tends to set the resonance ringing, it further enhances the audibility of the mistracking clicks by making them last longer.

On the other hand, a pickup whose frequency response is depressed within the 5,000-to-10,000 Hz range will reduce the audibility of tracking distortion, making the pickup sound as if it is tracking more cleanly than it actually is. This will also tend to kill much of the brilliance and "aliveness" of the reproduced sound, yet, among audiophiles, some of these pickups are very popular simply because they *do* reduce brilliance—the excessive brilliance that stems from "inaudible" amplifier distortion.

Audio engineers have always spent an inordinate amount of time trying to prove that measured distortion is not really all that audible. In the 1940's, it was claimed that harmonic distortion of less than 2% was inaudible.

By the 1950's, the minimum audible figure had become 1%, then it dropped to 0.5%, and by the end of the 1960's some designers were admitting that 0.1% might be audible "in certain ways under certain conditions." The figure is still dwindling, and today there are people who seem able to hear differences between two production samples of the same amplifier that are apparently identical except that one produces 0.003% distortion and the other 0.008%.

Brilliant Distortion. One of the ways in which distortion is made audible is as an increase in brilliance, as though the frequency response in the 5- to 10-kHz range has been exaggerated. And it is perhaps coincidental that this is the range where most tracking distortion shows up in the audio signal.

In live music, the so-called brilliance range is occupied by overtones—multiple harmonics of the musical fundamentals which lie below 2,000 Hz, and the overtones are relatively quite low in intensity. Yet our ears are acutely analytical of what they hear in this brilliance range, for it conveys much of the quality and timbre of the musical sounds. It takes little spurious energy to be audible in this range, and when that energy is harmonically related to the fundamentals, it takes very little of it to "brighten" the sound.

The *nature* of the distortion, too, has a profound effect on the sound. For example, an amplifier measuring over 0.1% total harmonic distortion could be producing 0.1% at the second harmonic, 0.05% at the third harmonic, and 0.001% at the third. Or, it could be producing 0.1% at the second harmonic and 0.08% at every other harmonic out past the sixth. The usual distortion meter wouldn't know the difference but the ears do, for it has been shown that the higher-order harmonics are much more offensive to the ear than the second harmonic. They make the sound harder, shriller, and, well, more brilliant. And, not surprisingly, they do the same for the sound of cartridge mistracking.

It is not clearly understood just what a distorting amplifier does to the mistracking impulses; but it appears that the program-material frequencies and the resulting sum-and-difference tone seem to splatter the original noise impulses through the entire upper frequency range. Not only does this tend to strengthen the impulses, it also produces more high-end energy from them. The mistracking distortion is exaggerated, and it sounds more unpleasant besides.

Just how low an amplifier's distortion must be before it ceases to exaggerate mistracking has not been determined, for every time a new one attains lower distortion than any other, mistracking becomes a bit less obtrusive. It has been observed, though, that the earlier stages of amplification seem far less tolerant of tiny amounts of distortion than later stages. A power amplifier may have to have 0.5% IM distortion at typical listening levels before it starts to exaggerate and harden breakup as much as a phono preamp stage with 0.05%. Some solid-state equipment, too, seems to have more of a tendency to exaggerate brilliance (and mistracking) than tube-type equipment, although much equipment with tubes has a tendency to soften so-called "hard transients" like the sounds of high percussion instruments. The characteristic hardness of some solid-state equipment is a major reason why some listeners are willing to pay high prices for the few top-notch tube-type components that are still available. They make mistracking easier to ignore.

On the other hand, there's always tape. But it has its problems too. ♦

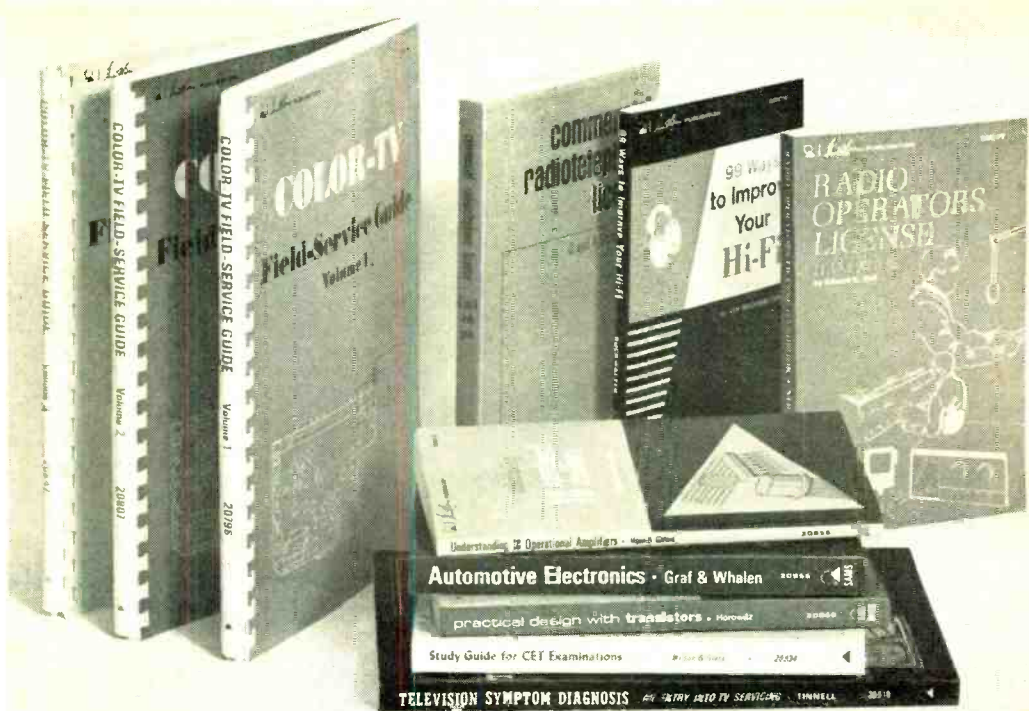

"Best Seller" Electronics Guides

Color-TV Field-Service Guides

Invaluable for servicing color-tv in the customer's home. Each volume contains 80 diagrams covering over 3,000 chassis... sensibly organized with detailed chassis layout charts on one page and specific adjustment procedures on opposite page. Indexed for instant reference.

- No. 20864 (3 Vol. set) \$14.85
- No. 20796 (Vol. 1) \$4.95
- No. 20807 (Vol. 2) \$4.95
- No. 20847 (Vol. 3) \$4.95

Study Guide for CET Examinations

By J. A. Wilson, CET, and Dick Glass, CET. A comprehensive review of the material covered by the CET (Certified Electronics Technician) examination. It's almost a "must" for gaining a CET designation, for passing a state or local licensing exam, or for a "brushing-up" when applying for a position in the electronics field. Includes question-and-answer sections and a 50-question test in each chapter. No. 20834 \$5.95

99 Ways to Improve Your Hi-Fi

By Len Buckwalter. This book covers many methods—many of them simple, little- or no-cost adjustments—for improving your hi-fi and stereo sound systems. All-inclusive coverage from the antenna to the speaker is divided into ten sections and supplemented, wherever necessary, by photos and illustrations. Basic or elementary knowledge, simple tools and equipment are all that is needed to make the most of the suggested innovations. No. 20876 \$3.50

Understanding IC Operational Amplifiers

By Roger Meien and Harry Garland. This book explains how IC op amps work and how they can be used in many practical cir-

When it comes to electronics, let a book in the modern Sams Technical Library be your guide. Send for our free catalog.

cuits. Discusses in detail basic semiconductor electronics, integrated op amp circuitry, practical design considerations in circuits using IC op amps, bias current, offset voltage, frequency compensation, slew rate, and more. No. 20855 \$3.95

Commercial Radiotelephone License Q and A Study Guide

By Woodrow Smith and Robert Welboir. This comprehensive study guide contains questions taken from the first four elements of past and present Government publications of "Study Guide and Reference Material for Commercial Radio Operator Examinations," and thus presents questions used in FCC examinations. No. 24027 \$5.95

Practical Design with Transistors—2nd Edition

By Manie Horowitz. This new and updated edition provides engineers and technicians with enough factual material to complete independent circuit designs. With the aid of this book, anyone with a working knowledge of algebra and radio electronics should have no difficulty in designing a transistor circuit. No. 20868 \$6.95

Radio Operators License Handbook—2nd Edition

By Edward M. Noll. Covers the laws, rules, regulations, and ac-

cepted operating procedures for the non-licensed operator, as well as the licensed operator. Questions and answers based on the FCC exams for Elements 2, 11, and 1X enable the reader to prepare for any FCC license up to, but not including, the Second-Class license. It is an invaluable study guide for obtaining Third-Class license with Broadcast Endorsement. This book is a complete and indispensable reference for the marine radio, telephone, aviation radio, citizens band or broadcast operator. No. 20877 \$3.95

Automotive Electronics

By Rudolf F. Graf and George J. Whalen. This book presents a complete picture of all the applications of electronics in a modern automobile. The electronic system of the automobile is divided into several smaller systems and each is explained in detail. A chapter on test equipment and its use will be very helpful to those who like to do their own troubleshooting and repair. No. 20856 \$6.95

Television System Diagnosis

By Richard W. Tinnell. A complete training program providing the necessary job-entry skills for students without previous knowledge of electronics circuitry. Upon completion of the course, the student is qualified to efficiently repair an inoperative black-and-white or color receiver. No. 20810 \$6.95

HOWARD W. SAMS & CO., INC. 4300 West 62nd Street, Indianapolis, Indiana 46226		<input type="checkbox"/> 20796 <input type="checkbox"/> 20855
Order from your Electronics Parts Distributor, or mail to Howard W. Sams & Co., Inc.		<input type="checkbox"/> 20807 <input type="checkbox"/> 24027
Send books checked at right, \$_____ enclosed.		<input type="checkbox"/> 20847 <input type="checkbox"/> 20868
Please include sales tax where applicable.		<input type="checkbox"/> 20864 <input type="checkbox"/> 20877
<input type="checkbox"/> Send FREE 1972 Sams Book Catalog		<input type="checkbox"/> 20834 <input type="checkbox"/> 20856
Name _____ (Please Print)		<input type="checkbox"/> 20876 <input type="checkbox"/> 20810
Address _____		<input type="checkbox"/> PE032
City _____ State _____ Zip _____		

CIRCLE NO. 29 ON READER SERVICE CARD



BRIG. GENERAL DAVID SARNOFF
1891-1971

The END of an ERA

Death of David Sarnoff marks end of an era of remarkable innovators and daring developers who made today's sophisticated communications systems a reality within a single generation.

THE passing of Brig. Gen. David Sarnoff, former Chairman of the Board of RCA, on Dec. 12, 1971, brought to a close an era in which men who head giant U.S. corporations were as well-known to the man in the street as to their fellow board members. David Sarnoff's public career with *Radio Corporation of America* (now RCA) began in 1930 when, at the age of 39, he was elected president. In 1947, he was named Chairman of the Board and Chief Executive Officer. He relinquished the post of Chief Executive Officer in 1966 on his 60th anniversary of service in the fields of communications and electronics.

Born on February 27, 1891 in a small village near Minsk in Russia, Mr. Sarnoff came to the U.S. in 1900. In 1906, he went to work as an office boy with the *Marconi Wireless Telegraph Company of America*. At 17, he became an operator at the Marconi wireless station at Saisconset on Nantucket Island. When he later became the Marconi station operator atop Wanamaker's store in New York, he attended evening engineering courses at Pratt Institute.

While on duty the fateful night of April 14, 1912, young Sarnoff picked up the mes-

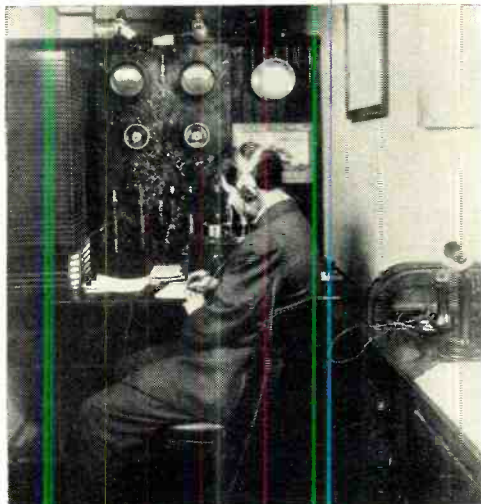

At radio station atop New York store, Sarnoff, on duty for 72 hours, reported sinking of Titanic to the world.

sage reporting the *Titanic's* distress signal and subsequent sinking. He stayed on duty continuously for 72 hours, relaying messages from the rescue ship to the anxious world.

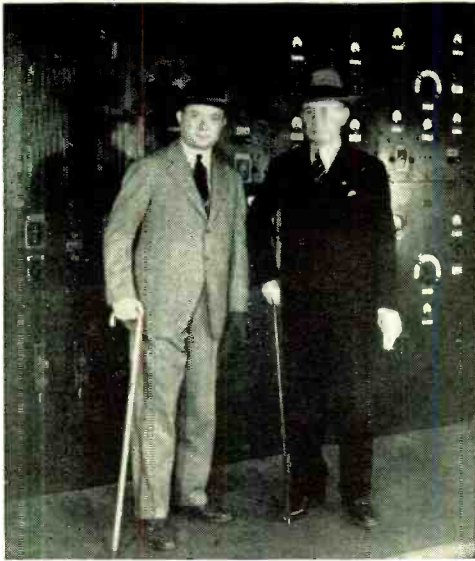

David Sarnoff and Guglielmo Marconi in a photograph taken in 1933 at the RCA transmitting center located in the town of Riverhead, Long Island.

With experience in military radio dating back to WWI, when he played an important role in helping to equip the American forces with wireless, he was appointed a Lieutenant Colonel in the U.S. Army in December 11, 1924. During WWII, he served in the office of the Chief Signal Officer in Washington, D.C. In 1944, he went overseas to serve as Special Consultant on Communications to General of the Army Dwight D. Eisenhower at SHAEF in Europe. Mr. Sarnoff was promoted to Brigadier General in 1944.

Although he was an innovator in many fields, Mr. Sarnoff is probably best known for his efforts in making good music available to the vast listening audience. He arranged for Dr. Walter Damrosch to conduct the weekly "Music Appreciation Hour" for schools throughout America, the broadcasting of the Metropolitan Opera to music lovers from coast to coast, and, in 1937, the creation of the NBC Symphony Orchestra for Maestro Arturo Toscanini, which continued under the Maestro's baton until his retirement in 1954.

Mr. Sarnoff was always in the forefront of developments in radio broadcasting, black-and-white TV, and all-electronic compatible color television. At his instigation, the David Sarnoff Research Center, Princeton, N.J. developed a wide range of

electronic equipment not only for consumer and commercial uses, but also for space applications.

Mr. Sarnoff was the recipient of innumerable awards and honorary degrees from grateful governments and groups around the world. He served as president of a number of associations and was granted honorary memberships in an impressive list of learned societies, who thus acknowledged his many contributions in electronics—particularly in the field of communications.

On his 60th anniversary in communications and electronics, more than 1500 industry leaders and outstanding citizens gathered at the Waldorf-Astoria in a "Salute to David Sarnoff" sponsored by the Electronic Industries Association, the Institute of Electrical and Electronic Engineers, and the National Association of Broadcasters. During the unprecedented event, tributes were paid to Mr. Sarnoff not only by industry leaders but by heads of state, governors, mayors, diplomats, cabinet officers, Supreme Court justices, as well as former Presidents Truman and Eisenhower.

General Sarnoff is survived by his wife of 52 years, three sons, and nine grandchildren. His eldest son, Robert, succeeded his father as Chairman of the Board of RCA.

The electronics industry is today poorer for the loss of David Sarnoff—one of its colorful pioneers and industry leaders for more than a half century. We join with the rest of the industry in mourning his passing and extend to his family and fellow workers our sincerest sympathy. ♦

In 1939, Sarnoff dedicated the RCA pavilion at the New York World's Fair. It was the first time a news event was ever covered by television.



Great careers

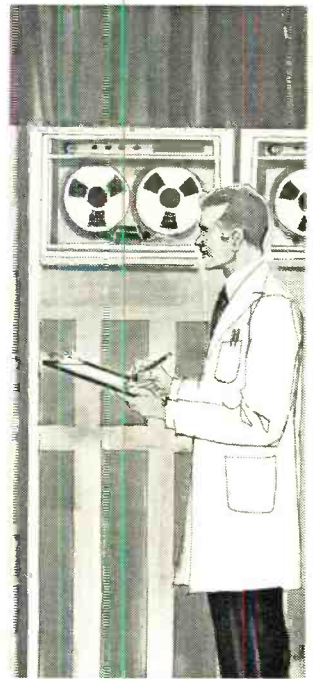
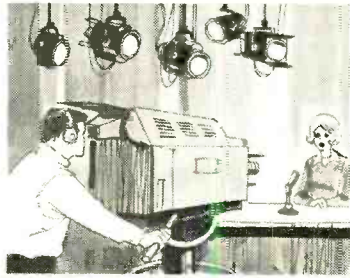

Join the high-paid electronics technicians who got their start through NTS Home Training.

Your home can become your own private classroom-workshop. NTS sends you everything you need to learn valuable technical skills in electronics. You get easy-to-grasp lessons, comprehensive kit manuals, large fold-out charts, and more. Plus the finest professional equipment available today. It's all included in your tuition, yours to keep.

Your equipment is sent to you in kit form, matched to lesson material. With the NTS Project Method, you start with simple projects, then move from basics to more complex concepts. You discover how electronic principles work by performing practical, fascinating experiments. Learn at your own pace.

You quickly become expert in the actual equipment and meth-

ods you'll use on the job. And soon you're ready to cash in on the tremendous opportunities in the expanding, exciting world of electronics!

If your field is television, you might decide to join a first-class TV repair center. Or start a shop of your own. Or specialize in industrial applications of television. Once you master an area of electronics, the direction you take is really up to you. And you'll be able to use the test instruments you buy yourself!

It all begins at home with NTS Project Method Training. Find out how fast and easy it is to learn skills that pay off. Check card or coupon today for your free full-color NTS Catalog and complete details. No obligation. No salesman will call.

NTS COLOR AND B&W TV SERVICING

Build the largest, most advanced color TV model. Over-all solid-state design, 315 sq. in. ultra-rectangular screen, matrix picture tube, built-in self-servicing features, "Instant On," A.F.T., solid-state VHF tuner, and much more! Also build and keep AM-SW Radio, Solid-State Radio, FET Volt-Ohmmeter, and Electronic Tube Tester. Learn trouble-shooting, hi-fi, stereo, multiplex systems, radio, color and B&W TV servicing.

Solid-state B&W TV
74 sq. in. picture cabinet included)

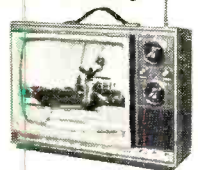

Learn sophisticated solid-state circuitry as you build this B&W TV receiver. Course covers the full range of home entertainment electronics.

begin at home.



New solid-state 315 sq. in. color TV

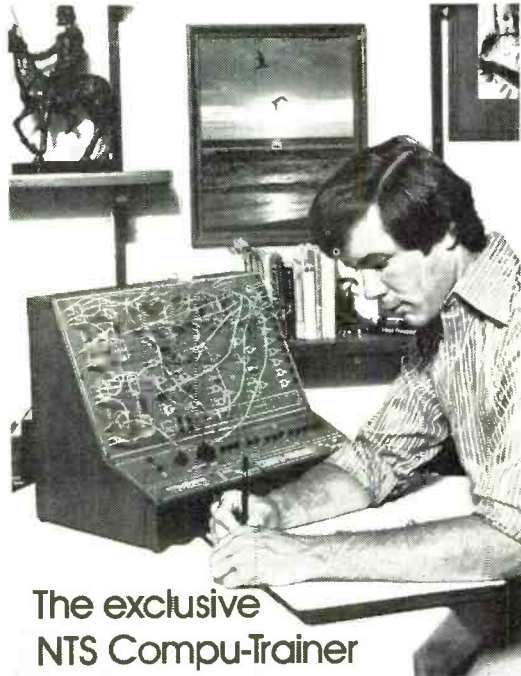

The exclusive NTS Compu-Trainer

NTS COMPUTER ELECTRONICS

Build and operate the exclusive NTS Compu-Trainer! Loaded with integrated circuits, it teaches you the how, what, and why of computers faster, more thoroughly. You perform all wiring and patch-cording. No short-cuts. No pre-wired circuit boards. Also receive an FET Volt-Ohmmeter and a 5" wide-band Oscilloscope.

NTS ELECTRONIC COMMUNICATIONS

Gain the prestige and earning power of owning an FCC First Class Radio Telephone License! Two exciting courses in the fields of transmitting and receiving. Experiment with an amateur phone 6-meter VHF transmitter, NTS' exclusive 6-transistor solid-state radio, and a fully transistorized volt-ohmmeter.

5-watt AM
transmitter/
receiver.



NTS AUTOMATION/ INDUSTRIAL ELECTRONICS

Systems automation is the future of industry — and you can play an important role! Enter the age of electronic controls by training on the NTS Electro-Lab — a complete workshop. Also receive a 5" wide-band professionally rated Oscilloscope. Build five industrial controls to regulate motor speed, temperatures, pressure, liquid level and much more.

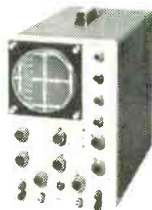

5" Oscilloscope

CLASSROOM TRAINING AT LOS ANGELES

You can take classroom training at Los Angeles in sunny Southern California. NTS occupies a city block with over a million dollars in facilities devoted exclusively to technical training. Check box in coupon.

APPROVED FOR VETERANS

Accredited Member: National Association of Trade and Technical Schools; National Home Study Council.

NATIONAL TECHNICAL SCHOOLS

WORLD-WIDE TRAINING SINCE 1905
4000 S. Figueroa St., Los Angeles, CA 90037

Please rush Free Color Catalog and Sample Lesson, plus information on course checked below. No obligation. No salesman will call.

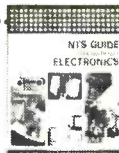

National Technical Schools

4000 S. Figueroa St. Los Angeles, CA 90037

- Master Course in Color TV Servicing Color TV Servicing (For Advanced Technicians)
- Master Course in B&W TV & Radio Servicing
- Master Course in Electronic Communications
- Practical Radio Servicing
- FCC License Course
- Master Course in Electronics Technology
- Automation & Industrial Electronics Computer Electronics
- Basic Electronics
- Stereo, Hi-Fi & Sound Systems
- High School at Home Dept. 205-032

Name _____ Age _____

Address _____

City _____ State _____ Zip _____

- Check if interested in Veteran Training under new G.I. bill
- Check if interested ONLY in Classroom Training at Los Angeles

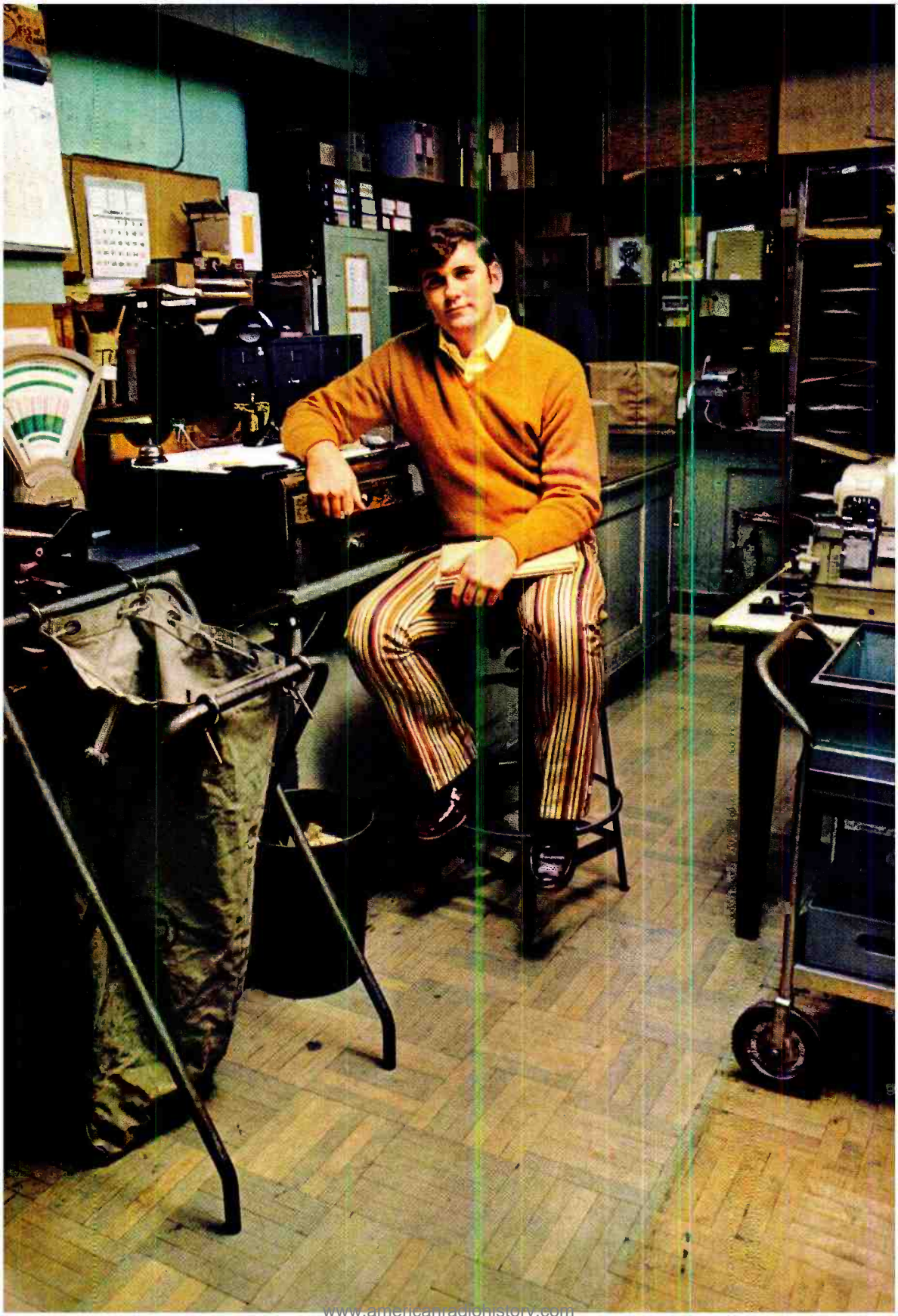

In the time it takes to get out of the mailroom, you could be into advanced electronics.

Working your way out of the mailroom and into a meaningful job could take years. So why not get into something that'll pay off in a matter of months?

Like advanced electronics.

If you have the aptitude and determination, you could trade in that job of yours for a career. In the United States Army Strategic Communications Command.

We'll supply all the electronics training you need. And the job to go with it.

In a few short months you could be working with some of the most sophisticated electronic communications equipment this side of the moon. From computers and cryptographic networks to microwave systems and communications satellites.

And you can pick the electronics speciality you want. Electronics Technician. Data Communications Specialist. Satellite Equipment Technician. Computer Technician. And others.

Or you can pick any one of five great places to work. Europe. The Pacific. Alaska. Korea. Panama. And we'll tell you what jobs are open. There's a good chance you'll get both the job and the place you want.

Ask your Army Representative about the STRATCOM option. It could be the start of a new career. One that'll pay off for you now. In the Army. And later in civilian life.

Today's Army wants to join you.

Army Opportunities Dept. 800, Hampton, Va. 23369	Date _____	2PE J-72
I'm interested in getting into advanced electronics. Please send me your free book.		
Name _____	Date of birth _____	
Address _____		
City _____	County _____	
State _____	Zip _____	Phone _____
Education _____		



News Highlights

RCA Drops ServiceAmerica

Effective at the end of last year, RCA went out of the ServiceAmerica business in which the company had been repairing other brands of TV receivers and other home entertainment products besides their own. Stores featuring the ServiceAmerica concept are expected to be closed down in Philadelphia, San Francisco, and Miami. RCA Service Co., not affected by the move, will be sticking to the company's own product line. ServiceAmerica was bitterly opposed by many independent service operators when it was first introduced some time ago.

Two More Intelsat IV's Launched

As of this time, we are awaiting word of the launching of a pair of new communications satellites in the Intelsat IV series. The first launch placed the satellite over the Atlantic Ocean at 19.5 degrees west longitude. The second satellite is planned for emplacement over the Pacific Ocean. The satellites are being launched by NASA. The Intelsat IV satellite has a capacity of 5000 to 6000 telephone conversations with an average antenna configuration. It could also carry twelve color TV channels or a combination of telephone, TV data and other forms of communication traffic. One Intelsat IV is already in service over the Atlantic Ocean.

CBS Phases Out Electronic Video Recording Hardware

Except for the production of software for its EVR system, CBS is phasing out its Electronic Video Recording operation. The reasons are the slowness with which the industry has been developing and the amount of foreign competition in manufacturing the players. After the phaseout operation, CBS involvement will be limited to patent royalty rights and to the production of entertainment and educational material for the cassette industry.

REACT Supports Class E Proposal for CB

REACT National Headquarters has indicated its support for a proposal for a new class E Citizens Radio Service in the 220-225 MHz frequency band. Proposed to the FCC by the Citizens Radio Section of the EIA, the class E service would provide 80 channels in the FM mode. The proposal provides for reserving channel 9 in the new service as an emergency channel. REACT teams would be encouraged to monitor the class E channel 9 as well as the class D channel 9.

Multi-color Light Emitting Diodes Available

Up to now solid-state light-emitting diodes that were commercially available were able to produce only one color, red. Now it is possible to get light-emitting diodes in either green or yellow as well. The devices are being produced by Monsanto Commercial Products Co. and are more expensive than the red-light diodes. The green diode uses an improved gallium phosphide material which emits radiation

very close to the maximum point of response of the human eye. Therefore it is easily visible in most ambient light conditions. The yellow diode uses gallium arsenide phosphide as the emitting material. The units are encapsulated in green or yellow epoxy to provide greater contrast.

CBS Records Releases 4-channel Discs

Recently released by CBS Records are a half dozen quadrasonic discs employing the company's SQ 4-channel system. When played back through a decoder, four channels of sound are produced for "all-around" listening. When the discs are played back on ordinary stereo systems, two combined channels are produced, so that the records are compatible with present 2-channel systems. The six releases are "Touch", created by Morton Subotnick; "Switched-on Bach"; "Antonia Abraxa"; "Chase"; "Stoney End" with Barbra Streisand; and "Also Sprach Zarathustra" performed by Leonard Bernstein and the N. Y. Philharmonic.

Sony Opens New New York Showroom

The press was invited to preview the new Sony showroom which opened recently at 714 Fifth Ave., New York City. The three-floor display area is a showcase for the company's wide range of electronic products for the general public and for business. Although no products are for sale in the showroom, just about all the company's products are on display. These include TV receivers, radios, stereo components, as well as color video cassette products, electronic calculators and dictating machines.

Goldmark Receives 1972 Mellon Award

Dr. Peter C. Goldmark, retired President and Director of Research of CBS Laboratories, has been named recipient of the 1972 Mellon Institute Award. The \$1000 award was established in 1967 to honor "individuals who have contributed outstandingly to science and its application to the progress of mankind." Dr. Goldmark is the fifth American to receive the award. He is retiring from CBS to head his own organization devoted to seeking practical solutions through communications technology to the environmental problems of society and business.

Giant Antenna to get Face-Lifting

The 1000-foot diameter antenna reflector of the National Astronomy and Ionosphere Center located near Arecibo, Puerto Rico is about to be resurfaced. The present wire mesh will be replaced by 37,000 adjustable panels, consisting of perforated aluminum sheeting over a 6-inch supporting structure. When the new surface is installed, the Arecibo antenna will become the world's largest radio telescope capable of operating at radio wavelengths from 6 to 1000 cm. The upgrading of the surface will make it possible to "see" features on Venus, located 26 million miles away, as though it were as close to earth as the 240,000-mile distant moon.

Superscope Sues Fair Trade Violators

Superscope, U.S. distributor of Sony tape recorders and Marantz hi-fi products, has brought suit against several New York state dealers for violation of the company's fair-trade policies. The company stated that although there was general compliance by most dealers in New York, there were a few dealers who refused to comply; hence, action was brought against these dealers.

THE DIFFERENCE BEING HEARD AND

Have you ever received a signal that hits a strong 9 on your S-meter but is completely unintelligible? That's because the signal is poorly modulated. You can have the strongest CB signal going, but with poor modulation you might as well not be transmitting. Don't let it happen to you.

Chances are, the single most effective thing you can do to clear and strengthen your CB signal is to start using a good pre-amplified microphone. If your microphone



CE BETWEEN NOT BEING HEARD

doesn't do its job, expensive transceivers and antennas are wasted. But with full modulation, even older and weaker transceivers can chop through the hash and noise. A pre-amplified microphone makes it possible to achieve full modulation.

Be heard. Get a pre-amplified microphone. Get the best. Get a Turner. Write for details, Turner Division, Conrac Corporation, 909 Seventeenth Street N.E., Cedar Rapids, Iowa 52402. Telephone (319) 365-0421. **CIRCLE NO. 36 ON READER SERVICE CARD**



TURNER DIVISION
CONRAC
CORPORATION

WHETHER you are a ham operator, telephone dialer, airline pilot, police dispatcher, computer operator, shortwave listener, or anyone who wants to exchange information by wire or radio, you're aware of a world in the midst of a communications explosion. Phone circuits are often clogged, radio frequencies are so congested that police in California speak over TV channels, and boat owners are forced to abandon some of their bands to commercial mariners. A million CB'ers seek more channels for personal talk and air traffic controllers urgently need data links to keep aircraft safely apart.

Long-range planners insist that these distressing symptoms only hint of what's to come. By the end of this decade, they see a whopping 500 percent increase in global communications. They predict the sound of human voices on phone lines will soon be

COMMUNICATIONS

exceeded by the chatter of machines conversing with each other. And the intense pressure to communicate can only increase as developing nations emerge, or as new electronic services are brought into the home.

But thanks to the communications satellite, there should be more room for everyone. Today, a single space vehicle can carry more traffic than all the transatlantic undersea cables combined. Merely three satellites deployed about the earth can "see" every point on the globe, and join any two of them as no cable can. Besides international coverage, a rising generation of "domestic" satellites is filling in sparsely populated regions. This is about to happen in the northern wilderness where cables are costly to lay. Canada has agreed to pay the U. S. \$30 million for launching three satellites in 1972, with a similar system planned for Alaska. These developments make it nearly incomprehensible that the first commercial communications satellite thundered off Cape Kennedy only seven short years ago.

Marconi Bridged the Ocean. The concept of a "radio relay tower in the sky" is often dated at 1945, but its genesis goes clear back to Marconi himself. He had stumbled on the "passive reflector" idea when his signals bridged the ocean in 1901. Although Marconi had no inkling why his signals crossed the Atlantic, it mattered little at the time. The breakthrough was that long-haul communications were finally freed from the wire. Until then, linking continents was done by the ship *Great Eastern* which carried on long voyages mountainous stores of food and equipment to lay cable on the ocean floor. It took two hours to merely lower the 30-ton cable to the bottom. After the job was completed, the system could carry only a limited number of messages. (Even the most modern cable proposed today has a capacity of only 840 telephone circuits.)

Marconi, on the other hand, had captured signals across the Atlantic on a kite, a 600-foot aerial, coils, capacitors, an earphone and an inefficient detector. He had unwittingly used nature's communications satellite, the ionosphere. This well-known

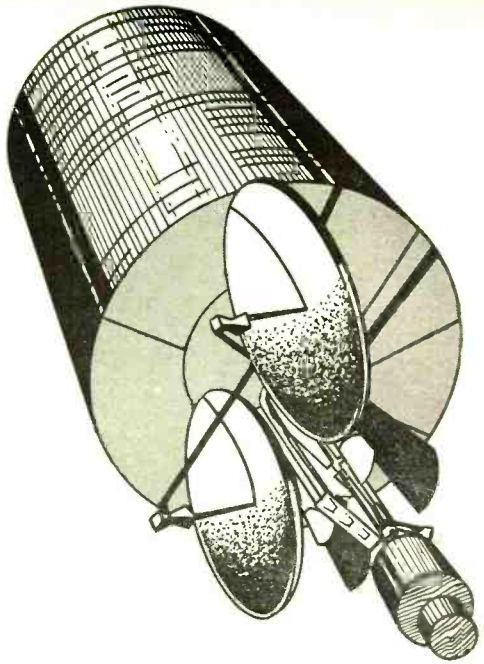

SATELLITES

THESE RADIO RELAYS IN THE SKY ARE HELPING US
COPE WITH TODAY'S COMMUNICATIONS EXPLOSION

electrical mirror hovers near the top of the atmosphere where it intercepts radio signals from the earth. If angles are correct, the signals are reflected downward and return to the surface at some distant point. The phenomenon is curiously reminiscent of the first generation of crude, passive communications satellites.

Besides achieving great distance, Marconi had produced a second miracle: tremendous increase in *bandwidth*, a precious commodity in any communications medium. His experiments soon led to the opening of a broad path for global communications and international broadcasting between 3 and 30 MHz. This is the high-frequency band (HF) where the ionospheric "skip" effect is most efficient. If a single voice message requires a total bandwidth of 4 kHz, then consider that the entire shortwave region from 3 to 30 MHz will accommodate only about 7,000 messages. As any ham or SWL knows, the actual capacity is much smaller because of fading, noise, solar flares, radio blackouts and other caprices of the iono-

sphere. Nevertheless it provided the most important transmission medium for the first half-century of global communications.

Today the ionosphere groans from overload. The ham who chases DX fights through unbelievable interference; CB'ers suffer from the howl of heterodynes from local and distant stations; and nations enter delicate negotiations to parcel out precious frequencies. And the pressure increases as the nature of our communications demands greater bandwidth than ever. A TV channel, for example, consumes a 6-MHz slice of the spectrum. This alone gobbles up about 1500 voice circuits and makes international TV a technical impracticality between 3 and 30 MHz.

Passive Reflectors. The first signs of relief appeared in 1946. Like Marconi forty-five years earlier, experimenters wanted to exploit a natural reflector, only now it was the moon. It was known that if a signal were high enough in frequency, it would pass through the ionosphere in a straight



Intelsat IV satellite is shown here being tested in Hughes r-f laboratory.

line and be lost in space. Why not, went the theory, use the moon as a passive reflector to return the signal? The U.S. Army Signal Corps did just that when it swung a radar antenna toward the lunar surface and fired a pulse of microwave energy. Slightly more than two seconds later a weak, noisy signal returned and was heard in the receiver. It was powerful evidence of the feasibility of a true communications satellite.

Suddenly an idea suggested a year earlier (1945) by a British science writer no longer smacked of science fiction. Arthur C. Clarke (who wrote the film "2001"), and others before him, had dreamed up a novel concept of artificial satellites orbiting the earth to serve as radio relay stations. He calculated that a satellite circling at a height of some 22,000 miles would seem to be fixed over a spot on the earth's surface. At this altitude the satellite would take 24 hours to revolve once around the planet. Since the earth also takes this time for one rotation, the satellite would appear to remain in one position. This could provide an unrivalled platform for retransmitting radio signals over the horizon. Clarke's predictions proved surprisingly accurate.

By 1958 the U. S. Air Force launched the first true communications satellite. Named Score, it was primitive by today's standards, its payload little more than a tape recorder playing a Christmas greeting back to earth from orbit. (President Eisenhower had pre-recorded the message on the ground.) The conventional batteries that powered the satellite went dead in 12 days. (Today the power lasts seven years.) But Score was hailed as the first "active" satellite because it didn't passively bounce back signals to earth but contained active, powered circuits.

The heyday of the passive reflector came in 1959 when Bell Telephone Labs in New Jersey communicated with colleagues in California during Project Moonbounce (again using the moon.) This soon led to a man-made reflector called Echo. Launched into orbit as a tiny packet, Echo reacted to the sun's rays by expanding into a 100-ft balloon with an aluminum foil skin. This created a metal surface orbiting 1000 miles aloft. Although it became wrinkled and deflated after three years, Echo was used to refine the technology needed in the ground stations. During this period, engineers developed horn-reflector antennas of great gain and directionality, extremely low-noise receivers and new tracking techniques by computer. The passive reflector idea, though, was short-lived.

A far more sophisticated package roared off the pad in 1960. Called Courier I-B, it was studded with 20,000 solar cells and could sustain itself by converting the sun's energy into electricity. Equipped with four receivers, four transmitters and five tape recorders it demonstrated the possibility of storing received signals on tape, then retransmitting them at a later time. This was the solution to the problem of linking two ground points that could not "see" the satellite at the same time. Technical difficulties brought Courier to a premature end after 18 days, but not until it had received and transmitted 118 million words.

Telstar and Later. Courier stirred great scientific interest but it only hinted of things to come. A series of sensational successes followed in the summer of 1962. Just before daybreak on a July morning a Thor-Delta rocket lifted off Cape Kennedy. Minutes later Telstar I, a 3-foot-wide craft was inserted into an orbit that ranged between 600 and 3,500 miles. During the sixth pass,

Telstar relayed the first live TV program between U.S.A. and Europe. It did it with no time delay or tape storage: Telstar received and transmitted *simultaneously*. Below the TV picture of singer Yves Montand appeared the sub-title on American home TV sets "Live From France."

Despite its dazzling success, the vehicle fell victim to the hostile environment of space. Two months after launch, engineers noted the vehicle was not executing the "T2" command, an order to turn off communications equipment when out of range. Otherwise there would be a serious drain on the electrical system. Some electronic detective work revealed the culprit. Sensing devices on Telstar reported the space vehicle had picked up 100 times more radiation than predicted as it skirted the Van Allen Belt (which girdles the earth with high-energy electrons.) Acting on this cue, engineers doused similar Telstar components in the lab with heavy radiation. They discovered that radiation could penetrate transistor casings and ionize the gas trapped within. Since gas ions are electrically charged, they interfered with normal transistor action. Telstar I fell silent six months after launch.

These findings protected Telstar II against similar misfortune. A new orbit swung the vehicle 3000 miles further into space and held it beyond strong radiation belts for longer periods. What's more, the troublesome gasses inside the transistors were care-

fully evacuated during manufacture.

The stage was now set for the first practical, work-a-day communications satellite. Much had been learned through experiments on these early "low-orbit" vehicles which swept over the earth to link two points on the earth's surface only hours at a time. Now the time had come for a satellite system that could provide continuous commercial service. It happened April 6, 1965, as Early Bird (Intelsat I) rose to its perch 22,300 miles above the Atlantic. Small by today's standards (it weighed 85 lb.), it had a capacity of 240 telephone circuits. But in a single leap it increased the transatlantic cable capacity by 50 percent! It also turned in a remarkable record of 100 percent reliability in 3½ years of service.

Just as Clarke predicted back in 1945, Early Bird and the "synchronous" satellites which followed give the illusion of standing still. Their velocity through space is about 7000 mph, as the earth's surface below moves at 1000 mph. The reason for the difference is easily seen by viewing a disc rotating on a phonograph. Although the disc near the spindle seemingly crawls around, the edge of the record moves quickly. Both areas, however, complete one turn in exactly the same time.

The satellite's synchronous orbit, which is also described as "geostationary," provides a big advantage in satellite communications. The craft is fixed so that it becomes the equivalent of a permanent tower high

The big 380-ton horn antenna at the earth station at Andover, Maine, is used by Comsat to transmit and receive satellite signals between U.S. and Europe.

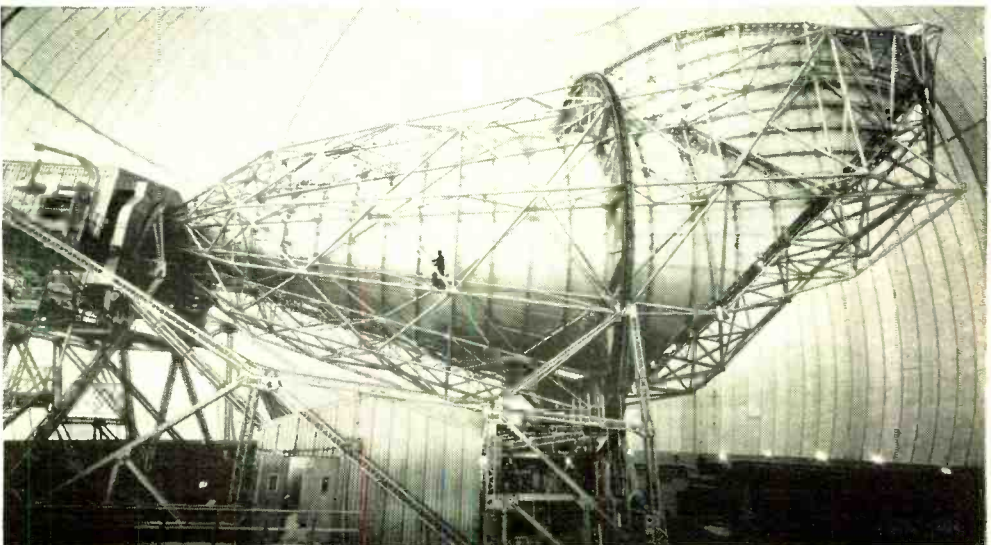

above the earth. This is in contrast to earlier satellites which rapidly looped around the globe to provide only fleeting periods of communication. The synchronous craft "transponds" continuously; that is, it receives signals from one earth station and relays them to another station thousands of miles away at the same time. The shortcoming, though, is that a synchronous satellite "sees" only one-third of the earth from its fixed position. This is solved by orbiting three equally spaced satellites for global coverage. Right now there are vehicles hovering above the Atlantic, Pacific and Indian Oceans to enshroud the earth.

The synchronous satellites have other shortcomings, too. Remaining parked in orbit is a tricky condition because celestial mechanics are hardly constant. The earth's gravitational pull has irregularities which cause orbital drift. The sun and moon exert pulls which affect the satellite with uneven forces. Even the tiny push of sunlight against a space craft threatens to disrupt its delicate balance. Such factors can wobble the vehicle off course and ultimately spin it to a fiery death in the atmosphere. To see how these problems have been solved, let's examine the techniques used in Intelsat IV, the newest of the communications satellites.

The Newest Satellite. The Intelsat IV was placed into service in March, 1971 over the Atlantic. Any irregular force on the vehicle is countered by pairs of onboard thrusters. Driven by hydrazine, the thrusters are positioned around the vehicle so command signals from earth can accelerate it in any direction. Sufficient propellant (270 lb) is stored to keep the craft on station during a design life of seven years.

Next, there's the matter of keeping certain surfaces pointed earthward. This is essential to exploit highly directional antennas which make most efficient use of electrical and radio power. This is done by "Spin-stabilization" to keep the vehicle rotating at 50 rpm. (Thrusters also regulate this action.) Thus the craft achieves rigidity in space from a gyroscopic effect. Not all of the satellite is allowed to spin since those directional antennas must be aimed and held with incredible accuracy. About half the vehicle, the part with the antennas, is "despun," or counter-rotated, to bring it to a halt with relation to earth. A transfer assembly on ball bearings carries power and signals between the rotating halves of the vehicle.

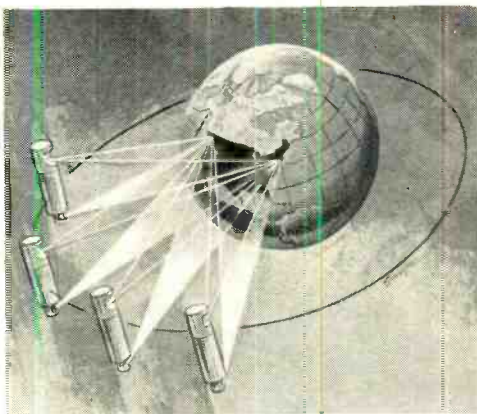

Four domestic satellites proposed by Bell System would provide 83,000 channels for voice, 24 TV, and 64 spares.

This stable arrangement supports a veritable antenna farm. Two high-gain horns receive signals from earth and two transmit them back. There are several non-directional antennas to handle the command and telemetry signals which monitor and govern the vehicle's condition. There are also "spot beam" antennas which can be precisely aimed at a small region on the earth for point-to-point traffic. These narrow signals can increase the number of circuits since energy is held within a beam only 4.5 degrees wide.

Thanks to high-gain antennas in the satellite, as well as huge horns on the ground, the transmitter power may be only six watts. In a typical transmission, a signal from the ground is sent to the satellite on a frequency of approximately 6 gigahertz (6,000 MHz). This is in the microwave spectrum where waves are extremely short in length and display no bending through the ionosphere. Upon receiving the signal, one of 12 transponders aboard the satellite retransmits the intelligence toward earth on 4 gigahertz (4,000 MHz). By separating arriving and departing signals in frequency, the relay is simultaneous, since the transmitter doesn't block the receiver.

Power for the satellite is derived from 40,000 solar cells which spin in the sunlight. They produce about 500 watts of primary electrical power (at 24 volts) to energize transponders and control systems. If a solar eclipse occurs, power is temporarily obtained from two nickel-cadmium batteries held on charge by about 3000 solar cells. The complete, self-sustaining vehicle is about the weight of a Volkswagen.

What does it add up to in communications capacity? With its 12 transponders operating, Intelsat IV can provide more than 9,000 two-way telephone circuits (each 4 kHz) or 12 television channels. In typical operation the satellite carries about 5,000 voice channels and TV. Some transponders aboard feed the spot-beam antennas for point-to-point traffic, while other transponders feed the horns which cover the viewable earth disc. Compare Intelsat IV's capacity—a total bandwidth of 432 MHz—with an ionosphere barely 30 MHz wide. And the satellite is virtually immune to the vagaries of sun and static. During 1970, the Intelsat III satellite series carried their traffic without fail during 99.55 percent of the time.

Support from the Ground. Orbiting hardware captures the headlines, but it would be so much debris without support from earth stations. To gain access to the system, 30 countries have erected 43 earth stations throughout the world. These figures are expected to double within the next three years as space communications continue to reduce traffic costs. It's notable that countries with traditionally poor communications (Latin America, the Far East, the Near East and Africa) are taking the great leap forward with the construction of their own earth stations to participate in the system.

Consider what you'd see at a typical ground facility, like the Bartlett Earth Station recently completed near Anchorage, Alaska. It communicates through Intelsat III positioned over the Pacific to provide a direct tie between Alaska and the lower 48 states or Hawaii, Australia and Japan. The station receives locally generated traffic (telephone, teletypewriter, TV or high-speed data) and sends it through a huge dish-shaped antenna 98 feet in diameter. Although the array weighs 315 tons, it can be rapidly rotated toward the satellite and zeroed on target with an accuracy of 2/100ths of a degree. Signals fly simultaneously to and from the satellite through the same dish, kept apart by a 2-gigahertz frequency difference. To keep ground receivers operating at the greatest possible gain, front-end amplifiers are cooled almost to absolute zero by helium. This slows the molecules in the circuit so they contribute less noise to the faint signals arriving from above. It takes 16 men to run Bartlett around the clock.

About 80 percent of the traffic now carried

by all satellites is the telephone message. And it's increasing at a rapid pace. The number of phone calls between Argentina and the U.S. jumped from 200 to 400 per day last year when satellite service commenced. TV news pickups and special events via live satellite relay are now routine, and this will surely increase due to major rate reductions. Today's cost for a minute of transatlantic TV is \$66—a mere 15 percent of the tariff back in 1965.

Despite the exciting success of the communications satellite, its future sparks plenty of lively controversy. The privately owned Communications Satellite Corp. (Comsat) in the U.S. is attempting to accommodate the differing needs of a common carrier like A.T.&T. and the TV networks. A renewed space race is brewing between three competing international systems: Intelsat, an organization of 79 nations in a joint venture; the Franco-German *Symphonie* satellite and the Russian *Molniya*. Technically, some interests are calling for a quick jump to much higher frequencies—as far as 30,000 MHz—where the bandwidth available is even greater. This is opposed by others who feel that the state of the art is still years behind such a plan. They point out that, as the frequencies grow higher, they behave more like light and are attenuated by rain and other obstacles. But it's a healthy battle with little of the wasteful duplication of the first space race. ♦

Ground station at Goonhilly Downs in Cornwall, England, uses steerable 85' parabolic dish to transmit, receive.

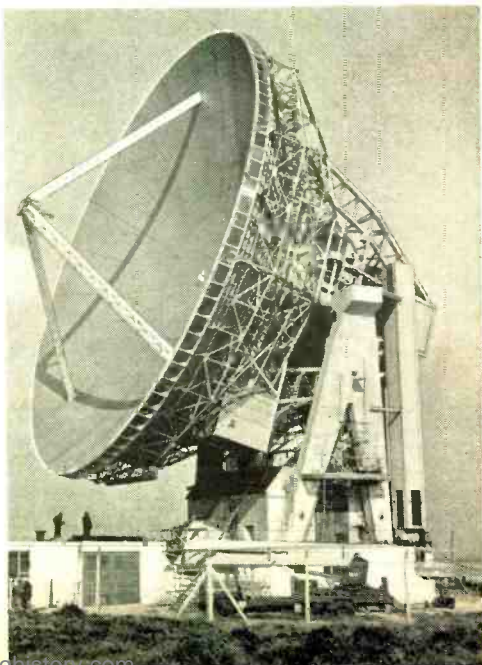

INEXPENSIVE WHEATSTONE BRIDGE

100 MILLIOHMS TO 10 MEGOHMS WITH 0.5% ACCURACY

WHEN it comes to measuring resistances, the Wheatstone bridge is superior to any voltohmmeter (except for some very expensive electronic types); but few experimenters can afford even a resistance bridge. So they usually fall back on the always-available VOM.

In today's circuits, such things as RC time constants (for instance) must be measured very accurately; and the precision of a voltage divider can make or break a circuit design. In such cases, the VOM can't always be counted on to do the proper job—primarily because of the readout system employed. You may be trying to read the resistance of a component that has an accuracy of 0.5% but as long as you have to interpolate the values on a meter scale, your efforts are in vain.

The resistance bridge described here is simple to construct and, since most of the parts can be obtained from a surplus store, it shouldn't cost more than \$15.00. What's more, it has an accuracy of 0.5% with a range of 100 milliohms to 10 megohms.

Construction. The circuit, shown in Fig. 1, is wired point-to-point, with #18 connecting wire. (This size wire is necessary to avoid inaccuracies in the lowest range.) The bridge can be assembled in a wooden or metal box about 2¼" x 7" x 7" or larger. All components are mounted on the front panel except the 4 "D" cells, which are secured to the case by a holder, and the 67½-volt battery which may be held by a clamp.

Calibration. Set *R1* to its maximum resistance and rotate selector switch *S3* to the *R7* (10,000-ohm) range. Connect a 10,000-ohm resistor between test jacks *J1* and *J2*; depress test switch *S1*; and adjust calibration potentiometer *R2* for a null (zero center) on meter *M1*. As the null is approached, depress meter sensitivity switch *S2* to make the final adjustment. When this operation is complete, the total resistance of *R2* and *R3* is equal to that of *R1*.

Remove the 10,000-ohm resistor from the test jacks. Once again depress the test

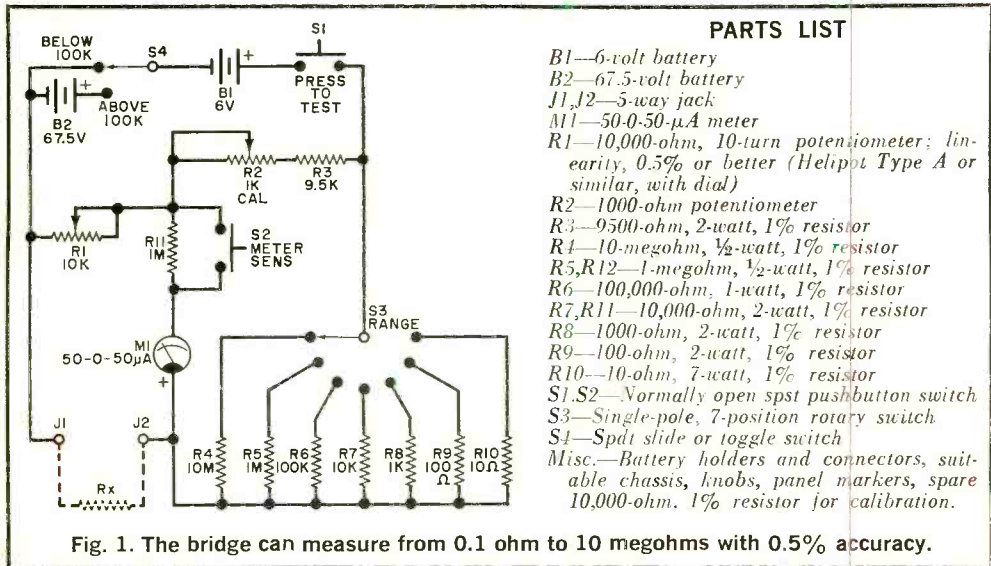

switch and note which way the meter deflects. Mark that side of the meter with a plus sign and the other side with a minus. The bridge is now balanced and ready for use.

Operation. To determine the value of an unknown resistance, connect the unknown across the test jacks. Always start with $S1$ in the BELOW 100K position. In the ABOVE 100K position, a potential of 73.5 volts is placed across the bridge; and if the resistance being tested were of low value, or if the range selector were in the low range, destruction of one or both could result. Now depress test switch $S1$. If the meter indicates on the plus side, the unknown resistance is larger than $R1$. If $R1$ is already at the maximum value (10), switch to the next higher range on $S3$. Continue until the meter is in the minus range. Now rotate the calibrated dial of $R1$ until the meter approaches a null. While holding down the test switch, depress sensitivity switch and adjust $R1$ for perfect null. After releasing the test and sensitivity switches, read the value of your unknown directly from the calibrated dial. For instance, if the dial reads 8.59 and the switch is on 10K, the unknown is 8.59K.

How It Works. Essentially, the resistance bridge is a ratio detecting network. When the value of $R1$ is in the same ratio to the

Short heavy leads reduce internal resistance. Note novel battery layout.

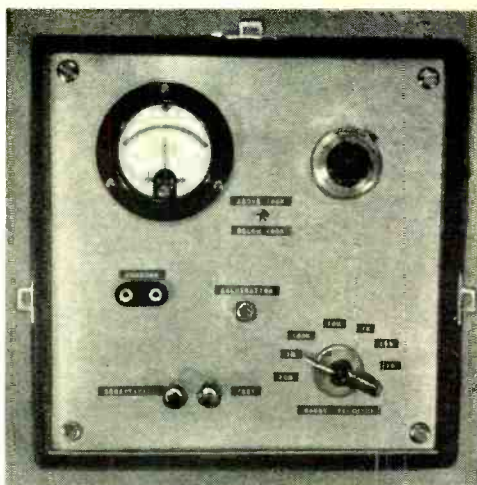
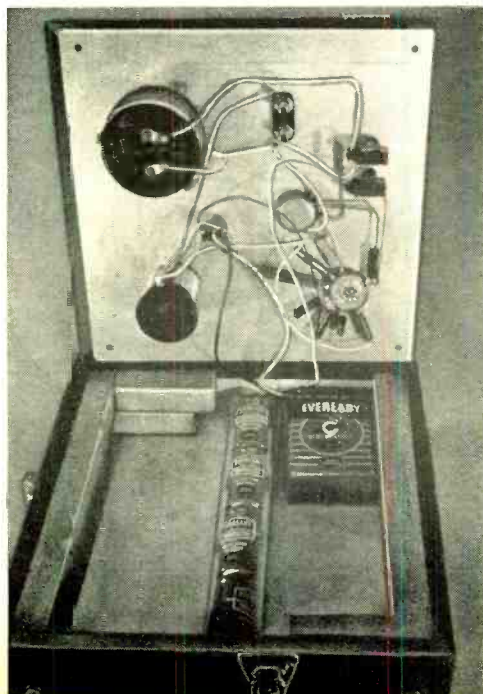

Although the prototype was built in a wood case, any type of construction may be used. Note the 10-turn dial.

unknown resistance as $R2 + R3$ is to the range select resistor (through $S3$), no current flows through the meter leg, producing a null on the meter. When the meter is nulled by adjusting $R1$, we are balancing the ratio of the corresponding resistance in the legs of the bridge. This ratio is mechanically coupled to the calibrated dial of $R1$ and direct readings are obtained.

Actually, $R1$ could be any value of ten-turn potentiometer as long as $R2 + R3$ is equal to it in resistance. The fact that most ten-turn pots, such as the one recommended in the Parts List, have 5% tolerance of the total value doesn't affect the bridge operation because of the built-in compensation with $R2$. What does concern us is the linearity of $R1$. In this case, it is 0.5%.

The range select resistors remain the same. For example: if $R1$ were a 5000-ohm potentiometer; $R2 + R3$ must also be 5000 ohms. Then if the unknown resistor were 5000 ohms, the range selector would be in the 10K range. The ratio of $R2 + R3$ to the range select is 2:1 and the meter would null when $R1$ was in a 2:1 ratio with the unknown. Then $R1$ must be 2500 ohms to null the meter and the resistance of $R1$ is one half of its full range. The dial would read 5.00.

In this bridge, $R1$ was chosen to be 10,000 ohms because this value is not so low that it will allow high current to flow when a 10-megohm resistance is being checked. Nor is it so high that it causes inaccurate measurements in the low ranges. ♦

CONTROLLING DC MOTORS

SPEED CONTROL, REVERSING,
AND DYNAMIC BRAKING
FOR DC SHUNT MOTORS

BY LAWRENCE FLEMING

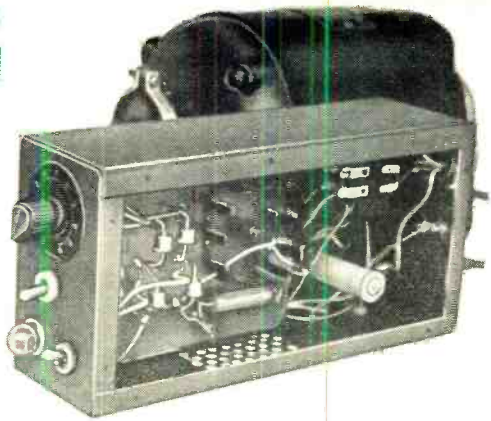

ELECTRONIC speed controls for ac motors usually use an SCR or Triac in conjunction with a phase-shifting network. However, for a dc motor, another approach must be used. The circuit schematic in Fig. 1 is for a speed control that has been successfully used for some time with a 1/8-hp dc shunt motor on a metalworking lathe that requires frequent starts and stops and imposes a wide range of loads, including over-

loads. The full-wave circuit provides speed control, reversing, and dynamic braking.

The motor armature is in series with the anode of SCR1, while the field is connected across the rectified but unfiltered ac line. The SCR is fired by D8, a low-cost silicon bilateral trigger diode (diac) that behaves like a neon lamp except that (besides being solid state) it fires at a lower voltage.

Assume that the SCR has just fired and

Motor field gets rectified dc and armature is controlled by current through SCR.

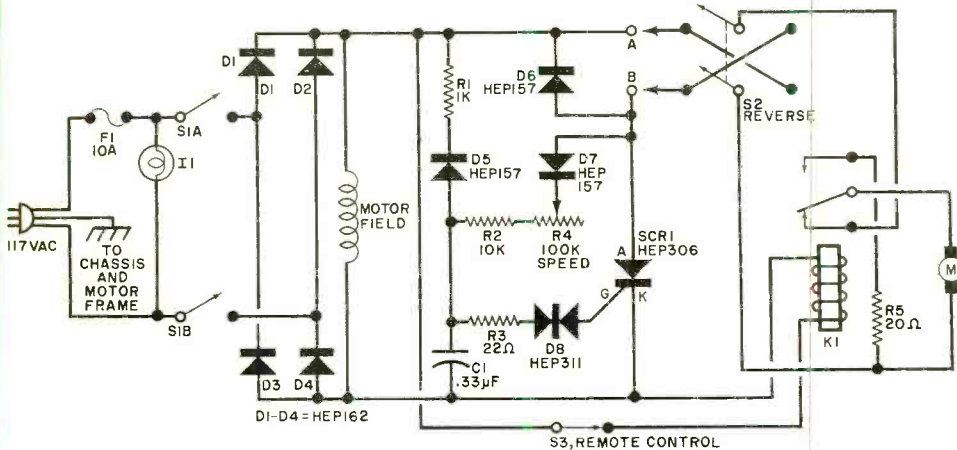

PARTS LIST

C1—0.33- μ F capacitor
D1-D4—HEP162 200V, 3A diode
D5-D7—HEP157 400V, 1A diode
D8—HEP311 bilateral trigger diode
F1—10A fuse and holder
I1—117V power-on indicator
K1—117V dc relay
R1—1000-ohm, 1/2-watt resistor
R2—10,000-ohm, 1/2-watt resistor
R3—22-ohm, 1/2-watt resistor

R4—100,000-ohm potentiometer
R5—20-ohm, 25-watt resistor
S1—Dpst slide or toggle switch
S2—Dpst slide or toggle switch
S3—Spst slide or toggle switch
SCR1—HEP306 silicon controlled rectifier
Misc.—22-ohm, 1-watt resistor and 0.1- μ F capacitor (optional); suitable chassis; perf board; mounting clips; three-way line cord; wire; mounting hardware; etc.

that its anode is at the same potential as the cathode and the motor is running. When the next zero point of the full-wave rectified ac is reached, the SCR is cut off. When the next positive-going cycle starts, *C1* starts to charge up through *R2*, *R4*, and *D7*. When the charge on *C1* reaches about 30 volts, *D8* breaks over and applies a short positive spike to the gate of *SCR1*. This turns on the SCR, supplying power to the motor. The cycle then repeats. Adjustment of *R4* determines the charging rate of *C1* and, hence, the firing time of *SCR1* and the motor speed.

However, if the back emf of the motor is high (at high speed), the SCR anode voltage does not rise so far and *C1* charges more slowly so that the SCR is fired later in the cycle. This produces a smaller power "burst" to the motor armature. If the back emf is low (motor slowing down), the SCR is fired earlier in the cycle, thus applying a heavier burst of power to the armature. In this way, speed regulation is attained.

Diode *D6* limits the inductive "kick-back" from the motor armature to prevent false firing of the SCR. Diode *D5* limits the charging current on *C1* to prevent undesirable transients.

Switch *S2* is connected to reverse the motor armature when this situation is required. Switch *S3* can be closed to activate *K1*, which connects a braking resistor (*R5*) across the motor armature. If the braking function is not desired, *S3*, *K1*, and *R5* can be omitted. If reversing is not required, omit *S2* and connect the motor armature directly to points A and B.

Construction. Since the entire circuit is necessarily "hot" from the ac power line,

extreme care must be used in construction. The circuit may be built on perf board and mounted in a metal chassis. A three-conductor power lead must be used, with the center (green) lead connected directly to the metal chassis and to the motor frame. All connectors and cables must have appropriate UL ratings.

If the control is to be used on 117-volt permanent magnet motors, omit the field connections. The dynamic braking relay (*K1*) must have high-current contacts (20 A minimum) to handle the peak currents.

Because the recovery time between half cycles of the rectified ac is short, a fast-recovery SCR is required. Modern units will work fine, but some of the older SCR's may be too slow. This circuit is not recommended for 230-volt operation unless the recovery time of the SCR has been checked with the manufacturer's specifications.

Some semiconductor manufacturers suggest the use of an RC "snubber" circuit across an SCR to prevent spontaneous firing due to rapid rate of voltage rise due to transients. Typical values for the components to be used are 0.1 microfarads and 22 ohms connected in series between the anode and cathode of the SCR. Do not omit the resistor; a capacitor alone could raise the peak current to the damaging point.

If the motor speed does not go to zero when *R4* is at maximum resistance, increase the capacitance of *C1* by 0.1 microfarad or so. If the motor does not run until *R4* is almost at its minimum and then runs fast and erratically, suspect the SCR. If an SCR other than the one specified is used, *R3* may have to be changed to reflect the different gate sensitivity. ♦

A PROFESSIONAL TOUCH FOR SWITCH PATTERNS

The more professional looking your project, the more eye appeal it has. Even a really well-built project can look second rate if the front panel's switch position markings are irregular in size, shape, or location. However, you can convert a potentially difficult task to an easy job with the aid of a drill and some escutcheon pins, the latter available from most hardware stores. First mount the switch on the panel, being careful to properly orient it. Place a pointer or index knob on

the shaft; then rotate the knob to each position, marking each location with a scribe or pencil. Locate each mark $\frac{1}{8}$ "- $\frac{3}{16}$ " from the index or pointer to achieve a regular arc or circle. Remove the switch and carefully drill a hole at each location. The holes should be just small enough to provide a driving fit for the pins. Cut the pins to the panel thickness length, and carefully drive them into the holes with light taps of a hammer.

—Gerald Larocque, WA1FRV

“At ComSonics we encourage all our technicians and engineers to enroll with CREI. Know why?”

WARREN BRAUN, *President, ComSonics Inc., Virginia Engineer Of The Year, ASE International Award Winner, CREI Graduate*





"As a CREI graduate myself, I know the advantages of their home-study programs. CREI education has proven an excellent tool of continuing education for our employees and for me. And I strongly believe in CREI's ability to teach a man to learn independently and to use reference materials on his own.

As President of ComSonics, I see changes taking place in our Electronics business every day. We're in closed circuit TV and acoustical engineering... and pioneered in Cable TV. CREI gives my men the knowledge they need to work in new areas... CREI's new course in Cable TV is an example. The CATV industry is expected to grow 250% in the next three years. I know the opportunities in Cable TV. I designed one of the first CATV systems in 1950. But technical advances are constantly changing the field. And since CREI's experts know most of what's going on in all areas of Electronics, I know that CREI can give my men some of the important, specialized training they'll need to maintain our position in Cable TV and our reputation in Electronics.

We've interviewed many technicians and engineers for jobs in the past year and had to reject them because their knowledge is archaic and out-of-date. A man is of no value to us if he doesn't keep up-to-date."

Some of the biggest names in electronics buy CREI courses for their own employees. CREI students and graduates prove themselves on the job. They move ahead of the pack by earning promotions and salary increases.

The Future Belongs To You

You've been in Electronics long enough to know that the field is changing more rapidly than ever. New industries, like Cable TV, are born almost overnight. But surveys show that three out of four men now working in Electronics aren't technically qualified to work in these new areas. Clearly, the future will belong to the man who gets the right education now.

Start Learning At Home

But what you learn depends on which school you choose. Here's why CREI is among the best.

With the CREI program you study at home. At your own pace. There are no classes to miss, no work to make up. Each lesson is explained in clear, easy-to-read language. That's why many men do far better in home study than they ever did in school... even if they've been out of school for years. And the study habits they learn from CREI are sustained through life.

As a CREI student, you'll be assigned to an experienced instructor who will grade your assignments and offer constructive comments and criticism. If there's a special problem, the instructor will work with you until you understand it fully. You'll receive personal attention from your instructor because he deals with each student individually—as a class of one.

What Will I Learn?

You'll be learning the latest in advanced technology, geared to specific industry programs. Both theory and practical material are presented to meet all phases of job-related training needs.

CREI courses are written for the man who knows basic Electronics, but whose advancement depends on keeping his technical know-how current. You choose what you want to learn. You study subjects which help you grow and advance

in your present job and which relate to your career objectives. CREI offers you the opportunity to continue your education throughout your working life.

Constantly Up-Dated Courses

Because of rapid changes in Electronics, CREI courses are constantly being revised and up-dated by professionals who work in Electronics every day. New developments are included as quickly as they occur. Right now, CREI students are getting the latest up-to-the-minute information on such things as Cable TV, LSI chips, microminiaturization, lasers and masers, telemetry systems, servomechanisms, and data links. If it's new in electronics, CREI—and you—will know about it!

Developed By Top Scientists And Engineers

CREI maintains a full-time advisory faculty of some of the top names in Electronics. Each is a specialist in his own field, an expert who plans and develops CREI lesson material. After each expert submits his course plan, it is carefully reviewed and written by the CREI educational staff. Then each course is broken down into individual lessons. And they make certain each lesson is clear and self-explanatory. Just the right length for easy understanding and effective study.

How Can I Qualify?

If you've read this far, your interest in getting ahead in Electronics is evident. Send for our famous book on how to prepare for tomorrow's jobs in Electronics—the book that has helped thousands of men just like you get ahead. For your free copy, simply mail postpaid card today.



Founded 1927

Accredited Member
of the National
Home Study Council

Free book tells you all about CREI programs. For your copy, mail coupon, postpaid card or write: CREI, Dept. E1203C, 3939 Wisconsin Avenue, Washington, D.C. 20016

CREI, A Division of the McGraw-Hill Continuing Education Company
Dept. E1203C, 3939 Wisconsin Ave.,
Washington, D.C. 20016

Please mail me free book describing CREI Programs.

I am interested in: College Credits for CREI Study
 Space Electronics Electronic Engineering Technology
 Computers Industrial Electronics Nuclear Engineering Technology
 Electronics Systems Engineering
 Nontechnical Course in Computer Programming
 CATV Engineering

Name _____ Age _____

Address _____

City _____ State _____ Zip Code _____

Employed by _____

Type of Present Work _____ G.I. Bill _____

APPROVED FOR TRAINING UNDER NEW G.I. BILL



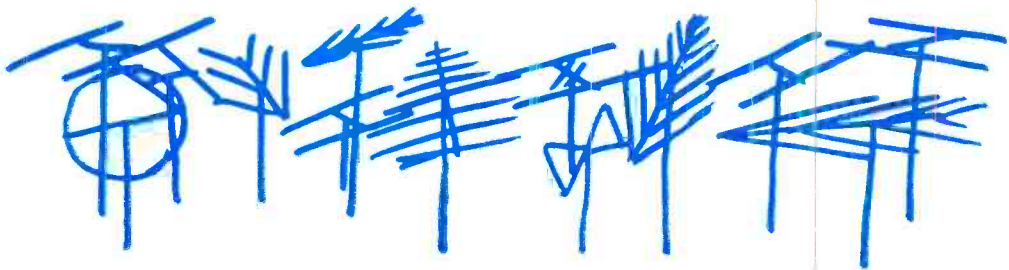

CHOOSING A TV ANTENNA

Complete listing of recommended antennas for your viewing area

BY FOREST H. BELT

NOT too long ago, the only people who tried to convince color-TV owners to buy rooftop antennas were the manufacturers of rooftop antennas. Today, any TV salesman who assures you of a prime picture with only the set's rabbit ears—well, he may disappoint you. Service technicians know; they get many requests to fix a color-TV when the only problem is a weak or ghostly signal.

So don't disdain the antenna ads. Still, for the sake of snow-free and color-true viewing, you should know what the ads try to say. Some play a numbers game, citing how many decibels (dB) of gain (sensitivity) one antenna has over another. Some ads tell of "front-to-back ratio," others of "side lobes" or some other equally technical term. Catchy names abound, too: "Color Brite," "Color Guard," "Color Spectrum," "Color Tuned," "Magic Color," "Sensor," "Stellar 2001," and so on.

The important matter is what kind of picture the antenna puts on the screen of your color receiver. That may depend on where you live. How far away are the stations you watch? How powerful are they? Are they vhf or uhf? How high can you have your outdoor antenna?

The accompanying full-page chart can guide your choice. Obviously, if you don't watch any uhf stations, a vhf antenna is enough. Or, in a uhf-only area, you certainly have no use for a vhf antenna. That is, you don't unless there's a not-too-distant vhf sta-

tion you can pick up with a high, sensitive antenna. In that case you might consider a powerful all-channel model. And, if you're in a vhf-only or uhf-only locality, ask around—a new station starting up soon might outmode your antenna.

Local, strong signals are usually received up to about 15 or 20 miles from the transmitting antenna; medium signals up to 30 or 50 miles; and fringe signals out to 70 or 100 miles. Vhf signals usually reach out somewhat farther than do uhf signals. Terrain modifies the TV signal. If you find hills between you and the station, consider a more sensitive antenna (from the next farther grouping). Likewise, if you live near the "far" end of a mileage grouping, you may prefer the stronger antenna even if the countryside is only mildly rolling. Beyond the mileages given above, even the best antenna brings in only a snowy picture—unless the terrain is very flat or you can put the antenna extremely high.

The chart lists the models suggested by major manufacturers for each signal category. Don't go only by price. Ask your dealer or distributor to show you the antenna you think best suits your requirements. Judge its sturdiness. Is it simple to put together and raise into position? Check its weatherproofing. Consider directionality and sensitivity (dB of gain). And, only then, compare prices.

Several popular antenna models are shown on these pages. Some have odd

shapes; but don't think those shapes are accidental. They are carefully thought out, for very special reasons.

For All Channels. One example is a uhf design (Fig. 1) patented by *Winegard*. What appears to be a folded dipole wrapped around the boom forms the only active element. The lead-in is fastened to the opening at the bottom. There's another gap at the top of the dipole—unlike ordinary folded dipoles which are solid along the side opposite the feed-line. Two phasing bars (you can see only one in the illustration), connected to the top gap, are just long enough at uhf to act like zero impedance (a short circuit) across the gap.

This peculiarity permits tacking the whole uhf array, which *Winegard* calls a "tetrapole collector," onto the front of a vhf antenna and using a single downlead. At vhf, the phasing bars and the uhf dipole have no resonance. They act as mere conductors tying the vhf antenna to the block where the lead-in fastens. For station signals in either uhf or vhf, the lead-in "sees" 300 ohms impedance.

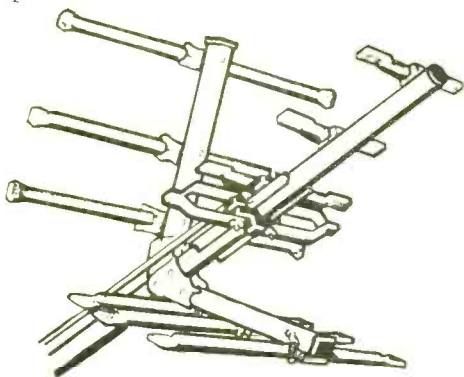

Fig. 1. Winegard uhf section fits in front of other companies' vhf units.

Element Shapes and Spacing. Another patented design principle applies to the *Finco* (*Finney Co.*) antenna in Fig. 2. The company tags the idea its "frequency-dependent principle" (FDP). Short elements, the ones that pick up high-numbered channels, are spaced far apart toward the front of the boom. This trick imparts higher gain as the frequency goes up, which makes up for natural losses in the TV spectrum.

Another special feature narrows the front lobe of this antenna. Dipoles are not straight across. Instead, they are staggered along

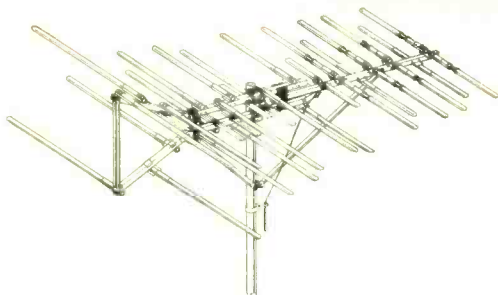

Fig. 2. This antenna from *Finco* uses their frequency dependent principle.

two electrically separate booms. Half of any given dipole is on one boom; its other half is further along on the other. In effect, this transposes the phasing of the feed centers from dipole to dipole. The twin lead-in connects directly to the ends of the two booms.

A design called the "delta reflector" adds a third feature to *Finco's* antenna. Staggered mounting of elements continues on the delta-shaped boom that connects at the back of the double boom. The delta array forms a closed resonant loop to smooth response across the entire vhf band. The delta reflector is said to block out signals from the rear more effectively than a straight reflector, improving the front-to-back ratio.

Take a close look at the reflector elements up front, too. They are not solid. Insulators divide them, to aid electrical breakup of longer elements so high-band vhf "cells" form. The object, of course, is to improve performance on channels 7-12, which is poor in some TV antennas.

Ordinary spacing, called "vagi spacing," places elements the same distance apart along the antenna boom. *Gavin* sells antennas of this design. Element lengths vary across the low vhf band, to spread the gain. As usual, the long elements operate in thirds for high-band vhf. Responses off the sides, called "side lobes," necessitate a slight forward-sweeping of reflectors—which also

Editor's Note: Over the past year, with only a few exceptions, outdoor TV antennas have not changed much. However, the selection of an antenna, especially for color TV, is important enough that we decided to update a chart of recommended antennas which appeared almost a year ago in *ELECTRONICS WORLD*. Major differences include new model numbers and some price changes.

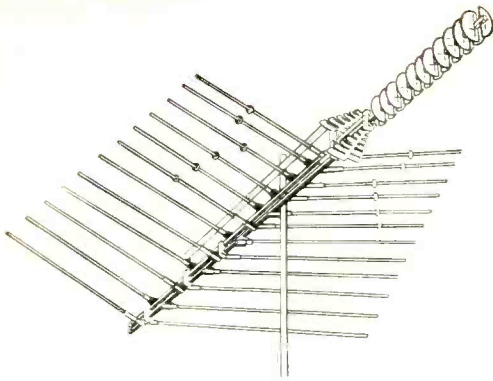

Fig. 3. Log-periodic antenna by JFD.

strengthens the front lobe and raises gain. Short directors aid high-band gain.

The Log-Periodic Idea. One design formula expresses a logarithmic relationship between the velocity of TV signals and the size and spacing of antenna elements. *JFD Electronics* pioneered this "log-periodic" principle. Gain goes up as frequency rises, and impedance across the low and high spectrum stays smooth.

An all-channel log-periodic model is pictured in Fig. 3. Twin booms with alternating half-dipoles accomplish feed transposition as already described, but the halves of each dipole are directly opposite each other. Several forward elements incorporate insulators. However, the JFD insulators are capacitive to "tune" the elements for high-band resonance.

Note that uhf array up front. Each set of flat dipoles (there are two, mounted in wedge formation) is stamped from one metal plate. Spacing and lengths of the dipoles follow the log-periodic formula, in the uhf band. The tapered configuration, both vertical and horizontal, captures uhf signals efficiently. Farther up front, the half-discs are broadband directors. JFD calculates they deliver twice the gain of linear directors.

GC Electronics, under the Audiotex brandname, markets a line of antennas that follow a different logarithmic formula. In Fig. 4, note the curved pattern outlined by the element lengths. This special tapering, say designers, improves broadband response. The dipoles are broken up by insulators, but not into thirds. The short outer stubs make a few of the driven elements parasitic to others, smoothing gain across the bands. You can't see them plainly, but small in-

sulated wires transpose the feed between each successive pair of elements.

Interestingly, the uhf array sandwiches in between the main vhf array and some high-band vhf directors up front. Insulators break those directors up into parasitic directors for the uhf band. This antenna thus has multiple use of elements to develop higher gain at highband vhf and at uhf, yet keeping overall response smooth.

Multi-Feature Type. Fig. 5 exemplifies a high-gain all-channel *Jerrold Electronics Corp.* model called the "VU-Finder." Elements are spaced yagi-style. Element lengths get shorter linearly from back to front. The feed harness is transposed, but it is through the unique disc-shaped boom insulators which have imbedded conductors. Every element is driven, with shorter elements acting as directors for longer ones, and longer ones acting as reflectors for shorter ones.

Parasitic elements that appear to be part of the uhf array boost high-band vhf gain too. A specially shaped bow-tie in the middle of the front array is the only driven uhf element. Jerrold named the patented design of the bow-tie an "extended resonance uhf dipole." The projections at each corner are angle-aluminum. The bow-tie itself is not flat; it is molded with half-cylinder depressions toward the sides.

Two V-angled booms carry the uhf parasitic elements, forming a corner reflector. To concentrate the front lobe and boost gain even further, another boomful of parasitic directors extends out in front of the bow-tie.

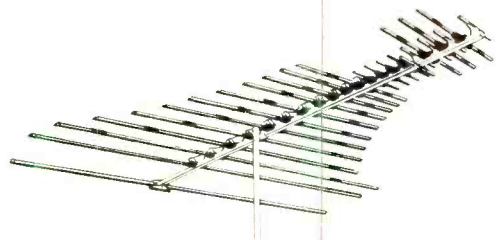

Fig. 4. Element lengths follow exponential formula in GC Audiotex design.

Indoor/Outdoor. Two unusual antennas are the *JFD Stellar 2001* and the *Winegard Sensor*. Both belong to a new breed of pre-amplified antennas designed for either attic or rooftop installation.

Their amplifiers are solid-state and are part of the mast-mounted antenna. Coaxial cable connects the antenna-and-amp unit to

RECOMMENDED TV ANTENNAS FOR VARIOUS SIGNAL AREAS

MANUFACTURER	COMBINATIONS													
	VHF ONLY					VHF-UHF								
	Local Signal	Medium Signal	Fringe Signal	Local Signal	UHF ONLY	VHF Local Signal	UHF Local Signal	UHF Fringe Signal	VHF Local Signal	UHF Local Signal	UHF Fringe Signal	VHF Local Signal	UHF Local Signal	UHF Fringe Signal
Antenna Corp. of America	AC505 \$9.95	AC511 \$23.95	AC525 \$62.95	AC320 \$7.95	AC310 \$14.95	AC315 \$16.95	AC710 \$20.95	AC720 \$39.95	AC712 \$25.50	AC720 \$39.95	AC717 \$29.95	AC725 \$49.95	AC720 \$39.95	AC725 \$49.95
Antennacraft	CS-500 \$12.95	CS-700 \$29.95	CS-1000 \$69.95	Y-11G \$9.95	Y-20G \$14.95	Y-28G \$19.95	CDX-750 \$34.95	CDX-1050 \$69.95	CDX-650 \$24.95	CDX-750 \$34.95	CDX-850 \$44.95	CDX-1050 \$69.95	CDX-1050 \$69.95	CDX-950 \$54.95
Blonder-Tongue Labs	0610 \$23.95	0611 \$31.50	0613 \$46.95	3518 \$8.45	0511 \$15.70	0512 \$27.20	0711 \$31.50	0712 \$38.95	0713 \$46.50	0713 \$46.50	0713 \$46.50	0714 \$35.50	0718 \$66.95	0718 \$66.95
Channel Master	3615 \$18.75	3612 \$50.75	1210 \$84.95	4305 \$10.95	4304 \$16.50	4310 \$25.65	3624 \$32.95	1262 \$32.95	3665 \$35.50	1252 \$35.50	1251 \$60.30	1251 \$60.30	3662 \$75.75	3661 \$89.50
Finney	CS-V5 \$21.30	70-V17 \$39.95	70-V28 \$74.95	CS-U1 \$12.05	CS-U3 \$18.35	CS-U2 \$26.40	CS-A1 \$23.50	CS-A2 \$28.50	CS-A3 \$37.15	70-18A \$56.95	70-18B \$62.95	CS-C3 \$72.35	70-23A \$73.95	70-29B \$80.95
Gavin Electronics	1011 \$31.50	1019 \$49.95	1026 \$65.95	CR-5 \$7.75	CR-5 \$7.75	CR-10 \$11.95	1106 \$20.95	1113 \$32.95	1110 \$25.50	1110 \$25.50	1118 \$41.50	1122 \$55.50	1118 \$41.50	1122 \$55.50
GC Electronics	32-706 \$16.52	32-709 \$24.84	32-719 \$41.49	32-8965 \$3.75	32-8978 \$7.91	32-8978 \$7.91	32-1300 \$8.78	32-507 \$16.52	32-1302 \$26.30	32-511 \$24.64	32-1200 \$27.10	32-519 \$41.49	32-1202 \$49.95	32-524 \$59.94
Jerrild Electronics	VIP-301 \$18.95	VIP-303 \$37.25	VIP-306 \$67.95	PAU-450 \$11.75	PAU-700 \$17.50	PAU-900 \$28.95	VU-931 \$25.75	VU-932 \$34.25	VU-932 \$34.25	PXB-48 \$33.75	VU-933 \$47.25	PXB-65 \$53.75	VU-934 \$58.75	VU-936 \$73.25
JFD Electronics	LPV-TV40 \$17.65	LPV-TV80 \$37.60	LPV-TV190 \$91.95	C-16 \$11.15	C-16 \$11.15	C-16 \$11.15	CPG-56 \$8.50	CPG-8G \$13.47	CPG-9G \$15.25	C-11G \$17.58	OPC-12G \$20.25	C-15G \$23.98	C-21G \$33.57	CT-34G \$56.40
Kay-Townes	CP-5G \$11.84	CP-15G \$30.20	CP-36G \$82.75	KW45 \$7.95	KW45 \$7.95	KW45 \$7.95	LU-840 \$34.35	LU-820 \$13.65	LU-800 \$17.20	LC-81 \$27.65	LC-82 \$32.00	LC-83 \$58.25	LC-38 \$34.95	LC-39 \$44.95
Lance Industries	LC-880 \$20.30	LC-881 \$29.90	LC-884 \$59.80	2BG04 \$4.85	2BG04 \$4.85	2BG04 \$4.85	48G13 \$21.95	48G20 \$31.95	48G23 \$42.50	48G30 \$53.25	48G23 \$48.23	48G30 \$53.25	48G36 \$68.95	48G69 \$84.95
RCA Parts & Acces.	2BG09 \$17.30	3BG13 \$24.95	3BG27 \$66.95	STP-7 \$15.95	STP-11 \$21.95	STP-28 \$59.95	STP-28 \$59.95	STP-28 \$59.95	STP-28 \$59.95	STP-28 \$59.95	STP-28 \$59.95	STP-28 \$59.95	STP-28 \$59.95	STP-28 \$59.95
RMS Electronics	STP-7 \$15.95	STP-11 \$21.95	STP-28 \$59.95	U-965 \$19.05	U-975 \$26.33	U-995 \$38.63	SC-520 \$100.00	SC-520 \$100.00	SC-520 \$100.00	SC-520 \$100.00	SC-520 \$100.00	SC-520 \$100.00	SC-520 \$100.00	SC-520 \$100.00
Winegard	SC-500 \$24.95	SC-520 \$37.25	CW-2002 \$100.00	973-83 \$21.50	973-85 \$44.50	973-87 \$69.50	973-101 \$49.95	973-101 \$49.95	973-101 \$49.95	973-101 \$49.95	973-101 \$49.95	973-101 \$49.95	973-101 \$49.95	973-101 \$49.95
Zenith Sales Co. Div.	973-83 \$21.50	973-85 \$44.50	973-87 \$69.50	973-94 \$21.50	973-96 \$44.50	973-98 \$69.50	973-99 \$44.50	973-99 \$44.50	973-99 \$44.50	973-99 \$44.50	973-99 \$44.50	973-99 \$44.50	973-99 \$44.50	973-99 \$44.50

* Separate uhf, vhf antennas more economical. Note: Prices are suggested list, not firm selling prices; they also vary with locality.

a power-supply distribution network at the set. The manufacturers claim a performance radius of 40 to 70 miles. Keep in mind, though, that very broadband devices such as these depend on fairly smooth terrain for any real distance.

Which brings up another point. Despite the need for a really good signal for acceptable color reception, you just might be situated where the signal is good enough that you can get by with an indoor antenna. Try it, but don't be disappointed if the unit that gives you a near-perfect black-and-white picture still doesn't "cut it" for color.

Gavin makes an indoor model with two uhf loops, one slightly smaller for high uhf channels. Some models have knobs to tune and orient the elements for ghost-free reception. You may have to retune for each station.

JFD makes a complex indoor antenna. You can switch the elements as well as move them around for various ghost conditions. The dipoles telescope, too, for best vhf reception, and an inductive-capacitive circuit in the base lets you tune each station.

Channel Master sells an elaborate amplified indoor antenna called the "Chroma 1." The vhf dipoles telescope, while the uhf ele-

ment is a trapezoid-shaped wire loop, inside of which is a small trapezoidal metal plate. A coaxial cable from the amplifier (in the base) feeds the signal to an impedance-matching uhf/vhf splitter that connects to the TV set. Base controls rotate the uhf an-

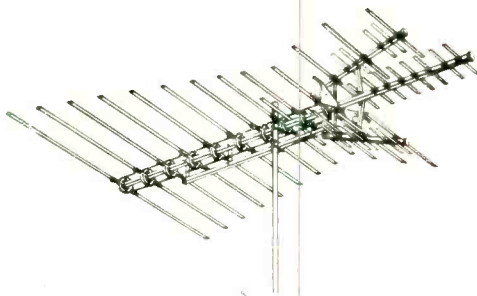

Fig. 5. Jerrold uses circular insulators.

tenna, switch from uhf to vhf, and tune the antenna-matching circuit for best performance on each station.

You take the first step to dependable color-TV reception when you recognize the need for a really good antenna. The second step is figuring out what antenna is "really good" for your house. The third step is to buy and install the antenna of your choice. ♦

First American-Made Quartz Watch

AN ADVANCED quartz crystal wristwatch has been introduced by Bulova into a limited number of Manhattan jewelers at a retail price of \$395. This is the first such watch to be miniaturized to traditional wristwatch size and the first to be completely manufactured in the U.S.

The crystal is a subminiature sealed type that oscillates at 32,768 Hz, which is two to four times as great as the crystal frequency in other quartz watches now on the market. The actual frequency of the crystal is divided down by IC circuitry to 341½ Hz to drive a tuning fork. The fork, in turn, drives the hands of the watch as well as the day and date indicators.

The IC used is a single plastic-encapsulated low-threshold CMOS (Complementary Metal Oxide Semiconductor) manufactured to Bulova specs by Intersil, of Cupertino, Calif.

Energy to power the watch is provided by an aspirin-size power cell, which lasts



Watch at right is Bulova's Accuquartz while one at left is earlier, bulky Swiss-made model selling for \$1000.

for about 1 year and must be changed by a jeweler. As for accuracy, the watch can be expected to gain or lose no more than 1 to 2 seconds per week when worn on the wrist. ♦

WHAT TO LOOK FOR IN A RECORDER. EXPLANATION OF SOME OF THE TECHNICAL TERMS.

By Julian D. Hirsch
Hirsch-Houck Laboratories

IF YOU are shopping for a reel-to-reel tape recorder, wouldn't you like to avoid an expensive mistake and get the model that best fits your needs? Using a systematic approach to the subject, with a basic understanding of some of the technical terms you will encounter in your search, is the best way to insure success.

First, decide what the recorder is to be used for. No single machine will be suitable for both portable use in the field, classroom, or lecture hall, and high-fidelity recording and playback through your home music system. Unless it is made with great precision—and has a correspondingly high price—a light, battery-operated recorder

will not have the low flutter or frequency response required for high-quality music recording and reproduction. By the same token, it is impractical to carry a large, heavy ac-operated recorder to many remote locations.

Most "portable" tape recording applications really require a self-contained, ac-operated recorder with playback power amplifiers and speakers, and a carrying handle or case. If battery operation and really good quality are required, however, you must be prepared to spend at least \$350.

Basic Performance Specifications. *Tape speed*—expressed in inches per second (ips)—affects both cost of operation and sound quality. High tape speeds consume more tape for a given operating time, but provide better high-frequency response. Although 7½ ips is still generally used when flat frequency response to 20,000 Hz or higher is required, a few recorders can meet that standard at 3¾ ips, cutting the tape cost in half. Many 3¾-ips recorders achieve a

HOW TO SELECT A REEL-TO-REEL TAPE RECORDER

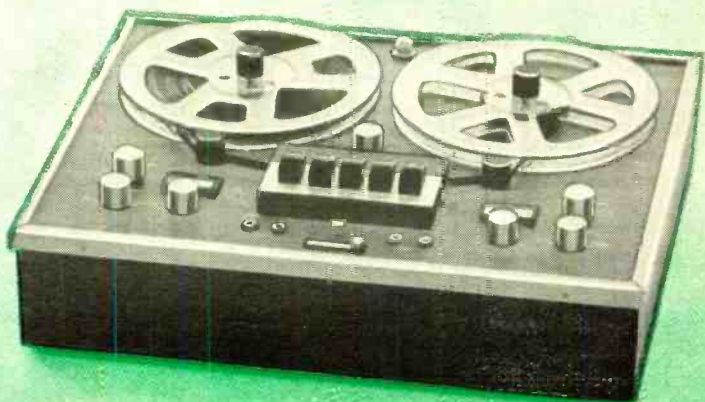

MARCH 1972

frequency response to beyond 12,000 Hz, which is adequate for taping almost all disc records and FM broadcasts. These two speeds are offered on virtually all home tape recorders, frequently in conjunction with a 1½-ips speed. Vocal material and background music can be recorded with adequate fidelity at 1½ ips, but the upper frequency limit is usually between 6000 Hz and 10,000 Hz.

Frequency response in a tape recorder is the range of frequencies which it can record and play back with a specified variation of output level. For example, a recorder rated at 40 Hz to 15,000 Hz ± 3 dB may have variations of plus or minus 3 dB over that range of frequencies, or a total spread of 6 dB between the maximum and minimum outputs. Although the audible frequency range is usually considered to cover from 20 to 20,000 Hz, a recorder with a 40-to-15,000-Hz frequency response will capture virtually all the frequency content of disc records and FM broadcasts. Watch out for frequency response specifications which lack a decibel tolerance, as they are meaningless and can be misleading.

On most recorders, the ½" wide tape is magnetized in four parallel *tracks*. With these *four-track*, or *quarter-track*, machines, a stereo recording is made on two tracks simultaneously. The two tape reels are interchanged after a complete passage through the recorder, and the recording (or playback) continues on the other two tracks which are interleaved with the first two. Many four-track recorders can be used for mono recording on one track at a time, passing the tape through the machine four times. Recorders designed specifically for mono operation (and some professional stereo machines) use the *two-track* or *half-track* format. Although playing time is halved (compared to four-track recording), the wider tracks provide an improved signal-to-noise ratio.

The standard 7" reel can hold from 1200 to 2400 feet of tape depending on tape thickness. This allows a program time of 1 to 2 hours at 7½ ips, interrupted only by the interchange of reels at the mid-point. Lower speeds extend the time proportionately. Some recorders accept a 10½" reel, which holds twice as much tape as a 7" reel. A few portable or compact machines are limited to a maximum reel size of 5", with half the capacity of a 7" reel.

The *heads*, which control the magnetic

condition of the tape, are a key factor in the performance of a tape recorder. At least two heads are required: an *erase head* and a combined *record/playback head*. A *tape player*, which cannot make recordings, has only a single playback head. Most low-priced (under \$200) recorders are two-head machines. Higher priced models usually have three heads, with separate recording and playback heads. This allows the design of each head to be optimized for its

Use a systematic approach and understand the

function. Another advantage of a three-head machine is its ability to monitor the recording directly from the tape an instant after it was made. This requires separate recording and playback amplifiers (since both are used simultaneously), as well as an extra head.

Since the heads are in contact with the moving tape, they are subject to wear and in time will lose some of their high-frequency performance. Recently designed heads use very hard ferrite materials, or glass coatings, to reduce wear, and can be expected to last the life of the recorder.

Many recorders use a single motor to drive the capstan (which controls tape speed) and, via belts and clutches, the two reels. Most higher priced machines use three motors, with each reel driven by its own motor. This simplifies the mechanical design of the recorder somewhat, and usually results in lower flutter. It also has the worthwhile advantage of faster rewind and forward operations. Most single-motor transports require 2 to 3 minutes to rewind 1200 feet of tape; three motor transports typically reduce this time by a factor of two or three.

Some recorders use a hysteresis synchronous motor for the capstan drive, instead of the more common induction motor. This offers no particular advantage to the home user, but its improved speed accuracy (and therefore, timing accuracy) is important in professional recording and broadcast work. The speed accuracy of a synchronous motor is no better than that of the frequency of

the ac power source, but a few machines use an electronically controlled motor system whose speed is independent of power line frequency.

Flutter and wow are caused by rapid fluctuations in tape speed, at rates between 0.5 Hz and 300 Hz. In tape recorders, these variations occur principally at rates of more than 10 Hz, giving rise to the effect known as *flutter*. In small amounts (less than 0.1%) flutter is generally undetectable by ear. It

technical specs to insure the best selection.

first becomes audible on music with sustained notes, and is particularly troublesome on piano and organ music, where it appears as a slight wavering of pitch. In many cases, flutter percentages of 0.15% to 0.20% are quite tolerable, and may not be noticed by many listeners. As the flutter percentage exceeds 0.2%, it is increasingly likely to be objectionable, producing a loss of clarity and eventually a rough or "gargly" sound on the reproduced program.

Low flutter requires carefully balanced rotating parts in the tape transport, plus uniform tape tension across the heads. The pivoted rollers in the tape path of many recorders serve as flutter dampers, smoothing out the minute tape speed fluctuations.

Another important tape specification is *signal-to-noise ratio* (S/N ratio). It expresses the range of signal levels that can be recorded and played back without causing excessive distortion on loud peaks, or losing very soft passages in the background noise. The magnetic tape coating is inherently noisy, due to irregularities in the microscopically fine particle structure. The very small voltage induced in the playback head must be amplified thousands of times, which also introduces noise.

Distortion of high level signals can be caused by saturation of the magnetic tape or the heads, or by overload of the amplifier stages. There are many interrelated factors affecting S/N ratio, including the tape coating itself, the recording bias level and

waveform, the recording level, and the equalization characteristics of the amplifiers.

The S/N ratio is expressed in decibels (dB) and defines the ratio of the signal voltage which produces 3% distortion, to the playback noise of the amplifier with no signal recorded on the tape. A 40-dB S/N ratio can be heard as a steady hiss in the background. If the S/N ratio is 50 dB, the hiss may be heard only during quiet portions of the program, or at high playback levels. A 60-dB S/N ratio provides a totally silent background under normal listening conditions (if the original program was that quiet).

Most reasonably good home recorders have a S/N ratio between 50 and 60 dB. Certain tapes achieve improved S/N ratios by allowing higher recording levels without distortion, finer tape coatings with less noise, or both. Usually they require changes in the recorder's bias and level adjustments, and a growing number of recorders have front panel switches to provide optimum performance with both standard and low-noise tapes.

Special Features. Until now, we have considered only those basic aspects of tape recorders which affect their sound quality. At every level of performance, there are numerous models from which to choose, and whose sound in most cases could not be distinguished from that of competition.

However, tape recorders have a multitude of special operating features, which relate to specific types of recording, and to their general convenience of use. Often the final choice will be based on these rather than purely sonic performance.

Interchanging the supply and take-up reels after a tape passage, to play or record the second pair of tracks, has always been an annoyance to tape users. One solution to this problem is *automatic reversal*, using a conducting foil or a special tone on the tape to reverse its direction in a couple of seconds. Most automatic reversing systems operate on playback only, so that the reels must still be switched manually at the midpoint when recording. A second playback head is usually added for reverse playback, so that these machines are called *four-head* recorders. One recorder uses a single playback head for both directions, mechanically shifting it to contact the second pair of tracks in reverse play. Most automatic-

reverse machines shut off after a complete play of the tape, but some can be set to reverse at both ends and repeat the tape indefinitely.

A few recorders can also record in the reverse direction, which minimizes the chance of missing part of the program while switching reels. The reverse action in recording is initiated by the operator pressing a button. Most such machines duplicate the normal three heads in both directions and are called *six-head* recorders. One model physically reverses the three normal heads for reverse operation.

If you expect to do much "live" recording, it would be well to select a machine with separate mixing level controls and inputs for microphone and line sources. Many recorders with microphone inputs cannot mix sources, since plugging in the microphone disconnects the line input. Incidentally, don't expect the microphones supplied with any tape recorder to compare in quality with the recorder itself. The price of a couple of good microphones will almost always make a greater improvement in the final sound than an equal amount spent on a better recorder.

If the recorder is to be used at home, and you have a reasonably good music system, you can buy a *tape deck* (which has no power amplifiers or speakers) and save at least \$100 compared to the same recorder with internal playback facilities. Of course, a complete recorder, with speakers, is a necessity if you will be using it away from your own system, but its quality will be limited by its own playback system. Tape recorder amplifiers are low powered and lacking in refinement, and their speakers are usually small and poorly baffled.

Consider the ease of operating the recorder's controls. Many mechanically controlled transports have stiffly detented knobs or levers. *Solenoid operation*, a feature of most recorders selling for more than \$300 to \$400, lets a light touch on a button (which can often be on a remote control unit away from the recorder) operate an electro-mechanical solenoid which does the work of shifting the transport mechanism.

Many recorders can provide special effects, such as echo, sound-on-sound, and sound-with-sound. These are only possible on three-head machines, since they require simultaneous operation of the recording and playback facilities. An *echo* is added by feeding a portion of the playback output from

each channel into its recording input. The time delay, due to the physical separation between the recording and playback heads, gives the echo effect. Best results are obtained at 7½ ips, since the time delay at the lower speeds is too long for a realistic echo effect.

Sound-on-sound recording allows a single performer to play several parts in a musical work. The recording is first made on one channel, then played back and re-recorded on the other channel together with the new material. This process may be repeated several times, adding new inputs with each re-recording. *Sound-with-sound* allows recording on one channel while listening to the other. It is useful in language instruction, since the instructor's voice on one channel can be imitated by the pupil, who can then compare his pronunciation to that of the instructor when both channels are played back.

Although most three head machines can record these special effects, some require external patch cords between the inputs and outputs. A more convenient arrangement is offered on other recorders, which do all the interconnection internally when a front-panel switch is operated. Obviously, if you plan to use these special effects to any extent, the latter type of recorder is preferable.

Special noise-reduction systems such as the Dolby Type B seem to have little use in reel-to-reel tape recorders. The 6-to-10-dB noise reduction they make possible is equally available in these machines, but is needed to a much lesser extent than in cassette recorders where this system has seen wide use. Built-in Dolby circuits are offered in only one home tape recorder at this time, but "add on" units are available from a couple of manufacturers. Other noise reduction accessories, operating on different principles, will be marketed in the near future.

Summary. If you carefully "think through" your tape recording needs, and study the features of competitive models in the price range that suits your budget, your chances of long-term satisfaction will be greatly improved. It is frequently possible to get more useful features, with no increase in cost, by choosing a recorder which lacks other costly features that will be of little value to you. It would also be helpful to investigate the listings in such publications as "1972 Stereo Directory" and "Tape Recorder Annual." ♦

THERE are many different approaches to designing an intrusion or burglar alarm: from a simple switch on a window to a sophisticated system such as those used to guard a ballistic missile site. The various types are usually distinguished by the means of detection used. Mechanical switches, for instance, are generally for "spot" detection; light beams are for "line" detection; and ultrasonic and microwave systems for "area" detection.

An infrared beam, however, can also be used in an area-coverage system, if it is intelligently placed. Since the beam cannot be seen, an intruder cannot easily avoid it, and the units of the system described here are small enough that they can be placed inconspicuously. This system is not easy to defeat since it uses a tone-modulated beam and has standby battery power to be used if the power line is cut.

Transmitter. In the transmitter, whose schematic is shown in Fig. 1, *IC1*, a dual 2-input gate, is cross-coupled to act as an oscillator whose frequency (approximately 1400 Hz) is controlled by the setting of *R2*. The output of *IC1* is squared up and divided by two in *IC2*, a JK flip-flop. Buffer *IC3* is then used to drive transistor *Q1* which powers the light emitting diode (LED) at a rate of approximately 700 Hz. The LED is turned on and off for equal periods of time. The average current through it is 50 mA.

Fail-safe power supplies are used for the transmitter and the receiver. Normally, the 117-volt ac line supplies the small amount of power to operate the circuits through simple regulators. The bases of these emitter-follower regulators are not referenced to a zener diode but to standby batteries. Only 1/100 of the total current drawn by the circuit is contributed by the battery during normal operation. However, if the power line fails, or is cut by an intruder, the emitter-base junction of the transistor becomes a forward biased diode and the full circuit current is delivered by the battery.

There is an optional "line failure" indicator lamp (*IL*) in the transmitter power supply which indicates (if it is not lit) that there has been a past power failure. The indicator is reset by momentarily closing push-button switch *S2*. This simple latching circuit uses an inexpensive SCR and a few resistors and capacitors to replace the holding relay often used to sense power dropouts. If it is not desired to incorporate this feature,

INFRARED INTRUSION ALARM

TUNED

INFRARED BEAM

DEFIES "FOOLING"

OR POWER LINE CUTOFF

BY HANK OLSON

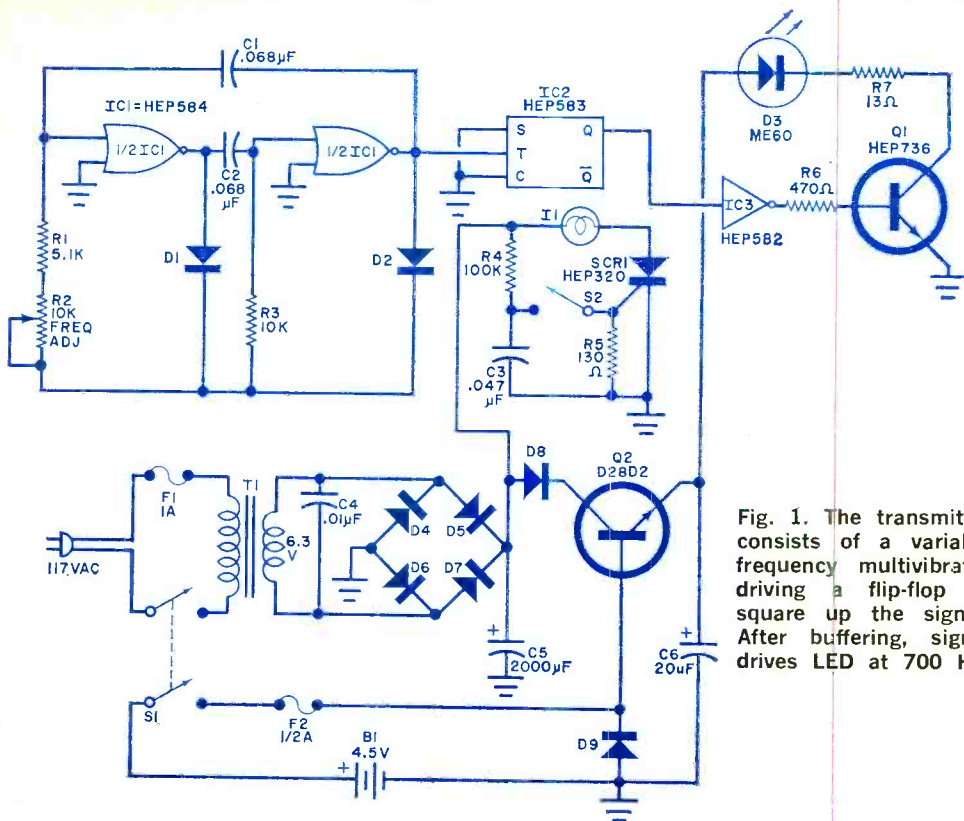

Fig. 1. The transmitter consists of a variable frequency multivibrator driving a flip-flop to square up the signal. After buffering, signal drives LED at 700 Hz.

PARTS LIST TRANSMITTER

- B1—4.5-volt battery
 C1, C2—0.068- μ F, 50-volt Mylar capacitor
 C3—0.047- μ F, 50-volt Mylar capacitor
 C4—0.01- μ F disc capacitor
 C5—2000- μ F, 15-volt electrolytic capacitor
 C6—20- μ F, 15-volt electrolytic capacitor
 D1, D2—1N4154, 1N914, or 1N658 diode
 D3—See text for ranges
 D4, D9—HEP156 or 1N4002 diode
 F1—1A, 3AG fuse and holder
 F2—0.5A, 3AG fuse and holder
 I1—1859, 1869, 344, or Mura L 10/20 lamp
 IC1—Dual 2-input gate (Motorola HEP584)
 IC2—JK flip-flop (Motorola HEP583)
 IC3—Buffer (Motorola HEP582)
 Q1—HEP 736, 2N5128, or 2N3641 transistor

- Q2—Transistor (GE D28D2 or D40D2)
 R1—5100-ohm, $\frac{1}{2}$ -watt resistor
 R2—10,000-ohm potentiometer
 R3—10,000-ohm, $\frac{1}{2}$ -watt resistor
 R4—100,000-ohm $\frac{1}{2}$ -watt resistor
 R5—130-ohm, $\frac{1}{2}$ -watt resistor
 R6—470-ohm, $\frac{1}{2}$ -watt resistor
 R7—13-ohm, $\frac{1}{2}$ -watt resistor
 S1—Dpst switch
 S2—Normally open pushbutton switch
 SCR1—HEP-320, 2N5060, or GE C103Y silicon controlled rectifier
 T1—Transformer: 6.3V, 500mA (Triad F13X or similar)
 Misc.—Suitable chassis, perf board, lens, telescope material, mounting hardware
 Note: A kit of parts is available for \$24.00, postpaid in U.S.A., from H. Olson, Box 339, Menlo Park, CA 94025

D8 can be replaced by a jumper and R4, R5, C3, I1 and SCR1 can be omitted. The 10-volt indicator lamp (I1) is operated at about 8 volts and should give long life.

As a goof-proof addition to the supplies (since the standby batteries are located outside the supply module), a fuse-diode protective circuit was added. Thus, if the batteries are accidentally reversed in polarity, fuse F2 will blow to protect the circuit. This method is superior to a series diode since it

does not have the 0.6-volt drop of a forward biased diode.

Receiver. The receiver circuit (Fig. 2) uses a silicon phototransistor (Q1) which has a peak spectral sensitivity at about 9000 Angstroms, closely matching the output wavelength of the transmitter's LED. The collector load of the phototransistor is tuned to the light-chopping frequency of the LED modulator (via L1 and C2) affording a de-

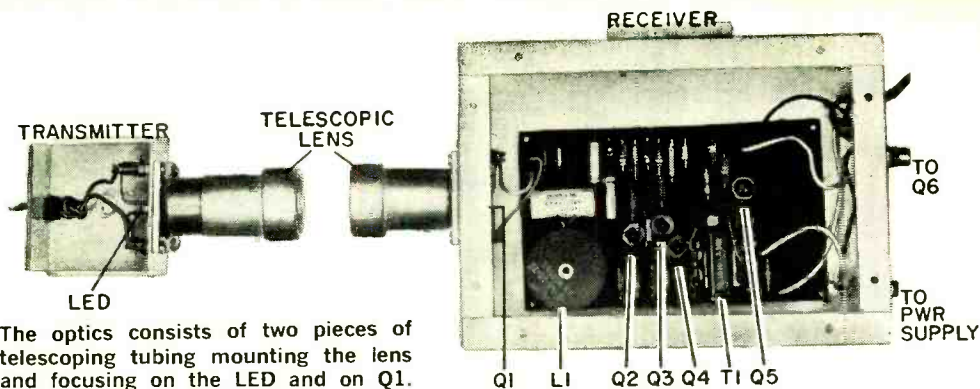

The optics consists of two pieces of telescoping tubing mounting the lens and focusing on the LED and on Q1.

gree of selectivity. The rest of the amplifier is conventional transistor stages utilizing relatively large resistance values to minimize dc current drain. Because the IR beam is chopped, it is possible to use ac-coupled amplifiers which are easily built to operate at low power.

The output of Q4 is transformer coupled to D1 and D2, a full-wave diode detector. Capacitor C8 filters the output, and Q5 and Q6 drive relay K1, turning it on when the diode detector output drops to zero (when the beam is interrupted).

Construction. There are three units in the alarm system: the transmitter head containing the LED with lens; the transmitter circuit chassis; and the receiver. The prototype units are shown in the photographs.

The transmitter head is a 2" x 2" x 2" two-piece chassis, with a 1" hole cut in one wall for the lens. The lens system is an inexpensive plano-convex lens element (Edmund Scientific Co. #94.044, diameter 27 mm, focal length 42 mm). Two pieces of telescoping brass tubing were used to make the adjustable lens mount. The lens is fixed in the movable portion so that the LED light output can be focussed on the receiver. The same lens mounting arrangement is used on the receiver with a small piece of infrared filter (Kodak wratten 87) directly behind the lens to provide ambient light rejection. (It should be noted that elaborate lensing is not always necessary and, in some cases, can be omitted completely.)

The electronic portion of the transmitter is mounted in a convenient small metal enclosure, making sure that a small hole is drilled for access to the R2 frequency-adjust potentiometer. Also, make provision for the cable to connect the transmitter head to the electronic chassis.

In making up the receiver chassis, be sure that the phototransistor has its active area facing the lens system. In the prototype, the battery was not mounted in the chassis.

Range. Using a Motorola HEP312 phototransistor receiver with a lens, the following ranges (in feet) were obtained for various LED transmitters without lenses: Monsanto ME60-9; RCA 40736R-28; GE SSL4-10; GE SSL34-12; GE SSL5C-25. Using a HEP312 receiver without a lens and RCA 40736R transmitter without a lens, a range of 4½ feet was measured. And, with a HEP312 with lens and Monsanto ME60 with lens, 80 feet was measured. The last range figure might have been extended, but the author ran out of room. The above data shows that some type of lens is imperative on the receiver and less necessary on the transmitter. In all of the tests, 3 volts on the receiver TPI was the criterion for satisfactory operation.

The transmitter connects to the LED via a length of two-conductor cable.

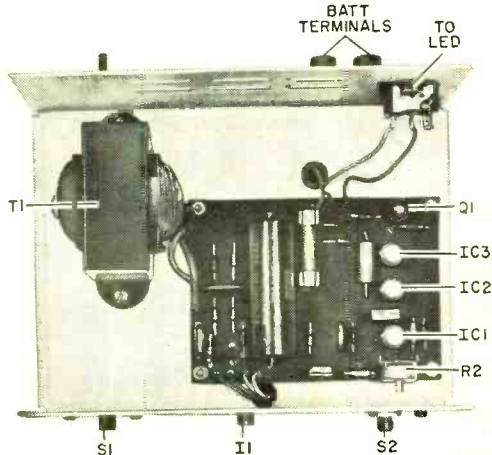

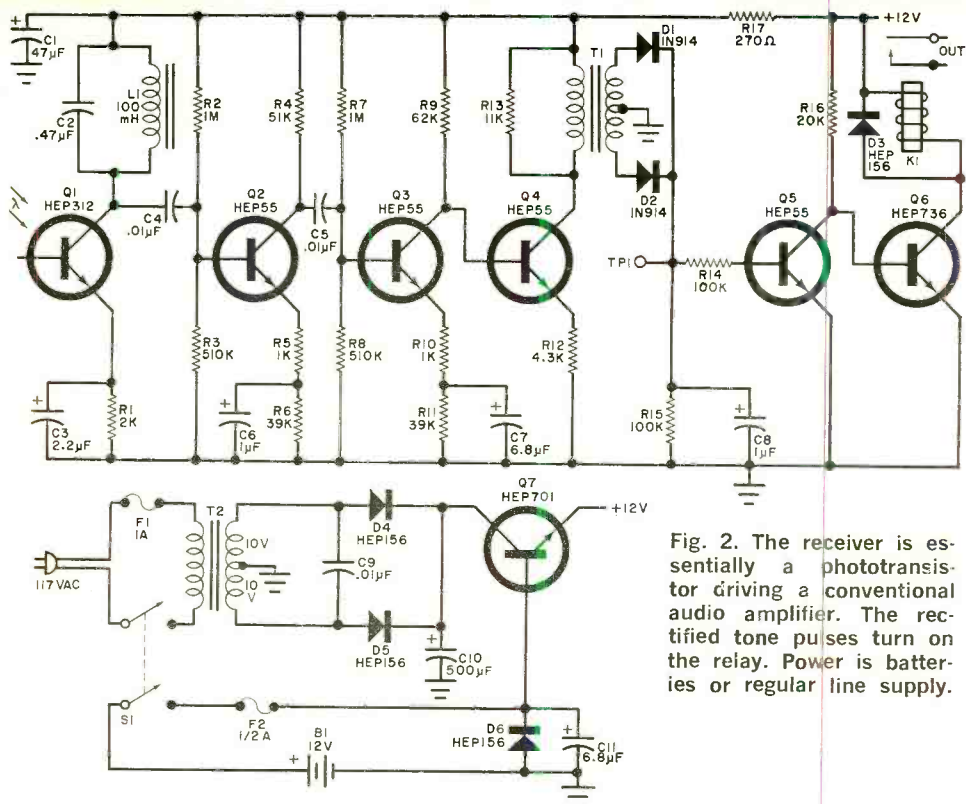

Fig. 2. The receiver is essentially a phototransistor driving a conventional audio amplifier. The rectified tone pulses turn on the relay. Power is batteries or regular line supply.

PARTS LIST RECEIVER

- B1—12-volt battery
 C1—47- μ F, 15-volt electrolytic capacitor
 C2—0.47- μ F, 50-volt Mylar capacitor
 C3—2.2- μ F, 15-volt electrolytic capacitor
 C4,C5,—0.01- μ F, 50-volt Mylar capacitor
 C6,C8—1- μ F, 15-volt electrolytic capacitor
 C7,C11,—6.8- μ F, 15-volt electrolytic capacitor
 C9—0.01- μ F, 1000-volt disc capacitor
 C10—500- μ F, 25-volt electrolytic capacitor
 D1,D2—1N914, 1N658, or 1N4454 diode
 D3,D6—HEP156 or 1N4002 diode
 F1—1A, 3AG fuse and holder
 F2—0.5A, 3AG fuse and holder
 K1—12-volt relay (Potter and Brumfield JRA1012 or similar)
 L1—100-mH toroid
 Q1—HEP312, MRD450, MRD14B, or GE L14B transistor
 Q2,Q5—HEP55, 2N3565, or 2N5133 transistor
 Q6—HEP736, 2N3643, or 2N5128

- Q7—HEP701, 2N3651, or 2N5128 transistor
 R1—2000-ohm, $\frac{1}{2}$ -watt resistor
 R2,R7—1-megohm, $\frac{1}{2}$ -watt resistor
 R3,R8—510,000-ohm, $\frac{1}{2}$ -watt resistor
 R4—51,000-ohm, $\frac{1}{2}$ -watt resistor
 R5,R10—1000-ohm, $\frac{1}{2}$ -watt resistor
 R6,R11—39,000-ohm, $\frac{1}{2}$ -watt resistor
 R9—62,000-ohm, $\frac{1}{2}$ -watt resistor
 R12—4300-ohm, $\frac{1}{2}$ -watt resistor
 R13—11,000-ohm, $\frac{1}{2}$ -watt resistor
 R14,R15—100,000-ohm, $\frac{1}{2}$ -watt resistor
 R16—20,000-ohm, $\frac{1}{2}$ -watt resistor
 R17—270-ohm, $\frac{1}{2}$ -watt resistor
 S1—Dpst switch
 T1—5000/80,000-ohm interstage transformer
 T2—20-volt CT transformer (Triad F90X or similar)
 Misc.—Suitable chassis, lens, alarm, mounting hardware, interconnect cables, etc.
 Note: A kit of parts (not including power supply) is available at \$22.00, postpaid in U.S.A., from H. Olson, Box 339, Menlo Park, CA 94025.

Setup and Operation. With the lenses of the transmitter and receiver aimed at each other, measure the voltage at TPI on the receiver, using a 20,000-ohms/volt (or more) dc voltmeter. Break the beam with your hand to make sure you are actually measuring the beam strength. Separate the two units until the reading drops to about 2

volts. Adjust the transmitter frequency control (R2) to peak the meter indication. If you are using lenses, adjust them also to obtain a peak reading.

If the distance between transmitter and receiver is over a few feet, it is best to use a length of twin-lead wire to connect the meter and receiver so you can see meter. ♦

Solid-State TV Camera Sensor

Will there be an all solid-state TV camera in the near future?

IMAGE-SENSING devices, such as those used in TV, started with the large and bulky iconoscope that resembled a bloated cathode-ray tube. This monster gave way to the vidicon which comes in various sizes—one of the smallest being $\frac{1}{2}$ " in diameter and 3" long. Now, thanks to modern semiconductor diffusion technology, we have the all solid-state image sensor in which a $\frac{1}{4}$ "-square chip of silicon can be used to generate a useful picture.

Developed by engineers at the RCA Laboratories in Princeton, New Jersey, the new experimental charge-transfer image sensor consists of a two-dimensional array of 1408 photosensitive elements arranged in a 32 x 44 matrix. Minute electrical charges representing separate bits of the picture are passed from one sensor element to the next, in a manner similar to the passage of water in an old-fashioned bucket brigade. While other charge-transfer sensors have been built, the new RCA unit is the largest yet announced.

As can be seen in the accompanying photograph, the experimental image sensor can produce a recognizable picture on the screen of an oscilloscope. The original was a slide projected onto the photosensitive surface of one of the experimental units.

RCA representatives feel that such a device might be used as the sensor for a small all-solid-state TV camera for use in space, defense, industry, and ultimately in the home. It could also be used in character-recognition equipment and punched-card readers.

When exposed to take a picture, each element develops a charge proportional to the amount of light falling on it. A clock pulse is applied to each element, starting at one end, to raise the potential of each successive element so that the charge flows

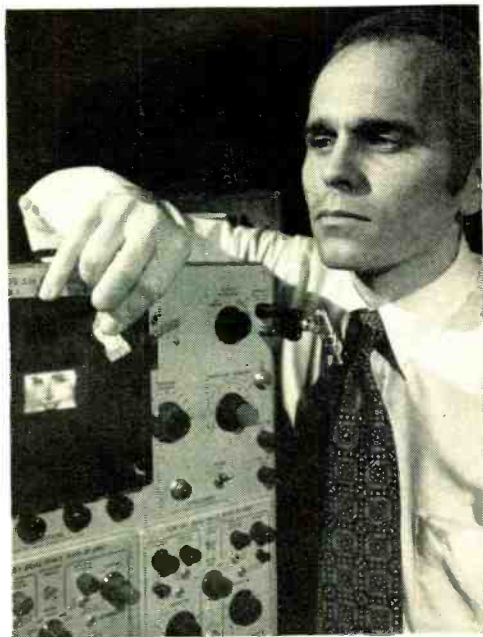

That tiny sensor has only a $\frac{1}{4}$ -square inch sensitive surface and is capable of producing the photograph as shown here on the scope screen. The sensor has 1408 sensitive elements.

(or falls) into the next element which is at a lower potential. Each row is read out in sequence one line at a time to form the overall picture.

In addition to the matrix of 32 rows of 44 photosensitive elements each, the chip also contains a 32-stage bucket-brigade counter shift register used for vertical scanning. In all, only nine leads are required to pass control signals to the new sensor and extract the video signal. The sensor is easy to fabricate since it relies on well-developed silicon MOS technology. ♦

One of our most successful students wrote this ad!

Harry Remmert decided he needed more electronics training to get ahead. He carefully "shopped around" for the best training he could find. His detailed report on why he chose CIE and how it worked out makes a better "ad" than anything we could tell you. Here's his story, as he wrote it to us in his own words.

By Harry Remmert

AFTER SEVEN YEARS in my present position, I was made painfully aware of the fact that I had gotten just about all the on-the-job training available. When I asked my supervisor for an increase in pay, he said, "In what way are you a more valuable employee now than when you received your last raise?" Fortunately, I did receive the raise that time, but I realized that my pay was approaching the maximum for a person with my limited training.

"Education was the obvious answer, but I had enrolled in three different night school courses over the years and had not completed any of them. I'd be tired, or want to do something else on class night, and would miss so many classes that I'd fall behind, lose interest, and drop out.

The Advantages of Home Study

"Therefore, it was easy to decide that home study was the answer for someone like me, who doesn't want to be tied down. With home study there is no schedule. I am the boss and I set the pace. There is no cramming for exams because I decide when I am ready, and only then do I take the exam. I never miss a point in the lecture because it is right there in print for as many re-readings as I find



Harry Remmert gives his CIE Electronics course much of the credit for starting him on a rewarding career. He tells his own story on these pages.

necessary. If I feel tired, stay late at work, or just feel lazy, I can skip school for a night or two and never fall behind. The total absence of all pressure helps me to learn more than I'd be able to grasp if I were just cramming it in to meet an exam deadline schedule. For me, these points give home study courses an overwhelming advantage over scheduled classroom instruction.

"Having decided on home study, why did I choose CIE? I had catalogs from six different schools offering home study courses. The CIE catalog arrived in less than one week (four days before I received any of the other catalogs). This indicated (correctly) that from CIE I could expect fast service on grades, questions, etc. I eliminated those schools which were slow in sending catalogs.

FCC License Warranty Important

"The First Class FCC Warranty* was also an attractive point. I had seen "Q" and "A" manuals for the FCC exams, and the material had always seemed just a little beyond my grasp. Score another point for CIE.

*CIE backs its FCC License-preparation courses with this famous Warranty: graduates will be able to pass the applicable FCC License exam on their tuition payments will be refunded in full. This warranty is valid during the entire completion time established for their course.

"Another thing is that CIE offered a complete package: FCC License and technical school diploma. Completion time was reasonably short, and I could attain something definite without dragging it out over an interminable number of years. Here I eliminated those schools which gave college credits instead of graduation diplomas. I work in the R and D department of a large company and it's been my observation that technical school graduates generally hold better positions than men with a few college credits. A college degree is one thing, but I'm 32 years old, and 10 or 15 years of part-time college just isn't for me. No, I wanted to *graduate* in a year or two, not just *start*.

"When a school offers both resident and correspondence training, it's my feeling that the correspondence men are sort of on the outside of things. I wanted to be a full-fledged student instead of just a tag-a-long, so CIE's exclusive home-study program naturally attracted me.

"Then, too, it's the men who know their theory who are moving ahead where I work. They can read schematics and understand circuit operation. I want to be a good theory man.

"From the foregoing, you can see I did not select CIE in any haphazard fashion. I knew what I was looking for, and only CIE had all the things I wanted.

Two Pay Raises in Less Than a Year

"Only eleven months after I enrolled with CIE, I passed the FCC exams for First Class Radiotelephone License with Radar Endorsement. I had a pay increase even before I got my license and *another* only ten months later.

"These are the tangible results. But just as important are the things I've learned. I am smarter now than I had ever thought I would be. It feels good to know that I know what I know now. Schematics that used to confuse me completely are now easy for me to read and interpret. Yes, it is nice to be smarter, and that's probably the most satisfying result of my CIE experience.

Praise for Student Service

"In closing, I'd like to get in a compliment for my Correspondent Counselor who has faithfully seen to it that my supervisor knows I'm studying. I think the monthly reports to my supervisor and generally flattering commentary have been in large part responsible for my pay increases. My Counselor has given me much more student service than "the contract calls for," and I certainly owe him a sincere debt of gratitude.

"And finally, there is Mr. Tom Duffy, my instructor. I don't believe I've ever had the individual attention in any classroom that I've received from Mr. Duffy. He is clear, authoritative, and spared no time or effort to answer my every question. In Mr. Duffy, I've received everything I could have expected from a full-time private tutor.

"I'm very, very satisfied with the whole CIE experience. Every penny I spent for my course was returned many

times over, both in increased wages and in personal satisfaction."

Perhaps you too, like Harry Remmert, have realized that to get ahead in Electronics today, you need to know much more than the "screwdriver mechanics." They're limited to "thinking with their hands" . . . learning by taking things apart and putting them back together . . . soldering connections, testing circuits, and replacing components. Understandably, their pay is limited—and their future, too.

But for men like Harry Remmert, who have gotten the training they need in the fundamentals of Electronics, there are no such limitations. He was recently promoted, with a good increase in income, to the salaried position of Senior Engineering Assistant working in the design of systems to silence submarines. For trained technicians, the future is bright. Thousands of men will be needed in virtually every field of Electronics from two-way mobile radio to computer testing and troubleshooting.

Send for Complete Information — FREE

Many men who are advancing their Electronics career started by reading our illustrated school catalog, "Succeed in Electronics." It tells of the many electronics careers open to men with the proper training. And it tells which courses of study best prepare you for the work you want.

If you're "shopping around" for the training you need to move up in Electronics, this interesting book may have the answers you want. We'll send it to you FREE. With it, we'll also include our other helpful book, "How To Get A Commercial FCC License."

To get both FREE books, just fill out and mail the bound-in postpaid card. If the card is missing, send the coupon below.

CIE Cleveland Institute of Electronics

1776 East 17th Street, Cleveland, Ohio 44114

Accredited Member National Home Study Council



**APPROVED
UNDER
NEW
G. I.
BILL**

All CIE career courses are approved for full tuition refund under the G. I. Bill. If you served on active duty since January 31, 1955, OR are in service now with more than 180 days active duty, check box on reply card or coupon for latest G. I. Bill information.

Cleveland Institute of Electronics
1776 East 17th Street, Cleveland, Ohio 44114

Please send me without cost or obligation:
1. Your illustrated school catalog, "Succeed in Electronics."

2. Your book on "How to Get A Commercial FCC License."

I am especially interested in:

- | | |
|---|--|
| <input type="checkbox"/> Electronics Technology | <input type="checkbox"/> Electronic Communications |
| <input type="checkbox"/> Broadcast Engineering | <input type="checkbox"/> Industrial Electronics and Automation |
| <input type="checkbox"/> First-Class FCC License | <input type="checkbox"/> Electronics Engineering |
| <input type="checkbox"/> Electronics Technology with Laboratory | |

Name _____ (PLEASE PRINT)

Address _____

City _____

State _____ Zip _____ Age _____

Veterans and Servicemen: check here for G. I. Bill information. PE-28

For men with prior electronics training . . . Electronics Engineering Course

. . . Covers steady-state and transient network theory, solid-state physics and circuitry, pulse techniques, computer logic and mathematics through calculus. A college-level course for men already working in Electronics.

CIRCLE NO. 8 ON READER SERVICE CARD

DIGITAL VOLT-OHMMETER PLUG-IN MODULE

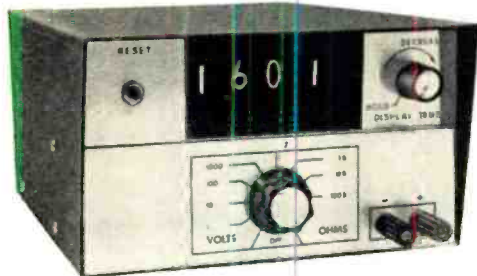

AND ADD TWO MORE FUNCTIONS
TO YOUR LOW-COST DIGITAL
MEASUREMENTS LAB

BY DANIEL MEYER

CONTINUING our popular series on a low-cost Digital Measurements Lab, begun in the November 1970 issue, here are the construction and assembly details for a digital volt/ohmmeter (DVOM) plug-in module. When used with the Lab main frame, the DVOM module provides measuring capabilities for dc potentials to a maximum 1999 volts in four ranges, and resistance from 1 ohm to 199,000 ohms in three ranges.

The accuracy of the DVOM plug-in module is not specified in the lower 5 percent of the instrument's range. Even so, after several months of using it on the test-bench, the DVOM module/mainframe combination proved to be an extremely versatile and easy-to-operate test center.

Converter Design. The basic circuit used in DVOM's is a voltage-to-frequency converter. Several approaches are used to change a voltage to a frequency. The most common one employed in digital instruments uses some type of capacitor-discharge analog-to-digital conversion process which depends on digitally representing the time needed to charge a capacitor to some reference voltage or to

the value of the input voltage being measured. An elementary system of this type compares the voltage to be measured to the voltage across a charged capacitor as shown in Fig. 1.

The comparator is a high-gain differential amplifier, the output of which changes very rapidly from zero to maximum when a difference exists between the two input voltages. The conversion begins when S_1 is opened and C begins to charge toward the level of the input voltage. The charge rate of the capacitor is linear due to the use of a constant current for charging. When S_2 is closed and S_1 is opened, the counter begins counting the pulses from the clock at the same time the capacitor begins to charge.

Now, when C charges to a slightly greater level than that of the voltage being converted, the comparator changes state and closes the gate through which the clock pulses pass into the counter. By this means, a reading directly proportional to the charging time of C is obtained.

This type of system, although simple, is prone to errors. Any change in clock frequency or in the value of C directly

affects the reading obtained. Any ac voltage, hum included, riding on the dc voltage being measured affects the point at which the comparator switches. These problems can be minimized by use of a crystal-controlled oscillator, a charging capacitor with very stable characteristics, and an input filter. The same results, however, can be obtained with a dual-slope integrator such as the basic system shown in Fig. 2.

Here, an operational amplifier is connected with the charging capacitor, C, from the output to the inverting input to form the integrator. The input voltage is applied to R and the resulting current into the input of the op amp charges C at a constant rate. The op amp itself is used as a constant charging source.

As soon as the voltage across C at the output of the op amp rises above ground, the comparator changes state and opens the gate to allow clock pulses to enter the counter. The input current, the value of C, and the clock frequency are designed to allow the counter to reach full scale before the capacitor can fully charge.

Since the amount of time required to run the counter to full scale with a given clock frequency is a constant, there is at this point a charge on C that is proportional to the input voltage. If at the time the counter reaches full scale, it is reset to zero and the op amp input is switched to a reference voltage, C can be discharged at a constant rate to provide

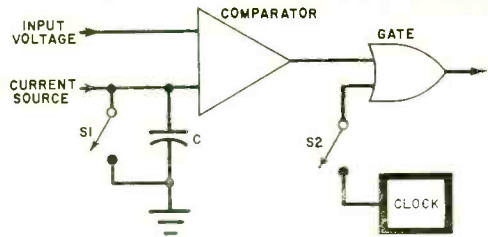

Fig. 1. Elementary capacitor-discharge analog-to-digital converter is typical of those used in digital instruments.

a counter reading proportional to the capacitor voltage and, thus, directly proportional to the input voltage.

Circuit Operation. In the DVOM Module circuit shown in Figs. 3 and 4, the input voltage is applied to range selector switch S1 and attenuator network R33-R36. If this voltage is greater than the basic 0-2-volt input range of the converter, it is reduced to this range by the attenuator resistors. The voltage obtained is then applied to Q1 which acts as an impedance converter. This FET has a very high input impedance which makes possible the 10-megohm input impedance of the plug-in, and the low output impedance needed to drive the circuits which follow. Resistor R1 and diodes D1 and D2 protect Q1 from overloads that might occur if S1 was not set to the proper range position and a high voltage was applied.

The voltage at the source of Q1 is ap-

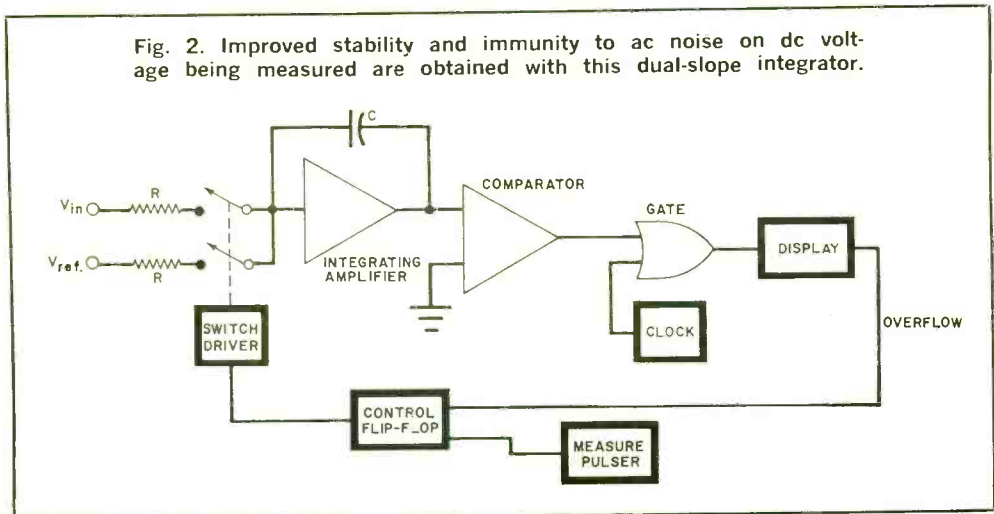

Fig. 2. Improved stability and immunity to ac noise on dc voltage being measured are obtained with this dual-slope integrator.

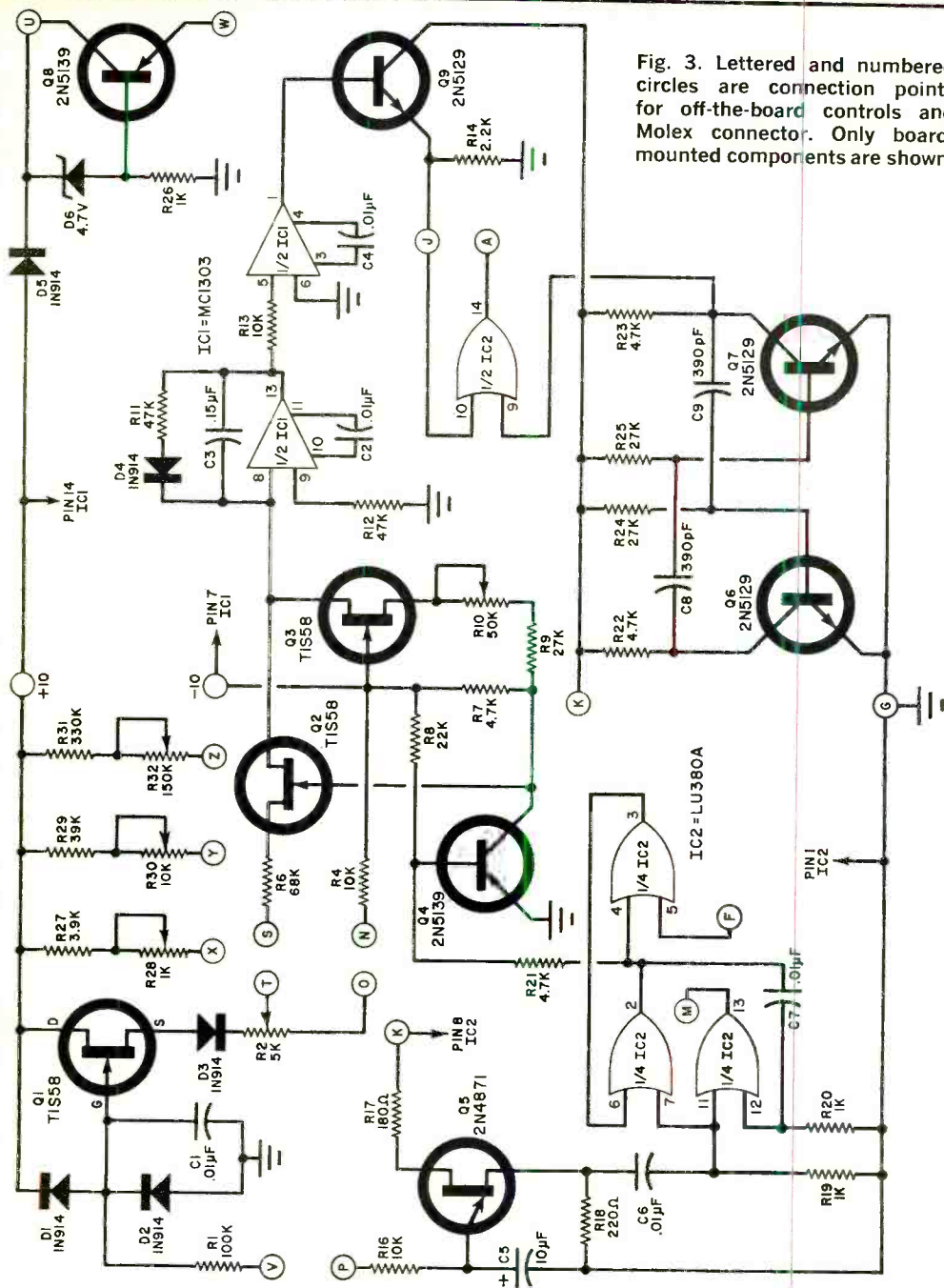

Fig. 3. Lettered and numbered circles are connection points for off-the-board controls and Molex connector. Only board-mounted components are shown.

plied to the integrator resistors. $R5^*$ and $R6$ through ZERO set control $R2$ and $D3$. Transistors $Q2$ and $Q3$ act as switches for the integrator and reference currents.

Now, if we consider the beginning point of the cycle to be the "measure"

signal, the following action takes place. Transistor $Q3$ is discharging the integrator, $IC1$, which is prevented from going positive by more than 0.5 volt by diode $D4$ in the feedback loop. Transistor $Q3$ is connected as a constant-current

PARTS LIST

- C1, C2, C4, C6, C7—0.01- μ F disc capacitor*
C3—0.15- μ F disc capacitor
C5—10- μ F, 15-volt electrolytic capacitor
C8, C9—3900-pF polystyrene capacitor
D1, D5—1N914 diode
D6—4.7-volt zener diode
IC1—Integrated circuit (Motorola MC1303)
IC2—Integrated circuit (Signetics LU 380A)
J1, J2—Banana jack or five-way binding post (one black, one red)
Q1, Q3—T1S58 field-effect transistor
Q4, Q8—2N5139 bipolar transistor
Q5—2N2817 unijunction transistor
Q6, Q7, Q9—2N5129 bipolar transistor
R1—100,000-ohm, $\frac{1}{2}$ -watt, 10% resistor
R4, R13, R16—10,000-ohm, $\frac{1}{2}$ -watt, 10% resistor
R6—56,000-ohm, $\frac{1}{2}$ -watt, 10% resistor
R7, R21, R23—4700-ohm, $\frac{1}{2}$ -watt, 10% resistor
R8—22,000-ohm, $\frac{1}{2}$ -watt, 10% resistor
R9, R24, R25—27,000-ohm, $\frac{1}{2}$ -watt, 10% resistor
R11, R12—47,000-ohm, $\frac{1}{2}$ -watt, 10% resistor
R14, R27—3900-ohm, $\frac{1}{2}$ -watt, 10% resistor
R17—180-ohm, $\frac{1}{2}$ -watt, 10% resistor
R18—220-ohm, $\frac{1}{2}$ -watt, 10% resistor
R19, R20, R26—1000-ohm, $\frac{1}{2}$ -watt, 10% resistor
R29—39,000-ohm, $\frac{1}{2}$ -watt, 10% resistor
R31—330,000-ohm, $\frac{1}{2}$ -watt, 10% resistor
R33—9-megohm, 1% precision resistor
R34—900,000-ohm, 1% precision resistor
R35—90,000-ohm, 1% precision resistor
R36—10,000-ohm, 1% precision resistor
R2—5000-ohm trimmer potentiometer
R10—50,000-ohm trimmer potentiometer
R28—1000-ohm trimmer potentiometer
R30—10,000-ohm trimmer potentiometer
R32—150,000-ohm trimmer potentiometer
R3—500-ohm standard potentiometer
R5—10,000-ohm standard potentiometer
R15—500,000-ohm standard potentiometer
S1—4-pole, 10-position rotary switch with spst add-on
Misc.—Printed circuit board; metal chassis; 15-contact Molex connector; solid and stranded hookup wire; control knob; 33,000-ohm, $\frac{1}{2}$ -watt resistor for current limiter on decimal point; machine hardware; solder; lacing cord; insulated spacers; etc.
Note—The following items are available post-paid from Southwest Technical Products Corp., Box 32040, San Antonio, TX 78216: etched and drilled printed circuit board No. VM-1b for \$2.65; complete kit of parts, including chassis and connector, No. VM-1 for \$29.95.

source. The -10 volts applied to the gate and a resistor in the source circuit determines the bias voltage and, therefore, the amount of current that passes through Q3. Variations in the -10-volt source have no effect on the current. Pin 2 of IC2 is at

a 0 logic level at this point in the cycle.

Transistor Q5 is a simple UJT generator, producing pulses at a rate governed by display control R15. When the voltage across C5 reaches the breakover point of Q5, a sharp pulse is supplied to pin 11 of IC2 through C6. This portion of IC2 is connected to form a SR flip-flop, or latch, circuit.

The pulse at pin 7 causes the output at pin 2 to go to a logic 1 at approximately 4 volts. This causes Q4 to conduct and brings the Q4 collector voltage to near ground potential, in addition to resetting the counter. In turn, this causes Q3 to go into cutoff and allows Q2, cut off until now, to conduct. At this point, the input voltage begins to charge integrator capacitor C3.

The output of the op-amp section switches into the circuit the comparator portion of IC1 as soon as the integrator output goes slightly negative. When the comparator switches, the voltage at pin 10 of IC2 goes to logic 0 and opens the gate, allowing clock pulses to enter the counter. This same logic signal is also applied to the blanking input of the counter to keep the display off during the measurement cycle.

When the counter reaches full-scale, the logic level at the overflow point changes and this signal is coupled to pin 5 of IC2. The pulse from the overflow indicator resets the RS flip-flop to its original state and resets the counter to zero. At this point, Q4 cuts off and Q3 begins supplying current to bring the integrator back to zero.

Counts are entered into the counter until the op-amp integrates back to zero, at which point the comparator changes state and closes the gate to the counter. The number displayed is proportional to the input voltage level. After a period of time, determined by the setting of R15, the cycle repeats.

The clock oscillator is a simple multi-vibrator operating at approximately 70 kHz. As already pointed out, the exact frequency is not critical, nor is stability. The only requirement is that it remain within 0.1 percent during the 0.1-second measurement interval.

Adding an ohmmeter circuit to the basic digital voltmeter is quite simple. All that is needed is a constant-current

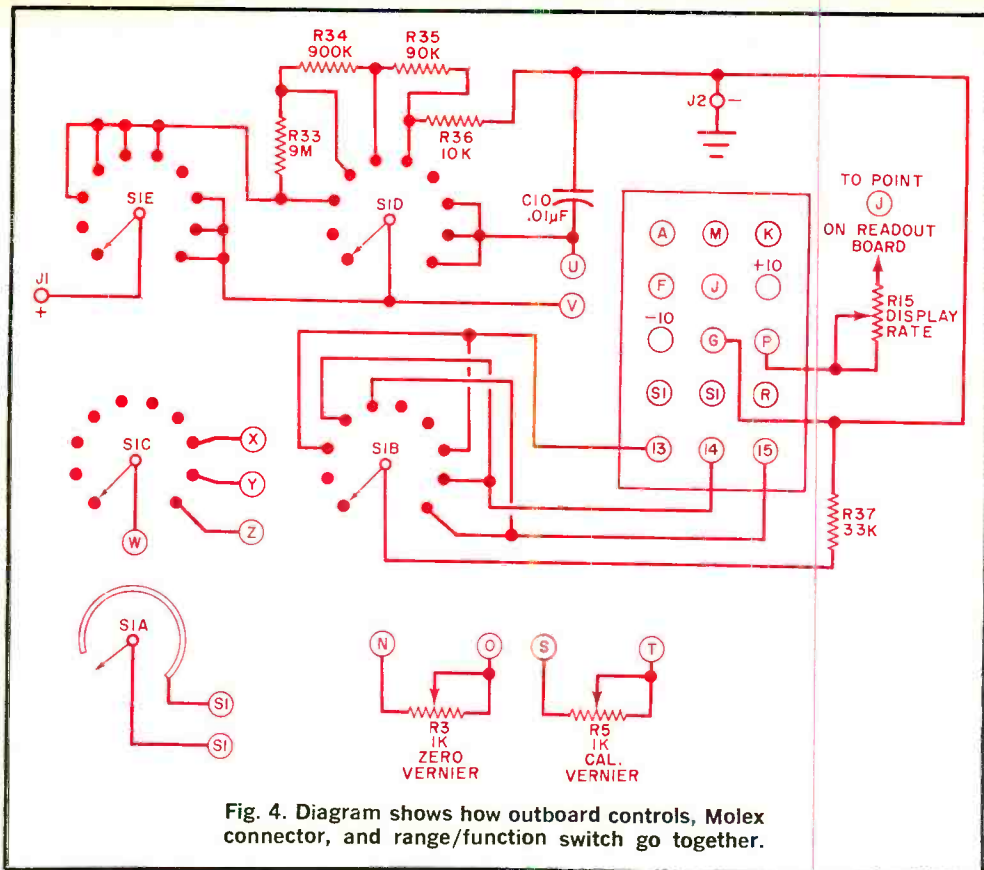
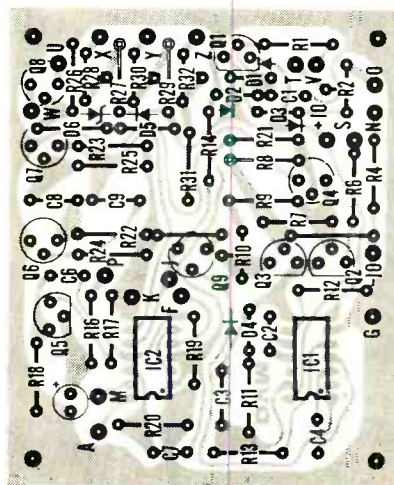

Fig. 5. Actual size drilling and etching guide and component placement and orientation diagram are shown left and below, respectively.



source to produce a dc voltage across the resistor under test. This current can be selected to provide a constant voltage that is directly proportional to the resistance. The voltmeter can then measure the voltage drop across the resistor. To accomplish this, the selector switch (S1) changes the emitter resistance in the current source circuit to provide the proper current for the 1999, 19.99 k, and 199.9 k ohm, full-scale, ranges. Transistor Q8 is the constant-current source.

Construction. Since all of the components that make up the DVOM Module mount on a single printed circuit board (see Fig. 5 for actual size etching and drilling guide and components placement diagram), assembly is very simple. The only off-the-board components are S1, the attenuator resistors, and a pair of potentiometers as shown in Fig. 6.

After wiring the PC board, connect and solder to the lettered holes 8" lengths of stranded hookup wire. Next, connect and solder the attenuator resistors to the multi-deck range/function switch. Mount the switch assembly, J1 and J2, and R3 and R5 on the chassis. Then connect and solder the appropriate wires from the circuit board to the switch. Likewise, connect and solder the appropriate wires from the board to the Molex connector contacts. Neatly bundle and tie the wires from the PC board to the switch and from the board to the connector.

Connect and solder the wires to R3 and R5 on the floor of the chassis. Then, using insulated spacers, mount the circuit board assembly on the floor of the chassis. Note that the circuit should not be grounded to the chassis at any point. The only ground connection to the case should be back to the dc power line.

Calibration. Plug the DVOM Module into the Mainframe via the connector. Turn on the power and check to make sure that the supply voltages are within 10 percent of their proper values. Set the control in the regulated 5-volt power supply section for between 4.5 and 5 volts output to the IC's.

Now, connect a shorting wire from J1 to J2 in the DVOM Module and place the range/function switch in the 1-volt position. Set R3 and R5 to midpoint. The display should show a reading as R2 is ro-

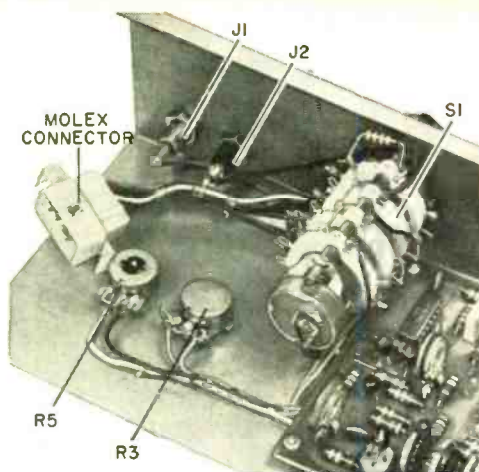

Fig. 6. Photo shows parts mounting details for off-board components.

tated. Set R15 for a 1-2 second display rate.

Now, adjust R2 for as close as possible to a zero reading. Remove the short from J1 and J2, and apply a known voltage to the input terminals. A mercury reference cell is probably the most commonly available voltage reference accurate enough to be used with this instrument. Remember that your readings are only as accurate as your calibration—which is only as good as the accuracy of the reference used.

With the reference voltage applied to J1 and J2, set R10 for as close as possible to the correct reading. Then set R3 and R5 with the voltage reference and with the short applied to the input terminals. Check the zero setting by rotating the range/function switch to the 100-volt range. If the reading obtained is not zero with a short across the input terminals, readjust R3 until it is. This calibration procedure should provide the voltmeter with a 1-percent or better accuracy.

The resistance ranges are set simply by connecting 1-percent tolerance precision resistors to J1 and J2 and adjusting R28, R30, and R32 to provide values that reflect those stamped on the resistors. If you can obtain 0.1-percent wirewound multiplier resistors, these make excellent standards to use for calibrating the resistance ranges.

This completes the calibration procedure for the DVOM Module. You are now ready to use the instrument. ♦

What Do HAMS Do?

Do you want to be a ham? You can join a net, enter amateur contests, build and operate equipment, or DX on your own.

WIEFW, WAIJVV, and WAINIO are all "traffic handlers" (that is, they provide a channel via amateur radio for the transmission of messages)—in varying degrees and for different reasons. WIEFW is a bank president and a long-time ham who has had military communications experience and who now thoroughly enjoys regular participation in organized, scheduled "net" activity. WAIJVV and WAINIO are both young high-school students; WAIJVV is proud of the recognition he has received for his traffic handling and enjoys the service aspect; WAINIO is still limited by the capabilities of his "rig" or station and finds it easy to get onto a net whenever he wants to get on the air.

There are many different kinds of nets in amateur radio—ranging from thoroughly organized cross-country and regional nets, all tied together and with regular schedules for operations and training for emergency conditions, to local, good-fellowship nets with no formal purpose. As amateur radio has grown in numbers, in technology, and in sophistication, interests have become diversified; various activities have developed—each with its particular adherents. Traffic handling is one such specialty.

Contests are another, and these run the gamut of both proficiency required and scope. One of the best known contests is Field Day (sponsored by the American Radio Relay League, or ARRL) conducted

once a year in June. Individual hams and especially local radio clubs as a group set up portable equipment, including portable generators, in the field and operate under simulated emergency conditions for a weekend, attempting to log as many contacts as possible. Another contest is the ARRL-sponsored Sweepstakes which is primarily on an individual basis—there is even a Novice Round-up for beginners. Various worldwide organizations in the ham field conduct their own specialized contests. In just about all cases the competitive spirit is at a fever pitch.

Another specialty whose adherents are among the most avid ham operators is DX or distant contacts. Protagonists try to make verified contacts with other hams in as many different countries and remote locations as possible. Verification following a contact is in the form of an exchange of QSL cards, post-card size, with imaginative, often very colorful designs. Every ham has his own personal QSL card and as a recipient of others may collect thousands of different ones over the years.

There is a DXCC—DX Century Club—in which a ham who has verified contacts with a hundred or more different "countries" (by amateur radio definition) receives an appropriate certificate. He gets endorsements for additional increments up to the 350 or so recognized "countries."

Most hams will "chase DX" to some ex-



One of the attractive QSL cards among the many which hams exchange after contacts. This elaborate card is printed in blue and yellow with bold orange letters.

tent, given the right conditions and the opportunity, but the true DXer is a special breed. Only a completely hooked type, for example, would actually mount an expedition—via ship or any other means—to some remote coral reef or uninhabited island in the middle of an ocean just to set up a portable station, go on the air, and originate QSL cards from another rare spot. This is called a DXpedition, and they take place all

Common denominator of amateur radio is direct communications between hams across town or around the world. This is "people-to-people" communications at its best, with no barriers.

the time and practically all around the world.

Many hams are builders, tinkerers, or experimenters. In the earliest days an amateur had to build his own equipment. Since World War II, however, commercially built amateur radio gear of all kinds and in a wide range of prices has appeared on the market. This is now a large market in itself, but there is still a special fascination and pride in doing it yourself. The term "home brew" is used to describe transmitters, receivers, and other gear constructed by the amateur. Even hams who do not want to tackle a major piece of equipment enjoy putting together simpler, auxiliary gadgets. Others actually get more pleasure out of construction or experimental projects than they do out of being on the air. Experimenters especially like to work with v.h.f. (very high frequency) equipment, FM, radio teletypewriter, and—particularly—amateur television.

To the vast majority of amateurs a favorite activity is still, as it always has been, "rag chewing," just getting on the air and talking to anyone. It may be an old friend or a brand-new contact; a ham around the corner or across the world. K1CC has had regular, scheduled weekly "talks" for more than 30 years with friends in Australia and New Zealand—and with his sister 500 miles away—all via cw or code; he has little use for new-fangled phone!



"Rag chewing" is really the common denominator, the staple among all radio amateurs.

The visitor to any ham's "shack," as he calls it, is usually impressed most of all by the array of seemingly complex electronic gear. He will also notice various objects hung or posted on the wall. Among them un-failingly will be an assortment of certificates, for hams are collectors too. There are certificates representing awards: WAS or Worked All States, WAC or Worked All Continents (awarded by the International Amateur Radio Union), Code Proficiency, and even RCC—Rag Chewers Club. Others may signify appointments in amateur radio field organizations—Official Observer, Official Bulletin Station, and many more. (Those referred to are issued by ARRL.)

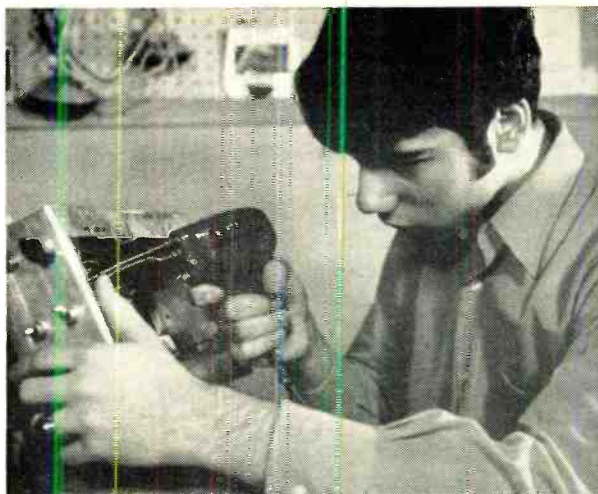

One of the many satisfactions found in amateur radio is "do it yourself." It may be a major construction project, experimenting with new gear, or just putting together some piece of auxiliary equipment for your old rig.

OPERATING IN OTHER COUNTRIES

If you are a world traveler, the United States and the following countries have negotiated bilateral agreements permitting their licensed amateurs to operate in each other's country. As a courtesy, a number of other countries grant temporary permission to U.S. (and other) amateurs to operate within their borders. Getting the necessary permission to operate in any of these countries usually involves filling out a simple form and furnishing a photocopy of your current U. S. amateur license. Allow plenty of time for the wheels to turn. Specific information on any country can usually be obtained upon request (with a stamped return envelope) from ARRL, 225 Main St., Newington, Conn. 06111. A query to the country's nearest consulate is also productive, but may be slower.

Argentina	France*	New Zealand
Australia	Fed. Rep.	Nicaragua
Austria	Germany	Norway
Barbados	Guatemala	Panama
Belgium	Guyana	Paraguay
Bolivia	Honduras	Peru
Brazil	India	Portugal
Canada	Indonesia	Sierre Leone
Chile	Ireland	Sweden
Colombia	Israel	Switzerland
Costa Rica	Jamaica	Trinidad &
Dominican	Kuwait	Tobago
Republic	Luxembourg	United
Ecuador	Monaco	Kingdom*
El Salvador	Netherlands*	Uruguay
Finland		Venezuela

*Includes overseas entities

Among the more exotic specialties engaged in by hams is the OSCAR (Orbiting Satellite Carrying Amateur Radio) program. To date hams have built five OSCARS which have been launched into space as hitchhikers on Air Force and NASA vehicles. These are communications satellites. OSCAR V was an international project, built in Australia, launched in the United States, and monitored by amateurs around the world. Reports were received from several hundred stations in at least 27 countries, including the Soviet Union. Under the direction of AMSAT, the Radio Amateur Satellite Corporation (a non-profit group), the OSCAR program is proceeding vigorously with even more ambitious projects in the future.

One of the first hams to bounce a radio signal off the moon was also an Australian, Ray Naughton, owner of a radio-TV-farm appliance store in the small village of Birchip, Australia. His moonbounce signal made history in 1966 when it was received at an amateur station in Crawford Hill, New Jersey.

A unique public-service activity by hams is Project MED-AID, a daily shortwave medical emergency service, operated by the Duke University Medical Center Amateur Radio Club in Durham, North Carolina. Since it went on the air in August 1966, it has often provided dramatic on-the-air medical advice and assistance to remote out-

posts in Central America, South America, and Africa. The MED-AID station bears the call letters, WB4BLK. In one case, a 10-year old boy, victim of a head injury, lay in a small Nicaraguan hospital with a severe concussion and signs of mounting pressure inside his skull. But brain surgery was a dangerous gamble in this remote hospital. The risk was minimized, and the outcome successful, after the local doctors were able to get rapid consultation with medical specialists thousands of miles away via MED-AID.

Radio amateurs provided communications for many early exploratory expeditions. In 1923, for example, an amateur named Donald Mix, now W1TS, accompanied Captain Donald B. MacMillan aboard the schooner "Bowdoin" on his Arctic Expedition. Mix's station, WNP—"Wireless North Pole"—kept the world informed of the expedition's progress and provided outside contact for the crew. The dirigible "Shenandoah" carried amateur radio equipment. Communications for then-Commander Richard E. Byrd's first Arctic expedition were furnished by amateurs, again on his first Antarctic expedition in 1928, and on later voyages as well.

MARS (the Military Affiliate Radio System) is an organization in each of the three armed services—Army, Navy/Marine Corps

and Air Force—composed of civilian radio amateurs who assist the services by providing morale communications between servicemen overseas and aboard ships around the world and their families back home, and by providing a communications reserve. In the process they also acquire valuable training. MARS operates in frequency bands outside the regular amateur bands. Perhaps the best known MARS operation is Senator Barry Goldwater's station in Arizona which is manned around the clock by a group of volunteer amateurs handling morale messages primarily to Vietnam.

Many amateurs have equipped their automobiles with compact two-way units which not only enable them to enjoy on-the-air activity while traveling but can be, and often have been invaluable in time of communications emergency. To anyone riding for the first time with W1PQ in his radio-equipped Volkswagen bus, the experience may be a bit disconcerting as Rog casually taps out and receives Morse Code messages in transit!

Ham radio is often a family affair. A somewhat unusual example is husband W1NHN, wife W1NHL, and their children W1NHJ, W1NHM, and W1NHK. If bathrooms can be a scramble for some families, imagine the congestion in this family if everyone wanted to go on the air at the same time!

There are more than 2000 amateur radio clubs across the country organized by local hams with a common interest, high schools, or other community groups. About 1300 of these are affiliated with the American Radio Relay League which gives them access to an extensive training-aids library of films and other material. Many of these clubs conduct regularly scheduled code and theory classes for newcomers; others operate club stations, have periodic auction of ham gear, participate as a group in contests like Field Day, publish club newsletters, and offer good fellowship among people with a common interest.

Hams also enjoy conventions and "ham-fests." Every year there are numerous regional and usually one national convention held by ARRL and other organizations. Here hams attend sessions on technological developments and operating activities, enjoy banquets and other social activities, and explore exhibits by commercial equipment manufacturers and amateur radio suppliers. ♦

THIRD-PARTY MESSAGES

International regulations forbid radio communications in behalf of "third parties" via amateur radio unless special arrangements have been made by the individual governments. The United States has negotiated agreements with the countries listed below to permit "unimportant" third-party messages to be exchanged. Most of the agreements also permit "emergency" messages to be exchanged—if the emergency messages are transferred from amateur to commercial channels as soon as possible.

Argentina	Cuba	Liberia
Barbados*	Dominican Republic	Mexico
Bolivia	Ecuador	Nicaragua
Brazil	El Salvador	Panama
Canada	Greenland**	Paraguay
Chile	Haiti	Peru
Colombia	Honduras	Uruguay
Costa Rica	Israel	Venezuela

*U.S. stations operating "portable 8P"

**XP calls only



TVI from the Victim's Viewpoint

By John T. Frye, W9EGV, KHD4167

MAC could hear Matilda's voice, shrill with anger, even before he opened the door. "I tell you, Barney," she was saying to the Number Two Technician of Mac's Service Shop, "I'm not going to have my lovely Englebert Humperdinck program ruined by any blabbermouth ham operating off his frequency."

"Now don't lose your cool, Matilda," Barney said soothingly. "How do you know it was an amateur interfering with your program? Are you sure it wasn't a CB station? Did you hear any call letters?"

"I certainly did," she answered, fishing a slip of paper from her purse, "and I wrote them down. They were KHD4167, and he was talking to a KKK something or other."

"It *was* a CB station," Barney stated triumphantly. "CB stations have three letters followed by four numerals. U.S. amateur stations have one or two letters followed by a numeral and then two or three more letters."

"What's all this about?" Mac asked, shrugging off his overcoat. "Has someone dared clobber our Girl Friday's dreamboat program?"

But she refused to be teased into a good mood. "I'm going to do something about this," she warned. "I can't expect Barney to help me because he is a ham, but I thought I could depend on you, Mac."

"Now just a cotton-picking minute!" Barney exploded. "Just because I'm a ham doesn't mean I go along with interference to radio or TV reception that is the fault of the transmitting station. I want to help you, too, but you've got to quit sizzling. Did you talk to the CB operator? He probably has no idea he is interfering with your reception."

"That's right, Matilda," Mac chimed in. "Barney and I are on your side, but we need more facts. Come to think of it, Barney, this is probably a good time to continue that review of interference problems we started a couple of months ago. You'll remember then we talked about interference to radios, PA systems, electronic organs, etc. Suppose now we talk about television interference, or TVI, while Matilda listens for clues that may help with her particular problem."

"I'm all ears." Barney agreed.

Television Interference. "The basic difference between radio interference and TV interference lies in the receiving frequencies involved," Mac began, lighting his pipe. "The radio broadcast band lies below the frequencies on which amateur and CB stations operate, while the TV channels lie above the frequencies of most amateur and CB stations. Also most radio receivers have an i-f frequency of about 455 kHz, while TV i-f frequencies are likely to be near 41 MHz, with older sets having i-fs from 21 to 27 MHz."

"I think I get it," Barney said slowly. "Radio interference almost always results from a lack of selectivity in the receiver or its propensity to respond to spurious signals, such as true images or harmonic images. But TV interference often comes from a transmitter putting out appreciable amounts of power in the form of harmonics, or multiples of the fundamental frequency, that fall in a TV channel. In such a case, nothing done at the receiver will help. The harmonics must be attenuated at the transmitter itself."

"That's right. While the fundamental fre-

quency of a ham station at 21 MHz might possibly get into the i-f of an old TV set because it was not properly shielded, the third harmonic of such a signal will fall in Channel 3, 60-66 MHz, and the fourth harmonic in Channel 6, 82-88 MHz. A 28-MHz ham station may have a second harmonic in Channel 2, 54-60 MHz, and a third in Channel 6. A CB station operating in the 27-MHz band can have a second harmonic in Channel 2 and a third in Channel 5, 76-82 MHz. These harmonics constitute actual signals appearing in the TV spectrum, and there's no way a receiver can differentiate between them and a duly transmitted TV signal. Other higher order harmonics fall in the upper vhf, channels 7-13, but ordinarily they are too weak to cause trouble except to nearby receivers picking up weak telecast signals."

"Does an unwanted signal cause the same amount of interference, no matter where it falls in a 6-MHz TV channel?"

"No. The worst interference results when the interfering signal falls near the picture carrier, 1.25 MHz from the low edge of the channel; the color subcarrier, 4.83 MHz from the low end; or the sound carrier, 0.25 MHz from the high end. In the first case, interference blacks out the picture entirely, makes a negative of it by reversing the light and dark areas, or produces bars and cross-hatching in the picture through beats between the harmonic signal and the picture carrier. In the second case, there's breakup of the color. A harmonic falling near the audio carrier interferes with the telecast sound. The degree of interference usually depends on how near the interfering signal is to one of these sensitive frequencies."

"Then TV interference is almost always the fault of the transmitting equipment!" Matilda said triumphantly.

"Whoa now! I didn't say that. I said such a possibility exists with TVI but it is not present with radio interference. A 'clean' transmitted signal with spurious radiations attenuated far below FCC requirements can still cause interference in a TV receiver by overloading stages in the front end, by cross-modulation, or by means of harmonics generated outside the transmitter by some non-linear device. In all these cases, the fault is not in the transmitter.

"Front-end overload is very common when the TV receiving antenna is quite near the transmitting antenna or in the beam of the latter. When an r-f stage is overloaded,

THE FIRST CROWN PREAMPLIFIER



IC 150

What would happen to a preamplifier design, if the design engineer could free himself from stereotyped ideas and start fresh with only a list of customers' requests? Well, at CROWN that has just happened, and the result is the **IC 150**, an exciting "new concept" control center with simplified circuitry, controls that are easy to understand and use, several exclusive features and unsurpassed quality — actually a \$269 preamplifier that outperforms other \$500 preamps.

Crown engineers discovered that preamp switches don't need to pop . . . that there is something better than the stereo mode switch . . . that the phono preamp can be dramatically improved . . . and, by using IC's, it can be priced to beat inflation.

Of course, the true uniqueness of such an innovative design cannot be appreciated by reading about it. We invite you to experience the **IC 150** yourself — to discover the preamp that gives you disc-to-tape recordings purer than any other, regardless its price. Write today for independent lab test reports and the name of your local CROWN dealer.

- World's quietest phono preamp
- Infinitely variable stereo panorama control
- Silent switching and automatic muting
- Industry's lowest distortion levels
- Unique full range tone and loudness controls
- Guaranteed phase response
- Adjustable gain controls to match cartridge output
- Three year warranty on parts, labor and shipping
- Price \$269, walnut enclosure — \$33

Ask your dealer also about Crown's new companion **D150** power amplifier, which delivers 150 watts RMS guaranteed at 8 ohms (typically 100 watts per channel). No amp in this power range — however expensive — has better frequency response or lower hum, noise or distortion. It offers performance equal to the famous **DC 300**, but at medium power and price. It's worth listening into!

Made only in
AMERICA 
Crown BOX 1000, ELKHART
INDIANA, 46514
CIRCLE NO. 9 ON READER SERVICE CARD

it operates nonlinearly and generates harmonics that are difficult to differentiate from transmitted harmonics. However, a properly installed high-pass filter at the TV tuner will greatly attenuate all signals below 54 MHz and usually cure front-end overload, but it will not affect transmitted harmonics. On the other hand, a low-pass filter installed on the transmitter output will attenuate harmonics that affect TV reception. So will proper bypassing, shielding, r-f choking, etc., but we can't go into measures taken to prevent the radiation of harmonics by ham or CB transmitters. There are books devoted to that subject."

"Don't forget a strong nearby signal can get into the audio amplifier of a TV set just as it does with a radio, PA amplifier, or any other audio amplifying device," Barney suggested. "A high-pass filter may or may not help this. That business of an external nonlinear device producing harmonics is a rough one. The device can be any oxidized joint between two pieces of metal, such as downspouting, electrical wiring shielding, a metal clothes line, joints in a metal tower, a bad lightning arrestor, or what have you. Often the condition is intermittent, to add to the confusion. *The Radio Amateur's Handbook* published by the ARRL is probably the best down-to-earth source of information on the cause and cure of all kinds of TVI."

"All very interesting—I think—but it doesn't solve my problem," Matilda said impatiently.

"Was the interference only with the audio or was the picture messed up, too?" Mac asked. "Did you try other channels? If so, were they OK?"

"The picture was not disturbed, only Humperdinck's lovely singing. Other channels were fine, but only Channel 5 carried Humperdinck."

Mac did a little figuring and then made a telephone call. "Now we're getting somewhere," he announced as he returned to the desk. "CB Channel 23 on 27.255 MHz has a third harmonic on 81.765 MHz, only 15 kHz away from the sound carrier frequency of Channel 5. A CB friend I know tells me the call letters you heard belong to a man living directly across the alley behind you. Here is his name. The local CB club has a TVI committee, as does the local ham club, and they will call you shortly and set up a time when they can run some tests and see where the fault lies: in his transmitter, your

receiver, or neither. Then they will do what they can to correct it."

"What if his transmitter is at fault but he'll not do anything about it?"

A Last Resort. "In that unlikely event you can, as a last resort, send a complaint to the FCC in Washington, D. C., giving the name, address, and call letters of the person causing the described interference. If he is licensed, they will send letters to him and to you. He will be given your name and address and the nature of your complaint and will be requested to contact you for the running of tests. He will be requested then to make a complete report, covering such items as his transmitting equipment and your receiving equipment, the tests he ran and the results, the measures he took to correct the condition and the success he had, your attitude, and the distance you live from the TV station being interfered with.

"If you are the only person in your neighborhood experiencing interference or if you are trying to receive a TV station beyond normal good-reception distance, the FCC probably will consider your complaint unreasonable and do nothing about it. On the other hand, if the transmitting station is causing widespread interference to the reception of good signals, the owner may be mandated to observe silence during prime viewing time until the condition is corrected. Note, however, that lodging a complaint does not mean the offending station is going to be automatically 'taken off the air.'"

"It might in one case," Barney offered. "If that station is operating illegally—is not properly licensed, has an antenna higher than the legal limit, or is running more power than permitted—the operator may be subject to a stiff fine. If he uses profane or obscene language over the air, this is a federal offense and the fine may be as much as \$10,000, accompanied by imprisonment. A station operating illegally certainly does not want the FCC monitoring truck parked in his alley."

"It's far better to settle the complaint at the local level," Mac pointed out. "A complaint sent the FCC usually means neighbors become enemies; yet they still must cooperate to clear up the trouble."

"One more thing," Barney interrupted.

"Yes?" Matilda questioned, her pencil poised.

"Don't call CB operators 'hams.' They are two entirely different kinds of cats!" ♦



Our town



The sun never sets in our town, nor do our microphones and sound systems get any rest. "Our town" is the mecca for sound specialists, and here, Shure Microphones and Vocal Master Sound Systems handle it all: you'll hear them in hotel show rooms and lounges used by famous professional entertainers whose livelihoods depend on sound excellence; you'll hear them in hotel convention halls, in club after club, in casino after casino; and you'll hear them 'round-the-clock as keno scores are announced. Why? Because the predictability and reliability of Shure microphones and sound systems simply make everyone's job a lot easier. The Shure sound is the Las Vegas sound — and we're proud of it.

Shure Brothers Inc.,
222 Hartrey Ave., Evanston, Ill. 60204.



CIRCLE NO. 31 ON READER SERVICE CARD

10 Reasons why RCA Home Training is your best investment for a rewarding career in electronics:

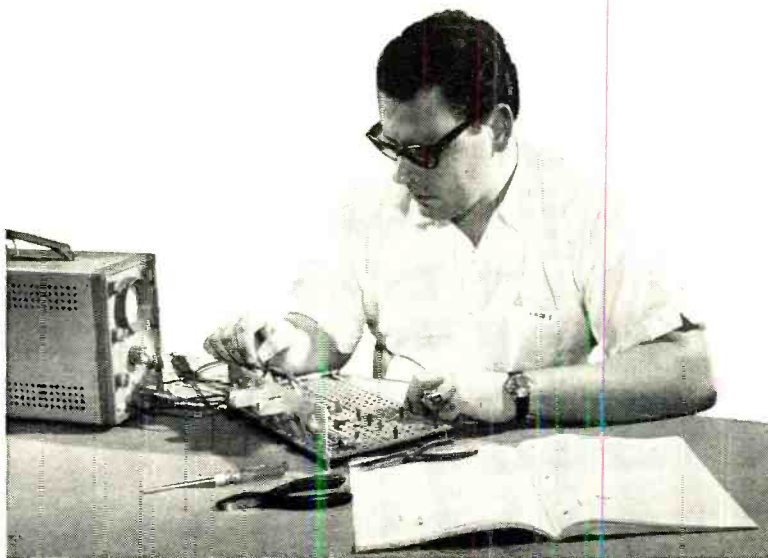

Performing transistor experiments on programmed breadboard — using oscilloscope

1 LEADER IN ELECTRONICS TRAINING

When you think of electronics, you immediately think of RCA... a name that stands for dependability, integrity, and pioneering scientific advances. For over half a century, RCA Institutes, Inc., a subsidiary of RCA, has been a leader in technical training.

2 RCA AUTOTEXT TEACHES ELECTRONICS FASTER, EASIER, ALMOST AUTOMATICALLY

Beginner or refresher. AUTOTEXT, RCA Institutes' own method of programmed Home Training will help you learn electronics more quickly and with less effort, even if you've had trouble with conventional learning methods in the past.

3 WELL PAID JOBS ARE OPEN TO MEN SKILLED IN ELECTRONICS

RCA Institutes is doing something positive to help men with an interest in electronics to qualify for rewarding jobs in this fascinating field. There are challenging new fields that need electronics technicians... new careers such as computers, automation, television, space electronics where the work is interesting and earnings are greater.

4 WIDE CHOICE OF CAREER PROGRAMS

Start today on the electronics career of your choice. On the attached card is a list of "Career Programs", each of which starts with the amazing AUTOTEXT method of programmed instruction. Look the list over, pick the one best suited to you and check it off on the card.

5 SPECIALIZED ADVANCED TRAINING

For those already working in electronics or with previous training, RCA Institutes offers advanced courses. You can start on a higher level without wasting time on work you already know.

6 PERSONAL SUPERVISION THROUGHOUT

All during your program of home study, your training is supervised by RCA Institutes experts who become personally involved in your efforts and help you over any "rough spots" that may develop.

7 HANDS-ON TRAINING

To give practical application to your studies, a variety of valuable RCA Institutes engineered kits are included in your program. You get over 250 projects and experiments and as many as 22 kits in some programs. Each kit is complete in itself. You never have to take apart one piece to build another. They're yours to keep and use on the job.

8 FCC LICENSE TRAINING—MONEY BACK AGREEMENT

Take RCA's Communications Career program—or enter with advanced standing and prepare immediately for your 1st, 2nd, or 3rd class FCC Radio Telephone License examinations. RCA Institutes money-back agreement assures you of your money back if you fail to pass the FCC examination taken within 6 months after completing the course.

9 CONVENIENT PAYMENT PLANS

You get a selection of low-cost tuition plans. And, we are an eligible insti-

tuition under the Federally Insured Student Loan Program.

10 RCA INSTITUTES IS FULLY ACCREDITED

RCA Institutes is an accredited member of the National Home Study Council. Licensed by N. Y. State—courses of study and instructional facilities are approved by the State Education Department.

VETERANS: TRAIN UNDER NEW GI BILL

SEND ATTACHED POSTAGE PAID CARD TODAY! FREE DESCRIPTIVE BOOK YOURS WITHOUT OBLIGATION!

If reply card is detached, send this coupon today!

RCA INSTITUTES, INC.
DEPT. 694-203-0
320 W. 31 ST.
NEW YORK, N. Y. 10001

Please send me FREE illustrated career catalog. I understand that I am under no obligation.

Name _____

Address _____

City _____

State _____ ZIP _____

Age _____

Veterans: Check here

Construction of Multimeter.

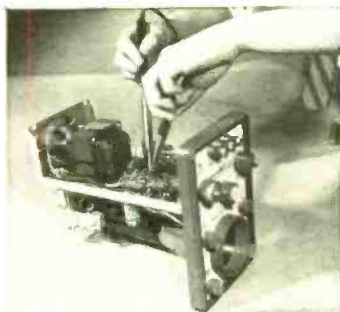

Construction of Oscilloscope.

Temperature experiment with transistors.

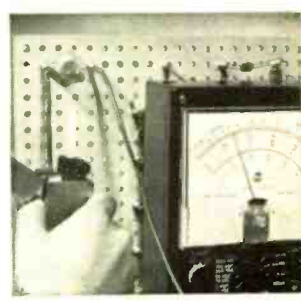

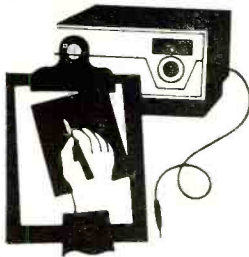

Product Test Reports

LAFAYETTE 4-CHANNEL STEREO AMPLIFIER (Model LA-44) (Hirsch-Houck Lab Report)

The Lafayette Radio Electronics Corp. Model LA-44 is an integrated amplifier capable of operation with discrete or matrixed 4-channel program sources. It has built-in circuits which can be used to extract L—R difference information from conventional 2-channel stereo programs. The extracted information is then used to drive an extra pair of amplifier channels that feed the rear speakers, thus simulating 4-channel programs by bringing some of the concert-hall reverberation into the listening room.

Actually two separate stereo amplifiers in one box with duplicate controls, the LA-44 is a compact unit that measures 13½" x 9½" x 4" and weighs only 15½ pounds. Its per-channel continuous output power rating is 20 watts into 8 ohms with 0.8 percent distortion at midrange frequencies. Separate pushbutton switches for the front and rear amplifiers allow the user to select from two high-level AUX., a TUNER, or a MAG PHONO cartridge source. The front and rear amplifiers each have concentric volume controls for the left and right channels and concentric bass and treble controls.

A function selector provides several modes of operation. For 2-channel stereo, either the front or the rear inputs can be channeled to all four speakers. A special 4 Channel Composer circuit can supply a derived L—R signal to the rear amplifiers while delivering the original 2-channel stereo signal to the front speakers. An external reverberation unit can be added in the rear signal path to enhance the "ambience" effect.

With discrete 4-channel program material, each input signal normally goes through its corresponding amplifier and out to the appropriate speaker with different input pro-

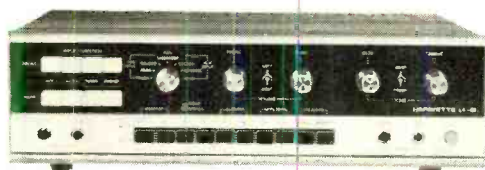

grams (if desired) and fully independent control of volume and tone characteristics. Two sets of speakers, making eight in all, can be controlled from the front panel, providing exceptional flexibility in distributing programs to different listening areas.

Pushbutton switches, duplicated for the front and rear amplifiers, control tape monitoring, mono/stereo mode, loudness compensation, high-cut filtering, and main and remote speaker selection. Tape recorder outputs are available through two front panel jacks as well as through jacks located on the rear apron near the tape inputs. Also on the front panel are two stereo headphone jacks, one each for the front and rear amplifiers.

The rear apron contains all the input and output connectors, speaker and line fuses, and two ac outlets, one of which is controlled by the power switch. A pair of 4-Ch Composer outputs carry the derived rear signals to the rear inputs for a 4-channel tape recorder so that 4-channel recordings can be made from 2-channel program sources.

Test Results. With only two channels driven, the LA-44 delivered 19.5 watts/channel into 8-ohm loads at the clipping point. Into 4 ohms, the output was 25.5 watts, and into 16 ohms, it was 12.8 watts. Most of our tests were made with all four channels simultaneously driven, an unus-

ually severe condition. Clipping power was 17.1 watts/channel into 8 ohms, 24 watts into 4 ohms, and 10.6 watts into 16 ohms.

The 1000-Hz harmonic distortion was less than 0.2 percent from 1 watt to about 16 watts (20 watts with two channels driven), and it was typically less than 0.1 percent. IM distortion was 0.33 percent at 0.1 watt, less than 0.1 percent from 1 watt to 14 watts, and 0.9 percent at 15 watts.

With 10 watts/channel as a reference "full power" level, distortion was less than 0.21 percent, 50-10,000 Hz. It rose to 0.55 percent at 20,000 Hz. At frequencies below 50 Hz, a more rapid rise was noted. At outputs of 5 watts and 1 watt, distortion was about 0.4 percent, 20-20,000 Hz, and between 0.1 and 0.2 percent at most intermediate frequencies.

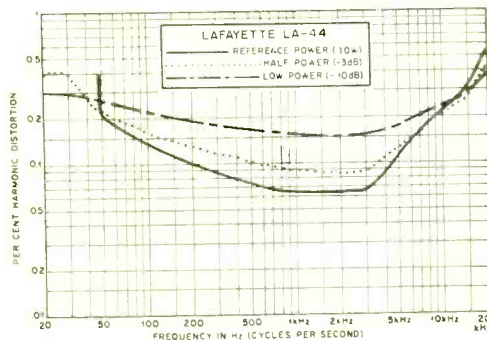
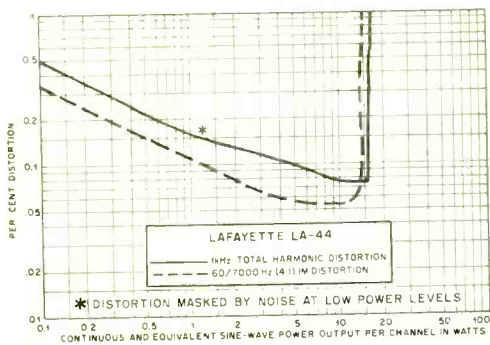

Top graph shows LA-44's THD and IM distortion plots. Graph immediately above shows amplifier's power response plots.

To obtain a 10-watt/channel output level, the LA-44 required signal levels of 175 mV on AUX, 390 mV on TUNER, and 2.6 mV on PHONO. Noise levels were very low; referred to 10 watts, they were, respectively, -80, -75, and -70 dB for the three inputs. The phono preamplifiers overloaded at 58 mV,

CUSTOM TAPE COMPONENTS



Model 87. Compact, inexpensive, yet highly reliable two speed, two motor open reel tape transport ideally suited for most manual recording/playback applications. Interlocked tape motion and record controls, pause and cue controls. Monaural or stereo head configurations. Available also three motor, electrically controlled series 230 tape transports.

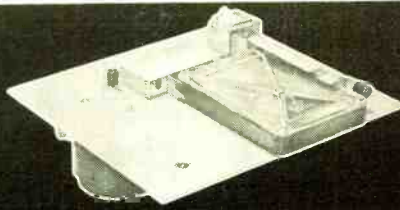

Broadcast quality transports for all NAB type endless loop tape cartridges. Three models — manual, semi-automatic or automatic for broadcast, industrial or commercial applications. Single or dual speed, in monaural or stereo head configurations.



Matching electronics for above. RP 84, professional solid state, monaural record and playback preamplifier for tape transports with two or three heads. Selectable equalization from 1-7/8 to 15 ips. A-B monitor switch. Mixing of line and mike inputs. Bias synch provision for multi-channel applications. Phone jack, VU meter, record light. 30-18,000 Hz \pm 3dB at 7.5 ips. Also model PB-10 playback preamplifier and model PA94F, 8 watt playback amplifier.

For free catalog and price information write

PRODUCTS OF SOUND RESEARCH
TELEX[®]
 COMMUNICATIONS DIVISION

9600 Aldrich Ave. So. • Minneapolis, Minn. 55420

CIRCLE NO. 34 ON READER SERVICE CARD

which is higher than would ever be developed by low- to medium-output phono cartridges.

The 4 Ch Composer reproduced a single input signal (either L or R) in the corresponding front output and both rear outputs at the same level. Crosstalk was -46 dB in the opposite front output. With an L+R input signal, the rear levels were down 15-20 dB. An L-R input signal produced rear signals 5.8 dB stronger than the front outputs the phases of which corresponded with the front signals on the same side of the room. These measurements were made with maximum volume settings (normally the rear levels would be reduced relative to the front levels).

The high-cut filter had a 6-dB/octave slope, beginning at 4500 Hz. Loudness compensation boosted both low and high frequencies at reduced volume control settings. The tone controls had good characteristics, although their action took place in about $\frac{3}{8}$ of the available rotation from center.

Listening Tests. Lafayette Radio's LA-44 amplifier sounded very good as was expected from its tested low noise and distortion figure. Although the output levels of about 20 watts/channel are modest by

contemporary standards, the fact that it has four channels makes a total output power of about 80 watts available when needed. We were able to drive some very low efficiency speakers to more than adequate volume levels in the 4-channel setup.

The Composer circuit adds a worthwhile amount of ambience to 2-channel programs. It resembles in operation the original Dynaco system with its rear speakers reproducing the L-R signals. Other similar systems in current use, such as Lafayette's 4-Channel adapter, provide some measure of rear left-to-right separation which the LA-44 does not and, so, are more effective in producing 4-channel effects with specially processed records. However, when enhancing 2-channel material from most sources, the difference is minor.

All in all, the LA-44 is a very versatile and fine sounding amplifier that can serve as a central distribution source for stereo throughout the home, for listening to two different programs simultaneously through headphones or speakers, or for 4-channel reproduction of any type of program source presently available or likely to be available in the future. It is a lot of amplifier for the \$219.95 asking price.

Circle No. 75 on Reader Service Card

SHURE STEREO PHONO CARTRIDGE (V-15 Type II Improved) (Hirsch-Houck Lab Report)

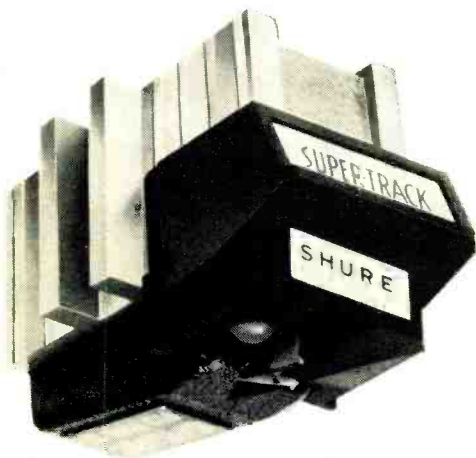

In terms of price and performance, the V-15 Type II (Improved) stereo phono cartridge is at the top of the Shure Brothers extensive line. As its somewhat cumbersome

nomenclature suggests, the V-15 Type II (Improved) cartridge is the latest model of a series which has evolved from the company's original model V-15 of several years ago. Although the current version bears little external resemblance to the first V-15, they are similar in basic design.

The V-15 series of cartridges was originally designed with the aid of an analog computer which enabled the Shure engineers to vary the many factors that affect cartridge performance while observing their effect on the final frequency response characteristics. In this way, they were able to optimize the cartridge design for "trackability." Trackability is the capacity of the cartridge's moving system to accurately follow the groove modulation over the full audio range at the highest recorded velocities likely to be encountered in commercial discs. It is expressed graphically by plotting modula-

tion velocity against frequency at various tracking forces.

Mis-tracking occurs whenever a cartridge is called upon to reproduce a signal exceeding its capabilities. It is heard as an easily recognized "shattering" distortion.

Although trackability specifications are not available from most cartridge manufacturers, Shure publishes them for many of their products. The V-15 Type II (Improved) is rated to track as high as 30-35 cm/s velocities over a range of 500-5000 Hz where the bulk of recorded material is concentrated. It can track at 15 cm/s at 15,000 Hz at a force of only 1.0 gram.

As with other Shure cartridges, the V-15 Type II (Improved) is a moving-magnet design. It has an easy-replacement stylus assembly which contains a "swing-away" plastic stylus guard. Tracking force rating is between $\frac{3}{4}$ and $1\frac{1}{2}$ grams. A 400-500-pF load capacitance (including arm wiring, cable, and amplifier input capacitances) is recommended for flattest frequency response. The stylus jewel is elliptical (0.2 mil x 0.7 mil).

Test Results. We measured the frequency response of the V-15 Type II (Improved) cartridge with the CBS STR-100 test record which sweeps from 40 Hz to 20,000 Hz. The most significant part of this sweep is the constant-velocity portion between 500 Hz and 20,000 Hz. For the test, the cartridge was mounted in an SME 3012 tone-arm and terminated in a parallel 500-pF/47,000-ohm network.

The two channels, which had identical midrange outputs, had slightly different responses beyond 10,000 Hz. In both cases, however, the overall response over the full range was within ± 2.5 dB. Channel separation was typically 18-20 dB across most of the frequency range, and it remained a strong 8-10 dB to 20,000 Hz. Noting that the output was still rising at 20,000 Hz, we repeated the measurement with the CBS STR-120 record which sweeps from 500 Hz to 50,000 Hz. This showed a rapid drop in output beyond 20,000 Hz, the principal resonant frequency between the stylus mass and the record's compliance. Separation, however, was maintained all the way up to 50,000 Hz.

This is a relatively low-output cartridge, delivering 3.25 mV/channel at 1000 Hz from a velocity of 3.54 cm/s. It tracked the very-high-level 32-Hz bands of the Cook

The Personal Communicator

LAFAYETTE MICRO 23 CB 2-WAY RADIO



★ Full 23-Channels
—All Crystals
Supplied

★ For Car, Boat,
Snowmobile,
Home, Office,
Farm

AMAZING ONLY
LOW PRICE **99⁹⁵**

Plus 3.80
Import
Surcharge
Stock No.
99-32575W

The Micro 23 has 23 crystal controlled channels with all crystals supplied, 5 watts of Talk Power, and yet it's only 5" wide. That makes the Lafayette Micro 23 the worlds smallest CB unit of it's type. So small it will fit almost anywhere, and is suitable for virtually any type of vehicle. The Micro 23 features a full 5 watt legal limit input, Range Boost circuitry for greater effective Talk Power, a sensitive dual converson receiver, 455 kHz mechanical filter for sharp selectivity, variable squelch, and automatic noise limiting. And with the optional micro-sized portable battery pack you can take the Micro 23 anywhere you go. An AC power supply is available for fixed station operation. Micro 23 size: 5"W x 1 $\frac{3}{4}$ "H x 7 $\frac{1}{2}$ "D. See it at your nearest Lafayette Dealer, or write for FREE Catalog.

FREE!
LAFAYETTE
1972
CATALOG



Lafayette Radio
Electronics
Dept. 35032
P.O. Box 10
Syosset, L.I.
N.Y. 11791

Send me the FREE 1972 LAFAYETTE Catalog 35032

Name

Address

City State Zip

(please include your Zip Code No.)

CIRCLE NO. 19 ON READER SERVICE CARD

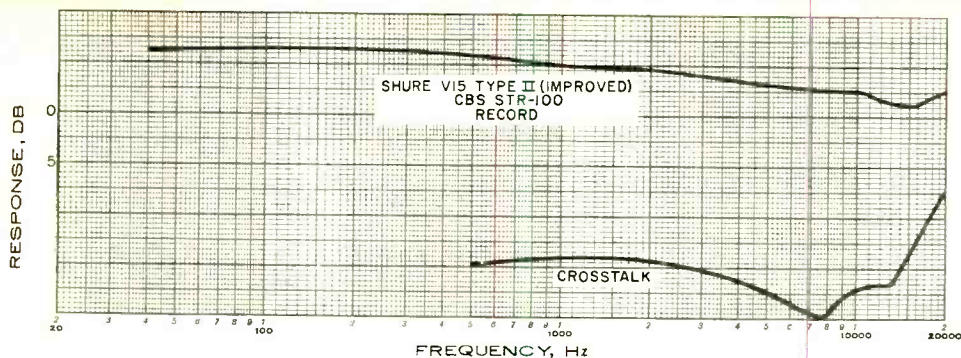

Frequency response and crosstalk curves for Shure V15 Type II (Improved) phono cartridge were obtained using CBS STR-100 record.

Series 60 record at only $\frac{3}{4}$ gram, and reproduced the 1000-Hz, 30 cm/s bands of the Fairchild 101 record with minimum distortion at 1 gram. Square-wave response, with the CBS STR-110 record, showed no significant ringing or overshoot.

The IM distortion was measured with the RCA 12-5-39 record. Up to 15 cm/s, distortion was less than 2 percent; it increased gradually to 6 percent at the highest velocity, 27.1 cm/s. Many very good cartridges are unable to track this band without severe distortion.

Our trackability test is a subjective one, using the Shure "Audio Obstacle Course" record. Various musical instruments are recorded at successively increasing velocities, allowing the cartridge's tracking ability to

be audibly evaluated. Except for the high levels of orchestral bells—which have been untrackable by any cartridge we have so far tested—the V-15 Type II (Improved) did a perfect job.

We have had considerable experience with this cartridge from its inception. The newest version is certainly one of the finest phono cartridges to be had at any price. It has a very neutral sound character, always smooth and easy and with no detectable coloration of its own. In addition, its ability to track almost any record made at only 1 gram should contribute substantially to long record life.

The Shure V-15 Type II (Improved) cartridge, packaged in an attractive wooden box, sells for \$67.50.

Circle No. 76 on Reader Service Card

E.F. JOHNSON CB TRANSCEIVER (Messenger Model 124-M)



The E.F. Johnson Co. Messenger Model 124-M is a solid-state 23-channel, crystal-synthesized AM CB transceiver that features a separate receiving section for monitoring a second channel without upsetting normal

operation. Supplied with a crystal for monitoring the REACT or emergency channel 9, the 124-M is unlike some setups that have a monitoring facility in that it is not restricted to monitoring only channel 9. It can be set up for any two different channels with the installation of the appropriate crystals.

Primarily a base station, this transceiver can also be used as a mobile unit. Normal operation is on 117 volts ac, but for mobile operation, the transceiver will operate from a 13.8-volt dc source.

For normal transceiver operation, there is an adjustable squelch control which also sets up the system for public-address work. In the PA mode, 3 watts of audio power

is delivered to an external speaker. An exceptionally good automatic noise limiter (anl) can be switched in and out as desired.

The large meter can be used to indicate S-unit signal strength, actual r-f power output, SWR, or modulation level. There is also a microphone gain control conveniently located on the front panel. It allows the user to optimize speech level by means of speech compression and clipping.

Transmitter Section. The transmitter operates at the full 5-watt legal input level. The carrier output tested out at 3.75 watts as indicated by an external wattmeter and the 124-M's own output-power meter. As for the latter, this is one of the few cases where we have found such a setup to be accurate with operation into a 50-ohm non-reactive load (1:1 SWR). With higher SWR loads, power meter reading accuracy will, of course, drop off accordingly.

Full 100 percent modulation was obtained with a clean waveform. As usual, clipping introduced by raising the microphone gain tends to square off the signal at the 100 percent point. However, no evidence of splatter was observed.

Receiver Section. The normal receiving section employs double conversion to provide 4.3 MHz and 455 kHz first and second i-f's. Excellent selectivity and fine overall bandpass for good voice intelligibility is obtained through the use of a four-pole crystal-lattice filter at the first i-f. Adjacent-channel rejection measured 50 dB, and image rejection was also 50 dB.

The monitor receiver utilizes single conversion to 455 kHz, with selectivity obtained from a single-crystal filter. Selectivity required a 70-dB adjacent-channel signal above the squelch threshold to actuate and be heard on the monitor channel. There are separate squelch and full-time anl for the monitor-receiver section.

Both receiver sections have r-f input stages. The sensitivity of the normal receiver measured $0.5 \mu\text{V}$ for 10 dB $S + N/N$ (rated at 8 dB). Squelch threshold sensitivity was adjustable between 0.3 and 1000 μV . A signal of 3 μV was required to activate the monitor receiver set up as follows:

A rocker switch is first set to the channel to be monitored. Then, with the rear-apron mode witch set to AUTO, a sufficiently strong signal that appears on the selected monitor channel causes the monitor receiver

**New electret
condenser
microphones for
flat response when
you record...**

**new dual-magnet
STEREO-V™
cartridges for flat
response when you
play back...**

**and exciting
4-channel sound
with new STEREO-4™
system.**

**Three of our latest
ideas for better
sound. For you.
We've got lots more.
Write for our
literature. It'll show
you the future.
Today.**



ELECTRO-VOICE, INC., Dept. 324P,
630 Cecil Street, Buchanan, Michigan 49107
In Canada: EV of Canada, Ltd., 345 Herberl Street, Gananoque, Ontario
In Europe: Electro-Voice, S.A., Lyss Strasse 55, 2560 Nidau, Switzerland

Electro-Voice®

a GULTON subsidiary

CIRCLE NO. 13 ON READER SERVICE CARD

to take over, lighting a lamp and passing the signal to the speaker.

With the mode switch set to ALERT, a signal on the monitor channel lights the lamp, but the normal receiver still remains active on any other channel to which it was set. This setup alerts the operator to the presence of a signal on the monitor channel while he can pursue normal communication on another channel.

In either mode switch position, the transmitter remains on the channel to which the main selector dial is set. If communication is then desired on the monitored channel, the main selector dial must be set accordingly. (The monitor receiver can also be set up for the Civil Air Patrol channel on 26.94 MHz, but transmissions cannot be conducted on this frequency.) The setup, in

a nut shell, is quite flexible and convenient for a variety of operational functions.

General Comments. The transceiver is a top-notch unit with a hefty transmit signal and some of the finest sounding a-f quality we have heard. The latter is enhanced by a tone control, located on the rear apron, which allows the user to adjust response to his liking.

The overall gain and age system are effective in virtually silencing background noise in the absence of an incoming signal. Also, with a more than 5 μ V input, the age is quite flat with only 4 dB a-f output change with 100 dB input-signal increase above 5 μ V.

The E.F. Johnson Messenger 124-M, with desk-type microphone, retails for \$355.45.

Circle No. 77 on Reader Service Card

WESTON DIGITAL FREQUENCY COUNTER

(Model 1250)

Four years ago, a new trend in test and measuring instruments began to assume a prominent place at the annual Institute of Electrical and Electronics Engineers Show, a kind of world's fair of electronics. Digital instruments were on their way in. Today, it appears that they are already solidly in as far as R&D labs and the like are concerned. In fact, they are catching on with service technicians and serious hams and electronics experimenters. Reflecting this trend, quite a few instrument manufacturers are turning out lines of digital testing gear at prices that virtually anyone can afford.

The latest digital frequency counter to come to our attention is Weston Instruments' Model 1250. It is capable of measuring frequencies in the range from 5 Hz to 32 MHz. Five light-emitting diode display stages are featured, supplying a maximum 99999 count display. This is supplemented by an automatic overrange indicator and a storage circuit that allows the system to display only the final count without blinking from number to number as the count proceeds.

Four switch-selectable ranges are provided. The ranges measure to a maximum of 10 kHz, 100 kHz, 10 MHz, and 32 MHz. Setting the range switch to the desired position also automatically positions the decimal point.

The accuracy of the Model 1250 is ± 1 count, plus or minus the time base stability



(which is very good). There is automatic blanking of the zeroes to the left of the actual displayed value to simplify reading. The input impedance of the frequency counter is 1 megohm, shunted by 30 pF. Sensitivity is 250 mV, while the maximum input level should not exceed 50 volts ac or dc. The input circuit has an automatic trigger level configuration that eliminates the need for a manually operated sensitivity control. Operating power can be taken from any 117-230-volt, 50-400-Hz ac line.

Physical Characteristics. The counter comes in a rugged fiberglass filled thermoplastic molded case that measures 8" x 7" x 3" and weighs only 4 pounds. Also available are a leather carrying case, panel

Going 4channel?



The Empire four channel cartridge uses four poles, four coils and three magnets (more than any other brand). This means ultra-wide frequency response and separation while tracking at forces so low they barely touch your records. RECORDS AND RECORDING MAGAZINE summed it up very well. They called the Empire cartridge "a design that encourages a music lover to clap his hands with joy." Empire four channel cartridges are available at better hi fi stores. For further information, write Empire Scientific Corp., 1055 Stewart Ave., Garden City, New York 11530.

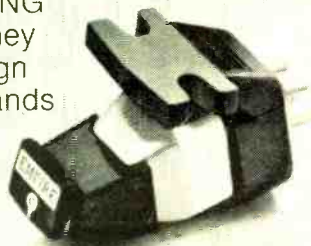

empire

World Famous Stereo Components



CIRCLE NO. 14 ON READER SERVICE CARD

MARCH 1972

TYMETER®

"Time At A Glance"

DIGITAL CLOCKS



MADE IN U.S.A.

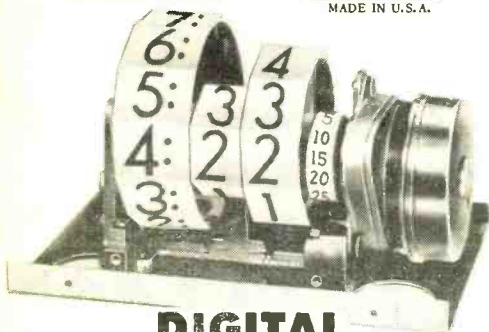

DIGITAL CLOCK MOVEMENTS

#130..12 HOUR #131..24 HOUR

DIGITS RESETTABLE INDIVIDUALLY

Available in 50, 60 cy., all voltages, AC. UL approved motor, cord. One Year Guarantee.

Complete Line of Count-Up and Count-Down Digital Computers

CATALOG ON REQUEST

PENNWOOD NUMECHRON CO.

TYMETER ELECTRONICS

7249 FRANKSTOWN AVE. PITTSBURGH, PA. 15208

CIRCLE NO. 27 ON READER SERVICE CARD

You don't have to be an engineer . . .

... to choose high fidelity components confidently. The purpose of high fidelity is simple — to re-create music accurately. But, explanations about how this is done are traditionally clouded by technical verbiage, and more often confuse than clarify.

Acoustic Research can help. The people at AR have written a series of comprehensive but non-technical articles explaining the essentials of high fidelity. You can obtain these articles and a copy of the current AR catalog by mailing the coupon below.



Acoustic Research, Inc.
24 Thorndike St.
Cambridge, Mass. 02141, Dept. YDHT

Please send me free copies of your articles on high fidelity plus the current illustrated AR catalog.

Name _____

Address _____

CIRCLE NO. 1 ON READER SERVICE CARD

mounting facilities, an optional rechargeable battery pack (can be recharged to full capacity overnight) which provides more than two hours of operation in field use, a split carrying handle which can be used as a tilt stand for the instrument, and a test position on the range switch that allows the user to test at a glance all segments of the seven-segment LED readouts.

On the front panel is located a BNC connector through which is available a 1-MHz signal. This signal, generated by a 1-MHz crystal-controlled oscillator, can serve as a frequency standard when needed. When the range switch is set to the EXT CLOCK function position, the 1-MHz output connector can be used to apply an external 1-MHz clock signal to the circuit.

The manual which accompanies the Model 1250 is very complete. It includes a section which discusses in full the theory of operation of the instrument and includes all schematic diagrams, waveforms, circuit board layouts, and test procedures which can be accomplished via controls accessible on the front panel. The user does not even have to open up the instrument's case.

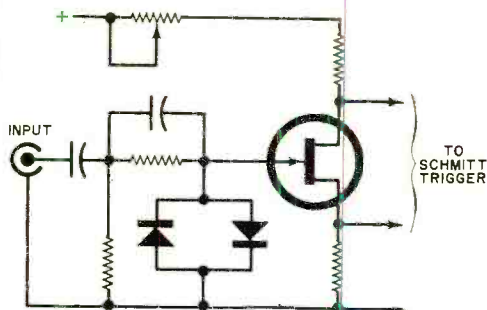

Input sensitivity is controlled automatically by this circuit in Weston counter.

FET Circuit. The diagram shown here illustrates the method used for overcoming the need for a manually operated sensitivity control. The input signal frequency to be counted is coupled to the gate of the field-effect transistor input stage and to a pair of diodes connected back-to-back between the FET's gate and ground. As long as the input signal level does not exceed the breakdown level of the diode junctions, it is safe to apply to the gate of the FET. In the event that a higher-level signal is applied, the diodes will automatically break down and the signal will be safely clipped. This feature has the advantage of squaring-off

The principle is the same. The potential is different.



Start with an inquiring mind. Add a passion for making things work. Then combine these qualities with a love of machines and a craftsman's hands, and you've got a natural born mechanic.

When the Air Force gets hold of a guy like that, they'll spend thousands of dollars to train him to be a master at his skill. And from automotive repair to computer maintenance, the skills the Air Force teaches can be as valuable out of the service as in it.

What are you interested in? Whether you know for sure or not, you've got to be interested in what an Air Force skill can mean to your future. And right now, as a special incentive, your local Air Force recruiter has a selection of jobs that he can guarantee you *before* you enlist. You just make your choice, and the skill of your life is locked in your future.

One more good reason to go Air Force is the recent pay raise that almost doubles your starting salary as an airman. For more information, mail in the coupon. Or, call

800-631-1972 toll free for the address of your nearest Air Force representative.*

Let the Air Force take your potential and make the most of it.

*In New Jersey call 800-962-2803

U.S. AIR FORCE RECRUITING SERVICE DIRECTORATE OF ADVERTISING (APV) RANDOLPH AIR FORCE BASE TEXAS 78148	1-PE-32
Name _____	
High School _____	
Address _____	
City _____ State _____ Zip _____	
Phone _____ Date of Birth _____	
I understand there is no obligation.	

Find yourself in the Air Force.

sine-wave inputs at this breakdown point, making the signal more useful in toggling the following circuits.

The output signal from the FET triggers a Schmitt trigger circuit which steepens the sides of any applied waveform, making them suitable for driving the TTL logic used in the counter. The sensitivity of the FET input stage is determined by a screw-driver adjustable potentiometer in the drain circuit of the FET stage in the actual unit.

Circle No. 78 on Reader Service Card

KIKUSUI AUDIO SIGNAL GENERATOR (Model ORC-27A)

A good sine/square wave audio signal generator, plus a good oscilloscope, provide one of the most versatile and flexible test setups on the audio service technician's workbench. There are many good audio generators to choose from. The one that we have used and run through tests recently is a multi-waveform Model ORC-27A low-frequency RC oscillator made by Kikusui Electronics Corp. of Japan.

This new instrument not only provides a wide range of sine and square waves, but it also features a complex wave output which comes in handy when making rough inter-modulation distortion tests.

The ORC-27A is a good example of how a classical vacuum-tube circuit, connected in the traditionally reliable Wien bridge configuration, can be updated and, with some good mechanical design, make an excellent service bench instrument.

The frequency coverage of the generator encompasses four switch-selectable ranges: 18-200 Hz; 180-2000 Hz; 1800-20,000 Hz; and 18,000 to 200,000 Hz. Calibration accuracy is 2 percent, while frequency stability is 1 percent with a 5 percent line-voltage variation.

Three outputs are provided. The sine wave output is rated at a maximum of 5 volts rms with the frequency response within 0.5 dB across the range and distortion less than 1 percent at 1000 Hz. The square wave output has an amplitude that is variable to 10 volts peak-to-peak while frequency response is flat to within 0.5 dB with sag and overshoot limited to less than 1 dB within the frequency range. The 10-volt peak-to-peak complex waveform employs a 4:1 mixture of 60 Hz and the adjustable frequency of the generator. The

The Model 1250 is an extremely simple instrument to use, even by a neophyte. Once the test-lead cable is snapped onto the input BNC connector on the front panel of the counter, the user merely sets the range switch as required and connects the test-lead cable to the appropriate points in the circuit under test.

Asking price for the Weston Instruments Model 1250 digital frequency counter is \$395.



output impedance on all functions and ranges is less than 3000 ohms.

Test Results. Our tests showed that the output of the ORC-27A had less than 0.1 dB overall variation between 18 Hz and 30,000 Hz. It dropped to -0.5 dB at 100,000 Hz and to -1.9 dB at 220,000 (the upper limit of the instrument). The specified frequency calibration of 2 percent over the entire frequency range was easily met. In fact, at most of our test points, it was within 1 percent.

At 20 Hz, total harmonic distortion was about 0.83 percent. At 1000 Hz, it was 0.32 percent. And at 20,000 Hz, it was down to 0.22 percent. The THD appears to be largely second harmonic distortion.

The frequency did not significantly shift with manual level changes. Switching from the sine- to the square-wave output shifted the frequency less than 0.2 percent. The square-wave output was good over the audio range, but beyond about 100,000 Hz, its symmetry deviated somewhat.

The complex output is intended for IM tests, with the adjustable frequency of the generator superimposed on a 60-Hz signal in the usual 4:1 ratio. This appears to be

a great idea, allowing wide latitude in frequency combinations for audio IM tests. Unfortunately, the mixed signal passes through an output cathode-follower—a step which evidently is responsible for much, if not most, of the distortion we found in our test unit. The residual IM distortion was 2-2.5 percent over the entire range of upper signal frequencies extending from 3000 to 7000 Hz. Hence, the instrument is suitable for only gross IM distortion tests. Even so, this does not in any way detract from the performance of the sine and square wave functions which we found to be very good.

General Comments. Mechanically, the ORC-27A is soundly built. It measures roughly 12" x 8" x 7" and weighs about 4 pounds. The smooth tuning dial gives this audio generator the "look" of a shortwave receiver. And the use of a mirror-backed scale ensures accurate settings of the dial.

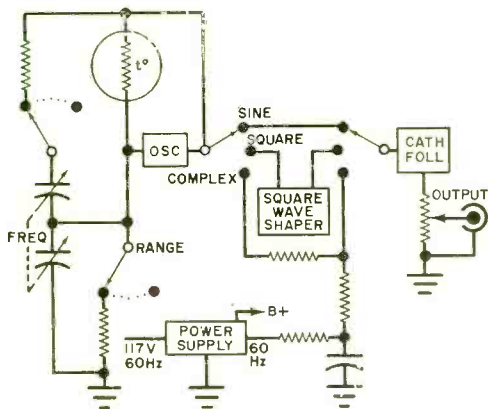

Feedback thermistor maintains good amplitude stability and reduces distortion.

As shown in the partial diagram, the circuit is essentially a Wien bridge with a special thermistor in the feedback circuit to maintain good amplitude stability and reduce distortion. The frequency of the oscillator is varied via a tuning capacitor. The square wave clipper is composed of a series-connected dual triode and is designed to convert the sine waves into clean square waves.

A resistor matrix permits the power-line-derived 60-Hz source to be combined with the selected audio frequency at a 4:1 ratio to make the complex waveform.

In an unusual move, the Kikusui people provide with the instrument a copy of the

AR guarantees its published specifications

At Acoustic Research we believe that the publication of complete performance data on our high fidelity components is obligatory. Otherwise, our guarantee would have little meaning.

Find out just what AR guarantees that its products will do. Mail the coupon below, and detailed technical literature will be sent to you free of charge.



Acoustic Research, Inc.
24 Thorndike Street
Cambridge, Mass. 02141
Dept. PE-3

Please send measured performance data on AR products to

Name _____

Address _____

CIRCLE NO. 2 ON READER SERVICE CARD

Technical excellence in electronics

On our small, friendly campus the emphasis is on Living as well as Learning. Extra-curricular social activities, student clubs, a student operated radio station, student government, new dormitory and a full sports program help provide a world of your own in which to prepare for tomorrow. Associate Degree in Engineering Electronics. B.S. obtainable. G.I. approved.



VALPARAISO TECHNICAL INSTITUTE
Dept. PE, Yellowstone Trail, Valparaiso, Indiana 46383

CIRCLE NO. 39 ON READER SERVICE CARD

original factory test data with entries of findings made by the test technicians. The test data form is hand-signed by an inspector and the final test technician and bears the date of inspection. Somehow, this almost

official documentation gives one the feeling of confidence so often lacking when buying other test instruments.

The Kikusui Model ORC-27A Audio Signal Generator sells for \$85.

Circle No. 79 on Reader Service Card

SENCORE FIELD EFFECT MULTIMETER (Model FE160 Senior)

Most people usually think of a multimeter as a plastic case with a pair of rotary switches, one for range and the other for function selection, designed to provide the user with facilities for measuring current, resistance, and voltage. Well, things have changed both cosmetically and operationally. It was quite a surprise to open the package of the latest all-solid-state Model FE160 Senior Field Effect Meter made by Sencore and see what \$190 buys.

To start with, the new multimeter is big and hefty, measuring 9" x 7" x 6" and weighing 6 pounds. There are two major reasons for the large size. One is to permit the instrument case to accommodate a 7" anti-parallax mirror scale with a 500- μ A meter movement. The scales on the movement face are clearly marked according to purpose.

The second reason for the large case

size is to permit the front panel to accommodate comfortably 18 pushbutton switches which replace the traditional rotary range and function switches found in most multimeters. These switches can be used in the proper combinations to provide up to 112 measurement ranges!

Imagine the possibilities offered. For dc voltage measurements, there are ten each for positive, negative, and zero-center ranges going from 0.1 volt all the way to 3000 volts full scale. Input resistance in the dc function is 15 megohms, shunted by 90 pF in the probe NORM position and 10 pF in the probe ISOLATION position. Full-scale accuracy is 1.5 percent with a 30-dB minimum ac rejection figure.

For ac voltage measurements, there are nine rms ranges, the same as for dc except that coverage goes up to only 1000 volts instead of 3000 volts full scale. Input impedance is 12 megohms, shunted by 50 pF. The ac frequency response is 3 dB, 5-500,000 Hz. Accuracy is 2.5 percent.

Ten positive, negative, and zero-center ranges are available, making a total of 30 in all, for measuring dc currents. They cover a range of from 30 μ A through 3 amperes full scale. The internal drop is 0.1 volt on all ranges, and accuracy is 2 percent.

There are ten ac current ranges with the same coverage as for dc. Again, the internal drop is 0.1 volt rms on all ranges.

The ohmmeter section is divided into two parts. There are eight high-power ranges that employ a 1.5-volt dc reference source and provide a measurement range of from 600 ohms to 600 megohms full-scale. Seven low-power ranges, employing a 0.08-volt dc reference source, also provide measurement capabilities of up to 600 megohms. Accuracy is 2 percent.

Why two types of ohmeter ranges? We assure you that there is method to the madness. The low-power function permits accurate in-circuit resistance measurements. The 0.08-volt source used in making the low-power measurements is not sufficient to



cause the transistors and diodes in a circuit to conduct and produce false indications. The high-power function allows the ohmmeter to be used in the same manner any other ohmmeter is used.

Finally, there is a built-in decibel measuring function with a nine-range format. It provides coverage of from -20 dB to $+60$ dB, referenced to 1 mW into 600 ohms.

An excellent, and welcome, feature of this instrument is its 1000 times overload

protection factor which prevents costly damage resulting from accidental misuse.

After using the FE160, plus its optional 39A30 High-Voltage Probe (\$12), we found it to be a handy piece of test gear. Not only is it easy to use, thanks to the simple pushbutton switching arrangement and large easy-to-read meter movement, but it is also a dandy all-around multimeter that will continue to see lots of service in the years to come.

Circle No. 80 on Reader Service Card

SIGNAL SCIENCE WHISTLE SWITCH

The elderly, the infirm, bed-ridden patients, lazy people, and those who just want the convenience of being able to remotely control a home appliance will welcome the "Whistle Switch" being marketed by Signal Science, Inc. The Whistle Switch is a rather unique remote control device that operates on blasts of a high-frequency whistle. It will turn on and off any appliance that is rated at up to 300 watts. Examples of appliances which can be so controlled are radio and TV receivers, lamps, motor-driven doors, etc.

Installation of the Whistle Switch is simple and foolproof. The user simply plugs the control unit into any convenient 117-volt ac wall outlet and plugs the appliance to be controlled into the receptacle mounted on the control box. Next, the appliance is turned on and left in this state. Now, when the user wishes to power the appliance, he simply sounds a blast on either of the two whistles provided. The control box responds by powering the appliance. Another toot of the whistle shuts down the power to the appliance.

Two high-frequency whistles, both designed to operate at a frequency of about 13,500 Hz, are supplied with the Whistle Switch. One of them is squeeze-bulb-operated, while the other is a conventional lung-powered type. Since the pitch of the whistles' sound is well within the normal range of human perception, any time the whistle is sounded it can be heard.

The control unit is housed inside a sealed plastic box that measure about 4"-long by 2"-square. A standard ac plug and chassis-mounted ac receptacle are riveted to the rear and front of the box, respectively. Inside the box, the switch consists of a high-frequency microphone element, an IC am-

plifier, a transistor driver, and a relay.

To prevent the control box from responding to high-frequency sounds not initiated by the supplied whistles, a screw-driver-adjustable sensitivity control is provided. Setting the sensitivity control for minimum, the range of the unit we tested was between 6 and 10 ft. Increasing sensitivity to maximum, however, increased the range to between 30 to 50 ft. A greater range is possible in large open areas. And the high-frequency whistle sound readily travels around obstacles and corners; so, it is not necessary for the user to be in direct line of sight with the microphone pickup on the control box to assure operation.

The Underwriters Laboratory listed Whistle Switch sells for \$14.95.

Circle No. 81 on Reader Service Card

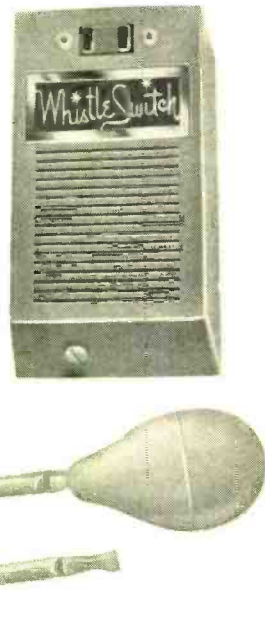

More kits than ever...over 350...all in your

The most advanced color TV kit we've ever offered.

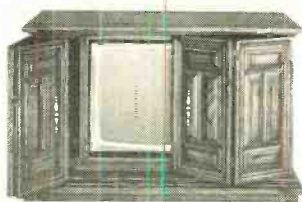
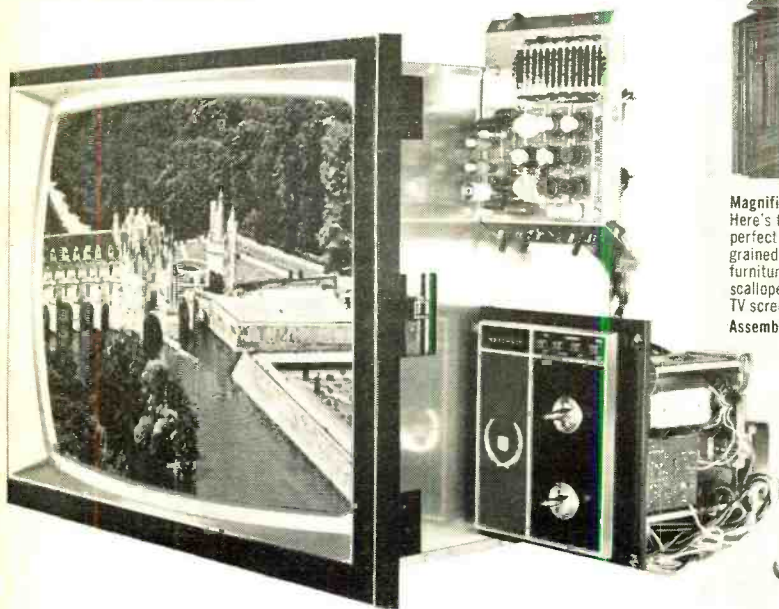

Magnificent Mediterranean Console. Here's the finest TV cabinet we offer, a perfect choice for a GR-900. Has deep-grained pecan veneers in hand-rubbed furniture grade hardwood solids. Two scalloped double-hinged doors hide the TV screen when not in use.
Assembled GRA-405-25, 100 lbs. . . . 179.95*

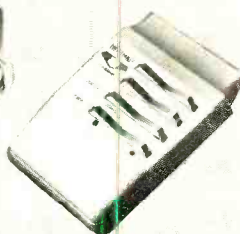

Wireless Remote for your GR-900. The ultimate in armchair viewing. Gives you eight-function across-the-room control of on/off, three preset volume levels, power tuning (up or down), color, tint, UHF/VHF channel selection. Also activates Custom Wall Mount doors.
Kit GRA-900-6, 6 lbs. 79.95*

The new Heathkit GR-900 25V Color TV has UHF/VHF detent tuning & varactor UHF tuner, angular tint control — more features than any other color TV kit! Better performance than any other set.

UHF/VHF detent power tuning. Push a button and you scan the channels in either direction with detent action locking in on VHF channels 2-13 and any 12 preselected UHF stations. A pushbutton selects either UHF or VHF mode, and a lighted dial indicates tuner position. And you can have full remote-control selection too for just a few dollars more.

New voltage-controlled varactor UHF tuner and specially designed VHF tuner with MOS Field Effect Transistor contribute to better fringe-area reception, increased sensitivity.

New angular tint control. A switch now gives you either "normal" or "wide angle" color demodulation to reduce tint and flesh tone change when changing stations and when programs change. Other deluxe features include "instant on" operation with override for conventional on/off operation; automatic fine tuning; adjustable tone control, and an output for playing TV audio through your stereo hi/hi system.

Exclusive Heath MTX-5 ultra-rectangular tube. It's the largest color screen you can buy anywhere, with a full 25 inch meas. diag., 315 sq. in. viewing area. You see virtually everything the station transmits, in the corners and at the sides. The specially etched face plate cuts glare, and reflection, increases contrast without sacrificing brightness, and each dot is projected through a matrix screen to stand out crisply against a solid black background.

Modular solid-state circuitry. Plug-in circuit boards and plug-in transistors make assembly, adjustment and servicing easy. There are 46 transistors, 57 diodes and four ICs — making this one of the most reliable sets we've ever designed.

Other features include automatic chroma control, adjustable video peaking, adjustable noise limiting, and gated AGC.

Exclusive Heath self-service built-ins. Your Heathkit GR-900 includes built-in dot generator, tilt-out convergence panel for set-up and periodic adjustments. A handy volt-ohm meter included in the circuitry helps you check your work during assembly, and can be used in conjunction with the manual for any servicing. Like all Heathkit color TVs, the GR-900 gives you complete installation flexibility. There are four beautiful Heath cabinets to choose from plus the new built-in electronic wall mount with hide-away tambour doors. Or you can custom install your GR-900. We think you'll agree, the GR-900 is truly the most impressive color receiver we've ever offered.

Kit GR 900, TV less cabinet, 125 lbs. 599.95*

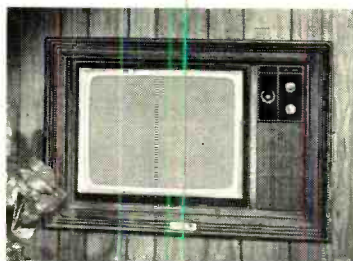

New Custom Wall Mount. Touch a button on the frame or on your Heathkit Remote Control unit and the folding tambour doors open to reveal your color TV. Kit includes everything needed to build your Heathkit GR-371MX or GR-900 into a wall.
Kit GRA-402-25, walnut finish, 50 lbs. 114.95*
Kit GRA-407-25, unfinished, 50 lbs. 109.95*

FREE '72 HEATHKIT Catalog



New AR-1500 stereo receiver 379.95*

Successor to the famed Heathkit AR-15, with impressive improvements in every critical area. 180 watts Dynamic Music Power, 90 watts per channel, 8 ohm load. Less than 0.2% IM and 0.25% harmonic distortion. Greater than 90 dB FM selectivity and 1.8 uV sensitivity. Vastly superior AM, too. It's the talk of the audio world. Order yours now. Kit AR-1500, 42 lbs. (less cabinet) . . . 379.95*
ARA-1500-1, walnut cabinet, 6 lbs. . . . 24.95*

New digital multimeter 229.95*



Now, a digital multimeter that meets lab specs at a low, low kit price! 3½ digits for 100 uV resolution on 200 mV range; 1V on 1000V; 5 DC ranges (100 uV—1000V, either polarity); 5 AC ranges (100 uV—500V); 10 current ranges (100 nA—2A AC or DC); 6 resistance ranges (0.1 ohm—20 megohms.) DC calibrator supplied for 0.2% accuracy without external equipment. Can be lab calibrated to 0.1%. Don't miss this outstanding instrument value. Kit IM-102, 9 lbs. 229.95*

New 10 MHz triggered scope 229.95*



A 5" triggered sweep scope at a low kit price you can't afford to pass up. AC—10 MHz response, calibrated attenuator, 50 ns sweep rate with magnification, AC-DC coupling, 50 mV sensitivity. One of the outstanding scope values on the market. Order one for your ham shack, shop, lab or classroom, today. Kit IO-103, 37 lbs. 229.95*

The better-than-ever '72 Heathkit Catalog has the world's largest selection of fun-to-build, money-saving electronic kits...including color TV, stereo/hi-fi, organs, home appliances, engine tune-up tools, radio control, portables, shortwave, marine gear, metal locator, instruments, hundreds more. If you don't have this catalog, you've missed seeing over 50 new kits, introduced since the last edition. Send today for your free copy.



New... Heathkit solid-state 100 MHz counter...only 269.95*

With the IB-1101, Heath closes the price gap in high frequency counters. Till now, "low cost" counters were confined pretty much to the 15 MHz range. Instruments above that range were complex, costly, and often more counter than you could ever use. Now, with the IB-1101, you have a truly low-cost counter in kit form with 1 Hz to 100 MHz capability and a list of features to rival counters costing much more. Compare for yourself.

Exclusive Heath-designed input circuit accepts input levels from less than 50 mV to over 200V, depending on frequency, without damaging the instrument; full 5-digit readout can be expanded to 8-digit capability with range selector and overrange circuitry; decimal point automatically positioned with range selection; MHz, kHz, overrange and gating conditions indicated by illuminated legends on front panel; one megohm input impedance & low input capacitance minimize possibility of circuit loading; all solid-state circuitry with cold cathode readout tubes for instant operation; count storage circuitry gives non-blinking or count-up readout, changing only with count; stable time-base crystal has better than ±3 ppm from 17° to 32° C; dual primary, 3-wire line cord & regulated supply for stable operation over long periods. About 10 hrs. assembly time puts the IB-1101 together. The 26 digital IC packages & readout tubes plug into sockets. All other components, including shielded MOSFET, 10 silicon transistors, 9 diodes & 2 zener diodes mount neatly on one double-sided fiberglass board. If you've been putting off buying that better counter because you "couldn't afford it"...you've just lost your excuse. Order your IB-1101, today!

Kit IB-1101, 8 lbs. 269.95*

Send for your FREE 1972 Heathkit Catalog today

HEATHKIT ELECTRONICS CENTERS - ARIZ.: Phoenix, 2727 W. Indian School Rd.; CALIF.: Anaheim, 330 E. Ball Rd.; El Cerrito, 6000 Potrero Ave.; Los Angeles, 2309 S. Flower St.; Redwood City, 2001 Middlefield Rd.; San Diego (La Mesa), 8363 Center Dr.; Woodland Hills, 22504 Ventura Blvd.; COLO.: Denver, 5940 W. 38th Ave.; FLA.: Miami (Hialeah), 4705 W. 16th Ave.; GA.: Atlanta, 5285 Roswell Rd.; ILL.: Chicago, 3462-66 W. Devon Ave.; Downers Grove, 224 Ogden Ave.; KANSAS: Kansas City (Mission), 5960 Lamar Ave.; Downers Grove, 224 Ogden Ave.; MASS.: Boston (Wellesley), 165 Worcester St.; MD.: Rockville, 5542 Nicholson Lane; MICH.: Detroit, 18645 W. Eight Mile Rd. & 18149 E. Eight Mile Rd.; MINN.: Minneapolis (Hopkins), 101 Shady Oak Rd.; MO.: St. Louis, 9296 Gravois Ave.; N.J.: Fair Lawn, 35-07 Broadway (Rte. 4); N.Y.: Buffalo (Amherst), 3476 Sheridan Dr.; New York, 35 W. 45th St.; Jericho, L.I., 15 Jericho Turnpike; Rochester, Long Ridge Plaza; OHIO: Cincinnati (Woodland), 10133 Springfield Pike; Cleveland, 5444 Pearl Rd.; PA.: Philadelphia, 6318 Roosevelt Blvd.; Pittsburgh, 3482 Wm. Penn Hwy.; TEXAS: Dallas, 2715 Ross Ave.; Houston, 3705 Westheimer; WASH.: Seattle, 2221 Third Ave.; WIS.: Milwaukee, 5215 Fond du Lac.

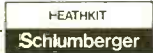

HEATH COMPANY, Dept. 10-3
Benton Harbor, Michigan 49022

Please send FREE Heathkit Catalog.

Enclosed is \$_____ plus shipping.

Please send model(s) _____

Name _____

Address _____

City _____ State _____ Zip _____

Prices & specifications subject to change without notice.
*Mail order prices; F.O.B. factory. CL-430-R

CIRCLE NO. 18 ON READER SERVICE CARD

A SIMPLE SW CONVERTER

BUCKING the trend toward more complexity in circuits, the simple converter shown here (submitted by Larry Lisle) is to be used with a portable transistor radio to pick up shortwave signals. The radio provides the i-f and audio amplifier, and any crystal in the shortwave frequencies can be used in the converter (crystal frequency 455 kHz different on either side of the desired shortwave).

In operation, the shortwave signals are picked up by the antenna and coupled to tuned circuit L1-C2. The inductor is 13 turns of #22 wire-wound on a 1/4" diameter, 1 3/16" long ferrite core, tapped 4 turns up from the ground end. Capacitor C3 connects to L1 at the best point for impedance matching. The signal is amplified by Q1 and mixed with the frequency generated by the crystal to produce an i-f at the difference between the two. This is passed on to the receiver i-f.

Any one of several types of transistors can be used for Q1 as long as it is of the high frequency type. Use a receiver with a transformer to avoid the possibility of shock.

To use the converter, hook up an outdoor antenna (20 feet is enough), turn on the power and start with C2 fully meshed. Slowly decrease C2 until shortwave signals are heard. As the frequency of the crystal is reached, the converter will go dead and then come on again as the frequency is passed. If the crystal frequency is lower than the desired signal, the first sensitive point is the image and the second is the real signal; and vice versa if the crystal frequency is higher.

—Larry Lisle

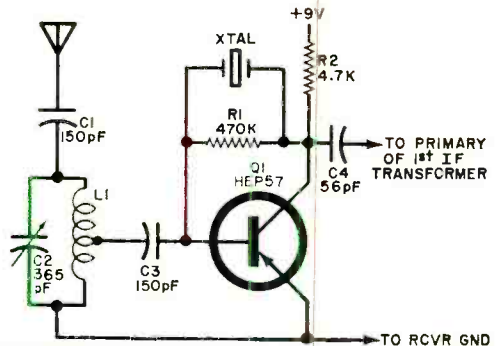

ELECTRONIC PARTS PARADISE

AT OVER 1300 RADIO SHACK AND ALLIED RADIO STORES NATIONWIDE!

"The Parts Place" for Builders & Hobbyists. You Name It, We've Got It! 1000's of Things That Make It Easy to Do-It-Yourself. A Few Examples:

PRINTED CIRCUIT KIT- EVERYTHING INCLUDED!
Only **695**

(A) Design & make real PC boards. Two blank boards, all chemicals, pen, drill bit. Fun, safe, easy.

(B) Pre-punched hole pattern for "pro" parts & transistor mounting and terminal connections. Copper clad. 6x3 1/2".

(C) For most miniature components and connectors. 6x3 1/2 x 1/8" thick. 1/8" dia. holes. Use with or without PERFBOX.

(D) Removable 3 1/2 x 6" Perf-Board front, bakelite case, rear pre-drilled for speaker, side-hole for wire entry. Very versatile. 3 3/4 x 6 1/8 x 2".

PATTERNED PERF-BOARDS
2 for **198**

5-PIECE PANEL SET
3 Perf-Boards,
1 Aluminum &
1 Bakelite Panel
169

PERFBOX®
169

"PUSH-IN" TERMINALS
For Perf-Boards
100 for **159**

**FREE!
Parts
Catalog**

Get it at your nearby store or by mail.

RADIO SHACK

AND
ALLIED RADIO STORES
A TANDY CORPORATION COMPANY

2725 W. 7th St. Ft. Worth, Texas 76107

CIRCLE NO. 3 ON READER SERVICE CARD

POPULAR ELECTRONICS Including Electronics World

if you go for four channel...

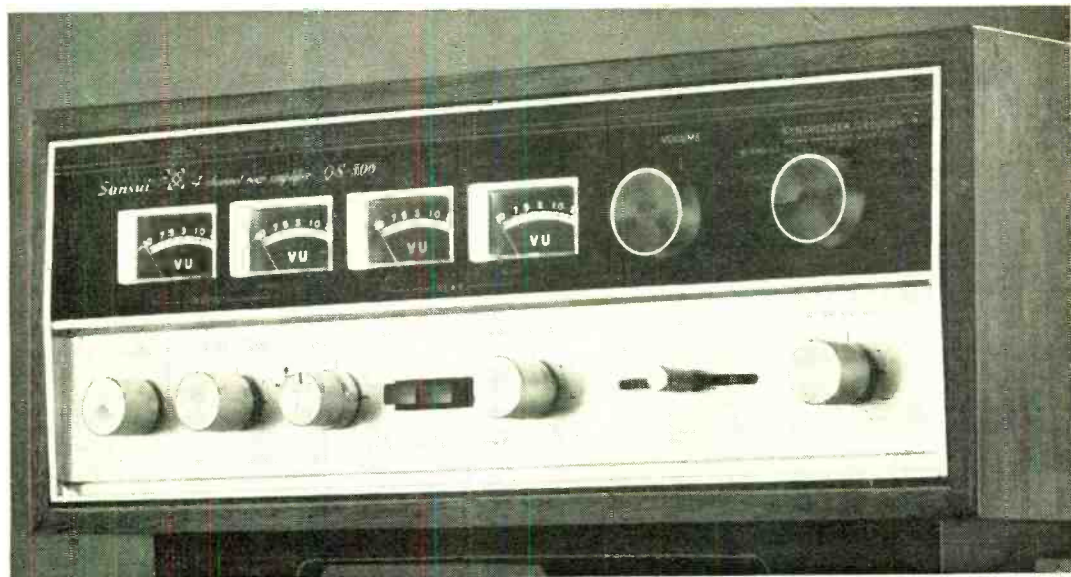

you don't have to go for broke

Buy yourself a miracle for as little as \$214.95. That's all it takes to get your conventional two-channel stereo to do anything any total four-channel receiver and control center can do, now or in the future.

The Sansui QS500 and QS100 converters are complete Four-Channel Synthesizer-Decoder-Rear-Amplifier-and-Control-Center combinations that transform standard two-channel stereo totally. The only other equipment you need is another pair of speakers.

You can decode any compatibly matrixed four-channel broadcasts or recordings and reproduce them in four authentic channels. You can detect the ambient signals present in most two-channel recordings or broadcasts and propagate them through the rear channels. In Sansui matrixing, the exclusive phase-shift technique prevents the cancellation of some signals and the change in location of others that occur in many matrixing systems. And the exclusive phase modulators restore the effect of the live sound field.

You can plug in a four-channel reel-to-reel or cartridge deck or any other discrete source. In the future — if you should have to — you can add any adaptor, decoder or what-have-you for any four-channel system for disc or broadcast that anyone's even hinted at. And a full complement of streamlined controls lets you select any function or make any adjustment quickly and positively.

The QS500 features three balance controls for front-rear and left-right, separate positions for decoding and synthesizing, two-channel and four-channel tape monitors, electrical rotation of speaker output, alternate-pair speaker selection, and four VU meters. Total IHF power for the rear speakers is 120 watts (continuous power per channel is 40 watts at 4 ohms, 33 watts at 8 ohms), with TH or IM distortion below 0.5% over a power bandwidth of 20 to 40,000 Hz. In its own walnut cabinet, the QS500 sells for \$289.95.

An alternate four-channel miracle-maker is the modest but well-endowed QS100, with total IHF music power of 50 watts (continuous power per channel of 18 watts at 4 ohms and 15 watts at 8 ohms). In a walnut cabinet, it sells for \$214.95.

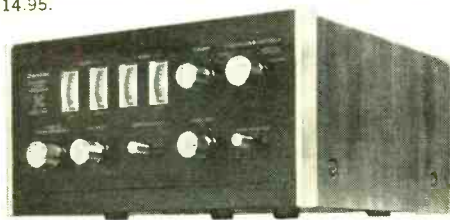

Sansui®

SANSUI ELECTRONICS CORP.

Woodsdale, New York 11377 • Gardena, California 90274

SANSUI ELECTRIC CO., LTD., Tokyo, Japan • Sansui Audio Europe S. A., Antwerp, Belgium

CIRCLE NO. 30 ON READER SERVICE CARD

With four-channel records a reality, you finally need all of Dual's precision.

Dual turntables have always been designed with "more precision than you may ever need." This is as it should be.

The tonearm should always be capable of tracking at considerably less than the optimum recommended force of the best cartridge available at the time.

Flawless tracking calls for near-absolute accuracy in all tonearm settings: balance, tracking force and anti-skating. It also calls for near-frictionless bearings, since light-tracking styli can't tolerate any drag from the pivot system.

With the four-channel record a reality (whatever recording technique might become the standard), one thing is certain. Demands on tonearm and turntable performance are more exacting than ever. Thus, Dual precision is no longer a luxury, but a necessity.

If you would like to know what several independent labs say about Dual precision, write for complete reprints of their reports.



United Audio Products, Inc.,
120 So. Columbus Ave., Mt. Vernon, N.Y. 10553.
Exclusive U.S. Distribution Agency for Dual.
CIRCLE NO. 37 ON READER SERVICE CARD

NEW IR LASER COMMUNICATOR

WALKIE-TALKIES have been used for many years and have become quite commonplace. Now, however, we have the "lookie-talkie" using the latest in communication devices—the solid-state laser. Looking like a three-lens binocular, this completely self-contained transceiver weighs only three pounds, and was developed by the Santa Barbara Research Center (a subsidiary of Hughes Aircraft Co.).

A gallium-arsenide laser, whose output is in the infrared region is mounted in one "lens", while the optical bandpass filter and receiver detector are mounted in the center leg; making the visual portion of the device a monocular. Signal transmission is accomplished by frequency modulating the pulse repetition rate of the laser. Output is 10 watts and each pulse has a duration of 100 nanoseconds. A press-to-talk pushbutton and built-in microphone are also included. Aural output is via a conventional headset.

The 2.5-inch diameter receiving aperture, coupled with the 2.5-degree laser divergence (beam spreading) provides a range of about four miles in good visibility. There is another version having a 3-degree beam spread that has a range of about 2.5 miles under the same visibility conditions. ♦



POPULAR ELECTRONICS Including Electronics World

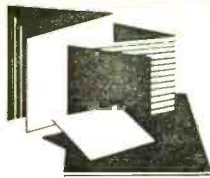

New Literature

TELEQUIPMENT SCOPE AND TRACER CATALOG

A 14-page booklet, Catalog No. 5, is available from *Tektronix, Inc.*, to present the company's Telequipment line of oscilloscopes and a curve tracer. The scopes, with built-in TV field and line triggering, find special application in TV service. Single-trace, dual-trace, and dual-beam scopes are discussed. Also listed are field engineering offices where technical assistance can be obtained. Address: Tektronix, P.O. Box 500, Beaverton, OR 97005.

GLADSTONE ELECTRONICS CATALOG

Canadian readers who find it difficult to buy parts and equipment should request catalog No. 8 from *Gladstone Electronic Supply Co.* The catalog lists hi-fi gear made by such companies as Sinclair, Garrard, Goodmans, and Eico; books from Howard W. Sams, Gernsback, and Tab; microphones by Shure; parts and batteries by J.W. Miller, Clarostat, Mallory, and Maxell; and soldering and hand tools by Weller, Ungar, Xcelite, and Vaco. A large segment of the catalog is devoted to test and communication equipment listings. Address: Gladstone Electronics, 1736 Avenue Rd., Toronto 382, Ontario, Canada.

HICKOK OSCILLOSCOPE BROCHURE

A newly published 4-page brochure which contains complete descriptions, specifications, and prices for the Models 5000A and 5002A oscil-

losopes is available from *The Hickok Electrical Instrument Co.* The brochure points out that the scopes described offer high performance, compact size, and rugged construction at an economical price. Options and accessories are also listed and described. Address: Hickok, Instrument & Controls Div., 10514 Dupont Ave., Cleveland, OH 44108.

GE LED PHOTOELECTRIC CONTROLS

A new *General Electric Co.* Brochure (GEA 9609) describes the recently introduced photoelectric control line featuring solid-state light sources. The 2-page, photo-illustrated brochure describes the line in detail and provides ordering instructions. The light-emitting diode controls are of special interest in invisible security applications, high ambient light applications, etc. Address: GE, Suite 1324, 777 14 St. N.W., Washington, DC 20005.

SBE DESCRIBES CB RADIO AND ITS USES

The availability of an SBE brochure describing the Citizens Radio Service and the advantages available to individuals who use CB communications was recently announced by *Linear Systems, Inc.* The pamphlet can be of substantial help in gaining a better understanding of what the Citizens Radio Service offers. It covers such subjects as licensing, methods of operation, installation, costs, and a description of what CB is and the many uses to which it can be put. Address: Linear Systems, 220 Airport Blvd., Watsonville, CA 95076.

BELDEN TECHNICAL BULLETIN

Technical Bulletin No. T/8-20-Issue 2 J/GA, available from *Belden Corp.* describes the company's Type 8290 shielded Permohm® cable. The 8290 is an 82-channel shielded twin-lead cable suitable for color and monochrome hook-ups between the antenna and TV receiver. All technical data and several pertinent discussions are provided. Address: Belden, P.O. Box 5070A, Chicago, IL 60680.

CALECTRO

GC ELECTRONICS
Rockford, Ill. 61101

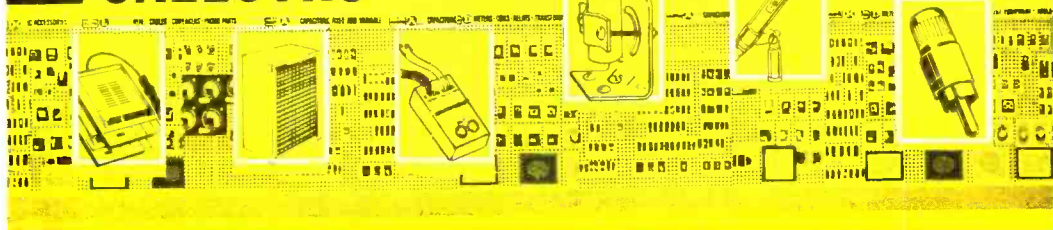

YOUR ELECTRONICS SUPERMARKET

CIRCLE NO. 15 ON READER SERVICE CARD



Communications Scene

By Richard Humphrey

THE electronic surplus and second-hand market scenes have had their ups and downs in recent years. There have been more "ups" than anything else since the emphasis has changed from high-frequency equipment to vhf and uhf. Some people have even said that the two-meter FM repeater growth isn't a result of progressive thought because about all that was available was gear adaptable only to two meters.

Ban on Medium-Frequency Band. The recent FCC ban on amplitude-modulated marine radiotelephones (January 1, 1972) for all new installations in the 2-3-MHz marine band, however, is having a double-barrelled effect. Not only do the two-meter ham buffs have an increasing buyers' market but those interested in 160- and 80-meter operation have been getting an unexpected bonus. And this windfall involves both new and used equipment.

Briefly: after January 1, 1972, no new installations of AM marinephones were allowed in the 2-3-MHz marine band. This is the band employed by pleasure boatmen, the heaviest users of marine two-way radios. In addition, vessels—commercial or recreational—equipped with new stations after that date must have vhf/FM

(156-162 MHz) equipment. Where 2-3-MHz communications was needed, new installations had to be single sideband and the FCC would grant a 2-3-MHz SSB license *only* if the boat had an existing vhf/FM transceiver aboard. AM rigs licensed *before* January 1, 1972, however, are allowed on the air until January 1, 1977.

This means that hams are able to get good buys on low- and moderate-power multi-channel crystal-controlled AM transceivers easily converted or swamped to 160 or 80 meters as dealers cleared their shelves of this outmoded equipment. The maximum power ranges from 30 to 150 watts dc input with most having fully solid-state receivers. There will be a steady flow of used gear for the next few years as boat owners gradually drift to the vhf/FM marine band.

For Two-Meter FM'ers. The picture for two-meter FM'ers is even better. The marine communications industry—reluctant at first—has finally swung wholeheartedly into vhf/FM production. Suddenly, an industry, which up to now has had little to offer as a source of ham equipment, has become a gold mine.

First, you have a wide selection of *new* multi-channel FM gear suitable for two-meter mobile operation in a range of prices from very reasonable to moderate. There's also a good choice of high-quality sets from firms familiar to hams (like Collins and Drake). The price tags are from slightly over \$200 for a 25-watt output rig all the way up to several thousand dollars.

These radios run from six crystal-controlled channels to 55 (the Collins) with the average from eight to twelve. Power output ranges from three to 25 watts except for the hand-held types which have

Marine Gear Windfall for Hams



**A serious accident.
Miles from the nearest phone.
A motorist on the scene
calls for help on CB Channel 9.
But the only CB operator within
range is on another channel.
Will he get the message?**

If he has a new Cobra 20, he will.

Cobra 20 is the 23-channel mobile Citizens Band radio with Emergency Channel 9 Scan-Alert. This exclusive Cobra feature lets you monitor emergency calls on Channel 9—while you transmit and receive on any of the 22 other CB channels at the same time.

If there's an emergency call, Scan-Alert cuts in.

In addition to Scan-Alert, the Cobra 20 offers many other features usually found only on higher-priced units. Full 5 watts power with Dynaboost speech compression.

Automatic noise limiter.

COBRA 20

Product of DYNASCAN CORPORATION / 1801 W. Belle Plaine / Chicago, Illinois 60613

Channel indicator lights. PWR/S meter. And more.

Emergencies don't wait.

Ask your CE dealer for the Cobra 20 CB radio. Always ready to cut in. So you can help out.



\$139.95

23-Channel CB Radio with Channel 9 Scan-Alert

CIRCLE NO. 48 ON READER SERVICE CARD

SEE...
COMPARE
SELECT!!

SBE

CB
SUPERSTARS

Catalina



23 CHANNEL AM MOBILE TRANSCEIVER
All crystals supplied • 5 watts • Hi-level modulation • Speech clipper and filter for higher average talk power • Exclusive SBE dynamic mic w/coil cord • Noise limiter • Squeelch • Unique back-lighted dial has largest channel readout ever • Silicon semiconductors throughout.

WRITE FOR BROCHURE

99⁹⁵



SBE 220 Airport Blvd., Watsonville, CA 95076
CIRCLE NO. 21 ON READER SERVICE CARD

one or two watts output. There is a wide selection of these, but they are fairly expensive. Almost all are fully solid-state except for those with a tube or two in the transmitter portion. This makes them fine for mobile operation which is where it's mostly at in two-meter repeater work.

Used Equipment Market. The used equipment market is wide open—as two-meter ops found out some time ago—and will be getting better. Much marine and land-mobile vhf equipment has lost its type acceptance in the last three years because of FCC action. While many land-mobile operators went right on using this obsolete, illegal gear, much of it found its way into the second-hand market and eventually into ham hands.

Most of this equipment was for trunk mounting with interconnecting cabling to an under-the-dash control head. Another reason a lot of trunk-mount equipment began disappearing was the increasing preference on the part of users for the smaller, easier-to-remove (to prevent theft) under-the-dash transceivers. In addition, these more compact units were

cheaper to maintain and repair.

Both the trunk-mount and the under-the-dash rigs, however, had the common drawback of being single channel. This was all right during the early days of two meters but now it's a virtual necessity to be multi-channel if you're going to get the most out of the band. This brings you right back to the marine vhf/FM radios which—with few exceptions—are multi-channel by FCC regulation.

In shopping for used marine equipment there are a few points to remember. In a mobile rig, be sure it has a 12-volt dc negative ground (unless you happen to have a 6-volt system in your car or a positive ground; either of which is rare). Many commercial vessels use 32 volts dc and some even use 110 volts dc. A few of the older boats have positive ground systems. A 110-volt dc, positive-ground vhf/FM transceiver will be about as useful as a third head.

Next, be sure the technical manual either comes with the set or is reasonably available. You'll need it if you have to do any converting to swamp the equipment down to two meters from its normal

FREE McIntosh CATALOG and FM DIRECTORY

Get all the newest and latest information on the new McIntosh Solid State equipment in the McIntosh catalog. In addition you will receive an FM station directory that covers all of North America.



MX 114

FM/FM STEREO TUNER
and STEREO PREAMPLIFIER

CIRCLE NO. 22 ON READER SERVICE CARD

SEND TODAY!

McIntosh Laboratory Inc.
2 Chambers St., Dept. PT-372
Binghamton, N.Y. 13903

NAME _____

ADDRESS _____

CITY _____ STATE _____ ZIP _____

156-162-MHz operating frequency. While under-the-dash units generally pose no problem, some of the trunk-mount equipment has to have the entire front end rebuilt.

The crystal multiplication factor should be checked, especially on older sets. Most equipment today multiplies the transmitting crystal frequency by 12 to get the operating frequency, and the receiver crystal frequency by three to which is then added the first i-f frequency to get the operating frequency. Example: you read the transmit rock frequency (usually on top of the holder) as 13.066 MHz. Multiplying by 12 gives you a transmitter operating frequency of 156.8 MHz, channel 16 in the vhf/FM marine band, so you know the 12X factor is OK. Check the receive crystal the same way: 48.7 MHz times three, for instance, gives you 146.1 MHz and adding 10.7 MHz i-f frequency results in 156.8 MHz. In some cases both the crystal frequency and the operating frequency are marked on the holder, which makes it simpler. If you're lucky enough or far-sighted enough to have the tech manual, you have no problem at all.

All sets that have this 12X and 3X-plus-1st-i-f arrangement can have their crystals swapped no matter who the manufacturer is, so long as the 1st i-f is the same. There may be exceptions but I've yet to run across one. The only problem may be in using a subminiature crystal in a set using miniature crystals and *vice versa*. The reason this multiplication factor is fairly important is that common crystals are plentiful and inexpensive. Chances of trading are better, too.

Finally, check the tube line-up. If you find 6BH6's, 6CL8's, 6CY5's, 6CM8's plus a scattering of 6BH6's you're all right. Power supplies with 2N442's or 2N443's rate an OK. But beware of a set with nine-hundred 7V7's or some other such nonsense. Also, vibrator-driven power supplies are all right but stay away from dynamotor-equipped gear (which is expensive to repair). The same reasoning applies here as for the crystals: common tubes are easy to replace and old or exotic ones are not.

This may seem like fundamental information that no one needs cautioning about. But believe me, I'm not talking down to anyone. Guess who's in the market for 7V7's . . . ?

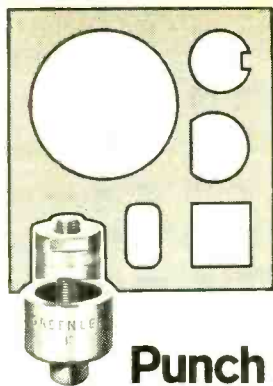

Punch clean, true holes in seconds.

A Greenlee chassis punch is the quickest way yet to cut round, square, key, D, or double-D holes in 16-gauge metal, hard rubber, plastics, epoxy, etc. Available at radio and electronics parts dealers. Or write for Catalog E-730 to: Greenlee Tool Co, 1758 Columbia Ave., Rockford, Ill. 61101.

GREENLEE TOOL CO



EX-CELL-O CORPORATION

CIRCLE NO. 16 ON READER SERVICE CARD

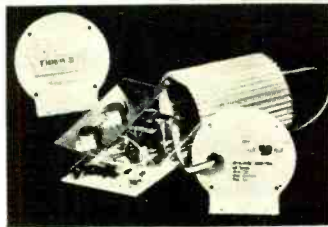

FROM KIT TO CAR IN 80 MINUTES!

Electronic ignition is "in". Update your car with the TIGER in power, efficiency and reliability — the TIGER SST capacitive discharge ignition (CDI).

The TIGER delivers everything other CDI's promise — and more: quicker starting, more power, more gas mileage, tune-ups eliminated, lifetime plugs and points, reduced repairs and pollution.

The TIGER can be built and installed in your car in 80 minutes. The TIGER is unique! Errors in construction or incorrect installation will not harm the TIGER or the engine. The TIGER will not operate under either condition.

The TIGER comes with a switch for TIGER or standard ignition for 12V negative ground only.

SATISFACTION GUARANTEED
or Money Back.

Simpli-Kit \$29.95 — Assembled \$39.95
POST PAID

WE ACCEPT:
Mastercharge or Bank Americard.
Send check or money order with order to:

Tri-Star Corporation

DEPT. W, P. O. Box 1946
Grand Junction, Colorado 81501

CIRCLE NO. 35 ON READER SERVICE CARD

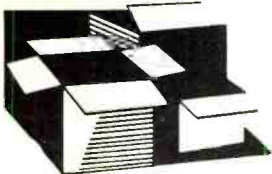

New Products

REALISTIC/E-V 4-CHANNEL ADAPTER

Radio Shack and Electro-Voice have teamed up to produce the New Realistic/Electro-Voice Stereo-4™ four-channel adapter. The adapter, which can be used with an existing stereo system plus an additional stereo amplifier and pair

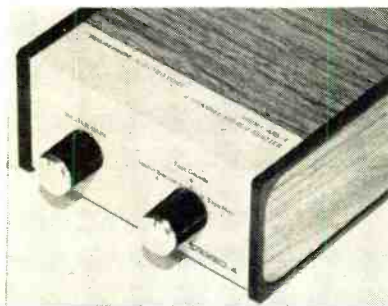

of speakers, provides true 4-channel reproduction from encoded program material now available on record discs, tapes, and stereo FM broadcasts. The Stereo-4 does not make obsolete present stereo equipment or program sources. In fact, playback of ordinary 2-channel material through the adapter can greatly enhance the program. Address: Allied Radio Shack, 2617 W. Seventh St., Fort Worth, TX 76107.

EDMUND 3-HEADED TREASURE FINDER

An inexpensive, versatile metal detector that comes with three different easily interchangeable search heads is now being offered as Stock No. 71,446 by *Edmund Scientific Co.* The 3" head is useful for finding such small objects as coins and rings. The 5" head is attracted to larger objects, while the 10" head is used for quick coverage of a large area. The detector signals a "find" with a loud beep from a 2½" speaker. Address: Edmund Scientific, 380 Eds-corp Bldg., Barrington, NJ 08007.

AUDIOTEX TELEPHONE PICKUPS

Two new low-impedance magnetic telephone pickups have been added to *GC Electronics'* Audiotex line. The pickups are designed to be used with the majority of today's transistor tape recorders and amplification devices. The No. 30-6000 is a conventional suction-cup type which can be used wherever there is a reason-

ably strong magnetic field present in the telephone. The No. 30-6002 is a deluxe model that slips over the earpiece of the telephone handset where it minimizes extraneous noise pickup. Address: GC Electronics, 400 S. Wyman St., Rockford, IL 61101.

INJECTORALL TV TUNER CARE KIT

Recognizing that TV tuners are often responsible for a variety of TV troubles, *Injectorall Electronics Corp.* has developed a heavy-duty tuner care kit that eliminates all tuner cleaning problems. The kit contains one can each of Royal Clean degreaser and Royal Lube lubricant and cleaner. Royal Clean is a fast-drying, nonflammable substance that does not react on plastics. It dissolves dirt, grease, and oil, then evaporates without leaving a residue. Royal Lube is a dripless foam spray that is applied directly to the tuner contacts to provide lasting lubrication. Address: Injectorall Electronics, Glen Cove, NY 11542.

UNIQUE B&K OSCILLOSCOPE

Dynascan Corp. has just extended their line of oscilloscopes with the introduction of the B&K Model 1440 dc-10-MHz oscilloscope. The scope features an exclusive Cali-Brain® which provides an instantaneous peak-to-peak voltage reading on the most complex waveforms. A digital readout on the display panel above the lighted graticule eliminates guesswork and saves valuable time when measuring peak-to-peak voltages. The 5" scope has sync-separator circuits and a dc amplifier for measurement of ac and dc components. It also has a front-panel vector-scope facility, is all solid state, and employs eight vertical scales ranging from 0.1 to 300 volts. Address: Dynascan, 1801 W. Belle Plaine Ave., Chicago, IL 60613.

HEATHKIT AM/STEREO FM RECEIVER

The New Model AR-1500 AM/stereo FM receiver takes its place at the top of the list of hi-fi components made by the *Heath Company*. Replacing the acclaimed AR-15 receiver, the AR-1500 is rated at 90 watts dynamic music

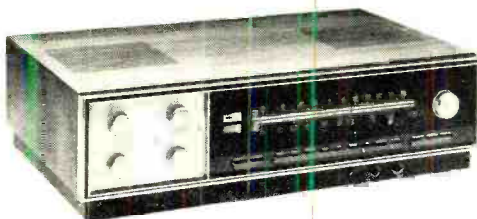

power per channel into 8 ohms, and has greater than 90 dB FM selectivity, 1.8 μV sensitivity, 1.5 dB capture ratio, and 100 dB image and i-f rejection. State-of-the-art components, including IC's, MOSFET's, and a 12-pole LC filter, in the r-f and i-f/multiplex sections as-

Free... and easy.

Probably the most convenient, time-saving freebie we've ever offered . . . our new 1972 catalog.

It gives instant relief from tedious multiple-source parts searching. Because all the latest in electronic components, security systems, cassette tapes and recorders are spelled out

for you. It's a complete catalog — indexed, easy to order from and beautifully illustrated.

Pick up a copy from your nearby Authorized Mallory Distributor, and soon. No better proof anywhere, that there's a place for everything . . . and everything in electronics is at your Mallory Distributor.



MALLORY

MALLORY DISTRIBUTOR PRODUCTS COMPANY

a division of P. R. MALLORY & CO., INC.
Indianapolis, Indiana 46206

Batteries • Capacitors • Controls • CRIME ALERT® • DURATAPE® • Resistors • Semiconductors • SONALERT® • Switches • Timers • Vibrators

A BRIEF MESSAGE FROM AUDIONICS, INC....

If you haven't received one of our catalogs recently, you may not be aware of what we've been up to!

Our group of products includes Radford Laboratory instruments, Radford stereo components and speakers . . . expensive but unsurpassed.

If you like to do things yourself, you'll be interested in Sinclair audio modules, which include the world's first *phase lock loop* FM stereo tuner.

We're even into security systems with our own group of security and detection devices; they're totally professional, with new innovations for both home and commercial applications.

Circle our reader service number for detailed product information. 25c brings a reply by first class mail.

AUDIONICS, INC.

8600 NE SANDY BOULEVARD
PORTLAND, OREGON 97220

MANUFACTURERS and DISTRIBUTORS
of Electro Acoustical Products

CIRCLE NO. 45 ON READER SERVICE CARD

FREE! RADIO SHACK Accessories & Parts Catalog

NEW 1972 Edition!

THE buying guide for kit builders, CB'ers, installers, experimenters, fix-it men, hobbyists, electricians — anyone in electronics in any way!

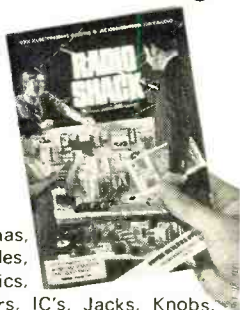

Electronics A to Z—Antennas, Batteries, Capacitors, Diodes, Educational Kits, Fiber Optics, Grille Cloth, Hi-Fi Speakers, IC's, Jacks, Knobs, L-Pads, Mikes, Needles, Oscillators, P-Boxes, Quadracs, Resistors, Semiconductors, Telephones, Ultrasonic Alarms, VHF Antennas, Wire, Xenon Strobe, "Y" Adapters, Zener Diodes plus our Science Fair and Knight-Kit electronic kits!



A TANDY CORPORATION COMPANY

Dept. PE-20

2725 W 7th St.
Fort Worth, Texas 76107

Send me your FREE 1972 Catalog #215

Please PRINT Clearly

Name _____ Apt. # _____

Street or Rte. & Box _____

City _____

State _____ Zip

CIRCLE NO. 4 ON READER SERVICE CARD

sure stable performance and eliminate the need for periodic i-f alignment. A fully adjustable FM squelch is both noise and deviation responsive. Address: Heath Co., Benton Harbor, MI 49022.

ARROW WIRE & CABLE STAPLERS

A gun tacker and stapler to accommodate every diameter of wire and cable up to 1/2" made by *Arrow Fastener Co., Inc* can be obtained through dealers. Three models of tackers are available. The Model T-18 is for wires up to 3/16" diameter; T-25 is for wires up to 1/4" diameter; and T-75 is for wires and cables up to 1/2" diameter. Typical uses for the T-18 and T-25 are fastening bell, telephone, intercom, and other low-voltage wires to walls and moldings.

RECORD CARE KITS

Two record-care kits have just been released by *Robins Industries Corp.* TLC (tender loving care) kit (Cat. No. PK-9) contains Robins' "Touch-of-Velvet" mit, foam applicator and cleaning cloths, polyfoam pad for cleaning velvet side of the mit, anti-static cleaner and lubricant in a plastic bottle, combined tonearm lift and record brush, and a stylus brush that can be adjusted for any tonearm height. The other kit (Cat. No. PK-2) contains a velvet cloth and anti-static cleaning and lubricating fluid. Address: Robbins, 5-58 127 St., College Point, NY 11356.

AIREX MARINE INTERCOM/HAILER

An intercom/hailer, Model HI-10B, that makes possible more efficient 2-way communications for boatmen can be obtained from *Airex of Ohio*. Capable of hands-free operation, the intercom hailer provides a greater degree of safety and convenience in operating a boat than is possible with other similar units. It is designed to operate from 12-14-volt dc sources with a drain of 500 mA maximum. The Model HI-10B has a volume/power control, talk/hold switch, and speaker selector. It comes complete with a weatherproof outdoor horn speaker. Address: Airex, 1822 Owen St., Toledo, OH 43605.

WAHL CORDLESS SOLDERING IRON

Wahl Clipper Corp. has a dandy soldering iron for servicemen who are often in the field where no power is available for soldering irons. It is their "Iso-Tip" cordless soldering iron. The unique soldering tip construction eliminates electrical leakage and the need for grounding and minimizes problems caused by high heat transfer. Tip performance is equivalent of a 50-watt element. Full charge gives up to 60 solder operations, depending on size of the work. The soldering iron uses long-life Ni-Cad batteries which can be recharged overnight. A special recharger stand is included with the cordless soldering iron. Address: WahlCorp, 2902 Locust St., Sterling, IL 61081.

The Wild Bunch

Five great, new CB "Cats" from Pearce-Simpson.



WILDCAT II \$69.95*

The world's smallest full 5-watt CB radio. The 6 Channel Wildcat II has Pearce-Simpson's exclusive 5-way meter (signal strength, relative RF output, "receiver on" indicator, "transmitter on" indicator, and "modulation" light).



BOBCAT 23B \$129.95*

An ultra small CB radio that sports a safety padded front panel and knobs. 23 channels, an illuminated S/RF meter, ceramic filter, and P.A. One of our best buys.



TIGER 23 \$149.95*

Look at these features: 23 channels, illuminated S/RF meter, Delta tune, automatic noise limiter, and it's all solid state with IC and FET. Plus you get a ceramic filter, P.A., external speaker jack, and TVI trap.



COUGAR 23 \$169.95*

Only standard mobile unit on the market with SWR bridge. It has exclusive 7-way meter (signal strength, relative RF output, SWR forward, SWR reflected, "receiver on" indicator, "transmitter on" indicator, and "modulation" indicator). Features include automatic noise limiter and true RF noise blanker; Delta tune; ceramic filter; and external speaker jack and P.A.



BEARCAT 23 \$199.95*

The greatest bargain in CB. It has a digital clock that sounds alarm and turns on set at pre-selected time; three illuminated meters including S/RF, SWR forward and SWR reflected; automatic noise limiter and true RF noise blanker; Delta tune; combination 12 VDC and 115 VAC power supply; P.A.; external speaker jack; all solid state with IC and FET; and earphone jack.

* Suggested list price

FAMOUS TALKING ANTENNAS BY PEARCE-SIMPSON

A complete line from 18 to 105 inches. In fiberglass or stainless steel. Base station and mobile antennas and antenna mounts. Get all the range and reception your CB can deliver.

For more information write: Pearce-Simpson, P.O. Box 800, Biscayne Annex, Miami, Florida 33152.

Pearce-Simpson

A Division of GLADDING Corporation



GLADDING

Don't go out without Gladding.

CIRCLE NO. 26 ON READER SERVICE CARD

ADD A FOURTH DIMENSION TO YOUR STEREO SYSTEM.

Enjoy 4-dimensional sound hidden in standard stereo records, tapes and FM broadcasts.

Just add the SOUND/4™ adaptor and two speaker systems — No additional amplifiers required.

EC-4700 KIT \$9.95



WIRED \$19.95

FREE 1972 EICO CATALOG

For latest catalog on EICO Test Instruments' Stereo, EICOCRAFT Projects, Environmental Lighting, Burglar/Fire Alarm Systems, and name of nearest EICO Distributor, check Reader Service Card. EICO, 283 Malta Street, Brooklyn, N.Y. 11207

SOUND/4
BY EICOCRAFT

CIRCLE NO. 41 ON READER SERVICE CARD

TUNER SERVICE

VHF, UHF, FM or IF Modules . . .

. . . All Makes

Fast **8** hr. Service!

1 YEAR GUARANTEE

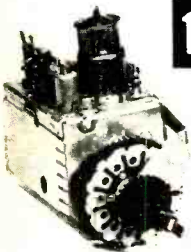

VHF-UHF-FM	\$ 9.95
UV-COMB.	\$16.95
IF-MODULE	\$12.50

Major Parts charged at Net Price
P.T.S. is overhauling more tuners for more technicians than any other tuner company in the world!

LIKE TO DO IT YOURSELF?

Send one Dollar (redeemable) for our 60 pages of top information

TUNER REPLACEMENT GUIDE AND PARTS CATALOG

For fastest service, send faulty tuner with tubes, shields and all broken parts to:

PTS ELECTRONICS, INC.

"Precision Tuner Service"



HOME OFFICE—
Box 272 • Bloomington, Ind. 47401 • Tel. 812. 824-9331
WEST—
Box 41354 • Sacramento, Calif. 95841 • Tel. 916. 482-6220
SOUTH—
Box 7332 • Longview, Tex. 75601 • Tel. 214. 753-4334
SOUTHEAST—
Box 6881 • Jacksonville, Fla. 32205 • Tel. 904. 380-9952
EAST—
Box 3189 • Springfield, Mass. 01103 • Tel. 413. 734-2737
MOUNTAIN—
Box 4245 • Denver, Colo. 80204 • Tel. 303. 244-2818

CIRCLE NO. 25 ON READER SERVICE CARD

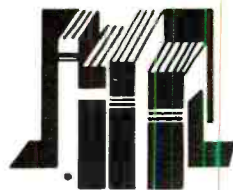

Electronics Library

ELECTRIC GUITAR AMPLIFIER HANDBOOK Third Edition

by Jack Darr

Many servicemen hesitate to service or repair guitar amplifiers due to the fact that information about these units is not readily available through the usual channels. Hence, this book has been written to dispel any qualms the serviceman may have about servicing these amplifiers. The Handbook is broken up into three major sections. Section I deals with how the guitar amplifier works; Section II with service procedures and techniques; and Section III with commercial instrument amplifiers. Section III contains complete manufacturers' schematic diagrams for popular amplifier models. In the Third Edition, the text has been completely revised and updated, and up-to-date material on transistors and IC's has been added.

Published by Howard W. Sams & Co., Inc., 4300 West 62 St., Indianapolis, IN 46268. Soft cover. 240 pages. \$5.95.

ELECTRONIC ORGAN SEMICONDUCTOR CROSS REFERENCE "MASTER"

The "Master" is a compilation of all semiconductor replacement information for the major brands and models of organs in a single, easy-to-use reference. Section I contains a complete listing of all organ manufacturers' semiconductor part numbers that are cross-referenced to the actual semiconductor type numbers listed in major parts catalogs. Section II is a complete listing of all semiconductors used in the organ industry. These are cross-referenced to organ manufacturer part numbers, other usable semiconductors, and general replacement semiconductors. Lead identification, device specifications, and coding systems used by many organ manufacturers are also given.

Published by H.A.B. Service & Supply Co., Rd 1, Box 463, Rock Creek, OH 44084. Soft cover. 104 pages. \$8.95.

CITIZENS BAND RADIO SERVICE MANUAL

by R.F. Burns & L.G. Sands

This new publication is an all-in-one troubleshooting and maintenance guide for all types of CB radio transceivers. It features a 36-page

foldout which contains complete schematics for such late-model units as the Courier CCT4, Cobra 25, Hallicrafters CB-21, SBE-6CB Side-bander, etc. The text contains point-to-point test procedures, trouble charts, and alignment procedures—in fact, all the information needed for servicing. In addition, individual chapters are discussions of the transmitter, receiver, and power supply sections that make up a complete transceiver.

Published by Tab Books, Blue Ridge Summit, PA 17214. 192 pages. \$7.95 hard cover, \$1.95 soft cover.

HANDBOOK OF PRACTICAL SOLID-STATE SERVICING

by John D. Lenk

This volume is a straightforward, very practical guide to pinpointing both circuit and component failures that occur in today's sophisticated solid-state and digital electronic equipment. The text discusses servicing and repair of basic circuits as well as specific equipment and systems, use of test equipment, and use of hand tools. Two entire chapters are devoted to troubleshooting digital circuits, including IC's. Keeping theory to a minimum, the book nevertheless offers direct and timely information that can be put to immediate use by the reader.

Published by Prentice-Hall, Inc., Englewood Cliffs, NJ 07632. Hard cover. 310 pages. \$12.00.

EVEREADY BATTERY APPLICATIONS AND ENGINEERING DATA HANDBOOK

This new edition of an extremely useful book is the most comprehensive reference guide ever assembled on the subject. It contains descriptions, specific listings, terminal drawings, and service-life tables on all six available electrochemical systems, covering almost 400 batteries—including 20 which have been added to the Eveready line since the last edition of the Handbook was published.

Published by Battery Engineering Dept., Union Carbide Corp., Consumer Products Div., 270 Park Ave., New York, NY 10017.

ELECTRONIC MEASUREMENTS AND INSTRUMENTATION

by B.M. Oliver & J.M. Cage

This timely book is geared to the day-to-day demands of engineers and physicists who must employ modern instruments and measurement techniques in research, development and testing. Even if the best instrument catalogs are available to him, the engineer can look to this book to select the best measurement techniques—and learn the inherent limitations of these techniques.

Published by McGraw-Hill Book Co., 330 West 42 St., New York, NY 10036. Hard cover. 729 pages. \$29.50.

MARCH 1972

AT LAST! PROFESSIONAL HOME PROTECTION EVERYONE CAN INSTALL AND AFFORD.

Model FC-100

\$49.95

WIRED

- Start your custom Burglar/Hold-up/Fire Alarm System with the FC-100. Add on Sensors, Alarms and Accessories to suit your own needs.
- "Do-it-Yourself" Installers Handbook included. No technical knowledge needed—No soldering.
- 100% Professional in Design, Reliability, Performance.



'Fail Safe'-SYSTEM BY EICO

A New Concept in "Do-it-Yourself" Home Protection

FREE 32 PAGE EICO CATALOG

For latest catalog on EICO Test Instruments, Stereo, EICOCRAFT Projects, Environmental Lighting, Burglar/Fire Alarm Systems, and name of nearest EICO Distributor, check Reader Service Card or send 25¢ for First Class mail service.

EICO 283 Malta Street, Brooklyn, N.Y. 11207



CIRCLE NO. 42 ON READER SERVICE CARD

D.I.P. SERVICE KIT #4930

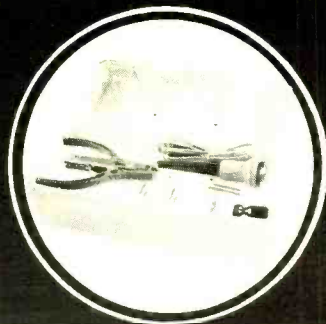

Eliminate bent leads and broken P.C. Boards. Enables you to quickly Service Components with D.I.P.'s in them. — Save expensive components, burned fingers and circuit boards. — Use the 4930 DIP Service Kit. — only \$39.95.

FREE New for '72'

198 Page Catalog

TECHNI-TOOL, INC.

1218 ARCH ST., PHILADELPHIA, PENNA.
ZIP: 19107 1 (215) 568-4457-4482

CIRCLE NO. 43 ON READER SERVICE CARD

Let Bell & Howell Schools help you get ready for a rewarding Color TV Service Business of Your Own

This new Program brings you a series of Bell & Howell Schools materials that are fully integrated with the Heathkit components you will receive a step at a time. The Color TV kit offers an ultra-rectangular 25" diagonal picture tube with 315-sq. inch screen. Lets you view more of the transmitted image. 25,000 volts. 45 transistors, 55 diodes, 4 advanced IC's. 3-stage, solid-state IF. Solid-state VHF/UHF tuners. Automatic fine tuning and many other quality features.

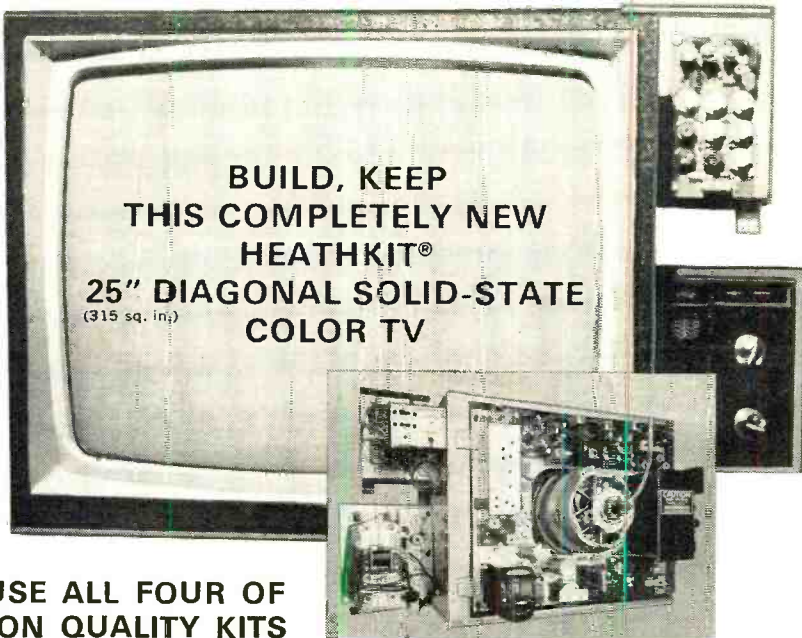

**BUILD, KEEP
THIS COMPLETELY NEW
HEATHKIT®
25" DIAGONAL SOLID-STATE
COLOR TV**
(315 sq. in.)

BUILD, KEEP, USE ALL FOUR OF THESE PRECISION QUALITY KITS

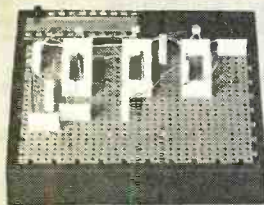

INCLUDES—
Design Console with built-in power supply, test light and speaker. Plus patented plug-in Modular Connectors.

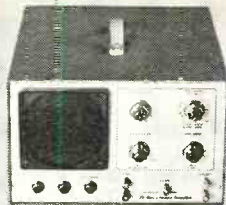

INCLUDES—
Portable 5-inch, wide-band oscilloscope calibrated for peak-to-peak voltage and time measurements.



INCLUDES—
Transistorized Meter combines most desired features of vacuum-tube voltmeter and quality multimeter. Measures very small current values.

FREE! MAIL CARD TODAY FOR ALL THE FACTS
No Postage Needed

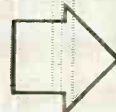

YOU'LL BE READY FOR COLOR TV . . . B&W AND MOST HOME ENTERTAINMENT ELECTRONICS DEVICES

This exciting new program offers you the *first* 315-sq. inch Solid-State Color TV available for at-home training.

As you follow the simple, step-by-step assembly procedures, you become thoroughly familiar with the most advanced solid-state TV circuitry. And as you build this kit you'll prepare yourself for a profitable Color TV service business of your own—either full or part time.

Why Color TV pays better.

Today, Color TV is the big seller. As Color Television goes completely solid-state, the man who has mastered this type of circuitry will be in demand. Obviously, this is where the money is going to be made.

This new Bell & Howell Schools program will also give you an in-depth knowledge of the basics as well as TV circuit theory and analysis. You'll get the theory and practical experience you need to handle radios, hi-fis, stereos, and tape recorders.

You will also receive three precision quality instrument kits which you assemble and keep. These are highly sensitive professional instruments which you'll use constantly.

**EXCLUSIVE ELECTRO-LAB®
IS YOURS TO KEEP, USE**

This unique at-home laboratory comes to you in 16 shipments and includes a remarkably instructive *design console*. You can rapidly "breadboard" a great variety of circuits without soldering. The *Oscilloscope* offers 3-way jacks to handle test leads, wires, plugs. Images on screen are bright, sharp. Your *Transistorized Meter* is fully portable, features a sensitive, 4-inch, jewel-bearing d'Arsonval meter movement. It registers the slightest power surge or lag on a large, easily read dial.

CONSIDER THESE ADVANTAGES:

Bell & Howell Schools' Electro-Lab-at-Home Plan gives you the most thorough background possible in solid-state Color TV. Everything

Note: TV picture is simulated.



FREE! MAIL CARD TODAY FOR ALL THE FACTS
No Postage Needed

MARCH 1972

comes to you by mail and you go at your own speed. You'll be prepared not only for a service business of your own but for many positions in the Electronics and Television industries. All without missing a paycheck!

When you have completed your program our *Lifetime National Employment Service* will help you locate in an area that interests you. This service is available at any time—now or in the future.

Approved for G.I. Benefits

If you've had six months continuous active duty, you're probably eligible for Veterans' Benefits. If you're a Vet, check the appropriate space in the card at left for full details. Our programs are approved for Veterans' Benefits.

Student Loans now available

If you are a non-veteran and need financial assistance, you may qualify for Student Loans, which are also available.

Special Help Sessions. These are scheduled regularly (Saturdays) at seven Bell & Howell Schools and in many other cities. Here you can get expert guidance by top instructors to help you over the rough spots.

Bell & Howell Schools offer you even more. Once you have finished your program at home, you may decide you want more advanced preparation. In this case, you may transfer to any one of our seven schools which are located all across the country.

Mail the postage-free card today for all the facts. There is no cost or obligation of any kind.



**BELL & HOWELL
SCHOOLS**

4141 Belmont, Chicago, Illinois 60641

324

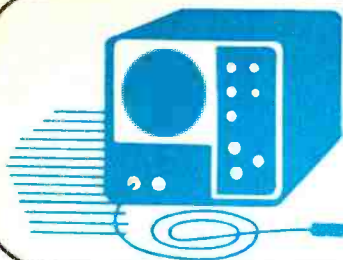

Test Equipment Scene

By Leslie Solomon, Technical Editor

THE "bread and butter" instrument used by more hobbyists and service technicians than any other single piece of electronic gear is the ubiquitous multirange tester known as the voltohmmeter, or VOM.

The VOM has been around for many years and was one of the first widely usable test instruments. Now being manufactured by a number of companies (Eico, RCA, B&K, Simpson, Triplett, Sencore, Heath, and others), the VOM is readily available from most electronic parts distributors.

The modern VOM has many features and uses not possessed by its predecessors. The VOM of the past had relatively low input impedance, somewhat limited ranges, and a small meter size. It thus became less and less useful as circuit impedances increased and the levels of measurement for voltages and resistances decreased. Thus, the older VOM is now largely relegated to appliance servicing, where exact measurements are not necessary.

As the need for more precise, non-loading measurements emerged, VOM's underwent some drastic changes. It was

necessary to have input impedances of 50,000 ohms per volt or more; accuracies of 1% were necessary and voltages under 1 volt had to be measured.

There were also important mechanical changes to be made. Not only did the physical size of the meter increase (to permit better interpolation of readings), taut band meters, which are inherently rugged and reliable, were incorporated. The low friction involved in the taut-band movement also provided highly repeatable measurements.

Another physical problem, the high mortality of VOM's due to case breakage, was attacked by a number of manufacturers (Heath and Weston, for example) by the introduction of high-impact plastic cases that resist breakage. Some modern VOM's even come with circuit breakers and diode meter protectors to eliminate accidental burnout. Even the rotary function switch has given way, in many cases, to multiple pushbutton selection of ranges and functions. One manufacturer (Sencore) has even come out with a meter with 112 ranges!

Enter the VTVM. Updated VOM's are good, but there arose a need for an even more precise, multirange instrument that would load the circuit even less and could cope with more difficult measurement problems. Thus the vacuum tube voltmeter (VTVM) was born.

The VTVM differs from the VOM in that the meter is driven by a vacuum tube circuit. In this way, a very high input impedance (11 megohms in typical) is obtained on almost all ranges, resulting in negligible circuit loading. Since the tube circuit acts as a buffer between the meter and the circuit being tested, the VTVM has a built-in meter protector. And, since the tube circuit has gain, a more sensitive

VOM's VTVM's and TVM's

measuring instrument can be designed. Another advantage of the VTVM—especially on the ac ranges—is that a tube circuit can be tailored to have a very wide frequency response. For example, a modern VTVM not only spans the audio range, but can reach high r-f when the proper probes are used. There are even special-purpose ac VTVM's—such as Eico's combination broadband ac VTVM and amplifier—to serve dual functions.

The biggest asset of most VTVM's is in working with semiconductor circuits. Because of the low voltages involved in this type of gear, most VTVM's have a low-end range of 0.5 volt or less. With the very high input impedance of the VTVM, this makes it easy to check low-level transistor voltages. At the high end, most VTVM's can read 1 kilovolt (5 kV or more with a probe) making them doubly useful for servicing vacuum-tube circuits.

Of course, VTVM's run somewhat higher in price than standard VOM's.

Then Came the TVM. It's only natural that semiconductors are replacing vacuum tubes in test equipment—as they have in many other applications. Especially significant has been the introduction of the field effect transistor (FET) with its high input impedance—an ideal characteristic for measurement. Thus the transistor voltmeter (TVM) has come into being. Essentially a solid-state version of the VTVM, the TVM usually incorporates all the good features of its predecessor. Since the semiconductor elements are small and require little power, TVM's can be made highly portable (using battery power supplies in many cases). Making use of all the latest advances in circuit design, TVM's have increased ranges, excellent sensitivity, and high input impedance. However, when selecting an instrument for your own use, there are a few things that should be kept in mind.

Sensitivity. The first thing to look for in selecting a VOM, VTVM, or TVM is the number of ohms-per-volt specified for the ac and dc ranges. Assume, for example, that a VOM is rated for 1000 ohms per volt. This means that the loading resistance of this instrument is 1000 ohms times the scale indication. Thus, with 10 volts input on the 10-volt range, the VOM

resistance is 10,000 ohms. That's pretty high but stop and consider that, when indicating 10 volts, the meter takes 1 milliampere from the circuit under test. That may be OK for testing a power supply but the effect is quite different when the meter is connected across a load of a half a megohm in a grid or base biasing circuit. In that case, will the meter indicate the true voltage value? Will the loading seriously affect the performance of the circuit? Remember that from an electrical viewpoint, the meter looks like a 10,000-ohm resistor. Think what a measurement of a very low voltage across such a low resistance looks like and you will see why the VTVM and TVM with their 11-megohm input resistances became popular.

Why are so many test meters specified at a much lower ohms-per-volt rating for ac measurements? Simply because they have dc meter movements and the quantity being measured must be rectified. And that means higher loading.

With ac measurement, you must also consider the relationships between rms, peak, peak-to-peak, and average values. Most ac measuring instruments, unless otherwise specified, use rms (root mean square) values as the basis for sine wave measurements. If you have a need to convert from one value to another, remember the following relationships:

$$\begin{aligned}\text{peak value} &= 1.414 \times \text{rms value} \\ &= \text{peak-to-peak} / 2 \\ \text{rms value} &= 0.707 \times \text{peak value} \\ \text{peak-to-peak value} &= 2.83 \times \text{rms value} \\ &= 2 \times \text{peak value} \\ \text{average value} &= 0.637 \times \text{peak value}\end{aligned}$$

Rectifier-type ac meters do not indicate true rms except for sine wave inputs. Actually, they respond to average rectified values. For half-wave rectification, the average is 0.637 times the peak value, while rms is 0.707 times peak. In most cases, the meter scale has been calibrated to indicate about 10% higher than average so as to indicate rms values.

Accuracy. This refers to the meter's ability to indicate true voltage, current, or resistance. Accuracy is normally specified as some percentage of full-scale deflection. For example, consider a 3% meter measuring 100 volts on the 150-volt scale. The accuracy would be within 3% of 150 volts, or 4.5 volts (maximum) at any point on the scale. Thus, in

measuring 100 volts, you may have a reading as low as 95.5 or as high as 104.5. That's not too bad, but suppose you were measuring 10 volts on the 150-volt scale. You could hit 5.5 volts on the low end or 14.5 on the high end—an error possibility of about 50%. That is why you should always try to make all measurements as near as possible to the high end of the scale.

Ranges. In the days when the vacuum tube was the predominant active element in most circuits, most voltages to be

measured, even those on grids and cathodes, were over one volt; and this fact was reflected in the use of 2.5 or 3 volts for the lowest range on most test instruments. Now, in the solid-state age, many voltages under one volt must be measured. A glance at the schematic for any semiconductor device will show what low levels have to be measured. This new low level of measurement is reflected in the 0.5-volt or less full-scale ranges on a modern VTVM or TVM. These instruments also have ranges up to 1 kilovolt or so for use in testing vacuum tube circuits.

True-Blue Sound at extra-green savings!

CTS Hi-Fi Stereo Speakers put pure sound in the enclosure you build—at factory-to-you prices.

FREE BROCHURE lists five CTS FUTURA speaker systems from 140-15,000 Hz to 40-20,000 Hz. Leading manufacturers use them. Enclosure specs, crossover values and hook-up schematics make it easy for you! Mail coupon!

DO IT YOURSELF!
CUT OUT
HIGH SPEAKER COSTS!



CTS of Paducah, Inc.
Dept. PE

1565 North 8th Street
Paducah, Ky. 42001

I want true-blue sound at extra-green savings—send Hi-Fi Stereo Speaker Catalog.

Name _____

Address _____

City _____ State _____ Zip _____



Resistance Measurements. Resistance is measured by impressing a voltage across the unknown resistance and measuring the voltage drop produced by the current flow. In most cases, the greater the voltage sensitivity of the instrument, the higher the measurable resistance values. Most VOM's, VTVM's and TVM's are perfectly capable of measuring the usual spread of resistance values found in electronic equipment. However, there is one point to be remembered: the usual ohmmeter uses 1.5 volts or more to make a resistance measurement; and this voltage, if applied to a resistor in a semiconductor circuit, may be high enough to forward bias the associated semiconductor junction. This makes any resistance measurement invalid and also may lead to the accidental burning out of the junction.

Many modern instruments use very low voltages to make in-circuit resistance measurements to avoid the forward bias effect. Remember that a silicon junction will switch on at about 0.6 volt forward bias, while a germanium junction requires only about 0.3 volt. Keep this in mind when

ADDED MOBILE POWER WHEN
YOU NEED ADDITIONAL COVERAGE
FOR CLEAR COMMUNICATIONS



170 WATT INPUT
Complete with remote power switch and indicator control panel plus mounting brackets.

\$129⁹⁵
12 VDC

FCC TYPE ACCEPTED
Parts 89, 91, 93

SMALL PACKAGED MOBILE POWER LINEAR R.F. POWER AMPLIFIER

Covers greater distances with increased transmit power. Can be used with SONAR BR20, FM40 or any similar FCC approved equipment with 1-15 watt output. Designed with top performance and dependable service when you need it. Automatic standby/transmit switching • Covers 25-50MHz range • transistorized power supply—negative ground • Used on amateur 28MHz for FM-AM-SSB. Small, compact, rugged design. Size: 2"H x 6"W x 8"D. Wt. 3 lbs. 12 VDC

SONAR RADIO CORP., 73 Wortman Avenue, Bklyn, N.Y. 11207
Please send information on Model BR 2906 Linear Amplifier.
Dept. 500

Name _____
Address _____
City _____ State _____ Zip _____

CIRCLE NO. 33 ON READER SERVICE CARD

using an ohmmeter to make in-circuit resistance measurements. This also applies when using an ohmmeter to "test" transistors. It is possible to deliver, unknowingly, enough current through a forward biased junction to completely destroy it through the thermal effect. The solution is to use an intermediate resistance range so that neither current nor applied voltage is excessive. The use of special low-power ohmmeter circuits will solve the problem.

Uses and Abuses. There is no reason why a VOM, VTVM, or TVM should not provide good service for many years if it is properly handled. Just don't forget the basic rules: always make sure that you are in the correct function (connecting an ohmmeter or current meter across a voltage source can be disastrous), and always start on the highest range, working your way down until the meter indication is as far upscale as possible. If you have a meter with color-coded banana jack inputs, check that the leads are properly connected. Black is usually ground, and red is the "hot" lead. With no power on the meter, make sure that the needle rests at zero. There is usually an adjustment screw on the front of the meter for zeroing.

There is also a small thing called static charge that can accumulate on a plastic meter face (especially on large ones) that can cause erratic meter deflections. Most units are treated to remove this effect; but if you do run into trouble, there are several anti-static compounds that can be used.

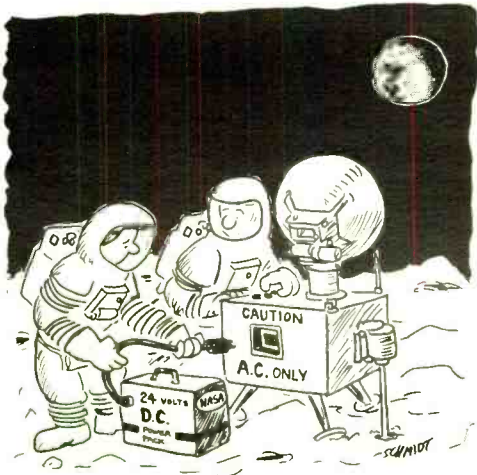

POLY-PLANAR IS SOUND ON WHEELS.

Powerful 18-watt, 7/8-inch thin automotive speaker system—fits anywhere in your car. Converts sun visors, doors, decks, kick panels, side panels—any automotive surface—into a hi-fi speaker system. Surface or flush mounting with one model. Send for detailed specifications and installation ideas.

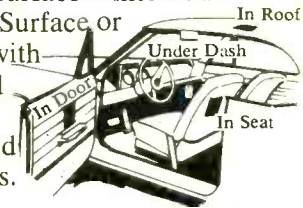

THE SPEAKER YOU DON'T HAVE TO SEE TO HEAR.

The Magitran Company

311 East Park Street • Moonachie, New Jersey 07074
CIRCLE NO. 44 ON READER SERVICE CARD

ANOTHER SUPERB VALUE
from **Olson**



Electronics
ONLY

\$10⁹⁸

DELUXE BATTERY TESTER

Compact precision tester checks all types of batteries from radio to industrial. 12 position switch selects most popular ranges from 1.5 volts to 240 volts. 1.5v to 15v ranges are tested under load. Complete with test leads and instructions.

Olson Electronics, Dept. 13, 260 S. Forge St.,
Akron, Ohio 44308

- I enclose \$10.98 plus \$1 for postage and handling. Send me the TE-237 Battery Tester.
- Send me the next seven issues of the Olson Catalog, without cost or obligation. **FREE**

Name _____
Address _____
City _____
State _____ Zip _____

CIRCLE NO. 24 ON READER SERVICE CARD



Surplus Scene

By Alexander W. Burawa, Associate Editor

THE SOLID-STATE PARTS MARKET

NOW that integrated circuits have become as important to home experimenter projects as are transistors and diodes, it seems as though they are becoming as scarce as they were when they were first made "available" to the experimenter. Nor is the availability problem limited solely to IC's; transistors, control devices, and even some lowly diodes types are becoming increasingly more difficult to find locally. Fortunately, a few of the Surplus Scene dealers are offering these important devices in large quantities.

Among the first of the companies to offer transistors and diodes for sale in the days when these were hot new items to the hobbyist was *Poly Paks* (P.O. Box 942, South Lynnfield, MA 01940). Their present-day offerings consist of bargain lots (and they really are bargains) of transistors and diodes, plus individual high- and low-power transistors, rectifiers, SCR's, diodes, triacs, FET's, UJT's, etc. Poly Paks also has quite an extensive listing of digital and analog IC's at rock-bottom prices. An example of the bargain packs is the "100-piece Semiconductor Grab Pak" listed at only \$2.25 in the current flyer. In the IC category, look for 709 and 741 dual op-amps for only \$1.49 and \$2.25, respectively. The listing can go on and on, but you get the idea.

John Meshna Jr. (P.O. Box 62, E. Lynn, MA 01904) and *Delta Electronics Co.* (P.O. Box 1, Lynn, MA 01903) make similar offerings. John Meshna, for example, lists an IC grab bag of a dozen RTL and DTL integrated circuits for only \$2.00; transistors and diodes are in grab-bag lots. Delta Electronics does not specialize in grab-bag lots per se, but they do offer the buyer quantities of given items at large reductions over the one-time prices.

They have fairly comprehensive listings for SCR's, digital logic IC's, zener diodes, and low-power transistors.

"Surplus electronics and optics at a fraction of the original cost" is prominently printed on the front cover of a compact, illustrated catalog you can obtain from *BF Enterprises* (P.O. Box 44, Hathorne, MA 01937). A quick glance through the catalog confirms the statement of policy. Get these prices: buy diodes by the foot and get 10 ft.—that's 600 diodes—for only \$15.00, Signetics "Utlologic II" IC's (extensively used in modern digital test instruments) for only \$1 and \$2 each, and an 80-percent discount on the latest digital IC's from Signetics, plus similar savings on IC's made by other manufacturers.

Interested in obtaining low-cost decimal readouts for your digital test instrument projects? Poly Paks has Burroughs Nixie® gas-discharge tubes for only \$4.95. John Meshna has no less than seven different types of readouts listed—incandescent dot matrixes for \$9.95 each, Amperex or Raytheon gas-discharge types for \$3 each or \$25 for 10, incandescent projection readouts for \$6 each, etc. And BF Enterprises offers an incandescent seven-segment readout system kit which includes readout cube, printed circuit board, 7490 and 8T04 integrated circuits for assembling a complete decimal counter display for only \$9.75 each. The same kit with a capability of up/down counting can be obtained for \$11. Add a 7475 latch, and the kit comes to \$13.

The above listings and examples are by no means complete, nor can they begin to convey the extensiveness of the offerings available from the Surplus Scene dealers. The best way to get this information is for you to write to the companies listed at the addresses given. ◆

ELECTRONICS MARKET PLACE

NON-DISPLAY CLASSIFIED: COMMERCIAL RATE: For firms or individuals offering commercial products or services, \$1.50 per word (including name and address). Minimum order \$15.00. Payment must accompany copy except when ads are placed by accredited advertising agencies. Frequency discount: 5% for 6 months; 10% for 12 months paid in advance. **READER RATE:** For individuals with a personal item to buy or sell, \$1.00 per word (including name and address.) No minimum! Payment must accompany copy. **DISPLAY CLASSIFIED:** 1" by 1 column (25/8" wide), \$185.00. 2" by 1 column, \$370.00. 3" by 1 column, \$555.00. Advertiser to supply cuts. For frequency rates, please inquire.

FOR SALE

FREE! bargain catalog. Fiber optics, LED's, transistors, diodes, rectifiers, SCR's, triacs, parts. Poly Paks, Box 942, Lynnfield, Mass. 01940.

GOVERNMENT Surplus Receivers, Transmitters, Snooperscopes, Radios, Parts, Picture Catalog 25¢. Meshna, Nahant, Mass. 01908.

ROCKETS: Ideal for miniature transmitter tests. New illustrated catalog, 25¢. Single and multistage kits, cones, engines, launchers, trackers, rocket aerial cameras, technical information. Fast service. Estes Industries, Dept. 18-K, Penrose, Colorado 81240.

LOWEST Prices Electronic Parts. Confidential Catalog Free. **KNAPP**, 3174 8TH Ave. S.W., Largo, Fla. 33540.

WE SELL CONSTRUCTION PLANS. TELEPHONE: Answering Machine, Speakerphone, Carphone, Phonovision, Auto Dialer, Touch Button Dialer, Central Dial System. **TELEVISION:** \$35.00 Color Converter, Video Tape Recorder, \$25.00 Camera. **HOBBYIST:** Electron Microscope, 96 Hour Tape Music System. Ultrasonic Dishwasher, Radar-Oven. Plans \$4.95 each. **NEW ITEM:** \$75. Electronic Pocket Calculator, \$7.50. **COURSES:** Telephone Engineering \$39.50. Detective Electronics \$22.50. Integrated Circuit Engineering, \$49.50. **NEW SUPER HOBBY CATALOG** plus year's subscription to Electronic New Letter **AIRMAILED \$1.00.** Don Britton Enterprises, 6200 Wilshire Blvd., Los Angeles, Calif. 90048.

JETCO ELECTRONIC INDUSTRIES, INC.
Dept. PEC, 3933 Barranca Dr., El Paso, Texas 79935.

FIND COINS-GOLD-RELICS-TREASURE metal locators by JETCO!

- Lightweight
- Easy to Use
- Comes Complete
- Made in USA
- 5 yr. Guarantee
- Immediate Delivery!
- Write for FREE Catalog.

priced from **\$39.95**



INVESTIGATORS, latest Electronics Aids. Free Literature. Clifton, 11500-L NW 7th Ave., Miami, Florida 33168.

ELECTRONIC PARTS, semiconductors, kits. **FREE FLYER.** Large catalog \$1.00 deposit. **BIGELOW ELECTRONICS**, Bluffton, Ohio 45817.

RADIO—T.V. Tubes—36¢ each. Send for free catalog. Cornell, 4213 University, San Diego, Calif. 92105.

NEW SEMICONDUCTOR LIGHT EMITTING DIODES—bright red lights replace light bulbs. Typical life 100 years. Operate at 1.65 volts, 50 milliamps. Order 2 for \$2.98 NOW. Data sheet and instructions included. Monsanto Company, Hobby Section, 10131 Bubb Road, Cupertino, California 95014.

CONVERT any television to sensitive, big-screen oscilloscope. Only minor changes required. No electronic experience necessary. Illustrated plans, \$2.00. Relco-A33, Box 10563, Houston, Texas 77018.

GENERAL INFORMATION: First word in all ads set in bold caps at no extra charge. All copy subject to publisher's approval. All advertisers using Post Office Boxes in their addresses **MUST** supply publisher with permanent address and telephone number before ad can be run. Closing Date: 1st of the 2nd month preceding cover date (for example, March issue closes January 1st). Send order and remittance to Hal Cymes, **POPULAR ELECTRONICS** Including **ELECTRONICS WORLD**, One Park Avenue, New York, New York 10016.

MECHANICAL, ELECTRONIC devices catalog 10¢. Greatest Values—Lowest Prices. Fertik's, 5249 "D", Philadelphia, Pa. 19120.

SCORE, B&K Test Equipment Unbelievable Prices. Free Catalog and Price Sheet. Fordham Radio, 265 East 149th Street, Bronx, N.Y. 10451.

ELECTRONIC Ignition. Various Types. Information 10¢. Anderson Engineering, Epsom, N.H. 03239.

BUILD YOUR OWN SPACE-AGE TV CAMERA

ONLY KNOWN SOLID-STATE CAMERA KIT! Ideal for experimenters, home, education, industry, etc. • High quality • Backed by over six years of lab & field testing • Fully Guaranteed • Connects to any TV set without modification • Step-by-step construction manual • Model XT-1A, Series D complete with vidicon \$149.99 postpaid anywhere in USA & Canada (less vidicon tube \$116.99pp)

PHONE OR WRITE FOR CATALOG.
DIAL 403-967-3771

Many other kits, parts and plans available including starter kits, focus diff., coll., vidicon tubes, const. plans, audio subcarrier kit, etc.

1301 BROADWAY ATV Research DAKOTA CITY, NEBR. 68731

POWER TRANSFORMER SPECIALS

Every electronic project starts with a power supply. Dual primaries, dual secondaries. Makes 12 volt 4 amp. or 24 volt 2 amp. or 48 volt 1 amp. supply.
STOCK NO. F9201 3.50 ea. 3/10.00

Two 12 volt 2 Amp. secondaries. Makes 2 12 volt 2 amp. or 1 12 volt 4 amp. or 1 24 volt 2 amp. supplies.
STOCK NO. F9202 2.95 ea. 2/5.00

42 volt ct. 4 amp. and 18 volt ct. 2 amp. secondaries. Many voltage combinations possible.
STOCK NO. F9250 3.25 ea. 2/6.00

All transformers come with wiring diagram, and several suggested power supplies.

HONEYWELL COMPUTER BOARD

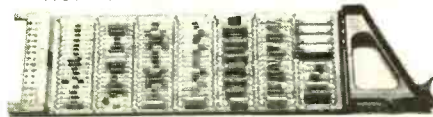

Honeywell Computer boards, 4 1/2"x12". Transistors, diodes, zeners, capacitors, precision resistors, heat sink, trimmers etc. 2 Different boards \$1.00. 3 lb. Stock No. F9082

COMPUTER GRADE CAPACITORS (BRAND NEW)

40,000 mfd. 10 volts 1.25 ea. 6/7.00 Stk. No. F2026
70,000 mfd. 10 volts 1.75 ea. 6/9.00 Stk. No. F2118
6000 mfd. 55 volts 1.50 ea. 7/9.00 Stk. No. F2117
3,750 mfd. 75 volts 1.75 ea. 6/9.00 Stk. No. F2116

MINIMUM ORDER \$3.00

Many other items—send for new 32 page catalog. All merchandise guaranteed. Please include postage. Excess will be refunded.



DELTA ELECTRONICS CO.

BOX 1, LYNN, MASSACHUSETTS 01903

CIRCLE NO. 10 ON READER SERVICE CARD

ELECTRONIC COMPONENTS—Distributor prices, Free catalog. Box 2581, El Cajon, California 92021.

DEALERS WANTED! Citizens Band, AM, SSB. Two-way Radios & Accessories. USA and Export models. We ship around the world. Send letterhead to: **BAGGY'S RADIO** P.O. Box 778, 6391 Westminster Ave., Westminster, Ca. 92683. 714-894-3301.

AMATEUR SCIENTISTS, Electronics Hobbyists, Experimenters, Students . . . Construction Plans—all complete, including drawings, schematics, parts lists with prices and sources . . . **Radar**—Build your own ultrasonic doppler radar. Detect motion of people, automobiles, even falling rain drops. Transistorized, uses 9 volt transistor battery—\$4.50 . . . Long-Range "Sound Telescope"—This amazing device can enable you to hear conversations, birds and animals, other sounds hundreds of feet away. Very directional. Transistorized. Uses 9V battery—\$3.50 . . . **Robot Man**—Moves hands and arms—\$3.50 . . . Or send 25¢ coin (no stamps) for complete catalog. Other items include Psychedelic strobes, light shows, lasers . . . 46 different projects. Technical Writers Group, Box 5994, State College Station, Raleigh, N.C. 27607.

ANTIGRAVITY, experiment and theory; Rushed—\$2.00. U.S. Inquiries, Intertech 7A6, Box 5373, Station-F, Ottawa, Canada.

LEARN the facts of electronics and your privacy. Send for the **Tron-X Manual**, P.O. Box 38155, Hollywood, CA 90038. \$5.95.

JAPAN HONG KONG DIRECTORY. World products information. \$1.00 today. Sekai Shogyo Annai, Hillyard, Washington 99207.

DEALERS WANTED!

CITIZENS BAND, AM, SSB, Two-way Radios & Accessories. USA and export models. We ship around the world. Send letterhead to:

BAGGY'S RADIO

P.O. Box 778, 6391 Westminster Ave.,
Westminster, California 92683
714-894-3301

EUROPEAN and Japanese bargains catalogs. \$1 each. Dee, P.O. Box 9308, North Hollywood, Calif. 91609.

BURGLAR ALARM SYSTEMS. We manufacture intruder-fire detection systems, radar and perimeter types. Accessories available. Free Literature. Inquiries for dealership and wholesale prices must be on letterhead. U.S. and Canada only. Microtech Associates, Inc., Box 10147, St. Petersburg, Florida 33733.

"LISTEN IN" TO POLICE-FIRE RADIO CALLS IN YOUR CAR!

WORKS WITH ANY CAR—Portable or HOME RADIO! Just PLUGS in—No wiring—3 minute hookup! Switch instantly from regular to ALL POLICE-FIRE-EMERGENCY-COMMERCIAL-TAXICAB-STATE-CITY-GOV'T 2 way Radio calls in YOUR AREA. DUAL—HI-LOW BANDS—OVER A MILLION Radio Cars/stations. USE Everywhere—anytime—always works!

SEND ONLY \$2.00 (cash, Ck., M.O.) and pay postman \$7.00 plus COD pkg or send \$9.99 for pnd Del in USA. COMPLETE, ready to use with instructions. One Year service Warranty—10 DAY MONEY BACK TRIAL (if retired). **AWAZING OFFER** good only by mail—**WESTERN RADIO Dept. BPE-3 KEARNEY, NEBR. 68847**



CONSTRUCTION PLANS: Laser . . . \$2.00. Investigation Aids—2-FM Microphone Transmitters . . . \$1.00. FM Telephone Transmitter . . . \$2.00. Sound Telescope . . . \$2.00. Space Monitor—Missile Tracker . . . \$2.00. Free equipment and kit catalog. Howard, 20174 Ward, Detroit, Michigan 48235.

CLEARANCE SALE rectifiers, transistors, 1000's other items. Catalog 15¢. General Sales Company, 254 Main, Clute, Texas 77531.

FREE catalog, parts, circuit boards for **POPULAR ELECTRONICS** projects. PAIA ELECTRONICS, Box C14359, Oklahoma City, Ok. 73114.

DIAGRAMS—Radios \$1.50, Television \$3.00. Give make and model. Diagram Service, Box 1151PE, Manchester, Conn. 06042.

NOW! Enjoy the great outdoors in comfort with your pocket size electronic Skeeter Skat mosquito repeller. \$9.95 postpaid USA. Satisfaction guaranteed. Detectron, Dept. G-3, P.O. Box 243, San Gabriel, Calif. 91778.

TV TUNER REPAIRS—Complete Course Details, 12 Repair Tricks, Many Plans. Two Lessons, all for \$1. Refundable. Frank Rokeck, Box 833, Redding, Calif. 96001.

RECONDITIONED Test Equipment. Reasonably priced. list available. Waiter, 2697 Nickel, San Pablo, CA. 94806.

PYROTECHNICAL chemicals, casings, tools, supplies, fuse, literature. Giant, illustrated catalogue/handbook includes formulas, instructions—50¢, with samples—\$1.00. Westech, Salt Lake City, 84108.

VHF ignition coil 60 times faster than conventional. Connects direct to any CD system. Molded epoxy \$9.95. Perkins Electric, 1022 Newton, Denver, Colorado 80204.

METERS—Surplus, new, used, panel or portable. Send for list. Hanchett, Box 5577, Riverside, CA 92507.

ELIMINATE distributor points with magnetic pickup system using your C.D. ignition or our complete system. Rugged and reliable, uses standard inexpensive parts. SES-1 plans for use with your C.D. \$4.50. SES-2 plans our complete system \$5.50. Both for \$7.50. SES Enterprises. Box 607, Ferndale Wash. 98248.

HOBBYISTS! Logic IC project kits. Combination Lock, \$5.95. Catalog free. John Huntley, 1351 Mahoney, Rodeo, Calif. 94572.

FREE catalog new electronic devices! World's smallest transmitter \$19.95! Telephone Answerer \$49.50! Telephone Recording Device \$19.95! Lie Detector \$19.95! Many more! Sonic Devices, 69-29E Queens Blvd., New York 11377.

INSTANT CIRCUITRY—apply on two enclosed PC boards, no liquids. Price \$3.00. Security Systems, P.O. Box 4754, Colorado Springs, Colorado 80910.

JOHNSON CB RADIOS. Low discount prices, prepaid shipping. MasterCharge. Free list. Hughes Electronics, Box 6487A, Asheville, N.C. 28806.

SUPREME twenty different radio-television volumes, \$50 value, only \$19.95, postpaid. Supreme Publications, 1760 Balsam, Highland Park, Illinois 60035.

BURGLAR Alarm Systems equipment, dealers and private. Write: United Security, Box 2428, Dublin, Calif. 94566.

INEXPENSIVE Antenna, amplifier, and quadasonic equipment. See Plans & Kits.

PANORAMA of industrial and government electronic surplus in our monthly picture catalogs. Startronics, Box 17127, Portland, Oregon 97217.

WE SELL Construction Plans, Kits and Wired Units—120 volts at 3,000 watts of electricity from ANY alternated vehicle using our special adapter! Operate electric drills, lights, heaters, portable saws, AC-DC TV's and many more AC devices! Arc weld 1/4" steel plates! Fully charge 6,12,24 volt batteries in minutes! Will not harm alternator! Installation takes only ten minutes! Send only \$14.20 for complete kit, \$17.20 for assembled unit or \$20.20 with voltage indicating light, comes on when alternator is producing 120 volts! Plus Many Other Products Just as Useful!—construction plans—alternator adapter—ultra-sensitive metal detector—x-ray fluoroscope machine—silver recovery unit—coin cleaner/electroplater—chemical formulary (home products)—boat radar unit—radar oven-infra-red viewing system—plans \$5.00 each—Plus Many More!—ask for our Free color catalog—Creative Products. 1551 East Loop 82C, Department EB, Fort Worth, Texas 76112.

ELECTRONIC HOBBYISTS and professional builders love our 3¢ film resistors: 16¢ electrolytics and 1% micas. Great catalog 35¢. Electrovalve-America. Box 276, Swarthmore, Pa. 19081.

ELECTROENCEPHALOPHONE, Brainwave feedback equipment. J&J Enterprises, 24120-E 3rd West, Bothell, Wash. 98011.

INVESTIGATORS—Detectives—Industrial Security Officers: Latest subminiature electronic equipment. Catalog 50¢. Jack, Box 19422, Sacramento, Calif. 95819.

ELECTRONIC ORGAN KEYBOARD, tone generator kits, etc. All types of components for building your own organ. Send 25¢ for catalog. Devtronix Organ Products, 5872 Amapola Drive, San Jose, Calif. 95129.

BUILD your own Programmable Calculator. Catalog 25c. Digital Concepts, Box 5424, Charlottesville, Virginia 22903.

BURGLAR-FIRE alarm supplies and information. Free catalog. Protecto Alarm Sales, Box 357-G, Birch Run, Michigan 48415.

AUTOMATIC Telephone Answering Equipment. Conference call devices. Many models at tremendous discounts. Easy to install. Complete instructions. Fully guaranteed. From \$109. Conference Callmaker only \$39.95. Free literature. Phone Control Systems, 18 Surrey Road, New Hyde Park, N.Y. 11040.

BURGLAR FIRE ALARMS. Lowest prices. Catalog. Gem, 6801 11th Avenue, Brooklyn, N.Y. 11219.

CREATIVE LIGHTING. Informative handbook/catalog \$1.00. One Trip Beyond, Box 2043K, Dearborn, Michigan 48123.

HOBBYISTS, Supersensitive F.M. microphone transmitter. Picks up normal voice at 30 feet, kit \$14.95, wired \$19.95. Write: Collin, Inc., P.O. Box 281, Route 25, Monroe, Conn. 06468.

REK-O-KUT Challenger overhead lathe disc recorder. William Stevenson, Kennan, Wisconsin 54537.

IC-s, books, low prices. Marco Enterprises, POB 216, Dayton, Ohio 45401.

FREE Kit Catalog: Shortproof powersupply \$39.50. Ultrasonic Alarm \$37.25. SWTPC, Box B32040, San Antonio, Tex. 78284.

FIRE & BURGLAR ALARMS 1972 Handbook & Catalog



Save Hundreds of Dollars

Professional equipment famous manufacturers, not readily available from local sources. **NEW & EXPANDED** to include laser photo-electronic systems, dialers, electronic sirens, perimeter controls, and a **NEW RADIO ACTUATED SYSTEM** that installs in less than 2 hours. Also includes switches, bells, control panels, wire and hardware. Save up to 75%. This handbook is a must for every homeowner and businessman. Just \$1 cash, check or M.O. \$1 refunded with first order.

ALARM COMPONENT DISTRIBUTORS

33 New Haven Ave., Dept. P.E., Milford, Conn. 06460

OVER 1,000 new electronic parts, list \$240.00, yours \$19.95. 28 Music pages \$1.25. All postpaid. Hobbytronics, 921 East 19th, San Angelo, Texas 76901.

GET "Music Only" FM Programs. SCA Adaptor fits any FM tuner or receiver. Free list of stations with order. Kit \$14.50 (with Squeelch \$19.50) Wired and Tested \$25.00 (with Squeelch \$29.95). All plus postage and insurance. Thousands Sold. SWTPC, Box E32040, San Antonio, Tex. 78284.

DISCOUNT electronic guaranteed goodies. Motorola HEP170 Epoxy Diode 2.5A 1000PIV 39¢; M0T 7090PAMP 50¢; Quote short-wave receivers. Industrial, Amateur, CB. Madison Electronics, 1508 McKinney, Houston, Texas 77002 (713) 224-2668.

FREE Kit Catalog: Color Organs \$11.00. Psychedelic Strobes \$17.50. Professional quality-lowest prices. SWTPC, Box F32040, San Antonio, Tex. 78284.

PLANS AND KITS

KITS—Color organs, synchronizers, strobes. Workshop, Box 3932, Bethpage, New York 11714.

KITS AND EQUIPMENT—FM Wireless microphone transmitters, FM Telephone transmitters, Infinity transmitters. Security Electronics, P.O. Box 265, Huntington, W. Va. 25707.

COMPUTER designed antenna plans. All-channel. UHF. VHF, one-channel, or any combination. Also television amplifier and quad-rasonic hi-fi adaptor plans available. Build your own for a fraction of the manufactured cost. All plans \$2.00 each. Satisfaction guaranteed! Computer Electronics, P.O. Box 2892, Champaign, Illinois 61820.

ALPHA-NUMERIC 7-SEGMENT READOUTS



Either Type — Only **\$3.95**

Buy any 3 — Take 10% Discount

A Poly Pak exclusive! Two different types. Both compatible with SN7446, SN7447, SN7448, SN7475, SN7490 and SN74192 IC's. Both with decimals, 0 to 9 numerals and 10 letters. With spaces & hooksups.

16-PIN MICRO MINIATURE

Fits into 16 pin dual in line socket. Life: 250,000 hours. Delivers 700-ft. Lamberts brightness with 5 volts B mills per segment. Characters .362" H. x .197" W.

9-PIN TUBE TYPE

For printed circuit board or socket. Life: 100,000 hours. Delivers 6,000-ft. Lamberts with 5 volts 23 mils per segment. Characters .47" H. x .26" W.



ALLEN BRADLEY'S "MICRO-POTS"

Type G, 1/2" dia. x 1 1/2" high. Counts 1/10th hole, with slotted linear, immersion-proof high freq.



Any
2
for
\$1

<input type="checkbox"/> 100	<input type="checkbox"/> 1.0K	<input type="checkbox"/> 10K	<input type="checkbox"/> 100K	<input type="checkbox"/> 1 Meg.
<input type="checkbox"/> 250	<input type="checkbox"/> 2.5K	<input type="checkbox"/> 25K	<input type="checkbox"/> 250K	<input type="checkbox"/> 2 Meg.
<input type="checkbox"/> 500	<input type="checkbox"/> 5.0K	<input type="checkbox"/> 50K	<input type="checkbox"/> 500K	<input type="checkbox"/> 5 Meg.

BRAND NEW! LINEAR IC AMPS

Type	Description	Sale	Price
<input type="checkbox"/>	703 RF-IF, 14 hooksups, TO-5	\$1.19	3 for \$3.00
<input type="checkbox"/>	709C Operational Amp***	.59	2 for 1.00
<input type="checkbox"/>	710C Differential Amp***	.59	2 for 1.00
<input type="checkbox"/>	711C Memory, Sense, Amp***	.59	2 for 1.00
<input type="checkbox"/>	723A Voltage Regulator (DIP)	1.49	3 for 3.75
<input type="checkbox"/>	TVR-2000 Hi-power 723 (DIP)	1.59	3 for 3.95
<input type="checkbox"/>	741C Freq. Comp. 709***	.95	3 for 2.50
<input type="checkbox"/>	748C Freq. Adjustable 741***	.95	3 for 2.50
<input type="checkbox"/>	709-709 Dual 99's (DIP)	1.49	3 for 4.00
<input type="checkbox"/>	741-741 Dual 741's (DIP)	1.98	3 for 5.50

*** State 1st, 2nd choice: Dual In Line, TO-5

GIANT SALE ON NEW TTL TEXAS & NATIONAL ICs

Buy Any 3 — Take 10%, Discount!

100 or more, 25% discount

Type	Function	Sale
<input type="checkbox"/>	SN7400N Quad 2 input NAND gate	.39
<input type="checkbox"/>	SN7401N SN7400 with open collect	.39
<input type="checkbox"/>	SN7402N Quad 2 input NOR gate	.39
<input type="checkbox"/>	SN7404N Hex inverter	.39
<input type="checkbox"/>	SN7405N Hex inverter, open collect	.39
<input type="checkbox"/>	SN7410N Triple 3 input NAND gate	.39
<input type="checkbox"/>	SN7420N Dual 4 input NAND gate	.39
<input type="checkbox"/>	SN7430N 8 input NAND gate	.39
<input type="checkbox"/>	SN7440N Dual 4 input NAND buffer	.39
<input type="checkbox"/>	SN7441N BCD-to-Decimal driver	1.50
<input type="checkbox"/>	SN7446N BCD-to-7 seg. dec. driver	2.25
<input type="checkbox"/>	SN7447N BCD-to-7 seg. dec. driver	2.25
<input type="checkbox"/>	SN7472N J-K Master slave flip-flop	.69
<input type="checkbox"/>	SN7473N Dual J-K Master slave flip-flop	.88
<input type="checkbox"/>	SN7474N Dual D triKerred flip flop	.69
<input type="checkbox"/>	SN7475N 4-bit stable latch	1.25
<input type="checkbox"/>	SN7476N SN7473, with preset-clear	.88
<input type="checkbox"/>	SN7481N 16-bit memory (scratch pad)	1.50
<input type="checkbox"/>	SN7483N 4-bit binary full adder	1.88
<input type="checkbox"/>	SN7490N Decade counter	1.39
<input type="checkbox"/>	SN7491N 8-bit shift register	1.50
<input type="checkbox"/>	SN7492N Divide by 12 counter	1.50
<input type="checkbox"/>	SN7493N 4-bit binary counter	1.25
<input type="checkbox"/>	SN7494N 4-bit shift register	1.50
<input type="checkbox"/>	SN7495N 4-bit register right-N-left	1.50
<input type="checkbox"/>	SN74154N Divide by 16	3.45
<input type="checkbox"/>	SN74181N Arithmetic Logic Unit	8.50
<input type="checkbox"/>	SN74192N Bi-directional counter	3.45
<input type="checkbox"/>	SN74193N Binary up-down counter	3.45

Terms: add postage. Rated: net 30, cond's 25/7.
Phone Orders: Wakefield, Mass. (617) 245-3829
Retail: 211 Albion St., Wakefield, Mass.

POLY PAKS

P.O. BOX 942 E
Lynnfield, Mass. 01940

CATALOG
15¢

CIRCLE NO. 28 ON READER SERVICE CARD

SEVEN SEGMENT COUNTER KIT Consisting of a 7 segment readout driven by 5 volts, having 5 1/2" numbers and a 7447 decoder and 7490 counter \$9.00

VARIABLE CAPACITANCE DIODES
(Similar to 1N5463A) used to tune VHF, color TV, & FM broadcast sets \$1.00
Similar to D13T, with data sheet \$1.00

PROGRAMMABLE UJT'S
Similar to D13T, with data sheet \$1.00

ER900 TRIGGER DIODES. These bidirectional trigger diodes are one of the best and cheapest methods to trigger SCR's and triacs 4/1.00

T1543 UJT'S50
2N13819 N channel FET'S .45
TTL IC SERIES (DIP)
7441 BCD Decimal Decoder 1.75

7475 Quad Bistable Latch 1.40
7476 Dual Mast-Slave JK FF 1.00
7490 Decade Counter 1.80
7492 Divide By Twelve 1.85
7481 16 bit read/write memory 1.75
7404 Hex Inverter40
7447 BCD to seven decoder driver 2.00
74121 Monostable multi-vibrator90
7413 Dual Schmitttrigger 1.75
7480 Full Adder 1.75

TRIACS
PRV 1A 10A 15A 20A
100 .40 .70 1.00 1.20
200 .70 1.10 1.50 1.60
300 .90 1.35 1.90 2.00
400 1.10 1.60 2.70 2.40
500 1.50 2.00 3.20 2.80

Silicon Power Rectifiers
PRV 1A 3A 12A 50A
100 .06 .09 .30 .85
200 .07 .16 .35 1.25
400 .09 .20 .45 1.50
600 .11 .30 .70 1.80
800 .15 .40 .85 2.30
1000 .20 .55 1.10 2.75

NIXIE TUBES
Similar to Raytheon 8754, with socket & data sheet \$3.00

Terms: FOB Cambridge, Mass. Send check or Money Order. Include Postage. Average Wt. per package 1/2 lb. No C.O.D.'s. Minimum Order \$3.00. Rated companies 30 days net

DECADE COUNTER KIT
Consisting of:
1-Nixie tube & socket (8754)
1-7490
1-7475
1-7441
\$7.50

709C OPER AMP \$.50
741 OPER AMP \$.80
723 VOLTAGE REGULATOR \$1.25

Silicon Control Rectifiers
PRV 3A 7A 20A 70A
50 .25 .32
100 .30 .45 1.00 3.50
200 .50 .75 1.25 6.50
300 .60 .90 1.50
400 .70 1.10 1.75 9.50
500 .80 1.25 2.00
600 .90 1.40 2.25 11.00
2N3055 7 amp NPN Silicon Transistor ... \$1.25

SOLID STATE SALES

Post Office Box 74A

Somerville, Mass. 02143

Tel. (617) 547-4005

CIRCLE NO. 32 ON READER SERVICE CARD

FREE Kit Catalog: Digital Microlab \$29.95. Also Segmented and Nixie Readouts, Timebases, Scaler, Electronic Digital Clocks (all featured in Popular Electronics) SWTPC, Box C32040, San Antonio, Tex. 78284.

PROTECT almost anything with Max-a-larm. Complete alarm kit under \$25.00. Information. Kustom Kit Electronics, Box 86, North Dartmouth, Mass. 024747.

FREE Kit Catalog: Amazing new Universal Digital Instruments with plugins as featured in Popular Electronics. Unbeatable prices. SWTPC, Box D32040, San Antonio, Tex. 78284.

FREE Kit Catalog: Why does every major College, University, Technical School, Research & Development Center buy from us? Because we have the highest quality and lowest prices. Free catalog. SWTPC, Box H32040, San Antonio, Tex. 78284.

ELECTRICAL SUPPLIES AND EQUIPMENT

PLATING Equipment, Portable Platers, Supplies and "Know-How." Build your own tanks for nickel, chrome, etc. Easy-to-install PVC liners. Rectifier components—all sizes. Schematics, parts lists, formulas, operating instructions for all plating. Guaranteed to save you 25%-75%. Some good units for sale. Write for details. Platers Service Company, 1511-PE Esperanza, Los Angeles, Calif. 90023.

WANTED

QUICKSILVER, Platinum, Silver, Gold, Ores Analyzed. Free Circular. Mercury Terminal, Norwood, Mass. 02062.

CASH immediately for old Gold, Silver, Platinum, Mercury, Watches, Diamonds. Free information. Rose Industries, 29-PB East Madison, Chicago Ill. 60602.

QUICK CASH . . . for Electronic Tubes, Semi-Conductors, Equipment (Receivers, Transmitters, Scopes, Vacuum Variables etc.) Send Lists now! Write: Barry Electronics, 512 Broadway, New York, NY 10012. (212) 925-7000.

PAY for instructions how to operate AN/APR4 receiver. P.O. Box 147, Queens, New York 11375.

SHOESTRING business opportunity. Free information. All-band TV antenna. Simplified building plans. Write: GJM Electronics, P.O. Box 218, Goleta, Cal. 93017.

UNIVERSITY Model S-8 Classic or Model S-7 "Dean" 3 way deluxe speaker system. Phone 717-246-1121, collect.

TUBES

RADIO & T.V. Tubes—36¢ each. Send for free Catalog. Cornell, 4213 University, San Diego, Calif. 92105.

RECEIVING & INDUSTRIAL TUBES, TRANSISTORS. All Brands—Biggest Discounts. Technicians, Hobbyists, Experimenters—Request **FREE** Giant Catalog and **SAVE!** ZALYTRON, 469 Jericho Turnpike, Mineola, N.Y. 11501.

SAVE money on parts and transmitting-receiving tubes, foreign-domestic. Send 25¢ for giant catalog. Refunded first order. United Radio Company, 56-P Ferry Street, Newark, N.J. 07105.

TUBES "Oldies," latest. Lists free. Steinmetz, 7519 Maplewood, Hammond, Indiana 46324.

ELECTRONIC TUBES, Semiconductors, Equipment, Telephones, Public Address, Intercoms, CB, Walkie-Talkies, etc. Quality Merchandise Only! Serving Engineers, Purchasing Agents, TV/Hi-Fi Servicemen and Hams for 28 years, Domestic and Export. Write for Catalog or call (212) 925-7000. **BARRY ELECTRONICS,** 512 Broadway, New York, N. Y. 10012.

TUBES receiving, factory boxed, low prices, free price list. Transleteronic, Inc., 1306 40th Street, Brooklyn, N.Y. 11218A, Telephone: 212-633-2800.

DISCARD tubes, solid state plug-ins, send stamped envelope for list, Precision Specialties, Box 912, Waco, Texas 76703.

HIGH FIDELITY

OVER 20 YEARS Successful Discounting of Audio Equipment insures best value and service. Specialize in Stereo Components, Tape Recorders, Cassettes, Magnetic Cartridges, Sleep Learn Equipment, etc. Low Quotes, Free Catalog. **DRESSNER 1523PE** Jericho Turnpike. New Hyde Park, New York 11040.

DIAMOND NEEDLES and Stereo Cartridges at Discount prices for Shure, Pickering, Stanton, Empire, Grado and ADC. Send for free catalog. All merchandise brand new and factory sealed. **LYLE CARTRIDGES,** Dept. P. P.O. Box 69, Kensington Station, Brooklyn, New York 11218.

HEGEMAN "OMNI-DIRECTIONAL" SPEAKERS \$100. Creighton Audio Labs, Haven Pl., Linden, N.J. 07036.

McGEE RADIO COMPANY
World's Best Selection of Speakers
Almost Every Size From 1 1/2 to 18"
WOOFERS — TWEETERS — CROSSOVERS
MANY HIGH FIDELITY KITS.
McGee's 176 Page Catalog
Sent Free Upon Request
NORELCO HI-FI SPEAKERS
An Added Full Line of Norelco Hi-Fi Speakers
For The System Builder
McGEE RADIO COMPANY,
1901 McGee Street PE,
Kansas City, Missouri 64108

STEREO Components at lowest prices. Send for free catalog. Carston, Box 1094-A, Danbury, Conn. 06810.

POPULAR ELECTRONICS Including Electronics World

100 WATT, Modular, all solid state stereo system. FET inputs, level meters, all front panel controls. \$69.95 complete—\$39.95 kit. For schematics and details, \$1.00 deposit. AKTRONICS, 2333, E. Bugle Drive, Chesapeake, Virginia 23321.

FREE Kit Catalog. Amplifiers: Lil Tiger \$11.10, Universal Tiger \$30.00. Preamp \$44.50 (Featured in Popular Electronics) Mixer-6 Input \$13.75. SWTPC, Box A32040, San Antonio, Tex. 78284.

TAPE AND RECORDERS

STEREO TAPE RENTAL for particular people. Free catalog. Gold Coast Tape Library, Box 2262, Palm Village Station, Hialeah, Fla. 33012.

STEREO TAPE TRANSPORT—7" reel—2 speeds—pause control—made for famous manufacturer—50 to 15,000 Hz—with rec/play and erase heads, without case. Send m.o. or check for \$19.50 to Alsheimer Audio Electronics, 218 Columbia St., Utica, N.Y. 13502. \$2.50 for prepaid shipping and insurance.

BUY Irish Tape Open Reel & Cassettes & 8-Track Blanks at Discount Prices. Write: Direct Mail Cassette Corp., Box 71, Plainview, N.Y. 11803.

RECORDING TAPE made by top American manufacturer, guaranteed not "seconds" or "white box"; 2400' mylar, \$2.29; 1800' mylar \$1.69; 1200' acetate \$.79. Send for information and quantity pricing. Alsheimer Audio Electronics, 218 Columbia Street, Utica, New York 13502.

OLD Radio Programs on cassettes or reels. High quality, low prices, thousands to choose from, professional equipment, catalog 50¢. Remember Radio Inc., Box 2513, Norman, Okla. 73069.

OLD Radio Programs. Catalog \$1.00. (Refundable). Radio Vault, Box 9032, Wyoming, Michigan 49509.

VIDEO TAPE, 1 inch x 1 mil. x 1700 feet. Used. On computer reels. \$12.00 each. LAHILL, P.O. Box 656, Martinsburg, W. Va. 25401.

SCOTCH TAPE #150, 1800 foot, 7" reel, polyester. \$1.95. post-paid. Recorders, cassettes, open reel music tapes (100-page discount catalog 25¢). Saxitone Tape Sales, 1776 Columbia Road, Washington, D.C. 20009.

RENT 4-Track open reel tapes—all major labels—3,000 different—free brochure. Stereo-Parti, 55 St. James Drive, Santa Rosa, Ca. 95401.

MEMOREX recording tape, audio & video lowest prices. write for free information. Bergetz Systems Co., Box 1181, Melrose Park, Ill. 60161.

Complete catalog!

**6,000
STEREO
TAPES**



• Pop • Rock • Jazz • Folk • Country
and Western • Classical • Complete
new entertainment guide. A must for
every owner of an open reel, 8-track
cartridge, or cassette player/recorder.
Send 25¢ in coin, check, or money
order to Ampeg, 2201 Lunt, Elk Grove
Village, Ill. 60007. ATTN: Dept. 145

AMPEX
STEREO TAPES

A SOUND TRACK brings life to slides. Free literature, "Slides with Sound." Synchronizer, Box 12375C, North Kansas City, Missouri 64119.

OLD radio programs catalog 50¢. Randall Dunford, 10126 Ferndale, Dallas, Texas 75238.

RECORDING? DUBBING? EDITING? Use the "Dubie" control. Integrate two or more recorders into your music system. End tangled cables, ruined tapes. Brochure M-5, Dubie Co., 1509 Oklahoma, Norman, Okla. 73069.

CAPITOL Tape reel-to-reel cassette, 8-track, at discount prices. Fordham Radio, 265 E. 149th St., Bx., N.Y. 10451, Dept. T.

REPAIRS AND SERVICES

TV Tuners rebuilt and aligned per manufacturers specification. Only \$9.50. Any make UHF or VHF Ninety day written guarantee. Ship complete with tubes or write for free mailing kit and dealer brochure. JW Electronics, Box 51C, Bloomington, Indiana 47401.

COLOR TV Repairs expensive? Get Dial-a-Fix! \$2.98. Details 25¢. KRK Enterprises, Dept. H, P.O. Box 176, Ilion, NY 13357.

DO-IT-YOURSELF

PROFESSIONAL ELECTRONICS PROJECTS—\$1.00 up. Catalog 25¢. PARKS, Box 25665A, Seattle, Wash. 98125.

PERSONALS

INVESTIGATORS, Latest Electronics Aids. Free Literature. Clifton, 11500-K NW 7th Ave., Miami, Florida 33168.

MAKE FRIENDS WORLDWIDE through international correspondence. Illustrated brochure free. Hermes, Berlin 11, Germany.

GREGORY ELECTRONICS
Reconditioned & Used
FM 2-WAY RADIO SAVINGS
Partial List—Send for New Catalog

GENERAL ELECTRIC
VOICE COMMANDER III
FULLY SOLID STATE FM
Transmitter-Receiver

132 to 172 MHz
1 WATT OUTPUT
½ MICRO-VOLT SENSITIVITY

Size: 9.5" x 5.3" x 1.7"

High performance, completely self-contained two-way FM radio. Compact, lightweight, easily operated and hand-carried. Housed in high-impact 2-section case. All external hardware polished stainless steel. Proper chargers available separately. \$15. each.

More than 15,000 items in stock
... send for new 1972 catalog



\$148.

Lots of 5
less 10% . . . \$133.20
Lots of 10
less 15% . . . \$125.80

GREGORY ELECTRONICS CORP.
249-F Rt. 46, Saddle Brook, N.J. 07662
Phone: (201) 489-9000

CIRCLE NO. 17 ON READER SERVICE CARD

MOVIE FILMS

PRO SPORTS on 200 Foot Reels for Instant Replay and Enjoyment. 50¢ Catalog saves \$1.00 on purchase. Super 8/Reg. 8. **SPORTLITE**, Elec. Dept., 20 N. Wacker Drive, Chicago 60606.

INSTRUCTION

LEARN ELECTRONIC ORGAN SERVICING at home all makes including transistor. Experimental kit—trouble-shooting. Accredited NHSC, Free Booklet. **NILES BRYANT SCHOOL**, 3631 Stockton, Dept. A, Sacramento, Calif. 95820.

LEARN WHILE ASLEEP, Hypnotize! Strange catalog free. Auto-suggestion, Box 24-ZD, Olympia, Washington 98501.

F. C. C. 1st phone license training in 5 weeks. R.E.I.'s intensive training produces outstanding results. For information and free brochure call toll free: 1-800-237-2251, or write home office, Radio Engineering Incorporated Schools, 1336 Main Street, Sarasota, Florida 33577. Florida residents call (813) 955-6922.

HIGHLY effective home study courses in Electronics Engineering Technology and Electronics Engineering Mathematics. Earn your Degree. Write for Free Descriptive Literature. Cook's Institute of Electronics Engineering, (Dept. 15), P.O. Box 10634, Jackson, Miss. 39209. (Established 1945).

ASSOCIATE DEGREE IN ELECTRONICS through correspondence instruction. G.I. Bill approved. Free catalog. Grantham, 1509 N. Western, Hollywood, California 90027.

F.C.C. TYPE EXAM . . . Guaranteed to prepare you for F.C.C. 3rd, 2nd, and 1st phone exams. 3rd class, \$7.00; 2nd class, \$12.00; 1st class, \$16.00; complete package, \$25.00. Research Company, 3206 Bailey Street, Sarasota, Florida 33580.

FCC 1972, First and Second tests, \$8.95. Electronic Tutoring, Box 24190, Cleveland, Ohio 44124.

F.C.C. EXAM MANUAL
The Original Test-Answers exam manual that prepares you at home for FCC First and Second class licenses. Includes updated multiple choice tests and key Schematic diagrams. PLUS - "Self-Study Ability Test." -- ONLY: \$9.95 Postpaid.
COMMAND PRODUCTIONS RADIO ENGINEERING DIVISION P.O. BOX 26348-P SAN FRANCISCO, CALIF. 94126

AVIATION ELECTRONICS TECHNICIAN—Prepare for exciting career in new field of "Avionics". Train at nation's largest aeronautical school. Indicate if eligible for G.I. Benefits. Spartan Airschool, International Airport, Dept. MMW, Tulsa, Oklahoma 74151.

AMATEUR RADIO. For getting that license in the shortest possible time, complete correspondence tape-recorded no textbook license courses. **AMATEUR RADIO LICENSE SCHOOL**, 12217 Santa Monica Blvd., Los Angeles, Calif. 90025.

INVENTIONS WANTED

INVENTIONS wanted. Patented; unpatented. Global Marketing Service, 2420-P 77th, Oakland, Calif. 94605.

INVENTORS! Don't sell your invention, patented or unpatented, until you receive our offer. Eagle Development Company, Dept. 9, 79 Wall Street, N.Y., N.Y. 10005.

PATENT Searches including Maximum speed, full airmail report and closest patent copies, \$6.00. Quality searches expertly administered. Complete secrecy guaranteed. Free Invention Protection forms and "Patent Information," Write Dept. 9, Washington Patent Office Search Bureau, 734 15th St. N.W., Washington, D.C. 20005.

FREE "Directory of 500 Corporations Seeking New Products." For information regarding development, sale, licensing of your patented/unpatented invention. Write: Raymond Lee Organization, 230-GR Park Avenue, New York City 10017.

INVENTORS: Protect your ideas! Free "Recommended Procedure". Washington Inventors Service, 422T Washington Building, Washington, D.C. 20005.

FREE PAMPHLET: "Tips on Safeguarding Your Invention." Write: United States Inventors Service Company, 501-H Thirteenth Street N.W., Washington, D.C. 20004.

GOVERNMENT SURPLUS

GOVERNMENT Surplus. How and Where to Buy in Your Area. Send \$1.00. Surplus Information, Headquarters Bldg., Box 30177-PE, Washington, D.C. 20014.

ELECTRONIC Equipment and Parts. Big 36 page Free Catalog. Send for your copy today! Fair Radio Sales, Box 1105-P, Lima, Ohio 45802.

JEES Typically from \$53.90 . . . Trucks from \$78.40 . . . Boats, Typewriters, Knives, Airplanes, Clothing, Multimeters, Oscilloscopes, Transceivers, Photographic, Electronics Equipment. Wide variety, condition. 100,000 Bid Bargains direct from government nationwide. Complete sales directory and surplus categories catalog \$1.00 (Deductible on orders from separate included catalog). Surplus Service, Box 820-J, Holland, Michigan 49423.

GOVERNMENT SURPLUS. Complete sales directory \$1.00. Surplus Publications, Box 26062Z, Los Angeles, Calif. 90026.

BOOKS

FREE catalog aviation/electronic/space books. Aero Publishers, 329PE Aviation Road, Fallbrook, California 92028.

FREE book prophet Elijah coming before Christ. Wonderful bible evidence. Megiddo Mission, Dept. 64, 481 Thurston Rd., Rochester, N.Y. 14619.

FREE CATALOG of books for every type of electronic projects. Drake Publishers, 381 Park Avenue South, New York, New York 10016.

BROADCASTING: Directory of broadcasting books, magazines. \$1.00. Heffro, RD2 Box 158, West Grove, Penna. 19390.

MANUALS, instruction books for gov't, surplus scopes, meters, test sets. List 25¢. Books, 4905 Roanne Drive, Washington D.C. 20021.

HYPNOTISM

"**MALE-FEMALE** Hypnotism" Exposed, Explained! "Secret Method"—They Never Know! \$2, Rushed. Guaranteed! Isabella Hall, Silver Springs, Florida 32688.

SLEEP learning. Hypnotic method. 92% effective. Details free. ASR Foundation, Box 7545PL, Fort Lauderdale, Florida 33304.

RECORDS

POPULAR organ albums factory direct. Concert Recordings, Lynwood, Calif. 90262.

CHAPEL Records Club—Free catalog. 1000-B Richmond, China Lake, Calif. 93555.

ORGAN albums. New and old releases. Catalog. Doric Records, P.O. Box 605, Alamo, Calif. 94507.

IMPOSSIBLE? BARGAINS IN SURPLUS ELECTRONICS AND OPTICS

SANKEN HYBRID AUDIO AMPLIFIERS AND SUPPLY KIT



We have made a fortunate purchase of Sanken Audio Amplifier Hybrid Modules. With these you can build your own audio amplifiers at less than the price of discrete components. Just add a power supply, and a chassis to act as a heat sink. Brand new units, in original boxes, guaranteed by B and F, Sanken and the Sanken U.S. distributor. Available in three

sizes: 10 watts RMS (20 watts music power), 25 watts RMS (50 watts M.P.) and 50 watts RMS (100 watts M.P.) per channel. 20 page manufacturers instruction book included. Sanken amplifiers have proved so simple and reliable, that they are being used for industrial applications, such as servo amplifiers and wide band laboratory amplifiers.

- 10 Watt RMS Amplifier \$ 4.75
- 25 Watt RMS Amplifier \$14.75
- 50 Watt RMS Amplifier \$22.50
- Complete kit for 100 watt rms stereo amplifier (200 watt music) including two 50 watt Sanken hybrids, all parts, instructions, and nice 1/16" thick black anodized and punched chassis \$88.00
- Same for 50 watt rms stereo amplifier includes two 25 watt Sankens, etc. \$58.00
- Same for 20 watt rms stereo, includes two 10 watt Sankens, etc. \$30.00

SUBMINIATURE TOGGLE SWITCHES



These are nice, American made switches, of a size compatible with subminiature equipment and digital control panels. Available in two electrical configurations, conventional on-off SPDT, or on-off-on momentary SPDT. Specify which type. All brand new, at 1/3 catalog price.

- Subminiature Switches (specify on-off or momentary)
 - \$1.00 each
 - 10 for \$ 8.50
 - 100 for \$75.00

THIS MONTH'S SUPER SPECIAL!

JENSEN HIGH COMPLIANCE SPEAKER SYSTEMS

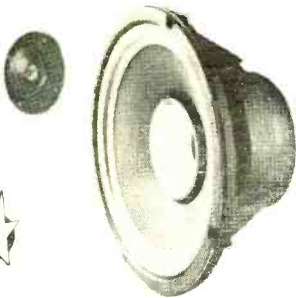

A local manufacturer went out of the speaker enclosure business, and we were lucky enough to buy his inventory of Jensen high-compliance (acoustic suspension) speaker systems. These systems consist of a 12" extended range woofer, a hemispheric dome tweeter, plus crossover. The dome tweeter response extends into the supersonic.

The dome shape provides an ideal polar pattern response. The system is ideal for use with our Sanken Amplifier Systems, or any system capable of putting out at least 20 watts rms per channel. Full instructions for cabinet construction are included.

- Single System (One Woofer, Tweeter and Crossover) . . . \$29.00
- Shipping weight 10 lbs.
- Stereo System (Two of Above) \$55.00
- Hi Compliance Woofer Only (8 lbs.) \$22.00
- Dome Tweeter only (3 lbs.) \$5.75

7 SEGMENT READOUTS



A

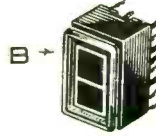

B

7 Segment Readouts. Two types are available, a large size model with wire leads for P.C. Board Mounting illustrated at (A) and a small size low-current version in a Dual In-Line type package for miniature battery operated instruments illustrated at (B).

- Large Size Readout (Illus. A) \$3.45
- Low Current Version (Illus. B) \$3.25
- Complete counter kit, including 7490 decade counter, 7447 decoder and printed circuit board, and choice of either readout. Price \$8.25
- Complete counter as above, with 7475 latch, for storage. Price \$10.25

- Complete Bi-directional counter, with 74192 instead of 7490, for up-down counting \$11.25
- Complete Bi-directional counter, with latch for storage (74192-7475-7447) \$12.25

RADIATION METER ("Geiger Counter")

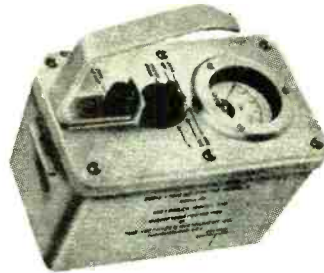

You can buy a complete radiation meter, complete with original instruction books, at less than the price of the meter movement a lone. Range is 0.02 to 50 Roentgens/hour. This is not sensitive enough for prospecting, but useful for other radiation measuring and monitoring purposes. If not used for its original function, then the case,

meter and battery holder alone are worth our asking price as a basis for building a metal locator, etc. Uses standard D cell and 22.5 volt Battery.

- Radiation Meter \$9.50 + \$1.00 postage & handling
- 80 PAGE CATALOG - Free with any order or send \$0.25

To our customers:

B and F is moving to a new location: 119 Foster Street, Peabody, Mass. 01960 (same address, but different building). Our apologies to any customers who experienced delays in shipments during the move. Our new expanded shipping and storage areas will allow us to service your order faster than ever before. Retail customers are now welcome at all working hours (Monday through Friday, 9 - 5, Saturday, 9 - 3). Special few of a kind items are being cleared out, so come and visit our new location with twenty five thousand square feet of surplus bargains.

ALL ITEMS (WHERE WEIGHT IS NOT SPECIFIED)
POSTAGE PAID IN THE U. S. A.

CHARGES WELCOME!

Phone in charges to 617 531-5774 or 617 532-2323. BankAmericard - Mastercharge. \$10.00 minimum. No C.O.D.'s please.

B. & F. ENTERPRISES

Phone (617) 532-2323
P.O. Box 44, Hathorne, Massachusetts 01937

CIRCLE NO. 6 ON READER SERVICE CARD

MAGAZINES

JAPAN PUBLICATIONS GUIDE Business, pleasure, education.
\$8.00. INTERCONTINENTAL, CPO 1717, Tokyo 100-91.

GUIDE TO EARNING EXTRA INCOME

A Ziff-Davis Publication



All new—first time ever published! Everything you need to know about full and part time money-making. How to start your own mail order business • 22 proven and profitable home business ideas • How to earn extra \$'s • Franchising • Vending machines • Advice on cutting living costs. Only 75¢.

Order from Ziff-Davis Service Division,
595 Broadway, New York, New York 10012.

Enclose an additional 25c for postage and handling.

MAGNETS

MAGNETS. All types. Specials—20 disc magnets, or 2 stick magnets, or 10 small bar magnets, or 8 assorted magnets, \$1.00. Maryland Magnet Company, Box 192H, Randallstown, Maryland 21133.

RUBBER STAMPS

RUBBER Address Stamps \$2.00. Signature \$3.50. Free Catalog. Jackson's, Box 443-G, Franklin Park, Illinois 60131.

LIBERTY PAYS MORE! WILL BUY FOR CASH

ALL TYPES:

- ★ ELECTRON TUBES
- ★ SEMICONDUCTORS
- ★ TEST EQUIPMENT
- ★ Military Electronic Equipment

WIRE—WRITE—PHONE COLLECT

We pay freight on all purchases—on above only!

LIBERTY OFFERS MORE! PRESTEL FIELD STRENGTH METER

(Model 6T4G)

Only

\$142.00

F.O.B. New York

Model MC16
Larger loud speaking
model-2.5
microvolt
only \$317.00 F.O.B.
New York

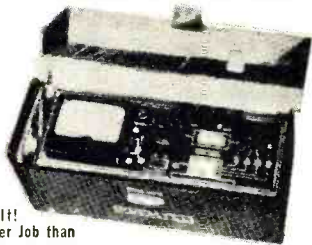

- ★ Never Anything Like It!
- ★ 1-Man Can Do A Better Job than 3 in the Same Time!
- ★ A Gold-Mine for Antenna Installers!

Calibrated from 40 to 230, and 470 to 860 in 4 Bands Megahertz, from 10 to 50,000 Microvolts. Nothing makes it easier to properly and speedily find the correct place to install TV, FM and Communication Antennas. You can measure and hear the signals with this 4½ volt battery economically powered unit.

LIBERTY ELECTRONICS, Inc.

548 Broadway, New York, New York 10012
Phone (212) 925-6000

CIRCLE NO. 20 ON READER SERVICE CARD

REAL ESTATE

FREE . . . BIG 256-page CATALOG! Describes and pictures hundreds of farms, ranches, town and country homes, businesses coast to coast! Specify type property and location preferred. UNITED FARM AGENCY, 612-EP West 47th St., Kansas City, Mo. 64112.

STAMPS

YOURS FREE! 88 DIFFERENT COUNTRIES!! Incredible collection of genuine postage stamps—from Afghanistan to Zambia! Own valuable stamps nearly 100 years old, moon stamps, etc. Also, exciting stamps on approval, returnable without purchases, cancel service anytime. But this Valuable Collection plus Big Illustrated Catalog are yours to keep . . . FREE! Send 10¢ for mailing. H.E. Harris, Dept. SS-25, Boston, Mass. 02117.

EMPLOYMENT INFORMATION

EXCITING Overseas jobs. Directory \$1.00. Research Associates, Box 942-E, Belmont, California 94002.

ELECTRONICS/AVIONICS Employment Opportunities. Report on jobs now open. FREE details. Aviation Employment Information Service, Dept. EW, Box 240, Northport, N.Y. 11768.

BUSINESS OPPORTUNITIES

I MADE \$40,000.00 Year by Mailorder! Helped others make money! Start with \$10.00—Free Proof. Torrey, Box 318-N, Ypsilanti, Michigan 48197.

\$200.00 DAILY In Your Mailbox! Your opportunity to do what mail-order experts do. Free details. Associates, Box 136-J, Holland, Michigan 49423.

START small, highly profitable electronic production in your basement. Investment, knowledge unnecessary. Postcard brings facts. Barta-PEL, Box 248, Walnut Creek, California 94597.

FREE CATALOGS. Repair air conditioning, refrigeration. Tools, supplies, full instructions. Doolin, 2016 Canton, Dallas, Texas 75201.

INEXPENSIVE, Home—Auto Fire, Burglar Alarms, Extinguishers. 200% Profits. Nation's Watchdog, Williamsburg, Ohio 45176.

PIANO TUNING learned quickly at home. Tremendous field! Musical knowledge unnecessary. GI Approved, Information Free. Empire School, Box 327, Miami Florida 33145.

MAILORDER MILLIONAIRE helps beginners make \$500 weekly. Free report reveals secret plan! Executive (1K3), 333 North Michigan, Chicago 60601.

MAILORDER—How to prepare your own catalog for pennies. Free catalog! Obie-BGC, Brooklyn, New York 11219.

SEVEN complete mail order opportunities. \$2.00 or write: AM Sales, 32-28(F) 100 Street, East Elmhurst, N.Y. 11369.

400,000 BARGAINS Below Wholesale! Many free! Liquidations . . . Closeouts . . . Job lots . . . Single Samples. Free details. Bargainhunters Opportunities, Box 730-J, Holland, Michigan 49423.

SELL HERTEL BIBLES—Part Time. Finest reference Bible available. Demonstrator and supplies furnished. Excellent commissions. Write International Book, Dept. PE, Box 118, Wichita, Kansas 67201.

FREE BOOK "999 Successful, Little-Known Businesses." Work home! Plymouth BGC, Brooklyn, New York 11218.

TREASURE FINDERS

TREASURE FINDER locates buried gold, silver, coins, treasures. 6 powerful models. \$19.95 up. Free catalog. Relco-A33, Box 10839, Houston, Texas 77018.

FREE: Jetco Electronics 24-page Treasure Finder Catalog. Find Gold, Silver, Coins, Metals, Minerals, relics. Jetco, Dept. PEC, 3933 Barranca, El Paso, Texas 79935.

FISHER DETECTORS. You deserve the best! Free literature. FRL, Dept. PE-3, Palo Alto, CA. 94303.

TREASURE Hunters! Prospectors! Rockhounds! Hobbyists! Find gold, silver, relics with world famous Detectron Metal Detectors. Free information. Delivery immediate. Detectron, Dept. 3-PE, Box 243, San Gabriel, Calif. 91778.

MUSICAL INSTRUMENTS

30% DISCOUNT name brand musical instruments. Free catalog. Freeport Music, 127-N Sunrise Highway, Freeport, N.Y. 11520.

WHOLESALE! Professional Amplifiers, PA Systems, Guitars. Free Catalog. Carvin, Escondido, Calif. 92028.

MUSIC



SONGWriters! POETS!

Spiritual and religious poems and songs wanted for recording by the Chapel Symphony Orchestra and Choir. We pay all recording costs.

Information: Write Dept. PE
CHAPEL RECORDING CO.
P.O. Box 162, Wollaston, Ma. 02170

MISCELLANEOUS

WINEMAKERS: Free illustrated catalog yeasts, equipment. Semplex, Box 12276, Minneapolis, Minn. 55412.

RETAIL DISPLAY PLAN

All magazine retailers in the United States and Canada interested in earning an allowance for the display and sale of a minimum of five publications of the Ziff-Davis Publishing Company, to be paid quarterly on the basis of ten per cent of the cover price of each sold copy, assuming that all terms and conditions of the contract are satisfied, are entitled to do so and are invited to write for full details and copies of the contract to

Mr. J. Robert Gallicano

Single Copy Sales Director

ZIFF-DAVIS PUBLISHING COMPANY

One Park Avenue, New York, New York 10016

POPULAR ELECTRONICS

Including Electronics World

MARCH 1972

ADVERTISERS INDEX

READER SERVICE NO.	ADVERTISER	PAGE NO.
1	Acoustic Research, Inc.	86
2	Acoustic Research, Inc.	89
3	Allied Radio Shack	96
4	Allied Radio Shack	106
5	Ampex Stereo Tapes	FOURTH COVER
45	Audionics, Inc.	106
6	B. & F. Enterprises	125
7	B & K Division, Dynascan Corporation	11
	Bell & Howell Schools	110, 111, 112, 113
	CREI, A Division of the McGraw-Hill	
	Continuing Education Company	38, 39, 40, 41
7	Center for Technical Development, Inc., The	47
8	Cleveland Institute of Electronics	56, 57, 58, 59
48	Cobra Communications, Dynascan Corporation	101
9	Crown	71
10	Delta Electronics Co.	119
11	Delta Products, Inc.	13
41	EICD	108
42	EICO	109
12	Edmund Scientific Corp.	128
13	Electro-Voice, Inc.	83
14	Empire Scientific Corp.	85
15	GC Calctec	99
16	Greenlee Tool Co.	103
17	Gregory Electronics Corporation	123
18	Heath Company	92, 93, 94, 95
19	Lafayette Radio Electronics	81
20	Liberty Electronics, Inc.	126
22	McIntosh Laboratory, Inc.	102
44	Magitran Company, The	117
	Mallory Distributor Products Company	105
23	Motorola Hep Semiconductors	7
	National Radio Institute	SECOND COVER, 1, 2, 3
	National Technical Schools	18, 19, 20, 21
24	Olson Electronics	117
25	PTS Electronics, Inc.	108
26	Pearce-Simpson, Inc.	107
27	Pennwood Numechron Co.	86
28	Poly Paks	121
	RCA Institutes, Inc.	74, 75, 76, 77
21	S B E	102
29	Sams & Co., Inc., Howard W.	15
30	Sansui Electronics Corp.	97
31	Shure Brothers, Inc.	73
32	Solid State Sales	122
33	Sonar Radio Corp.	116
43	Techni-Tool, Inc.	109
34	Telex Communications Division	79
35	Tri-Star Corporation	103
36	Turner Division, Conrac Corporation	26, 27
	U.S. Air Force Recruiting Service	87
	U.S. Army	22, 23
37	United Audio Products, Inc.	98
39	Valparaiso Technical Institute	89
40	Xcelite, Inc.	8
	CLASSIFIED ADVERTISING	119, 120, 121, 122 123, 124, 126, 127



LIVE IN THE WORLD OF TOMORROW... TODAY! NEW PRODUCTS, NEW MATERIALS, NEW IDEAS!

UNUSUAL ECOLOGICAL SCIENCE BOYS

UNIQUE HARD-TO-FIND BARGAINS FOR FUN, STUDY OR PROFIT



NEW ELECTRONIC CALCULATOR - \$199.50



Really terrific imported value. Loaded with big machine capabilities. 1st truly personal electronic calculator. Absolutely silent answers in milliseconds. Only 3 lbs.—six¹/₂" high. Add, subtract, multiply, divide, perform mixed calculations. 8 digit entry & readout w/ 16-digit cap. Auto. precise to the decimal. Features underflow, zero suppression, minus sign, for true credit balance, error correction, keyboard roll over memory. Solid state reliability. 1 year guar. for normal use.

Stock No 78.000AV

\$199.50 Ppd.

\$8.95 ELECTRONIC STROBE



Hand-sized solid state electronic strobe light at fantastically low price. Produces bright psychedelic effects like larger, far more expensive Xenon strobes. Yet it's just 2 3/4" x 4" x 1 3/4" thick. Adjustable flash rate approximately 3-10 flashes per second. Make stop motion effects, posters come alive. Great to take with you to parties, dances, quizzes, etc. Requires 2 9V transistor batt. (not incl.). Instructions. Stock No. 41.443AV \$8.95 Ppd. 4 REPLACEMENT LAMPS AV \$1.00 Ppd. P-41.444AV

BLACK-LIGHT MIGHTY MITES

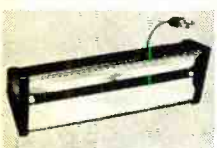

Relatively small (12") fixtures give surprisingly bright black-light. Mirror-finished reflector makes instant starting. 8-watt, high-intensity bulb look like 40-watts. Up to 1000 hours of safe, long-wave (3660A) black-light to really turn on parties, Heli & theatrical shows, psychedelic decor, holiday decorations. Shockproof end-caps remove for safe, easy replacement of bulb and starter. Stands upright or horizontal. Aluminum case. Stock No. 71.274AV \$14.95 Ppd. DELUXE OUTDOOR INDOOR MODE \$29.95 Ppd. Stock No. 71.299AV \$19.95 Ppd.

PSYCHEDELIC LIGHTING HANDBOOK



100 information packed pages! Fully explains latest in psychedelic lighting equipment, techniques, developments. Covers all facets of psychedelic light-show production including strobes, black light projectors, crystals, organic slides, mirrors, color organs, polarized color, light boxes, MusicVision, etc. Shows how to "psychedelize" parties, musical groups, shows or how to set up "electric tripps" for private gatherings. 8 1/2" x 11" looseleaf paper for 3 flizes. Stock No. 9100AV \$3.00 Ppd.

HELIUM BALLOONS MAKE A "BALL"



Anytime there's a balloon the air is festive. Especially when the "air" is helium which makes a balloon perky and adventurous. Now here's 25 times the fun—25 various colored balloons of 4, 5, or 6" diameter when inflated. With them, a pressurized (360 lbs. sq. in.) can containing 21 liters of helium to inflate all 25. For adults or kids, parties, give-aways, prizes, or just demonstrating "lighter than air." Helium is a safe non-toxic inert gas. Stock No. 71.289AV \$3.00 Ppd.



MAIL COUPON FOR GIANT FREE CATALOG!

148 PAGES • MORE THAN 4000 UNUSUAL BARGAINS!

Completely new Catalog. Packed with huge selection of telescopes, microscopes, binoculars, magnets, magnifiers, prisms, photo components, ecology and unique lighting items, parts, kits, accessories—many hard-to-get surplus bargains. 100's of charts, illustrations. For hobbyists, experimenters, schools, industry.

EDMUND SCIENTIFIC CO.

300 Edscorp Building, Barrington, N.J. 08007
Please rush Free Giant Catalog "AV"

Name _____

Address _____

City _____ State _____ Zip _____

EDMUND SCIENTIFIC CO. 300 EDSCORP BLDG. BARRINGTON, NEW JERSEY 08007

CIRCLE NO. 12 ON READER SERVICE CARD

Printed in U.S.A.

TRENDING WAR SURPLUS VALUE \$15,000 RANGEFINDER

In excellent condition. Mark 57. Mod O. 1-meter Erect Image Coincidence Rangefinder—ranges from 100-10,000 yds., accurate to 12-arc seconds. Optics & mount alone worth more than price. Fabulous precision optical instrument. 5 1/2" x 7" dia. Yellow, dark neutral, polarizing & clear ray glass filters. Non-magnetic construction. 2 bearing mounting surfaces (1 1/4" x 5/16" O.D. & 1 1/4" x 3/16" O.D.). Storage box, instructions. No. 85.208AV (Shipp. Wt.—200 lbs.) \$450.00 F.O.B. \$1,250 HAND HELD 50 CM MODEL No. 85.213AV (Shipp. Wt.—11 lbs.) \$600.00 F.O.B.

\$15,000 RANGEFINDER

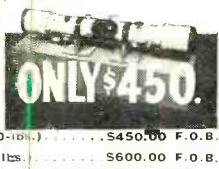

Adds professionalism to Light Shows or A/V presentations. Permits synchronized control of 2 projectors for dramatic fade-in, fade-out, smooth dissolves. Eliminates eye-fatiguing blackouts! Designed for Kodak Carousel and Ektagraphic slide projectors, unit (3 1/2" x 5 1/4" x 6 3/4") permits cont. showing of up to 380 slides, 110-120v, 60 Hz. funds & instructions. Stock No. 71.567AV \$71.50 Ppd. VERSATILE DEFLINE AUTO UNIT Stock No. 71.563AV \$202.00 Ppd.

LOW-COST DISSOLVE UNIT



POWER HORN BLASTS A MILE

Frighten prowlers, muggers, vicious dogs with 118 decibels. Just press and this Ficon powered pocket-sized horn can be heard a mile away to signal for help or fun. Great for boating (at boats), biking, camping, hunting, seashore, scouting for your team. Can be heard over traffic and const. noises to sound fire drill, lunch break or emergency. Weighs only 7 oz. but contains up to 100 mile-piercing blasts. A real bargain. Stock No. 41.423AV \$3.25 Ppd. 2 Refill Cartrs. (P-41.424AV) \$2.75 Ppd.

POWER HORN BLASTS A MILE



Go treasure hunting on the bottom!

Fascinating fun & sometimes profitable! Tie a line to our 5 1/2-lb. Magnet—drop it anywhere in bay, river or ocean. Trawl it along bottom—your "treasured" haul can be outboard motors, anchors, other metal valuables. 3 1/2-lb. Magnet is war surplus—Alnico V Type—Gov't. cost \$50. Lifts over 150 lbs. on land—much greater weights under water. No. 70.751AV 5 1/2 lbs. \$14.00 Ppd. No. 60.215AV 1 1/2 lbs. \$5.75 Ppd. Stock No. 70.570AV 3 1/2 lbs. (40 lbs.) \$8.75 Ppd. Stock No. 85.152AV 15 3/4 lbs. (350 lbs.) \$33.95 F.O.B.

'FISH' WITH A MAGNET



NEW! ELECTRONIC DIGITAL COMPUTER KIT!

Solve problems, play games, predict weather with this actual working model of giant electronic brains. Amazing new fun way to learn all about computer programming—logic, decimal, binary systems. Laws of Sets—even do your own programming after completing simplified 116 page instructive booklet. Includes step-by-step assembly diagrams, circuit changes. Readout from illuminated control panel. Req. 2 "D" batt. (not incl.). Best model we've seen for home school, industry. Stock No. 71.434AV (11" x 12 1/2" x 4") \$31.50 Ppd.

AMAZING NEW Wankel Engine KIT!

Thrill to the fun of building your own see-through motorized model of revolutionary pistonless type engine, rights for which GM recently paid \$50 million! Only engine experts think economically modifiable to meet new pollution standards. Replaces piston, cylinder, crank assemblies with rotating discs (sections removed for firing chambers). Smaller than conventional; fewer parts, greater reliability, same speed w/ less horsepower. Feat: flashing plugs, rubber fan belt, stick-shift on-off switch. Req. 2 "D" batt. (not incl.). Stock No. 71.424AV (4 1/2" x 5 1/2" x 5 1/2") \$6.75 Ppd.



Bargain kit ideal for economical experimenting with amazing L.E.D.s. The tiny solid state monochromatic lamps that use low voltage DC, last up to 1MM hrs. Lead in 100's of colors, character recognition, hi-speed detectors, all kinds of electro-optical applications. Kit incl. 2 L.E.D. emitting blue-violet (MLED 600, MV 50, MLED 930); 2 visible red emitting (6600) A's; infra-red emitting (9000) A's; 4 resistors; 1 20mm plastic light optic light pipe; instructions. Stock No. 41.597AV \$5.95 Ppd.

NEW LIGHT-EMITTING-DIODE KIT

