

ANSWERING YOUR QUESTIONS ABOUT STEREO

Popular Electronics

FIFTY CENTS / NOVEMBER 1971

Electronic Desk Calculator You Can Build

**SELECTING BOOKS FOR
YOUR ELECTRONICS BOOKSHELF**

WHAT MAKES A TRANSISTOR WORK?

**UNDERSTANDING COMMUNICATIONS
RECEIVER NOISE AND SENSITIVITY**

**BUILD: MUSCLE WHISTLER,
SCR COMBINATION LOCK**

**PRODUCT TESTS: TEAC A-24 CASSETTE
DECK, LAFAYETTE 924 CB TRANSCEIVER,
HEATHKIT CHART RECORDER**



**NRI "hands-on" training in
Television, Communications,
Electronics and Computers
can give you as much
as 2 years of on-the-job
experience.**



EARN YOUR FCC LICENSE – OR YOUR MONEY BACK

NRI Communications training programs will qualify you for a First Class Commercial Radiotelephone License issued by the FCC. If you fail to pass the FCC examinations for this license after successfully completing an NRI Communications course we will, on request, refund in full the tuition you have paid. This agreement is valid for the period of your active student membership and for six months after completion of your training. No school offers a more liberal FCC License agreement.

Experience is still your best teacher



NRI Achievement Kit is educator-acclaimed and the original "starter" kit in home study training. Imitated but never duplicated, this kit is designed and personalized for you and your training objective. It has one purpose — to get you started quickly and easily.



"Bite-Size" Texts average an easily-digested 40 pages of well-illustrated, scientifically prepared subject matter in the course of your choice. Questions in each book are carefully hand-graded and returned to you with helpful instructional notes. You get unlimited personal help from the day you enroll.



Designed-For-Learning Equipment

Like this phone-cw transmitter (Kit #7 in the Communications course) is engineered from chassis up to demonstrate principles you must know. NRI does not use modified hobby kits for training, but the finest parts money can buy, professionally and educationally applied.

... here's how you get it with unique NRI training at home

Ask any teacher, job counselor, engineer, technician or prospective employer about the need for practical application of theory in Electronics. He'll tell you Electronics is as much a "hands-on" profession as dentistry or chemistry. That's how you learn at home with NRI. You prove the theory you read in "bite-size" texts, by actual experimentation with the type of solid-state, transistor and tube circuits you'll find on the job today — *not* hardware or hobby kits. You introduce circuit defects, analyze results, discover quickly the kind of trouble-shooting and design techniques that will make you employable in Electronics.

Train with the leader — NRI

NRI lab equipment is designed from chassis up for effective, fascinating training — not for entertainment. The fact that end results are usable, quality products is a bonus. In Communications, for example, you build and analyze, stage by stage, your own 25-watt phone/cw transmitter. It's suitable for use on the 80-meter amateur band, if you have an interest in ham radio. In TV-Radio Servicing your practical training gives you your choice of monochrome or color TV sets. All training equipment is included in the low tuition — you pay nothing extra. Discover for yourself the ease, excitement and *value* of NRI training. Mail postage-free card today for new NRI Catalog . . . or use the coupon below. No obligation. No salesman will call on you. NATIONAL RADIO INSTITUTE, Washington, D.C. 20016.

APPROVED UNDER NEW GI BILL

If you have served since January 31, 1955, or are in service now, check GI line on postage-free card or in coupon.

MAIL THIS COUPON IF CARD IS GONE



NATIONAL RADIO INSTITUTE

Washington, D.C. 20016

1-111

Please send me your new NRI Catalog. I understand no salesman will call and there is no obligation.

Name _____ Age _____

Address _____

City _____ State _____ Zip _____

Check for facts on new GI Bill

ACCREDITED MEMBER NATIONAL HOME STUDY COUNCIL

Popular Electronics

WORLD'S LARGEST-SELLING ELECTRONICS MAGAZINE

FEATURE ARTICLES

- | | | |
|--|------------|--------------------------------|
| AN ELECTRONIC DESK CALCULATOR YOU CAN BUILD <i>Add, subtract, multiply, and divide</i> | 27 | <i>Ed Roberts</i> |
| UNDERSTANDING RECEIVER NOISE FIGURE AND SENSITIVITY <i>How an important spec is measured</i> | 33 | <i>James T. West</i> |
| CAN AN AMPLIFIER TUBE HAVE ZERO TRANSCONDUCTANCE? | 42 | <i>John T. Bailey</i> |
| THE ELECTRONICS BOOKSHELF <i>Good books on communications</i> | 44 | <i>Cori C. Drumeller, W5JJ</i> |
| WHAT MAKES THE TRANSISTOR TICK? <i>Understand transistors without math</i> | 49 | <i>Robert B. Wood</i> |
| SCR COMBINATION LOCK <i>Simple 12-volt security system</i> | 53 | <i>David E. Fohnstock</i> |
| A SUBSTITUTE FOR METERS IN BRIDGE CIRCUITS | 62 | <i>Ed Friedman</i> |
| VOLTAGE MONITOR <i>When the voltage drops, a light comes on</i> | 63 | <i>Jeffrey P. Hommes</i> |
| THE PRODUCT GALLERY <i>Teac A-24 Stereo Cassette Deck Lafayette Telsat 924 CB Transceiver Heathkit IR-18M Chart Recorder</i> | 65 | |
| STEREO SCENE <i>Answering reader mail</i> | 70 | <i>J. Gordon Holt</i> |
| OPPORTUNITY AWARENESS | 72 | <i>David L. Heiserman</i> |
| COMMUNICATIONS | 79 | <i>Leslie Solomon</i> |
| SOLID STATE <i>Voice-operated telephones</i> | 82 | <i>Lou Garner</i> |
| TIPS & TECHNIQUES | 90 | <i>Vic Bell and Joe Kish</i> |
| TRUE-FALSE LOGIC QUIZ | 102 | |

DEPARTMENTS

- | | | |
|-------------------------------|---------------|--------------------------|
| DIRECTOR & CURRENT | 7 | <i>Milton S. Snitzer</i> |
| INTERFACE | 8 | |
| ELECTRONICS LIBRARY | 12 | |
| READER SERVICE PAGES | 15, 99 | |
| NEW LITERATURE | 16 | |
| NEW PRODUCTS | 24 | |

POPULAR ELECTRONICS is Indexed
in the Reader's Guide
to Periodical Literature

Copyright © 1971 by ZIFF-DAVIS PUBLISHING COMPANY. All rights reserved.

William Ziff, President; Hershel B. Sarbin, Senior Vice President and Secretary; Philip Sine, Financial Vice President and Treasurer
POPULAR ELECTRONICS, November 1971, Volume 35, Number 5. Published monthly at One Park Ave., New York, N.Y. 10016.
One year subscription rate for U.S., U.S. Possessions and Canada, \$6.00; all other countries, \$7.00. Second class postage paid
at New York, N.Y., and at additional mailing offices. Authorized as second class mail by the Post Office Department, Ottawa,
Canada and for payment of postage in cash. Subscription service and Forms 3579: P.O. Box 1096, Flushing, N.Y. 11352.
Editorial offices for manuscript contributions, reader inquiries, etc.: One Park Ave., New York, N.Y. 10016.

This month's cover photo by
Justin Kerr

CIRCLE NO. 7 ON READER SERVICE PAGE →

POPULAR ELECTRONICS

"Very Heavy." That's the recording artist's hip way of expressing satisfaction after a recording session because every single sound has been captured exactly as it was created. Ultimate fidelity. Audio perfection. And chances are it was achieved on Ampex sound equipment. Which is why Ampex is in 90% of the world's recording studios.

Now for the first time, you can experience virtually this same studio versatility and quality at home. We created the AX-300 for the man who has a passion for true, pure sound. The audio perfectionist! And because the AX-300 has more professional innovations than others, we dubbed it the 45 Lb. Studio. You'll soon see... and hear... why it warrants this distinction.

The AX-300 is a six head bi-directional stereo tape deck. The Ampex Deep-Gap heads are symmetrically located so that tape is always pulled over heads in either direction for better tape-to-head interface. 3 motor drive system. Heavy duty hysteresis synchronous capstan motor assures steady, even tape motion regardless of voltage fluctuations.

Symmetrically arranged push-buttons control all tape motion functions thru positive action solenoid operation.

Exclusive motion sensing controlled solid-state logic circuit prevents tape stretch, breaks and spills, even when changing from fast wind directly to play. Built-in studio 4 line mixer. 4 separate controls let you mix 4 independent sources for mono, or 2 stereo sources for stereo recording.

Function programmer. Operates independently of mixer panel and allows total recording and playback convenience with choice of stereo operation,

THE AMPEX 45 lb. STUDIO



channel 1 mono, channel 2 mono, sound-on-sound or sound-with-sound. All programmed internally without external patching.

Stereo echo effect. Allows addi-

tion of controlled feedback in both channels without the use of external patchcords.

Controlled bandwidth. Built-in active filtering limits the bandwidth to allow full bias, provides

extremely clean recordings throughout the audio spectrum. Provides extremely high signal-to-noise ratio, virtually eliminates intermodulation distortion and dropouts.

Externally adjustable bias and VU meter calibration. Automatic reverse and repeat play. Pause/edit control. Variable noise reduction filter. Source/tape monitoring. 6 solid state pre-amps. Auto shut-off. 3-speed operation. Optional remote control. Plus many more features we simply don't have room to list.

AX-300 means studio innovations, studio capabilities for the audio perfectionist. One of the most technically versatile decks you can buy. Yet it's a breeze to operate. We built in everything you need. And nothing you don't.

For in-depth coverage of all the features of the AX-300, order the AX-300 instruction manual. Just send \$1.00 to cover postage and handling to Ampex, Dept 300, 2201 Landmeier Road, Elk Grove Village, Illinois 60007. Or stop by your audio dealer and ask him about the AX-300. And be prepared to do a lot of listening. The 45 Lb. Studio Very Heavy, Indeed!

AMPEX



THE SOUND IDEA PEOPLE

Very Heavy



Now, Find the Circuit You
Need—in Minutes!

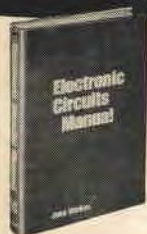

ALL NEW!

Over 3,000 advanced electronic circuits in one master volume. Locate any application in minutes. Beats any computer retrieval system now in existence—for speed... variety and range of circuits offered.

JUST OFF PRESS!

Electronic Circuits Manual

by John Markus

Over 950 pp., 8½"x11", \$19.75
More Than 3,000 Illustrations

For hobbyists... experimenters... engineers... technicians. Includes all latest developments in solid-state components... integrated circuitry electronic tube designs. First use pays for book many times over.

115 new operational amplifier circuits... 93 motor control circuits... 39 lamp dimmer circuits... 56 automotive circuits... 23 optoelectronic circuits... 64 counter circuits—and over 2,000 more!

Special Features

- 99 chapters group similar circuits for easy comparison
- Complete data on all component values
- Concise descriptions of significant circuit features, performance and operating data, and source citations
- Circuits arranged for quick, accurate evaluation of advantages and drawbacks
- Many outstanding designs from other countries

Partial Contents: Audio Control Circuits... Automotive Control & Ignition Circuits... Code Circuits... Flasher Circuits... Hobby Circuits... High-voltage Circuits... Lamp Control & Dimmer Circuits... Metal Detector Circuits... Power Supply Protection Circuits... Tachometer Circuits... Telephone Circuits... and many, many more!

10-Day Free Trial-Order Today!

McGraw-Hill Book Company

330 W. 42nd St., N.Y., N.Y. 10036

Please send me *Electronic Circuits Manual* (040444-5) for 10 days on approval. At the end of that time I will remit \$19.75 plus local tax, postage, and handling or return the book and owe nothing. (This order subject to acceptance by McGraw-Hill.)

Name

Address

City

State Zip

Offer good only in the U.S. 23-PE 1171

CIRCLE NO. 22 ON READER SERVICE PAGE

Popular Electronics

LAWRENCE SPORN
Publisher

MILTON S. SNITZER
Editor

LESLIE SOLOMON
Technical Editor

JOHN R. RIGGS
Managing Editor

EDWARD I. BUXBAUM
Art Director

ALEXANDER W. BURAWA
Associate Editor

ANDRE DUZANT
Technical Illustrator

JUDITH L. HOGAN
Editorial Assistant

J. GORDON HOLT
L. E. GARNER, JR.
DAVID L. HEISERMAN
Contributing Editors

RICHARD J. HALPERN
Advertising Manager

MADELEINE LITTMAN
Advertising Service Manager

STANLEY NEUFELD
Associate Publisher

FURMAN H. HEBB
Group Vice President
Electronics and Photographic

ZIFF-DAVIS PUBLISHING COMPANY
Editorial and Executive Offices
One Park Avenue, New York, New York 10016
212 679-7200

Midwestern Office
The Patis Group, 4761 West Touhy Ave.,
Lincolnwood, Illinois 60644, 312 679-1100
GERALD E. WOLFE, DICK POWELL

Western Office
9025 Wilshire Boulevard, Beverly Hills, California 90211
213 CRestview 4-0265; BRadshaw 2-1161
Western Advertising Manager, BUD DEAN

Japan: James Yagi
Oji Palace Aoyama; 6-25, Minami Aoyama
6-Chome, Minato-Ku, Tokyo 407-1930/6821

Circulation Office
P.O. Box 1096, Flushing, N.Y. 11352

- William Ziff, President
W. Bradford Briggs, Executive Vice President
Hershel B. Sorbin, Senior Vice President and Secretary
Stanley R. Greenfield, Senior Vice President
Philip Sine, Financial Vice President and Treasurer
Walter S. Mills, Jr., Vice President, Circulation
Phillip T. Heffernan, Vice President, Marketing
Frank Pomerantz, Vice President, Creative Services
Arthur W. Butzow, Vice President, Production
Edward D. Muhlfield, Vice President, Aviation Division
Irwin Robinson, Vice President, Travel Division
George Morrissey, Vice President
Sydney H. Rogers, Vice President

Ziff-Davis also publishes *Airline Management*, *Boating*, *Business & Commercial Aviation*, *Car and Driver*, *Cycle*, *Electronics World*, *Flying*, *Modern Bride*, *Popular Photography*, *Skiing*, *Skiing Area News*, *Skiing Trade News*, *Stereo Review*, and *Travel Weekly*.

Forms 3579 and all subscriptions correspondence should be addressed to POPULAR ELECTRONICS, Circulation Department, P.O. Box 1096, Flushing, N.Y. 11352. Please allow at least eight weeks for change of address. Include your old address as well as new—enclosing if possible an address label from a recent issue.

EDITORIAL CONTRIBUTIONS must be accompanied by return postage and will be handled with reasonable care; however, publisher assumes no responsibility for return or safety of art work, photographs or manuscripts.



Member Audit Bureau
of Circulations



By Milton S. Snitzer, Editor

ELECTRONICS AND NOISE POLLUTION

Occasionally we run articles on how electronics is helping to fight noise pollution. Those of us who live in or near urban areas don't have to be told about the constant harassment on our eardrums by blaring auto horns, roaring mufflers, and clangorous construction work. Our homes are not peaceful havens for quiet contemplation either, with their clattering appliances, excessively loud sound systems, and traffic noise from outside. Most of all of this is a result of our basic insensitivities to our own and our neighbors' ears.

There is a Federal Occupational Safety and Health Act which specifies noise exposure standards for workers in industry. If noise levels in industries can't be reduced to be acceptable, as measured by electronic sound-level meters, then the industry must provide employees with some form of ear protection. The same sort of protection must be given to ground workers at airports near jet planes.

On the home front, the Environmental Design Dept. of the University of Wisconsin (under the sponsorship of stereo-headphone maker Koss Electronics), recently studied just how noisy our homes are. Sound pressure levels measured in kitchens for range-vent fans, blenders, dishwashers, knife sharpeners, garbage disposers, and mixers were in the range of 70 to 90 dB. The report stated that the annoyance threshold for intermittent sounds is between 75 and 85 dB, at which level, involuntary nervous responses begin to narrow the arteries, raise blood pressure, and reduce the supply of blood to the heart. The researchers urged appliance manufacturers to design for minimum noise levels—say under 65 dB. Otherwise, housewives may have to wear special noise-reducing headphones around the home.

A New York City bank took a full-page newspaper ad the other day urging prevention of noise pollution. Some of the suggestions they got from readers included: have a 24-hour city phone number for reports of noise violations; have emergency vehicles equipped with distinct two-note horns, rather than screaming sirens; authorize citizens to hand out noise summonses; rig cars so that they can only blow their horns when standing still; put an extra auto horn above the driver as well as under the hood; don't give tips to cab drivers who blow horns unnecessarily; and make construction and utility companies provide soundproof self-inflatable bubbles to cover sites where pneumatic drills are used. Shortly thereafter, Mayor Lindsay proposed a comprehensive noise-control code that would set specific noise-level standards for construction equipment, air conditioners, PA systems, garbage trucks, emergency sirens, and other city noises.

Of course, electronics can certainly help measure and monitor noise levels in industry, in the home, around airports, and in our streets. But it's up to each of us to do his share in fighting the real battle against noise pollution.



INTERFACE

THOSE RMS POWER RATINGS AGAIN

In response to the letter from Marc Saul ("Interface," August 1971), I take exception to his statements concerning the so-called "rms power" ratings. While it is true that the square of the rms value of the output voltage divided by the load resistance yields an average power, it does not follow that there is "no such thing as rms power." The power curve produced from an rms voltage and current in a resistive circuit is a sine-square function rather than a sine wave. But all such functions have an rms value. The rms value of a power curve in a resistive circuit happens to be 0.6124 of the peak power.

Although I object to Mr. Saul's disclaimer of an rms power value, it is true that it is not useful. I also agree that the present usage of rms power should be dropped and

replaced by a term with more accuracy. Continuous power could be used, although it, too, is incorrect without specifying the time interval over which it is continuous in order to show deficiencies due to thermal limitations in the amplifier.

All in all, I think the Federal Trade Commission has a real job on its hands in attempting to adopt a standard power rating. And I expect a compromise based on several of the proposals. But this compromise will most likely still be technically incorrect.

Raymond J. Cox
Willingboro, N.J.

DISAPPOINTED AT POLL RESULTS

I was very much surprised to read in the August 1971 "Opportunity Awareness" column that there was very little response to your January poll regarding a home medical electronics course. I see more and more electro-medical equipment coming into hospitals each year with hospitals just now beginning to realize that they will need qualified people to maintain it, and I see very few training programs to meet this expanding need.

Hence, I was surprised at the relatively few responses. At a time when most of the economy is not expanding, I would think young graduates would be looking at the

*the tape that
turned the
cassette into
a high-fidelity
medium*



TDK SUPER DYNAMIC (SD) TAPE



TDK

Until TDK developed *gamma ferric oxide*, cassette recorders were fine for taping lectures, conferences, verbal memos and family fun—but not for serious high fidelity.

Today you can choose among high-quality stereo cassette decks.

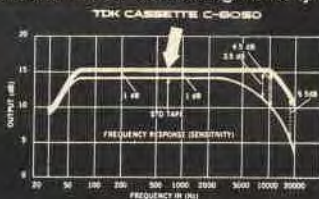

The new magnetic oxide used in TDK Super Dynamic tape distinctly differs from standard formulations in such important properties as coercive force, hysteresis-loop squareness, average particle length (only 0.4 micron!) and particle width/length ratio. These add up to meaningful performance differences: response capability from 30 to 20,000 Hz, drastically reduced background hiss, higher output level, decreased distortion and expanded dynamic range. In response alone, there's about 4 to 10 db more output in the region above 10,000 Hz—and this is immediately evident on any cassette recorder, including older types not designed for high performance. There's a difference in clarity and crispness you can hear.

Available in C60SD and C90SD lengths.

TDK ELECTRONICS CORP.

LONG ISLAND CITY, NEW YORK 11103

CIRCLE NO. 30 ON READER SERVICE PAGE

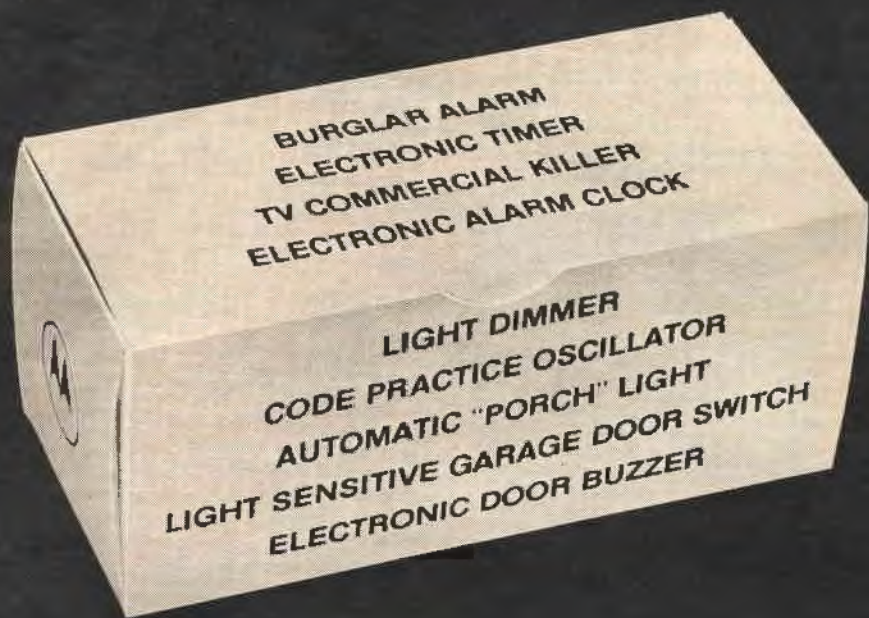

**Just a few of the projects for which
we've got solid state devices.
All in one package
For only \$4.95**

If you bought the semiconductors for any one of these projects separately, they'd cost about seven bucks. Be our guest for \$4.95. And treat yourself to an easy, really fun electronic project with a really useful product on the other end.

The electronic timer is in great demand for darkroom and photography work, at sports events, etc. The automatic "porch" light and burglar alarm are, shall we say, quite timely. The TV commercial killer works off a regular flashlight, for stay-seated dousing of objectionable commercial audio. The code practice oscillator, the garage door switch, the alarm clock — all are excellent projects you'll be proud to have completed.

This project package (HEK-4) includes all five semiconductors needed, and a brochure with directions and circuit schematics for all projects (plus bonus project). Look for it. At your HEP supplier now.

Happy soldering.



MOTOROLA HEP[®] Semiconductors

P. O. Box 20924, Phoenix, Arizona 85001

CIRCLE NO. 21 ON READER SERVICE PAGE

SQUARE DEALS

BY REALISTIC AT OVER 1100 RADIO SHACK STORES

Our Exclusive
Weatheradio™

"Talking
Barometer"

1495
Post
Paid*



FM
Deskube™

1595
Post
Paid*



AM
Deskube™

995
Post
Paid*



Unique 3" Square Matching Radios

Our **Weatheradio** gets 24-hour U.S. Gov't. weathercasts on 162.55 MHz. It's battery powered and pre-set for instant, automatic listening. Just touch the Play Bar to turn on-off. Simulated rosewood.

Our **FM Deskube** gets good music instantly, automatically. Hidden controls—pre-set any station, tune it in again and again with a touch of your finger. AFC, telescopic antenna, battery powered.

Our **AM Deskube** makes it a threesome. Get complete three-radio coverage that covers only 27 square inches.



At Your
Nearby
Store
Or By
Mail

ALLIED RADIO SHACK

A TANDY CORPORATION COMPANY

2725 West 7th Street Fort Worth, Texas 76107

*Available in U.S.A. Add Your State Sales Tax

CIRCLE NO. 2 ON READER SERVICE PAGE

possibilities in the medical community. It's an exciting time to become involved if a person is genuinely interested in providing the technical support medicine now requires by its ever-increasing reliance on electronics.

Please reconsider your plans to "shelve your campaign." Instead, I believe you should publicize more the growing opportunities in medical electronics.

Barton R. Klein
Medical-Electronics Engineer
Director, Medical-Electronics Dept.
Tufts—New England Medical Center

MAGNETIC REPULSION, TOO

I just read J. Gordon Holt's "15 Things We Do Know About Phono Cartridges" (June 1971). After reading about magnetic attraction between a magnetic cartridge and an iron or steel turntable, I thought you might be interested in knowing that there is also a magnetic repulsion force at work. When a magnet moves over a conducting surface or vice versa, currents are induced in the conducting surface, tending to form an image magnet.

The formation of the image magnet causes a repulsive force to be applied to the magnet. The strength of this repulsive force is dependent on the relative velocity of the conducting surface (turntable) and the conductivity of the surface. The newer aluminum turntables exhibit a stronger repulsive force than do ferrous turntables. The repulsive force is greater near the outside of the turntable and reduced toward the inside because the relative velocity of the cartridge over the turntable is greater near the outside than it is near the center. Though the repulsive force is small, with cartridges tracking at one gram or less, it might be noticeable since the repulsion would cause the tracking force to be less than when measured statically.

JOHN R. MALIN
Physics Dept.
Polytechnic Institute of Brooklyn
Brooklyn N.Y.

WORDS OF APPRECIATION

The format and contents of the articles in POPULAR ELECTRONICS are exceptionally good—the best I have seen in any magazine to date. Articles concerning the state-of-the-art devices newly introduced to the hobbyist market I find interesting both as a means of education and as construction stories. The only improvement I can think of now is that you go to a larger size magazine and put more in each issue. Keep up the good work.

E. R. Marshburn
Fort Valley, Ga.

POPULAR ELECTRONICS

Why buy a CB radio that butts in on your conversation?

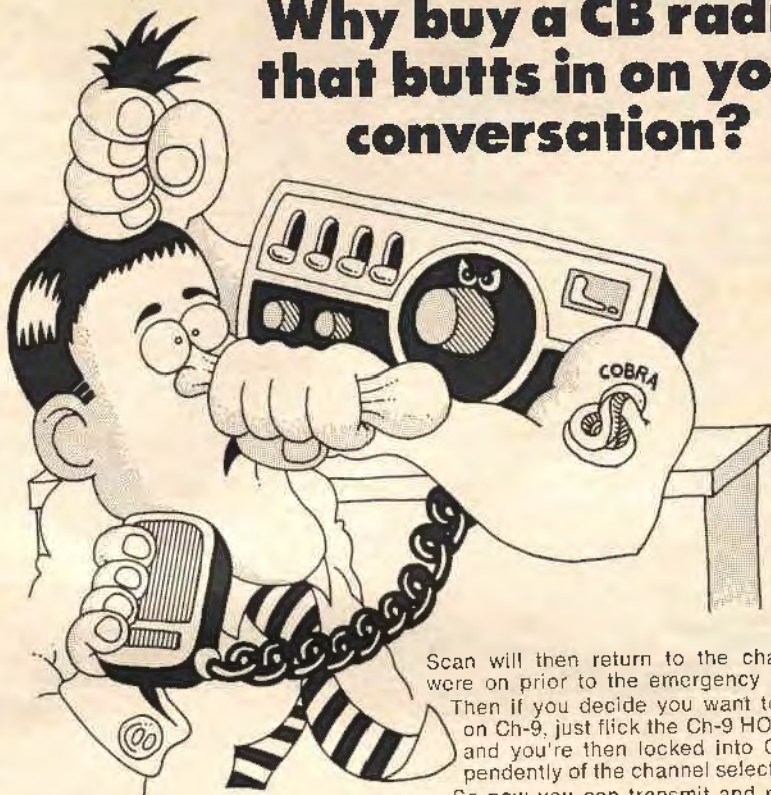

Because emergencies don't wait to happen. They interrupt.

That's why we created the new Cobra 28 Citizen's Band radio. With the Cobra 28, if a distress call comes in on emergency Channel-9, it's going to butt in on you. No matter what channel you're operating on. You can be transmitting or receiving on any one of the Cobra 28's other 22 channels and still be monitoring Ch-9 at the same time.

This practical new feature is called the Emergency Channel-9 Scan-Alert, and you get it on the Cobra 28.

Here's how the Scan-Alert works. Just slide the Ch-9 Scan switch to "scan" position. Then if you're operating on any of the other 22 CB channels and an emergency call comes in on Ch-9, it'll cut right in on whatever frequency you're already on. After the call has been received, the

Scan will then return to the channel you were on prior to the emergency call.

Then if you decide you want to transmit on Ch-9, just flick the Ch-9 HOLD switch and you're then locked into Ch-9 independently of the channel selector switch.

So now you can transmit and receive on Ch-9 without resetting the channel selector.

Of course, the Ch-9 Scan-Alert is switchable. Just turn the Scan switch to the "off" position if you don't want Ch-9 to butt in on you.

Also included in the new Cobra 28: Full 5 watts power with Dynabooast speech compression, RF Noise blanker, automatic noise limiter, PA system output, Delta tune control, ANL/NB switch, channel indicator lights, PWR/S Meter and many other features that make the Cobra 28 the most complete Mobile CB radio at a fantastic price.

This new Cobra is the perfect way to help with emergencies in your area.

So butt in on your local CB dealer and ask to see the new Cobra 28. Or write us direct for more information.

23 Channel CB Radio with Ch-9 Scan-Alert **\$169.95**



COBRA 28

Product of DYNASCAN CORPORATION • 1801 W. Belle Plaine • Chicago, Illinois 60613

CIRCLE NO. 36 ON READER SERVICE PAGE

IDENTICAL TWINNS



Professional or CB...we use identical components. You get identical performance.

Police communicators demand the things you want in a mobile antenna. Maximum range. Reliability. Long life. That's why A/S mobile CB antennas are built exactly like their professional counterparts—used by 9 out of 10 police vehicles. Put John Law's experience to work in your mobile.

M-176 Quick Grip®
CB antenna. Only

\$21.95
(suggested resale).



Be an "antenna specialist!" These top quality jackets with safety reflector stripes available only from your A/S dealer—just \$8.95.

**the antenna
specialists co.**



"Stripes of Quality"

Div. of **allen** Electric & Equipment Co.
12435 Euclid Ave., Cleveland, Ohio 44106
EXPORT: 220 Shames Dr., Westbury, L.I., New York 11690
CANADA: A. C. Simmonds & Sons, Ltd.



ABC'S OF CAPACITORS, Second Edition

by William F. Mullin

This book bridges the gap between engineering technology and practical circuit theory. Written in an informal, easy-to-read style, it begins with the basics of capacitor operation and includes a brief discussion of the early history of the capacitor. It goes on to describe how various types of capacitors are made, their typical characteristics and applications, points to consider when selecting replacements, and several practical testing and measuring methods. This revised edition contains information covering the latest developments in capacitor design and construction, including the monolithic or "chip" ceramic type.

Published by Howard W. Sams & Co., Inc.,
4300 West 62 St., Indianapolis, IN 46268.
Soft cover. 112 pages. \$2.95.

EVEREADY® BATTERY APPLICATIONS AND ENGINEERING DATA

What you don't know about batteries could fill a good-sized volume, and to prove it, the people at Union Carbide have crammed into this 752-page manual all sorts of interesting tidbits about primary and secondary batteries. Every type of battery (carbon-zinc, alkaline, Ni-Cad, mercuric-oxide, silver-oxide, and lead-acid) is given comprehensive treatment, and a new line of Eveready "Hustler" fast-charging nickel-cadmium batteries is introduced. The descriptions include both electrical and mechanical specifications.

Published by Union Carbide Corp. Consumer Products Division, 270 Park Ave., New York, NY 10017. Soft cover. 752 pages. \$6.95.

ENGINEERING CIRCUIT ANALYSIS, Second Edition

by W.H. Hayt, Jr. & J.E. Kemmerly

This book is intended for use with a first course in electrical engineering in conjunction with an introductory course in physics in which the basic concepts of electricity and magnetism are introduced. Only a basic course in the differential and integral calculus

800-631-1972

Call this number
toll free for a
guaranteed choice
of jobs in the
U.S. Air Force

(In New Jersey
Call 800-962-2803)

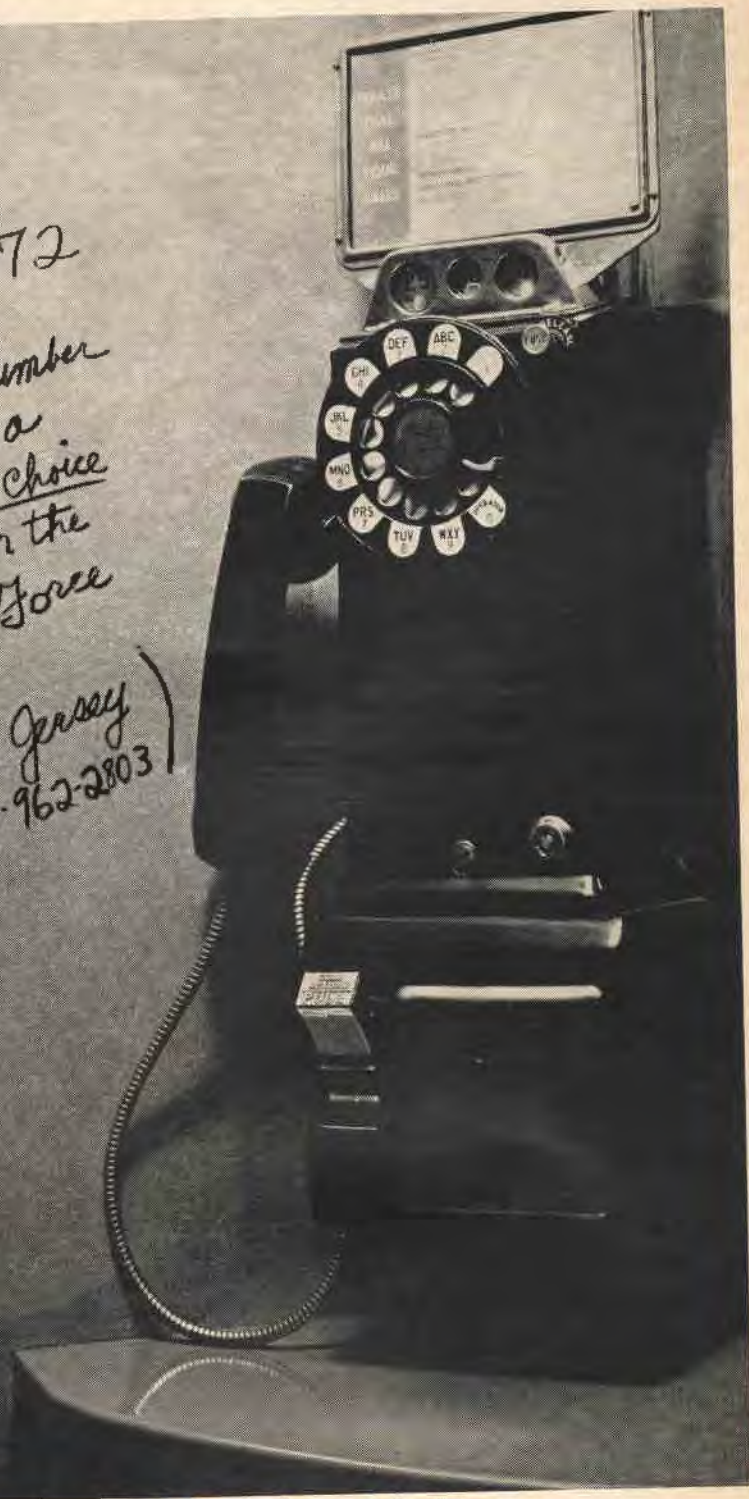

Find yourself in the Air Force.

CIRCLE NO. 32 ON READER SERVICE PAGE

Technical excellence in electronics

On our small, friendly campus the emphasis is on Living as well as Learning. Extra-curricular social activities, student clubs, a student operated radio station, student government, new dormitory and a full sports program help provide a world of your own in which to prepare for tomorrow. Associate Degree in Engineering Electronics. B.S. obtainable. G.I. approved.



VALPARAISO TECHNICAL INSTITUTE

Dept. PE, Yellowstone Trail, Valparaiso, Indiana 46383

CIRCLE NO. 34 ON READER SERVICE PAGE

AR guarantees its published specifications

At Acoustic Research we believe that the publication of complete performance data on our high fidelity components is obligatory. Otherwise, our guarantee would have little meaning.

Find out just what AR guarantees that its products will do. Mail the coupon below, and detailed technical literature will be sent to you free of charge.



Acoustic Research, Inc.
24 Thorndike Street
Cambridge, Mass. 02141
Dept. PE-11

Please send measured performance data on AR products to

Name _____

Address _____

CIRCLE NO. 1 ON READER SERVICE PAGE

need be considered as a prerequisite to reading this book. Circuit elements are introduced and defined in terms of equations and only incidental comments are offered about the pertinent field relationships. The book is written to the student—not the instructor—so that the text can be used for self-study.

Published by McGraw-Hill Book Co., 330 West 42 St., New York, NY 10036. Hard cover. 654 pages. \$15.50.

AMATEUR RADIO NOVICE-CLASS LICENSE STUDY GUIDE

edited by Ken Sessions

The lack of books written for the rank beginner to amateur radio has made it difficult for the newcomer to surmount the Novice exam theory requirements, forcing all but the most eager bookworms to find a friendly ham or radio club to fill in the gaps. This new book, however, is so simply written (by the staff of 73 Magazine) and easy to understand that it is difficult to see how one reading will not equip the reader to pass his FCC exam. The reason for this is that the book was written solely for those people who know nothing about technical electronics and want to become ham radio operators.

Published by Tab Books, Blue Ridge Summit, PA 17214. 160 pages. \$6.95 hard cover, \$3.95 soft cover.

UNDERSTANDING OSCILLATORS

by Irving M. Gottlieb

Oscillator circuits seem to pop up, in endless variety, almost everywhere you look in electronic equipment. Yet, the ancestry of each of them can probably be traced back to one of the basic oscillators found in this new book. The book discusses well-known oscillators, such as the Hartley and the Colpitts, as well as some not-so-well-known ones, such as the Meissner, the Meacham Bridge, the Franklin, etc. The text discusses what the technician and engineer wants and needs to know about oscillators: how they work, their strong and weak points, and how they are used in practical applications. Equally thorough treatment is given to both tube- and transistor-type oscillators.

Published by Howard W. Sams & Co., Inc., 4300 West 62 St., Indianapolis, IN 46268. Soft cover. 160 pages. \$4.50.

BASIC PRINCIPLES OF ELECTRONICS, Volume 2

by J. Jenkins & W. H. Jarvis

The fact that this book is "Volume 2" does
(Continued on page 100)

Popular Electronics

READER SERVICE PAGE

free information service:

Here's an easy and convenient way for you to get additional information about products advertised or mentioned editorially (if it has a "Reader Service Number") in this issue. Just follow the directions below, and the material will be sent to you promptly and free of charge.

1. On coupon below, circle the number(s) that corresponds to the key number(s) at the bottom or next to the advertisement or editorial mention that is of interest to you. (Key numbers for advertised products also appear in the Advertisers' Index.) Print or type your name and address on the lines indicated.

2. Cut out the coupon and mail it to: POPULAR ELECTRONICS, P.O. Box 8391, Philadelphia, PA 19101.

note: If you want to write to the editors of POPULAR ELECTRONICS about an article on any subject that does not have a key number, write to POPULAR ELECTRONICS, One Park Avenue, New York, N.Y. 10016. Inquiries concerning circulation and subscriptions should be sent to POPULAR ELECTRONICS, P.O. Box 1096, Flushing, N.Y. 11352.

11/71-1

Void after December 31, 1971

Popular Electronics

P.O. BOX 8391
PHILADELPHIA, PA. 19101

1 2 3 4 5 6 7 8 9 10 11 12 13 14 15 16 17 18 19 20
21 22 23 24 25 26 27 28 29 30 31 32 33 34 35 36 37 38 39 40
41 42 43 44 45 46 47 48 49 50 51 52 53 54 55 56 57 58 59 60
61 62 63 64 65 66 67 68 69 70 71 72 73 74 75 76 77 78 79 80
81 82 83 84 85 86 87 88 89 90 91 92 93 94 95 96 97 98 99 100

NAME (Print clearly) _____

ADDRESS _____

CITY _____ STATE _____ ZIP CODE _____

TURNER PUT A LOT INTO THE M+3 MOBILE MICROPHONE



Modu-Gard®
Compression circuit
to prevent over
modulation, ensure
constant output.

**Slide-Action
Volume Control**
Positive action,
precision adjustment
for transistorized pre-amp.

Modern Styling
An easy-to-grip design
so distinctive it's patented.

Hypalon Cord
Blue coil cord with a memory,
keeps its shape without stretching.

The Turner Name
Superior product design,
manufacturing and quality—made in USA.

YOU'LL GET A LOT OUT OF IT.

TURNER DIVISION
CONRAC
CORPORATION

909 17th Street N.E.,
Cedar Rapids, Iowa 52402
Telephone (319) 365-0421

CIRCLE NO. 31 ON READER SERVICE PAGE



To obtain a copy of any of the catalogs or leaflets described below, fill in and mail the Reader Service Page 15 or 99.

A new series of miniature "tini-telephone" patch cords and replacement cords are described in a product bulletin from *Switchcraft, Inc.* The literature provides detailed features of the new series TT-840 and TT-860 cords, such as bronze tinsel conductors covered with durable moisture-proof thermoplastic insulation, a braided shield (75% coverage), and braided black nylon outer jacket for longer life and service.
Circle No. 75 on Reader Service Page 15 or 99

Hard-to-find precision and special-purpose tools are listed in a 40-page catalog just issued by *Brookstone Co.* The firm's 3rd 1971 expanded edition contains scores of new and extremely useful tools rarely sold by industrial distributors or found in hardware stores. Listed are both power and hand tools for the machinist, woodworker, technician, designer, and maintenance and service personnel. Each tool is fully described, with a photo and price listing.
Circle No. 76 on Reader Service Page 15 or 99

Electric soldering irons, tips, and related accessories are the subject of the *Hexacon Electric Co.* 32-page catalog titled "Soldering Tips For 1971." The indexed catalog describes the company's Durotherm, Xtradur, and copper tips, supported by more than 250 sketches of the most popular tip sizes and shapes. Engineering data, giving detailed specifications of base materials and coatings of various grades of tips, are included. A tip selection guide describes the effects of tip length, diameter, and point shape in various applications. Selective tinning and ceramic dielectric coatings are also described.

Circle No. 77 on Reader Service Page 15 or 99

A new 22-page catalog that describes AR's complete line of hi-fi components and deals with some of the more technical aspects of the design of acoustic suspension woofers
(Continued on page 101)

FREE!

1972 LAFAYETTE
CATALOG 720

**JUST OFF THE PRESS!!
SEND FOR YOUR EXCITING COPY NOW!**



Our 51st Year

**YOUR 1st GUIDE TO
EVERYTHING IN
ELECTRONICS**

1972
LAFAYETTE
CATALOG
720



The Latest in 4-Channel Stereo Sound

- ★ CITIZENS BAND
2-WAY RADIO
- ★ STEREO/HI-FI
COMPONENTS
- ★ MUSICAL INSTRUMENTS
AND AMPLIFIERS

- ★ PUBLIC ADDRESS
- ★ AMATEUR RADIO
- ★ TEST EQUIPMENT
- ★ PARTS
- ★ PORTABLE AND
TABLE RADIOS

- ★ PHOTO EQUIPMENT
- ★ TOOLS-BOOKS
- ★ AUTO ACCESSORIES
- ★ EDUCATIONAL
AND OPTICAL
- ★ TV AND ANTENNAS

Your Complete Buying Guide to Everything in Electronics

LAFAYETTE Radio ELECTRONICS
Dept. 35 111 P.O. Box 10
Syosset, L.I., N.Y. 11791

Mail the Coupon Today
for your FREE Lafayette
Catalog

Send me the FREE 1972 LAFAYETTE Catalog 35 111

Name

Address

City State

Zip

(please include your Zip Code No.)

CIRCLE NO. 18 ON READER SERVICE PAGE



Train on this
315 sq. in.
picture
color TV
and get the
skills that
mean a
high-paying
career!

Solid-State — the newest development

Count on NTS training to always feature the latest electronic equipment.

Now included in two exciting NTS color TV courses, this set is the largest, most advanced color television made. Guided by the NTS "Lab-Project Method" of combining professional kits and easy-to-follow lessons, you build this color TV step by step — learning TV Servicing as you go! NTS has successfully trained thousands of men at home for rewarding careers as electronics technicians. Prepare for the great opportunity fields of TV-Radio Servicing, Computers, Communications, and Automation.

This solid-state color set contains: 45 transistors, 55 diodes, 2 silicon controlled rectifiers, and 4 advanced Integrated Circuits representing an addi-

tional 46 transistors and 21 diodes. The first solid-state color TV this large — yours to keep! It features Automatic Fine Tuning; "Instant On"; an Ultra-Rectangular Screen (25 in. diagonal measurement) that lets you see the complete transmitted image for the first time — a full 315 square inches; exclusive built-in Self Servicing features which eliminate the need to buy costly test equipment; exclusive design Solid-State VHF Tuner with an MOS Field Effect Transistor; 3-stage Solid-State IF; Automatic Chroma Control; Adjustable Noise Limiting and Gate Automatic Gain Control; High Resolution Circuitry; Matrix Picture Tube; and a specially formulated Etched Face Plate that eliminates unwanted glare, and heightens contrast. Colors are more vivid,

fresh tones more natural, and the picture is sharper than ever before. By training on this unique color TV, you'll gain the most up-to-date skills possible in TV Servicing!

Other valuable equipment you build and keep includes an AM SW Radio, Solid-State Radio, FET Volt-Ohmmeter, and Electronic-Tube Tester. All included in your tuition. You learn troubleshooting, hi-fi, multiplex systems, stereo, and color TV servicing. Step right into a technician's job at top pay or open a business of your own! For complete details on all NTS electronics courses, mail the coupon today for the full-color NTS Catalog. No obligation. No salesman will call.

**Build this set
and learn
solid-state
circuitry—the
electronics
of today!**

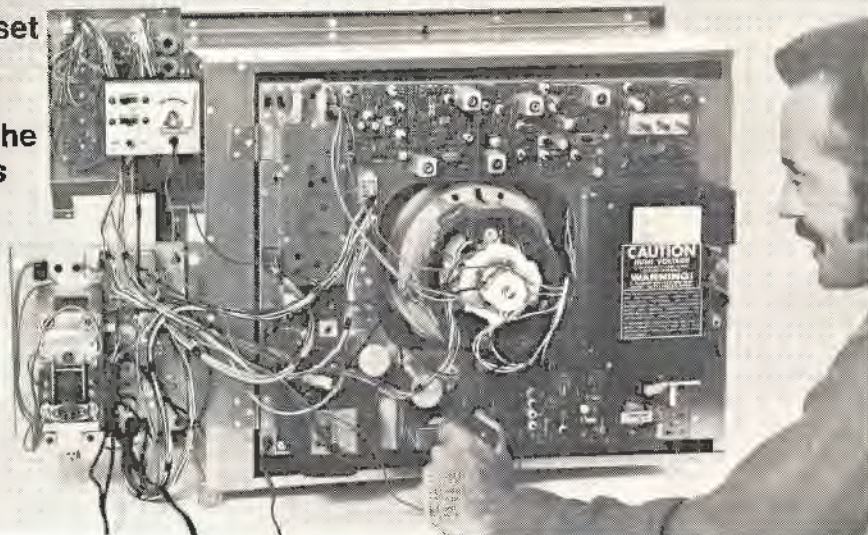

in color TV — comes to home training.

NTS ELECTRONICS & COMPUTER TECHNOLOGY

Build this exclusive NTS Computer-Trainer! Loaded with integrated circuits, it shows you the how, what, and why of computers. Learn this exciting field faster, more thoroughly. You also assemble and learn to operate an FET Volt-Ohmmeter and 5" wide band Oscilloscope.

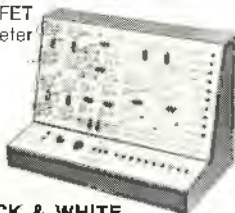

NTS BLACK & WHITE TV AND RADIO SERVICING

Learn all phases of television, radio, stereo, and hi-fi. You receive this 74 sq in. picture Solid-State B&W TV, Lo-Silho "Superhet" Radio, FET Volt-Ohmmeter, Solid-State Radio, Electronic Tube Checker, and Signal Generator. Start earning extra money even before you complete the course!



NTS ELECTRONICS COMMUNICATIONS & F.C.C.

Gain the security and prestige of owning an F.C.C. First Class Radio-Telephone License! Two comprehensive NTS courses cover the big opportunity field of transmitting and receiving. You build 14 kits, including a 5 watt AM Transceiver, 6 Transistor Pocket Radio, and FET Volt-Ohmmeter. Learn 2-way radio, Citizens Band, micro-waves and radar.



NTS INDUSTRIAL & AUTOMATION ELECTRONICS

Automation is the future of industry and you can play an important part! Learn industrial controls by training on the NTS Electro-Lab — a complete workshop. You also build and operate this 5" wide band Oscilloscope. And you perform experiments that involve regulating motor speeds, temperature, pressure, liquid level, and much more.



Classroom Training

at Los Angeles. You can take classroom training at Los Angeles in sunny Southern California. NTS occupies a city block with over a million dollars in technical facilities. Check box in coupon.

APPROVED FOR VETERANS
Accredited Member: National Association of Trade & Technical Schools; National Home Study Council.

NATIONAL TECHNICAL SCHOOLS
WORLD WIDE TRAINING SINCE 1905
4000 South Figueroa Street, Los Angeles, Calif. 90037

Please rush Free Color Catalog and Sample Lesson, plus Information on course checked below. No obligation. No salesman will call.



National Technical Schools
4000 S. Figueroa St.
Los Angeles, Calif. 90037

- Master Course in Color TV Servicing
- Color TV Servicing (For Advanced Technicians)
- Master Course in B&W TV & Radio Servicing
- Master Course in Electronic Communication
- Practical Radio Servicing
- FCC License Course
- Master Course in Electronics Technology
- Industrial and Automation Electronics
- Computer Electronics
- Basic Electronics
- High School at Home Dept. 205 111

Name _____ Attn _____
Address _____
City _____ State _____ Zip _____

Check for service districts in coupon. Training at Los Angeles.



When you jump, it's just you.

Airborne is an outfit that can show you who you are. Somebody who counts. One of a special breed of men.

When you jump, it's just you. Every time is like the first time. You get that jolt in your gut. The world turns at your feet. You know who you are.

Join this special breed. Get a special knowledge of yourself. Go Airborne. You'll get the best training there is. You'll get into better shape than you've ever been in. You'll get the extra money they call jump pay. You'll be somebody.

And in today's Army, if you pack the gear, the top has no roof. There's never been more opportunity. For education. For advancement. To see some of the world. To know some of the people in it. To get to know what you really can do.

See your Army representative. Or send the coupon. Get ahead. All the way. Airborne.

**Today's Army
wants to join you.**

| | |
|---|---------------------|
| Army Opportunities Dept. 200, Hampton, Va. 23669 | Date _____ |
| I want to jump my way up. Send me information on the Airborne. | 2 PS-11-71 |
| Name _____ | Date of birth _____ |
| Address _____ | |
| City _____ | County _____ |
| State _____ | Zip _____ |
| Phone _____ | Phone _____ |
| Education _____ | |



NEW PRODUCTS

Additional information on products described in this section is available from the manufacturers. Each new product is identified by a corresponding number on the Reader Service Page. To obtain additional information on any of them, circle the number on the Reader Service Page, fill in your name and address, and mail it in accordance with the instructions.

NEW MODEL SPEAKER SYSTEM FROM KENWOOD—A new three-way, three-speaker system, the Model KL-3080, has been added to the Kenwood Electronics, Inc., line of hi-fi components. Incorporating a 10" free-edge type woofer, 5" cone-type midrange driver, and 1½" cone-type tweeter, the new speaker system has a frequency range of 45-20,000 Hz, crossover frequencies at 800 Hz and 5000 Hz, and crossover network of 12 dB/octave. The impedance of the system is 8 ohms, and maximum input power is 40 watts, while sensitivity is 100 dB. A specially designed four-position tone selector gives the listener a choice of emphasizing clear, normal, sweet, or soft tone characteristics. Price \$199.95 pair.

Circle No. 84 on Reader Service Page 15 or 99



WHITE'S LIGHTWEIGHT METAL DETECTOR—There is adventure, fun, and profit in treasure hunting or prospecting with the Coinmaster IV featherweight metal and mineral detector from White's Electronics, Inc. The detector has a tuned semi-three-coil, sensitive 6" loop developed to provide for maximum depth efficiency when searching for small metal objects. When metals or minerals are detected, depending on the Coinmaster's settings, the detector reacts with an audible tone signal and meter movement deflection. The transmitter/receiver Coinmaster weighs only 4 lb 6 oz, complete with loops and batteries. Its retail price of \$199.50 includes mineral and metal samples, detailed instructions, and a two-year warranty.

Circle No. 85 on Reader Service Page 15 or 99

POMONA ELECTRONICS MINI-TEST CLIP—A new series of Mini-Test Clips with connecting leads, designed for testing densely packed miniature electronic assemblies, has been introduced by Pomona Electronics, Co., Inc. The test clips feature a spring-loaded contact hook which can be quickly and positively connected to component leads or terminals. Another version has a probe tip that slips down over 0.025"-square wire-wrap pins. The series includes four models: 3780 with a Mini-Test Clip on one end only; 3781 with Mini-Test Clips on both ends; 3782 with a Mini-Test Clip on one end and a banana jack on the other end; and 3783 with a Mini-Test Clip on one end and a slip-on wire-wrap terminal clip on the other end. The molded nylon probes are completely insulated from the point of connection.

Circle No. 86 on Reader Service Page 15 or 99

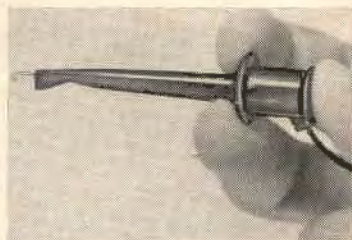

KESTER'S NEW SILVER SOLDER—A special solder for the do-it-yourselfer or the electronics hobbyist for working with jewelry, antique silver, and critical connections is available from Kester Solder. One of ten different

NEW PRODUCTS

solder items that compose the company's point-of-purchase display of solders and fluxes, the silver solder is an alloy of 4 percent silver and 96 percent tin. A special flux is contained in the core of the 5' length of solder.

Circle No. 87 on Reader Service Page 15 or 99

CHEMTRONICS PLASTIC REPAIR KIT—"Plas-T-Pair" from Chemtronics, Inc., is a new two-part-compound plastic repair kit for all soluble plastics. Usable either as a cement or a plastic putty, it is ideal for repairing radio and TV knobs, cracked or broken cabinets, screw mounts, carrying handles, etc. The two-part compound consists of a powder and a liquid solvent which, when combined, can be poured or brushed onto a repair as a liquid plastic cement, or it can be mixed and let stand for a few minutes to be molded onto the repair area as a plastic putty. Repairs are completed and the repaired item is ready for use in 15 minutes.

Circle No. 88 on Reader Service Page 15 or 99

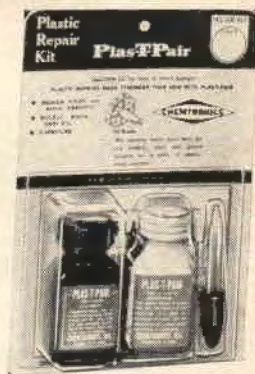

SHAKESPEARE DUAL-ARRAY CB ANTENNA—Co-phasing in Shakespeare Co.'s Model 464 dual-array fiberglass antenna provides higher performance and increased gain from a mobile CB transceiver. Co-phasing also provides increased capture area, a mutual impedance match that offers a lower SWR than possible with a single antenna, and a more symmetrical radiation pattern. The two quarter-wave, top-loaded antennas that make up the system operate in-phase with the mutual impedance matched for 50 ohms. Height is 4 ft.; weight is 2 lb.; polarization is vertical; power rating is 100 watts; and SWR is 1.5 to 1 or less. Price \$38.95.

Circle No. 89 on Reader Service Page 15 or 99

KOSS 4-CHANNEL STEREO HEADPHONES—The first headphones specifically designed for use in four-channel stereo systems are currently being manufactured by Koss Electronics, Inc. The Model K2+2 "Quadrafone" is a true four-channel system, employing four separate driver elements to produce exceptional surround sound. The headphones, however, are also fully compatible with conventional stereo amplifiers. The Quadrafone comes with carrying case and bears a retail price of \$85.00.

Circle No. 90 on Reader Service Page 15 or 99



EICO "QUATRASONIC" 4-CHANNEL ADAPTOR—The hidden depths of most modern stereo recordings and stereo FM broadcasts can be revealed when using the Eico QA-4 "Quatrasonic" adaptor and an extra pair of speaker systems with a conventional stereo system. The QA-4 extracts from conventional stereo sources the ambience information present in two-channel stereo programs and feeds the extracted information to two speakers located behind the listener. The two front speakers function in the normal left-to-right stereo mode. Two controls are provided: a 4-position mode switch and a rear speaker level control. The QA-4 sells for \$17.95 in kit form, \$29.95 factory wired.

Circle No. 91 on Reader Service Page 15 or 99

The RCA portable color bar generator



Performs like the big ones Costs only \$75*

- Provides color bar, dot, cross hatch, and blank raster patterns
- All solid state circuitry including ICs
- Pattern signals, RF output frequency and color subcarrier all crystal-controlled
- Battery operated, AC adapter available

- Lightweight — less than 20 oz., only 6½" wide x 4" deep x 3" high

For all the technical specs get in touch with your RCA Distributor. RCA | Electronic Components | Harrison, N.J. 07029.

* Optional User Price

RCA

CIRCLE NO. 25 ON READER SERVICE PAGE

An Electronic Desk Calculator You Can Build



THE PINNACLE OF DIGITAL PROJECTS—ADD, SUBTRACT, DIVIDE, AND MULTIPLY TO 16 DIGITS OF DISPLAY FOR UNDER \$180

COVER STORY BY ED ROBERTS/MITS

JUST HOW MANY functions can be performed by a single integrated circuit? No one knows the ultimate answer to that question, but it's a cinch that semiconductor fabrication techniques that have produced what is known as "Large scale integration" (LSI) are well on the way to the final goal. You will understand why when you build the "POPULAR ELECTRONICS Calculator," the first hobbyist project to use these latest semiconductor devices. With this breakthrough in design, you can build, for less than \$180, a desk calculator which is the equivalent of many costing between \$400 and \$600. The calculator has a 128-word, 1920-bit memory and can add, subtract, multiply, divide, and operate on constants.

An outstanding feature of the calculator is that, while the display shows only eight digits at one time, calculations can actually be made to sixteen digits. Momentarily depressing a display shift key results in the instantaneous recall and display of the eight least significant digits (LSD). (Depending on the location of the decimal point; LSD to the right of the decimal point resulting from an operation such as division cannot be displayed.)

Another convenient feature of the calculator is the overload warning indicator. If the calculator is asked to perform an impossible operation (such as dividing by zero), an "E" is displayed on the extreme left-hand readout. The E is also displayed if too many digits are entered to begin with.

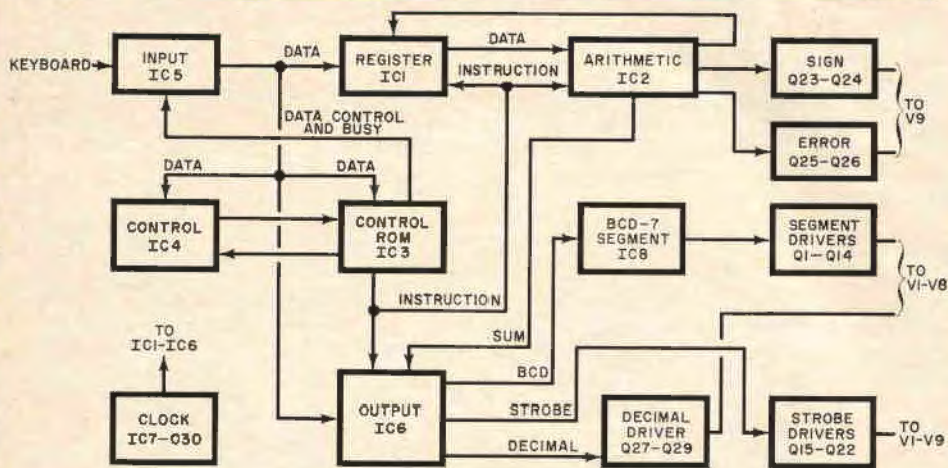

Fig. 1. Although this basic logic flow looks relatively simple, there are over 8000 transistors in this circuit, mostly in six LSI chips. The keyboard enters digits and operations, while the nine display tubes present final readouts.

PARTS LIST

The following are available from MITS, 2016 San Mateo, N.E., Albuquerque, NM 87110:

Complete calculator kit, including case, \$179.00 plus \$5 for postage, insurance, and handling.

Complete calculator assembled, \$275, plus \$5 for postage, insurance, and handling.

Display board assembly, \$65, plus \$3.50

for postage, etc.

Main board, keyboard, case, hardware, etc., less LSI's, \$65, plus \$2.50 for postage, etc.

Six LSI IC's (EA S-80), \$75; keyboard, \$21; display board, \$12.50; main board \$13.50; capacitor board, \$4.50.

Five foil patterns, component layout diagrams, full-size mechanical interconnection, and complete schematics (M100-P), \$2.00, postpaid.

In this calculator, leading zeros are suppressed, unless the number is less than one. Thus, .415 is displayed as 0.415, not 00000.415; and 3.1416 is displayed as is, not 0003.1416. This results in a much more easily read display, with fewer resulting errors.

An interesting construction feature of the calculator is that double-sided printed circuit boards are used. Plated-through holes serve to connect the two sides. The use of these boards serves several purposes: an excessive number of jumper wires is eliminated; the overall size of the calculator is considerably reduced; and the task of getting good solder connections is greatly simplified by the plated holes.

The calculator is also the first POPULAR ELECTRONICS project to use electro-luminescent display tubes. Volume production of the tubes has reduced their price so that it is possible to take advantage of their superior qualities.

Basic Design. The overall logic design of the calculator is shown in Fig. 1. There are six large-scale integrated circuits: IC1, the read-write memory register; IC2, arithmetic; IC3, read only memory (control); IC4, control; IC5, input; and IC6, output. The six LSI's are the equivalent of over 8000 transistors. They employ the common method of serial-parallel addition—digits are added in parallel and words serially.

All other parts and circuits in the calculator may be considered as auxiliaries to the LSI IC's. The keyboard, for instance is custom designed to operate with the LSI's used. It has, in addition to the digits 0 through 9, all the standard calculating instruction keys. The "constant multiply key" is separate since it is an on off function and requires a latching switch rather than a momentary contact. Although the use of the keyboard shown on the prototype is recommended because its performance is known to be

adequate, a satisfactory keyboard using standard momentary contact, normally open pushbutton switches can be constructed using the keyboard matrix shown in Fig. 2. In choosing a switch, remember that the bounce time of the key is highly critical, as it is closely related to the clock frequency of the calculator. In general, the bounce time must be less than 512 clock cycles or 2 milliseconds.

The clock circuit provides the timing base for calculator operations which must operate in a sequenced manner. The clock frequency determines the rate at which the calculator performs operations. Although the LSI IC's are designed to operate at a clock frequency no higher than 200 kHz, the clock in the calculator operates at 130 kHz to provide an adequate margin while still giving extremely fast operation.

Integrated circuit IC7 uses diode transistor logic (DTL) and has three NAND gates connected to form an astable multivibrator which oscillates at 130 kHz. The output of the oscillator is buffered by a fourth NAND gate and is fed to the voltage amplifier, Q30. The output of Q30 is a square wave with rise and fall times of less than 100 nanoseconds. This output is used by all of the LSI's as a reference signal.

Decoding functions are performed by IC6 and IC8. Output IC6 determines which digit to display (based on time); determines what the BCD data is for that digit; transmits that information to the decoder; determines the proper place of the decimal point; and detects leading non-significant zeros and suppresses them. Decoder IC8 is a BCD-to-seven-segment converter that takes the number from IC6 and sends the correct signals to the display section.

Data presented to the display section is in BCD format in serial form. (Digits of a number are relayed sequentially, rather than simultaneously.) The largest number is presented first. The output of IC8 (Fig. 3) is in the form of lines which are pulsed in accordance with the number to be displayed. Each line feeds a segment driver circuit (Q1 through Q14) which converts the pulses into voltages compatible with the display tubes. Each segment driver is connected to the same segment of tubes V1 through V8 (the

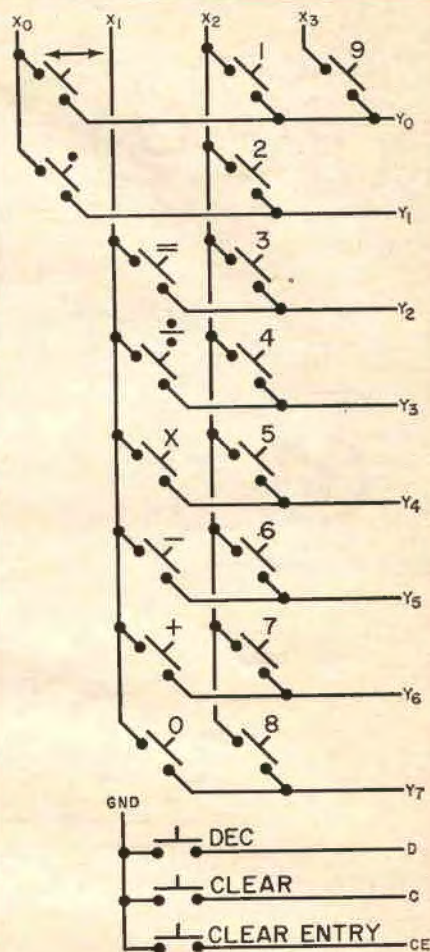

Fig. 2. The keyboard matrix may use a commercial keyboard, or any good pushbutton switches. Connections are to similarly marked board terminals.

EDITOR'S NOTE

This article presents an exciting new breakthrough construction project—a modern, high-speed 16-digit calculator. This makes it possible for anyone to own his own home calculator and at the same time complete a fascinating electronics hobby project. Although the project is an involved one, the construction is no more difficult than most, if a reasonable amount of care is used in its assembly. It is well within the capabilities of most amateur electronics enthusiasts.

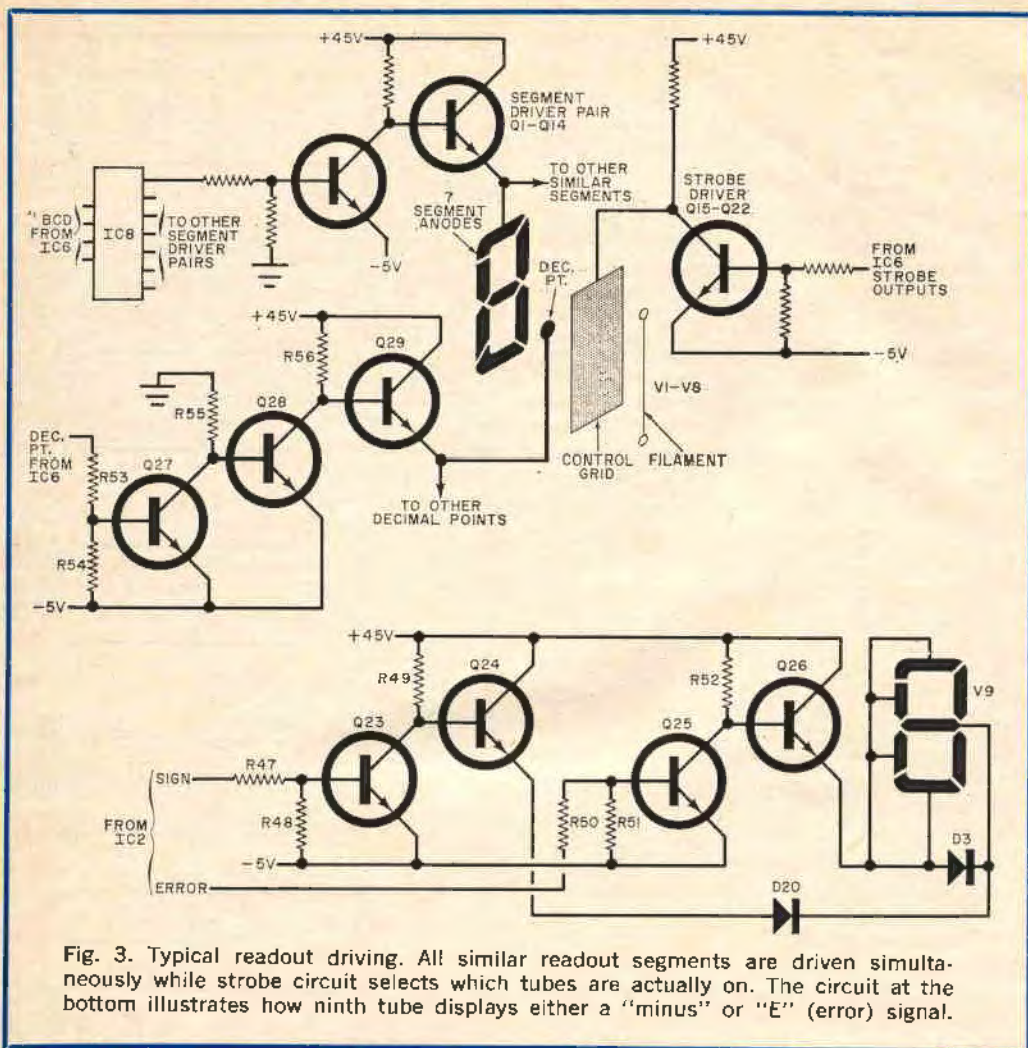

Fig. 3. Typical readout driving. All similar readout segments are driven simultaneously while strobe circuit selects which tubes are actually on. The circuit at the bottom illustrates how ninth tube displays either a "minus" or "E" (error) signal.

numerical displays). That is, segment one of tubes V1 through V8 is driven by one segment driver, segment two of all tubes is driven by another segment driver, and so on. Thus, any time a number is relayed from the output IC, the segment driver provides plate voltage to the proper segments of all the numerical display tubes. However, none of the tubes will illuminate since a control grid voltage must be simultaneously applied. This is the job of the strobe drivers (Q15-Q22).

In addition to providing data to the decoder, IC6 determines the display tube on which the number is to appear. When a strobe drive line is actuated, it provides a negative voltage to the strobe driver base, switching off the transistor

and raising its collector potential to a high positive value. The collector is connected to the control grid of a display tube. When the grid goes positive, current flows to any plate elements in the tube which have been switched on by the decoder and segment drivers. This causes the phosphor on the selected segments of the tube to glow.

Output IC6 begins the process with tube V8 by actuating its strobe line. Then approximately 500 microseconds later, the strobe line switches to V7; and so on through V1. Thus, each tube is turned on approximately 250 times a second. With the rapid switching and the natural fluorescence of the tubes, the display appears to be on constantly.

In addition to the strobe lines, IC6 has a decimal driver output, coupled through Q27, Q28, and Q29 to the decimal points on all the display tubes. Output IC6 determines which digit should be the one's digit and activates the decimal driver line simultaneously with the activation of the strobe driver for that digit.

Tube V9 displays the sign and error indications. Arithmetic IC2 activates Q23 and Q24 to provide plate voltage to the center element of V9 to form the minus sign when this tube is strobed. The overflow line from IC2 drives Q25 and Q26 to provide plate voltage to V9 and form the "E" for error.

The electro-luminescent display tubes operate in a manner quite similar to a cathode ray tube. Electrons from the filament are accelerated past a control grid toward positively charged phosphor coated plates. When the electrons impinge on a plate, they cause the phosphor to glow. In the tubes are seven segments which, by various combinations, can form the numbers 0 through 9. Each individual segment is a plate.

The power supply in the calculator has five output voltage: an unregulated +45V for the plates of the display tubes; an unfiltered, unregulated -2.4V for the series-parallel filament drive of the display tubes; a regulated -14V and -26V for the LSI IC's; and a regulated -5V for the other semiconductors. Regulation is provided by zener diodes.

Construction. The calculator consists of three PC boards and the keyboard. The six LSI IC's and the power supply are mounted on the largest board; the display tubes and associated circuits are on the second board; and power supply filter capacitors are on the smallest board.

The foil patterns for the boards are too large for reproduction here. They may be obtained as noted in the Parts List.

The main board, with the LSI's must be assembled with great care. Before installing the six LSI's, take a good look at them. The only difference between them is an identifying number stamped on the top surface. The pins are slightly pre-sprung to insure good contact. Each has a dot or notch to identify pin 1. Use a 25-to-30-watt soldering iron (not a gun).

When installing the display tubes, their

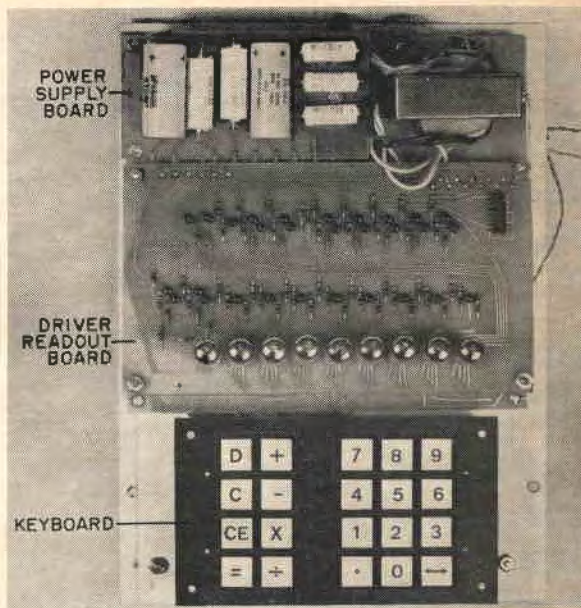

The calculator has lots of room to assist construction. The driver-readout board is mounted above the main board using spacers to tilt the readouts for better visibility.

leads should be clipped in rotation so that each lead is about 1/8 inch shorter than the previous one. This simplifies installing the tubes in their sockets. Make sure that all tubes are mounted correctly with regard to the viewing plane. The remainder of the components (one IC, 4 diodes, 29 transistors, and 56 resistors) can then be soldered in place. Observe polarities and, again, use a low-power soldering iron. Any holes on the board that remain empty are connections to the foil pattern on the back of the board.

Interconnections between the three boards are made with short lengths of insulated wire, color coded to prevent errors.

The large board forms the "base" of the calculator, with the display board above it, tilted so that the display is at the desired angle. The small board is mounted directly over the power supply end of the main board.

Checkout. Other than a detailed inspection, making sure that all components are properly installed and that there are no solder bridges, there is no way to check the complete assembly prior to operation. Pay particular attention to board-to-board and keyboard-to-board connec-

tions. Remember that a mistake found during pre-operation inspection is easily corrected; once the power is on, it could be quite expensive.

Use. Operating the calculator is so simple that it takes only a few minutes to "catch on." Here are the basics:

The button labeled "C" clears the entire machine. Any time you want to start all over, use it; but avoid it if you are in the middle of a computation and don't want to start over.

When you first turn the calculator on, the decimal point will be on the far right tube. To move it, press the "D" button and one of the number buttons, depending on how many spaces you want to move the decimal. Press the two buttons simultaneously.

Now pressing any of the number buttons enters a number. To multiply, add, subtract, or divide this number by any other, press the appropriate function button, then the second number, and then the "equals" button.

If, at any time, you enter a wrong number and want to get rid of it but not the previous calculations, press the "CE" button. This clears only the last number entered, and you can enter the correct number and proceed with the calculation.

When you enter too many digits to be displayed or try to do something impossible (like dividing by zero), the E light will come on. If you subtract a large number from a smaller one, a minus sign will appear at the left.

To multiply or divide by a constant, turn on the constant "K" switch, enter the first number to be operated on and then the constant. Pressing the equal button will give the answer. Then to operate on any other number, enter the number and press the equal sign. For instance, if 5 is to be a constant, and you want to multiply it by 20, 30, and 40. Press 20, the times sign, 5, and the equals sign. The answer is 100. Now the 5 is entered as a constant. Press 30 and the equals sign, the answer is 150; press 40 and the equals sign, the answer is 200. This function is very valuable in calculating interest, percentages, etc. To change the constant, clear the machine. Be sure to turn off the K switch when you are through working with constants.

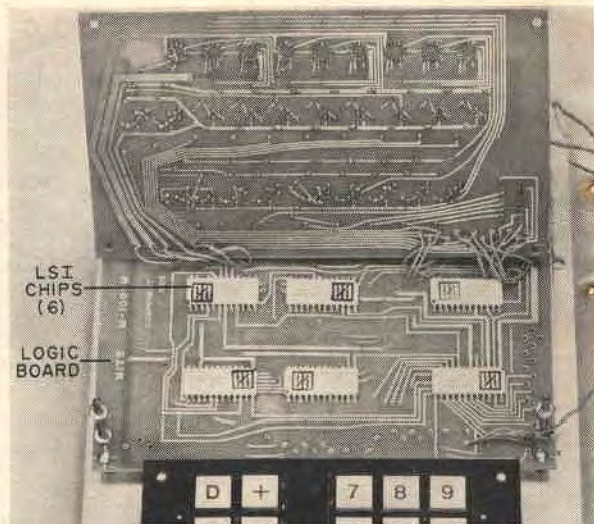

The two main boards have in-line interconnects, while the keyboard connections are at the bottom of the logic board. Note the six large LSI's on the double-sided board.

The button with the two-headed arrow is used to view the least significant digits of a number that is over 8 digits long (to left of decimal). For instance, with the decimal at the extreme right, multiply 789,456 by 789,456. The answer will appear as 623240775936 but only the first four digits will appear at first. To see the other eight digits, press the arrow-head button. ♦

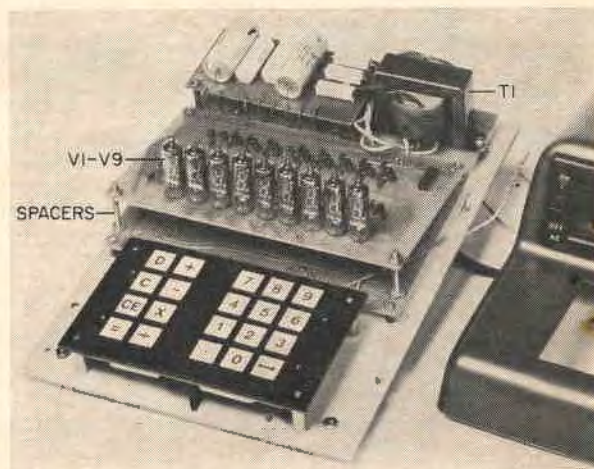

The complete calculator including injected plastic case. Note how the display board is tilted via spacers to fit the case window.

UNDERSTANDING RECEIVER NOISE FIGURE AND SENSITIVITY

MEANING OF AN IMPORTANT SPEC AND HOW IT IS MEASURED

BY JAMES T. WEST

ONE of the first characteristics mentioned in the specifications for a receiver is "sensitivity." Unfortunately, the value given (usually in microvolts) is not as reliable an indication of quality as it might seem. To give the term sensitivity any meaning, more must be known about the conditions under which the measurement was made. In communications equipment, a receiver's sensitivity is usually defined as "the input voltage, from a matched source, required to produce a 10-dB S/N (signal-to-noise ratio), measured at the i-f stage output." Since the amount of noise power presented to a receiver is dependent on its bandwidth, the sensitivity is also dependent on that bandwidth.

Thus a good sensitivity voltage for one type of receiver may be a poor value for another. For instance, 2 microvolt sensitivity might be excellent for an FM BCB receiver, yet entirely inadequate for use on CB. To evaluate properly a receiver's performance, then, we need a quality factor which is independent of bandwidth and unaffected by whatever standard of S/N we employ.

While receivers may be designed to perform different types of service, use different bandwidths, and produce different S/N outputs, the final requirement is the same: a wanted signal must be dis-

cernable from random noise. A certain amount of input noise is unavoidable, but it is imperative that the receiver add as little noise as possible. The basic receiver quality factor indicates the amount of noise added by the receiver and is appropriately called the "noise figure." To understand the importance of the noise figure, however, it is necessary first to develop a few other concepts.

Understanding Noise. To many of us, the term noise is rather elusive. This is partly due to the fact that we do not distinguish properly between thermal (or device) noise, which is caused by random electron motion in matter, and the various forms of environmental noise. It is thermal noise which is of interest in studying noise in receivers. The amount of noise energy generated by random electron collisions in matter is proportional to temperature and is referred to as "thermal white noise." In any resistive material, thermal noise represents an amount of "noise power," and, due to its random nature, it appears evenly distributed in frequency across the entire spectrum. However, the exact amount of noise power which affects a receiver or r-f amplifier is restricted by the receiver's bandwidth. For narrow-band r-f amplifiers, the noise bandwidth may be as-

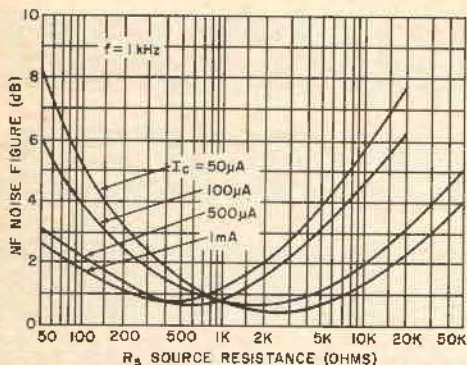

Fig. 1. Effect of source resistance and collector current on noise figure for a 2N4402 transistor. (From a Motorola data sheet.)

sumed to be the same as the half-power bandwidth (3 dB below the midband power gain).

The constant that relates temperature and bandwidth to thermal noise power is Boltzmann's constant ($k = 1.38 \times 10^{-23}$ joules/°K). Thermal noise power in watts, then, is equal to the product of Boltzmann's constant, the bandwidth (B) and the temperature in degrees Kelvin (0° Kelvin = -273° C). Thus, $N = kTB$.

If an amplifier is connected to a resistor equal to its input resistance, the thermal noise input will be represented by the above equation. For example, a citizens' band receiver with a 6-kHz bandwidth is connected to a matching resistor at a temperature of 300°K (about 80°F). The receiver will see a noise input of about 10^{-17} watts, or about 0.02 microvolts across 50 ohms.

This noise input is not appreciable, even when multiplied by a high-gain amplifier. It would indeed be nice if the amplifier added no additional noise. Unfortunately, this is not the case. Any amplifier we can design will add some noise. This noise comes from several sources which are random in nature; and, for the most part, it is this amplifier noise that limits a receiver's "minimum usable signal."

One type of noise generated by both vacuum tubes and semiconductor devices is referred to as "shot noise," which is similar to thermal noise in that it is completely random in nature. In tubes, shot noise is caused by the emission of electrons by the cathode; and in semiconductors, by the recombination and

generation of free electrons and positive ions within the material. The amount of noise contributed by an amplifier varies with the active device employed and the circuit design. Figure 1 shows how the source resistance, a design parameter, can affect a transistor amplifier's noise generation. Specially designed vacuum tubes, certain bipolar transistors, field effect transistors, tunnel diodes, and varactor diodes are among devices which add a minimum amount of noise.

There are two other sources of noise which should be mentioned: atmospheric and environmental. Atmospheric noise is generated by lightning; environmental noise is man-made. Examples of the latter include "static" from automotive ignition systems, electric motors, discharge-type lighting, and, of course, interfering radio transmissions. Most of this type of noise is restricted to that part of the radio spectrum below about 30 MHz. In the lower-frequency services, such as AM BCB (535-1605 kHz) and the 40- and 80-meter amateur bands, atmospheric and environmental noise often dominate thermal noise. At these frequencies, an extremely low-noise, high-sensitivity receiver is of questionable value. Of more concern is weather, locale, time of day, and antenna directivity and polarization. However, at higher frequencies, thermal and amplifier noise become the limiting factor in determining good reception.

Defining Noise Figure. We need a quantitative way to express the additional noise contributed by an amplifier. A logical method of rating an amplifier would be to compare the amount of noise power at its output (N_{out}) to the output noise power of an ideal amplifier—one which adds no noise. The output of the ideal amplifier would be the thermal noise input ($N_{in} = kTB$) multiplied by the amplifier gain (G). The ratio of actual noise power to ideal noise power is called the "noise figure" (NF) of the amplifier, and is expressed as $NF = N_{out}/GN_{in}$.

Notice that the more noise power an amplifier adds, the larger is its noise figure. Also, for a perfect amplifier, $NF = 1$.

Noise figure can also be expressed in another highly useful way. Since output signal power (S_{out}) is equal to the product of the input signal power (S_{in}) and the

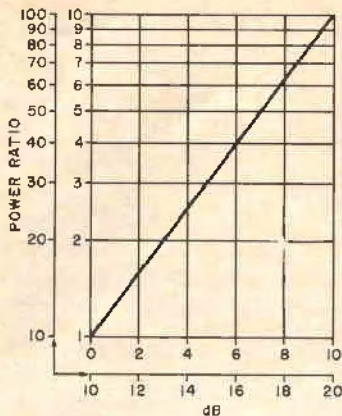

Fig. 2. Use this graph in converting power ratios to decibels. Scales are doubled over.

power gain, we can substitute S_{out}/S_{in} for G in the expression for NF , giving $NF = (S_{in}/N_{in}) / (S_{out}/N_{out})$. This is the ratio between input signal-to-noise and output signal-to-noise; and it makes a reasonable expression since the amplifier, in effect, degrades the input signal-to-noise by adding noise.

Noise figure is a dimensionless quantity and is often expressed in decibels. To convert from the linear quantity to dB, use the expression NF (in dB) = $10 \log_{10} (NF)$; or refer to the graph in Fig. 2. Unless you are skilled in the use of logarithmic quantities, it is wise to convert back to a linear quantity before making calculations.

The signal-to-noise ratio generally accepted in communication equipment is 10 dB, measured at the output of the i-f stage. Some manufacturers may specify a quantity called "signal plus noise to noise" which is simply the signal-to-noise ratio (not in dB) plus one. For example, a $(S + N)/N$ of 10 is the same as a S/N of 9. The input noise power is always assumed to be a simple thermal noise source, $N = kTB$. Substituting $S_{out}/N_{out} = 10$ and $N_{in} = kTB$, then the noise figure is $NF = S_{in}/10kTB$.

If the minimum input signal power needed for a 10-dB S/N is known, the noise figure can be determined. For easy approximations, the nomogram in Fig. 3 has been constructed. For convenience, the nomogram has input signal power specified in terms of voltage (V_{in}) combined with input resistance (R). The S/N output is assumed to be dB and the temperature is $300^\circ K$.

Note that the Institute of High Fidelity Manufacturers (IHF) rating for sensitivity as applied to commercial broadcast FM receivers is not arrived at through quite the same procedure as used here. The IHF values specify a "distortion level" at the audio output, rather than a S/N at the i-f output.

As an example of the use of the nomogram, suppose a receiver has an overall bandwidth of 50 kHz and is rated as having an input sensitivity of 1 microvolt into 50 ohms. Then, on the nomogram, a line is drawn from 50 ohms on the R scale to 1

Fig. 3. This nomogram is useful in determining either noise figure or sensitivity when the other characteristics of the receiver are known.

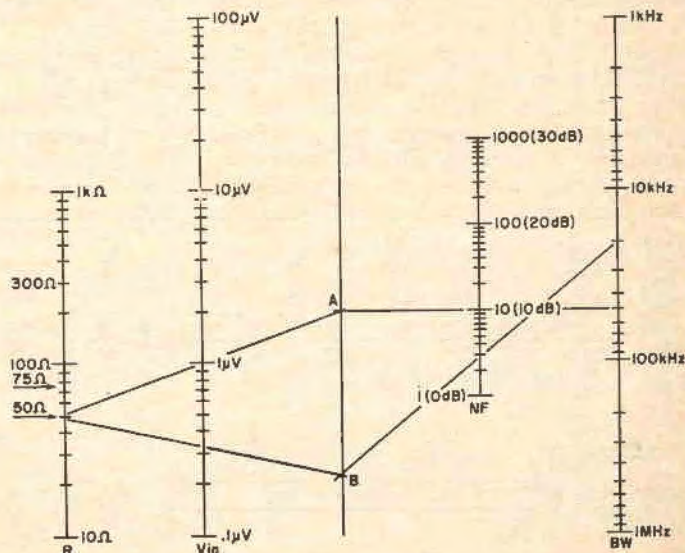

microvolt on the V_{10} scale. This line is then extended until it intersects the unmarked line at point A. Now a line is drawn between this point A and 50 kHz on the bandwidth scale. The second line intersects the noise figure scale at 10. The specifications in this example are characteristic of most AM broadcast band receivers. The r-f bandwidth is made considerably larger than necessary (10 kHz) for simplicity and tuning ease. The 10-dB noise figure is not particularly bad in this case since the prevalence of atmospheric and environmental noise [largely other interfering stations] lessens the need for a sensitive, low-noise receiver.

The nomogram in Fig. 3 can also be used to find sensitivity when the noise figure is known. To illustrate, suppose a CB receiver boasted a noise figure of 3 (4.8 dB) and had a standard 50-ohm input and bandwidth of 20 kHz. A line is drawn from 20 kHz through 3 on the noise figure scale and extended to point B on the unmarked line. Connecting point B with the input impedance of 50 ohms yields a sensitivity of about 0.34 microvolts.

The foregoing example brings up a good point about determining receiver quality. For instance, let's vary some of the receiver parameters while maintaining the relatively good value for noise figure of 4.8 dB. If we decrease the bandwidth to 3 kHz (about that required for SSB), the sensitivity becomes 0.13 microvolt. If just the output impedance were changed—to 300 ohms—the sensitivity would be about 0.80 microvolts. If we changed the bandwidth to 200 kHz and R_{in} to 300 ohms, the "good" sensitivity would become about 2.5 microvolts. The obvious question at this point is: Just which value is really good? Well, since 4.6 dB is a fairly good value for noise figure, we can safely say that these are all good sensitivities. It is

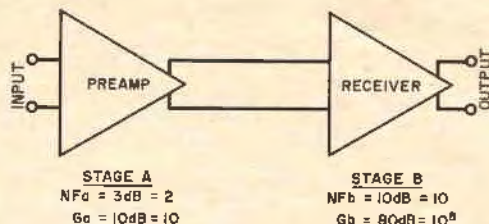

Fig. 4. Preamplifier stage can be added between receiver and antenna to lower overall noise figure and improve the sensitivity.

quite apparent that voltage sensitivity is not a very reliable standard for comparing quality. A much more sensible measure would be noise figure, with r-f bandwidth and input impedance for reference.

We have seen how noise figure is related to receiver sensitivity. Now, let's consider ways of lowering the noise figure for an existing receiver system.

Adding a Preamp. The overall noise figure of a system may be significantly improved by the addition of a low-noise, high-gain preamplifier. Suppose a receiver has a noise figure of 10 dB and a gain through the i-f output of 80 dB. We want to improve the sensitivity by adding an r-f preamp connected at the antenna input. The preamp has a noise figure of 3 dB and a gain of 10 dB. The layout of the system is shown in Fig. 4. The bandwidths of the two stages are equal. The overall system noise figure is then: $NF = NF_a + (NF_b - 1)/G_a$. All values are linear quantities [not in dB]. For the values given above, the NF turns out to be 2.9, or 4.6 dB, a considerable improvement over the original value of 10 dB.

Notice that the effect of the preamp's gain has been to reduce the receiver's contribution to the overall noise figure. If the preamp had had a gain of 20 dB, the overall noise figure would have been 2.09, or about 3.2 dB. The higher the

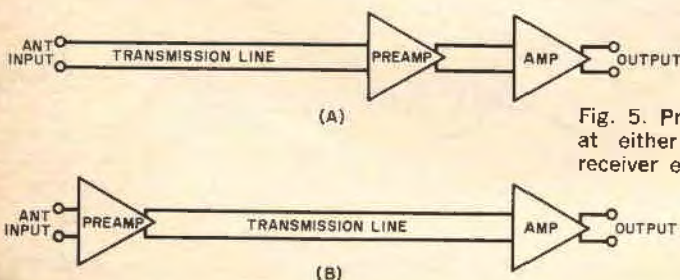

Fig. 5. Preamplifier can be connected at either the antenna end or the receiver end of your receiving system.

MEASURING NOISE FIGURE

Noise figure measurements are really quite simple to make with the proper equipment: a noise generator/noise figure meter. This instrument reads out noise figure directly on a meter. However, it is a specialized piece of equipment and not readily available to the average experimenter.

An approximate value of noise figure can be found using a conventional r-f signal generator whose impedance matches the receiver's input. Connect an r-f meter (ac voltmeter, dB meter, or power meter) to the receiver's i-f output. With the r-f generator off, adjust the receiver's controls for a convenient reading on the output meter. Then turn the r-f generator on, turn to the center of the receiver's pass band, and adjust the output control of the generator for twice the original receiver output power (3 dB higher for a dB power meter, 3 dB or 1.4 times the voltage on an ac voltmeter.)

The input power from the signal generator is now equal to the effective noise input due to the receiver. Note the r-f generator's output by reading an output meter or an r-f voltmeter and calculate noise figure using the following equation:

$$NF = E_g^2(2.5 \times 10^{20})/BR_g$$

where E_g is rms voltage output of the r-f generator, R_g is the output resistance of the r-f generator, and B is the receiver's bandwidth in Hz.

Note that if the receiver has noise limiting or automatic gain control circuits, they will have to be disconnected.

preamp gain, the closer the system noise figure approaches that of the preamp.

To find the exact effect that adding a preamp has on the sensitivity, the bandwidths of receiver and preamp as well as the desired S/N ratio must be considered. If the receiver in the example were a typical FM tuner, a reduction in noise figure from 10 to 2.9 might represent an improvement in sensitivity of as much as 2.3 microvolts.

After the decision has been made to add a preamp to a receiving system, one must determine the proper location for the preamp in relation to the rest of the system. Any practical receiving system must, of course, include an antenna and a length of transmission line. The attenuation of the transmission line can effectively add noise to the system, to an extent

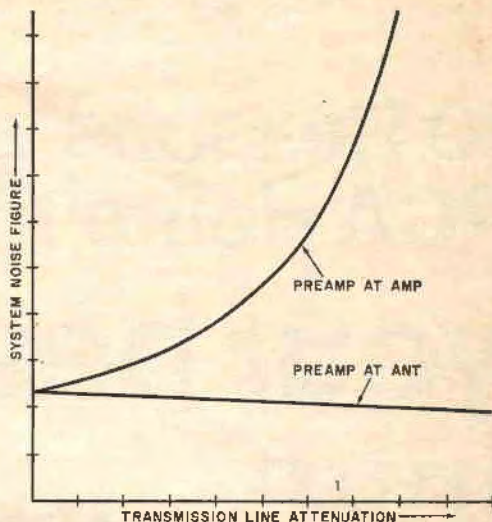

Fig. 6. Graph of system noise figure versus transmission line attenuation for receiving system with different preamp locations.

determined primarily by the placement of the preamp.

Because of the environmental noise picked up by an antenna, it is not practical to employ an "overall system noise figure" to compute the actual output S/N ratio for a given received signal. However, by replacing the antenna with a matching resistance, we can use expressions for the system NF to determine optimum system configuration. Two basic configurations for a simple system are shown in Fig. 5. The detailed calculations for the two are beyond the scope of this article, but the graphical presentation in Fig. 6 shows which is better. For this typical system, the noise figure actually decreases slightly for an increase in attenuation if we connect the preamp at the antenna. Furthermore, if the preamp cannot be located at the antenna, it is imperative that cable loss be as small as possible. Otherwise, the system NF will be too great to tolerate. Of course cable loss must be kept small in any case, since the receiving system must have enough overall gain to produce a usable signal power output.

In this article, we have seen how receiver sensitivity is always tied in with receiver noise, and we have shown how this noise is produced and measured. The effect of adding a low-noise preamp stage has also been covered. ♦

10 Reasons why RCA Home Training is your best investment for a rewarding career in electronics:



Performing transistor experiments on programmed breadboard — using oscilloscope

1 LEADER IN ELECTRONICS TRAINING

When you think of electronics, you immediately think of RCA... a name that stands for dependability, integrity, and pioneering scientific advances. For over half a century, RCA Institutes, Inc., a subsidiary of RCA, has been a leader in technical training.

2 RCA AUTOTEXT TEACHES ELECTRONICS FASTER, EASIER, ALMOST AUTOMATICALLY

Beginner or refresher, AUTOTEXT, RCA Institutes' own method of programmed Home Training will help you learn electronics more quickly and with less effort, even if you've had trouble with conventional learning methods in the past.

3 WELL PAID JOBS ARE OPEN TO MEN SKILLED IN ELECTRONICS

RCA Institutes is doing something positive to help men with an interest in electronics to qualify for rewarding jobs in this fascinating field. There are challenging new fields that need electronics technicians... new careers such as computers, automation, television, space electronics where the work is interesting and earnings are greater.

4 WIDE CHOICE OF CAREER PROGRAMS

Start today on the electronics career of your choice. On the attached card is a list of "Career Programs", each of which starts with the amazing AUTOTEXT method of programmed instruction. Look the list over, pick the one best suited to you and check it off on the card.

5 SPECIALIZED ADVANCED TRAINING

For those already working in electronics or with previous training, RCA Institutes offers advanced courses. You can start on a higher level without wasting time on work you already know.

6 PERSONAL SUPERVISION THROUGHOUT

All during your program of home study, your training is supervised by RCA Institutes experts who become personally involved in your efforts and help you over any "rough spots" that may develop.

7 HANDS-ON TRAINING

To give practical application to your studies, a variety of valuable RCA Institutes engineered kits are included in your program. You get over 250 projects and experiments and as many as 22 kits in some programs. Each kit is complete in itself. You never have to take apart one piece to build another. They're yours to keep and use on the job.

8 FCC LICENSE TRAINING—MONEY BACK AGREEMENT

Take RCA's Communications Career program—or enter with advanced standing and prepare immediately for your 1st, 2nd, or 3rd class FCC Radio Telephone License examinations. RCA Institutes money-back agreement assures you of your money back if you fail to pass the FCC examination taken within 6 months after completing the course.

9 CONVENIENT PAYMENT PLANS

You get a selection of low-cost tuition plans. And, we are an eligible insti-

tution under the Federally Insured Student Loan Program.

10 RCA INSTITUTES IS FULLY ACCREDITED

RCA Institutes is an accredited member of the National Home Study Council. Licensed by N. Y. State—courses of study and instructional facilities are approved by the State Education Department.

**VETERANS: TRAIN
UNDER NEW GI BILL**

SEND ATTACHED POSTAGE PAID CARD TODAY! FREE DESCRIPTIVE BOOK YOURS WITHOUT OBLIGATION!

If reply card is detached, send this coupon today.

RCA INSTITUTES, INC.,
DEPT. 694-111-1
320 W. 31 ST.
NEW YORK, N. Y. 10001

Please send me FREE illustrated career catalog. I understand that I am under no obligation.

Name _____

Address _____

City _____

State _____ ZIP _____

Age _____

Veterans: Check here

Construction of Multimeter.

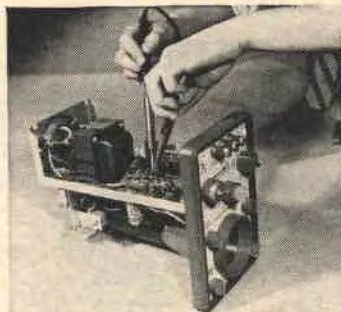
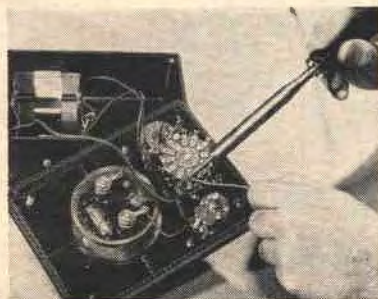

Construction of Oscilloscope.

Temperature experiment with transistors.

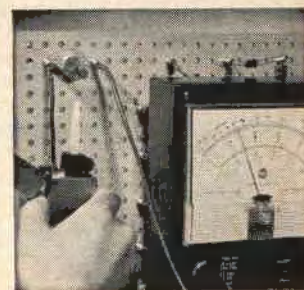

RCA

CAN AN AMPLIFIER TUBE HAVE ZERO TRANSCONDUCTANCE?

or—How Slim and Mho Got Together

BY JOHN T. BAILEY

“WELL, Slim,” said Joe, the shop owner, to his technician. “now that you have that diploma from your electronics’ course, do you feel that you are fully qualified to cope with the technical problems in this business? But, wait! Before you say ‘yes’ to that question, let me warn you that I have a test I would like for you to struggle with.”

“Go right ahead,” answered Slim with assurance. “If it is a reasonable test for a beginner, I’ll handle it all right.”

“Don’t worry about that. The test involves a very basic concept that your instructor must have explained early in your studies. Here’s the problem: Suppose you connect the plate of a triode to a power supply, with a milliammeter

in the plate circuit, and the grid to an adjustable bias supply. What happens when you vary the grid bias? That’s a simple question, isn’t it?”

Slim responded quickly. “The plate current changes as the bias is varied. Everyone knows that a change in grid bias changes the plate current.”

After an ominous pause, Joe said, “Are you sure, Slim? Don’t you want to think over what you just said?”

“Of course not,” retorted Slim. “Let me say it again. A change in grid bias changes the plate current. That’s what transconductance is all about. If one volt change in grid bias causes the plate current to change 10 mA then the transconductance is 10,000 micromhos. If the plate current didn’t change at all, the tube would have zero transconductance, and that’s impossible. If you want more proof, look at a family of plate characteristic curves for a triode. For a fixed plate voltage, a change in grid voltage changes the plate current. Right?”

“Well, before I mark you wrong, let me ask another question. Suppose this same triode is connected to a current-regulated power supply instead of to a conventional fixed voltage supply. As you probably know, a current-regulated supply puts out a constant current re-

This constant-current source uses a pentode whose screen and control grids have their voltages fixed. Varying the 6AU6 cathode potentiometer controls the current flowing in the series circuit. The 100K pot is used for demonstrating the constant-current effect.

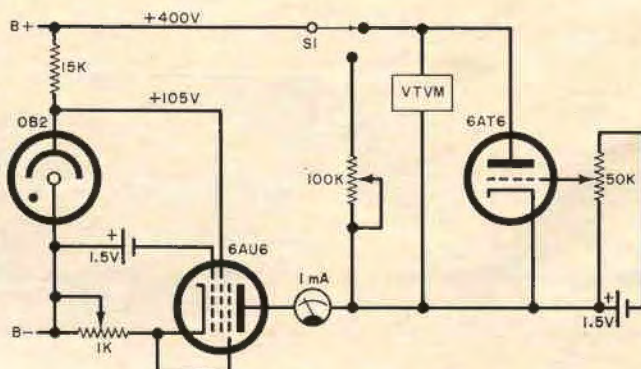

ardless of the load connected to it. Now, suppose you vary the triode's grid bias. What happens?"

Slim looked thoroughly puzzled. Then, he remarked, "The poor tube must be completely frustrated. A change in its grid bias should change its plate current, but the current-regulated supply won't let the current change. It's like the irresistible force and the immovable object."

"OK," said Joe. "Think it over while you are out on this house call. The lady says her new TV won't turn on."

"Does she have it plugged in?"

"Yes, she does. Now hurry up. I will trust you not to stop at the school lab and breadboard this problem to find out what happens. When you get back, I hope to have it hooked up here so your education can be polished up."

"But we don't have a current-regulated power supply," Slim pointed out.

"I'll make one," said Joe. "Now get going."

When Slim returned, it was obvious from his expression that he hadn't figured out whether the plate current would change or not. To forestall the embarrassment a little, he reported that the lady couldn't turn on her new TV because it had a pull-push type of on-off switch; and she had upset all the linearity, hold, and size control adjustments trying to find the way to turn on the set.

"Well," queried Joe, "what is your conclusion?"

"Frankly, I don't know," confessed Slim. "If I guess at it, you will want to know why I concluded one way or the other, and I can't think of any explanation for either case. I suppose, as in most impasses, the answer will have to be a compromise. The plate current will change just a little. Is that right?"

"I'll let you decide after you try it out with this breadboard hook-up," Joe countered while he sketched the circuit.

"First, I hooked up a 6AU6 to give us a constant current of 1 mA. You know that the plate current of a pentode with sharp cutoff is almost constant if the screen and control voltage are held fixed. This holds true for plate supply voltages above about 100 volts. This cathode potentiometer lets me adjust the current to a convenient figure—say 1 mA—and it also provides some compensation to

offset the very slight increase in plate current that occurs with an increase in voltage. Notice that the screen is tied to 105 volts across the OB2 gas regulator tube. The grid bias is provided by a 1.5-volt dry cell, and the plate supply is 400 volts from our power pack. In checking this circuit out, you will find that the milliammeter reads a fairly constant 1 mA when the plate load is varied from 0 to 100,000 ohms. Now, let's replace the plate load with a 6AT6 whose grid voltage can be varied from -1.5 to 0 volts by means of a pot across another dry cell. Now, my perplexed friend, vary the bias on the 6AT6 grid and watch the milliammeter. You will find the solution to your impasse."

Slim twisted the pot from one extreme to the other and exclaimed, "The plate current didn't change a bit!" Then he added, "But I still don't know why."

"Maybe this will help," Joe offered. "Connect your VTVM across the 6AT6 and see what happens to the plate voltage when you vary the bias."

Slim did this and noted that, as the grid bias was reduced from -1.5 volts to zero, the plate voltage went down from about 175 volts to about 50 volts.

"Now, what does that tell you? Does changing the bias of a triode actually change the plate current as you so confidently told me earlier?" asked Joe.

Slim pondered the question for a long moment, and then the light dawned. "How stupid can I be! A change in grid voltage doesn't change the plate current at all. It changes the plate resistance, and when the tube is connected to a fixed voltage supply, the changed plate resistance causes a change in plate current. Good old Ohm's Law.

"And, when the tube is connected to a constant-current supply, the plate voltage changes as a result of a change on the grid because the changed plate resistance times the constant plate current means the voltage is different. Good old Ohm's Law again! Joe, thanks for straightening me out. I was taught that changing the grid voltage changes the plate resistance; but, since tubes are invariably connected to fixed voltage supplies, I guess I fell victim to the general and incorrect impression that the grid voltage always affects the plate current. This is one lesson I'll remember." ♦



PART I—
BOOKS ON COMMUNICATIONS

THE ELECTRONICS BOOKSHELF

SOME PERSONAL EVALUATIONS AND RECOMMENDATIONS
FOR BUYING ELECTRONICS BOOKS

BY CARL C. DRUMELLER, W5JJ

BUYING BOOKS devoted to electronics is no easy task nowadays—if it ever was. There are literally thousands of volumes published annually in the United States alone, covering every subject area at every level. To make matters worse, every topic has been covered and covered again so that there are almost as many approaches to each subject as there are authors.

With the multitude of electronics books currently available, it is disappointing to find that there are no really definitive guidelines to help the buyer in making intelligent choices. Advertising and catalog descriptions—usually the only means by which a prospective buyer comes to know about books without visiting a book store—are often incomplete and misleading. So, where does one go to find out which books are “best”?

In any given area of electronics, the best books are usually those which have

been around awhile. These books, periodically updated and rereleased in numbered editions (some are updated annually), are usually old-time favorites that have withstood the test of time.

In this two-part story, we will discuss some of our favorite books. In this first part, attention is focused on radio communication books for amateur and commercial radio. Part II (which will appear next month) will be devoted to books on the technical school level, dealing with electronics in general.

At first glance, the number of different books suitable for the study of radio communication seems almost limitless. But by paring away the very specialized books, a great many titles are removed from the list of possible choices. In the titles remaining on the list we find many old favorites.

The first series of books to be discussed are concerned with amateur (or

ham) radio communication. This group is subdivided into handbooks, study guides for license preparation, guides for assembling ham stations, construction project manuals, etc. Very few, however, deal with the important subject of station operation.

For the person with a budding interest in ham radio and who wants to find out more about it, there are three inexpensive books which will help him to decide whether or not he wishes to get involved in the hobby. They are all softcover books. The titles are: *How To Become A Radio Amateur* (\$1.00); *101 Questions And Answers About Amateur Radio* (\$2.95); and *So You Want To Become A Ham* (\$4.50).

How To Become A Radio Amateur starts off with a discourse on the lure of ham radio to people in all walks of life. It takes up a small amount of theory, just enough to acquaint the reader with what he'll be expected to know should he decide to push on for his license. This is followed by directions for building a simple receiver and low-powered transmitter. The book also provides information on obtaining a license, learning code, setting up a station, and getting on the air.

A different approach to ham radio is employed by the authors of *101 Questions And Answers About Amateur Radio*. This book anticipates questions that might be asked and supplies satisfactory answers. Although its publication date is 1968, the information this book contains is still valid. The book tells what amateur radio is and—of equal importance—what it isn't. Being an amateur, as contrasted to becoming a ham, is given more thorough treatment than you will find in most books. Hence, this book emphasizes getting on the air through discussions of operating procedures, handling message traffic, participating in local and national clubs and organizations, and the various public service aspects of ham radio.

So You Want To Become A Ham gives an excellent presentation of amateur radio. It leads off with the usual background information, telling the reader how to get his license, how to buy equipment, and how to get on the air. A unique feature of this book is its comparison between radiotelegraphy and radiotele-

phony, giving a brief description of each. Safety is stressed, and test procedures are outlined. Operating the ham station is given outstanding treatment, making this possibly one of the best ham radio books available.

Another series of books dealing with ham radio concentrates on preparing the reader to take and pass the various FCC licensing exams. Some of the books are concerned with only one class of license (Novice, General, Advanced, or Extra Class). Most, however, cover all classes since much of the information is common to all classes, differing only in degree of detail.

Again, three titles come highly recommended: *Radio Amateur's License Manual* (\$1.00); *Amateur Radio Advanced Class License Study Guide* (\$6.95); and the rather expensive *Electronic Communication* (\$12.00). The last book is concerned with both amateur radio and commercial radio communication.

The *Radio Amateur's License Manual*, though the most economical booklet, is one of the most valuable guides around. Much of its value accrues from the frequency of its revisions: with every pertinent change in FCC regulations, the manual is updated to assure that the reader will not be confused by obsolete and/or incorrect material. One unusual feature of the manual is that it describes the format of the FCC exam form and gives advice on procedures for marking answers. Information is given on the procedures for modifying and renewing licenses, portable and mobile operation, and for complying with operational requirements. Thirty pages are devoted to rules and regulations.

Although it is titled *Amateur Radio Advanced Class License Study Guide*, Jim Kyle's book is suitable for use in preparing for Technician, Conditional, and General Class license exams. The material in this guide is based on the 51 study guide questions provided by the FCC. The questions are grouped into ten subject areas, each of which is given a thorough explanation. The object is to provide a smoothly coordinated discourse on the whole subject. The style of writing is chatty and the reading is easy; yet the exposition is thorough. The text goes deeply into theory in a manner that

leaves the reader thinking that he has been exposed to only casual reading.

A third approach to the preparation for a radio operator's license is presented by Robert L. Shrader in his *Electronic Communication*. This book is well worth its high \$12 cost by virtue of its thorough treatment of every aspect of each subject introduced. It smoothly accomplishes the formidable task of schooling the reader to prepare him for securing every grade of operator license offered by the FCC—both amateur and commercial! This is accomplished without "snowing" the reader who is interested in a Novice Class license and without boring the experienced technician who is preparing for his commercial Radiotelephone First Class Operator License.

Electronic Communication begins with basic topics, making no assumptions that the reader knows anything about the subject. At the end of each chapter in the book there are questions relating to the FCC exams and/or just plain review questions. The FCC exam questions are for commercial operator licenses; those for amateur radio licenses are grouped near the end of the book. Math questions do not exist as such; math explanations in the text are given only as a means of backing up or clarifying the narrative. And no math beyond high school level is used.

This author recommends two of the many handbooks published for general use by hams, technicians, and engineers. They are *The Radio Amateur's Handbook* (\$4.50) and *Radio Communication Handbook* (imported from Great Britain, \$12.95). Both books are outstanding in their own rights.

The *Radio Amateur's Handbook*, cur-

rently in its 48th Edition, has long been a standard reference for radio amateurs, and its total sales puts it at the top of the list of all-time best selling technical publications. To achieve such a rating, the Handbook has provided a complete blanketing of amateur radio technology. Individual chapters treat the specialized phases of theory, construction, and operation. Throughout the Handbook, liberal and effective use is made of photos, drawings, graphs, and tables.

This is a unified handbook, devoting detailed attention to both theory and practice and providing construction and fabrication directions. There is a limited amount of information given about the operating procedures to be followed in the legal and ethical operation of a ham station. In all, if one were to master completely all of the technical knowledge put forth in this Handbook, he would be a very talented electronics technician and a superior ham.

Going one step further into amateur radio technology, the *Radio Communication Handbook* published by the Radio Society of Great Britain ranks as an outstanding manual for radio amateurs and hobbyists who are interested in understanding construction projects, and for technicians concerned with almost any phase of electronic communication. An outline of the subjects treated in this book would be quite similar to that of *The Radio Amateur's Handbook* mentioned above. But there is a difference: the *Radio Communication Handbook* goes into greater depth and detail. This is evident not only in the theory explanations but in the instructions for building equipment as well.

Few American publications give the precise details that are customary in

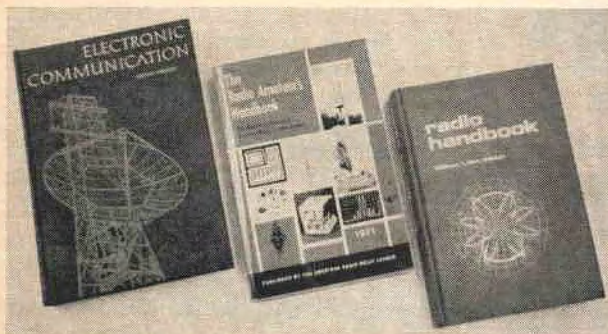

Among the best of volumes that are devoted to commercial, amateur, and general electronic communications, these books are noted for in-depth coverage.

PUBLISHERS & SUPPLIERS

American Radio Relay League (ARRL),
225 Main St., Newington, CT 06111
Comtec Book Div., Box 592, Amherst,
NH 03031
Editors and Engineers, Ltd., New Au-
gusta, IN 46268
McGraw-Hill Book Co., 330 West 42 St.,
New York, NY 10036
Rider Publications, 116 West 14 St.,
New York, NY 10011
Howard W. Sams & Co., Inc. 4300 West
62 St., Indianapolis, IN 46268
Tab Books, Blue Ridge Summit, PA
17214
D. Van Nostrand Co., Inc., 120 Alex-
ander St., Riverside, NJ 08540

British magazines and handbooks. But even among the British publications, *Radio Communication Handbook* is remarkable for the pains taken to omit no information that could be of use to the reader. (We have also found the "Radio Handbook" by Wm. I. Orr, published by Editors and Engineers, Ltd., a worthy addition to the electronics bookshelf.—Editor)

It is not feasible to discuss books on every specialized area in electronics. However, among those people interested in radio communication, there is heated interest in VHF and SSB topics. Two good books on the topic of very-high frequencies (VHF) are the *VHF Handbook* (\$2.95) and the *Radio Amateur's VHF Manual* (\$2.50). Each gives excellent treatment to the subject. The material presented is authoritative, avoiding questionable "fad" projects that diminish the worth of almost every "how-to" book currently available. It would be difficult to make a choice between these two books, although the *Radio Amateur's VHF Manual* offers more pages for less money. But at these prices, it is worthwhile to buy both books.

Single Sideband (SSB) transmitters have become the standard for ham radio communication; yet there is less general understanding of its principles and practices than once was common for the formerly universal double sideband with carrier transmitter. Many books have attempted to amend this situation. Only a few have succeeded. The best recognized book on SSB is *Single Sideband Principles And Circuits* (\$14.95) written by au-

thors of unquestioned technical capability. The reading of this book is not light; the reader is assumed to be an earnest student of the art. But what the reader learns is beyond doubt the most authoritative explanation of SSB available.

Studying for the several grades of commercial radiotelegraph and radiotelephone operator licenses can be through either the question-and-answer (Q & A) approach or by perusing general theory, law, and applications. The former is justified only when the manual is used as a vehicle for review of material already

RADIO COMMUNICATION BOOK TITLES

- How to Become a Radio Amateur** (ARRL). Soft cover. 95 pages.
- 101 Questions and Answers About Amateur Radio** (Sams) by Bourne, Brown & Sands. Soft cover. 112 pages.
- So You Want to Become a Ham** (Sams) by Robert Hertzberg. Soft cover. 183 pages.
- Radio Amateur's License Manual** (ARRL). Soft cover. 100 pages.
- Amateur Radio Advanced Class License Study Guide** (Tab) by Jim Kyle. Hard cover. 189 pages.
- Electronic Communication** (McGraw-Hill) by Robert L. Shrader. Hard cover. 682 pages.
- The Radio Amateur's Handbook** (ARRL). Soft cover. 610 pages text, 32 pages tables.
- Radio Handbook** (Editors and Engineers, Ltd) by Wm. Orr. 896 pages.
- Radio Communication Handbook** (Comtec) (Radio Society of Great Britain). Soft cover.
- Radio Amateur's VHF Manual** (ARRL). Soft cover.
- Radio Amateur's VHF Handbook** (ARRL). Soft cover.
- Single Sideband Principles and Circuits** (McGraw-Hill) by Pappenfus, Bruene & Schoenike. Hard cover. 382 pages.
- The Radio Manual** (Van Nostrand) by Sterling & Monroe. 900 pages.
- First Class Radiotelephone License Handbook** (Sams) by Edward M. Noll. Soft cover.
- Radio Operating Questions and Answers** (McGraw-Hill) by Hornung & McKenzie. Hard cover.
- Radio Operator's License Q and A Manual** (Rider) by Milton Kaufman. Hard cover.

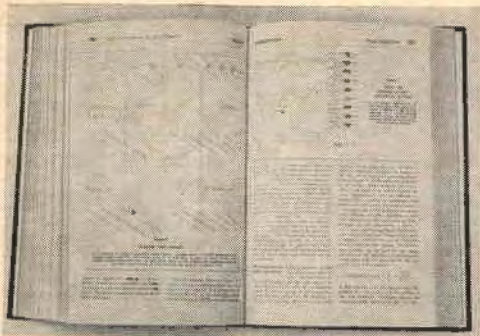

Best books ("Electronic Communication" shown) use many illustrations to support text.

known. Used otherwise, they tend to encourage memorization and not true learning.

For the self-study handbook, one book has enjoyed a well-earned reputation since its first edition in 1928. Updated at intervals, *The Radio Manual* is a book for serious study. The tone of the text is a bit ponderous, but the depth of subject treatment and scope of text rank it as one of the most effective sources of application techniques and exam preparation. Just about everything is covered from theory to FCC Rules and regulations to the International Telecommunications Union treaty commitments of the U.S. This is a handbook that will be well-thumbed long after its owner has acquired his commercial "ticket."

In the less expensive soft-cover category, Edward M. Knoll's *First Class Radiotelephone License Handbook* (\$4.95)

offers much the same material as is presented in the more expensive hard-cover manual but in a somewhat more condensed version. The style of writing is lighter and the reading is easier as a result. Good use is made of diagrams and sketches. This book is both a handbook and a Q & A "cramming" guide, combining the better features of each.

In the purely Q & A category, there are two hard-cover books that share top rating: *Radio Operating Questions And Answers* and *Radio Operator's Q & A Manual*. Each of these books is very thorough in its treatment of the subject; the answers are unstinting with words and explanatory diagrams and graphs. Both books cover commercial radiotelephony equipment and practices, related power equipment, test equipment and practices, ship radar, and the laws and regulations relating to equipment operation. The first book also includes a section on aircraft telegraphy operation and a very extensive appendix—quite outstanding in value to any radio operator.

No evaluation of any of the smaller books that deal with only one class of commercial license is given above. All of the information needed for Third, Second, and First Class Radiotelephone license preparation is included in the books mentioned and is usually presented in a better manner. Studying such manuals as those already mentioned does away with time lost in traversing topics common to each class of license.

(Watch for Part 2, *General Theory and Hobby Books*, next Month.)

EDITOR'S NOTE

Inescapably, any assessment of the value of a book is affected by the background, biases, and opinions of the evaluator. The recommendations and evaluations presented in this two-part story are no exceptions to that rule. However, they are based on 40 years of the author's active participation in electronics. This participation includes involvement as an amateur radio operator, commercial radio operator, Signal Corps Communications Officer, electronics engineer, instructor in a technical institute, and manager of a technical bookstore. The biases may be there, but experience is a good tutor.



What Makes the TRANSISTOR Tick?

UNDERSTAND TRANSISTORS WITHOUT MATH

BY ROBERT B. WOOD

THE TRANSISTOR is, without a doubt, the most important component known to modern electronics technology. It can be found, in discrete form or as one of many transistors in integrated circuits, in every electronic device that typifies our modern technology. The sophistication of electronic computers, communications and telemetry systems, electronic diagnosis equipment in medicine, and many consumer items can be traced directly to the transistor.

But as complicated in use as the transistor appears to be, understanding its physical makeup and how it operates is really simple. What frightens most beginners to the study of solid-state devices is the high technical and mathematical levels most tutorial works employ in explaining the devices. Many times, a better understanding of transistor theory can be obtained from a nonmathematical treatment—a device employed in the following pages.

Germanium and silicon are the basic crystal materials from which all transistors are made. Because they have most

of the properties of metals, which conduct electricity from one point to another in the conductor, but under ordinary circumstances are nonconductive in the manner of insulators, germanium and silicon are borderline substances. They are, consequently, neither conductors nor insulators according to the common definitions.

In nature, an atom containing four electrons in its outermost electron ring is a stable, or electrically inert, structure. Since electrons are the primary current carriers in the conduction of electricity, it is easy to see that any atom with a full outer electron ring is, by definition, an insulator, incapable of giving up an electron to serve in the current carrying process.

In their pure states, germanium (Ge) and silicon (Si) crystals are electrically inert and behave in the manner of an insulator. However, Ge and Si can be transformed into current carriers simply by adding minute amounts of impurities to the pure crystalline substances through a process known as "doping." The addition of impurities does not by any means transform Ge and Si into good conductors

in the manner of metals such as silver and copper. Instead, the doped crystals behave like a poor conductor, conducting only small amounts of current. Hence, they have come to be termed semiconductors.

To understand why a semiconductor does not perform in the traditional manner of a conductor, it is best to compare it to copper, the second-best conductor available. Each copper atom has only one electron in its outer ring. This electron is loosely bound to the nucleus of the atom and, under electrical influence, is relatively free to wander as a conductor of current. In Ge, on the other hand, due to the privileged electron of the impurity, there may be only one so-called "free" electron per million atoms.

Now, when a copper conductor is subjected to electrical influence, electron swarms are free to circulate. This is not true when a doped Ge or Si crystal is subjected to the electrical influence. Although the free electrons do circulate, there are no dense swarms of them since they are very few and far between.

The type of impurity added to the pure Ge and Si crystal determines whether the semiconductor will be n- or p-type. Although the following analysis will focus attention on Ge, it should be understood that the discussion applies equally well to Si.

To make n-type Ge, which has electrons as the principal current carriers, a small amount of arsenic or phosphorous (to mention just two elements currently in use) is scattered throughout the crystal. Each of these impurities has five electrons in its outermost electron ring. Now, if only four electrons are required for a stable electron configuration, arsenic and phosphorous have one extra electron apiece left over for current-carrying purposes.

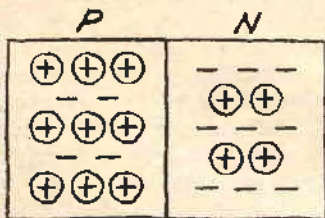

Fig. 1. Typical pn junction representation.

The p-type Ge, on the other hand, has impurities such as boron, aluminum, or indium added. In the uncharged state, each of the impurity elements has only three electrons in its outermost ring. So, to attain stability, it must "borrow" an electron from a neighboring Ge atom.

Once the Ge atom gives up an electron, it has one more proton in the nucleus than there are electrons in the electron rings. Hence, it becomes a positive charge

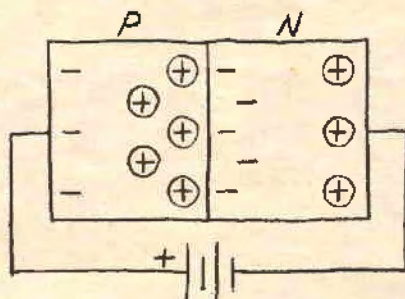

Fig. 2. Pn junction is shown forward biased.

known as a "hole." The word "hole" derives from the fact that there is a vacancy in the Ge atom into which electrons can fall.

From our discussion thus far, it is easy to see that in p-type Ge, holes are the principal current carriers. (Although in reality it is the electron that carries the current; but the holes appear to do the moving.) In the n-type Ge, electrons are the principal current carriers.

The simplest semiconductor device, the diode, can be represented by the diagram in Fig. 1. The diode consists of a sandwich of n- and p-type material. Where the two types of material touch, we have a junction which is responsible for providing both transistor and diode action.

The hole carriers, which are circled plus signs, predominate in the p-type material. The electron carriers, which are represented by minus signs, predominate in the n-type material. Note that in both types of material, the current carriers are in a pronounced minority.

With no voltage applied to the diode, no voltage difference exists between the two types of material and the current carriers stay put. Now, connect a battery across the diode as shown in Fig. 2, and observe what happens.



Fig. 3. Supermarket checkout counter can be used to explain "hole" flow in a transistor.

The positive pole of the battery repels the holes and attracts the electrons in the p-type material. Likewise, the negative pole of the battery repels the electrons and attracts the holes. The repelled charges move toward the junction where some of the holes and electrons combine and become neutral Ge atoms. For every atom thus "neutralized," an atom in the p-type material loses an electron to the positive pole of the battery and begins a migration toward the junction.

With the battery connected to the diode as shown, the semiconductor is forward biased. In this condition, the continuous hole replacement and drift toward the junction process makes up the current flow. The process will continue until the battery is disconnected or it runs down.

As mentioned earlier, holes are only apparent current carriers. It is the electron that still carries the current through the semiconductor material to provide current flow. During the interchange, no atom of Ge leaves its place in the crystal.

To simplify the process of hole movement, let us make an analogy to a supermarket checkout station. In Fig. 3, we see four customers at the checkout counter. One customer has already checked and vacated the position in front of the cashier, thus creating a hole. The next customer moves up to the counter, in turn, creating a hole behind him, and so on down the line until all four customers

have moved up one position. The checkout counter remains where it is, just as the Ge atom remains put in the semiconductor. Only the customers have moved, just as only the electrons in the semiconductor move. The vacated space made by each customer as he moves up only appears to have moved, just as the holes in the semiconductor appear to move.

With the hole movement problem cleared up, let us reverse the polarity of the battery to obtain the setup shown in Fig. 4. Here, the holes attracted by the negative post of the battery move away from the junction in the p-type material, and the electrons attracted by the positive post of the battery move away from the junction in the n-type material. No current flows, and the semiconductor is said to be back, or reverse, biased, allowing a minute amount of current to flow in the reverse direction. If an alternating voltage were applied to the junction instead of dc, the current would flow each time the junction is forward biased and cease when the junction is reverse biased.

In a vacuum tube rectifier, half of the ac cycle is neatly and cleanly eliminated because of the large distance between the anode and cathode of the tube—compared with the contact made between the n and p parts of a semiconductor diode. In the latter, the minute reverse current flow resulting from the privileged carriers does not allow complete rectification. A small portion of the unwanted half cycle gets through, but it does not hamper effective rectification and, in most cases, can be disregarded.

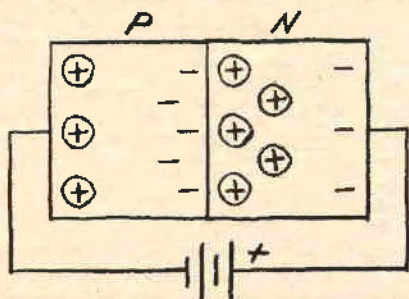

Fig. 4. Junction is shown in reverse bias.

The transistor can be viewed as two diodes connected back-to-back as illustrated at the upper left in Fig. 5. Each diode consists of a block of n-type and a block of p-type material (remaining drawing at top of Fig. 5). In the transistor, the center block is shared by each of the outer blocks in turn to make up the diodes.

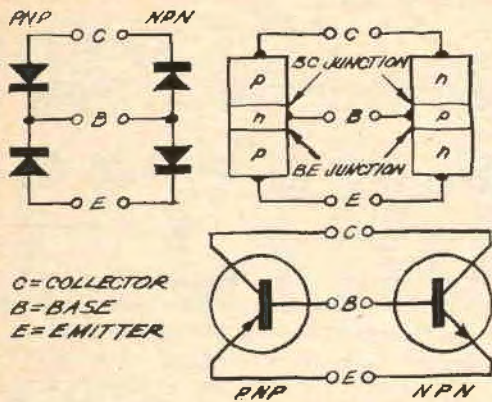

Fig. 5. Three methods of drawing transistor.

There are two basic types of transistors. One is an npn with a block of p-type material sandwiched between two blocks of n-type material; the other is a pnp, with two blocks of p-type material separated by a block of n-type material. Schematic symbols for each type are shown at the bottom of Fig. 5. Note that in the schematic representations the arrow on the emitter always points toward the n-type material (direction of hole flow)—toward the base in the pnp transistor and away from the base, or the emitter itself, in the npn transistor.

The center block in the transistor is known as the base, while the outer two blocks are the emitter and collector. In the practical transistor, the base is much thinner than are the emitter and collector blocks. This is done to aid in the amplifying ability of the transistor.

In Fig. 6, we see both types of transistors connected in amplifier configurations. In both cases, the base-emitter junction is forward biased in the direction of easy current flow, while the base-collector junction is reverse biased to oppose the free flow of current. Hence, the emitter and collector are said to be connected series aiding, with control of the majority carriers from the former to the latter directly dependent on the base drive.

Bear in mind that the transistor is a

current amplifier. This means that a base drive signal in the form of a voltage must first be converted to a current by passing it through base resistor R_B . Once converted to a current and applied to the base, it allows current to flow across the base-emitter junction. The current traversing the junction is limited by the value of R_B and the level of the potential supplied by input drive battery B_1 . As long as current circulates through the base-emitter junction, there will be current flow through both junctions.

The collector current, resulting from the flow of majority carriers from the emitter through the base, is many times larger and directly proportional to the base current that initiates it. Because the base region is narrow, most of the carriers moving through the emitter and into the base are propelled into the collector. In practical transistors, 92-99 percent of the carriers from the emitter reach the collector. Hence, almost all of the current from the emitter flows through the collector (on the order of hundreds of milliamperes), while it is controlled by a very small base current (usually on the order of only tens or hundreds of microamperes). That's amplification!

The amount of current that flows through the collector is controlled by the degree to which the base is biased by B_1 (our base-drive signal), the collector potential supplied by B_2 , and the load resistor R_L . If we fix the value of R_L and the voltage of B_2 and substitute a variable-voltage input signal for B_1 , we can easily vary the output from zero to maximum. Hence, it is possible to use the amplifier for audio and r-f purposes.

The output signal from the amplifier is in the form of a voltage. As the current passes through the transistor and R_L it causes a voltage drop across each. The voltage drop across the transistor, from emitter to collector, is the output signal. It is necessary for R_L to be in the circuit so that a voltage drop can be developed across the transistor. ♦

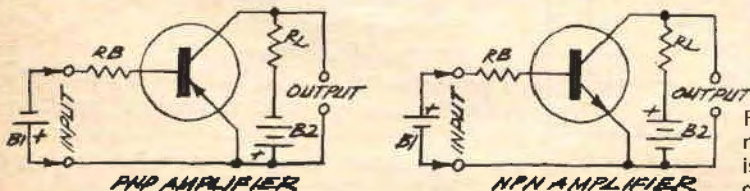

Fig. 6. Biasing arrangement for npn transistor is same as for pnp, except battery polarities.

SCR COMBINATION LOCK

SIMPLE CIRCUIT
OPERATES
ON 12 VOLTS

BY DAVID E. FAHNSTOCK

LOCK THE DOOR and throw away the key! With an electronic combination lock, you never have to worry about losing the keys or locking them inside. All you have to do is remember a five-number combination. What's more the combination lock described here needs only a 12-volt supply so it can be used on your car or boat with no attachments or problems. The circuit of the lock is unusually simple and uses silicon controlled rectifiers for trouble-free operation.

The basic system, whose schematic is shown in Fig. 1, uses only five pushbutton switches for 120 combinations. However, you can easily add to the circuit to provide for more combinations (720 for six pushbuttons, 5040 for seven, etc.). The combination can be changed easily and quickly if you think someone has learned what it is.

In addition, the system is timed so that, even if the first number is chosen correctly, the rest of them must be chosen within 3 seconds (which can be adjusted) or the process must be started over again.

Theory of Circuit Design. The circuit of the combination lock is essentially five SCR's in series, with the last SCR in the chain controlling a relay. The chain is controlled by a UJT timing circuit and "feedback" from the relay.

When switch *S1* is operated, its normally open section turns on SCR2 and it latches in. With SCR2 on, there is a potential of about 12 volts across R7, with the junction of R7, C3 and SCR2 negative. This voltage is applied to the timer circuit, charging C2 through R4 and C3 through R5. Capacitor C1 also starts to receive a charge through R1, and when this charge is sufficient, Q1 starts to conduct, producing a positive going spike across R2. If the relay is de-energized, its normally closed contacts are in series with SCR1. Thus, the positive spike from Q1 causes SCR1 to turn on. The resistance of R4 is too high to permit enough current to flow through SCR1 to latch it in. However, sufficient current is supplied by the charge on C2 to maintain the latch until C2 is discharged.

While C2 is discharging, a voltage is developed across R5 which is added to that across C3. This causes the anode of SCR2 to be at the same potential as its cathode, turning it off. Since SCR2 is the first in the SCR chain, which it turns off, the complete chain is disabled.

When the various switches are operated before the Q1 circuit runs out of time, the relay is energized. This simultaneously applies power to the external circuit and opens the cathode circuit of SCR1. Thus, as long as the relay is energized, SCR1 cannot turn off the chain

PARTS LIST

C1—15- μ F, 25-volt electrolytic capacitor
 C2—10- μ F, 25-volt electrolytic capacitor
 C3—6- μ F, 25-volt electrolytic capacitor
 K1—12-volt dpdt dc relay
 Q1—2N2646 or HEP310 unijunction transistor
 or
 R1—150,000-ohm, $\frac{1}{2}$ -watt resistor
 R2, R5—270-ohm, $\frac{1}{2}$ -watt resistor
 R3—470-ohm, $\frac{1}{2}$ -watt resistor

R4—100,000-ohm, $\frac{1}{2}$ -watt resistor
 R6, R8, R10, R12, R14—1000-ohm, $\frac{1}{2}$ -watt resistor
 R7, R9, R11, R13—10,000-ohm, $\frac{1}{2}$ -watt resistor
 S1-S5—Spdt pushbutton switch
 SCR1-SCR6—Silicon controlled rectifier (GE C106Y2 or C106Y1, or Motorola HEP320)
 Misc.—14-conductor cable (may be made from individual wires), suitable mounting plate for switches, mounting for PC board, power relay (optional)

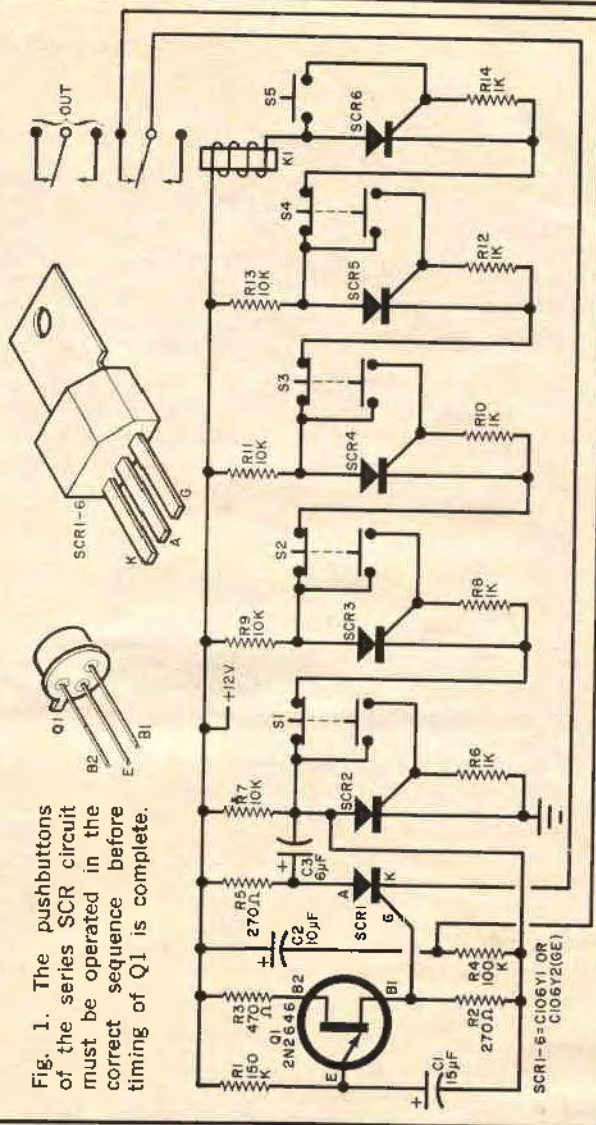

Fig. 1. The pushbuttons of the series SCR circuit must be operated in the correct sequence before timing of Q1 is complete.

even though Q1 keeps generating pulses.

To reset the alarm, any switch other than S5 is operated. For example, if S3 is depressed, the series circuit is broken and SCR5 and SCR6 are turned off, de-energizing K1. This enables SCR1 to operate at the next UJT pulse.

Construction. The circuit is assembled on a printed circuit board whose foil pattern is shown in Fig. 2, which also shows component layout. Install the semiconductors carefully and observe the polarities of the electrolytic capacitors. Use a heat sink (such as long nose pliers) on

the leads of the semiconductors when soldering and use a low-power (35 watts) soldering iron.

In the prototype, the printed circuit board and the switch plate were built as two separate units, interconnected by a length of multi-conductor cable. In this way, the electronics board can be hidden, with only the pushbuttons available for use. The pushbuttons can be arranged in any configuration—as long as you know which is which. The combination can be changed by changing the positions of the switches. The combination shown in the prototype is 1-4-3-2-5.

Although the pushbutton panel is mounted in the open, the actual control board should be hidden from view. If higher control power is needed, the output relay can be used to operate a power relay.

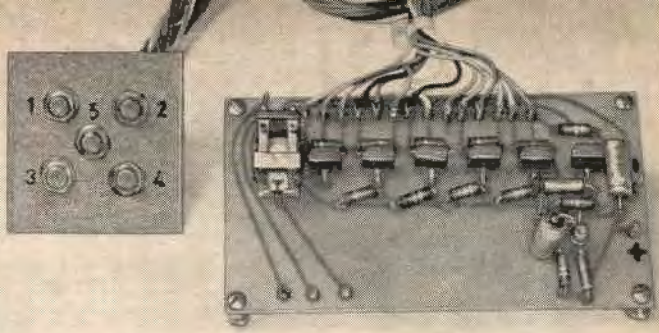

If you want to decrease the 3-second timing for completion of the combination, reduce the value of R1 or C1. To make the time longer, increase the value of either of the two components.

The relay used can be any 12-volt type requiring low coil current. If the existing contacts will not carry sufficient current

for your needs, use an external relay activated through the contacts of the relay on the board.

The lock described here was designed for use with a 12-volt battery. However, if you want to use it on the 117-volt commercial power line, a simple 12-volt dc supply can be added. ♦

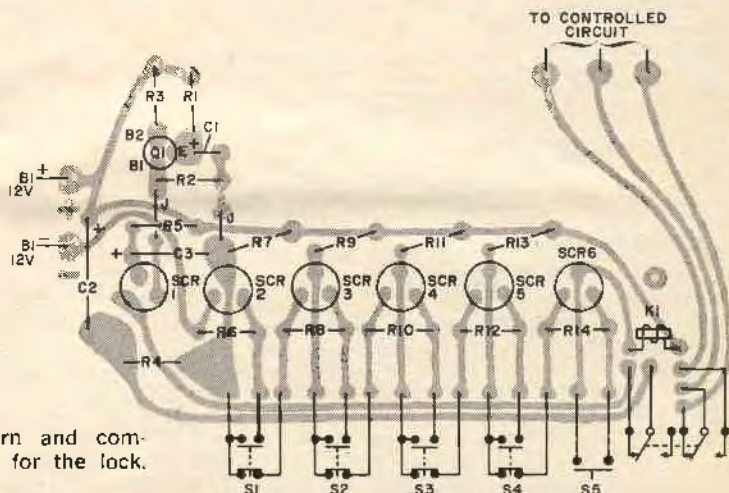
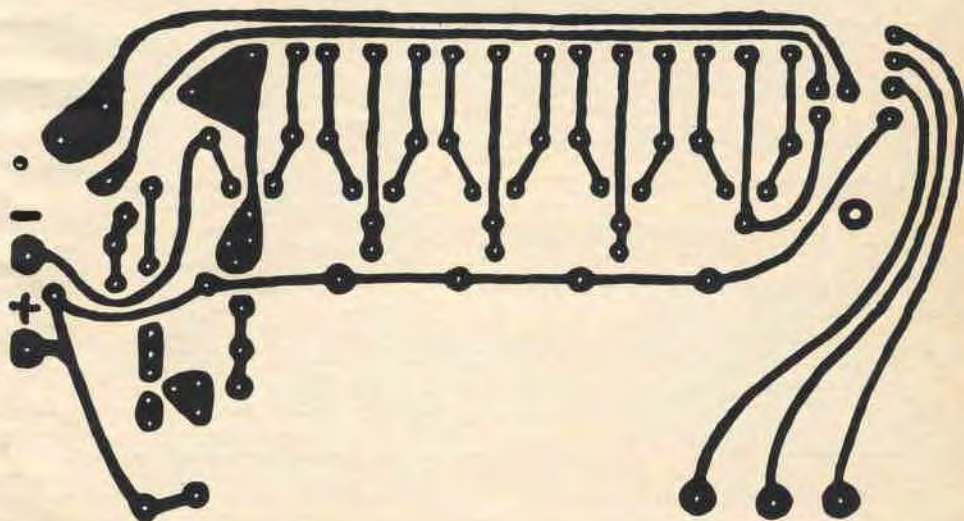

Fig. 2. Foil pattern and component installation for the lock.





How to prepare for today's competitive job market, tomorrow's new opportunities in electronics

Competition for jobs and promotions is severe in the electronics industry today. But experts say that exciting new electronic products will create thousands of new jobs in the next few years.

One thing is certain: in good times or bad, the best opportunities come to the man with an advanced, specialized knowledge of electronics. He has a better chance of survival in a recession and will profit more in times of prosperity than the man with ordinary qualifications.

But how can you get the additional education in electronics you need to protect your future—and the future of your family? Going back to school isn't easy for a man with a job and family obligations.



College Credits for CREI Students

Recently CREI affiliated with the New York Institute of Technology for the express purpose of making it possible for CREI students to earn college credits for their studies. The New York Institute of Technology is fully accredited by the Middle States Association of Colleges and Universities and is chartered by the New York State Board of Regents.

For the many CREI students who are not interested in college credits, but simply in improving their knowledge of advanced electronics, this affiliation with NYIT will provide additional assurance of the high quality of CREI home study education.

If you want to know more about earning college credits for CREI study, check the appropriate box when you mail the postpaid card for complete information on CREI Programs.

CREI Home Study Programs offer you a practical way to get more education without going back to school. You study at home, at your own pace, on your own schedule. And you study with the assurance that what you learn can be applied on the job immediately to make you worth more money to your employer.

You're eligible for a CREI Program if you work in electronics and have a high school education. Our FREE book gives complete information. Mail postpaid card for your copy. If card is detached, use coupon or write: CREI, Dept. E1211B, Wisconsin Ave. & Tilden St., Washington, D.C. 20016.

Founded 1927

CREI

Accredited Member of the National Home Study Council



Free book tells all about CREI programs. For your copy, tear out and mail postpaid card or write: CREI, Dept. E1211B, Wisconsin Ave. & Tilden St., Washington, D.C. 20016

CREI, A Division of the McGraw-Hill Continuing Education Company

Dept. E1211B, Wisconsin Ave. & Tilden St., Washington, D.C. 20016

Please mail me free book describing CREI Programs. I am employed in electronics and have a high school education.

Name _____ Age _____

Address _____

City _____ State _____ Zip Code _____

Employed by _____

Type of Present Work _____ G.I. Bill

- I am interested in College credit for CREI study Space Electronics
 Electronic Engineering Technology Computers Industrial Electronics
 Nuclear Engineering Technology Electronics Systems Engineering
 Non-technical course in computer programming CATV Engineering

APPROVED FOR TRAINING UNDER NEW G.I. BILL

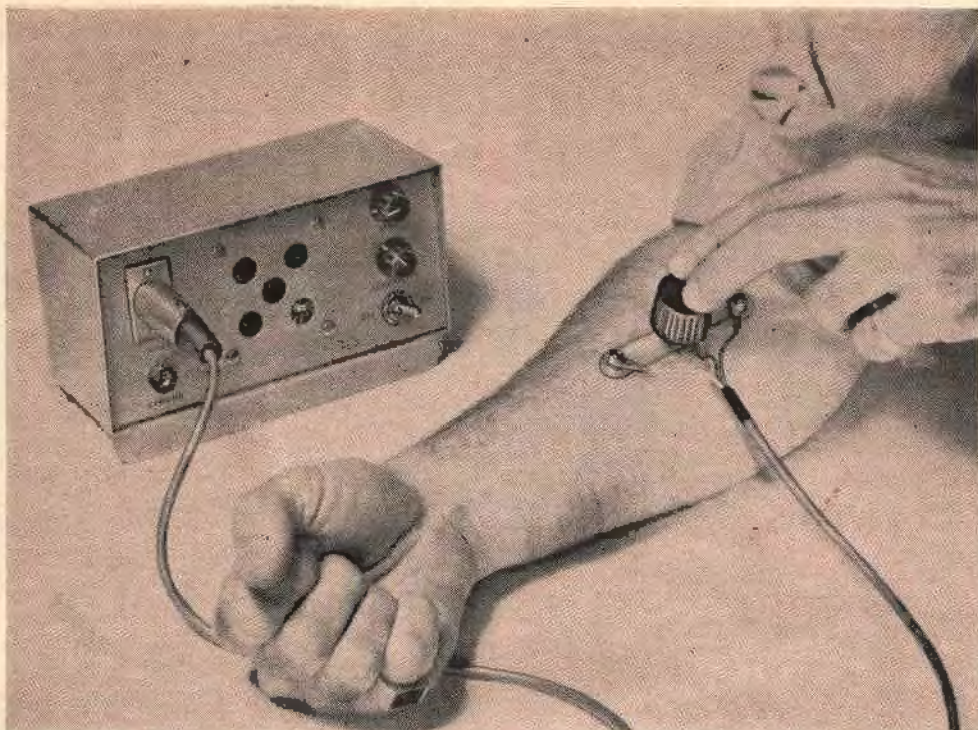

Build the Muscle Whistler

LISTEN TO YOUR BICEPS DO THEIR THING

BY HARRY GARLAND
AND ROGER MELEN

There are 656 muscles in the human body and all of them generate a small voltage potential when they are activated. This voltage, called myoelectricity or EMG, is present on the surface of the skin surrounding the muscle. The detection of this signal is important in both clinical medicine and medical research.

Reaction time, for example, can be measured by noting the time lag between a stimulus and the onset of EMG activity. Audible EMG monitoring has been used experimentally in training athletes—it has been hypothesized that athletes can learn complicated, coordinated muscle skills faster by listening to their muscles during training.

The Muscle Whistler, described here, can monitor many of the muscles in the body, producing a whistling tone each time a muscle is activated. Try it, for instance, with the electrodes on the biceps

muscle (upper arm) and lift a heavy object. Signals can also be picked up with the electrodes on the triceps (back of upper arm) when you try to push something. The flexor muscles (on the front of the lower arm) are active when you clench your fist, and the gastrocnemius muscle (in the calf of the lower leg) is active when you stand on your toes. You may be surprised to hear muscle activity even when you think a muscle is relaxed. This is called "muscle tone" and is characteristic of all muscles.

Whether you listen to the Muscle Whistler to monitor the force generated by your muscles, measure your reaction time, or improve your golf swing, this project will provide an entertaining introduction to an important area of medical electronics.

Construction. The circuit of the Muscle

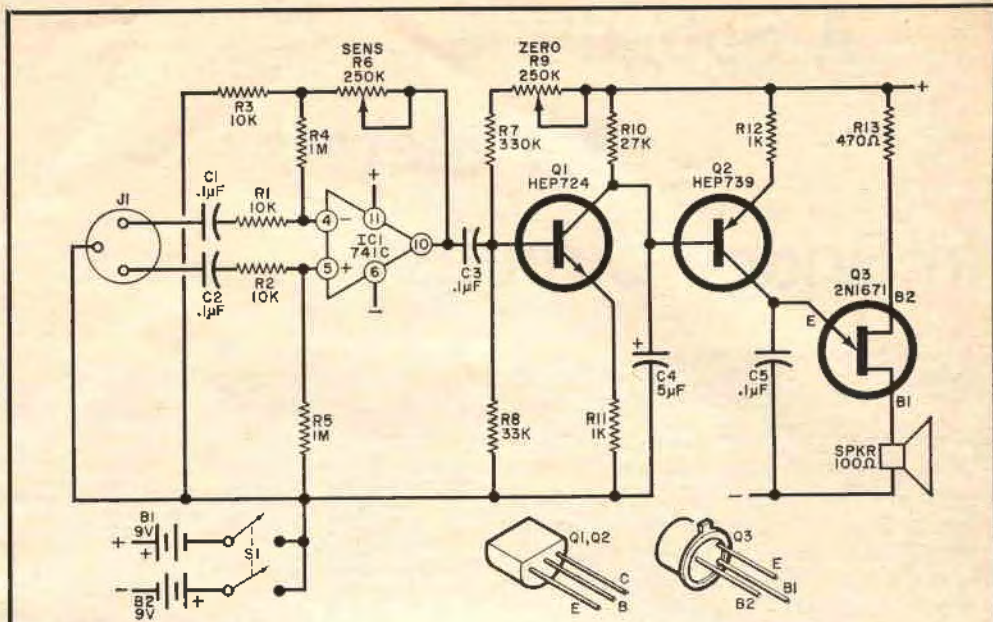

Fig. 1. Essentially, the skin voltage signals applied to the op amp high-gain differential amplifier control the frequency of the UJT.

PARTS LIST

B1, B2—9-volt battery
 C1-C3, C5—0.1- μ F disc capacitor
 C4—5- μ F, 15-volt electrolytic capacitor
 IC1—Operational amplifier (Fairchild μ A741C)
 J1—Three-pin microphone connector
 Q1—Transistor (Motorola HEP724)
 Q2—Transistor (Motorola HEP739)
 Q3—2N1671 transistor
 R1-R3—10,000-ohm resistor
 R4, R5—1-megohm resistor
 R6, R9—250,000-ohm potentiometer

R7—330,000-ohm resistor
 R8—33,000-ohm resistor
 R10—27,000-ohm resistor
 R11, R12—1000-ohm resistor
 R13—470-ohm resistor
 S1—Dpst slide or toggle switch
 SPKR—100-ohm speaker
 Misc.—Battery connectors, battery mounting clips, knobs (3), IC socket (optional), three-lead cable, plastic strip for electrodes, solder lugs (3), electrode hardware, perf board, component clips, etc.

Whistler is shown in Fig. 1. The prototype was built on a piece of perf board, though any other method may be used. The components are mounted on small clips, except that a 14-pin dual in-line socket may be used for the IC if desired. The input connector (J1), the speaker, the zero and sensitivity potentiometers (R9 and R6, respectively), and the on-off switch (S1) are mounted on the front panel of the selected chassis.

A conventional three-lead microphone jack with an associated three-lead microphone connector and a few feet of three-lead cable are used to connect the muscle electrodes to the circuit.

The electrodes are fashioned from two screws mounted 3 or 4 inches apart on a

narrow piece of plastic as shown in Fig. 2. A third screw midway between the other two forms the ground electrode. Solder lugs under the nuts are used to connect the three color-coded leads from the circuit. The center screw is longer than the other two so that a knob, or some other type of handle, can be attached.

Operation. With power applied to the circuit, adjust R9 so that there is no output from the speaker when there is no input signal. The output varies from a whistle down to a series of slow clicks. Adjust R9 until the clicks just stop. With the sensitivity control (R6) turned up
 (Continued on page 103)

A Substitute for Meters in Bridge Circuits

BY ED FRIEDMAN

ONE OF THE MOST common and useful electronic measurement circuits is the Wheatstone bridge (see Fig. 1A). In its usual form, a zero-center microammeter or milliammeter is used to indicate a null when the four legs of the bridge are balanced. There are, however, some disadvantages to this arrangement: the meter face must be relatively large to provide accurate readings, the meter cannot be subjected to much mechanical abuse, and a good-quality zero-center meter is fairly expensive.

If an accurate null indication is all that is required, there is a good, inexpensive way to avoid the zero-center meter. The idea is to use an operational amplifier integrated circuit as a high-sensitivity voltage comparator. The basic circuit is shown in Fig. 1B. Inputs X and Y to the op amp are connected to the same points on the bridge. Polarities are not important. A conventional VOM or VTVM can then be connected to the output of the op amp to indicate when the bridge is balanced (within a couple of millivolts in most cases). The null point is determined by the point that just causes the meter to change indication. The small amount of offset voltage within the op amp can usually be disregarded.

For extreme accuracy, however, a snappable offset voltage can be applied to make this minute correction. To limit the output swing, parallel back-to-back diodes can be connected from the output to the input of the op amp as shown in Fig. 1C. If germanium diodes are used, the swing will be limited to about 0.3 volt; with silicon diodes the swing will be about 0.7 volt.

If you want to eliminate the meter en-

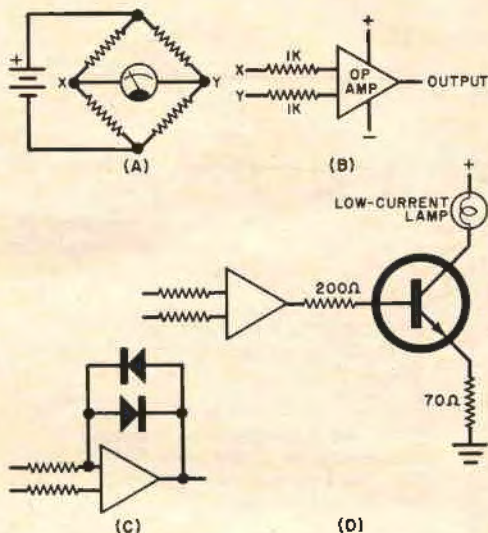

The zero-center meter in the standard Wheatstone bridge (A) can be eliminated by using an op amp as in (B) with a VOM. To limit output swing, two diodes are used as in (C). Circuit (D) eliminates a meter altogether by using another transistor and small lamp.

tirely, a lamp driver circuit such as that shown in Fig. 1D can be used. Any switching transistor, capable of handling the lamp current may be used. The emitter resistor which limits the cold filament current flow is optional. The base resistor limits the output current of the op amp when the transistor saturates. Of course, the lamp may be replaced by a low-current relay to control external equipment. The indication of null occurs just as the lamp changes states—that is, goes from off to on in one direction of the balance; and from on to off in the other direction. ♦

WHEN THE VOLTAGE
DROPS
A LIGHT COMES ON

BY JEFFREY P. HAMMES

VOLTAGE MONITOR

IN SOLID-STATE equipment, the dc supply voltage level is often quite critical. Many times, if the voltage drops below a specific level, the circuit does not operate properly. When a battery supply is used, it is highly desirable to have a means of checking on the voltage level.

Described here is a solid-state, voltage drop-out indicator that has in excess of 110 megohms input resistance so that it will not load the supply. When the supply

voltage drops below a preset level, it will turn on an indicator lamp. It can be built on a small printed circuit board, all parts costing about \$6. Although the indicator is designed to keep tabs on a 12-volt supply, a variety of voltages may be monitored by changing a few resistors.

The schematic is shown in Fig. 1. The circuit is essentially a five-stage dc amplifier using a FET input. When a sufficiently high negative voltage is applied

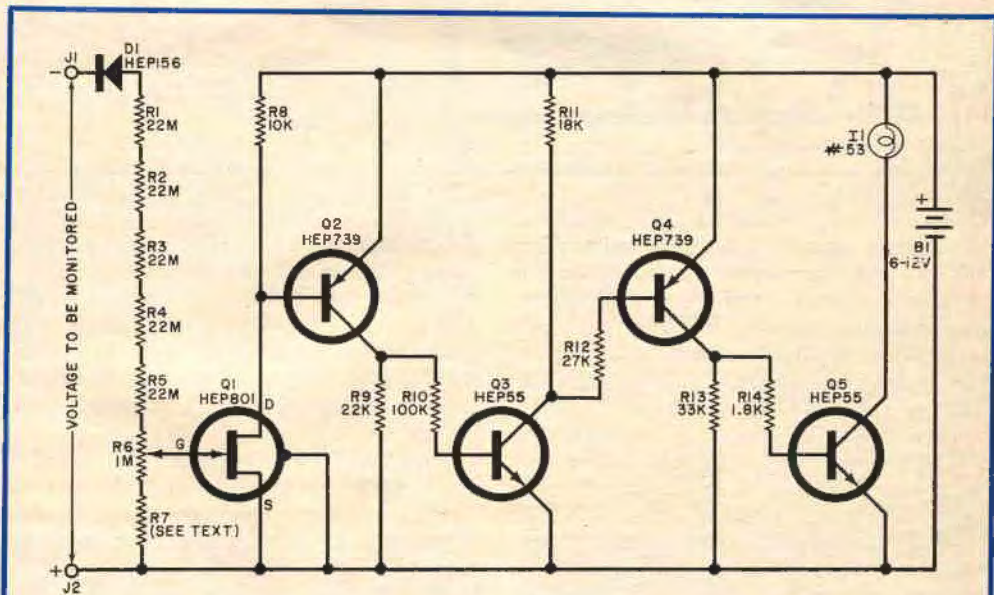

Fig. 1

PARTS LIST

B1—6-to-12-volt battery
D1—HEP156 diode
I1—#53 lamp (see text)
J1, J2—Five-way binding post (one red, one black)
Q1—HEP801 transistor
Q2, Q4—HEP739 transistor
Q3, Q5—HEP55 transistor
R1-R5—22-megohm, ½-watt resistor
R8—10,000-ohm, ½-watt resistor

R9—22,000-ohm, ½-watt resistor
R10—100,000-ohm, ½-watt resistor
R12—27,000-ohm, ½-watt resistor
R13—33,000-ohm, ½-watt resistor
R14—1800-ohm, ½-watt resistor
R6—1-megohm, multi-turn potentiometer (Bourns 3068-P or similar)
R7—See text
Misc.—Suitable chassis, lamp socket, hardware, wire, solder, etc.

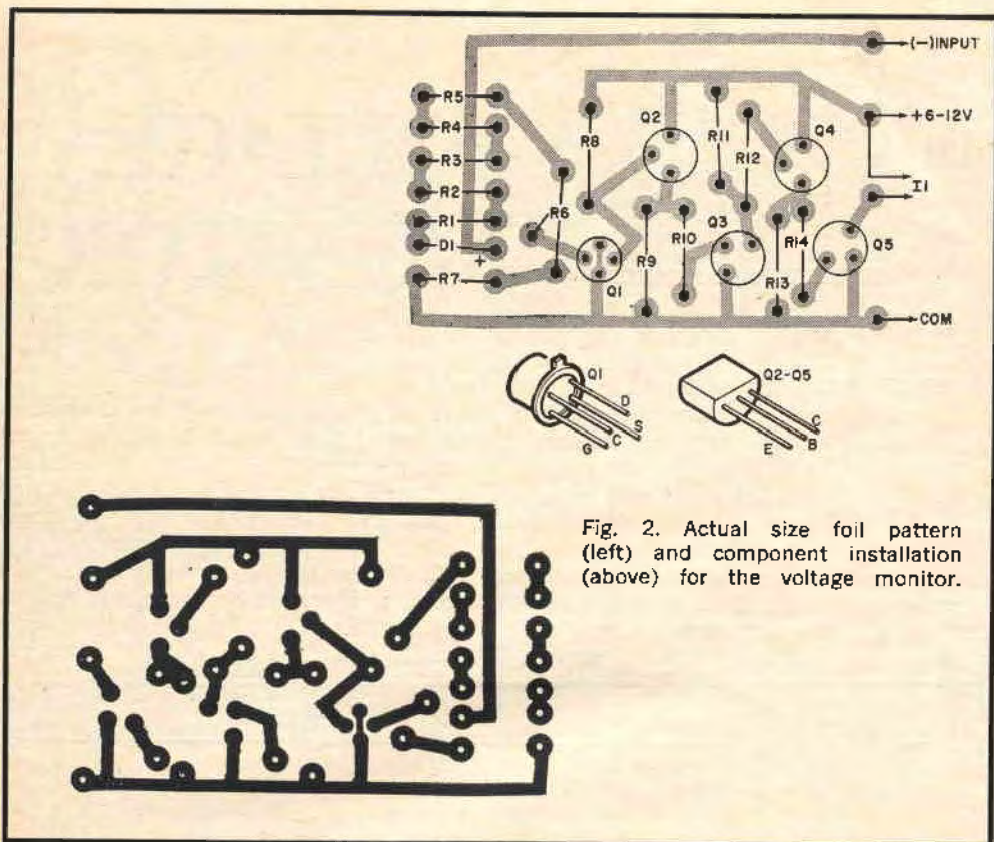

Fig. 2. Actual size foil pattern (left) and component installation (above) for the voltage monitor.

to the gate of the FET, the transistor has a very high resistance. In this case the remainder of the amplifier is cut off and the indicator light is off. When the gate voltage drops below a certain level, the FET turns on—as well as the amplifier and the indicator light.

The switching point (the monitored voltage level at which the circuit changes states) is determined by the voltage divider consisting of R1 through R7, with R6 being adjustable to set the voltage precisely. Diode D1 is a safety device which prevents damage to the FET in case the input voltage is accidentally reversed.

The resistance used for R7 depends on the voltage level to be monitored. With R6 set at the center of its rotation, select a value for R7 so that the indicator lamp can be turned off with just a small rotation of R6. If you are monitoring a voltage less than 10 volts, one or more of the five 22-megohm resistors may be omitted. For a relatively high voltage, you may have to introduce one or more additional 22-meg-

ohm resistors into the divider network. In any case, there should always be some point in the rotation of R6 that causes the indicator lamp to go out. Once R6 is preset so that the lamp just goes out, then any time the monitored voltage drops below the preset level, the indicator will go on.

Note that the monitoring circuit is isolated from the dc source being monitored. Therefore, when using a metal chassis, do not use the chassis as a common ground.

Any type of assembly may be used; and if desired, a PC board such as that shown in Fig. 2 may be used. This illustration also shows the component installation if you make the board. Use care in installing the semiconductors. The indicator lamp used is determined by the battery. The #53 lamp called for in the Parts List is good for a 12-volt battery, but any other low-power indicator lamp may be used as long as the rating is not exceeded. ♦



THE PRODUCT GALLERY

Fifteenth in a Monthly Series by "The Reviewer"

TEAC A-24 STEREO CASSETTE DECK (Hirsch-Houck Lab Report)

Unlike most stereo cassette decks, the Teac A-24 has an input, or source, selector that operates independently of the receiver or amplifier with which the deck is used. There are two high-level inputs—one each for TUNER and LINE—and a low-level MIC input, which also goes to a DIN-type connector located on the rear apron of the deck. The fourth position on the source switch, PLAY, is used when tapes are played back on the A-24.

The recording levels for the two channels are set by adjusting concentric controls and are monitored on two meters on the slanting front of the deck. Playback levels are set by another pair of concentric controls. Recessed into the front of the deck are two miniature jacks for microphones and one for 8-ohm stereo headphones. The remaining input and output jacks are located on the deck's rear apron.

The tape transport controls, piano-key levers, are interlocked to prevent incorrect operation. Normally, the STOP lever must be operated before going from one mode to another, but it is possible to shuttle the tape back and forth by going directly from fast forward to reverse, or vice-versa. The fast forward lever must be held down during operation, but all others latch when depressed, released by operating the STOP lever.

The A-24 has a desirable double-action STOP control. If the tape is stationary, operating the control opens the cassette loading slot to allow removal of the tape. When the tape is in motion, however, depressing STOP brings the tape to a halt and simultaneously disengages the RECORD safety interlock if the deck was in the recording mode. But if the user wishes simply to stop tape motion without releasing the record interlock, he need only depress the PAUSE lever. The STOP lever must be depressed twice when the tape is in motion and the user wishes to eject the cassette; once to stop tape motion and a second time to eject



the cassette. This eliminates the annoying characteristic of most decks which eject the cassette in one operation when STOP is pushed too far.

Another problem encountered in many cassette decks is the lack of mechanical disengagement of the capstan drive when the tape runs out. Many decks shut off the motor at this point, but unless the user remembers to push STOP, there is the risk of developing a "flat" on the rubber drive wheel. Teac has solved this problem by incorporating into the A-24 an automatic, completely mechanical release that is triggered when the tape runs out.

Test Results. We tested the A-24 with TDK SD tape. A 0-dB recording level required an input of 76 mV on the LINE and TUNER inputs and 0.23 mV on the MIC input. The corresponding specification limits issued by Teac are 100 mV and 0.3 mV, respectively.

The output from a 0-dB input level was 0.35 volt (rated 0.3 volt). Distortion was 2.2 percent at 0 dB, and increased at higher levels. But if care is taken not to drive the recording meters into the red zones, there should be no problem with distortion.

The signal-to-noise ratio, referred to 0 dB, tested out at 48.5 dB, typical of the better cassette recorders with low-noise tape. Teac's specification is 45 dB. Stereo cross-talk at 1 kHz was down 34.5 dB, and wow and flutter were 0.18 percent unweighted

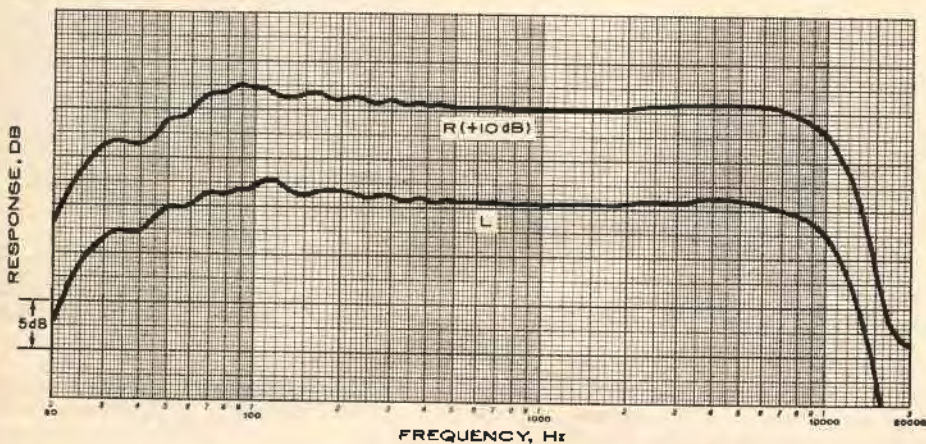
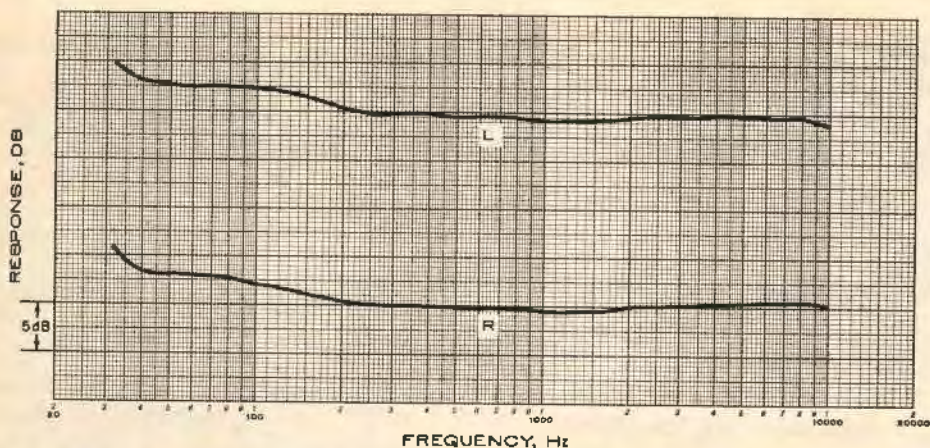

Upper set of curves shows playback response of Teac A-24 cassette deck using BASF cassette; lower curves show overall record/playback response using TDK SD cassette.

(specified at 0.2 percent maximum) using Philips TC-FL3 test tape.

The playback frequency response, with a BASF test cassette, was ± 0.5 dB from 200 to 10,000 Hz, rising slightly at the low end to +5 dB at 32 Hz. Overall record/playback response was ± 3 dB from 30 to 10,500 Hz (rated at 40-12,000 Hz with dB deviation unspecified).

User Comments. The A-24 proved to be a clean sounding cassette deck with a notably low subjective noise level. While we appreciated the double-action STOP control,

we found it a trifle awkward to have to switch the input selector to PLAY in order to listen to a tape we had just recorded. No doubt, after a short time, one would do this automatically.

The mechanical operation of the deck was smooth, and there were no problems connected with its use. Teac suggests using only C-60 and C-90 cassettes with it, a condition with which we concur.

The A-24, including its supplied walnut base, measures 13 $\frac{5}{8}$ " wide by 4 $\frac{1}{4}$ " high by 9 $\frac{5}{8}$ " deep and weighs in at 11 pounds. The price is \$179.95.

Circle No. 92 on Reader Service Page 15 or 99

LAFAYETTE TELSAT 924 CB TRANSCEIVER

The citizen band user with a special interest in monitoring the emergency channel (9) will find a real bonus in Lafayette's Telsat 924. The solid-state, 23-channel trans-

ceiver has a second crystal-controlled receiving section permanently set for channel 9. No matter what other channel may be in use, if there is a signal on channel 9, a light flashes to warn the operator. He can then depress a panel button to listen to the information on channel 9. If the call proves

to be an emergency and he needs further communication on channel 9, he can switch over to the normal transceiver circuits. The system thus provides effective emergency monitoring without disturbing normal operation.

Another feature not usually found is a headphone jack on the front panel to permit reception without being distracted by outside noises and without disturbing others in the room. There also is a phono jack for applying the receiver output to a tape recorder.

The transmitter section employs Lafayette's popular "range-boost" a-f compression system to maintain a high modulating level without introducing distortion. A relatively new facility that is being used on CB units is a meter that is designed to indicate actual r-f power into the transmission line rather than relative output. However, as usual, it also acts as a receiver S meter.

The Telsat 924 also has a full-time noise limiter, variable squelch (individual ones for the normal audio monitor receiver), Delta tune, PA operation for use with an external speaker, AM operation with 5 watts of carrier input, transmit/modulation indicator lamp, built-in front-facing speaker, and operation from a 117-volt ac source (with built-in power supply) or from an external 11.5-to-14.5-volt d-c source. The change requires only substitution of power cords.

The transceiver measures $4\frac{3}{16} \times 11\frac{1}{16}$ " x 8" and is styled as a base-station unit but can be adapted to mobile installation with the mounting brackets supplied. The weight is 8½ lb and a push-to-talk detachable microphone is furnished.

Technical Highlights. Dual conversion is employed for the normal receiver. High image rejection is insured with a first i-f near 11 MHz while selectivity is obtained at a second i-f of 455 kHz, using a mechanical filter. Selectivity is rated at 6 and 8 kHz at the 6- and 45-dB points respectively—close to what we measured. Adjacent channel rejection is 50 dB, and i-f image rejection amounted to more than 80 dB.

A bandpass-coupled circuit at the r-f amplifier input allows a uniform response over the band with a measured sensitivity of 0.5 μ V for 10 dB (S + N)/N. This circuit also improves rejection of out-of-band signals. Bipolar transistors are used at the r-f amplifier and first mixer, and a diode is used in the second mixer.

A problem that often occurs in solid-state CB units is susceptibility to overload, resulting in spurious responses. This can often be minimized by the use of FET's rather than the bipolar transistors used in the Telsat 924, where we found that signals of 1000 microvolts or more on certain channels

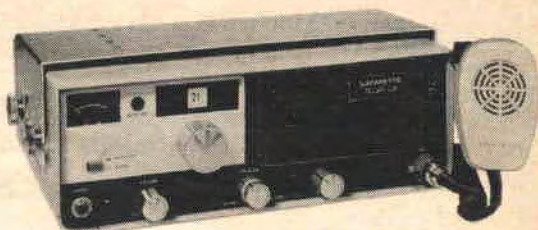

could also be heard at a lower signal level on another channel. Ordinarily this might not be evident, except with signals transmitted from within the immediate vicinity.

The frequency synthesis is obtained by heterodyning the CB signal with one of 12 crystal-controlled frequencies in the 38-MHz range at the first mixer to produce an i-f of 11.310 or 11.250 MHz. The i-f is then converted to 455 kHz at the second mixer by heterodyning with a crystal-controlled frequency of 11.765 or 11.715 MHz. Fourteen crystals are used to provide the necessary oscillator injection signals at both mixers.

Delta tuning, intended for optimizing reception of signals slightly off frequency (within legal tolerances), is set up in an unusual way. Instead of using a variable capacitor to provide a continuous fine-tuning range, the frequency of either the 11.765- or 11.715-MHz crystal in the second mixer oscillator is "rubbered" by switching fixed capacitors in or out to provide a frequency change of 1.5 kHz. Continuous tuning is not needed since the selectivity curve is broad enough to accommodate signals at the intermediate points. Actually, from our experience with most CB operation, the Delta tuning setups are usually superfluous (except for SSB) and seldom used.

The monitor receiver is single conversion with a 435-kHz i-f produced by heterodyning the channel 9 signal with a 27.5-MHz crystal-controlled frequency. A tuned input circuit for the r-f amplifier is coupled to the output of the antenna-input bandpass circuit of the normal receiver. This markedly improves image rejection which turned out to be 37 dB as compared to 12-20 dB usually experienced with single-conversion setups having a 455-kHz i-f. Two i-f stages are transformer coupled and it was found that the adjacent-channel selectivity here was only 32 dB so that a fairly strong channel 10 signal could activate the monitor system.

Each receiver has its own diode detector which also provides agc potential. For the normal receiver, this held the a-f output to within 5 dB with r-f input-signal variations of 80 dB (1-10,000 microvolts). A diode rectifier at the last i-f of each receiver provides a dc potential (relative to the signal level) for operating the S meter. With normal operation, a 100- μ V signal was required to

cause an S-9 reading, while 1 μV produced a reading of S-4.

The pushbutton used for changeover between normal and monitor reception, switches the meter from one rectifier to the other and switches the a-f amplifier from one receiver detector to the other. The a-f amplifying system ends up with a class B output stage.

The squelch for each receiver is an agc-activated type that causes the collector-emitter current of a transistor to alter the voltage drop through a voltage-divider arrangement in the base-base circuit of the first a-f stage. This provides either a cutoff bias to silence the a-f amplifier during no-signal conditions or allows an operating bias for normal amplifier operation.

The monitor-receiver squelch also activates a dc amplifier that drives the monitor indicator lamp which is made to flash by means of a time-constant network.

The squelch for the normal receiver has an adjustable sensitivity range of 0.3 to 100,000 microvolts. With the monitor receiver, a signal of about 1.5 μV was required to open the squelch when set for maximum sensitivity. A 2- μV signal was needed to make the indicator lamp respond. The monitor squelch can be set to lock out signals of up to 10,000 μV .

Transmitter. On transmit the appropriate 38-MHz crystal frequency is combined in a mixer with a crystal-controlled frequency of 11.310 or 11.260 MHz, the difference producing an on-channel signal. A bandpass filter after the mixer minimizes spurious responses. This is followed by an amplifier and driver for the output amplifier. The output circuit is the usual dual-section pi net-

work designed to operate into a 50-ohm antenna load; however, an adjustable loading control makes it possible to work into loads of 30 to 100 ohms. Included is a TVI trap. An unusual twist here is that these circuits are switched from the PA to the bandpass input coupler for the receiver, thus further attenuating out-of-band signals on receive.

Both the drive and the PA stages are modulated using the receiver a-f output amplifier, the preceding a-f stages of which now function as the speech amplifier.

Performance Tests. With our unit, the carrier output power measured 3½ watts on both an external commercial power meter and the transceiver's output-power meter. Note that readings on the latter are accurate only with a 50-ohm load or those presenting an SWR of 1:1. Modulation peaks ran right up to 100% with good waveform—in contrast to the clipped or squared signals usually found. In addition, unlike many CB rigs, the negative peaks did not go beyond 100% and break up the carrier which otherwise could cause splatter. Needless to say, the Telsat 924 thus provides a clean signal while maintaining a good punch.

Excellent signals with crisp quality were experienced both on receive and transmit. Squelch operation was smooth without "plopping." On-the-road tests proved the noise limiter to be quite effective. Although no emergency calls were encountered on channel 9, the associated monitoring setup should be a worthwhile feature, particularly for those especially involved with operations such as REACT.

At the price of \$139.95, the Telsat 924 covers a lot of ground and is a good investment.

Circle No. 93 on Reader Service Page 15 or 99

HEATHKIT MODEL IR-18M 12-SPEED CHART RECORDER KIT

The fact that several instruments previously found only in well-endowed labs are appearing in technician shops exemplifies the direction modern electronics technology has taken in just the last three years. The earliest lab items to filter down to the technician market at vastly reduced prices included the digital frequency counter, the timer, and the volt/ohmmeter. Now there is a precision chart recorder kit in the offing from Heathkit as their Model IR-18M for the budget price of only \$149.95.

Make no mistake about it; the IR-18M is a true precision instrument. Properly calibrated, it can accurately measure voltages over the ranges of 0-1 mV and 0-10 mV, depending on whether or not a jumper wire is in or out of the circuit. To minimize test

circuit loading, a high-impedance input is employed. A three-terminal floating input permits monitoring and measurements when the test circuit and recorder are at different ground potentials.

To eliminate the problems common to mechanical choppers, the IR-18M employs a light-operated modulator. Operating at a frequency of 240 Hz, the modulator greatly reduces the effect of 60-Hz noise. While most chart recorders require an internal reference battery, the IR-18M does not since it utilizes a temperature-stabilized reference voltage circuit. Both coarse and fine zero position controls are featured, allowing the user to set pen positioning quickly and accurately.

The servo drive used for moving the pen across the graphed chart paper functions smoothly and responds quickly. The only sound that can be heard during pen movement is a whir that originates from the

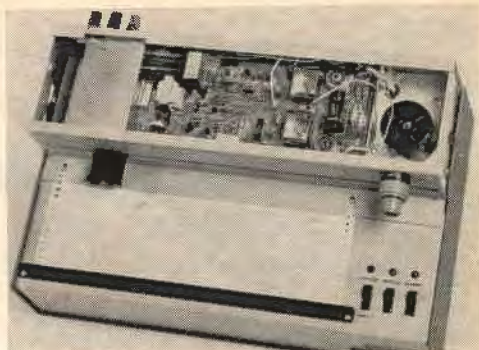
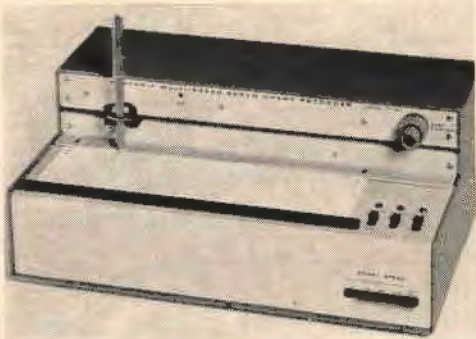

Cabinet of fully assembled chart recorder (above) completely encloses servo amplifier (above right) and the drive motor and digital countdown speed circuit (below right).

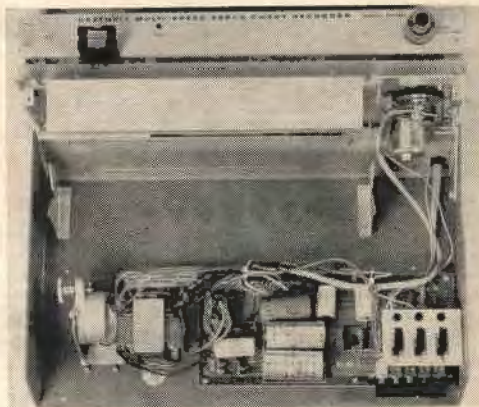

servo motor, and this is barely loud enough to become annoying.

The chart recorder is equipped with 12 speeds and covers a paper movement rate of from 5 s/in. to 200 min/in. Speed selection is provided by a bank of five pushbutton switches located on the front apron. The 60-Hz line frequency is used as a base for the paper drive. And instead of using a mechanical gearing system to provide the different speeds, a digital logic countdown system, in conjunction with a synchronous motor, is employed. Paper travel is, therefore, smooth and as accurate as the line frequency will permit.

The versatile pen holder is designed to accept virtually any writing instrument (Heathkit provides a fountain pen with ink cartridges in the kit, but we recommend a felt marking pen if the slow paper travel speeds are to be used to prevent ink bleed). Three rocker switches are on the paper deck control: chart motor on/off; servo motor and circuit on/off; and power on/off (shuts down power to all circuits and motors in off position).

When fully assembled, the IR-18M encloses all circuits. The pen holder and pen drive circuit housing is hinged to allow quick and easy replacement of the chart roll.

Aside from the usual precautions referring to soldering into place solid-state components—especially with reference to the close spacing between IC leads—building the kit presented no problems. Almost all components in the recorder mount on either the pen drive or paper drive printed circuit boards, both of which are commercial-quality epoxy-glass types. Dealing with the IC's is simplified by the fact that they do not themselves have to be soldered into place; instead, they plug into specially designed

pin clips which solder to the PC board foil pattern.

Mechanical assembly is as easy to perform as is the wiring. Some special care seems to have been taken to make certain that all metal members properly line up without having to stress the pieces to get them together. The whole kit, from start of assembly to finish of calibration, should not take the experienced kit builder more than 12 hours to complete while working at a leisurely pace. This is due mainly to the fact that the assembly/operating manual is up to the usual Heath excellence.

Since the chart recorder is, in its own way, almost as versatile as an oscilloscope, it would be difficult to enumerate the many uses to which it can be put on a workbench or in a laboratory. But to give some idea of its versatility, it is worthwhile here to note that the IR-18M can be used to monitor time-variant dc voltages directly and, with the aid of suitable transducers, to measure and monitor temperature changes, variations in light intensity, velocity, rpm, position, and frequency. Unlike an oscilloscope, however, the chart recorder provides a permanent record of all tests and measurements made. ♦

Circle No. 94 on Reader Service Page 15 or 99



Fifteenth in a Monthly Series by J. Gordon Holt

I REGRET that time does not permit me to answer all of our readers' letters individually, but ones of general interest I will try to answer from time to time in this space.

Dear Mr. Holt:

I have been following your monthly columns in PE ever since they started, and I must say I've enjoyed most of them. I am bothered, though, by your preoccupation with the kind of equipment that few of us can even find in the stores, let alone afford if we could find them. Certainly it is a lot of fun to read about thousand-dollar preamplifiers and two-thousand-dollar loudspeakers, but what good is that kind of reading for someone who must make do with a seventy-dollar preamp and a pair of ninety-nine-dollar speakers? I know I still don't have the best possible system. I want to step up to better components, and I am in a buying mood these days, but your columns tell me nothing about what to buy.

Why not pay some attention to us budget-strapped shoppers?

Norman Ogilvy
Atlanta, Ga.

You must have missed a column. I did devote a whole piece to the art of buying a champagne system on a beer budget (December 1970). Generally, though, you're right; I don't pay much attention to middle- or low-cost equipment, and for several reasons. First, a lot of it is unabashedly mediocre, and each model frequently differs so much from its competition in the character of its sound that it is almost entirely a personal matter which set of colorations a buyer will want. The stuff has to be matched to the buyer, because while buyer A can ignore boomy bass to enjoy a natural-sounding presence range, buyer B can't stand boom no matter how the presence-range sounds.

Secondly, there are so many components in the middle- and low-price classes, and

the models change so frequently, that I don't stand a chance of getting to hear, let alone to test, more than one or two percent of the whole field for a given year. So while I may be able to report how the ones I do test stack up against the best available, it is senseless for me to try and rank them among their peers.

And thirdly, although I don't mean to sound snobbish about this, I find top-of-the-line equipment a lot more interesting to test and to write about because the top of the line is usually where the advances in the state of the art are being made.

This column is not actually supposed to be a buyer's guide. It is supposed to concern itself with what is going on in the field of audio, and the top of the line is where most of it is going on. Of course, it's going on in lower places, too. Things are happening in the compact-tape field and the quadraphonic field, and I'll have much to say about both in the near future. But as long as the best available sound is being improved at the top, I'll continue to report on developments there. Eventually, they usually filter down the line and show up as im-



provements in the equipment most of us can afford to buy .

Dear Sir:

It is obvious from your columns that you are a dedicated classical-music listener; but I would like to ask, do you like anything but classical music? I begin to think you are a musical snob.

R. D. Pitcairn
Philadelphia, Pa.

I am a musical snob. I do not care for garbage, whether it be hee-haw blue grass, mindlessly repetitive rock, or meandering, noodling classics. I like some rock, some blue-grass, and most classics written before "serious" composers started playing mathematical games for each other's approval. I also like some background music, some jazz, some film music, some folk music, some musicals, some religious music, and practically all musical satire and parody from the (sadly) now-disbanded Mothers to P.D.Q. Bach.

Most of my listening, though, is to classics, because I own more classical recordings than anything else, and because a good symphonic or operatic recording will test the mettle of a reproducing system as well as anything else.

Dear Sir:

It strikes me that you are unreasonably critical of the audio equipment you write about in your POPULAR ELECTRONICS columns. Have you ever come across anything in which you didn't find at least one fault?

Werner Dietze
Philadelphia, Pa.

Two, in fact: The Soundcraftsmen SE-20-12 multi-band equalizer, and the Koss ESP-9 headset (latest production samples). That is not to say that I won't eventually find something about them to cavil about, but I haven't to date.

Dear Sir:

You don't seem to have much to say about the compact-tape media that have been mushrooming during the past few years. Are you against them, disinterested in them, or ignorant of them?

R. Yates
Springfield, Mass.

I found it hard to drum up any enthusiasm over cassettes or cartridges when all they had to offer in exchange for their convenience was monstrous wow and flutter and obtrusive hiss. But as their more flagrant failings are dropping by the wayside, my interest has grown.

Currently, I have four cassette units in the house (on loan). All are contenders for top-of-the-line position in the competition hierarchy; three have built-in Dolby B noise reduction; and two have DuPont Crolyn provisions (at the push of a button). Of these, only one was delivered from the factory in proper adjustment; the other three were sufficiently out of whack that their playbacks differ audibly from their original signals, and what's more, their channels were different in playback. All four have wow and flutter that is clearly audible on a sustained sine wave tone, and barely audible with most music, most of the time. The rest of the time, they flutter intolerably badly, intermittently, for periods of from a second to a few minutes. And don't tell me it's the cassettes themselves. All cassettes do it, occasionally, and some of the better ones will occasionally go all the way through without any problems. The Dolbyed tapes are very quiet, though.

While I expect to see further improvements in cassette fidelity, I do not expect the same news from the 8-track cartridge market place. Already, manufacturers have shown their feelings about the cartridge's potential fidelity by incorporating Dolbys and Crolyn tape provisions in cassette units only. They are improving still, while cartridge machines are improving little if at all. Cartridges still hold the lead on dollar sales because they came out some time before the cassettes, but since a cassette can do anything a cartridge can do, plus a lot of things a cartridge can't do, I expect to see cassettes cornering the compact-tape field within a few years, with cartridges going the way of the 45-rpm disc.

Dear Sir:

I am intensely interested in high fidelity, I like music, I have a very good ear for reproduced sound, and I would like to make audio my occupation. I am not much interested in the selling end of the business, though; and while I think I would like to get into equipment design, neither am I much interested in sitting behind a desk and fiddling with a slide rule and a lot of schematics.

Is there any job in the audio field where I could "use my ears" toward the design of new equipment?

Christopher D. Morris
Boulder, Col.

There are very few. While a golden ear is useful in evaluating a new component, it is a very dubious device for designing anything. The golden ears that work for equipment manufacturers usually work in some

(Continued on page 98)



OPPORTUNITY AWARENESS



Thoughtful Reflections On Your Future

Nineteenth in a Monthly Series by David L. Heiserman

First Class License with Radar Endorsement

I am interested in obtaining a First Class Radiotelephone License with a Radar Endorsement. At the same time, I'd like to get a better knowledge of solid-state logic and control circuits. But there are so many schools available, I don't know where to start.

• I have located two schools (approved by the National Home Study Council) that offer courses combining basic electronics, solid-state technology, and radar. They are the National Radio Institute (NRI) and National Technical Schools (NTS).

The NRI course that will interest you (called "Complete Communications") has about 80 lessons beginning with the fundamentals of electronics, going through vacuum tube and transistor circuits, and ending up covering virtually every phase of modern communications—including radar and marine, airborne, and mobile equipment. An average student can complete this course in about 2 years, and NRI guarantees a graduate will be able to get a First Class Commercial Radiotelephone License with Radar Endorsement. The course includes 7 training kits, and the total cash price is currently \$340.

NTS's course is called "Master Course in Electronic Communications," and it covers about the same material as the NRI course, in 115 lessons. Average completion time is 18 months, and NTS also guarantees that the successful student will get the desired license. This course includes 14 kits and the cash price is \$267.

It is impossible to say which of these courses is the best for the money. You should write a personal letter to each of them, asking for a complete course outline and an appointment with a representative. After you have had a chance to see exactly what they offer, you can make the final choice yourself.

Another home study school, CREI, offers courses in navigation and radar systems, but they are intended for graduate engineers. You might write to them to find out what further qualifications you need to take some of these college-level courses.

The addresses of the schools are:

National Radio Institute
3939 Wisconsin Ave., NW
Washington, DC 20016

National Technical Schools
4000 South Figueroa St.
Los Angeles, CA 90037

CREI
Home Study Divisions
McGraw-Hill Book Co.
3224 Sixteenth St., NW
Washington, DC 20010

Self Teachers Answer Their Own Questions

As my career as an electronics technician progresses, I find that I rely more on self teaching than on resident or home study schools for the new and specialized knowledge I need. The deeper I go, however, the harder it becomes to answer my own questions. Do you have any suggestions on how a self teacher can answer his own questions effectively?

• Answering questions is, indeed, a special kind of problem for self teachers. Classroom students can get immediate answers to questions from their teachers. And, home study students can get answers by writing in. But unless a self teacher happens to know a teacher or a knowledgeable engineer, he is stuck when it comes to answering all his own questions. Nevertheless, I believe it is possible for a self teacher to turn his problem into an actual advantage. By learning to answer his own questions, a self teacher gears his mind to the kind of original thinking and "stick-to-it" attitude that is char-

acteristic of the most successful engineers and inventors.

Most of the tough questions self teachers encounter stem from a mixed-up point of view. Usually, his own point of view is out of kilter, and he can master the tricky problem by approaching it from a different angle. Often this is done by studying different references—authors sometimes omit things they don't think are important or approach a problem in a manner peculiar to their own thinking. Another author's version may clear up the problem easily.

As a self teacher, you should not be afraid to spend time trying to answer relevant questions that occur. A day, a week, or even a month spent searching for answers to your questions can be well worth the effort. You will certainly understand the question and the answer better than the student who asks someone else to do all the thinking for him. And you will probably learn a lot of additional things in your search for the answer.

Making Experience Count

Ever since I was a Boy Scout, I have been building homemade electronic circuits and assembling electronic kits of all kinds. I have also repaired TV sets and radios for friends. Now I am about to complete a home study course in electronics technology and I would like to know how to use my experience to get a better start in my electronics career.

- You can, indeed, use your own practical experience with electronics to get a head start on your career. Experience, even the

homebrew variety, puts you in a better bargaining position at a job interview. The only problem is working out a way to present all of your past experience in an organized and convincing manner.

I suggest you make a formal worksheet for every piece of electronic equipment you built on your own. Start by listing all the projects with an approximate completion date for each. This may take a little time and effort, but it will be worth it.

Make a neat 8½ x 11 worksheet for each project and place the name of the project and the completion date at the top of each page. Don't forget to include worksheets for any kits or circuits you might have worked on as part of your home study course.

Draw a formal schematic and make up a parts list for the simpler circuits; for the more complicated ones, include the original schematic. A Polaroid photo of each circuit or piece of equipment you built can be an effective addition to the worksheet. If you can't get the photo, and if you are a fairly good artist, some simple line drawings might be helpful. Don't bother to attach pictures cut from catalogs or instruction manuals; they don't prove anything.

The last part of the worksheet should be a description of how well the project worked when you finished it. Tell what you did with the project and how long you used it. If you modified the original circuit, tell exactly what you did, and why.

You may have had trouble getting some of the projects to work, and some of them must have conked out at one time or another. Describe the symptoms in detail and tell what you did to get the thing working again. If you never did get it to work, give

INSTANT REPLAY WITH INSTRUCTIONAL VIDEOTAPE

A new self-contained automatic videotape record and playback unit which eliminates the problem of tape handling and the need for a trained operator is now available for use in audio-visual applications. Originally designed for coin-operated use at golf courses and other recreation facilities, National Instant Replayer Corp.'s TV Instant Replayer has been modified for use in school, college, business, and industrial instruction programs.

The Instant Replayer can be programmed to record for a pre-set period of time, following which it automatically rewinds and then replays the recorded material on a high-resolution 18-inch TV monitor—all at the touch of a single button. Freeze-frame and slow-motion playback are also possible.



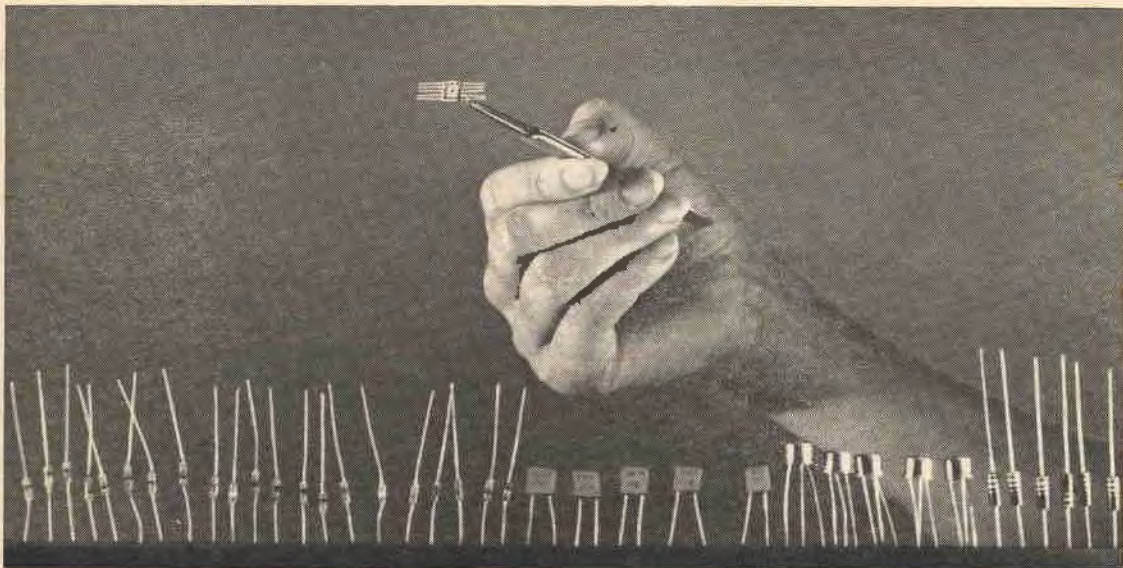

50 functions in a single chip. The functions of 50 separate transistors, diodes, resistors and capacitors can now be performed by the tiny dot in the center of the integrated circuit held by the tweezers.

The "Chip" ...will it make or break your job future?

TINY ELECTRONIC "CHIPS," each no bigger than the head of a pin, are bringing about a fantastic new Industrial Revolution. The time is near at hand when "chips" may save your life, balance your checkbook, and land a man on the moon.

Chips may also put you out of a job...or into a better one.

"One thing is certain," said *The New York Times* recently. Chips "will unalterably change our lives and the lives of our children probably far beyond recognition."

A single chip or miniature integrated circuit can perform the function of 20 transistors, 18 resistors, and 2 capacitors. Yet it is so small that a thimbleful can hold enough circuitry for a dozen computers or a thousand radios.

Miniature Miracles of Today and Tomorrow

Already, as a result, a two-way radio can now be fitted inside a signet ring. A complete hearing aid can be worn entirely inside the ear. There is a new desk-top computer, no bigger than a typewriter yet capable of 166,000 operations per second. And it is almost possible to put the entire circuitry of a color television set inside a man's wristwatch case.

And this is only the beginning!

Soon kitchen computers may keep the housewife's refrigerator stocked, her menus planned, and her calories counted.

Money may become obsolete. Instead you will

simply carry an electronic charge account card. Your employer will credit your account after each week's work and merchants will charge each of your purchases against it.

Doctors will be able to examine you internally by watching a TV screen while a pill-size camera passes through your digestive tract.

New Opportunities for Trained Men

What does all this mean to someone working in Electronics who never went beyond high school? It means the opportunity of a lifetime—if you take advantage of it.

It's true that the "chip" may make a lot of manual skills no longer necessary.

But at the same time the booming sales of articles and equipment using integrated circuitry has created a tremendous demand for trained electronics personnel to help design, manufacture, test, operate, and service all these marvels.

There simply aren't enough college-trained engineers to go around. So men with a high school education who have mastered the fundamentals of electronics theory are being begged to accept really interesting, high-pay jobs as engineering aides, junior engineers, and field engineers.

How To Get the Training You Need

You can get the up-to-date training in electronics fundamentals that you need through a carefully

chosen home study course. In fact, some authorities feel that a home study course is the best way. "By its very nature," stated one electronics publication recently, "home study develops your ability to analyze and extract information as well as to strengthen your sense of responsibility and initiative." These are qualities every employer is always looking for.

If you do decide to advance your career through spare-time study at home, it makes sense to pick an electronics school like the Cleveland Institute of Electronics. We teach only Electronics—no other subjects. And our courses are designed especially for home study. We have spent over 30 years perfecting techniques that make learning Electronics at home easy, even for those who previously had trouble studying.

Your instructor gives your assignments his undivided personal attention. He grades your work, analyzes it, and he mails back his comments the same day he gets your lessons, while everything is still fresh in your mind.

Always Up-to-Date

Because of rapid developments in Electronics, CIE courses are constantly being revised. This year, for example, CIE students are receiving exclusive up-to-the-minute lessons in Microminiaturization, Logical Troubleshooting, Laser Theory and Application, Single Sideband Techniques, Pulse Theory and Application, and Boolean Algebra. For this reason CIE courses are invaluable not only to newcomers in Electronics but also for "old timers" who need a refresher course in current developments.

Get FCC License or Money Back

No matter what kind of job you want in Electronics, you ought to have your Government FCC License. It's accepted everywhere as proof of your education in Electronics. And no wonder—the Government licensing exam is tough. So tough, in fact, that without CIE training, two out of every three men who

Tiny TV camera for space and military use is one of the miracles of integrated circuitry. This one weighs 27 ounces, uses a one-inch vidicon camera tube, and requires only four watts of power.



take the exam fail. But better than 9 out of every 10 CIE graduates who take the exam pass it.

This has made it possible to back our FCC License courses with this famous Warranty: you *must* pass your FCC exam upon completion of the course or your tuition is refunded in full.

Mail Card for Two Free Books

Want to know more? The postpaid reply card bound in here will bring you a free copy of our school catalog describing today's opportunities in Electronics, our teaching methods, and our courses, together with our special booklet on how to get a commercial FCC License. If card is missing, use the coupon below.

ENROLL UNDER NEW G.I. BILL

All CIE courses are available under the new G.I. Bill. If you served on active duty since January 31, 1955, or are in service now, check box on reply card for G.I. Bill information.

CIE Cleveland Institute of Electronics

1776 East 17th Street, Cleveland, Ohio 44114

NEW COLLEGE-LEVEL COURSE IN ELECTRONICS ENGINEERING

for men with prior experience in Electronics. Covers steady-state and transient network theory, solid state physics and circuitry, pulse techniques, computer logic and mathematics through calculus. A college-level course for men already working in Electronics.

Cleveland Institute of Electronics
1776 East 17th Street, Cleveland, Ohio 44114

Please send me without cost or obligation:

1. Your 44-page book "How To Succeed In Electronics" describing the job opportunities in Electronics today, and how your courses can prepare me for them.
2. Your book on "How To Get A Commercial FCC License."

I am especially interested in:

- | | | |
|--|---|--|
| <input type="checkbox"/> Electronics Technology | <input type="checkbox"/> Broadcast Engineering | <input type="checkbox"/> First Class FCC License |
| <input type="checkbox"/> Electronic Communications | <input type="checkbox"/> Industrial Electronics | <input type="checkbox"/> Electronics Engineering |

Name _____ Age _____

Address _____

City _____ State _____ Zip _____

Check here for G.I. Bill information.

PE-22

Accredited Member National Home Study Council • A Leader in Electronics Training... Since 1934

at least a brief outline of what you think was wrong and describe what you would do to fix it now that you have some formal electronics training.

Make up a similar worksheet for every piece of electronic equipment you have repaired on your own. No need for schematics or pictures here, but all the other details can be important—especially those that describe the steps you took to get the equipment working.

A formal set of worksheets for all experiences with homemade electronic circuits and kits can also be a valuable asset to technicians already working in electronics. For example, an employer might be pleasantly surprised to find that one of his digital technicians has been dabbling with communications equipment on his own for many years. Such a discovery might lead to a promotion, higher pay, and a job that holds more interest.

Some Helpful Information on Getting a Patent

How do I go about getting a patent on an electronic circuit?

• The answer to this question is very simple—though it is a hard one for many would-be inventors to swallow. Take your invention to a registered patent attorney or agent. Getting a foolproof patent has become a job for experts. You may have to pay a couple of hundred dollars for the attorney's services; but, if you think the idea is worth it, you'll come out ahead in the long run.

Here are a few good reasons why you should get professional help:

(1) You don't even know whether or not your idea is patentable until a thorough patent search has been run. Patent attorneys and agents know how to do this in the shortest possible time; and it might take you weeks (assuming you knew how to do it properly in the first place).

(2) The Patent Office demands a certain kind of written presentation that takes a lot of experience and talent to master. An application won't be accepted until it is done properly; and do-it-yourselfers waste a lot of time and money (their own and the taxpayers') shuttling applications back and forth.

(3) It is safe to say that just about every patent has some legal loopholes in it. A good patent attorney or agent tries to minimize the loopholes and words the presentation so that it automatically fills any holes he might have missed. Chances are you can't do this kind of job yourself; and if you try, you run the risk of losing the whole invention.

Look for a local patent attorney or agent in the phone book or check your library for a copy of *The Directory of Registered Patent Attorneys and Agents*. To get your own copy of this book, send a check or money order for \$1.50 to the Superintendent of Documents, Government Printing Office, Washington, DC 20402. Request the book by title and cataloging number C219/2:968.

For another 30¢, the GPO will send you a helpful pamphlet called "General Information Concerning Patents." The catalog number for this one is C21.2:P27/969.

By the way, don't take your invention to one of the "inventions wanted" places until you find out whether or not the firm or its agents are in the Government directory mentioned above.

A Tip for Highly Trained Specialists

I have been reading your ideas about careers in medical electronics with great interest. None of your suggestions, however, applies to my case. I am now working on my masters in biophysics and I have an associate degree in engineering technology. I have been working in a bioengineering research lab at the university for four years, but I would like to move out into a better paying job in industry. The trouble is that very few firms have a need for full-time individuals with my qualifications. Any suggestions?

• Yes! Go into the consulting business. Highly trained, experienced specialists of all kinds are doing quite well as consultants nowadays. Perhaps this is because so many industries find they have to reach out into specialized fields that are unfamiliar to them. A company that makes closed-circuit TV systems, for instance, might want to develop a small line of medical electronic equipment. When they can't justify the services of a permanent, full-time specialist, they look for a consultant. That's where you come into the picture.

The need for temporary expertise is rising rapidly and the pay is quite good. As a competent consultant, you can draw anything from \$10 an hour to \$300 a day—and up—depending on the job and your ability.

Ease into the consulting business a bit at a time. Keep your present job for awhile, but make sure you can get away for an afternoon now and then to visit clients. Advertise in the Yellow Pages of telephone books in several large cities. This is expensive, but it will pay off in the long run.

One note of caution! Don't bill yourself as an engineer unless you qualify as a Professional Engineer in the states where you want to work. ♦



CB SWL HAM RTTY FAX TV SSB AM FM CW LSB CB SWL HAM RTTY FAX TV

COMMUNICATIONS

SSB AM FM CW LSB CB SWL HAM RTTY FAX TV SSB AM FM CW LSB CB SWL HAM RTTY FAX TV

By Leslie Solomon, Technical Editor

SHERLOCK VIDEOFILE

It used to be that all a good detective needed was superior vision, an excellent memory, and a voluminous notebook. Now it would appear that the Illinois Department of Law Enforcement has brought in a real heavyweight—an all-knowing Ampex Videofile information system. What will this master crimefighter do? It can handle fingerprint records, photographs, and criminal histories totalling more than 11 million documents. The system combines both videotape recording and computer technology and can store the equivalent of 122,000 conventional 8½" by 11" documents (nine four-drawer file cabinets) on one 10½" reel of 2" video tape. Recall time is minutes compared to the many hours of manual work formerly needed.



The Illinois Dept. of Law Enforcement will install a \$1.2-million Ampex Videofile system to speed and automate fingerprint records, photographs and other criminal histories. The system is a combination of videotape recording and computer technologies to aid the police searches.

All of the data on file has special digital codes. When a request for information comes in, an analyst converts the sought data to a digital code, and the machine searches it out on its reels, at speeds of over 1000 recordings per second. Output is on a special CRT. But keeping out of Illinois is no way to escape the all-seeing eye. Similar systems are being used by the Royal Canadian Mounted Police, the Southern Pacific Railroad, and the Los Angeles County Sheriff's Dept.

WEATHER BROADCASTS

There are many weather (162.55 MHz) receivers on the market; and, of course, many people get them and use them. However, lots of other people feel that a special weather receiver is a luxury if you don't use it all the time. There is

COMMUNICATIONS

a solution to the problem. If you have a conventional shortwave receiver, you can get the latest update on the weather from the International Flight Service of the Federal Aviation Administration, which provides excellent weather service for trans-Atlantic planes. The information covering local airports and much of the surrounding area can be very useful to travellers during the hurricane season or winter storms. The frequencies used are 3.001, 5.362, 8.868, and 13.272 MHz.

These broadcasts are believed to be the only ones that give such weather conditions as visibility, ceilings, wind velocities, temperature, haze, rain, snow, etc. Whereas most other weather broadcasts have considerable time lags, these broadcasts are right up to the moment—on the hour and the half hour.

VHF DX'ING

All the years I've been listening to shortwave, I always thought that 30 MHz was the top end. Sure, I've heard of guys who get distant TV reception when the weather is right; but I thought there was something a little weird about sitting around all night looking for strange TV signals. Now, to my surprise, I find that they have gotten together in the wee hours and formed a club by the name of Worldwide TV-FM DX Association. To indoctrinate others, they are putting out a booklet that tells how to get started, the equipment needed, propagation and techniques—everything the VHF DX'er ought to know. They also hope to put out supplements. If you want to get in on this, send 25¢ (three IRC's outside USA and Canada) to Worldwide TV-FM DX Assoc., P.O. Box 5001-PE, Milwaukee, WI 53204. A special edition for overseas DX'ers is 50¢ or 4 IRC's.

CABLE-TV RECEIVER

According to Magnavox, there are about 6 million CATV subscribers serviced by 2573 systems. It would appear that the bulk of the viewers are using conventional TV receivers to pick up the images. Now, Magnavox is putting out a receiver especially designed for cable systems. Called the "TV101 Cable TV Terminal," this new color set offers 31 channels for cable reception, as well as the standard UHF channels required on all TV receivers. The 31-channel capacity is accomplished by inserting eight channels between 6 and 7 and adding 11 channels above 13. Using detented tuning and double shielding to prevent interference from off-the-air signals, it is claimed that the new set has excellent adjacent channel rejection.

SUPER TIME

If you ever needed an accurate time source to set your clocks, you invariably went to WWV on one of the high-frequency bands. Or, if you lived on the East Coast, you used CHU. Both of these sources are very good, if you can hear them above the electronic racket nearby or if fading doesn't occur just when you least want it. Now, if you can locate a good low-frequency receiver (or throw together a converter), you can listen to WWVB down there at 60 kHz (that's right 60). The station, located at Fort Collins, Colorado, operates at 13 kW ERP, and puts about 100 microvolts per meter on each Coast (more the closer you get to Fort Collins). Not only do you have a pretty good 60-kHz frequency standard, but you also get a binary coded decimal time signal 24 hours a day. Station identification is a little different than might be expected. The carrier is not interrupted for station identification since a characteristic phase advance by 45° at 10 minutes after each hour, followed by a similar phase retardation 5 minutes later serves to identify the station. The time markers are generated using a level shift carrier time code synchronized to the 60-kHz carrier.

SUPER-DUPER TIME

Still on the subject of time telling, the U. S. Dept. of Commerce is testing a TV system that will give the time to a billionth of a second—in case you care! They transmit a special code over the TV networks (in the vertical interval) and put this into a decoder to be displayed on the screen. However, don't rush to modify your TV set, as the system is still undergoing experimental changes and is only available on a couple of TV stations at the moment. When the special decoder is activated, one line of digits displays the master clock time in hours, minutes, and seconds. Another line shows the difference in millionths of a second between the top line and the clock where the TV transmitter is located. By flipping a switch, the bottom line will show the difference in billionths of a second.

THE NEW ARMY

"Why son, in my day, the Army wuz the Army. Sergeants could hardly read or write and officers could count up to 20—if they had their shoes off." But like all things the Army has changed. Take a look at officer training, for example. Up at West Point, they have put together an 85-line time-sharing computer system using teleprinter input/output terminals (made by GE). There are 65 active terminals scattered about the Point, strategically located in groups of one to 15 printers. These terminals give cadets access to the computer 24 hours a day, 7 days a week to help them solve complex problems in a variety of academic subjects. The whole network operates from a Honeywell 635 computer and is interconnected by telephone lines.



Training in the use of data communications tools is part of a mandatory computer training course which must be completed by cadets in their first year at the U. S. Military Academy.

In the usual four years of study, it is estimated that a cadet may spend about 100 hours communicating with the computer—not all of it for mathematics. In one case the computer was programmed by an instructor for a course in German vocabulary so that the cadet not only received material but was graded on his answers also.



SOLID STATE

One Hundred Eighty-fifth in a Monthly Series by Lou Garner

SCIENCE-FICTION and fantasy writers have been describing voice-controlled computers, robots and machines for many decades. While theoretically possible for many years, such concepts were composed mainly of the fabric of dreams because the necessary circuitry to achieve sophisticated voice control of even relatively simple operations would have required, literally, a roomful of electronic equipment. Today, however, the increasing availability of complex functions in miniature IC devices has made feasible not only the practical design of compact voice controls, but also has opened the door to even more exotic possibilities.

Engineers at the Bell Laboratories (Holmdel, NJ) are now testing an experimental device that can dial a telephone number when given spoken commands. Voice control is achieved through a relatively simple integrated circuit that converts sound waves into electrical pulses to open and close the electromechanical switches necessary for obtaining a dial tone, executing dialing, and terminating a call.

The voice control device is used in conjunction with a small circular display of ten lamps labeled with the numerals zero through nine. The lamps light automatically in numerical sequence. Any oral command spoken in coincidence with a lighted numeral will activate that number, with the corresponding lamp numeral remaining lit in the display for a slightly longer interval to indicate registration in the device's memory. As the desired numerals are activated in order, the device stores in its memory all of the digits of the telephone number and then transmits it as a series of electrical pulses to telephone dialing circuitry when a final oral command is given. The "voice-dialed" number remains in the memory even after it is dialed and can be reused at any time if the special dialing command is given. Storing a new number automatically erases the old one from the memory.

According to its developers, Bell engineers Meb Awipi, Cliff Hoffman and Gerald Soloway, the new device will respond to any utterance spoken in coincidence with each lighted numeral. Most persons, however,



Gerald Soloway, co-developer of a new Bell Labs voice controlled device, "dials" a telephone number simply by speaking into a microphone as numbers appear on the lighted display.

find it more convenient to speak the actual desired numbers in order when using the instrument. Literally, the user *calls his call*.

With further refinement, the new voice control device may one day take its place alongside other standard telephone equipment to provide "hands-free" communications service for motion handicapped persons as well as those whose occupations require critical manual activity. Still later, sophisticated versions of the instrument could be developed for the control and operation of complex electrical equipment, computers and electromechanical machinery, both through direct connection and remotely over telephone lines.

While exciting and exotic by present standards, the potentialities of the new Bell Labs' voice control instrument dim before the fantastic visions conjured up by research work now being conducted by Doctors Fred Hegge and Guy Sheatz of the Army Institute of Research at the Walter Reed Army Medical Center in Washington, D. C. These erudite scientists are part of a team studying the use of brain waves to control and operate electronic, electrical and electro-mechanical equipment.

Most of the initial research work has been

purely investigative in nature, with the scientific team developing circuitry to detect, sense, amplify and respond to specific brain wave patterns. Among the techniques being studied is the use of IC devices similar to the Signetics SE/NE 567 Tone Decoder [see "Solid State", June 1971] to sense and respond to specific brain wave frequencies, developing output signals which, in turn, can be used to actuate relays or solid-state switching devices, such as triacs or SCR's.

Although the immediate scientific goals anticipate the potential use of brain wave control equipment for patient monitoring and alarm, it takes but a small dash of imagination to envision practical applications in our conventional world. Consider, for example, the possible use of compact instruments to detect and respond to the brain wave patterns associated with drowsiness or sleep. Used in trucks, buses, trains and planes, such equipment could serve to sound an alarm if the driver or pilot started to doze, greatly reducing accidents caused by someone "asleep at the wheel." Similar equipment assembled in a helmet or cap could serve to keep military sentries and bank, industrial security or police guards

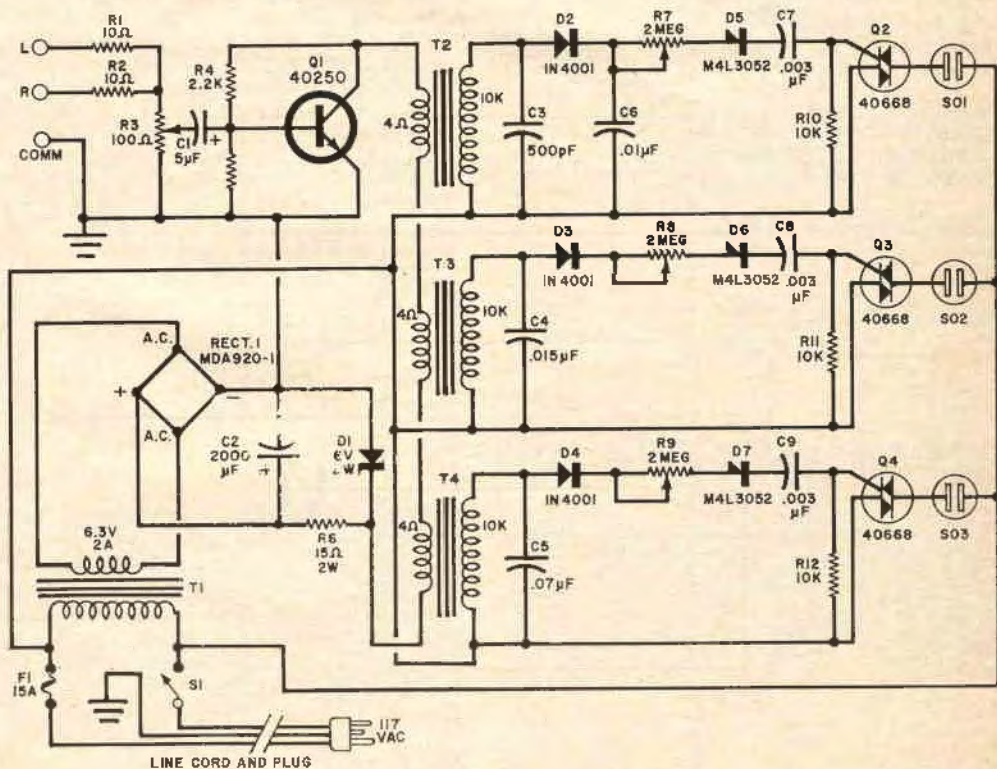

Fig. 1. Triacs are used in this color organ circuit instead of SCR's to avoid need for a large dc power supply. Amplifier/mixer improves sensitivity and combines stereo signals.

alert at all times. Coupled to small radio transmitters, such equipment also could act to signal headquarters if a patrolman or guard were knocked unconscious by an intruder, burglar or saboteur. In the more distant future, engineers and scientists might well develop brain wave controls for industrial machinery, computers, and communications equipment.

If these prospects seem remote, just remember that a few decades ago many people would have scoffed at the idea of live color TV from another planet, and even skilled engineers and scientists would have expressed doubts about the possibility of monitoring, from Earth, the heartbeats and body temperature of a human being walking on the surface of the Moon.

Useful Circuits. Seeking a simple, but effective and reliable, sound-to-light translator for his home stereo system, reader Ronald B. Atkinson (5008-A Goodnow Road, Baltimore, MD 21206) searched through his collection of technical magazines and project booklets for a suitable design. He finally decided on Don Lancaster's "Musette Color Organ," as described in POPULAR ELECTRONICS' July, 1966 issue. Unfortunately, Don's design, while excellent, didn't quite fit Ron's idea of what he wanted in the instrument, so Ron modified the original circuit, reducing the number of channels

from five to three, substituting modern triacs for the original SCR's (thus eliminating the need for a heavy duty dc power supply), and adding an amplifier/mixer which serves both to improve sensitivity and to combine the two stereo channel signals for his light display. Ron's revised circuit is given in Fig. 1.

Audio signals from the stereo's left (L) and right (R) loudspeakers are combined through isolation resistors R1 and R2 in gain control R3, and, from here, applied through coupling capacitor C1 to amplifier Q1. The transistor's base bias is established by voltage-divider R4-R5, while its dc source is a conventional regulated power supply consisting of step-down transformer T1, bridge rectifier RECT1, filter capacitor C2, voltage dropping resistor R6, and zener diode D1.

All three channels function in similar fashion. The combined and amplified audio signal supplied by Q1 is coupled through an audio step-up transformer (T2, T3 or T4) to a triac control network, consisting of a half-wave rectifier (D2, D3 or D4), level control (R7, R8 or R9), 4-layer trigger diode (D5, D6 or D7), coupling capacitor (C7, C8 or C9), and gate return resistor (R10, R11 or R12). Shunt capacitors C3, C4 and C5 are used to tune audio transformers T2, T3 and T4 to the high, middle and low frequency ranges, respectively. Finally, triacs Q2, Q3 and Q4,

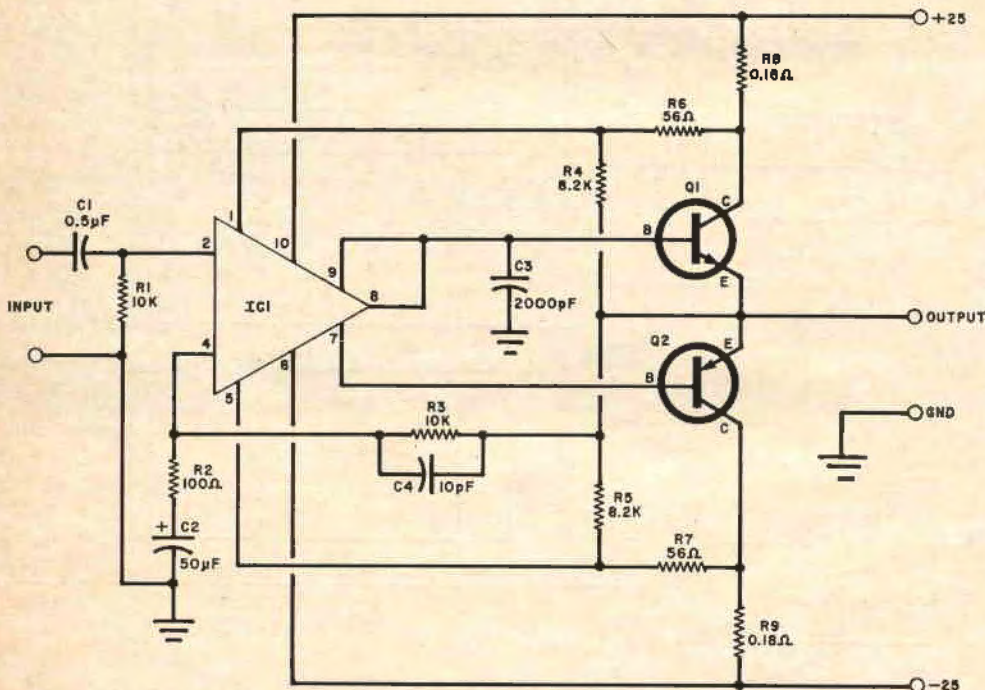

Fig. 2. The Signetics SE/NE 540L class AB power amplifier integrated circuit is used here in a 35-watt audio amplifier to drive two complementary transistors in output stage.

operated directly from the ac line, furnish power to the colored display lamps connected to output sockets SO1, SO2 and SO3.

In summary, then, audio signals from the stereo system's Left and Right channels are mixed electronically, amplified, selected according to frequency by tuned coupling transformers, rectified, and used to trigger triacs which, in turn, control the power supplied to external display lamps.

Neither parts layout nor lead stress is overly critical and, therefore, the individual builder may follow his own inclinations when duplicating Ron's circuit. Good shop practice should be observed, of course, with the transformers mounted on a sturdy base, such as a conventional metal chassis, and insulated heat sinks provided for the triacs. Either perf or etched wiring boards may be used for the amplifier and triac control circuits. Under no conditions, however, should either side of the ac line be connected to chassis or circuit ground.

In practice, the instrument may be used to operate virtually any combination of standard incandescent lamps, provided the total load on any one channel does not exceed the triac's maximum rating of 8 amperes. The lamp color choice, too, is optional, although many prefer red for the low frequency channel, green or yellow for

the middle range, and blue for the high range.

One of eight practical circuits suggested in the specifications brochure for the SE/NE 540L, the 35-watt audio amplifier circuit illustrated in Fig. 2 requires but three active devices—an integrated circuit, IC1, and a complementary pair of power transistors, Q1/Q2. Among the other circuits featured in the brochure, published by the Signetics Corporation (811 East Arques Ave., Sunnyvale, CA 94086), are four voltage regulator designs and three other power amplifiers, including a 1-watt circuit using a single IC, a 3-watt design requiring two IC's, and a 70-watt complementary symmetry bridge amplifier utilizing two IC's and two complementary power transistor pairs. The brochure also includes a complete full-scale etched circuit board layout and parts placement diagram suitable for the assembly of a 35-watt amplifier.

A monolithic silicon class AB power amplifier, the SE/NE 540L featured in the circuit is designed specifically to drive a pair of complementary output transistors. Assembled in a 10-lead "TO" style package, the device comprises 31 transistors and 26 resistors, has an input impedance of approximately 20,000 ohms, requires a quiescent (standby) current of only 13 mA, and can



MAKING "WAVES"

CADENCE—the musical instrument speakers

Making better, clearer, amplified sound waves is the **THING** Cadence does... better than anything else in the industry. Cadence Speakers are built to withstand heat from sustained notes at a high power level and the vibrations and stresses which are continually placed upon them. Cadence is guaranteed **one full year** at the power level specified. This proven speaker family has been selected by the manufacturers of most of the world's fine amplified music instruments.

If making beautiful, clear sound waves is your thing, ask for **CADENCE SPEAKERS**. For complete information and the name of your Cadence Dealer, write:

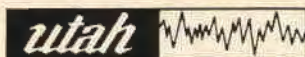

UTAH ELECTRONICS DIVISION
Utah-American Corporation
1124 East Franklin Street
Huntington, Indiana 46750

CIRCLE NO. 33 ON READER SERVICE PAGE

ELECTRONICS KNOW-HOW

1972 ELECTRONIC EXPERIMENTER'S HANDBOOK—WINTER EDITION

Join in this big semi-annual projects festival! You'll get 33 electronics construction projects, each one lab tested by the editors, complete with parts list, easy "how-to-do-it, how-it-works" instructions, and many with actual size PC foil patterns and I. C. diagrams! Build these brain-busters for home and car, for experience, for fun—The Frisky Four Speaker System ■ Automatic Lightning Protector ■ Super Flash ■ Remote Camera Shutter Release ■ Design Your Own Printed Circuits ■ Laser Beam Communicator ■ Modify Your Electric Guitar Sound ■ Electronic Overload Protection ■ Electronic Combination Ignition Lock ■ Build A Low-Cost Relay ■ Photocell Motor Control Demonstrator ■ Wire Music ■ Super Substitution Box—Plus 20 More!



1971 COMMUNICATIONS HANDBOOK

tunes you in on everything you need to know about CB, SWL or HAM

Completely updated and revised. Also features Police and Fire Dispatcher Frequencies of 250 cities.

Here it is in one single package—the combined knowledge and experience of the top men in each field—Citizens Radio (CB), Shortwave Listening and Amateur Radio. Everything you need to know about getting licenses . . . equipment to buy and how to set it up . . . efficient operations . . . a whole bookful of up-to-the-minute data to make your listening hours more enjoyable! Fact-filled with time charts . . . station data . . . maps . . . country lists . . . awards . . . and much more. Photos galore.

Plus: BUYER'S GUIDE of CB and HAM RADIO GEAR. SPECIAL SECTION on LONG RANGE TV RECEPTION.

Copies of the Spring 1971 Electronic Experimenter's Handbook are still available. This edition includes 20 challenging electronics construction projects. Use the coupon below to order your copy.

ZIFF-DAVIS SERVICE DIVISION—Dept. W
595 Broadway, New York, N.Y. 10012

Please send me the annuals I've checked below:

- 1972 ELEC. EXPERIMENTER'S HANDBOOK — Winter, \$1.25
 1971 ELEC. EXPERIMENTER'S HANDBOOK — Spring, \$1.50
 1971 COMMUNICATIONS HANDBOOK, \$1.50

In U.S.A., add 35c for postage and handling for each copy ordered. PE-11-71

Outside U.S.A., copies are \$2.50 each postpaid.

TOTAL ENCLOSED \$ _____

print name _____

address _____

city _____

state _____

zip _____

PAYMENT MUST BE ENCLOSED WITH ORDER

SOLID STATE

(Continued from page 85)

supply output drive currents of over ± 100 mA. In practical circuits, the device can furnish a typical gain of 40 dB, with its ± 1 dB frequency response to 100 kHz or better. Harmonic and intermodulation distortion figures are well under 1% in most applications. The NE 540L nets for only \$3.00 each in unit quantities, while the premium quality SE 540L is priced at \$5.10 each. The "NE" and "SE" versions are virtually identical except for maximum operating temperature range, maximum supply voltage ratings, and maximum frequency response.

Although Signetics did not specify output transistor types in their brochure, on the basis of published specifications, any of a number of commercial types should be suitable for this circuit, including RCA's types 2N6111 and 2N5295, GE's D45C and D44C, or Motorola's 2N4901 and 2N5067 complementary pairs.

Except for IC1, all other components are standard units; R8 and R9 are 5-watt resistors, the remainder half-watt types; C2 is a 50-volt electrolytic; while the other capacitors may be either low-voltage ceramics or paper or plastic tubulars.

Designed to drive an 8-ohm loudspeaker load, the power amplifier requires a dual 25-volt, well filtered dc power source capable of supplying at least 3 amperes. The amplifier can be used with any standard preamp or tuner.

Brochures, Booklets and Bulletins. RCA's Solid State Division (Route 202, Somerville, NJ 08876) has recently issued revised editions of two of their most popular and useful publications—RCA High-Speed, High-Voltage, High-Current Power Transistors and the RCA Transistor, Thyristor, & Diode Manual. Both publications should be available through all RCA franchised semiconductor distributors or may be ordered from RCA Commercial Engineering, Harrison, NJ 07029.

Carrying an optional \$2.00 list price, RCA's 96-page power transistor booklet, publication No. PM-81, is prepared primarily for circuit designers, educators, serious experimenters, and students. It contains the latest information on theory, structures, geometries, packaging, safe operating areas, thermal fatigue, thermal-cycling ratings, and the operation and requirements of power transistors in both linear and switching applications. Typical circuits are included

to illustrate the use of power transistors in series voltage regulators, linear amplifiers, switching regulators, and inverters and converters, as well as the application of complementary pairs. Selection charts are included to simplify the choice of optimum types for various applications.

Some 768 pages thick, the new RCA Transistor, Thyristor, & Diode Manual, publication No. SC-15, contains the latest information on basic technology, operating principles, characteristics, ratings, applications, and testing of bipolar transistors, MOSFETs, thyristors, silicon rectifiers and other solid-state diodes. More than 200 pages are devoted to basic tutorial information on the operation, application, and testing of solid-state devices, with the 15 chapters covering basic semiconductor physics and the design, fabrication, electrical characteristics, circuit configurations, and other important features of these devices. Various applications are discussed, while test and measurement techniques are explained in detail.

Technical data are given for more than 1,000 devices, divided into seven major categories, with comprehensive data and design curves shown in display format, accompanied by terminal basing diagrams.

Of particular interest to hobbyists and experimenters are the schematic diagrams, descriptions, and detailed parts lists which are provided for 35 practical circuits. Included are radio receivers, FM tuners, an FM stereo multiplex demodulator, a ham band preamp, a 2-meter converter, a VFO, an audio preamp, audio amplifiers with outputs from 1 to 70 watts, CB and CW transmitters, VHF power amplifiers, audio and code-practice oscillators, an electronic keyer, a power supply, voltage regulators, a servo amplifier, battery chargers, an electronic heat control, an automotive "light minder," a grid-dip meter, a light flasher, and light dimmers.

In our opinion, a must for every electronics library, RCA's SC-15 is well worth its nominal \$2.50 price tag.

RCA is also the source of an interesting new technical bulletin entitled *Thyristor Control of Incandescent Traffic-Signal Lamps*. Identified as Application Note AN-4537, the 8-page publication discusses triac operation and its application to incandescent lamp circuits. Although directed specifically to the problems faced by the traffic-control designer, the bulletin contains much information of direct interest to experimenters or hobbyists working with light flashers, color organs, and similar projects.

If you're interested in optoelectronics (isn't everyone?), you'll probably want to obtain copies of publications released recently by Texas Instruments, Inc. (P.O. Box

SOLDERING + DESOLDERING + RESOLDERING =

SOLDERABILITY

ELEMENTARY TO ELITE
WORLD'S MOST PRACTICAL SOLDER HANDLING TOOLS

SOLDAPULLIT

SOLDAVAC™



- LIGHT WEIGHT, PORTABLE
- SELF-CLEANING
- FAST, VACUUM ACTION

SOLDASIP™

RESOLDERING TIPS

ERBA™ SOLDERING TOOLS



One tip applies, removes solder

- EXPERT CRAFTSMANSHIP
- FAST SOLDERING CYCLES

LONER SOLDERING INSTRUMENT

IN A CLASS BY ITSELF FOR YOU ALONE



EASY KNOB CONTROL

ELECTRONICALLY CONTROLLED

TEMPERATURE SETTING

Send for our FREE 12 page SOLDERABILITY manual.

EDSYN
15094 ARBINGER STREET
VAN NUYS, CALIFORNIA 91406
PHONE (213) 909-2324
TELEX NO. 65-1400 EDSYXK VAN

• U.S. and Foreign Patents Applied For.
Ads in EEM, MAS, EBG, AE, TR, and EPAC Catalogs

idle rest

THERMAL GUARD
SOLDERING INSTRUMENT
HOLDER



idle rest
with
LONER

CIRCLE NO. 16 ON READER SERVICE PAGE

POPULAR ELECTRONICS SUBSCRIBER SERVICE

Please include an address label when writing about your subscription to help us serve you promptly.

Write to: P.O. Box 1096, Flushing, N.Y. 11352

CHANGE OF ADDRESS: Please let us know you are moving at least six to eight weeks in advance. Affix magazine address label in space below and print new address in space provided. If you have a question about your subscription, attach address label to your letter.

If you have no label handy, print OLD address here.

name _____ please print
address _____
city _____
state _____ zip-code _____

TO SUBSCRIBE: Check these boxes: -- New -- Renewal
 5 years \$21 3 years \$15 1 year \$6
SPECIFY: Payment enclosed—You get 1 extra issue per year as a BONUS! Bill me later.

0571

name _____ please print
address _____
city _____ state _____ zip _____

Add'l postage: \$1 per year outside U.S., Its possessions & Canada.

color TV sets, the MC1345 can provide a 10-volt range of either positive or negative going agc voltage to a tuner and a 16-volt peak-to-peak sync output. The second new IC is the MC 1398P color processor, a single device which can serve as a chroma i-f amplifier with automatic chroma control, color killer, and injection lock reference system. Featuring an internal feedback oscillator that locks into phase at levels above 200 μ V, the MC1398P can provide 40 dB of chroma gain with an agc range of 23 dB and 60 dB of manual chroma gain control range, producing a 2-volt peak-to-peak chroma output. Its internal color killer uses a Schmitt trigger to furnish hysteresis action, squelching the chroma output during monochrome or weak color telecasts.

The Micro Switch Division of Honeywell (Freeport, IL 61032) is now marketing a series of magnetically operated solid-state switches. Extremely small, these new devices utilize a combination of a Hall effect sensor with a trigger and amplifier in a single silicon integrated circuit. Switching operation is produced by the magnetic field from either a permanent magnet or an electromagnet. Identified as the 1SS Series and the type 2SS1, the unique units provide a digital output of 3 volts at 10 mA, and can be operated indefinitely at very high speeds. They may be used in such applications as limit, control, synchronizing and timing switches for high-speed machinery, or as shaft speed or position sensors.

A new series of high density plugboards with overall grids of pre-plated holes on 0.1" centers has been announced by the Vector Electronic Co. (12460 Gladstone Ave., Sylmar, CA 91342). Excellent for experimental circuit assembly, the boards will accommodate any component with lead spacing on 0.1" multiples, and, therefore, can be used with IC DIP packages or sockets from 14 through 36 leads, as well as with discrete components or hardware items such as test jacks and clips. The new boards are offered in several styles and sizes, together with mating receptacles with a choice of solder eye termination or 0.025" square posts for wrapped wire connections. Prices range from \$6.00 to \$8.00 each, depending upon the type of board and style.

Fairchild MOD (2513 Charleston Rd., Mountain View, CA 94040) has introduced an intriguing variation of the optically coupled isolator in which the LED light source and phototransistor light detector are mounted parallel to each other, making it necessary to use an external reflective surface or object to complete the optical path. Appropriately, the new device, type FPLA 850, is dubbed a Light Reflection Transducer. It is priced at \$9.00 each in unit quantities. ♦

Hey! Hams, Engineers, Hobbyists MARK LIKE MAGIC



Any surface can be marked with **DATAK'S DRY TRANSFER** titles and symbols. The results are professional, it looks like the finest printing!

Write for your **FREE SAMPLE** and Catalog, listing hundreds of letter sheets and symbol sets.

Order from your distributor or directly from:

THE DATAK CORPORATION

* From #K-64 1/2" letters and numerals... \$1.99
Also available #9581 professional title set for electronic equipment... \$5.95

85 Highland Ave. / Passaic, New Jersey 07055

CIRCLE NO. 11 ON READER SERVICE PAGE

Build this magnificent Schober Theatre Organ



for only
\$*1730!

*Includes finished walnut console. Amplifier, speaker system, optional accessories extra. Only \$1256 if you build your own console.

You couldn't touch an organ like this in a store for less than \$3500—and there hasn't been a musical instrument with this vast variety of *genuine* Theatre Organ voices since the days of the silent movies! If you've dreamed of the grandeur of authentic big-organ sound in your own home, you won't find a more satisfying instrument anywhere—kit or no kit.

You can learn to play it. And you can build it, from Schober Kits, world famous for ease of assembly without the slightest knowledge of electronics or music, for design and parts quality from the ground up, and—above all—for the highest praise from musicians everywhere.

Send right now for your copy of the full-color Schober catalog, containing specifications of the five Schober Organ models, beginning at \$499.50.

The *Schober* Organ Corp., Dept. PE-38
43 West 61st Street, New York, N.Y. 10023

- Please send me Schober Organ Catalog and free 7-inch "sample" record.
 Enclosed please find \$1.00 for 12-inch L.P. record of Schober Organ music.

NAME _____
ADDRESS _____
CITY _____ STATE _____ ZIP _____

CIRCLE NO. 27 ON READER SERVICE PAGE

Put it to Work!

NEW AND ONLY
FROM EICO—
THE INDUSTRY'S
LOWEST-PRICED
PROFESSIONAL
FET V.M.

Model 239
\$39.95
KIT



Use the battery powered Solid State EICO 239 on your bench or in the field. Check semiconductor and vacuum tube circuits. 11 Megohm DC input impedance. Read AC rms and DC voltages in seven steps from 1 to 1000 volts on large 4½" meter. Measure and read peak-to-peak AC to 2800 volts. Check resistance from 0.2Ω to 1000MΩ on seven ranges. Provides a total of 28 useful ranges on 12 accurate scales. Automatic battery check. Includes exclusive DC/AC ohms Uniprobe™. Factory Assembled, \$39.95.

FREE 32 PAGE EICO CATALOG

For latest catalog on EICO Test Instruments, Stereo, EICOCRAFT Projects, Environmental Lighting, Burglar/Fire Alarm Systems, and name of nearest EICO Distributor, check Reader Service Card.

EICO, 283 Malta Street, Brooklyn, N.Y. 11207



CIRCLE NO. 13 ON READER SERVICE PAGE

ABOUT YOUR SUBSCRIPTION

Your subscription to POPULAR ELECTRONICS is maintained on one of the world's most modern, efficient computer systems, and if you're like 99% of our subscribers, you'll never have any reason to complain about your subscription service.

We have found that when complaints do arise, the majority of them occur because people have written their names or addresses differently at different times. For example, if your subscription were listed under "William Jones, Cedar Lane, Middletown, Arizona," and you were to renew it as "Bill Jones, Cedar Lane, Middletown, Arizona," our computer would think that two separate subscriptions were involved, and it would start sending you two copies of POPULAR ELECTRONICS each month. Other examples of combinations of names that would confuse the computer would include: John Henry Smith and Henry Smith; and Mrs. Joseph Jones and Mary Jones. Minor differences in addresses can also lead to difficulties. For example, to the computer, 100 Second St. is not the same as 100 2nd St.

So, please, when you write us about your subscription, be sure to enclose the mailing label from the cover of the magazine—or else copy your name and address exactly as they appear on the mailing label. This will greatly reduce any chance of error, and we will be able to service your request much more quickly.

PARTS/METHODS/IDEAS/GADGETS/DEVICES

tips & techniques

HOMEBREW TEST PROBE FROM DEFUNCT BALLPOINT PEN

The ballpoint pen is a handy item to have on your workbench, even after it runs out of ink. A defunct "Bic" or similar type of pen can actually be converted into an excellent test probe with very little effort. The first step is to remove the ink cartridge/point assembly. Next, pry off the plastic cartridge and discard it. Now, if there is any ink still in the well of the point assembly, soak the assembly in acetone, thinner, or other chemical that will remove the ink. Remove and discard the cap from the other end of the pen body, and feed one end of a length of flexible test lead down the body of the pen. Strip ¼" of insulation from the test lead and tin the exposed conductors and the well of the point assembly. Insert the tinned test lead in the point well and sweat solder. Allow the point to cool to room temperature; then push the point into place. Connect a snittable plug to the other end of the test lead.

—John Middleton

OSCILLOSCOPE AND AUDIO GENERATOR DOUBLE AS ELECTRONIC TACHOMETER

The electronics experimenter who needs a tachometer but doesn't have one handy can turn his oscilloscope and audio signal generator into a tach. Simply tape a small magnet onto the end of the shaft of the motor. Then mount a 1000-ohm or greater (dc resistance) coil ¼"-½" away from the magnet, connecting the coil leads via a shielded cable to the scope's vertical input. Now, the spinning magnetic field will turn the system into a tiny ac generator. Connect the generator to the horizontal input of the scope, start the motor, and tune the generator to obtain a 1:1 Lissajous pattern on the CRT. The frequency of the generator is the number of revolutions/sec of the motor. To obtain rpm, simply multiply the generator setting by 60.

—Jim Tszuka

MAKE YOUR OWN THREE-ELEMENT NEON-GLOW TRIGGER TUBES

The uses of the neon-glow lamp are as well known to the average experimenter as they are legion. But many electronic circuits often require three-element trigger tubes (NE77's and the like) which never seem to be available when they are most needed. However, you can convert an ordinary garden variety into a three-element trigger tube with the help of a plate cap from an octal tube or a strip of metal rolled into a clamp shape. Simply slip a two-element neon-glow tube into the cap or clamp and wire the latter into the circuit as the third element. In the great majority of cases, your home-made trigger tube will operate satisfactorily.

—Joe Riedel

USE PRESSURE-SENSITIVE VINYL WHEN MAKING PRINTED CIRCUIT BOARDS

Several manufacturers produce pressure-sensitive plastic in large sheets in various patterns and textures. The smooth transparent type is particularly handy for the hobbyist who makes printed circuit boards at home. Properly applied to a board blank, it makes an excellent resist during etching. After cleaning the copper in the usual manner, cover the bare foil with the pressure-sensitive vinyl, making sure that no air bubbles exist. Then use a sharp knife or a razor blade to carefully cut away the vinyl covering the areas that are to be etched away. With a tissue dampened with lighter fluid, remove any residual adhesive from the exposed copper. After etching the board, peel off the remaining vinyl, and drill whatever component lead holes are needed.

—Stephen R. Troy

THINNER SAFELY AND ECONOMICALLY CLEANS AEROSOL PAINT CAN NOZZLES

The manufacturers of aerosol paints state that the cans should be inverted and the nozzle depressed until no paint comes out when the user is finished painting. This is excellent from the sales angle but is rather expensive for the user. Furthermore, it is not surefire. But using a fine wire to clear the microscopic nozzle hole is not the answer either. You can solve forever the problem of clogged nozzles if, after every use, the nozzle is immersed in a small jar of thinner. Stored in the thinner, the nozzle will be always ready for instant use.

—H. St. Laurent

Convert your stereo system to 4-dimensional sound! QUATRASONIC™ BY EICO



KIT \$17.95
WIRED \$29.95

Enjoy 4-dimensional sound hidden in standard stereo records, tapes and FM broadcasts. Just add the QUATRASONIC™ adaptor and two speaker systems — No additional amplifiers required.

FREE 32 PAGE EICO CATALOG

For latest catalog on EICO Test Instruments' Stereo, EICOCRAFT Projects, Environmental Lighting, Burglar/Fire Alarm Systems, and name of nearest EICO Distributor, check Reader Service Card. EICO, 283 Mailla Street, Brooklyn, N.Y. 11207



CIRCLE NO. 14 ON READER SERVICE PAGE

FREE! RADIO SHACK Accessories & Parts Catalog

NEW 1972 Edition!

THE buying guide for kit builders, CB'ers, installers, experimenters, fix-it men, hobbyists, electricians — anyone in electronics in any way!



Electronics A to Z—Antennas, Batteries, Capacitors, Diodes, Educational Kits, Fiber Optics, Grille Cloth, Hi-Fi Speakers, IC's, Jacks, Knobs, L-Pads, Mikes, Needles, Oscillators, P-Boxes, Quadacs, Resistors, Semiconductors, Telephones, Ultrasonic Alarms, VHF Antennas, Wire, Xenon Strobe, "Y" Adapters, Zener Diodes plus our Science Fair and Knight-Kit electronic kits!

ALLIED RADIO SHACK Dept. PE-11
A STANLEY CORPORATION COMPANY 7275 W. 7th St.
Fort Worth, Texas 76107

Send me your FREE 1972 Catalog #215
Please PRINT Clearly

Name _____ Apt. # _____

Street or Rte. & Box _____

City _____

State _____ Zip _____

CIRCLE NO. 5 ON READER SERVICE PAGE

Announcing 16 exciting new Heathkit projects for wintertime kitbuilding fun!



Meet the second generation AR-15 ...new Heathkit AR-1500!

From the AR-15, hailed at the time of its introduction in 1967 as the most advanced receiver of its kind, comes the AR-1500... with impressive improvements in every critical area! **180 Watts Dynamic Music Power**, 90 watts per channel (8 ohm load); 120 watts dynamic music power per channel under 4 ohm load, with less than 0.1% intermod distortion, less than .25% harmonic distortion. A 14-lb. power transformer and massive output transistor heat sink are mute testimony to the power at your command. Direct coupled output and drive transistors are protected by limiting circuitry that electronically monitors voltage and current. **FM selectivity greater than 90 dB**, better phase linearity, separation, and less distortion are the result of two computer-designed 5-pole LC Filters. An improved 4-gang 6-tuned circuit front end offers better stability, 1.8 μ V sensitivity, 1.5 dB capture ratio, and 100 dB image and IF rejection. Four ICs are used, three in the IF and one in the Multiplex. Patented automatic FM squelch is both noise and deviation activated, fully

adjustable for sensitivity. **Vastly Superior AM**, an "also ran" with many receivers, has two dual-gate MOSFETS in the RF and Mixer stages, one J-FET in the oscillator, 12-pole LC Filter in the IF, and broad-band detector. Result: better overload characteristics, better AGC action, and no IF alignment. **Greatly simplified kit construction**. Ten plug-in circuit boards, two wiring harnesses and extensive use of pre-cut wiring with installed clip connections make the AR-1500 a kit builder's dream. Built-in test circuitry uses signal meter to make resistance and voltage checks before operation. **Other advanced features** include Black Magic panel lighting that hides dial markings when set is not in use; flywheel tuning; pushbutton function controls; outputs for two separate speaker systems, bi-amplification, oscilloscope monitoring of FM multipath; inputs for phono, tape, tape monitor and aux. sources — all with individual level controls. **Versatile installation** in optional new low-profile walnut cabinet, in a wall, or black-finish dust cover included. Join the "NOW" Generation in audio technology...order your Heathkit AR-1500 today!

Kit AR-1500, less cabinet, 42 lbs. **349.95***
ARA-1500-1, walnut cabinet, 6 lbs. **24.95***

New Heathkit Stereo Cassette Recorder



119.95*

Frequency response of ± 3 dB, 30-12 kHz, brings your stereo system into the cassette age. Features built-in bias adjustment to accommodate the new chromium dioxide tape; counter; automatic motor shutoff; preassembled and aligned transport mechanism. The AD-110 offers fidelity recording and playback of stereo or mono when used with your stereo system.

Kit AD-110, 10 lbs. **119.95***

New Heathkit Stereo-4 Decoder



29.95*

Compatible with your present stereo system and FM receiver, lets you hear all Stereo-4 material currently being broadcast by a number of stations across the country. Additionally, imparts a 4-channel effect to your existing stereo library. Requires second amplifier and 2 speaker systems for installation with conventional stereo system.

Kit AD-2002, 5 lbs. **29.95***

New Heathkit Stereo Phonograph with AM Radio



109.95*

Gets it together in a portable package with a purple plum snakey skin that's as far out as today's sounds. Solid-state 18-watt amplifier, fold-down 4-speed automatic changer and swing-out high compliance speakers. Speakers can be separated up to 5'. A flip of the mode switch and you're into AM radio! 45 spindle adapter included.

Kit GD-111, 50 lbs. **109.95***



Now Heath's finest color TV package comes wrapped in a handsome new optional cabinet!

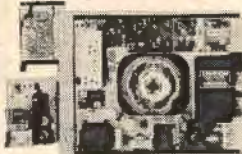

Here's the inside story... the Heathkit 25" solid-state color TV with exclusive MTX-5 ultra-rectangular tube to bring you the largest color picture in the industry! The etched, bonded tube face cuts glare, increases contrast for sharper picture, purer colors, more natural flesh tones. But the true story of color TV reliability starts in the solid-state modular circuitry... 45 transistors, 55 diodes, 2 silicon-controlled rectifiers, 4 ICs containing another 46 transistors, 21 diodes, and just two tubes (picture and high-voltage rectifier). Major circuit functions are contained on individual plug-in glass epoxy boards (see chassis inset above) to simplify assembly, service and adjustment. And, of course, only Heathkit color TV offers you the money-saving advantages of home-serviceability... with the built-in dot generator and tilt-out convergence panel to let you perform the periodic adjustments required of all color receivers.

Other advanced design features include solid-state VHF tuner with MOSFET for greater sensitivity, lower noise and cross modulation; solid-state UHF tuner with hot-carrier diode design for greater sensitivity; 3-stage solid-state IF for higher gain and superior picture quality; Automatic Chroma Control for constant color quality under different signal conditions; adjustable video peaking; adjustable noise limiting and gated AGC; "Instant-On"; VHF power tuning on 13 channels plus one preselected UHF channel; Automatic Fine Tuning; Tone-Control; and an output to your stereo/hi-fi system for the ultimate in sound reproduction.

And to wrap it all up... your Heathkit GR-371MX is available in a magnificent new Mediterranean cabinet with doors that transform your home television theater back into an attractive center of decor. This finest cabinet in the Heathkit line features deep-grained pecan veneers on hand rubbed furniture grade hardwood solids. Two beautifully scalloped double-hinged bi-fold doors hide the TV screen when it's not in use, fold neatly to the cabinet sides when opened. Ornate brass "Canterbury Antique" handles add the perfect finishing touch. Measures 29 5/8" H x 56 1/4" W x 22 3/4" D.

- Kit GR-371MX, TV less cabinet, 125 lbs. 579.95*
- GRA-404-25, assembled cabinet, 87 lbs. 139.95*

New Heathkit Solid-State Wireless Intercom



29.95*

Plug two of them into standard 105-130 VAC outlets for 2-way communications. Three channels let you carry on 3 conversations in a 6-unit system, call one unit without disturbing the others in a 3-unit network. Intercoms have channel selectors, spring loaded "talk" button, slide-action volume control, and "dictate" for extended one-way communication.

Kit GD-113, 5 lbs. each 29.95*

New Heathkit Solid-State Shortwave Receiver



59.95*

Four over-lapping bands provide continuous coverage from 550 kHz to 30 MHz, giving you local AM plus international, amateur, marine & weather and citizens band broadcasts. Features band-spread tuning for close station separation; BFO control for receiving code; signal meter, front-panel headphone jack; noise limiter; built-in AM antenna.

Kit SW-717, 10 lbs. 59.95*

New Heathkit Automatic Battery Charger...



Charges 12-volt batteries automatically. 10 amp max. charge rate. Impossible to hook up wrong. No charge setting to make... can be left hooked up indefinitely. Meter monitor charge. Kit GP-21, 13 lbs. 29.95*

New Heathkit Automotive Timing Light...



Completely self-contained. Bright flash lets you work in sunshine. Adapter for connecting to distributor. Hi-impact plastic case.

Kit CI-1020, 2 lbs. 19.95*

there's a Heathkit present



229^{95*}

New Heathkit Solid-State Digital Multimeter...

Here's a breakthrough in instrumentation. The new Heathkit IM-102 gives you a true digital multimeter for about half what you'd pay for comparable wired DMM's! And with an accuracy that's better than many wired digital units on the market... decidedly superior to most analog type instruments. This great new meter measures AC and DC voltages and currents, and resistance with no need to change probes or switch for changes in DC polarity. Automatically displays a positive or negative DC voltage and current, indicating the correct amplitude and polarity. Five overlapping ranges measure voltage from 100 μ V to 1000 V on DC (either polarity); five ranges cover 100 μ V to 500 V on AC; 10 ranges measure 100 nanoamperes to 2 amperes on AC or DC, and six ranges show resistance from .1 ohm to 20 megohms. Input impedance is exceptionally high — approximately 1000 megohms on 2V range (10 megohm on higher ranges), with overload protection built-in on all ranges. Decimal point is automatically placed with range selection and over-range is indicated by a front panel light.

Ends parallax and interpolation errors! There's no mistaking a digital display — everyone reads it the same way. High quality precision components, 3½ digits and ease of calibration contribute to the IM-102's lab-grade accuracy. Analog to digital conversion is accomplished by a patented, dependable Dual Slope Integrator that does not depend on a stable clock frequency for accuracy. A Heath-designed and assembled precision DC calibrator is furnished with each IM-102. An internal circuit and transfer method provides accurate AC voltage calibration. The all solid-state design incorporates cold cathode readout tubes and a "memory" circuit to assure stable, non-blinking operation. Features include detachable 3-wire line cord (no batteries needed), dual primary power transformer, isolated floating ground and completely enclosed, light-weight aluminum cabinet with die-cast zinc front panel and tinted viewing window. Kit includes standard banana jack connectors complete with test leads. Assembles in approximately 10 hours. The new Heathkit IM-102 Digital Multimeter will be the pride of your bench!

Kit IM-102, 9 lbs., mailable229.95*

New Heathkit Vector Monitor...



49^{95*}

Designed for use with the Heathkit IG-28 Pattern Generator or similar units which display either "rainbow" (offset carrier) or NTSC patterns, the IO-112B vector display helps you perform fine tuning, static and dynamic convergence,

purity, 3.58 oscillator, reactance coil, phase detector transformer, demodulator angle check, and chroma bandpass adjustments. Represents exactly the color signals fed to CRT guns.

Kit IO-112B, 10 lbs.49.95*

New Heathkit Electronic Switch... 39^{95*}

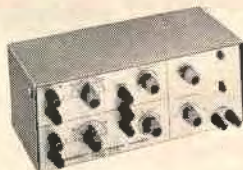

Provides simultaneous visual display of 2 input signals on a single trace oscilloscope. Has DC coupling and DC-5 MHz \pm 3 dB frequency response. Conventional binding posts permit fast

hook-up. Can be left connected to scope. Ideally suited for digital circuit work; amplifier input and output for gain and distribution checks; simultaneous monitoring of 2 stereo channels.

Kit IO-101, 6 lbs.39.95*

for every age, every hobby!

New Heathkit "Minimizer" kitchen waste compactor...

Today's most modern refuse handling method in easy-to-assemble kit form! Now you can own the most exciting kitchen appliance on the market for less than you'd pay for any other comparable compactor. The Heathkit Minimizer lets Mom throw out the unsightly waste baskets and garbage cans for the latest in clean, convenient, odor-free disposal. The Minimizer handles all normal household trash — food wastes, glass and plastic containers, tin cans, wrappings, boxes, floor sweepings, light bulbs, etc. The packing ram descends with 2,000-lb. force to reduce refuse to almost 1/4 of its original size, packaging the material in a strong disposable bag — one bag holds an entire week's trash for a family of four! When the bag's full, Mom simply folds over the top and removes a neat, dry package for normal rubbish pickup. And the Minimizer deodorizes the contents each time the drawer is opened and closed. The sanitation man will love Minimizer, too!

Simple, safe operation! To use, Mom merely inserts a Minimizer plastic-lined bag in the drawer and starts the compacting cycle. In less than a minute the ram forces down the trash, returns to its normal position, and the Minimizer shuts itself off. For maximum safety, the Minimizer uses a key lock switch and an interlock which automatically turns unit off if drawer is not fully closed or is accidentally opened during cycling. Your Heathkit Minimizer can be built-in under the kitchen counter or left free-standing. Its bright white enamel finish with marble-tone vinyl-clad top complements any decor. And you can build it yourself in 6 to 10 hours. Has long-life 1/2 hp motor, plugs into 110-120 VAC conventional household outlet. Kit includes 5 plastic-lined bags, one 9 oz. aerosol can of deodorant. Minimizer measures 34 3/4" H x 15" W x 25 1/2" D.

Kit GU-1800, 203 lbs. 199.95*
GUA-1800-1, 15 plastic-lined bags, 5 lbs. 4.99*

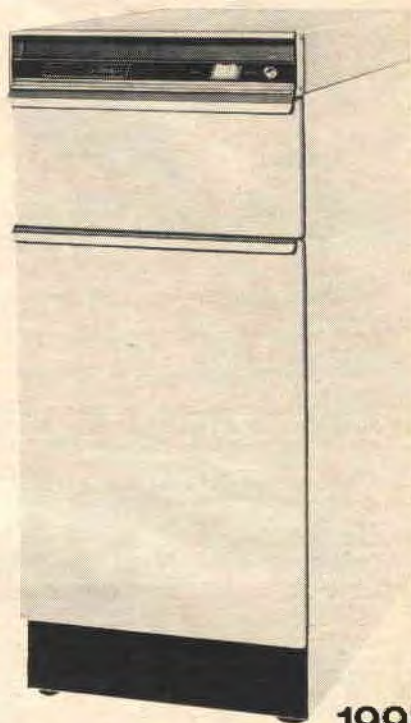

199.95*

New Heathkit Slotless 1/32-Scale Raceway

129.95*



You race up to 4 GT cars — each with independent acceleration, deceleration and steering! Make all the maneuvers of real high-speed drivers. You can even turn around completely and backtrack. Kit includes track sections for 8'x4' oval, power transformer, 2 cars and controllers.

Kit GD-79, 13 lbs., mailable 129.95*
Kit GDA-79-1, extra car and controller, 3 lbs., mailable ... 21.95*

New Heathkit Electronic Workshops

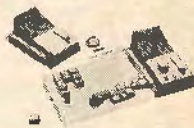

Completely self-contained electronics labs teach youngsters the basics of electronics. Each contains basic electronic components in easy-to-work-with module form. Kids simply follow the instructions, arrange the blocks on the board to form actual working circuits for code flashers, timers, alarms, etc.

Kit JK-1033, 36 experiments, 11 lbs. 29.95*
Kit JK-1022, 25 experiments, 8 lbs. 24.95*
Kit JK-1011, 12 experiments, 6 lbs. 19.95*

SEE THESE KITS AT YOUR LOCAL HEATHKIT ELECTRONIC CENTER... or send for FREE catalog!

CALIF.: Anaheim, 330 E. Ball Road; El Cerrito, 6090 Potrero Avenue; La Mesa, 8363 Center Drive; Los Angeles, 2309 S. Flower St.; Redwood City, 7901 Middlefield Rd.; Woodland Hills, 22504 Ventura Blvd.; COLO.: Denver, 5940 W. 38th Ave.; GA.: Atlanta, 5285 Roswell Road; ILL.: Chicago, 3462-66 W. Devon Ave.; Downers Grove, 224 Ogden Ave.; MD.: Rockville, 5542 Nicholson Lane; MASS.: Wellesley, 165 Worcester St.; MICH.: Detroit, 18645 W. Eight Mile Rd.; MINN.: Hopkins, 101 Shady Oak Rd.; MO.: St. Louis, 9296 Gravois Ave.; N.J.: Fair Lawn, 35-07 Broadway (Rte. 4); N.Y.: Jericho, L.I.; 15 Jericho Turnpike; New York, 35 W. 45th Street; OHIO: Cleveland, 5444 Pearl Rd.; Woodlawn, 10133 Springfield Pike; PA.: Philadelphia, 6318 Roosevelt Blvd.; Pittsburgh, 3482 William Penn Hwy.; TEXAS: Dallas, 2715 Ross Avenue; Houston, 3705 Westheimer; WASH.: Seattle, 2221 Third Ave.; WIS: Milwaukee, 5215 Fond du Lac.

Retail Heathkit Electronic Center prices slightly higher to cover shipping, local stock, consultation and demonstration facilities. Local service also available whether you purchase locally or by factory mail order.



HEATHKIT COMPANY, Dept. 10-11
Benton Harbor, Michigan 49022

Enclosed is \$....., plus shipping.
 Please send model (s).
 Please send FREE Heathkit Catalog.

Name.....
Address.....
City.....State.....Zip.....

*Mail order prices; FOB factory.
Prices & specifications subject to change without notice. GL-422

QUICK-PICK Pat. Pend.

- Makes removal of transistors and capacitors from a "forest" of parts easy



- Seven (7) tools clamp on over 25 different outlines of transistors or can capacitors. Therefore, it can be used on hundreds of types of transistors and capacitors.
- Makes an excellent heat sink while unsoldering or replacing parts.
- Permits more attention to be given the soldering operation. Will leave both hands free to unsolder the leads. A slight pull on the Quick-Pick will remove the part when the leads are free.
- Colored handles permit Quick size selection.
- Packaged in an attractive carrying case.

995

Lendell Products set of 7 tools postpaid
939 S. 7th St. DeKalb, Illinois 60115
CIRCLE NO. 19 ON READER SERVICE PAGE



KITS FEATURED IN

POPULAR ELECTRONICS

AND FROM OTHER SOURCES

| | |
|--------------------------|---------|
| Psychedelic Strobe Light | \$17.50 |
| "UT" Stereo Amplifier | \$80.00 |
| FET Preamp | \$44.50 |
| SCA Adaptor | \$14.50 |
| Ultrasonic Alarm | \$37.25 |
| Regulated Power Supply | \$39.50 |

Prices plus postage and insurance

Also:

Psychedelia I Color Organ, Sonolite, Nixie Readouts, Frequency Counters, Sports Timers, Ultrasonic Alarm, etc.

WRITE FOR **FREE** CATALOG

Southwest Technical Products
219 (PE) W. Rhapsody
San Antonio, Texas 78216

CIRCLE NO. 29 ON READER SERVICE PAGE

STEREO SCENE

(Continued from page 71)

other capacity most of the time—sales managing, quality-control managing, or some such. Their ears are called on when needed for listening evaluations, and they do their titled job the rest of the time.

You could consider some such position, basing your specific choice on preference as well as on your likely educational status by the time you'll be seeking employment.

Dear Sir:

I have been waiting to see you comment on RCA's new, floppy "Dynaflex" discs, and you have never mentioned them. Any comments about them?

Dean Hamill
Bronx, N. Y.

Yes, one or two. First, contrary to appearances, the Dynaflex disc is not just a way of cutting costs on vinyl. RCA's research showed that the thinner disc accepts molding easier and better than the usual-thickness disc, and produces fewer blemishes like bubbles, pits, etc. Of course, the fact that Dynaflex would save vinyl was not a source of dismay to RCA.

I've used a few of the Dynaflexes, and while they didn't behave any less satisfactorily than ordinary discs, mine did not seem substantially quieter than previous RCA discs. They are, however, not usable at all on some record changers, because the dropping mechanisms malfunction with the thinner discs.

Dear Sir:

Why is it that professional tape recorders cost such a horrible amount of money when they don't have any of the features you find in home machines like sound-on-sound recording, echo and the like?

Most of a professional recorder's high cost goes into things you can't see—a super-rugged drive system, die-cast and machined deck frame, high-reliability resistors and capacitors—which contribute to the machine's durability and dependability. As for the features found in home machines, any of these things can be done with a professional machine by appropriate patch cord hookups which make the same connections that can be switched in on a home-type recorder.

Finally, the simple fact that fewer professional machines are sold than home-type machines means that the costs of the recorder's design must be recouped. ♦

Popular Electronics

READER SERVICE PAGE

free information service:

Here's an easy and convenient way for you to get additional information about products advertised or mentioned editorially (if it has a "Reader Service Number") in this issue. Just follow the directions below... and the material will be sent to you promptly and free of charge.

1. On coupon below, circle the number(s) that corresponds to the key number(s) at the bottom or next to the advertisement or editorial mention that is of interest to you. (Key numbers for advertised products also appear in the Advertisers' Index.) Print or type your name and address on the lines indicated.

2. Cut out the coupon and mail it to: POPULAR ELECTRONICS, P.O. Box 8391, Philadelphia, PA 19101.

note: If you want to write to the editors of POPULAR ELECTRONICS about an article on any subject that does not have a key number, write to POPULAR ELECTRONICS, One Park Avenue, New York, N.Y. 10016. Inquiries concerning circulation and subscriptions should be sent to POPULAR ELECTRONICS, P.O. Box 1096, Flushing, N.Y. 11352.

11/71-2

Void after December 31, 1971

Popular Electronics

P.O. BOX 8391
PHILADELPHIA, PA. 19101

1 2 3 4 5 6 7 8 9 10 11 12 13 14 15 16 17 18 19 20
21 22 23 24 25 26 27 28 29 30 31 32 33 34 35 36 37 38 39 40
41 42 43 44 45 46 47 48 49 50 51 52 53 54 55 56 57 58 59 60
61 62 63 64 65 66 67 68 69 70 71 72 73 74 75 76 77 78 79 80
81 82 83 84 85 86 87 88 89 90 91 92 93 94 95 96 97 98 99 100

NAME (Print clearly) _____

ADDRESS _____

CITY _____ STATE _____ ZIP CODE _____

LIBRARY

(Continued from page 14)

not in any way take away from the fact that it can stand alone; it is a complete and comprehensive volume on semiconductors. The book begins with a discussion of conduction in the solid state, goes on to the p-n junction, and dives deeply into transistor theory and physics. The treatment, in most respects is full, touching on all phases of the subject.

Published by Pergamon Press, Inc., Maxwell House, Fairview Park, Elmsford, NY 10523. 254 pages. \$7.00 hard cover, \$4.75 soft cover.

SIMPLIFIED RADIOTELEPHONE LICENSE COURSE, Volumes 1 thru 3

By Leonard C. Lane

Presenting a completely new approach to studying for FCC commercial radiotelephone license exams, this three-volume course covers theory and all the latest test questions by subject area. Each chapter starts out with a theory discussion and is followed by a series of FCC exam questions accompanied by detailed answers. Wherever necessary, circuit diagrams are included

and sample problems are fully worked out. All questions are based on the latest revised FCC Study Guide.

Published by Hayden Book Co., Inc., 116 West 14 St., New York, NY 10011. 136 pages Vol. 1, 308 pages Vol. 2, 136 pages Vol. 3. \$11.95 hard cover containing all three Volumes; \$12.85 for set containing individual soft cover volumes.

PULSE AND SWITCHING CIRCUIT ACTION PULSE AND SWITCHING CIRCUIT MEASUREMENTS

by Henry C. Veatch

These two books—the first on theory and the second devoted to practical laboratory experiments—are companions to each other and should, thus, be discussed together. Their treatment of pulse and switching circuits is as excellent as it is timely. Although each volume can stand alone on its own merits, it is interesting to note that, used together, they can provide a complete and comprehensive course of study in the most current topic in electronics—as good as any you'll find in more academic works.

Published by McGraw-Hill Book Co., 330 West 42 St., New York, NY 10036. *Pulse & Switching Circuit Action*: Hard cover. 470 pages. \$12.95. *Pulse & Switching Circuit Measurements*: Soft cover. 181 pages. \$4.95.



- ◆◆ 30 Day Money Back Guarantee and 5 Year Service Warranty Protection.
- ◆◆ 40,000 to 50,000 miles between tune-ups. A tuned car pollutes less!
- ◆◆ Will not overheat or freeze-up. Shockproof, waterproof and ideal for marine use.

THOR-GO

A Dependable C. D. I. Unit At A Reasonable Price . . . \$34.50

DEPENDABLE AUTOMOBILE PERFORMANCE THAT PAYS FOR ITSELF!

THOR-GO, a Capacitive Discharge Ignition System, is an advanced solid state automobile ignition designed to eliminate the inherent problems of the standard system. Point and plug erosion is reduced to 1/10th of the standard ignitions erosion (40,000 to 50,000 miles between tune-ups). By eliminating tune-ups, THOR-GO keeps your engine operating at peak performance and saves you money (\$30 plus per tune-up). Through more efficient ignition operation THOR-GO produces instant all-weather starting and a 10% to 20% gas mileage increase. THOR-GO burns fuel more effectively, producing less combustion contaminants to pollute the air. When you can experience increased performance, stop wasting your money, stop polluting the air and enjoy faster starting with decreased maintenance problems; it makes sense to buy THOR-GO. Prove it to yourself with our 30 day money back guarantee.

*Reviewed by Popular Electronics
on page 72 of the August, 1970, issue.
Ask your Dealer or Write Today!*

Alpha Lunco Corp., Box 1164, Norman, Ok. 73069 or Box 1861 Binghamton, N.Y. 13902

CIRCLE NO. 6 ON READER SERVICE PAGE

NEW LITERATURE

(Continued from page 16)

and dome-radiator tweeters is available from Acoustic Research, Inc. Detailed technical descriptions of AR's newest products, the AR-6 speaker system and the AR FM tuner, are included.

Circle No. 78 on Reader Service Page 15 or 99

More than 31,000 semiconductor devices are cross-referenced to HEP replacements in the 1971 HEP Semiconductor Cross-Reference Guide and Catalog available for 35¢ from Motorola Inc., Semiconductor Products Div., 5005 E. McDowell Rd., Phoenix, AZ 85008. Included in the listings are 1N, 2N, 3N, JEDEC, manufacturers' regular and special "house" numbers and many international devices. There are 471 HEP item listings, including kits, books, and accessories.

Three new product folders are available for the asking from Craig Corp. They describe the company's 1971-1972 line of: (1) car stereo cartridge players, receivers, and a home adapter with speakers; (2) home entertainment tape recorders, players, and receivers; and (3) portable cassette and cartridge players and receivers. Each item listed in the folders is supported by a photo, technical description and accessory and price listing.

Circle No. 79 on Reader Service Page 15 or 99

A whole new world has opened up for the science-minded rocketeer with the introduction by Estes Industries of the "TRANSROC" miniature multipurpose transmitter for use with model rockets. This item, as well as all other items in the company's TRANSROC line (including extra and replacement parts, crystals, accessory packages and modules, etc.) are described in a

brochure that is available on request.

Circle No. 80 on Reader Service Page 15 or 99

The ARP Division of AVX/Aerovox has just issued a full-color, 20-page catalog (form No. SE-571) of service replacement capacitors. The catalog contains descriptive information and rating charts for electrolytic, paper-film, filter, ceramic, mica, and ac capacitors. Listings include the more popular values for radio and TV receivers, audio equipment, ham radio equipment, hearing aids, appliances, and industrial applications. Also included is a section on popular decade boxes featuring four resistance, three capacitance, and four inductance decades.

Circle No. 81 on Reader Service Page 15 or 99

A new diversified line of communications equipment and accessories is described in the Electronic Products Catalog available from Midland Communications Co. Listed are base, mobile, and hand-held transceivers in both AM and SSB versions, scanning monitor with automatic hi-lo intermix, H.E.L.P. mobile CB rig with automatic 2-channel logic scanner, mirror-scaled multimeters, and a full selection of speakers, microphones, stereo headsets, electronic parts, and accessories.

Circle No. 82 on Reader Service Page 15 or 99

Some of the more unique and memorable projects that have graced the pages of this magazine are listed in kit form in a new catalog available from PAIA Electronics. The kit listing includes such items as an in-out annunciator, optical tachometer, 200-watt dual flasher, Carpenter's Mate tiny metal locator, surf synthesizer, and a wired wireless remote control unit. The audio/music kits described are the Drummer Boy, a rotating speaker simulator, rhythm and accompaniment box, electronic Waa-Waa, and an electronic guitar sound modifier.

Circle No. 83 on Reader Service Page 15 or 99

Sonar SENTRY VHF MONITOR RECEIVERS WITH ADJUSTABLE SQUELCH

With Battery,
Earphone, &
less Crystals
\$5.00 ea.

\$49.95

SOLID STATE
with ADJUSTABLE SQUELCH
POCKET SIZE

FR-103SA (150-175 MHz) FR-106SA (IN FOUR FREQ. 30-50 MHz)

3 CHANNELS

LISTEN TO: POLICE, FIRE, & WEATHER REPORTS!

for Industrial, Commercial, Utility & Govt. Use
3 CHANNELS • BROADCAST BAND • CRYSTAL CONTROLLED

Designed and engineered for simplicity of operation, compact enough to fit a shirt pocket yet powerful enough to deliver a clear clean signal—it's dependable • Operates on three crystal controlled VHF channels plus broadcast band • Adjustable squelch • Completely solid state for long life use • Visible battery indicator to show battery condition at all times • Built in antenna • 5 7/8" H x 2 1/2" W x 1 3/8" D. Wt. 11 oz.

SONAR RADIO CORP., 73 Wortman Ave., Bklyn, N.Y. 11207

Please send information on VHF Monitor Receivers.

Dept. 425

Name _____

Address _____

City _____

State _____

Zip _____

CIRCLE NO. 28 ON READER SERVICE PAGE

TRUE-FALSE LOGIC QUIZ

By Vic Bell and Joe Kish

- Binary number 1101 is equal to eleven.
- Boolean Algebra is valuable in the analysis of switching circuits.
- DTL, RTL, TTL, ECL are big-name IC manufacturers.
- Most logic circuit are internally direct coupled.
- MSI and LSI stand for medium- and large-scale integration, respectively.
- In an RS flip flop, the RS stands for Read-Shift.
- A hex inverter IC contains 6 inverting amplifiers.
- Another way of saying a "triple 3 input gate" is "3 gates with 3 inputs each."
- A unique feature of the 4-input expander is that it has no collector loads.
- In logic equations, a line drawn over a symbol means NOT.
- A mechanical analogy sometimes used for the inverter is a seesaw.
- SSI is a new mind-expanding drug uncovered as a by-product of transistors.
- "T-squared" logic is sometimes used to mean transistor-transistor logic.

with a single chip containing all the functions of a calculating machine.

6. False. RS means Reset and Set.

7. True. Hex inverter means exactly what it says.

8. True. Or still another way: one package with three gates, each having three inputs.

9. True. The 4-input expander requires external loading.

10. True. In other words, the answer to question 14 is false with a line over it (not false, but true).

11. True. When the input is low, the output is high. When the input is high, the output is low.

12. False. SSI means small-scale integration.

13. True. Basically "T squared" is conversational. It stands for TT.

1. False. If you got eleven, you read the numbers from the wrong end. Binary numbers start with the lowest power on the right, where 2 to the zero power is 1, and ascend to the highest power on the left, where 2 cubed is 8. The answer is 13.

2. True. Boolean algebra, a logical study of propositions, is used to build truth tables for analysis. It is often used to convert word descriptions to formulas which can be translated to circuits.

3. False. DTL means diode coupled logic; TTL, transistor-transistor logic; ECL, emitter-coupled logic.

4. True. In chip construction, it is easier to add several transistor stages than to add a resistor, capacitor, or transformer.

5. True. Both MSI and LSI use large chips which have thousands of transistor functions. LSI is being manufactured

QUIZ ANSWERS



MODEL
SPR-4
\$499.95
NET

COMMUNICATIONS RECEIVER

A general purpose receiver, the SPR-4 may be programmed to suit any interest: SWL, Amateur, Laboratory, Broadcast, Marine Radio, etc. Frequency Coverage: 150-500 KHz plus any (23) 500 KHz ranges, 500 to 30 MHz.

FEATURES: • Linear dial with 1 KHz readout • 4-pole crystal filter in first IF • 4-pole LC filter in second IF • Three bandwidths: 0.4 KHz, 2.4 KHz, and 4.8 KHz for: CW, SSB, AM • Superior cross-modulation and overload performance • Power: 120 VAC, 220 VAC, and 12 VDC • Crystals supplied for LW, BC and seven SW bands • Built-in speaker • Notch Filter.

ACCESSORIES: 100 KHz calibrator, noise blanker, transceiver adapter (T-4XB), DC power cord, loop antenna, crystals for other ranges.

- Direct Frequency Dialing • All Solid State
- Programmable Coverage • FET Circuitry

For more details write: **R. L. DRAKE COMPANY** 540 Richard St., Miamisburg, Ohio 45342

MUSCLE WHISTLER

(Continued from page 61)

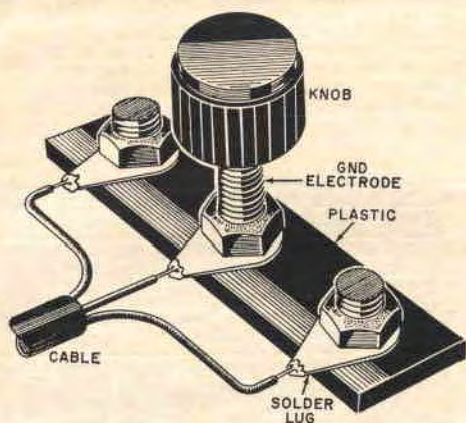

Fig. 2. Electrodes are mounted on a small length of plastic as shown here. An insulated knob on the ground screw acts as the handle.

slightly, touching one of the end electrodes on the muscle probe should cause the circuit to squeal due to imbalance in the operational amplifier circuit. (It is actually pickup from the field created by the 60-Hz power line.) However, when both electrodes are touching the skin, virtually all of this ambient noise is rejected by the differential amplifier.

Good electrical contact must be made between the electrodes and the skin. Use a commercial electrode paste or make your own by mixing salt, water, and flour in a good paste consistency. The

paste is rubbed into the area of skin where the electrodes are to be applied.

Before the electrodes are placed against the skin, set R6 partially up and be sure R9 is adjusted to give no output. Place the electrodes against the skin. There will be a change in the tone of the output. Adjust R9 just below the oscillation point and adjust R6 until the output changes frequency as the muscle is activated. Each time the muscle is flexed, the whistle changes frequency—the tenser the muscle, the higher the frequency.

Theory of Circuit Design. Operational amplifier IC1 is a very high gain differential amplifier whose gain (sensitivity) is controlled by feedback potentiometer R6. The differential input to the op amp is picked up by the electrodes applied to the skin.

Unijunction transistor Q3 is wired in the classical UJT oscillator configuration with C5 determining the frequency and the emitter-collector resistance of Q2 (with limiting resistor R12) acting as the charging resistor. The interelement resistance of Q2 is a function of the applied base current and the voltage to move this current is stored in capacitor C4, which is charged up by amplifier Q1. The size of the steady-state charge on C4 is determined by the setting of R9.

When a muscle voltage is amplified by IC1 and fed to Q1, the collector voltage on Q1 varies, thus changing the charge on C4. This, in turn, varies the UJT oscillator frequency. The speaker forms the load for Q3, and the audible tone consists of a series of spikes, each occurring as the UJT fires. ♦

FREE McIntosh CATALOG and FM DIRECTORY

Get all the newest and latest information on the new McIntosh Solid State equipment in the McIntosh catalog. In addition you will receive an FM station directory that covers all of North America.



MX 114

FM/FM STEREO TUNER
and STEREO PREAMPLIFIER

CIRCLE NO. 23 ON READER SERVICE PAGE

SEND TODAY!

McIntosh Laboratory Inc.
2 Chambers St., Dept. PT-1171
Binghamton, N.Y. 13903

NAME _____

ADDRESS _____

CITY _____ STATE _____ ZIP _____

Popular Electronics Market Place

NON-DISPLAY CLASSIFIED: COMMERCIAL RATE: For firms or individuals offering commercial products or services, \$1.25 per word (including name and address). Minimum order \$12.50. Payment must accompany copy except when ads are placed by accredited advertising agencies. Frequency discount: 5% for 6 months; 10% for 12 months paid in advance. **READER RATE:** For individuals with a personal item to buy or sell, 80¢ per word (including name and address.) No Minimum! Payment must accompany copy. **DISPLAY CLASSIFIED:** 1" by 1 column (2 3/4" wide), \$185.00. 2" by 1 column, \$370.00. 3" by 1 column, \$555.00. Advertiser to supply cuts. For frequency rates, please inquire.

FOR SALE

FREE! bargain catalog. Fiber optics, LED's, transistors, diodes, rectifiers, SCR's, triacs, parts. Poly Paks, Box 942, Lynnfield, Mass. 01940.

GOVERNMENT Surplus Receivers, Transmitters, Sniperscopes, Radios, Parts, Picture Catalog 25¢. Meshna, Nahant, Mass. 01908.

ROCKETS: Ideal for miniature transmitter tests. New illustrated catalog. 25¢. Single and multistage kits, cones, engines, launchers, trackers, rocket aerial cameras, technical information. Fast service. Estes Industries, Dept. 18-K, Penrose, Colorado 81240.

LOWEST Prices Electronic Parts. Confidential Catalog Free. KNAPP, 3174 8TH Ave. S.W., Largo, Fla. 33540.

WE SELL CONSTRUCTION PLANS. TELEPHONE: Answering Machine, Speakerphone, Carphone, Phonovision, Legal Connector, Auto Dialer, Central Dial System. **TELEVISION:** \$35.00 Color Converter, Tape Recorder, 3DTV. \$25.00 Camera. **HOBBYIST:** Electron Microscope, 96 Hour Tape Music System, Ultrasonic Dishwasher, Radar-Oven, Electronic Tranquilizer. Plans \$4.95 each. **COURSES:** Telephone Engineering \$39.50. Detective Electronics \$22.50. Anti-Detective Electronics \$27.50. **NEW SUPER HOBBY CATALOG AIRMAILED \$1.00.** Don Britton Enterprises, 6200 Wilshire Blvd., Los Angeles, Calif. 90048.

JETCO ELECTRONIC INDUSTRIES, INC.
Dept. PEC, 3933 Barranca Dr., El Paso, Texas 79935.

**FIND COINS-GOLD-RELICS-TREASURE
metal locators by JETCO!**

- Lightweight
- Easy to Use
- Comes Complete
- Made in USA
- 5 yr. Guarantee
- Immediate Delivery!
- Write for FREE Catalog.

priced from

\$39.95



WEBBER LAB's. Police & Fire Converters. Catalog 25¢. 72 Cottage Street, Lynn, Mass. 01905.

INVESTIGATORS, latest Electronics Aids. Free literature. Clifton, 11500-L NW 7th Ave., Miami, Florida 33168.

ELECTRONIC PARTS, semiconductors, kits. **FREE FLYER.** Large catalog \$1.00 deposit. BIGELOW ELECTRONICS, Bluffton, Ohio 45817.

RADIO—T.V. Tubes—36¢ each. Send for free catalog. Cornell, 4213 University, San Diego, Calif. 92105.

NEW SEMICONDUCTOR LIGHT EMITTING DIODES—bright red lights replace light bulbs. Typical life 100 years. Operate at 1.65 volts, 50 milliamperes. Order 2 for \$2.98 **NOW.** Data sheet and instructions included. Monsanto Company, Hobby Section, 10131 Burb Road, Cupertino, California 95014.

CONVERT any television to sensitive, big-screen oscilloscope. Only minor changes required. No electronic experience necessary. Illustrated plans, \$2.00. Relco-A33, Box 10563, Houston, Texas 77018.

GENERAL INFORMATION: First word in all ads set in bold caps at no extra charge. All copy subject to publisher's approval. All advertisers using Post Office Boxes in their addresses **MUST** supply publisher with permanent address and telephone number before ad can be run. **Closing Date:** 1st of the 2nd month preceding cover date (for example, March issue closes January 1st). Send order and remittance to Hal Cymes, **POPULAR ELECTRONICS,** One Park Avenue, New York, New York 10016.

MECHANICAL, ELECTRONIC devices catalog 10¢. Greatest Values—Lowest Prices. Fertik's, 5249 "D", Philadelphia, Pa. 19120.

SCORE, B&K Test Equipment Unbelievable Prices. Free Catalog and Price Sheet. Fordham Radio, 265 East 149th Street, Bronx, N.Y. 10451.

ELECTRONIC ignition. Various Types. Information 10¢. Anderson Engineering, Epsom, N.H. 03239.

SPACE-AGE TV CAMERA KITS & PLANS



BE A PIONEER IN HOME TELECASTING! Build your own TV CAMERA, Model XTVA, Series D, \$169.95 pp. Single-Step, step-by-step construction manual. High quality. Connects to any TV without modification. Ideal for home, experimenters, education, industry, etc.

PHONE or WRITE for CATALOG.
DIAL 402-967-3771

Many other kits, parts and plans available including starter kits, focus/defl. coils, vidicon tubes, chst. plans, etc.

1301 N. BROADWAY **ATV Research** DAKOTA CITY, NEBR. 68731

ELECTRONIC COMPONENTS—Distributor prices, Free catalog. Box 2581, El Cajon, California 92021.

FREE Kit Catalog: Shortproof Powersupply \$39.50. Ultrasonic Alarm \$37.25. SWTPC, Box B32040, San Antonio, Tex. 78216.

AMATEUR SCIENTISTS, Electronics Hobbyists, Experimenters, Students . . . Construction Plans—all complete, including drawings, schematics, parts lists with prices and sources . . . **Radar**—Build your own ultrasonic doppler radar. Detect motion of people, automobiles, even falling rain drops. Transistorized, uses 9 volt transistor battery—\$4.50 . . . **Long-Range "Sound Telescope"**—This amazing device can enable you to hear conversations, birds and animals, other sounds hundreds of feet away. Very directional. Transistorized. Uses 9V battery—\$3.50 . . . **Robot Man**—Moves hands and arms—\$3.50 . . . Or send 25¢ coin (no stamps) for complete catalog. Other items include Psychedelic strobes, light shows, lasers . . . 46 different projects. Technical Writers Group, Box 5994, State College Station, Raleigh, N.C. 27607.

DEALERS WANTED! Citizens Band, AM, SSB, Two-way Radios & Accessories. USA and Export models. We ship around the world. Send letterhead to: Baggy's Radio P.O. Box 778, 6391 Westminster Ave., Westminster, Ca. 92683. 714-894-3301.

CITIZENS BAND—Shortwave Listener-Ham equipment from Amrad Supply, Inc. Free Flyer, 1025 Harrison St., Oakland, Calif. 94607.

PSYCHEDELIC Strobe Kit: Complete with 110w/sec. tube, reflector, chassis and cabinet \$17.50 plus postage and insurance. 2 lbs. (Extra tubes \$3.50) SWTPC, Box E32040, San Antonio, Texas 78216.

ANTI GRAVITY, experiment and theory; Rushed—\$2.00. U.S. Inquiries, Intertech 7A2, Box 5373, Station-F, Ottawa, Canada.

LEARN the facts of electronics and your privacy. Send for the Tron-X Manual, P.O. Box 38155, Hollywood, CA 90038. \$5.95.

JAPAN HONG KONG DIRECTORY. World products information. \$1.00 today. Sekai Shogyo Annai, Hillyard, Washington 99207.

INTEGRATED CIRCUITS—Factory Prices, Catalog 10¢. Silling, Box 6257, Seattle, Washington 98188.

DEALERS WANTED!

CITIZENS BAND, AM, SSB, Two-way Radios & Accessories. USA and export models. We ship around the world. Send letterhead to:

BAGGY'S RADIO

P.O. Box 778, 6391 Westminster Ave.,
Westminster, California 92683
714-894-3301

FREE Kit Catalog: Color Organs \$11.00, Psychedelic Strobes \$17.50, Professional quality—lowest prices. SWTPC, Box F32040, San Antonio, Texas 78216.

EUROPEAN and Japanese bargains catalog. \$1 each. Dee, P.O. Box 9308, North Hollywood, Calif. 91609.

BURGLAR ALARM SYSTEMS. We manufacture intruder-fire detection systems, radar and perimeter types. Accessories available. Free Literature. Inquiries for dealership and wholesale prices must be on letterhead. U.S. and Canada only. Microtech Associates, Inc., Box 10147, St. Petersburg, Florida 33733.

"LISTEN IN" TO POLICE-FIRE RADIO CALLS IN YOUR CAR!

WORKS with ANY CAR—Portable or HOME RADIO! Just PLUGS in—No wiring—5 minute hookup! Switch instantly from regular to ALL POLICE-FIRE-EMERGENCY-COMMERCIAL-TAXICAB-STATE-CITY-GOV'T 2 way Radio calls in YOUR AREA. DUAL-HI-LOW BANDS—OVER A MILLION Radio Car stations. USE Everywhere—anytime—always works!

Send only \$2.00 (cash, Ck., M.O.) and pay post-man \$7.99 plus COD post or send \$9.99 for post Del in USA. COMPLETE, ready to use with instructions. One Year service Warranty—10 DAY MONEY BACK TRIAL (if refund). AMAZING OFFER good only by mail—WESTERN RADIO Dept. BPE-11 KEARNEY, NEBR. 68847



CONSTRUCTION PLANS: Laser . . . \$2.00. Investigation Aids—2-FM Microphone Transmitters . . . \$1.00. FM Telephone Transmitter . . . \$2.00. Sound Telescope . . . \$2.00. Space Monitor—Missile Tracker . . . \$2.00. Free equipment and kit catalog. Howard, 20174 Ward, Detroit, Michigan 48235.

ALL BAND TRAP ANTENNA!

Reduces Noise on All Makes Short Wave Receivers. Makes World-Wide Reception Better. Complete with 90 ft. 72 ohm leadline. Sealed beam antenna. Features: Eliminates 5 separate antennas with excellent performance on all 80-40-20-15-10 meter bands. Complete 102 ft. \$19.95. 40-20-15-10 meter bands. 51 ft. best for world-wide short wave reception! \$18.95. Send only \$3.00 (cash, ck. m.o.) and only postman balance COD plus postage on arrival or send full price for post-paid delivery. Complete instructions included. WESTERN ELECTRONICS Dept. E-11 Kearney, Nebraska 68847

OVER 1,000 new electronic parts, list \$240.00, yours \$19.95. 28 Music pages \$1.25. All postpaid. Hobbytronics, 921 East 19th, San Angelo, Texas 76901.

FREE catalog, parts, circuit boards for POPULAR ELECTRONICS projects. PAIA ELECTRONICS, Box C14359, Oklahoma City, Ok. 73114.

DIAGRAMS—Radios \$1.50, Television \$3.00. Give make and model. Diagram Service, Box 1151PE, Manchester, Conn. 06042.

FREE ELECTRONICS Catalog. Tremendous bargains. Edu-Kits, Department C-707-D, Hewlett, New York 11557.

COUNTERS, Relays, Switches, Meters, Experimenter Parts, send dime (refunded on order) for lists. R-E-C, P.O. Box 32, Haddon Heights, N. J. 08035.

SCREWDRIVER with built-in light eases the strain. 4 blades Order now—only \$1.75. Valley Sales, Dept. 11B1, 235 Lloyd, Livermore, Calif. 94550.

1972 ELECTRONICS Catalog 25¢. McCord Electronics, Box 412, Sylvania, Ohio 43650.

ALPHA, Theta-wave Biofeedback. Relaxed awareness, meditation, body control. Inner Space Electronics, Box 319PE, Fairfax, Calif. 94930.

CB POWERGAGE & Dummyload. PL259 "glowmodule" shows relative output power & modulation. \$2.00 Postpaid! CENTORE, 33 Ferris, Edison, N. J. 08817.

NOVEMBER 1971

PYROTECHNICAL, rocketry, laboratory supplies, chemicals, tubes, tools, igniters, colored smoke tracers. Illustrated catalogue/handbook includes formulas, instructions—50¢. Westech, Salt Lake City, Utah 84108.

TV TUNER REPAIRS—Complete Course Details, 12 Repair Tricks, Many Plans, Two Lessons, all for \$1. Refundable. Frank Boeck, Box 833, Redding, Calif. 96001.

TINY indicator lights, other unique items. Catalog, samples \$1.00. GH Products, Dept. E, P.O. Box 1438, Irving, Texas 75060.

TRANSISTOR circuit boards 25¢, Thermocouples 25¢, Solar Cells, Zeners, IC's, Trimpots, Bargains Galore, catalog 10¢. Chaney, Box 133, Tempe, Arizona 85281.

LASER once used for surveying. \$600.00; Kerr cell power supply for laser modulation \$300.00. Giosa, 363 Albany St., Boston, Mass. 02118.

INVESTIGATORS—Detectives-Industrial Security Officers. Latest subminiature electronic equipment. Catalog 50¢. Jack, Box 19422, Sacramento, Calif. 95819.

BRAINWAVE Feedback. Electroencephalophone teaches alpha-wave control, I&J Enterprises, 8102-E, Bainbridge, Wash. 98110.

REPEAT of Sell Out—Four Track auto tape players as is repairable. Originally \$49.95 now \$4.95 post paid. VGRS, 2239 East 55th Street, Cleveland, Ohio 44103.

67KC SCA adapter. Solid State, wired, tested. Operates on 9 to 30 volts. Use between FM tuner and audio amplifier. \$15.50. Postpaid USA with instructions, station list. Mark and Alan, P.O. Box 172, Chesterland, Ohio 44026.

SEMICONDUCTORS: Buy from single source. Serving experimenters, hobbyists. No minimums. SN 7400N, \$1.95; MC724P, \$1.19, etc. RLabs, Box 253, Burlington, Ma. 01803.

RESISTORS—High quality, low prices. Free flyer. Kingtree, Box 3092, Columbus, Ohio 43210.

2400 SEMICONDUCTORS, 75 Electronic Circuit Kits, Catalog 25¢. Electronic Laboratories, Box 738, College Park, Md. 20740.

LIGHT Emitting Diodes, \$1.00 each. Free "Uses of Led's" manual with purchase. J-Square, 4165 Stein Road, Ann Arbor, Michigan 48103.

WE SELL CONSTRUCTION PLANS, KITS AND WIRED UNITS—alternator adapter, 110 volts at 3,000 watts from ANY alternated vehicle!—silver recovery unit—x-ray fluoroscope machine—ultra sensitive metal detector—auto theft guard—golfers range finder—hypnotic disc—electronic deodorizer—birth control pill!—instant fish kit—automatic wheel balancers—lifetime match—make your own hand soap, laundry detergent, hair oil, cologne at a fraction of the cost you're paying now—ask for our FREE catalog—Creative Products, 1708-E Tierney Road, Fort Worth, Texas 76112.

TELEPHONES . . . Modern, Continental, components. Free brochure. Comet Communications Co., Dept-B, 639 50th St., Brooklyn, New York 11220.

FIRE & BURGLAR ALARMS

1972 Handbook & Catalog

Save Hundreds of Dollars



Professional equipment famous manufacturers, not readily available from local sources. NEW & EXPANDED to include laser photo-electronic systems, dialers, electronic sirens, perimeter controls, and a NEW RADIO ACTUATED SYSTEM THAT installs in less than 2 hours. Also includes switches, bells, control panels, wire and hardware. Save up to 75%. This handbook is a must for every homeowner and businessman. Just \$1 cash, check or M.O. \$1 refunded with first order.

ALARM COMPONENT DISTRIBUTORS

33 New Haven Ave., Dept. P.E., Milford, Conn. 06460

New Midland Call, P.A., Meters, 5 Watts Warranty, A11 23 \$113.65, 6 Channels \$60.95. G. Enterprises, P.O. Box 14, O'Fallon, Ill. 62269.

RESISTORS . . . Retma Values; 1/2w 5¢, 1w 6¢, 2w 8¢. Comet Communications, Dept. E, 639 50th St., Bklyn., N.Y. 11220.

PLANS AND KITS

FREE Kit Catalog: Digital Microlab \$29.95. Also Segmented and Nixie Readouts, Timebases, Scalers, Electronic Digital Clocks (all featured in Popular Electronics) SWTPC, Box C32040, San Antonio, Tex. 78216.

FREE Kit Catalog. Why does every major College, University, Technical School, Research & Development Center buy from us? Because we have the highest quality and lowest prices. Free catalog. SWTPC, Box H32040, San Antonio, Tex. 78216.

PROTECTION! Alarm acts before entry. Free information, plans \$2.00. Millers, 1896 Maywood, Cleveland, Ohio 44121.

LEARN to build your own color organ, sound to light translator. For complete plans and instructions send 50¢ in coins to: LIGHT, Box 100, Malverne, New York 11565.

HOBBYISTS—Programmable electronic combination lock kit. Five IC's, plans, theory. \$5.95. Catalog free. John Humley, 1351 Mahoney, Rodeo, Calif. 94572.

FREE kit Catalog: Amazing new Universal Digital Instruments with plugins as featured in Popular Electronics. Unbeatable prices. SWTPC, Box D32040, San Antonio, Tex. 78216.

COLOR Organs, Strobes, Plans, brochure 10¢. Raeco, P.O. Box 14, Readville, Mass. 02187.

STATE of the Art Color Organ kit, four 1,000 watt channels, OpAmp buffered stereo inputs. Leo photoisolation \$75.00. f.o.b. Norton Media, 311 West 37th, Austin, Texas 78705.

KITS—Color organs, synchronizers, strobes, Workshop, Box 393Z, Bethpage, New York 11714.

CAMERA FANS: Build quality SA-4 Shutter Speed Meter, Precision Calibrator about \$25-\$50. Seven linear ranges. Plans, pictorials, \$5.45. Brochure, 15¢. A. Mangieri, 1170 Seventh St., New Kensington, Pa. 15068.

★ KIT ★ This one really works ★ KIT ★

THE MINI-LOGIC DESIGN STATION

**LEARN DIGITAL DESIGN NOW!
DESIGN AND BUILD YOUR OWN
LOGIC CIRCUITS!**

Use as an IC TESTER for DTL & TTL IC's.

SEND ONLY \$2995 ORDER TODAY!

Complete instructions and guide for designing your own digital circuits including clocks, registers, adders and dozens more!

- ★ 20 clip leads.
- ★ 4 ea.—JK FF's, NAND gates, inverters, lamps, state switches.
- ★ Conditioned pulse gen.
- ★ Sturdy P.C. Construction.
- ★ Measures 8 1/2" x 7 1/2" x 3 1/2". batteries not included.
- ★ Modern DTL IC's.
- ★ Self contained, portable.

BHD, inc., P.O. Box 4387, Topeka, Ks. 66604

LOUDSPEAKERS KITS, complete or cabinet only. Great savings factory direct. Catalog 25¢. R.C.S. Co., P.O. Box 30312, Santa Barbara, Calif. 93105.

KITS AND EQUIPMENT—FM Wireless microphone transmitters, FM Telephone transmitters, infinity transmitters. Security Electronics, P.O. Box 265, Huntington, W. Va. 25707.

AUTOMATIC Morse Code Copying Machine. Featured in Ham Radio Magazine this fall. Copy up to 120 wpm with knowing CW! Simply hook to your receiver's audio and read printout. Send \$14.95 for detailed construction plans. VMG Electronics 2138P West Sunny-side, Phoenix, Arizona 85029.

LIGHT EMITTING DIODES. Five diode kit, Instructions \$2.95, Free catalog. SUPER VALUE KITS, Box 1364, Cupertino, Calif. 95014.

COLOR Organ Kits \$7.50. IC's 25¢. Catalog. Murphy, 204 Roslyn Ave., Carle Place, N.Y. 11514.

HIGH FIDELITY

TAPE RECORDERS, Hi-Fi, components, Sleep Learning Equipment. tapes, Unusual Values. Free Catalog. Dressner, 1523R, Jericho Turnpike, New Hyde Park, N.Y. 11040.

FREE Kit Catalog. Amplifiers: Lil Tiger \$11.10, Universal Tiger \$30.00, Preamp \$44.50 (Featured in Popular Electronics) SCA Adaptors \$14.55. SWTPC, Box A32040, San Antonio, Tex. 78216.

DIAMOND NEEDLES and Stereo Cartridges at Discount prices for Shure, Pickering, Stanton, Empire, Grado and ADC. Send for free catalog. All merchandise brand new and factory sealed. LYLE CARTRIDGES, Dept. P, P.O. Box 69, Kensington Station, Brooklyn, New York 11218.

LOW, Low quotes: all components and recorders, HiFi, Roslyn, Penna. 19001.

SPEAKERS: For extremely high powered amps. Many types and sizes. All guaranteed for life and your satisfaction. Prices from \$15 to \$70. Aluminum domes. Send \$3 for operational diagrams, specifications, engineering test reports and complete catalog. Acoustidyne Electronics, P.O. Box 1387 Springfield, Illinois 62705.

WANTED

CASH PAID! Unused tubes, electronic equipment. Barry, 512 Broadway, NYC 10012.

QUICKSILVER, Platinum, Silver, Gold, Ores Analyzed. Free Circular. Mercury Terminal, Norwood, Mass. 02062.

CASH immediately for old Gold, Silver, Platinum, Mercury, Watches, Diamonds. Free information. Rose Industries, 29-PB East Madison, Chicago Ill. 60602.

TUBES

RECEIVING & INDUSTRIAL TUBES, TRANSISTORS. All Brands—Biggest Discounts. Technicians, Hobbyists, Experimenters—Request **FREE** Giant Catalog and **SAVE!** ZALYTRON, 469 Jericho Turnpike, Mineola, N.Y. 11501.

RADIO & T.V. Tubes—36¢ each. Send for free catalog. Cornell, 4213 University, San Diego, Calif. 92105.

TUBE Headquarters of World! Send 10¢ for Catalog (tubes, electronic equipment) Barry, 512 Broadway, N.Y.C. 10012.

SAVE money on parts and transmitting-receiving tubes, foreign-domestic. Send 25¢ for giant catalog. Refunded first order. United Radio Company, 56-P Ferry Street, Newark, N.J. 07105.

2,000 TUBES, 90% off list. Rhodes, Box 808, Watervliet, Michigan 49098.

TAPE AND RECORDERS

STEREO TAPE RENTAL for particular people. Free catalog. Gold Coast Tape Library, Box 2262, Palm Village Station, Hialeah, Fla. 33012.

STEREO TAPE TRANSPORT—7" reel—2 speeds—pause control—made for famous manufacturer—50 to 15,000 Hz—with rec/play and erase heads, without case. Send m.o. or check for \$19.50 to Alshemer Audio Electronics, 218 Columbia St., Utica, N.Y. 13502. \$2.50 for prepaid shipping and insurance.

RENT 4-Track open reel tapes—all major labels—3,000 different—free brochure. Stereo-Parti, 55 St. James Drive, Santa Rosa, Ca. 95401.

BARGAIN MUSIC, Tape, Equipment Catalog, 25¢. Saxitone, 1776 Columbia Road, Washington, D.C. 20009.

BUY Irish Tape Open Reel & Cassettes & 8-Track Blanks at Discount Prices. Write: Direct Mail Cassette Corp., Box 71, Plainview, N.Y. 11803.

RECORDING TAPE made by top American manufacturer, guaranteed not "seconds" or "white box"; 2400' mylar, \$2.29; 1800' mylar \$1.69; 1200' acetate \$1.79. Send for information and quantity pricing. Alshemer Audio Electronics, 218 Columbia Street, Utica, New York 13502.

OLD Radio Programs on cassettes or reels. High quality, low prices, thousands to choose from, professional equipment, catalog 50¢. Remember Radio Inc., Box 2513, Norman, Okla. 73069.

OLD Radio Programs. Catalog \$1.00. (Refundable). Radio Vault, Box 9032, Wyoming, Michigan 49509.

REPAIRS AND SERVICES

TV Tuners rebuilt and aligned per manufacturers specification. Only \$9.50. Any make UHF or VHF Ninety day written guarantee. Ship complete with tubes or write for free mailing kit and dealer brochure. JW Electronics, Box 510, Bloomington, Indiana 47401.

COILS Made; Parts machined to your Specs. Electro-Wire Products, 2805 E. 117th Street, Cleveland, Ohio 44120.

PERSONALS

MAKE FRIENDS WORLDWIDE through international correspondence. Illustrated brochure free. Hermes, Berlin 11, Germany.

INVESTIGATORS. Latest Electronics Aids. Free Literature. Clifton, 11500-K NW 7th Ave., Miami, Florida 33168.

SECRET LOANS BY MAIL. Borrow \$100 to \$1500 for any good reason in absolute privacy. No interviews, no endorsers, no cosigners. Fast service. Write Dial Finance Co., Dept. L-593, 410 Kilpatrick Bldg., Omaha, Nebraska 68102.

INVENTIONS WANTED

INVENTIONS wanted. Patented: unpatented. Global Marketing Service, 2420-P 77th, Oakland, Calif. 94605.

INVENTORS! Don't sell your invention, patented or unpatented, until you receive our offer. Eagle Development Company, Dept. 9, 79 Wall Street, N.Y., N.Y. 10005.

PATENT Searches including Maximum speed, full airmail report and closest patent copies, \$6.00. Quality searches expertly administered. Complete secrecy guaranteed. Free Invention Protection forms and "Patent Information." Write Dept. 9, Washington Patent Office Search Bureau, 711 14th Street, N.W., Washington, D.C. 20005.

FREE "Directory of 500 Corporations Seeking New Products." For information regarding development, sale, licensing of your patented/unpatented invention. Write: Raymond Lee Organization, 230-GR Park Avenue, New York City 10017.

INVENTORS: Protect your ideas! Free "Recommended Procedure". Washington Inventors Service, 422T Washington Building, Washington, D.C. 20005.

FREE PAMPHLET: "Tips on Safeguarding Your Invention." Write: United States Inventors Service Company, 501-H Thirteenth Street N.W., Washington, D.C. 20004.

INSTRUCTION

LEARN ELECTRONIC ORGAN SERVICING at home all makes including transistor. Experimental kit—trouble-shooting. Accredited NHSC, Free Booklet. NILES BRYANT SCHOOL, 3631 Stockton, Dept. A, Sacramento, Calif. 95820.

LEARN WHILE ASLEEP. Hypnotize! Strange catalog free. Auto-suggestion, Box 24-ZD, Olympia, Washington 98501.

FREE brochure self-improvement books. Eldon McBrayer, 412 Arthur Street, Huntsville, Ala. 35805.

DEGREE in electronics Engineering earned mostly by correspondence. Free brochure. Dept. G-9, Grantham School of Engineering, 1505 N. Western Ave., Hollywood, California 90027.

F. C. C. 1st phone license training in 5 weeks. R.E.I.'s intensive training produces outstanding results. For information and free brochure call toll free: 1-800-237-2251, or write home office, Radio Engineering Incorporated Schools, 1336 Main Street, Sarasota, Florida 33577. Florida residents call (813) 955-6922.

HIGHLY effective home study courses in Electronics Engineering Technology and Electronics Engineering Mathematics. Earn your Degree. Write for Free Descriptive Literature. Cook's Institute of Electronics Engineering, (Dept. 15), P.O. Box 10634, Jackson, Miss. 39209. (Established 1945).

F.C.C. TYPE EXAM . . . Guaranteed to prepare you for F.C.C. 3rd, 2nd, and 1st phone exams. 3rd class, \$7.00; 2nd class, \$12.00; 1st class, \$16.00; complete package, \$25.00. Research Company, 3206 Bailey Street, Sarasota, Florida 33580.

BECOME a certified electronics technician. Sample Tests and information about examination. Remit \$5.95 to Missouri Technical School, 3840 Washington, St. Louis, Missouri 63108.

MEMORIZE STUDY: "1971 Test-Answers" for FCC First and Second Class License—plus—"Self-Study Ability Test." Proven! \$9.95. Satisfaction guaranteed. Command, Box 26348-P, San Francisco 94126.

GOVERNMENT SURPLUS

GOVERNMENT Surplus. How and Where to Buy in Your Area. Send \$1.00. Surplus Information, Headquarters Bldg., Box 30177-PE, Washington, D.C. 20014.

MANUALS for surplus electronic equipment. List 25¢. Books, 4905 Roanne Drive, Washington, D.C. 20021.

JEEPS Typically from \$53.90 . . . Trucks from \$78.40 . . . Boats, Typewriters, Knives, Airplanes, Clothing, Multimeters, Oscilloscopes, Transceivers, Photographic, Electronics Equipment. Wide variety, condition. 100,000 Bid Bargains direct from government nationwide. Complete sales directory and surplus categories catalog \$1.00 (Deductible on orders from separate included catalog). Surplus Service, Box 820-J, Holland, Michigan 49423.

GOVERNMENT Surplus. Complete Sales Directory \$1.00. Surplus Publications, Box 26062Z, Los Angeles, Calif. 90026.

BOOKS

FREE catalog aviation/electronic/space books. Aero Publishers, 329PE Aviation Road, Fallbrook, California 92028.

FREE book prophet Elijah coming before Christ. Wonderful bible evidence. Megiddo Mission, Dept. 64, 481 Thurston Rd., Rochester, N.Y. 14619.

HYPNOTISM

"MALE-FEMALE Hypnotism" Exposed, Explained! "Secret Method!"—They Never Know! \$2. Rushed. Guaranteed! Isabella Hall, Silver Springs, Florida 32688.

SLEEP learning. Hypnotic method. 92% effective. Details free. ASR Foundation, Box 7545PL, Fort Lauderdale, Florida 33304.

PHOTOGRAPHY—FILM, EQUIPMENT, SERVICES

SCIENCE Bargains Request Free Giant Catalog "CJ"—148 pages—Astronomical Telescopes, Microscopes, Lenses, Binoculars, Kits, Parts. War surplus bargains. Edmund Scientific Co., 300 Edscorp Bldg., Barrington, New Jersey 08007.

MAGAZINES

INDEX TO 'POPULAR ELECTRONICS'!

Ten years of electronic ingenuity are at your fingertips! Handy 32-page index lists every article from Jan. '61 thru Dec. '70. Over 1200 entries, divided into 52 major categories for quick, easy location. Also indicates nature and length of each article, plus any later corrections! Only \$2.00 Postpaid. PERIODICAL INDEXES, BOX 178, SAN LUIS OBISPO, CALIF. 93401

JAPAN PUBLICATIONS GUIDE Business, pleasure, education. \$8.00. INTERCONTINENTAL, CPO 1717, Tokyo 100-91.

OVER 2,000,000 backdate magazines! Specify needs. Midtown, Box 917-PE, Maywood, New Jersey 07607.

RECORDS

POPULAR organ albums factory direct. Concert Recordings, Lynwood, Calif. 90262.

EMPLOYMENT OPPORTUNITIES

RECORDISTS. Make records. We train, equip, provide exclusive territory. Modest investment. Director Group, Englewood, Ohio 45322.

YOUNG Hobbyist wanted to assist project building Saturdays, Tuesdays or evenings at my place. Write: Thain, 520 5th Avenue, New York, New York 10036 giving age and experience.

EMPLOYMENT INFORMATION

EXCITING Overseas jobs. Directory \$1.00. Research Associates, Box 942-E, Belmont, California 94002.

BUSINESS OPPORTUNITIES

I MADE \$40,000.00 Year by Mailorder! Helped others make money! Start with \$10.00—Free Proof. Torrey, Box 318-N, Ypsilanti, Michigan 48197.

FREE BOOK "999 Successful Little Known Businesses" Work home, Plymouth 445-K, Brooklyn, N.Y. 11216.

\$200.00 DAILY In Your Mailbox! Your opportunity to do what mail-order experts do. Free details, Associates, Box 136-J, Holland, Michigan 49423.

MAILORDER! Make big money working home. Free report reveals millionaire's trade secrets! Executive (1K11), 333 North Michigan, Chicago 60601.

PIANO TUNING learned quickly at home. Tremendous field! Musical Knowledge unnecessary. GI Approved. Information Free. Empire School, Box 327, Miami, Florida 33145.

\$1000 DAY—150% Profit. Selling by mail. No investment in inventory. Part time—full time. Unlimited potential. Complete details \$1.00. National, Box 7212S, Chicago, Illinois 60680.

START small, highly profitable electronic production in your basement. Investment, knowledge unnecessary. Postcard brings facts. Barta-Electronics, Box 248, Walnut Creek, California 94597.

SELL HERTEL BIBLES—Part Time. Finest reference Bible available. Demonstrator and supplies furnished. Excellent commissions. Write International Book, Dept. PE, Box 118, Wichita, Kansas 67201.

FREE CATALOGS. Repair air conditioning, refrigeration. Tools, supplies, full instructions. Doolin, 2016 Canton, Dallas, Texas 75201.

MAILORDER Moneymaking Kit Home Business. Valuable lists, concrete information, detailed steps. Capital unnecessary. Free details, pictures. Prudential, Box 327-PEB, Boston, Mass. 02199.

TREASURE FINDERS

GOLD, Silver, Relics! Located with powerful Detectron Metal Detectors. Free Information. Terms, Detectron, Dept. PE11, Box 243, San Gabriel, California 91778.

TREASURE FINDER locates buried gold, silver, coins, treasures. 5 powerful models. \$19.95 up. Free catalog. Relco-A33, Box 10839, Houston, Texas 77018.

FISHER DETECTORS has something new! Free literature. Fisher Research, Dept. PE-11, Palo Alto, CA 94303.

FREE: Jetco Electronics 24-page Treasure Finder Catalog. Find Gold, Silver, Coins, Metals, Minerals, relics. Jetco, Dept. PEC, 3933 Barranca, El Paso, Texas 79935.

MAGNETS

MAGNETS. All types. Specials—20 disc magnets, or 2 stick magnets, or 10 small bar magnets, or 8 assorted magnets, \$1.00. Maryland Magnet Company, Box 192H, Randallstown, Maryland 21133.

SPORTS ACTION FILMS

FILMS—BEST GIFT YET for Sportsmen . . . treat yourself, too! Free Gift Catalog. Super 8/8mm. B&W, Color. SPORTLITE, Elec. Dept., Box 24-500, Speedway, Indiana 46224.

MUSICAL INSTRUMENTS

30% DISCOUNT name brand musical instruments. Free catalog. Freeport Music, 127-N Sunrise Highway, Freeport, N.Y. 11520.

WHOLESALE! Professional Amplifiers, PA Systems, Guitars. Free Catalog. Carvin, Escondido, Calif. 92028.

PROFITS from Organ service. Complete Semiconductor substitution Manual for Electronic Organ repair. \$8.95 also free literature on Organ service products. H.A.B. Service, Rock Creek, Ohio 44084.

IMPORT—EXPORT

RADIOS, COMPONENTS, Testers, Electronics Equipment. Many More. 200,000 Products You Can Buy Direct From Overseas Manufacturers Outlets. Prices Below U.S. Wholesale. Save Hundreds On The Products You Want. Complete Directory \$1.00. Worldwide Opportunities, Box 730-J, Holland, Michigan 49423.

REAL ESTATE

FREE . . . New 256-page Fall catalog! Describes and pictures hundreds of farms, ranches, town and country homes, businesses coast to coast! Specify type property and location preferred. Zip Code, please. United Farm Agency, 612-EP West 47th St., Kansas City, Mo. 64112.

MISCELLANEOUS

WINEMAKERS: Free illustrated catalog yeasts, equipment. Semplex, Box 12276, Minneapolis, Minn. 55412.

WINE RECIPES and Catalog, 25¢. Country Winemaker, Box 191E, RFD 1, Mattapoisett, Massachusetts 02739.

PENFRIENDS. For free information, write: Papyrus, Box 11604PE, Winston-Salem, N.C. 27106.

POPULAR ELECTRONICS
NOVEMBER 1971
ADVERTISERS INDEX

| R.S. NO. | ADVERTISER | PAGE NO. |
|----------|--|------------------------------|
| 1 | Acoustic Research, Inc. | 14 |
| 2 | Allied Radio Shack | 10 |
| 5 | Allied Radio Shack | 94 |
| 6 | Alpha Luno Corp. | 100 |
| 7 | Ampex | 5 |
| 8 | Antenna Specialists Co., The | 12 |
| 4 | Avanti Research & Development Co., Inc. FOURTH COVER CRE1, Home Study Div., McGraw-Hill Book Co. 56, 57, 58, 59 | |
| 16 | Cleveland Institute of Electronics | 74, 75, 76, 77 |
| 11 | Datak Corp., The | 89 |
| 12 | Drake Company, R.L. | 102 |
| 36 | Cobra Communications Division, DYNASCAN CORP., .. | 11 |
| 13 | EICO Electronic Instrument Co., Inc. | 90 |
| 14 | EICO Electronic Instrument Co., Inc. | 91 |
| 15 | Edmund Scientific Co. | 110 |
| 18 | Edsyn, Inc. | 87 |
| 17 | Heath Company | 92, 93, 94, 95, 96, 97 |
| 18 | Lafayette Radio Electronics | 17 |
| 19 | Lendell Products | 98 |
| 21 | Motorola (HEP) | 9 |
| 22 | McGraw-Hill Book Co. | 6 |
| 23 | McIntosh Labs | 103 |
| | National Radio Institute | SECOND COVER, 1, 2, 3 |
| | National Technical Schools | 18, 19, 20, 21 |
| 24 | Olson Electronics | 109 |
| 25 | RCA Electronic Components & Devices | 26 |
| | RCA Institutes, Inc. | 38, 39, 40, 41 |
| 26 | Russound | 109 |
| 27 | Schuber Organ Corp. | 89 |
| 3 | Shure Brothers, Inc. | THIRD COVER |
| 28 | Sonar Radio Corp. | 101 |
| 29 | Southwest Technical Products | 98 |
| 30 | TDK Electronics Corp. | 8 |
| 35 | Techni-Tool, Inc. | 88 |
| 31 | Turner Microphone Co., The | 16 |
| | U.S. Army | 22, 23 |
| 32 | U.S. Air Force | 13 |
| 33 | Utah Electronics | 85 |
| 34 | Valparaiso Technical Institute | 14 |

CLASSIFIED ADVERTISING 104, 105, 106, 107, 108

IMPEDAVERTER™ IMP I

•IMPROVES MICROPHONE PERFORMANCE•



1. Converts high to low impedance.
2. Use cables to 500 feet with minimum loss of response, and minimum hum.
3. Switchable gain/loss and phase.
4. Quick disconnect, stand clamps provided.

\$29.95
\$1.25 postage



RUSSOUND | FMP

KEYED TO A-B-C-D

P.O. BOX 204

STRATHAM, N.H. 03885

MULTI-MIXER™ TMS-1
HANDLES UP TO THREE RECORDERS



INTRODUCTION
PRICE
\$19.95
\$1.25 postage

1. Record or play back any or all simultaneously.
2. Eliminates jury-rig multiple connections.
3. Establishes a main control system for multiple usage.
4. MTG BKTS provided for permanent installation.

WRITE DEPT. R
FOR NEW PRODUCT RELEASES

CIRCLE NO. 26 ON READER SERVICE PAGE

ANOTHER SUPERB VALUE
from Olson

Electronics

ONLY

\$28

DELUXE
WIRELESS
INTERCOM



Save steps, keep in touch with this compact two-station intercom. Needs no cable. Just plug into any AC outlet in your home wiring system and talk between them. Can continuously monitor baby's room, sick-room or any desired location.

Olson Electronics, Dept. IW, 260 S. Forge St.,
 Akron, Ohio 44308

- I enclose \$28, plus \$1 for postage and handling. Send me the AM-366 Wireless intercom.
- Send me the next seven issues of the Olson Catalog, without cost or obligation. **FREE**

Name _____
 Address _____
 City _____
 State _____ Zip _____

CIRCLE NO. 24 ON READER SERVICE PAGE

KEEP PACE WITH SPACE AGE! SEE MOON SHOTS—LANDINGS, SPACE FLIGHTS, CLOSE-UP!

AMAZING SCIENCE BUYS

for FUN, STUDY OR PROFIT



HELIUM BALLOONS MAKE A "BALL"



Anytime there's a balloon the air is festive. Especially when the air is helium which makes a balloon jerky and adventurous. Now there's 25 times the fun—25 vibrant colored balloons of 4, 5, or 8" diameter when inflated. With them, a pressurized 300 lbs. tank can contain 21 liters of helium to inflate all 25. For adults or kids' parties, giveaways, bazaars or just demonstrating "lighter than air".

Helium is a safe non-toxic inert gas. Stock No. 71.2894V \$3.00 Ppd.

3-CHANNEL COLOR ORGAN BARGAIN!

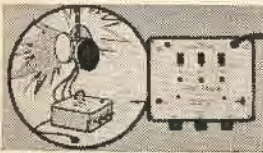

Create tremendous variety of unusual & beautiful lighting effects with this low-cost top-quality 1500Watt, 1500 W. low channel. Compare with others selling for twice the price. Has pilot light, plus individual sensitivity controls and channel indicator lights. Can operate on 150 W. "spots" or 200 Christmas lights. Uses reg. house current —attaches to audio source w/ RCA-type phone plug. 5 1/2" x 4 1/2" x 2 1/2" lbs. Thermal

setting plastic case, 6 ft. cord. Including complete instructions. Stock No. 71.2834V \$44.50 Ppd.

\$8.95 ELECTRONIC STROBE



Hand-sized solid state electronic strobe light at fantastically low price. Produces bright psychedelic steady like larger, far more expensive Xenon strobes. Yet it's just 3 1/4" x 1 1/4" thick. Adjustable flash rate, approximately 3-10 flashes per second. Make stop motion effects, parties come alive. Great to take with you to parties, dances, outings, etc. Requires 2 9V transistor batt. (not incl.). Instructions. Stock No. 71.4234V \$8.95 Ppd.

4 REPLACEMENT LAMPS AV P-41,444 1.00 Ppd.

BLACK-LIGHT MIGHTY MITES



Relatively small (12") fixtures give surprisingly bright black-light. Mirror-finished reflector makes instant starting 8-watt, high-intensity bulb look like 40-watt. Up to 5-10 hours of safe, long-wave (3600A) black-light to really turn on parties, light & theatrical shows, psychedelic discos, holiday decorations. Shockproof end-caps remove for safe, easy replacement of bulb and wiring. Stand upright or horizontal. Aluminum case.

Stock No. 71.2744V DELUXE OUTDOOR, INDOOR MODEL Stock No. 71.2994V \$19.95 Ppd.

PSYCHEDELIC LIGHTING HANDBOOK



100 information packed pages! Fully explains latest in psychedelic lighting equipment, techniques, developments. Covers all facets of psychedelic light-show production including strobes, black lights, projectors, organic, organic slides, mirrors, color organs, polarized color, light boxes, Musicvision, etc. Shows how to "psychedelicize" parties, musical groups, shows or love to set up "electric trips" for private gatherings. 8 1/2" x 11" booklet paper for 3 rings.

Stock No. 9100AV \$3.00 Ppd.

Order by Stock No.—Check or M.O.—Money-Back Guarantee
EDMUND SCIENTIFIC CO., 300 EDSCORP BLDG., BARRINGTON, N.J. 08007

WRITE FOR GIANT FREE CATALOG "AV"



Completely new edition. New look, new color, illustrations. 148 easy-to-read pages packed with 3000 unusual items. Dozens of electrical and electronic parts, accessories. Enormous selection of Astronomical Telescopes, Microscopes, Binoculars, Magnifiers, Magnets, Lenses, Lasers, Prisms. May even surprise items for hobbyists, experimenters, workshops, factory. Write for catalog "AV."

See moon shots, orbits, stars, craters! NEW 3" ASTRONOMICAL REFLECTOR TELESCOPE

60 to 180X

DE-LUXE FEATURES
AT ECONOMY PRICE



Amazingly priced Apollo Space Explorer brings the wonders of the universe up close. 3" aluminum & overcoated f/10 mirror. Reaches theoretical limits of resolution & definition. 60X standard sized 1 1/4" O.D. eyepiece. 15" F.L. 3X adjustable Barlow. 6X center telescope. High impact plastic tube, locking ring, dark mark w/ positive locking. 50° hardwood tripod. Included FREE: 272p. Handbook, Star Chart, Instructions, Best value ever.

- Stock No. 80.182AV \$59.50 Ppd.
- REG. 3" REFLECTOR TELESCOPE Stock No. 85.050AV \$34.50 Ppd.
- 4 1/4" ASTRONOMICAL REFLECTOR TELESCOPE Stock No. 85.105AV \$94.50 Ppd.
- 6" ASTRONOMICAL REFLECTOR TELESCOPE Stock No. 85.086AV \$239.50 F.O.B.

SPECIAL VISUAL EFFECTS PROJECTOR SET

Dazzling, avant-garde visual effects. Fantastic variety. Incredibly beautiful. Special package offer contains all necessary apparatus. Creative floating, exploding, fiery bursts of color like "Symphony of Spheres", "Chromatic Starburst". Features 3500m 500 W. fan cooled projector—produces big image at short distance. Access. two diam. wheels (Dry Kaleidoscope & Hexidroscope), 2 cylindrical accessories (Prismal Closed & Hexidroscope w/ six internal mirrored walls). Perfect for entertaining, parties, photography.



Stock No. 71.212AV \$79.50 Ppd.
Stock No. 71.295AV Deluxe Model \$99.50 Ppd.

NEW! ELECTRONIC DIGITAL COMPUTER KIT!

Solve problems, play games, predict weather with this actual working model of part electronic brains. Amazing new fun way to learn all about computer programming, logic, decimal, binary systems. Lots of facts—well do your own programming after completion simplified 116 page instruction booklet. Includes step-by-step assembly diagrams. Circuits easily changed. Removable illuminated control panel. Req. 2 9V batt. (not incl.). Best model we've seen—for home, school, industry. Stock No. 71.434AV (11"X12 1/2"X4") \$31.50 Ppd.



AMAZING NEW Wankel Engine KIT!

Thrill to the fun of building your own see-through motorized model of revolutionary pistonless Wankel engine, type for which Ed recently paid \$50 million! Only engine experts think economically modifiable to meet new pollution standards. Replaces piston, cylinder, crank assemblies with rotating discs. Needless removal for 4100 cc chambers. Smaller than conventional two-cylinder, greater reliability, same speed w/ less horsepower. Feet: lasting plugs rubber fan belt, 1/4" ball, (not incl.). Req. 2—stock-belt on-off switch. Req. 2— Stock No. 71.424AV (4 1/2"X5"X9") \$6.75 Ppd.



CHROMATIC "MACHINE-GUN" STROBE

Red, Green & Blue light barrage the eyeballs every 8 seconds with best low-cost top-quality mechanical strobe that can run continuously without fear of burning up. Dazzling effects over 500 ft. sq. area. Created by rotating color wheel in front of 100W, 120V reflector floodlamp (incl.). Elements seem to flash on & off as colors fluctuate. Turns store windows, posters, parties into fashion, pulsating productions. Operation coded. Rugged wrinkle finish metal case. Adjustable hanger bracket. Req. house current.



Stock No. 71.423AV (9" X 6" X 6") \$32.75 Ppd.

EDMUND SCIENTIFIC CO.

ORDER BY STOCK NUMBER - SEND CHECK OR MONEY ORDER - MONEY-BACK GUARANTEE
300 EDSCORP BLDG.
BARRINGTON, NEW JERSEY 08007

CIRCLE NO. 15 ON READER SERVICE PAGE

Printed in U.S.A.



We make the microphones, too.



So, if you purchase, operate, or use public address and audio-visual systems, either vocationally or avocationally, Shure microphones and related circuitry products can take many headaches out of your job. Modestly speaking, we are internationally known for our problem-solving microphones. Less well known, perhaps, is the fact that we've developed an entire array of ingenious, low-cost public-address circuitry products to solve dozens of pesky problems. These include nearly a dozen different modular, add-on *microphone mixers* . . . an *Audio Control Center* that actually matches audio response to the room acoustics . . . an effective *Audio Level Controller* . . . and plug-in problem-solvers to cure all sorts of knotty problems — instantly. Write:

Shure Brothers Inc.,
222 Hartrey Ave., Evanston, Ill. 60204



SHURE

CIRCLE NO. 3 ON READER SERVICE PAGE

6
good
reasons
why the revolutionary
Avanti Astro Plane is the best
omni-directional C.B. antenna
you can buy.

1. It has **top radiation** which means that your signal gets out from the highest part of your antenna. This is especially important where antenna height is limited because your signal radiates about 15 feet higher than other antennas which radiate near the bottom. This 15 feet means you get increased range and fewer dead spots.
2. The **ASTRO PLANE has a lower angle of radiation** which makes more efficient use of the radiated signal by allowing it to hug the curvature of the earth instead of shooting your power up into the sky. This also gives you greater distance than an ordinary omni-directional antenna, one thing the professional users really look for.
3. The **ASTRO PLANE has 4.46 db gain** (over an isotropic source) which gives you a stronger signal and better, clearer reception.
4. You'll get **long lasting, trouble free performance** because it is compact in design—without long drooping radials, without coils to burn or short out, and with direct ground construction to dissipate static charges and lightning.
5. You'll find it **easy to install** because of its lightweight construction (less than 5 lbs.) and only 12 feet of total height and 30 inches in diameter.
6. **All of these features need not cost you more money.** Part of good engineering is how to make a better product for less money—by eliminating the coils for example we not only make the Astro Plane more reliable, but cheaper. Just like a radio back in the 30's cost \$100.00, today they're even better for \$20.00 or \$30.00! So you can buy this advanced antenna for only \$29.95 and it is guaranteed for one full year against mechanical or electrical defects.

If your local C.B. Dealer does not have an ASTRO PLANE in stock, have him order you one or write direct to AVANTI.

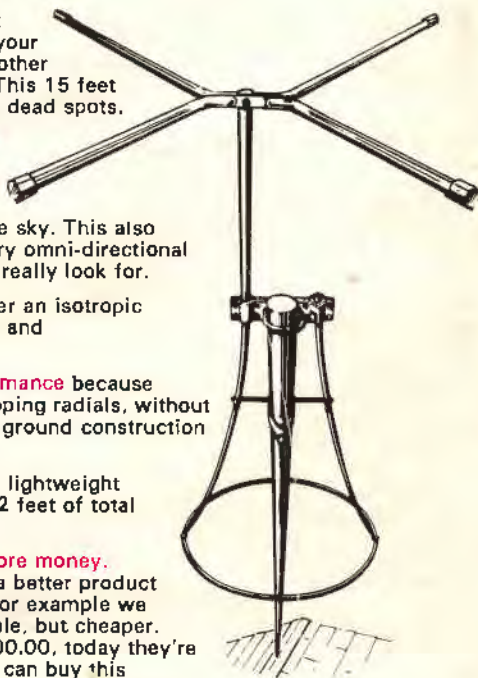

avanti

AVANTI RESEARCH & DEVELOPMENT, INC.

THE PACESETTER IN HIGH PERFORMANCE ANTENNAS

33-35 WEST FULLERTON AVENUE,
ADDISON, ILLINOIS 60101