

BUILD A "DIFFERENT" METAL LOCATOR

POPULAR ELECTRONICS

FEBRUARY
1969

50
CENTS



CB'ers & HAMS BATTLE IT OUT

**THRIFTY 3-WAY SPEAKER
FOR \$35**

**FACSIMILE —
BRIGHT FUTURE IN '69**

**BUILD 200-WATT
DUAL FLASHER**

HOROSCOPES BY COMPUTER

BUILD 7-SEGMENT DCU

**HOW EMOTIONAL
DO YOU GET?**

(see page 27)



Discover the ease and excitement of learning Electronics with programmed equipment NRI sends you

When you train at home with NRI, you train with your hands as well as your head. You learn the WHY of Electronics, Communications, TV-Radio the NRI pioneering "3-Dimensional" way. NRI training is the result of more than half a century of simplifying, organizing, dramatizing subject matter, and providing personal services unique for a home study school. You get the kind of technical training that gives you priceless confidence as you gain experience equal to many, many months of training on the job.

NRI—The 53 Year Leader in Electronics Training



APPROVED UNDER NEW GI BILL

If you served since January 31, 1955, or are in service, check GI line in postage-free card.



*Earn \$5 or more an hour
spare or full time in*

TV-RADIO SERVICING

Color Television has arrived. Sales are soaring, along with the continuing popularity of other home entertainment equipment like portable radios, tape recorders, hi-fi sets, phonographs and auto radios. TV-Radio servicing is one of your best routes to spare-time earnings, a good paying job or a business of your own. NRI not only trains you quickly and expertly, but also shows you how to get started in Servicing soon after you enroll, earning as you learn. NRI trains you in today's methods of installing and repairing all Electronic equipment for the home—including booming Color TV. You even build, experiment with and keep to enjoy your own solid-state radio and your choice of black-and-white or Color TV receiver. Like thousands of others, you can be earning \$5 or more an hour extra in spare time starting soon.

*There's money and
success awaiting you in*

BROADCASTING— COMMUNICATIONS

The experience you gain from intensely practical NRI training in Complete Communications equals as much as two years of training on the job. With NRI, you can train for a choice of careers ranging from mobile, marine and aviation radio to TV broadcasting and space communications. You learn how to install, maintain and operate today's remarkable transmitting and receiving equipment by actually *doing* it. You build and experiment with test equipment, like a VTVM you keep. You build and operate amplifier circuits, transmission line and antenna systems, even build and use a phone-cw transmitter suitable for transmission on the 80-meter amateur band. Whichever of five NRI Communications courses you choose, you prepare for your FCC License exams, and you must pass your FCC exams or NRI refunds your tuition in full.

*Move ahead in America's
fast growing industry as*

ELECTRONICS TECHNICIAN

Electronics touches everyone's lives. This vast field of opportunity is open to you with NRI training. Industrial/Military Electronics training—like all NRI courses—prepares you quickly, thoroughly the practical "hands on" way. You build with, and learn to understand the functions of, today's miracle solid-state components like printed circuits, diodes and transistors. You build and experiment with Electronic circuitry used in automation, data processing, ultrasonics, telemetry. Whatever your interest in Electronics, NRI training can fill your needs. Prove to yourself what nearly a million NRI students could tell you ... that you get more for your money from NRI. Check the postage-free card and mail it today for your FREE NRI Color Catalog. No salesman will call. NATIONAL RADIO INSTITUTE, Electronics Division, Washington, D.C. 20016.

YOU GET MORE FOR YOUR MONEY FROM NRI— Build, test, explore, discover. Everything you see here is included in one NRI course—including Color TV. Other courses equally complete. And you'll be surprised at the low tuition costs. Text for text, kit for kit, dollar for dollar—you get more for your money from NRI.



POPULAR ELECTRONICS

VOLUME 30 NUMBER 2

FEBRUARY, 1969

WORLD'S
LARGEST-SELLING
ELECTRONICS
MAGAZINE

SPECIAL CONSTRUCTION PROJECT

BUILD A PSYCH-ANALYZER 27 ROBERT E. DEVINE

Check out your friends

SPECIAL FEATURE

THIRD-GENERATION DCU 43 C. P. TROEMEL

IC counter with 7-segment readout

FEATURE ARTICLES

FAX 33 DANIEL M. COSTIGAN

Facsimile process shows new strength

HOBNOBBING WITH HARBAUGH 42

BUILD 200-WATT DUAL FLASHER 50 JOHN S. SIMONTON, JR.

Alternating blinking lights

BUILD A "DIFFERENT" METAL LOCATOR 53 LESLIE HUGGARD

Buried treasure the sure way

BUILD THE THRIFTY 3-WAY 59 DAVID B. WEEMS

Hi-fi speaker system for \$35

FROM A.C. TO ZENER 68 VIC BELL

Test your electronics knowledge

HOROSCOPE BY COMPUTER 69

Modern electronics in an ancient art

BUILD YOUR OWN POWER SUPPLY 72

THE HATFIELD HAMS AND THE CB MCCOYS 73 CAROLE H. ALLEN, W5NQQ/K9AMD

Who's winning the old feud?

THE PRODUCT GALLERY 76

Knight-Kit KG-980 Stereo Receiver

Murch 86D Short-Wave Antenna

ENGLISH-LANGUAGE BROADCASTS TO NORTH AMERICA 78 ROGER LEGGE

ON THE CITIZENS BAND 79 MATT P. SPINELLO, KHC2060

Explorer Scouts do their duty

SOLID STATE 81 LOU GARNER

SHORT-WAVE LISTENING 83 HANK BENNETT, W2PNA

DX country awards presented

AMATEUR RADIO 85 HERB S. BRIER, W9EGQ

Report on Russian hams

BUILD LOW-COST TOUCH ALARM 92

DEPARTMENTS

LETTERS FROM OUR READERS 8

ELECTRONICS LIBRARY 12

READER SERVICE PAGES 15, 115

NEW LITERATURE 16

NEW PRODUCTS 22

OPERATION ASSIST 110

OUT OF TUNE 111

"Mannerly Table Lamp"

SHORT-WAVE MONITOR CERTIFICATE APPLICATION 114

POPULAR ELECTRONICS is indexed
in the Readers' Guide
to Periodical Literature

This month's cover photo by
Justin Kerr

Copyright © 1969 by ZIFF-DAVIS PUBLISHING COMPANY. All rights reserved.

POPULAR ELECTRONICS, February 1969, Volume 30, Number 2, Published monthly at 307 North Michigan Avenue, Chicago, Illinois 60601. One year subscription rate for U.S., U.S. Possessions and Canada, \$5.00; all other countries, \$6.00. Second class postage paid at Chicago, Illinois and at additional mailing offices. Authorized as second class mail by the Post Office Department, Ottawa, Canada and for payment of postage in cash. Subscription service and Forms 3579, Portland Place, Boulder, Colorado 80302. Editorial offices for manuscript contributions, reader inquiries, etc.: One Park Ave., New York, N.Y. 10016.



Pat Powers, Computer Technology



Ronald Wanat, Circuitry Design



Tom Geary, Automation



Robert Kastiger, Broadcasting

These 4 successful men all got started the same way: they sent in a coupon like this

DE VRY INSTITUTE OF TECHNOLOGY
4141 BELMONT AVE., CHICAGO, ILL. 60641

BELL & HOWELL SCHOOLS

Please send free booklets and information about careers in electronics. I am interested in the following fields (check one or more).

Nuclear Instrumentation Testing PE-2Z
 Automation
 Broadcasting/telecasting
 Radar
 TV-radio service

Name _____ Age _____

Address _____ Apt. _____

City _____ State _____ County _____ Zip Code _____

Veterans: Check here. If you were discharged after Jan. 31, 1955, the "G. I. Bill" may cover the entire cost of your tuition. 118

Why don't you?

Accredited Member, National Home Study Council

DE VRY INSTITUTE OF TECHNOLOGY
4141 BELMONT AVE., CHICAGO, ILL. 60641

BELL & HOWELL SCHOOLS

Weller®

...the soldering tools
professionals depend on



The original Dual Heat Soldering Guns

Preferred by technicians for their fast heating copper tips, exclusive trigger-controlled dual heat, and high soldering efficiency. Available in 3 watt-age sizes, each with spotlight.

100/140-watt Model 8200, 145/210-watt Model D-440, and 240/325-watt Model D-550. Also in complete kits:



Utility Kit includes Weller 100/140 watt gun, extra tips, tip-changing wrench, flux brush, soldering aid and solder. Model 8200PK



Heavy-Duty Kit features Weller 240/325 watt gun with soldering, cutting and smoothing tips, wrench and solder. Model D-550PK

Dependable MARKSMAN Irons in a size for every job



Ideal for deep chassis work and continuous-duty soldering. Marksman irons outperform others of comparable size and weight. All five feature long-reach stainless steel barrels and replaceable tips.

- 25-watt, 1 1/4-oz. Model SP-23 with 1/8" tip (In kit with extra tips, soldering aid, solder—Model SP-23K)
- 40-watt, 2-oz. Model SP-40 with 1/4" tip
- 80-watt, 4-oz. Model SP-80 with 3/8" tip
- 120-watt, 10-oz. Model SP-120 with 1/2" tip
- 175-watt, 16-oz. Model SP-175 with 3/4" tip

Complete Weller Line includes replacement tips and solder

WELLER ELECTRIC CORPORATION, Easton, Pa.
WORLD LEADER IN SOLDERING TOOLS

CIRCLE NO. 30 ON READER SERVICE PAGE

POPULAR ELECTRONICS

PHILLIP T. HEFFERNAN
Publisher

OLIVER P. FERRELL
Editor

LESLIE SOLOMON
Technical Editor

JOHN R. RIGGS
Managing Editor

EDWARD I. BUXBAUM
Art Director

ALEXANDER W. BURAWA
Associate Editor

ANDRE DUZANT
Technical Illustrator

PATTI MORGAN
Assistant Editor

AURORA NARDOZZI
Editorial Assistant

H. BENNETT, W2PNA
H. S. BRIER, W9EQQ

L. E. GARNER, JR.

CHARLES J. SCHAUERS, W6QLV
M. P. SPINELLO, KHC2060
Contributing Editors

RICHARD J. HALPERN
Advertising Manager

ARDYS C. MORAN
Advertising Service Manager

LAWRENCE SPORN
Associate Publisher

ZIFF-DAVIS PUBLISHING COMPANY

Editorial and Executive Offices

One Park Avenue, New York, New York 10016
212 679-7200

Midwestern Office

307 North Michigan Avenue, Chicago, Illinois 60601

312 726-0892

Midwestern Advertising Manager, JAMES WEAKLEY

GERALD L. TAYLOR

Western Office

9025 Wilshire Boulevard, Beverly Hills, California 90211

213 Crestview 4-0265; BRadshaw 2-1161

Western Advertising Manager, BUD DEAN

Japan: James Yagi

Ishikawa Mansion, #4, Sakuragaoka

Shibuya-ku, Tokyo, 462-2911-3

Circulation Office

Portland Place, Boulder, Colorado 80302

William B. Ziff, Chairman of the Board (1946-1953)

William Ziff, President

W. Bradford Briggs, Executive Vice President

Hershel B. Sarbin, Senior Vice President

Philip Sine, Financial Vice President

Walter S. Mills, Jr., Vice President, Circulation

Stanley R. Greenfield, Vice President, Marketing

Phillip T. Heffernan, Vice President, Electronics Division

Frank Pomerantz, Vice President, Creative Services

Arthur W. Butzow, Vice President, Production

Edward D. Muhlfeld, Vice President, Aviation Division

Irwin Robinson, Vice President, Travel Division

Furman Hebb, Administrative Vice President

George Morrissey, Vice President

Sydney H. Rogers, Vice President

Ziff-Davis also publishes Airline Management and Marketing, Business & Commercial Aviation, Car and Driver, Cycle, Electronics World, Flying, Stereo Review, Modern Bride, Popular Photography, Skiing, Skiing Area News, and Skiing Trade News. Travel Weekly is published by Robinson Publications, Inc., a subsidiary of Ziff-Davis Publishing Company.

Forms 3579 and all subscription correspondence should be addressed to POPULAR ELECTRONICS, Circulation Department, Portland Place, Boulder, Colorado 80302. Please allow at least six weeks for change of address. Include your old address, as well as new—enclosing if possible an address label from a recent issue.

EDITORIAL CONTRIBUTIONS must be accompanied by return postage and will be handled with reasonable care; however, publisher assumes no responsibility for return or safety of art work, photographs or manuscripts.



Member Audit Bureau
of Circulations

Here's a new, complete ICS course in TV Servicing that costs less than \$100.

With the first two texts, you can repair 70 percent of all TV troubles.

You need no previous experience to take this complete, practical course in TV Repairing.

You don't even have to know a vacuum tube from a resistor. Yet in a matter of months, you can be doing troubleshooting on color sets!

Course consists of 6 texts to bring you along quickly and easily. 936 pages of concise, easy-to-follow instruction, plus 329 detailed illustrations. You also receive a dictionary of TV terms geared directly to course material so you'll understand even the most technical terms.

Instruction is simple, very easy to grasp. Photos show you what a TV screen looks like when everything is normal, and what it looks like when trouble fouls it up. The texts tell you how to remedy the problem, and why that remedy is best.

Quizzes are spotted throughout the texts so you can check your progress. At the end of the course,

you take a final examination. Then you get the coveted ICS® diploma, plus membership in the ICS TV Repairman Association.

By the time you've finished the course, you should be able to handle tough, multiple TV problems, on color sets as well as black and white.

This new TV Servicing and Repair Course has been approved by National Electronic Associations for use in their Apprenticeship program. Because of its completeness, practicality and price, it is the talk of the industry. The cost is less than \$100—just slightly over ½ the price of any comparable course on the market today.

Remember, the sooner you get started on your course, the sooner you'll be turning your spare time into real money. Fill out the coupon and mail today. We'll rush you a complete information at no obligation to you.

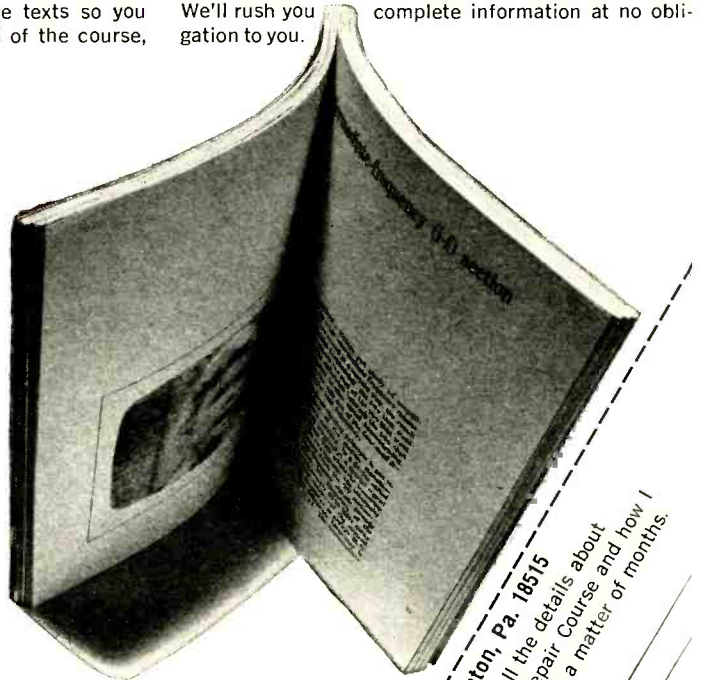

ICS, Dept. M5481A, Scranton, Pa. 18515

Yes, I would like to have all the details about your new TV Servicing/Repair Course and how I can break into TV work in a matter of months.

Name _____
Street _____
City _____
State _____
Zip _____

The Quint- essence of record reproduction



The Synchro-Lab Series™

Garrard's five superb synchronously powered automatic turntables... each the ultimate in its class... each assuring perfectly constant record speed that cannot vary to affect pitch or cause distortion. From \$57.50 to \$129.50. Other models from \$37.50.

For literature, write Garrard, Dept. AB139, Westbury, N.Y. 11590.

Garrard®

World's Finest

British Industries Co., division of Avnet, Inc.

CIRCLE NO. 12 ON READER SERVICE PAGE

letters

FROM OUR READERS

KEEP THOSE IC PROJECTS COMING

In regard to J. F. Lycett's letter ("Letters From Our Readers," October, 1968), I would like to state that I echo in some respects, his reactions to IC projects. After all, where is the interest in plugging an entirely pre-assembled circuit into a project without knowing what's in that circuit?

However, I have found that working with IC's is challenging. For example, they simplify project design, biasing problems are virtually eliminated, and maximum gain is obtained from a minimum-volume package. As a result, I have changed my outlook toward IC's and now say: Keep those IC projects coming.

BOB CONWAY
Austin, Texas

You have half the battle won. We still don't feel that it is necessary to publish a schematic diagram for every IC used in POPULAR ELECTRONICS. They can be obtained easily from the manufacturer—just as the characteristics of transistors, for example, are obtained. When using an IC in a project, treat it as any other discrete component containing more than two terminals. Put another way, if you don't have to know how many turns are employed in the primary and secondary windings of a power transformer, you don't really have to know how many and what types of components are employed in an IC.

TELECOMMUNICATIONS STAMPS WANTED

I am a topical stamp collector. At the present time, I am starting a collection of postage stamps depicting any and all aspects of telecommunications. My interest covers all areas of communications including broadcasting, communications satellites, radar equipment and facilities, buildings that house telecommunications administrations, etc., etc. In exchange for such stamps, I will gladly send five U.S. or foreign commemorative stamps for each stamp I receive.

TSGT PAUL A. MATTHIEU
2523 Spur Drive
San Antonio Texas 78227

If you can help Sgt. Matthieu in his search for these stamps, write to him directly.

OHMMETER CAPACITOR CHECK

In the "Letters From Our Readers" column in the September, 1968, issue of POPULAR ELECTRONICS, you mentioned that a simple

POPULAR ELECTRONICS

F.C.C. COMMERCIAL OPERATOR LICENSE

Training

is part of the Grantham

A. S. E. E.

(Associate in Science in Electronics Engineering)

DEGREE CURRICULUM

In today's world of electronics employment, an FCC license is important — sometimes essential — but it's not enough! Without further education, you can't make it to the top. Get your FCC license without fail, but don't stop there. To prepare for the best jobs, continue your electronics education and get your Associate Degree in Electronics.

This is good common sense for those who want to make more money in electronics. It also makes sense to prepare for your FCC license with the School that gives degree credit for your license training — and with the School that can then take you from the FCC license level to the Degree level.

The first two semesters of the Grantham degree curriculum prepare you for the first class FCC license and radar endorsement. These two semesters, in addition to other parts of the Grantham

This booklet
FREE!

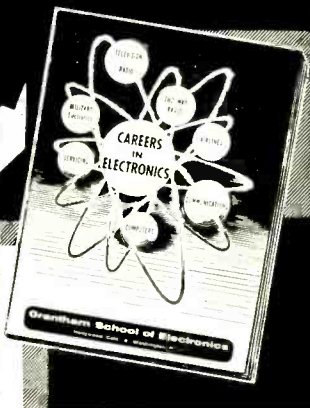

This free booklet explains what an FCC license and ASEE degree can do for your future.

degree curriculum, are available by correspondence* at very reasonable tuition. *The ASEE Degree can be earned by correspondence with a minimum of two weeks in residence.*

Accreditation, and G.I. Bill Approval

Grantham School of Electronics is *accredited* by the Accrediting Commission of the National Home Study Council, and is *approved* for both correspondence and resident training under the G.I. Bill. Mail the coupon, or simply write or telephone for your free copy of our Associate Degree Bulletin which gives complete details of our educational program.



GRANTHAM School of Electronics



*Semesters 1, 2, and 3 of the Grantham electronics curriculum are available *also in resident classes* at our Washington, D.C. school — at the address shown below.

• Established in 1951 •

Grantham School of Electronics

1505 N. Western Ave.
Hollywood, Calif. 90027

or

818 18th Street, N.W.
Washington, D.C. 20006

Telephone:
(213) 469-7878

Telephone:
(202) 298-7460

Grantham School of Electronics

PE-2-69

1505 N. Western Ave., Hollywood, Calif. 90027

Please mail me your free catalog, which explains how Grantham training can prepare me for my FCC License and Associate Degree in electronics. I understand no salesman will call.

Name _____ Age _____

Address _____

City _____ State _____ Zip _____

Looking for INTEGRATED CIRCUITS

At Hobbyist-Experimenter Prices??

We've got 'em!

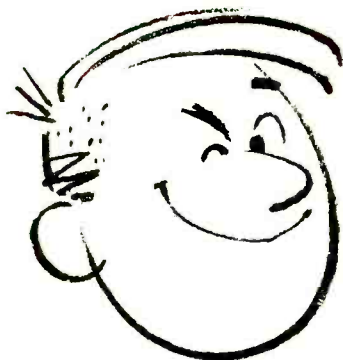

Power Amplifiers	Wide Band Amp Discriminators	3-Input Gates
Stereo Preamps	J-K Flip-Flops	Dual Buffers
OP Amps	Dual J-K Flip-Flops	Bias Drivers
RF Amplifiers	4-Input Gates	Quad Gates
IF Amplifiers	Dual 2-Input Gates	Half Adders

plus...

14 Pin, 10 Pin, and 8 Pin I.C. sockets
to put them in!

All at prices you can afford!!

Get HEP... Check into the Integrated Circuits available from your local Motorola HEP Distributor. Pick up a free copy of "Tips On Using IC'S" while you're there; it includes a good IC Cross Reference Guide, and eight IC Project Circuits. If you can't find a Motorola HEP Distributor near you, write us.



MOTOROLA HEP SEMICONDUCTORS
HOBBYIST • EXPERIMENTER • PROFESSIONAL
P. O. BOX 20924 / PHOENIX, ARIZONA 85034

CIRCLE NO. 16 ON READER SERVICE PAGE

LETTERS (Continued from page 8)

ohmmeter check can be used to determine whether a capacitor is good or bad. Could you tell me how it is done?

HENRY GRENIER
Providence, R.I.

Although an ohmmeter check for capacitors is less reliable than checks made with a laboratory-type capacitance bridge, it is still a useful technique for determining the state of capacitors. The results obtained from ohmmeter checks vary widely from one type of capacitor to another.

To test a capacitor with an ohmmeter, place the ohmmeter's probes across the capacitor's leads and observe the meter's pointer. If the pointer dips toward the low end of the meter scale at the instant of contact, then slowly rises almost to infinity, the capacitor is good. If the pointer deflects in the proper manner but rises to less than, say, 10,000 ohms, the capacitor is leaking excessively. If the meter pointer fails to deflect in either direction, it is bad (open if no deflection, shorted if deflection is to zero). Small value capacitors are less likely to cause a large dip of the pointer than are large value capacitors.

ENTHUSIASTIC RESPONSE TO LAB PROJECTS

Many thanks for the inroads POPULAR ELECTRONICS made into the chemical laboratory project area ("Solid-State pH Meter" and "Build Variable-Speed Magnetic Stirrer," November, 1968). I hope this will be just the beginning of a whole series of projects involving lab equipment. I am Director of Research for a company that normally buys ready-made lab equipment, but I personally like to tinker with homebrew projects. Occasionally, I even put my projects on-line to supplement what we already have.

While scanning through the November issue, I also saw the possibility of adapting a digital readout ("All-Purpose Nixie Readout") to the pH meter for greater accuracy. Not being overly knowledgeable with the type of circuit involved, I can only say that the counter would have to be reversible, covering a range of +1400 mV to -1400 mV when used as an adapter for the pH meter. Perhaps you might include an auxiliary project that would do this in one of your future issues. I can't speak for other labs, but mine would greatly benefit from such a project.

FREDERIC J. JUENEMAN
Director of Research
Innovative Concepts Associates, Inc.
San Jose, Calif.

I was very pleased to see R.C. Dennison's "Solid-State pH Meter" and "Build Variable-Speed Magnetic Stirrer" articles in the November, 1968, issue of POPULAR ELECTRONICS. Particularly interesting was the short section explaining pH. As electronic instrumentation

(Continued on page 117)

They hide under dashboards and bite way out with striking power. The CB solid-state Cobras.

Coiled up under your dash ready to strike. Mysteriously attractive, but all business. Their bite radiates a long way. Penetrates through layers of interference.

When a Cobra bites, you'll be surprised at all the people who know about it.

Because tucked away in the Cobra's throat is the exclusive Dyna-Boost circuit that fills out the sidebands to give you a lot more talking range. Full 5 watts input. 100% modulation.

Both Cobra 27 and Cobra V are all solid state. Which means all solid-state switching. Switching that can't wear out, can't corrode. Solid state also means thick-skinned reliability. Extremes in temperature and humidity have practically no effect on performance and life span.

Cobras are also very sensitive and receptive to the human voice. Very

selective, too, when it comes to rejecting adjacent channel interference. And a Cobra will give you a sharper bite, because all channels are crystal controlled.

If you go solid state, get the bite of the Cobra. For base station as well as mobile applications. (Ask your distributor for the snake or write us for detailed information.)

Cobra 27, 23-channel CB transceiver, complete with all necessary crystals ready for immediate operation on all 23 channels. **\$179.95**

Cobra V, 5-channel CB transceiver. (Channel 11 crystal supplied) **\$99.95**



A Division of DYNASCAN CORPORATION
1801 W. Belle Plaine • Chicago, Illinois 60613
Where electronic innovation is a way of life.

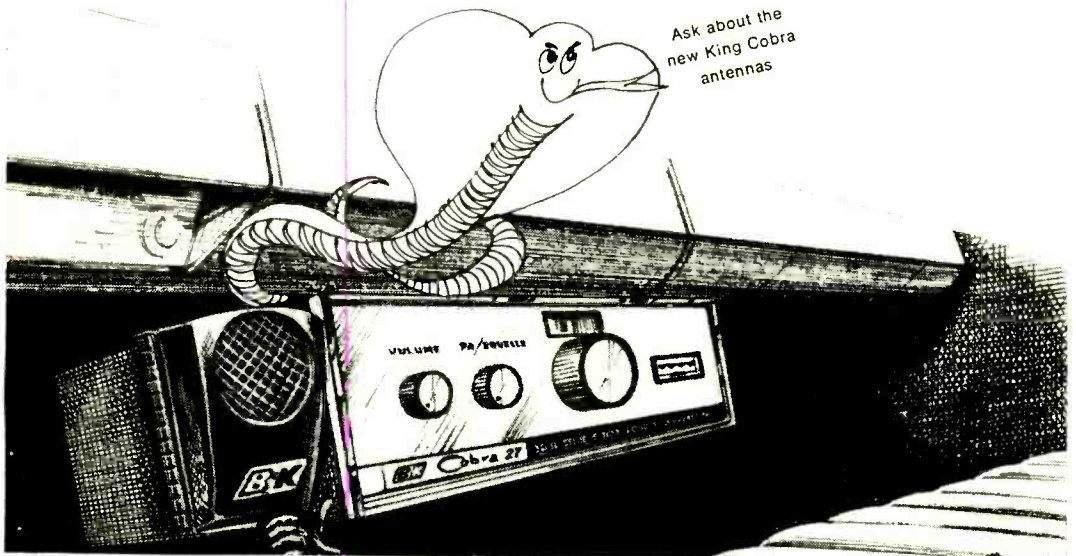

Ask about the
new King Cobra
antennas

Scott's new LR-88
receiver takes the



out of kit building

Ladies and children needn't leave the room when you build Scott's new LR-88 AM/FM stereo receiver kit. Full-color, full-size assembly drawings guide you through every stage . . . wires are color-coded, pre-cut, pre-stripped . . . and critical sections are completely wired and tested at the factory.

In about 30 goof-proof hours, you'll have completed one great receiver. The LR-88 includes FET front end, Integrated Circuit IF strip, and all the goodies that would cost you over a hundred dollars more if Scott did all the assembling.

Performance? Just check the specs below . . . and write to Scott for your copy of the detailed LR-88 story.

LR-88 Control Features: Dual Bass and Treble; Loudness; Balance; Volume compensation; Tape monitor; Mono/stereo control; Noise filter; Interstation muting; Dual speaker switches; Stereo microphone inputs; Front panel headphone output; Input selector; Signal strength meter; Zero-center meter; Stereo threshold control; Remote speaker mono/stereo control; Tuning control; Stereo indicator light. **LR-88 Specifications:** Music-Power rating (IHF), 135 Watts (a. 4 Ohms); Usable sensitivity, 2.0 μ V; Harmonic distortion, 0.6%; Frequency response, 15-25,000 Hz \pm 1.5 dB; Cross modulation rejection, 80 dB; Selectivity, 45 dB; Capture ratio, 2.5 dB; Signal/noise ratio, 65 dB; Price, \$334.95 (Recommended Audiophile Net)

You'll swear by it



SCOTT

H. H. Scott, Inc., Dept. 520-02, Maynard, Mass. 01754
Walnut case optional

© 1968, H. H. Scott, Inc.

CIRCLE NO. 23 ON READER SERVICE PAGE

ELECTRONICS library

QUIET

COMPUTERS FOR THE AMATEUR CONSTRUCTOR

by R. H. Warring

Most books concerning computers are written for the professional computer technologist; this one, for a change, will interest the hobbyist and experimenter. Using an elementary approach, it breaks down computer design into basic circuits and elements, explaining how each performs in the overall scheme of the computer. The bulk of the book is devoted to practical descriptions of computer circuits that are within the capabilities of anyone to build. It introduces the common jargon used in the computer field and provides the fundamentals of computer language—binary numbers, logic, and arithmetic functions. Profusely illustrated with schematic diagrams, parts lists, and construction tips, the book is a worthwhile investment for anyone interested in computers.

Published by Museum Press Limited, London, England. Distributed by Sportshelf, P.O. Box 634, New Rochelle, N. Y. 10802. Hard cover. 104 pages. \$5.50.

TRANSISTOR CIRCUIT GUIDEBOOK

by Byron G. Wels

Whether you are a hobbyist or a design experimenter, you'll find this book, containing a collection of 104 transistor circuits, a valuable reference. The book is divided into sections headed by the particular areas covered (such as amplifiers, tuners, temperature indicators, counting circuits, computers, etc.) for easy location of the circuit of interest. The operation of each circuit is described briefly and unusual features and applications are pointed out. Included are circuits for a shift register, a decimal counter, and a complete color TV receiver including parts list.

Published by Tab Books, Blue Ridge Summit, Pa. 17214. Hardbound, \$6.95; soft cover, \$4.59. 224 pages.

SPECIAL SEMICONDUCTOR DEVICES

by Walter A. Sowa and James M. Toole

Semiconductor technology has one big flaw: to obtain necessary information about all of the various specialized devices that are available, one needs almost as many books as there are devices. This new book attempts to solve the dilemma by bringing the pertinent in-

CIRCLE NO. 9 ON READER SERVICE PAGE →

World's largest selling mobile/base CB rig! \$189.



Courier 23 — the most popular mobile/base CB transceiver ever built! A greater value than ever before, with 100% modulation featuring Courier's exclusive Modulation Sampler® — boosts your talk power electronically! Dollar for dollar, offers more of what you want in CB: 23 crystal-controlled channels, dual conversion, built-in solid-state 12v mobile power supply, illuminated S-RF meter and channel selector, PA system, modulation indicator, full-time Range-expand, adjustable noise limiter, super efficient squelch. Heavy-duty triple-plated chrome cabinet with stainless steel front panel. Just \$189 complete with crystals for all 23 channels.

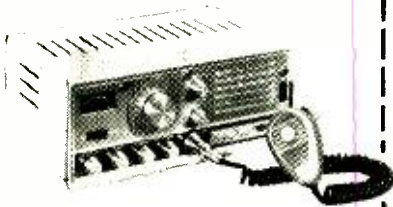

COURIER ROYALE

All the performance money will buy, no matter what you're willing to spend. The ultimate in power, selectivity, sensitivity, quietness. All 23 channels, with all crystals supplied. Complete **\$279** (and we mean complete)



COURIER COMMUNICATIONS, INC.
439 Frelinghuysen Avenue, Newark, N.J. 07114
a **Whittaker** Company

Yes! I'd like to know all about the Courier 23 — world's largest-selling CB rig!

Send me data on COURIER ROYALE

Name _____

Address _____ PE-92

City _____ County _____

State _____ Zip _____

Get the last word every time.

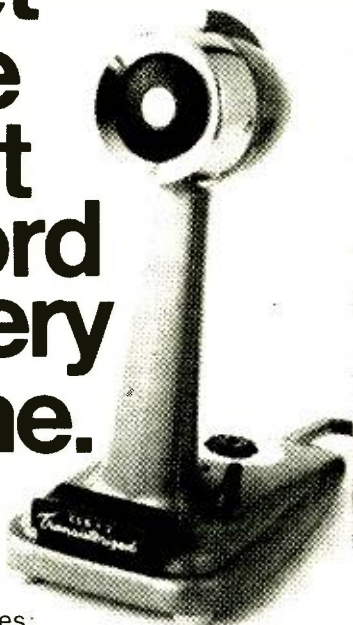

Get Turner's "+2" series:

+2 base station mike (List Price: \$55.00) and M+2/U mobile mike (List Price: \$39.50). Up to 50 times the modulation of other mikes. No more fade outs. No more static. (Even at great distances). Both "+2" series microphones use a

two - transistor pre-amp and work with all transistor and tube sets. See them at your CB dealer or distributor soon. And get the last word.

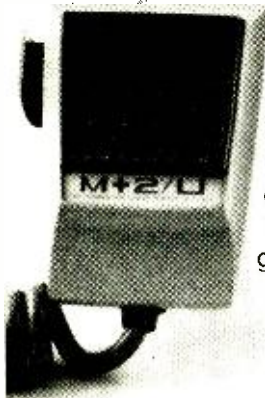

TURNER

919-17th Street N.E.,
Cedar Rapids, Iowa 52402
In Canada: Tri-Tel Associates, Ltd.

CIRCLE NO. 55 ON READER SERVICE CARD

LIBRARY (continued from page 12)

formation together in a single volume. It explains the principles and use of seven semiconductor devices, including photoelectric devices, zener and tunnel diodes, silicon controlled rectifiers, diffused-junction transistors, triacs, diacs, UJT's and FET's. The only prerequisites for the use of this book are a working knowledge of the basic principles of the transistor and familiarity with basic algebra.

Published by Holt, Rinehart and Winston, Inc., 383 Madison Ave., New York, N. Y. 10017. Soft cover. 190 pages. \$3.59.

TRANSISTOR FUNDAMENTALS, Four-Volume Set

Written with a programmed learning format, this set of four text books provides an entire technician-level training course in transistor technology. Each volume is written by a recognized authority in the field of transistors. Volume 1, "Basic Semiconductors and Circuit Principles," by Robert S. Brite, begins with a brief description of transistors, then covers the all-important electrical principles of transistors. "Basic Transistor Circuits," by Charles A. Pike, Vol. 2, introduces the circuit concepts used in the design of amplifiers and oscillators. Then Volume 3, "Electronic Equipment Circuits," by Martin Gersten, covers the circuits used in audio, radio, and television equipment. Rounding out the set, "Digital and Special Circuits," by Reginald H. Peniston and Louis Schweitzer, covers digital circuits, the binary number system, and applications in computers, test equipment, and tracking and sensing equipment. Each volume is available separately.

Published by Howard W. Sams & Co., Inc., 4300 West 62 St., Indianapolis, Ind. 46206. Vol. 1, 240 pages; Vol. 2, 208 pages; Vol. 3, 192 pages; Vol. 4, 208 pages. All soft cover, \$4.50 each. Four-volume set, \$15.95.

PRACTICAL CB RADIO SERVICING

by R. R. Freeland and L. Sands

This book provides the theory and detailed procedures needed for the technician and serviceman to repair and maintain CB radio equipment with the competence of a professional. The book is broken up into chapters, each of which isolates a specific phase in repair and maintenance, providing an ideal tool for spot checking and troubleshooting CB rigs. Included are extensive appendixes providing characteristics tables, operational checks, troubleshooting charts, and a brief glossary of the terms commonly encountered in CB radio. Exact detailed procedures are given for checking fixed and mobile installation frequencies, measuring modulation levels, aligning equipment, etc.

Published by Hayden Book Company, Inc., 116 West 14 St., New York, N.Y. 10011. Soft cover, 192 pages. \$4.75.

POPULAR ELECTRONICS READER SERVICE PAGE

free information service:

Here's an easy and convenient way for you to get additional information about products advertised or mentioned editorially (if it has a "Reader Service Number") in this issue. Just follow the directions below... and the material will be sent to you promptly and free of charge.

1. Print or type your name and address on the lines indicated. Circle the number(s) on the coupon below that corresponds to the key number(s) at the bottom of the advertisement or editorial mention(s) that interest you. (Key numbers for advertised products also appear in the Advertisers' Index.)

2. Cut out the coupon and mail it to the address indicated below.

3. This address is for our product "Free Information Service" only. Editorial inquiries should be directed to POPULAR ELECTRONICS, One Park Avenue, New York 10016; circulation inquiries to Portland Place, Boulder, Colorado 80302.

**POPULAR
ELECTRONICS**

P.O. BOX 8391
PHILADELPHIA, PA. 19101

VOID AFTER MARCH 31, 1969

1 2 3 4 5 6 7 8 9 10 11 12 13 14 15 16 17 18 19 20
21 22 23 24 25 26 27 28 29 30 31 32 33 34 35 36 37 38 39 40
41 42 43 44 45 46 47 48 49 50 51 52 53 54 55 56 57 58 59 60
61 62 63 64 65 66 67 68 69 70 71 72 73 74 75 76 77 78 79 80
81 82 83 84 85 86 87 88 89 90 91 92 93 94 95 96 97 98 99 100

NAME (Print clearly) _____

ADDRESS _____

CITY _____ STATE _____ ZIP CODE _____

2 ea

UNUSUAL BARGAINS

... MANY U. S. GOV'T SURPLUS

FREE!
GIANT
CATALOG



"See" Your Music in Dazzling Action with

Dramatic Audio-Visual Breakthrough



Add a spectacular new dimension to world of music display entertainment. Actually see music translated into fantastic patterns of beautiful color—each individual note creating its own unique, twisting, radiating shape... each shape dancing and prancing, whirling and swirling in perfect time with the music. Combines science, art and electronics with amazing results. First new development in converting music to a visible image since color organ was invented in 1860. Use on small serenades, large halls, stages, whole auditoriums. Attaches in seconds to radio, tape recorder, hi-fi or stereo with two alligator clips. Loads of fun! Practical too! Great for parties, "see-ins", special effects for bands, dances, exhibits, sales meetings, class rooms. Complete line available from DO-IT-YOURSELF KITS to full SETS and self-contained, portable MINI-MODELS to CONSOLES. Order by Stock No. Listed below. Money-back guarantee if not 100% satisfied. Full details in FREE CATALOG or send 25c in coin for new, fully illustrated 16-page Booklet No. 0006AV "Introduction to Music-Vision."

- No. 71.009AV 8" DO-IT-YOURSELF KIT \$22.50 Ppd.
- No. 71.030AV 8" SET 45.00 Ppd.
- No. 71.032AV 12" SET 57.50 Ppd.
- No. 71.124AV COMPACT MINI-MODEL 46.50 Ppd.
- No. 85.181AV WALNUT CABINET MODEL 99.50 F.O.B.
- No. 71.057AV 500 WATT SPECIAL EFFECTS PROJECTOR 48.50 Ppd.
- No. 71.002AV REMOTE CONTROL PROJECTOR 39.50 Ppd.



NEW! PROJECTION KALEIDOSCOPE

Infinite variety of brilliant color patterns which do not repeat. Spectrally designed 9" diam. liquid wheel. 2" projection lens and Edmund Special Effects Projector make it all possible. Easily operated. Large screen image at short projection distance perfect for backgrounds. Light shows, parties, dances, etc. Front of clear projection. **\$15.00 Ppd.**

- Stock No. 71.121AV SOLID MULTI-COLORED GLASS ACCESSORY WHEEL \$15.00 Ppd.
- Stock No. 71.122AV—(9" Diam.)

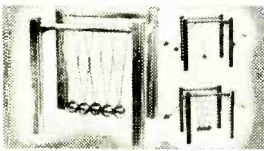

REACTION... IN ACTION!

Fascinating demonstration of Newton's 3rd law. Swing up to 4 polished steel balls away from others—let go. They strike remaining ones—but pop some number on other side. Process continues until friction overcomes kinetic energy. Real attention-getter! Entertaining movement and rhythmic clicking course constant experimenting! Perfect for exec. desks, educators, displays.

- Stock No. 71.133AV \$8.00 Postpaid



NEW LOW-COST ULTRASONIC CLEANER

Top-quality hard pint unit for only \$349.95! Cleans dirt, grime completely, quickly, safely. Small delicate parts, precision electronic items, lab instruments, jewelry, and even dentures sparkle like new! American-made—operates on regular house current. Solid state generator w/automatic turn-off. Power regulation. No shocks. No radio interference. 6" x 4" x 4" stainless. **\$39.95 Ppd.**

- Stock No. 71.003AV LARGE INDUSTRIAL 1 1/2 GAL. SIZE (Wt. 37 lbs.) \$249.95 F.O.B.
- No. 85.128AV



3" Astronomical Telescope

See the stars, moon, phases of Venus, planets close up. 60 to 180 power. Aluminized and over-coated 3" diameter F/10 primary mirror, ventilated cell. Equatorial mount with locks on both axes. Equipped with 6X eyepiece and mounted Barlow lens. 3X finder telescope. Hardwood tripod. Included: "STAR CHART", 272-page "HANDBOOK OF HEAVENS". **\$29.95 Ppd.**

- Stock No. 85.050AV \$29.95 Ppd.
- Stock No. 85.105AV 4 1/2" REFLECTOR \$4.50 F.O.B.
- Stock No. 85.085AV 6" REFLECTOR \$199.50 F.O.B.

Order by Stock No.—Check or M.O.—Money-Back Guarantee
EDMUND SCIENTIFIC CO., 300 ESCORP BUILDING
BARRINGTON, NEW JERSEY 08007

GIANT FREE CATALOG "AV"



Completely new 1969 edition. New items, categories, illustrations. 148 easy-to-read pages packed with 1000 unusual items. Dozens of electrical and electromagnetite parts, accessories. Enormous selection of Astronomical Telescopes. Microscopes. Binoculars. Magnifiers. Microfilm. Loupes. Prisms. Many war surplus items; for hobbyists, experimenters, workshops, factory. Write for catalog "AV". Include Zip.

ORDER BY STOCK NUMBER • SEND CHECK OR MONEY ORDER • MONEY-BACK GUARANTEE
EDMUND SCIENTIFIC CO. 300 ESCORP BUILDING
BARRINGTON, NEW JERSEY 08007
CIRCLE NO. 10 ON READER SERVICE PAGE

TAKE ONE

new literature

To obtain a copy of any of the catalogs or leaflets described below, simply fill in and mail the coupon on page 15 or 115.

Virtually everything an SWL could want for his listening post is described in the new 16-page catalog, "The World of SWL'ing," available from *Gilfer Associates, Inc.* Among the items listed are top-brandname receivers, books covering the hows and whys of SWL'ing, log books, call books, digital and conventional clocks, maps, globes, etc. There are reporting letter forms, QSL card holders, and a circular slide rule that tells times around the world and gives beam headings for great circle paths.

Circle No. 75 on Reader Service Page 15 or 115

The new "High Trackability Easy-Mount" phono cartridges, as well as other high-fidelity stereo cartridges, tone arms, styli, and headphone amplifiers are illustrated in an eight-page catalog now available from *Shure Brothers, Inc.* Complete specifications and performance information, along with charts and definitions of trackability are provided for the Model V-15 Type II "Super-Track" and other cartridges in the Shure line.

Circle No. 76 on Reader Service Page 15 or 115

Sandwiched into the 16 pages of catalog No. 158 are descriptions of the complete line of electric power tools and soldering irons made by *Wen Products, Inc.* This three-color, pre-punched (for ring binders) catalog provides information on tool performance, characteristics, and applications. Among the items listed are drills of all chuck sizes and power ratings, rotary and sabre saws, sanders, a grinder, an electric plane, the full Wen line of soldering guns and pistols, and all applicable accessories.

Circle No. 77 on Reader Service Page 15 or 115

High Fidelity Sound Products Catalog No. 165-P recently issued by *Jensen Manufacturing Division* describes all of the new Jensen speaker systems, including the recently introduced Models TF-15 and TF-25. This colorful catalog illustrates and describes the "Sigma," "Delta," and "Triaxial" speakers, plus the complete series of hi-fi component accessories, including the Model HS-2 stereo headphones.

Circle No. 78 on Reader Service Page 15 or 115

NOW YOU CAN UN SOLDER...



FOR SOLDERING



AND DESOLDERING

uniline mark vii

SOLDER AND DESOLDER WITH ONE TOOL!

The Uniline Mark VII is a dual purpose pencil soldering-desoldering tool. This truly revolutionary system allows you to solder and desolder any joint with finger tip ease and control. Simply press the button to desolder. How about that!

The tool is composed of three basic components that give it unprecedented versatility. You can select what you need from: **FOUR DIFFERENT COLORS OF HANDLES, FOUR INTERCHANGEABLE HEAT CARTRIDGES (20-30-40 & 50 WATTS), DOZENS OF DIFFERENT TIPS IN MANY DIFFERENT STYLES AND SHAPES.**

How's that for a combination tool? Exciting, isn't it! If you are interested in saving time and money you need one right now. See your local distributor today, and tomorrow start enjoying cost reduction you never thought possible.

AS LOW AS
\$12.95
20 WATT ONLY

SEE YOUR LOCAL DISTRIBUTOR TODAY!

VANGUARD
ELECTRONIC TOOLS INC. NEWTON, KANSAS

**Someone
should develop
an easy way
to learn
electronics at
home**

**RCA Institutes
did!**

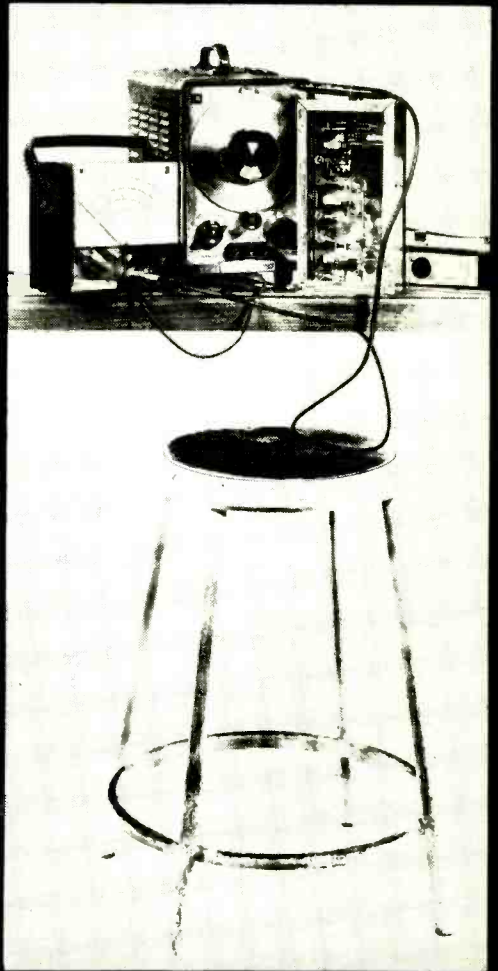

Here is a whole new approach to learning electronics at home! RCA Institutes, one of the nation's largest schools devoted to electronics, has developed a faster, easier way for you to gain the skills and the knowledge you need for the career of your choice. Here for the first time is a student-proved, scientifically designed way to learn. If you have had any doubts in the past about home training in electronics—if you have hesitated because you thought you might not be able to keep up—or that electronics was too complicated to learn—here is your answer! Read how RCA Institutes has revolutionized its home training ideas!

NEW CAREER PROGRAMS BEGIN WITH "AUTOTEXT" INSTRUCTION METHOD!

**Start to learn the field of your choice immediately!
No previous training or experience in electronics needed!**

With this new revolutionized method of home training you pick the career of your choice—and *RCA Institutes trains you for it*. RCA's Career Programs assure you that everything you learn will help you go directly to the field that you have chosen! No wasted time learning things you'll never use on the job! The Career Program you choose is especially designed to get you into that career in the fastest, easiest possible way!

And each Career Program starts with the amazing "AUTOTEXT" Programmed Instruction Method—the new, faster way to learn that's almost automatic! "AUTOTEXT" helps even those who have had trouble with conventional home training methods in the past. This is the "Space Age" way to learn everything you need to know with the least amount of time and effort.

CHOOSE A CAREER PROGRAM NOW

Your next stop may be the job of your choice. Each one of these RCA Institutes Career Programs is a complete unit. It contains the know-how you need to step into a profitable career. Here are the names of the programs and the kinds of jobs they train you for. Which one is for you?

Television Servicing. Prepares you for a career as a TV Technician/Serviceman; Master Antenna Systems Technician; TV Laboratory Technician; Educational TV Technician.

FCC License Preparation. For those who want to become TV Station Engineers, Communications Laboratory Technicians, or Field Engineers.

Automation Electronics. Gets you ready to be an Automation Electronics Technician; Manufacturer's Representative; Industrial Electronics Technician.

Automatic Controls. Prepares you to be an Automatic Controls Electronics Technician; Industrial Laboratory

Technician; Maintenance Technician; Field Engineer.

Digital Techniques. For a career as a Digital Techniques Electronics Technician; Industrial Electronics Technician; Industrial Laboratory Technician.

Telecommunications. For a job as TV Station Engineer, Mobile Communications Technician, Marine Radio Technician.

Industrial Electronics. For jobs as Industrial Electronics Technicians; Field Engineers; Maintenance Technicians; Industrial Laboratory Technicians.

Nuclear Instrumentation. For those who want careers as Nuclear Instrumentation Electronics Technicians; Industrial Laboratory Technicians; Industrial Electronics Technicians.

Solid State Electronics. Become a specialist in the Semiconductor Field.

Electronics Drafting. Junior Draftsman, Junior Technical Illustrator; Parts Inspector; Design Draftsman Trainee Chartist.

SEPARATE COURSES

In addition, in order to meet specific needs, RCA Institutes offers a wide variety of separate courses which may be taken independently of the Career Programs, on all subjects from Electronics Fundamentals to Computer Programming. Complete information will be sent with your other materials.

2 CONVENIENT PAYMENT PLANS

RCA Institutes offers a unique tuition plan that lets you progress at your own pace. You only pay for lessons as you order them. You don't sign a contract obligating you to continue the course. There's no large down-payment to lose if you decide not to continue.

However, if you desire, RCA Institutes also offers a convenient monthly payment plan.

VALUABLE EQUIPMENT

You receive valuable equipment to

keep and use on the job—and you never have to take apart one piece to build another.

New—Programmed Electronics Breadboard. You now will receive a scientifically programmed electronic breadboard with your study material. This breadboard provides limitless experimentation with basic electrical and electronic circuits involving vacuum tubes and transistors and includes the construction of a working signal generator and superheterodyne AM Receiver.

Multimeter and Oscilloscope Kits At No Additional Cost. You will receive with most RCA Institutes Career Programs the instruments and kit material you need to build a Multimeter and Oscilloscope. The inclusion of both these kits is an RCA extra.

CLASSROOM TRAINING ALSO AVAILABLE

RCA Institutes maintains one of the largest schools of its kind in New York City where classroom and laboratory training is available in day or evening sessions. You may be admitted without any previous technical training; preparatory courses are available if you haven't completed high school. Coeducational classes start four times a year.

JOB PLACEMENT SERVICE, TOO!

Companies like IBM, Bell Telephone Labs, GE, RCA, Xerox, Honeywell, Grumman, Westinghouse, and major Radio and TV Networks have regularly employed graduates through RCA Institutes' own placement service.

SEND ATTACHED POSTAGE PAID CARD FOR COMPLETE INFORMATION, NO OBLIGATION.

All RCA Institutes courses and programs are approved for veterans under the new G.I. Bill.

Accredited Member
National Home Study Council

IF REPLY CARD IS DETACHED—SEND THIS COUPON TODAY

RCA INSTITUTES, Inc., Dept. PEQ-29
320 West 31st Street, N.Y., N.Y. 10001

Please rush me FREE illustrated catalog. I understand that I am under no obligation.

Name _____ Age _____

(please print)

Address _____

City _____

State _____ Zip _____

RCA



NEW PRODUCTS

Additional information on products covered in this section is available from the manufacturers. Each new product is identified by a code number. To obtain further details on any of them, simply fill in and mail the coupon on page 15 or 115.

FM CHANNEL SELECTOR

In step with the current digital readout trend, *CM Laboratories* has developed the Model 804 FM "Channel Selector" that eliminates the need for the conventional slide-rule tuner dial. The channel selector employs a crystal frequency synthesizer that produces only 100 frequencies—the same number of channels allotted to the FM broadcast



band. Each of these discrete frequencies is precisely tuned to one of the FM band channels. Then, selection of the desired frequency is accomplished by operating a two-position switch in the front panel. This switch, in turn, operates two 10-position stepping relays that seek out the desired channel's frequency. The result is displayed on the front panel on four computer-type digital readout tubes. Channels can be tuned individually or swept at a rate of 100 in five seconds. As a result, the 804 is a channel selector—not a tuner.

Circle No. 79 on Reader Service Page 15 or 115

FET VOLT-OHMMETER

The Model 3000 FET-VOM available from *Delta Products, Inc.*, employs several features not commonly found in the average transistorized volt-ohm-milliammeter. For instance, an IC operational amplifier provides optimum accuracy, 10-turn zero and ohms potentiometers are used, and a feedback network eliminates the need for calibration. A field effect transistor with current regulation and voltage clippers for overload protection is employed in the input stage. The meter is fully temperature compensated to minimize zero drift. Specifications—accuracy: $\pm 2\%$ full scale on d.c. voltage and current, $\pm 3\%$ full scale on a.c. voltage, $\pm 5\%$ between 10% and 90% of scale on ohms; input impedance: 10 megohms; ranges, a.c. and d.c. volts: 30 mV to 1000 volts full scale in eight ranges, d.c. current; 0.03 μ A to 300

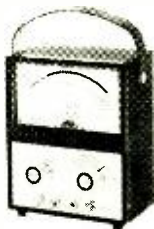

mA full scale in eight ranges resistance; 0-1000 megohms (10-ohm center scale) in seven ranges.

Circle No. 80 on Reader Service Page 15 or 115

FM MONITOR RECEIVER

The "Reporter" is a compact VHF/FM communications monitor receiver made by *Uni-metrics, Inc.*, for monitoring fire, police, special emergency, civil defense, and other emergency radio services. It can also be used for business and industrial radio communications and VHF ship-to-shore and ship-to-ship communications. The "Reporter" is designed to operate on up to six crystal-controlled channels in either the 30-50-MHz or the 152-174-MHz bands. The receiver employs a dual-conversion, solid-state superhet circuit which can be operated directly from a 12-volt d.c. source, or from 117 volts a.c. (with accessory power supply). In addition to a built-in speaker, an external speaker can be connected to a jack provided with the receiver. Also, "Uni-Tone" encoders and decoders are available for use with the "Reporter" when an alerting system is required.



Circle No. 81 on Reader Service Page 15 or 115

ELECTRONIC SPINET ORGAN

Knight-Kit's Model KG-388 electronic spinet is small enough for home use, yet is versatile enough and big enough in sound to be used in churches, schools, and entertainment halls. For successful assembly without prior kit-building experience, nearly all wiring is performed on 14 numbered printed circuit boards. Voices are selected by pressing tabs that light up when in use, and a built-in reverb system allows the organ



to be adjusted to room acoustics. The manual ranges overlap, but the lower manual goes lower for accompaniment and the upper manual goes higher for melody. The pedals produce one complete octave, starting from three octaves below middle C. Vibrato is fully controllable, and the expression pedal gives instant-to-instant volume control. Specifications: upper manual—36 notes, F3-E6; lower manual—29 notes C3-E6; 14 voices; output power—25 watts r.m.s., 39 watts music, 78 watts peak.

Circle No. 82 on Reader Service Page 15 or 115

PRINTED CIRCUIT KIT

As an aid to the experimenter and hobbyist, *Injectorall Electronics Corp.* has developed Printed Circuit Kit No. 500, containing all the items needed for turning out professional-quality printed circuit boards. Each kit contains two 4 $\frac{1}{4}$ " x 3 $\frac{3}{4}$ " copper-clad boards,



It's no picnic. Never has been.

Valley Forge, Meuse-Argonne, Monte Cassino, Pork Chop Hill — they were dirty jobs.

And not without sacrifice. But freedom lived.

American soldiers have never ducked the dirty job. And free men everywhere are grateful. But it's never been done for thanks. Or gain. Or even glory.

When freedom cries help, men who have known freedom hear the call. And they go. It's no fun. But they go. Every time.

Your future, your decision...choose ARMY.

Army Opportunities
Department 200
Hampton, Va. 23369

PE 2-69

Tell me about soldiering and service to my Country.

Name _____ Age _____

Address _____

City _____ County _____

State _____ Zip _____

PRODUCTS (Continued from page 22)

resist pen, 2-oz bottle of resist ink solvent, 6-oz bottle of etchant, and a 1/16" drill bit. The kit is packaged in a clear plastic box that can be used as a developing tray. Complete step-by-step instructions are furnished, and professional results are assured if these instructions are followed.

Circle No. 83 on Reader Service Page 15 or 115

CASSETTE/FM RECEIVER COMBINATION

Recently introduced by *H.H. Scott, Inc.*, is the Model 3600 "Casseiver" that combines in a single component a cassette tape player/recorder and a 65-watt FM stereo receiver. The front end of the receiver employs FET's that virtually eliminate all cross modulation and drift, providing 2.5 μ V sensitivity with 80-dB cross modulation rejection. For wider range of tone control, the tone circuits also use FET's. Integrated circuits are used in the FM i.f. strip for improved capture ratio and selectivity, and in the preamplifiers for higher gain and low distortion. The cassette mechanism is driven by a synchronous a.c. motor that reduces wow and flutter. And the time-sharing multiplex circuit features 30-dB separation and a 2.5-dB capture ratio. The system is rounded out with a full complement of inputs and outputs.



Circle No. 84 on Reader Service Page 15 or 115

SINE-SQUARE WAVE GENERATOR

The Model IG-18 Sine-Square Wave Generator is the newest addition to the *Heath Company's* line of Heathkit test instruments. The sine-wave output is continuously variable over a range from 1 Hz to 100 kHz, using one multiplier, two selector switches, and a vernier control. Eight output voltage ranges between 0.003 and 10 volts r.m.s. with an external load of 10,000 ohms or more are featured in addition to six output ranges between 0.003 and 1 volt r.m.s. (-62 to +22 dB) with a built-in 600-ohm load. Sine-wave output is limited to less than 0.1% distortion from 10 to 20,000 Hz. The square-wave output section has a frequency range of 5 Hz to 100 kHz at switch-selected outputs of 0.1, 1, and 10 volts, peak-to-peak, with a rise time of less than 50 ns. Both sine and square waves are available simultaneously.



Circle No. 85 on Reader Service Page 15 or 115

ULTRASONIC INTRUSION ALARM

Ultrasonic intrusion alarm, Model A-1, available from *Euphonics Corporation* fills the need for a low-cost, no installation, and fool-

proof intruder detector for a wide range of requirements, both private and commercial. The alarm can be set up by anyone, simply by plugging it into a convenient a.c. receptacle and adjusting the position and range for adequate coverage of the area to be protected. Then, any moving object within the 10' to 30' range of the A-1 will "trip" the alarm. Six different modes of operation are available to allow the user to select the one that best suits his requirements. In addition, a complete line of indoor and outdoor bells and a remote key lock switch are available.



Circle No. 86 on Reader Service Page 15 or 115

HIGH-EFFICIENCY SPEAKER SYSTEM

Capable of handling 25 watts of power with smooth transient response over a frequency range of 35-20,000 Hz, the Model CS-5 speaker system by *Pioneer Electronics U.S.A. Corp.* makes possible sound reproduction at high volume with relatively low input power. The woofer employed in the CS-5 has a cone that is designed to avoid sound breakup with maximum power input, and greater compliance is obtained from the special cloth cone surround. The woofer's long-throw voice coil also assures excellent bass reproduction. The cone-type tweeter is specially designed to provide wide-angle dispersion. The CS-5 is an intermediate-sized speaker system that readily fits on a shelf or can be hung on a wall by its built-in hanger.



Circle No. 87 on Reader Service Page 15 or 115

HIGH-TRACK STEREO PHONO CARTRIDGES

Recently announced by *Shure Brothers, Inc.* is a series of three "High Trackability" stereo phono cartridges that are designed for the highest quality performance at economy prices. The series in descending price-quality order, includes the Models M91E, M92E, M93E. The M91E is ultra-lightweight for optimum performance in low-mass tone arms and is designed to track at 3/4 to 1 1/2 grams. The M92E also tracks at 3/4 to 1 1/2 grams, and the M93E tracks at 1 1/2 to 3 grams. All three cartridges are equipped with an elliptical diamond stylus—the ME91E and ME92E styli are 0.2 x 0.7 mils, while the M93E stylus measures 0.4 x 0.7 mils.



Circle No. 88 on Reader Service Page 15 or 115

THREE-POINT TOUCH-TO-TEST PROBE

For the first time, a practical method of making three-termination touch-to-test con-

(Continued on page 112)

measure

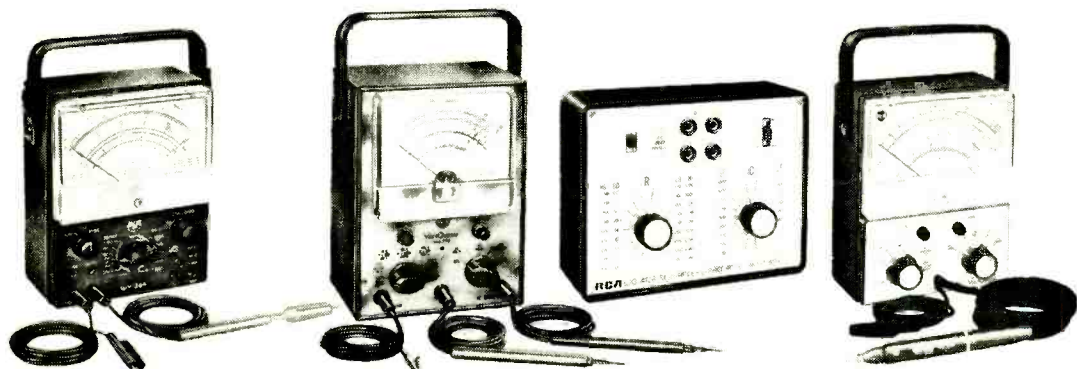

The RCA WV-38A Volt-Ohm Milliammeter is a rugged, accurate, and extremely versatile instrument. We think it's your best buy. Only \$52.00.* Also available in easy to assemble kit, WV-38A (K).

The RCA WV-77E Volt-Ohmyst[®] can be used for countless measurements in all types of electronic circuits. Reliability for budget price. Only \$52.00.* Also available in an easy to assemble kit, WV-77E (K).

The RCA WG-412A R-C circuit box can help you speed the selection of standard values for resistors and capacitors, either separately or in series or parallel R C combinations. Only \$30.00.* It's easy to use, rugged, and compact.

The RCA-500A all solid state, battery operated VoltOhmyst eliminates warm-up time, eliminates zero-shift that can occur in tube operated voltmeters. Completely portable. Only \$75.00.* Comes with shielded AC/DC switch probe and cables.



The RCA-WT-501A in-circuit out-of-circuit transistor tester is battery operated, completely portable. It tests both low and high power transistors, has NPN and PNP sockets for convenient transistor matching for complementary symmetry applications. Only \$66.75.*

The RCA WC-506A transistor-diode checker offers a fast, easy means of checking relative gain and leakage levels of out-of-circuit transistors. Compact and portable, it weighs 14 ounces, measures 3 3/4 by 6 1/4 by 2 inches. Only \$18.00.*

The RCA WV-98C Senior VoltOhmyst is the finest vacuum-tube voltmeter in the broad line of famous RCA VoltOhmysts. Accurate, dependable, extremely versatile, it is a deluxe precision instrument. Only \$88.50.* Also available in an easy to assemble kit, WV-98C (K).

For a complete catalog with descriptions and specifications for all RCA test instruments, write RCA Electronic Components, Commercial Engineering, Dept. W63B, Harrison, N.J. 07029.

*Optional Distributor resale price. Prices may be slightly higher in Alaska, Hawaii, and the West.

LOOK TO RCA FOR INSTRUMENTS TO TEST/MEASURE VIEW MONITOR GENERATE

CIRCLE NO. 32 ON READER SERVICE PAGE

RCA

The Active One...

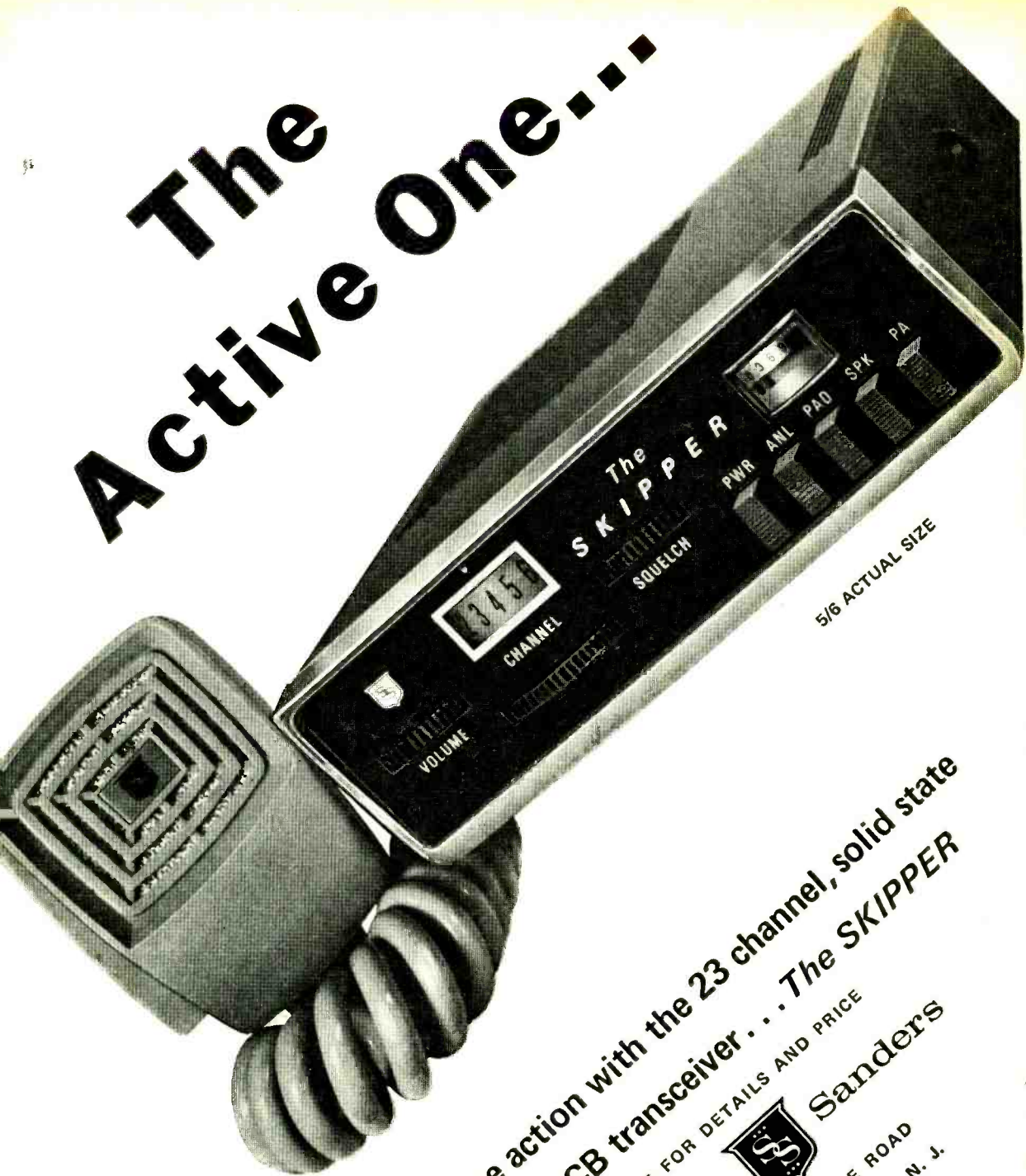

5/6 ACTUAL SIZE

get in on the action with the 23 channel, solid state
full 5 watt CB transceiver... The SKIPPER

WRITE FOR DETAILS AND PRICE

Squires Sanders

MARTINSVILLE ROAD
LIBERTY CORNER, N. J.
07938

CIRCLE NO. 25 ON READER SERVICE PAGE

POPULAR ELECTRONICS

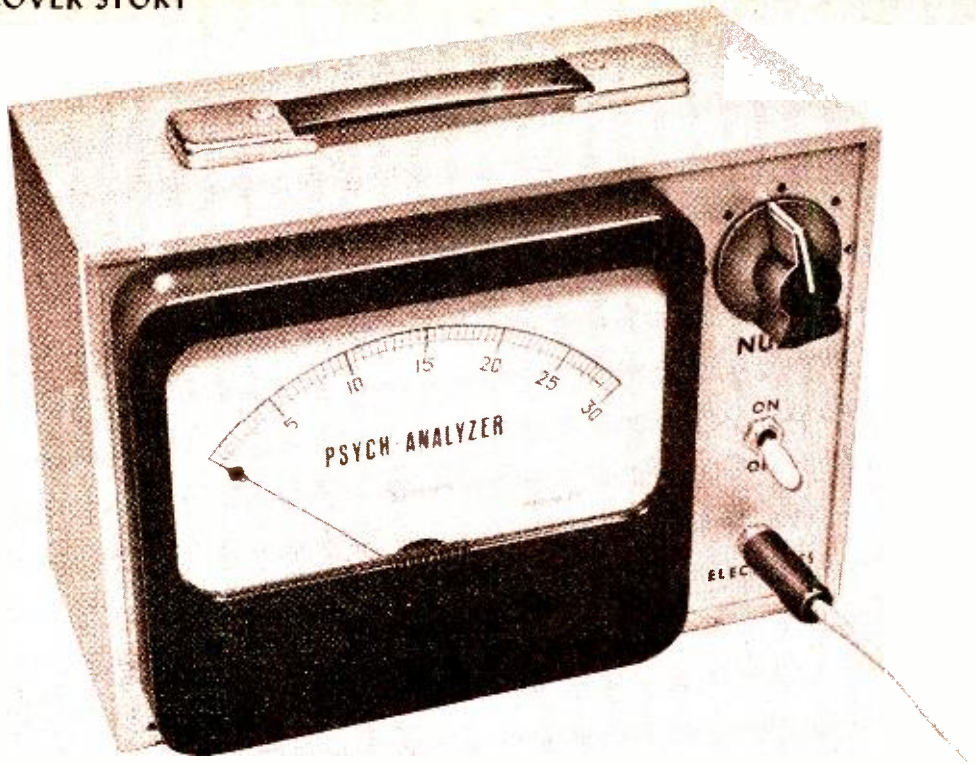

Build a **PSYCH-ANALYZER**

CHECK EMOTIONS AND SENSIBILITIES

BY GALVANIC SKIN RESISTANCE

BY ROBERT E. DEVINE

AFTER SEEING the latest adventures of your favorite TV detective, have you ever wished you had a lie detector of your own? You could check your friends' psyches—determine their likes, dislikes, phobias, and idiosyncrasies! You can do it with the "Psych-Analyzer"—a device that's easy to construct and will provide you and your friends with many entertaining (and maybe revealing) hours.

The term "lie detector" is actually a misnomer. The Psych-Analyzer can only detect and display variations in the electrical resistance of the subject's skin. Such variations are directly related to physiological fluctuations caused by emotional stress and are beyond the control of the subject; hence, psychologists call

them "autonomous." It is the examiner's job to observe and interpret the responses. Detecting a lie requires skill in the interpretation.

The professional lie detector (best known in the Keeler polygraph) simultaneously measures and records several parameters of physiological response that are known to fluctuate under emotional stress. These include blood pressure, depth and rate of breathing, pulse rate, and skin resistance. Of these, the most easily observed and the most dramatic in its dependability is the skin resistance in the palm of the hand. It is this meandering value of resistance that the Psych-Analyzer detects and displays—the significance is complex. Only a professional psychologist could determine

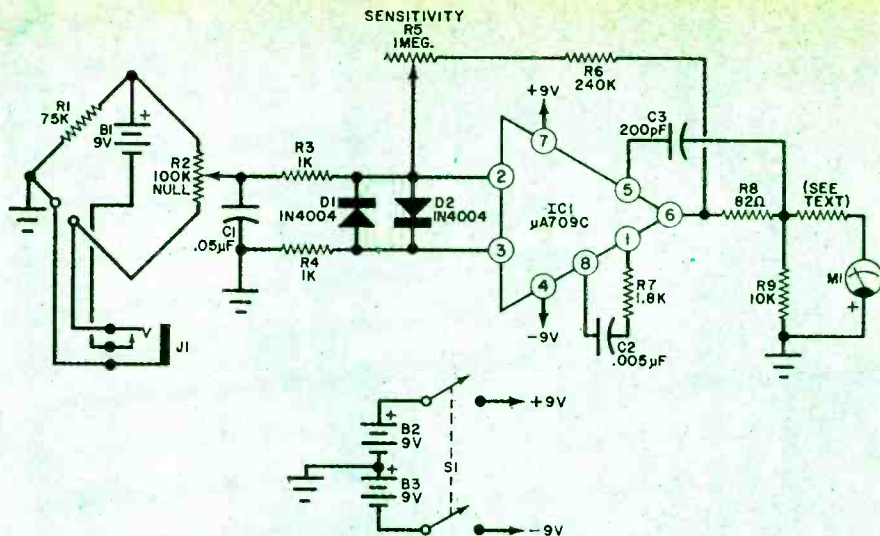

Fig. 1. The low-level d.c. error signal generated in the bridge is amplified by the high-gain IC amplifier and displayed on the meter.

PARTS LIST

B1-B3—9-volt battery
 C1—0.05- μ F capacitor
 C2—0.005- μ F capacitor
 C3—200-pF capacitor
 D1,D2—1N4004 (or any silicon diode)
 IC1—Integrated circuit (Fairchild μ A709C). See text.
 J1—Modified closed-circuit jack. See text.
 M1—0-1-mA meter with series resistor (2500 to 3000 ohms) to measure 3 volts.
 R1—75,000-ohm, $\frac{1}{2}$ -watt resistor
 R2—100,000-ohm potentiometer

R3,R4—1000-ohm, $\frac{1}{2}$ -watt resistor
 R5—1-megohm potentiometer (miniature preferred)
 R6—240,000-ohm, $\frac{1}{2}$ -watt resistor
 R7—1800-ohm, $\frac{1}{2}$ -watt resistor
 R8—82-ohm, $\frac{1}{2}$ -watt resistor
 R9—10,000-ohm, $\frac{1}{2}$ -watt resistor
 S1—D.p.s.t. switch
 Misc.—Eight-pin TO-5 socket (for IC1), two 1"-square pieces of heavy copper or two large foreign coins, pair of bicycle clips, length of insulated wire, battery clips (3), case as desired, mounting hardware, etc.

the true meaning—in the meantime, have some fun!

Construction. The complete schematic of the Psych-Analyzer is shown in Fig. 1. Since it is basically a d.c. amplifier and problems due to lead length or placement are not likely to occur, the project lends itself to breadboard-type construction. Interfering high frequencies, caused by r.f. pickup, are bypassed to ground at the output of the bridge. Before final packaging, a conventional VOM, VTVM, or TVM switched to its 2.5- or 3-volt range can be used to test the circuit instead of the regular output meter.

To insure a neat finished product, however, and to avoid inadvertent wiring errors, it is preferable to use an etched circuit board (shown actual size in Fig. 2). Once the board is complete, all com-

ponents except IC1 can be installed as shown in Fig. 3. The IC is mounted in an 8-pin, TO-5 socket that fits into the hole drilled in the circuit board. Notch out a small indentation in the board for the socket locating projection, noting that this projection is at pin 8 of the IC. The tab on the IC is also located at pin 8. Push-fit the IC socket into the hole and solder the leads to the adjacent solder pads of the foil. When soldering the components, take care not to use excessive heat as this can damage diodes D1 and D2.

Before installing IC1 in its socket, its leads should be trimmed down to approximately $\frac{1}{4}$ " in length. Do not use a conventional side cutter for this purpose since the cutting force of typical side cutters can damage the IC. Common wire strippers, hinged like a pair of scissors

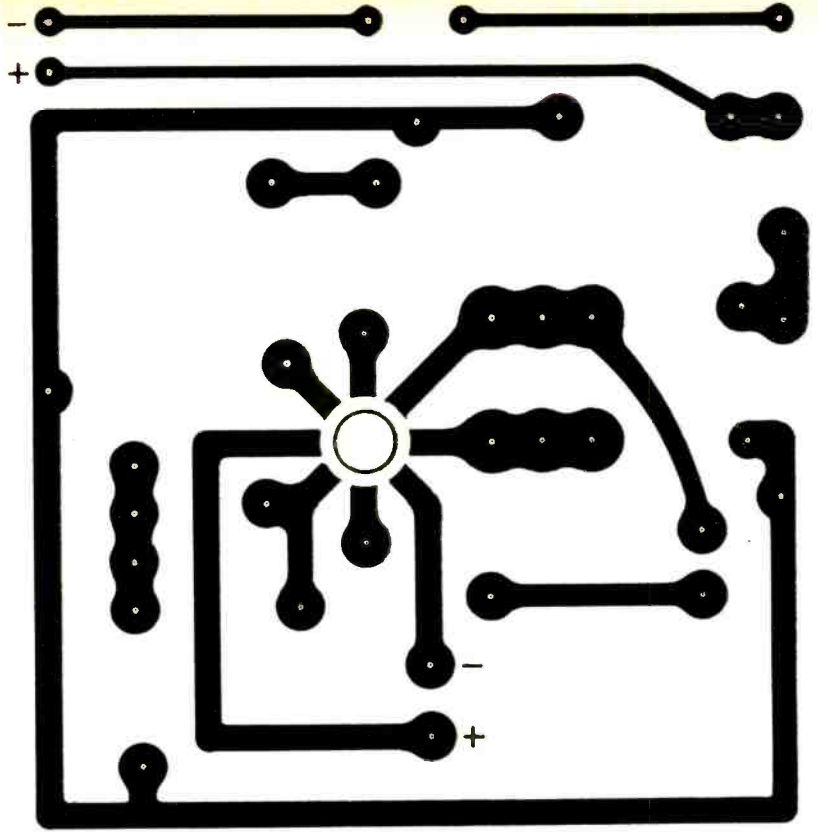

Fig. 2. Actual-size printed board foil layout. You can create this circuit on perf board if desired.

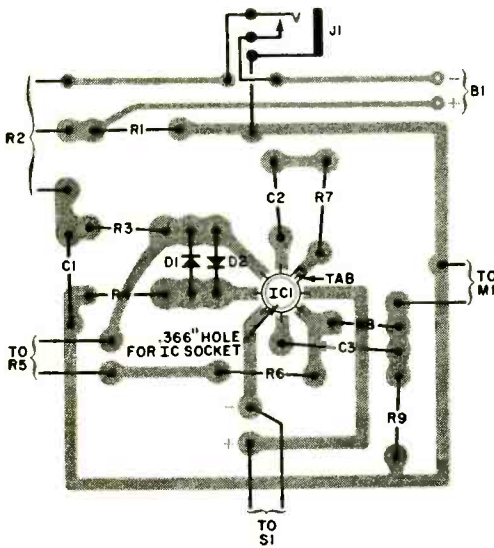

Fig. 3. Install the components as shown here. Note that J1 is arranged to close when plug is inserted.

and having a relatively gentle cutting action, should be used.

A jack, for *J1*, that has one contact that closes when the mating plug is inserted may be difficult to find. You can use a jack that has a normally closed circuit and modify it so that it fits the circuit as shown in Fig. 1. Just be sure before you buy the jack that it is a type that can be modified (by bending the top contact so that it is on the bottom).

Any type of d.c. voltmeter capable of indicating to 2.5 or 3 volts can be used for *M1*. If you use a 1-mA ammeter, insert a 2500-3000-ohm resistor in series with the meter to convert it to a suitable voltmeter.

At the time of the writing of this article, the price of the μ A709C varied from \$4.10 (Fairchild Semiconductor) to \$9.75 (ITT). The suffix "C" signifies a low-cost commercial unit and should be used when ordering. Without a "C" the 709 is a military IC and may cost \$15 or more. This IC is also made as a dual,

in-line, or flatpack unit, so be sure you get it in the TO-5 package.

Any type of case can be used to house the analyzer. Mount meter *M1*, NULL control *R2*, power switch *S1*, and jack *J1* on the front panel. Although the author mounted SENSITIVITY control *R5* on the back panel, it also can be mounted on the front if desired. Control *R5* should be marked LO when its rotor is away from *R6*, HI with its rotor adjacent to *R6*, and MED in the middle.

The batteries can be mounted on one wall of the chassis, using strips of aluminum to secure them in place. Mount the PC board using standoffs.

Electrodes. The electrodes are made from pieces of 1"-square, $\frac{1}{8}$ "-thick copper slightly rounded with a ball-peen hammer so that they are convex to fit the palm of the hand. You can also use two large foreign coins (such as Mexican 20-centavo pieces). Although copper is preferred for the electrodes, the large coins will work. (Note that the electrodes must be kept clean during use. Polish them occasionally with a piece of fine sandpaper, especially if the copper or other metal gets to be dark or oxidized.

Solder a small U-shaped bracket to the concave side of the electrode to hold one end of the clamp. The clamps hold the electrodes snugly in the palms of the hand and are made from a pair of bicycle pants clips, available at bike supply shops. The spring tempering at one end

of each clip must be removed through heat treatment. Using any form of heat (gas stove, blowtorch, etc.) heat one end (for an inch or less) of each clip until it is cherry red, then allow it to cool slowly. After it has cooled, insert this end under the U-shaped bracket allowing about $\frac{1}{4}$ " to protrude. Make a sharp bend on this small tip so that the clip cannot come out of the bracket. When this is done, the electrode should be able to pivot freely on the end of the clip and position itself automatically in the palm of the hand. The remainder of each clip can be bent so that the electrodes fit snugly in the hands. For comfort and to insulate the back of the hand, cover the clips with cambric tubing.

To connect the electrodes to the detector, use a 2-to-4-ft. piece of two-wire cable and separate the two leads at one end for about 1 foot. Solder one wire to each electrode and put a male plug on the other end to mate with *J1*. No wiring polarity need be observed. At the electrode end, secure the wire to the cambric-covered clip to prevent its being accidentally torn loose from the electrode.

Testing. Even if power switch *S1* is in the ON position, the amplifier section does not have an output if the bridge circuit is not energized. This is done by inserting the electrode plug into *J1*. Never leave the electrodes plugged in even if *S1* is turned off, since the bridge circuit power is automatically applied whenever the plug is inserted. To shut off the de-

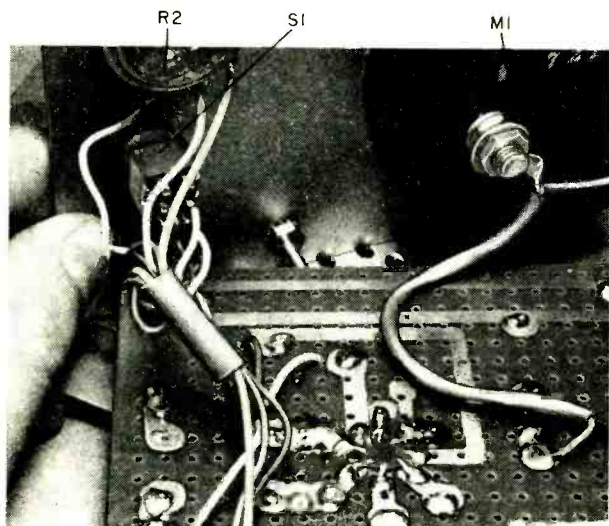

Lengths of insulated tubing can be used to create neat-looking cabling between the PC board and front-panel components. Use wires of different colors for each lead to facilitate signal tracing.

tector completely, place *S1* in the OFF position and remove the electrode plug.

To check system performance, temporarily clip a fixed resistor of 50,000 or 100,000 ohms between the electrodes. Insert the electrode plug in *J1*. Place the SENSITIVITY control on LO and the NULL control near its mid-scale position. When you turn *S1* on, rotating *R2* should cause the meter needle to swing smoothly from zero to full scale. A 75,000-ohm resistor will cause the meter to indicate zero with the NULL control near its center of travel.

If the system works all right so far, pinch both sides of the temporary resistor with the thumb and forefinger of each hand. This reduces the effective resistance and should make the meter indicate up scale. If the indication is down scale, check the polarity of the meter connections or the battery connections to the bridge circuit.

Rotating *R5* to MED or HI increases the sensitivity proportionately. In actual practice, it is seldom necessary to use high sensitivity unless the subject has extremely high skin resistance or abnormally low emotional activity.

Unplug the electrodes and turn *S1* off. Always do this if the detector is to be left off for any period of time.

Using the Psych-Analyzer. To protect the meter from unnecessary overload, before using the analyzer, set the NULL control (*R2*) near its center of rotation, set the SENSITIVITY control at MED, and place the electrodes on the subject's palms.

With the subject seated comfortably, an electrode on each palm, insert the plug into jack *J1* and turn on the power switch. Bring the meter needle to a point just above zero by use of the NULL control. Hereafter, aside from "noise" due to a change in the pressure of the electrodes against the subject's skin or any slight motion of the subject's muscles, all meter movements represent bona fide changes in skin resistance. From time to time you will have to re-zero the meter as the absolute level of skin resistance changes slightly. Generally speaking, the absolute level represents the subject's state of arousal.

There are innumerable stimuli that will cause a subject to react and start an

internal chain reaction beyond his control. The end result is an upward swing of the meter signifying a decrease in skin resistance. The stimulus can be conveyed through touch or sound or any of the other senses, but the most dramatic reaction—particularly for aural stimuli—will result from a stimulus that has strong emotional attachments (the names of loved ones, for instance) or that is distasteful (taboo words).

The *expectation* of stimulus can also cause an indication on the analyzer. For instance, clang two pieces of metal together, and the subject will almost invariably exhibit a large response. After things have returned to normal (30 to 60 seconds) pretend to make the same noise again but stop just short of doing so. The response will be almost as great as before.

A point of interest is the latency or delay between the occurrence of a stimulus and the meter response. One authority in the field claims that the latency is 1.7 seconds for an aural stimulus and 2.1 seconds for a visual stimulus. If you have a stopwatch, you can check this.

Another authority has a theory about

HOW IT WORKS—ELECTRONICALLY

The circuit of the Psych-Analyzer is divided into three sections: a measurement bridge, a d.c. amplifier, and an output indicator.

The bridge is made up of *R1*, *R2*, and the subject's skin resistance. Resistor *R1* corresponds to the known resistor of a Wheatstone bridge, while the skin resistance is the unknown. The output voltage of the bridge is nulled by rotation of *R2* to balance the bridge. If, after the bridge is balanced, the resistance of the subject's skin varies, the bridge is unbalanced, and a d.c. voltage appears on the arm of *R2*. This low-level d.c. signal is amplified by the operational amplifier *IC1*. Capacitor *C1* is used to bypass unwanted a.c. signals that may be induced into the circuit from stray power-line pickup or r.f. from nearby radio stations.

To protect the IC from excessive input, series resistors *R3* and *R4* limit the current flow and diodes *D1* and *D2* reduce transients by limiting the input level to 0.6 volts. (Incidentally, there are 15 transistors in the *IC1*, TO-5-size case.)

The operational amplifier is used to perform certain mathematical operations in computer applications. The amplifier gain can be controlled by varying the amount of feedback from output to input (pin 6 to pin 2). This is done by varying the setting of *R5*.

The resistor-capacitor circuit (*C2-R7*) between pins 1 and 8 and capacitor *C3* between the output and pin 5 are used for frequency compensation. Resistor *R8* protects the IC against overload damage if the output is accidentally shorted.

The voltmeter has a 1000-ohm-per-volt movement with a 0-to-3-volt scale.

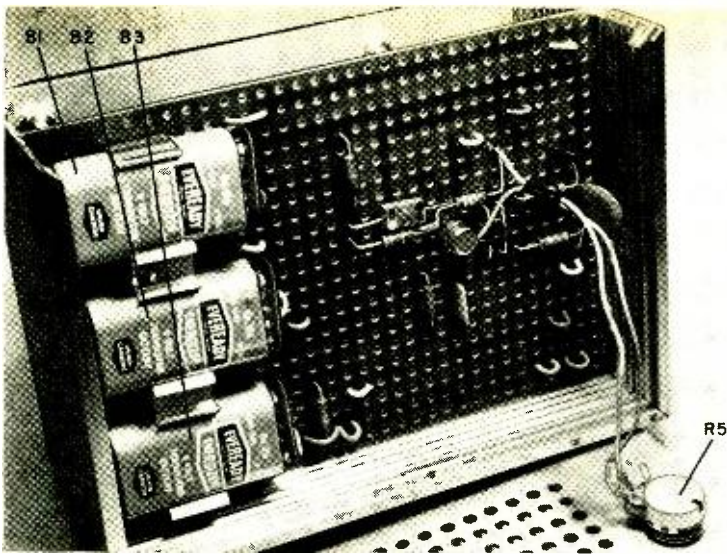

The three 9-volt batteries are supported by clips at one end of the oversize perf board. Although the author mounted R5 (sensitivity control) on rear, it could just as well be mounted on the front panel.

HOW IT WORKS—PHYSIOLOGICALLY

In 1888, a scientist named Féré found that if he attached an electrode to each forearm of a human subject and connected these electrodes in series with a weak source of d.c. and a galvanometer, the galvanometer needle would have rapid, upscale deflections when the subject was emotionally stimulated. The phenomenon is still sometimes referred to as the Féré effect, but is now more commonly called GSR, galvanic skin response (or resistance). Most electronics experimenters have noted this effect when they hold the leads of an ohmmeter in their hands.

Tests have shown that the GSR effect is actually strongest in the palms of the hands and soles of the feet, the back of the hand and wrist being less responsive. In 1929, another scientist (Richter) noted that the GSR effect disappears when the electrodes pierce the skin.

It would be natural to assume that the GSR effect is a function of the amount of perspiration on the skin, a common indication of emotional stress. Although this might play a small part, it is not the whole answer. Experiments have shown that, if two small pieces of toweling are soaked in warm salt water (to simulate heavy perspiration) and placed between the skin and the electrode, the GSR effect does not disappear.

Since there is still no absolute explanation of the GSR effect, feel free to form your own opinion.

of the same nature—a matter of adaptation on his part. A period of rest will restore the subject to his previous state of reaction.

As mentioned previously, the absolute level of skin resistance at any particular time represents a measure of general activation or arousal. This is sometimes referred to as Base Line Conductance. (Conductance is the inverse of resistance.) The base is high (high conductance and low resistance) when the subject is wide awake and alert and low when he is drowsy or asleep.

An easy way to determine the validity of the Psych-Analyzer as a lie detector
(Continued on page 116)

Each electrode should fit snugly in the palm of the hand. The modified bicycle-clip clamp should be insulated with tubing to provide electrical isolation.

latency when taboo words are used. By mixing pleasing words with unpleasant ones he discovered that the latency was much greater with the unpleasant ones. He attributes this to "fear of punishment." Although his subjects were college students, he felt that they unconsciously put up a defense (inbred from childhood) against these forbidden words and therefore took longer to recognize them. You will also find that a subject's response declines with repeated stimuli

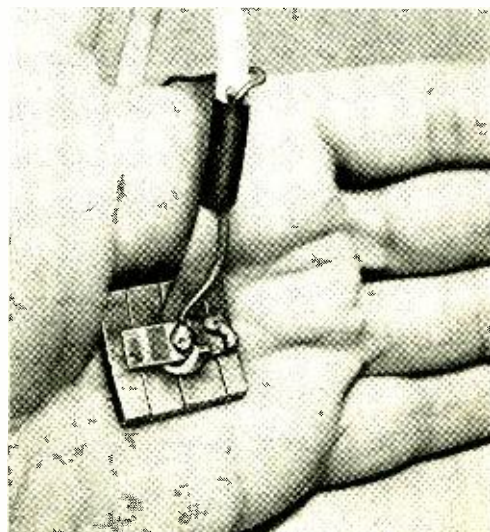

FAX

Bright Future for Ageless Wonder

BY DANIEL M. COSTIGAN

A BURGLARY suspect is booked and fingerprinted in an outlying precinct of a large city. Within minutes a copy of his prints emerges from a special printer at an identification center miles away.

The Seattle branch of a large manufacturer receives an order, and in the time it would have taken to prepare it for mailing, an exact copy of the customer's letter appears at the firm's Eastern headquarters. The order is processed the same day.

These are but two of a wide variety of daily jobs performed by facsimile, an electrical communication process demonstrated more than a century ago—80 years before television. In the years since its introduction, the facsimile process (or "fax" as it is called in the trade) has had its ups and downs; but in many respects, the future of this enduring offshoot of telegraphy appears brighter today than ever before.

Behind the current rosy glow are a couple of new factors. One is the introduction of techniques that promise to improve the economics of transmitting whole pictures and documents by radio and wire. The other is the burgeoning information explosion, which, coupled with the impact of the computer revolution, has created a critical need for speedier means of disseminating documents of all sorts.

Fax has had to take a back seat to modern data communication techniques that are capable of transmitting characters at the rate of 300 or more per second over ordinary telephone lines. By

contrast, conventional "message fax," operating at the standard rate of 1 $\frac{1}{8}$ inch per minute, takes about 6 minutes to send one letter-size document.

Still, fax is appreciably faster than mail and it has the advantage over digital data transmission of not having errors created during conversion of printed matter to data form. What's more, while data techniques are ideal for information in the form of numbers, letters and conventional symbols, fax is unrivaled when it comes to transmitting pictorial matter such as maps, graphs, and photos.

At the rate engineering drawings and flow charts are being generated in support of modern technology, the makers of fax equipment have good reason to be optimistic about the future—in a business whose dollar value has grown 800 percent in the past seven years!

How Fax Works. Fax is an electromechanical system whose operation is based on a relatively simple principle. In the conventional scanner, an incandescent lamp and an optical system are used to bounce a needle-sharp beam of light from the document (text or picture) to a photocell. There the light is converted to an electrical analog of the dark and light elements within each scanned segment. Traditionally, the document is wrapped around a cylinder about the size of a rolling pin and is scanned "lathe" fashion with the beam inching slowly along the length of the cylinder as it spins.

The amplified output of the scanner is

sent out over the transmission circuit—usually an ordinary “voice grade” wireline—to a receiver (recorder) which reproduces the document. Reproduction is achieved either by the reaction of photosensitive paper to signal controlled light or by the “direct” discoloring effect of electrical impulses on specially treated paper. Photosensitive recording is used primarily in the reproduction of news photos. Direct recording is more popular, however, since it requires no processing.

The paper used for direct fax recording is usually one of two basic types. The more popular is an electrolytic paper containing chemicals such as azo dyes that darken the paper permanently in proportion to the signal strength at the contact point between the recording stylus and paper. The other basic paper is electroconductive and has a white coating that turns black due to arcing in response to signal variations where the stylus contacts it.

Another direct recording method, less widely used, employs an electromagnetic stylus that literally “hammers out” the recording through a pressure-sensitive ink medium.

Synchronization between the fax scanner and recorder is achieved initially by phasing pulses from the transmitter. These occur at scan-line intervals during the first few seconds of transmission—just long enough to align the start-of-scan times at the two ends of the system. Thereafter, if the scanner and recorder are served by the same 60-hertz commercial power, they are kept in step by synchronous motors.

If, on the other hand, two distant ends of a system have separate commercial power sources, scanner and recorder drive motors get their power from generators which are synchronized by phasing pulses from the transmitter at the start of each scan line.

New Trends. Consistent with its growing stature, fax has become more sophisticated in recent years. There has been a notable departure from the method of wrapping documents and recording papers around cylinders. The preference today is for slot feeding of documents at the scanner and continuous feeding of rolled recording paper at the receiver.

But more significant than these me-

chanical innovations is the trend toward electronic scanning and printing. Fax lends itself readily to the use of cathode ray tubes for both functions; the result is quieter operation and a considerable reduction in precision components.

Xerox's LDX (Long Distance Xerography) system uses CRT's for both scanning and recording. Scanning is by a



In this fax system, documents retrieved from a microfilm storage are scanned and recorded at high speed for later transmission at low speed on telephone lines. (Photo courtesy of Alden E. & I. R. Co.)

more or less conventional application of the flying spot principle, the spot being bounced from the document to a photomultiplier tube through a light pipe. The recording scheme, however, is unique in that the CRT image is projected onto a rotating selenium drum and then transferred to plain paper by xerography.

Another interesting CRT recording technique is that used in A. B. Dick's Videograph fax system. In a specially designed CRT, the electrostatic charge of the scan spot is brought to the outer surface of the tube through metal pins imbedded in the glass faceplate. As the modulated electron beam sweeps over the inside ends of the pins, a latent electrostatic image is formed on special coated paper contacting the outer face of the tube. The image is “developed” by electrostatic ink, which clings to the charged spot on the paper.

In other CRT recording systems, the recording medium—an electrosensitive film—is actually placed within the evacu-

ated interior of the CRT and bombarded directly by the electron beam. The result is a scan spot many times smaller than that produced by more conventional means. This provides reproductions in the form of space-saving microcopies.

As yet, there are few fax systems on the market in which scanning or recording is wholly electronic. But the trend is nonetheless evident. Feasibility has been demonstrated, and it is only a matter of time before fax becomes as demechanized as TV, which actually began as an electromechanical device.

From Pendulums to Electronic News.

With fax becoming more and more electronic and with new developments coming along to speed up transmission, the basic distinctions between it and TV are that fax deals only in static (non-moving) images and it always produces a record of the received image.

Although fax and TV appear to have much in common today, historically they are separate and distinct inventions, the only real bond being their common use of scanning techniques.

Fax was first demonstrated by a Scot, Alexander Bain, in 1842. The principle of TV originated in Germany 42 years later and was not successfully demonstrated until 1926.

Bain's objective was to perfect an electrochemical recording telegraph. He did so by attaching a metal stylus to the end of a pendulum to "scan" a message specially prepared in metallic lettering. As the pendulum swung, the board containing the message was automatically advanced a fraction of an inch with each

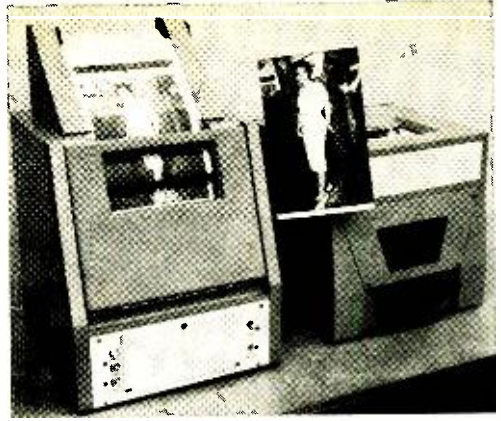

In units about the size of a breadbox, conventional fax system records photo by insertion at right and reproduces at left. (Photo International Scanatron)

sweep. The electric pulses generated by the intermittent contact between stylus and lettering were transmitted over wires to a receiving device containing a similar stylus-equipped pendulum and advancing mechanism.

In Bain's receiving apparatus, the pulses produced a pattern of dark spots on specially treated paper (the method still used today). With proper synchronism, the pattern formed an almost perfect facsimile of the metallic "document" at the other end.

Bain's invention caught on at once, but was soon abandoned in favor of the more efficient electromechanical printing telegraphs that had been developed.

Thereafter, fax was virtually forgotten until the 1920's when it was adopted by the news agencies for transmission of photographs. Pendulums and flat-bed message boards had been replaced by

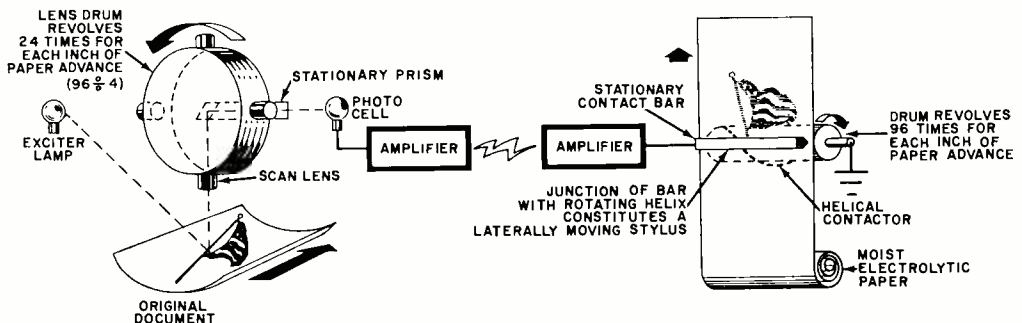

Electromechanical scheme of a typical 96 line/inch "message fax" system which records document in slot-fed scanner at left and reproduces it on recorder at right. Roll feeding of recorder is now common method.

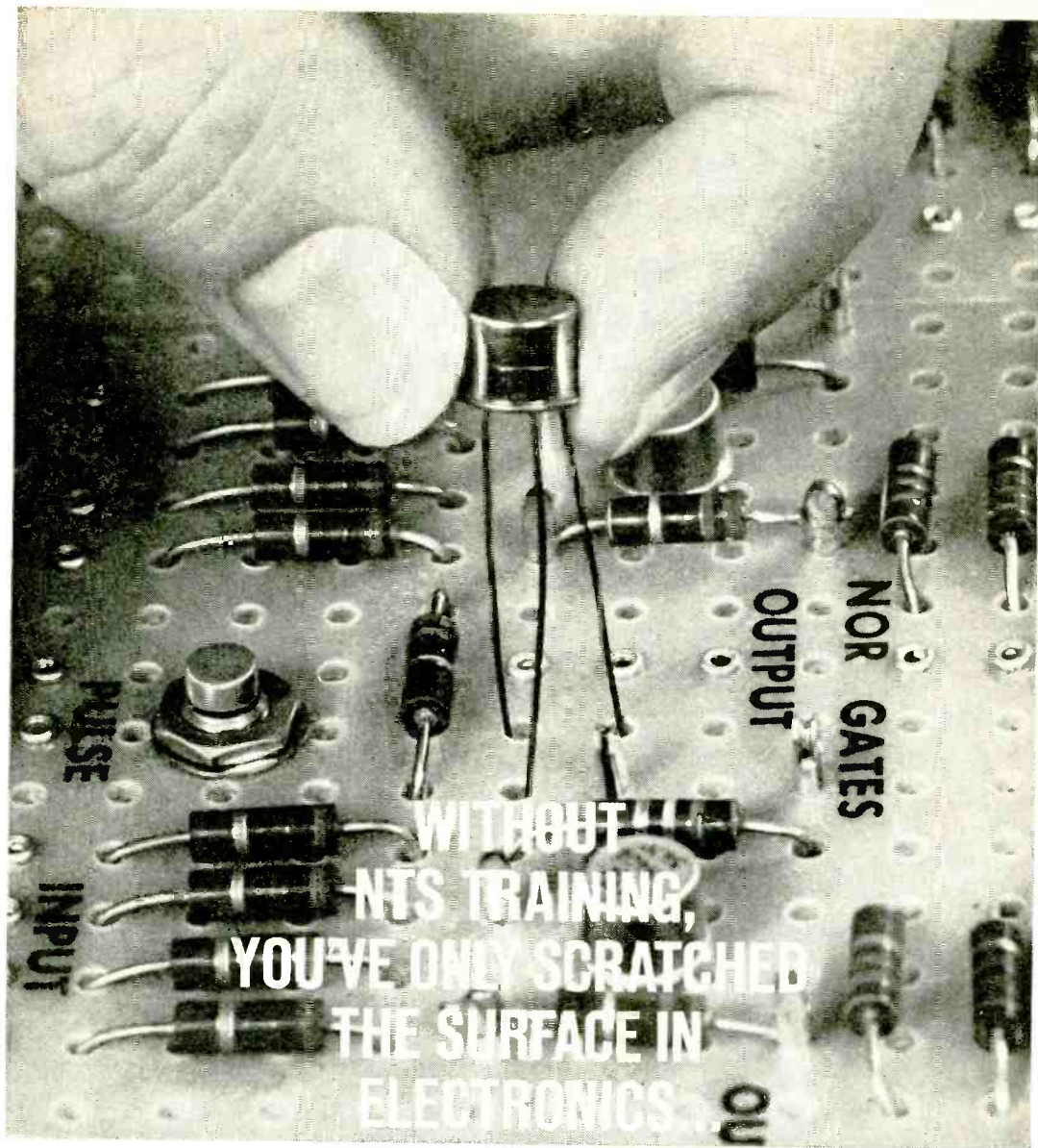

Only NTS penetrates below the surface. Digs deeper. Example? Take the above close-up of the first transistorized digital computer trainer ever offered by a home study school.

It's called The Compu-Trainer®—an NTS exclusive. Fascinating to assemble, it introduces you to the exciting world of computer electronics. Its design includes advanced solid-state NOR circuitry,

flip-flops, astable multivibrators and reset circuits. Plus two zener and transistorized voltage-regulated power supplies. The NTS Compu-Trainer® is capable of performing 50,000 operations per second.

Sound fantastic? *It is!* And at that, it's only one of many *ultra-advanced* kits that National Technical Schools offers to give you incomparable, in-depth career training.

PROVE IT YOURSELF. SEND FOR OUR NEW CATALOG. SEE THE LATEST, MOST ADVANCED KITS AND COURSES EVER OFFERED BY A HOME STUDY SCHOOL.

NTS...THE FIRST HOME STUDY SCHOOL TO OFFER LIVE EXPERIMENTS WITH INTEGRATED CIRCUIT KITS

You build a computer sub-system using the new, revolutionary integrated circuits. Each one, smaller than a dime, contains the equivalent of 15 resistors and 27 transistors.

And your kits come to you at no extra cost. These kits are the foundation of the exclusive *Project-Method* home study system... developed in our giant resident school and proven effective for thousands of men like yourself.

With Project-Method, all your kits are carefully integrated with lesson material. Our servicing and communication kits are real equipment—not school-designed versions for training only. As you work on each of the projects, you soon realize that even the most complicated circuits and components are easy to understand. You learn *how* they work. You learn *why* they work.

NTS Project-Method is a practical-experience approach to learning. The approach that works *best!* An all-theory training program can be hard to understand — difficult to remember. More than ever before you need the practical experience that comes from working with real circuits and components to make your training stick.

NTS SENDS YOU KITS TO BUILD THESE IMPORTANT ELECTRONICS UNITS!

- ◆ 25" COLOR TV
- ◆ 21" BLACK & WHITE TV
- ◆ SOLID-STATE RADIO
- ◆ AM-SW TWIN-SPEAKER RADIO
- ◆ TUBE-TESTER
- ◆ TRANSCEIVER
- ◆ COMPU-TRAINER®
- ◆ VTVM
- ◆ SIGNAL GENERATOR
- ◆ 5" OSCILLOSCOPE

See them all illustrated in
the new NTS Color Catalog.

CLASSROOM TRAINING AT LOS ANGELES: You can take classroom training at Los Angeles in sunny California. NTS occupies a city block with over a million dollars in facilities devoted exclusively to technical training. Check box in coupon.

NATIONAL TECHNICAL SCHOOLS

WORLD-WIDE TRAINING SINCE 1905
4000 So. Figueroa Street, Los Angeles, Calif. 90037

APPROVED FOR VETERANS

Accredited Member: National Home Study Council
Accredited Member: National Association of
Trade and Technical Schools



COMMUNICATIONS

This transceiver is included in Communications courses. You build it. With it, you easily prepare for the F.C.C. license exam. You become a fully-trained man in communications, where career opportunities are unlimited.

25" COLOR TV ▼

Included in Color TV Servicing Courses. With it you advance yourself into this profitable field of servicing work. Color is the future of television, you can be in on it with NTS training.



YOUR OPPORTUNITY IS NOW

New ideas, new inventions, are opening whole new fields of opportunity. The electronic industry is still the fastest growing field in the U.S. There's a bigger, better place in it for the man who trains today. So, whatever your goals are—advanced color TV servicing, broadcasting, F.C.C. license, computers, or industrial controls, NTS has a highly professional course to meet your needs.

GET THE FACTS! SEE ALL NEW COURSES AND KITS OFFERED IN THE NEW NTS COLOR CATALOG. SEND THE CARD OR COUPON TODAY!

There's no obligation. You enroll by mail only. No salesman will call.

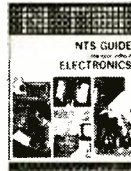

DEPT. 205-29

NATIONAL TECHNICAL SCHOOLS

4000 S. Figueroa St., Los Angeles, Calif. 90037

Please rush Free Color Catalog and Sample Lesson, plus information on field checked below. No obligation.

- | | |
|---|--|
| <input type="checkbox"/> MASTER COURSE IN COLOR TV SERVICING | <input type="checkbox"/> FCC LICENSE COURSE |
| <input type="checkbox"/> COLOR TV SERVICING | <input type="checkbox"/> MASTER COURSE IN ELECTRONICS TECHNOLOGY |
| <input type="checkbox"/> MASTER COURSE IN TV & RADIO SERVICING | <input type="checkbox"/> INDUSTRIAL & AUTOMATION ELECTRONICS |
| <input type="checkbox"/> PRACTICAL TV & RADIO SERVICING | <input type="checkbox"/> COMPUTER ELECTRONICS |
| <input type="checkbox"/> MASTER COURSE IN ELECTRONIC COMMUNICATIONS | <input type="checkbox"/> BASIC ELECTRONICS |

NAME _____ AGE _____

ADDRESS _____

CITY _____ STATE _____ ZIP _____

Check if interested in Veteran Training under new G. I. Bill.

Check if interested ONLY in Classroom Training at Los Angeles.

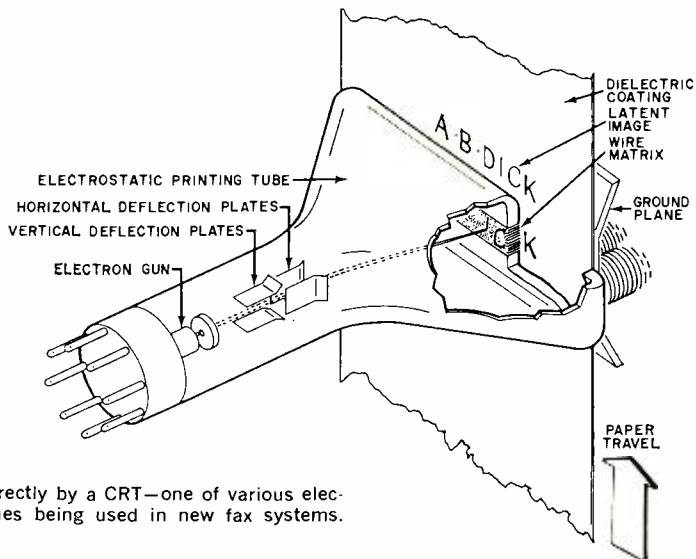

Fax printing directly by a CRT—one of various electronic techniques being used in new fax systems.

light beams and cylinders, and, by 1926, photographs were being transmitted by radio as well as by wire.

In the next decade there was new interest in fax for use by businesses with scattered branch offices, and new, low-cost apparatus was developed for the purpose. Meanwhile, the idea of transmitting daily newspapers directly into the home had begun to take shape. Experiments were conducted during the 1930's but it wasn't until after World War II that the scheme finally materialized—just in time to be smothered by commercial TV.

Two newspapers with FM radio outlets, the Miami *Herald* and the Philadelphia *Inquirer*, pioneered the fax news venture with broadcasts of daily editions in the spring of 1947. They were soon joined by two other major daily papers and in June, 1948, the FCC officially authorized commercial fax broadcasting on a limited scale.

The FCC limited fax broadcasting to one hour daily over the commercial FM band and specified certain technical standards. Speed of transmission was set at 360 scan lines per minute, with 105 lines per inch (comparing favorably with 180 lines per minute and 96 lines per inch for conventional message fax) on an 8.2-inch wide page. This gave a transmission time of about 15 minutes for one standard newspaper page. Meanwhile two major manufacturers, General Electric and

Stewart-Warner, had introduced special transmitting and receiving apparatus to accommodate the new service.

The experiment scored well on everything but public acceptance and, consequently, by the end of the forties, the whole fax news venture was chalked up as just another of fax's habitual false starts.

The World and Beyond. While the dream of a fax receiver in every home may still persist in the minds of its more ardent exponents, fax is making a big play these days in a number of less ambitious, behind-the-scenes applications. The two cited at the beginning of this article are typical, but they scarcely begin to show the total scope.

Railroads and airlines have adopted fax to expedite freight service by dispatching waybills (or airbills) from the point of origin to a central control point. The dispatching was once done by mail. From the National Meteorological Center in Suitland, Maryland, master weather charts are distributed regularly by fax to hundreds of weather stations across the country. At an aircraft plant on the West Coast, a project engineer can exchange essential data by fax with a subcontractor nearly 3000 miles away. And at a university library in upstate New York, a student can receive in minutes a fax copy of an otherwise unobtainable document from New York City's Public Library.

The fax revolution is by no means confined to the United States. Besides its wide use as a weather reporting and message medium in several countries, major newspaper chains in Japan and Sweden use fax to transmit full-page printing masters from a central composing room to branch plants. The masters are transmitted over broad-band circuits at the rate of about 5 minutes per page, and the fax reproductions are used to make the photoengravings needed for printing at the satellite locations. (In the U.S., the *Wall Street Journal* uses the system between its two West Coast plants.)

Meanwhile, the Japanese appear to be taking the fax-in-every-home idea quite seriously. Right now, there's a fight going on between the country's big newspapers and the government-operated broadcast network over the control of fax news

broadcasts. Special cathode ray tubes have been developed for the electronic home receivers that will be built and marketed once the control question has been settled.

In both Holland and the U.S., systems have been developed (by Philips and RCA, respectively) that make use of commercial TV's vertical blanking period for broad-band fax transmission. The blanking pulses occur at the rate of 50 to 60 a second (50 in Europe, 60 in the U.S.) and, within the space of each pulse, 20 or more fax scan lines can be transmitted. A document can be sent in as little as 2½ seconds. Both the U.S. and Dutch systems have been tested and are ready for marketing.

Even in space technology, fax has carved a comfortable niche for itself. Snapshots of the earth's cloud cover tak-

(Continued on page 102)

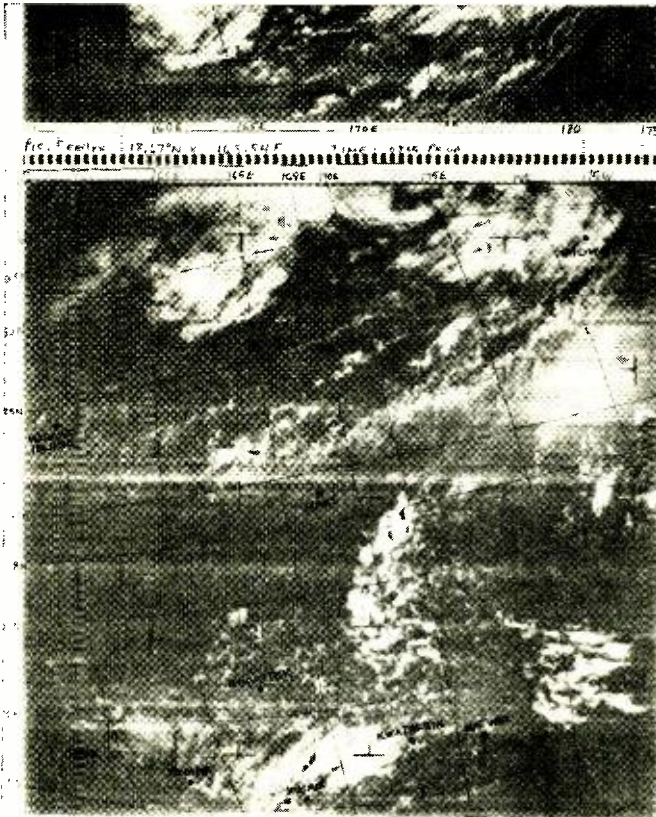

Cloud pattern over the North Pacific, as seen by TV camera of a weather satellite and reproduced by fax from slow-scan TV signals received at Kwajalein ground station. (Photo courtesy of the Alden E. & I.R. Company)

Hobnobbing
with
Harbaugh

I fixed your changer.



Tell your old man to put in 6 more a.c. outlets and I'll bring the combo over.



No, I don't wanna blow my mind.



Wow! Did you hear that reverb?

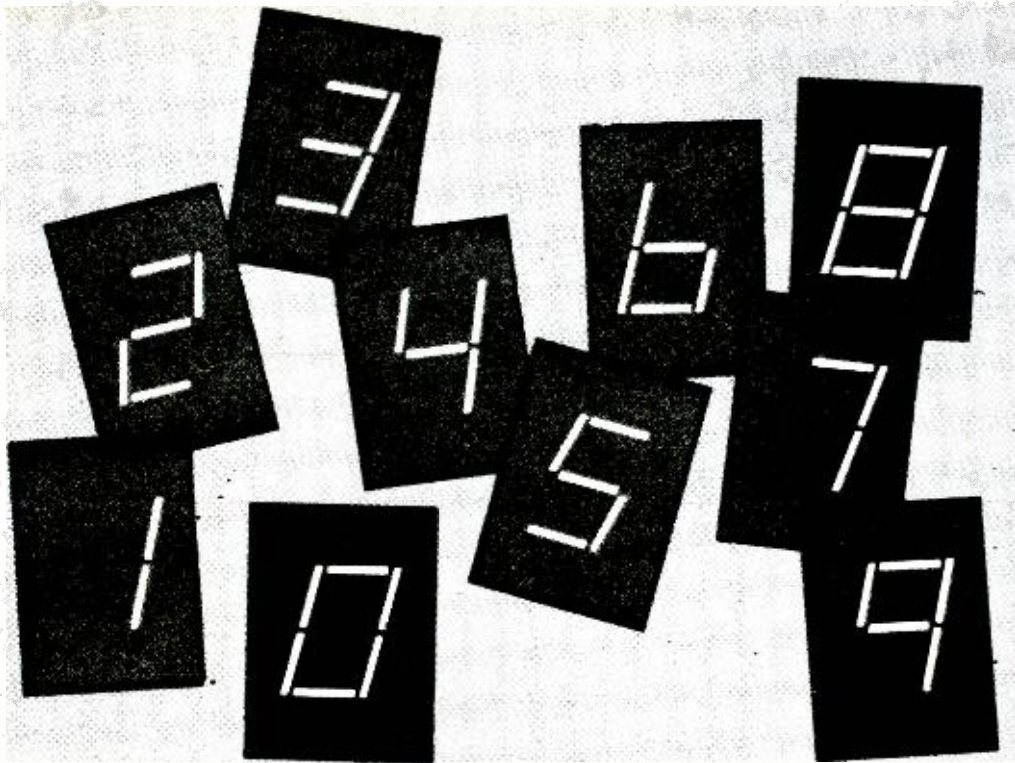

THIRD-GENERATION DCU

NEW, BRIGHT, LEGIBLE DIALCO 7-SEGMENT READOUT

BY C. P. TROEMEL

IN THE PAST year, POPULAR ELECTRONICS has introduced two new approaches to the design of digital readout equipment. The first was the "Low-Cost Counting Unit" using incandescent lamps (February, 1968—also in 1969 Winter Edition of ELECTRONIC EXPERIMENTER'S HANDBOOK) and the second was the "All-Purpose Nixie Readout" (November, 1968). The incandescent unit costs \$10.90 per decade; the Nixie readout, while higher priced, at \$30 per decade, is still much less than equivalent commercial units.

In this article, we will describe a third approach to digital readout—a low-cost decade counter having a single-plane number indicator. In this type of indicator, the numerical presentation does not

float up and down as it does in an incandescent display or go back and forth as in a Nixie tube. The single-plane indicator can be read from a considerable distance at viewing angles up to 150°.

How much does this third-generation readout cost? If you make your own display as described here, it is \$13.50; if you use a commercially available display, about \$6 more.

You have probably seen single-plane readouts on expensive test equipment and computers, in stock market quotation machines, or on airline arrival-departure boards. The basic seven-segment pattern is shown in Fig. 1. The 10 numerals created are shown above.

The counter can operate at rates up to 8 MHz, can be reset to zero at any

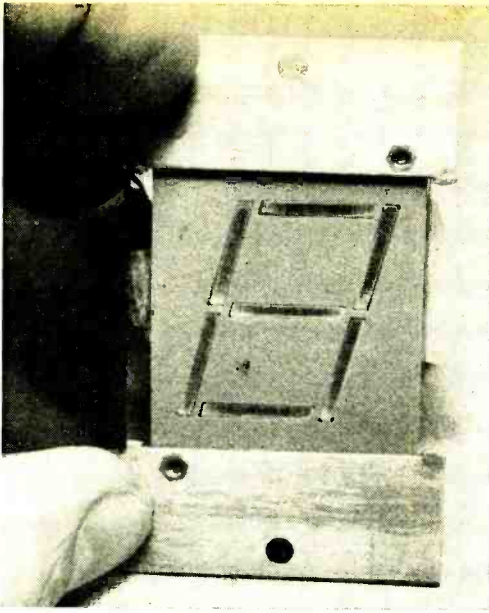

Fig. 1. Front view of the commercial seven-segment readout showing the numerical pattern. Mounting frames are available to hold several such readouts.

time, and can be cascaded to produce counts up to 99, 999, etc. Because the counting logic in the new readout uses the same integrated circuits as those of the "Low-Cost Counting Unit," it can be substituted for the incandescent lamp readouts used in other POPULAR ELECTRONICS projects such as the Stopwatch (March, 1968), Sports Timer (October, 1968), Digital Volt-Ohmmeter (December, 1968), and other digital readout instruments to be described in future issues. The logic circuit for the third-generation counter is shown in Fig. 2.

Construction. While the use of a printed circuit board is not mandatory, it does make the counter much easier to build and eliminates any chance of wiring errors. A foil pattern is shown in Fig. 3, with drilling and jumper information given in Fig. 4. Components are mounted on the board as shown in Fig. 5. Be sure that the IC's are positioned as shown. The numbers on the sides of the foil pattern refer to the segments of

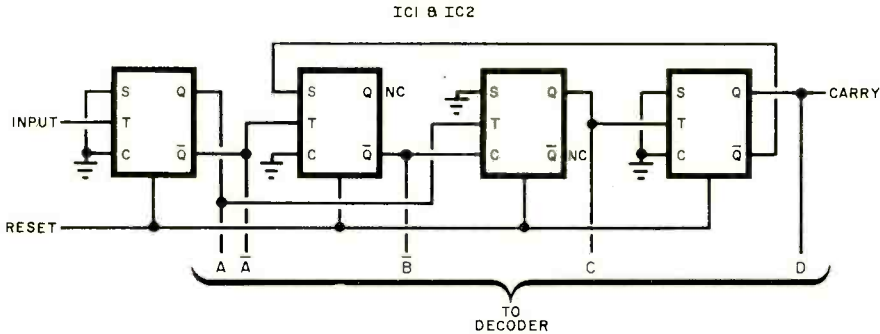

Fig. 2. The logic circuit (above) accepts the input pulses and produces certain discrete voltage levels at the outputs. The decoder (right) processes these voltages and causes only certain matrix segments to remain lit, creating a number.

PARTS LIST

- IC1, IC2—Dual JK flip-flop integrated circuit (Motorola MC790P)*
 IC3, IC5—Quad 2-input gate integrated circuit (Motorola MC724P)*
 IC4—Quad 2-input gate integrated circuit (Motorola MC717P)*
 IC6—Hex inverter integrated circuit (Motorola MC789P)*
 I1-I7—6.3-volt, 50-mA pilot lamp
 Q1-Q8—MPS3393 or 2N5129*
 R1—1500-ohm, 1/4-watt resistor
 1—Display unit (Dialco)**
 Misc.—PC board, indicator-to-board wire, #24 wire for jumpers, solder, etc.
 * Available from Allied Electronics, 100 N. Western Ave., Chicago, Ill. 60680. When ordering, specify as follows: 50E26—(type number)—

- MOT. Prices and type numbers are: MC790P, \$2; MC789P, \$1.08; MC724P, \$1.08; MC717P, \$1.08; and MPS3393, \$8.40.
 **Dialight Corp., 60 Stewart Ave., Brooklyn, N.Y. 11237. Order part number 710-0306. \$5.46. Colored plexiglass fronts, red (712-0103-001) or green (712-0105-001) are available at \$.53 each. A mounting bracket (713-0100-001) is also available at \$1.33. For color filters and brackets in lengths of more than one unit, consult Dialight Corp.
 Note—An etched and drilled PC board, ±159 at \$3.50, and a complete kit of parts, including the PC board and seven bulbs, #159 at \$13.50, are available from Southwest Technical Products Corp., 219 W. Rhapsody, San Antonio, Texas 78216.

the display and are used when connecting it to the board. Use a 25-watt soldering iron with a very narrow tip and thin solder (0.040" diameter) to install the IC's and transistors. Excessive heat may damage the semiconductors, while in-

sufficient heat may result in poor connections.

You can use one of two types of displays. The first, and best, is the commercial indicator unit given in the Parts List in Fig. 2. A rear view of this display

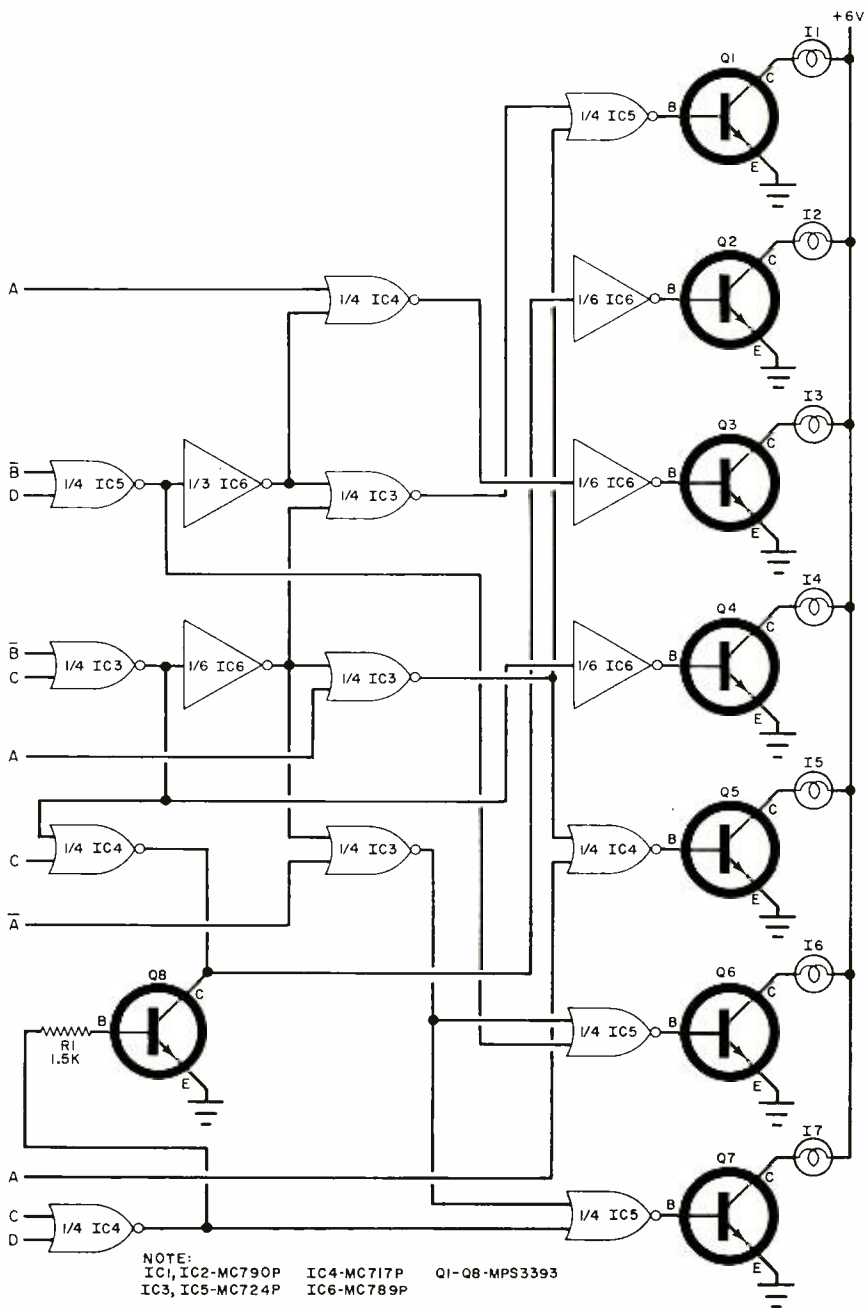

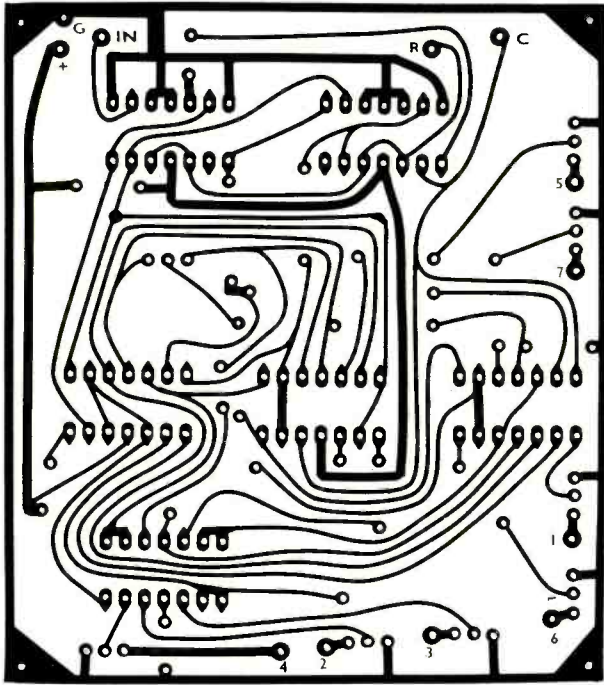

Fig. 3. Actual-size printed circuit foil pattern for the DCU. The use of this pattern is suggested because of the complexity of the circuit. Point-to-point wiring is not to be recommended.

with the appropriate lamp connections, keyed to the numbers on the circuit board, is shown in Fig. 6. Remove the rear cover of the indicator and install the seven lamps as shown in Fig. 6. One lead of each lamp is connected to a common tie point, which is connected directly to the +6-volt output of the power supply.

Using Fig. 5 as a guide, connect each lamp to its proper point on the circuit board. The eight wires from the readout can be made several inches long and laced together into a cable. This permits the mounting of the board some distance from the display. If a number of circuit boards (for a number of decades) are to be used, this approach permits low-profile stacking of the board with the displays mounted on a front panel. Almost any desired type of color filter may be used over the displays.

If you prefer to make your own display, first make a front panel as shown at the top in Fig. 7. Use thin cardboard, opaque plastic, or thin metal for this piece. Using thin cardboard and glue, isolate each segment of the front-panel as shown at the bottom of Fig. 7. The lamps can just lay in the compartments with their lead wires extending out. Plas-

tic tape can then be placed over the rear to hold the lamps in and keep light from coming out. If desired, you can cut a piece of cardboard to fit the back of the box and punch holes for each compartment just big enough to accommodate a lamp. The lamps can then be wired from the outside of the display. Pilot lamp sockets can also be used if desired. Wire the lamps to the circuit board as described before. The front panel of the display can be covered with a translucent material of any color to diffuse the light and give the display a commercial appearance.

Power Supply. The power supply is wired point-to-point using the schematic shown in Fig. 8. There are only three connections to the rest of the instrument—ground and 3.6 volts to the circuit board and 6 volts to the display lamps. To extend the life of the lamps, one or more diodes (*D6*) can be connected in the 6-volt line to reduce the voltage slightly (to 5.0 or 5.5). This lowers the lamp brilliance very slightly. A low-value resistor can also be used for this purpose. Do not reduce the value of *C1* or the resultant ripple may cause erratic readings. Maximum current consumption of

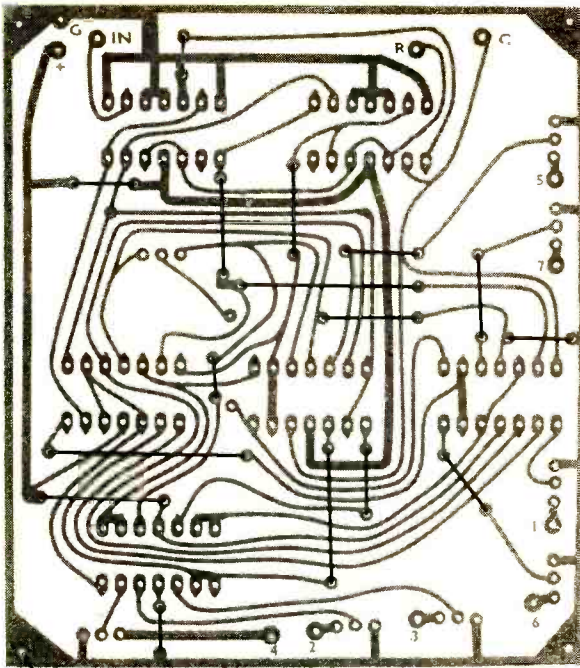

1/8" DRILL (4) #64 DRILL FOR REMAINING HOLES
16 JUMPERS TO BE MOUNTED ON COMPONENT SIDE

Fig. 4. Other than the four corner holes (for mounting), use a #64 drill for all holes. Wire the required 16 jumpers on the component side of the PC board.

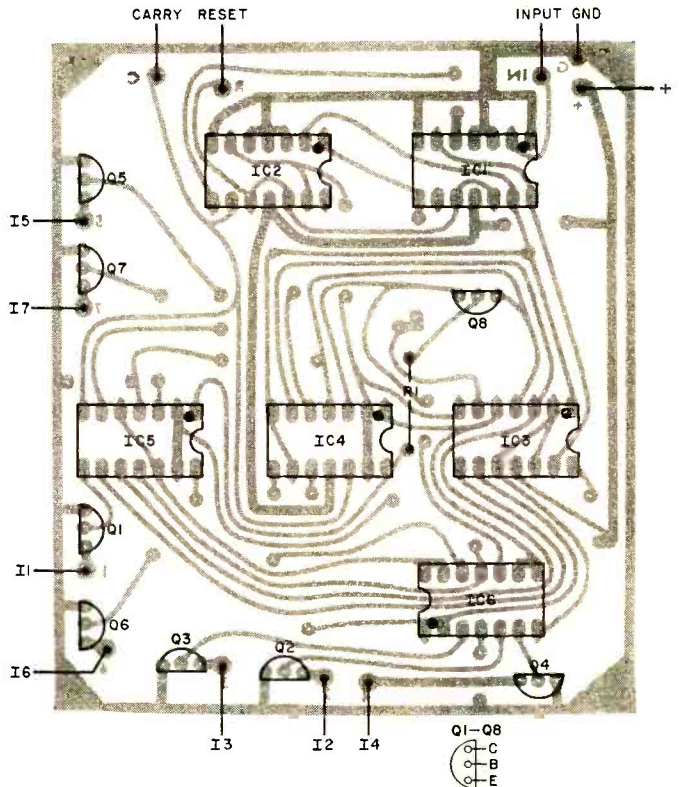

Fig. 5. Install the six IC's, 8 transistors, and R1 as shown here. Observe the notch and dot code on the IC's and orientation of the transistors. Note that each transistor is numbered the same as its segment on readout. The jumpers are not shown in this figure.

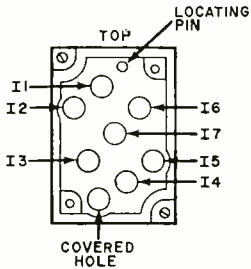

Fig. 6. Rear view of the commercial display unit showing the location of the seven segment-illuminator bulbs.

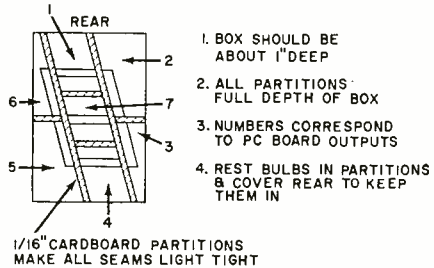
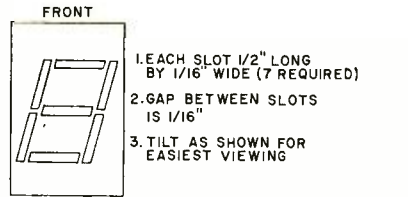

Fig. 7. You can make your own readout by following construction information shown here.

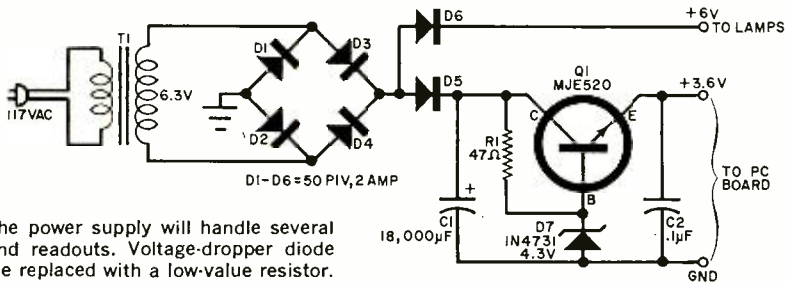
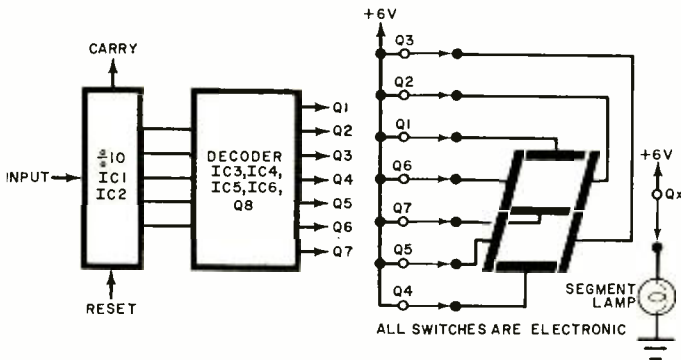

Fig. 8. The power supply will handle several DCU's and readouts. Voltage-dropper diode D6 can be replaced with a low-value resistor.



HOW IT WORKS

The heart of the third-generation counter is a single-plane, seven-segment display in which individual segments remain stationary and are illuminated in various combinations to produce the necessary numeral.

As shown in the diagram, all switches (transistors Q1 through Q7) are normally closed (transistors conducting) and their associated lamps are lit. This forms the numeral 8. If Q7 is turned off, the center bar goes dark and the numeral 0 is formed. As another example, if Q4, Q5, Q6, and Q7 were all turned off, a 7 would appear on the display. Other numbers are formed

by turning off other combinations of lamps.

The input signal to be counted is applied to a divide-by-ten circuit consisting of dual-JK flip-flops in IC1 and IC2. Each input pulse advances the counter one state until the count of 9 is reached. The next value resets the counter to zero and provides a carry pulse to the next decade.

Each state of the counter (0 through 9) presents a unique set of voltage levels at the individual JK flip-flop output leads. Unique combinations of these output levels are selected for application to gating circuits which, in turn, actuate the associated transistors.

The finished boards can be stacked (using spacers between them) to form a low-silhouette package. Connection between each board and its readout is made via a neat bundle of leads.

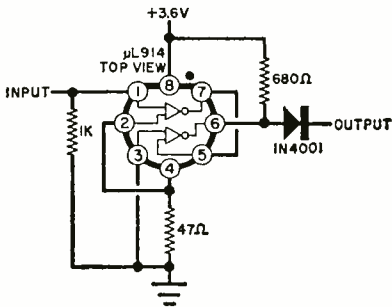
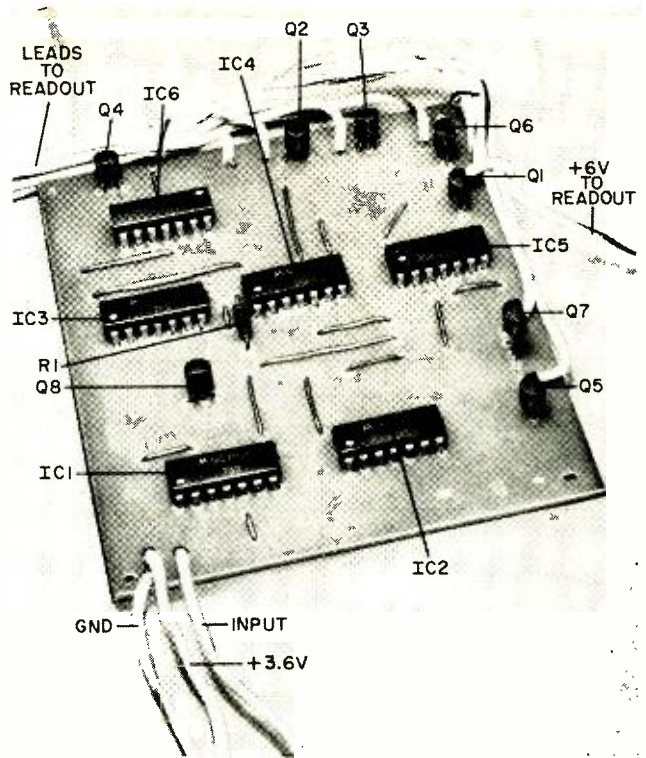

Fig. 9. This shaper will convert a sine-wave to a square wave of same frequency.

each decade is approximately 500 mA (when an 8 is displayed).

When mounting regulator transistor Q1, use plastic mounting hardware and mount the metal side of the transistor against the metal chassis with a mica washer and heat-sink (silicone) grease between the transistor and the chassis. If a metal screw is used, take care not to damage the transistor.

Operation. The reset lead (Fig. 2) is normally grounded. When it is raised to +3.6 volts and grounded again, the counter resets and indicates a zero on the display. The carry lead is connected to the input of the next decade to increase the count as necessary. The count of the decade unit is increased by one each time the signal level at the input drops from +3.6 volts to zero. The input signal must have a fall time of less than 0.1 microsecond. Any audio sine-wave generator can be used to test the counter. A low test frequency should be used so that the display can be observed easily. To shape the input signal properly, the circuit of Fig. 9 can be used.

There may be times when the input lead to the counter acts as a noise "antenna" and causes erratic counter operation. In such a case, connect a 1000-ohm resistor between the input lead and ground.

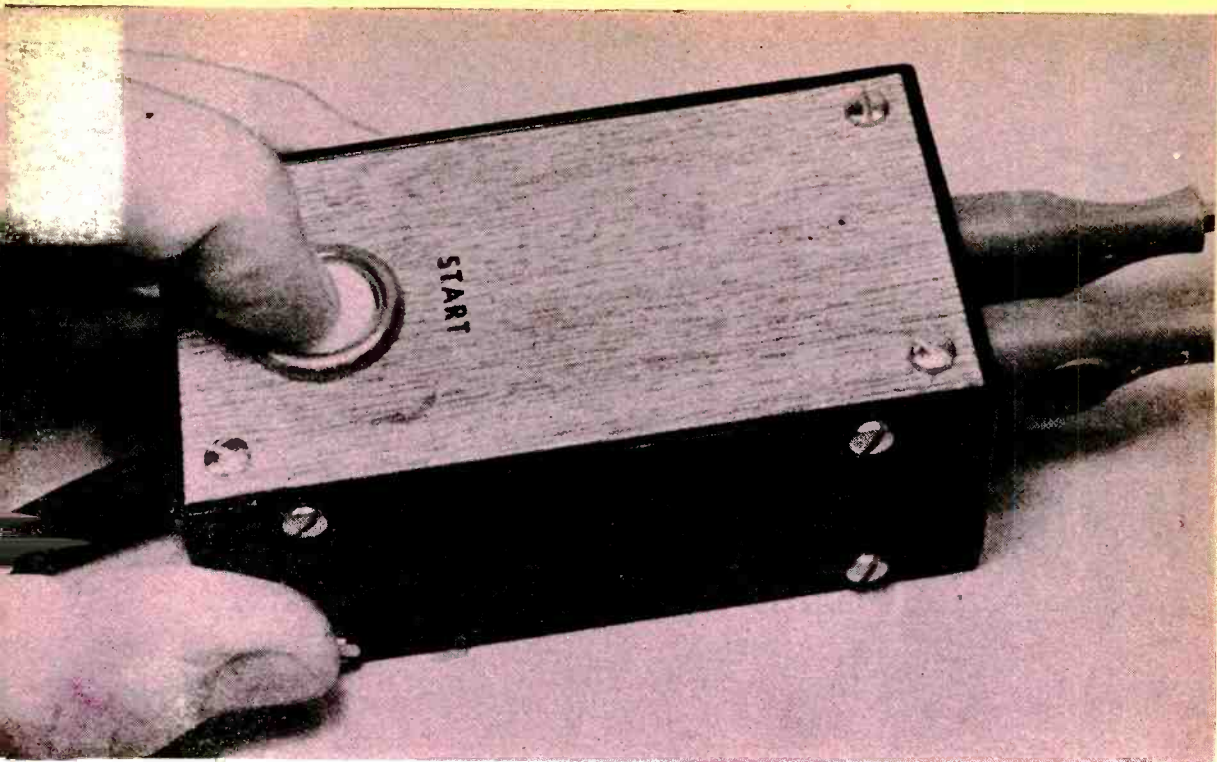

BUILD

200-WATT DUAL FLASHER

Off-On-Off Blink Incandescent Bulbs

BY JOHN S. SIMONTON, JR.

THERE ARE few devices which the electronics experimenter can build that have a wider variety of uses than light flashers. Alternately blinking lights attract attention to displays in store windows, guide the seafarer home to a safe harbor, and warn the unwary of all types of obstacles and perils.

Whether your need for a lamp flasher is serious or just for fun, the "SCR Dual Flasher" can handle it easily and economically. Using only a few components, this simple circuit (Fig. 1) will alternately flash two 117-volt light bulbs with ratings up to 200 watts each. The bulbs need not be the same wattage, and their ratings do not noticeably affect the flash rate. The component values shown pro-

duce a cycle of about one second on and one second off for each lamp.

Construction. The circuit can be assembled using any conventional wiring techniques, but a circuit board simplifies the job and lends a professional appearance to the finished product. A board can be etched using Fig. 2 as a guide or one can be purchased (see Parts List). Install the individual components as shown in Fig. 3.

The author's prototype was built in a $1\frac{3}{4}'' \times 4'' \times 2\frac{1}{8}''$ plastic enclosure. Metal housings can be used, but every precaution must be taken to prevent any part of the circuit from coming in contact with the metal case. Because 117-volt

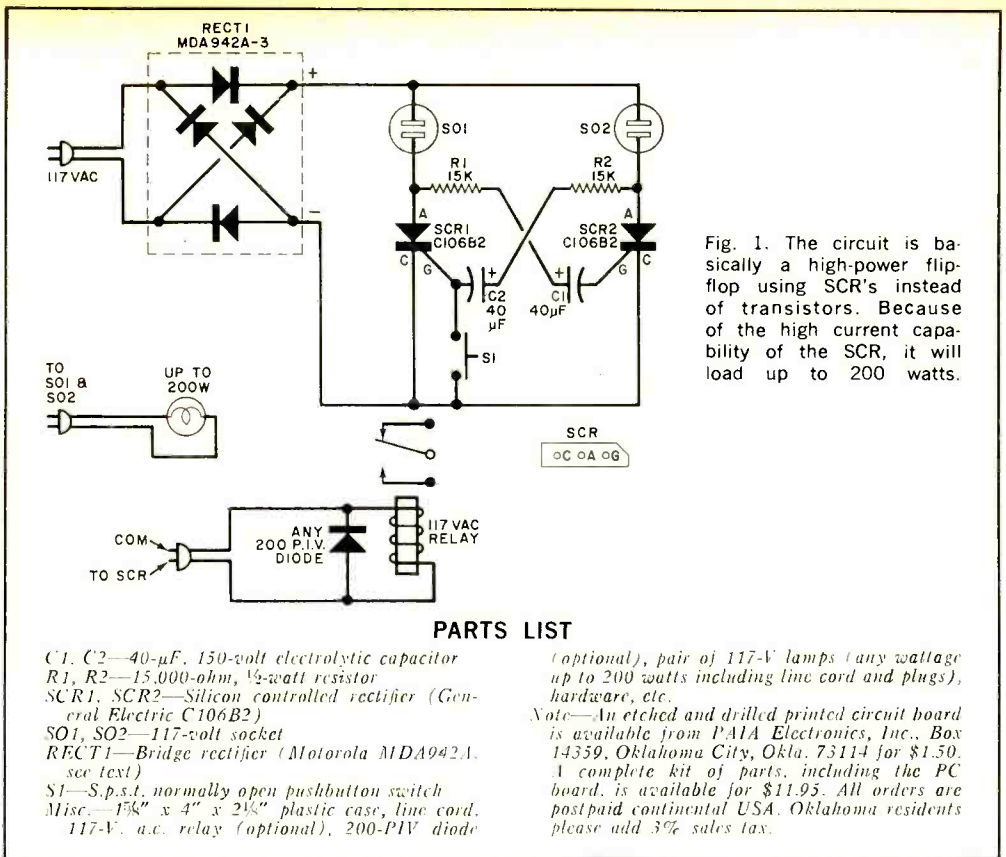

a.c. line power is used in this device, be very careful of component polarities and short circuits, as a wrong connection can easily destroy components or vaporize the conducting path on the circuit board.

The author used a Motorola MDA-942A-3 bridge rectifier assembly because it is compact and the price compares favorably with the cost of individual components. However, if you have a supply of four rectifier diodes with an inverse voltage rating of 200 volts or better and an average current rating of at least 1 A (such as 1N4721), they will work just as well.

Operation. All you have to do to operate the Flasher is to plug a pair of incandescent lamps (up to 200 watts) into *SO1* and *SO2*. If alternate bulb blinking does not occur immediately, momentarily depress *S1* to start the operation.

To create an eye-catching effect, use two lamps of different wattage (150 and 25, for example) and put them in the same frosted-glass enclosure. When the

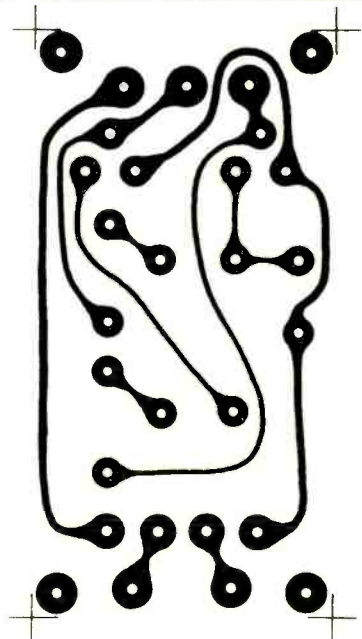

Fig. 2. You can make an actual-size PC foil pattern by following this layout.

HOW IT WORKS

The circuit of Fig. 1 is an astable multivibrator using SCR's as the active elements. Plug incandescent lamps into *SO1* and *SO2*. Their wattages need not be equal. To visualize the operation of the unit, assume that *SCR1* is conducting and *SCR2* is not conducting (*SO1* powered and *SO2* unpowered). The voltage drop across *SCR2* causes a current flow through *C2*, *R2*, and the gate-cathode junction of *SCR1*. As long as this current is above the value required to hold *SCR1* in its conducting state, lamp *SO1* remains powered; but, as *C2* charges, the current decreases until it is below the minimum needed for triggering. At this point, *SCR1* turns off, removing the power to *SO1*, and the voltage drop across *SCR1* jumps to line potential. This causes a current to flow through *C1*, *R1*, and the gate-cathode junction of *SCR2*. This current turns on *SCR2*. The operation is now the mirror image of the sequence when *SCR1* was on, *C1* charges, and *SCR2* turns off placing the circuit back at the starting point. As each SCR is triggered, it places the positive end of the capacitor which was being charged at ground potential. Because of the stored charge, the gate of the non-conducting SCR is held at a more negative voltage than its cathode, assuring that it will remain off.

If the unit has been off several hours, both lights may go on when it is first plugged in. This is caused by the initial surge of current through *C1* and *C2*, turning on both SCR's simultaneously, and will only happen if both capacitors are completely discharged. Depending on more or less random conditions, this may or may not be a stable state and the lamps may both remain on. Pushbutton *S1* provides a means of initiating oscillation if this situation arises. Closing *S1* shorts the gate of *SCR1* to ground and causes it to stop conducting. The resulting voltage drop across *SCR1* causes *C1* to begin charging and starts the flashing sequence. Since it takes several hours for the capacitors to discharge completely, power failures of up to an hour or more will not prevent the unit from flashing when power is restored.

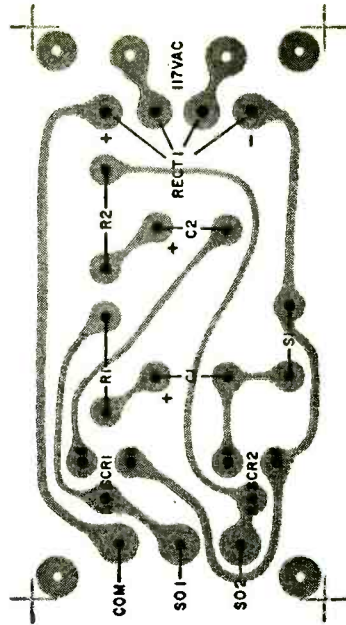
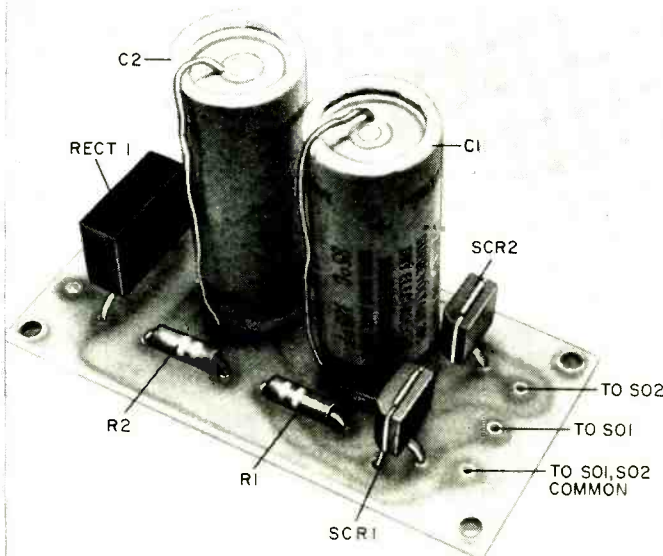

Fig. 3. When installing the components, make sure all polarities are observed.

flasher is operating, you will get the distinct impression of a rotating beacon as a bright flash is followed by a dim flash.

If one or two 117-volt a.c. power relays are substituted for the lamps, external devices can be operated alternately. To prevent damage to the relay coils, don't forget to include the diode as shown in Fig. 1.

-30-



Physical arrangement of a finished PC board. Note that both capacitors are vertical to the board while other components are conventionally installed. Two connections to *S1* are hidden behind the capacitors. When installing, remember that the circuit is "hot" to ground and you can get shocked if not careful.



**BUILD A
“DIFFERENT”
METAL
LOCATOR**

*Use audio-frequency coupling
for increased stability*

BY LESLIE HUGGARD

TREASURE HUNTERS use all kinds of schemes and gimmicks in trying to find their fortune—divining rods, extra-sensory perception, ancient pirate maps, and so on. Experience has shown, however, that the most successful treasure hunters use some form of electronic metal finder.

The operation of most buried-metal locators is based on a type of heterodyning principle with the frequency of one of a pair of interacting oscillators being changed when foreign metal is near. One of the oscillators operates at a fixed fre-

quency and the tuning coil of the other is usually a loop of wire at the end of a non-metallic carrying handle. When the loop is brought near metal, the oscillator frequency changes and an audio beat note is created between the two oscillators. This audio signal can be picked up on a speaker or headset. Metal detectors operating on this principle require semi-critical tuning of one of the oscillators for best results. Their operation can often be disturbed by nearby electrical noise sources or powerful radio stations in the vicinity.

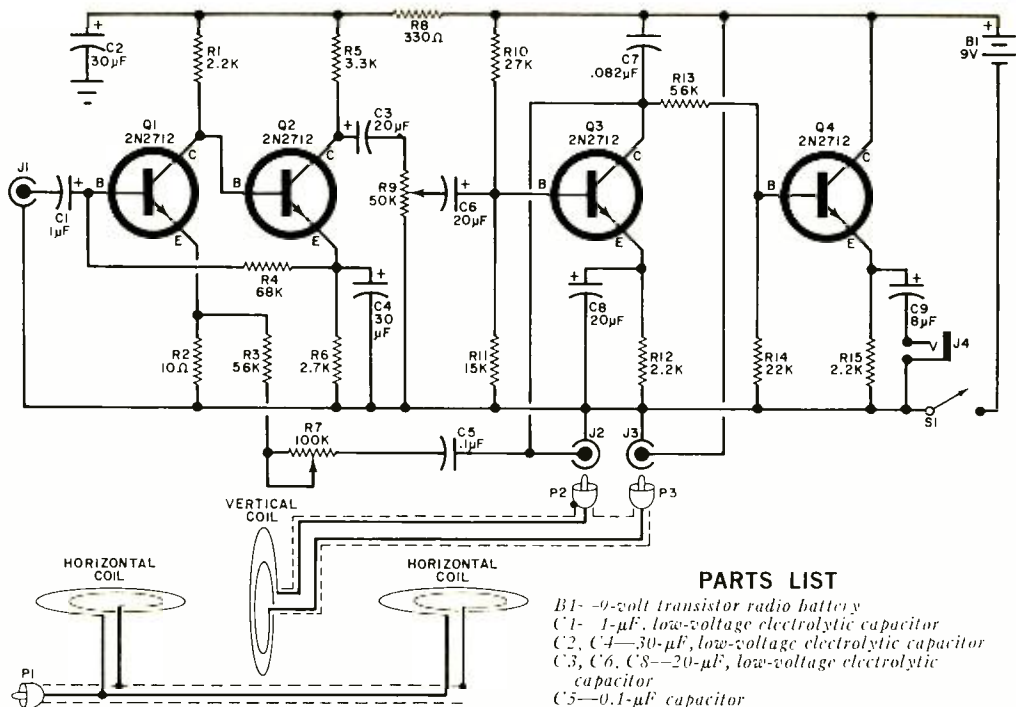

Fig. 1. Basically an unstable high-gain audio amplifier, the circuit breaks into oscillation when metal is detected between horizontal and vertical coils.

PARTS LIST

- B1—9-volt transistor radio battery
- C1—1- μ F, low-voltage electrolytic capacitor
- C2, C4—30- μ F, low-voltage electrolytic capacitor
- C3, C6, C8—20- μ F, low-voltage electrolytic capacitor
- C5—0.1- μ F capacitor
- C7—0.082- μ F capacitor
- C9—8- μ F, low-voltage electrolytic capacitor
- J1-J3—RCA phono jack
- J4—Headphone jack
- P1-P3—Phono plug
- Q1-Q4—2N2712 or similar
- R1, R12, R15—2200-ohm
- R2—10-ohm
- R3, R13—56,000-ohm
- R4—68,000-ohm
- R5—3300-ohm
- R6—2700-ohm
- R8—330-ohm
- R10—27,000-ohm
- R11—15,000-ohm
- R14—22,000-ohm
- R7—100,000-ohm potentiometer
- R9—50,000-ohm potentiometer
- S1—S.p.s.t. switch
- Misc.—Headphones greater than 2000 ohms impedance, metal enclosure, perf board, spacers, battery connector, $\frac{1}{2}$ lb #32 wire, wood for coil assembly and handle, six nylon screws, knobs, paint or varnish, plastic electrical tape, etc.

All resistors
1/2-watt

In spite of the considerable publicity that metal locators have received in the past few years, one type of locator has received very little attention because it has been used only in high-priced commercial equipment. The locator described here is of this type; it uses an "inductance bridge" method of detection. Audio-frequency coupling is used rather than r.f. The inductance bridge consists of two sets of coils, at right angles to each other, forming the input and output circuits for a high-gain audio amplifier. If the coils are constructed so that they are very close to being at right angles to each other, there is not enough inductive coupling between them to produce the feedback required to make the amplifier oscillate. However, if the coil set is brought near any metal, the metal forms a coupling between them, the amplifier oscillates, and an audio signal is produced.

Because the intensity of a magnetic field falls rapidly with distance and the influence on the magnetic field produced

by a metallic conductor within it decreases rapidly as the conductor gets smaller, it is very difficult to make a device that will detect small objects at a distance. In the detector which uses a loop to locate the metal, varying the size of the loop can produce problems. For a given number of turns and a given amount of current in the loop, the field at a distance along the axis of the loop depends on the diameter of the loop. The greater the diameter, the farther the field extends. However, the greater the

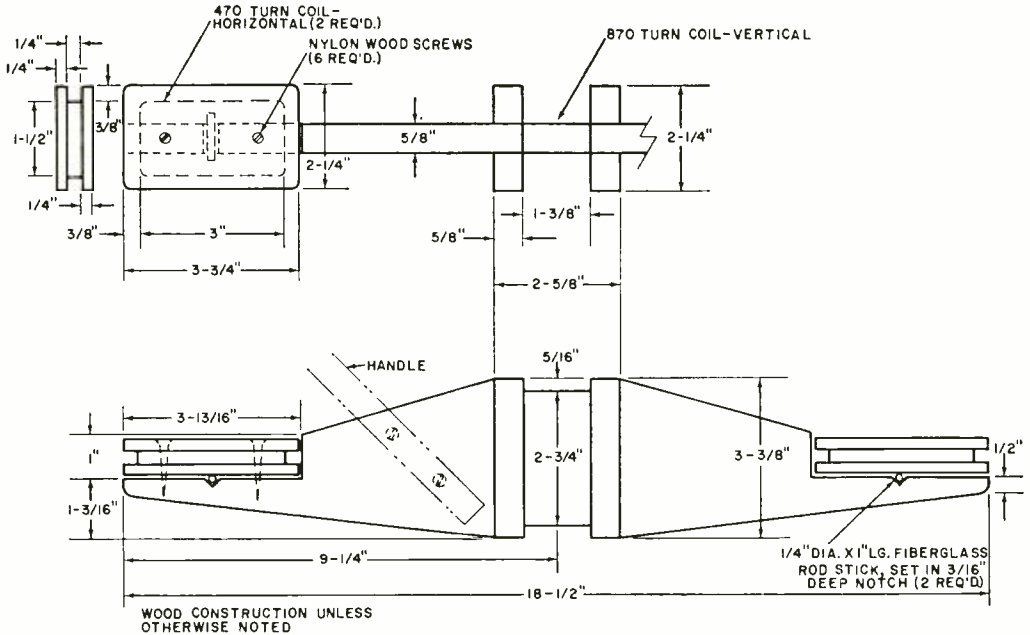

Fig. 2. Except for copper wire in the three coils, no metal is used in the search head construction. Nylon screws secure the two horizontal coils. Use a strong glue or cement for overall assembly.

loop diameter, the larger the metal object must be to have any effect on the field. Thus, in this type of locator, it is necessary to compromise between the size of the object to be located and the distance at which it can be located.

The locator described here will detect

an aluminum bottle cap or a three-inch nail at a depth of 2 inches. Larger objects (such as a garbage-can lid) can be detected at a depth of 2½ feet. The locator is more sensitive to ferrous materials than others since iron-based metal has a greater effect on the magnetic field.

The electronics may be assembled on perf board. Any arrangement can be used as long as the input and output circuits are as far apart as possible to prevent unwanted coupling.

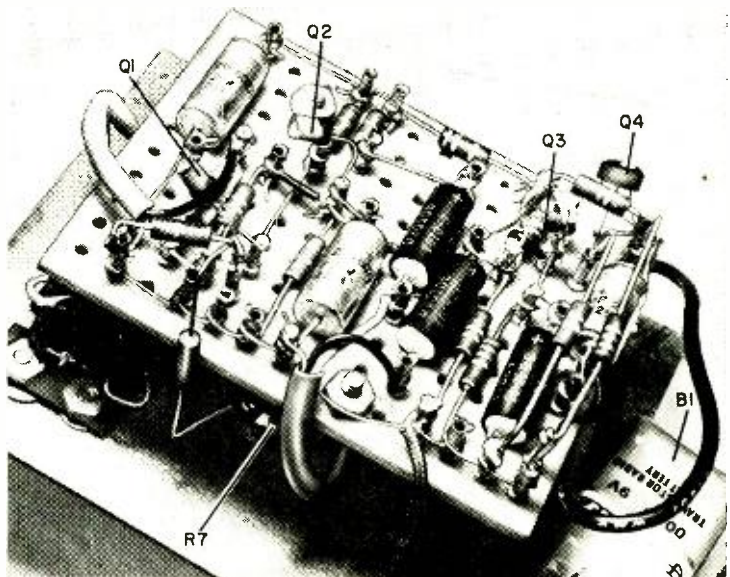

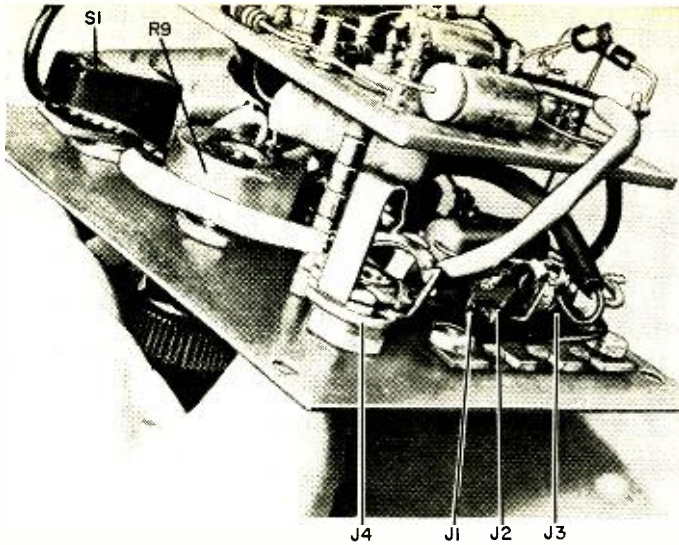

The perf board is mounted on four long spacers to provide room for the front-panel components. The battery is secured in a clip affixed to the panel.

Construction. The locator consists of two principal parts: a search head which is a rigid assembly of three coils and a control box containing the electronic circuits which energize the coils and produce the audible output signal.

The electronic circuit, shown in Fig. 1, can be constructed on perf board. In laying out the components, be sure to keep the input components as far as possible from the output components to avoid unwanted feedback. The two potentiometers, *R7* and *R9*, switch *S1*, search-head jacks *J1*, *J2*, and *J3*, along with the head-phone jack, *J4*, can be mounted on the front panel of a small metal box. The author used a 5" × 4" × 3" aluminum enclosure. Once the front-panel controls are mounted, connect them to the perf board and mount the perf board on the front panel using insulating spacers. Use shielded leads between the three jacks and the two potentiometers. Ground the shields to the perf board common and make sure that the board common is well grounded to the metal enclosure. When wiring is complete, recheck the circuit for possible polarity errors in electrolytic capacitors and transistors and be sure that all resistor values are correct. Also check the solder connections for cold solder joints or accidental shorts.

In constructing the search head, there are three important points to remember: the assembly should be as rigid as possible, the two horizontal coils should be identical, and no metal other than the

coil wire and leads should be used. This means *no* metal screws. All the parts making up the assembly are wood, and strong glue or wood cement should be used in fabrication.

Construct the wood head assembly as shown in Fig. 2. Note that nylon adjusting screws are used to tilt the horizontal coils slightly. This permits the setting of both horizontal coils exactly at right angles to the vertical coil. If you use care during the construction and make sure that the vertical and horizontal coils are as close to perpendicular as possible, the nylon screws will not have to be used. The horizontal coils should be made separately from the rest of the frame and not mounted until wound. All the wood parts should be given two coats of paint or varnish before winding the coils.

When starting to wind a coil, put a layer of plastic electrical tape around the core. Solder a length of fine multi-strand plastic-covered wire to the end of the coil wire and insulate the joint carefully with plastic electrical tape. The piece of fine wire should be long enough to make one complete turn with enough left over to make a connection outside of the coil (two or three inches). Leaving this length of the fine wire hanging free (or anchored temporarily to some other object to keep it out of the way), wind the coil with the proper number of turns. Each horizontal coil requires 470 turns of #32 wire, while the single vertical coil takes 870 turns. Wind the coil wire as

Details of the vertical coil. After winding, wrap plastic electrical tape around the coil to prevent accidental damage and keep out any moisture.

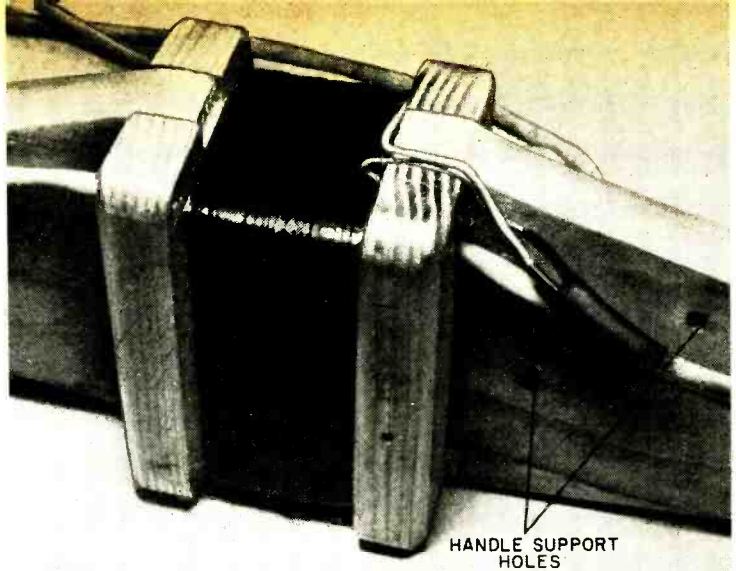

evenly and firmly as possible and avoid kinking the wire. When the winding is finished, protect it with a couple of layers of plastic electrical tape. Be sure that you can identify each end of the coil.

Winding the horizontal coil will be easier if you drill a hole in the center of the coil form and push a long machine screw through it. Anchor the screw at one end with a nut and clamp the screw in the chuck of a hand drill. Let an assistant operate the drill while you hold the wire and count the number of turns. In winding the vertical coil, drill a small hole at each end of the form and push a round nail (with the head removed) in each hole. Use one nail as a pivot and put the other in the hand drill. Be sure to remove the nails and bolts after winding the coils.

Once all three coils are wound, assemble them as shown in Fig. 2. The handle, fastened to the frame with nylon screws, can be any shape or length.

Use shielded twin-conductor cable about 6' long to connect the coils to the appropriate jacks on the electronic package. Connect the vertical coil as shown in Fig. 1. For the horizontal coils, the two wires in the cable are connected together to form one lead with the shield used as the other lead. At this time, connect only one horizontal coil to the cable.

Testing. After the complete detector has been assembled, hang the search coil assembly so that it is well clear of any metal objects (about six feet). With the headphones plugged in and the power turned on (*S1*), turn up gain control *R9*.

Three nylon screws are shown here because the author trimmed the mounting for a true 90-degree fit. Normally, only the two outer screws are used and the coil form rotates about a thin plastic rod.

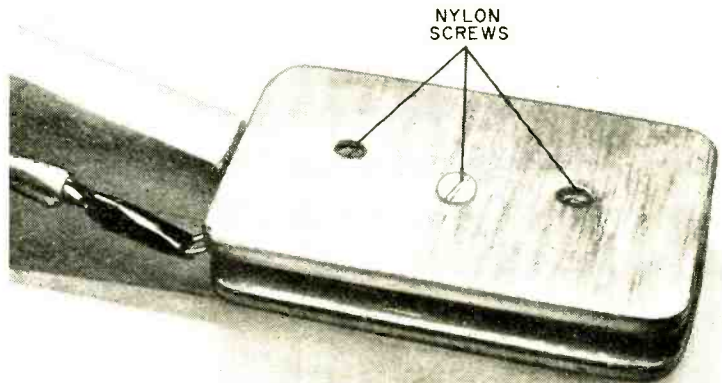

At some point, the circuit will oscillate and a tone of about 2000 Hz will be heard. Turn the gain down until the circuit just stops oscillating. At this point, turn up the feedback control (*R7*) until the oscillation is just audible. Bring a ferrous metal object (pliers, large screwdriver, etc.) near the coil assembly about midway between the vertical coil and the horizontal coil that is hooked up. At some short distance from the coil assembly, the circuit oscillation will increase rapidly, creating a loud tone in the phones. If it does not and the faint oscillation tone disappears instead, exchange the connections to the horizontal coil and repeat the test. Identify both leads of the horizontal coil, disconnect it, and repeat the procedure with the other horizontal coil connected. Identify these leads also and then connect both coils to the cable. After soldering the coil leads to the cable, insulate the connections with plastic tape. Then retest the entire locator head by bringing a metal object midway between the vertical coil and either of the horizontal coils. You can now experiment with various metal objects of various sizes to get the "feel" of the detector's operation.

To test for a true right angle between the vertical and horizontal coils, an external audio generator capable of delivering 2 kHz is required. Unplug both vertical coil connectors and insert a

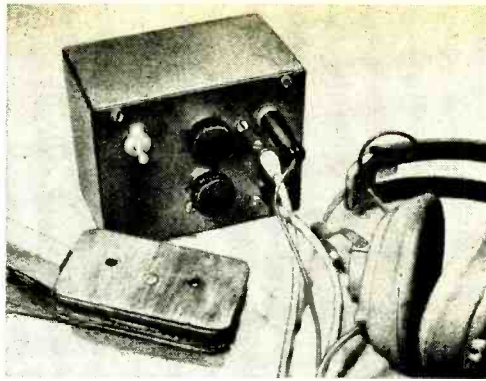

The complete assembly consists of the search coil, a pair of headphones and the electronics package.

2200-ohm, ½-watt resistor between *J2* and *J3*.

Connect the audio oscillator, set at 2 kHz, to the vertical coil connectors, *P2* and *P3*. Rotate the feedback control, *R7*, fully counterclockwise (maximum resistance) and set the gain control, *R9*, at about its midpoint. Adjust the output of the audio generator until a tone is heard in the headphones. Very carefully tip one horizontal coil about the horizontal until the tone is minimized. Fix the coil in this position using the nylon screws. Repeat the procedure with the other horizontal coil. When the tone is at a minimum, the coils are at right angles and should be fixed that way. When this test is complete, attach the wooden handle with the two remaining nylon screws.

HOW IT WORKS

The electronic circuit is basically a high-gain audio amplifier whose gain is controlled by *R9*. Positive feedback is provided through *R7* and *C5*. A tuned circuit consisting of the vertical coil and *C7* is connected to the collector of *Q3*.

The two horizontal coils are connected to the amplifier input. Because the coil sets are at right angles to each other, coupling and feedback are at a minimum. However, there is always some slight electrical noise in an amplifier, and this is sufficient to set up a weak magnetic field around the vertical coil.

The lines of flux along the axis of the vertical coil are parallel with the planes of the horizontal coil. If a metal object comes within this field, the lines of flux are distorted so that some of them link with a horizontal coil. The coils are connected so that the signal input to the amplifier is in phase with the output of the amplifier when there is a disturbance in the magnetic flux. When this happens, the circuit breaks down with positive feedback and the output is similar to the feedback obtained between an audio amplifier speaker and a microphone. The oscillation has a frequency of about 2 kHz. Unlike most r.f. beating systems used in metal locators, this circuit requires no tuning.

Operation. With the detector assembled, earphones plugged in and on the head, turn on the power. Hold the coil assembly up in the air so that it is well clear of the ground and any metal. Rotate the feedback control to full counterclockwise and turn up the gain control until oscillation is just heard. Then back it off slightly until the oscillation just stops. Adjust the feedback control until the circuit just trembles on the edge of oscillation. Now proceed with a search pattern, bringing the coil assembly down to ground level and making wide sweeping motions in arcs over the top of the ground. When a metal object is detected, the barely audible tone will suddenly increase in volume as the hidden metal reaches an area just midway between either horizontal coil and the vertical coil.

-30-

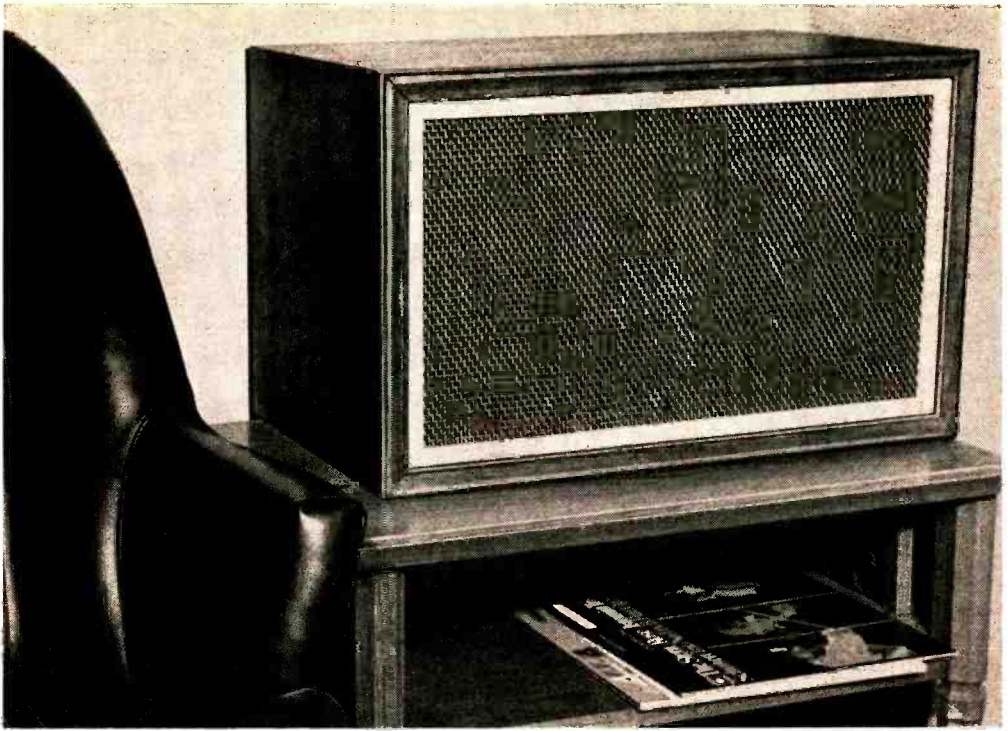

BUILD THE THRIFTY 3-WAY

FULL-RANGE HI-FI SPEAKER SYSTEM FOR \$35

BY DAVID B. WEEMS

IF YOU THINK a "full-size" compact three-way speaker system has to be expensive, you're wrong. By doing most of the work yourself—putting together a sturdy cabinet and winding a couple of coils—you can be in business for \$35.00 or less.

The "Thrifty Three-Way" speaker system described here is built around an unusually designed 12" woofer. The woofer has a "poly foam" suspension that brings its free-air resonance down below 25 Hz. According to the manufacturer, the woofer's suspension will not harden with the passage of time as do conventional "accordion" type suspensions. (Tests conducted by the author show that the suspension is also not affected by changes in humidity.)

Build an enclosure, add a midrange speaker, a tweeter, homemade crossover networks, and you have a real money saver. The frequency range and performance of the system are similar to these of much more expensive 3-way systems. And the midrange and tweeter controls, refinements not found in bargain systems, allow you to adjust the system response to suit your listening tastes.

Enclosure Assembly. The enclosure can be assembled with the aid of common hand tools if you can get your lumber yard to miter the joining edges of the top, bottom, and side plates of the enclosure at 45° angles. Then, referring to the three-dimensional drawing provided

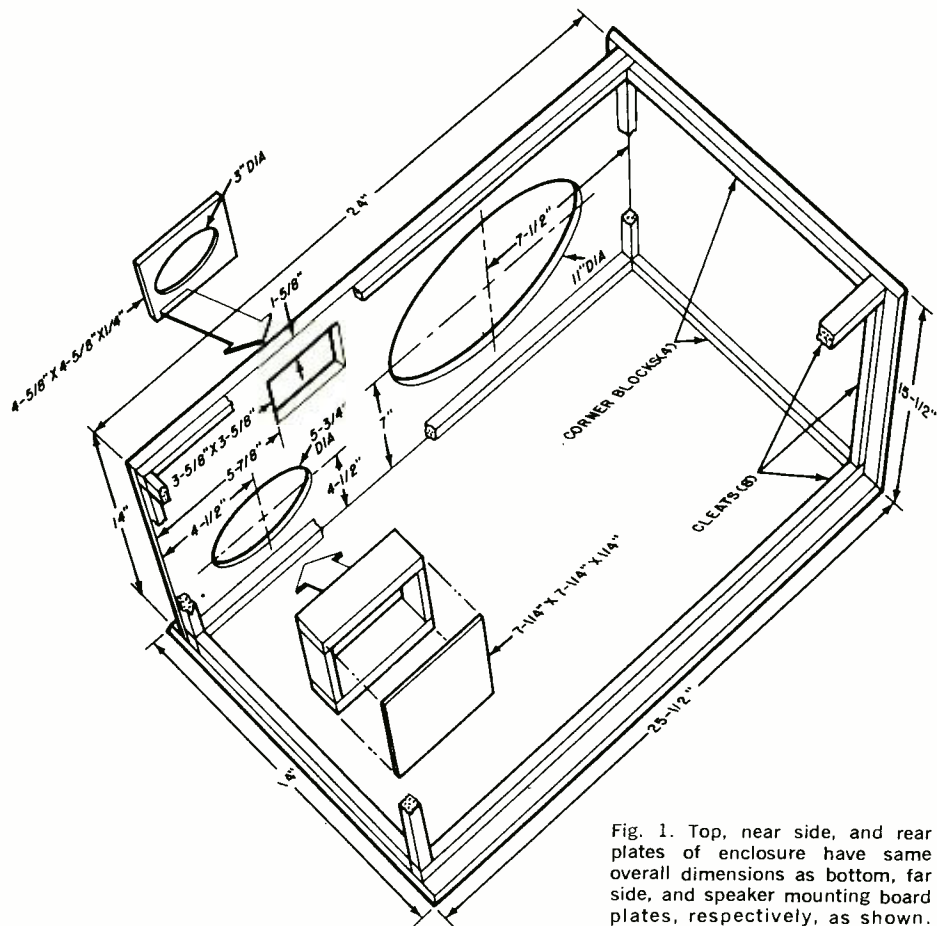

Fig. 1. Top, near side, and rear plates of enclosure have same overall dimensions as bottom, far side, and speaker mounting board plates, respectively, as shown.

in Fig. 1, prepare the main enclosure's rear plate, speaker mounting board, and cleats and corner blocks. (Note: Only one side, the bottom, and the speaker mounting board are illustrated in the drawing. The remaining side is the same size as the side shown; the same applies to the rear and top plates, which are identical in size to the speaker mounting board and bottom plate respectively.)

Before starting assembly, it is a good idea to drill the screw guide holes through the cleats and corner blocks. For the corner blocks, drill the holes through in both directions, while for the cleats drill in only one direction.

Now select one of the long plates for top or bottom, and glue and screw a long cleat in place $\frac{3}{4}$ " in from the rear edge. Measure $1\frac{5}{8}$ " in from the front edge, draw a line along this mark, and glue

and screw the other long cleat's outer edge along the line. Now, glue and screw the two 10" corner blocks along the edges of the short sides of this plate.

Proceed with assembly by gluing and screwing the other three plates together, framing each with the appropriate cleats and corner blocks as you go. Set the assembly aside to allow the glue to set.

Meanwhile, prepare the speaker mounting board, tweeter mounting board, and midrange speaker enclosure as shown. The midrange speaker enclosure is made up of lengths of pine (sides) and a $\frac{1}{4}$ " plywood back plate (see Bill Of Materials for dimensions). After preparing the tweeter mounting board, chamfer the outer edge of the speaker cutout to remove any sharp edges.

Apply glue to the front surfaces of the midrange speaker enclosure, and sym-

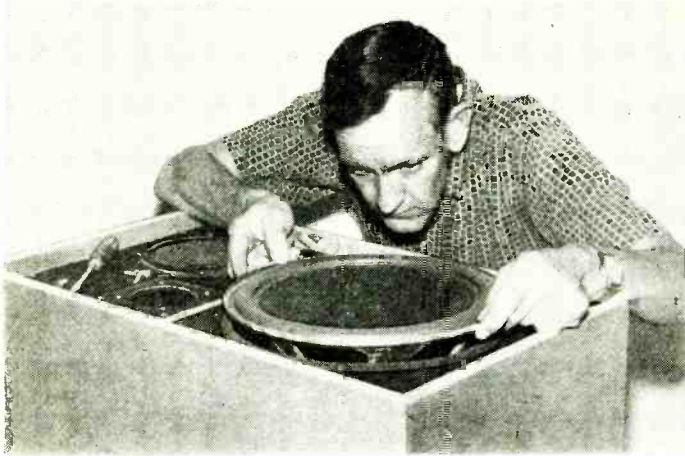

Fig. 2. To insure proper air seal, be sure to place rubber, felt, or other adequate gasket material between speaker rims and speaker mounting board.

metrically locate the enclosure over its hole on the speaker mounting board. Now, anchor the enclosure in place with screws driven from the front of the speaker mounting board into the sides of the enclosure.

Apply a coat or two of flat black paint to the front surfaces of the tweeter and speaker mounting boards. Then sand and stain or paint the outside surfaces of the previously prepared assembly. When both assemblies are dry, drop the speaker mounting board into place, and anchor it down with screws and glue.

Now, peel off the backing from a length of foam rubber weather strip, and carefully press it down around the woofer cutout, bending it as necessary to form a circle. Do the same for the midrange speaker cutout. The speakers are front mounting types, so the weather stripping must be placed on the front surface of the speaker mounting board.

Next, install the tweeter on its board, and solder a 3' length of zip cord to its lugs (do NOT bypass the capacitor). Then mount the speaker board assembly symmetrically over the square cutout in

BILL OF MATERIALS

- | | |
|---|---|
| 1—12" woofer* (No. 12RUB 16-8) | 4—10" pieces of $\frac{3}{4}$ " x $\frac{3}{4}$ " pine for corner blocks |
| 1—6 $\frac{1}{2}$ " Ciraudagraph "Special Design" mid-range speaker* (No. C-6-1 $\frac{1}{2}$ MR) | 1—7' length of $\frac{3}{4}$ " x $\frac{3}{4}$ " pine for grille frame |
| 1—Ciraudagraph "Special Design" tweeter* (No. TS 6070) | 1—7' length of 1 $\frac{3}{8}$ " x $\frac{1}{4}$ " plain trim for grille frame |
| 1—25- μ F nonpolarized capacitor for C1 | 1—7' length of 1 $\frac{1}{8}$ " channeled "cabinet" molding |
| 1 lb—#18 magnet wire (Belden No. 8075 or similar) | 2—1 $\frac{1}{8}$ " x 1" diameter wood dowels for coil forms |
| 2—8-ohm L-pads (Calrad No. LP-S or similar) | 4—2 $\frac{3}{4}$ " x 2 $\frac{1}{4}$ " pieces of $\frac{1}{8}$ " Masquite for coil forms |
| 2—25 $\frac{1}{2}$ " x 14" pieces of $\frac{3}{4}$ " plywood for top and bottom of enclosure (sides and joints miter cut) | 1 box—#8 x 1 $\frac{1}{4}$ " flathead wood screws |
| 2—15 $\frac{1}{2}$ " x 14" pieces of $\frac{3}{4}$ " plywood for sides of enclosure (sides miter cut) | 1 doz—#8 x $\frac{3}{4}$ " flathead wood screws for tweeter mounting board and rear of midrange enclosure |
| 2—24" x 14" pieces of $\frac{3}{4}$ " plywood for speaker mounting board and rear of enclosure | 8—#12 x 1" panhead screws for woofer |
| 1—4 $\frac{5}{8}$ " x 4 $\frac{5}{8}$ " piece of $\frac{3}{4}$ " plywood for tweeter mounting board | 4—#8 x 1" panhead screws for midrange speaker |
| 1—7 $\frac{1}{4}$ " x 7 $\frac{1}{4}$ " piece of $\frac{3}{4}$ " plywood for rear of midrange speaker enclosure | 1 roll—10' x $\frac{3}{8}$ " x 3/16" sponge rubber weather strip tape for speaker gaskets |
| 1—8" x 2 $\frac{3}{4}$ " piece of $\frac{1}{2}$ " plywood for crossover network | 6—#8 x $\frac{3}{4}$ " brass screws for coil forms and crossover network mounting |
| 2—7 $\frac{1}{4}$ " x 1 $\frac{5}{8}$ " pieces of $\frac{3}{4}$ " pine | 2—#4 x $\frac{1}{2}$ " brass screws for terminal strips |
| 2—5 $\frac{3}{4}$ " x 1 $\frac{5}{8}$ " pieces of $\frac{3}{4}$ " pine | 1—2-lug terminal strip |
| 4—24" pieces of $\frac{3}{4}$ " x $\frac{3}{4}$ " pine for top and bottom cleats at front and rear | 1—4-lug terminal strip |
| 4—12 $\frac{1}{2}$ " pieces of $\frac{3}{4}$ " x $\frac{3}{4}$ " pine for side cleats at front and rear | Misc.—Grille cloth; glue; wire brads; zip cord; paint; stain; solder; fiberglass wool; sandpaper; etc. |
- *Speakers are available from McGee Radio Co., 1801 McGee St., Kansas City, Mo., for \$19.95 (includes cost of 25- μ F nonpolarized capacitor); stock numbers are given in parentheses above.

**“He’s a good worker.
I’d promote him
right now if he had
more education
in electronics.”**



Could they be talking about you?

You'll miss a lot of opportunities if you try to get along in the electronics industry without an advanced education. Many doors will be closed to you, and no amount of hard work will open them.

But you can build a rewarding career if you supplement your experience with specialized knowledge of one of the key areas of electronics. As a specialist, you will enjoy security, excellent pay, and the kind of future you want for yourself and your family.

Going back to school isn't easy for a man with a

full-time job and family obligations. But CREI Home Study Programs make it possible for you to get the additional education you need without attending classes. You study at home, at your own pace, on your own schedule. You study with the assurance that what you learn can be applied to the job immediately.

CREI Programs cover all important areas of electronics including communications, radar and sonar, even missile and spacecraft guidance. You're sure to find a program that fits your career objectives.



NEW!
 Expanded coverage of solid state electronics including integrated circuits!

You're eligible for a CREI Program if you work in electronics and have a high school education. Our FREE book gives complete information. Mail postpaid card for your copy. If card is detached, use coupon at right or write: CREI, Dept. 1202H, 3224 16th St., N.W., Washington, D.C. 20010.

Founded 1927



CREI, Home Study Division
 McGraw-Hill Book Company
 Dept. 1202H, 3224 Sixteenth Street, N.W.
 Washington, D.C. 20010

Please send me FREE book describing CREI Programs. I am employed in electronics and have a high school education.

NAME _____ AGE _____

ADDRESS _____

CITY _____ STATE _____ ZIP CODE _____

EMPLOYED BY _____

TYPE OF PRESENT WORK _____ G.I. BILL

- I am interested in Electronic Engineering Technology
 Space Electronics Nuclear Engineering Technology
 NEW! Digital Communications

APPROVED FOR TRAINING UNDER NEW G.I. BILL

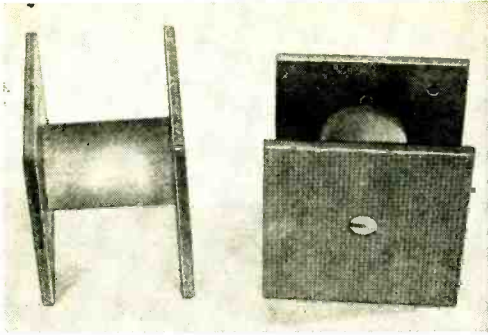

Fig. 3. Each Masonite section is $2\frac{1}{4}$ " square by $\frac{1}{8}$ " thick; wood dowel is $1\frac{1}{8}$ " long by 1" diameter.

the speaker mounting board. Mount the midrange speaker and woofer in their respective holes, as shown in Fig. 2.

Drill two holes in the rear plate of the midrange speaker enclosure, and mount a conducting bolt, two solder lugs, and a machine nut in each. Solder the leads from the midrange speaker to the solder lugs, and mark the lugs connected to the wire near the red dot. Anchor the rear plate to the enclosure, using two screws to each side, and seal the joint with aluminumized duct tape.

Solder a 3' length of zip cord to the woofer's terminals and another 3' length to the exterior solder lugs on the rear of the midrange speaker enclosure. This concludes the assembly of the basic enclosure.

Coil Assembly and Wiring. Fabricate the two coil forms according to the details provided in Fig. 3, using glue and screws for durability. When the glue sets, wind the coils. Coil *L1* (see Fig. 4) consists of 320 turns of #18 magnet wire, while coil

L2 consists of 128 turns of #18 magnet wire.

Start winding by feeding the free end of the wire through the hole in the coil form nearest the wood dowel. Then, layer wind the coil, working back and forth one layer at a time. When you have two layers wound, wrap with masking tape to prevent unraveling.

You will find that ten neat layers will suffice for *L1*, and four layers for *L2*. When each coil is fully wound, wrap two layers of masking tape over the windings, and bring the second free end of the

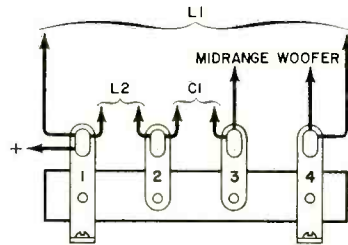
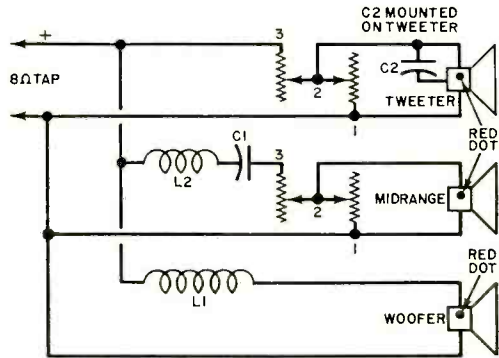
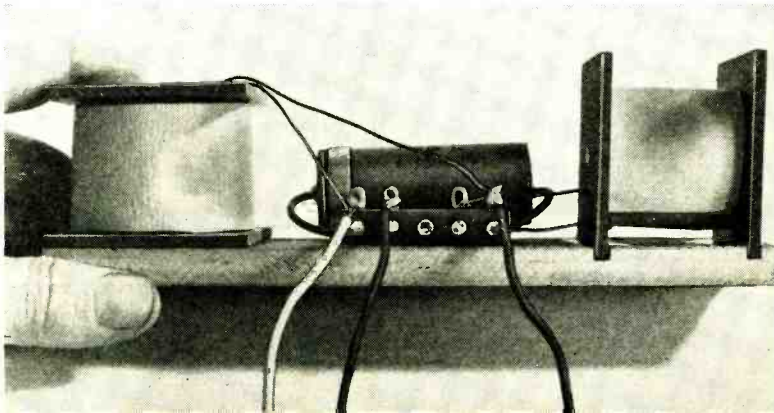

Fig. 4. Upper drawing is wiring diagram for entire system. Proper terminal strip wiring for crossover system is illustrated in lower drawing.

All elements in crossover network mount on a single board. From left to right are *L1*, *C1* and terminal strip, and *L2*. Note use of tongue-and-groove mounting for *L2*.



wire out through the remaining holes in the coil forms. Scrape away about $\frac{1}{2}$ " of the insulating enamel from the free ends of the coil windings.

Now prepare the mounting board for the crossover network. This board can be

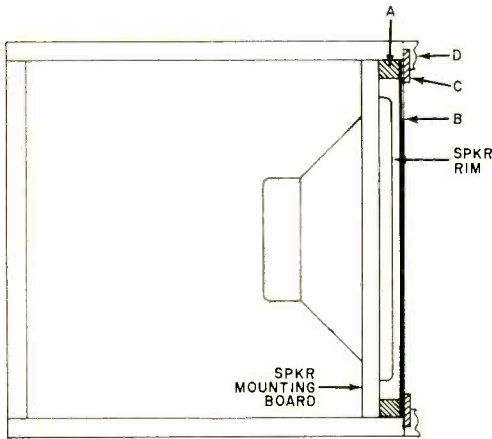

Fig. 5. In alphabetical order are the square pine frame, grille cloth, flat pine frame, and picture frame molding.

any scrap piece of $\frac{1}{2}$ "-thick plywood or pine, cut to dimensions of $8" \times 2\frac{1}{4}"$. After cutting the board to size, set *L1* and *L2* on it as shown in the photo on opposite page, and mark the outlines of both coil forms.

Remove and temporarily set aside the coils. Then cut two $\frac{1}{8}"$ by about $\frac{1}{8}"$ grooves in the mounting board to accept the edges of the *L2* coil form. Glue both coils in their respective locations, and mount *C1* and a four-lug terminal strip on the mounting board.

When the glue sets, wire the crossover network together as shown in Fig. 4, and mount the assembly on the inside surface of the enclosure's rear plate. Drill two holes for and mount the tweeter and mid-range speaker controls on the enclosure's rear plate, and wire the controls to the crossover networks. Then finish wiring the system, carefully observing the proper speaker polarities.

Connect the fully-wired speaker system to your amplifier, turn on the amplifier, and set the volume control to a low level. Check to see that the crossover networks are working properly. If satisfied, disconnect the amplifier, and loosely

(Continued on page 103)

Photo shows correct placement and orientation of all system components. Tweeter and midrange controls are at top of rear plate of enclosure (left in photo).

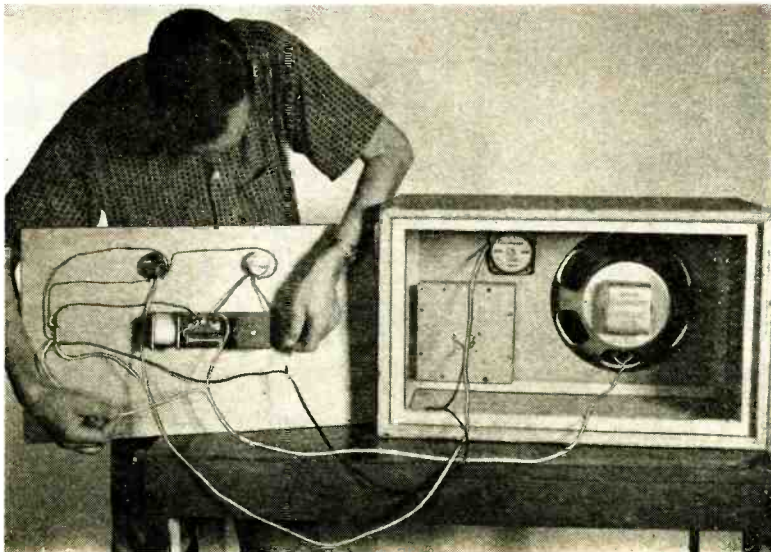

From A.C. to Zener

A BROAD-BASED QUIZ TO TEST YOUR KNOWLEDGE OF ELECTRONICS

(Answers on page 118)

BY VIC BELL

- 1 A secondary battery cell, unlike a primary cell can be recharged. TRUE_____ FALSE_____
- 2 Equalizing pulses are used in the broadcast TV signal for d.c. restoration. TRUE_____ FALSE_____
- 3 High-level demodulation, referring to color TV circuitry, means that only peak chroma information is demodulated. TRUE_____ FALSE_____
- 4 A cathode-filament short in the bandpass amplifier of a color TV receiver could cause a color hum bar to be seen only during color broadcasts. TRUE_____ FALSE_____
- 5 Saturable reactors are usually energized with a radioactive material such as Cobalt 60. TRUE_____ FALSE_____
- 6 Digital readout voltmeters for a.c. measurements are in the developmental stage. TRUE_____ FALSE_____
- 7 Mu-metal is a specially processed metal which has the ability to amplify. TRUE_____ FALSE_____
- 8 A gas voltage-regulator tube may be added to most power supply circuits parallel to the output capacitor if the series B+ resistor is adjusted accordingly. TRUE_____ FALSE_____
- 9 It is not necessary for a capacitor to be installed in some tank circuits. TRUE_____ FALSE_____
- 10 "Stagger-tuned" refers to any i.f. in which the tuning is non-critical or "sloppy". TRUE_____ FALSE_____
- 11 A "beat frequency" is one which no longer meets requirements in a system. TRUE_____ FALSE_____
- 12 The commonly used abbreviation for the image orthicon camera tube is I.O. TRUE_____ FALSE_____
- 13 DTL stands for digital transistor logic. TRUE_____ FALSE_____
- 14 The trinitron is the newest of the one-gun color picture tubes. TRUE_____ FALSE_____
- 15 A flying spot scanner is being employed by one manufacturer in its new color TV receiver line. TRUE_____ FALSE_____
- 16 A silicon diode assembly has been designed to replace the high-voltage rectifier in some color TV receivers. TRUE_____ FALSE_____



HOROSCOPE BY COMPUTER

20th CENTURY ELECTRONICS INVADES THE ANCIENT ART
OF ASTROLOGY

“ASTROLOGY, as I understand it, is a technique based on the *assumption* that there is a correlation between what happens here on earth (more specifically, the characteristics and life histories of individuals) and the motion of astronomical bodies. It does not postulate that the stars in any way control mankind and it does not postulate anything about predetermination; but it does emphasize that one has free will only within the limits of one’s circumstances. That briefly is my definition of astrology. I find that most people have quite an erroneous idea about it.”

Those are the words of Katina Theodossiou, astrologer and Director of Research for the Time Pattern Research

Institute. Unlike most astrologers, Miss Theodossiou and her organization use modern, high-speed digital computers in an attempt to bring order to astrological techniques and investigate the possible connections between man and the heavens.

Because astrology breeds a kind of superstitious mysticism, people are either strong believers or violent skeptics, with little or no middle ground. According to Miss Theodossiou, computerized techniques may someday prove or disprove astrology once and for all. To prove it, it will be necessary to show some order or pattern in the horoscopes of thousands of people who were born at exactly the same time in a wide range



First step in making horoscope is putting subject's birth data on punched card for use in the computer.

of geographical locations. (The latter is important because of the possible influence of environmental conditions.)

The proof of the validity of astrology would be even stronger if the date on which the people were born were one with particular astrological significance. For instance, on May 11, 1941, seven planets were in the sign of Taurus—a very unusual event. In the last few years, significant things should have happened to most of the people born on that day. Miss Theodossiou feels that she (or any other competent astrologer) could determine a great deal about the credibility of astrology if she could compare the vital characteristics of these people and what has happened to them over the years. To make such a study without the use of a computer for memory storage and rapid-fire correlation possibilities is of course impossible. It is the lack of such information that has hindered the growth of astrological techniques.

Through the use of infallible and instant-recall electronic memories, pertinent data could be stored, recalled when necessary, and compared to provide meaningful conclusions. A formula could be created for a particular time period showing how persons born in a specific period compare physically, emotionally, etc. Once these data were available, scientists could either prove or disprove the validity of astrology.

Basic Horoscope. A horoscope is a diagram showing the relative positions of the planets and the signs of the zodiac at the exact time and location of your birth. It is these relative positions that supposedly influence your emotions, traits, and, to an extent, your physical makeup. Supposedly, also, they provide information about your life span and indicate the times and dates of favorable and unfavorable happenings.

There are horoscopes of several levels of sophistication. The broad, general structure used mostly in newspaper columns does not take into account the location or exact time of a reader's birth and provides, as a result, only generalities. Monthly horoscopes published in many magazines are somewhat more refined but they still are very general. Personal horoscopes, prepared by an astrologer from personal data, provide the highest level of information.

The most exact horoscope can only be produced when the location of birth is known to within 60 miles (approximately one degree of latitude or longitude) and within 4 to 6 minutes of actual delivery time.

Manual Preparation. Hand-prepared horoscopes are time consuming and, therefore, expensive. Depending on the astrologer, prices range from tens to hundreds of dollars per horoscope.

In preparing a horoscope, the first step is to convert birth time to star time (sidereal). Then using this and the exact place of birth, the positions of the various stars and planets are determined from astronomical tables and plotted on

Magnetic memory tapes can store astrological and astronomical information covering many centuries.





Each of three memory discs holds 7½ million bits of horoscope information which is constantly updated.

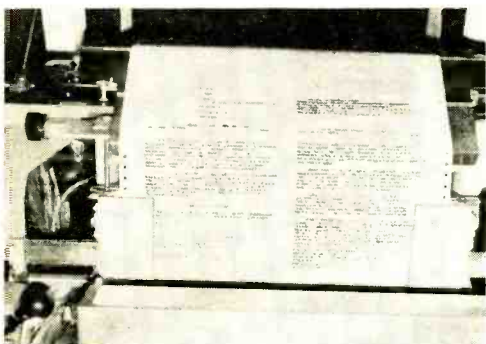

Horoscope is printed by computer at 10,000 words per minute—a week's job for a human astrologer.

CLASSIC DEFINITION OF ASTROLOGY

Astrology is the ancient art or science of divining the fate and future of human beings from indications given by the positions of the stars and other heavenly bodies. The study of astrology and the belief in it, as part of astronomy, is found in a developed form about 5000 years ago and formed the cornerstone of the Mesopotamian civilization. The Babylonians, descendants of the Sumarians—historically the first astrologers—erected great stone ziggurats (the first astronomical observatories) in the eighth century B.C.

Astrology spread to Greece about the middle of the 4th century B.C. and was in widespread use in Rome before the opening of the Christian Era. In India and China, astronomy and astrology largely reflect Greek theories and speculations. Similarly, both astronomy and astrology were actively cultivated in Egypt during the Hellenistic and Roman periods. Astrology was further developed by the Arabs from the 7th to the 13th centuries and in Europe, during the 14th and 15th centuries, astrologers were a dominating influence at court. Until the 16th century, astrology and astronomy were closely related. However, they were separated by the scientific revolution that occurred when the Copernican system of astronomy displaced Aristotelian physics.

According to some experts, there are probably fewer than 100 people in the Western world who can honestly claim to be masters of astrology. In every horoscope, there are at least 57 factors—stars, planets, signs, houses, aspects, and groupings, to name a few—which must be considered. All of these factors combine and interlock to influence each other in thousands of different ways.

the horoscope. The results are then interpreted through mathematics, consultation with various astrological tables and cross-correlations. When the horoscope is complete, it consists of a general interpretation and a forecast. It may take a week or more to prepare.

Computer Methods. The amount of data and information required to prepare a good horoscope is truly tremendous. The computer is invaluable in storing and sorting out the maze of combinations
(Continued on page 104)

After first pass through computer, data is re-entered with second programming to complete horoscope.

BORN	NEW YORK, N.Y.	04/04/1927	11 00AM	073 50 W	ZONE STANDARD-05-0	TIME ADJ-0-0	MALE	Z200007	
			ST= 23 52	40 40 N					
1--SUN--1	2-VENUS-2	3-MERCURY-3	4--MOM-4	5-SATURN-5	6-JUPITER-6	7--MARS-7	8-JIRANUS-8	9-NEPTUNE-9	0-PLUTO-0
L O N G I T U D E, BIRTH ARI-13-54 TAU-15-26 PIS-17-03 TAU-19-51 SAG-07-24 PIS-17-59 GEN-22-51 ARI-00-13 LEO-24-27 CAN-13-48 CAN1723									
PROG. TAU-23-20 CAN-03-13 TAU-17-23 SCD-05-00 SAG-05-13 PIS-26-25 CAN-16-35 ARI-02-14 LEO-24-13 CAN-14-42									
A L I G N E D BIRTH 10-266-31 11-298-03 09-239-40 11-301-28 05-140-01 09-240-36 12-335-28 09-252-50 02-037-04 01-356-25 PIS 28									
PROG. 11-305-57 12-345-50 11-300-00 04-107-37 05-137-50 09-249-02 01-359-12 09-254-51 02-036-50 01-357-19									
D E C L I N A T I O N . . . 8-05 P-18 8-17 P-26 8-06 P-16 8-14 P-09 8-20 P-19 8-06 P-02 8-25 P-24 8-01 P-00 8-14 P-14 8-21 P-21									
A S P E C T S 2 3 4 5 6 7 8 9 10 11 12									
1234567890 1234567890 1234567890 1234567890 1234567890 1234567890 1234567890 1234567890 1234567890 1234567890									
--P-PS--4 --SC-S--4S PS-54C--1 -CS-S--4S T-A--T-- PSCS--4--T S-4--A-4S --7-A-- --4-A--5 4ST-T--									
-4--4--P --CS-S-- --P--S-- --P--S-C-- 4S--C--									
-----C-----O-----C-----O-----C-----O-----C-----									

BUILD YOUR OWN POWER SUPPLY

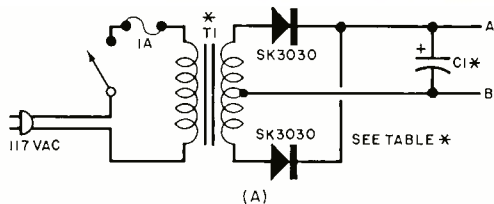

MANY READERS have asked us to print a circuit design for a power supply that would be simple yet would provide the unusual d.c. voltages that may be required in experiments and project constructions involving semiconductors. In answer to these requests, we suggest a circuit given in the *RCA Solid-State Hobby Circuits Manual*. (The handbook is available at most electronics parts distributors for \$1.75.)

Four building-block circuits are described—two transformer-rectifier units, a series regulator, and a shunt regulator. By using the proper transformer voltage and regulator, you can build a supply for any one of eleven voltages

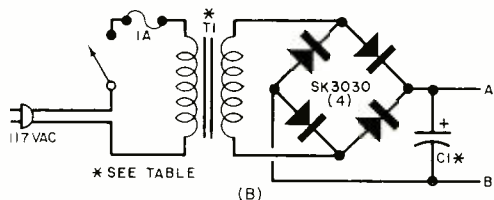

as shown in the table. The manual also describes circuit refinements and elaborations for building continuously variable supplies for the same voltage ranges.

The transformer-rectifier circuit shown at A can be used for power sup-

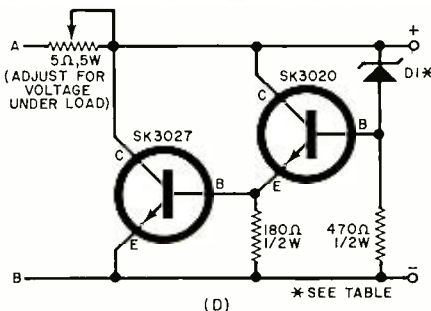
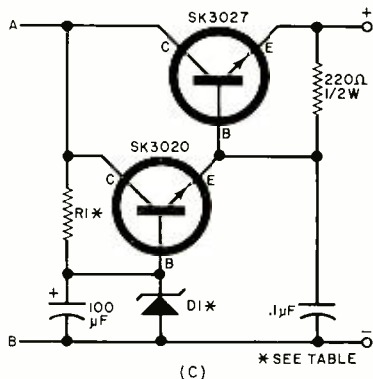

plies delivering 15 volts or less, while that at B is for 3- to 35-volt outputs. Below 15 volts, take your pick—two less rectifier diodes are required for circuit A.

The series regulator shown at C is for supplies delivering at least 6 volts; below 6 volts, use the shunt regulator, circuit D.

In any case, use a one-ampere fuse in the transformer primary. The transformer should have a 117-volt primary and a 1-ampere secondary rating at the voltage given in the table. A check of your electronics catalogs will show a number of transformers that fill the bill.

D. C. OUTPUT VOLTAGE	TRANSFORMER SECONDARY VOLTAGE (A) (B)	C1 μ F/VOLTS MINIMUM	REGU- LATOR CIRCUIT	D1 VOLTAGE RATING	R1 OHMS/WATTS	
3	12.6	6.3	2500/10	D	*	5/5
4.5	12.6	6.3	2500/10	D	3.3	5/5
6	20	10	4000/15	D	4.7	5/5
6	20	10	4000/15	C	7.5	390/1/2
9	30	15	4000/15	C	10	820/1/2
10	30	15	4000/25	C	11	680/1/2
12	30	15	4000/25	C	13	330/1/2
15	40	20	2500/50	C	16	680/1/2
18	—	22.5	2500/50	C	9.1 and 10 in series	1000/1/2
20	—	28.5	2500/50	C	11 and 11 in series	470/1/2
29	—	38	2500/50	C	15 and 15 in series	1200/1/2
35	—	40	2500/75	C	36	680/1/2

*Use 3 forward-biased SK3020 in series

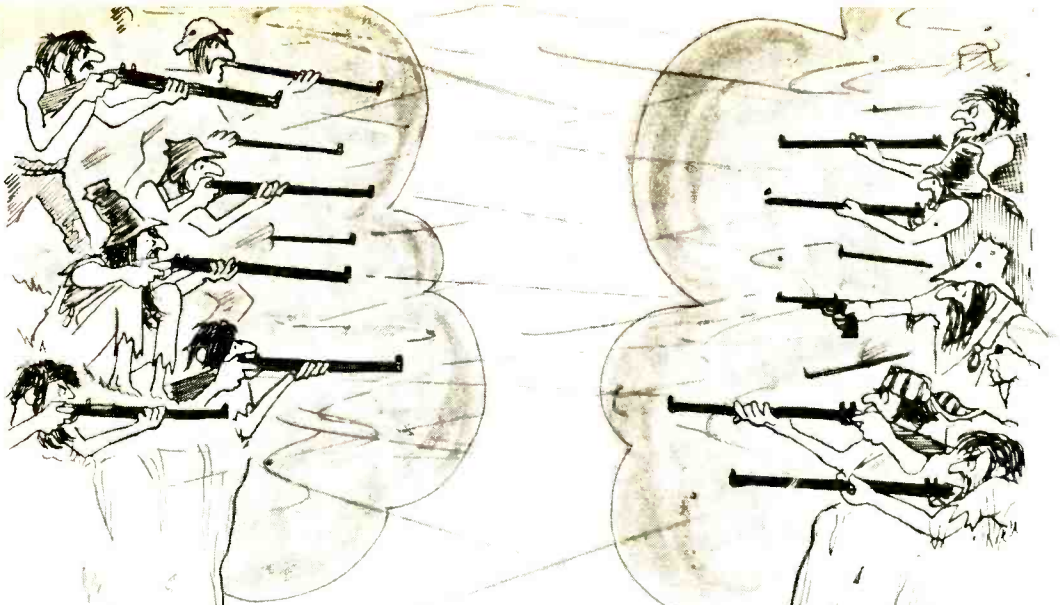

THE
HATFIELD HAMS
AND THE
CB M^CCOYS

*Is anybody
really
winning?*

FIVE YEARS ago the mere suggestion that the Citizens Band was good for amateur radio could get you tarred and

BY CAROLE H. ALLEN,
W5NQQ/K9AMD

feathered, and the least you could expect was the scorn of all the hams in the community. By now, tempers have cooled enough to permit reasonable discussion of the subject.

If you happen to be a new license holder, either amateur or CB, you may not know how this unfortunate feud got started.

Briefly, the Federal Communications Commission stirred up the ruckus on September 11, 1958, when it set up frequencies for a new Class D Citizens Radio Service and included the 11-meter band, which had previously been cherished by many hams. Since there was little to be done about it anyway, most amateurs grumbled but accepted the fact that 11 meters would now be used "for short distance radio-communication facilities for the business or personal activities of licensees" (Citizens Band'ers) according to Part 95, Volume VI of the Federal Communications Commission Rules and Regulations.

Unfortunately, within a year, hams saw two distinct groups of CB operators emerging. There were, of course, those law-abiding souls who used the new frequencies strictly for business and personal reasons. There was also another more gregarious group. They were rag-chewing like old-time two-letter-call hams, working skip stations whenever they could, bragging about running more power than the legal 5 watts input, and putting up antennas that couldn't possibly comply with the "20 feet above supporting structure" rule.

Hams felt that, while they studied Morse code and sweated over theory books in order to pass rigid FCC exams, some carefree CB'ers were enjoying ham privileges merely by filling out a form and waiting for the mailman to bring a license. Sure, it wasn't legal, but with the rapidly increasing number of CB stations compared to a handful of FCC monitors, expecting the violators to be heard and penalized was as likely as finding a contact lens in a haystack!

The Feud Begins. Enough was enough—amateurs and CB'ers squared off like the Hatfields and the McCoys. Those CB'ers who operated legally were lost in the shuffle and John Q. Ham regarded anyone with a long license number on

the rear window of his car as a mortal enemy. He felt that the FCC was loaded with traitors and that his only recourse after writing his Congressman was to reject the Citizens Band'er on a local level. The amateur bands cracked with bitter remarks such as "They're swapping QSL cards and showing contacts with skip stations that the FCC has said 'Thou shalt not work!'" Every amateur radio club meeting included at least one 30-minute tirade about the injustice



Hams turn purple when CB'ers assist police.

of the situation, and any reminder that rules and regulations are sometimes broken by hams themselves was drowned out.

This wrangling and resentment of CB or anyone who dared whisper "10-4" went on for years before some realistic hams started to face the facts. Amateur radio was no longer growing by leaps and bounds as it had immediately after World War II. Hams were not the only ones now with licenses, radio transceivers, and cars with whip antennas. The simple truth was that CB was booming but ham radio was not.

For years, hams had been a pretty exclusive group. They did little to destroy the myth that before getting a license and putting a station on the air you needed a very large piggy bank, a spa-

cious home, two limousines, and grey hair. In fact, most newcomers got little help or encouragement in getting their own licenses. Many ham clubs never gave theory or code lessons, and a newcomer was left to sink or swim on his own. If he did manage to get a license, he could attend the club meeting—if he cared to!

Hams See the Light. But with the handwriting on the wall and the decline of new people in the hobby, a change had to be made and soon. Clubs began extending a big hand of friendship to anyone with the least spark of interest; more classes were formed to teach code and theory; and campaigns were launched around the country to publicize the fun of hamming. Also concerned was the American Radio Relay League; it asked its affiliated clubs to roll out the welcome mat to members of local CB clubs and attempt a recruitment program. After all, anyone interested enough in electronics to get even a CB license and spend money on equipment and antennas might lean toward ham radio. Of course, some do and some don't.

Many persons who read thoroughly FCC Form 505 for a Citizens Band application before filling it out realize they only want to do the things specifically ruled out by Question 12. It reads, "If the station is to be used for voice communication, does applicant certify that it will not be used either for communication over a distance exceeding 150 miles or for the exchange of chit-chat, idle conversation, discussion of equipment, or hobby-type communications?" People who want to do these things are excellent prospects for amateur radio. Others, on bad advice, obtain CB licenses and spend money on equipment before learning that the rag-chewing and DX'ing they enjoy just isn't legal on 11 meters.

Although some hams have never smoked a peace pipe with the CB'ers, many hams do their best to welcome new people to their hobby whether they hold CB licenses or not. Actually, the two groups of licensees have several things in common. When a disaster such as a hurricane, tornado, flood, fire, or other tragedy disrupts regular communication, the Federal Communications Commission encourages both hams and CB'

ers to roll up their sleeves and get to work. Many hams do not know that the FCC rules specifically provide for the use of CB "in emergencies involving the immediate safety of life or property." Also, in FCC Bulletin 1001a entitled "How to Use CB Radio," the use of station-to-station CB calls for other public service ventures is quite clearly encouraged. For example, "assisting the police and fire department when requested, helping at parades, boat races, rallies, and charity events" are all recommended activities.

Public Service for All. Many hams turn purple with rage when they see a club assisting the police or helping at a public function without realizing that such ser-
(Continued on page 104)



It's (not) too late to bury the hatchet.

the product gallery

REVIEWS AND COMMENTARY ON ELECTRONIC GEAR AND COMPONENTS

50-WATT FM STEREO RECEIVER KIT (Knight-Kit Model KG-980)

Only a few years ago, the cost of a high-watt, high-power stereo receiver would have been considered beyond the budget of the average family. But, believe it or not Knight-Kit is presently marketing (through Allied Radio Corp., 100 N. Western Ave., Chicago, Ill. 60680) a 50-watt FM stereo receiver kit at the almost unbelievable price of \$139.95 (plus \$15.95 for an oiled walnut cabinet). At this price, anyone can build up a stereo system without cramping his budget.

Don't be misled into thinking that the Model KG-980 FM receiver kit is of inferior quality because of its low price. Price alone is not a yardstick for measuring quality and performance. For ease of assembly and operation, versatility, power output, and crystal-clear sound reproduction, the KG-980 belongs among the top three low-cost stereo receivers.

Three large printed circuit boards simplify wiring of the KG-980 and keep assembly time to a minimum. In addition, the "front end" and FM i.f. strip are supplied factory-wired and aligned to eliminate critical adjustments. The point-to-point wiring of the power supply and audio power output circuits present no difficulties, even for the novice kit builder.

The KG-980 incorporates complementary symmetry circuits in the audio amplifier to ensure stability. The amplifier section is transformerless and has the widest possible frequency and power response. Two r.f. stages in the tuner provide top sensitivity for stereo FM reception. Automatic stereo-mono FM switching, a stereo indicator light, and a tuning meter help to simplify operation of the receiver.

The Model KG-980 receiver has a wide array of controls, including rocker-type switches. Inputs include magnetic phono, ceramic phono (auxiliary), and tape monitor, while outputs are provided for two speakers, tape, and stereo headphones. In operation, no power is applied to the tuner, i.f./multiplex

SHORT-WAVE ANTENNA (Murch Electronics Model 86D)

Short-wave listeners are notorious for one particularly bad habit. They invariably buy a receiver that is many times better than the antenna they have strung out in the backyard. And, of course, they then complain that they aren't hearing any DX stations. If the same SWL put up one or more of the good antennas manufactured just for short-wave listening, he could recoup the investment in his Super-Doooper receiver.

Recently, your product reviewer uncovered a second SWL antenna that deserves considerable praise: the Model 68D manufactured by Murch Electronics, Franklin, Maine 04634. (The first was the Mosley SWL-7 antenna, as described in this column in May 1968.)

The Murch 86D is a dipole with a flattop section totalling 100 feet. This, admittedly, is pretty long; but it is part of the secret to the performance of the antenna. The antenna is fed from the exact center through a special matching section of twin-lead and coaxial cable. The lead-in is about 55 feet long and should not be shortened. It can be lengthened with more coax—up to maybe 10 or 15 feet.

We compared the Murch against a long-wire and a SWL-7. On 11 and 13 meters the SWL-7 was far the best, but on 16 meters, the 86D started to shine. On 19 and 25 meters it was a tossup between the three antennas, with the edge going to the SWL-7. At 31 meters and above, the long wire and 86D started to fight it out, leaving the SWL-7 far behind. On 60 and 90 meters, we heard DX that the long wire left down in the noise. And, much to our amazement, the 86D was also hot on the AM broadcast band.

Since the 86D sells for \$17.95 (assembled and postpaid) we consider it quite a bargain—but, oh, that 100-foot flattop. Make sure you can hang the 86D up before you buy it!

or tuning meter indicator lamp until the selector switch is set to TUNER. The receiver's audio preamplifiers are enclosed in a metal shield to keep induced hum to a minimum.

Circle No. 90 on Reader Service Page 15 or 115



KNIGHT-KIT STEREO RECEIVER

Two optional cabinets are available for the KG-980 receiver. One is a plain wrap-around, and the other is specially designed (photo above) to accept a top-mounting record changer. Clockwise from bottom left in photo at right are FM tuner, power transformer and filter capacitor, audio power amplifier circuits, and audio preamplifiers (enclosed by an audio shield). At center is i.f./multiplex board.

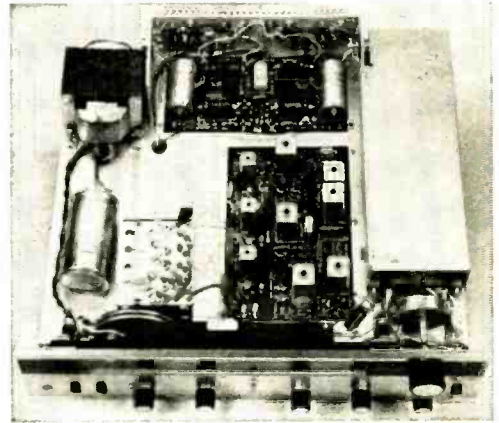

KG-980 TECHNICAL SPECIFICATIONS

Tuner Section:

Usable IHF sensitivity: $3 \mu\text{V}$
 Response: 30-15,000 Hz ± 1 dB
 Harmonic distortion: less than 1%
 Hum and noise: -50 dB
 Tuning range: 88-108 MHz
 Capture ratio: 3 dB

Image and i.f. rejection: more than 80 dB
 AM suppression: more than 30 dB
 Stereo FM channel separation: 30 dB

Amplifier Section:

Output power: 50 watts IHF (34 watts continuous sine-wave power at 8 ohms)
 Frequency response: 18-30,000 Hz ± 1 dB
 Power bandwidth: 20-20,000 Hz
 Input hum and noise: -65 dB Aux; -60 dB Mag. phono (RIAA equalized)
 Channel separation: more than 50 dB
 Output impedance: 4-16 ohms
 Damping factor: 50
 IM distortion: less than 1% at 60 Hz and 7000 Hz mixed 4:1 at rated power

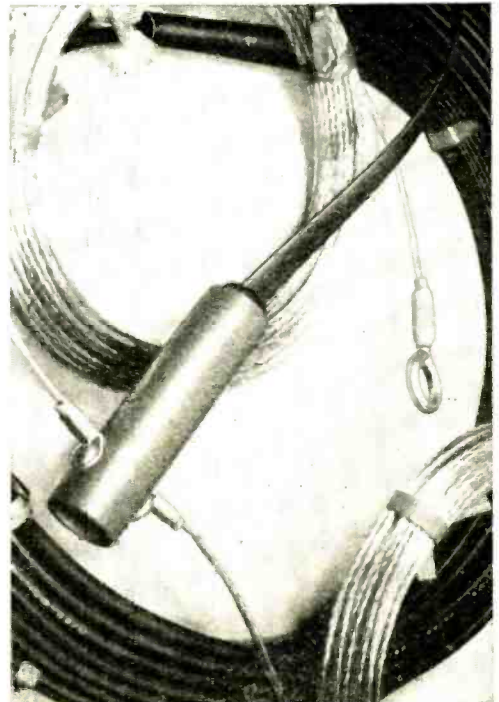

MURCH SHORT-WAVE ANTENNA

The antenna consists of a 100-foot dipole with twin-lead and coaxial cable for the lead-in to the receiver, about 55 feet. For its price, the performance, particularly on 60 and 90 meters, is excellent.

ENGLISH LANGUAGE BROADCASTS FOR THE MONTH OF FEBRUARY

Prepared by **ROGER LEGGE**

TO EASTERN AND CENTRAL NORTH AMERICA		TO WESTERN NORTH AMERICA	
TIME—EST	STATION AND LOCATION	TIME—PST	STATION AND LOCATION
	FREQUENCIES (MHz)		FREQUENCIES (MHz)
7:15 a.m.	Melbourne, Australia	8:00 a.m.	Tokyo, Japan
	9.58, 11.71		15.32, 17.84, 21.74
7:45 a.m.	Montreal, Canada	6:00 p.m.	Melbourne, Australia
	9.625, 11.72		15.235, 17.825, 21.64
5:30 p.m.	Copenhagen, Denmark	6:30 p.m.	Tokyo, Japan
	15.165		9.695
6:00 p.m.	Vilnius, USSR (Fri., Sun.)		Bonaire, Neth. Antilles
	9.675, 9.685		Johannesburg, South Africa
6:45 p.m.	Montreal, Canada	7:00 p.m.	London, England
	9.625, 11.945, 15.19		6.11, 7.13, 9.58
7:00 p.m.	Tokyo, Japan		Madrid, Spain
	15.445, 17.825		6.13, 9.76
	6.11, 9.58, 11.78		Peking, China
	9.685, 9.76, 11.87		15.095, 17.675, 17.795
	9.70		9.745, 11.765, 15.115
7:30 p.m.	Sofia, Bulgaria		15.43
	9.833, 11.91		Taipei, Taiwan
	9.705, 11.875, 15.22		15.125, 15.345, 17.89
	9.665, 9.685		15.18, 17.775, 17.88
	5.99		Yerevan, USSR (via Khabarovsk)
7:50 p.m.	Stockholm, Sweden	7:20 p.m.	(Tues., Wed., Fri., Sat.)
	6.125		Berlin, Germany
	9.615, 11.895, 15.285		5.93, 7.345, 9.63, 11.99
8:00 p.m.	Vatican	7:30 p.m.	Prague, Czechoslovakia
	9.50, 9.73		11.705
	9.525		Stockholm, Sweden
	7.12, 9.78, 17.713		6.20, 7.30
	5.93, 7.345, 9.54, 11.99		9.525
	6.01, 9.575		Havana, Cuba
8:30 p.m.	Rome, Italy	8:00 p.m.	Lisbon, Portugal
	6.12, 9.535, 11.715		6.025, 9.68, 11.935
	6.185, 9.64, 9.735		9.54, 11.85, 15.18
	9.59, 11.73		Moscow, U.S.S.R. (via Khabarovsk)
	6.20, 7.30, 9.50		15.095, 17.675, 17.795
	9.475		9.70
9:00 p.m.	Cairo, Egypt	8:30 p.m.	Sofia, Bulgaria
	6.025, 9.68, 11.935		Budapest, Hungary
	6.11, 7.13, 9.58		9.833, 11.91
	15.32, 17.84		Kiev, U.S.S.R. (Mon., Thu., Sat.)
	9.745, 11.765, 15.115		9.665, 9.685
9:30 p.m.	Beirut, Lebanon	8:45 p.m.	Berne, Switzerland
	11.785		6.12, 9.72
10:00 p.m.	Moscow, U.S.S.R.	9:00 p.m.	Cologne, Germany
	9.675, 9.70, 9.76		6.145, 9.545, 9.65
			Havana, Cuba
			9.525, 11.76
			Tokyo, Japan
			9.505
			Moscow, U.S.S.R. (via Khabarovsk)
			9.735, 11.85, 15.18
			Havana, Cuba
			11.93



ON THE CITIZENS BAND

By MATT P. SPINELLO, KHC2060, CB Editor

SMALL TOWN IN THE SPOTLIGHT

LIBERTYVILLE, Illinois, one of the smaller communities in the U.S. (population 9200), is situated north of Chicago's loop on Interstate Highway 94. It is a modern suburb that takes great pride in its school system, which is rated in the top 5% of the state. During a visit to the community, we monitored a CB dispatcher who handled incoming calls and made split-second decisions to guide his patrols, with the cool of a champion football quarterback. We decided that if this dispatcher were any indication, the CB operators in the area might also be rated in the top 5% of the state. An in-person gab session verified our suspicions.

Dispatcher Mike Whitmarsh can handle nine CB transmissions, request police support by telephone, and return to a discussion with your CB editor in two minutes flat—picking up where he left off as though there had been no interruption.

After our ten years of active use of the CB channels, monitoring CB from New York to San Francisco, we think 16-year-old Mike Whitmarsh is the smoothest CB operator we have ever tuned. Upon investigating Mike's attitude toward how Citizens Radio should be used effectively, we were not surprised to learn that he is president of Explorer Post #185. As dispatching coordinator for the post's Police Communications Patrol, Mike handles each and every transmission calmly, quickly, and intelligently. He tolerates no chit-chat or horseplay. Individuals from outside the team's communications link who are tempted to "break" into the patrol's activities are informed politely that the channel is being used for emergency action.

Police Explorer Post #185 acts as an extension to the Libertyville Police Department's communications and patrol force as needed or requested. The master control center is on the second floor of the police department and operates under the village CB license, KHC9774. The system is employed for municipal purposes during week-



Mike Whitmarsh, President of Explorer Post #185 in Libertyville, Ill., takes a breather during a six-hour CB patrol activity handling communications between seventeen mobile members of the CB team.



Police dispatcher Vi Miller relays information from Explorer Scouts to mobile police squads in field.

day hours, available to the Explorers after 4:30 p.m.

Mike and other Explorer Scouts have been actively involved with communications team activities for three years. They serve annually as a Halloween patrol group, generally with a minimum of 17 members, some on foot, armed with walkie-talkies, others in cars. Reports to Mike during "pumpkin patrols" are relayed to police dispatcher Vivian (Vi) Miller, who in turn sends police out when necessary.

Vi informed us that "they're a great bunch of guys," referring, of course, to Mike and his efficient team of mobile CB Explorer Scouts. Vi, to the "guys," is accepted as their honorary "den mother," and they treat her as such—to the extent that she is more commonly referred to as "Mom."



Members of Police Explorer Post #185 standby for assignments from group president Mike Whitmarsh as he receives request for assistance from other CB-equipped scouts who are on group's mobile patrol.

If there were a national award for the CB'er of the year, we would have to promote as many votes as possible for 16-year-old Mike Whitmarsh. KRK9684, Libertyville, Ill.

A New CB Generation? While thousands of juvenile-acting adults are cluttering the Citizens Radio Service band with nonsensical chit-chat, groups of adult-acting juveniles have been meeting "off the air" (an unidentified source reports) to discuss ways and means of educating the veteran CB operators in the proper use of radio through an understanding and application of the FCC's Rules and Regulations, Part 95.

The new generation admits there are problem children among CB'ers in their age bracket of 18 to 21 years. They are mainly perturbed, however, over reports during the last two years that attempt to put every

teenager in the category of "flagrant mis-user of the CB channels." Their educational program will aim at curbing the tactics of adult operators who "persist in reverting to grade school terminology" (use of code names, nonuse of FCC assigned license numbers as required by law, etc.).

Spokesmen for the group claim that one of the primary objectives is to clear CB of unfounded accusations by adult users that "the kids are creating CB's problems."

The mini-operators are claiming support of their movement by the younger CB generation in 27 states. In their attempts to prove that "juvenile attitudes" on the air have nothing to do with age, the groups have pledged 24-hour monitoring sessions by volunteering for individual air-check time periods. Another unofficial report states that certain radio distributors will supply blank tape to the group without charge to help them clear the air of adult shenanigans.

Adult mis-users of CB will be requested to police their own transmissions. If verbal requests fail, plans include forwarding recorded rules infringements to the FCC. During transmissions in which code names are employed to avoid detection, the groups will retaliate by employing direction-finding equipment (also said to be supplied by sympathizing distributors) to pinpoint the violators. Recorded segments will then be sent to the FCC accompanied by names, addresses, number of offenses by same licensee, and dates and times of the infringements.

The new generation will ignore the Communications Act of 1934 in which a "secrecy" clause protects current violators to the extent that it purportedly does not permit persons to divulge the contents of a transmitted radio message. The group feels that if CB violators can overlook present FCC regulations by breaking the law willfully, the youth group should be entitled to bend the law a little to help nab lawbreakers.

CB Jamboree in Florida. The Charlotte County Citizens Band Radio Club, Inc., will hold its Fourth Annual Jamboree on Feb. 2, 1969, from 10 AM to 6 PM at the American Legion Hall, Harbor Blvd., Port Charlotte, Fla. Camper space will be available for a small fee; motel reservations can be made by letting the committee know 3 weeks in advance. Trophies and prizes will be awarded for the largest club attendance, the oldest licensed CB'er present, and the CB'er who traveled the farthest to attend. For further information, write or call: Al Effrick, Chairman, KKP1006, P.O. Box 1673, Punta Gorda, Fla. 33950.

I'll CB'ing you,

—Matt, KHC2060



SOLID STATE

By LOU GARNER, Semiconductor Editor

A RELATIVELY simple, but effective, modification in transistor manufacturing methods has enabled Motorola Semiconductor Products, Inc. (P.O. Box 955, Phoenix, Ariz. 85001) to increase its yield rate and thus lower its production costs for some types of transistors.

Ever since the late 50's and early 60's, perhaps the most popular transistor production technique has been one involving gaseous diffusion and epitaxial deposition. In practice, thin wafers of crystalline semiconductor material are masked, etched, and exposed to various gaseous mixtures at relatively high, but carefully controlled, temperatures. These gases add impurity elements to the basic semiconductor wafer, or substrate, forming, in order, layers of *p*-type and *n*-type material and establishing the *p-n* junctions necessary to transistor operation. Special photographic masks are used to divide each wafer into small rectangular areas called *dice*, each of which represents a single transistor. Additional masks are used to define the collector, base, and emitter elements. The actual process, then, utilizes photolithographic selective etching and subsequent vapor diffusion carried out in alternate, but interrelated, steps. Later, after all process steps are completed, the wafers are cut into individual dice using a thin diamond-edged saw. Each die is mounted on a *header*, lead wires are attached to the various electrodes, and, after testing, the resulting device is sealed in a small metal can or molded into an epoxy (plastic) package.

Until recently, virtually all semiconductor manufacturers used round wafers in the production process, since they were the natural result of slicing across a standard, cylindrical, grown crystal ingot. But a round shape is not the most efficient form from a production viewpoint. The expensive induction furnaces used for vapor diffusion have rectangular work areas and round wafers waste a lot of useful space. In addition, many of the transistor dice around the edge of the circle are cut by its circumference, thus wasting the semiconductor material itself, as illustrated in Fig. 1. The amount of

waste depends on the size of the individual die and the diameter of the wafer, but it averages about 35%.

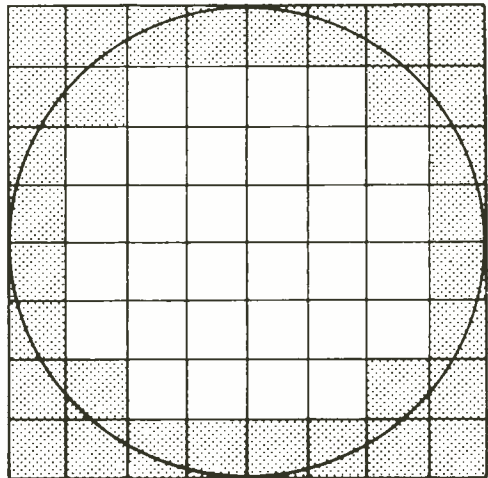

Fig. 1. Shaded areas show how transistor dice are wasted when the wafer is round instead of square.

Motorola's new technique involves a shift from round to square (or rectangular) wafers. Typically, the process starts with a crystal ingot approximately 2.8 inches in diameter. The crystal is trimmed to produce a 2" x 2" x 6" block. This block is sliced longitudinally with a diamond bandsaw to make thin 2 x 6-inch slabs which, afterwards, are lapped and polished to the proper thickness. The whole face of each resulting polished wafer is usable for transistor dice, as shown in Fig. 2. Any waste resulting from trimming of the rough crystal ingot



Fig. 2. The 2" x 6" slab at right provides great savings in basic material compared to disc, left.

can be recycled for use in the manufacture of other semiconductor devices.

A secondary advantage of the new rectangular format is a reduction in losses due to accidental damage. If a 2" x 6" wafer breaks or cracks, any parts remaining that are at least two inches square can be processed normally. This contrasts with round wafers, in which a split or crack in the edge complicates masking and generally requires that the whole wafer be discarded.

The new wafers are being used initially in epitaxial-base silicon power transistors, including Motorola's extensive line of complementary transistors for outputs of up to 100 watts. Among the transistors being produced this way are those in plastic *Thermopad* packages, which contain dice as large as 0.200" square, and some metal-cased types utilizing dice as large as 0.275" square.

In the future, it is likely that other lines of semiconductor devices will use the large rectangular wafers. Integrated circuits, and particularly LSI units, are well suited to this type of improved production technique.

Reader's Circuit. "I enclose an AM transmitter circuit which I designed and built for a wireless phonograph. You probably receive a lot of phone oscillator circuits, but this one is different." Thus started a recent letter from reader Gary McClellan of La Habra, Calif. Gary is right—his circuit, shown in Fig. 3, is *different*. The overwhelming majority of "home broadcaster" circuits use modulated oscillators, with one or more stages of audio amplification, and almost all of them have performance limitations, since a modulated oscillator is not overly stable. Frequency modulation as well as amplitude modulation may be present, and the circuit's basic frequency may shift with higher modulation levels or changes

in antenna loading. Gary's circuit, on the other hand, has a modulated buffer amplifier between the r.f. oscillator and the antenna, thus insuring greater overall stability. His basic concept is similar to that used in the design of commercial transmitters.

Referring to the schematic diagram, *Q1* serves as a modified Hartley oscillator, with its basic operating frequency determined by tuned circuit *L1-C1*. The r.f. signal is coupled to the buffer amplifier (*Q2*) by interstage capacitor *C2*. A common collector load, *R1*, is used for both the buffer and modulator (*Q3*) stages, with the modulated r.f. signal appearing across this load coupled to the antenna through isolation capacitor *C3*. Audio input is via coupling capacitor *C4*.

Gary has used inexpensive, readily available components in his design. All resistors are half-watt types. *C5* is a 15-volt electrolytic, and *C4* may be either a low-voltage ceramic disc or a tubular paper capacitor. Inductor *L1* is a standard tapped broadcast-band oscillator coil, while a single battery or series-connected penlight or flashlight cells furnishing from 9 to 12 volts may be used for the power supply, *B1*.

Although good wiring practice should be observed, with all r.f. signal-carrying leads kept short and direct, the circuit's overall layout and lead dress are not especially critical. The unit can be assembled on an etched circuit or perf board or even on a conventional metal chassis, as preferred. Breadboard assembly may be used for demonstration of Science Fair applications.

In operation, the audio signal source is connected to the input terminals through a shielded cable. Adequate drive may be obtained from a high-output crystal or ceramic cartridge or from a conventional

(Continued on page 94)

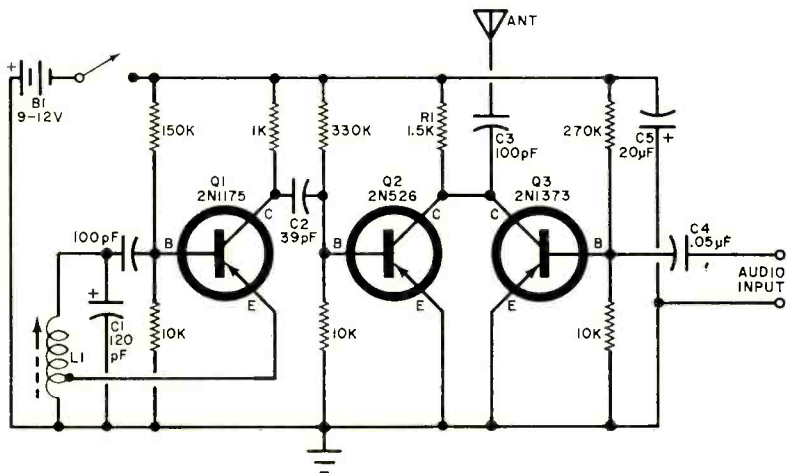

Fig. 3. Unusual AM transmitter circuit has modulated buffer amplifier to improve overall stability of audio system.



SHORT-WAVE LISTENING

By **HANK BENNETT**, W2PNA/WPE2FT
Short-Wave Editor

BONAIRE NOORD

RADIO NEDERLAND'S own relay station, *Bonaire Noord*, is rapidly nearing completion, as this is being written. The first 300-kW transmitter is probably now on the air; the second is expected to be ready for testing during February. Frequencies for these tests include 6085, 9590, 11,730, 15,320, and 17,810 kHz. Listeners in North, Central and South America are especially urged to report the tests on 6085 kHz as they will be relaying the medium-wave 800-kHz outlet with an omnidirectional antenna. The scheduled English transmission to Spain at 2130 GMT on 17,810 kHz is for test purposes only and will be replaced with Spanish as soon as *Bonaire Noord* is fully operative. Radio Nederland also reports that its Madagascar (Malagasy) project is now definite and will be in operation in 1971. It will probably be a duplication of the new Bonaire facilities.

Trans World Radio. This station has a special program for DX clubs to keep them up to date on frequencies currently in use by TWR. As we go to press, the times and frequencies for this DX special are: from Bonaire on Friday at 1105 GMT on 11,820 kHz to N.A. and at 2100 on 15,435 kHz to Europe. Repeated on Saturday and Sunday at 0335 on 9695 kHz to N.A. From Monte Carlo on Saturday at 0610 on 7290 kHz to Europe. The latter 41-meter channel, while not beamed to N.A., is generally well heard along the East Coast and into the Midwest.

CBS and WNYW. The CBS Radio Network has announced affiliation with Radio New York Worldwide, Inc. to permit transmission of network programming to Europe, Africa and Latin and Central America. This service, already in effect, is expected to send some 85% of the broadcasts of the CBS

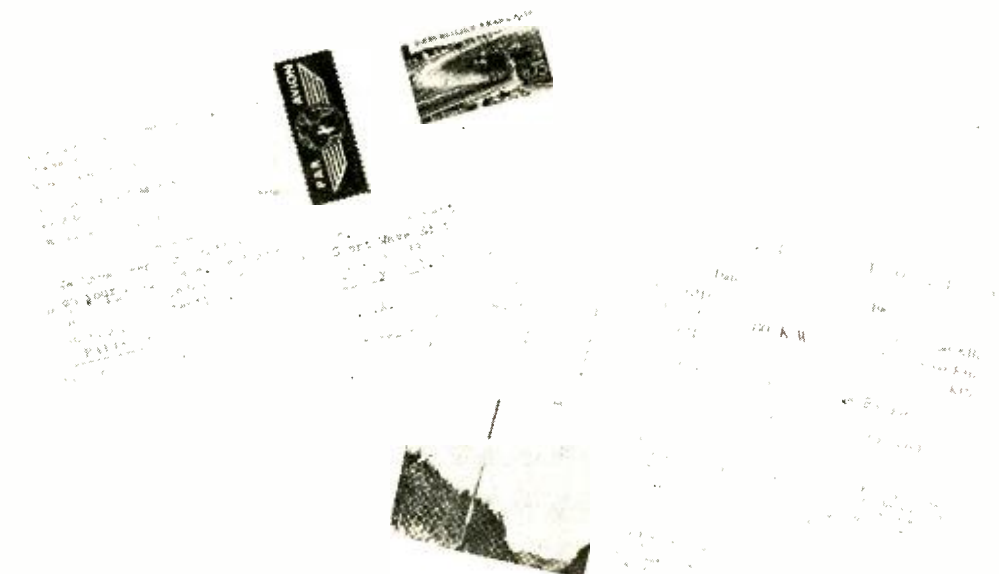

This is a QSL card received from Euzkadi Irratia (Radio Euzkadi), a clandestine short-wave station operating with 80 kW on 13,250 and 15,080 kHz. The location is probably in extreme southern France.

DX COUNTRY AWARDS PRESENTED

To be eligible for one of the DX Country Awards designed for WPE Monitor Certificate holders, you must have verified stations in 25, 50, 75, 100, or 150 different countries. ("Letters of Certification" will be issued to those who have over 150 countries verified in steps of 10.) The following short-wave DX listeners have recently qualified for and received their Country Awards.

25 COUNTRIES VERIFIED

Ronnie Clark (WPE4JRX), Savannah, Ga.
Miss Barbara Kay (WPE2PTD), Union, N. J.
Rick Shindle (WPE3HQK), Waynesboro, Pa.
Fred Lynch (WPE9JHD), Girard, Ill.
Brian Morrow (WPE2QCC), Massena, N. Y.
Sam Chmell (WPE9ITW), Elmwood Park, Ill.
Paul Burgess (WPE8JFB), E. Cleveland, Ohio
Robert Guinter (WPE2QIZ), Morristown, N. J.
Howard Kreutzberg (WPE1HDO), Mystic, Conn.
James Wilson (WPE3HPQ), Norristown, Pa.
Ronnie Foltz (WPE4JDL), Winston-Salem, N. C.
Arvidas Jarasius (WPE9JFS), Lansing, Ill.
Mark Ondrejko (WPE8JIQ), Maple Heights, Ohio
Thomas Lamphere (WPE2QDB), Johnson City, N. Y.
Daniel Polansky (WPE2QFH), Rochester, N. Y.
John Hames (WPE8IHP), Kettering, Ohio
Fred Osterman (WPE2QEU), Williamsville, N. Y.
Ron Wicks (VE5PE6B), Cut Knife, Sask.
Ernest Cote (WPE1HKX), Milford, N. H.
Raymond Burlison (WPE6HBA), San Jose, Calif.
Allan Keizer (WPE2QCS), Brooklyn, N. Y.
Lee Boggus, Jr. (WPE4JLC), Atlanta, Ga.
John Gibson, Jr. (WPE3HNM), Philadelphia, Pa.
Joseph Breton (WPE1HKW), Methuen, Mass.
Jeff Wilson (VE3PE2NL), Sarnia, Ont.
Andrew Borson (WPE2QEV), Plainville, N. Y.
Richard Du Shane (WPE8JNB), Flint, Mich.
Robert Dunlap (WPE8JWF), Coshocton, Ohio
Neil Sommerfield (WPE4JTX), W. Palm Beach, Fla.
Joel Dennis (WPE3HJJ), Shickshinny, Pa.
Chris Plescia (WPE1HAX), Meriden, Conn.
Richard Carstensen (WPE8JEQ), Troy, Ohio
E. V. Hulse (WPE3HMD), Catonsville, Md.
Rudolph Menna (WPE3HIV), Philadelphia, Pa.
Edward Nemeroff (WPE2QGR), Brooklyn, N. Y.
Martin Miron (WPE8JTN), Warren, Mich.
John De Angelis, Jr. (WPE3HDD), New Castle, Pa.
Ron Budziack (WPE9JHK), Cicero, Ill.
Ronald Christen (WPE2NZJ), Cheektowaga, N. Y.
Jay Miller (WPE4JQV), Memphis, Tenn.
Robert Asbury (WPE2PYT), Williston Park, N. Y.
John Jordan (WPE9HVP), Elmhurst, Ill.

50 COUNTRIES VERIFIED

Tom Taggart (WPE8IHL), Lakewood, Ohio
Jim Homan (WPE0EUS), Florissant, Mo.
Arthur Harris (WPE2MJS), Hollis, N. Y.

Jim Kowalski (WPE9GZB), Two Rivers, Wisc.
Mike Esposito (WPE2MFO), Brooklyn, N. Y.
Alvin Pollock (WPE4IRE), Clinton, N. C.
John Zaharek (WPE1GUM), Torrington, Conn.
Robert Hagerman (WPE8INH), Hemlock, Mich.
Richard Spear (WPE3HEI), Baltimore, Md.
Robert March (VE7PE1CF), Victoria, B. C.
Edward Hula, Jr. (WPE4IKD), Merritt Island, Fla.
Eric Lebowitz (WPE2JJY), Jackson Heights, N. Y.
Alfred Wirtenberg (WPE2GDS), Bronx, N. Y.
John Beckerle (WPE0EZD), Saint Charles, Mo.
David Conder (WPE9IHV), Centralia, Ill.
John Mraz, Jr. (WPE3HIT), Phoenixville, Pa.
Victor Tan Yew Seng (9V1PE1B), Raffles Park, Singapore
Jurgen Durst (DJ3PE1A), Frankfurt, West Germany
Barry Woodyard (WPE8JVP), Norwalk, Ohio
Douglas Meyer (WPE2OUS), New Rochelle, N. Y.
Glen Whitney (WPE6GQY), Canoga Park, Calif.
Harry Smith (WPE6IHZ), Springfield, Ohio
Carl Bruesch (WPE1HJK), New Canaan, Conn.
Walter Poppinga (WPE9CBC), Lafayette, Ind.

75 COUNTRIES VERIFIED

Roger Thering (WPE6FUB), Barstow, Calif.
David Meisel (WPE4IRS), Charlottesville, Va.
Don Billingsley (WPE6GXM), Sacramento, Calif.
Trevor Clegg (WPE6FAF), Fresno, Calif.
Leo Baca (WPE5CLR), E. Bernard, Texas
Robert Ulmer (WPE2LRG), Bloomfield, N. J.
Marion Lilienthal (VE3PE2DO), Waterloo, Ont.
Donald Gross (WPE7CQX), Roseburg, Ore.
Steve Kennedy (WPE4IAX), Sarasota, Fla.
Dean Hanson (WPE6MF), Redwood City, Calif.

100 COUNTRIES VERIFIED

Fred Noakes (VE2PE2E), Montreal, Que.
Jack Lane (WPE9EVU), Lafayette, Ind.
Richard Pistek (WPE9HOA), Chicago, Ill.
Reg Firth (WPE2GFO), Amsterdam, N. Y.
Robert French (WPE8FGH), Bellaire, Ohio
Timothy Armstrong (WPE6GGJ), Suisun, Calif.

150 COUNTRIES VERIFIED

Charles Mattered (WPE6DGA), San Leandro, Calif.
Mike Mandrick (WPE2GVF), Rochester, N. Y.
Gary Ligon (WPE4JAX), Cliffside, N. C.
Robert Eddy (WPE8EQW), Newport, Ohio

network overseas through the facilities of WNYW's five high-power transmitters located at Scituate, Mass.

Do You Need Hong Kong? Dx'ers needing the crown colony of Hong Kong should check the aeradio channels for the colony's only short-wave outlet. The station, in Kowloon, operates 10 and 40 minutes past each hour on 2980, 5574, and 8905 kHz and it verifies with no return postage required. A good way to lock onto the right channel is to tune for Oakland, Calif., aeradio on the same frequencies for its broadcasts at five and 35 minutes past the hour. Hong Kong follows immediately after Oakland's broadcasts.

DX Zone Awards. The first of the DX

Zone Awards have been issued. Recipients of the first award in each of the four categories were: John Sawhill, Jr., WPE1GPN, New Canaan, Conn. (10 zones); Paul Slater, WPE1FRT, Medford, Mass. (20 zones); Paul Kilroy, WPE3FOB, Washington, D.C. (30 zones); and James Young, WPE6ENA, Wrightwood, Calif. (40 zones). To avoid any misunderstanding, the first award in each category was based on the first qualifying list with the earliest postmark. Check with the 1969 COMMUNICATIONS HANDBOOK for full details on the Zone Award requirements. The HANDBOOK also contains a new country and zone listing.

Reports to Radio Peking. A note from the postmaster at San Francisco, concerning a
(Continued on page 99)

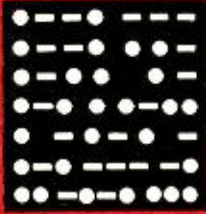

AMATEUR RADIO

HERB S. BRIER, W9EGO
Amateur Radio Editor

AMATEUR RADIO IN RUSSIA

TEN PER CENT of the approximately 15,000 Russian amateur radio operators are women. (It should be noted that the figure of 15,000 is the number of call letters assigned to clubs and individuals. If we include SWL's who are authorized to transmit at club stations, the total number of amateur radio operators is considerably larger.) Before getting a license, each prospective Russian amateur must pass an "SWL" examination consisting of a 10-WPM code test and a technical exam. Then he or she must spend six months as an active short-wave listener. At this point he is eligible for the 3rd class amateur exam, consisting of a

12-WPM code test and another technical exam. Third-class amateurs operate on 80 and 40 meters CW with 10 watts power.

Next step up is the 2nd class license which authorizes use of CW on all Russian amateur frequencies except 15 meters and phone on 10 and 20 meters with 40 watts of power. At the top of the Russian amateur structure, the 1st class license requires passing an 18-WPM code test and a stiff written exam. It authorizes all Russian amateur privileges, including transmitter power of 200 watts (sometimes more).

There is a good bit of Russian amateur VHF work but little teletype or TV. Phone

AMATEUR STATION OF THE MONTH



One difficulty with the 7th and 8th grade science classes at the El Roble School, Claremont, Calif., is that the students don't want to leave after class is over. And they want William L. Manley, who teaches the class and is also trustee of the El Roble Amateur Radio Club station WA6ERX, to stay with them so that they can operate the station and study for amateur licenses. Bill has helped at least 50 youngsters—and oldsters, too—to get their licenses. The club's Heathkit DX-60 transmitter and HR-10 receiver have been used to work 45 states and many foreign countries. We are sending Bill Manley and the El Roble Amateur Radio Club a 1-year subscription to POPULAR ELECTRONICS for winning this month's Amateur Station Photo Contest. You can enter the contest by sending a clear photograph (preferably black and white) of yourself at the controls of your station, including some details about your amateur career, to Amateur Radio Photo Contest, c/o Herb S. Brier, Amateur Radio Editor, POPULAR ELECTRONICS, P.O. Box 678, Gary, Ind. 46401.

is fairly popular, but CW is the big thing. The average Russian amateur is a good operator; however, the signal quality of their largely home-constructed transmitters is not always the best. As a group, Russian amateurs are very interested in contests. Especially popular are hidden transmitter hunts in which the hunters are afoot and carry all their equipment on their backs! In addition, they participate in all the normal types of operating activities



Henry Kirk, WA3DZE, Muncy, Penn., must like Heathkit equipment. However, a Hallicrafters HA-1 electronic keyer; Ham-M beam rotator; and an Astatic D-104 microphone appear amid the SB-110A 6-meter transceiver; SB-401 transmitter; SB-301 receiver; SB-201 linear amplifier; and other Heathkit gear.

February Operating Events. ARRL Novice Roundup: 6:00 p.m., local time, February 1, until 6:00 p.m., local time, February 16, Novices may operate a total of 40 hours on any or all Novice frequencies to work as many stations as possible in the different ARRL sections. Exchange contest numbers and the names of ARRL sections (see front of any QST for your section) with each station worked. Final score equals the number of stations worked, plus the highest code speed indicated on the contestant's ARRL Code-Proficiency certificate, multiplied by the number of different sections worked. High Novice scorers in each section will be awarded certificates. Although only Novices are eligible to win certificates in the Novice Roundup, all other amateurs are invited to work the Novice participants. Novice Roundup score sheets and an ARRL section map are available upon request from the Communications Department, American Radio Relay League, Inc., 225 Main St., Newington, Conn. 06111.

ARRL DX Contest: Phone: 0001, GMT, February 1, to 2359, GMT, February 2; and 0001 GMT, March 1, to 2359, GMT, March 2. CW: 0001 GMT, February 15, to 2359 GMT, February 16; and 0001, GMT, March 15, to 2359, GMT, March 16. In

this umpteenth return of the world's first amateur DX contest. United States and Canadian amateurs work the world (including Alaska and Hawaii). They earn one point for sending a signal report and the name of their state or province to each station worked. They earn two points for receiving their signal report and the other station's power input from each station worked. A maximum of three points may be earned by working the same station on each band, but it may be worked again for additional points on another band. A participant's total score equals the sum of his QSO points multiplied by the sum of the different countries worked on each band.

If you hope to run up a big score in the ARRL DX Test, we suggest asking ARRL (address above) for official log and check sheets, because incorrectly prepared scores will not be considered for a winner's certificate.

News From Here and There. Warning to all amateur (and CB) clubs. The Rochester, N.Y. Post Office balked at handling the September, 1968 issue of the *RaRa Rag*, published by the Rochester Amateur Radio Association, because the paper included a hamfest announcement which listed "door prizes" as a feature of the affair. Door prizes, raffles, chances, etc., violate anti-lottery laws and cannot be legally pub-



Not all the QSL cards in this shot were earned by Stuart Hacken, WA2BBS, South Ozone Park, N.Y., on the VHF's with Gonset G-50 and Heathkit "Tower" transceivers. Other hams in family are father Arnold, WB2PPA, and brother Dave, WB2PPB.

licized by U.S. Mail! Consequently, the club officials were forced to pick up all copies of the *Rag* from the Post Office, unstaple each one, black out the offending words, restaple the papers, and return them to the Post Office for remailing.

Ethel Smith, K4LMB, writing about the annual Amateur Radio Emergency Corps Simulated Emergency Test (SET), sched-

(Continued on page 97)

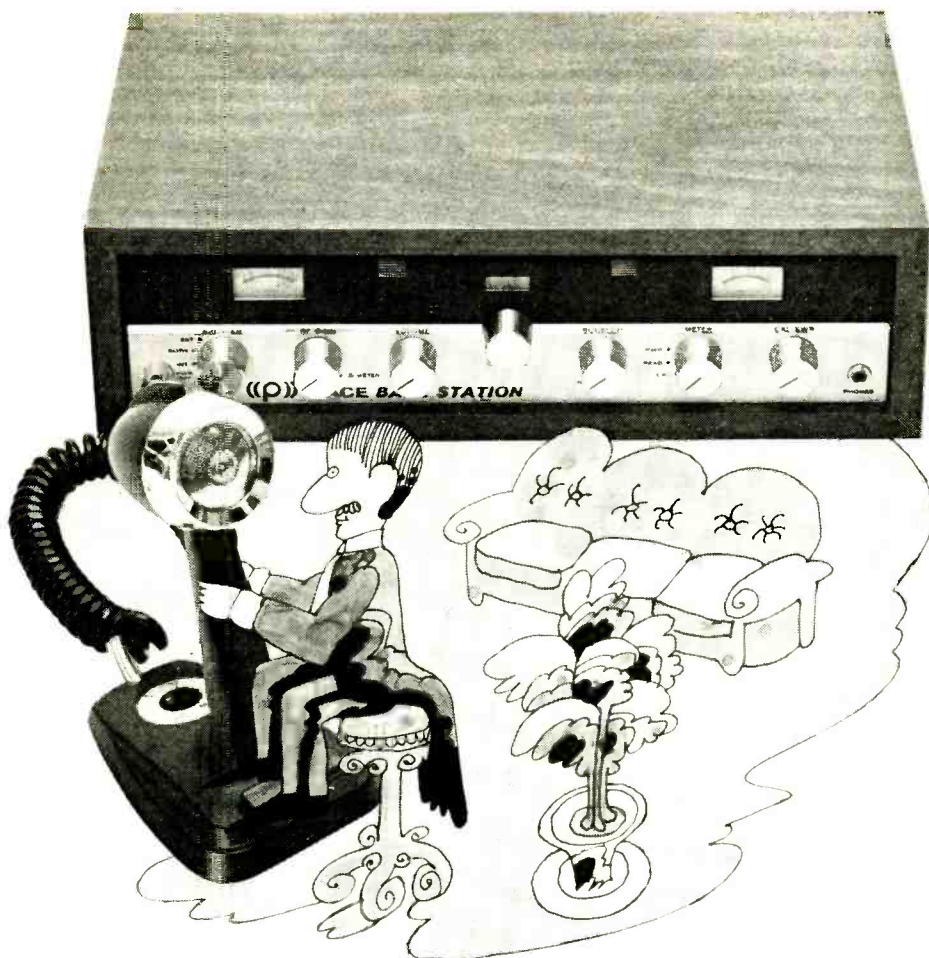

conversation piece.

Just look at the Pace Base! Forget for a second that it's the complete CB two way radio that needs no extras. What makes it more unusual is how it looks. So attractive, so decorative. With wood grained cabinet and elegant over-all appearance, even the lady of the house likes to have

it around. The Pace Base Station is neat—and complete. Included in one unit are standing wave ratio meter, power meter, S meter and variable output control mike. All for \$330.00.

See your electronic dealer or write us.

((P)) PACE COMMUNICATIONS CORP.
a NOVATECH company

24049 S. Frampton Ave., Harbor City, California 90710
ENGINEERED WITH THE ENGINEER IN MIND

"Performance-Plus" Kits For Home And



NEW
kit AD-27
\$169⁹⁵

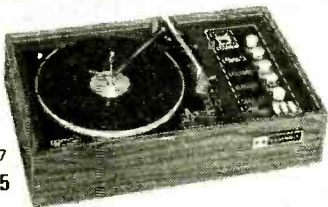

NEW
kit AD-17
\$109⁹⁵

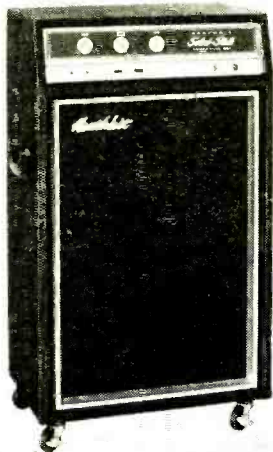

NEW
kit TA-38
\$225⁰⁰



NEW
kit GR-58
\$47⁹⁵

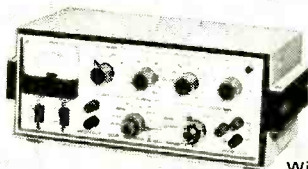

NEW
kit IG-18
\$67⁵⁰
Wired IGW-18
\$99⁵⁰

HEATHKIT AD-27 FM Stereo Compact

The new Heathkit "27" Component Compact was designed to change your mind about stereo compact performance. How? By sounding as if it were made of top quality stereo components... which in fact it is. Heath engineers took their highly rated AR-14 solid-state Stereo Receiver, modified it physically to fit the cabinet, and matched it with the precision BSR McDonald 500A Automatic Turntable. Performance? Here's the AD-27 in detail. The amplifier delivers 30 watts music power... 15 honest watts per channel — enough to drive any reasonably efficient speaker system. Response is virtually flat from 12 Hz to 60 kHz, and Harmonic & IM distortion are both less than 1%, at full output. Tandem Volume, Balance, Bass & Treble controls give you full range command of all the sound. Select the FM stereo mode with a flick of the rocker-type switch and tune smoothly across the dial, thanks to inertia flywheel tuning. You'll hear stations you didn't know existed in your area, and the clarity and separation of the sound will amaze you. The adjustable phasing control insures best stereo separation at all times. And the automatic stereo indicator light tells you if the program is in stereo. AFC puts an end to drift too. The BSR Automatic Turntable has features normally found only in very expensive units, like cueing and pause control, variable anti-skating device, stylus pressure adjustment and automatic system power too. Comes complete with a famous Shure diamond stylus magnetic cartridge. The handsome walnut cabinet with sliding tambour door will look sharp in any surroundings, and the AD-27 performs as well as it looks. For the finest stereo compact you can buy, order your "27" Component Compact now. 41 lbs.

HEATHKIT AD-17 Stereo Compact

Using the component approach of the AD-27, Heath engineers took the solid-state stereo amplifier section of the AD-27, matched it with the high quality BSR-400 Automatic Turntable and put both of these fine components in a handsomely styled walnut finish cabinet. The result is the "17" — featuring 30 watts music power, 12 Hz to 60 kHz response, auxiliary & tuner inputs, less than 1% Harmonic & IM distortion, adjustable stylus pressure & anti-skate control and much more. Order your "17" now. 27 lbs.

HEATHKIT TA-38 Solid-State Bass Amplifier

The new Heathkit TA-38 is the hottest performing bass amp on the market, for quite a few reasons. First, there's all solid-state circuitry for reliability. Then there's the tremendous power — the TA-38 puts out 120 watts of EIA music power, 240 watts peak, or 100 watts continuous. Extremely low harmonic & IM distortion too. Many amps suffer from "blow-out" problems, but not the new TA-38 — YOU CAN'T BLOW IT... it boasts two 12" heavy duty special design speakers with giant 3 pound 6 ounce magnet assemblies mounted in a completely sealed, heavily damped ¾" pressed wood cabinet — those speakers will take every watt the amp will put out, and still not blow. Sound? The TA-38 is tailored to reproduce the full range of bass frequencies delivered by bass guitars and its sound with combo organs and other instruments is remarkable. Easy 15 hour assembly to the wildest bass amp on the market. Order one now and surprise the guys with the high-priced gear. 130 lbs.

HEATHKIT GR-58 Solid-State AM/FM Clock Radio

The easy way to get up in the morning. Choose the morning news & weather on AM or the bright sound of FM music. AFC makes FM tuning easy. The "Auto" position on the Telechron™ clock turns only the radio on, or use the "Alarm" setting for both the radio and the alarm. You can even enjoy fresh coffee when you awake in the morning, thanks to the clock-controlled accessory AC socket on the back of the new GR-58. The handy "snooze" alarm feature lets you wake up gradually for ten minutes to the sound of the radio, then the alarm goes on... push the "snooze" button to silence the alarm for ten minutes more of music or news — the alarm sounds automatically every ten minutes and the "snooze" button turns it off, cycling continuously until the selector switch is moved to another position. Fast, easy circuit board construction, smart blue hi-impact plastic cabinet and top reliability make this GR-58 the clock radio for you. 8 lbs.

HEATHKIT IG-18 Solid-State Sine-Square Wave Generator

A precision source of sine or square waves at a low kit price... that's the new solid-state IG-18 from Heath. Delivers 5% accuracy thru the wide range of 1 Hz to 100 kHz. The sine wave section features less than 0.1% distortion thru the audio range, 8 output voltage ranges from 0.003 to 10V, switch-selected internal 600 ohm load or external load and metered output of both voltage & dB. The square wave section has a 50 nS rise time and three output voltage ranges from 0.1 to 10 V P-P. Both sine & square waves are available simultaneously and the frequency is switch-selected for constant repeatability and fast operation. Circuit board construction makes the new IG-18 easy to build... new Heathkit styling and engineering excellence make it easy to use. Put the new IG-18 on your bench now. 10 lbs.

Hobby... From The Leader



Now There are 4 Heathkit Color TV's...
All With 2-Year Picture Tube Warranty

NEW Deluxe "681" Color TV With Automatic Fine Tuning

The new Heathkit GR-681 is the most advanced color TV on the market. A strong claim, but easy to prove. Compare the "681" against every other TV — there isn't one available for any price that has all these features. Automatic Fine Tuning on all 83 channels... just push a button and the factory assembled solid-state circuit takes over to automatically tune the best color picture in the industry. Push another front-panel button and the VHF channel selector rotates until you reach the desired station, automatically. Built-in cable-type remote control that allows you to turn the "681" on and off and change VHF channels without moving from your chair. Or add the optional GRA-681-6 Wireless Remote Control described below. A bridge-type low voltage power supply for superior regulation; high & low AC taps are provided to insure that the picture transmitted exactly fits the "681" screen. Automatic degaussing, 2-speed transistor UHF tuner, hi-fi sound output, two VHF antenna inputs... plus the built-in self-servicing aids that are standard on all Heathkit color TV's but can't be bought on any other set for any price... plus all the features of the famous "295" below. Compare the "681" against the others... and be convinced.

GRA-295-4, Mediterranean cabinet shown... \$119.50
Other cabinets from \$62.95

Deluxe "295" Color TV... Model GR-295

Big, Bold, Beautiful... and packed with features. Top quality American brand color tube with 295 sq. in. viewing area... new improved phosphors and low voltage supply with boosted B+ for brighter, livelier color... automatic degaussing... exclusive Heath Magna-Shield... Automatic Color Control & Automatic Gain Control for color purity, and flutter-free pictures under all conditions... preassembled IF strip with 3 stages instead of the usual two... deluxe VHF tuner with "memory" fine tuning... three-way installation — wall, custom or any of the beautiful Heath factory assembled cabinets. Add to that the unique Heathkit self-servicing features like the built-in dot generator and full color photos in the comprehensive manual that let you set-up, converge and maintain the best color picture at all times, and can save you up to \$200 over the life of your set in service calls. For the best color picture around, order your "295" now.

GRA-295-1, Walnut cabinet shown... \$62.95
Other cabinets from \$99.95

Deluxe "227" Color TV... Model GR-227

Has same high performance features and built-in servicing facilities as the GR-295, except for 227 sq. inch viewing area. The vertical swing-out chassis makes for fast, easy servicing and installation. The dynamic convergence control board can be placed so that it is easily accessible anytime you wish to "touch-up" the picture.

GRA-227-1, Walnut cabinet shown... \$59.95
Mediterranean style also available at \$99.50

Deluxe "180" Color TV... Model GR-180

Same high performance features and exclusive self-servicing facilities as the GR-295 except for 180 sq. inch viewing area. Feature for feature the Heathkit "180" is your best buy in deluxe color TV viewing... tubes alone list for over \$245. For extra savings, extra beauty and convenience, add the table model cabinet and mobile cart.

GRS-180-5, table model cabinet and cart... \$39.95
Other cabinets from \$24.95

Now, Wireless Remote Control For Heathkit Color TV's

Control your Heathkit Color TV from your easy chair, turn it on and off, change VHF channels, volume, color and tint, all by sonic remote control. No cables cluttering the room... the handheld transmitter is all electronic, powered by a small 9 v. battery, housed in a small, smartly styled beige plastic case. The receiver contains an integrated circuit and a meter for adjustment ease. Installation is easy even in older Heathkit color TV's thanks to circuit board wiring harness construction. For greater TV enjoyment, order yours now.

kit GRA-681-6, 7 lbs., for Heathkit GR-681 Color TV's... \$59.95

kit GRA-295-6, 9 lbs., for Heathkit GR-295 & GR-25 TV's... \$69.95

kit GRA-227-6, 9 lbs., for Heathkit GR-227 & GR-180 TV's... \$69.95



kit GR-681
\$499.95
(less cabinet)



kit GR-295
now only
\$449.95
(less cabinet)



kit GR-227
now only
\$399.95
(less cabinet)



kit GR-180
now only
\$349.95
(less cabinet)

New Wireless
TV Remote Control
For GR-295, GR-227
& GR-180
\$69.95

New Wireless
TV Remote Control
For GR-681
\$59.95



NEW

FREE 1969 CATALOG!

Now with more kits, more color. Fully describes these along with over 300 kits for stereo, hi-fi, color TV, electronic organs, electric guitar & amplifier, amateur radio, marine, educational, CB, home & hobby. Mail coupon or write Heath Company, Benton Harbor, Michigan 49022.



HEATH COMPANY, Dept. 10-2
Benton Harbor, Michigan 49022
In Canada, Daystrom Ltd.

Enclosed is \$ _____, plus shipping.

Please send model (s)

Please send FREE Heathkit Catalog.

Please send Credit Application.

Name _____

Address _____

City _____

State _____

Zip _____

Prices & specifications subject to change without notice.

CL-150

BUILD LOW-COST TOUCH ALARM

BY RUDOLF F. GRAF

MOST CONVENTIONAL intruder alarms operate on the premise that the intruder either breaks a beam of light or opens an interlocked electrical circuit to make the alarm sound. However, there may be cases where it is difficult to install a light beam or make wired connections, and where it is de-

sirable that an alarm be given if the object to be protected is simply touched. This would include a doorknob, a screen door, a metal statue, or any not-too-large metal area. When the contact with the metal object is broken, the alarm stops.

The "Touch Alarm" described here is a low-cost intruder detector that can be constructed entirely within a 117-volt a.c. bell housing for use as an alarm, or it can be used to turn on any line-operated device such as a power relay or a 200-watt lamp when the protected item is touched.

How It Works. Capacitor *C1* (see schematic diagram), resistor *R1*, and the touch-contact-to-ground capacitance (*Cx*) form a capacitance voltage divider across the a.c. power line. The voltage across *C1* depends on the ratio of *C1* to *Cx*.

The capacitance of *Cx* depends on the capacitance to ground of the body of the person touching the loose end of *R1*, which is connected to the object to be protected. As contact is made, the voltage developed across *C1* exceeds the breakdown potential of neon lamp *I1*, and supplies a brief voltage pulse to the gate of the SCR. The SCR and the 117-volt a.c. bell are connected in series across the power line. When the SCR conducts, it acts like a closed switch, thus power is applied to the bell. When contact to the touch plate is removed, the SCR assumes a non-conducting state and acts like an open switch, cutting off power to the bell. Resistor *R1* acts like an isolator to prevent accidental shock when contact is made to the touch plate.

Construction. If you use the bell called out in the Parts List, the entire alarm can be housed within it. To do this, remove the bottom cover of the housing to expose the wiring and disconnect one side of the power line feeding the bell coil. Remove one of the screws supporting the coil frame and mount the three-lug terminal strip by replacing the screw. The SCR anode heat-sink tab is soldered to one end lug along with the loose wire from the bell coil. The normal anode lead of the SCR can either be cut off near the body or bent back out of the way so that it cannot make contact with any

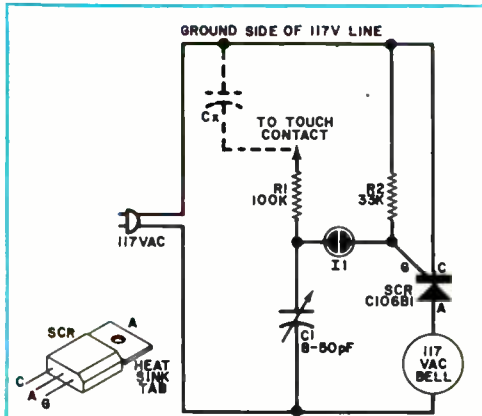

The capacitance of the body, *Cx*, when contact is made with lead to *R1*, causes voltage on *C1* to break down *I1* and fire SCR.

PARTS LIST

- C1*—8-50-pF trimmer capacitor (screwdriver adjustable)
- I1*—NE-2 neon lamp
- R1*—100,000-ohm, 1/2-watt resistor
- R2*—33,000-ohm, 1/2-watt resistor
- SCR—Silicon controlled rectifier (GE C106B1 or similar)
- Bell—117-volt a.c. electric bell in plastic case (Lafayette 99T9023 or similar)
- Misc.—Three-lug terminal strip (none grounded), plastic tape, length of insulated wire, alligator clip (optional), 117-volt a.c. relay (optional), 117-volt, 200-watt hdb (optional).

other part. The other components—*R2*, *I1*, and *C1*—can be installed on the terminal strip as desired, making sure that the screwdriver adjustment of *C1* is facing the bottom of the housing so that when the bottom cover is replaced, the capacitor can be tuned through a small hole cut in the cover. Isolating resistor *R1* has one end soldered to its place on the terminal strip and the other end sol-

lead is released. If the bell does not ring, reverse the power plug in its socket.

Because the Touch Alarm operates on a capacitance effect, do not make the touch lead too long (a few feet will suffice), and also do not connect it to too large a piece of metal. In both these cases, there may be sufficient stray capacitance to ground to cause the bell to ring whether the touch terminal is

The entire circuit is easily accommodated in bell housing. Be sure that there are no short circuits when the cover is put back on the bell.

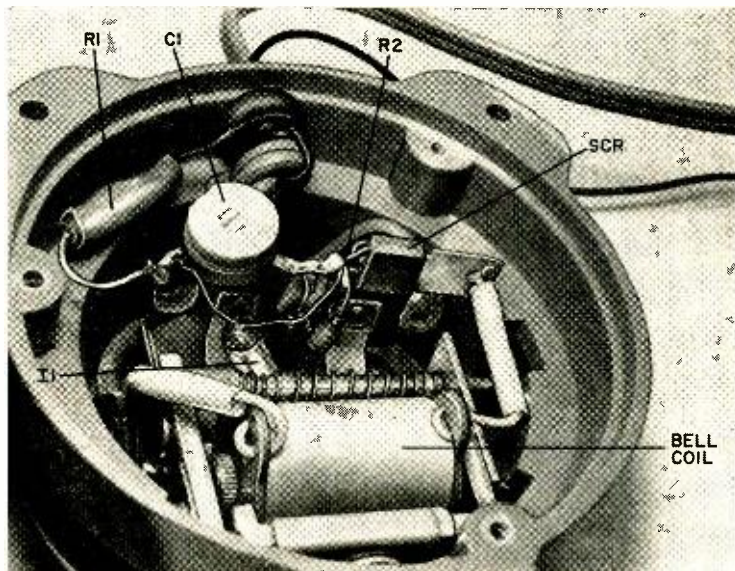

dered to a length of insulated wire (the touch contact connector lead). Insulate *R1* and its soldered contacts using plastic tape. Pass the loose end of the contact wire through the same rubber grommet holding the a.c. power line. The alarm is now ready to test.

If it is desired to use the Touch Alarm to turn on a light or other line-operated device, use the same circuit, except replace the bell coil with the coil of a 117-volt a.c. relay (used to control any external device), or install a 117-volt (up to 200 watts) bulb in the circuit in place of the bell coil.

Operation. After making sure that the Touch Alarm is wired properly, insert the line cord into a 117-volt a.c. power outlet. (Do not use a d.c. source of power, as once the *SCR* conducts it will not turn off when the touch contact is broken.) Touching the bare end of the lead coming from the bell housing should make the bell ring and stop it when the

contacted or not. Also, do not connect the lead to any metal building structure—aluminum screen door or casement window screens, for example—because these metal areas may be grounded through the building structure and the Touch Alarm will not operate. The alarm will work on doorknobs used on wooden doors or windows or door screens mounted in wooden frames. A small alligator clip can be used at the terminal end of the touch lead to make temporary contact with the metal.

Obviously, any metal object insulated from the metal building structure by non-metals (wood, plastic, etc.) can be protected. Once an object has been selected, connect the touch lead to it, and then touch the object. The bell should ring if the power plug is inserted in the correct way. Capacitor *C1* can be adjusted for a slight change in sensitivity and its setting is not critical. Rotating toward an increase in capacitance will improve the sensitivity somewhat.

Live Better Electronically With

LAFAYETTE RADIO ELECTRONICS

1969 Catalog 690 **FREE!**



**Now OFF PRESS
BETTER THAN EVER
Over 500 Pages**

Stereo Hi-Fi • Citizens
Band • Ham Gear • Tape
Recorders • Test Equip-
ment • TV and Radio Tubes
and Parts • Cameras •
Auto Accessories • Musical
Instruments • Tools • Books

Featuring Everything in Electronics for
• HOME • INDUSTRY • LABORATORY
from the "World's Hi-Fi & Electronics Center"

LAFAYETTE Radio ELECTRONICS
Dept. 35029 P.O. Box 10
Syosset, L.I., N.Y. 11791

Send me the FREE 1969 catalog 690.

35029

Name
Address
City
State Zip

CIRCLE NO. 14 ON READER SERVICE PAGE

**Argos' new speaker technology
creates a genuine
price breakthrough in
two-way system design.**

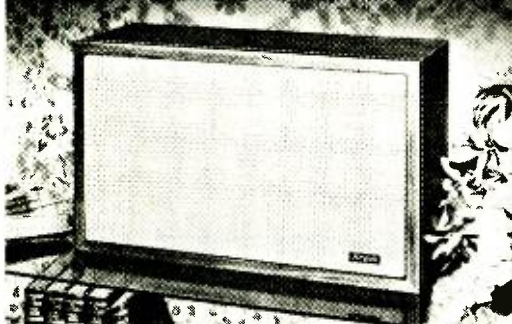

The new Argos TX-200 is a totally new dimension in high fidelity sound reproduction systems—a superb instrument offering fine-furniture construction, big-system performance and compactness for maximum versatility. The TX-200 matches a specially-designed high compliance, low-resonance woofer with a new high-compression horn-loaded driver component to produce distortion-free response from 30 Hz to the inaudibles at 18,000 Hz.

Specifications

Cabinet: Select walnut, Belgian linen
grille. Size: 18 7/8" x 11 1/8" x 7 7/8"
Price: Audiophile net \$45.00.

Argos
Products Company
Genoa, Illinois 60135

CIRCLE NO. 2 ON READER SERVICE PAGE

SOLID STATE

(Continued from page 82)

audio preamp. The antenna length is not critical, but, in general, it should be as short as is consistent with desired range and signal strength. As in any "home broadcaster," the unit's output frequency should be preset (by adjusting *L1*'s slug) to avoid interference with local broadcast stations.

Manufacturer's Circuit. The hearing-aid circuit illustrated in Fig. 4 is one of five practical designs featured in *Applications Report No. S-139*, a 13-page booklet published by the Semiconductor and Microcircuits Division of the Amperex Electronics Corp. (Slatersville, R.I. 02876). With an overall voltage gain of 74 dB, it has a frequency response flat within 3 dB from about 150 Hz to 40 kHz. Although the amplifier can supply up to 0.9 mW output to a matched load, its d.c. power requirement is less than 2.0 mA from a 1.3-volt power source.

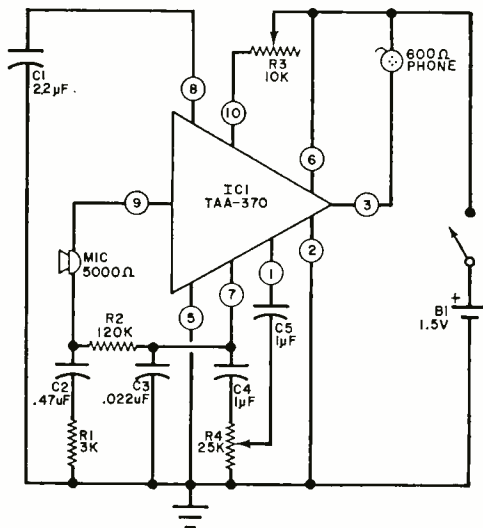
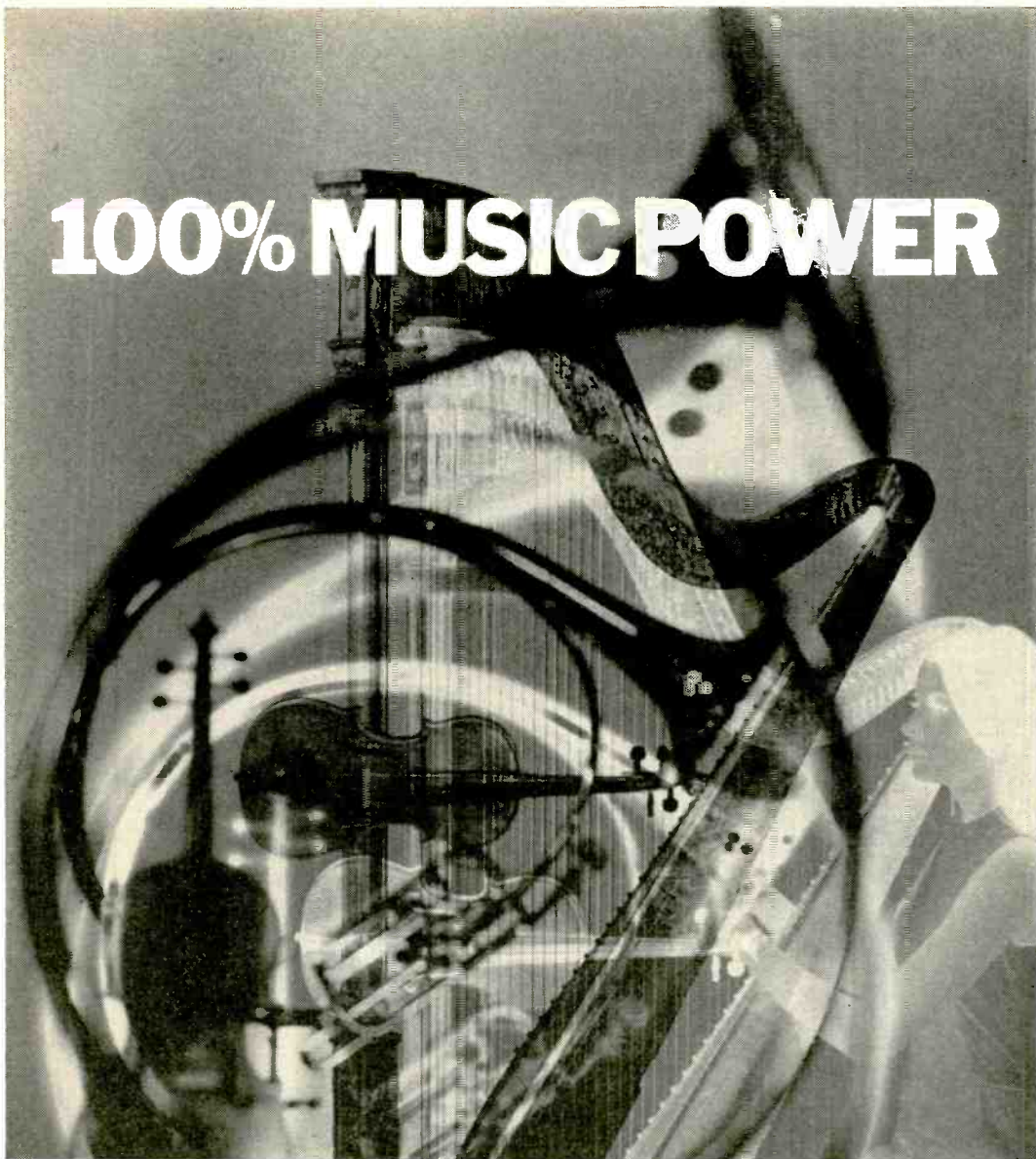

Fig. 4. Hearing-aid amplifier using a linear IC has a voltage gain of 74 dB and a 0.9-mW output to a matched load. Power source is only 1.3 volts.

Referring to the diagram, the design uses an ultra-compact, linear integrated circuit amplifier, *IC1*, which has 7 *npr* transistors and 9 resistors on a silicon chip measuring only 9 mm square and encapsulated in a standard 10-pin flat pack. External feedback around the first three amplifier stages is provided by a network made up of *R2* in

100% MUSIC POWER



Words are inherently limited in stimulating the emotions aroused by music. This is especially so in describing how high fidelity components perform.

With cartridges, for example, we speak of flat frequency response, high compliance, low mass, stereo separation. Words like these enlighten the technically minded. But they do little or nothing for those who seek only the sheer pleasure of listening.

We kept both aspects in mind when developing the XV-15 series of cartridges. We made the technical measurements. And we listened.

We listened especially for the ability of these cartridges to reproduce the entire range

of every instrument. With no loss of power. That's what it takes for a cartridge to recreate the most subtle nuances that distinguish one musical instrument from another. An oboe from an English horn. A trumpet from a cornet.

We call this achievement "100% music power."

When you play your records with an XV-15, you won't be concerned with even that simple phrase.

Instead, you'll just feel and enjoy the renewed experience of what high fidelity is really all about.

PICKERING



THE NEW PICKERING XV-15/750E.

PREMIER MODEL OF THE XV-15 SERIES. TRACKS AT 1/2 TO 1 GRAM. DYNAMIC COUPLING FACTOR OF 750 FOR USE IN FINEST TONEARMS. \$60.00. OTHER XV-15 CARTRIDGES FROM \$29.95. PICKERING & CO., PLAINVIEW, L. I., N. Y.

CIRCLE NO. 21 ON READER SERVICE PAGE

conjunction with *R1-C2* and *C3*. Capacitor *C1* serves as a power supply bypass, while *C4* and *C5* are interstage coupling capacitors. A conventional volume (gain) control, *R4*, is used. Adjustable resistor *R3* is used to preset d.c. operating conditions and thus compensate for minor differences in production units. A microphone serves as the input signal source and a small earphone as the instrument's load.

Except for integrated circuit *IC1*, an Amperex type TAA-370, the choice of parts used for circuit assembly depends primarily on the unit's intended application. If it is assembled for experimental or demonstration purposes, or if final size is not critical, then conventional 1/2-watt resistors, standard controls, and full-sized capacitors may be used for the specified components, with power supplied by a penlight cell. On the other hand, if the circuit is wired for use as a compact hearing aid, 1/10-watt resistors, low-voltage ceramic capacitors, and other sub-miniature parts are preferred, with power furnished by a small mercury battery. In both cases, a 50,000-ohm microphone and a 600-ohm earphone should be used.

Neither layout nor wiring dress is overly critical, but coupling between the input and output circuits should be avoided. A semi-breadboard layout on perf board may be used for test or experimental purposes, but etched wiring construction is preferred for minimum size. After assembly and check-out, *R3* should be adjusted for optimum performance (that is for the best compromise between current drain, distortion, and gain). Generally, *R3*'s adjusted value will be close to 7,000 ohms.

New Literature. Over a dozen contributors helped to write a new *Silicon Power Transistor Handbook* recently published by the Westinghouse Electric Corporation's Semiconductor Division (Youngwood, Pennsylvania 15697). Identified as publication No. B-9394, the thick spiral-bound book sells for only \$2 per copy, and contains ten major chapters, each of which is full of practical technical data, ranging from basic theory to design techniques and practical circuits. Transistor specifications are defined, test methods detailed, and practical design calculations outlined. Switching, power supply, linear, and high-frequency applications are discussed, and there are even chapters on cooling methods, reliability consideration, and procurement procedures. Among the more interesting practical circuits described are a 10-kW Sonar amplifier (that's right, 10 kilowatts) and a 100-watt-per-channel stereo amplifier.

If you are using digital IC's, you should obtain a copy of the valuable *Integrated*

Circuit Cross Reference Guide recently published by Sylvania Electronic Components (100 First Ave., Waltham, Mass. 02154). The handy pocket-size booklet lists Motorola, Philco-Ford, Raytheon, Transitor, and Westinghouse digital IC type numbers, cross-referencing each to equivalent Sylvania products.

A number of practical crystal oscillator circuits, including several transistorized arrangements, are illustrated and described in a new catalog released recently by the International Crystal Manufacturing Co., Inc. (10 North Lee, Oklahoma City, Okla. 73102). The 44-page booklet also lists a number of interesting and useful products, ranging from individual quartz crystals to oscillator modules, frequency meters, CB gear, and even a microwave oven.

RCA (Electronic Components Division, Harrison, N.J. 07029) has published a useful 36-page *Integrated Circuits Product Guide*. Carrying a nominal 25c per copy price, the booklet is identified as publication No. CDL-820B and lists both linear and digital IC's, giving type numbers, basic specifications, maximum ratings (where applicable), application information, and internal circuitry.

Transitips. Unless you work with semiconductor devices on a day-to-day basis, you may have trouble remembering the correct d.c. polarities for each electrode of the many different units in common use. A few simple "memory tricks" can be helpful.

Consider bipolar transistors. "Bi" means "two," as in bicycle. Hence this reminds us that two of the electrodes have identical polarities with respect to the emitter. Next, look at the middle letter of the three which identify the class—*npn* or *pnP*. If it is a *p*, the base and collector polarities are both *positive* with respect to the emitter; if it is an *n*, the voltages are *negative*.

Field effect transistors (FET's) might prove troublesome unless you remember the clue "First Examine Tubes." In a vacuum tube, the grid bias (equivalent to the gate in a FET) and plate (drain) voltages are of opposite polarity with reference to the cathode (source). Ditto with FET's. Next, remember that gate bias is identified by the channel designation. In an *n*-channel FET, then, the gate is *negative* with respect to the source, hence the drain (opposite polarity, remember) is positive. Conversely, in a *p*-channel FET, the gate is *positive* with respect to the source, drain *negative*.

Diode and SCR polarities can be remembered easily, for their schematic symbols include an arrowhead indicating the direction of classical current flow, which, to keep things properly confused, is just the oppo-

site of electron flow. Hence the arrowhead is the anode and normally connects to a positive d.c. source with respect to the cathode which, happily, is identified by a short line closely resembling the standard symbol for "negative" polarity.

Zeners can be bothersome for a moment until we recall that the letter z is at the opposite end of the alphabet, which reminds us that Zeners generally are wired in opposite fashion to conventional diodes—i.e., the arrowhead (anode) is generally negative with respect to the cathode.

But what about Triacs? These are bidirectional devices used to control a.c., so d.c. polarity doesn't count.

In closing, remember that "happiness is" a circuit that works the first and every time!

Until next month,

—Lou

AMATEUR RADIO

(Continued from page 86)

uled for January 25, 26, in *Auto Call*, published by the Foundation for Amateur Radio, Washington, D.C., comments that ham radio is the only hobby that she can think of in which a large percentage of the participants insist that they don't want to work to become proficient. She writes, "So often you hear, 'Ham radio is a hobby, and I don't intend to make work out of it.'" Yet, Ethel points out that, when an emergency strikes, everyone wants to become an instant hero by providing emergency communications, and complains because an efficient communications network does not spring into instant being.

Of course, the Amateur Radio Emergency Corps is designed to set up a nucleus of emergency communications network, and the annual SET arranged by the American Radio Relay League in conjunction with the American Red Cross, tests its functioning by transmitting messages from local American Red Cross units to regional offices.

The Lake County Amateur Radio Club, Inc. announces its 16th Annual Banquet to be held at 6:30 p.m., CST, February 8, at Teibel's Restaurant, (U.S. 30 and 41). Chicken dinner, speeches, entertainment. Bring your wife or girl friend. Tickets \$4.00 each from Bud Coulter, K9KFM, 319 N. Colorado St., Hobart, Ind. 46342. No tickets at door.

New Code Practice Frequencies. In line with the new subdivisions of the amateur bands, the daily code practice transmissions from W1AW, the ARRL Headquarters sta-

February, 1969

The remarkable difference about Pearce-Simpson's Guardian 23 and Guardian 23-B: they work.

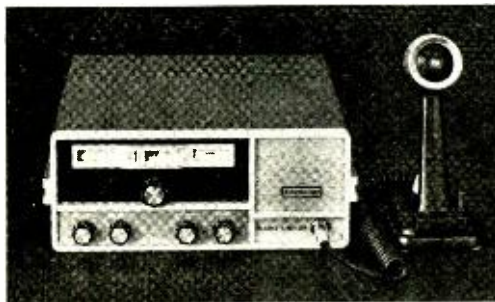

What's the most important thing about a CB base-station and mobile-unit combination?

When some guy says something, the guy at the other end should be able to hear it.

In other words, "10-4" should sound like "10-4" — not "snap, crackle and pop."

So the great thing about the Pearce Guardian 23 and Guardian 23-B (in fact all Pearce-Simpson's radios) is that the transmitters transmit and the receivers receive.

Don't laugh. Not every CB manufacturer can make that statement.

If you want to get technical, here's the explanation. Pearce-Simpson's exclusive HetroSync circuitry sharpens transmitted signals. High level saturation limiting provides automatic speech clipping. And the Superhet receiver hears signals that ordinary sets distort or fade.

Guardian 23 comes with palm microphone, mounting cradle, AC and DC power cords. Guardian 23-B comes complete with built-in, all transistor, solid state pre-amplifier that lets you stay a comfortable distance from your mike and still broadcast loud and clear. And Pearce-Simpson's new SuperMod desk mike is available as an option.

Guardian 23 and Guardian 23-B — Pearce-Simpson's super twins.

They work.

For more details on all our New CB Radios write Pearce-Simpson, Inc., Dept. PE-269, P.O. Box 800, Biscayne Annex, Miami, Fla.* 33152

Pearce-Simpson

Division of GLADDING Corp.

CIRCLE NO. 20 ON READER SERVICE PAGE

tion at Newington, Conn., are now made 20 kHz in from the bottom edge of each band. The schedules are: daily, 6:30 p.m., EST (0030 GMT) 10, 13, 15 WPM. Monday, Wednesday, Friday, 8:30 p.m., EST (0230 GMT) 15-35 WPM; Sunday, Tuesday, Thursday, Saturday, 5-25 WPM. Frequencies: 1820, 3520, 7020, 14,020, 21,020, 50,020, and 144,020 kHz.



Bob Lee, Roger Shea, and Mark Chapman operating WA6ERX, Amateur Radio Club station of El Roble School, Claremont, Calif. See Amateur Station of the Month for details. (Claremont Courier photo)

NEWS AND VIEWS

Lou Goldberg, WB25SM, has been named Chairman of the Amateur Radio Division of the National Rare Blood Club. The club, an offshoot of the Knights of Pythias, supplies over 3000 pints of rare blood free of charge to the recipients each year. Further information is available from WB2SSM, National Rare Blood Club, 164 Fifth Ave., New York, N.Y. 10010 . . . **Larry Alwardt, WA9WPO**, R.R. 1, Strasburg, Ill. 62465, admits that he failed the code test of his first trip to the FCC for his General ticket, but he made the grade the second time. As a Novice, Larry worked 15 states and has added 10 more states, Canada, and Mexico to the list as a General. He uses a Hallcrafters HT-37 transmitter, Drake 1-A receiver, Mosley TA-33 tri-band beam on a 50' tower, and dipoles for 80 and 40 meters. He will sked you on SSB or CW on 80 through 10 meters if you need a QSL card from Shelby County, Ill. . . . **Jack Yeager, VE2DKJ**, 7529 Bailey Road, Montreal 22, Que., Canada, has been a ham for a month and has worked 35 states and 17 countries! His second contact, in fact, was with DL4FE in Germany. A Johnson Valiant transmitter and a Drake 1-A receiver share time with a trap vertical antenna on 80, 40, and 20 meters. He finds that rainy weather improves the efficiency of the antenna. Jack will sked anyone needing a Quebec contact, especially on Friday afternoon and Saturday morning. By the way, Jack shares his station with his father, Norman, VE2DLA.

Steve Korn, WN2FKE, 12 Sanderson, West Caldwell, N.J. 07006, will be "sweating out" the arrival of his General ticket as you read this. In his 2-month Novice career, Steve worked 35 states and 17 countries. His tools are a Knight-Kit T-60 transmitter, Lafayette HA-500 receiver, and a Hy-Gain 18-AVQ vertical antenna. Probably having the antenna mounted 64 feet above ground on the roof of a building helps its radiating efficiency . . . **Don J. Lacroix, WN1JWS**, 47 Salisbury St., Woonsocket, Rhode Island 02895, says that most of the operators he works tell him he is their first Rhode Island contact. He uses a Johnson Viking-II transmitter and a Hammarlund HQ-140-X receiver in conjunction with several dipole antennas. He works 80,

40, and 15 meters, but likes 15 meters best . . . **Sunil Abeyesundere, 457AB**, 19/3 De Fonseka Place, Colombo 4, Ceylon, has been licensed for two months. At 20 years of age, he is Ceylon's youngest amateur. Although Sunil has dipole antennas for 80, 40, and 20 meters, each 40 feet high, so far he has operated only on 40-meter CW, where he has worked 21 countries. He receives on a modified Hammarlund Super-Pro receiver and transmits on a homebrew transmitter using a pair of 807 tubes in the output stage. Sunil looks for USA hams between 7000 and 7040 kHz between 2330 and 0200 GMT and is also interested in swapping local curios for small radio parts.

Gary L. Bowes, 129 Woodward Ave., Lock Haven, Penn. 17745, reports that he and other operators in Vietnam unofficially used underground antennas with good results. The version he describes is a 40-meter dipole fed with coaxial cable in the usual manner and buried eight inches in the ground. According to Gary, it and similar antennas give excellent results over a 350-mile radius. Some users encase the antenna in plastic tubing before burying it, but Gary says this refinement is not necessary. Actually, underground antennas sometimes give surprising results, and are, therefore, interesting to experiment with.

Rus Bauer, WN1JKZ, 23 Felton St., Woburn, Mass., 01801, works the three low-frequency Novice bands with a Heathkit DX-20 transmitter driving an 80-, 40-meter trap dipole that apparently also does a good job on 15 meters. He receives on a Hallcrafters SX-100. His record includes 36 states, 15 countries, and RCC and 15-WPM code-proficiency certificates. Oh yes, his General class ticket is on the way . . . Coincidental with the earlier letter from 4S7AB, **George Downing, WB6JPQ**, reports that the U.S. Hospital Ship "Hope" is now stationed in the harbor at Colombo, Ceylon. To comply with the wishes of the Ceylon authorities, George signed "WB6JPQ/MM (Maritime Mobile) aboard the 'S. S. Hope' in Colombo harbor" while operating from the ship. W7EOC is presently the radio operator on the ship. Thanks to the *WCAR Sentinel* . . . **Bob Collom, WN0TWL**, 2600 9th, Boulder, Colo. 80302, has made over 400 contacts in 48 states since starting his amateur career with an old Globe Scout transmitter last March. He now uses a Drake T-4XB transmitter, Heathkit DX-40, Drake R4A receiver, and a Hy-Gain 14-AVS vertical antenna.



Using simple wire antennas in his attic and a Drake TR-3 transceiver backed up by a Drake R-4 receiver, Donald J. Perlstein, WB2TBP, has worked 50 states and 98 countries. Don has an Extra class license.

Now is the time to send that letter and that picture to "News and Views," and please keep your club papers coming. The address is: Herb S. Erier, W9EGQ, Amateur Radio Editor, POPULAR ELECTRONICS, P.O. Box 678, Gary, Ind. 464401.

73, Herb, W9EGQ

SHORT-WAVE LISTENING

(Continued from page 84)

letter addressed to *Radio Peking*, Peking, China, states "Postal authorities of continental China indicate that unless mail is addressed to *People's Republic of China*, it will be detained and confiscated according to the laws of that country." Please keep this in mind when sending reception reports to *Radio Peking*.

Band Surveys. Two new DX aids have just been published by Gilfer Associates, Inc. Called "Band Surveys," one covers international broadcasters in the 13-meter band, the other the 16-meter band. Each "Band Survey" gives the schedule, power and target area for each broadcaster. The information is extraordinary for accuracy and timeliness. The 13-meter Survey is \$1.25; the 16-meter Survey, \$1.50 (both plus postage). Gilfer also sells many other SWL items. Address: P.O. Box 239, Park Ridge, N.J. 07656.

CURRENT STATION REPORTS

The following is a resume of current reports. At time of compilation all reports were as accurate as possible, but stations change frequency and/or schedule with little or no advance notice. All times shown are Greenwich Mean Time (GMT) and the 24-hour system is used. Reports should be sent to Short-Wave Listening, P. O. Box 333, Cherry Hill, N. J. 08034, in time to reach your Short-Wave Editor by the fifth of each month; be sure to include your WPE identification and the make and model number of your receiver.

Albania—A station with s/on at 0400 on 5060 kHz is thought by some to be Aden; however, some concentrated efforts by veteran DX'ers indicate the station is *R. Tirana* in one of its numerous broadcasts in language, with native and Balkan music. List as Tirana, tentatively, until we get more positive information. Meanwhile, *R. Tirana* has been logged on another new frequency of 7066 kHz in English from 2215.

Algeria—*R. Algiers* has this current schedule: National Network in Arabic at 0600-0900 and 1100-0000 (Sunday 0600-0000) on 11,810 kHz and in Kabyl at 0600-0800 and 1200-0000 (Sunday 0600-0000) on 9685 kHz. The International Network, French only, is listed 0600-0800, 1200-1500 and 1700-0000 (Saturday 0600-0800 and 1200-0000; Sunday 0600-0000) on 11,835 and 9510 kHz., 0600-0800 and 1700-0000 (Sunday 0600-0900 and 1700-0000) on 6080 kHz and 1200-1500 (Saturday to 1700; Sunday 0800-1700) on 15,200 kHz. Comprehensive reports on both 9685 and 11,810 kHz from 2000-2230 show no English at all. Reports (make them in French, if you can) go to *Radiodiffusion Television Algerienne*, Direction des Services Techniques, 21, Boulevard des Martyrs, Alger, Algeria.

Angola—*Emissora Oficial de Angola*, Caixa Postal 1329, Luanda, sent this new schedule (Sunday schedule is in parenthesis): On 11,955 kHz at 0758-1600 (0620-1600), 9535 kHz at 0715-1555 (0620-1700), 7245 kHz at 0500-1700 (0620-1655), 6025 kHz at 1858-

CB'ers Build-It-Yourself

AND

Save

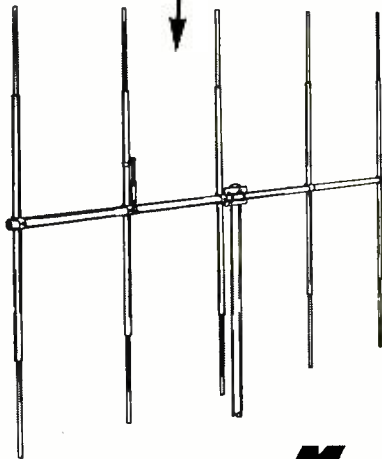

... With The NEW **Mosley**
X-27 CB Antenna Kits.

If you are one of those rugged individualists who prefer to Do-It-Yourself, let Mosley show you how to Save Time and Expense on your next antenna project. Real talk-power is assured with any one of our 3, 4 or 5 element beam kits.

Get all the facts . . . See your nearest authorized Mosley dealer, or clip the coupon and forward to factory direct for your FREE detailed brochure.

Mosley Electronics Inc. Bridgeton Missouri 63042

Please send me your FREE brochure on the New Mosley X-27 CB Antenna Kits No. 133.

Name _____

Address _____

City/State _____ Zip _____

Mosley Electronics Inc. 4610 N. Lindbergh Blvd.,
Bridgeton Missouri 63042

CIRCLE NO. 15 ON READER SERVICE PAGE

0000 (same but until 0200 Saturday). 4820 kHz at 0500-0715 and 1605-2300 (1605-2300), and on 3375 kHz at 1555-0000 (1605-0000; Saturday xmsn until 0200). A new frequency for *A Voz de Angola* is 5960 kHz, s/on at 0505 with drums and an anthem.

Bolivia—New stations include CP89. *R. Santa Ana*, Santa Ana y Correo Central, 3390 kHz, 250 watts and CP114. *R. San Miguel*, Riberalta, 4805 kHz, 250 watts. *R. Universo*, La Paz, has a new outlet: CP71. 6195 kHz, 1 kW, in parallel with 5015 kHz.

Brazil—ZYE2, *R. Cultura do Macapa*, Amapa, was noted on 4911 kHz with best listening time at 0900 s/on. *R. Visconde do Rio Branco*, Visconde do Rio Branco, 4770 kHz, is weak around 0100 in Portu-



Harold Price, WPE4HUE, Fort Mitchell, Ky. has logged and verified 22 countries as well as virtually all of the U.S. and Canada. His equipment includes an r.f. wattmeter; Regency Flight Monitor, Lafayette HE-30, and Hallicrafters CRX-1 and CRX-2 receivers; and a Browning Golden Eagle transmitter-receiver.

guese, ZY025. *R. Capixaba*, Vitoria, 4945 kHz, verified after nine years; noted to 0200 close. ZYZ5. *R. A Voz do Oeste*, Cuiaba, 4985 kHz, verified after 10 years stating that previous reports were never received. However, their letterhead shows an address different from that in World Radio TV Handbook for 1968. (Editor's note: please send us the new address so we may pass it on.)

Canary Islands—*R. Nacional de Espana*, Tenerife, 15.360 kHz, is often good from 0115-0300 with news, opera and light music in an all-Spanish xmsn from Madrid beamed to L. A.

Ceylon—*R. Ceylon*, Colombo, is generally good on 15.230 kHz from 0130-0230 with all English and music. News from London is given at 0200. The 15,120-kHz outlet was noted at 0130 s/on with drums IS and into language but you'll have to tune carefully to avoid QRM from HCJB, Ecuador.

China—*R. Peking* to East Coast N.A. is scheduled at 0000-0055 on 17.673 and 17.855 kHz, 0100-0155 on 17.900, 17.715, 9780 and 7120 kHz (and also found on 6220 kHz) and 0200-0255 on 17.900 and 17.715 kHz. All channels heard fairly well on the East Coast.

Ecuador—A new station is *R. Luz y Vida*, Loja, 4785 kHz (as announced but listed for 4712 kHz) and heard to 0200 but this may be extended at times. The listed power is 2 kW.

Egypt—*Voice of the Arabs* is listed at 0300-0600 on 15.300 and 7215 kHz, 0600-0800 on 11.980 and 7215 kHz, 0800-1100 on 17.840 and 15.345 kHz, 1100-1400 on 17.905, 17.840 and 15.345 kHz, 1400-2100 on 17.905 and 15.345 kHz, 2100-2200 on 15.300 and 9525 kHz and 2200-0300 on 17.905, and 15.360 and 9525 kHz. Monitored xmsns include 17,975 kHz at 1405 ending English language lessons, 17.875 kHz at 2315 in

Arabic and 11,965 kHz at 2129-2200 in Arabic with singing and some talks.

England—London is scheduled to Canada, U. S. and Mexico until spring at 1500-1545 and 1700-1730 on 21.610 kHz and at 2115-0030 on 11.780, 9580 and 6110 kHz. The outlets on 9410 and 11,720 kHz are often good at 2300-2330 to Asia with news, commentary and a documentary feature.

Ethiopia—ETLF, Addis Ababa, noted with multi-lingual anmts at 0330 on a new frequency of 11.875 kHz. English from this station is listed in their new schedule as follows: (Transmitter I) 0530-0555 to W. Africa on 11.890 kHz, 1330-1345 to India on 15.315 kHz, 1655-1710 to Ethiopia on 6065 kHz, and 1930-2015 to W. Africa on 11.895 kHz, (Transmitter II) 0400-0425 to E. Africa on 9600 kHz, 1330-1400 to India on 15,400 kHz, 1700-1715 to E. Africa on 9695 kHz and 1800-1900 to S. Africa on 9705 kHz.

Greenland—A letter from Mr. B. Knogh of *Gronlands Radio* advises that the station broadcasts daily in Danish and Greenlandic at 2030-0230 on 3990, 5960 and 5980 kHz, all 1 kW, and on medium waves 570 kHz, 25 kW, and 650 and 820 kHz, both 5 kW.

Gabon — *Radiodiffusion Television Gabonaise*, Libreville, 4777 kHz, tuned at 2120-2130 s/off with music, anthem and ID.

Holland—*R. Nederland*, Hilversum, has this English schedule: to N.A. (Tuesday and Friday) at 1425-1445 on 21.570 kHz, 1525-1545 on 25.610 and 17.810 kHz, 1655-1715 on 21.570 and 17.810 kHz and



One of our monitors in the Far North is Clifford Duncan, VE5PE5V, Cut Knife, Saskatchewan, Canada. He uses a Trio 9R-59 receiver, and RCA transistorized portable recorder and an inverted L antenna. He has DX awards for 50 states and 20 zones.

2030-2050 on 11.730 and 9715 kHz: Sunday ("Happy Station Program") at 1855-2020 on 15,125, 11.730 and 6020 kHz; weekdays 2055-2150 on 11.730 and 9715 kHz and daily (via Bonaire) at 0125-0220 on 11.730 kHz. Weekdays to New Zealand and Australia at 0725-0820 on 11.730, 9715 and 9525 kHz, to S. Asia and Europe at 1425-1520 on 21,480, 17,810 and 6020 kHz, to Africa and Europe at 1855-1950 on 15.220, 11.730 and 6020 kHz and to Europe at 1955-2050 on 6085 and 6025 kHz; lastly, to W. Africa daily (via Bonaire) at 2125-2220 on 15.220 kHz.

India—*All India Radio*, Delhi, is good in English at 2300-2345 and again at 0045-0115 with DX items, news, talks and music: this on 15.235 kHz.

Iran—*R. Iran*, Teheran, 15.135 kHz, carries Russian at 1730, Turkish at 1800, Arabic at 1830, German at 1900, French at 1930, English at 2000 and a special program in Farsi at 2030-2130.

Ivory Coast—*R. Abidjan*, 11,920 kHz, is being reported at 2100-2200 s/off and 2230-2330 in French with news at 2200 and 2230, and on 4940 kHz at 2130-2145 and 2300-0000, also in French with news at 2355.

Korea (South)—*HLK5*, Seoul, 9640 kHz, is good with an all-Japanese program at 1330-1400, then into Mandarin Chinese to S.E. Asia.

SHORT-WAVE ABBREVIATIONS

annt—Announcement	N.A.—North America
B C—Broadcasting	QRN—Station Inter-
ID—Identification	ference
IS—Interval Signal	s off—Sign-off
kHz—Kilohertz	s on—Sign-on
kW—Kilowatts	xmsn—Transmission
L.A.—Latin America	xmtr—Transmitter

Kuwait—Numerous reports are being received on *R. Kuwait's* tests on 11,940 kHz at 1600-1730 in English. Your Editor has heard them from 1600-1900 with all English except for a brief period of chanting around 1800-1810. News is given around 1615-1625. Reports go to P.O. Box 397, Kuwait, Persian Gulf.

Lebanon—*R. Beirut* is now using 11,785 kHz in its xmsn to Europe, N.A. and the Caribbean at 0130-0400 with English at 0230 daily.

Malagasy Republic—*Radiodiffusion Nationale Malgache*, Tananarive, is fair to poor at 0500 on 15,270 kHz with lively music in French and address. A new outlet on 4960 kHz is weak around 0400 with French prior to that time. Reports go to B. P. 142, Tananarive.

Malaysia—*R. Malaysia Sarawak*, Kuching, was logged on 4835 kHz from 1230-1325 fade in their Malay evening service. The Malay ID is *Ini-lah Radio Malaysia Sarawak* and for the benefit of our new readers, the "k" in "Sarawak" is silent.

Maldivé Islands—A QSL from Male gives this schedule with only opening times shown: 0100 on 7150 kHz, 0300 on 6150 kHz, 0500 on 1507 kHz (medium-wave), 0700 on 9538 kHz, 0900 on 7150 kHz, 1100 on 6150 kHz, 1300 on 3331 kHz and 1515 on 1740 kHz. Power ratings: 30 kW on 4740 kHz, 15 kW on 9538 and 3331 kHz, 7.5 kW on 1507 kHz, 2.7 kW on 6150 and 7150 kHz.

Mexico—*XEUW, El Eco de Sotavento*, Vera Cruz, 6020 kHz, was noted at 1210-1240 with marimba music, news bulletins, commercials, request music and an English anmt for the Mexican Federal Highway Police.

Mozambique—*Laurence Marques* has been found on 11,783 kHz from 0300 s/on and on 3218 kHz at 0630 with English and Afrikaans and the usual format of pop music, commercials and time checks. A new regional station, *R. Clube Mozambique*, at Beira will begin tests in June, 1969, with two 10-kW xmtrs, one of 25 kW and one of 100 kW but no frequencies have yet been disclosed.

Nigeria—The latest schedule from *Voice of Nigeria* shows English at 0545-0730 on 21,455, 15,255 and 7275 kHz, 1500-1600 on 21,455, 15,255, 9690 and 7275 kHz, 1700-1900 on 21,455, 15,255, 11,770 and 7275 kHz, and 2100-2200 on 15,255, 11,770, 9690 and 7275 kHz. All of these xmsns are beamed to various parts of Europe and Africa.

Pakistan—*R. Pakistan*, found on 0100 s/on in language on 15455 kHz, is thought to be from Dacca. A new frequency from Karachi is 15,382 kHz, noted at 0230 and 0300 with language ID's.

Portugal—The latest schedule from *R. Portugal* shows this confusing bit of information: English to the U. S. at 0200-0245 and 0345-0430 on 6025, 9680 and 11,935 kHz, French to Canada at 0215-0300 and English to Canada at 0300-0345, also on 11,935 kHz.

Qatar—*Qatar B/C Service*, P.O. Box 1414, Doha, broadcasts in Arabic on 674 kHz and to neighboring Arabic countries on 9570 kHz with 100 kW

daily at 0330-0530 and 1400-1730 (Friday 0330-0700). Has anyone heard?

Senegal—*Radiodiffusion du Senegal*, Dakar, tuned from 2100-2225 on 15,115 kHz with news in French at 2100 and 2200, and on 4890 kHz at 0600 in French with chanting and steel-drum music.

Sweden—*R. Sweden* presently has English to N.A. East Coast at 1100-1130 on 11,705 kHz, 1400-1430 on 21,675 kHz, 0030-0100 and 0200-0230 on 5990 kHz, and to the West Coast at 1600-1630 on 15,310 kHz and 0330-0400 on 11,705 kHz.

Switzerland—English to N.A. from Berne: To East Coast at 0130, 0230 and 0300 on 6120, 9535 and 11,715 kHz, and to West Coast at 0445, 0545 and 0615 on 6120 and 9720 kHz.

Vatican City—More new channels in use by *R. Vaticano*: on 17,690 kHz from 1130 s/on, 11,720 kHz from 1800 s/on in language, 9780 kHz at 0035 in Spanish and on 9615 kHz with English ID and music at 0049.

Venezuela—*YVKT, R. Libertador*, Caracas, noted at 0515-0532 with L.A. music and slightly under its listed frequency; *YVLG, R. Juventud*, Barquisimeto, 4900 kHz, at 0300-0330 with instrumental music and all Spanish anmts; *R. Maracaibo*, Maracaibo, 4870 kHz, at 0500-0530 with L.A. music and Spanish anmts.

Weke Island—Medium-wave DX hunters should look for *KEAD*, 1490 kHz, operating in English 24 hours daily.

SHORT-WAVE CONTRIBUTORS

Cliff Reno (*WPEIHRN*), New Canaan, Conn.
 Stephen Ruggles (*WPEIHCH*), Lunenburg, Mass.
 Vincent Geraci (*WPEIHMP*), Shelton, Conn.
 Craig Seufert (*WPEIHNS*), Newtown, Conn.
 Bill Feidt (*WPEIIM*), Mt. Rainier, Md.
 Peter Marinta (*WPEIORKB*), Kearny, N. J.
 Martin Shulman (*WPEIOLF*), Spring Valley, N. Y.
 O. P. Ferrell (*WPEIYZ*), New York, N. Y.
 Robert Naale (*WPEIDIA*), Allentown, Pa.
 Paul Kilroy (*WPEIFOB*), Washington, D. C.
 George Sprout (*WPEIGMB*), Reading, Pa.
 Dan Ferguson (*WPEIICUL*), Coral Gables, Fla.
 Dr. Stanley Kaplan (*WPEIBIX*), Gainesville, Fla.
 Grady Ferguson (*WPEIFE*), Charlotte, N. C.
 Kenneth Powell (*WPEIFEI*), Falls Church, Va.
 James Daly (*WPEIJR*), Atlanta, Ga.
 David Potter (*WPEIJNO*), Key West, Fla.
 Evan Newlon (*WPEIETA*), Albuquerque, N. M.
 Bruce Sebrinan (*WPEIGT*), Bethel Island, Calif.
 Paul Farmanian (*WPEIGUG*), Glendale, Calif.
 Dan Seibel (*WPEIHCU*), San Leandro, Calif.
 Jeff Utter (*WPEIHDI*), Carlsbad, Calif.
 Robert Halsall (*WPEISDG*), Willard, Ohio
 Jerry Heien (*WPEIBOD*), Broadview, Ill.
 Richard Pistek (*WPEIHDI*), Chicago, Ill.
 Jim Bochaint (*WPEIJD*), Du Bois, Ill.
 Jack Widner (*WPEIJD*), Indianapolis, Ind.
 Fred Lynch (*WPEIJD*), Girard, Ill.
 Douglas Goodman (*WPEIJJ*), Lombard, Ill.
 William Turner (*WPEIJJM*), Grayslake, Ill.
 A. R. Niblack (*WPEIKM*), Vincennes, Ind.
 John Weaver (*WPEIKIE*), Pueblo, Colo.
 Bud Whitlock (*WPEIKON*), Augusta, Kansas
 Jim Merrill (*WPEIKFO*), Sioux Falls, S. D.
 Jack Perolo (*WPEIKIC*), Sao Paulo, Brazil
 Fred Wilson (*WPEIKIC*), New Glasgow, N. S.
 Jeff Wilson (*WPEIKIC*), Sarnia, Ont.
 Mike Wilson (*WPEIKIC*), Calgary, Alta.
 Clayton Curfiss, Auburn, Wash.
 Randy Hatcher, Muncie, Ind.
 Lawrence Kushner, Bronx, N. Y.
 Michael Le Blanc, Moncton, N. B.
 John Patterson, Oswego, Ill.
 Thomas Roach, Spartanburg, S. C.
 Bruce Roberts, Wyanlesboro, Va.
 Gerry Swann, Brandon, Fla.
 Vaughn Thompson, Park Ridge, Ill.
 Brian Walls, Fullerton, Calif.
Emisora Oficial de Angola, Luanda, Angola
 ETLF, Addis Ababa, Ethiopia
R. Portugal, Lisbon, Portugal
R. Sveden, Stockholm, Sweden
R. Switzerland, Berne, Switzerland
Sweden Calling DX'ers bulletin, Stockholm, Sweden

Deluxe POPULAR ELECTRONICS MAGAZINE CASES

DESIGNED TO HOLD A FULL YEAR'S COPIES

These decorative cases are just what you've been looking for to keep your copies of Popular Electronics Magazine in easy-to-find order.



Constructed of reinforced fibreboard and covered in rich leatherette, these durable cases guard against soiling and tearing of your magazines while lending themselves handsomely to the decor of any room. The magazine cases are available with embossed gold lettering in either all black or attractive maroon back with black sides.

\$3.50 ea., 3 for \$10, 6 for \$19
FULLY GUARANTEED!

Ziff-Davis Publishing Co., Dept. SD

1 Park Ave., N.Y., N.Y. 10016

Please send me _____ Popular Electronics Magazine

Files as checked below:

- All black, gold embossed
 Maroon back, gold embossed/black sides

NAME _____

PE-29

ADDRESS _____

CITY _____

STATE _____

ZIP _____

Enclosed is \$ _____ at \$3.50 per case,
3 for \$10, 6 for \$19 (Quantity prices apply for combination orders of more than one title). Orders outside U.S.A. \$4.50 ea., 3 for \$13, 6 for \$25.

(Payment must accompany order)

Olson



*** FREE**

Fill in coupon for a **FREE One Year Subscription to OLSON ELECTRONICS' Fantastic Value Packed Catalog—Unheard of LOW, LOW PRICES on Brand Name Speakers, Changers, Tubes, Tools, Stereo Amps, Tuners, CB, and other Values. Credit plan available.**

NAME _____

ADDRESS _____

CITY _____

STATE _____

GIVE ZIP CODE _____

If you have a friend interested in electronics send his name and address for a **FREE** subscription also.

OLSON ELECTRONICS

324 S. Forge Street Akron, Ohio 44308

CIRCLE NO. 17 ON READER SERVICE PAGE

FAX

(Continued from page 41)

en by vidicon cameras aboard the ESSA (Nimbus and Tiros) weather satellites are reproduced by conventional fax recorders in ground stations all around the globe. The charge pattern for each exposure on the vidicon's storage element is read out at the rate of 4 lines a second and radioed to earth via a 5-watt FM transmitter operating on a frequency of 137.5 MHz. Pictures are snapped by the orbiting camera at 3½-minute intervals to provide ample time for transmission.

The fax recorder at the ground station turns out a continuous succession of detailed, 800-line reproductions of everything the satellite sees while it is within range of the station. Radio amateurs obtain good reproductions of the cloud pictures on homemade fax recorders.

Things to Come. Much of what's to come for fax is, in large part, already here. It is possible, for example, to transmit a sequence of documents over broad-band channels at TV speeds (a fraction of a second per document), and it is possible to "compress" the fax signal by analyzing and encoding it automatically so that only the text, and not the white space, of a document is actually transmitted.

Couple these capabilities with transmission economies obtained through use of digital techniques (encoding of waveforms into short-duration pulses), and fax begins to shape up into a mighty appealing package.

The odds are that in the not-too-distant future, we will be seeing, among other things, large blueprints being sent over ordinary voice circuits in a matter of seconds; x-ray photos being sent to a specialist a thousand miles away and his diagnosis returned in minutes; businessmen in different cities exchanging messages and documents with the same ease and speed as if they were in adjacent offices.

And, who knows? We may yet see the mass marketing of inexpensive fax receivers for the home. The way things are going, it may happen sooner than we think.

—30—

THRIFTY 3-WAY

(Continued from page 67)

fill the enclosure with fiberglass wool. Screw on the rear plate of the enclosure.

Finishing Touches. The front mounting speakers require that the enclosure employ a removable grille cloth to provide access to the speakers. Also, the grille cloth must be spaced about $\frac{3}{4}$ " away from the front surface of the speaker mounting board to clear the speakers.

One way to maintain the proper spacing between the speakers and grille cloth is illustrated in Fig. 5. First, construct a frame of $\frac{3}{4}$ " \times $\frac{3}{4}$ " pine (A) just large enough to frame the front of the speaker mounting board and fit within the confines of the enclosure walls.

Next, cut the grille cloth (B) to size, stretch it, and tack it to the frame. Then fabricate another frame (outer dimensions approximately $24\frac{1}{4}$ " \times $14\frac{3}{4}$ "), using $1\frac{3}{8}$ " \times $\frac{1}{4}$ " plain pine molding (C). As with the walls of the enclosure, the ends of this second frame should be miter cut at 45° angles. When properly constructed, paint or stain this second frame; a good color is white for contrast.

Nail the second frame symmetrically over the first frame and grille cloth, using wire brads. At this point, the second frame should overhang the first frame by about $\frac{3}{8}$ " on all sides.

Finally, miter cut the decorative "cabinet" molding to form a frame $25\frac{1}{2}$ " \times $15\frac{1}{2}$ " (the same size as the enclosure). Stain and finish the decorative molding, and symmetrically glue it onto the second frame. Now, set the grille assembly into place in the front of the speaker enclosure. The fit should be a little tight to hold the assembly firmly in place. However, if the fit is too loose to accomplish this, remove the grille assembly, and add as many layers of tape to the $\frac{3}{4}$ "-square frame to make a friction fit.

That's it! Construction is complete, and now all you have to do is connect the "Thrifty Three Way" to your amplifier, start a disc whirling, and adjust the tweeter and midrange controls to complement the acoustics of your listening room. Now sit back and enjoy the sound.

now...a dozen tools for dozens of jobs in a hip pocket set!



Really compact, this new nut driver/screwdriver set features 12 interchangeable blades; and an amber plastic (UL) handle. All are contained in a slim, trim, see thru plastic case which easily fits hip pocket. Broad, flat base permits case to be used as a bench stand. Ideal for assembly and service work.

7 NUTDRIVERS:

$\frac{3}{16}$ ", $\frac{7}{32}$ ", $\frac{1}{4}$ ", $\frac{9}{32}$ ", $\frac{5}{16}$ ", $\frac{11}{32}$ ", $\frac{3}{8}$ " hex openings.

2 SLOTTED SCREWDRIVERS:

$\frac{3}{16}$ " and $\frac{9}{32}$ " tips.

2 PHILLIPS SCREWDRIVERS:

#1 and #2 sizes.

EXTENSION BLADE:

Adds 4" reach to driving blades.

HANDLE:

Shockproof, breakproof. Exclusive, positive locking device holds blades firmly for turning, permits easy removal.

WRITE FOR CATALOG 162

XCELITE

XCELITE INC. • 20 BANK ST., ORCHARD PARK, N. Y.

Send Catalog 162 with information on 99PS-50

name _____

address _____

city _____

state & zone _____

CIRCLE NO. 31 ON READER SERVICE PAGE

103

HOROSCOPE BY COMPUTER

(Continued from page 71)

and possibilities. A new astrological study organization, Time Pattern Research, uses IBM equipment featuring magnetic storage discs, each containing $7\frac{1}{2}$ million bits of information on the latitude and longitude of most major cities of the world; the various time zones with conversions to GMT; the positions of each planet, the sun, and the moon for each 24-hour period from 1880 to 1970; the table of all astrological houses referred to sidereal time; and sign information indexed by latitude. The stored information is continuously updated to reflect new astronomical findings.

Information concerning the subject's birth is supplied to the computer on a punched card. The computer is programmed to take this information and prepare a basic flow chart which is an intermediate step in the preparation of the final horoscope. The flow chart shows ascendent, house, and sign positions of each natal and progressed planet to the minute; natal and progressed declination; natal planetary aspects; planetary aspects progressed monthly; lunar aspects; monthly new-moon aspects; and eclipse aspects.

This data is then fed back into the computer, which is programmed a second time to perform the necessary astrological calculations and produce the final readout. This is a report of about 20 pages containing details on the subject's character, mental attributes, emotional makeup, material potentialities (including a listing of possible vocations, significant periods, financial prospects, etc.), personal relationships (with birth dates of people in harmony), health, judicious places for travel, etc.

The use of a computer to remove the "personal" element from the preparation of a horoscope has attracted considerable public attention. It has also removed much of the mysticism and placed astrology on a *sink or swim* course to prove itself as a true science.

The stars do sometimes foreshow such things as happen, but they are not the enforcing causes of such things as happen.

Robert Gray, *An Alarum to England, 1609*

HATFIELD HAMS

(Continued from page 75)

vice is quite legal. Actually, there are plenty of jobs for both groups, and the enthusiasm of most CB clubs has been an excellent stimulus for stagnant hams. When only amateur radio clubs were available to perform community services such as traffic control, etc., hams could be independent about volunteering for extra evening and weekend chores, but with a CB club around, the hams have to get busy or the CB'ers will pounce on the good publicity.

There is another serious point for hams to ponder. Although there are persons who get CB licenses just because it is an easy way to get hold of a microphone, there are many who choose amateur radio because it provides a challenge. A testimonial to this fact is Scott Millick, K9PPX, of Litchfield, Illinois, who became a General class ham when he was only 11 years old. After several years of DX'ing, he became KPK1475 and put his ham rig on the shelf. Recently, however, he passed his Advanced class amateur radio examination and said of his own experience: "Pride of accomplishment is a very big plus for ham radio. I had almost forgotten how it feels to achieve."

With the advent of single side band, solid-state circuits, and fast moving developments in the world of electronics, amateur radio continues to challenge anyone and everyone. According to FCC regulations, the Citizens Radio Service was created for short-range communication of a non-hobby nature. For thousands who depend on it for just those purposes, it is extremely valuable. Regrettably, some CB'ers break the rules and so do a few hams, but recognition must be given to those who use their licenses properly and legally.

It's a shame that the hams and CB'ers got off to such a bad start back in '58, but who says it's too late to bury the hatchet for good? It's time for each of us, no matter what license he or she holds, to decide what can be done to improve relations with the other fellow. After all, it's just a matter of communication, isn't it?



OPERATION ASSIST

Through this column we try to make it possible for readers needing information on outdated, obscure, and unusual radio-electronics gear to get help from other P.E. readers. Here's how it works: Check the list below. If you can help anyone with a schematic or other information, write him directly—he'll appreciate it. If you need help, send a postcard to Operation Assist, POPULAR ELECTRONICS, One Park Avenue, New York, N.Y. 10016. Give maker's name and model number of the unit. If you don't know both the maker's name and the model number, give year of manufacture, bands covered, tubes used, etc. State specifically what you want, i.e., schematic, source for parts, etc. Be sure to print or type everything legibly, including your name and address. Do not send an individual postcard for each request; list all requests on one postcard. Because we get so many inquiries, none of them can be acknowledged. POPULAR ELECTRONICS reserves the right to publish only those items not available from normal sources.

Contact Model CB 7000 transceiver. Need bandpass filter (L10) #119T-65-01. (Roland J. Fortin, 49 Soundview Ave., Bridgeport, Conn. 06606)

Sylvania Model 400 TV oscilloscope. Schematic and specifications needed. (Jonathan Mensel, 122 Lovers Lane Rd., Albany, Georgia 31705)

Dumont Type 164-E oscillograph. Schematic needed. (Mark Brent, 6047 N. 11 St., Philadelphia, Pa. 19141)

B&K Model 650 tube tester. Panel 615 with schematic for wiring needed. (Robert F. Eager, 1225 Saunders Settlement Rd., Niagara Falls, N.Y. 11305)

Stromberg-Carlson Custom 800 AM-FM tuner/amplifier, circa 1955. Schematic and tube diagrams needed. Also location and source for parts. (Norman Hochfeld, 9010 S. Jeffery Blvd., Chicago, Ill. 60617)

Philco Model 65, chassis 384280 or similar. Schematic needed. (Dempsey Merritt, 2343 Ernest, Jacksonville, Fla. 32201)

Triumph Model 333S multirange volt-ohmmeter. Schematic needed. (Stanton Drummond, 152 N. Crescent Dr., Rome, N.Y. 13410)

Westinghouse Model WR-29 BC and SW. Operating instructions and parts supply needed. (Michael Friend, 2862 March Circle, Omaha, Neb. 68123)

Hallicrafters Model S-36A VHF receiver. Schematic, operating manual, and alignment instructions needed. (Charles T. Aldridge, Jr., QTRS 203-E Ford Is., Honolulu, Hawaii 96818)

RCA Type TMV-97-C test oscillator. Schematic needed. (Stan King, 7046 Reynolds St., Pittsburgh, Pa. 15208)

Hallicrafters "Sky Buddy." Schematic, operating manual, and alignment data needed. (A.J. Hawkins, 604 Walnut Way, Freeport, Pa. 16229)

Heath AT-1 transmitter. Operating instructions and/or manual needed. **Hallicrafters** Model SX-2SA receiver, circa 1940. Source for parts (S-meter) needed. (Alan Hallaurer, 224 London Rd., Webster, N.Y. 14580)

Utica Model PT-27 CB. Schematic, operating manual, and source for parts needed. (William Gillian, 606 Hamilton St., N.W., Washington D.C. 20001)

(Continued on page 110)

Which of these
4 fascinating
Radio-TV
careers
interests
you?

disc jockey
 newscaster
 sportscaster
 announcer

Our Free Voice Analysis Tells You Whether You Have The Talent To Become A Broadcast Personality!

IMMEDIATE DEMAND • Radio-TV stations everywhere need both men and women to take over important good-paying jobs right now. **NATIONWIDE PLACEMENT ASSISTANCE** at No Extra Cost.

TRAIN AT HOME OR IN ONE OF OUR STUDIO SCHOOLS • You can study broadcast techniques at home, in your spare time, or in one of our many studio schools throughout the country under the supervision of our Directing Faculty of 10 Famous Broadcasters. **Accredited Member National Home Study Council and National Association of Trade and Technical Schools.**

Approved for Veterans' Educational Assistance Benefits ("G.I. Bill")! Check coupon for special information

Send to CAREER ACADEMY's division of famous broadcasters for free booklet, record and voice analysis details!

CAREER ACADEMY

825 North Jefferson Street • Studio 297
Milwaukee, Wisconsin 53202

I want to know if I have broadcasting aptitude worth developing. Please rush more information.

name age

address phone

city/state/zip

074087201

I am interested in: Home Study

School Study G. I. Bill





Hunting for a better job?

**Here's the
license
you need
to go after
the big ones**

A Government FCC License can help you bring home up to \$10,000, \$12,000, and more a year. Read how you can prepare for the license exam at home in your spare time—with a passing grade assured or your money back.

IF YOU'RE OUT TO BAG A BETTER JOB in Electronics, you'd better have a Government FCC License. For you'll need it to track down the choicest, best-paying jobs that this booming field has to offer.

Right now there are 80,000 new openings every year for electronics specialists—jobs paying up to \$5, \$6, even \$7 an hour... \$200, \$225, \$250, a week... \$10,000, \$12,000, and up a year! You don't need a college education to make this kind of money in Electronics, or even a high school diploma.

But you *do* need knowledge, knowledge of electronics fundamentals. And there is only one nationally accepted method of measuring this knowledge... the licensing program of the FCC (Federal Communications Commission).

Why a license is important

An FCC License is a legal requirement if you want to become a Broadcast Engineer, or get into servicing any other kind of transmitting equipment—two-way mobile radios, microwave relay links, radar, etc. And even when it's not legally required, a license proves to the world that you understand the principles involved in *any* electronic device. Thus, an FCC "ticket" can open the doors to thousands of exciting, high-paying jobs in communications, radio and broadcasting, the aerospace program, industrial automation, and many other areas.

So why doesn't everyone who wants a good job in Electronics get an FCC License and start cleaning up?

The answer: it's not that simple. The government's licensing exam is tough. In fact, an average of two out of every three men who take the FCC exam fail.

There is one way, however, of being pretty certain that you will pass the FCC exam. And that is to take one of the FCC home study courses offered by Cleveland Institute of Electronics.

CIE courses are so effective that better than 9 out of 10 CIE graduates who take the exam pass it. That's why we can back our courses with this iron-clad Warranty: Upon completing one of our FCC courses, you must be able to pass the FCC exam and get your license—or you'll get your money back!

They got their licenses and went on to better jobs

The value of CIE training has been demonstrated time and again by the achievements of our thousands of successful students and graduates.

2 NEW CIE CAREER COURSES

1. BROADCAST (Radio and TV) ENGINEERING... now includes Video Systems, Monitors, FM Stereo Multiplex, Color Transmitter Operation and CATV.

2. ELECTRONICS ENGINEERING... covers steady-state and transient network theory, solid state physics and circuitry, pulse techniques, computer logic and mathematics through calculus. A college-level course for men already working in Electronics.

Ed Dulaney, Scottsbluff, Nebraska, for example, passed his 1st Class FCC License exam soon after completing his CIE training...and today is the proud owner of his own mobile radio sales and service business. "Now I manufacture my own two-way equipment," he writes, "with dealers who sell it in seven different states, and have seven full-time employees on my payroll."

Daniel J. Smithwick started his CIE training while in the service, and passed his 2nd Class exam soon after his discharge. Four months later, he reports, "I was promoted to manager of Bell Telephone at La Moure, N.D. This was a very fast promotion and a great deal of the credit goes to CIE."

Eugene Frost, Columbus, Ohio, was stuck in low-paying TV repair work before enrolling with CIE and earning his FCC License. Today, he's an inspector of major electronics systems for North American Aviation. "I'm working 8 hours a week less," says Mr. Frost, "and earning \$228 a month more."

Send for FREE book

If you'd like to succeed like these men, send for our FREE 24-page book "How To Get A Commercial FCC License." It tells you all about the FCC License... requirements for getting one... types of licenses available... how the exams are organized and what kinds of questions are asked... where and when the exams are held, and more.

With it you will also receive a second FREE book, "How To Succeed In Electronics." To get both books without cost or obligation, just mail the attached postpaid card. Or, if the card is missing, just mail the coupon below.

ENROLL UNDER NEW G.I. BILL. All CIE courses are available under the new G.I. Bill. If you served on active duty since Jan. 31, 1955, or are in service now, check box on reply card for complete details.

CIE Cleveland Institute of Electronics

1776 E.17th St., Cleveland, Ohio 44114

Accredited Member National Home Study Council
A Leader in Electronics Training... Since 1934



Cleveland Institute of Electronics
1776 East 17th Street, Cleveland, Ohio 44114

Please send me without cost or obligation:
Your 40-page book "How to Succeed In Electronics" describing job opportunities in Electronics today, and how your courses can prepare me for them.
Your book on "How To Get A Commercial FCC License."

I am especially interested in:

- Electronics Technology Electronic Communications
 Broadcast Engineering Industrial Electronics
 First Class FCC License Electronics Engineering

Name _____ (PLEASE PRINT)

Address _____

City _____

State _____ Zip _____ Age _____

Check here for G.I. Bill information PE-77

CIRCLE NO. 7 ON READER SERVICE PAGE



not by a long shot it isn't !!

There's certainly nothing top secret about Popular Electronics' classified pages. They're wide open to every buyer in the market for the product or service he knows can be found in Electronics Market Place.

More than 400,000 buyers of Popular Electronics, largest readership of any electronics magazine in the world, guarantee that your ad is being read by people constantly looking for and buying electronics products. It is these people to whom you MUST direct YOUR advertising as do the many key advertisers appearing in this issue and in each issue throughout the year.

No doubt about it—there's a vast market of buyers searching the classified advertising pages of Popular Electronics and it's important that your ad be exposed to them. Prove to yourself that the leading electronics magazine MUST ALSO be the leader in sales responses to the many classified ads presently enhancing its pages—it makes a great deal of sense—give it a try.

See classified section for rate information or write to HAL CYMES, *Classified Advertising Manager*
ZIFF-DAVIS PUBLISHING COMPANY
One Park Avenue, New York, N. Y. 10016

NEW! SOLID STATE KITS

METAL-MINERAL DETECTOR
IN EASY-TO-BUILD KIT FORM

Treasure Locator

MODEL TRL-1 KIT . . . \$29.95

Detects objects as small as a dime.
Sensitive stable circuit uses
3 FET's and 2 silicon transistors.
Unique 6" etched circuit search coil.
Smooth vernier tuning control.
Weights only 24 oz.
3-ft. handle folds in half.
Adjustable search coil.
9-volt battery operated.
Complete with all parts,
headphone, instructions.
Build in only 3 hours.
No test equipment needed.
Shipping weight: 2½ lbs.

Order direct or request free
data sheets on TRL-1 and
other kits.



CARINGELLA ELECTRONICS, Inc.
P.O. Box 327 ■ Upland, California 91786
Phone 714-985-1540



CIRCLE NO. 6 ON READER SERVICE PAGE

ASSIST

(Continued from page 105)

Westinghouse Model 175C TV. Schematic and tube complement needed. (David Kerr, 11 Prospect Ave., Rumford, Me. 04276)

Precision Model 117B special scintillator. Sodium iodide crystal and 6199 photomultiplier tube needed. (Richard Frankovsky, 40-07 Taylor Rd., Fair Lawn, N.J.)

Atwater-Kent Model 30. Schematic, speaker, and tubes needed. (Sammie McCrea, 312 S. Harper, Santa Ana, Calif.)

Blaufunkt E52WSH. Schematic needed. (Alberto E. Genta, P.O. Box 444, Montevideo, Uruguay, S.A.)

Grunow Model 8E, chassis Type 871. Schematic, parts list, and any information needed. (Loren S. Howe, 69 2nd St., Gloversville, N.Y. 12078)

Superior Instruments Model 400 electronic multimeter. Schematic and service manual needed. (Robert Kegyly, 6341 Eilerts, Wichita, Kn. 67218)

Hallicrafters Model S-118 SW set. Schematic, instruction manual, and price when new needed. (Martin S. Boccamaiello, 129 Giddings Ave., Windsor, Conn. 06095)

Meissner exciter unit Type 02133, unit of transmitting equipment Model 150B, World War II vintage. Schematic needed. (F.F. Stewart, 1201 Willow Ln., Cocoa, Fla. 32922)

Paco Model T-65 transistor tester. Copy of test data sheets needed. (Joe Downey, Box 131, Grand Forks, N.D. 58201)

Dumont Type 211 scope. Manual needed. **Teletype** Model 19. Service Manual needed. (Heard S. Lowry, 915 Madison St., Manchester, Tenn. 37355)

Heathkit IO-11 oscilloscope, circa 1958. Servicing and instruction manual needed for scope and power supply. (Michael Zachariash, 1238 S. Ogden Dr., Los Angeles, Calif. 90019)

Hickok Model 155 traceometer (or Model 156). Schematic and operating manual needed. (Calvin D. Peterson, 622 S. 15th St., Bismarck, N.D. 58501)

Radio Shack Select-Comm, circa 1965. 32 A 8 Japanese tubes or diagram to convert to another tube needed. (Capt. Richard Miller, Goldman Fire Dept., Rt. 2, Hillsboro, Mo. 63505)

Silvertone Model 1967. Schematic needed. (Joseph M. Benoit, 6340 Cottage St., Philadelphia, Pa. 19135)

Hallicrafters Model S-107 SW receiver. Manual, schematic, and calibration instructions needed. (Steven Gregory, 456 Twining Dr., Dayton, Ohio 45431)

Weston Model 983 oscilloscope. Schematic, parts source, and any information needed. (Mark Bednar, 719 Lee Blvd., Hillside, Ill. 06162)

Sony Model TFM-116A portable AM/FM. Schematic needed. (Maurice Katz, 3550 Dover St., Los Angeles, Calif. 90039)

Standard Transformer Model ST-202-A transmitter. Schematic and operating manual needed. **Triumph** Model 841 3" oscilloscope. Schematic and operating manual needed. (M. R. Lambert, 8173 Baldwin Rd., Lemon Grove, Calif. 92045)

Heathkit Model ES-400 modular analog computer. Assembly manuals for components with model Nos. ES-2, -50, -100, -151, -201, -401, -405, -505, -600 needed. (Tim Sharon, 1206 N. Fairlawn, Santa Ana, Calif. 92703)

International Radio Corp. Model 950 AM/SW receiver. Manual, schematic, and alignment data needed. (James Viviano, 71-12 165th St., Flushing, N.Y. 11365)

Hallicrafters Model S-38E SW receiver. Schematic and parts list needed. (Brian Meldrum, 19 Novella St., Lewiston, Me. 04240)

Hallicrafters Model SX-25 HF communications receiver. Schematic needed. (H. A. Wickert, 5 Deerview Ln., Asheville, N.C. 28804)

Zenith Model 6R0S7 ZZ AM receiver/phono; serial

number A871799. Schematic needed. (Wayne Wettenstein, 223 Roger Dr., Stratford, Conn. 06197)

National Model NC-173. Operating manual and schematic needed. (David Demers, 228 White St., Lunenburg, Mass. 01162)

Triumph Model 841 J^o oscillograph. Operating manual, schematic and specs needed. (Gerald Koske, 1106 E. Nw. Hwy., Arlington Heights, Ill. 60004)

Hallicrafters Model HT-5B transmitter. Schematic and/or operating manual needed. (Marc Kauffman, 8221 Forrest Ave., Philadelphia, Pa. 19150)

Madison Fielding (Crosby) Model 650 stereophonic receiver. Instruction manual needed. (Richard Cochran, 249 Kent Place Blvd., Summit, N.J. 07901)

Electronics Design Model 100 VTM. Supreme Instrument Corp. Model 561 signal generator. Schematics needed. (H. A. Dillon, 65 Washington St., Cloversville, N.Y. 12078)

Harvey-Wells Model TBS-50C Senior Bandmaster. Operating manual needed. (Fred Messer, Moretown, Vt. 05860)

Atwater Kent Model 7570 receiving set, circa 1925. Operating manual, schematic, and any information needed. (Marvin Peterson, Bonanza, Alberta, Canada)

Hallicrafters SX-25 Super Defiant receiver. BFO pitch coil (L2) and source for parts needed. (Justin E. Devault, Jr., 610 Foxx St., Johnson City, Tenn. 37601)

Atwater Kent Models 40 and 37. Schematics for receivers and power supplies needed. (T. A. Drogoski, 507 Coal Valley Rd., Clairton, Pa. 15025)

Hallicrafters Model SX-25 receiver. Power transformer and source for parts needed. (Paul Hoy, 130 E. Main St., Tremont, Pa. 17981)

Grundig Model KS620U stereogram. ECH800 tube needed. (John Hupke, Jr., 4826 Walsh Ave., E. Chicago, Ind. 46312)

RCA Model 158 cathode-ray oscillograph. Schematic needed. (Harold R. Chapman, RR #1, Box 101, Bourbon, Ind. 46504)

Waterman Products Model S-11A "Pocketscope." Schematic and/or operating manual needed. (John G. Linn, Jr., 21 Stuart Pl., Manhasset, N.Y. 11030)

Freed-Eiseman battery-operated, five-tube "neutrodyne" radio with phones and cone reproducer. Technical and/or operating information and schematic needed. (D. Barfoot, 247 Central Ave., Dover, N.H. 03820)

Western Electric Model 41-B radio receiver. Schematic and tech manual needed. (Doug Garrett, RR 2, Crestline, Ohio 44827)

RCA Model 4T101 TV set. Schematic, parts list, and any information needed. (Julio N. Varas, 93-11 49th Ave., Elmhurst, L.I., N.Y. 11373)

Hallicrafters Model S-77-A receiver. Schematic and

operating manual needed. (Tom Ziegler, 1801 NW 3rd Terr., Ft. Lauderdale, Fla. 33311)

Motorola Model FPTR 1(B)L1 "handie-talkie" FM radio telephone pack. Schematic and operating information needed. (Robert V. Pietruszka, 4016 California Ave. # 2, Carmichael, Calif. 95608)

Webcor Model 2005-1 2-track monaural tape recorder. Specs, schematics, parts, and operating manual needed. (D. Brown, 200 Grant Dr., Hanover, Pa. 17331)

Motorola Model VT 71MB-A TV, circa 1948. Schematic needed. Lawrence Volin, Hampshire Country School, Rindge, N.H. 03461)

Hammarlund Model SP-200-S or SP-200-X. Front end and S meter needed. (Wayne N. Storch, 1616 Campbell St., Joliet, Ill. 60135)

National Model HRO-7 general coverage receiver. Coil sets E-F-G-H-J-K-AA-AB-AC needed. (John Farris, 1720 Stanton Ave., Whiting, Ind. 46394)

OUT OF TUNE

MANNERLY TABLE LAMP, November 1968, a connection between the lamp and the ON terminal of *S1* was accidentally omitted on the schematic. While the lamp will operate as described without this connection, there will be a slight delay before the lamp turns on after *S1* is set to the ON position. The omitted connection, however, permits the lamp to be turned on immediately when the switch is set to ON.

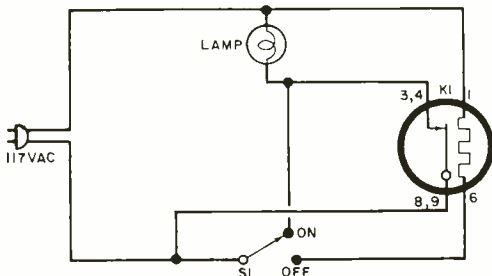

Ranked #1 in lightweight tracking ability¹

Able to track the toughest test-record bands at 0.8 gram², ...
With a frequency response flat within +2.5, -2 db from 20 to 20k Hz^{1, 2}, ...
And 30 db of stereo separation^{1, 2}, ...
Plus a flawless square wave^{1, 2}, ...

EMPIRE's 999VE

The Long-Playing Cartridge • \$74.95

1. *HiFi/Stereo Review*, July 1968. 2. *High Fidelity*, June 1968

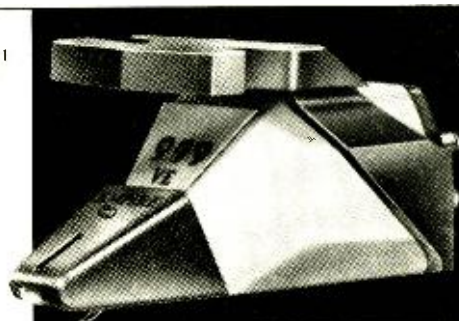

Empire Scientific Corp.,
1055 Stewart Avenue, Garden City, N.Y. 11530

CIRCLE NO. 11 ON READER SERVICE PAGE

POPULAR ELECTRONICS SUBSCRIBER SERVICE

Please include an address label when writing about your subscription to help us serve you promptly. Write to: Portland Place, Boulder, Colo. 80302

CHANGE OF ADDRESS:

Please let us know you are moving at least four to six weeks in advance. Affix magazine address label in space to the right and print new address below. If you have a question about your subscription, attach address label to your letter.

TO SUBSCRIBE:

Check boxes below.

- New Renewal
 5 years \$20
 3 years \$13
 1 year \$5

SPECIFY:

- Payment enclosed
 —You get 1 extra issue per year as a BONUS!
 Bill me later.

← AFFIX LABEL →

If you have no label handy, print OLD address here.

name _____

city _____

address _____

state _____

zip-code _____

please print

[Add'l postage: \$1 per year outside U.S., its possessions & Canada.]

name _____ please print 0332

address _____

city _____

state _____ zip-code _____

PRODUCTS

(Continued from page 24)

tacts simultaneously with only one hand is possible with the B&K Division's "Dyna-Flex" probe. Designed specifically for printed circuit work, the probe has three spring-loaded, needle-point tips which tilt or swivel on ball joints to permit automatic adjustment to any spacing between 1/32" and 3/4" to fit the terminations of a wide variety of components—especially transistors. Three leads, color-coded to their respective tips, terminate in insulated alligator clips for easy connection to the test instrument being used. The "Dyna-Flex" is specifically designed for use with in-circuit transistor testers, VTVM's, and VOM's.

Circle No. 91 on Reader Service Page 15 or 115

SOLID-STATE REVERBERATION AMPLIFIER

Now you can add real concert-hall reverberation effects to your home music system with the Lafayette Radio Electronics Model R-777 reverberation amplifier. The new reverb amp is specially designed to operate



with a stereo receiver or amplifier that is equipped with a three-way speaker selector (main, remote, and main-remote).

The third channel originates from the remote output terminals of your receiver or amp. The reverb amplifier features a "percentage of reverberation" control that allows adjustments to best suit your room acoustics, and includes tone, volume and power controls for full flexibility. Power output is 10 watts r.m.s. into an 8-ohm load, and output impedance is a nominal 8 ohms. This four-transistor/four-diode reverb amp is housed in a walnut wood enclosure and has a brushed aluminum front panel.

Circle No. 92 on Reader Service Page 15 or 115

AUDIO TEST CENTER

Designed to meet the most urgent needs of audio equipment troubleshooting, the Century General Corp. Model 140 Audio Test Center combines up to six different instruments in a single unit. The all-solid-state instrument incorporates



an r.f./i.f./a.f. signal tracer, tone generator, multi-input amplifier, and oscilloscope preamplifier. And it is designed to prevent overload and damage to transistors. Specifications: signal tracer—crystal diode connected to a high-gain amplifier; tone generator—provides 1000-Hz audio signal for signal injection tests; multi-input audio amp—70-dB gain over a frequency range of 100-12,000 Hz ± 3 dB, 200 mW output; oscilloscope preamp—70-dB gain with 500-ohm output; other—70-dB gain with volume control, —60-dB noise

FIND BURIED TREASURE!

\$17⁸⁸

Plus \$1.00 Shipping
**10-DAY MONEY
 BACK GUARANTEE**
SEND ONLY \$3.00.

Pay \$14.88 plus postage and C.O.D. when delivered, or send \$18.88 for postpaid shipment to

TREASURE ENTERPRISES

Dept. K 37, Box 10947, Houston, Texas 77018

Find buried gold, silver, coins, war relics with new sensitive detector. Works for days on a common 60¢ 9-V battery. Fully transistorized. 1969 model. Ideal for beach combing, treasure and coin hunting, prospecting for gold. So sensitive it will detect a single coin or gold nugget. NOT A KIT. Complete, ready to operate. Nothing else to buy. Gives loud, clear signal, when metal is detected. Sensitive earphone included for treasure hunting in secrecy. Weighs 2 pounds.

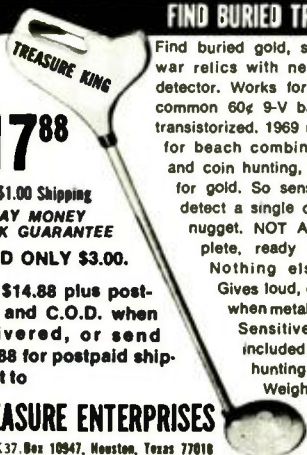

level, less than 3% harmonic distortion. 100-000- and 50-150-ohm inputs, 8- and 500-ohm outputs, 9-volt d.c. at 50 mA power supply.

Circle No. 93 on Reader Service Page 15 or 115

OMNIDIRECTIONAL SPEAKER SYSTEM

A full 360° sound dispersion is possible with the *Harman-Kardon* Model HK50 omnidirectional speaker system. When used in a stereo system, two speakers can be placed anywhere in the listening room—even behind furniture—and the full stereo effect can be heard. The reflected-sound concept employed in the HK50 makes possible random-placement stereo setups. The HK50 is also said to increase stereo depth dramatically and offer greater transparency of sound.



Circle No. 94 on Reader Service Page 15 or 115

FM STEREO RECEIVER

Fully automatic motor tuning plus precision manual tuning put *Panasonic's* Model SA-4000 FM stereo receiver in a class by itself. A preset memory master tuning system allows the listener to preselect up to five stations with push-button ease. To insure high sensitivity, four FET's and six IC's are employed in the tuner. Computer logic circuits and a multiplex circuit that incorporates a ceramic filter combine to produce automatic stereo/mono switching for incoming signals and prevent the accidental triggering of the stereo indicating lamp. A full complement of audio and tuner controls, including push button switches and precision sliding potentiometers, are featured. Output power of the SA-4000 FM stereo receiver is rated at 160 watts.

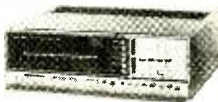

Circle No. 95 on Reader Service Page 15 or 115

COLOR ORGAN

Edmund Scientific Co. recently announced the introduction of a series of color organ systems designed for the music enthusiast who enjoys visual effects. The organs control groups of colored lamps that are usually triggered by music. Each lamp in the system responds to a certain band of frequencies and the intensity of the music input. This causes the lamps to blink and vary in brightness in relation to the rhythm, volume, and pitch of the music. The result is a continuous flashing, pulsating series of colored lighting effects. The color organs are available in a price range of \$40 to \$195, in three- and four-channel systems, and power-handling abilities of 600 to 2000 watts. There is also a single-channel do-it-yourself kit that can be purchased for less than \$10.

Circle No. 96 on Reader Service Page 15 or 115

SYDMUR

The Last Word In Ignition Systems



SAVE MONEY
on GAS! COILS!
SPARK PLUGS!
TUNE-UPS!

The most advanced solid state CD ignitions systems available. Take advantage of the latest technology ... get the most out of your car's engine.

- Increased mileage
- Greatly extended spark plug life
- Fast cold weather starting
- Fewer tune ups

Well built, conservatively rated components. Every Sydmur part is pre-tested and guaranteed. The easy to install Sydmur is fully adaptable; 6 or 12 volt systems, positive or negative ground.

Fly-away assembled	\$60.00 prepaid
Fly-away kit	44.50 prepaid
Compac assembled	\$34.75 plus 75¢ handling
Compac kit	24.95 plus 75¢ handling

Or Build Your Own—Free Instructions!!

Transformer plus detailed instructions

SPC4 (6 and 12 volt) \$14.95

As described in June 1965 Popular Electronics (New York State residents add sales tax)

Recommended by many of the world's leading automotive manufacturers. Send check or money order today.

For free literature and parts list write:

SYDMUR ELECTRONIC SPECIALTIES

1268 East 12th Street Brooklyn, NY 11230
CIRCLE NO. 26 ON READER SERVICE PAGE

FREE



**GIANT 1969
RADIO-TV
ELECTRONICS
CATALOG**
228 GIANT
VALUE-PACKED
PAGES

WRITE FOR YOUR FREE COPY TODAY

BURSTEIN-APPLEBEE CO., DEPT. PE-B
5199 MERCIER ST., K.C., MO. 64111

NAME _____

ADDRESS _____

CITY _____ STATE _____ ZIP _____

CIRCLE NO. 4 ON READER SERVICE PAGE

SHORT-WAVE MONITOR CERTIFICATE APPLICATION

ALL RADIO listeners interested in furthering the hobby of SWL'ing—regardless of whether they DX on the BCB, VHF, TV, SW, or FM bands—are eligible to apply for a POPULAR ELECTRONICS "Certificate of Registration." You must have verified (have QSL cards from) a minimum of five radio stations, one of which is outside the United States. There is no age limit or special equipment qualification; the only "requirement" is that the applicant have a sincere interest in radio communications.

All certificates are filled in and lettered before mailing; they are mailed flat and unfolded. If you want to register and receive your WPE identification sign, fill in the application blank below. Mail with 50 cents in coin (or stamps) to: MONITOR, P.O. Box 333, Cherry Hill, N.J. 08034. (Personal checks will not be acceptable.) Canadians should use their own currency; other applicants not in the U.S.A. should use 10 International Postal Reply Coupons. Allow 4-6 weeks for processing.

(Please Print)	(Do not fill out)
Name	
Street, City and Zone	
State and Zip	
Receivers in use	
Make	Model
Make	Model
Age	Occupation
Ham / CB call - letter assignment(s)	
I listen mostly to SW Broadcast Hams CB BCB VHF VLF	
I use the following antennas	
I have QSL cards and countries verified. Check if subscriber to P.E.	
Signature	Date

NEW / CB TRANSCEIVER SOLID STATE PRE-AMP

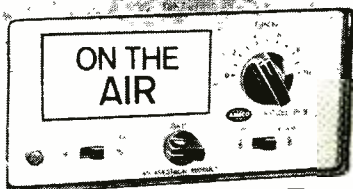

- Improves CB Base Station Performance
- Works on tube or transistor equipment
- No Modification to CB unit
- On-the-air sign automatically lights when transmitting

Model PCB with built-in power supply, transfer relay, connecting cables, wired and tested..... **\$49.95**

Write for free literature



AMECO / DIVISION OF AEROTRON, INCORPORATED
P. O. BOX 6527 • RALEIGH, NORTH CAROLINA 27608

CIRCLE NO. 1 ON READER SERVICE PAGE

READER SERVICE PAGE

free information service:

Here's an easy and convenient way for you to get additional information about products advertised or mentioned editorially (if it has a "Reader Service Number") in this issue. Just follow the directions below... and the material will be sent to you promptly and free of charge.

1. Print or type your name and address on the lines indicated. Circle the number(s) on the coupon below that corresponds to the key number(s) at the bottom of the advertisement or editorial mention(s) that interest you. (Key numbers for advertised products also appear in the Advertisers' Index.)

2. Cut out the coupon and mail it to the address indicated below.

3. This address is for our product "Free Information Service" only. Editorial inquiries should be directed to POPULAR ELECTRONICS, One Park Avenue, New York 10016; circulation inquiries to Portland Place, Boulder, Colorado 80302.

**POPULAR
ELECTRONICS**

P.O. BOX 8391
PHILADELPHIA, PA. 19101

VOID AFTER MARCH 31, 1969

1 2 3 4 5 6 7 8 9 10 11 12 13 14 15 16 17 18 19 20
21 22 23 24 25 26 27 28 29 30 31 32 33 34 35 36 37 38 39 40
41 42 43 44 45 46 47 48 49 50 51 52 53 54 55 56 57 58 59 60
61 62 63 64 65 66 67 68 69 70 71 72 73 74 75 76 77 78 79 80
81 82 83 84 85 86 87 88 89 90 91 92 93 94 95 96 97 98 99 100

NAME (Print clearly) _____

ADDRESS _____

CITY _____ STATE _____ ZIP CODE _____

2 b

BREAKTHROUGH



IN ELECTRONICS CALCULATING

Still plodding through math and electronics problems the slow pencil-and-paper way? Smash the paperwork barrier with this new Electronics Slide Rule.

Even if you've never used a slide rule before, you can whiz through resonant frequency calculations and inductive or capacitive reactance problems. You can find reciprocals for resistance formulas instantly. You can even locate tricky decimal points in a jiffy.

You can also work regular math problems in a flash: multiplication...division...square roots...logarithms...trigonometry.

Anyone can use this sturdy 12-inch, all-metal slide rule. We show you how with our complete 4-lesson instruction course. Slide rule, course, and handsome leather carrying case deliberately priced low as our way of making friends with men in Electronics. FREE booklet gives full details. Mail coupon below today.

MAIL THIS COUPON FOR FREE BOOKLET

CIE Cleveland Institute of Electronics
1776 East 17th Street, Cleveland, Ohio 44114

Please send me your FREE booklet describing the Electronics Slide Rule and 4-lesson instruction course. Also FREE if I act at once—a handy pocket-sized Electronics Data Guide.

Name _____ (PLEASE PRINT)
Address _____
City _____
State _____ Zip _____

PE-153

CIRCLE NO. 8 ON READER SERVICE PAGE

IT'S WHAT'S IN THE CAN THAT COUNTS!



For Quality
Results Tell
Us Your Needs



TEXAS CRYSTALS DIVISION
of Whitehall Electronics Corp.

1000 Crystal Drive Fort Myers, Florida 33901
Telephone Area 813 - WE 6-2100
Plants in Fort Myers and Los Angeles

CIRCLE NO. 27 ON READER SERVICE PAGE

PSYCH-ANALYZER

(Continued from page 32)

is through the use of playing cards. Show a subject five playing cards and ask him to select mentally one of them. Instruct him to say, loudly and with real conviction, "No! That is NOT my card!" every time you show him one of the cards and ask, "Is *this* your card?" Four times he will be telling the truth, the other he will be lying. Don't let the subject watch the meter, but keep your eyes on it all the time.

Sometimes the subject will show a marked response to two cards, and you will have to work a bit longer to discover which of the two he picked. Female subjects are sometimes so responsive that you can perform this test without words, merely showing the cards to the subject. Just the sight of the card causes the meter to jump.

Experience has shown that long-time poker players sometimes respond to an ace or a joker even though it is not the card chosen. Likewise, players experienced in the game of Hearts will react to the sight of the queen of spades without having chosen it. The experiment will be easier, therefore, if you leave out cards with specific connotations.

The Psych-Analyzer should be a natural for parties. It has great possibilities as a "passion meter"—if you keep things under control! You might discover that some person who is very blasé on the surface is actually a bit prudish underneath. You might find out who sent you that unsigned Valentine card that was supposed to be funny but didn't strike you that way. Or you might try a game where someone commits a "crime" while the lights are out. Then you try to find the guilty party. *However*, don't "hang" anyone just on the basis of the skin resistivity of his palms.

As a quick check of whether or not your Psych-Analyzer is functioning, connect it to a subject's palms—or even to your own—and have him take a deep breath. The meter should give a definite indication after the relaxation of the deep breath has passed and the air has been exhaled. There may be some latency in this indication also.

-30-

LETTERS

(Continued from page 10)

becomes more widely used in chemistry labs, it becomes increasingly more important for chemists to understand the fundamentals of electronics, and, conversely, for the people in electronics to understand the fundamentals of chemistry. I am, as a result, looking forward to more articles and projects for the chem lab.

T.C. O'HAVER
Asst. Professor of Chemistry
University of Maryland
College Park, Md.

The response we have received to our laboratory equipment projects has been quite enthusiastic. POPULAR ELECTRONICS plans to continue publishing lab equipment projects worthy of note, as they develop. Unfortunately, we do not at the present time have a Nicie-type readout adapter planned for the pH meter.

IMPROVED FIRE SENSORS

I can think of at least two methods of making a fire sensor that are better than the method illustrated in Fig. 4 of the "Prowler Howler" article (November, 1968). Both methods eliminate the possibility of missing the wire. In the first method, the sensing wire is routed through an eyehook that is anchored to the wood block and suspended by an elastic band. Then, when excessive heat causes the elastic band to sag, the eye hook breaks the sensing wire.

In the second method, the sensing wire is broken to accommodate a banana jack and plug. Assembly is similar to the first method mentioned. However, when the rubber band sags, the eyehook simply removes the plug from the jack to trip the alarm. Thus, the system is resettable.

LEE DUNLAP
Washington, D.C.

The description of the fire alarm setup for the "Prowler Howler" was incorrect. A rubber band is the mechanical analog of a thermistor; it has a negative expansion when heat is applied. Granted, when the fire burns through the rubber band, the block will fall—but before that it will rise. A more effective system

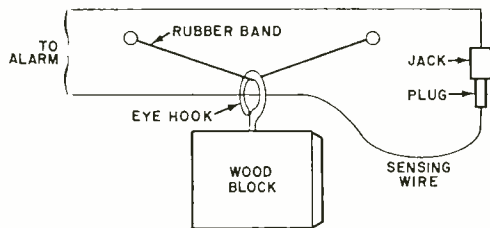
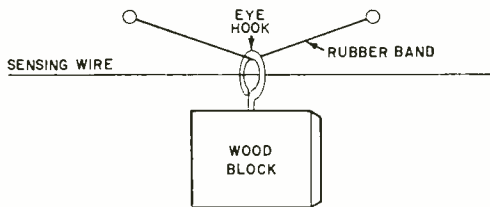

would be to use a length of solder (preferably the low-temperature kind) in place of the rubber band. The solder will melt through when heat is applied, and the block will fall as described.

NORMAN P. HUFFNAGLE
Lincoln, Neb.

Both of Lee's suggestions for making a heat sensor are better than the one that originally appeared in the article. The preferable method is the one employing the jack-plug idea. Then, too, Norman is correct in describing the phenomenon of the rubber band when heat is applied. We might add to his suggestion of using solder in place of the rubber band that the solder not only be of the low-heat type, but that it be as small in diameter as practical to assure the quickest possible separating time in the presence of heat.



LISTEN TO: POLICE & FIRE REPORTS

FOR INDUSTRIAL, COMMERCIAL, UTILITY AND GOVERNMENT USE

CRYSTAL CONTROLLED • DUAL CONVERSION • LOW POWER DRAIN

Specifically designed for simplicity of operation and efficiently engineered for dependable service. Fits the smallest autos yet powerful enough to deliver a clean clear signal. Features: 6 crystal controlled frequencies, Dual Limiter, Quadruple tuned RF stage for greater image rejection, Noise Free squelch, PLUG IN crystals for instant freq. change. Compatible with all major continuous tone systems. Operates on 117VAC & 12VDC. Size: 6 1/2" x 2 3/4" x 8 1/2" / Wt: 3 lbs. 8 oz.

Perfect For
POLICE • FIRE
Other Law Agencies
• Tow Trucks
• Civil Defense •

Complete with AC and DC power cables, Mounting bracket, less crystals. Crystals \$5.00 ea.

FR-104
(25-50 MHz)
FR-105
(150-175 MHz)

\$140⁰⁰

SONAR RADIO CORP., 73 Wortman Ave., Bklyn, N. Y. 11207

Please send information on FR-104/105 FM Monitor Receivers. Dept. 869

Name _____

Address _____

City _____ State _____

ABOUT YOUR SUBSCRIPTION

Your subscription to POPULAR ELECTRONICS is maintained on one of the world's most modern, efficient computer systems, and if you're like 99% of our subscribers, you'll never have any reason to complain about your subscription service.

We have found that when complaints do arise, the majority of them occur because people have written their names or addresses differently at different times. For example, if your subscription were listed under "William Jones, Cedar Lane, Middletown, Arizona," and you were to renew it as "Bill Jones, Cedar Lane, Middletown, Arizona," our computer would think that two separate subscriptions were involved, and it would start sending you two copies of POPULAR ELECTRONICS each month. Other examples of combinations of names that would confuse the computer would include: John Henry Smith and Henry Smith; and Mrs. Joseph Jones and Mary Jones. Minor differences in addresses can also lead to difficulties. For example, to the computer, 100 Second St. is not the same as 100 2nd St.

So, please, when you write us about your subscription, be sure to enclose the mailing label from the cover of the magazine—or else copy your name and address exactly as they appear on the mailing label. This will greatly reduce any chance of error, and we will be able to service your request much more quickly.

ELECTRONIC EXPERIMENTER'S HANDBOOK



The most fascinating and challenging construction projects for the electronics hobbyist. Over 148 pages.

1968 Winter Edition #50
 1967 Spring Edition #49
 1966 Fall Edition #39
 1966 Spring Edition #36
 1965 Fall Edition #9

Titles listed above \$1.25 each

Order by number from

Ziff-Davis Service Div., 595 Broadway • New York, N.Y. 10012. Enclosed add'l 15¢ per copy for shipping and handling (50¢ for orders outside U.S.A.)

PAYMENT MUST BE ENCLOSED WITH ORDER

GET INTO ELECTRONICS

V.T.I. training leads to success as technicians, field engineers, specialists in communications, guided missiles, computers, radar, automation. Basic & advanced courses. Electronic Engineering Technology and Electronic Technology curricula both available. Associate degree in 24 months. B.S. obtainable. (G.I. approved. Start February, September, January, August. High school graduate or equivalent. Catalog

VALPARAISO TECHNICAL INSTITUTE
 DEPARTMENT PE, VALPARAISO, INDIANA 46383



A.C. TO ZENER QUIZ ANSWERS

(Quiz appears on page 56)

- 1 True. Nickel-cadmium and lead-acid batteries are secondary cells and fall into this category.
- 2 False. Equalizing pulses are used to permit interlace.
- 3 False. High-level demodulation means that the signal level is high enough after demodulation to be applied directly to the CRT.
- 4 True. The resulting 60-Hz signal in the color information would create a color hum bar which could be cut off by the color killer when no color signal was present.
- 5 False. Saturable reactors may be compared to 3-winding transformers where the a.c. transferred between two of the windings is controlled by the core saturation, which in turn is controlled by applying d.c. to a third winding.
- 6 False. Several a.c. digital meters are on the market.
- 7 False. Mu-metal is a specially treated magnetic shield. It is frequently used around oscilloscope CRT's.
- 8 False. The tube and capacitor combination frequently sets up a relaxation oscillator circuit.
- 9 True. Capacity is necessary but capacitors are not. The capacity in many coils is sufficient to form the required tank circuit.
- 10 False. Stagger-tuned means that consecutive transformers in an i.f. strip are tuned to different center frequencies. This method is used for broadband gain.
- 11 False. The term beat frequency refers to the frequency generated by heterodyning when two other frequencies are mixed.
- 12 True. When broadcast technicians refer to the image orthicon, they call it the I.O.
- 13 False. DTL stands for diode transistor logic, the diode and transistor being the active components in the logic circuit.
- 14 True. The trinitron, developed by Sony, will be introduced in their 1969 sets.
- 15 True. Sylvania has built a flying spot scanner into some new color sets so 35-mm film slides can be shown on the TV screen.
- 16 True. The device consists of about 50 silicon chips stacked and matched to withstand 35 KV PIV and about 200 mA peak current.

ELECTRONICS MARKET PLACE

COMMERCIAL RATE: For firms or individuals offering commercial products or services. \$1.15 per word (including name and address). Minimum order \$11.50. Payment must accompany copy except when ads are placed by accredited advertising agencies. Frequency discount: 5% for 6 months; 10% for 12 months paid in advance. **READER RATE:** For individuals with a personal item to buy or sell. 70c per word (including name and address). No Minimum! Payment must accompany copy.

FOR SALE

FREE! Giant bargain catalog on transistors, diodes, rectifiers, SCR's, zeners, parts. Poly Paks, P.O. Box 942, Lynnfield, Mass. 01940.

GOVERNMENT Surplus Receivers, Transmitters, Snooperscopes, Radios, Parts, Picture Catalog 25¢. Meshna, Nahant, Mass. 01908.

BUG DETECTOR: WILL DETECT AND LOCATE SURREPTITIOUS TRANSMITTING DEVICES IN CONFERENCE ROOMS, HOME AND OFFICES, ETC. WRITE FOR DETAILS. WIS ELECTRONICS, 737 NORTH SEWARD, HOLLYWOOD, CALIF. 90038.

ROCKETS: Ideal for miniature transmitter tests. New illustrated catalog, 25¢. Single and multistage kits, cones, engines, launchers, trackers, rocket aerial cameras, technical information. Fast service. Estes Industries, Dept 18, Penrose, Colorado 81240.

LOWEST Prices Electronic Parts. Confidential Catalog Free. **KNAPP**, 3174 8th Ave. S.W., Largo, Fla. 33540.

TREASURE Hunters! Prospectors! Relco's new instruments detect buried gold, silver, coins. Kits, assembled models. Transistorized. Weighs 3 pounds. \$19.95 up. Free catalog. Relco-A33, Box 10836, Houston, Texas 77018.

EUROPEAN and Japanese bargains catalogs. \$1 each. Dee, 10639E Riverside, North Hollywood, Calif. 91602.

TRANSISTORIZED CONVERTER KITS: Two models, converts car radio. Receive 30-50mc or 100-200mc (one mc tuning) \$5.00 with simple instructions. Crystal \$2.50. Meshna, No. Reading, Mass. 01864.

MECHANICAL, ELECTRONIC de ices catalog 10¢. Greatest Values—Lowest Prices. Fertik's, 5249 "D", Philadelphia, Pa. 19120.

MUSIC LOVERS, CONTINUOUS, UNINTERRUPTED BACKGROUND MUSIC FROM YOUR FM RADIO, USING NEW INEXPENSIVE ADAPTOR. FREE LITERATURE. ELECTRONICS, 11500-Z NW 7th AVE., MIAMI, FLORIDA 33168.

WE SELL CONSTRUCTION PLANS. TELEPHONE: Answering Machine, Speakerphone, Carphone, Phonevision, Legal Connector, Auto Dialer, Central Dial System. **TELEVISION:** \$35.00 Color Converter, Tape Recorder, 3DTV, \$25.00 Camera. **DETECTIVE:** Infinity Transmitter, Tail Transmitter, Police Radar Detector. **HOBBYIST:** Electron Microscope, 96 Hour Tape Music System, Ultrasonic Dishwasher, Radar-Oven, Electronic Tranquillizer. Plans \$4.95 each. **COURSES:** Telephone Engineering \$39.50, Detective Electronics \$22.50, Anti-Detective Electronics \$27.50. **SUPER HOBBY CATALOG** 25¢. Don Britton Enterprises, 7906 Santa Monica Blvd., Hollywood, Calif. 90046.

CIRCUIT Boards, Parts for "Poptronics" projects. Free catalog. S.W. Technical, Box 16297, San Antonio, Texas 78216.

WEBBER LAB'S. Police & Fire Converters. Catalog 10¢. 72 Cottage Street, Lynn, Mass. 01905.

RADIO—T.V. Tubes—33¢ each. Send for free catalog. Cornell, 4213 University, San Diego, Calif. 92105.

WHO'S SALE COMPONENTS: Manufacturers and distributors only. Request free catalog on business letterhead. **WESCOM**, Box 2536, El Cajon, California 92021.

CONVERT any television to sensitive, big-screen oscilloscope. Only minor changes required. No electronic experience necessary. Illustrated plans, \$2.00. Relco-A33, Box 10563, Houston, Texas 77018.

RECTIFIERS, transistors, other components. Catalog free. Electronic Components Co., Box 2902C, Baton Rouge, La. 70821.

JAPAN DIRECTORY. Electronics products and parts. General merchandise and Asia trade information. Just \$1.00 today. Ippano Kaisha Ltd., Box 6266, Spokane, Washington 99207.

GENERAL INFORMATION: First word in all ads set in bold caps at no extra charge. Additional words may be set in bold caps at 10c extra per word. All copy subject to publisher's approval. Closing Date: 1st of the 2nd preceding month (for example, March issue closes January 1st). Send order and remittance to: Hal Cymes, POPULAR ELECTRONICS, One Park Avenue, New York, New York 10016.

WPE—HAM—CB QSL's samples 25¢. Dick, W8VXX, Gladwin, Mich. 48624.

LINEAR AMPLIFIERS: "Hornet" 50 watts output—\$98.50; "Raider"—100 watts—\$139.50; "Maverick-250"—250 watts—\$244.95. AM and SSB. "Scorpion"—50 watt 12 V. Mobile amplifier—\$99.95; "Bandit II"—12 V. Mobile Amplifier—\$169.95. Frequency range 20-35 megacycles (illegal for class D 11 meters.) Dealer inquiries invited. D & A Manufacturing Co., 1217 Avenue C, Scottsbluff, Nebraska 69361.

WRITE now for free 1969 catalog, McGee Radio Company. 1001 bargains. Speakers—Parts—Tubes—High Fidelity Components—Record Changers—Tape Recorders—Kits. Everything in Electronics. 1901 McGee Street, Kansas City (GE), Missouri 64108.

ELECTRONIC ignition, various types. Free literature. Anderson Engineering, Epsom, N.H. 03239.

DIAGRAMS—Radios \$1.50. Television \$3.00. Give make and model. Diagram Service, Box 1151PE, Manchester, Conn. 06042.

GARRARD Record Changers, Hi-Fi Components, Cartridges, Needles, Tape, TV Parts, Schematics. Write for Unbelievable Prices. Gregg Electronics, P.O. Box 184, Glen Head, N.Y. 11545.

SEND ONLY 25¢ for TWO new & unique gift catalogs of unusual items for home & auto. You'll also receive certificate for \$1.00 refund on your first order. Great ideas! Send now! J. Ross, 80-34 Kent St., Jamaica, N.Y. 11432. Dept. PE.

INVESTIGATORS, LATEST ELECTRONIC AIDS. FREE LITERATURE. CLIFTON, 11500-L NW 7th AVE., MIAMI, FLORIDA 33168.

LABORATORY chemicals supplies 1969 catalog has over 400 listings. Many scientific publications catalogues \$25. Casco, Dept. X, P.O. Box 77, Riverdale, New Jersey 07457.

FREE ELECTRONICS PARTS FLYER. Large catalog \$1.00 deposit. BIGELOW ELECTRONICS, BLUFFTON, OHIO 45817.

SURVEILLANCE equipment construction plans. Includes: Infinity Transmitter, Martini-Olive Transmitter, Automobile and Personnel Tailing Devices, Room Bugs, Telephone Bugs, Debuggers, etc. All these plans for \$5.00. Bylina (PE), P.O. Box 09131, Chicago, Illinois 60609.

HOBBYISTS, EXPERIMENTERS, amateur scientists, students . . . Construction Plans—All complete including drawings, schematics, parts list with prices and sources . . . Laser—Build your own coherent-light optical laser. Operates in the visible light range, pulsed mode—\$6.00 . . . Radar—Build your own ultrasonic doppler radar. Detect motion of people, automobiles, even falling rain drops. Transistorized, uses standard small 9-volt battery—\$4.00 . . . Tic Tac Toe Machine—You play against machine. Automatic. Can you beat the machine? Sometimes yes, usually no—\$4.00 . . . Long Range "Sound Telescope"—This amazing device can enable you to hear conversations, birds, other sounds hundreds of feet away. Very directional. Transistorized, uses 9-volt battery—\$3.00 . . . Or send 25¢ coin or stamps for complete catalogue . . . Technical Writers Group, Box 5994, State College Station, Raleigh, N.C. 27607.

POLICE-FIRE RADIO DIRECTORIES! Frequencies! Callsigns! Catalog for stamp. Communications, Box 56-PE, Commack, N.Y. 11725.

SURVEILLANCE DEVICES: Law enforcement agents only. Request brochures on Official Letterhead. **SILMAR**, 3476 N.W. 7th Street, Miami, Florida 33125.

FAILSAFE ALARM! Be safe, secure! New design, ultra reliable! Alarm sounds when: power fails, returns, component fails, loop interrupted. Use for: fire, pressure, burglar, temperature, level, etc. Build for \$25.00, simple, safe. **DELUXE CONSTRUCTION MANUAL** \$2.00. Satisfaction Guaranteed. **BECO**, Box 27011, Minneapolis, Minnesota 55427.

FLYING SAUCER DETECTOR—automatically alerts you when UFO is near. Gives general direction. Send 10¢ for information. Sin/Dec Company, 6202 P Vine St., Elmwood Place, Ohio 45216.

1200 VOLT shocker module \$5.95. Fun, pranks, property protection. Uses 3 flashlight batteries. No battery drain until electrodes are touched. Effective. Non-lethal. Electronic, scientific catalog 25¢. Franks Scientific Co., P.O. Box 156, Martelle, Iowa 52305.

BUILD TV CAMERA IN SINGLE EVENING using solid-state encapsulated modules. Previous TV knowledge unnecessary. Ideal for students, experimenters, etc. Economical! Exciting details **FREE**. Also request catalog describing other camera kits, plans, etc. **ATV RESEARCH**, 1301 Broadway, Dakota City, Nebr. 68731.

POCKET MONITOR RECEIVER, crystal controlled, low priced. Free catalog. JMD Electronics, 328 Madison Ave., West Hempstead, N.Y. 11552.

SHOCKER MODULES. 9 volts input, 150 output. \$4.95. Free list, lowest prices, tape recorders, Hi-Gain police receivers, Hi-Fi's, etc. Arch Electronics, 11040 Larimore Rd., St. Louis, Mo. 63138.

NOW motors, tubes, chassis, gear units, components, government and industrial surplus. Catalog 20¢. Mechtronics, Dept. 5PE 25260 Gratiot, Roseville, Mich. 48066.

AMAZING Performance! Newest Models—Treasure Detectors. Sensational low prices! Complete models and kits from \$14.95 to \$129.50. Let us prove it. Free catalog. Jetco Electronics, Box 132-PE, Huntsville, Texas 77340.

SCHEMATICS, airmailed, \$2. Make, model. Brown's, 321 East Price, Philadelphia 19144.

FIND BURIED TREASURE with the most popular transistorized metal detector in the country. Treasure Probe available as kit (\$14.88), assembled (\$18.88), with powerful built in speaker (\$24.88). Schematic, parts list, and step by step instructions \$1.00. Ten day money back guarantee. Free catalog available. Treasure Probe, Dept. PGL, P.O. Box 64, Lakewood, New Jersey 08701.

BUY—SELL TELETYPE PARTS, EQUIPMENT. TYPETRONICS, BOX 8873, FT. LAUDERDALE, FLA. 33310.

BUILD-IT-YOURSELF. Save big dollars. Transistor stereo amplifiers. Color organs. Speakers. Write Workshop, Box 393, Bethpage, New York 11714.

KITS, metal detector \$5.95. Audio Telescope \$5.95, others. Lec-tro-nix, Box 42, Madison Heights, Michigan 48071.

SOLAR FLYING SAUCERS. (brand new, solid state engine, fantastic performance, flies for miles on sun's power, lifts animals, send mes-sages, parachutes, build easily for next to nothing with everyday ma-terials, many sizes, many designs). Complete plans, descriptions, drawings. \$1.00. Spacetronics, Box 31043-PE, San Francisco, Calif. 94131.

COIL WINDING Handbook—50¢. Experimenter's catalog includes 250 exclusive items—25¢, refundable. Laboratories, 12041-L Sheridan, Garden Grove, Calif. 92640.

METAL DETECTOR, for complete plans, diagrams, to construct a sensitive metal detector. \$2.00. Phaeton Corp., 292 West Boylston St., W. Boylston, MA. 01583.

BUILD F.M. Bugging Devices, two revolutionary schematics \$1.00. Howard, 20174 Ward, Detroit, Michigan 48235.

OSCILLOSCOPE improvement kits. High speed Triggersweep elimi-nates sync problems. Dual trace FET switch displays two wave-forms together. Solid-State Services, P.O. Box 901, Cupertino, California 95014.

NI-CAD BATTERY CHARGER—GE'S new economical D, C and AA cells, now available for toys, recorders, flash cameras, radios, etc., are rechargeable thousands of times with this easy-to-build unit. Designed specifically for charging nickel cadmium batteries. Plans—\$1.00. Complete kit—\$5.95. Trans-World, P.O. Box 13101, Orlan-do, Florida 32804.

ENJOY FM MUSIC ONLY, No commercials, no interruptions. Complete plans and instructions for transistor sub-carrier detector which plugs in the multiplex jack of your FM tuner. All parts used are off the shelf items. Use with any FM tuner. \$2.50. Write Roberts, Box 282, Concord, Calif. 94520.

POWER SUPPLY KITS, \$2.75—\$8.50. Triacs, Zeners, Nixies, \$9.50. Catalog. Murphy, 204 Roslyn Ave., Carle Place, N.Y. 11514.

INTEGRATED CIRCUIT KITS: COMPUTER, AUDIO, Others. New catalog free. **KAYE ENGINEERING**, Box 3932-A, Long Beach, California 90803.

PLANS AND KITS

BEGINNERS Allwave \$5.00, Two Band \$5.00, F-M Tuner Chassis \$10.00, Headset \$2.50, Two Band Wired \$10.00. Ekeradio, Box 131, Temple City, Calif. 91780.

CLASSIFIED ADVERTISING ORDER FORM

Please refer to heading on first page of this section for complete data concerning terms, frequency discounts, closing dates, etc.

1	2	3	4	5
6	7	8	9	10
11	12	13	14	15
16	17	18	19	20
21	22	23	24	25
26	27	28	29	30
31	32	33	34	35

_____ Words } @ 70¢ (Reader Rate) } = \$ _____
 } @ \$1.15 (Commercial Rate) }

Insert _____ time(s) Total Enclosed \$ _____

NAME _____

ADDRESS _____

CITY _____ STATE _____ ZIP _____

Signature _____

WORD COUNT: Include name and address. Name of city (Des Moines) or of state (New York) counts as one word each. Zip Code numbers not counted. (Publisher reserves right to omit Zip Code if space does not permit.) Count each abbreviation, initial, single figure or group of figures or letters as a word. Symbols such as 35mm, COD, PO, AC, etc., count as one word. Hyphenated words count as two words. PE-269

SHORTWAVE LISTENING

POLICE—FIRE—AIRCRAFT—MARINE—AMATEUR CALLS on your broadcast radio with **TUNAVERTER!** Tunable and crystal in one! Guaranteed! Free catalog. Salch Co., Woodsboro-PEC, Texas 78393.

HIGH FIDELITY

FREE! Send for money saving stereo catalog \pm P2E and lowest quotations on your individual component, tape recorder, or system requirements. Electronic Values, Inc., 200 W. 20th St., New York, N.Y. 10011.

HI-FI Components, Tape Recorders, at guaranteed "We Will Not Be Undersold" prices. 15-day money-back guarantee. Two-year warranty. No Catalog. Quotations Free. Hi-Fidelity Center, 239 (P) East 149th Street, New York 10451.

LOW, Low quotes: all components and recorders. HiFi, Roslyn, Penna. 19001.

TAPE RECORDERS, Hi-Fi, components, Sleep Learning Equipment, tapes. Unusual Values Free Catalog. Dressner, 1523R, Jericho Turnpike, New Hyde Park, N.Y. 11040.

DDN'T THROW YOUR OLD CARTRIDGE AWAY. Send us \$19.95 and any old cartridge. We will ship **PREPAID** any one of the following top rated elliptical diamond stereo cartridges **NEW:** Shure M75E, M91E, M92E, M93E, Empire 888E, Pickering V15AME3, XV15 ATE, ADC 660E, 550E. Write for lowest quotations all stereo components. **DEFA ELECTRONICS,** 2207 Broadway, New York, N.Y. 10024.

NEW Record Changers. BSR-\$13; V.M.—\$16; Garrard—\$22; Radio-Phone stereo—\$15. "CHANGERS-PE", 2737 Third Ave., Bronx, N.Y. 10451.

ACOUSTIC RESEARCH products now available to overseas personnel, diplomats, and citizens of foreign countries. Write for full product and dealer information. AR International, Dept. PE, 24 Thorndike St., Cambridge, Mass. 02141.

DDN'T THROW YOUR OLD CARTRIDGE AWAY. Send us \$50.00 and any old used cartridge and we will ship you via air Prepaid anywhere the following Top Stereo Cartridges: Shure V-15 Type II, Empire 999VE, ADC 10EMK II, Stanton 681EE. Write for lowest quotations all stereo components. **DEFA ELECTRONICS,** 2207 Broadway, New York, N.Y. 10024.

WANTED

CASH Paid! Unused tubes, electronic equipment. Barry, 512 Broadway, NYC 10012.

QUICKSILVER, Platinum, Silver, Gold, Ores Analyzed. Free Circular. Mercury Terminal, Norwood, Mass. 02062.

TUBES

TUBES "Oldies", latest. Lists free. Steinmetz, 7519 Maplewood, Hammond, Indiana 46324.

RECEIVING & INDUSTRIAL TUBES, TRANSISTORS. All Brands—Biggest Discounts. Technicians, Hobbyists, Experimenters—Request **FREE** Giant Catalog and **SAVE!** ZALYTRON, 469 Jericho Turnpike, Mineola, N.Y. 11501.

TUBE Headquarters of World! Send 10¢ for Catalog (tubes, electronic equipment) Barry, 512 Broadway, N.Y.C. 10012.

RADIO & T.V. Tubes—33¢ each. Send for free list. Cornell, 4213 University, San Diego, Calif. 92105.

THOUSANDS and thousands of types of electronic parts, tubes, transistors, instruments, etc. Send for Free Catalog. Arcturus Electronics Corp., MPE, 502-22nd St., Union City, N.J. 07087.

TUBES—lowest prices in the world. Hard to get British, German, Foreign and American obsolete and present day special purpose transmitting tubes. Send for giant tube and parts catalog. United Radio Co., Dept. Y-56 Ferry Street, Newark, N.J. 07105.

TAPE AND RECORDERS

BEFORE Renting Stereo Tapes try us. Postpaid both ways—no deposit—immediate delivery. Quality—Dependability—Service—Satisfaction—prevail here. If you've been dissatisfied in the past, your initial order will prove this is no idle boast. Free Catalog. Gold Coast Tape Library, Box 2262, Palm Village Station, Hialeah, Fla. 33012.

HI-FI Components, Tape Recorders, at guaranteed "We Will Not Be Undersold" prices. 15-day money-back guarantee. Two-year warranty. No Catalog. Quotations Free. Hi-Fidelity Center, 239 (PT) East 149th Street, New York 10451.

WHOLESALE—4, 8 track STEREOTAPES—Car, Home PLAYERS—CB, Recorders. MUSICO, Box 11045, Montgomery, Alabama 36105.

RENT 4-Track open reel tapes—all major labels—3,000 different—free brochure. Stereo-Parti, 55 St. James Drive, Santa Rosa, Ca. 95401.

TAPE RECORDER SALE. Brand new nationally advertised brands, \$10.00 above cost. Amazing discounts on stereo components. Arky Electronics, 1028-C Commonwealth Avenue, Boston, Mass. 02215.

STEREO TAPE CLUB: AVERAGE COST \$3.78—\$4.20. Cartridges, Cassettes, Reels, No minimum monthly purchases. Mail—10¢—catalog. Star Recordings, Box 1055, El Paso, Texas 79946.

TAPEMATES makes available to you **ALL 4-TRACK STEREO TAPES—ALL LABELS**—postpaid to your door—at tremendous savings. For free brochure write: **TAPEMATES,** 5727 W. Jefferson Blvd., Los Angeles, California 90016.

STERED TAPES, Save 30% and up; no membership or fees required; postpaid anywhere U.S.A. Free 70-page catalog. We discount batteries, recorders, tape/accessories. Beware of slogans, "not undersold", as the discount information you supply our competitor is invariably reported to the factory. **SAXITONE,** 1776 Columbia Road, N.W., Washington, D.C. 20009.

REPAIRS AND SERVICES

TV Tuners rebuilt and aligned per manufacturers specification. Only \$9.50. Any make UHF or VHF. Ninety day written guarantee. Ship complete with tubes or write for free mailing kit and dealer brochure. **JW Electronics,** Box 51C, Bloomington, Indiana 47401.

PERSONALS

MAKE FRIENDS WORLDWIDE through international correspondence. Illustrated brochure free. **Hermes,** Berlin 11, Germany.

LEMURIAN VIEWPOINT—Meaningful discussions of Cosmic Truth: the purpose of human life, reincarnation, man's place in a Higher Plan, and subjects from the Lemurian Philosophy. Send for **FREE** copy. Lemurian Fellowship, Dept. 909, Box 397, Ramona, Calif. 92065.

INVESTIGATORS, LATEST ELECTRONIC AIDS. FREE LITERATURE. CLIFTON, 11500-K NW 7th AVE., MIAMI, FLORIDA 33168.

SECRET plans revealed. Free brochure. Audiotronix E2, 156 Fifth Avenue, New York, N.Y. 10010.

DISCOVER YOURSELF—DISCOVER A GOLD MINE! "Creativity" is man's supreme expression and experience. Small wonder it produces success, money, and personal satisfaction! Thus, our lives will adjust in accordance with this ability. The ultimate in creative technique is revealed in "How to Solve Problems by the Scientific Method." A single concept solves Mathematical, Literary, and Inventive problems. An innovation! 163 pages; \$1.60. Ten-day satisfaction guarantee, or money back. **JAICD,** Box 3262B, Saginaw, Michigan 48605.

YOUR BEST BET FOR OUTSTANDING MAIL ORDER SALES IS CLASSIFIED ADVERTISING IN THESE COLUMNS. The pages of the **ELECTRONICS MARKET PLACE** are read thoroughly each month by hobbyists seeking products and services found only here. Almost 400,000 readers will see your ad monthly if you submit copy and payment now to the address noted at the top of pg. 119.

INSTRUCTION

LEARN While Asleep, hypnotize with your recorder, phonograph. Astonishing details. sensational catalog free! Sleep-learning Association, Box 24-ZD, Olympia, Wash. 98501.

LEARN ELECTRONIC ORGAN SERVICING at home all makes including transistor. Experimental kit—trouble-shooting. Accredited NHSC. Free Booklet. **NILES BRYANT SCHOOL,** 3631 Stockton, Dept. A, Sacramento, Calif. 95820.

ASSOCIATE Degree in Electronics Engineering earned through combination correspondence-classroom educational program. Free brochure. **Grantham Technical Institute,** 1505 N. Western Ave., Hollywood, Calif. 90027.

HIGHLY EFFECTIVE home study course in Electronics Engineering Mathematics with circuit application. Earn your Associate in Science Degree. Free Literature. Cook's Institute of Electronics Engineering, P.O. Box 36185, Houston, Texas 77036. (Established 1945.)

FCC First Class License in six weeks—nation's highest success rate—approved for Veterans Training. Write Elkins Institute, 2603B Inwood Road, Dallas, Texas 75235.

R.E.I.'s famous (5) week course for the First Class Radio Telephone License is the shortest, most effective course in the nation. Over 98% of R.E.I. graduates pass F.C.C. exams for 1st class license. Total tuition \$360.00. Job placement free. Write for brochure. Radio Engineering Incorporated Schools, 1336 Main Street, Sarasota, Florida 33577—or 3123 Gillham Road, Kansas City, Missouri 64109—or 809 Caroline Street, Fredericksburg, Virginia—22401—or 625 E. Colorado Street, Glendale, California 91205.

COMPUTER programming systems official template. \$1.00! Complete programming course, \$15.00! ACI-PE, Box 15684, Tampa, Florida 33614.

HOME electronics course only \$26.95. Free literature. Edu-Kits, Department 683D, Hewlett, New York 11557.

DRAFTING—home courses \$25.00. Send \$2.00 first lesson. Prior Inc., 23-09 169th Street, Whitestone, New York 11357.

SHIP RADIO OFFICER TRAINING—SHIPS have been held up awaiting needed personnel, train now at Long Beach, the home of the Queen Mary. Radio officers earn to \$1800.00 monthly. Write for free information. Western Technical School, 5459 Atlantic Ave., Long Beach, Calif. 90805, Desk B. Approved for veterans.

INVENTIONS WANTED

INVENTIONS wanted. Patented; unpatented. Global Marketing Service, 2420-P 77th, Oakland, Calif. 94605.

PATENT Searches including Maximum speed, full airmail report and closest patent copies, \$6.00. Quality searches expertly administered. Complete secrecy guaranteed. Free Invention Protection forms and "Patent Information." Write Dept. 9, Washington Patent Office Search Bureau, 711 14th Street, N.W., Washington, D.C. 20005.

QUALITY Patent Searches! Preferred by Professional Inventors, Lawyers, Manufacturers. "Confidential Report" Including related United States patent copies "Airmailed Certified." **FREE** information! United States Inventors Service Company, 501-H Thirteenth Street, N.W., Washington, D.C. 20005.

INVENTORS. We will develop, help sell your idea or invention, patented or unpatented. Our national manufacturer clients are urgently seeking new items for outright cash sale or royalties. Financial assistance available. 10 years proven performances. For free information, write Dept. 41, Wall Street Invention Brokerage, 79 Wall Street, New York, N.Y. 10005.

INVENTORS! OUR FREE EXPERT ANALYSIS of your invention can save valuable time, help you realize full sale value. Strictly confidential. **FREE INVENTION CERTIFICATE.** Write today: Pioneer Invention Service, Dept. 35, 150 Broadway, New York, N.Y. 10038.

INVENTORS! Sell your invention for cash or royalties! Our client manufacturers eagerly seek new items. Patented. Unpatented. Financial assistance if needed. 25 years proven performances. For free information, write Dept. 20, Gilbert Adams, Invention Broker, 80 Wall St., New York, N.Y. 10005.

FREE "Directory of 500 Corporations Seeking New Products." For information regarding development, sale, licensing of your patented/unpatented invention. Write: Raymond Lee Organization, 230-GR Park Avenue, New York City 10017.

PATENT SEARCHES, including copies of related United States Patents. Inventors, attorneys, manufacturers use our "World-Wide" Airmail service! Free: "Invention Record" form and "Information Every Inventor Needs", Hayward Company, 1029HR Vermont, Washington, D.C. 20005.

GOVERNMENT SURPLUS

JEEPS Typically From \$53.90 . . . Trucks From \$78.40 . . . Boats, Typewriters, Airplanes, Multimeters, Oscilloscopes, Transceivers, Electronics Equipment, Wide Variety, Condition. 100,000 Bid Bargains Direct From Government Nationwide. Complete Sales Directory and Surplus Catalog \$1.00. (Deductible First \$10.00 Order). Surplus Service, Box 820-J, Holland, Michigan 49423.

GOVERNMENT Surplus How and Where to Buy in Your Area. Send \$1.00 to: Surplus Information PE, Headquarters Building, Washington, D.C. 20036.

BOOKS

FREE catalog 950 aviation/electronic/space books. Aero Publishers, 329PE Aviation Road, Fallbrook, California 92028.

UNUSUAL Books! Catalog free! International, Box 7798 (PE), Atlanta, Georgia 30309.

FREE Book Prophet Elijah Coming Before Christ. Wonderful Bible Evidence. PE Megiddo Mission, Rochester, New York 14619.

FREE CATALOG. BOOKS FOR ADULTS. CATALOG, 2217 LACKLAND, ST. LOUIS, MISSOURI 63114.

AMAZING self help books. Write Lynn, Box 1573, Waco, Texas 76703.

AUTHORS' SERVICES

AUTHORS! Learn how to have your book published, promoted, distributed. **FREE** booklet "ZD," Vantage, 120 West 31 St., New York 10001.

MUSIC

POEMS wanted for new songs. Nashville Music Institute, Box 532-E, Nashville, Tennessee 37202.

MUSICAL INSTRUMENTS

ACCORDIONS, GUITARS, AND INSTRUMENTS! Save to 50%. Terms. Trades. Free Trial. Free catalog. Mention instrument. Music Mart, 5535-PE Belmont, Chicago 60641.

HYPNOTISM

FREE Hypnotism, Self-Hypnosis. Sleep Learning Catalog! Drawer H400, Ruidoso, New Mexico 88345.

"MALE-FEMALE HYPNOTISM" EXPOSED, EXPLAINED! "SECRET METHOD"—THEY NEVER KNOW! \$2, RUSHED GUARANTEED! ISABELLA HALL, SILVER SPRINGS, FLORIDA 32688.

AMAZING HYPNOTIC record kit releases fantastic mental power! Free offer expires soon. Write: Forum, Studio AA2, 333 North Michigan, Chicago 60601.

HYPNOTIC sleep learning recordings produce fabulous results. Catalogue Free. ASR Foundation, Box 702leg Henry Clay Station, Lexington, Ky. 40502.

HYPNOTIZE MALES, FEMALES!—Unnoticed! Quickly! Nerves! Exciting! \$2.25. Research Enterprises, 29-SN21 Samoset, Woburn, Mass. 01801.

HYPNOTIZE SUCCESSFULLY! "By Telephone"—"Instantaneous"—"One Word"—"Against Will" methods exposed! 10" Hypnodisk. "Secret Nerve Pressure Technique"—They never know! \$2.00 **RESULTS ABSOLUTELY GUARANTEED!** Fowler, Box 4396, Woodbury, N.J. 08096.

PHOTOGRAPHY—FILM, EQUIPMENT, SERVICES

MEDICAL Film—Adults Only—"Childbirth"—1 reel 8mm \$7.50—16mm \$14.95. International-E, Greenvale, L.I., New York 11548.

SCIENCE Bargains Request Free Giant Catalog "CJ"—148 pages—Astronomical Telescopes, Microphones, Lenses, Binoculars, Kits, Parts, War surplus bargains. Edmund Scientific Co., Barrington, New Jersey 08007.

RECORDS

SPECIAL INTEREST RECORDS AVAILABLE, PRODUCED BY THE EDITORS OF THE WORLD'S LEADING SPECIAL INTEREST MAGAZINES. SEND FOR FREE CATALOG. RECORD CATALOG-PE ZIFF-DAVIS PUBLISHING COMPANY, ONE PARK AVENUE, NEW YORK, N.Y. 10016.

19¢ RECORDS from your tapes. Write Concert Recording, Lynwood, California 90262.

MAGNETS

MAGNETISM as I see it—by Jesse Costa—a 100 page pictorial manuscript describing my latest theories and experiments in basic magnetism. (\$3.00) Box 26, Waquoit, Massachusetts 02536.

PLASTICS

NEW LIQUID PLASTICS for creating unusual gifts with real flower embedments, photographs, special collections. Reproducing originals. Hundreds of other profitable ideas. Illustrated information free. Castolite, Dept. 9C5B, Woodstock, Ill. 60098.

REAL ESTATE

400,000,000 ACRES government public land located in 25 states. Low as \$1.00 acre detailed 1969 report. Send \$1.00. Land Information 422-PE2, Washington Building, Washington, D.C. 20005.

FREE . . . 232-page Spring 1969 CATALOG! Describes and pictures hundreds of farms, ranches, town and country homes, businesses coast to coast! Specify type property and location preferred. Zip code, please. **UNITED FARM AGENCY**, 612-EP West 47th St., Kansas City, Mo. 64112.

PRINTING

THERMOGRAPHED business cards, \$3.49—1,000, free samples. Gables—405A Clifton, Glenshaw, Pa. 15116.

FREE LITERATURE: Address labels, business cards, printing, Rubber Stamps. **JORDAN'S**, 552 West O'Connor, Lima, Ohio 45801.

BUSINESS OPPORTUNITIES

INVESTIGATE ACCIDENTS: Earn to \$1000 monthly. Men urgently needed. Car furnished. Business expenses paid. No selling. No College education necessary. Pick own job location. Investigate full time or earn to \$8 hour spare time. Write for **FREE** information. No obligation. Universal Schools, CZ-2, 6801 Hillcrest, Dallas, Texas 75205.

RAISE Rabbits for us on \$500 month plan. Free details. White's Rabbitry, Mt. Vernon, Ohio 43050.

FREE CATALOGS. Repair air conditioning, refrigeration. Tools, supplies, full instructions. Doolin, 2016 Canton, Dallas, Texas 75201.

PIANO TUNING learned quickly at home. Tremendous field! Musical knowledge unnecessary. GI Approved. Free Information. Empire School, Miami, Florida 33145.

FREE Book "990 Successful little-known Businesses." Work home. Plymouth 345T, Brooklyn, N.Y. 11218.

ELECTROPLATING Equipment and supplies. All types for home workshops and industrial. Send \$1.00 (refundable) for equipment guide formulas, operating data, catalog. HBS Equipment Division 90, 3543 East 16th, Los Angeles, California 90023.

I MADE \$40,000.00 Year by Mailorder! Helped others make money! Start with \$10.00—Free Proof. Torrey, Box 318-N, Ypsilanti, Michigan 48197.

\$200.00 DAILY In Your Mailbox! Your opportunity to do what mail-order experts do. Free details. Associates, Box 136-J, Holland, Michigan 49423.

BIG EARNINGS selling Hertel Bibles. New 3-dimension cover, finest reference edition sells fast. Demonstrator furnished. Big commissions. International Book, Dept. PE, Box 118, Wichita, Kansas 67201.

MAILORDER . . . Operate cash-in-advance business! Details. Methods, 1411-F.D., Lafayette Hill, Pennsylvania 19444.

PROFITS IN MAILORDER. Learn from the experts the secrets of mailorder. Free details. Edward's, Box 559, New Castle, Delaware 19720.

INSTALL burglar-fire alarms. Big profit. Send \$1.00 (refundable) for catalog and information. **SILMAR**, 3476 N.W. 7th Street, Miami, Florida 33125.

EARN \$240.00 a month at home, spare time, doing only two \$5.00 Invisible Mending jobs a day. Big money paid for service that makes cuts, tears disappear from fabrics. Steady demand. Details free. **FABRICON**, 1572 Howard, Chicago 60626.

SELL America's Biggest value wedding line! Big 40% profit showing wedding invitations and over 50 exciting accessory items. Side-line for printing, Christmas card salesmen. Free display album. Elmcraft, 7201 S. Cicero, Dept. EW-186, Chicago, Illinois 60629.

BUSINESS LOANS—\$500 to \$2,000,000. Free details. Over 1000 easy sources. Counselor-48, Harlingen, Texas 78550.

CHRONICLE magazine profitable opportunities. Sample 40c. Mc-Plastens, PEM1432 First, San Diego, Calif. 92101.

STAMPS

RUSSIA HIGH-VALUE COLLECTION. 32 different Russia—some over 50 years old! Commemoratives, Czarist Issues, Airmails. Catalog price \$2.99. Special Get-Acquainted Offer—all for only 10¢! H.E. Harris, Dept. GG-13, Boston, Mass. 02117.

WOW! 110 all different Germany 10¢—Commemoratives, airmails, high values, big catalog, bargain lists also, fine stamps from our approval service, which you may return without purchases and cancel service at any time. Jamestown Stamp, Dept. A29EG, Jamestown, N.Y. 14701.

COINS

PROFIT from collecting coins. How to start and sell. Valuable coin list \$1.00. CNO Sales, 4013 Flory, El Paso, Texas 79904.

EMPLOYMENT INFORMATION

FOREIGN and **USA** job opportunities available now. Construction, all trades. Earnings to \$3,000.00 monthly. Paid overtime, travel bonuses. Write; Universal Employment, Woodbridge, Conn. 06525.

OVERSEAS jobs openings all trades and professions. Free information. Write National Employment Service, Box 2235 A.M.F., Miami, Florida 33159.

EMPLOYMENT OPPORTUNITIES

BOOMING AUSTRALIA wants You—Good jobs, Adventure. Forms and Australian Handbook (1969) describing Australian assisted passage, passport-visa, advantages, opportunities \$1.00. Buckeye, Box 1032TP, Fairborn, Ohio 45324.

MISCELLANEOUS

WINEMAKERS: Free illustrated catalog of yeasts, equipment. Semplex, Box 7208, Minneapolis, Minn. 55412.

BILLS PAID WITHOUT BORROWING—Nobody refused up to \$18,000.00. Bad credit no problem—Not a Loan Company. Write for **FREE** application—**INTERNATIONAL ACCEPTANCE**, Dept. 50A, Phoenix, Arizona 85012—711 14th St., N.W., Washington, D.C. 20005—507 Carondelet St., New Orleans, La. 70130.

STOP BURGLARS THE EASY WAY!! Affix authentic "Protected by Electronic Sentry Alarm" Decals to auto windows, door & windows of home, retail stores, vending machines, etc. Whether you have an alarm or not—thieves stay away! Only \$1.00 each set of two. J. Ross, 80-34 Kent St., Jamaica, N.Y. 11432, Dept. PE.

"ADULT" Books, Magazines . . . Free illustrated catalogue. Clifton's, Box 1068-E4, Saugus, Calif. 91350.

LONG RANGE TV RECEPTION EASY! Booklet outlines methods to receive distant TV stations using inexpensive materials. \$1.50 post-paid. **PRACTICAL PLANS**, Box 56-D, Killeen, Texas 76541.

STAMMER — Stutter — No more. (Dr. Young.) Write Gaucho, Box 9309-E8, Chicago 60690.

FREE—1001 things—162 pages LISTS WHERE. Rush \$1.00. Refundable. Staidry, Whitestone, New York 11357.

BEERS, PEACH BRANDY, WINES—Strongest Formulas, \$2.25. (complete brew supplies—hydrometers catalog included)—Research Enterprises, 29-D Samoset, Woburn, Mass. 01801.

EMPLOYMENT Resumes. Get a better job & earn more! Send only \$2.00 for expert, complete Resume Writing Instructions. J. Ross, 80-34 Kent St., Jamaica, N.Y. 11432, Dept. PE.



Winter 1968 ELECTRONIC EXPERIMENTER'S HANDBOOK
 Special 10th Anniversary Issue! Complete schematics, illustrations, parts lists and easy-to-follow instructions that guarantee you perfect finished products.

Spring 1968 ELECTRONIC EXPERIMENTER'S HANDBOOK
 Another big package containing over 30 of the most challenging, fun-to-build electronics projects ever! Be sure to order this one today!

1968 STEREO/HI-FI DIRECTORY
 A giant 182-page buyer's guide to virtually every new audio component on the market today. Over 1600 products in all! Includes valuable "what to look for—how to buy" advice!

6 Vital Components
For Knowledge... For Profit... For Sheer Electronics Enjoyment!
ONLY \$1.25 EACH



1968 TAPE RECORDER ANNUAL
 Contains over 130 pages, 19 complete features, covering every aspect of tape recording. PLUS complete directories of machines and accessories!

1968 COMMUNICATIONS HANDBOOK
 For the ham, CB'er, SWL'er or business radio operator. 150 pages of "how to do it better" information. Directories of ham and CB gear!

1968 ELECTRONICS INSTALLATION & SERVICING HANDBOOK
 Now, get the tricks of the trade for servicing everything. A 140-page "encyclopedia" that's a must for every serviceman and serious hobbyist!

ZIFF-DAVIS SERVICE DIVISION • Dept. W
 595 Broadway, New York, N.Y. 10012

Please send me the annuals I've checked below:

Winter 1968 Electronic Experimenter's Handbook
 Spring 1968 Electronic Experimenter's Handbook
 1968 Stereo/Hi-Fi Directory
 1968 Tape Recorder Annual
 1968 Communications Handbook
 1968 Electronics Installation & Servicing Handbook

\$1.25 each. In U.S.A., add 15c each for shipping and handling. Outside U.S.A., add 50c each.

TOTAL ENCLOSED \$ _____

print name _____

address _____

city _____ PE 19

state _____ zip _____

PLEASE PRINT CLEARLY IN THE ORDER SHOWN

POPULAR ELECTRONICS
FEBRUARY 1969
ADVERTISERS INDEX

READER SERVICE NO.	ADVERTISER	PAGE NO.
1	AMECO, Division of Aerotron, Inc	114
2	Argos Products Company	94
3	B & K	11
	Bell & Howell Schools	5
4	Burstein-Applebee Co	113
	CREI, Home Study Division, McGraw-Hill Book Company	62, 63, 64, 65
5	Career Academy	105
6	Caringella Electronics, Inc	110
7	Cleveland Institute of Electronics	106, 107, 108, 109
8	Cleveland Institute of Electronics	116
9	Courier Communications, Inc	13
10	Edmund Scientific Co	16
18	Electro-Voice, Inc	FOURTH COVER
11	Empire Scientific Corp	111
12	Garrard	8
	Grantham School of Electronics	9
13	Heath Company	88, 89, 90, 91
	ICS	7
22	Johnson Company, E.F.	THIRD COVER
14	Lafayette Radio Electronics	94
15	Mosley Electronics, Inc	99
16	Motorola HEP Program	10
	National Radio Institute	SECOND COVER, 1, 2, 3
	National Technical Schools	36, 37, 38, 39
17	Olson Electronics	102
19	Pace Communications	87
20	Pearce-Simpson	97
21	Pickering & Company	95
32	RCA Electronic Components and Devices	25
	RCA Institutes, Inc	18, 19, 20, 21
23	Scott, Inc., H.H.	12
24	Sonar Radio Corporation	117
25	Squires-Sanders, Inc	26
26	Sydmar Electronic Specialties	113
27	Texas Crystals	116
	Treasure Enterprises	112
55	Turner Company, Inc	14
28	U.S. Army	23
	Valparaiso Technical Institute	118
29	Vanguard Electronic Tools Inc	17
30	Weller Electric Corp	6
31	Xcelite, Inc	103

CLASSIFIED ADVERTISING 119, 120, 121, 122, 123

NEW

**...a 23 channel
base station offering
the best of Johnson's
experience!**



\$199⁵⁰ \$214⁹⁵

(without mike) (with mike)

Brought to you by the same engineering team that designed the famous Messengers "I" and "Two", the Messenger 223 has the same rugged circuitry and even greater "Talk Power" capability. With at least 15 db more audio gain than the "I" and "Two", the "223" punches out a clear, penetrating signal. As with all Johnson radios, your signal will stand out compared to all others.

Ten tubes, eight diodes and six transistors form a rugged base station transceiver that can't be beat for reliable day-in, day-out performance. A built-in illuminated "S" meter /power meter measures input strength of RF signals and relative power output of the transmitter. Ready to go on all 23 channels, the Messenger 223 is FCC Type Accepted and DOT Approved.

See your Johnson dealer today for complete details!

E. F. JOHNSON COMPANY

2474 Tenth Ave. S.W., Waseca, Minnesota 56093

Providing nearly a half-century of communications leadership



What do you call
an etched circuit board
that eliminates 49 chances
for trouble in every
Electro-Voice modular
stereo receiver?



We call it
"Mother"!



Model E-V 1282 80 watt AM/Stereo FM Receiver, \$256.00.
CWR1 case, \$22.00.

E-V Our big etched circuit board is at the bottom of a significantly better way to make stereo receivers. With one stroke, Electro-Voice has eliminated hand-wiring from almost every signal circuit.

Each major section of the new Electro-Voice modular receivers is built on its own etched board. As many as seven modules in all. The modules then plug directly into the "mother" board. No errors in wiring. No cold solder joints. Gone are the ills that plague even the most carefully assembled hand-wired receivers.

There's another advantage. Before being locked into the "mother" board, each module is first plugged into an elaborate tester. Then, with pre-tested modules in place, the finished receiver is re-tested completely. This double assurance of quality means dramatically improved reliability and better performance for

your stereo dollar.

"Mother" helps in other ways, too. For instance, even slight movement of ordinary wiring can "de-tune" vital RF circuits. But our modular circuits are permanently etched in place—to within .015". So you receive full performance from our Field Effect Transistors and Integrated Circuits. And good ideas like thick-film hybrid circuits simply plug in place. In short—laboratory specifications are exactly duplicated in every production Electro-Voice modular receiver.

Look into any new E-V receiver. We offer four. Your choice of 40 or 80 watts (IHF) with Stereo FM or AM/Stereo FM. From \$199.95. Just tell the man "mother" sent you.

ELECTRO-VOICE, INC., Dept. 294P
630 Cecil Street, Buchanan, Michigan 49107

**FREE! Call (800) 243-0355 any time, day or night,
for name of nearest Electro-Voice high fidelity specialist.
In Connecticut call (collect) 853-3600.**

Electro-Voice

A SUBSIDIARY OF GULTON INDUSTRIES, INC.

CIRCLE NO. 18 ON READER SERVICE PAGE