

IT'S SUPER—BUILD THE BIG SIX SPEAKER SYSTEM

POPULAR ELECTRONICS

JANUARY
1969

50
CENTS



MAKE ACCURATE
AUDIO MEASUREMENTS

TWO-WATT
IC AMPLIFIER

SOLID-STATE
AM TUNER FOR HI-FI

SAVE MONEY—CHOOSE
THE RIGHT BATTERY

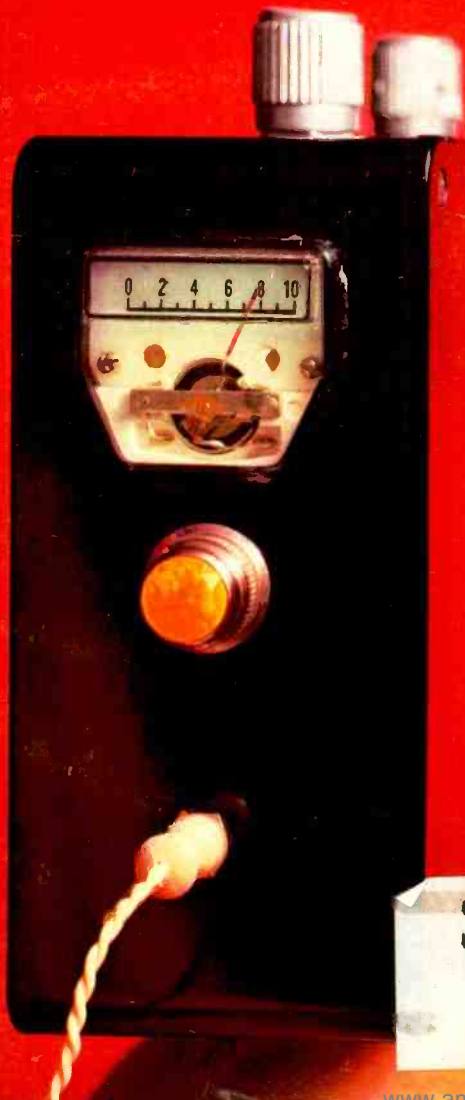

E0969 648480855037350G41
C E BOSSLER
373 SOUTH ST
POTTSTOWN PA 19464

DETECTOR

Electronics comes alive with NRI Training Kits

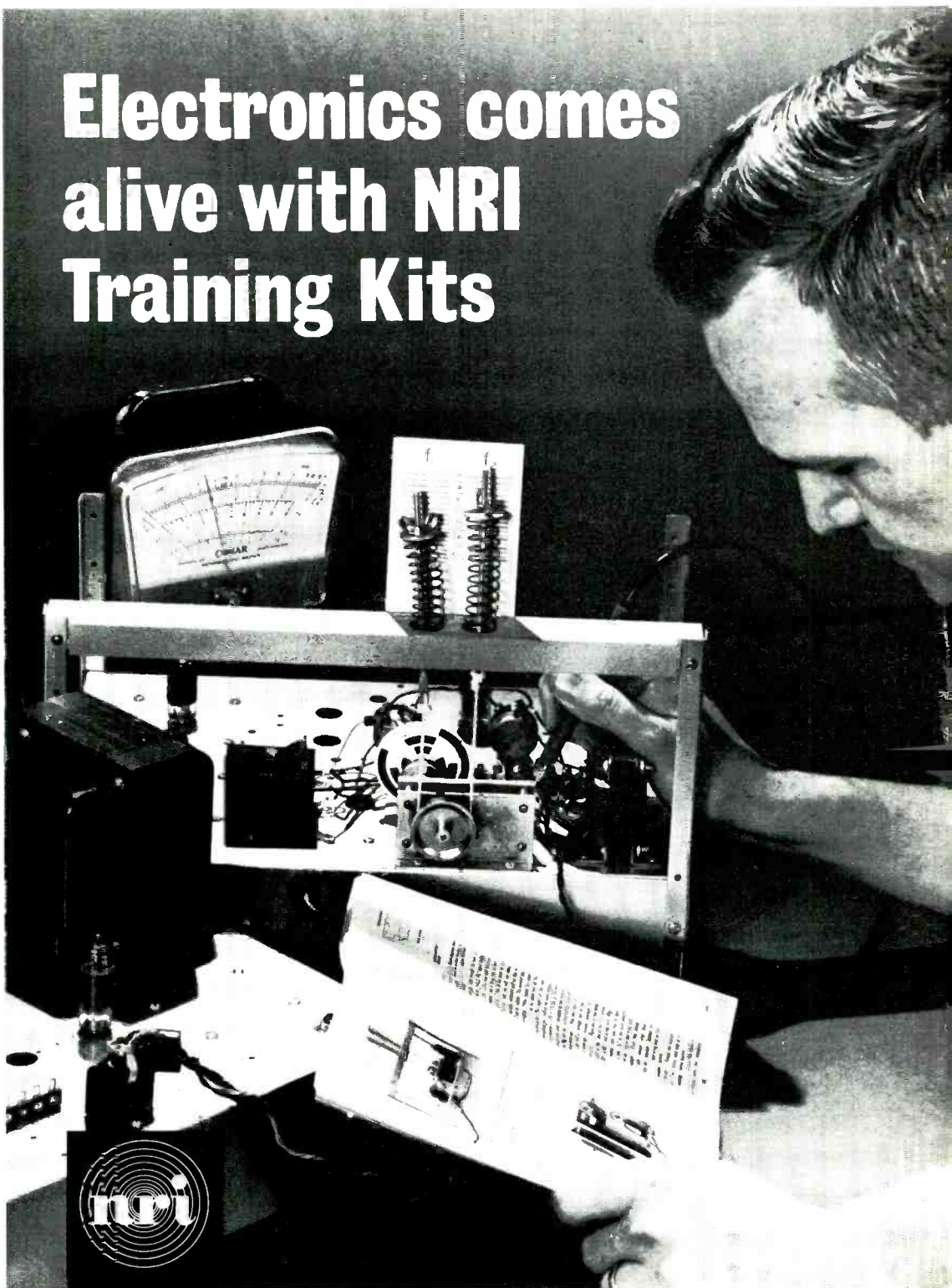

DISCOVER THE EASE AND EXCITEMENT OF TRAINING AT HOME THE NRI WAY

New Achievement Kit—Custom Training Kits—"Bite Size" Texts

Only NRI offers you this pioneering method of simplified "3 Dimensional" home-study training in Electronics, TV/Radio and Broadcasting/Communications. It's a remarkable teaching idea unlike anything you have ever encountered, the result of more than half a century of simplifying, organizing and dramatizing learning-at-home techniques. If you are an ambitious man—regardless of your education—you can effectively learn the Electronics field of your choice the NRI way.

NRI has *simplified* Electronics by producing "bite size" lesson texts averaging only 40 pages each. Dozens of illustrations open wide a picture window through which you'll see and understand practical uses of Electronics. You start out with NRI's exclusive Achievement Kit, containing everything you need to get started fast. (Illustrated at right.)

NRI has *organized* Electronics training to take you step-by-step from the first stages into more intriguing areas. Once you know the fundamentals thoroughly, it's easy to grasp more advanced theory and techniques. You move with confidence and enthusiasm into a new adventure filled with the excitement of discovery.

NRI has *dramatized* Electronics through the careful development of special training equipment that is *programmed* into your training systematically . . . beginning with your first group of lessons. Things you read about come alive in your hands as you build, experiment, purposely cause "problems" in circuits—and solve them. You learn to use test equipment, to build radios and TV sets, transmitter, or computer circuits. It's the priceless "third dimension" in NRI training . . . practical experience.



YOU GET MORE FOR YOUR MONEY FROM NRI

Mail postage-free card now for your free NRI catalog. Then, compare. You'll find—as have thousands of others—NRI training can't be beat. Read about the new Achievement Kit sent the day you enroll; about "bite-size," texts and custom designed training equipment. See why NRI gives you more value. Whatever your reason for wanting more knowledge of Electronics, NRI has an instruction plan for you. Choose from major programs in TV/Radio Servicing, Industrial Electronics and Complete Communications. Or select from special courses to meet specific needs. Check the course of interest to you on postage-free card and mail today for free NRI catalog. No salesman will call. NATIONAL RADIO INSTITUTE, Electronics Div., Washington, D.C. 20016.

Available Under NEW GI BILL

If you served since January 31, 1955, or are in service, check GI line in postage-free card.

More than 50 years of leadership
in Electronics Training



Career? Part-Time Earnings? Hobby? Choose From 12 Training Plans

1. TELEVISION-RADIO SERVICING — Learn to fix all TV sets, including Color. Includes your choice of NRI Color Kit or 19" black-white TV Kit. Also covers radios, stereo hi-fi, etc. Profitable field spare or full-time.

2. INDUSTRIAL-MILITARY ELECTRONICS — Basics to computers. Starts with fundamentals, covers servos, telemetry, multiplexing, phase circuitry, other subjects.

3. COMPLETE COMMUNICATIONS* — Operation, service, maintenance of AM, FM and TV broadcasting stations. Also covers marine, aviation, mobile radio, facsimile, radar, microwave.

4. FCC LICENSE* — Prepares you for 1st Class FCC License exams. Begin with fundamentals, advance to required subjects in equipment and procedures.

5. MATH FOR ELECTRONICS — Brief course for engineers, technicians seeking quick review of essential math: basic arithmetic, short-cut formulas, digital systems, etc.

6. BASIC ELECTRONICS — For anyone wanting a basic understanding of Radio-TV Electronics terminology and components, and a better understanding of the field.

7. ELECTRONICS FOR AUTOMATION — Not for beginners. Covers process control, ultrasonics, telemetry and remote control, electromechanical measurements, other subjects.

8. AVIATION COMMUNICATIONS* — Prepares you to install, maintain, service aircraft in-flight and landing systems. Earn your FCC License with Radar Endorsement.

9. MARINE COMMUNICATIONS* — Covers electronic equipment used on commercial ships, pleasure boats. Prepares for FCC License with Radar Endorsement.

10. MOBILE COMMUNICATIONS* — Learn to install, maintain mobile transmitters and receivers. Prepares for FCC License exams.

11. ELECTRICAL APPLIANCE REPAIR — Learn to repair all appliances, including air conditioning, refrigeration, small gas engines. Leads to profitable part or full-time business.

12. ELECTRONICS FOR PRINTERS — Operation and maintenance of Electronic equipment used in graphic arts industry. From basics to computer circuits. Approved by major manufacturers.

*You must pass your FCC License exams (any Communications course) or NRI refunds in full the tuition you have paid.

POPULAR ELECTRONICS

VOLUME 30 NUMBER 1

JANUARY, 1969

WORLD'S
LARGEST-SELLING
ELECTRONICS
MAGAZINE

SPECIAL CONSTRUCTION PROJECTS

- BUILD INFRARED SENSOR** 27 JAMES G. SLOAT
Super-sensitive fire or burglar alarm
- BUILD THE BIG SIX** 33 DAVID B. WEEMS
A big speaker system—in all ways

FEATURE ARTICLES

- POPULAR ELECOMICS** 32
- LAMP BRIGHTNESS QUIZ** 42 ROBERT P. BALIN
- TOP-RATED AM TUNER** 43 JIM CUCCIA
Solid-state tuner for hi-fi
- MINI-WATT IC AMPLIFIER** 47 WILLIAM KIRES
Provides 1 or 2 watts output
- SETTING UP YOUR A.C. BENCH SUPPLY** 52 B. W. BLACHFORD
- CHOOSING THE RIGHT BATTERY** 53 LEWIS A. HARLOW
A guide to transistor batteries
- ADVANCED HAM FREQUENCY CALIBRATOR** 57 NEIL JOHNSON, W2OLU
- BUILD SOUND-SIGNAL THERMOMETER** 59 FRANK H. TOOKER
"Hear" the temperature
- BROADBAND DIPOLE FOR 75/80 METERS** 66 BOB DAHLQUIST, WB6KGF
- BUILD A CHEAPIE METRONOME** 67 KARL GREIF
- EXTENDED DOUBLE ZEPP ANTENNA** 70 JOHN NELSON
- PRECISION AUDIO VOLTAGE STANDARD** 71 TOM GILBERT
A useful check for your test instruments
- BUILD A VOLT BOX** 77 FREDERICK W. CHESSON
- IMPROVING MILLIAMETER ACCURACY** 78 JACK SMALL
- VR WITH IC** 79 TOM THORKELESON
Voltage regulator in TO-5 case
- BUILD THE LAMPLEAK** 82 IMRE GORGENYI
Test your transistors
- ON THE CITIZENS BAND** 84 MATT P. SPINELLO, KHC2060
- SOLID STATE** 86 LOU GARNER
- ENGLISH-LANGUAGE BROADCASTS TO NORTH AMERICA** 92 ROGER LEGGE
- SHORT-WAVE LISTENING** 93 HANK BENNETT, W2PNA
- AMATEUR RADIO** 95 HERB S. BRIER, W9EGQ

DEPARTMENTS

- LETTERS FROM OUR READERS** 4
- ELECTRONICS LIBRARY** 14
- READER SERVICE PAGES** 15, 115
- NEW LITERATURE** 16
- NEW PRODUCTS** 22
- OPERATION ASSIST** 102

POPULAR ELECTRONICS is Indexed
in the Readers' Guide
to Periodical Literature

Copyright © 1968 by ZIFF-DAVIS PUBLISHING COMPANY. All rights reserved.

POPULAR ELECTRONICS, January 1969, Volume 30, Number 1, Published monthly at 307 North Michigan Avenue, Chicago, Illinois 60601. One year subscription rate for U.S., U.S. Possessions and Canada, \$5.00; all other countries, \$6.00. Second class postage paid at Chicago, Illinois and at additional mailing offices. Authorized as second class mail by the Post Office Department, Ottawa, Canada and for payment of postage in cash. Subscription service and Forms 3579: Portland Place, Boulder, Colorado 80302. Editorial offices for manuscript contributions, reader inquiries, etc.: One Park Ave., New York, N.Y. 10016.

This month's cover photo by
Bruce Pendleton

This is the biggest coupon in this magazine because we wouldn't want you to miss a big opportunity to make something of yourself.

Here is the chance of a lifetime to start earning extra money fast. All you need is just a few weeks' training in your own home and in your spare time and your income will go up \$10, \$20, \$30 a week or more. RTTA will show you how easily and how quickly you can do this.

You'll get a complete set of easy-to-read, easy-to-understand lessons that will let you earn money almost from the very beginning. You'll get a complete set of the most modern test equipment; a vacuum-tube voltmeter, a scope, a signal generator — everything you need to help qualify you as a highly-paid electronics technician.

WITHIN ONE WEEK AFTER YOU START YOU'LL BE WORKING WITH ELECTRONICS!

And look at these extras at no additional charge:

- advisory placement service and technical service booklets: • student discount card
- complete electronics workshop tool kit

Act now! All of this equipment and the bonus extras can be yours to keep and to use. The extra money you earn or a new or better job can be yours. Fill in the coupon for full information and start your way up.



16 KITS
Yours to build
and keep



Radio-Television Training of America 229 Park Avenue South, New York, N.Y. 10003

Name _____ Age _____

Address _____

City _____ State _____ Zip _____

Phone _____ pe-1

APPROVED FOR VETERANS

Licensed by the New York State Department of Education
Member of the National Home Study Council

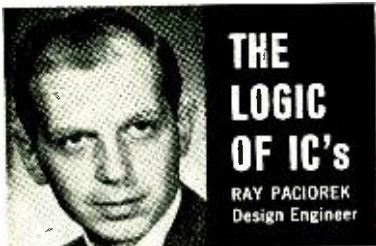

**THE
LOGIC
OF IC's**
RAY PACIOREK
Design Engineer

One of a series of brief discussions by **Electro-Voice engineers**

Computers are proving their worth in the design of high fidelity equipment. Not only are engineers using the computer to assist in design, but they are also using elements designed for the computer to improve the performance of high fidelity equipment for the home.

For instance, Integrated Circuits (IC's) were developed initially for computer logic circuits, but are now found in many stereo receivers, particularly in IF stages. There are several significant reasons why engineers have welcomed the IC as a design element.

Most important is its contribution to stable, optimum design of a critical stage. With no need to neutralize the circuit externally, the IC can be "plugged in" to replace 5 or more transistors (with their associated resistors and capacitors) as a single discrete unit.

With proper matching of the input, output, and power supply of the IC, optimum stable gain is achieved easily and quickly. The reduction in the number of circuit elements also increases the reliability of the design (reliability is always adversely affected by an increase in the number of elements and/or terminations in a circuit). The cumulative advantage of IC's becomes more significant as circuit complexity increases to provide more design features or higher performance standards.

Although several engineers may use identical IC's in their receivers, this is no guarantee of identical results. The IC simply provides gain at RF and IF frequencies. Selectivity must still be provided externally with transformer design. And features such as muting, or "stereo only" circuitry must be added. In addition, parts layout and other circuit parameters will have serious effect on overall performance of the completed design.

It is anticipated that the future will see greatly increased use of "packaged" circuits like the IC. In addition to RF and IF circuits, there appear to be applications in multiplex, AM, and eventually almost every audio circuit in modern receivers. Some present-day phono pre-amp circuits now use a thick film hybrid circuit to provide better performance. A thin film IC would offer superior signal/noise ratio plus more useful gain. Such a device is very close to reality today.

The rapid proliferation of packaged circuits promises to provide the user with more performance for his high fidelity dollar than ever before. In addition, features based on rather complex circuitry are now more easily added to provide superior performance without reducing overall reliability.

For reprints of other discussions in this series, or technical data on any E-V product, write: **ELECTRO-VOICE, INC.**, Dept. 193P, 630 Cecil St., Buchanan, Michigan 49107



CIRCLE NO. 13 ON READER SERVICE PAGE

POPULAR ELECTRONICS

PHILLIP T. HEFFERNAN
Publisher

OLIVER P. FERRELL
Editor

LESLIE SOLOMON
Technical Editor

JOHN R. RIGGS
Managing Editor

EDWARD I. BUXBAUM
Art Director

ALEXANDER W. BURAWA
Associate Editor

ANDRE DUZANT
Technical Illustrator

PATTI MORGAN
Assistant Editor

AURORA NARDOZZI
Editorial Assistant

H. BENNETT, W2PNA
H. S. BRIER W9EQG

L. E. GARNER, JR.

CHARLES J. SCHAUERS, W6QLV
M. P. SPINELLO, KH2060

Contributing Editors

RICHARD J. HALPERN
Advertising Manager

ARDYS C. MORAN
Advertising Service Manager

LAWRENCE SPORN
Associate Publisher

ZIFF-DAVIS PUBLISHING COMPANY

Editorial and Executive Offices
One Park Avenue, New York, New York 10016
212 679-7200

Midwestern Office
307 North Michigan Avenue, Chicago, Illinois 60601
312 726-0892

Midwestern Advertising Manager, JAMES WEAKLEY
GERALD L. TAYLOR

Western Office

9025 Wilshire Boulevard, Beverly Hills, California 90211
213 CResview 4-0265; BRadshaw 2-1161
Western Advertising Manager, BUD DEAN

Japan: James Yagi

Ishikawa Mansion, #4, Sakuragooka
Shibuya-ku, Tokyo, 462-2911-3

Circulation Office

Portland Place, Boulder, Colorado 80302

William B. Ziff, Chairman of the Board (1946-1953)
William Ziff, President

W. Bradford Briggs, Executive Vice President
Hershel B. Sarbin, Senior Vice President

Philip Sine, Financial Vice President

Walter S. Mills, Jr., Vice President, Circulation

Stanley R. Greenfield, Vice President, Marketing

Phillip T. Heffernan, Vice President, Electronics Division

Frank Pomerantz, Vice President, Creative Services

Arthur W. Butzow, Vice President, Production

Edward D. Muhlfeld, Vice President, Aviation Division

Irwin Robinson, Vice President, Travel Division

Furman Hebb, Administrative Vice President

George Morrissey, Vice President

Sydney H. Rogers, Vice President

Ziff-Davis also publishes Airline Management and Marketing, Boatman, Business & Commercial Aviation, Car and Driver, Cycle, Electronics World, Flying, Stereo Review, Modern Bride, Popular Photography, Skiing, Skiing Area News, and Skiing Trade News. (Travel Weekly is published by Robinson Publications, Inc. a subsidiary of Ziff-Davis Publishing Company.)

Forms 357 and all subscription correspondence should be addressed to POPULAR ELECTRONICS, Circulation Department, Portland Place, Boulder, Colorado 80302. Please allow at least six weeks for change of address. Include your old address, as well as new enclosing if possible an address label from a recent issue.

EDITORIAL CONTRIBUTIONS must be accompanied by return postage and will be handled with reasonable care; however, publisher assumes no responsibility for return of safety of art work, photographs or manuscripts.



Member Audit Bureau of Circulations

POPULAR ELECTRONICS

Earn Your DEGREE in Electronics!

This is the "electronics age." Advancements in electronics are coming, one on top of another, so rapidly that the *average technician* cannot stay abreast of the changes. But *some* technicians — those who thoroughly understand fundamental principles — *are* able to stay up with these changes, and they make top pay because of their special ability.

Is *your* electronics knowledge obsolescent? If so, nothing can make you obsolete so quickly as to neglect the study of basic concepts and fundamental principles.

Upgrade Your Knowledge and Earn Your Degree

Grantham's strong-foundation educational program in electronics leads to non-obsolescent skills — to skills based more on reasoning than on merely doing — and leads first to the Associate and then to the Bachelor of Science Degree.

The Grantham Engineering Degree Program in electronics places heavy stress on fundamental concepts of logic and mathematics rather than on superficial manipulative skills. Since these fundamental ideas are largely unfamiliar to many electronics technicians, it is necessary to develop them in a systematic manner.

Get Your FCC License Along The Way

You have heard and read, over and over again, about how important an FCC license is to your success in electronics. It is certainly true that an FCC license is important — sometimes essential — but it's not enough! Without further education, you can't make it to the top. Get your FCC license without fail, but don't stop there. To prepare for the best jobs, continue your electronics education and get your degree.

This kind of thinking makes good common sense to those who want to make more money in electronics. It also makes good common sense to prepare for your FCC license with the School that gives degree credit for your license training — and with the School that can then take you from the FCC license level to the DEGREE level. The first *two semesters* of the 7-semester Grantham degree curriculum prepare you for the first class FCC license and radar endorsement.

Grantham School of Electronics

1505 N. Western Ave. 818 18th Street, N.W.
Hollywood, Calif. 90027 or Washington, D.C. 20006

Telephone:
(213) 469-7878

Telephone:
(202) 298-7460

Accreditation, and G.I. Bill Approval

Grantham School of Electronics was established in Hollywood, California in 1951, and the Eastern Division of the School was opened in Washington, D.C. in 1955.

The School is *approved* in California by the California State Department of Education, is *approved* in the District of Columbia by the D.C. Board of Education, is *approved* under the "Cold War G.I. Bill" to offer resident courses in Hollywood and Washington and correspondence courses from Hollywood, is *accredited* by the Accrediting Commission of the National Home Study Council, and is *authorized* under the laws of the State of California to grant academic degrees.

The Grantham Engineering Program

The entire Grantham Electronics Engineering Curriculum consists of seven semesters (or sections), as listed below. The first six semesters lead to the Associate in Science Degree, and Semester 7 (together with transfer credits in "the humanities") lead to the Bachelor of Science Degree.

Semester 1 — Basic Electronics Technology
(80 lessons, by correspondence or in residence)

Semester 2 — Communications Circuits and Systems
(80 lessons, by correspondence or in residence)

Semester 3 — Electronics Laboratory
(16 weeks, in residence in Hollywood or Washington — or credit may be given for at least one year of practical experience)

Semester 4 — Physics, Engineering Analysis, & Computers
(80 lessons, by correspondence)

Semester 5 — Analytic Geometry and Calculus
(80 lessons, by correspondence)

Semester 6 — Solidstate Physics, Circuit Design, and Technical Writing
(80 lessons, by correspondence)

Review & Exam — Review and Comprehensive Examination on Semesters 1 thru 6, for the Associate in Science Degree
(two-week resident class, meeting in Hollywood)

Semester 7 — Advanced Electronics Engineering
(16-week resident class, meeting in Hollywood)

Transfer Credits — Certain credits in English, Social Studies, etc., in addition to Grantham Semesters 1 thru 7, are required for the *Bachelor of Science Degree in Electronics Engineering*.

Mail the coupon below for our free Bulletin.

Grantham School of Electronics

PE-1-69

1505 N. Western Ave., Hollywood, Calif. 90027

Please mail me your free Bulletin, which explains how the Grantham educational program can prepare me for my FCC License, my Associate in Science Degree, and my Bachelor of Science Degree in Electronics Engineering. I understand no salesman or counselor will call.

Name _____ Age _____

Address _____

City _____ State _____ Zip _____

The silence of a Garrard

is a pleasure to hear.



In a fine automatic turntable, silence speaks more eloquently than any other factor. With Garrard's superlative SL 95, you hear the music without rumble, resonance or distortion, exactly as recorded. The brilliant new, ultra-quiet Synchro-Lab Motor provides absolutely constant synchronous speed to preserve correct musical pitch. The magnificent tonearm floats virtually friction free on needle pivots within a gyroscopically gimbaled mounting—tracks with featherweight precision for flawless record reproduction. Cueing and anti-skating controls provide convenience and record protection.

For literature, write Garrard, Dept. AA139, Westbury, N.Y. 11590. British Industries Co., division of Avnet, Inc.

CIRCLE NO. 14 ON READER SERVICE PAGE

letters

FROM OUR READERS

SPEED THINGS UP

In reference to "Color TV That Isn't" (October, 1968), shouldn't the second paragraph under the heading "TV Applications" on page 75 read: "The Butterfield disc is rotated at 5 rev/s" instead of "5 rev/m"?

S. J. MAGGIO
Bayside, N.Y.

It certainly should!

THERE ARE SIMPLER WAYS

The story "Who Left the Car Lights On?" (August, 1968) proposes some overly complicated solutions for a very simple problem. An approach similar to that shown in Fig. 1 of the article is used by Lafayette Radio Electronics in their "Lite Buzzer." The buzzer consists of two coil windings, one of which is fed through an interrupter from the light switch; the other operates directly from the ignition switch and holds the interrupter closed while the ignition is on.

Incidentally, the best place to connect the "lights" wire is at the panel light fuse. This way, the buzzer sounds off if either the parking or the the headlights are left on. If you want to operate the headlights on purpose, just dim the panel lights until the buzzer quits.

FRED MOORE
Rockville, Md.

I'm becoming tired of reading articles devoted to automobile "lights-on" alarm systems that are written around "relatively" bulky, expensive components and complex circuits. The best designs are the simplest and usually most reliable. Therefore, I submit that the best "auto lights-on" alarm is composed of a diode, buzzer, and limiting resistor as shown in the schematic diagram. The

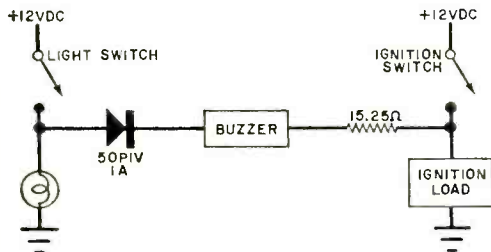

POPULAR ELECTRONICS

They hide under dashboards and bite way out with striking power. The CB solid-state Cobras.

Coiled up under your dash ready to strike. Mysteriously attractive, but all business. Their bite radiates a long way. Penetrates through layers of interference.

When a Cobra bites, you'll be surprised at all the people who know about it.

Because tucked away in the Cobra's throat is the exclusive Dyna-Boost circuit that fills out the sidebands to give you a lot more talking range. Full 5 watts input. 100% modulation.

Both Cobra 27 and Cobra V are all solid state. Which means all solid-state switching. Switching that can't wear out, can't corrode. Solid state also means thick-skinned reliability. Extremes in temperature and humidity have practically no effect on performance and life span.

Cobras are also very sensitive and receptive to the human voice. Very

selective, too, when it comes to rejecting adjacent channel interference. And a Cobra will give you a sharper bite, because all channels are crystal controlled.

If you go solid state, get the bite of the Cobra. For base station as well as mobile applications. (Ask your distributor for the snake or write us for detailed information.)

Cobra 27, 23-channel CB transceiver, complete with all necessary crystals ready for immediate operation on all 23 channels. **\$179.95**

Cobra V, 5-channel CB transceiver. (Channel 11 crystal supplied) **\$99.95**



A Division of DYNASCAN CORPORATION
1801 W. Belle Plaine - Chicago, Illinois 60613
Where electronic innovation is a way of life.

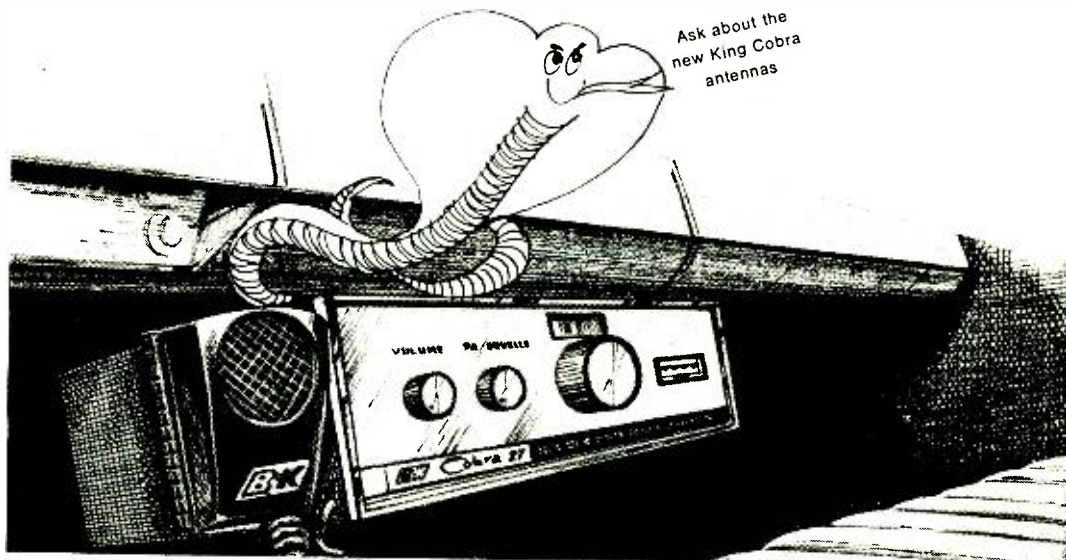

With a GRAYMARK self-instructive kit BUILD YOUR OWN RADIO Take a journey into learning

For years, teachers have used Graymark classroom projects to provide (1) the basics of electronics theory and (2) valuable and workable end products. Now, for the first time, Graymark offers certain of these projects to the public. You can now embark on an exciting, step-by-step journey toward the building of your own highly professional, eight-transistor or five-tube radio... besides learning a great deal about electronics. Each project comes complete with all parts and easy-to-follow instructional manual. All parts fully warranted.

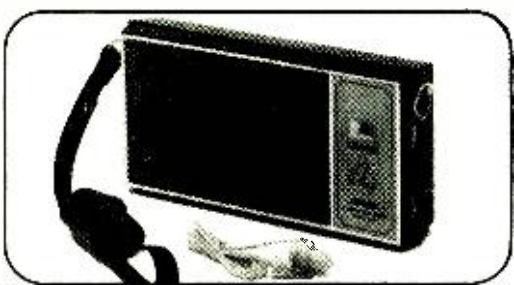

"COMACHO" EIGHT-TRANSISTOR RADIO. Project provides basics of superheterodyne transistor theory operation. Builds into an attractive printed circuit-board radio, mounted in plastic case. Compares favorably with more expensive units. Earphone included. \$19.95 each.

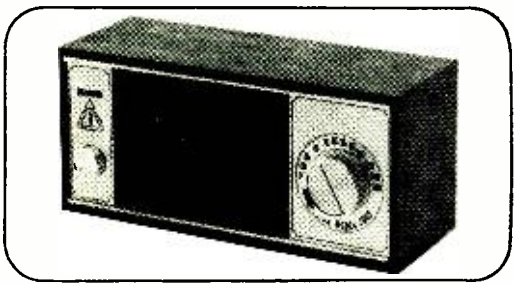

"SCALLON" FIVE-TUBE RADIO. Easy-to-understand project approach to superheterodyne circuitry. Assembles into a distinctive table-type radio. Tubes, contemporary walnut cabinet included. \$21.95 each.

Send order today to:
GRAYMARK Enterprises, Incorporated
Dept. 101, P.O. Box 54343, Ter. Annex, Los Angeles, Calif. 90054

Send Projects Checked
 COMACHO (\$19.95 ea.) SCALLON (\$21.95 ea.)
 Send Postpaid. Enclosed find check/money order for full amount. (Calif. Res. add 5% to total purchase)
 Send C.O.D. I will pay full amount, plus postage.

Name _____
 Address _____
 City & State _____ Zip _____

CIRCLE NO. 16 ON READER SERVICE PAGE

LETTERS (Continued from page 8)

diode serves as a switch which allows the buzzer to sound off only when the light switch is closed and the ignition is turned off. The components can usually be mounted inside the buzzer's housing, and the buzzer can be affixed to the steering column.

LEONARD H. ZANDEL
Los Angeles, Calif.

Both suggestions show sound reasoning, and both should work at least as well as the authors claim.

BINARY ADDER IS FIRST-PRIZE WINNER

I built the "Binary Adder" ("Demonstrating Binary Computation With the Binary Adder," April, 1968) and entered it in a science fair. I won first prize—a \$200 set of encyclopedia. I am now building another computer but have been unable to locate a power transformer with secondary windings capable of delivering 125 volts at 25 mA and 6.3 volts at 1 ampere. Could you please tell me where I can obtain this transformer?

TOM KOZICKI
Wheeling, W. Va.

We can't locate a power transformer with your exact specifications, but a good substitute is the 125-volt, 50-mA and 6.3-volt, 2-ampere (stock number 54 E 1411) power transformer available from Allied Electronics, 100 N. Western Ave., Chicago, Ill. 60680. The price is \$3.88 each.

COSTLY SIDE EFFECT

Working with Neil Johnson's "A.C. Amp-Watt Adaptor" (January, 1968), I have encountered a costly side effect. The instantaneous high current of a load and the power surge in the transformer have destroyed the FET in my transistor voltmeter and the rectifier in my VOM. I've found that the safest way to use this adaptor is to first turn on the appliance, then connect the meter. This hint may just save some readers a costly repair bill.

BILL ZUCKER
Westbury, N.Y.

It well might if you're using a TVM without adequate overload protection. But even if your TVM does have adequate protection, it's always good practice to connect a voltmeter to a circuit after power is applied.

SIMPLE DIODE POLARITY RULE

The "Noise Blanker" ("Build Noise Blanker," October, 1968) is just what the doctor ordered to clear up my problem. Being a ham and living right off one of the busiest thoroughfares in New York, I am constantly plagued by electrical noise from passing vehicles. So, I built the "Noise Blanker," but I destroyed five diodes before I realized that someone goofed—the polarities of the bat-

(Continued on page 117)

CIRCLE NO. 10 ON READER SERVICE PAGE →

World's largest selling mobile/base CB rig! \$189.



Courier 23 — the most popular mobile/base CB transceiver ever built! A greater value than ever before, with 100% modulation featuring Courier's exclusive Modulation Sampler® — boosts your talk power electronically! Dollar for dollar, offers more of what you want in CB: 23 crystal-controlled channels, dual conversion, built-in solid-state 12v mobile power supply, illuminated S-RF meter and channel selector, PA system, modulation indicator, full-time Range-expand, adjustable noise limiter, super efficient squelch. Heavy-duty triple-plated chrome cabinet with stainless steel front panel. Just \$189 complete with crystals for all 23 channels.

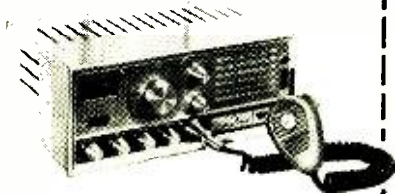

COURIER ROYALE

All the performance money will buy, no matter what you're willing to spend. The ultimate in power, selectivity, sensitivity, quietness. All 23 channels, with all crystals supplied.

Complete **\$279**
(and we mean complete)



COURIER COMMUNICATIONS, INC.

439 Frelinghuysen Avenue, Newark, N.J. 07114
a **Whittaker** Company

Yes! I'd like to know all about the Courier 23 — world's largest-selling CB rig!

Send me data on COURIER ROYALE

Name _____

Address _____ PE-91

City _____ County _____

State _____ Zip _____

"Performance-Plus" Kits For Home And



NEW
kit AD-27
\$169⁹⁵

HEATHKIT AD-27 FM Stereo Compact

The new Heathkit "27" Component Compact was designed to change your mind about stereo compact performance. How? By sounding as if it were made of top quality stereo components . . . which in fact it is. Heath engineers took their highly rated AR-14 solid-state Stereo Receiver, modified it physically to fit the cabinet, and matched it with the precision BSR McDonald 500A Automatic Turntable. Performance? Here's the AD-27 in detail. The amplifier delivers 30 watts music power . . . 15 honest watts per channel — enough to drive any reasonably efficient speaker system. Response is virtually flat from 12 Hz to 60 kHz, and Harmonic & IM distortion are both less than 1% at full output. Tandem Volume, Balance, Bass & Treble controls give you full range command of all the sound. Select the FM stereo mode with a flick of the rocker-type switch and tune smoothly across the dial, thanks to inertia flywheel tuning. You'll hear stations you didn't know existed in your area, and the clarity and separation of the sound will amaze you. The adjustable phasing control insures best stereo separation at all times. And the automatic stereo indicator light tells you if the program is in stereo. AFC puts an end to drift too. The BSR Automatic Turntable has features normally found only in very expensive units, like cueing and pause control, variable anti-skating device, stylus pressure adjustment and automatic system power too. Comes complete with a famous Shure diamond stylus magnetic cartridge. The handsome walnut cabinet with sliding tambour door will look sharp in any surroundings, and the AD-27 performs as well as it looks. For the finest stereo compact you can buy, order your "27" Component Compact now. 41 lbs.

NEW
kit AD-17
\$109⁹⁵



HEATHKIT AD-17 Stereo Compact

Using the component approach of the AD-27, Heath engineers took the solid-state stereo amplifier section of the AD-27, matched it with the high quality BSR-400 Automatic Turntable and put both of these fine components in a handsomely styled walnut finish cabinet. The result is the "17" — featuring 30 watts music power, 12 Hz to 60 kHz response, auxiliary & tuner inputs, less than 1% Harmonic & IM distortion, adjustable stylus pressure & anti-skate control and much more. Order your "17" now. 27 lbs.

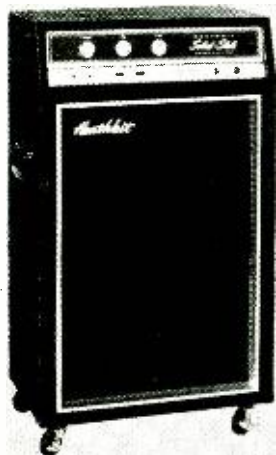

NEW
kit TA-38
\$225⁰⁰

HEATHKIT TA-38 Solid-State Bass Amplifier

The new Heathkit TA-38 is the hottest performing bass amp on the market, for quite a few reasons. First, there's all solid-state circuitry for reliability. Then there's the tremendous power — the TA-38 puts out 120 watts of EIA music power, 240 watts peak, or 100 watts continuous. Extremely low harmonic & IM distortion too. Many amps suffer from "blow-out" problems, but not the new TA-38 — *YOU CAN'T BLOW IT* . . . it boasts two 12" heavy duty special design speakers with giant 3 pound 6 ounce magnet assemblies mounted in a completely sealed, heavily damped 1/2" pressed wood cabinet — those speakers will take every watt the amp will put out, and still not blow. Sound? The TA-38 is tailored to reproduce the full range of bass frequencies delivered by bass guitars and its sound with combo organs and other instruments is remarkable. Easy 15 hour assembly to the wildest bass amp on the market. Order one now and surprise the guys with the high-priced gear. 130 lbs.

NEW
kit GR-58
\$47⁹⁵



HEATHKIT GR-58 Solid-State AM/FM Clock Radio

The easy way to get up in the morning. Choose the morning news & weather on AM or the bright sound of FM music. AFC makes FM tuning easy. The "Auto" position on the Telechron[®] clock turns only the radio on, or use the "Alarm" setting for both the radio and the alarm. You can even enjoy fresh coffee when you awake in the morning, thanks to the clock-controlled accessory AC socket on the back of the new GR-58. The handy "snooze" alarm feature lets you wake up gradually for ten minutes to the sound of the radio, then the alarm goes on . . . push the "snooze" button to silence the alarm for ten minutes more of music or news — the alarm sounds automatically every ten minutes and the "snooze" button turns it off, cycling continuously until the selector switch is moved to another position. Fast, easy circuit board construction, smart blue hi-impact plastic cabinet and top reliability make this GR-58 the clock radio for you. 8 lbs.

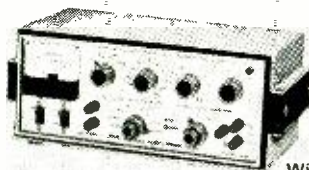

NEW
kit IG-18
\$67⁵⁰
Wired IGW-18
\$99⁵⁰

HEATHKIT IG-18 Solid-State Sine-Square Wave Generator

A precision source of sine or square waves at a low kit price . . . that's the new solid-state IG-18 from Heath. Delivers 5% accuracy thru the wide range of 1 Hz to 100 kHz. The sine wave section features less than 0.1% distortion thru the audio range, 8 output voltage ranges from 0.003 to 10V, switch-selected internal 600 ohm load or external load and metered output of both voltage & dB. The square wave section has a 50 nS rise time and three output voltage ranges from 0.1 to 10 V P-P. Both sine & square waves are available simultaneously and the frequency is switch-selected for constant repeatability and fast operation. Circuit board construction makes the new IG-18 easy to build . . . new Heathkit styling and engineering excellence make it easy to use. Put the new IG-18 on your bench now. 10 lbs.

Hobby... From The Leader



Now There are 4 Heathkit Color TV's...
All With 2-Year Picture Tube Warranty

NEW Deluxe "681" Color TV With Automatic Fine Tuning

The new Heathkit GR-681 is the most advanced color TV on the market. A strong claim, but easy to prove. Compare the "681" against every other TV — there isn't one available for any price that has all these features. Automatic Fine Tuning on all 83 channels... just push a button and the factory assembled solid-state circuit takes over to automatically tune the best color picture in the industry. Push another front-panel button and the VHF channel selector rotates until you reach the desired station, automatically. Built-in cable-type remote control that allows you to turn the "681" on and off and change VHF channels without moving from your chair. Or add the optional GRA-681-6 Wireless Remote Control described below. A bridge-type low voltage power supply for superior regulation; high & low AC taps are provided to insure that the picture transmitted exactly fits the "681" screen. Automatic degaussing, 2-speed transistor UHF tuner, hi-fi sound output, two VHF antenna inputs... plus the built-in self-servicing aids that are standard on all Heathkit color TV's but can't be bought on any other set for any price... plus all the features of the famous "295" below. Compare the "681" against the others... and be convinced.

GRA-295-4, Mediterranean cabinet shown..... **\$119.50**
Other cabinets from \$62.95

Deluxe "295" Color TV... Model GR-295

Big, Bold, Beautiful... and packed with features. Top quality American brand color tube with 295 sq. in. viewing area... new improved phosphors and low voltage supply with boosted B+ for brighter, livelier color... automatic degaussing... exclusive Heath Magna-Shield... Automatic Color Control & Automatic Gain Control for color purity, and flutter-free pictures under all conditions... preassembled IF strip with 3 stages instead of the usual two... deluxe VHF tuner with "memory" fine tuning... three-way installation — wall, custom or any of the beautiful Heath factory assembled cabinets. Add to that the unique Heathkit self-servicing features like the built-in dot generator and full color photos in the comprehensive manual that let you set-up, converge and maintain the best color picture at all times, and can save you up to \$200 over the life of your set in service calls. For the best color picture around, order your "295" now.

GRA-295-1, Walnut cabinet shown..... **\$62.95**
Other cabinets from \$99.95

Deluxe "227" Color TV... Model GR-227

Has same high performance features and built-in servicing facilities as the GR-295, except for 227 sq. inch viewing area. The vertical swing-out chassis makes for fast, easy servicing and installation. The dynamic convergence control board can be placed so that it is easily accessible anytime you wish to "touch-up" the picture.

GRA-227-1, Walnut cabinet shown..... **\$59.95**
Mediterranean style also available at \$99.50

Deluxe "180" Color TV... Model GR-180

Same high performance features and exclusive self-servicing facilities as the GR-295 except for 180 sq. inch viewing area. Feature for feature the Heathkit "180" is your best buy in deluxe color TV viewing... tubes alone list for over \$245. For extra savings, extra beauty and convenience, add the table model cabinet and mobile cart.

GRS-180-5, table model cabinet and cart..... **\$39.95**
Other cabinets from \$24.95

Now, Wireless Remote Control For Heathkit Color TV's

Control your Heathkit Color TV from your easy chair, turn it on and off, change VHF channels, volume, color and tint, all by sonic remote control. No cables cluttering the room... the handheld transmitter is all electronic, powered by a small 9 v. battery, housed in a small, smartly styled beige plastic case. The receiver contains an integrated circuit and a meter for adjustment ease. Installation is easy even in older Heathkit color TV's thanks to circuit board wiring harness construction. For greater TV enjoyment, order yours now.

kit GRA-681-6, 7 lbs., for Heathkit GR-681 Color TV's..... **\$59.95**
kit GRA-295-6, 9 lbs., for Heathkit GR-295 & GR-25 TV's..... **\$69.95**
kit GRA-227-6, 9 lbs., for Heathkit GR-227 & GR-180 TV's..... **\$69.95**



kit GR-681
\$499.95
(less cabinet)



kit GR-295
now only
\$449.95
(less cabinet)



kit GR-227
now only
\$399.95
(less cabinet)



kit GR-180
now only
\$349.95
(less cabinet)



New Wireless
TV Remote Control
For GR-295, GR-227
& GR-180
\$69.95
New Wireless
TV Remote Control
For GR-681
\$59.95



NEW

FREE 1969 CATALOG!

Now with more kits, more color. Fully describes these along with over 300 kits for stereo/hi-fi, color TV, electronic organs, electric guitar & amplifier, amateur radio, marine, educational, CB, home & hobby. Mail coupon or write Heath Company, Benton Harbor, Michigan 49022.

HEATH COMPANY, Dept. 10-1
Benton Harbor, Michigan 49022
In Canada, Daystrom Ltd.

Enclosed is \$

plus shipping.

Please send model (s)
 Please send FREE Heathkit Catalog.
 Please send Credit Application.

Name _____

Address _____

City _____

State _____

Zip _____

Prices & specifications subject to change without notice.

CL-350

Scott's new LR-88
receiver takes the



out of kit building

Ladies and children needn't leave the room when you build Scott's new LR-88 AM/FM stereo receiver kit. Full-color, full-size assembly drawings guide you through every stage . . . wires are color-coded, pre-cut, pre-stripped . . . and critical sections are completely wired and tested at the factory.

In about 30 goof-proof hours, you'll have completed one great receiver. The LR-88 includes FET front end, Integrated Circuit IF strip, and all the goodies that would cost you over a hundred dollars more if Scott did all the assembling.

Performance? Just check the specs below . . . and write to Scott for your copy of the detailed LR-88 story.

LR-88 Control Features: Dual Bass and Treble; Loudness; Balance; Volume compensation; Tape monitor; Mono/stereo control; Noise filter; Interstation muting; Dual speaker switches; Stereo microphone inputs; Front panel headphone output; Input selector; Signal strength meter; Zero-center meter; Stereo threshold control; Remote speaker mono/stereo control; Tuning control; Stereo indicator light. **LR-88 Specifications:** Music-Power rating (IHF), 100 Watts *a.* 4 Ohms; Usable sensitivity, 2.0 μ V; Harmonic distortion, 0.6%; Frequency response, 15-25,000 Hz \pm 1.5 dB; Cross modulation rejection, 80 dB; Selectivity, 45 dB; Capture ratio, 2.5 dB; Signal/noise ratio, 65 dB; Price, \$334.95 (Recommended Audiophile Net)

You'll swear by it



SCOTT[®]

H. H. Scott, Inc., Dept. 520-01, Maynard, Mass. 01754
Walnut case optional

© 1968, H. H. Scott, Inc.

CIRCLE NO. 27 ON READER SERVICE PAGE

ELECTRONICS library

QUIET

VAN NOSTRAND'S SCIENTIFIC ENCYCLOPEDIA

More than 2.4 million words, 125,000 definitions, 16,500 separate articles, and 2000 photos and diagrams make this Scientific Encyclopedia as unique and valuable a reference source as you can find. In its fourth edition, this one-volume reference work has been completely revised and enlarged into a format to accommodate the wealth of material in science and technology. It is so complete and accurate that it not only provides the information needed by the professional, its simple format can be used and understood by virtually any reader. The volume contains a survey of mathematics, the physical and biological sciences, all phases of engineering (including electronics), and medical technology. It appears that every effort has been made by the authors, who are specialists in their fields, to update the information on new scientific developments.

Published by D. Van Nostrand Co., Inc., 120 Alexander St., Princeton, N.J. 08540. Hard cover. 2008 pages. \$42.75.

UNDERSTANDING ELECTRONIC ORGANS

by Thomas Jaski

Many books have been written about the various home organs that are currently available and popular. However, most of these books are specifically applicable to particular instruments—many of which may soon be obsolete. This book takes a general approach, providing a basic understanding of the complex circuits used in electronic organs and explaining why the circuits are used as they are. This approach should help the reader become familiar with new organs as they are introduced. The book is full of useful information, including a review of what sound is and a discussion of organ pipes and how electronic circuits attempt to reproduce the sounds of pipes. It also explains how to perform minor repairs without the tools and instruments used by the professional organ technician.

Published by Hayden Book Co., 116 West 14 St., New York, N.Y. 10011. Soft cover, 224 pages. \$4.95.

RADIO AND ELECTRONIC HANDBOOK

by G. R. Wilding

This one-source reference work is the technician-level counterpart of conventional en-
(Continued on page 116)

READER SERVICE PAGE

free information service:

Here's an easy and convenient way for you to get additional information about products advertised or mentioned editorially (if it has a "Reader Service Number") in this issue. Just follow the directions below... and the material will be sent to you promptly and free of charge.

1. Print or type your name and address on the lines indicated. Circle the number(s) on the coupon below that corresponds to the key number(s) at the bottom of the advertisement or editorial mention(s) that interest you. (Key numbers for advertised products also appear in the Advertisers' Index.)

2. Cut out the coupon and mail it to the address indicated below.

3. This address is for our product "Free Information Service" only. Editorial inquiries should be directed to POPULAR ELECTRONICS, One Park Avenue, New York 10016; circulation inquiries to Portland Place, Boulder, Colorado 80302.

**POPULAR
ELECTRONICS**

VOID AFTER FEBRUARY 28, 1969

P.O. BOX 8391
PHILADELPHIA, PA. 19101

1 2 3 4 5 6 7 8 9 10 11 12 13 14 15 16 17 18 19 20
21 22 23 24 25 26 27 28 29 30 31 32 33 34 35 36 37 38 39 40
41 42 43 44 45 46 47 48 49 50 51 52 53 54 55 56 57 58 59 60
61 62 63 64 65 66 67 68 69 70 71 72 73 74 75 76 77 78 79 80
81 82 83 84 85 86 87 88 89 90 91 92 93 94 95 96 97 98 99 100

NAME (Print clearly) _____

ADDRESS _____

CITY _____ STATE _____ ZIP CODE _____

If you plan to spend less than \$74.50 for a record changer, you're reading the wrong magazine.



Most of the people who read this magazine know that you can't get high fidelity sound from a cheap record changer. Or the peace of mind that comes with knowing that your records are being handled with precision and care.

If you spend less than \$74.50 (the price of the Dual 1212) you won't get a changer that will track a high-compliance cartridge at one gram, flawlessly. Or compensate precisely for skating.

Cheaply made record changers tend to be plagued by audible rumble, wow and flutter. (Rumble, wow and flutter of the Dual 1212 easily surpass NAB standards for broadcast turntables.)

And no cheap changer includes a feathertouch cueing system. Or a variable-speed pitch control that lets you "tune" any record over a half-tone range.

So if you want a high fidelity record changer, and you're willing to spend a few extra dollars to get one, you've just read the right ad.

United Audio Products, Inc.

535 Madison Ave., 
New York, N.Y. 10022.

CIRCLE NO. 31 ON READER SERVICE PAGE

TAKE ONE

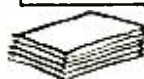

new literature

To obtain a copy of any of the catalogs or leaflets described below, simply fill in and mail the coupon on page 15 or 115.

Many new semiconductor devices are listed for the first time in HEP Catalog MHA27-4, available from *Motorola Semiconductor Products, Inc.*, and Motorola distributors. The devices cover the entire gamut, from low-voltage/low-power diodes and transistors to high-voltage/high-power diodes and transistors. Also included are bilateral trigger diodes, low-power sensitive SCR's, triacs, digital RTL and linear IC's, an IC kit, IC sockets and a TO-5 heat sink. An addition to the HEP line of special interest to service technicians is the "Equal-or-Better" replacement series that includes many devices not generally available before such as automobile press-fit rectifiers, high-voltage zener diodes, drift-field replacements, etc.

Circle No. 75 on Reader Service Page 15 or 115

A 16-page Fall, 1968 catalog available from *Tab Books*, publishers of the Gernsback Library books, describes over 100 current and forthcoming books. The subject areas of these books cover broadcasting, basic technology, CATV, electric motors, electronic engineering, test instruments, transistors, etc.

Circle No. 76 on Reader Service Page 15 or 115

Allied Radio Corporation recently issued its 536-page catalog number 280 for 1969. The catalog lists the latest in major brands of hi-fi components and tape recorders; video tape recorders, monitors, and cameras; transistorized FM-AM and SW receivers; TV portables in various screen sizes; and specialized equipment for the ham, CB'er, experimenter, and hobbyist. Specialty lines included in the catalog illustrate hobby and craft kits, electric guitars, music instrument amplifiers, movie and 35-mm cameras, binoculars, adjustable lamps and fluorescent fixtures, weather instruments, and an electronic organ.

Circle No. 77 on Reader Service Page 15 or 115

More than three hundred electronic kits for every interest and budget are featured in the *Heath Company's* 1969 catalog. Stereo/hi-fi components; ham radio equipment;

(Continued on page 113)

The New 1969 Improved Model 257 **A REVOLUTIONARY NEW TUBE TESTING OUTFIT**

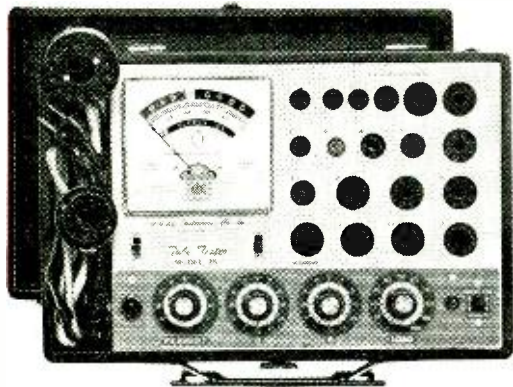

COMPLETE WITH ALL ADAPTERS AND ACCESSORIES, NO "EXTRAS"

STANDARD TUBES:

- ✓ Tests the new Novars, Nuvisitors, 10 Pins, Magnovals, Compactrons and Decals.
- ✓ More than 2,500 tube listings.
- ✓ Tests each section of multi-section tubes individually for shorts, leakage and Cathode emission.
- ✓ Ultra sensitive circuit will indicate leakage up to 5 Megohms.
- ✓ Employs new improved 4½" dual scale meter with a unique sealed damping chamber to assure accurate, vibration-less readings.
- ✓ Complete set of tube straighteners mounted on front panel.

BLACK AND WHITE PICTURE TUBES:

- ✓ Single cable used for testing all Black and White Picture Tubes with deflection angles 50 to 114 degrees.
- ✓ The Model 257 tests all Black and White Picture Tubes for emission, inter-element shorts and leakage.

COLOR PICTURE TUBES:

- ✓ The Red, Green and Blue Color guns are tested individually for cathode emission quality, and each gun is tested separately for shorts or leakage between control grid, cathode and heater. Employment of a newly perfected dual socket cable enables accomplishments of all tests in the shortest possible time.

The Model 257 is housed in a handsome, sturdy, portable case. Comes complete with all adapters and accessories, ready to plug in and use. No "extras" to buy. Only

\$47⁵⁰

NOTICE

We have been producing radio, TV and electronic test equipment since 1935, which means we were making Tube Testers at a time when there were relatively few tubes on the market, 'way before the advent of TV. The model 257 employs every design improvement and every technique we have learned over an uninterrupted production period of 32 years. Accurate Instrument Co., Inc.

SEND NO MONEY WITH ORDER PAY POSTMAN NOTHING ON DELIVERY

Try it for 10 days before you buy. If completely satisfied then send \$10.00 and pay the balance at the rate of \$10.00 per month until the total price of \$47.50 (plus P.P., handling and budget charge) is paid. If not completely satisfied, return to us, no explanation necessary.

ACCURATE INSTRUMENT CO., INC.

Dept. 619 2435 White Plains Road, Bronx, N. Y. 10467

Please rush me one Model 257. If satisfactory I agree to pay \$10.00 within 10 days and balance at rate of \$10.00 per month until total price of \$47.50 (plus P.P., handling and budget charge) is paid. If not satisfactory, I may return for cancellation of account.

Name _____

Address _____

City _____ Zone _____ State _____

Save Money! Check here and enclose \$47.50 with this coupon and we will pay all shipping charges. You still retain the privilege of returning after 10 day trial for full refund.

CIRCLE NO. 1 ON READER SERVICE PAGE

Join "THE TROUBLESHOOTERS"

**They get paid top salaries
for keeping today's
electronic world running**

Suddenly the whole world is going electronic! And behind the microwave towers, push-button phones, computers, mobile radio, television equipment, guided missiles, etc., stand

THE TROUBLESHOOTERS
—the men needed to inspect, install, and service these modern miracles. They enjoy their work, and get well paid for it. Here's how you can join their privileged ranks—without having to quit your job or go to college in order to get the necessary training.



JUST THINK how much in demand you would be if you could prevent a TV station from going off the air by repairing a transmitter...keep a whole assembly line moving by fixing automated production controls...prevent a bank, an airline, or your government from making serious mistakes by servicing a computer.

Today, whole industries depend on Electronics. When breakdowns or emergencies occur, someone has got to move in, take over, and keep things running. That calls for one of a new breed of technicians—The Troubleshooters.

Because they prevent expensive mistakes or delays, they get top pay—and a title to match. At Xerox and Philco, they're called Technical Representatives. At IBM they're Customer Engineers. In radio or TV, they're the Broadcast Engineers.

What do you need to break into the ranks of The Troubleshooters? You might think you need a college degree, but you don't. What you need is know-how—the kind a good TV service technician has—only lots more.

Think With Your Head, Not Your Hands

As one of The Troubleshooters, you'll have to be ready to tackle a wide variety of electronic problems. You may not be able to dismantle what you're working on—you must be able to take it apart "in your head." You'll have to know enough Electronics to understand the engineering specs, read the wiring diagrams, and calculate how the circuits should test at any given point.

Learning all this can be much simpler than you think. In fact, you can master it without setting foot in a classroom...and without giving up your job!

For over 30 years, the Cleveland Institute of Electronics has specialized in teaching Electronics at home. We've developed special techniques that make learning easy, even if you've had trouble studying before. Our AUTO-PROGRAMMED® lessons build your knowledge as easily and solidly as you'd build a brick wall—one brick at a time. And our instruction is personal. Your teacher not only grades your work, he analyzes it to make sure you are thinking correctly. And he returns it the same day received, while everything is fresh in your mind.

Always Up-To-Date

To keep up with the latest developments, our courses are constantly being revised. This year CIE students are

NEW COLLEGE-LEVEL COURSE IN **ELECTRONICS ENGINEERING**

for men with prior experience in Electronics. Covers steady-state and transient network theory, solid state physics and circuitry pulse techniques, computer logic and mathematics through calculus. A college-level course for men already working in Electronics.

getting new lessons in Laser Theory and Application, Microminiaturization, Single Sideband Techniques, Pulse Theory and Application, and Boolean Algebra.

In addition, there is complete material on the latest troubleshooting techniques including Tandem System, Localizing through Bracketing, Equal Likelihood and Half-Split Division, and In-circuit Transistor Checking. There are special lessons on servicing two-way mobile radio equipment, a lucrative field in which many of our students have set up their own businesses.

Your FCC License—or Your Money Back!

Two-way mobile work and many other types of troubleshooting call for a Government FCC License, and our training is designed to get it for you. But even if your work doesn't require a license, it's a good idea to get one. Your FCC License will be accepted anywhere as proof of good electronics training.

And no wonder. The licensing exam is so tough that two out of three non-CIE men who take it fail. But our training is so effective that 9 out of 10 CIE graduates pass. That's why we can offer this famous warranty with confidence: If you complete a license preparation course, you get your FCC License—or your money back.

Mail Card for 2 Free Books

Want to know more? Send for our 44-page catalog describing our courses and the latest opportunities in Electronics. We'll send a special book on how to get a Government FCC License. Both are free—just mail the bound-in postpaid card. If card is missing, use coupon below.

ENROLL UNDER NEW G.I. BILL

All CIE courses are available under the new G.I. Bill. If you served on active duty since January 31, 1955, or are in service now, check box on card or coupon for G.I. Bill information.

CIE Cleveland Institute of Electronics

1776 East 17th Street, Cleveland, Ohio 44114

Cleveland Institute of Electronics

1776 East 17th Street, Cleveland, Ohio 44114

Please send me without cost or obligation:

1. Your 44-page book "How to Succeed in Electronics" describing the job opportunities in Electronics today, and how your courses can prepare me for them.
2. Your book on "How To Get A Commercial FCC License."

I am especially interested in:

- | | | |
|--|---|--|
| <input type="checkbox"/> Electronics Technology | <input type="checkbox"/> Broadcast Engineering | <input type="checkbox"/> First Class FCC License |
| <input type="checkbox"/> Electronic Communications | <input type="checkbox"/> Industrial Electronics | <input type="checkbox"/> Electronics Engineering |

Name _____ (PLEASE PRINT)

Address _____

City _____ State _____ Zip _____

Check here for G. I. Bill information.

PE-74



NEW PRODUCTS

Additional information on products covered in this section is available from the manufacturers. Each new product is identified by a code number. To obtain further details on any of them, simply fill in and mail the coupon on page 15 or 115.

SOLID-STATE STEREO RECEIVER

Two hundred watts output is a big boast for any stereo receiver, but the Model TK-140x AM/FM receiver from *Kenwood Electronics, Inc.*, has just that. The front end of the receiver employs a four-gang tuning capacitor, three FET's, and four IC's (in the i.f. strip). Sensitivity is down to a low 1.7 μ V, so a mere 1-dB difference in signals on the same frequency will allow the TK-140x to capture one station and reject the other. Also, FM image rejection, cross modulation, and i.f. rejection are all better than 100 dB, while alternate channel selectivity is 45 dB and harmonic distortion is less than 0.5% at 400 Hz, 100% modulated signal. Included are two sets of output taps, convenient two-channel preamplifier outputs, and main amplifier inputs.



Circle No. 78 on Reader Service Page 15 or 115

CB TV INTERFERENCE FILTER

The CB'er can now eliminate TV interference caused by his transceiver with a TVI filter being offered by *Gold Line Connector, Inc.* The TVI filter features a tuning control to facilitate adjustment for maximum television interference rejection, guaranteed 40 dB or better. When he transmits, the CB'er simply adjusts the control knob on the filter until the TVI is corrected.

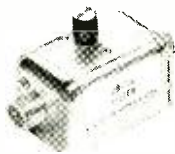

Circle No. 79 on Reader Service Page 15 or 115

ELECTRIC GUITAR BROADCASTER

A wireless electric guitar broadcaster that plugs into the output jack of any electric-guitar has been introduced by *Saxton Products, Inc.* The broadcaster converts guitar sound into FM radio signals that can be picked up by any FM radio within a 50-foot radius. Miniature antenna, tuning control to insure extended quality reception, and phone plug are included. Tuning range is from 88 to 94 MHz; frequency response is 20-15,000

Hz; and input power to the antenna is 6 mW. For best results, a Saxton B-101 battery is recommended as the power source.

Circle No. 80 on Reader Service Page 15 or 115

LOW-COST, LOW-VOLTAGE POWER SUPPLY

An inexpensive 1-15-volt d.c. power supply, Model IP-18, is available from *Heath Company*. This all-silicon-transistor supply features voltage regulation within 40 mV from no load to full load and less than 0.5% change in output voltage with input variations from 105 to 125 volts a.c. The IP-18 also features current limiting, continuously variable between 10 and 500 mA. Ripple and noise are maintained at less than 0.1 mV, and transient response is 25 μ sec. Output impedance is 0.5 ohms or less up to 100 kHz.



Circle No. 81 on Reader Service Page 15 or 115

INDUCTION-BALANCE METAL DETECTOR

Designed to locate buried metal objects to depths of five feet, the Model 70 "Metalert" metal detector by *Fisher Research Laboratory* can be used practically anywhere—even in shallow water. The Model 70 is so finely balanced and lightweight that the user can hold and tune it simultaneously with the same hand. Featured are high sensitivity, a waterproof loop mounted on an adjustable shaft, 9-volt battery operation, built-in battery condition tester, and a cushioned headset. Accessories such as a plug-in speaker/amplifier and carrying case are available separately.

Circle No. 82 on Reader Service Page 15 or 115

HIGH-QUALITY HI-FI SPEAKER SYSTEMS

The "Imperial I" and "Imperial II" speaker systems available from *Marantz Company, Inc.*, feature three-way, five-speaker design. The Imperial I system has a walnut enclosure with a hand-rubbed French lacquer finish and a selection of decorator-design grille fabrics. The Imperial II is hand-crafted from selected hardwoods with antique finish and hand-carved wood grille. Technical specifications: 40-20,000 Hz frequency response (crossovers at 700 and 6000 Hz); 40-watt power-handling capability; and 8-ohm impedance. Both speaker systems feature built-in acoustical balancing controls.



Circle No. 83 on Reader Service Page 15 or 115

MOBILE CB ANTENNA

The "Avanti One" available from *Avanti Research and Development, Inc.*, incorporates rugged, durable fiberglass with an exclusive tuning device for precisely adjusting SWR to 1:1. The fiberglass shaft of the antenna is capped with a unique stainless steel adjust-

BESTSELLING SAMS BOOKS

for every electronics interest

JUST PUBLISHED—IMPORTANT!

Short-Wave Listener's Guide, 2nd Ed.

Lists all short-wave stations by country, city, call letters, frequency, power, and transmission time. Includes Voice of America and Radio Free Europe stations and a listing of stations operating behind the Iron Curtain. With conversion chart and handy log. Order 20695, only.....\$2.25

Amateur Radio SSB Guide

Essential for anyone owning or planning to build or buy ssb equipment. Covers basic principles, purpose of ssb transmission; detailed analysis of the balanced modulator circuit and its application in a typical transmitter. Includes schematic diagrams for those interested in building or troubleshooting ssb transmitters and receivers, along with circuit analysis. Order 20629, only.....\$3.95

Learning Electronics Through Troubleshooting

A new and practical approach to learning and understanding electronics theory. Provides a thorough grasp of the subject through the technique of solving practical troubleshooting problems. Includes two appendices containing valuable reference data. Order 20651, only.....\$6.95

101 Questions & Answers About Fixed Radio Communications

A valuable reference for all who work with microwave and other fixed radio systems. Covers long distance, high-frequency voice and teletype communications, short range vhf and uhf links, low-density and high-density microwave multi-channel transmission of telephone, telegraph, data, tv, and other intelligence. Essential for anyone who designs, operates, or maintains fixed radio communications systems. Order 20589, only.....\$3.95

Using and Understanding Miniature Neon Lamps

Describes the neon lamp in detail: electrode size, gases used, firing, extinction voltages, aging characteristics, and maintenance. Explains its uses as an indicator, voltage regulator and voltage reference, oscillator, pulse-generator, flasher, and applications in computers. Includes fascinating, easy-to-build circuits for the experimenter. Order 20698, only.....\$2.95

Novel Electronic Circuits

Offers 77 novel circuits and devices for the experimenter, ham, or technician. Circuits range from functional devices, such as light sensor, audio oscillator, and infrared sensor, to unusual scientific types, such as an electronic lock and an earth telephone. Includes thorough descriptions and illustrations for each device. Order 20692, only.....\$2.50

Motorcycle Service Manuals, 2nd Ed.

Provides full information on how to service virtually every present-day scooter or motorcycle. The two volumes cover hundreds of popular domestic and foreign models. Vol. 1. Order 20665, only.....\$4.95
Vol. 2. Order 20666, only.....\$4.95
2-Vol. Set. Order 20667, only.....\$9.50

These and over 300 other SAMS books are available from your Electronic Parts Distributor—or send coupon.

RECENT, TIMELY BOOKS!

49 Easy Transistor Projects

Provides simple, easy instructions, schematic diagrams, and parts lists for building a-m and f-m radios, light relay controls, audio amplifiers, code-practice oscillators, and test equipment, using inexpensive or salvage parts. A fascinating, instructive book. Order 20617, only.....\$1.75

101 Questions & Answers About CATV & MATV

Describes the growing applications of catv (community antenna television) and matv (master antenna television) in the fields of home entertainment, schools, public safety, and industry. Fully covers equipment and system designs and installation, and the future for this field. Order 20655, only.....\$2.50

101 Questions & Answers About Color TV

Here are the complete and clear answers to the most frequently asked questions about color tv—about its basic theory, installation, servicing, and modifications. Answers are reinforced by dozens of schematics, illustrations, and photographs. Order 20624, only.....\$1.75

ABC's of Electrical Soldering

An invaluable book on the art of soldering—what it is and does, how to make a good connection, how to make solder repairs. Explains solder alloys, fluxes, soldering irons, instant-heat guns, production soldering, and other connecting methods. Order 20627, only.....\$2.95

Semiconductor Handbook

Here, in one comprehensive heavily illustrated volume, is the most complete, modern sourcebook for industrial semiconductor data. Covers latest circuitry in a wide variety of applications; provides full data on industrial semiconductors, including grown-junction, alloyed-junction, drift, MADT, mesa, planar, and epitaxial mesa types. Order 20620, only.....\$5.75

How to Repair Major Appliances

This fact-packed volume explains theory, functioning, major components, and repair of refrigerators, freezers, washing machines, dryers, ranges, dishwashers, garbage disposers, room air conditioners, water heaters, humidifiers, and dehumidifiers. Order 20650, only.....\$4.95

MORE BEST SELLING SAMS TITLES

ABC's of Transformers and Coils. 20612.....	\$2.50
Understanding Electronic Test Equipment. 20613.....	\$4.50
101 Questions & Answers About CB Operations. 20604.....	\$2.50
Modern Dictionary of Electronics. 3rd Ed. 20600.....	\$9.95
ABC's of Vacuum Tubes. 20576.....	\$2.95

HOWARD W. SAMS & CO., INC.

Order from any Electronic Parts Distributor, or mail to Howard W. Sams & Co., Inc., Dept. PE-1
4300 W. 62nd St., Indianapolis, Ind. 46268

Send the following books: Nos. _____

_____ \$ _____ enclosed

Send FREE 1969 Sams Book Catalog

Name _____

PLEASE PRINT

Address _____

City _____ State _____ Zip _____

PRODUCTS (Continued from page 22)

able tip. Tuning is accomplished by a simple adjustment of the tip length, after which the tip is locked in position, providing maximum power transfer to the antenna. Available in two models (4' and 6'), the Avanti One is designed to fit rooftop, trunk, cowl, bumper, or marine mounts. A chrome-plated brass ferrule permits easy installation on standard brackets.

Circle No. 84 on Reader Service Page 15 or 115

COLOR-BAR PATTERN GENERATOR

The Model LCG-389 color-bar pattern generator, used extensively for production testing and field service, is now available from *Leader Instruments Corp.* This ultra-compact, all-solid-state instrument, designed for convergence and synchronization adjustments of color and monochrome TV receivers, features five basic patterns—among them, gated rainbow color bars; vertical and horizontal lines; crosshatch; small, well-defined dots. Gun killers are provided for convergence adjustments. Technical specifications: channels 5 and 6 selectable r.f. output; 10 gated rainbow color bars; 21 vertical and 15 horizontal lines for vertical and horizontal lines and crosshatch patterns; continuously adjustable 0-200% chroma level; 105-125 volts, 50-60 Hz operation.

Circle No. 85 on Reader Service Page 15 or 115

MARINE AUDIO SYSTEM

The "Sound Center" audio system, available from *Simpson Electronics, Inc.*, is designed to provide maximum clarity and range in voice projection and sound pickup for marine use. The new multi-purpose system includes a manual and automatic fog horn, intercom, an alarm that can warn of fire, bilge leaks, or break-ins, and a high-quality carbon microphone with a press-to-talk switch. Also included is a fully adjustable weather-resistant speaker horn made by Electro-Voice. Construction of the "Sound Center" is all solid state, including integrated circuits. The system operates on 12 volts d.c.

Circle No. 86 on Reader Service Page 15 or 115

LISTENING ACCESSORIES FOR STEREO

Stereo-Magic has developed two new adapters for stereo headphones. The Model HAD-1 adapter allows the user to add a plug-in jack to any stereo receiver, phonograph, or tape player. The second adapter lets the user change the volume of any stereo headphone set to adjust for hearing differences from one

ear to the other. Also available is a set of matching headphones with foam rubber lined ear cups in a lightweight frame for maximum comfort. Frequency range is 30-20,000 Hz.

Circle No. 87 on Reader Service Page 15 or 115

CARTRIDGE FM TUNER

Capable of plugging into all 4- and 8-track cartridge tape players, *Eastern Specialties Corporation's* "Stereo-Magic" universal FM tuner adds a new dimension to the ordinary tape player. The shape and size of an ordinary tape cartridge, Stereo-Magic plugs in like one. Technical specifications: 88-108-MHz tuning range; 10.7-MHz i.f.; power consumption, 6 mA at 9 volts; "C" type rod antenna and built-in antenna connector; 10 μ V/meter at 0.1 volt output coil sensitivity; and 23 dB at 0.1 volt signal-to-noise ratio. This all solid-state tuner employs eight transistors and three diodes.

Circle No. 88 on Reader Service Page 15 or 115



SQUELCH FOR R.F. CONVERTER

The first squelch control for noise-free monitoring on HF and VHF "Tunaverters," making it possible to have receiver squelch performance with economical converter usage, was recently introduced by *Tompkins Radio Products.* The new squelch attachment requires only a single coaxial cable hookup to the converter. It has complete electronic control without relays, fully adjustable squelch setting, power switch, and 9- or 12-volt operation. The squelch attachment is available in two models: Model ST fastens to the bottom of the Tunavert; Model SU has its own mounting bracket.

Circle No. 89 on Reader Service Page 15 or 115



100-WATT AM/FM STEREO RECEIVER

Two separate methods of tuning the FM band are featured in *Fisher Radio's* model 250-T all-transistor stereo receiver. In addition to conventional flywheel tuning, the 250-T employs Fisher's "Tune-O-Matic" push-button tuning of five FM stations. The FM section has a.f.c. for center-of-channel accuracy, FET front end, IC i.f. amplifier, and a Stereo Beacon. Technical specifications: amplifier section—100 watts \pm 1 dB music (30 watts/channel r.m.s.) power at 8 ohms; 0.5% harmonic distortion; 1% at 30 watts IM distortion; hum and noise 90 dB below rated output. AM tuner section—10- μ V/m usable sensitivity; 50-dB selectivity; 80-dB image rejection; 85-dB i.f. rejection. FM tuner section—2- μ V usable sensitivity; 65-dB signal-

(Continued on page 114)



The best thing in electronics is

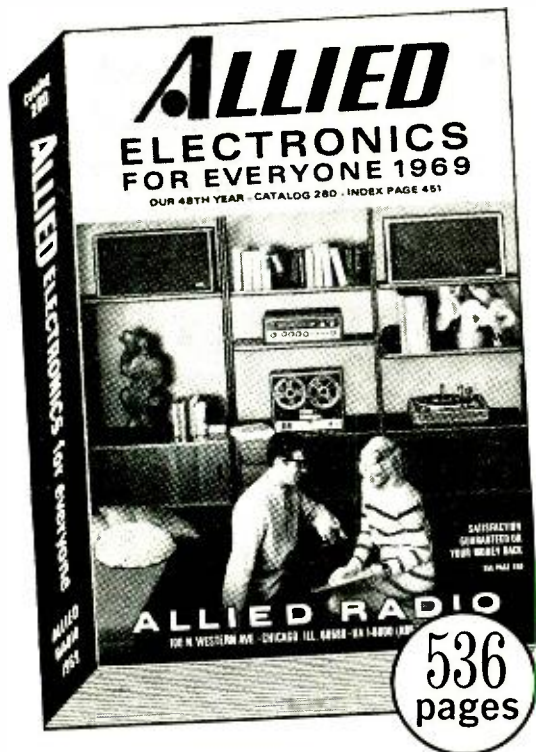

FREE 1969 ALLIED CATALOG

Brand new! Fresh off the press! Allied's 1969 Catalog. The world's most famous catalog of electronic equipment featuring hundreds of new and exclusive items and special Allied values.

536 pages—including the most complete inventory of Hi-Fi, Radios, Tape Recorders, CB, Electronic Equipment, Parts and Tools ever assembled... all at money-saving prices.

BIG SAVINGS ON THE BEST IN ELECTRONICS FOR EVERYONE

- Stereo Hi-Fi
- Electronic & Hobby Kits
- Tape Recorders and Tapes
- Citizens Band Equipment
- Walkie-Talkies
- Shortwave Receivers
- Phonographs
- Speakers
- Record Changers
- FM, AM & VHF Radios
- Portable TV Sets
- Amateur Gear
- Intercoms
- P. A. Equipment
- Test Equipment
- Antennas
- Tubes and Transistors
- Automotive Electronics
- Tools & Hardware
- Books
- Cameras
- Needles
- Headphones
- Microphones
- Integrated Circuits
- Wire & Cable
- Parts and Batteries

NO MONEY DOWN • UP TO 2 YEARS TO PAY!

Write
for your
copy today!

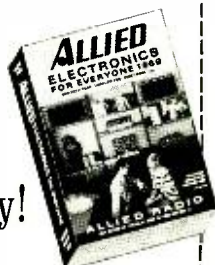

ALLIED RADIO, Dept. 066

P.O. Box 4398, Chicago, Illinois 60680

Send me your free catalog for 1969

(please print)

NAME _____ First _____ Middle _____ Last _____

ADDRESS _____

CITY _____

STATE _____ ZIP CODE _____

The Active One...

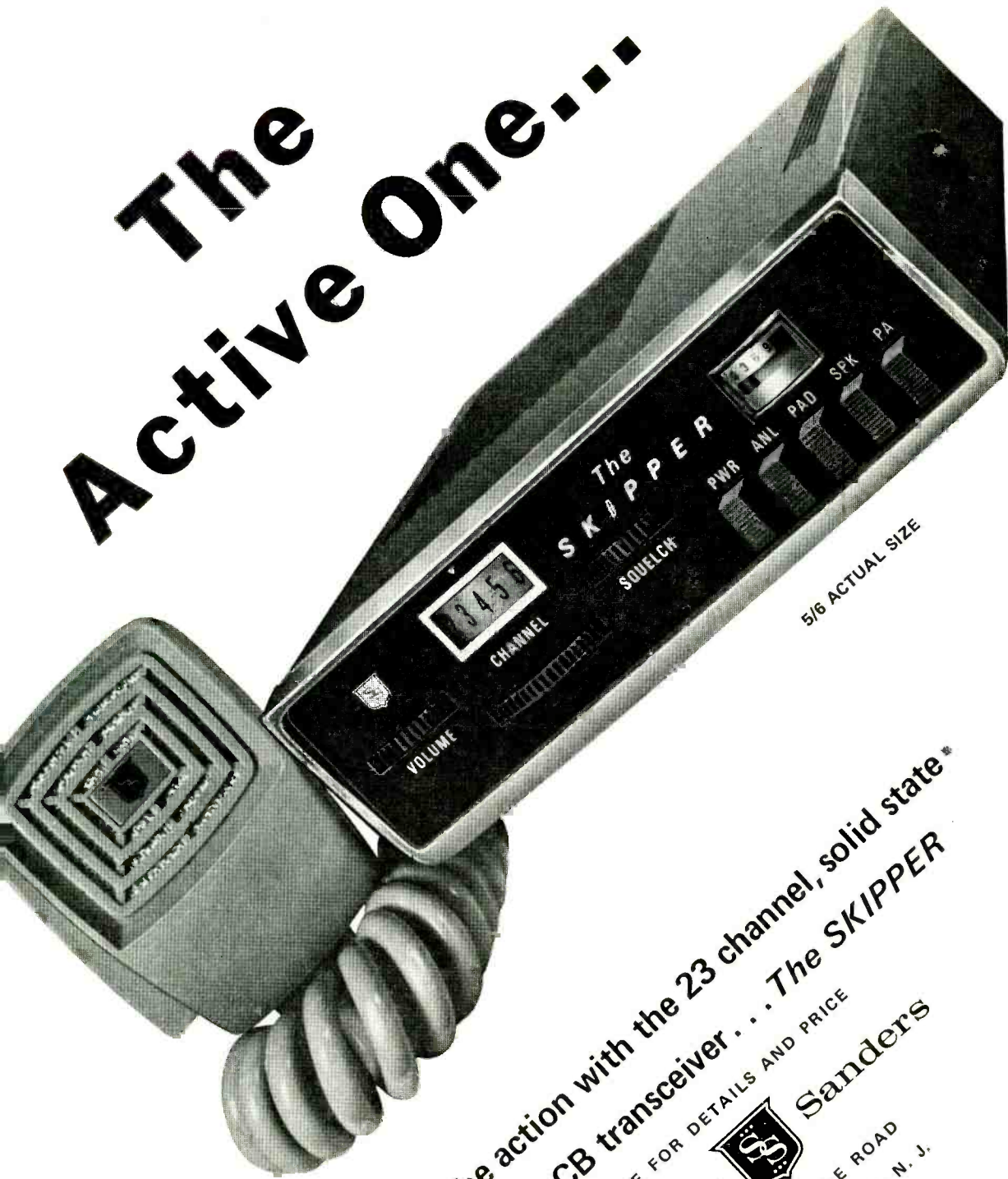

5/8 ACTUAL SIZE

get in on the action with the 23 channel, solid state[®]
full 5 watt CB transceiver . . . The SKIPPER

WRITE FOR DETAILS AND PRICE

Squires Sanders

MARTINSVILLE ROAD
LIBERTY CORNER, N. J.
07938

CIRCLE NO. 30 ON READER SERVICE PAGE

POPULAR ELECTRONICS

Build Infrared Sensor

IR "HOTBOX
DETECTOR"
HAS
FANTASTIC
SENSITIVITY



HAVING a fire alarm in a house or office is a good idea—sometimes, it's a life saver. However, most commercial alarms use sensors that only operate at some critical temperature before they actuate the alarm. Under these conditions, if a fire starts some distance from the sensor, a lot of building can burn away before an alarm is given. What is needed is a device that can detect the infrared (IR) radiation from a smoldering or unusually hot object. This radiation can be sensed from a distance.

In the realm of burglar alarms, most low-cost units use either a frangible trip wire or a light beam to detect intruders. Trip wires, in many cases, can be seen and light beams can either be seen directly or can be detected by the dust motes in the air. This, or course, nullifies the alarm. What is needed here is an invisible beam of IR and a detector

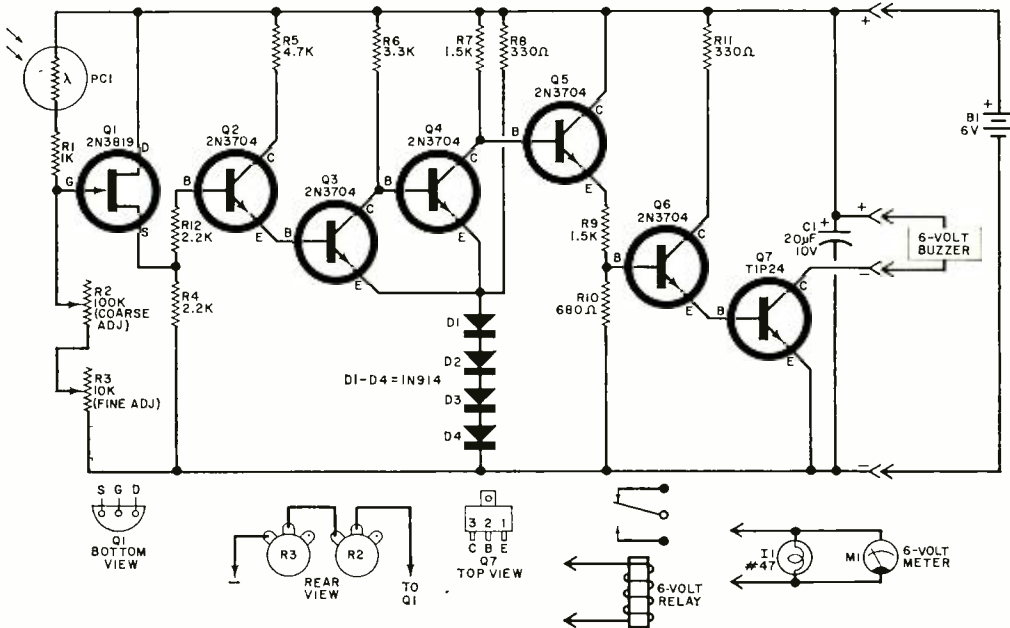

Fig. 1. No power is applied to output indicator until PC1 "sees" a predetermined level of infrared.

that responds only to IR and not to visible light.

Incidentally, the infrared portion of the electromagnetic spectrum lies between the highest radio frequencies and visible light. Because all material emits IR radiation if its temperature is above absolute zero, the amount of IR radiated is a measure of heat (not necessarily actual flames).

The "Hotbox" IR detector described here not only makes an ideal fire or burglar alarm, but has many other uses. For example, it can check for over-heating conditions in electrical and mechanical equipment or detect the difference between a cloudy and a clear sky. When not serving some truly practical purpose, it can tell you when your soldering iron is up to temperature, turn on your hi-fi or TV when you light a cigarette, or provide a low-cost test instrument for studying the IR properties of various materials.

Because the Hotbox is, by necessity, a low-cost device, its IR range is limited. It responds only to objects that are at least 75°C hotter than the ambient temperature of the detector. Therefore it does not respond to the warmth of a

PARTS LIST

- B1—6-volt lantern battery
- C1—20-µF, 10-volt electrolytic capacitor
- D1-D4—1N914 diode
- PC1—Infrared detector kit, including reflector and filter (Radio Shack #276-035 or similar)
- Q1—2N3819 field-effect transistor (see text)
- Q2-Q6—2N3704 transistor (see text)
- Q7—Power transistor (Texas Instruments TIP24 or similar, see text)
- R1—1000-ohm
- R4, R12—2200-ohm
- R5—4700-ohm
- R6—3300-ohm
- R7—1500-ohm
- R8, R11—330-ohm
- R9—1500-ohm
- R10—680-ohm
- R2—100,000-ohm potentiometer
- R3—10,000-ohm potentiometer
- I1—#47 indicator lamp and holder
- M1—6-volt meter movement

Misc.—Plastic case and cover (Harry Davis type 260 or similar), 6-volt d.c. buzzer (optional), 6-volt d.c. relay (optional), miniature jack and plug with carphone-type lead, perf or PC board, camera pistol grip (optional), knobs (2), cement or epoxy, mounting hardware wire, etc.

Note—An etched and drilled PC board may be purchased from Excello Circuits Co., 847 W. 23 St., Houston, Texas 77008, for \$3.95.

human body. Commercial IR detectors are submerged in cryogenic (extremely low temperature) chambers making the detector sensitive not only to humans, but also to very low levels of IR.

Similar to visible light, IR can be reflected around corners by shiny sheets of metal or conventional mirrors, thus enabling the device to "see" around cor-

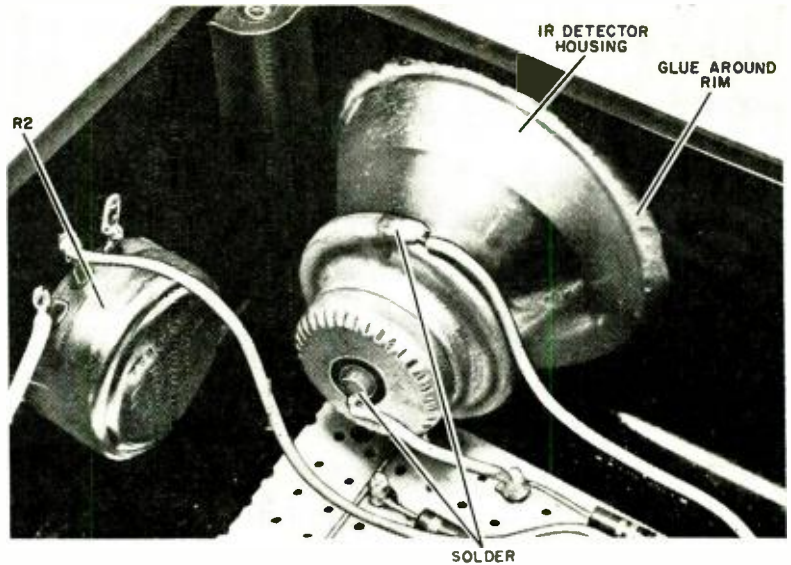

When soldering the lead to the IR detector housing, work fast so that you do not overheat the IR element within the reflector. Other connection is made to bulb tip.

ners if desired. The reflector unit specified in the Parts List for Fig. 1 is as directional as a flashlight, so that the device can be pointed very precisely at the IR source.

Construction. Putting the Hotbox together is simple and straightforward. Lead dress is not critical and the circuit

(shown in Fig. 1) is very flexible with regard to resistor values and transistor parameters. In fact, almost any silicon *npn* transistors can be used for *Q2* through *Q6*. Most *n*-channel FET's will work for *Q1*, while almost any *npn* power transistor can be used for *Q7*.

The author used perf-board construction (see photos), although a printed-

This is what good perf-board construction looks like. Note the clean, almost polished look of the solder connections and the neat arrangement of parts.

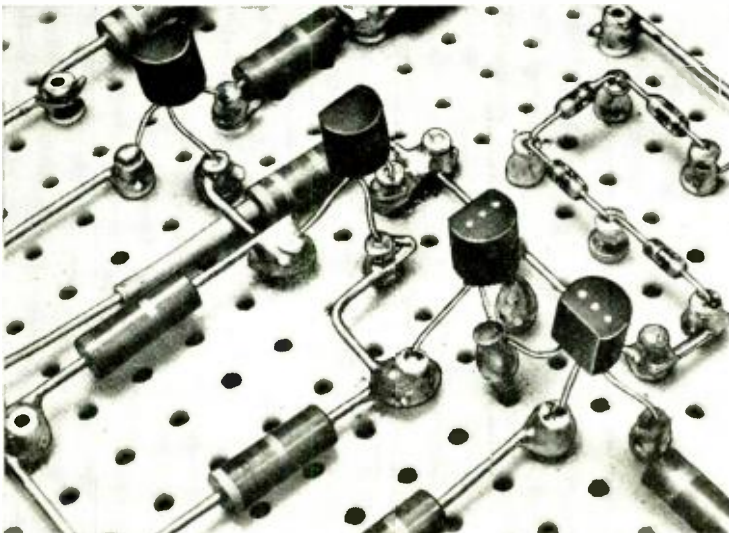

HOW IT WORKS

The heart of the circuit is a threshold detector composed of transistors *Q2*, *Q3*, and *Q4* and their associated components. Each of silicon diodes *D1* through *D4* has a constant 0.6-volt drop when forward biased with a few milliamperes. Under all conditions, current flows through *R8* and forward biases the four series-connected diodes so that the voltage at the emitters of *Q3* and *Q4* is fixed at 2.4 volts. This fixed voltage establishes the operating point for the circuit.

If the detector *PC1* is shielded from IR radiation, *Q2* and *Q3* are turned off, and current flows through *R6* into the base of *Q4*. Thus *Q4* is turned on and appears as a short circuit between its collector and emitter. The collector voltage of *Q4* is therefore close to 2.4 volts.

Emitter follower *Q5* acts as a buffer between the threshold detector and the output stage. Because its base-emitter junction behaves like a forward-biased diode, the emitter of *Q5*, under all circuit conditions, is about 0.6 volt below the collector of *Q4*. When *Q4* is conducting, the emitter of *Q5* is at about 1.8 volts. Voltage divider *R9* and *R10* presents slightly less than one third of *Q5*'s emitter voltage to the base of *Q6*. With 1.8 volts on the emitter of *Q5*, the voltage at the base of *Q6* is about 0.55 volt, which is not enough to turn on *Q6*. Since no current flows through *Q6*, *Q7* does not receive base drive and is turned off.

If an indicator is connected in series with the collector of *Q7*, it is not energized as long as *Q7* is in the off state.

Assume now that the voltage at the base of *Q2* increases. This transistor must be conducting in order for *Q3* to conduct. However, this requires a bias of at least 3.6 volts on the base of *Q2* to overcome the emitter bias on *Q3*. When this condition is satisfied, *Q2* and *Q3* both turn on, and the base-emitter junction of *Q4* is bypassed. This turns *Q4* off and its collector voltage jumps from 2.4 volts to about 5.5 volts. The emitter voltage of *Q5* jumps correspondingly from 1.8 to about 4.9 volts. Under this condition, voltage divider *R9* and *R10* provides a forward bias for *Q6*, causing it to conduct. This turns *Q7* on and the output indicator is energized.

Field-effect transistor *Q1* is connected as a source follower with the detector *PC1* and a pair of trimming potentiometers *R2* and *R3*, determining its gate voltage. The sensitive area of the detector is lead sulphide whose resistance decreases when exposed to infrared radiation. If the detector is shielded from IR and the trimmer potentiometers are adjusted for a *Q1* gate level of 3 volts, then, when *PC1* is exposed to IR, the voltage at the gate of *Q1* goes above 3.6 volts. The remainder of the circuit is then triggered on. Adjustment of the coarse and fine potentiometers determines at what IR level the Hotbox produces an output signal.

circuit board is available. The components layout for the perf board is shown in Fig. 2.

To prepare the case, use a circle cutter or fine saw to cut a hole in one end of the case slightly smaller than the rim diameter of the IR detector reflector. Secure the reflector to the case using high-quality cement or epoxy. The filter provided with the IR detector must be cut to size, with the protective paper left on it during the cutting process. Cut the filter slightly larger than the diameter of the reflector hole. When you are ready to affix the filter, remove the paper from both sides and glue the filter into place, covering the reflector.

At the top of the case, drill holes for the two potentiometers, *R2* and *R3*. In the end opposite the IR reflector, drill appropriate holes for indicator lamp *I1* and a miniature phone jack for the battery power leads. The author used the type of phone jack and earphone cable and plug usually furnished with imported transistor radios. The battery is carried on the waist belt. If desired, a hole can be cut out for an optional 6-volt meter. This meter is used for daylight indications when the glow of the lamp may be obscured by bright light.

Once the case has been prepared,

mount the perf board (or PC board) in the case, using a standoff at each corner. Connect the circuit board to the other components according to Fig. 1. The schematic also shows the correct way to wire potentiometers *R2* and *R3*. One of the connections to the IR detector must be made to the reflector. Use a small file to clean away the protective coating. Tin this area soon after filing, avoiding excessive heating of the detector. If you want to use the Hotbox to trigger an external relay, mount a pair of binding posts near the power input jack. Connect the binding posts in parallel with the indicator lamp.

Checkout. Check all wiring for circuit errors, wrong component installation, and faulty soldering. Assuming that all is well, connect the 6-volt battery to the circuit being careful to get the polarity correct. Aim the IR detector end of the Hotbox so that it does not "see" any incandescent lamp, hot soldering iron, or other source of IR energy. With both *R2* and *R3* completely counterclockwise, the indicator light should be off (and the optional meter should indicate zero). Slowly rotate *R2* clockwise. At some point, the indicator light will come on. Once it is on, back off on *R2* until the light

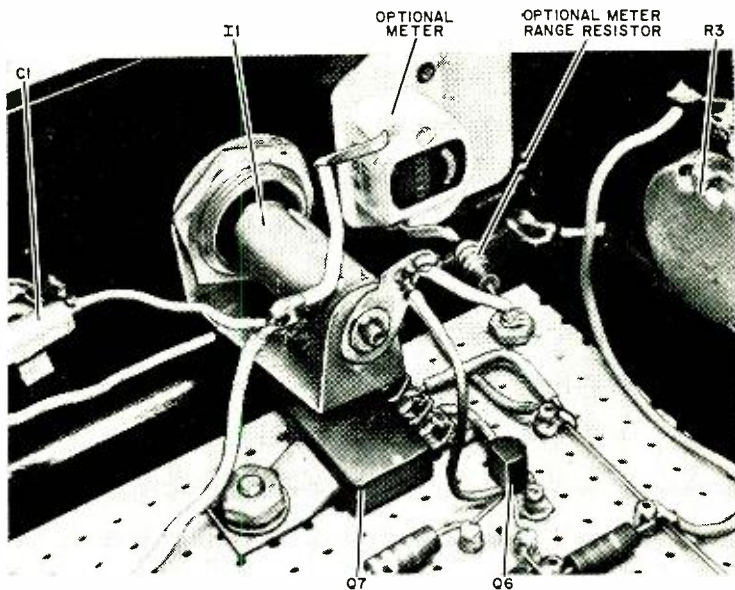

goes off. Now turn *R3* clockwise until the light comes on again. Then rotate *R3* slowly counterclockwise until the light just goes off. The detector is now set for maximum sensitivity. Potentiometer *R2* is used as the coarse control while *R3* is the fine adjustment. The settings of these controls determine at what level the Hotbox responds. If a particular device normally runs hot, set the controls
(Continued on page 110)

The optional meter range resistor converts the low-current meter into a 6-volt full-scale indicator. The resistor value depends on the type of meter. The meter reads the voltage drop across *I1*.

Fig. 2. Internal arrangement of the detector. The optional camera pistol grip is secured with its own screw and makes portable use very convenient. With it, you can aim the detector where desired.

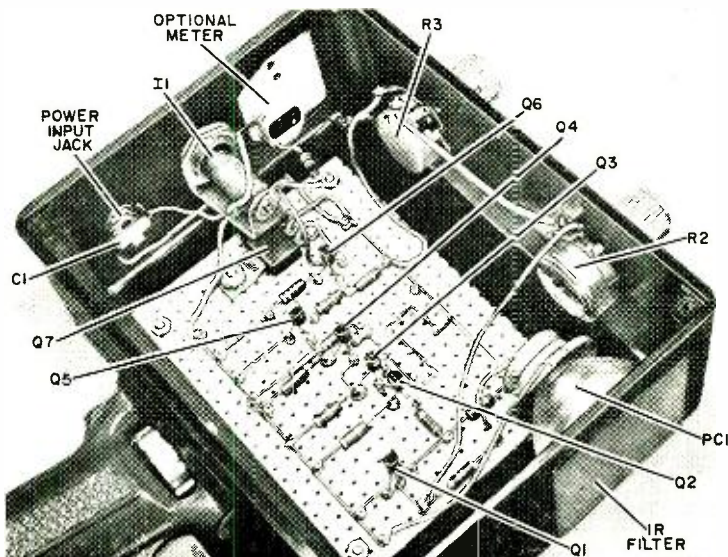

Popular EleComics



I understand you have a hi-fi bug in your house.



Think of it—in three days you'll no longer be a single sideband.



Here's a nifty little job, owned by an old guy who never called more than 2 miles.

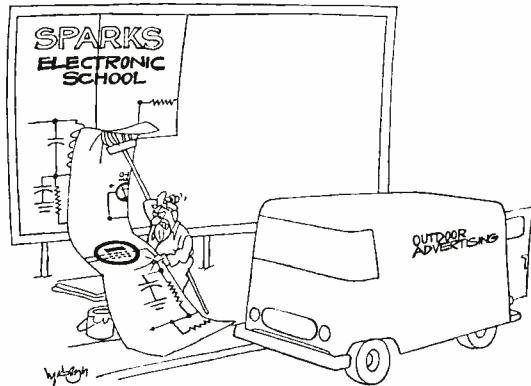

BUILD *The
Big
Six*

**THE SPEAKER SYSTEM
THAT'S BIG—
AND PROUD OF IT**

BY DAVID B. WEEMS

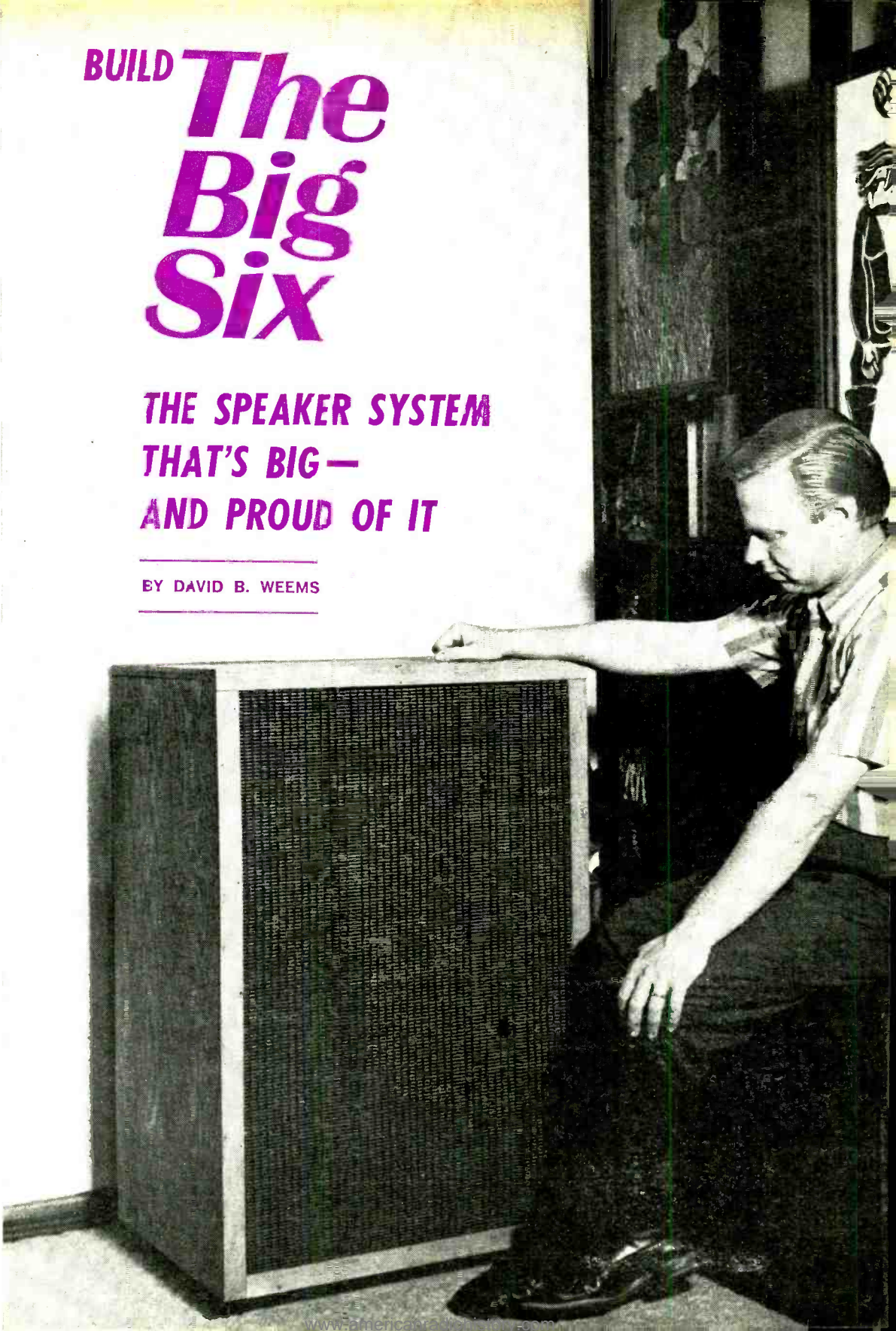

THERE IS more to some large speaker systems than impressive size—namely, quality. Some compact speaker systems have an amazingly low resonance and use long-throw woofer design to reduce distortion. But think of the results you could get by using a woofer whose resonance is already at the low end of the audio spectrum and putting it in an enclosure designed to maintain the speaker's resonance below that of any available compact. The enclosure might be much larger than any compact, but the system would be capable of producing deeper, smoother bass response right down to the bottom of the music spectrum.

The "Big Six" speaker system described here uses this approach and also provides room for another feature you're not likely to find in any compact system—a column of four midrange speakers. Add a super tweeter and a crossover network, and you have a speaker system that doesn't have to apologize for its

large size. The performance of the Big Six speaks for itself.

Overall System. The Big Six speaker system is built around a low-resonance Jensen Model W12NF "Flexaire" woofer, mounted inside a modified labyrinth. The 20-Hz characteristic resonance of the woofer is raised somewhat by the enclosure, partly because the labyrinth is shorter than the optimum quarter-wave length. (Fourteen feet, after all, would be a bit large for the average-size listening room.) The cross-section area of the labyrinth is greater than the theoretical maximum because experiments indicate that the larger "tube" produces deep, unrestricted bass.

Four economy priced Cinaudagraph 6 $\frac{1}{2}$ " midrange speakers are arranged in a sealed column to prevent interaction with the woofer. As a result, they provide an extremely wide frequency response and upgrade the overall quality of the Big Six.

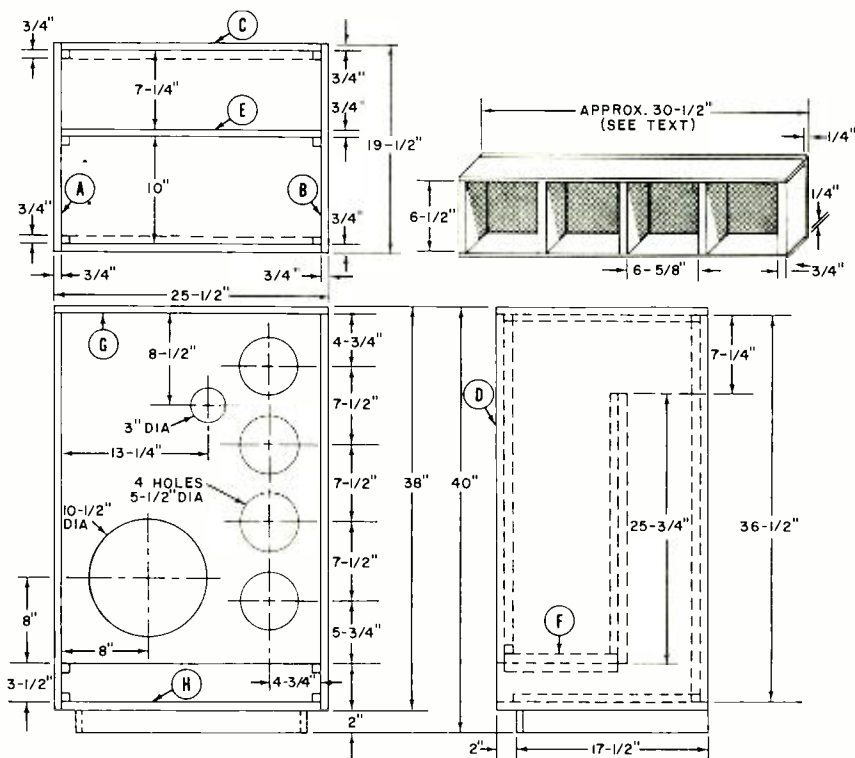

Fig. 1. To avoid confusion, all plates in basic enclosure are identified by letter symbols A through H. Cleats and corner blocks are referred to by lengths as they are used in text.

To round out the speaker system, a University Model T-202 "Sphericon" super tweeter is used because of its superior high-frequency dispersion characteristics. However, if you wish to economize, you can substitute a less expensive tweeter with dispersion characteristics similar to those of the Sphericon's. Further economizing can be accomplished by substituting less expensive fixed crossover networks for the more versatile ones specified in the Bill of Materials. Do not, however, substitute the "Flexaire" woofer or you will degrade system performance.

Construction. To avoid confusion during construction, the eight major parts of the enclosure are identified by letters A through H in the text, Bill of Materials, and dimensioned drawings of Fig. 1. Instructions for fastening parts together (with the exceptions of speaker mounting board D, rear enclosure wall C, and the rear wall of the midrange speaker column) mean "glue and screw."

Start construction by attaching the 16½" cleats ¾" in from the side edges and 1½" in from the front and rear edges of plates G and H. Then attach the 30¾" cleats to the front and the 25" cleats at the center of side plates A and B. Make sure the front cleats are flush with the top edges and recessed ¾" in from the front edges of the side plates, and that the center cleats are 7¼" from the top and 10" from the front edges. The rear

BILL OF MATERIALS

- 1—Jensen Model W12NF "Flexaire" woofer
- 1—University Model T-202 "Sphericon" tweeter
- 4—Cinacograph 6½" midrange speakers (stock no. 6-½"-MR from McGee Radio, 1901 McGee St., Kansas City, Mo.)
- 1—University Model N-2A crossover network
- 1—University Model N-2B crossover network
- 1—University Model AP-8 L-pad for midrange control
- 2—37½" × 19½" pieces of ¾" plywood (parts A and B)
- 1—36½" × 24" piece of ¾" plywood (part C)
- 1—33" × 24" piece of ¾" plywood (part D)
- 1—25¾" × 24" piece of ¾" plywood (part E)
- 1—24" × 10" piece of ¾" plywood (part F)
- 1—25½" × 19½" piece of ¾" plywood (part G)
- 1—24" × 19½" piece of ¾" plywood (part H)
- 5—6½" × 2¾" pieces of ¾" white pine for ends and partition separators of midrange column
- 2—30¼" × 25⅞" pieces of ¼" Masonite for sides of midrange column (see text)
- 1—30¾" × 7" piece of ¼" Masonite for rear of midrange column (see text)
- 2—35¾" pieces of ¾" × ¾" pine (rear cleats for parts A and B)
- 4—24" pieces of ¾" × ¾" pine (top and bottom cleats at rear, top cleat for part D, and front cleat for part F)
- 4—16½" pieces of ¾" × ¾" pine (top and bottom side cleats)
- 2—25" pieces of ¾" × ¾" pine (side cleats for part E)
- 2—30¾" pieces of ¾" × ¾" pine (front side cleats)
- 2—10" pieces of ¾" × ¾" pine (side cleats for part F)
- 1—21½" piece of 2" × ¾" pine (front of footing)
- 2—16¾" pieces of 2" × ¾" pine (sides of footing)
- 30—¾" × #10 flathead wood screws for Masonite parts in midrange column
- 120—1¼" × #8 flathead wood screws
- 4—1¼" × #12 panhead sheet metal screws for woofer
- 28—¾" × #10 panhead sheet metal screws for midrange speakers, tweeters, and crossover networks
- 4—¾" × 1" bolts for conductors
- 25"—2" × 24" fiberglass house insulation (see text)

Misc.—Pine for front trim; grille cloth; stain; paint; hookup wire; spade and ring lugs; solder; aluminized "duct" tape, etc.

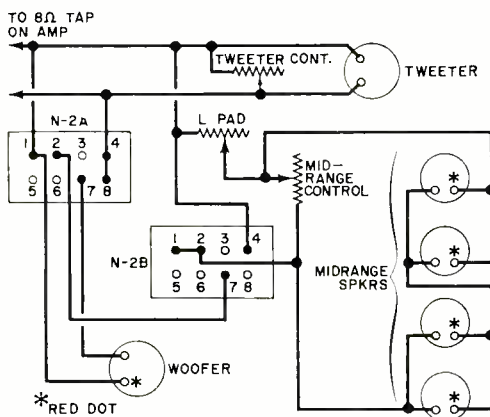

Fig. 2. To obtain proper phasing, be sure to wire all speakers together as shown here. Terminal numbers are stamped right on crossover networks.

cleats for plates A and B will be attached later.

Invert top plate G onto a clean, flat surface, and secure the side plates in place. Now do the same for plate H. During construction make frequent reference to the dimensioned drawings in Fig. 1 to insure that each part of the enclosure is properly fitted into place.

To complete assembly of the enclosure shell, anchor the footing pieces to the bottom of plate H by driving the screws down through the bottom plate and into the footing. Set the enclosure shell aside temporarily.

**Someone
should develop
an easy way
to learn
electronics at
home**

**RCA Institutes
did!**

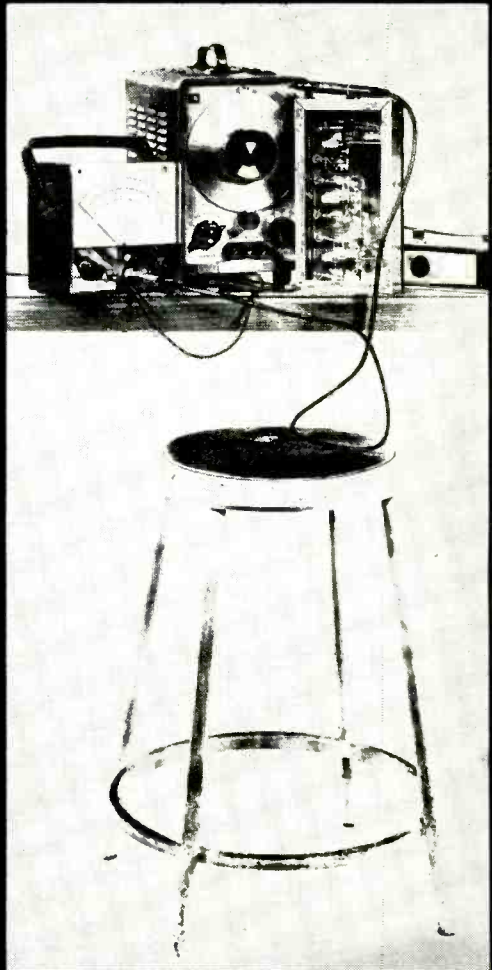

Here is a whole new approach to learning electronics at home! RCA Institutes, one of the nation's largest schools devoted to electronics, has developed a faster, easier way for you to gain the skills and the knowledge you need for the career of your choice. Here for the first time is a student-proved, scientifically designed way to learn. If you have had any doubts in the past about home training in electronics—if you have hesitated because you thought you might not be able to keep up—or that electronics was too complicated to learn—here is your answer! Read how RCA Institutes has revolutionized its home training ideas!

FREE OFFER!

**Mail card today
for sample of
AUTOTEXT
lesson.**

NEW CAREER PROGRAMS BEGIN WITH "AUTOTEXT" INSTRUCTION METHOD!

**Start to learn the field of your choice immediately!
No previous training or experience in electronics needed!**

With this new revolutionized method of home training you pick the career of your choice—and RCA Institutes trains you for it. RCA's Career Programs assure you that everything you learn will help you go directly to the field that you have chosen! No wasted time learning things you'll never use on the job! The Career Program you choose is especially designed to get you into that career in the fastest, easiest possible way!

And each Career Program starts with the amazing "AUTOTEXT" Programmed Instruction Method—the new, faster way to learn that's almost automatic! "AUTOTEXT" helps even those who have had trouble with conventional home training methods in the past. This is the "Space Age" way to learn everything you need to know with the least amount of time and effort.

CHOOSE A CAREER PROGRAM NOW

Your next stop may be the job of your choice. Each one of these RCA Institutes Career Programs is a complete unit. It contains the know-how you need to step into a profitable career. Here are the names of the programs and the kinds of jobs they train you for. Which one is for you?

Television Servicing. Prepares you for a career as a TV Technician/Serviceman; Master Antenna Systems Technician; TV Laboratory Technician; Educational TV Technician.

FCC License Preparation. For those who want to become TV Station Engineers, Communications Laboratory Technicians, or Field Engineers.

Automation Electronics. Gets you ready to be an Automation Electronics Technician; Manufacturer's Representative; Industrial Electronics Technician.

Automatic Controls. Prepares you to be an Automatic Controls Electronics Technician; Industrial Laboratory

Technician; Maintenance Technician; Field Engineer.

Digital Techniques. For a career as a Digital Techniques Electronics Technician; Industrial Electronics Technician; Industrial Laboratory Technician.

Telecommunications. For a job as TV Station Engineer, Mobile Communications Technician, Marine Radio Technician.

Industrial Electronics. For jobs as Industrial Electronics Technicians; Field Engineers; Maintenance Technicians; Industrial Laboratory Technicians.

Nuclear Instrumentation. For those who want careers as Nuclear Instrumentation Electronics Technicians; Industrial Laboratory Technicians; Industrial Electronics Technicians.

Solid State Electronics. Become a specialist in the Semiconductor Field.

Electronics Drafting. Junior Draftsman, Junior Technical Illustrator; Parts Inspector; Design Draftsman Trainee Chartist.

SEPARATE COURSES

In addition, in order to meet specific needs, RCA Institutes offers a wide variety of separate courses which may be taken independently of the Career Programs, on all subjects from Electronics Fundamentals to Computer Programming. Complete information will be sent with your other materials.

2 CONVENIENT PAYMENT PLANS

RCA Institutes offers a unique tuition plan that lets you progress at your own pace. You only pay for lessons as you order them. You don't sign a contract obligating you to continue the course. There's no large down-payment to lose if you decide not to continue.

However, if you desire, RCA Institutes also offers a convenient monthly payment plan.

VALUABLE EQUIPMENT

You receive valuable equipment to

keep and use on the job—and you never have to take apart one piece to build another.

New—Programmed Electronics Breadboard. You now will receive a scientifically programmed electronic breadboard with your study material. This breadboard provides limitless experimentation with basic electrical and electronic circuits involving vacuum tubes and transistors and includes the construction of a working signal generator and superheterodyne AM Receiver.

Multimeter and Oscilloscope Kits At No Additional Cost. You will receive with most RCA Institutes Career Programs the instruments and kit material you need to build a Multimeter and Oscilloscope. The inclusion of both these kits is an RCA extra.

CLASSROOM TRAINING ALSO AVAILABLE

RCA Institutes maintains one of the largest schools of its kind in New York City where classroom and laboratory training is available in day or evening sessions. You may be admitted without any previous technical training; preparatory courses are available if you haven't completed high school. Coeducational classes start four times a year.

JOB PLACEMENT SERVICE, TOO!

Companies like IBM, Bell Telephone Labs, GE, RCA, Xerox, Honeywell, Grumman, Westinghouse, and major Radio and TV Networks have regularly employed graduates through RCA Institutes' own placement service.

SEND ATTACHED POSTAGE PAID CARD FOR COMPLETE INFORMATION, NO OBLIGATION.

All RCA Institutes courses and programs are approved for veterans under the new G.I. Bill.

Accredited Member
National Home Study Council

IF REPLY CARD IS DETACHED—SEND THIS COUPON TODAY

RCA INSTITUTES, Inc., Dept. PEZ-19
320 West 31st Street, N.Y., N.Y. 10001

Please rush me FREE sample of a lesson and illustrated catalog. I understand that I am under no obligation.

Name _____ Age _____
(please print)

Address _____

City _____

State _____ Zip _____

RCA

Start construction of mid-range speaker enclosure by assembling sides, ends, and compartment separators. Use glue and screws to anchor the members together.

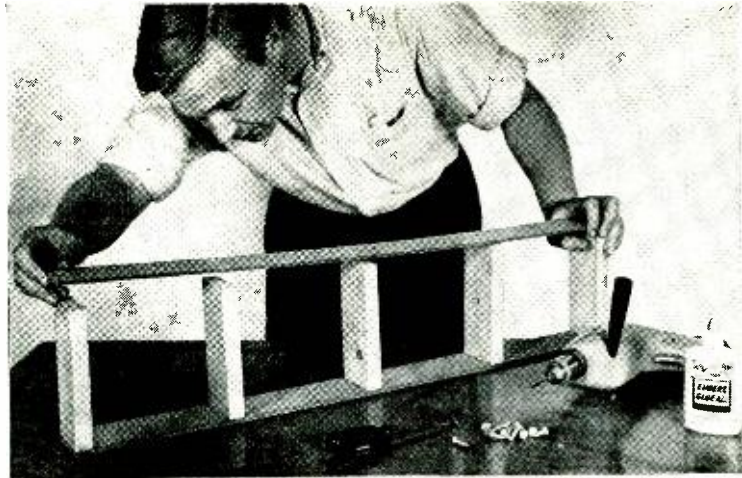

Attach 10" cleats to the bottom side edges of plate F and the 24" cleat to the front top edge. Anchor plates E and F together by letting E overlap F at the rear (see side view drawing in Fig. 1 for details).

Coat with glue the interior surfaces that will make final contact with plates E and F. Slide the E-F assembly into place and anchor it with wood screws along both cleats at the sides. Attach the 30³/₄" cleats at the front and the 35³/₄" cleats at the rear of plates A and B. (Note, the front and rear cleats will be recessed 3/4" in from the front edges of the side plates.)

Prepare back plate C by drilling the guide holes for the anchoring screws and two 1¹/₄" holes to accommodate the bolts for electrical hookup. Finally, drill two 3/8" holes near the top of this plate to accommodate the midrange and tweeter controls.

Referring to the front view drawing, carefully prepare speaker mounting board D. Now you can begin assembling the midrange speaker column.

First, drill 1/2" holes through the centers of the three compartment separators to facilitate routing of the wiring. Temporarily set the partition separators, sides, and ends of the column over the speaker cutouts, and check for the proper locations of each part. (Because of the possibility of slight variations in the locations of the speaker cutouts, the length dimension given in the top right drawing in Fig. 1 is only approximate.)

If necessary, trim either the column

or the cleats to insure that the column fits properly between the top and bottom cleats on the speaker mounting board when all parts are in place. When satisfied with the fit, assemble the column enclosure (except rear wall) with glue and screws, and set it temporarily in place on plate D. Scribe with a pencil the outline of the column and partitions. Remove the column from the speaker mounting board, and drill countersunk guide holes through plate D, two for each partition and end. Locate these holes 1" in from both ends of the individual partitions and ends. Attach the column.



When properly mounted, the crossover networks should be located between woofer and tweeter.

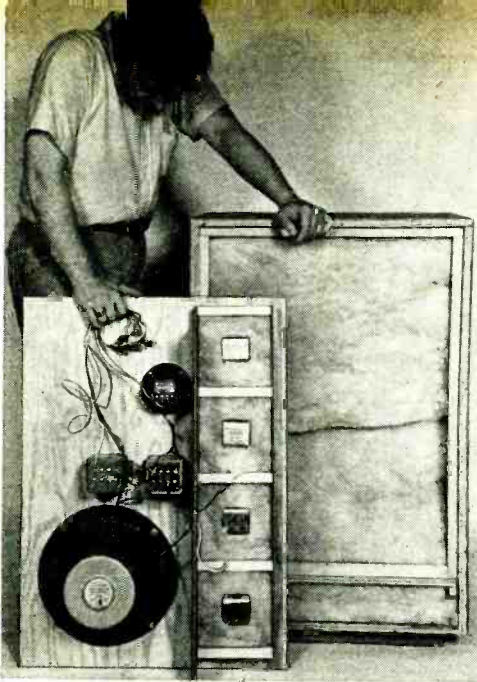

Fig. 3. For proper damping, loosely folded fiberglass wool should fill entire enclosure volume.

Fill the enclosure with fiberglass wool. (Because of the amount of fiberglass wool needed, about 25' x 24" x 2", it is suggested that you use house insulation fiberglass to effect savings. The cost of a 50' length of this material is generally less than \$5, and you will have enough to fill two enclosures.) First strip the fiberglass wool of its aluminum foil backing. Cut a 3' length, fold it in half, and place it on the floor of the enclosure. Triple fold another 8' to 9' length, and

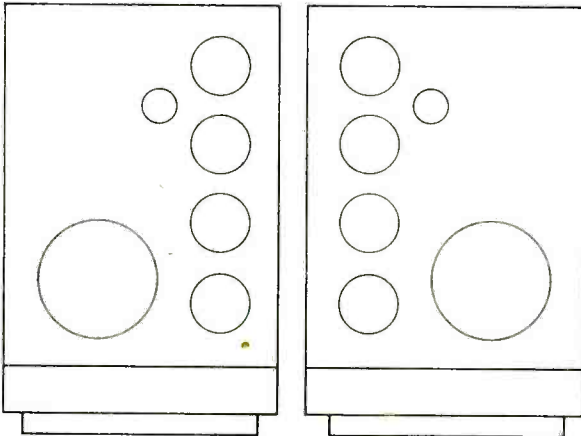

Fig. 4. Speaker mounting boards must be mirror images of each other for proper balancing of stereo.

place it in the well immediately behind the speaker mounting board, arranging a hole for the woofer. Finally, fill the rear well of the enclosure with folded fiberglass wool.

Install the midrange speakers in the column, and wire them according to Fig. 2. One of the terminals on each of these speakers is color coded with a red dot; so be sure to use these dots as guides during wiring. Then terminate the wires in conducting bolts (which you can mount on the rear wall of the column's enclosure). Code the bolt that connects to the terminals with the red dots.

Now, cut four squares of fiberglass wool to a size just large enough to fit into the speaker compartments, and remove the centers to make room for the magnet assemblies (see Fig. 3). Set the squares over the speakers, and screw the Masonite rear panel in place, using two screws for each partition and end and placing the screws one inch in from the sides of the enclosure. Test the mid-range column with a battery (all speaker cones move in the same direction when the terminals of the battery are momentarily touched against the conducting bolts.) Then tape the rear corners of the column with aluminized cloth "duct" tape to seal the column against air leaks.

(Continued on page 111)

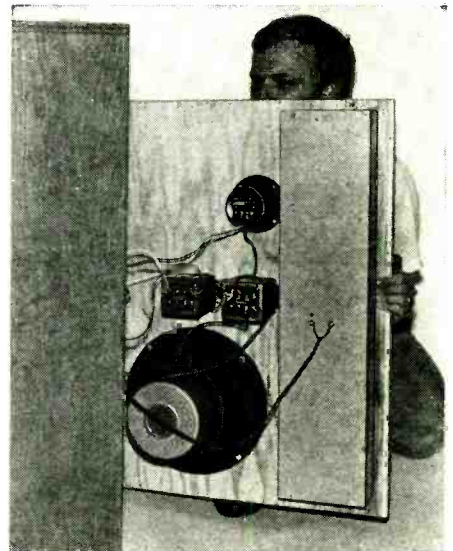

Assembled and wired speaker board is anchored to enclosure front with flathead wood screws.

Lamp Brightness Quiz

BY ROBERT P. BALIN

<p>1</p>	<p>5</p>	<p>7</p>
<p>2</p>	<p>The brightness of a lamp operated on a.c. depends on the average current through its filament during each cycle. A rectifier connected in series or parallel with a lamp can be used to control the current on alternate half cycles. In lamp circuits, current paths and individual lamp brightness may be considerably altered, and some interesting effects produced. To test your ability to analyze lamp and rectifier circuits, try to determine which lamp is the brightest in each of the ten circuits shown here. Assume that the diodes have zero forward resistance and infinite back resistance and that all lamps and supplies are identical. Answers are on page 101.</p>	<p>8</p>
<p>3</p>		<p>9</p>
<p>4</p>		<p>10</p>

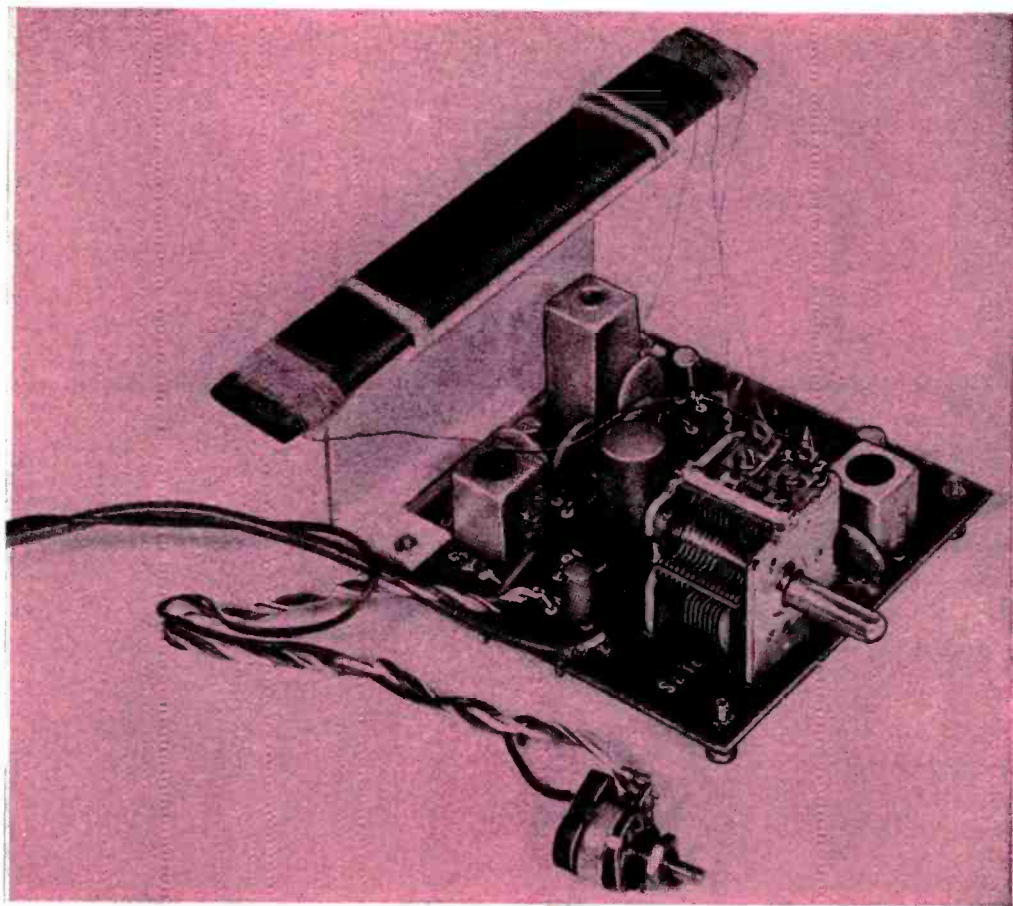

Top-Rated AM Tuner

SOLID-STATE BROADCAST-BAND TUNER FOR HI-FI RIGS

BY JIM CUCCIA

HIGH-QUALITY broadcast-band AM tuners are scarce. Most hi-fi enthusiasts either pay extra for the addition of AM to their FM receivers or tuners, or they use makeshift improvisations for reception of the AM broadcast band.

With the introduction of a new line of high-performance, yet low-cost transistors, it is now practical to build a high-quality AM tuner at low cost, with performance rivaling that of many commercial units.

The excellent performance is achieved through careful circuit design (see Fig. 1) and the use of a separate mixer-local-

oscillator combination and a.g.c. in both the mixer and i.f. stages. As for the technical details: frequency tuning range is 550 to 1600 kHz; $(S+N)/N$ is 20 dB; a.g.c. figure of merit, 30 dB; image rejection, 48 dB; and adjacent channel attenuation, 26 dB.

Construction. To avoid circuit wiring errors and keep the tuner as small as possible, the use of a printed board, such as that shown actual size in Fig. 2, is recommended. All components, with the exception of the volume control (*R11*) and the ferrite antenna (*L1*) are mount-

PARTS LIST

- C1, C2—Variable capacitor. C1A—5.3-190 pF, C1B—12 pF. C2A—5-77pF. C2B—12 pF (Southwest Technical Products C-190 or similar)
 C3, C6, C9, C11, C12—0.05- μ F disc capacitor
 C4—390-pF. 150-volts polystyrene capacitor
 C5—100- μ F, 25-volt electrolytic capacitor
 C7—0.001- μ F, disc capacitor
 C8—0.005- μ F, 50-volt disc capacitor
 C10—10- μ F, 15-volt electrolytic capacitor
 C13—4.7-pF capacitor
 C14—0.02- μ F capacitor
 C15—10- μ F, 25-volt electrolytic capacitor
 D1—1N34 or similar germanium diode
 L1—Ferrite BC8 antenna with low-impedance secondary winding
 Q1—Transistor (RCA 40487)
 Q2—Transistor (RCA 40488)
 Q3—Transistor (RCA 40489)

- R1, R2—6800-ohm
 R3—22,000-ohm
 R4—270,000-ohm
 R5—820-ohm
 R6—2200-ohm
 R7—82,000-ohm
 R8—680-ohm
 R9—18,000-ohm
 R10—1000-ohm
 R11—5000-ohm potentiometer
 T1—Local oscillator transformer (Southwest Technical Products 7E-050-1A)
 T2—First i.f. transformer (Southwest Technical Products 7E-505-2)
 T3—Second i.f. transformer (Southwest Technical Products 7E-050-3)

All resistors
 $\frac{1}{2}$ -watt

Misc.—Non-conducting support for ferrite antenna, dial mechanism to suit builder, knobs for tuning and volume control, cabinet, solder, etc.
 Note—A complete kit of parts listed above, including the PC board, is available from Southwest Technical Products Corp., 219 W. Rhapsody, San Antonio, Texas 78216, for \$10.00 plus \$0.30 postage.

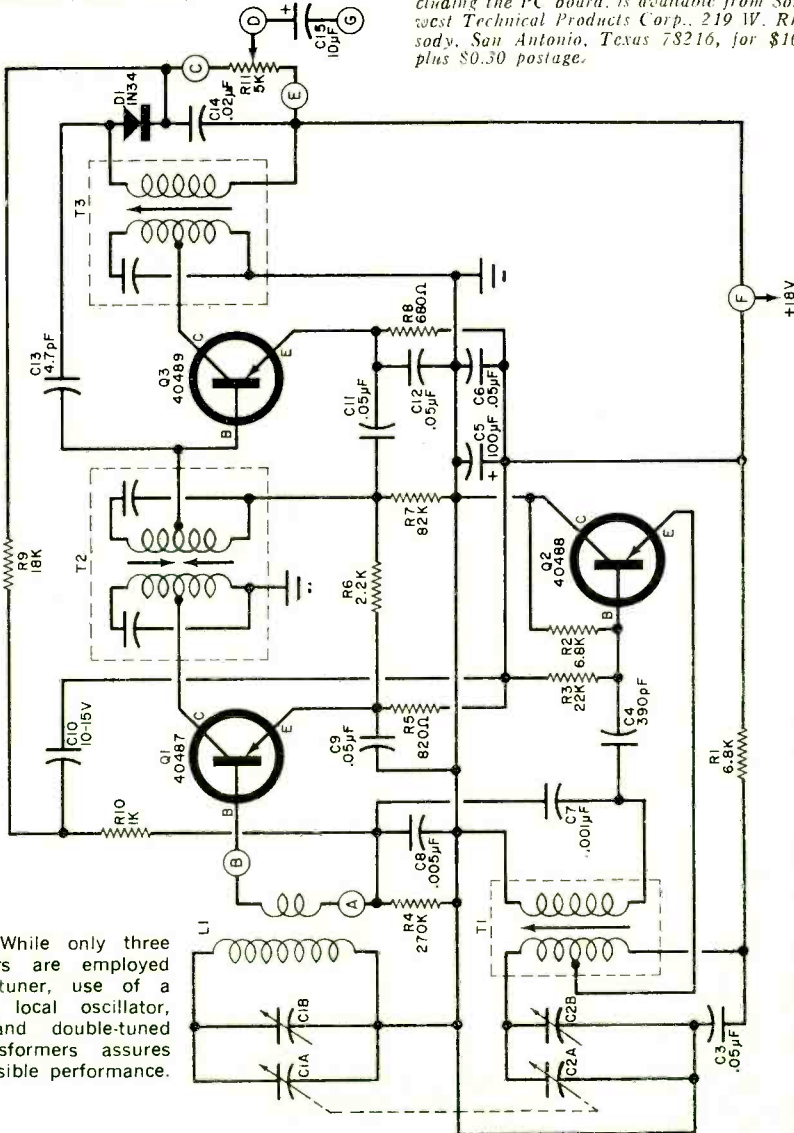

Fig. 1. While only three transistors are employed in the tuner, use of a separate local oscillator, a.g.c., and double-tuned i.f. transformers assures best possible performance.



Fig. 2. If you make your own printed circuit board, carefully copy this actual-size etching and drilling guide.

Fig. 3. Transistors are located on circuit board as follows: Q1—to right of R6; Q2—directly above C4; Q3—directly above C11. When mounting transistors, match widely-spaced leads to widely spaced holes in board.

ed on this board as shown in Fig. 3. When installing the components, be careful to observe the polarities of the semi-conductors, the electrolytic capacitors, and the diode. If you use the printed circuit board shown and the parts called for in Fig. 1, oscillator transformer *T1* as well as the second i.f. transformer *T3* can only be installed one way. However, the first i.f. transformer *T2* can be inserted two ways. To avoid this, cut off pin 1 of this transformer (see Fig. 4) before installation.

Mounting of the ferrite antenna is not critical as long as it is kept away from large metallic masses. Cement the antenna to a piece of cardboard or other non-conducting material which is then attached to the rear of the circuit board. Use caution in working with the antenna as the ferrite core is fragile and cracks easily.

Volume control *R11* can be located wherever it is most convenient. The arrangement of the tuning dial is also optional and can be designed to match other components in a system or to match the cabinet. Any convenient cabinet can be used.

Any 18-volt power supply can be used with the tuner, or power can be taken

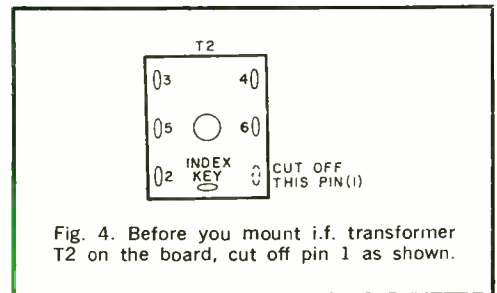
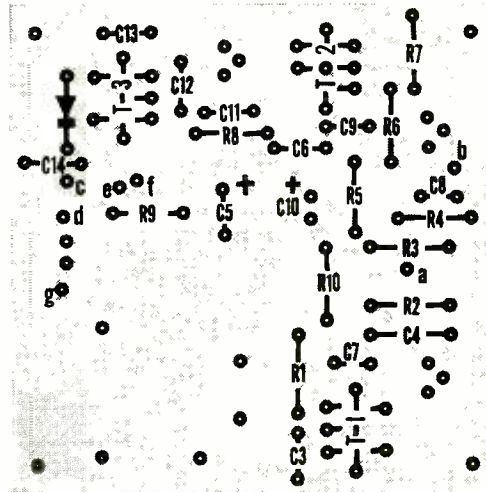

Fig. 4. Before you mount i.f. transformer *T2* on the board, cut off pin 1 as shown.

HOW IT WORKS

This tuner uses a separate mixer and local-oscillator combination ($Q1$ and $Q2$ respectively in Fig. 1) with a.g.c. fed to the mixer through a divider consisting of $R4$, $R9$, and $R10$. The mixer stage operates with collector currents of 20 microamperes (maximum a.g.c.) to 1.6 milliamperes (minimum a.g.c.).

The received signal is applied to the base of the mixer along with the local-oscillator signal, which has been reduced to an optimum level by a divider formed by $C7$ and $C8$. This configuration of mixer/local oscillator produces very low noise and results in excellent overload performance without the need for an overload diode. At the same time, the grounded-collector local oscillator provides excellent frequency stability with varying load and varying supply voltage.

The resultant i.f. (455 kHz) is fed to a double-tuned i.f. transformer ($T2$) to provide good selectivity. If a single-tuned transformer were used, two stages of i.f. and three transformers would be required to obtain the same selectivity. The i.f. signal is amplified by $Q3$ acting as a high-gain neutralized amplifier. Power gain of this stage is in excess of 40 dB and neutralization is provided by capacitor $C13$. Biasing of $Q3$ is such that it has large signal-handling capability and partial gain control when receiving strong signals. Base bias is provided by $R5$, $R6$, and $R7$, with $R5$ being the emitter resistor of $Q1$. This network produces partial a.g.c. for the i.f. amplifier.

Transformer $T3$ is a single-tuned unit that, in conjunction with $T2$, provides more than adequate selectivity. Diode $D1$ acts both as the signal detector and as a source for the a.g.c. voltage. Capacitor $C14$ is used for r.f. bypassing and potentiometer $R11$ is the volume control. The basic design of the tuner is sound and substitution of transistors offers no real problem.

Once completed, the AM tuner can be mounted in any type of cabinet as only the tuning capacitor shaft is fixed. Any dial mechanism can be used, depending on installation. Volume control (with attached power switch) can be mounted remote from the tuner. Be sure the ferrite antenna is clear of metal objects for best results.

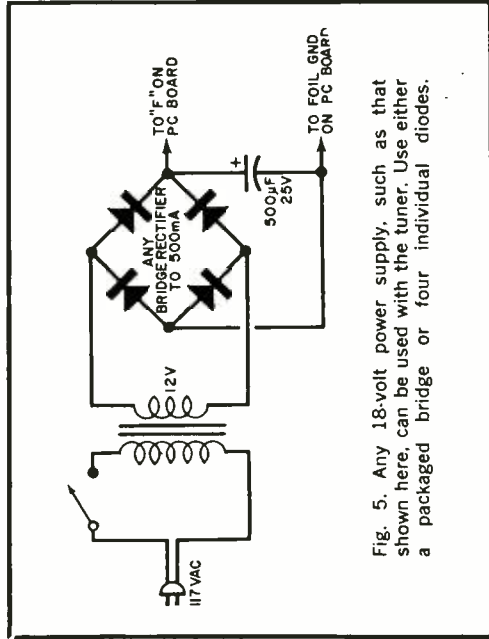
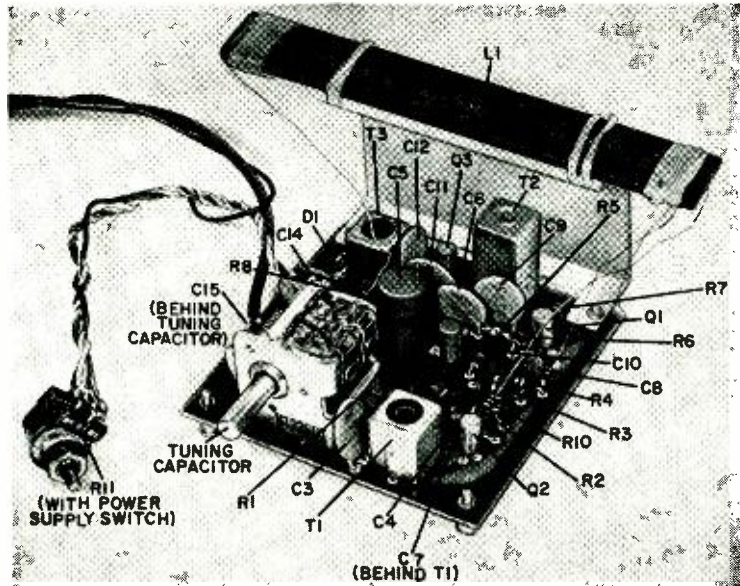
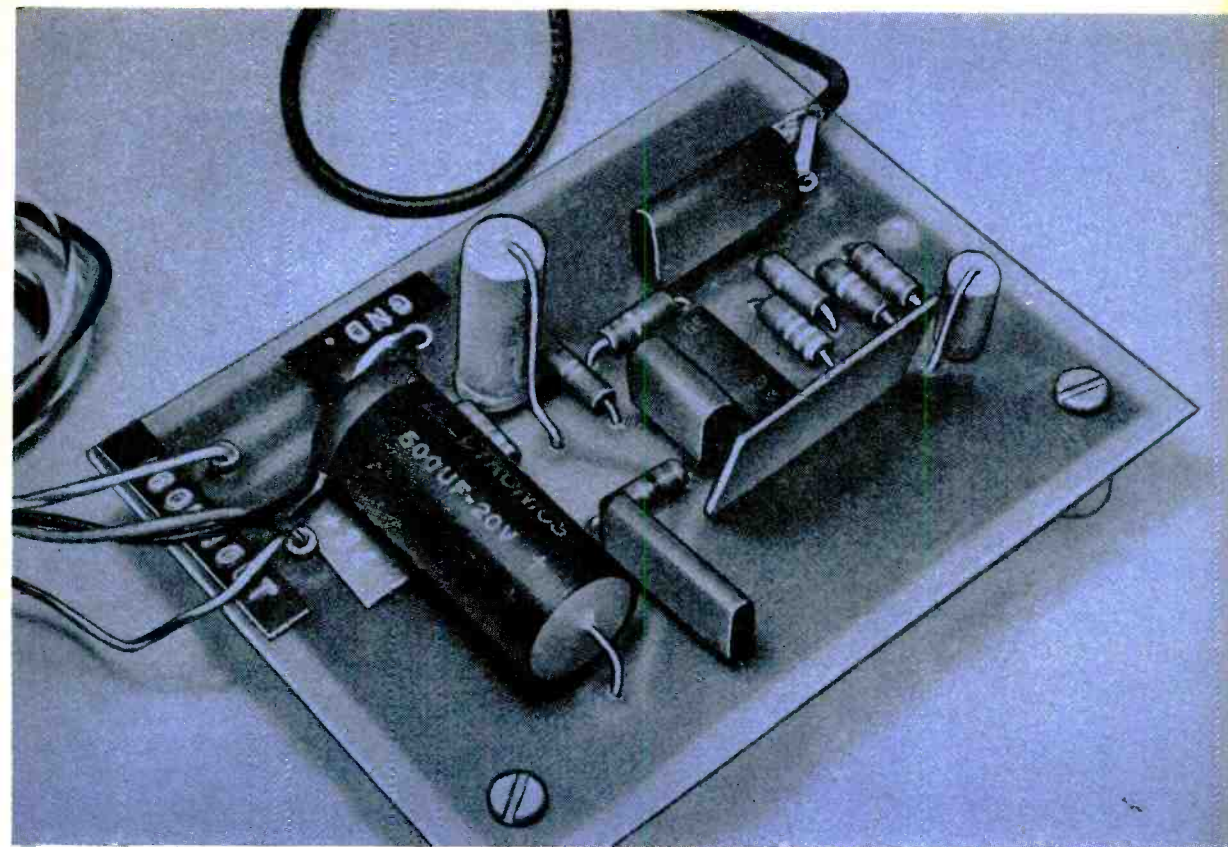

Fig. 5. Any 18-volt power supply, such as that shown here, can be used with the tuner. Use either a packaged bridge or four individual diodes.

from the audio system with which it is being used. A typical power supply circuit is shown in Fig. 5.

Alignment. After construction, examine the circuit board carefully for wiring or placement errors. Also look for solder (Continued on page 112)



Mini- Watt IC Amp

SINGLE IC HAS 2-WATT OUTPUT

BY WILLIAM KIRES

General Electric Company

WHEN YOU ARE building or experimenting with a tuner or an audio-signal generator, one thing you need is an amplifier to bring the signal up to an audible level. You can use an amplifier from another system; but it's a real convenience to have a small, simple amplifier designed especially for the purpose.

The amplifier described here can be built to provide either 1 or 2 watts output (with some minor circuit differences). For the 2-watt unit, you'll need a 24-volt power supply, which is also described. The 1-watt unit can be operated from a 12-volt battery such as that used in your car or boat. (This makes it good for use with a portable phono on picnics or outings.)

The secret of this low-cost, compact amplifier is an integrated circuit designed for audio circuits. The IC is rated for a 24-volt input with a 2-watt output, but with a 12-volt input it will still deliver 1 watt, which may be just what you need.

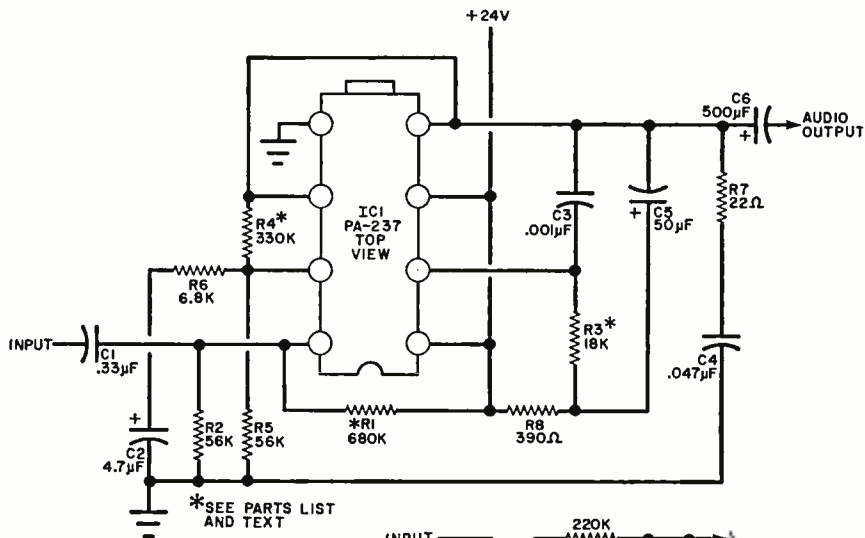
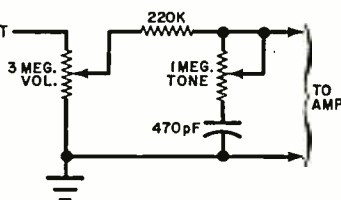

Fig. 1. The IC is a seven-transistor power amplifier requiring 8mV to deliver 2 watts audio control. Tone and volume control circuits at right.

PARTS LIST

- C1—0.33- μ F capacitor
- C2—4.7- μ F, 15-volt electrolytic capacitor
- C3—0.001- μ F capacitor
- C4—0.047- μ F capacitor
- C5—50- μ F, 25-volt electrolytic capacitor
- C6—500- μ F, 20-volt electrolytic capacitor
- IC1—Integrated circuit (General Electric PA-237)
- R1—680,000-ohm*
- R2, R5—56,000-ohm
- R3—18,000-ohm*
- R4—330,000-ohm*
- R6—6800-ohm
- R7—22-ohm
- R8—390-ohm

All resistors
1/2-watt



Misc.—1" x 1" x 3/2" copper sheet heat sink, printed circuit board, insulated standoffs (optional, 4 if used)

*For a 1-watt amplifier, with 12-volt supply, use R1—390,000 ohms, R3—12,000 ohms, R4—180,000 ohms, all 1/2 watt.

Note: An etched and drilled printed circuit board #158B is available from Southwest Technical Products Corp., 219 W. Rhapsody, San Antonio, Texas 78216, for \$2.00, postpaid. A kit, #158CP, containing the PC board and all parts to be mounted on it, including the PA-237 is also available from the same source for \$7.50, postpaid.

Construction. The circuit for the 2-watt amplifier is shown in Fig. 1. It is assembled on a printed circuit board such as the one shown actual size in Fig. 2. When you have completed the board, mount all of the components, except IC1, as shown in Fig. 3. To prepare the IC for mounting, use a pair of long-nose pliers to bend its leads, including the large heat-sink tab, so that they are at right angles to the body of the IC. Be sure that the IC is properly positioned before mounting it on the board; a small notch at one end of the IC must be oriented as shown in Fig. 3.

After bending the leads, insert the IC pins and the heat-sink tab into the board and solder them to the foil. Use no more

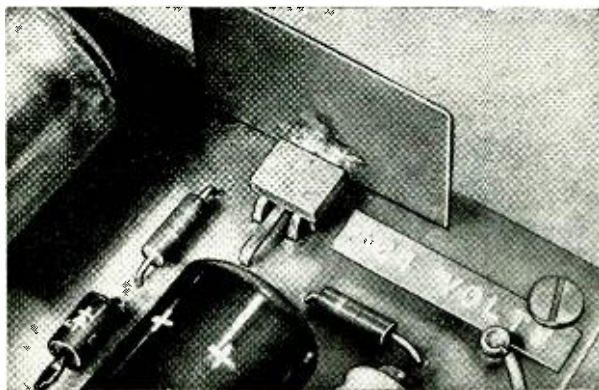

In the power supply, the copper heat sink is soldered to both transistor tab and PC board foil.

Fig. 2. Use this actual size layout for the PC board for the amplifier. Large amount of foil left on the board acts as an extra heat sink for IC1.

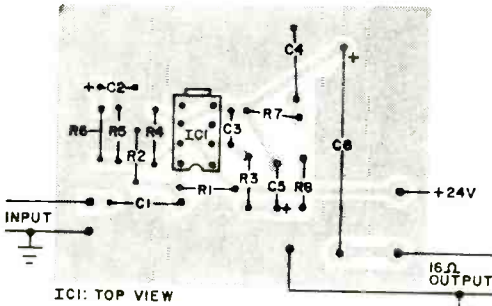
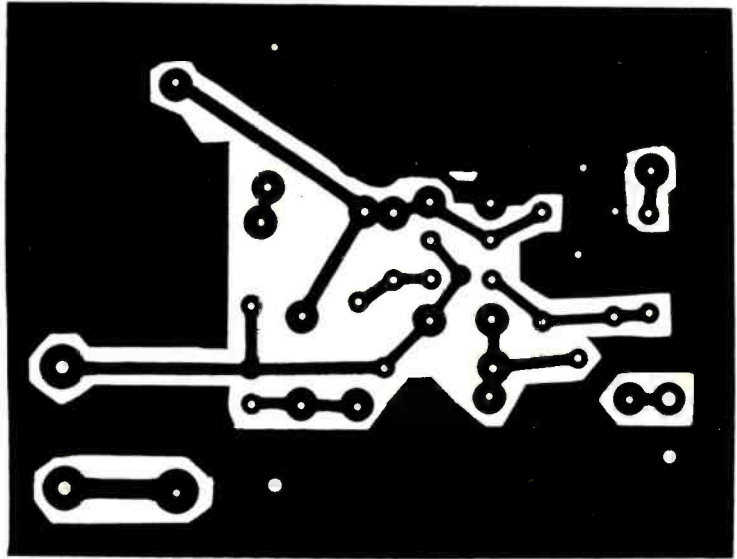
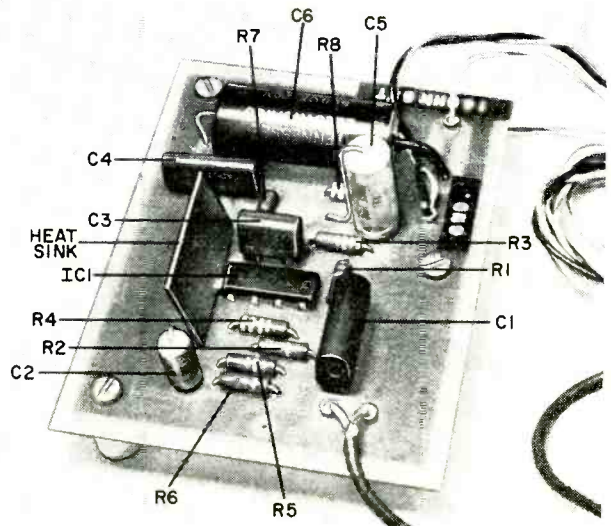

Fig. 3. Install the components as shown here. If you don't have a 16-ohm speaker, use two 8-ohm units in series. Be sure they are phased right.

heat than is necessary to get a good solder joint.

To make a heat sink for the IC, cut out a 1"-square piece of heavy-gauge copper (at least $\frac{1}{8}$ " thick). Tin the center of one edge of the copper and tin the piece of the IC heat-sink tab that is on the component side of the board. Solder the heat sink to the tab of the IC so that the heat sink is vertical to the board. This completes the 2-watt amplifier.

To use this design for a 1-watt amplifier with a 12-volt supply, use the same printed circuit board but make the fol-



Although not required, you can mount the finished amplifier on four stand-offs, as shown. In attaching the heat sink to the IC and PC board, do not apply too much heat to the IC tab while soldering since heat can damage the IC. Tin both connections before joining and flow solder in.

Fig. 4. Besides the 24 volts required by the 2-watt amplifier, the power supply has a 12-volt, 5-mA output for use with a preamplifier.

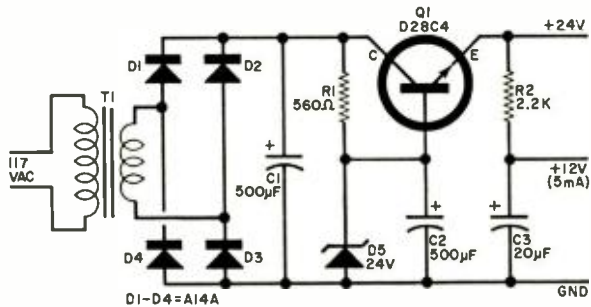

PARTS LIST

C1, C2—500- μ F, 50-volt electrolytic capacitor
 C3—20- μ F, 25-volt electrolytic capacitor
 D1-D4—1-ampere, 100-volt rectifier diode (GE A14A or similar)
 D5—24-volt, 1-watt zener diode
 Q1—Power transistor, npn (GE D28C4 or similar)

R1—560-ohm, $\frac{1}{2}$ -watt resistor
 R2—2200-ohm, $\frac{1}{2}$ -watt resistor
 T1—Power transformer, secondary—24 volts, 1.2 amperes.
 Misc.—1" x 1" x $\frac{1}{8}$ " copper sheet heat sink, printed circuit board, line cord, insulated stand-offs (optional, 4 if used)

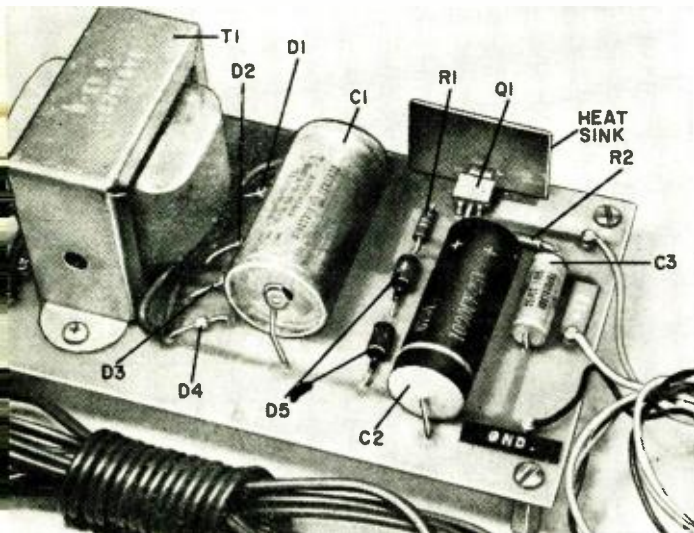

If you do not have a 24-volt zener, use a pair of 12-volt units in series as shown here. You must break the foil that shorts one diode connection.

Fig. 6. Component installation for power supply. Only one zener diode is shown here for 24-volt D5.

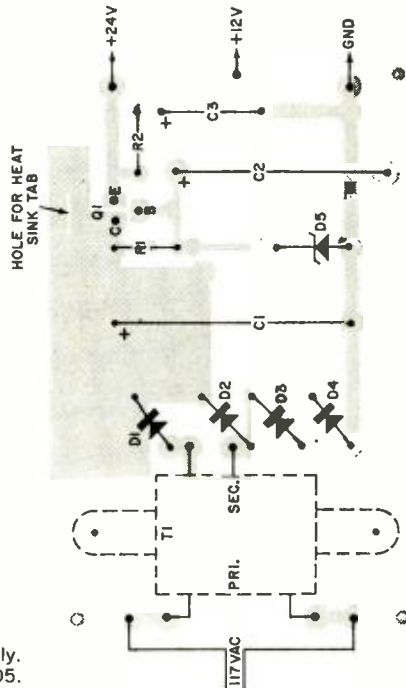

lowing component changes: for R1 use 390,000 ohms, for R3, 12,000 ohms, and for R4, 180,000 ohms.

Power Supply. The schematic of a 24-volt d.c. regulated supply for the 2-watt amplifier is shown in Fig. 4. The circuit also has a 12-volt, 5-mA output for a

preamplifier. This power supply can be constructed on a printed circuit board, if desired, using the actual-size foil layout shown in Fig. 5. When the board is finished, install the components as shown in Fig. 6.

To make a heat sink for the transistor, cut out a 1" square of heavy-gauge cop-

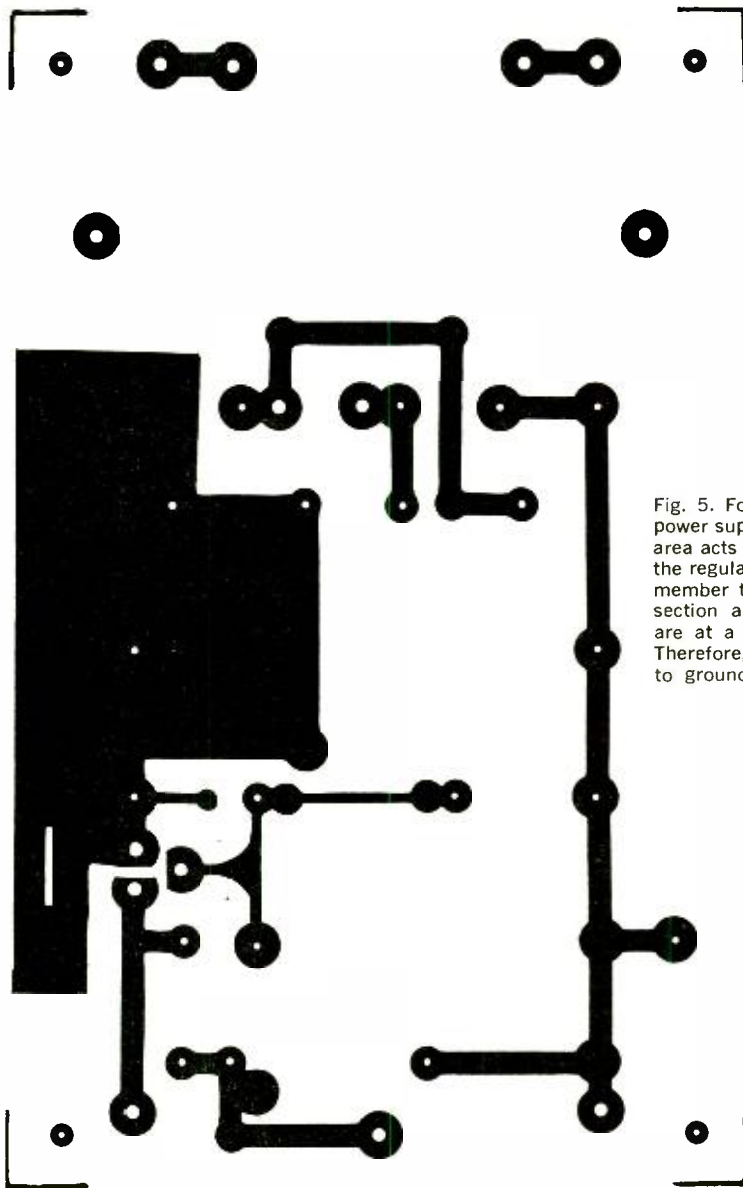

Fig. 5. Foil pattern for the power supply. The large foil area acts as a heat sink for the regulator transistor. Remember that both this foil section and the heat sink are at a full 24-volt level. Therefore, don't short them to ground for any reason.

per (at least $\frac{1}{32}$ " thick) with a $\frac{3}{16}$ " wide by $\frac{1}{4}$ " long tab at the center of one edge of the square. This tab is to be inserted through the PC board for mounting the heat sink. Solder the heat sink to the heat-sink tab on the transistor and to the foil on the bottom of the board. On this transistor, the heat-sink tab is actually connected to the collector and is at a potential of 24 volts so be sure that neither the tab nor the heat sink is shorted to ground. Position the copper

heat sink so that it is vertical to the board.

Volume and Tone Controls. If volume and tone controls are desired for the amplifier, insert a circuit such as that shown in the inset in Fig. 1 at the input to the amplifier. The tone control is of the "losser" type so that, as the rotor of the tone-control potentiometer approaches the capacitor end, the high frequencies are attenuated.

Setting Up Your A.C. Bench Supply

THOUGHTS ON MAKING
A VARIAC MORE VERSATILE

BY B. W. BLACHFORD

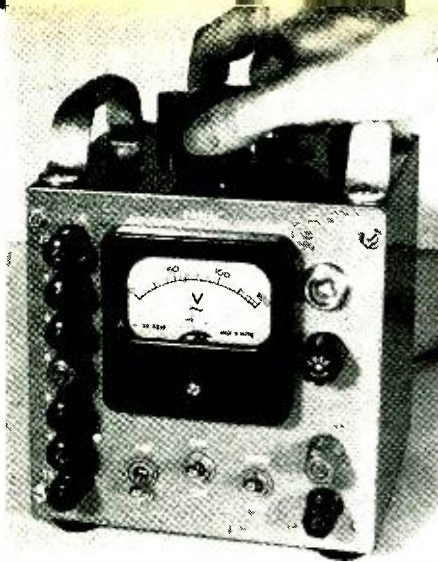

One of the most versatile and necessary pieces of equipment on the test bench of many an engineer, technician, experimenter, or hobbyist is the variable-voltage transformer. Although it is a relatively uncomplicated, usually dependable device, there are several points you should keep in mind when setting up your transformer to obtain a good, versatile supply.

Protection. Fuses on the input (primary) side of a variable-voltage transformer do not give good protection against overloads. Fuses should be in the output (secondary) side. Also, since the device is an autotransformer, protection from burnout due to grounding can be obtained only by fusing both sides of the secondary circuit.

Use fuses with current ratings no larger than required by the job at hand. This protects not only the transformer, but the circuit being supplied as well.

Under no circumstances should the fuse ratings be larger than the maximum rated output current of the transformer.

Controls and Meter. The ON-OFF switch in the line side of the transformer should be a double-pole switch with one pole in each side of the line. A single-pole switch should only be used on ordinary fixed-ratio transformers where the primary and secondary windings are insulated from each other.

Many variable-voltage transformers have a tap on the winding, usually at a point about 20 volts below the upper terminal of the full winding. To achieve versatility in your supply, it is advantageous to include a s.p.d.t. switch to permit connecting the incoming line ei-

(Continued on page 66)

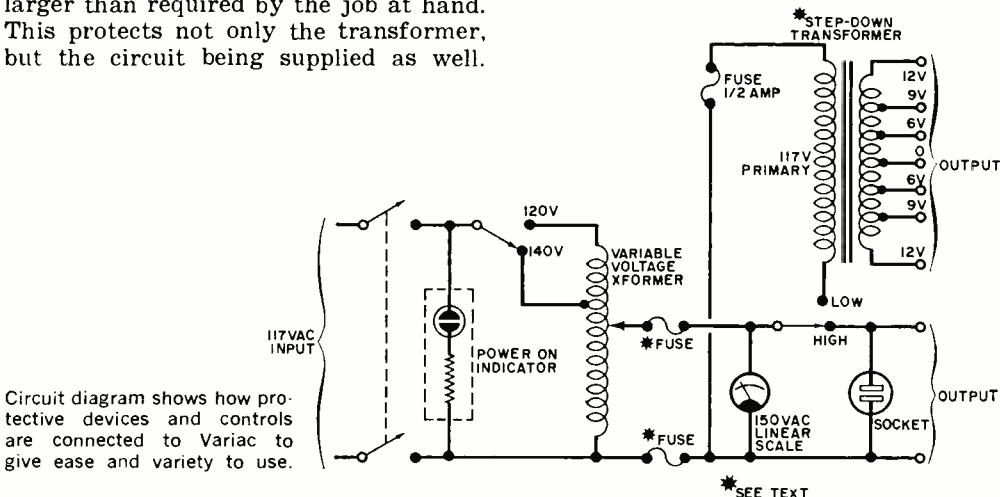

Circuit diagram shows how protective devices and controls are connected to Variac to give ease and variety to use.



Choosing the RIGHT Battery

ACCELERATED LIFE
TESTS DEMONSTRATE
BIG DIFFERENCES
IN PER-HOUR COSTS

BY LEWIS A. HARLOW

WHEN IT COMES to calling out the battery, the usual parts-list instruction is: Use an ordinary transistor radio battery. Of course, the voltage required is given—1.5, 3.0, 4.5, or 9.0 volts—but there are literally scores of batteries of all different sizes, shapes, and prices that fill this requirement. And, strangely enough, there appears to be no fixed set of rules for selecting the “right” battery. Even if you are replacing a battery in a portable radio receiver or transceiver, you must still choose between two or three different types of batteries—regardless of the physical volume and shape limitation!

To add insult to injury, there are identical batteries—in terms of external appearance—that have vastly different current-output ratings and life cycles. There is no perfect answer to the problem of battery selection, but there are

important guidelines, some new, some old, but all worth reviewing.

First Things First. If the physical size of the battery is not a hindrance, the one basic specification that you must know is how much current is going to be drawn from the battery. If you have designed your own circuit, you can estimate the current drain the hard way, or you can measure the drain from your low-voltage bench power supply from a temporary battery hookup. The answer should be in the range of 1 to 20 milliamperes—rarely more.

A current drain measurement should also be made on commercial gear; however, in this instance, try to use a fresh battery of a type similar to that recommended by the manufacturer. The answer you get is very helpful in making the right battery selection.

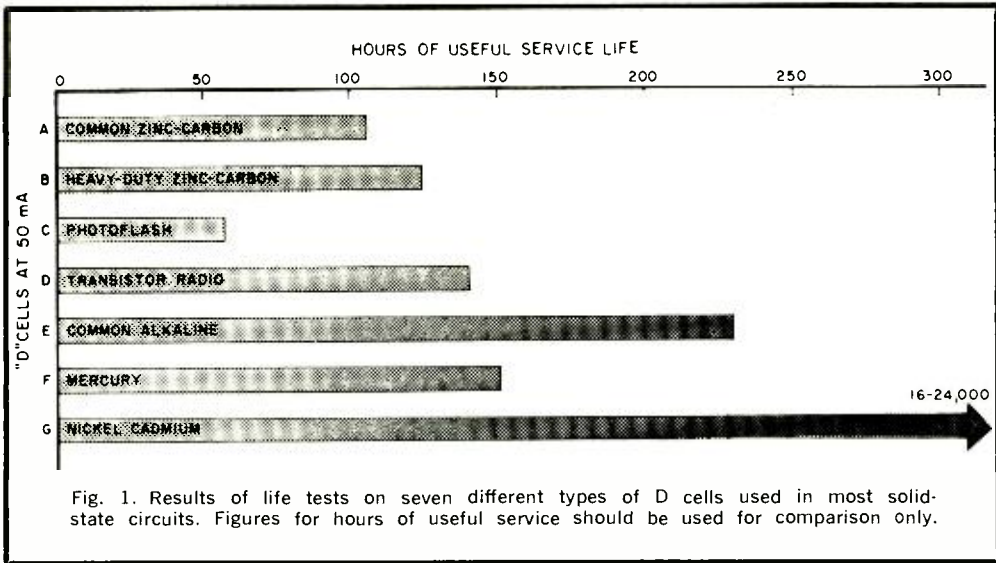

Fig. 1. Results of life tests on seven different types of D cells used in most solid-state circuits. Figures for hours of useful service should be used for comparison only.

Physical Size. A primary principle of battery engineering is that batteries of the same chemical composition have a service life directly related to the weight of the battery. A good, big battery has a longer service life than a good, small battery of the same chemical makeup.

You can prove this to your own satisfaction by testing the three different sizes of the common 1.5-volt battery—the D cell, the C cell and the AA cell. The author tested three typical cells on the basis of four hours of service per day at a drain of 15 mA. The test was halted when the cell output under load dropped to 1.0 volt. The results were:

D cell—service life, 360 hours

C cell—service life, 180 hours

AA cell—service life, 38 hours

From this information we can safely assume that the D cell has approximately twice the service life of the C cell and almost nine times that of the AA cell. Since all three have essentially identical chemical compositions, service life is directly proportional to the physical size of the cell.

Impedance. This may seem to be a strange term to find in an article on battery selection, but the impedance of a dry cell is important in all solid-state applications. You want as little internal battery impedance as possible. Impedance and the voltage/current output of the

battery are, of course, related; the greater the internal impedance, the greater the internal voltage drop under load. When the internal impedance of the battery is too high it may become a source of audio-signal distortion or r.f. oscillator instability.

The internal impedance of a fresh zinc-carbon D cell at normal room temperature is 0.277 ohms. This figure rises sharply as the cell discharges. The internal impedance of a fresh alkaline D cell is 0.15 ohms and it remains fairly constant throughout the life of the battery. The impedances of mercury and nickel-cadmium cells are said to be even less than that of an alkaline cell.

Shelf Life and Voltage Droop. Although in many solid-state applications the shelf life of a battery is not an important problem, most battery users neglect to include in overall life expectancy the periods when the equipment in which the battery is installed is not in use. No battery lasts indefinitely, and the life of any battery is shortened by high temperatures—and, conversely, somewhat lengthened by low temperatures. Roughly speaking, an AA cell stored for 24 months at 70°F retains only 50% of its initial capacity. A mercury cell, on the other hand, retains nearly 90% of its initial capacity. Alkaline cells have shelf and storage lives similar to mercury cells,

but a nickel-cadmium cell generally loses more than 10% of its charge in one month and about 60% in one year.

Comparative Service Life. The author subjected seven different D cells—commonly used in solid-state projects—to identical service-life tests. A current-drain of 50 mA was chosen for this test. Admittedly, this is a high load level, but it is the lowest that includes the ratings of all seven D-cell types.

The bar chart in Fig. 1 shows the result of the author's tests. The figures for "hours of useful service life" should be used only for comparative purposes. All of the batteries used in the D-cell test (and in the 9-volt representative test) are identified in the interchangeability table.

The service lives of four zinc-carbon D cells are shown by bars A, B, C, and D in Fig. 1. In the accelerated test, the "usual" zinc-carbon D cell that had a service life at 15-mA load of 360 hours only survived 102 hours with a load of 50 mA. This is the 15-16¢ battery commonly seen in hardware stores, drug stores, etc. For only one or two cents more you can buy the so-called "heavy duty" D cell that had an accelerated service life represented by bar B. This is the D cell used by night watchmen and in the flashlights of gas, water and electric meter readers.

The surprisingly low service life of the battery represented by bar C is due to the fact that this battery was never destined to be used in solid-state circuits. Its chemical composition is adjusted to favor brief surges of maximum current. Consequently the battery is of greatest use to the photographer. It is listed here only because you may happen to wonder if this particular battery has any magic properties.

The last zinc-carbon D cell, the so-called "transistor radio" cell, is represented by bar D. In this instance, the chemical composition has been adjusted to favor long service at a reasonably low current drain, and in this respect it is the exact opposite of the photoflash D cell (bar C). The service life of this battery under the loads it is designed to handle is approximately 700 hours at 10 mA, 510 hours at 15 mA, and 300 hours at 25 mA.

The Non-Zinc-Carbon D Cells. Bar E in Fig. 1 represents the accelerated test for a common 50¢ alkaline D cell. Even with the accelerated drain of 50 mA the battery performed excellently for approximately 230 hours. The alkaline D cell has a low internal impedance and the output voltage remains reasonably stable throughout its life. The impedance and voltage stability minimize audio distortion and help stabilize oscillator performance in portable receivers. The service life at very low drains is almost astronomical. All things considered, the alkaline D cell is probably the best buy for solid-state projects.

Where it is necessary to obtain a battery with a very low internal impedance and superb voltage stability, the mercury D cell is the obvious choice. The accelerated service life of a mercury D cell is shown in bar F. The figures are not too impressive—indicating 150 hours at 50 mA. The price of a mercury D cell exceeds \$3 and it is obvious that the real value of the mercury-type battery is not found in the D-cell size. However, mercury battery construction lends itself to miniaturization and miniature mercury batteries are the best choice for stable low-drain voltage requirements over very long periods of time.

It is difficult to approximate the "life" of a rechargeable nickel-cadmium D cell, which is represented by bar G in Fig. 1. A typical battery (costing about \$5.50) had a service life at 50 mA of only 80 hours. However, this life value must be multiplied by the 200 to 300 times that this type of battery can be recharged. On the other hand, recharging a nickel-cadmium cell is a critical operation and the charge rate is determined by the ca-

BATTERY INTERCHANGEABILITY LIST

	Burgess	Everready	RCA	Mallory	Ray-O-Vac	NEDA
A*	2	950	VS036	M13F	2D, 2LP	813, 13F
B	210	1150	—	M13X	3LP, 3D	13C
C	220	850	VS736	M13P	210LP	13P
D	230	1050	VS336	M13R	13	13
E	AL2	E95	VS1336	MN1300	—	813, 13A
F	Hg42R	E42N	—	RM42R	—	—
G	CD10	CH4	—	—	—	—
H	2U6	216	VS323	M1604	1604	1604
I	2MN6	222	—	—	M1604	1604D
J	Hg136R	E136N	—	TR136R	—	—
K	2N6	246	VS305	M1602	1602	1602
L	M6	266	VS322	M1605	1605	1605

*Letters correspond to bars in Figs. 1 and 2.

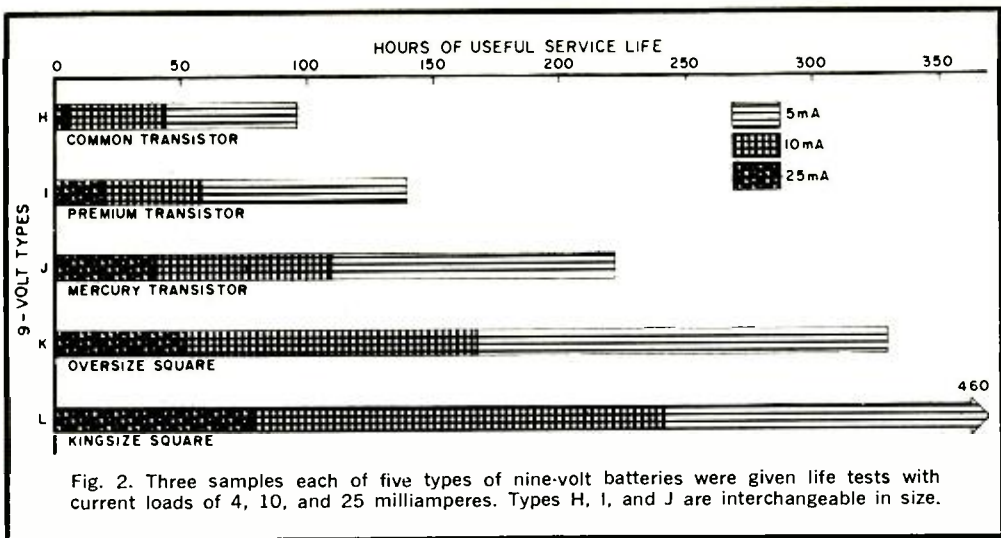

Fig. 2. Three samples each of five types of nine-volt batteries were given life tests with current loads of 4, 10, and 25 milliamperes. Types H, I, and J are interchangeable in size.

capacity of the cell. Commercially available chargers are generally tailored to the needs of a specific size of battery cell and are therefore difficult to adapt to any other type of battery charging. This has resulted in the phenomenon of the cordless razor and cordless carving knife that are always sold with a "charging stand."

If you are not scared away by the complications of recharging, the nickel-cadmium battery is a very good buy for solid-state service. Internal impedance is low and stable. The battery holds its rated voltage output throughout most of the life of the charge. In the long term, the cost-per-hour of use of the nickel-cadmium battery is surprisingly low.

The Nine-Volt Batteries. The other standard of battery-powered solid-state equipment—one that is sold by the millions of units—is the 9-volt battery. There are not too many 9-volt batteries to test, but accelerated life tests of several different examples are represented by the bars in Fig. 2.

Bar H is the common low-cost 9-volt "transistor radio battery." Bar I is the better grade of the common zinc-carbon 9-volt battery. Although this premium battery is an exact physical replacement, it has a somewhat different internal structure. Equated at list prices the premium battery saves you only 0.04¢ an hour at the 5-mA rate.

Bar J represents the expected life of a mercury 8.1-volt battery replacement for the common "transistor radio battery." This battery offers the real advantage of very low internal impedance and excellent voltage stability. Don't be disturbed by the 8.1-volt rating of the mercury battery. The zinc-carbon 9-volt batteries drop to this voltage level as soon as they are put in operation, whereas the mercury battery delivers close to its full voltage rating throughout most of its life.

The batteries represented by bars H, I and J are all interchangeable, but if you have the physical room, the following larger 9-volt zinc-carbon batteries should be considered. In bar K we see the expected life of a square-type battery that costs about twice as much as the common "transistor radio battery." In bar L is another square-top zinc-carbon battery of somewhat greater physical dimensions. The cost between the batteries shown in bars K and L is only a matter of a few pennies.

We have shown what you can expect from 12 different types of 1.5- and 9-volt batteries. Since all batteries were purchased and tested as being "fresh" and given the same accelerated life test, the comparisons are felt by the author to be perfectly legitimate. Using the information here, however, you will know what to do when a schematic calls for a "1.5- or 9-volt battery."

-30-

Advanced Ham Frequency Calibrator

COMPLY WITH NEW RULES—CHECK YOUR OPERATING FREQUENCY TO 25 KHZ

BY NEIL JOHNSON, W2OLU

THE MAJORITY of American hams has been content to comply with FCC rules for checking operating frequency by using a 100-kHz crystal-controlled frequency standard. Under the latest FCC regulation, however, Advanced and Extra class licensees are required to check their operating frequencies to make certain that they fall within certain 25-kHz sub-bands in the conventional ham bands. At present, there is no low-cost commercial unit available for this purpose. The crystal-controlled calibrator described here fills the need.

It would be natural to assume that such a device would incorporate the latest in semiconductor devices. However, a casual survey of hams in the N.Y. metropolitan area showed that over 95% of them are still using vacuum-tube receivers. This being the case, the frequency calibrator was designed to work in conjunction with this type of receiver.

Because power can be obtained from the receiver, the frequency calibrator can be built directly into the receiver cabinet, with only a couple of front-panel switches to control operation. Power requirements are low for a vacuum-tube unit: 600 mA for filaments and 10 mA or less for the plates. One switch determines whether the frequency output is at 200-kHz or

25-kHz intervals and the other turns the calibrator on and off.

Construction. The author elected to construct his calibrator on perf board, although point-to-point or printed-circuit board construction can be used. The use of good-quality components, especially in the crystal oscillator stage, is recommended. Silver mica, or zero-temperature-coefficient ceramic capacitors should be used. By-pass capacitors should be ceramic or Mylar, while tube sockets should be either ceramic or mica-filled. Do not use tube shields as they tend to attenuate the higher harmonics of the circuit. Use as short a lead as possible from the r.f. output of the calibrator to the receiver antenna terminals. Avoid the use of lengthy coaxial cable as this reduces the signals above 30 MHz. Neon lamp *11* and its associated dropping resistor *R13* are optional. Between 150 and 200 volts d.c. is required by the plate circuits, and this can be obtained from the receiver power supply. If the available B+ is higher than 200 volts, a 2-watt dropping resistor can be inserted between *R14* and the B+, allowing 100 ohms for each volt to be dropped. For example, if the B+ is 250 volts, the resistor should be approximately 5000 ohms.

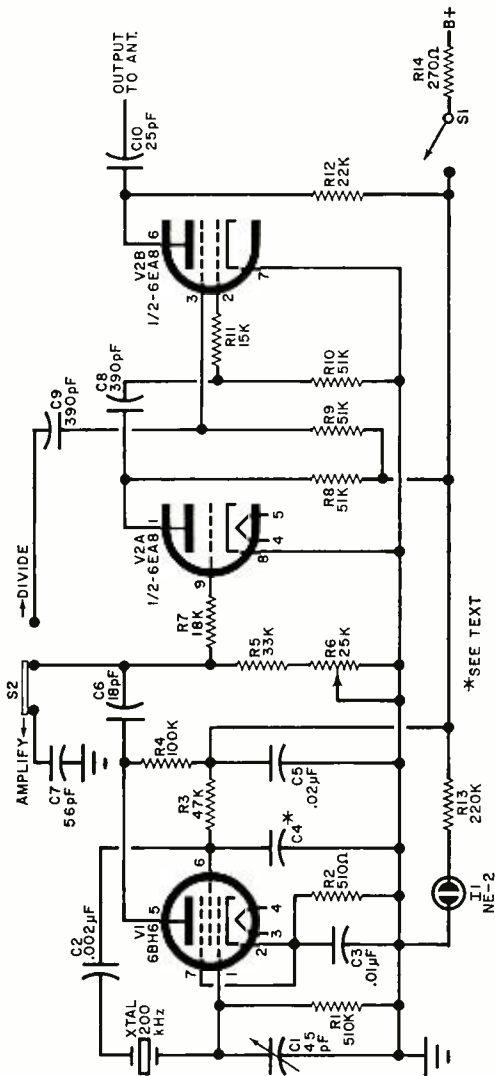

No tuned circuits are used, giving the crystal oscillator a harmonic-rich output. The second stage (V2) acts as a frequency divider controlled by R6.

Avoid the use of World War II surplus crystals. The best type is the HC6U, a source for which is given in the Parts List.

Note that no value is given for C4, the screen bypass capacitor for V1. Values will vary from 150 pF maximum to 50 pF minimum, depending on the crystal used. With the crystal specified in the Parts List and a 51-pF screen bypass capacitor, the crystal resonated with 15 MHz from WWV.

PARTS LIST

- C1—3.2- to 50-pF trimmer capacitor (E.F. Johnson type S or similar)
 - C2—0.002- μ F capacitor
 - C3—0.01- μ F capacitor
 - C4—See text
 - C5—0.02- μ F capacitor
 - C6—18-pF capacitor
 - C7—56-pF capacitor
 - C8, C9—300-pF capacitor
 - C10—25-pF capacitor
 - V1—NE-2 neon lamp (optional)
 - R1—510,000-ohm
 - R2—510-ohm
 - R3—47,000-ohm
 - R4—100,000-ohm
 - R5—33,000-ohm
 - R7—18,000-ohm
 - R8-R10—51,000-ohm
 - R11—15,000-ohm
 - R12—22,000-ohm
 - R13—220,000-ohm
 - R14—270-ohm
 - R6—25,000-ohm potentiometer
 - S1—S.p.s.t. switch
 - S2—S.p.d.t. switch
 - V1—6BH6 tube
 - V2—6EA8 tube
 - XTAL—200,000-kHz HC6U*
- Misc.—Perf board, ceramic tube sockets (one 7-pin, one 9-pin), ceramic crystal socket, mounting hardware, terminal strips, wire, etc.
- *A 200,000-kHz HC6U crystal is available from J.A.V. Crystals, 2400 Crystal Drive, Fort Myers, Florida 33901, for \$2.30 (\$2.50 with socket) postpaid.

All resistors
1/2-watt

Operation. With power applied to the calibrator and the r.f. output connected to the antenna terminal of the receiver, turn on switch S1. The optional neon indicator lamp should come on. Place S2 in the AMPLIFY position and, with the receiver BFO turned on, note that, as the receiver tuning is operated, a signal is heard at each 200-kHz interval along the dial. Turn off the calibrator and tune the receiver to any of the WWV standard frequency stations. Once you have accurately set a zero beat (using the receiver BFO) with WWV, turn the calibrator back on, turn off the receiver BFO, and adjust C1 until the calibrator and WWV zero beat with each other. Use a drop of cement to lock C1 in place.

Place S2 in the DIVIDE position. Adjust frequency division potentiometer R6 until seven calibrator signals are heard between the 200-kHz intervals on the dial. In the author's prototype, this occurred with R6 set at about 11,000 ohms. Flip S2 back and forth between its two positions, making sure that the 25-kHz "birdies" return whenever S2 is on DIVIDE. If not, a slight readjustment of R6 is required.

—30—

THERMISTOR-CONTROLLED TONE GENERATOR USED FOR AUDIBLE TEMPERATURE READINGS

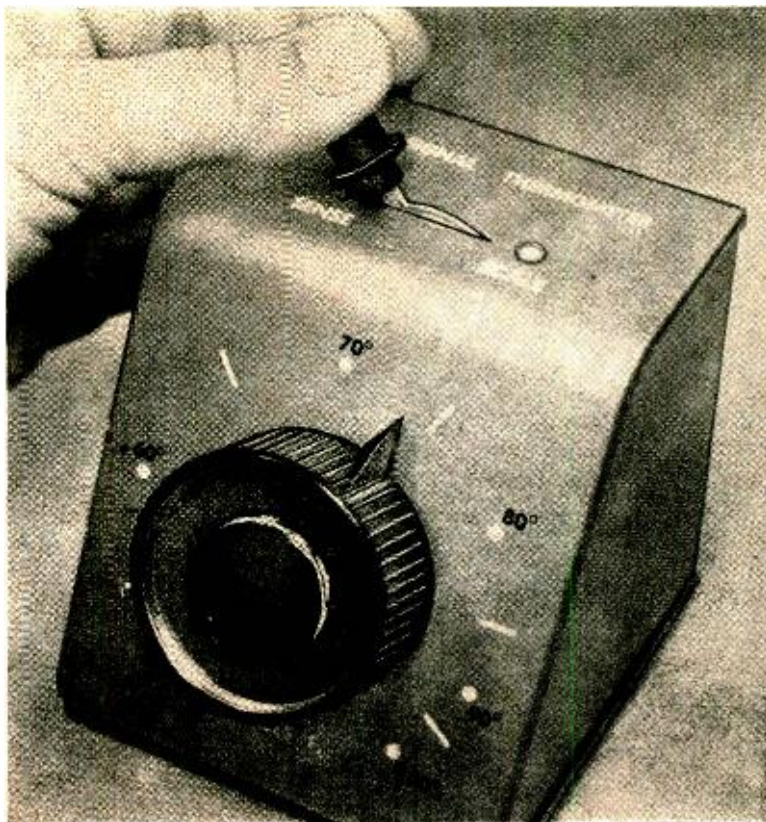

BUILD Sound-Signal THERMOMETER

BY FRANK H. TOOKER

AIR TEMPERATURE CAN be measured in many ways—with a conventional mercury thermometer, a bimetal strip turning a pointer on a dial, or a thermocouple operating a digital read-out. However, all of these systems have one thing in common—you have to be able to see the indicating device to be able to determine the temperature.

Some of us have friends or relatives who have difficulty seeing and who would welcome a device or technique to help them in going about their daily tasks. The "Sound-Signal Thermometer" is an electronic device that any experimenter can build and that will enable

even a sightless person to tell the temperature. By flicking a switch and making a dial adjustment, he can "read" the temperature by comparing two sound signals. The range of the electronic thermometer is from 55 to 100 degrees Fahrenheit.

Construction. The layout of the components is not critical so any assembly arranged for convenience can be used. The author's version (see photos) is assembled in a small, sloping-panel metal cabinet. Switch *S1* is mounted on the top, potentiometer *R1* is on the sloping front, and battery *B1* is clip-mounted to the

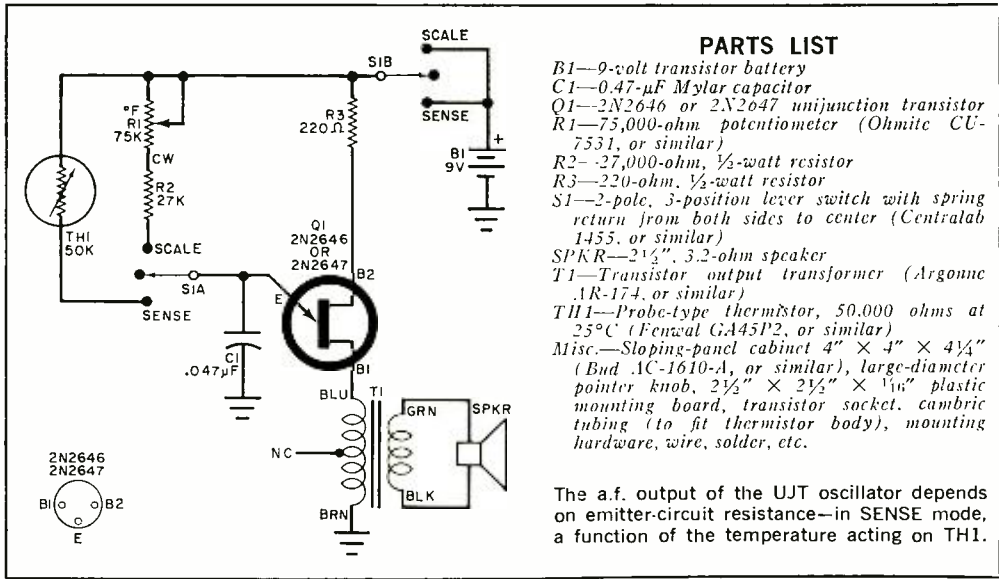

bottom of the chassis. The output transformer *T1* and the loudspeaker are on the other half of the cabinet. The remainder of the components are assembled on a small piece of plastic mounted on L brackets within the cabinet. The dial knob used for *R1* should be large, with a distinct pointer, and the calibration marks can be either numerical (in degrees F) or in Braille.

The most critical part of the assembly is the mounting and connecting of the thermistor. The probe-type compo-

nent recommended for this unit is a small, very delicate device. It is easily damaged by both careless handling and excessive heat. The author found it expedient to mount the thermistor in a snug-fitting, short length of cambric spaghetti tubing, held in place on the plastic circuit board by a small metal clamp. Plastic insulation, slipped over the two thermistor leads, is cemented to the cambric tubing.

Keep the thermistor leads as long as practical in the assembly. Solder them

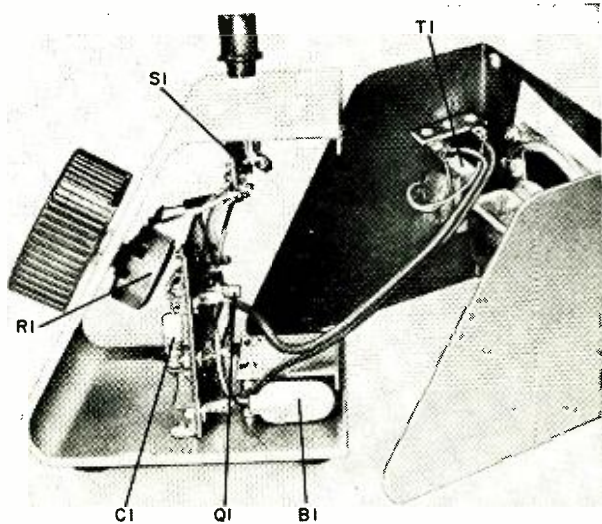

The entire electronic thermometer is contained within a small cabinet. The circuit is not critical, so any other mechanical arrangement can be used. If you wish to measure outside temperature, mount the thermistor out of a window in a weather-protected spot, and connect it to the thermometer via a twisted pair. This pair can enter the cabinet through a rubber grommet.

quickly, keeping the heat of the soldering iron well away from the thermistor at all times. Once overheated, a thermistor's characteristics may change and drift indefinitely. In this event, permanent accuracy of the instrument is impossible.

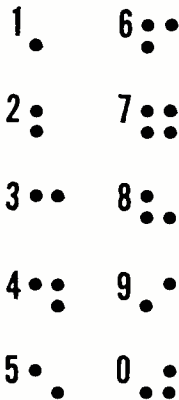

Braille numbers, in various combinations, can be embossed on front panel for use by a blind person.

Calibration. There are several ways of calibrating the thermometer, most of them are somewhat complex. However, there is one simple method that is accurate enough for almost all purposes.

Assemble the thermometer, except for the thermistor. Connect a pair of 15- to 20-inch leads between the thermistor and its terminals on the circuit board. Using a large container of water and an accurate mercury thermometer, adjust the water temperature consecutively (from 55 to 100 degrees F) to the various temperature values to be calibrated. With the thermistor placed two thirds of its length into the water, set *R1* until the frequency of the audible tone is the same in both the *SENSE* and *SCALE* positions of *S1*. Mark the *R1* dial in accordance with the thermometer readings. Calibration at 5° intervals is adequate. Do not allow the thermistor leads to get wet as this may produce inaccurate temperature indications.

When calibration is complete and has been checked, remove the auxiliary leads from the thermistor and reinstall it in the cabinet.

HOW IT WORKS

Unijunction transistor *Q1* is an oscillator whose frequency is determined by the combination of emitter capacitor *C1* and the resistance of either the thermistor *TH1* or calibration potentiometer *R1*. Audio output is obtained from B1 of *Q1* through transformer *T1*.

Switch *S1* is spring-loaded to return to its center position. If it is moved to either of its two other positions (*SCALE* or *SENSE*) and released, it will automatically return to the off position.

When *S1* is moved to *SENSE*, thermistor *TH1* supplies the resistance for the *RC* circuit which controls *Q1*. The transistor then oscillates at a frequency determined by capacitor *C1* and the resistance (at ambient temperature) of *TH1*. A thermistor is a semiconductor device whose resistance varies inversely with temperature; as the temperature goes up, the resistance goes down. Therefore, the audible output frequency is a function of thermistor resistance and, hence, the temperature.

The values of potentiometer *R1* and resistor *R2* have been selected so that, over the range of 55 to 100 degrees Fahrenheit, the resistance of *TH1* can be duplicated by adjustment of *R1*. Thus, when *S1* is in the *SCALE* position, *R1* can be adjusted to duplicate the tone generated by the thermistor.

Installation. The Sound-Signal Thermometer can be placed in any convenient place in the house and is always ready for immediate use. If desired, the thermistor can be mounted outside a window, with the cabinet on a window sill, ready to make outside temperature measurements within its range. When using external mounting, the thermistor leads must be waterproofed to prevent resistance changes caused by rain. -30-

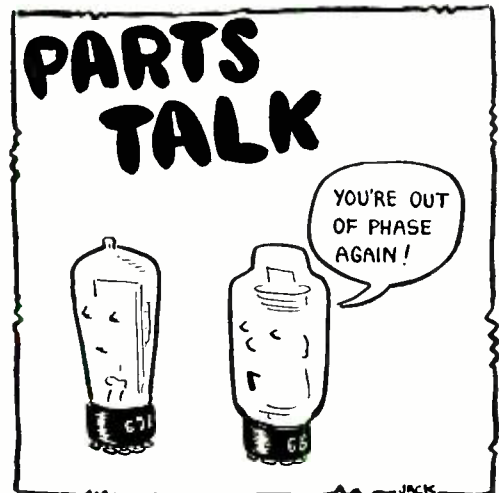

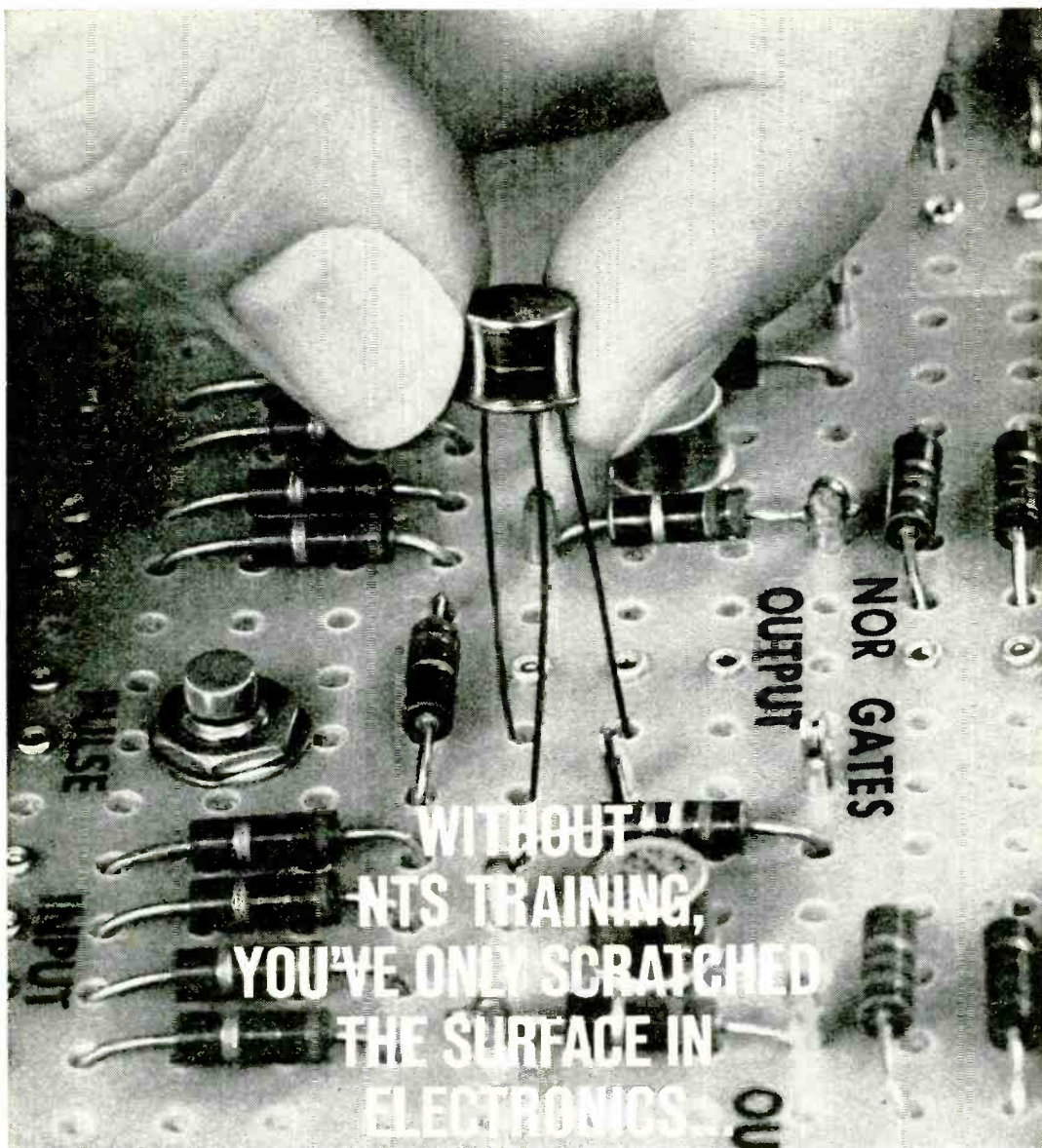

Only NTS penetrates below the surface. Digs deeper. Example? Take the above close-up of the first transistorized digital computer trainer ever offered by a home study school.

It's called The Compu-Trainer®—an NTS exclusive. Fascinating to assemble, it introduces you to the exciting world of computer electronics. Its design includes advanced solid-state NOR circuitry,

flip-flops, astable multivibrators and reset circuits. Plus two zener and transistorized voltage-regulated power supplies. The NTS Compu-Trainer® is capable of performing 50,000 operations per second.

Sound fantastic? *It is!* And at that, it's only one of many *ultra-advanced* kits that National Technical Schools offers to give you incomparable, in-depth career training.

PROVE IT YOURSELF. SEND FOR OUR NEW CATALOG. SEE THE LATEST, MOST ADVANCED KITS AND COURSES EVER OFFERED BY A HOME STUDY SCHOOL.

NTS...THE FIRST HOME STUDY SCHOOL TO OFFER LIVE EXPERIMENTS WITH INTEGRATED CIRCUIT KITS

You build a computer sub-system using the new, revolutionary integrated circuits. Each one, smaller than a dime, contains the equivalent of 15 resistors and 27 transistors.

And your kits come to you at no extra cost. These kits are the foundation of the exclusive *Project-Method* home study system... developed in our giant resident school and proven effective for thousands of men like yourself.

With Project-Method, all your kits are carefully integrated with lesson material. Our servicing and communication kits are *real* equipment—not school-designed versions for training only. As you work on each of the projects, you soon realize that even the most complicated circuits and components are easy to understand. You learn *how* they work. You learn *why* they work.

NTS Project-Method is a practical-experience approach to learning. The approach that works *best!* An all-theory training program can be hard to understand—difficult to remember. More than ever before you need the practical experience that comes from working with real circuits and components to make your training stick.

NTS SENDS YOU KITS TO BUILD THESE IMPORTANT ELECTRONICS UNITS!

- ◆ 25" COLOR TV
- ◆ 21" BLACK & WHITE TV
- ◆ SOLID-STATE RADIO
- ◆ AM-SW TWIN-SPEAKER RADIO
- ◆ TUBE-TESTER
- ◆ TRANSCEIVER
- ◆ COMPU-TRAINER®
- ◆ VTVM
- ◆ SIGNAL GENERATOR
- ◆ 5" OSCILLOSCOPE

See them all illustrated in
the new NTS Color Catalog.

CLASSROOM TRAINING AT LOS ANGELES: You can take classroom training at Los Angeles in sunny California. NTS occupies a city block with over a million dollars in facilities devoted exclusively to technical training. Check box in coupon.

NATIONAL TECHNICAL SCHOOLS

WORLD-WIDE TRAINING SINCE 1905

4000 So. Figueroa Street, Los Angeles, Calif. 90037

APPROVED FOR VETERANS

Accredited Member: National Home Study Council
Accredited Member: National Association of
Trade and Technical Schools



COMMUNICATIONS

This transceiver is included in Communications courses. You build it. With it, you easily prepare for the F.C.C. license exam. You become a fully-trained man in communications, where career opportunities are unlimited.

25" COLOR TV ▼

Included in Color TV Servicing Courses. With it you advance yourself into this profitable field of servicing work. Color is the future of television, you can be in on it with NTS training.



YOUR OPPORTUNITY IS NOW

New ideas, new inventions, are opening whole new fields of opportunity. The electronic industry is still the fastest growing field in the U.S. There's a bigger, better place in it for the man who trains today. So, whatever your goals are—advanced color TV servicing, broadcasting, F.C.C. license, computers, or industrial controls, NTS has a highly professional course to meet your needs.

GET THE FACTS! SEE ALL NEW COURSES AND KITS OFFERED IN THE NEW NTS COLOR CATALOG. SEND THE CARD OR COUPON TODAY!

There's no obligation. You enroll by mail only. No salesman will call.

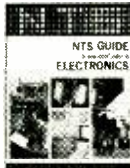

NATIONAL TECHNICAL SCHOOLS

4000 S. Figueroa St., Los Angeles, Calif. 90037

Please rush Free Color Catalog and Sample Lesson, plus information on field checked below. No obligation.

- | | |
|---|--|
| <input type="checkbox"/> MASTER COURSE IN COLOR TV SERVICING | <input type="checkbox"/> PRACTICAL TV & RADIO SERVICING |
| <input type="checkbox"/> COLOR TV SERVICING | <input type="checkbox"/> FCC LICENSE COURSE |
| <input type="checkbox"/> MASTER COURSE IN TV & RADIO SERVICING | <input type="checkbox"/> INDUSTRIAL & COMPUTER ELECTRONICS |
| <input type="checkbox"/> MASTER COURSE IN ELECTRONIC COMMUNICATIONS | <input type="checkbox"/> STEREO, HI FI & SOUND SYSTEMS |
| | <input type="checkbox"/> BASIC ELECTRONICS |

NAME _____ AGE _____

ADDRESS _____

CITY _____ STATE _____ ZIP _____

- Check if interested in Veteran Training under new G.I. Bill.
 Check if interested ONLY in Classroom Training at Los Angeles.

BENCH SUPPLY

(Continued from page 52)

ther to the full winding or to the tap. With the switch in the latter position, you can get an output approaching 140 volts.

It is also a good idea to have a means of obtaining very low voltages without depending on the setting of the variable transformer. For this purpose, use a HIGH-LOW switch which, in the LOW position, puts a step-down transformer across the output of the variable transformer. The author uses a multi-tap transformer here, but any step-down transformer with a 12-volt center-tapped secondary which is capable of carrying at least 1 ampere would be suitable.

Having a meter in the output of the supply is extremely convenient and time-saving. A meter with a 0-150 volt linear scale is best. Unfortunately, a number of inexpensive a.c. voltmeters have nonlinear scales. Although they serve perfectly

well in other applications, such meters do not have a scale range that is sufficiently detailed to be of value when used with a variable-voltage transformer.

You can use the meter for the low-voltage output if you determine the voltage (turns) ratio of the step-down transformer accurately and apply this ratio to the meter reading.

Packaging the Supply. The assembly shown in the photo uses a 2.4-ampere Variac mounted in a 6" × 6" × 6" aluminum cabinet, with the knob for the Variac on the top. Two large handles also on the top can be used to carry the supply; they also protect the Variac knob so that it can't be accidentally moved and they provide a place to rest the palm of your hand while making a setting of the knob.

Although the schematic diagram shows only one 120-volt output receptacle, the author's setup has two wired in parallel for added convenience. They are located on the rear of the cabinet so that cords plugged into them are out of the way of the work area and the controls.

-50-

Broadband Dipole For 75 / 80 Meters

BY BOB DAHLQUIST, WB6KGF

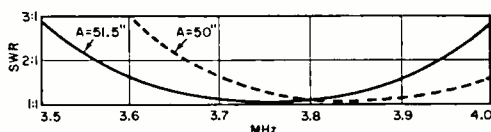
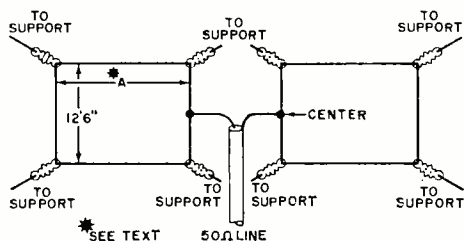

Length of side A depends on coverage desired and determines the standing wave ratio for the dipole.

THIS ANTENNA WILL ALLOW you to load your transmitter across the entire 500 kHz of the 75-80-meter band without using an antenna tuner, and with a SWR less than 3:1.

Construction is shown in the diagram. About 260 feet of antenna wire is required, as well as eight insulators, a conventional Hy-Gain center insulator (or substitute), and a length of 50-ohm transmission line long enough to go from the antenna to the transmitter. You will also need three antenna supports, masts or trees, between 20 and 30 feet high. Although these supports should be in a reasonably straight line, the antenna will work if it is folded up to 90°, making a horizontal Vee.

For coverage of the entire band, side A should be 51 feet, 6 inches. To cover just the phone portion of the band, side A is made 50 feet long. The resultant SWR is also shown in the diagram.

Because the SWR is affected by the height of the antenna and whether or not it is folded, you may have to shorten or lengthen side A to obtain the lowest SWR.

-50-

build a cheapie metronome

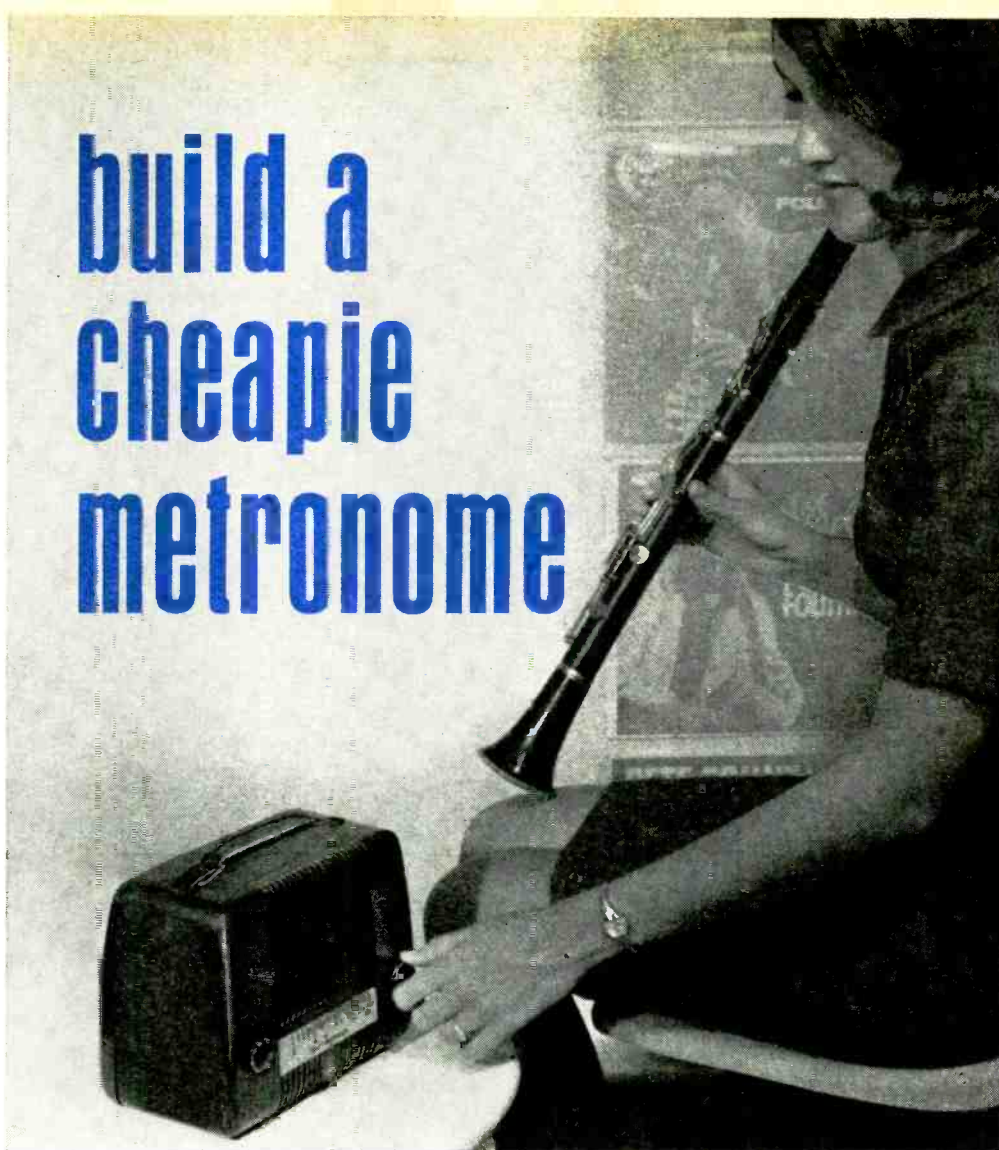

USE OLD RADIO PARTS FOR A MUSICAL ACCESSORY

BY KARL GREIF

THERE ARE TIMES when a seemingly useless electronic device can find service in a capacity other than the purpose for which it was designed. This was the case when an old tube-type portable AM BCB radio I had kicking around my shop fell prey to an idea I had for building an electronic metronome.

Making the conversion wasn't difficult, and aside from providing me with several hours of good clean experimenting and fabrication time, it provided my musically inclined sister with a first-class metronome. The portable radio was a fairly common type, but you can use almost

any other similar-size radio receiver to accomplish the same results. Most of the parts you probably have on hand from cannibalizing old radios, phonographs, or TV receivers, so cost-wise, this project is "dirt cheap."

About The Circuit. The schematic diagram of the "Electronic Metronome" is shown in Fig. 1. It is fairly simple, built around two gas-type tubes (*V1* and *V2*) and a transformerless voltage-doubler power supply.

With the power supply shown, a potential on the order of 200 to 300 volts ap-

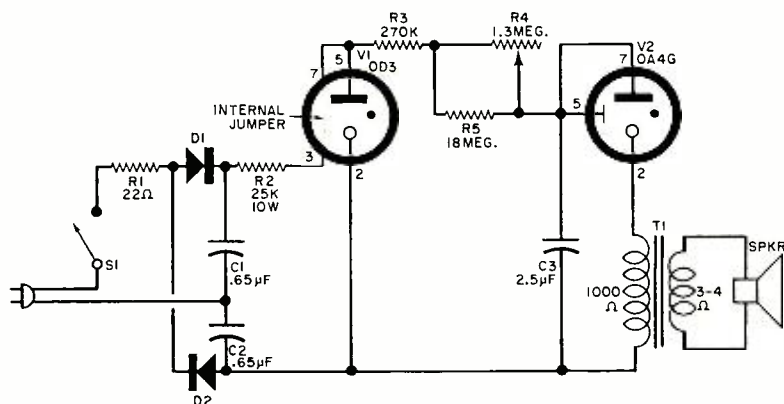

PARTS LIST

C1, C2—0.5- μ F (or higher), 400-volt capacitor
C3—2.5- μ F, 200-volt bathtub capacitor (see text)
D1, D2—See text
R1—22-ohm, $\frac{1}{2}$ -watt resistor
R2—25,000-ohm, 10-watt resistor
R3—270,000-ohm, $\frac{1}{2}$ -watt resistor
R4—1.3-megohm potentiometer (see text)
R5—18-megohm, $\frac{1}{2}$ -watt resistor
S1—S.p.s.t. switch (salvaged from radio)

T1—1000-ohm primary/4-ohm secondary impedance-matching transformer
V1—6X4 or OD3 gas tube
V2—6X4 cylindrical plate gas tube
1—3-4 ohm speaker
1—Old tube-type radio or similar size utility box (see text)
 Misc.—Dial cord and pulley (optional); wire; solder; etc.

Fig. 1. The voltage-doubler power supply's output is voltage regulated to provide a constant output, maintaining a uniform charge-discharge action from RC elements in oscillator V1.

pears across the *C1-C2* combination. This filtered potential is then regulated by *V1* and ballast resistor *R2* before being applied to the *V2* relaxation oscillator stage. The output of *V1* always remains constant at 150 volts regardless of line voltage—a very important feature if you want the beat rate of the metronome to remain stable.

The 150-volt output from *V1* is then applied to the RC network formed by *R3, R4-R5*, and *C3* with a conventional charge and discharge action through *V2*. Current flowing through the resistors charges *C3* at a rate determined by the total resistance presented in series with the capacitor and *V1*. The larger the resistance, the slower the charging rate, and vice versa.

As *C3* charges, the potential across it rises proportionally until it reaches the firing potential of *V2*. At this point, the gas in *V2* ionizes, effectively connecting *C3* to *T1*. As a result, *C3* rapidly discharges, producing a beat note in the speaker. Immediately upon discharge, *V2*

de-ionizes and stops conducting, allowing *C3* to begin charging again. The rate at which the beats are produced can be varied by changing the setting of *R4* which is in parallel with *R5* and controls the charging path to *C3*.

Construction. Since this is essentially a "spare-parts" box project, it is best to breadboard the components you plan to use to make sure the circuit will operate as desired. Diodes *D1* and *D2*, for example could be any type of selenium rectifiers containing five or more plates each or a pair of 2-ampere 250-volt silicon diodes—whichever you have handy.

Select a potentiometer on the order of 2 megohms for *R4* if you use the 2.5- μ F capacitor called out for *C3*. If you use a different value capacitor, make the proper adjustment in the potentiometer value. However, the capacitor chosen, being the heart of the circuit, is fairly critical; it must retain a stable capacitance value with respect to temperature, and it should have no (at least constant)

Fig. 2. Salvaged receiver chassis easily accommodates all of the metronome's parts. Bathtub capacitors (lower left) can be bolted to floor of receiver cabinet once chassis is in place.

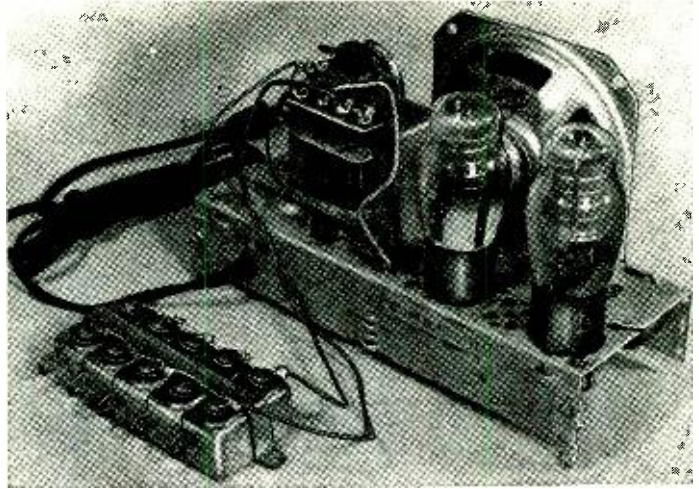

leakage current. A bathtub type capacitor seems to have the best characteristics.

Once you have breadboarded the circuit and are satisfied it works (the beat rate range should be continuously variable at least between the limits of 40 and 208 beats/min on the upper and lower ends), you're ready to begin converting that old radio chassis and cabinet. The first step is to remove the innards of the radio.

Mount the metronome parts, and wire them together, using Figs. 1 and 2 as guides. Location of the parts is not critical, and if you use a different radio chassis—or even, as a last resort, build the circuit into a utility box—there is nothing to prevent you from exercising your own mechanical ingenuity. With the radio chassis and cabinet shown in the photo on the first page of this article, you can even calibrate and hand-letter a dialplate that will permanently locate the various beat-rate settings of *R4*.

To use the dialplate gimmick, you can fashion an L-bracket to hold the potentiometer fixed in a position where its shaft will accept a tuning dial pulley in line with the tuning dial control shaft. Then all you have to do is string the dial, making sure the pulley will allow a complete 280° revolution of the shaft on the potentiometer.

Finally, slide the chassis into the radio case, and it's ready to use. Plug the line cord into a convenient a.c. outlet,

close *S1*, and allow about a minute of warm-up time. Now, calibrate the dial, using a stopwatch or a sweep second hand on a conventional time piece. The number of dial markings you select will depend on the taper of the potentiometer selected and the amount of space available for lettering.

For large group practice sessions, the Metronome can be connected to a public address system by tapping the output from the speaker terminals. -30-

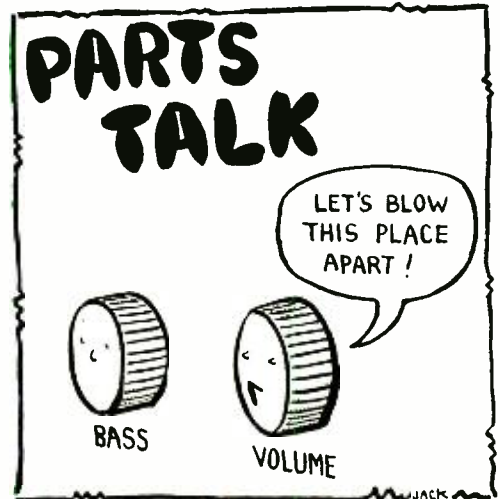

Extended Double Zepp Antenna

BY JOHN NELSON

ADD A FEW INCHES TO YOUR ANTENNA
AND WATCH THE SIGNAL LEVEL IMPROVE

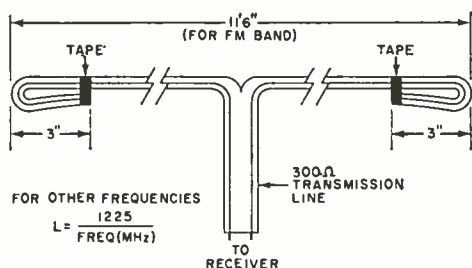

For 88-108-MHz FM band, the extended double Zepp is made of 11 feet 6 inches of split 300-ohm line.

MOST INDOOR antennas for FM or TV are conventional half-wave dipoles. Thousands of dipoles have been bought or made up by experimenters from a length of conventional 300-ohm transmission line. Usually the length of a dipole is restricted to half of the wavelength at the frequency of interest.

However, most experimenters don't realize that if they made the antennas slightly longer than half a wavelength, the gain would be increased noticeably. In fact, some AM BCB stations, in order to increase their coverage area without increasing transmitter power, use a $\frac{5}{8}$ -wavelength radiator. This improves the low-angle radiation and gives these broadcasters greater coverage than they can get with the usual half-wave antenna.

Hams who are familiar with this principle of extending the dipole, often use a center-fed antenna $1\frac{1}{4}$ wavelengths long. This gives a net gain of 3 dB. The same

What's a Zepp? In early short-wave radio, an antenna consisting of a half-wave dipole, end-fed through a quarter-wave transmission line was developed as an antenna system for the then popular Zeppelin airship. Because of the large metal base of the Zeppelin, the antenna system had to be designed so that only the antenna proper, and not the transmission line, radiated. This antenna later became popular with hams under the name "Zepp."

principle is used in the design of the "Extended Double Zepp" (EDZ) antenna described here.

The EDZ can be supported by string, rubber bands, or thumbtacks; it can be placed under a rug or hidden behind wall mouldings; it has no bulky or breakable insulators; and, if you should forget and leave it out in the woods on a camping trip, all you lose is about 50¢.

Fabrication. To make an EDZ antenna for the 88-108-MHz FM band, use the dimensions given in the illustration. Cut a piece of conventional twin-lead, 300-ohm TV line that is 6 feet long plus enough to go from the antenna to your receiver. Cut down the center of the twin lead for 6 feet. Make a knot (using the two loose ends) to keep the twin-lead from being further torn apart. At each of the two free ends, form a loop to permit the antenna to be hung. Use plastic tape to close the loops. This completes the antenna itself; the remainder of the uncut twin lead is used as the transmission line to the receiver. The latter should be only as long as necessary to keep signal loss to a minimum.

To construct an antenna for other than the FM band, calculate the length of the antenna portion by dividing 1225 by the frequency in megahertz. If you want to cover a relatively wide band, cut the antenna length for the highest frequency.

Using the Antenna. You can mount the antenna anywhere but remember that its directivity is rather sharp. It should be placed so that its length is broadside to the stations you want to hear.

Some further signal enhancement can be obtained by wrapping a 6-inch square of aluminum foil around the transmission line and sliding the foil up and down the line until the desired signal is maximized. Use a piece of plastic insulating tape to secure the foil to the line at the desired spot.

-30-

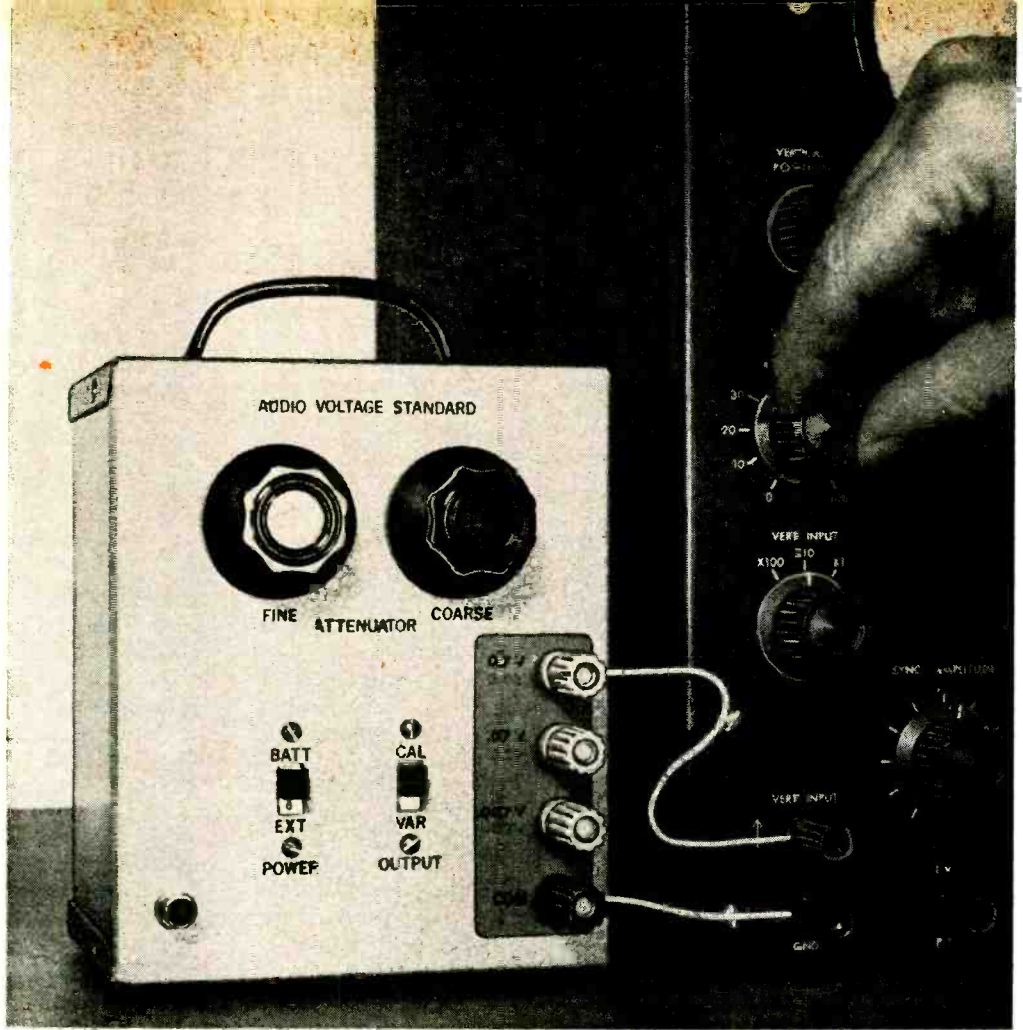

Precision Audio Voltage Standard

A LAB/WORKSHOP INSTRUMENT FOR ACCURATE MEASUREMENTS

BY TOM GILBERT

ELECTRONIC measuring instruments are so sophisticated—versatility combined with style and ease of use—that we often take the instrument's accuracy for granted. An audio VTVM, for example, may have a claimed accuracy of $\pm 5\%$ and we might assume that this means it is accurate to 5% at any time. However, the VTVM can have a *total variation* of 10% and still be within the manufacturer's specifications! In other words, unless the calibration is checked

frequently, and readjusted as necessary, $\pm 5\%$ can easily be 0 and -10% or 0 and $+10\%$.

Of course VTVM's can be calibrated using their internal calibration circuits, but age and temperature affect such circuits and the calibration is sometimes not as accurate as might be desired.

As another example, many oscilloscopes don't even have built-in calibrators; and, of those that do, the line voltage may be used as the calibration

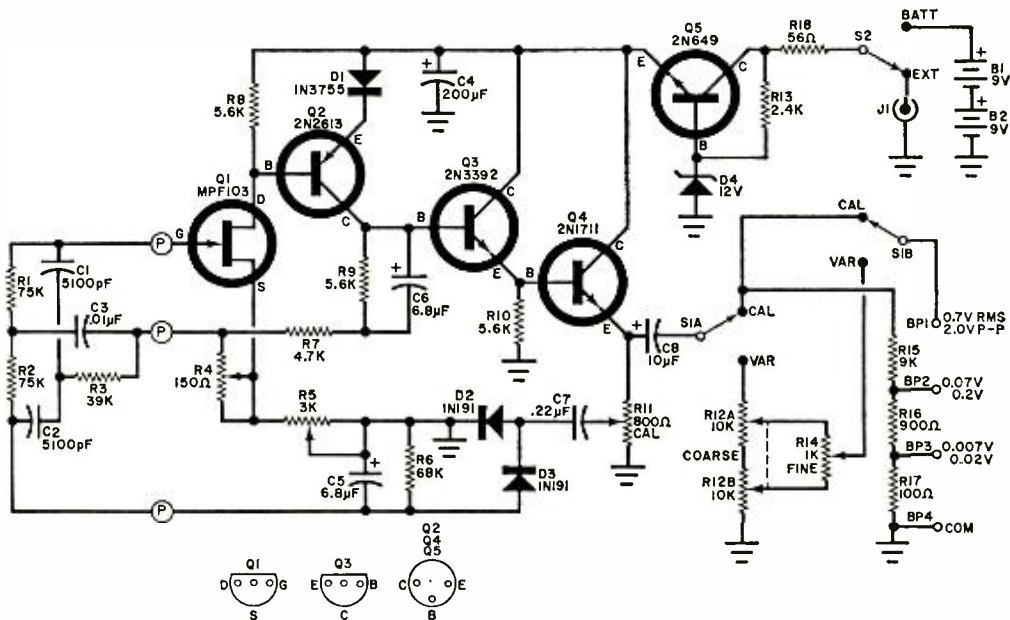

Fig. 1. The twin-T feedback oscillator incorporates both positive and negative feedback for stability and waveform purity. Frequency can be changed by replacing the twin-T filter.

PARTS LIST

- B1, B2—9-volt alkaline transistor battery (Mallory MX1604B or similar)
 BP1-BP3—5-way binding post, yellow (E. F. Johnson type 111-107 or similar)
 BP4—5-way binding post, black (E. F. Johnson type 111-103 or similar)
 C1, C2—5100-pF, 5%, polystyrene capacitor (Mallory type SX or similar)
 C3—10,000-pF, 5%, polystyrene capacitor (Mallory type SX or similar)
 C4—200- μ F, 12-volt, miniature electrolytic capacitor
 C5, C6—6.8- μ F, 6-volt, polarized solid-tantalum capacitor (Sprague type 150D or similar)
 C7—0.22- μ F, 100-volt Mylar capacitor
 C8—10- μ F, 12-volt subminiature electrolytic capacitor
 D1—1N3755 diode
 D2, D3—1N91 diode
 D4—12-volt, 1-watt zener diode
 J1—RC-A-type phono jack
 Q1—MPF103 field-effect transistor
 Q2—2N2613 transistor
 Q3—2N3392 transistor
 Q4—2N1711 transistor
 Q5—2N649 transistor
 R1, R2—75,000-ohm*
 R3—39,000-ohm*

- R4—150-ohm, miniature PC-type, wire-wound potentiometer (Clarostat type U-39 or similar)
 R5—3000-ohm, miniature PC-type, wire-wound potentiometer (Mallory type MR3000P or similar)
 R6—68,000-ohm*
 R7—4700-ohm*
 R8-R10—5600-ohm*
 R11—800-ohm, miniature PC-type, wire-wound potentiometer (Clarostat type U-39 or similar)
 R12—Dual potentiometer, 10,000 ohms per section, molded composition, linear taper (Ohmite type CCU or similar)
 R13—2400-ohm*
 R14—1000-ohm, molded-composition potentiometer, linear taper (Ohmite type CU or equal)
 R15—9000-ohm, 1% precision resistor
 R16—900-ohm, 1% precision resistor
 R17—100-ohm, 1% precision resistor
 R18—56-ohm, 10%, 1/2-watt resistor
 S1—D.p.d.t. slide switch
 S2—S.p.d.t. slide switch
 1—6"x5"x4" aluminum cabinet
 Misc.—Glass-epoxy PC board stock, L-brackets, 1/4"-I.D. soft rubber grommets (3), short lengths of 1/4"-diam. metal rod, dual battery clip, battery connectors (2), knobs, carrying handle, rubber feet (4), hardware, wire, solder, etc.
 *These resistors are 2%, 1/2-watt (IRC Metal-Glaze type RG-20).

source. At best, the accuracy of this type of calibration is no more dependable than the accuracy of the power-line potential. Even a zener-controlled calibrator can be in error by as much as 20%, depending on the tolerance of the diode.

Thus, to obtain reliable use from in-

struments such as the audio VTVM or the oscilloscope, you need an accurate audio voltage calibration standard. Using such a standard, it is possible to tell immediately whether the instrument is reading high or low—and by how much. The instrument calibration can then be

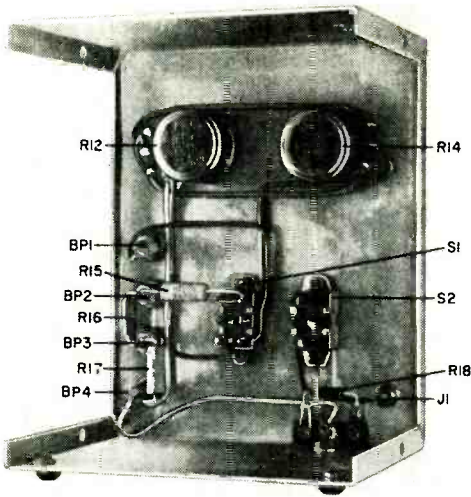

Fig. 2. Rear view of front panel showing component mounting. The four rubber feet are optional.

touched up to bring its accuracy up to that of the standard.

A commercial audio voltage standard can be quite expensive. The instrument described here, however, can be assembled for about \$35.00. When properly calibrated, it has an accuracy of $\pm 1\%$ over a temperature range from 60° to 90° F. Negligible variation occurs in the output signal level when the supply voltage is varied between 12 and 20 volts d.c. Compensating for temperature and voltage variations accounts for much of the cost of commercial instruments.

Actually the standard shown in Fig. 1 can be used for three purposes. It is a precise audio voltage standard; it is a

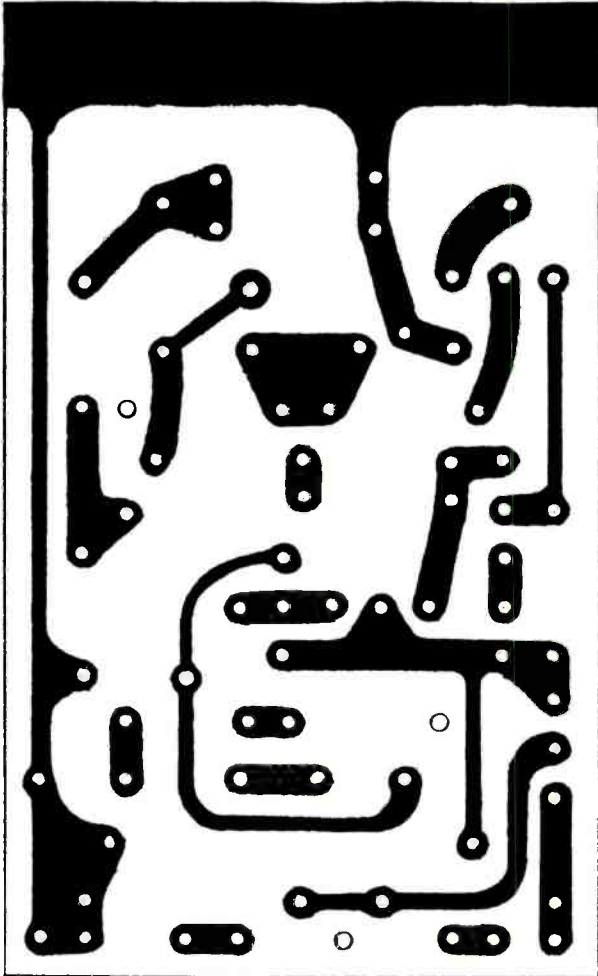
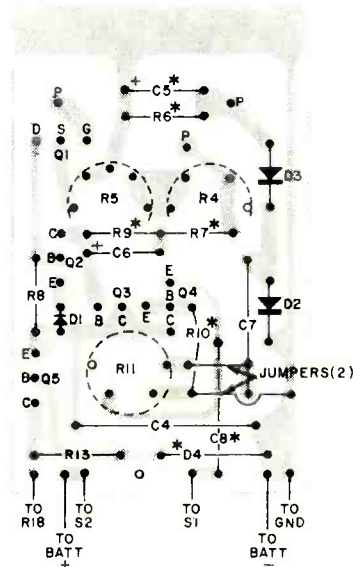

Fig. 3. Actual size foil pattern for the standard. Drill all holes including the three isolated plain circles.



* MOUNTED ON FOIL SIDE
P-MOUNTING HOLE FOR TWIN-T MODULE

Fig. 4. Note that some of the components are mounted on the foil side of the board to ease construction.

calibrator with accurate output levels of 0.7, 0.07, and 0.007 volts r.m.s.; and it is a 400-Hz audio signal generator with a clean, highly stable, sine-wave output of zero to 0.7 volts r.m.s., which is continuously variable and controlled by a double attenuator to provide both fine and coarse adjustments.

The seemingly odd value of 0.7 volts output is no accidental or arbitrary selec-

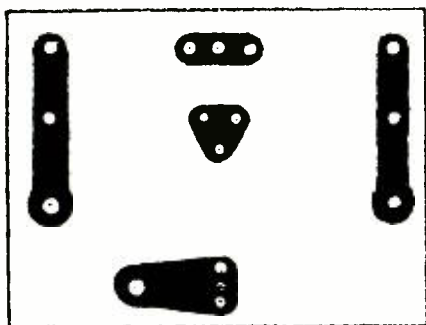

Fig. 5. Actual-size foil pattern for the twin-T PC board. A separate board is used so that, if it is desired to change frequency, you merely remove three screws and insert a new twin-T filter PC board.

tion. Actually the figure is 0.707, the reciprocal of the square root of 2. Thus 0.7 volts r.m.s. is 2 volts peak-to-peak. The r.m.s. value is used in calibrating a VTVM; 2 volts peak-to-peak is used to calibrate the vertical deflection of an oscilloscope. Both values are marked next to the output binding posts on the calibrator.

Power consumption for the instrument, from two 9-volt alkaline batteries connected in series, is about 90 milliwatts.

Construction. The audio voltage standard is assembled in a 6" × 5" × 4" metal enclosure, whose front-panel layout is shown in Fig. 2. The rest of the components are mounted on a pair of printed-circuit boards attached to the back of the front panel. Two circuit boards are used so that the twin-T frequency-determining network can be a separate, interchangeable unit. It is mounted on the main PC board using three 5/8"-high aluminum-alloy spacers and three 4-40 binder-head screws. Thus when it is desired to change the basic operating frequency of the standard, it

is only necessary to replace the twin-T board.

The main PC board is prepared using the actual-size foil layout of Fig. 3. The preferred material for the board is glass epoxy. After the board has been fabricated, assemble the components as shown in Fig. 4. Note that R_6 , R_7 , R_9 , R_{10} , C_5 , C_8 , and D_4 are mounted on the foil side.

The twin-T board can be prepared using the actual-size foil layout shown in Fig. 5. After etching, mount the components on the board (Fig. 6) noting that C_3 is mounted on the foil side. When both boards are complete, attach the twin-T board to the main board. The assembled PC board should be mounted securely in the cabinet, but preferably *not rigidly*. In the prototype, a three-point flexible mounting was made by using soft rubber grommets, short length of 1/4"-diameter rod (which fits the inner diameter of the rubber grommets snugly), flat washers, screws and nuts. Two of these assemblies were fitted to a 4 1/4" L-bracket at the top of the cabinet, and one was centrally located attached to a 1 1/8" bracket at the bottom. (See Fig. 7.) The grommet hole in the lower bracket was elongated to permit a vertical play of about 1/16". Details of the flexible board mount are shown in Fig. 8. The batteries are secured to the bottom of the chassis. The finished chassis is shown in Fig. 9.

Adjustment and Calibration. You will need a variable-voltage power supply capable of adjustment from zero (or near zero) to at least 18 volts d.c.; an oscilloscope; an accurate 400-Hz voltmeter standard; and a stable electronic audio voltmeter which can be calibrated against the voltmeter standard at 0.7 volt r.m.s. If you don't have a voltmeter standard, the audio voltage standard may be calibrated as accurately as available means

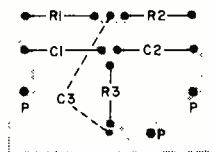

Fig. 6. Capacitor C_3 is mounted on the foil side of the twin-T PC board. The three holes marked "P" mate with similar holes on the main circuit board.

HOW IT WORKS

The standard consists of an audio oscillator (*Q1* and *Q2*), a buffer current amplifier (*Q3*), and an output current amplifier (*Q4*). To control the operating level, a portion of the output signal is rectified in a voltage-doubler circuit (*D2* and *D3*), filtered, and applied as reverse bias to the gate of *Q1*. This type of circuit is similar to the a.v.c. used in a radio receiver and, in this case, will hold the output voltage level extremely close to its calibrated setting.

Operating frequency is determined by a twin-T network (*R1*, *R2*, *R3*, *C1*, *C2*, and *C3*). Both positive (through *R4*) and negative (through *R5*) feedback are used to obtain stability and waveform purity (minimum harmonic content). Although the twin-T network described is designed for 400 Hz, any other frequency may be used.

The frequency stability of the circuit is excellent—on the order of $\pm 0.5\%$ at 400 Hz. To make the circuit independent of power supply variations, a supply regulator is used. Because the circuit consumes only 90 milliwatts, internal batteries are used, but provisions have been made for the use of any external power supply that can deliver regulated 18-volt d.c.

permit and can be depended on to hold this calibration for reference and comparison, even though its output may not be precisely 0.7 volt r.m.s.

The first step is to set the negative feedback control *R5* so that oscillation begins when the d.c. power-supply level is at 10.5 volts. To do this, first set OUTPUT switch *S1* at CAL, and POWER switch *S2* at EXT. On the main PC board, set potentiometer *R4* at maximum resistance and potentiometers *R5* and *R11* at midposition.

Connect the oscilloscope to the 0.7 V and COM output binding posts. Connect the variable-voltage d.c. power supply to J1 (lower left corner of the front panel). Set the power supply for zero output voltage and turn it on.

Advance the output control of the d.c. power supply *slowly* while observing the oscilloscope screen. Stop as soon as oscillation shows on the oscilloscope and note the output level of the power supply. If it is below 10.5 volts, *R5* should be advanced slightly; if it is above 10.5 volts, *R5* should be set for lower resistance. Set the power supply back to zero output, adjust *R5* as necessary, and make the check over again. Continue this process until oscillation begins at exactly 10.5 volts of power supply. Once oscillation begins, it will continue until the power supply has been reduced to 8 volts or

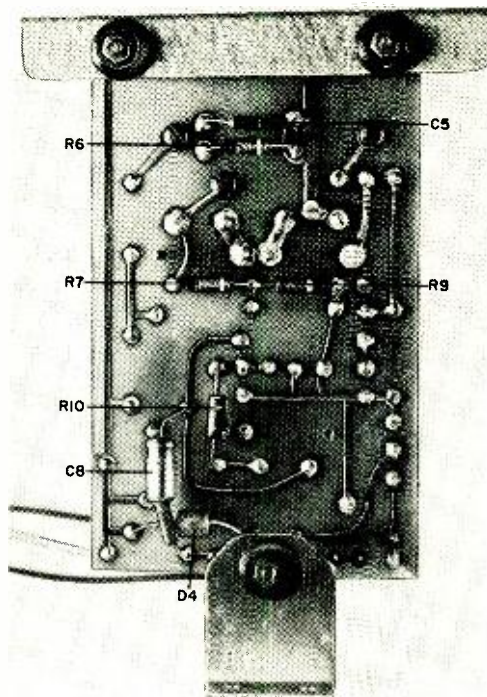
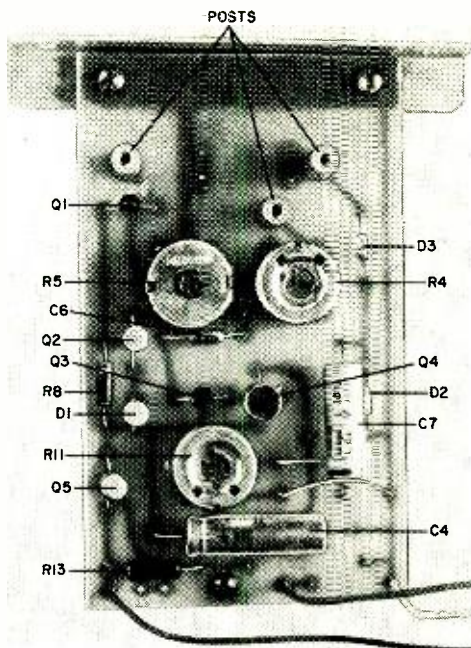
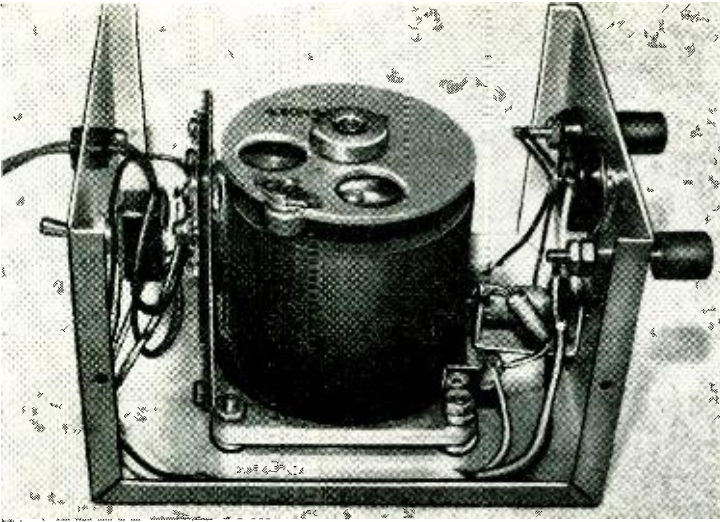

Fig. 7. Component location on the main PC board. The lower view also shows the method of installing the two flexible mountings. Use of these mountings reduces the possibility of instrument vibration which affects the stability of the oscillator.



Note how the Variac is mounted in the center of the enclosure with input components on one end, output on the other. This is bottom view of chassis.

regulated, insulation testing, TV picture tube temporary brightener, and vacuum-tube "burn-in" procedures. In fact, in any application where an a.c. power supply up to the maximum voltage available is required, the Volt Box can be used.

-30-

IMPROVING MILLIAMMETER ACCURACY

BY JACK SMALL



IN MANY CASES, a milliammeter is used in an application where only a small segment of its range is of importance. One such application is current monitoring in critical and semi-critical circuits. Here, only one specific reading is of any real importance; any deflection above or below that point indicates trouble.

The accuracy of the meter employed in such an application can usually be improved by comparing its reading in use against that of an instrument of known accuracy. If the two readings do not agree, simply adjust the milliammeter's mechanical zeroing screw (see photo) until both meters indicate the same value.

Of course, an adjustment of this kind generally makes the milliammeter even more inaccurate over other portions of its scale and will likely disturb its zero setting. But since only one deflection indication is of any real importance, no harm is done.

-30-

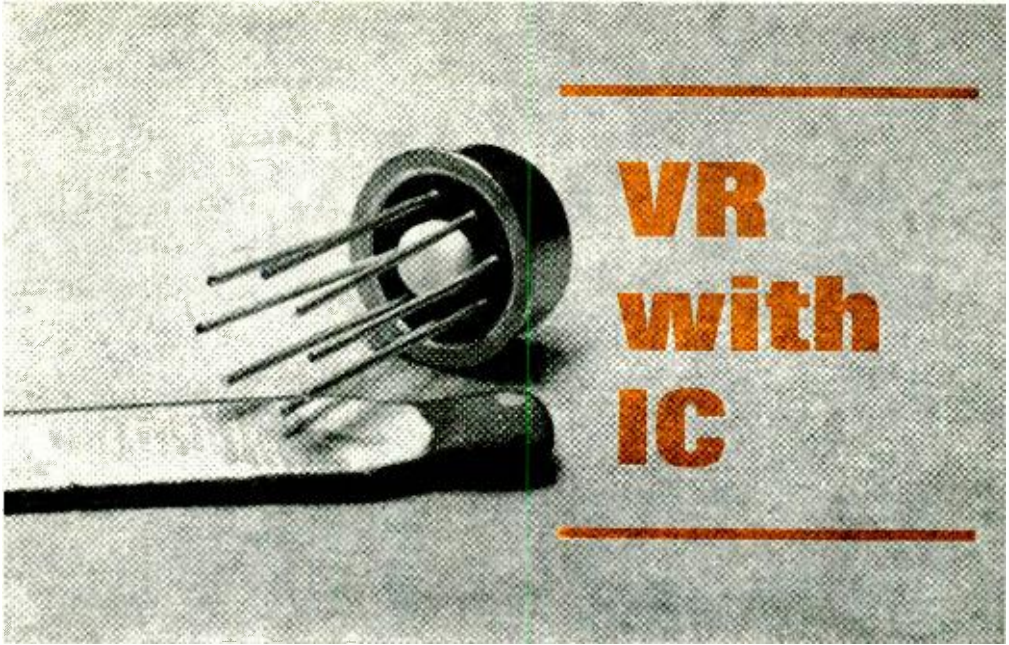

PRECISE REGULATION IN A TO-5 PACKAGE

BY TOM THORKELSON

THE WIDESPREAD popularity of the integrated circuit has brought to light the urgent need for an inexpensive regulated d.c. power supply that can be safely used for IC experimentation. Working on the assumption that most experimenters already have an unregulated power supply on their benches, the problem was to design an inexpensive accessory that could upgrade the common power supply to provide lab features.

Now, for less than \$5, such an accessory is obtainable in the form of the NJS300 voltage regulator available from New Jersey Semiconductor Products, Inc., Blue Star Shopping Center, U.S. Highway 22, Watchung, N.J. 07060.

This new voltage regulator IC employs 12 transistors, eight resistors, and three diodes—two of which are zeners—all contained in a compact TO-5 eight-lead package. The NJS300 accepts unregulated d.c. inputs ranging from +8 to +30 volts, and delivers any regulated d.c. output voltage between +2 and +20 volts.

When connected to the output of an unregulated power supply, voltage regu-

lation is 0.5% for load changes and 0.1% for a 1-volt change in input. The input-output voltage differential ranges from 3 volts minimum to 20 volts maximum. Additionally, the voltage regulator gives short-circuit protection, fast action regulation, choice of output voltages, and low idle drain.

With the addition of external components, you can build a power supply to deliver almost any regulated current. The short circuit protection simply shuts down the power supply when the output terminals are shorted together; removing the short restores the voltage to its former value.

How to Use. The voltage regulator's pin designations are shown in Fig. 1. You can leave pin 1 unconnected for standard regulator operation, or connect a resistor between pins 1 and 8 to provide current limiting. The resistor value can be determined from the relationship $R = 0.350/I$, where I is the desired current limit in amperes. For example, if you want to limit the current to 10 mA

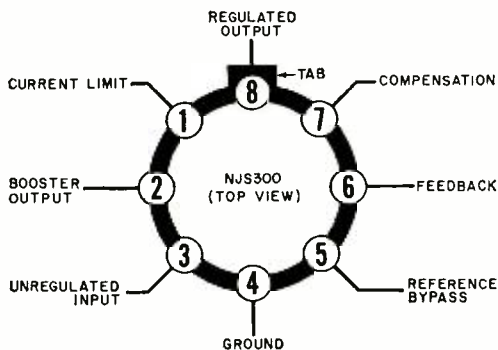

Fig. 1. Voltage-regulator pin arrangement. Components are added to provide for various load types.

(0.01 ampere) the resistance needed is $0.350/0.01$ or 35 ohms.

If you want to use the regulator for output currents not in excess of 12 mA, connect pin 2 to pin 3. For output currents exceeding 12 mA, other external components (to be given later) are needed.

The unregulated input voltage is applied to pin 3 and must never exceed 30 volts. An input below 8 volts cannot be properly regulated, though it is possible to get a regulated 2-volt output with the unregulated 8-volt input. In any case, the unregulated input must be at least 3 volts greater than the desired output.

Pin 4 is normally connected to the circuit ground. Do not make any connection to pin 5.

A portion of the regulated output is applied to pin 6 as feedback. The amount

of feedback used depends on the output desired. Two resistors are used as a voltage divider to obtain a portion of the output for the feedback. The ohmic values of these two resistors are determined from the curves in Fig. 2. For example, assume that a 4-volt regulated output is desired. The values of R_1 and R_2 (see How It Works) are found to be 5000 and 4000 ohms respectively.

A 47-pF capacitor should be connected between pins 6 and 7 for all applications to improve compensation response time.

Applications. Three different current-limiting circuits, suitable for a variety of

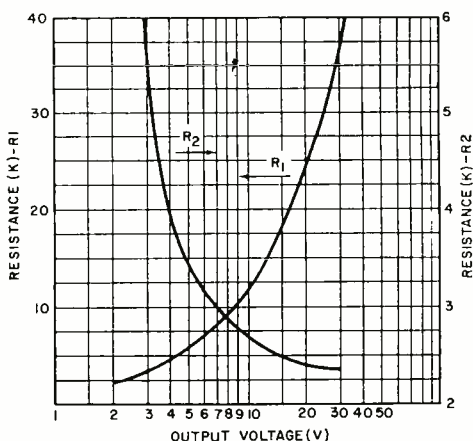
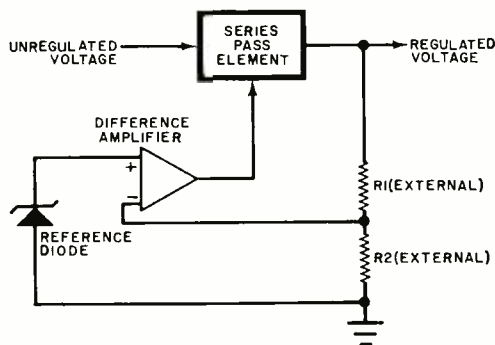

Fig. 2. Resistance values (in kilohms) for R_1 and R_2 in feedback circuit versus desired output volts.

HOW IT WORKS

The NJS300 voltage regulator consists of 12 transistors, 8 resistors, and 3 diodes, all deposited and interconnected on a single silicon chip $\frac{1}{16}$ " square. These 23 elements make up a feedback control system as shown in the diagram.

The unregulated d.c. input is applied to a series-pass element that is controlled by an error voltage from a difference amplifier. The error is determined in the amplifier by comparing a portion of the regulated output voltage with the voltage across a precise voltage reference diode. (The sample of regulated output is taken from an external voltage divider consisting of resistors R_1 and R_2 .) If the regulated output voltage is not correct, the error voltage developed by the difference amplifier causes the series-pass element to adjust the output until it returns to the predetermined value.



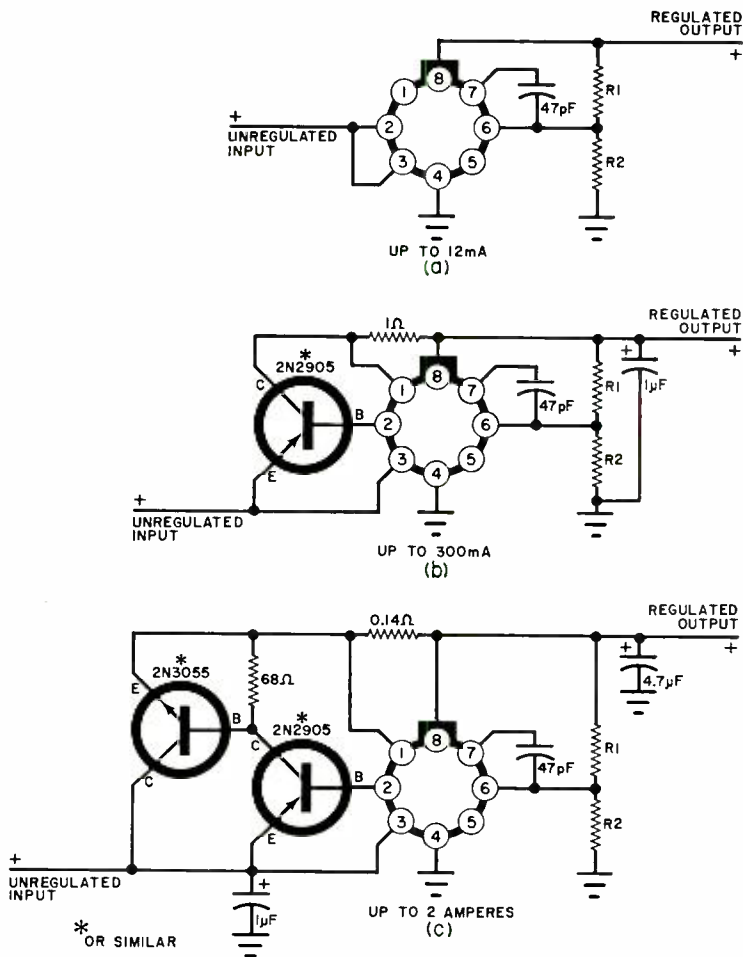
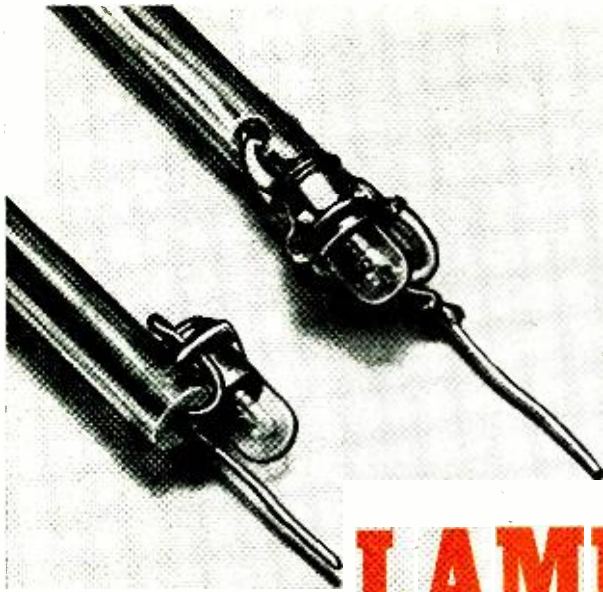

Fig. 3. Circuit at (a) provides a regulated output under 12 mA. Booster transistor is added in circuit (b) for output to 300 mA with smoothing capacitor. Second transistor (c) provides up to 2 A.

experimenters' power supplies are shown in Fig. 3. In Fig. 3(a), the current-limiting resistor between pins 1 and 8 is omitted because the current output demand should not exceed 12 mA. (A resistor could be added, of course, if a lower current limit is desired.) A transistor and resistor have been added in Fig. 3(b) to provide output current up to 300 mA. In Fig. 3(c), a pair of tran-

sistors is used to provide an output up to 2 amperes. In the second and third circuits, solid-tantalum filter capacitors have been added to improve smoothing. Also, in these two cases, the current-limiting resistors have been determined for the approximate maximum current value. If a lower current limit is required, the resistor value should be changed accordingly.



BUILD THE LAMPLEAK

FOOLPROOF TESTER CHECKS TRANSISTORS AND DIODES

BY IMRE GORGENYI

When you want to test a semiconductor, in or out of a circuit, you usually have two options: use a semiconductor test set (which you probably don't have) or an ohmmeter. The trouble with using an ohmmeter is that you might "pop" the transistor due to excessive current flow through the junction. Besides, you can never remember which lead goes where in order to identify transistor types.

Now, at very low cost, you can build the "Lampleak", a perfectly safe semiconductor test set that can be used with any type of diode or transistor without fear of getting the polarities wrong, or destroying the device due to excessive current flow. This tester does not tell the "quality" of the semiconductor—only whether or not it works.

The circuit consists of half of the secondary of a 6.3-volt filament transformer connected in series (through the probe tips) with a parallel circuit of two low-current pilot lamps and two diodes. If the two probe tips are connected directly

together, both lamps glow at a very low level, due to the low current flow through them. This current is not enough to damage any transistor or diode connected to the probes.

The circuit is arranged so that, if the probe tips are connected across a diode, regardless of which tip is connected to which end of the diode, only the lamp associated with the probe on the anode

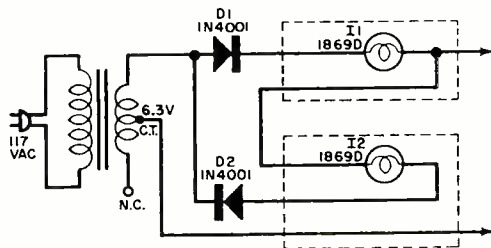

The lamps are connected so that, with equal potential on both probes, both lamps glow very dimly.

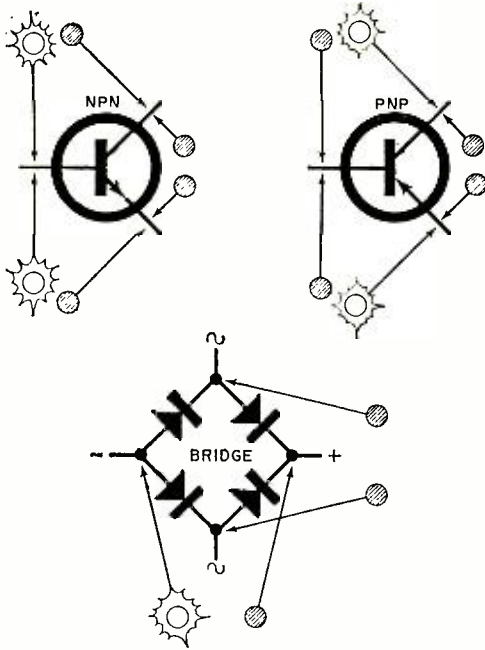

To check a transistor for type, connect probes as in two diagrams at top. If unit is npn, the lamp connected to the base will glow; if it is pnp, the lamp connected to either emitter or collector will glow. In a bridge rectifier, the lamp connected to the low side of d.c. glows.

glows, indicating a good diode. If neither lamp glows or if both lamps glow, the diode is bad.

Since transistors are similar to two back-to-back diodes, the sex of the unknown transistor can be determined easily. Merely connect one probe to the base lead, the other to either the emitter or collector. If the base lamp glows, the transistor is npn, if the lamp connected to the emitter or collector glows, the transistor is pnp. In a good transistor, of either type, connecting the probes between the emitter and collector should cause neither lamp to glow. If they do, leakage of less than 500 ohms is present. These tests, along with a test for a conventional bridge rectifier, are also shown in the illustration.

The author mounted the filament transformer and the two rectifier diodes in a small enclosure. The shells from a pair of ball-point pens were used as insulated probes. A hole, sufficient to accommodate the base of the pilot lamp, was drilled near the working end of each probe. The lamp wiring was fished through the probe and soldered directly to the bulb. Although the author used General Electric 1869D lamps, any similar type of low-current, 10-to-28-volt lamp can be used. The diodes can be any silicon rectifier type.

-30-

The transformer is mounted directly on the chassis with its secondary connected to the diodes mounted on terminal strip.

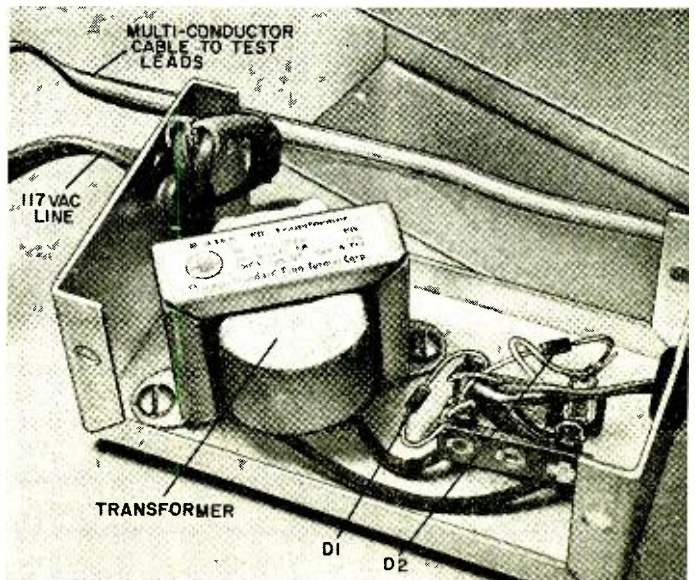



ON THE CITIZENS BAND

By MATT P. SPINELLO, KHC2060, CB Editor

WHAT'S CB?

AFTER 48 out of 50 people, when asked what they know about CB, say they never heard of it, the questioner realizes that he really is a foreigner. That was the case when your CB Editor spent nearly a month visiting London and Reading, England; Paris and Versailles, France; Frankfurt, Stuttgart, Boeblingen, and Fussen, Germany; portions of Austria; and Zurich, Switzerland.

Federal Communications Commission officials warned us before we left that, although getting a portable CB transceiver into Europe might present no problem, getting it back into the U.S. might be more difficult. So we left the rig at home (A wise move since we had plenty of trouble getting our battery-operated cassette recorder back in—the Customs officer could see plainly that it was “made in Austria”!)

Our main interest was to monitor the 11-meter band to determine the extent of skip conditions and to see how various Europeans might be using the band. The first thing we found out was that CB is against the law in most of Europe.

Sp/4 Paul Sojka, stationed in Europe, but by now on his way home to Perth Amboy, N.J., gave us a U.S. Army bulletin, issued April 15, 1968, entitled “Unauthorized Operation of Citizens Band (CB) Radio Equipment” in the European Command area. It states that the frequency band 26,960 kHz to 27,280 kHz is allocated by the countries concerned to uses in the areas of public safety, law and order, commerce, trades and sports clubs. “Use of the band for individual personal communications known as ‘Citizens Band’ operation is not authorized.” The prohibition includes every type of radio equipment capable of radiating a radio signal in the band, regardless of power, including home installations, walkie-talkie type portables, and “toy” radios capable of emitting a signal.

Although operation of CB equipment is not authorized in the European theater, it is available for purchase in exchanges, audio clubs and other sales outlets. The operation of such equipment purchased must be de-

ferred, however, until the purchaser returns to the U.S. Personnel operating CB gear within the Command obviously render themselves liable to prosecution by the civil authorities of the country concerned, including confiscation of the equipment, fines, and other punitive action.

Getting the Facts. In England, six electronics sales engineers pleaded guilty to having no prior knowledge of the CB concept; a seventh had a storehouse of knowledge about CB clubs, their functions, CB jamborees, and emergency team activities. He quoted many of the statistics from our U.S. Monitor—he is a POPULAR ELECTRONICS subscriber!

Ten German electronics engineers in Sindelfingen, Germany, shook their heads in unison when asked about personal communications: “no CB, no Citizens Radio, no Citizens Band.” They had never heard of it! Walkie-talkies they had heard of, but the ones they knew were khaki in color and were used only by a helmeted soldier—like TV. “We are not allowed personal two-way radio,” Hans Deiter Schmidt told us. “Those frequencies are reserved for governmental use!” He was right, at least in Germany.

Despite the laws, Rotterdam, Holland readers supplied us with a shocker when they told us that their CB club has had at least 300 contacts with U.S. CB'ers—all confirmed by QSL's. The club secretary admits that the members' callsigns (nearly 400) are made up by the club and that they also use “skip-names.” The secretary's code name is “Batman.”

The Holland CB Club sports its own newsletter and printed stationery, to boot. Members say they have recently contacted U.S. stations such as “Wild Cat,” “Red Robin,” “Dean Walker,” and several untalented ones in Tennessee. We appreciate their choice of POPULAR ELECTRONICS as their “most popular paper outside Holland,” but we frown on their admittedly illegal operating tactics—in which they are sticking out their necks farther than their antennas!

More Ports Abroad. Sp/4 Bill Wilhelm, currently serving a hitch in Vietnam, returns to the U.S. for a 30-day leave about the time this column goes to press. Formerly active as KBQ7415 in Tampa, Fla., Bill is interested in receiving word from other CB'ers active in the H.E.L.P. program. Parties interested in corresponding with him during his brief leave and again after another six-month hitch in Vietnam may contact him at 3210 W. Minnehaha, Tampa, Fla. 33614.

Murray Bott, 46 Arundel St., Hillsborough, Auckland 4, New Zealand, reports that he and several other New Zealanders are interested in learning more about the American Citizens Band operation.

Attention Fox-Charlie-Charlie. Trouble spots reporting illegal CB operation include *Norwalk, Conn.*, where unsolicited comments, some of them nasty and profane, are said to be cutting in on legal communications . . . *Metairie, La.*, linears in use; code names: "Gator," "Bones," "Slick Foot," "Louisiana Anna," and "Toad Frog." . . . *Pittsburgh, Penn.*, "The Crusher," reported to be a skinny beatnik, has everyone believing he is a tough guy; "The Whisper," who reportedly drives around in an expensive, beefed-up car, makes filthy remarks on the air; informants say "reliable source indicates violators are tipped off when FCC is coming to town, and lay low until the all-clear is sounded." . . . *Grand Rapids, Mich.*, short-wave listener suspects "bootlegged" transmitter operating far above 5 watts; on-air interchange exceeding 35 minutes; illegal operators using the names like "Tweety Bird," "Old Fox," "Redstick," "Flying Irishman"; skip from New Brunswick, Louisiana, Alabama, and North Carolina, working Michigan.

Our answer to the situations noted above can be summed up by the Electronics Industries Association, Citizens Radio Service Section, Washington, D.C., in its current message to Citizens Radio Operators:

"ANY NUT CAN BREAK THE LAW— but it takes a *man* to respect the rights of others. And in the citizens radio service, that's what 'the law' is all about, of course—simple, common-sense rules to help insure *the right of all to communicate.*

"Maybe most of the real problems are created by that small 'obnoxious minority,' but aren't all of us a little too windy at times? A little too quick to make that next call? A little too willing to work that beautiful skip signal 'just this once'?"

"Let's *all* come out of our shells and
(Continued on page 116)

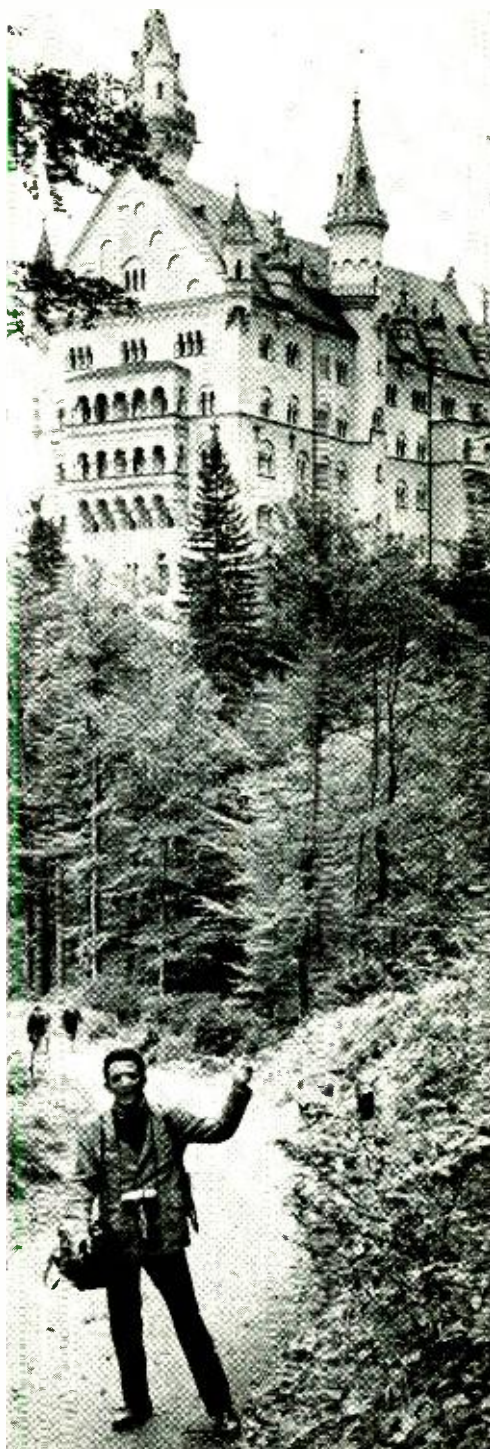

CB Editor Sp nello, complete with tape recorder and cameras, stands near the back door to the Royal Castle, Neuschwanstein, in Fussen, Germany. The castle in Disneyland is said to be a model of it.



SOLID STATE

By LOU GARNER, Semiconductor Editor

EVERYONE HAS HIS "moment of truth"—ours comes in January when we examine our predictions for the previous year. Here were our predictions for 1968—and how we scored on them:

● *IC's and SCR's in toys.* Home run! Montgomery Ward introduced an IC project kit in the toy section of its 1968 Christmas catalog; REMCO, a major toy manufacturer, offered remote control toys using SCR circuits.

● *High-power FET's.* Home run! Although a majority of currently available FET's have maximum power dissipation ratings of only a few hundred milliwatts, the 2N3970-72, 2N4091-93, and 2N5018-19 types are all rated at 1.8 watts, while the CP600-603 series has ratings up to 9 watts, and the CP 650-653 series carries 8-watt ratings.

● *A portable solid-state color TV receiver.* Not a hit, but score a base on balls. While we find no listing of a fully transistorized portable color-TV set in available catalogs, a number of receivers employ hybrid (part tube, part transistor) circuitry. One semi-portable receiver, for example, has forty-six semiconductor devices and only eleven tubes.

● *Development of a new type of semiconductor transducer.* Home run! Refer to our mention of an infrared-to-visible-light converter in March, to our discussion of the Pitran pressure transducer in November, and, finally, to our description of a new ultraviolet sensor in December, 1968.

● *A solid-state video recorder at a price competitive with high-quality audio tape recorders.* Home run! A studio-quality tape recorder may sell for well over \$1,000 while top-quality professional units, such as the Tandberg Model 64X, sell for over \$500. In contrast, the Sony Model CT-2100 Videorecorder is offered in Allied Radio's current catalog for only \$795.

● *A.C. control devices with integral-triggering elements.* Home run! See our February, 1968 column for a practical circuit using RCA's model 40431 triac, a medium-power, bi-directional control device with an integral trigger component.

● *An inexpensive solid-state oscilloscope kit.* Strike-out! Optimistic, we felt sure some-

one (anyone?) would introduce such a kit, but apparently our enthusiasm wasn't shared by industry.

● *A drop in the cost of medium- to high-power high-frequency transistors, making them generally competitive with tubes for ham and communications applications.* Home run! Motorola's 2N3866, with 5 watts power dissipation and an f_T of 800 MHz, nets for less than \$3 each in small quantities, while RCA's 2N2631, which can handle 7.5 watts at 50 MHz, now nets for under \$4.

● *Introduction of project kits featuring IC's as their main circuit elements.* Home run! Lafayette Radio's latest catalog features several such kits, including RCA's popular KD-2112, described in "The Product Gallery" in our April, 1968 issue.

● *IC's featuring FET's.* Home run! As reported in our April, 1968 column, a major test instrument manufacturer, Tektronix, has been successful in combining 5 p-channel FET's and 30 npn bipolar transistors on a single IC chip.

● *Development of a radically new type of semiconductor manufacturing process.* Home run! Several new manufacturing methods were announced during 1968, including Bell Telephone Laboratories' new technique for producing ultra-dense IC's, as described in our September, 1968 column.

So, we scored 9 home runs, 1 base on balls, 1 strike-out in eleven times at bat.

Things to Come. Now—like a fool rushing in where angels fear to tread—here are our predictions for 1969. *Development of an r.f. power transistor capable of handling well over 100 watts . . . a solid-state oscilloscope (either kit or factory-built) for approximately \$100 . . . IC's at over-the-counter prices of \$1 (or less) each . . . another major firm introducing a line of experimenter/hobbyist semiconductor devices . . . expanded use of solid-state equipment in the war against crime, including the use of radios by foot patrol officers . . . lower prices for semiconductor lasers, making them suitable for some experimenter applications . . . higher manufacturing efficiencies, resulting in lower prices for FET's as well as high-*

voltage diodes and bipolar transistors . . . development of new microwave semiconductor devices which can challenge even the more exotic vacuum tubes.

Transistips. With literally thousands of transistor types now offered by semiconductor manufacturers, one is likely to forget that there are a number of basic characteristics which are common to each class of device, regardless of individual specifications. A bipolar transistor, for example, has a relatively low-to-moderate input impedance (in the common-base configuration) when compared to either vacuum tubes or field-effect transistors (FET's), no matter what its voltage rating, frequency response, gain, or power dissipation. Similarly, an insulated-gate FET (IGFET or MOSFET) has the highest input impedance of any amplifying device.

Intended as a general guide for students, hobbyists, experimenters, technicians, designers and practical engineers, the table below compares the characteristics of vacuum tubes, small-signal and high-power bipolar transistors, and junction and insulated-gate FET's. In each case, the characteristics listed are those encountered in the most common circuit configuration.

Reader's Circuit. In a broad sense, heat is the natural "enemy" of electronic components. Prolonged moderately high temperatures can cause electrolytics to dry out and lose capacitance (or even short), insulation to become brittle and break down, coil impregnants to melt, etc. Excessively high temperatures, even for short periods, may cause permanent changes in semi-conductor device characteristics. Recognizing these facts, reader Bruce J. LaVaia (67-25 FT "A" School, SCC NTC, Bainbridge, Md. 21905) devised the solid-state

temperature-sensing and control circuit illustrated in Fig. 1. Bruce writes that he has installed such a circuit in his personal hi-fi equipment and suggests its use not only in audio amplifiers, but in TV sets, communications receivers, medium-power transmitters, and other types of electronic equipment.

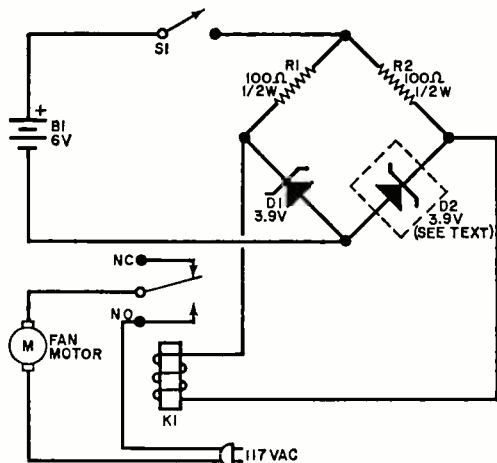

Fig. 1. Zener diode, D2, in electronic equipment, senses heat, unbalances bridge and turns on fan.

Referring to the schematic, fixed resistors R1 and R2 form a temperature-sensing bridge network in conjunction with zener diodes Z1 and Z2, with the latter mounted within the critical (high-temperature) area. Bridge power is furnished by B1, controlled by S1. In operation, a rise in Z2's temperature results in a corresponding shift of its conduction characteristics, unbalancing the bridge, and furnishing coil power to relay K1, which closes, operating a ventilation (Continued on page 99)

COMPARATIVE CHARACTERISTICS OF ACTIVE DEVICES

CHARACTERISTIC	VACUUM TUBE	SMALL-SIGNAL TRANSISTOR	HIGH-POWER TRANSISTOR	JUNCTION FET	MOSFET
Input impedance	High	*	Very low	High	Very high
Output impedance	High	*	Low/moderate	High	High
Noise	Low	Low	Moderate	Low	Unpredictable
Warm-up time	Long	Short	Short	Short	Short
Power consumption	Large	Small	Moderate	Very Small	Very small
Aging	Appreciable	Low	Low	Low	Moderate
Reliability	Poor	Excellent	Very good	Excellent	Very good
Overload sensitivity	Excellent	Good	Fair	Good	Poor
Size	Large	Small	Moderate	Small	Small

*Impedances depend on circuit arrangement:

	Input Impedance	Output impedance
For common base	Low (10's of ohms)	High (megohms)
For common emitter	Medium (kilohms)	Medium (10's of kilohms)
For common collector	High (100's of kilohms)	Low (100's of ohms)

6 good reasons to get into electronics:

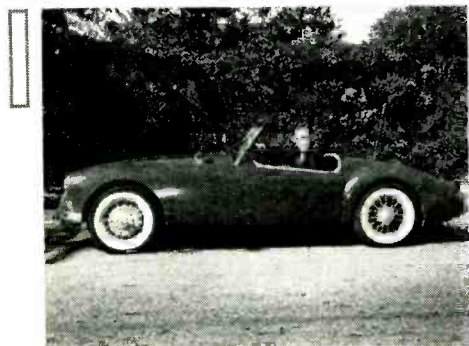

Want more reasons? Read on...

A future? Electronics *is* the future. Build your career in a field that's growing this fast, and you should grow fast.

Security? When you're an electronics technician, you have the kind of security a man really wants: the knowledge that there now are more good jobs in your field than men to fill them.

Travel? Excitement? Advancement? Yes. Electronics has the good things you're looking for . . . and maybe even a few more that will surprise you.

Don't forget money. There's money in electronics. You can make a good living. And when it comes right down to it, that's what a career is all about.

What's the catch?

Just this: nobody can do it for you. You have to want to get into electronics. You can't become a highly-paid electronics technician by just saying a magic word.

It takes some work. But we can teach you what you need to know—in one of our schools—or at home, by mail. It's probably a lot easier and a lot faster than you think. Why not find out? Make the first move. Send in the post card . . . and make things start happening!

DE VRY INSTITUTE OF TECHNOLOGY
4141 BELMONT AVENUE, CHICAGO, ILLINOIS 60641

119R



ONE OF THE

BELL & HOWELL SCHOOLS

ENGLISH-LANGUAGE BROADCASTS TO NORTH AMERICA FOR THE MONTH OF JANUARY

Prepared by **ROGER LEGGE**

TO EASTERN AND CENTRAL NORTH AMERICA		TO WESTERN NORTH AMERICA	
TIME—EST	STATION AND LOCATION	TIME—PST	STATION AND LOCATION
	FREQUENCIES (MHz)		FREQUENCIES (MHz)
7:00 a.m.	Melbourne, Australia	8:00 a.m.	Oslo, Norway (Sun.)
7:15 a.m.	Montreal, Canada		Stockholm, Sweden
7:45 a.m.	Copenhagen, Denmark		Tokyo, Japan
9:00 a.m.	Stockholm, Sweden	5:00 p.m.	Melbourne, Australia
4:00 p.m.	Hilversum, Holland	6:00 p.m.	Lisbon, Portugal
6:00 p.m.	Montreal, Canada		Tokyo, Japan
7:00 p.m.	Peking, China	6:30 p.m.	Johannesburg, South Africa
	Sofia, Bulgaria	7:00 p.m.	Budapest, Hungary
7:30 p.m.	Budapest, Hungary		London, England
	Johannesburg, South Africa		Madrid, Spain
	Stockholm, Sweden		Peking, China
7:50 p.m.	Brussels, Belgium		Quito, Ecuador
	Vatican City		Seoul, Korea
8:00 p.m.	Berlin, Germany	7:30 p.m.	Berlin, Germany
	London, England		Bonaire, Neth. Antilles
	Moscow, U.S.S.R.		Prague, Czechoslovakia
	Prague, Czechoslovakia		Stockholm, Sweden
	Rome, Italy		Tirana, Albania
8:30 p.m.	Berne, Switzerland	8:00 p.m.	Havana, Cuba
	Bucharest, Rumania		Lisbon, Portugal
	Cologne, Germany		Moscow, U.S.S.R. (via Khabarovsk)
	Hilversum, Holland		Peking, China
	Tirana, Albania		Sofia, Bulgaria
9:00 p.m.	Havana, Cuba		Tokyo, Japan
	Lisbon, Portugal	8:30 p.m.	Bucharest, Rumania
	Madrid, Spain	8:45 p.m.	Budapest, Hungary
	Peking, China		Berne, Switzerland
	Quito, Ecuador		Cologne, Germany
9:30 p.m.	Bonaire, Neth. Antilles	9:00 p.m.	Havana, Cuba
	Johannesburg, South Africa	10:00 p.m.	Moscow, U.S.S.R. (via Khabarovsk)
	Budapest, Hungary		Tokyo, Japan
	London, England	10:30 p.m.	Havana, Cuba
	Moscow, U.S.S.R.		
	Prague, Czechoslovakia		



SHORT-WAVE LISTENING

By HANK BENNETT, W2PNA/WPE2FT
Short-Wave Editor

THE POWER RACE CONTINUES

WITH THE PASSAGE of time, more and more short-wave stations (and medium-wave stations, too) are turning to transmitters of super power ratings to make themselves heard through the maze of same- and co-channel interference. Not too long ago a short-wave station with a power output of 50 kW was really something!

A good example of a really small station entering into the high-power race is *Radio Barlavento*, Cape Verde Islands. Currently operating on 3910 kHz with a mere 1000 watts, the station has ordered a new transmitter with a power rating of 100 kW!

The *Voice of America*, with super stations of 1000 kW (that's one million watts), located on Okinawa on 1178 kHz and in the Philippines on 1140 kHz, has added another unit with the same power rating at Bangkok, Thailand (1580 kHz). It's not positively confirmed, but *Radio Kuwait* is said to be using 750 kW on 539 kHz. Saudi Arabia has a huge station reportedly operating with 2000 kW on 647 kHz and the largest broadcaster may be in Urumchi, China, used by *Radio Peking* for Russian service to Europe on 1525 kHz. It is listed by some sources at no less than 8000 kW!

News Items. *Radio Nederland* has announced that it will repeat its two previous radio courses: Short-Wave Propagation and Transistors. You can still enroll in its All-Around DX'ers course also. Mail separate requests to (name of course), DX Juke Box, *Radio Nederland*, P.O. Box 222, Hilversum, Holland.

According to a statement made by Wieslaw Groszecki, new editor-in-chief of the German section of the Polish *Radio*, and which was published by *Deutsch Volkzeitung*, the German broadcasts from Warsaw have been increased from two and one-half to four hours a day. A new pop show will be broadcast daily at 1900, and a new Polish-language course will be offered. Complete details and booklets may be obtained at no charge by writing to *Radio Warsaw*, Warsaw, Poland.

Operations in the 11-meter band continue in spite of slowly lowering sunspot activity. Monitors in the past month have logged the following: London on 25,650 kHz at 1447-1515 with "Radio Newsreel"; *Radio RSA*, Johannesburg, South Africa, 25,790 kHz, from 1745 with English news; Oslo, Norway, on 25,900 kHz at 1755-1826 and on 25,730 kHz from 1615-1631, both with Norwegian programming but an English ID on the hour or half-hour.

Radio Euzkadi, a clandestine Basque station, often rumored to be in various parts of Europe as well as in South America, has a mailing address (as we gave it last October) of B.P. 59, Poste Centrale, 75-Paris (16), France. This is correct. Thinking at that time was that the station was located near the west coast of Europe or near the Spanish-French border. For what it's worth, and this may be the missing clue, a recent QSL, received in three weeks, was postmarked from St. Jean de Luz in the French Basque province of Basses Pyrenees. This indicates that the station is using a high-powered fixed installation rather than a mobile unit.

Birthday greetings are in order, belatedly, to *Radio New Zealand*, which celebrated its



Javad Masbahi, of Shiraz, Iran, uses a Hammarlund HQ-150 receiver and has a Hallicrafters S-38 for a standby. As a licensed radio amateur, callsign EP2DM, he has worked in excess of 100 countries with his 50-watt transmitter and a dipole antenna.

20th anniversary in September, and to the International Short Wave Club of England on its 40th anniversary last October 4th. Little known among SWL's is the fact that the ISWC was founded in 1929 right here in the USA. We wish both many pleasant years of further activity.

Radio Zaracay, Santo Domingo de los Colorados, Ecuador, often good on 3390 kHz between 0400-0500 with musical programming, is having building fever. Currently underway are four transmitters, each 3500 watts (two for short-wave but no frequencies given), two emergency power plants, a four-story studio and office building, a 5000-seat auditorium, and a vacation villa at San Jacinto de Manabi Beach for the benefit of vacationing station personnel.



New newsroom of Radio New York Worldwide, Inc. at 485 Madison Ave., New York City, is large enough to accommodate 20 journalists and has five United Press lines, one Associated Press, Reuters and United Nations lines. The company operates WNYW, the only international commercial radio station in the United States, and FM stereo station WRFM-New York.

We urge all of our readers to check the newsstands for the new 1969 COMMUNICATIONS HANDBOOK. Among other features it contains a completely revised and updated combined country and zone listing to be used in conjunction with the new All Zones Awards. The ground rules for the new Zones Awards were given in our October column and may also be found in the new Handbook. Please note that the new Country-Zone listing will be the only official listing accepted for the POPULAR ELECTRONICS DX Award Program.

CURRENT STATION REPORTS

The following is a resume of current reports. At time of compilation all reports were as accurate as possible, but stations change frequency and/or schedule with little or no advance notice. All times shown are Greenwich Mean Time (GMT) and the 24-hour system is used. Reports should be sent to Short-Wave Listening, P. O. Box 333, Cherry Hill, N. J. 08034, in time to reach Your Short-Wave Editor by the fifth of each month. Be sure to in-

clude your WPE identification and the make and model number of your receiver.

Albania—Tirana's latest English schedule calls for xmsns of one half-hour at 0030 and 0130 on 6200 and 7300 kHz and 0300 on 9510 kHz. The IS is 9 notes on two trumpets in a minor key. Other loggings include one in Albanian on 9665 kHz until 0230 s/off; in Spanish on 11,860 kHz at 1725 and in Portuguese on the same channel from 2130 s/on; on 7135 kHz in Arabic at 0330-0400 and from 0430; jamming noted before 0330 and from 0400-0430.

Austria—The latest schedule from *Austrian Radio* reads: to N. A. in English on even dates at 0000-0400 on 6155 kHz and 2300-0000 on 9770 kHz and on odd dates at the same times but with the frequencies reversed. Dates are based on GMT.

Belgium—"Belgium Speaking" in English is broadcast as a part of the xmsns for Belgians abroad in French and Flemish. These xmsns are scheduled at 2205-2215 on 6010, 9615 and 15,335 kHz and at 0050-0100 on 6010, 6125 and 11,885 kHz. A mailbag is aired Thursday. These English segments will be longer in the future.

Bolivia—*La Voz del Ferroviario*, Uyuni, 5990 kHz, verified an old report stating that they are off the air due to government intervention. No date for return. CP90, R. Juan XXIII, San Ignacio Velasco, 4951 kHz, verified after many attempts; it runs 1 kW with daily closing between 0300-0330.

British Honduras—*R. Belize*, Belize, 3300 kHz, continues to be widely reported from 0125-0435 s/off with mostly English programming. Your Editor often finds the medium-wave outlet on 834 kHz to have a better signal.

Congo (Dem. Rep.)—The frequency of 11,866 kHz is again in use with an English ID of "This is the Voice of the African Brotherhood" at 1900 and in French as "La Voix de la Fraternite Africaine". The ID is followed by pop music. Location is Lubumbashi.

Costa Rica—*R. Reloj*, San Jose, has effected another move as noted with an ID at 0210 in usual Spanish on 6067 kHz. American pop tunes follow. TIQ, R. Casino, Puerto Limon, 5954 kHz, has American gospel programs in English on Sunday at 0500-0600.

Czechoslovakia—Prague has English for 15 minutes after each hour during the 1800-2100 xmsn on 21,450, 11,990, 9600, 9505, 6055 and 5930 kHz. Other channels in use include 1286, 7345, 9575, 11,800, 15,310, 17,840, and 21,700 kHz for various xmsns in German, English, French and Italian. An unlisted channel in use at press time is 9762 kHz, noted at 2330-2358 s/off in Spanish to Latin America, as announced.

Ecuador—HCMP2, *La Voz de la Peninsula*, (location unknown) runs 350 watts on 4898 kHz but they expect to move "soon" to 3905 kHz. Best listening time is after 0300.

Ethiopia—ETLF, Addis Ababa, heard s/on at 0330 to E. Africa in Swahili on 9600 kHz and at 0430 s/on on 15,180 kHz. One veteran monitor claims that the xmsns around this time of night often provide far more consistent reception.

Formosa—The 0200 English release on 17,720 kHz is now beamed to Hong Kong, Macau, Australia and New Zealand, as well as to the US, Hawaii and Japan.

Gabon—*Radiodiffusion Gabonaise*, Libreville, was heard with native folk music and French anmts on a Saturday at 2235-2312 s/off on 4777 kHz.

Germany (East)—*R. Berlin International* is on 21,475 kHz with English until 1730 s/off and in French to Africa at 1815.

Guatemala—TGQB, R. Nacional, Quetzaltenango, has been found testing on 11,700 kHz around 2230 and earlier in English and Spanish and requesting reports on their new international service. TGCH, R. Chortis, Jocotan, 3380 kHz, is good as early as 0200 with US and Guatemalan music and commercials; news in Spanish at 0255-0300 s/off.

Holland—*R. Nederland*, Hilversum, has English to N.A. at 2055-2150 on 15,425 kHz (repl. 17,810

(Continued on page 104)

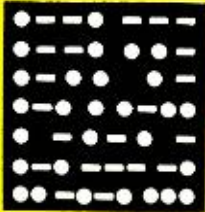

AMATEUR RADIO

By **HERB S. BRIER**, W9EGO
Amateur Radio Editor

THE FCC WRITES LETTERS/TAKES ACTION

TO KEEP the record straight, our September, 1968 item that the FCC had decided that Technicians who had never held any other amateur licenses were eligible for Novice licenses was in accord with a Commission letter dated May 2, 1968. On September 20, 1968, Mr. James E. Barr, Chief, Safety and Special Services Bureau, informed your columnist that the May letter was in error: the Commission has never had any intention of issuing a Novice license to an already-licensed Technician.

As reported last month, the FCC has proposed that Section 97.9 (f) of the amateur regulations be modified to make any citizen who has not held an FCC-issued amateur license within the preceding 12 months eligible for a Novice license. However, paragraph 5 of this proposal (RM-1288) states: "No person would be permitted to hold Novice and Technician Class licenses concurrently."

In another letter (to Al Fisher, W6ZHH) printed in the *WCARSentinel*, Reno, Nevada, the FCC states that any amateur who originates or relays messages (including

phone patches) into commercial establishments to buy, sell, or to enquire about prices or shipping information of radio gear either for himself or others is engaged in a prohibited remunerative operation and has a pecuniary interest in his license. The prohibition does not apply to an individual amateur who occasionally buys, sells, or swaps a piece of old radio equipment over the air, although the FCC does not encourage such transactions.

The FCC has recently taken action against several amateur operators for alleged violations of the Rules. Sam A. Johnson, Jr., WA4MVY, lost his Conditional class license for six months for malicious or willful interference with other amateurs. Five operators had their license suspended for six months or a year on various charges such as damaging the equipment of a licensed station, malicious or willful interference, and transmitting music: Joseph S. Renzi, WB6FNV; Brandon H. Sinay, WB60FD; Michael S. Ingram, WB6RBR; Norman A. Scott, WB6TRQ; and William K. Ingram, WB6RBQ. Charges of willfully damaging

AMATEUR STATION OF THE MONTH



Proving that AM phone on low frequencies is not forgotten, Paul "Mike" Desharnais, WA1PD, 22 Cote St., Somersworth, N. H. 03878, worked 28 states and 10 countries with his Johnson Valient transmitter and Hammarlund HQ-110C receiver—in six months on Sunday mornings! His antenna is a multi-bander fed with openwire transmission line via a Johnson Match Box. As Amateur Station of the Month, WA1PD gets a 1-year subscription to **POPULAR ELECTRONICS**. If you would like to enter this monthly contest, send a sharp, black-and-white photo of yourself at the controls of your station and details of your radio career to: Herb S. Brier, Amateur Radio Editor, **POPULAR ELECTRONICS**, P.O. Box 678, Gary, Ind. 46501.

the equipment of a licensed radio station brought against Damian A. Osterday, WB6RYE, have been withdrawn after he supplied evidence to prove that he was in the clear.

Incidentally, from *Radio Communications* (London), we learn that half a dozen Englishmen were recently convicted of unlicensed amateur operation. They were assessed relatively heavy fines and court costs, and most of them had all or part of their equipment confiscated.



Tom Clancy, WA3GUI, Beltsville, Md., has worked all states and 64 countries. He has a Heathkit DX-60B transmitter, HR-10 receiver—aided by an AMECO preamp—and a trap dipole antenna. WA3GUI has an Advanced license and a 25-wpm certificate.

Eye-Bank Network in Operation. Via George, W6AEV, and the *WCARSentinel* comes the information that a 19-year-old "hippie" girl literally almost scratched her own eyes out while on a "pill trip." In an effort to save her sight, the Los Angeles Eye Bank initiated a request for fresh corneas for transplants to her eyes. The plea went out on the Eye Bank Network, which meets twice daily on 75-meter phone. The eye banks in New York, Baltimore, and Denver immediately air-shipped corneas to California for the transplant operations.

January Operating Events. January 4-5. ARRL VHF SS (Sweepstakes) Contest. Operate between 2:00 p.m., local time, Saturday, January 4, and midnight, January 5, on the amateur frequencies above 50 MHz. Work other amateurs in the different ARRL "sections," exchanging "message preambles" with each station worked. The same station may be worked once per band. Two points are earned for each complete contact; total score equals the sum of your contact points multiplied by the number of different sections worked. Rules and log sheets are avail-

able from: American Radio Relay League, Inc., 225 Main St., Newington, Conn. 06111.

Fourth Annual Louisiana QSO Party, 1800 GMT, Saturday, January 18, to 2200 GMT, Sunday, January 19. Suggested frequencies: 3.6, 3.91, 7.075, 7.26, 14.075, 14.3, 21.075, 21.4, 28.1, and 28.7 MHz. Louisiana works the world, and the world works Louisiana. Each contact counts one point, and the same station may be worked on phone and CW segments of each band. Exchange contact numbers, signal reports, and names of state, province, country, and parish with each station worked. Louisiana stations multiply contact points by number of states, Canadian provinces, and other countries worked; outside stations multiply contact points by number of Louisiana parishes worked. The Louisiana winner will receive a trophy, and second and third placers will receive certificates. State, province, and country winners outside Louisiana will earn certificates. Send complete contest logs to Lafayette Amateur Radio Club, 123 Normandy Rd., Lafayette, La. 70501, before February 28. Include a stamped return envelope for a list of winners.

New Rules for Ragchewer's Club (RCC) Certificates. Any amateur who chats (rag chews) with a member of the RCC for a minimum of 30 minutes is eligible for membership in the RCC. Under previous rules, both the applicant and the RCC member sent the contact information to ARRL, who then issued the certificate. Under the new system, the RCC member sends his information to the RCC applicant who then forwards it with his request for membership in the Rag Chewers' Club to ARRL, 225 Main St., Newington, Conn. 06111.

Coil Winding Contest. *Break-In* (Christchurch, New Zealand) for August, 1968, re-



Using a Heathkit MS-301/SB-401 receiver/transmitter combination, Gary Buda, WA0NDN, Hopkins, Minn., works 10 to 80 meters with various antennas.

ports an interesting contest between members of Wellington branch of the NAZRT. Each member selected a coil form, length of wire, and a fixed capacitor of marked capacitance from boxes containing an assortment of these components and attempted to wind a coil that would resonate at 7000 kHz with the selected capacitor. The club supplied a 2-terminal oscillator (a grid-dip meter could also be used) and a calibrated receiver for measuring frequencies. The entry of ZL2WY resonated at 7100 kHz, and ZL2BD's at 7200 kHz; the remaining entries covered the spectrum from 1.5 to 13 MHz.



Twenty-five states have been worked by Bernard Skoch, WN5VPE, 1001 N. Gray St., Jacksonville, Ark. His equipment: a DX-20 transmitter, a Mosley GM-1 Receiver, and a Hy-Gain 18-V vertical antenna.

NEWS AND VIEWS

Bob Samson, WN7KOB, Rt. 2, Box 2314, Kennewick, Wash. 99336, learned about amateur radio through the POPULAR ELECTRONICS *Communications Handbook*. Using an EICO 720 transmitter and a borrowed ARC-5, war-surplus receiver on 40 meters, Bob has worked 13 states and three Canadian provinces. This record represents daytime effort because of receiver deficiencies. But Bob is saving his pennies for a receiver of his own so he can operate all bands when he obtains his General ticket—soon, he hopes. . . . **Bill Corcoran, WA9UNR**, 4336 N. Mozart St., Chicago, Ill. 60618, went from Novice to Advanced in a year and says he can now copy code at 35 wpm. A Johnson Ranger transmitter, Knight-Kit T-50 transmitter, Heathkit Twoer transceiver, Hammarlund HQ-129X, and several pieces of homebrew gear are some of the equipment which Bill shares with his brother, Ray, WN9VVU. Aided by 40- and 20-meter dipoles, Bill has worked 40 states and eight countries. He is a member of the QRP (low-power) club, the Rag Chewers' Club, ARRL "Intruder Watch," and the Chicago Amateur Radio Club. Contact him for details about the CARC's code and theory classes. . . . Short and to the point, **David Axinn, WA3JAE**, 722 Wyndale Road, Jenkintown, Pa., would like to hear from anyone interested in forming a 75-meter teen-age net.

Steve Cabral, WN1JIE, 51 Brookings St., Medford, Mass. 02155, took two months after getting his license to get on the air. Then, using his EICO 720 transmitter, National NC-98 receiver, and Hy-Gain 18-V vertical antenna he quickly worked seven states, including Oregon and California. In the

New Decorator DO-IT-YOURSELF FLEXI-CAB®

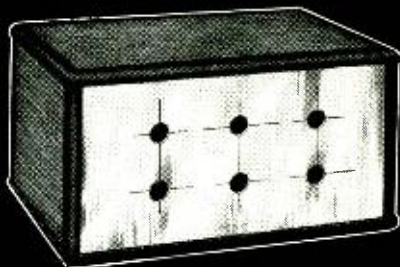

Unique custom cabinets for Kit Builders, Experimenters, Hobbyists!

You'll be proud to show your handiwork in these beautiful cabinets. Assembled in minutes with our unique "vise-grip" mitered slides—no screws, rivets, adhesives or hand tools required. Rugged, 26 gauge vinyl clad decorative steel side panels in a choice of beautiful walnut wood grain or black leather; front panel is brass or chrome plated, with gleaming mirror finish. Plastic slides will not mar fine furniture. □ Prepunched holes in front and rear panels to fit most applications; also available without holes. Complete with pressure sensitive labels to identify controls. *Patent pending.

**Bell Educational Laboratories—Div.
Beltronix Systems, Inc.**

123 Marcus Blvd., Hauppauge, N.Y. 11787

Please rush. . . . Flexi-cab®(s) to me:

- 3" x 4" x 4" — \$3.25 3" x 4" x 6" — \$4.05
 3" x 6" x 9" — \$4.75

with or without prepunched holes.

Indicate choice of finish & front panel:

- | Finish | Front Panel |
|--|---|
| <input type="checkbox"/> Walnut Wood Grain | <input type="checkbox"/> Mirror Finish Brass |
| <input type="checkbox"/> Black Leather | <input type="checkbox"/> Mirror Finish Chrome |

I enclose full payment, you pay postage.

For special hole configuration please enclose additional 25¢ and drawing.

Ship C.O.D. I will pay postage.

name.....

address.....

city & state.....zip.....

CIRCLE NO. 4 ON READER SERVICE PAGE

UNUSUAL BARGAINS

FREE!
GIANT
CATALOG

... MANY U.S. GOV'T SURPLUS



SEE MUSIC IN DAZZLING ACTION

Dramatic Breakthrough In
Audio-Visual Enjoyment



Actually see favorite musical selections translated into fantastic patterns of beautiful color—each individual note creating its own unique, twisting, radiating shape each shape dancing and prancing, whirling and swirling in perfect form with the music. Easily attached to stereo,

radio tape recorder. Send 25¢ in coin for 16-page booklet #9096AV.
No. 85.1512V—WALNUT CABINET MODEL \$99.50 FOB
No. 71.030AV—8" SET 45.00 Ppd.
No. 71.009AV—8" DO-IT-YOURSELF KIT 22.50 Ppd.



NEW!

PROJECTION KALEIDOSCOPE

Infinite variety of brilliant color patterns which do not repeat. Specially designed 9" diam. liquid wheel, 3" projection lens and Edmund Special Effects Projector make it all possible. Easily operated. Large screen image at short projection distance perfect for backgrounds, light shows, parties, dances, etc. Front or rear port.

Stock No. 71.121AV \$34.00 Postpaid
SOLID MULTI-COLORED GLASS ACCESSORY WHEEL
Stock No. 71.122AV—(9" Diam.) \$15.00 Ppd.

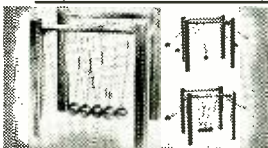

REACTION . . . IN ACTION!

Fascinating demonstration of Newton's 3rd law. Swing up to 4 polished steel balls away from others—let go. They strike remaining ones . . . out pop same number on other side. Process continues until friction overcomes kinetic energy. Great attention-getter. Entrancing movement and rhythmic clacking cause constant experimenting. Perfect for exc. desks, educators, displays.

3 1/2" high.
Stock No. 71.133AV \$8.00 Postpaid

TOP QUALITY LOW-COST STROBE



Genuine electronic strobe creates psychedelic or old-time movie effects. Terrific for parties, experiments . . . for combos, night clubs, dances, exhibitions. Best party ice-breaker ever—'freezes' the action and 'unfreezes' guests. Practical too—check action of moderate-speed machinery. Xenon lamp gives one million flashes, 6 1/2" diam. reflector. Uses reg. 110-120 volt A.C. current. Handsome

solid walnut cabinet, 9 1/4" x 9 3/4" x 4". Send for Bulletin #75—describes other startlingly new unique lighting effects.
Stock No. 70.989AV \$79.95 Ppd.

NEW LOW-COST ULTRASONIC CLEANER



Top-quality 1/2rd pint unit for only \$39.95. Cleans dirt, grime completely, quickly, safely. Small delicate parts, precision screws from lab instruments, jewelry, coins, even dentures sparkle like new. American-made—operates on regular house current. Solid state generator w/automatic turn-off. Power regulating knob. No shocks. No radio interference. 6" x 4" x 4" stainless.

Stock No. 71.003AV \$39.95 Ppd.
LARGE INDUSTRIAL 1 1/2 GAL. SIZE
Stock No. 85.128AV \$249.95 FOB



3" Astronomical Telescope

See the stars, moon, phases of Venus, planets close up. 60 to 180 power. Aluminized and over-coated 3" diameter f/10 primary mirror, ventilated cell. Equatorial mount with locks on both axes. Equipped with 60X eyepiece and mounted Barlow lens. 3X finder telescope, hardwood tripod. Included: "STAR CHART", 27-page "HANDBOOK OF HEAVENLY BODIES".

ENR's "HOW TO USE TELESCOPE" book. . . . \$ 29.95 Ppd.
Stock No. 85.050AV \$ 84.50 FOB
Stock No. 85.086AV 6" REFLECTOR \$199.50 FOB

Order by Stock No.—Check or M.O.—Money-Back Guarantee
EDMUND SCIENTIFIC CO., 300 EDCORP BUILDING
BARRINGTON, NEW JERSEY 08007

GIANT FREE CATALOG "AV"



Completely new 1969 edition. New items, categories. Illustrations. 148 easy-to-read pages packed with 4000 unusual items. Dozens of electrical and electromagnetic parts, accessories. Enormous selection of Astronomical Telescopes, Microscopes, Binoculars, Magnifiers, Markets, Lenses, Prisms. Many war surplus items; for hobbyists, experimenters, workshops, factory.

Write for catalog "AV", include Zip.
ORDER BY STOCK NUMBER • SEND CHECK OR MONEY ORDER • MONEY-BACK GUARANTEE
EDMUND SCIENTIFIC CO., 300 EDCORP BUILDING
BARRINGTON, NEW JERSEY 08007

CIRCLE NO. 12 ON READER SERVICE PAGE

meantime, WN1JIE passed his General exam; at the time of writing, he was waiting for the new ticket to come. A new homebrew, 10-meter beam and a new phone transmitter are ready and waiting for this happy event . . . **WN6ZXN** was the only Novice among the 457 making perfect copy of the 25-wpm Armed Forces Day (May 18) message from the Secretary of Defense. Five-hundred-sixty-seven perfect copies of the radioteletype version of the message were submitted, and 9048 "crossband" amateur-to-military contacts were made as part of the Armed Forces Day communications tests. If you worked WAR, NSS, NPG, or AIR during the test and did not receive a QSL card, you may request one from Armed Forces Day Contest, Room 5B960, The Pentagon, Washington, D.C. 20315. Include your call letters, the call of the military station worked, its frequency, and the time of the contact . . . **Bob Lauzon, WB2NSD**, 151 West Jefferson Rd., Pittsford, N.Y. 14534, our Amateur Station of the Month winner last March, verifies our statement that he was "studying like crazy" for his Extra class license by passing the exam in September.



All those QSL cards show the success of Mike Welch, WN1GTH, Williamstown, Mass., working DX with an EICO 720 transmitter and a Lafayette receiver.

Don Decaria, WA7GQD, 825 Adams St., Layton, Utah 84041, worked 35 states on 40 meters with a 15-watt transmitter as a Novice. As a General, using a Heathkit DX-100 running 100 watts to drive a vertical on 20 meters, Don worked 44 states and 20 countries. Just to keep his hand in, he passed the Advanced class exam and is waiting for two years to pass; so that he can take the Extra class exam. By the way, Don receives on a National NC-125 and will sked you on 20 meters, if you need Utah. Being Activities Manager for the Layton Amateur Radio Club, he can probably arrange a sked with another station, if you can't work "20" . . . **Doug Pongrance, WA3JBN**, 316 Donnell Rd., Lower Burrell, Pa. 15068, closed out his Novice career with 40 states and six countries worked on the 80-, 40-, and 15-meter Novice bands. He used vertical antennas on 80 and 15 meters and a horizontal doublet on 40 meters, but a new Mosley TA-33, 10-, 15-, 20-meter beam awaits the arrival of his General ticket—he has already passed the test . . . Commenting on the efforts of various groups to simplify the U.S. Novice exam, **S. Erlichman**, Willowdale, Ontario, Canada, wishes that someone would simplify the Canadian amateur examinations. Their simplest exam includes a 10-WPM code test and a written/oral technical examination about equivalent to the U.S. General class written test. For what consolation it may be to Mr. Erlichman, neither the FCC nor the Canadian authorities seem disposed to

simplify their amateur exams; but on a percentage basis, the number of Canadian amateurs is increasing slightly faster than the number of U.S. amateurs.

Will your "News and Views," picture, or comments appear in your column next month? Send your contributions, including club papers, to: Herb S. Brier, W9EGQ, Amateur Radio Editor, POPULAR ELECTRONICS, P.O. Box 678, Gary, Ind. 46401.

73. Herb, W9EGQ.

SOLID STATE

(Continued from page 87)

fan. As Z2 cools, bridge balance is restored, the relay opens, and the fan motor is turned off.

Bruce uses conventional components in his design; R1 and R2 are half-watt resistors, while Z1 and Z2 are low-to-medium wattage 3.9-volt zener diodes comparable to types 1N748 or 1N4730. The 6-volt relay is moderately sensitive, similar to P & B type RS5D. A special low-noise blower assembly is preferred for optimum performance (Model B-52HK, Alpha Components Corporation, 4087 Glencoe, Venice, Calif. 90291, for example).

With neither parts arrangement nor lead dress critical, the circuit may be assembled using any construction method—perf board, etched circuit, or point-to-point wiring. The basic circuit should be installed in an out-board case, but the temperature sensing zener (Z2) *must be mounted inside* the equipment that is to be protected, preferably near a "heat well" (a point at which heat tends to be high). The blower fan should be mounted on the equipment's cabinet or back cover and positioned so that its air stream is directed over the main heat producing components. Finally, relay sensitivity should be adjusted for best operation by *minor* adjustment of the armature spring.

Manufacturer's Circuit. With automobile thefts rising, the auto burglar alarm circuit in Fig. 2 should be of real interest to most car owners. Abstracted from "Economy Power Semiconductor Applications," a booklet published by GE's Semiconductor Products Department, the circuit is suitable for use in any car equipped with a standard 12-volt negative-ground electrical system.

In operation, the alarm circuit, once set, sounds the auto's horn continuously if the car door is opened by a potential thief. The car's owner (or regular driver), on the other

NOW YOU CAN
UNSOLDER...



FOR SOLDERING AND DESOLDERING

uniline mark VII

SOLDER AND DESOLDER WITH ONE TOOL!

The Uniline Mark VII is a dual purpose pencil soldering-desoldering tool. This truly revolutionary system allows you to solder and desolder any joint with finger tip ease and control. Simply press the button to desolder. How about that!

The tool is composed of three basic components that give it unprecedented versatility. You can select what you need from: **FOUR DIFFERENT COLORS OF HANDLES, FOUR INTERCHANGEABLE HEAT CARTRIDGES (20-30-40 & 50 WATTS), DOZENS OF DIFFERENT TIPS IN MANY DIFFERENT STYLES AND SHAPES.**

How's that for a combination tool? Exciting, isn't it! If you are interested in saving time and money you need one right now. See your local distributor today, and tomorrow start enjoying cost reduction you never thought possible.

AS LOW AS
\$12.95
20 WATT ONLY

SEE YOUR LOCAL DISTRIBUTOR TODAY!



vanguard

ELECTRONIC TOOLS INC. NEWTON, KANSAS

CIRCLE NO. 32 ON READER SERVICE PAGE

STATEMENT OF OWNERSHIP, MANAGEMENT AND CIRCULATION (Act of October 23, 1962; Section 1369, Title 39, United States Code).

1. Date of filing: October 1, 1968.
2. Title of publication: Popular Electronics.
3. Frequency of issue: Monthly.
4. Location of known office of publication: 307 N. Michigan Avenue, Chicago, Illinois 60601.
5. Location of the headquarters or general business offices of the publishers: One Park Avenue, New York, New York 10016.
6. Names and addresses of publisher, editor, and managing editor: Publisher, Phillip T. Heffernan, One Park Avenue, New York, New York 10016; Editor, Oliver P. Ferrell, One Park Avenue, New York, New York 10016; Managing Editor, John R. Biggs, One Park Avenue, New York, New York 10016.
7. Owner: (If owned by a corporation, its name and address must be stated and also immediately thereunder the names and addresses of stockholders owning or holding 1 percent or more of total amount of stock. If not owned by a corporation, the names and addresses of the individual owners must be given. If owned by a partnership or other unincorporated firm, its name and address, as well as that of each individual must be given.) Ziff-Davis Publishing Company, One Park Avenue, New York, New York; William G. Ziff, One Park Avenue, New York, New York; Priscilla K. Stafford, One Park Avenue, New York, New York.
8. Known bondholders, mortgagees, and other security holders owning or holding 1 percent or more of total amount of bonds, mortgages or other securities: None.
10. Extent and nature of circulation

Average No. Copies Each Issue During Preceding 12 Months	Actual Number of Copies of Single Issue Published Nearest to Filing Date
--	--

A. Total No. Copies printed (Net Press Run)	478,519	478,221
B. Paid circulation		
1. Sales through dealers and carriers, street vendors and counter sales	83,308	78,300
2. Mail subscriptions	305,818	308,135
C. Total paid circulation	389,126	386,435
D. Free distribution (including samples) by mail, carrier or other means	3,982	3,800
E. Total distribution (Sum of C and D)	393,108	390,235
F. Office use, left-over, unaccounted for, spoiled after printing	85,411	87,086
G. Total (Sum of E and F—should equal net press run shown in A)	478,519	478,221

I certify that the statements made by me above are correct and complete.

PHILIP SINE, Treasurer

PHOTOGRAPHY ANNUAL

A selection of the World's finest photographs compiled by the editors of Popular Photography. All editions \$1.25 each:

1966 — \$1.25 #1
1967 — \$1.50 #38
1964 — \$1.25 #3

Order by number from Ziff-Davis Service Div., 595 Broadway • New York, N. Y. 10012. Enclose add'l 15¢ per copy for shipping and handling (50¢ for orders outside U.S.A.)

hand, can disable the alarm in advance by operating a hidden switch.

An SCR supplies power to the horn when its gate is triggered by voltage from the door-switched dome light. The gate signal is applied through isolation diode *D1* and current-limiting resistor *R1*. Series switch *S1* serves as the system disabling switch and is left closed whenever the car is parked and locked; it is opened by the owner before the car door is opened or whenever it is necessary to reset the system. Once sounded, the alarm cannot be silenced except by operating *S1*, disconnecting the horn, or disconnecting the car's battery . . . and few thieves would take the time either to hunt for a switch or to work under the hood.

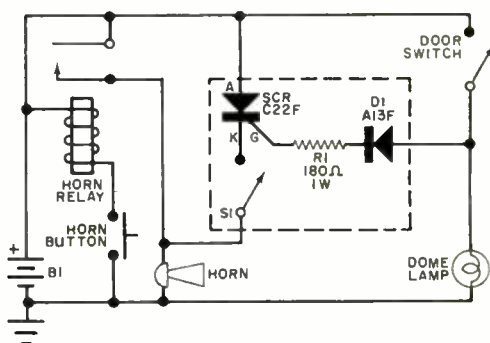

Alarm circuit uses an SCR to supply power to the car's horn if door is opened by potential thief.

Relatively simple, the circuit requires only four electrical components: a type C22F SCR, a type A13F diode (*D1*), a 180-ohm 1-watt resistor (*R1*), and a heavy-duty s.p.s.t. key, toggle or rotary switch (*S1*). Layout is not critical and the circuit may be assembled quite easily in a small outlet box or similar metal case.

As indicated on the schematic, only three lead connections are needed for installation. Physically, the basic control assembly should be mounted in an unobtrusive location away from the heat of the engine compartment, with *S1* in a hidden, but accessible, location outside the car's passenger space.

Industry Items. A rating of 325 volts—the highest of any EIA-registered germanium power type—is combined with low cost in a new transistor recently introduced by Motorola Semiconductor Products, Inc. (P.O. Box 955, Phoenix, Ariz. 85001). One of two new epitaxial-base types, the 2N5325, shown in Fig. 3, is ideal for power switching, inverters, TV deflection, switching regulators, amplifiers, and industrial power-supply ap-

plications. Its companion unit, the 2N5324, carries a 250-volt rating, and both are suitable for operation on line power supplies. The rated power dissipation for both types is 56 watts at 25°C.



New Motorola epitaxial-base power transistor has rating of 325 volts, highest of germanium types.

The National Semiconductor Corporation (2975 San Ysidro Way, Santa Clara, Calif. 95051) is now producing a new AM receiver i.f. subsystem integrated circuit. Identified as the type LM172/LM272 AM i.f. strip, the new IC includes 14 transistors, 9 diodes, 16 resistors, and 5 capacitors in its amplifier, second detector, and a.g.c. circuitry. It is designed for both i.f. and TRF applications over the range from 50 kHz to 2 MHz when used with appropriate external tuning elements. Suitable for operation on 6-to-15-volt d.c. supplies, the device has a 60-dB a.g.c. range, and can deliver as much as 0.8 volts peak-to-peak when driven with a 50- μ V, 80% modulated signal.

That's our January story . . . until next month, keep your fingers crossed.

—Lou

LAMP BRIGHTNESS QUIZ ANSWERS

- | | |
|-----|------|
| 1-C | 6-B |
| 2-B | 7-A |
| 3-A | 8-B |
| 4-C | 9-C |
| 5-A | 10-B |

January, 1969

WORLD'S SMALLEST



"LISTEN-IN" ON ANY FM RADIO!

This miniature electronic marvel picks up the slightest sounds and clearly transmits them to any standard FM radio up to 150 feet away! Latest engineering advances in micro-miniaturization have reduced this unit to ONE HALF THE SIZE OF A REGULAR LENGTH CIGARETTE! Completely self contained unit including sensitive sub-miniature mike and battery!

Many uses include: Portable public address system, burglar alarm, improve sales talks, personal baby sitter, guitar amplifier, etc. Comes complete including battery and plastic screwdriver for changing frequency (88-108mcs).

29⁹⁵

ORDER NOW! ALL ORDERS RUSHED BY RETURN MAIL!

10 DAY FREE TRIAL!

Dealer inquiries invited!

© 1968

SONIC DEVICES Dept. PE-1
69-29 Queens Blvd., Woodside, N. Y. 11377

Please rush my transmitter! I will examine it in my home for 10 full days and if I am not 100% satisfied I will return it for a full and prompt refund.

Name.....City.....

Address.....State & Zip.....

FIVE COURSES FOR TECHNICIANS WITH EXTENSIVE LABORATORY TRAINING!



ALL Courses approved for Veterans' training

Electronics Technicianeight, 10-week sessions
Electronics Mechanicsix, 10-week sessions
Broadcast Engineersix, 10-week sessions
Radiotelegraph Operatorfive, 10-week sessions
Radio-TV Servicingfour, 10-week sessions

1969 dates: January 20, March 31, June 9,
September 2, and November 10

New Sessions follow in 10 week intervals from dates listed.

PORT ARTHUR COLLEGE

1500 Proctor, Box 310, Port Arthur, Texas 77640

FREE BROCHURE

CIRCLE NO. 25 ON READER SERVICE PAGE

101

ABOUT YOUR SUBSCRIPTION

Your subscription to POPULAR ELECTRONICS is maintained on one of the world's most modern, efficient computer systems, and if you're like 99% of our subscribers, you'll never have any reason to complain about your subscription service.

We have found that when complaints do arise, the majority of them occur because people have written their names or addresses differently at different times. For example, if your subscription were listed under "William Jones, Cedar Lane, Middletown, Arizona," and you were to renew it as "Bill Jones, Cedar Lane, Middletown, Arizona," our computer would think that two separate subscriptions were involved, and it would start sending you two copies of POPULAR ELECTRONICS each month. Other examples of combinations of names that would confuse the computer would include: John Henry Smith and Henry Smith; and Mrs. Joseph Jones and Mary Jones. Minor differences in addresses can also lead to difficulties. For example, to the computer, 100 Second St. is not the same as 100 2nd St.

So, please, when you write us about your subscription, be sure to enclose the mailing label from the cover of the magazine—or else copy your name and address exactly as they appear on the mailing label. This will greatly reduce any chance of error, and we will be able to service your request much more quickly.

Olson



* **FREE**

Fill in coupon for a **FREE One Year Subscription to OLSON ELECTRONICS' Fantastic Value Packed Catalog—Unheard of LOW, LOW PRICES on Brand Name Speakers, Changers, Tubes, Tools, Stereo Amps, Tuners, CB, and other Values. Credit plan available.**

NAME _____

ADDRESS _____

CITY _____ STATE _____

GIVE ZIP CODE _____

If you have a friend interested in electronics send his name and address for a **FREE** subscription also.

OLSON ELECTRONICS

308 S. Forge Street Akron, Ohio 44308

CIRCLE NO. 21 ON READER SERVICE PAGE



OPERATION ASSIST

Through this column we try to make it possible for readers needing information on outdated, obscure, and unusual radio-electronics gear to get help from other P.E. readers. Here's how it works: Check the list below. If you can help anyone with a schematic or other information, write him directly—he'll appreciate it. If you need help, send a postcard to Operation Assist, POPULAR ELECTRONICS, One Park Avenue, New York, N.Y. 10016. Give maker's name and model number of the unit. If you don't know both the maker's name and the model number, give year of manufacture, bands covered, tubes used, etc. State specifically what you want, i.e., schematic, source for parts, etc. Be sure to print or type everything legibly, including your name and address. Do not send an individual postcard for each request; list all requests on one postcard. Because we get so many inquiries, none of them can be acknowledged. POPULAR ELECTRONICS reserves the right to publish only those items not available from normal sources.

Philmore Model CPM-1. CB power supply needed for xmitter CT-1 and CC-1 converter. (Roger J. Dubay, 18501 Brohl, Roseville, Mich. 48066)

Hallicrafters Model S-22-R. circa 1946. Plug-in ballast tube (BK 29D) needed. (Kevin McGown, 103 Darwin Ln., Oak Ridge, Tenn. 37830)

Hallicrafters Model S-36A receiver. Schematic and operating manual needed. (Danny Boyer, P.O. Box 556, Eldorado, Texas 76936)

Zenith Model 34P receiver. Schematic and source for no. 27 tubes needed. (David Roit, 70 Cranston St., Westfield, Mass. 01085)

Hallicrafters S-38B receiver. Schematic and operating manual needed. (Scott Daniels, 1749 Popham Ave., New York, N.Y. 10453)

Dumont type 292 cathode ray oscillograph. Power transformer and schematic needed. (Kent Leach, 5428 N. 83 St., Milwaukee, Wisc. 53218)

Simpson Model 305 tube tester. Schematic, supplements to manual, and data for adding different sockets needed. (John P. Chevalier, 25 Standard Ave., W. Warwick, R.I. 02893)

Clough-Brengle Model 185 unimeter. **Heathkit** Model A-5 amplifier. Schematics and instruction manuals needed. (Andrew Dickey, 80 Nordica Dr., Croton, N.Y. 10520)

Grundig TK 819-820 tape recorder. Motor with good bearings and capstan needed. (R.B. Reithel, 808 Georgia Ave., Pittsburgh, Pa. 15210)

Superior Model TV-50A Genometer. Schematic and operating manual needed. (C.J. Hershfield, 302 Texas NE, Albuquerque, N.M. 87108)

Heathkit Model 0-8 oscilloscope. Schematic and operating manual needed. (Reid Larson, 215 S. Grant, Westmont, Ill. 60559)

Radio City Products Model 668 electronic multi-tester VTVM. Schematic and operating manual needed. (J.F. Waynick, 1309 Ritcherson Dr., Reidsville, N.C. 27320)

Sylvania type 400 TV oscilloscope. Schematic and instruction manual needed. (Leonard S. Waller, 330 W. 25 St., New York, N.Y. 10001)

Premier Model 570 signal generator. Schematic, operating manual, and parts source needed. (Wallace F. Peterson, RR #1, Box 248, Thompson, Conn. 06277)

Atwater-Kent Model 41 receiver. Schematic, parts list, operating manual, and parts source needed. (John L. Timm, 78 Orchard St., Cos Cob, Conn. 06807)

Solar Model CE Capacitor Exam-eter. Power transformer designated CF-5 in operating manual needed (or source for same). (Virgil W. Treadwell, 915 S. 31 Ave., Yakima, Wn. 98902)

Harvey-Wells Models TBS-50 and TBS-50D. Schematics for both and operating manual for latter. Also schematic for AFS-50. Stephen Sant Andrea, 490 Coolidge St., W. Hempstead, N.Y. 11552)

McMurdo Silver Masterpiece V all-wave receiver, circa 1936. Schematic needed. (David Baird, P.O. Box 3036, Cocoa, Fla. 32922)

Heathkit DX-35 transmitter. Assembly and operating manual needed. (Fred Elliott, 312 Church St., Dallas, Ore. 97338)

Westinghouse Model WR-306 receiver. Antenna coil assembly for broadcast band needed. (Part #RC 9577). Gregory Zablocky, 2415 W. Becher St., Milwaukee, Wisc., 53215)

Atwater-Kent type F-4-A radio speaker. Information on type and amount of voltage needed to energize magnet coil; replacement speaker paper needed. (David Bandfield, 24 Circle Dr., Plandome Manor, N.Y. 11030)

Scott marine SLRM; has 11 tubes. Schematic and operating manual needed. (John Davies, 331 Alexander St., Memphis, Tenn. 38111)

Stromberg-Carlson Model 112146 TV. Tube chart needed. **Stewart-Warner** Model 01-6E receiver. Tube chart and schematic needed. (Mike Bialaski, 12850 Coyle St., Detroit, Mich. 48227)

Hammarlund Model HQ-140-X. Plastic main tuning dial and mounting needed. (Tom Rose, 1305 Rancho Rd., Roswell, N.M. 88201)

Precision Apparatus series 920 tube and set tester. Instruction manual and schematic needed. (Charles L. Bagley, Rte. 1, Box 601, Clearwater, Fla. 33516)

Heathkit Model AV-2. Manual needed. **RCA** Model 165A VoltOhmyst Jr. Schematic and manual needed. (A.D. Illein, 263 Pine Ave., Garwood, N.J. 07027)

Hickok Model 530 tube tester. Schematic and tube chart needed. (N. W. Zimmerman, 1904 W. 46 Ave., Anchorage, Ak. 99503)

Telephone Electronics Co. S/N 3901 CB transceiver. Schematic, tech manual, and any information needed. (Jim Maschmann, 3340 S. Eudora, Denver, Colo. 80222)

Harvey-Wells Bandmaster Senior, transmitter Model TBS-50C. Schematic and operating manual needed. (Henry C. Lambert, Box 604, W. Yarmouth, Mass. 02673)

Lafayette Model 60 radio, 1925. **Lowry** Organo, Model 5J serial 1123 manufactured by Central Commercial Industries. Schematics needed. (B. R. Meschke, 3824 Ridgeview Dr., Indianapolis, Ind. 46226)

Heath Model SB-10 SSB adapter. Schematic or operating manual needed. Also any information on converting the **Heath** DX-100 amateur transmitter to SSB operation. (Gerald I. Miles, RT Div., U.S.S. Belmont (AGTR-4), FPO New York 09501)

RCA Model AR-936 Radiola 18. Schematic and parts list needed. (Joseph Mazury, Jr., 136 Liberty Ave., New Kensington, Pa. 15068)

DeForest Model D-12 receiver. Schematic needed (Bob Knutson, 1000 23 Ave., S.W., Austin, Minn. 55912)

Dumont type 292, serial 6A57 oscilloscope. Operating manual or schematic needed. (Edward M. Arand, Jr., 5344 115 Pl., Inglewood, Calif. 90304)

Hallicrafters Model SX-71. Schematic and alignment data needed. (John W. McWhirter, 6250 Condon Ave., Los Angeles, Calif. 90056)

Majestic Model 20. Screen Grid Superheterodyne. **Stromberg-Carlson** self-contained house-current receiver; has 6 tubes, high/low voltage selector switch. **Silver-Marshall** Model 30 chassis broadcast band receiver. Schematics and tube location charts needed. (Dean R. Kazmierczak, 886 Eggert Dr., N. Tonawanda, N.Y. 14120)

Heathkit Model DX-100B. Schematic and operating instructions needed. (A. Barry, 135 N.W. Dr., Patrick AFB, Fla. 32925)

Philco Model 46-480 radio. Schematic needed. (Gary Rakes, 903 10th Ave., Nebraska City, Neb. 68410)

Philco Model 66 AM & SW receiver, 1935. Schematic and source for tubes needed. (J. A. Colombo, Totoket Rd., Northford, Conn. 06472)

Philco Model 050 tube tester. Tube charts and schematic needed. (Irvan Mitchell, 1509 Bashor Rd., Goshen, Ind. 46526)

Triumph Model S41 3" oscilloscope. Schematic and manual needed. (Ronald Burgess, 89 Clinton St., Portsmouth, N.H. 03801)

Texas Research & Electronics Model 190 CB transceiver. **Globe** Model CB-100 CB transceiver. Schematics needed. (John Davis, 132 Thackeray Dr., Millington, N.J. 07946)

Superior Instruments, Model 670A multimeter. Meter and other parts needed. (Allen H. Leonard, R.D. #2, Box 305-A, Ashland, Ohio 44805)

Sonar DF4X direction finder. Schematic, sense antenna, loop antenna, meter, operating manual, and information needed. (Robert Rioja, 166 Wright St., Staten Island, N.Y. 10304)

Crosley 6-tube BC receiver, 1925; has type D Musicone speaker. Tube layout and battery wiring diagram needed. (G.W. Craven, 11915 Price St., N.E., Alliance, Ohio 44601)

Atwater-Kent Models 35 and 20 radio receivers.. Operating manual and/or schematic needed. (Leroy Corbin, 32 Anderson Rd., Bernardsville, N.J. 07924)

Hammarlund Model HQ-140X. Audio gain switch needed. (N.D. Sheppard, Mountain Village, Ak. 99632)

Hallicrafters Model S-3S-E. Schematic and instruction manual needed. (James Blumenfeld, Belmont Dr., Monticello, N.Y. 12701)

Bell Model 603 4-track tape recorder for RCA-type cartridge. Source for drive belt & capstan flywheel, and owners manual needed. (Richard McCreedy, 16554 Blackstone, Detroit, Mich. 48219)

Knight Model KN3203 32-watt amplifier. Assembly manual and schematic needed. (Jim Batug, 136 Mallard Dr., McKees Rocks, Pa. 15138)

ALL NEW



LISTEN TO: POLICE & FIRE REPORTS

FOR INDUSTRIAL, COMMERCIAL, UTILITY AND GOVERNMENT USE

CRYSTAL CONTROLLED • DUAL CONVERSION • LOW POWER DRAIN

Specifically designed for simplicity of operation and efficiently engineered for dependable service. Fits the smallest autos yet powerful enough to deliver a clean clear signal. Features: 6 crystal controlled frequencies, Dual Limiter, Quadruple tuned RF stage for greater image rejection, Noise Free squelch, PLUG IN crystals for instant freq. change. Compatible with all major continuous tone systems. Operates on 117VAC & 12VDC. Size: 6 7/8" x 2 1/4" x 8 1/2" / Wt: 3 lbs. 8 oz.

Perfect For

POLICE • FIRE
Other Law Agencies
• Tow Trucks
• Civil Defense •

Complete with AC and DC power cables, Mounting bracket, less crystals. Crystals \$5.00 ea.

FR-104
(25-50 MHz)

FR-105
(150-175 MHz)

\$140⁰⁰

SONAR RADIO CORP., 73 Wortman Ave., Bklyn, N. Y. 11207

Please send information on FR-104/105 FM Monitor Receivers. Dept. 860

Name _____

Address _____

City _____ State _____

CIRCLE NO. 28 ON READER SERVICE PAGE

POPULAR ELECTRONICS SUBSCRIBER SERVICE

Please include an address label when writing about your subscription to help us serve you promptly. Write to: Portland Place, Boulder, Colo. 80302

CHANGE OF ADDRESS:

Please let us know you are moving at least four to six weeks in advance. Affix magazine address label in space to the right and print new address below. If you have a question about your subscription, attach address label to your letter.

TO SUBSCRIBE:

Check boxes below.

- New Renewal
 5 years \$20
 3 years \$13
 1 year \$5

SPECIFY:

- Payment enclosed
 —You get 1 extra issue per year as a BONUS!
 Bill me later.

← AFFIX LABEL →

If you have no label handy, print OLD address here.

name _____

address _____

city _____

state _____ zip-code _____

[Add'l postage: \$1 per year outside U.S., its possessions & Canada.]

name _____ please print 0331

address _____

city _____

state _____ zip-code _____

GET INTO ELECTRONICS

V.T.I. training leads to success as technicians, field engineers, specialists in communications, guided missiles, computers, radar, automation, basic & advanced courses. Electronic Engineering Technology and Electronic Technology curricula both available. Associate degree in 29 months, B.S. obtainable. G.I. approved. Start February, September, Darns, campus. High school graduate or equivalent. Catalog.

VALPARAISO TECHNICAL INSTITUTE
 DEPARTMENT PE, VALPARAISO, INDIANA 46383



COMMUNICATIONS HANDBOOK

World's most complete guide to communications. 148 fact packed pages of features by experts in each category.

1968...\$1.25...#53

1967...\$1.25...#47

Order by number from

Ziff-Davis Service Div., 595 Broadway, New York, N.Y. 10012. Enclose add'l 15¢ per copy for shipping and handling (50¢ for orders outside U.S.A.)

SHORT-WAVE LISTENING

(Continued from page 94)

kHz) and 11,730 kHz with world and home news, commentary, music and some talks.

Iran—*R. Iran*, Teheran, 15,135 kHz (announces 15,105 kHz) monitored from 1548-2029; best signals noted during French xmsn at 1930-2000 and English segment with news, music and talks on Iran at 2000-2029.

Italy—"Nocturne From Italy", a daily program of pop songs, opera, dance music, symphony and jazz, with short news bulletin in four languages is aired at 2306-0459 from Rome 2, 845 kHz; Milan 1, 899 kHz; and the Caltanissetta, Sicily, outlets A, 6060 kHz, and B, 9515 kHz. This is a good chance for medium-wave DX'ers to look for Rome and Milan.

Ivory Coast—Abidjan has placed 7215 kHz into service, dual to 11,920 kHz, where it has a short newscast in French until 0000 closing.

Japan—Tokyo is good at times to Europe in German at 2000 and in English at 2030 on 11,965 and 9700 kHz.

Kuwait—We learn at press time that all test or experimental xmsns from Kuwait have been suspended but they may have been resumed by the time you read this. From monitoring, the apparent English xmsns seem to be scheduled for 0400-0600 and 1600-1900 on 1133 kHz (1 kW), 1345 kHz (200 kW), 4967.5 kHz (10 kW) and 9520 kHz (50 kW). The frequencies listed for experimental xmsns include 6055, 11,940, 15,150, 17,750 and 21,525 kHz, all 250 kW. Others may be used as well.

Lebanon—Beirut continues to wander around in the 19-meter band with Arabic news at 0325-0330 on 15,370 kHz and in Arabic and French at 0130 s/on on 15,440 kHz.

Martinique—Fort-de-France, 3315 kHz, can often be heard from 0210-0240 s/off with mostly classical music. This xmsn is in French.

Mexico—XETS, *R. Tapachula*, Tapachula, 6120 kHz, is extremely difficult to log. One West Coast expert lists it as being audible only around 1200 with "Amanecer Ranchero" (Mexican folklore music). Otherwise it cannot be heard.

Nigeria—Lagos noted on the new frequency of 9690 kHz in English to Europe at 2100-2205 with news, commentary, native Nigerian music, talks and pop music dedications.

Pakistan—*R. Pakistan* opens to S. E. Asia in English at 0030 on 15,358 kHz. The station also has English at 1500-1515 on the new frequencies of 15,190 and 17,855 kHz. Two new 100-kW short-wave xmters have been installed at Dacca and Islamabad to provide a radio link between East and West Pakistan. Three additional stations are to go into operation in 1970.

Peru—OBX1Q, *R. San Juan*, Piura, listed 4970 kHz but operating on 4967 kHz, noted in Spanish to 0300 closing with heavy QRM from a Colombian on 4965 kHz.

Poland—*R. Warsaw* has an English xmsn to Africa at 2200 on 17,800 kHz with generally fair to good signals.

South Africa—*R. RSA*, Johannesburg, tuned from 2200 s/on in Portuguese on a new frequency of 15,245 kHz.

Spanish Guinea—EAJ206, *R. Santa Isabel*, Fernando Po, was noted fading in at 2306 with classical piano music and annts in Spanish. The s/off came at 2301 with an ID in Spanish and the anthem "Los Voluntarios." *R. Ecuatorial*, Bata, Rio Muni, was heard with good signals at 2156 fade-in with Spanish pop music; an ID is given at 2158. Pop and classical music followed until s/off at 2300 with an anthem.

Switzerland—Late schedule changes as given by Berne: Portuguese to Brazil at 2315 on 11,845 and

15,305 kHz (repl. 11,715 and 15,125 kHz); Portuguese to South America at 0030 on the same channels; English to N.A. at 0130 on 5985 kHz, repl. 15,305 kHz. Berne has also been noted on 11,880 kHz at 2005 with answers to radio questions of interest to DX'ers. This Monday program was heard until close at 2028.

Tunisia—We've made further checks here as indicated last month: the station on 11,900 and 5985 kHz is definitely *Huna Al-Idha-A Att-Tounoussia (R. Tunis)* as heard with good signals from 0430 s/on with Arabic chanting and ammits until 2358 s/off with ID and band music. It is *not* Saudi Arabia.

Turkey—Ankara, 15,160 kHz. was observed with IS at 0420, then s/on and into Turkish at strong level, covering Budapest on the same channel. This outlet is also noted from 2200 with English news, fading out by 2215 when the news ended.

USSR—*R. Alma Ata*, 10,530 kHz, is heard at 0120-0140 fade with dance lessons, a short commentary and Russian music. A letter from the station states flatly that they do not operate on 9380 kHz despite many loggings to the contrary.

Vatican City—A new frequency for *R. Vaticana* is 9670 kHz, noted from 2205 s/on in English to Australia and New Zealand.

Unidentified—On 11,795 kHz, a station has been reported by several monitors as being on the air from 1830-2030 with light music but absolutely no ID's or announcements of any kind during the entire two-hour period. Some fading is noted but reports indicate that it is one of the strongest signals in the 25-meter band. An overseas bulletin reports the same—or similar—station on 6135 kHz with an identical format. It definitely is not an image or a local station harmonic. Can anyone help?

73, Hank

SHORT-WAVE CONTRIBUTORS

Christopher Lobdell (*WPE1GCI*), Reading, Mass.
Vincent Geraci (*WPE1HMP*), Shelton, Conn.
Richard Pendleton (*WPE1HMV*), East Braintree, Mass.

Paul Kilroy (*WPE3FOB*), Washington, D. C.
John Black (*WPE3HRO*), Baltimore, Md.
Dan Ferguson (*WPE4AUL*), Coral Gables, Fla.
Grady Ferguson (*WPE4BC*), Charlotte, N. C.
Bruce Tindall (*WPE4JOO*), Chapel Hill, N. C.
Steve Joiner (*WPE5E1P*), Dallas, Texas
Charles Bennett (*WPE5SW*), Sumrall, Miss.
Trevor Clegg (*WPE6FAF*), Fresno, Calif.
Paul Farmanian (*WPE6GVG*), Glendale, Calif.
Frank Hanley (*WPE6GWQ*), Orangevale, Calif.
Arthur Bair (*WPE6GXV*), San Francisco, Calif.
Walter Dick (*WPE6HAX*), Santa Monica, Calif.
Jeff Utter (*WPE6HDI*), Carlsbad, Calif.
Robert French (*WPE6FGH*), Bellaire, Ohio
Richard Pistek (*WPE6H0A*), Chicago, Ill.
Craig Cook (*WPE9JBI*), Milwaukee, Wisc.
A. R. Niblack (*WPE9KM*), Vincennes, Ind.
John Beaver (*WPE9AE*), Pueblo, Colo.

C. Vernon Hyson (*WPE9CNF*), Somerville, N. J.
Philip Carney (*WPE9FCD*), Minneapolis, Minn.
Jack Bacon, Jr. (*WPE9FDJ*), Bloomington, Minn.
Michael Clow (*VE1PE1AM*), Moncton, N. B.
Fred Baines (*VE1PE2C*), New Glasgow, N. S.
Rejean Lavoie (*VE2PE1MT*), Clomede, Que.
Gery Couture (*VE2PE1NB*), Louxucuit, Que.
Mike Wilson (*VE6PEAN*), Calgary, Alta.
Jack Perolo (*PY2PE1C*), Sao Paulo, Brazil
Charles Albertson, Scottsdale, Ariz.
Steve Briggs, La Canada, Calif.
Guy Cavallo, Arlington, Va.
Richard Daly, Bronx, N. Y.
Mike Davis, Moberly, Mo.
Bruce Frahm, Colby, Kansas
Andrew Galik, Jr., Clifton, N. J.
Michael Gessner, Lakeland, Fla.
Leonard Hyde, Jr., Lexington, N. C.
Warren Lauzon, APO (Philippines)
Mark Nodine, Salem, Ore.
Euzene Paradis, Fairfield, Maine
SP4 George Weir, APO (Qui Nhon, Vietnam)

Sweden Calling DX'ers Bulletin, Stockholm, Sweden

Build New Schober Music Kits DYNABEAT RHYTHM

If you want rhythm Schober's got it—10 real trap sounds in a small carrying case. Add bass drum, snare drum, cymbals, and 7 other great rhythm effects to your combo, piano, or organ playing, each at the touch of a button the instant you want it—or have a ball playing traps along with records and radio! The Schober Portable Dynabeat connects to any guitar, hi-fi, or p.a. amplifier, makes you an instant drummer. Kit \$139.50, all built \$169.50. Special Dynabeat for all Schober Organs (not other brands) synchronizes the sounds you want with manuals and pedals. \$150 for the kit.



TUNESMITH MELODY INSTRUMENT



The Schober Tunessmith makes the one-finger artist an instrumental soloist. Produces one note at a time on the 2½-octave keyboard while you control tone color (6 voices), vibrato, pitch, volume, as you play. Carry the melody for a combo or play with piano or organ accompaniment—or along with records and radio. Easily portable (13 lbs.), connects to any amplifier. Easy to build kit \$149.50; assembled, ready to plug in and play \$189.50.

Send right now for the full-color Schober catalog, with all details on Dynabeat and Tunessmith as well as Schober's five kit organ models and unique reverberation system. No charge, no obligation. If you like music, you owe yourself a Schober instrument!

THE Schober ORGAN CORP., Dept. PE-28
43 West 61st Street, New York, N.Y. 10023

- Please send me a Schober Organ Catalog.
 Enclosed is 50 cents for 7-inch LP demonstration record of DYNABEAT and Portable TUNESMITH.

NAME _____

ADDRESS _____

CITY _____ STATE _____ ZIP _____

CIRCLE NO. 26 ON READER SERVICE PAGE

ELECTRONIC EXPERIMENTER'S HANDBOOK



The most fascinating and challenging construction projects for the electronics hobbyist. Over 148 pages.

1968 Winter Edition #50
1967 Spring Edition #49
1966 Fall Edition #39
1966 Spring Edition #36
1965 Fall Edition #9

Titles listed above \$1.25 each

Order by number from

Ziff-Davis Service Div., 595 Broadway • New York, N.Y. 10012. Enclosed add'l 15¢ per copy for shipping and handling (50¢ for orders outside U.S.A.)

PAYMENT MUST BE ENCLOSED WITH ORDER

**“Get more
education
or
get out of
electronics
...that’s my advice.”**





Ask any man who really knows the electronics industry.

Opportunities are few for men without advanced technical education. If you stay on that level, you'll never make much money. And you'll be among the first to go in a layoff.

But, if you supplement your experience with more education in electronics, you can become a specialist. You'll enjoy good income and excellent security. You won't have to worry about automation or advances in technology putting you out of a job.

How can you get the additional education you must have to protect your future—and the future of those who depend on you? Going back to school isn't easy for a man with a job and family obligations.

CREI Home Study Programs offer you a practical way to get more education without going back to school. You study at home, at your own pace, on your own schedule. And you study with the assurance that what you learn can be applied on the job immediately to make you worth more money to your employer.

You're eligible for a CREI Program if you work in electronics and have a high school education. Our FREE book gives complete information. Airmail postpaid card for your copy. If card is detached, use coupon below or write: CREI, Dept. 1201H, 3224 Sixteenth Street, N.W., Washington, D.C. 20010.

Founded 1937



Accredited Member of the National Home Study Council



**CREI, Home Study Division
McGraw-Hill Book Company
Dept. 1201H, 3224 Sixteenth Street, N.W.
Washington, D.C. 20010**

Please send me FREE book describing CREI Programs. I am employed in electronics and have a high school education.

NAME _____ AGE _____

ADDRESS _____

CITY _____ STATE _____ ZIP CODE _____

EMPLOYED BY _____

TYPE OF PRESENT WORK _____ G.I. BILL

- I am interested in Electronic Engineering Technology
 Space Electronics Nuclear Engineering Technology
 Industrial Electronics for Automation
 Computer Systems Technology

APPROVED FOR TRAINING UNDER NEW G.I. BILL

Live Better Electronically With

LAFAYETTE RADIO ELECTRONICS

1969 Catalog 690 **FREE!**



Now OFF PRESS
BETTER THAN EVER
Over 500 Pages

Stereo Hi-Fi • Citizens
Band • Ham Gear • Tape
Recorders • Test Equip-
ment • TV and Radio Tubes
and Parts • Cameras •
Auto Accessories • Musical
Instruments • Tools • Books

Featuring Everything in Electronics for
• HOME • INDUSTRY • LABORATORY
from the "World's Hi-Fi & Electronics Center"

LAFAYETTE Radio ELECTRONICS
Dept. 35019 P.O. Box 10
Syosset, L.I., N.Y. 11791

Send me the FREE 1969 catalog 690.

35019

Name

Address

City

State Zip

CIRCLE NO. 19 ON READER SERVICE PAGE



new
angle
on
speakers

Striking contemporary art frame design in Dusk Walnut or Antique Birch. Mount traditionally or in diamond position. Special 8" dual cone speaker designed exclusively for Argos. Excellent for stereo or as extension speakers. Audiophile net \$13.95

Troubador model TSW-8S by

Argos

PRODUCTS COMPANY

Dept. C, 600 Sycamore St., Genoa, Illinois 60135

CIRCLE NO. 3 ON READER SERVICE PAGE

IR DETECTOR

(Continued from page 31)

so that the Hotbox does not respond to this normal temperature but will respond to any higher temperature. Also remember that, although the Hotbox does not respond very readily to visible light, it does respond quite rapidly to the source of such light if it is hot—such as the filaments of incandescent or fluorescent bulbs, sunlight, etc. Keep this in mind when installing the Hotbox as a fire alarm.

Once the device is working properly, aim it at a source of IR energy—incandescent or fluorescent lamp filaments, lighted cigarette, hot soldering iron, etc. The indicator lamp should come on as the "beam" of the IR detector crosses the hot spot. You can determine the size of the detector's beam by placing the detector on one side of a pane of glass and moving a lit cigarette around the other side of the glass, marking the glass with a grease pencil where the detector goes on and off. You can make the calibration or measurement at various distances between the Hotbox and the glass pane.

For many applications, an external signal indication is desirable or necessary. In this case, a 6-volt d.c. relay coil can be substituted for the indicator lamp, with its contacts used to actuate a remote signalling system. A 6-volt d.c. buzzer can also be substituted for the relay for a local audible signal.

To use the detector as a burglar alarm, get a conventional IR lamp (heat lamp) from a drug or department store and position it so that the Hotbox can see it either directly or through a series of mirrors. Arrange the relay output so that, as long as the Hotbox sees the IR source, the external signalling device will not be actuated. If an intruder breaks the IR beam, the alarm should go off. This is a fail-safe system since, if the intruder sees the IR source and turns it off, the alarm will sound anyway.

If a high-power alarm system is to be used, a power relay whose contacts can carry the required current can be activated by contacts on the relatively low-current relay that is driven directly by the Hotbox.

-30-

BIG SIX

(Continued from page 41)

Now, install the crossover networks, tweeter, and woofer on the speaker mounting board. Carefully observing polarity, complete speaker/crossover system wiring. If you plan to paint or stain the enclosure, now is the time to do so. And, while you're at it, apply a coat or two of flat black paint to the front of the speaker mounting board.

Set the speaker mounting board close to the enclosure, and thread the leads to the two L-pad controls and conducting bolts on the rear of the enclosure. Install the controls. The basic system is now ready for testing.

Temporarily set the speaker mounting board in place on the front of the enclosure, and hold it in place with four screws. Connect your amplifier, and start a record playing. Now, listening carefully, test the range of the controls. There should be more than enough range to allow adjustment of the sound reproduction to the acoustical environment of your listening room. When you are satisfied, turn off the power amplifier, and disconnect the feed cable.

Complete construction by installing the rest of the screws for the speaker mounting board and the grille cloth and trim.

Stereo Setup. If you build two Big Six speaker systems for stereo reproduction, make the speaker mounting boards mirror images of each other. In this way, the sound will be balanced. A diagram of a mirror-image stereo system is shown in Fig. 4.

Because the midrange speakers are mounted off center and the two speaker mounting boards are mirror images of each other, the two speaker systems can be reversed to alter the stereo effect.

What is the sound reproduction like from the Big Six speaker system? As mentioned earlier, the bass is deep and smooth, but not obtrusive. (So use a turntable with negligible rumble). The midrange is full and smooth, with the column adding to the effectiveness of the sound distribution. And the treble is expansive.

-50-

January, 1969

The remarkable difference about Pearce-Simpson's Guardian 23 and Guardian 23-B: they work.



What's the most important thing about a CB base-station and mobile-unit combination?

When some guy says something, the guy at the other end should be able to hear it.

In other words, "10-4" should sound like "10-4" — not "snap, crackle and pop."

So the great thing about the Pearce Guardian 23 and Guardian 23-B (in fact all Pearce-Simpson's radios) is that the transmitters transmit and the receivers receive.

Don't laugh. Not every CB manufacturer can make that statement.

If you want to get technical, here's the explanation. Pearce-Simpson's exclusive HetroSync circuitry sharpens transmitted signals. High level saturation limiting provides automatic speech clipping. And the Superhet receiver hears signals that ordinary sets distort or fade.

Guardian 23 comes with palm microphone, mounting cradle, AC and DC power cords. Guardian 23-B comes complete with built-in, all transistor, solid state pre-amplifier that lets you stay a comfortable distance from your mike and still broadcast loud and clear. And Pearce-Simpson's new SuperMod desk mike is available as an option.

Guardian 23 and Guardian 23-B — Pearce-Simpson's super twins.

They work.

For more details on all our New CB Radios write Pearce-Simpson, Inc., Dept. PE-169, P.O. Box 800, Biscayne Annex, Miami, Fla. 33152

Pearce-Simpson

Division of GLADDING Corp.

CIRCLE NO. 23 ON READER SERVICE PAGE

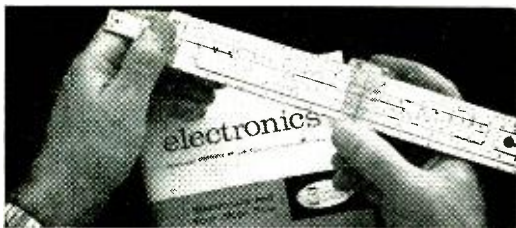

LOOK! A NEW ELECTRONICS SLIDE RULE WITH COMPLETE INSTRUCTION COURSE

Professional 10" all-metal Electronics Slide Rule. Designed specifically for technicians, engineers, students, hobbyists. Has special scales not found on any other rule. Enables you to solve electronics problems quickly, accurately. Made to our rigid specs by Pickett, Inc. Slide Rule plus four lesson AUTO-PROGRAMMED Instruction Course with grading service, and top-grain leather carrying case . . . a \$50 value for less than \$25! Send coupon for FREE booklet. Cleveland Institute of Electronics, Dept. PE-152, 1776 E. 17th St., Cleveland, Ohio 44114.

SEND COUPON FOR FREE BOOKLET

Cleveland Institute of Electronics

1776 E. 17th St., Dept. PE-152,
Cleveland, Ohio 44114

Please send FREE Electronics Slide Rule Booklet. SPECIAL BONUS: Mail coupon promptly and get FREE Pocket Electronics Data Guide, too!



GET THIS FREE!

NAME _____ (Please Print)

ADDRESS _____ COUNTY _____

CITY _____ STATE _____ ZIP _____

A leader in Electronics Training . . . since 1934

CIRCLE NO. 9 ON READER SERVICE PAGE

FIRST WITH

- ★ Digital Integrated Circuits
- ★ 4 Crystal-Controlled Oscillators
- ★ Battery & AC Operation Standard



The New Pace-Setting CONAR Model 680

COLOR GENERATOR KIT \$89.50 WIRED \$121.50

Until now, no commercially available color generator has offered so many quality features in a single instrument at such a low price. Only the CONAR COLOR GENERATOR has all these features at any price: exclusive digital integrated circuits; exclusive 4 crystal-controlled oscillators; exclusive AC or battery operation standard; completely solid state; color amplitude control; color phase adjustment; regulated power supply; stability control; TV station sync and blanking pulses; nine patterns; red, blue and green gun killers; compact; lightweight; portable.

For details write Dept. AA-9C

CONAR instruments

DIVISION OF NATIONAL RADIO INSTITUTE
3939 Wisconsin Ave., Washington, D.C. 20016

WRITE FOR FREE CONAR CATALOG

AM TUNER

(Continued from page 46)

bridges between foil sections and make sure that all solder connections are good. Using a d.c. VTVM, measure the voltage from each transistor emitter to ground. It should be between 15 and 18 volts on the mixer and i.f. stages ($Q1$ and $Q3$, respectively) and between 10 and 14 volts on the oscillator. Connect the output from terminal g on the PC board to an oscilloscope or a.c. VTVM in parallel with the input to the audio system.

The oscillator transformer ($T1$) slug should be set about 4 or 5 turns in from the top of the can and the top slug of $T2$ should be in between 2 and 4 turns. Rotate the tuning capacitor through its range, listening for a station or watching for an indication on the test instrument.

Locate a known station near the low-frequency end of the dial (near 550 kHz) and adjust the slug of $T1$ until the dial reads the known frequency of the station. Then tune to a station near the high-frequency end of the dial and adjust the trimmer capacitor on $C2$ to locate that station where it belongs on the dial. Adjust the antenna trimmer $C1A$ to maximize the high-frequency signal.

Adjust the slug in $T3$ for maximum signal when the tuner is set at 950 kHz. Then adjust the bottom slug of $T2$ to further increase the signal level. Once you hit the maximum signal with $T2$, back the bottom slug out about $\frac{3}{4}$ of a turn. You may have to repeat the i.f. transformer adjustment because of some slight interaction, but when complete, the tuner will be aligned.

If you have a 455-kHz signal generator, you can align the tuner by injecting a signal into the antenna (at 455 kHz) and adjusting the three i.f. transformer slugs for maximum response. Back off the bottom slug of $T2$ about $\frac{3}{4}$ of a turn. Then inject a 550-kHz signal, set tuning capacitor $C1-C2$ fully meshed and adjust the slug of $T1$ for maximum response. A signal of 1600 kHz can be used, with the tuning capacitor fully open, to adjust oscillator trimmer $C2B$ and antenna trimmer $C1B$ for a maximum response. The tuner is now aligned.

-30-

LITERATURE

(Continued from page 16)

test, service, and lab equipment; CB radio; and photographic aids are among the many general and special interest items illustrated, some in full color, in this 116-page catalog. Among the new items appearing for the first time are a 295 sq. in. color TV receiver featuring automatic fine tuning, remote control, power channel selector, and built-in servicing aids; the "Boonie Bike" high-powered trail and snow bike kit; and the Heath/Mitchell "Color Canoe" color processor.

Circle No. 90 on Reader Service Page 15 or 115

Four do-it-yourself illustrated instruction sheets for the electronics experimenter are offered by *DeVry Institute of Technology*. Step-by-step construction details are given for: a printed circuit, a radio-controlled model plane, a field-effect transistor timer circuit, and a motor speed control. The printed circuit, timer, and motor speed control can be used in dozens of different ways in the home workshop.

Circle No. 91 on Reader Service Page 15 or 115

"At Home with Stereo" is a well-illustrated, full-color, 20-page brochure from *H. H. Scott, Inc.* describing their 1969 line of stereo consoles in a collection of decorator-styled room settings. Included are many informative features on high fidelity, choosing the correct console to match individual room decor, and complete explanations, in nontechnical terms, of the more technical aspects of stereo consoles.

Circle No. 92 on Reader Service Page 15 or 115

Edmund Scientific Co.'s new Catalog 691 contains a complete selection of hard-to-find products for countless applications. Included are a compact ($\frac{1}{2}$ pint) ultra-sonic cleaner, which uses sound waves to scrub any kind of small machine parts; a line of MusicVision systems ranging from consoles to do-it-yourself kits, which can be attached to radio, record player, or hi-fi/stereo to provide colorful patterns in time with the music; a variety of special visual effects products, such as a polarized color projector, a kaleidoscope projector, strobe lights, etc.; a ceiling motor for use in rotating lights and displays; and a chromatology kit by which chemical analyses of soluble materials by means of color-band separations can be made.

Circle No. 93 on Reader Service Page 15 or 115

Which of these
4 fascinating
Radio-TV
careers
interests
you?

disc jockey
 newscaster
 sportscaster
 announcer

Our Free Voice Analysis Tells You Whether You Have The Talent To Become A Broadcast Personality!

IMMEDIATE DEMAND • Radio-TV stations everywhere need both men and women to take over important good-paying jobs right now. **NATIONWIDE PLACEMENT ASSISTANCE** at No Extra Cost.

TRAIN AT HOME OR IN ONE OF OUR STUDIO SCHOOLS • You can study broadcast techniques at home, in your spare time, or in one of our many studio schools throughout the country under the supervision of our Directing Faculty of 10 Famous Broadcasters. **Accredited Member National Home Study Council and National Association of Trade and Technical Schools.**

Approved for Veterans' Educational Assistance Benefits ("G.I. Bill")! Check coupon for special information

Send to CAREER ACADEMY's division of famous broadcasters for free booklet, record and voice analysis details!

CAREER ACADEMY

825 North Jefferson Street • Studio 286
Milwaukee, Wisconsin 53202

I want to know if I have broadcasting aptitude worth developing. Please rush more information.

name age

address phone



city/state/zip

07N087200

I am interested in: Home Study
 School Study G. I. Bill

CIRCLE NO. 7 ON READER SERVICE PAGE

PRODUCTS

(Continued from page 24)

to-noise ratio; 45-dB selectivity; 70-dB i.f. rejection; 55-dB image rejection; 38-dB stereo separation; 0.5% harmonic distortion.

Circle No. 94 on Reader Service Page 15 or 115

230-CHANNEL INDUSTRIAL PAGER

Lafayette Radio Electronics Corp. recently announced the addition of the 230-channel "Priva Com 10" encoder/decoder industrial pager to their line of CB gear. (Also available is the "Priva Com 11A," with up to 23 paging channels.) The Priva Com 10 is designed to operate in conjunction with a Lafayette 27-MHz CB transceiver. Selection of the transceiver channel and Priva Com call button automatically breaks the individual-coded pager's silence and permits private one-way communications. A reset switch on the pocket-size pager quiets



the unit at the completion of the call. The 18-transistor, five-diode superhet circuit features 0.7- μ V sensitivity, a mechanical filter, dual-tone squelch, and an internal ferrite antenna.

Circle No. 95 on Reader Service Page 15 or 115

CUBICAL QUAD CB ANTENNA

The Model MCQ-27 cubical quad CB antenna, available from Mosley Electronics, Inc., embodies the latest developments in CB base station antenna design. Featuring three widely spaced elements, the antenna's high signal directivity eliminates unwanted side and back signals, while its low radiation angle assures maximum distance transmission. An accessory allows the user, with the flip of a switch, to change from horizontal to vertical polarization. Technical specifications: forward gain, 9 dB over reference dipole. 11.1 dB over isotropic source; 25-dB or better front-to-back ratio; 1.5/1 or better SWR; gamma match with 52 ohms nominal

feed impedance; unidirectional radiation; 23-channel operation; 3 elements; 7.55 sq ft wind surface; 151-lb wind load (80 mi/hr EIA Standard).

Circle No. 96 on Reader Service Page 15 or 115

VOLT-OHM-MILLIAMMETER WITH FET

The Mercury Electronics Corp. Model 4000 transistorized volt-ohm-milliammeter, employing a field-effect transistor input, combines the features of a VTVM and portability of a VOM in a single instrument. The Model 4000 can be operated from the a.c. power line or from its own batteries. Features include a full-view 6" (200 μ A) meter movement, instant operation, and direct readout of battery condition on meter scale. Technical specifications: 0.5-volt low-d.c. range; 0-1, 3, 10, 100, 300, and 1000 volts d.c. and a.c. voltage ranges; 0.2-1000 megohm, with 10 ohms center scale, resistance measuring capability in seven ranges; five d.c. current ranges from 0 to 1000 milliamperes.



Circle No. 97 on Reader Service Page 15 or 115

AM/FM STEREO RECEIVER

Integrated circuits, ceramic filters, and slide controls are featured in the Model DB250 solid-state stereo receiver available from Boyen Communications Division. The IC's provide better limiting, improved capture ratio, lower distortion, and greater reliability, while the ceramic filters provide more than ten times better selectivity than with conventional filter circuits. The AM portion of the receiver has a mechanical filter to improve selectivity and eliminate interstation heterodyning. Selectivity in the FM mode is rated at 60 dB, and a balanced bridge FM detector reduces distortion to 0.3%. A zero-center meter for FM switches automatically to a signal-strength meter for AM. Rated at 75 watts (1HF) output power, the audio section exhibits 0.8% harmonic distortion at full rated output.



Circle No. 98 on Reader Service Page 15 or 115

GONSET® G17 CITIZENS COMMUNICATOR

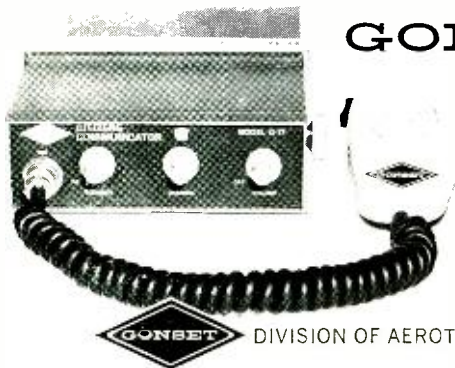

- Full Solid State
- Full legal FCC Power (Type Accepted)
- 12 Channels
- Built-in public address
- Most modern dual conversion receiver circuitry
- Interchangeable base or mobile

Free literature

DIVISION OF AEROTRON, INC. / P. O. Box 6527 Raleigh, North Carolina 27608

CIRCLE NO. 15 ON READER SERVICE PAGE

READER SERVICE PAGE

free information service:

Here's an easy and convenient way for you to get additional information about products advertised or mentioned editorially (if it has a "Reader Service Number") in this issue. Just follow the directions below... and the material will be sent to you promptly and free of charge.

1. Print or type your name and address on the lines indicated. Circle the number(s) on the coupon below that corresponds to the key number(s) at the bottom of the advertisement or editorial mention(s) that interest you. (Key numbers for advertised products also appear in the Advertisers' Index.)

2. Cut out the coupon and mail it to the address indicated below.

3. This address is for our product "Free Information Service" only. Editorial inquiries should be directed to POPULAR ELECTRONICS, One Park Avenue, New York 10016; circulation inquiries to Portland Place, Boulder, Colorado 80302.

**POPULAR
ELECTRONICS**

P.O. BOX 8391
PHILADELPHIA, PA. 19101

VOID AFTER FEBRUARY 28, 1969

1 2 3 4 5 6 7 8 9 10 11 12 13 14 15 16 17 18 19 20
21 22 23 24 25 26 27 28 29 30 31 32 33 34 35 36 37 38 39 40
41 42 43 44 45 46 47 48 49 50 51 52 53 54 55 56 57 58 59 60
61 62 63 64 65 66 67 68 69 70 71 72 73 74 75 76 77 78 79 80
81 82 83 84 85 86 87 88 89 90 91 92 93 94 95 96 97 98 99 100

NAME (Print clearly) _____

ADDRESS _____

CITY _____ STATE _____ ZIP CODE _____

1 b

Free Sound Catalog

The largest selection of speaker system components. Anywhere.



Send for your free copy...today!

Jensen

Jensen Manufacturing Division, The Muter Company
5655 West 73rd Street • Chicago, Illinois 60638

NAME _____

ADDRESS _____

CITY _____ STATE _____ ZIP _____

CIRCLE NO. 18 ON READER SERVICE PAGE

NEW! SOLID STATE KITS

METAL-MINERAL DETECTOR
IN EASY-TO-BUILD KIT FORM

Treasure Locator

MODEL TRL-1 KIT . . . \$29.95

Detects objects as small as a dime.
Sensitive stable circuit uses
3 FET's and 2 silicon transistors.
Unique 6" etched circuit search coil.
Smooth vernier tuning control.
Weighs only 24 oz.
3-ft. handle folds in half.
Adjustable search coil.
9-volt battery operated.
Complete with all parts,
headphone, instructions.
Build in only 3 hours.
No test equipment needed.
Shipping weight: 2½ lbs.

Order direct or request free data sheets on TRL-1 and other kits.



CARINGELLA ELECTRONICS, Inc.
P.O. Box 327 ■ Upland, California 91786
Phone 714-985-1540

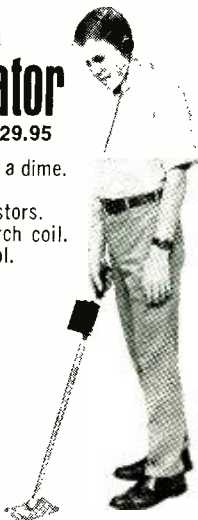

CIRCLE NO. 6 ON READER SERVICE PAGE

LIBRARY

(Continued from page 14)

gineering reference texts. It brings together in a single volume the important principles, applications, and formulas that would normally be spread out among many electronics textbooks. The book is divided into four sections—direct-current theory, alternating-current theory, valve (tube) theory and applications, and transistor theory and applications. Worked-out sample problems and schematic diagrams are employed to clarify important or difficult points in the text. The prerequisites for understanding and using this book are a working knowledge of elementary algebra and trigonometry.

Published by Iliffe Books Ltd., Dorset House, Stamford St., London, S.E. 1. Distributed by Gilfer Associates, PO Box 259, Park Ridge, N.J. 07656. Soft cover. 149 pages. \$3.25.

FEEDBACK AMPLIFIERS AND OSCILLATORS

by Robert E. Sentz and Robert A. Bartkowiak

Written specifically for technical institutes and junior colleges, this book is also eminently suited for home study. An integrated transistor and vacuum-tube approach is employed in the discussions, but emphasis is on transistors. The book covers the entire field of oscillators and feedback amplifiers, from the fundamental types of feedback through UHF and microwave oscillators. Numerous worked-out problems are presented to illustrate various applications and formulas, and practice exercises conclude most chapters. In addition, selected transistor data is included in the appendix to aid the reader in understanding the points developed in the text.

Published by Holt, Reinhart and Winston, Inc., 383 Madison Ave., New York, N.Y. 10017. Soft cover. 218 pages. \$3.95.

CITIZENS BAND

(Continued from page 85)

get cracking on the whole problem. Start by re-reading Part 95. Resist the temptation to stretch your nickels into dimes. Use your call numbers. And respect the 'unwritten law' of Channel 9 for emergencies.

"If we really discipline ourselves, the Federal Communications Commission will have plenty of time to crack down on the nuts."

Have a happy '69 and I'll CB'ing you!

Matt, KHC2060

LETTERS

(Continued from page 10)

teries are reversed in the project! As a result, the excessive current flow through the diodes causes them to break down. After I replaced the diodes and reversed the battery connections, the "Noise Blanker" worked fine.

NAME WITHHELD
Forest Hills, N.Y.

Neither the batteries nor the diodes in the schematic diagram of the "Noise Blanker" article are reversed. The description of the "trouble" points up an important fact that has been brought to our attention several times in the past—some readers fail to identify properly the leads of the common diode.

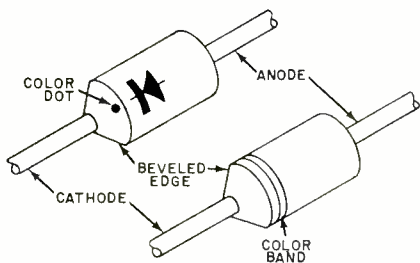

In a schematic diagram, the arrow is the anode and the bar is the cathode. Physically, the cathode is identified by some type of mark or by the shape of the body of the diode. In a circuit where the diode is reverse biased, the positive voltage is connected to the cathode. Therefore, the diode does not conduct until the input level exceeds the total of the internal conduction requirements of the diode and the reverse bias.

RESISTANCE SOLDERING HANDPIECE

Where can I purchase the Redy handpiece shown in Melvin Whitmer's "Resistance Soldering" story (September, 1968) on page 82? Also, where can the different electrodes be obtained?

FRANK SAGNOG
Chicago, Ill.

The only thing we can suggest is that you write to Redy Company, Belleville, Kansas 66935 for this information concerning the resistance soldering handpiece. A similar handpiece is available from Newark Electronics Corporation, 500 North Pulaski Rd., Chicago, Ill. 60624. When ordering, specify catalog No. 34F712 and include payment of \$10.50 plus postage. The electrodes are also available from Newark Electronics; for a package of six metal electrodes, specify catalog No. 34F708, and for the carbon electrodes, specify catalog No. 34F710. The prices of the electrode packets are 50¢ and \$1.50, respectively.

Deluxe POPULAR ELECTRONICS MAGAZINE CASES

DESIGNED TO HOLD A FULL YEAR'S COPIES

These decorative cases are just what you've been looking for to keep your copies of Popular Electronics Magazine in easy-to-find order.



Constructed of reinforced fibreboard and covered in rich leatherette, these durable cases guard against soiling and tearing of your magazines while lending themselves handsomely to the decor of any room. The magazine cases are available with embossed gold lettering in either all black or attractive maroon back with black sides.

\$3.50 ea., 3 for \$10, 6 for \$19

FULLY GUARANTEED!

Ziff-Davis Publishing Co., Dept. SD

1 Park Ave., N.Y., N.Y. 10016

Please send me _____ Popular Electronics Magazine

Files as checked below:

- All black, gold embossed
 Maroon back, gold embossed/black sides

NAME _____ PE-19

ADDRESS _____

CITY _____

STATE _____ ZIP _____

Enclosed is \$ _____ at \$3.50 per case, 3 for \$10, 6 for \$19 (Quantity prices apply for combination orders of more than one title). Orders outside U.S.A. \$4.50 ea., 3 for \$13, 6 for \$25.

(Payment must accompany order)

FREE

RADIO-TV ELECTRONICS

69

ANNUAL CATALOG
No. 691

THE BIG BOOK OF THE ELECTRONICS INDUSTRY

BURSTEIN-APPLEBEE WITH STORES IN...		QUICK INDEX	
* KANSAS CITY, MISSOURI	1000	* KANSAS CITY, MISSOURI	1000
* OVERLAND PARK, KANSAS	1000	* KANSAS CITY, MISSOURI	1000
* SPRINGFIELD, MISSOURI	1000	* KANSAS CITY, MISSOURI	1000
* WICHITA, KANSAS	1000	* KANSAS CITY, MISSOURI	1000

THIS IS A VALUE-PACKED CATALOG—KANSAS CITY, MISSOURI 64111
1100 MERCIER ST., KANSAS CITY, MO. 64111

GIANT 1969
RADIO-TV
ELECTRONICS
CATALOG
228 GIANT
VALUE-PACKED
PAGES

WRITE FOR YOUR FREE COPY TODAY

BURSTEIN-APPLEBEE CO., DEPT. PE-A
3199 MERCIER ST., K.C., MO. 64111

NAME _____

ADDRESS _____

CITY _____ STATE _____ ZIP _____

CIRCLE NO. 5 ON READER SERVICE PAGE

ELECTRONICS MARKET PLACE

COMMERCIAL RATE: For firms or individuals offering commercial products or services. \$1.15 per word (including name and address). Minimum order \$11.50. Payment must accompany copy except when ads are placed by accredited advertising agencies. Frequency discount: 5% for 6 months; 10% for 12 months paid in advance. **READER RATE:** For individuals with a personal item to buy or sell. 70¢ per word (including name and address). No Minimum! Payment must accompany copy.

FOR SALE

FREE! Giant bargain catalog on transistors, diodes, rectifiers, SCR's, zeners, parts. Poly Paks, P.O. Box 942, Lynnfield, Mass. 01940.

GOVERNMENT Surplus Receivers, Transmitters, Snooperscopes, Radios, Parts, Picture Catalog 25¢. Meshna, Nahant, Mass. 01908.

BUG DETECTOR: WILL DETECT AND LOCATE SURREPTITIOUS TRANSMITTING DEVICES IN CONFERENCE ROOMS, HOME AND OFFICES, ETC. WRITE FOR DETAILS. WJS ELECTRONICS, 737 NORTH SEWARD, HOLLYWOOD, CALIF. 90038.

ROCKETS: Ideal for miniature transmitter tests. New illustrated catalog, 25¢. Single and multistage kits, cones, engines, launchers, trackers, rocket aerial cameras, technical information. Fast service. Estes Industries, Dept 18, Penrose, Colorado 81240.

LOWEST Prices Electronic Parts. Confidential Catalog Free. **KNAPP**, 3174 8th Ave. S.W., Largo, Fla. 33540.

TREASURE Hunters! Prospectors! Relco's new instruments detect buried gold, silver, coins, kits, assembled models. Transistorized. Weighs 3 pounds. \$19.95 up. Free catalog. Relco-A33, Box 10836, Houston, Texas 77018.

EUROPEAN and Japanese bargains catalogs. \$1 each. Dee, 10639E Riverside, North Hollywood, Calif. 91602.

TRANSISTORIZED CONVERTER KITS: Two models. converts car radio. Receive 30-50mc or 100-200mc (one mc tuning) \$5.00 with simple instructions. Crystal \$2.50. Meshna, No. Reading, Mass. 01864.

MECHANICAL, ELECTRONIC devices catalog 10¢. Greatest Values—Lowest Prices. Fertik's. 5249 "D", Philadelphia, Pa. 19120.

MUSIC LOVERS, CONTINUOUS, UNINTERRUPTED BACKGROUND MUSIC FROM YOUR FM RADIO, USING NEW INEXPENSIVE ADAPTOR. FREE LITERATURE. ELECTRONICS, 11500-Z NW 7th AVE., MIAMI, FLORIDA 33168.

NEW Sensitive Treasure Metal Detectors. New low prices. Professional models from \$29.95 to \$129.50. Write for free catalog today. Jetco Electronics, Box 132-E, Huntsville, Texas 77340.

JAPANESE or **EUROPEAN** DIRECTORY 200 firms \$1.00. **SURVEILLANCE SECURITY EQUIPMENT**, Catalog 25¢. **SUBMINIMIKE** 3/8 X 3/8 X 3/16 14.00. **SIERRATRONICS**, Box 7497, Las Vegas, Nev. 89101.

WE SELL CONSTRUCTION PLANS. TELEPHONE: Answering Machine, Speakerphone, Carphone, Phonevision, Legal Connector, Auto Dialer, Central Dial System. **TELEVISION:** \$35.00 Color Converter, Tape Recorder, 3DTV, \$25.00 Camera. **DETECTIVE:** Infinity Transmitter, Tail Transmitter, Police Radar Detector. **HOBBYIST:** Electron Microscope, 96 Hour Tape Music System, Ultrasonic Dishwasher, Radar-Oven, Electronic Tranquilizer. Plans \$4.95 each. **COURSES:** Telephone Engineering \$39.50, Detective Electronics \$22.50, Anti-Detective Electronics \$27.50. **SUPER HOBBY CATALOG** 25¢. Don Britton Enterprises, 7906 Santa Monica Blvd., Hollywood, Calif. 90046.

CIRCUIT Boards, Parts for "Poptronics" projects. Free catalog. S.W. Technical, Box 16297, San Antonio, Texas 78216.

WEBBER LAB'S. Police & Fire Converters. Catalog 10¢. 72 Cottage Street, Lynn, Mass. 01905.

RADIO—T.V. Tubes—33¢ each. Send for free catalog. Cornell, 4213 University, San Diego, Calif. 92105.

SECURITY AND PRIVACY PROTECTION DEVICES. FREE DATA: SECURITY ELECTRONICS PE, 15 EAST 43RD STREET, NEW YORK, N.Y. 10017.

GENERAL INFORMATION: First word in all ads set in bold caps at no extra charge. Additional words may be set in bold caps at 10¢ extra per word. All copy subject to publisher's approval. Closing Date: 1st of the 2nd preceding month (for example, March issue closes January 1st). Send order and remittance to: Hal Cymes, POPULAR ELECTRONICS, One Park Avenue, New York, New York 10016.

WHOLESALE COMPONENTS: Manufacturers and distributors only. Request free catalog on business letterhead. **WESCOM**, Box 2536, El Cajon, California 92021.

CONVERT any television to sensitive, big-screen oscilloscope. Only minor changes required. No electronic experience necessary. Illustrated plans, \$2.00. Relco-A33, Box 10563, Houston, Texas 77018.

TELEVISION CAMERA KITS! Wide selection tube and transistor models. Starter kits, \$18.95 up. Complete kits \$149.50 up. Plans available separately; tube camera \$3.00, transistor camera \$5.00. TV station \$1.00, ATV literature anthology \$2.50. Catalog **FREE**. **ATV RESEARCH**, 13th & Broadway, Dakota City, Nebraska 68731.

WPE—HAM—CB QSL's samples 25¢. Dick, W8VXK, Gladwin, Mich. 48624.

RECTIFIERS, transistors, other components. Catalog free. Electronic Components Co., Box 2902C, Baton Rouge, La. 70821.

JAPAN DIRECTORY. Electronics products and parts. General merchandise and Asia trade information. Just \$1.00 today. Ippano Kaisha Ltd., Box 6266, Spokane, Washington 99207.

LINEAR AMPLIFIERS: "Hornet" 50 watts output—\$98.50; "Raider"—100 watts—\$139.50; "Maverick 250"—250 watts—\$244.95. AM and SSB. "Scorpion"—50 watt 12 V. Mobile amplifier—\$99.95; "Bandit II"—12 V. Mobile Amplifier—\$169.95. Frequency range 20-35 megacycles (illegal for class D 11 meters.) Dealer inquiries invited. D & A Manufacturing Co., 1217 Avenue C, Scottsbluff, Nebraska 69361.

WRITE now for free 1969 catalog. McGee Radio Company. 1001 bargains. Speakers—Parts—Tubes—High Fidelity Components—Record Changers—Tape Recorders—Kits. Everything in Electronics. 1901 McGee Street, Kansas City (GE), Missouri 64108.

ELECTRONIC ignition, various types. Free literature. Anderson Engineering, Epsom, N.H. 03239.

EXCITING values in Portable Monitor Receivers, Ameco Converters, accessories. Details, Free Antenna Offer: Griffin's, 322 West State, Ithaca, N.Y. 14850.

ALARMS! Controls and components. Complete stock. Installers welcome! Free catalog writing letterhead, business card. Otherwise \$1.00 refundable first purchase. **SILMAR ELECTRONICS**, 3476-78 N.W. 7th Street, Miami, Florida 33125.

MAGNETISM as I see it—by Jesse Costa—a 100 page pictorial manuscript describing my latest theories and experiments in basic magnetism. (\$3.00) Box 26, Waquoit, Massachusetts 02536.

S.S.S. Send 20¢ for our catalog featuring rectifiers, transistors, SCR's, IC's and other useful solid state devices. Solid State Sales, Box 74F, Somerville, Mass. 02143.

DIAGRAMS—Radios \$1.50, Television \$3.00. Give make and model. Diagram Service, Box 1151PE, Manchester, Conn. 06042.

GARRARD Record Changers, Hi-Fi Components, Cartridges, Needles, Tape, TV Parts, Schematics. Write for Unbelievable Prices. Gregg Electronics, P.O. Box 184, Glen Head, N.Y. 11545.

GERMAN and Japanese tubes and parts. Matthews Foreign Equipment Service Center, Box 151, Lawton, Oklahoma 73501.

ETCH your own Printed Circuit Boards. Save time, money. **COMPLETE INSTRUCTIONS** \$2.00. Logue, Box 82, Bayville, N.Y. 11709.

SEND ONLY 25¢ for **TWO** new & unique gift catalogs of unusual items for home & auto. You'll also receive certificate for \$1.00 refund on your first order. Great ideas! Send now! J. Ross, 80-34 Kent St., Jamaica, N.Y. 11432. Dept. PE.

INVESTIGATORS, LATEST ELECTRONIC AIDS. FREE LITERATURE. CLIFTON, 11500-L NW 7th AVE., MIAMI, FLORIDA 33168.

NEW PATENT PENDING TRANSDUCER SYSTEM MAKES USEFUL VOLTAGE ONLY READ FULL SCALE. MINIATURE METERS NOW PRACTICAL ON SMALL ELECTRONIC DEVICES. ANY POPULAR BATTERY PACK FROM 1.5 TO 15.0 VOLTS. CATALOGUE 25¢. V F MANUFACTURING COMPANY, BOX 18422, DALLAS, TEXAS 75218.

21ST CENTURY SCIENCE PRODUCTS. Incredible science products of the future, available now! Amazing catalog and gift—50¢. R.J. Graham, 171 East Bank, Fond du Lac, Wisconsin 54935.

1200 VOLT shock module \$5.95. Fun, pranks, property protection. Uses flashlight batteries. Effective. Non-lethal. Catalog 20¢. Franks Scientific Co., P.O. Box 156, Martelle, Iowa 52305.

LABORATORY chemicals supplies 1969 catalog has over 400 listings. Many scientific publications catalogues \$.25. Casco, Dept. X, P.O. Box 77, Riverdale, New Jersey 07457.

POLICE NEW "10" CODE 50¢, three \$1.00. IRC, Box 19288, Washington, D.C. 20036.

SHOCKING PAPERWEIGHT. Transistorized. For fun desk, etc. Labeled "World's Heaviest Paperweight". When lifted gives harmless, potent continuous shock. Matchbox size. \$9.95 SHOCKER MODULES. 9 volts input, 150 output. \$4.95. Free list, lowest prices, tape recorders, Hi-Gain police receivers, Hi-Fi's, etc. Arch Electronics, 11040 Larimore Rd., St. Louis, Mo. 63138.

FREE ELECTRONICS PARTS FLYER. Large catalog \$1.00 deposit. BIGELOW ELECTRONICS, BLUFFTON, OHIO 45817.

SURVEILLANCE equipment construction plans. Includes: Infinity Transmitter, Martini-Olive Transmitter, Automobile and Personnel Tailing Devices, Room Bugs, Telephone Bugs, Debuggers, etc. All these plans for \$5.00. Bylina (PE), P.O. Box 09131, Chicago, Illinois 60609.

TRANSISTORS, capacitors, miniature electronic parts. Catalog 25¢. ECD Company, Box 5231, Lansing, Michigan 48905.

TRANSISTOR sentry detects proximity of human body. Plans, instruction \$2.50. If you want all electronic parts free add 25¢ for handling. Barta, Box 15083, San Francisco, Calif. 94115.

TELEVISION Doctor, \$1.00. Thomas Garber, 104 Ashley Street, Korn Krest, Wilkes-Barre, Penna. 18702.

HOBBYISTS, EXPERIMENTERS, amateur scientists, students . . . Construction Plans—All complete including drawings, schematics, parts list with prices and sources . . . Laser—Build your own coherent-light optical laser. Operates in the visible light range. pulsed mode—\$6.00 . . . Radar—Build your own ultrasonic doppler radar. Detect motion of people, automobiles, even falling rain drops. Transistorized, uses standard small 9-volt battery—\$4.00 . . . Tic Tac Toe Machine—You play against machine. Automatic. Can you beat the machine? Sometimes yes, usually no—\$4.00 . . . Long Range "Sound Telescope"—This amazing device can enable you to hear conversations, birds, other sounds hundreds of feet away. Very directional. Transistorized, uses 9-volt battery—\$3.00 . . . Or send 25¢ coin or stamps for complete catalogue . . . Technical Writers Group, Box 5994, State College Station, Raleigh, N.C. 27607.

PLANS AND KITS

BEGINNERS Allwave \$5.00. Two Band \$5.00. F-M Tuner Chassis \$10.00, Headset \$2.50, Two Band Wired \$10.00. Ekeradio, Box 131, Temple City, Calif. 91780.

BUILD-IT-YOURSELF. Save big dollars. Transistor stereo amplifiers. Color organs. Speakers. Write Workshop, Box 393, Bethpage, New York 11714.

KITS, metal detector \$5.95. Audio Telescope \$5.95, others. Lec-tronix, Box 42, Madison Heights, Michigan 48071.

"DISTANCE CRYSTAL SET CONSTRUCTION" Handbook—50¢. "Coil Winding"—50¢. Catalog. Laboratories, 12041-L Sheridan, Garden Grove, Calif. 92640.

FANTASTIC, FIBER-OPTICS kit, \$12.95 PPD. Chriscyberbionics, Box 15763, West Palm Beach, Florida 33406.

FOUR CHANNEL COLOR ORGAN. WELL DESIGNED CIRCUIT. EASY TO BUILD. COMPLETE PLANS \$1.00. WITH PRINTED CIRCUIT BOARD \$2.50. WAYNE THOMPSON, BOX 244, EL GRANADA, CALIF. 94018.

TESLA COIL—40" SPARKS! Plans \$5.00. Information 50¢. Huntington Electronics, Box 9, Huntington, Conn. 06484.

INTEGRATED CIRCUIT KITS: COMPUTER, AUDIO, Others. New catalog free. KAYE ENGINEERING, Box 3932-A, Long Beach, California 90803.

STROBE-LIGHT PLANS: \$1.50. Spacetrronics, Box 3153, Buena Park, California 90620.

SOLAR FLYING SAUCERS. (brand new, solid state engine, fantastic performance, flies for miles on sun's power. lifts animals, send messages, parachutes, build easily for next to nothing with everyday materials, many sizes, many designs). Complete plans, descriptions, drawings. \$1.00. Spacetrronics, Box 31043-PE, San Francisco, Calif. 94131.

SHORTWAVE LISTENING

POLICE—FIRE—AIRCRAFT—MARINE—AMATEUR CALLS on your broadcast radio with TUNAVERTER! Tunable and crystal in one! Guaranteed! Free catalog. Salch Co., Woodsboro-PEC, Texas 78393.

HIGH FIDELITY

FREE! Send for money saving stereo catalog #PIE and lowest quotations on your individual component, tape recorder, or system requirements. Electronic Values, Inc., 200 W. 20th St., New York, N.Y. 10011.

Hi-Fi Components, Tape Recorders, at guaranteed "We Will Not Be Undersold" prices. 15-day money-back guarantee. Two-year warranty. No Catalog. Quotations Free. Hi-Fidelity Center, 239 (P) East 149th Street, New York 10451.

LDW, Low quotes: all components and recorders. HiFi, Roslyn, Penna. 19001.

TAPE RECORDERS, Hi-Fi, components, Sleep Learning Equipment, tapes. Unusual Values Free Catalog. Dressner, 1523R, Jericho Turnpike, New Hyde Park, N.Y. 11040.

DON'T THROW YOUR OLD CARTRIDGE AWAY. Send us \$19.95 and any old cartridge. We will ship PREPAID any one of the following top rated elliptical diamond stereo cartridges NEW: Shure M75E, M91E, M92E, M93E, Empire 888E, Pickering V15AME3, XV15 ATE, ADC 660E, 550E. Write for lowest quotations all stereo components. DEFA ELECTRONICS, 2207 Broadway, New York, N.Y. 10024.

NEW Record Changers. BSR—\$13; V.M.—\$16; Garrard—\$22; Radio-Phono stereo—\$15. "CHANGERS", 2737 Third Ave., Bronx, N.Y. 10451.

ACOUSTIC RESEARCH products now available to overseas personnel, diplomats, and citizens of foreign countries. Write for full product and dealer information. AR International, Dept. PE, 24 Thorndike St., Cambridge, Mass. 02141.

DON'T THROW YOUR OLD CARTRIDGE AWAY. Send us \$50.00 and any old used cartridge and we will ship you via air Prepaid anywhere the following Top Stereo Cartridges: Shure V-15 Type II, Empire 999VE, ADC 10EMK II, Stanton 681EE. Write for lowest quotations all stereo components. DEFA ELECTRONICS, 2207 Broadway, New York, N.Y. 10024.

WANTED

CASH Paid! Unused tubes, electronic equipment. Barry, 512 Broadway, NYC 10012.

QUICKSILVER, Platinum, Silver, Gold, Ores Analyzed. Free Circular. Mercury Terminal, Norwood, Mass. 02062.

CASH for terminals—red, blue, yellow. HALCAP, Box 19183, Houston, Texas 77024.

TUBES

TUBES "Oldies", latest. Lists free. Steinmetz, 7519 Maplewood, Hammond, Indiana 46324.

RECEIVING & INDUSTRIAL TUBES, TRANSISTORS. All Brands—Biggest Discounts. Technicians, Hobbyists, Experimenters—Request FREE Giant Catalog and SAVE! ZALYTRON, 469 Jericho Turnpike, Mineola, N.Y. 11501.

TUBE Headquarters of World! Send 10¢ for Catalog (tubes, electronic equipment) Barry, 512 Broadway, N.Y.C. 10012.

RADIO & T.V. Tubes—33¢ each. Send for free list. Cornell, 4213 University, San Diego, Calif. 92105.

THOUSANDS and thousands of types of electronic parts, tubes, transistors, instruments, etc. Send for Free Catalog. Arcturus Electronics Corp., MPE, 502-22nd St., Union City, N.J. 07087.

DON'T BUY TUBES—Radios, TV-Xmitting, special-purpose types until you get our price list! Lowest prices in U.S.A. 5,000 types—Guaranteed Brand New. Send postcard for TV-Special Purpose Price List. **UNITED RADIO COMPANY, P.O. BOX 1000, NEWARK, N.J. 07101.**

TAPE AND RECORDERS

BEFORE Renting Stereo Tapes try us. Postpaid both ways—no deposit—immediate delivery. Quality—Dependability—Service—Satisfaction—prevail here. If you've been dissatisfied in the past, your initial order will prove this is no idle boast. Free Catalog. Gold Coast Tape Library, Box 2262, Palm Village Station, Hialeah, Fla. 33012.

HI-FI Components. Tape Recorders, at guaranteed "We Will Not Be Undersold" prices. 15-day money-back guarantee. Two-year warranty. No Catalog. Quotations Free. HiFidelity Center, 239 (PT) East 149th Street, New York 10451.

WHOLESALE—4, 8 track **STEREOTAPES**—Car, Home **PLAYERS**—CB, Recorders. **MUSICO**, Box 11045, Montgomery, Alabama 36105.

RENT 4-Track open reel tapes—all major labels—3,000 different—free brochure. Stereo-Parti, 55 St. James Drive, Santa Rosa, Ca. 95401.

TAPE RECORDER SALE. Brand new nationally advertised brands, \$10.00 above cost. Amazing discounts on stereo components. Arkay Electronics, 1028-C Commonwealth Avenue, Boston, Mass. 02215.

STEREO TAPE CLUB: AVERAGE COST \$3.78—\$4.20. Cartridges, Cassettes, Reels, No minimum monthly purchases. Mail—10¢—catalog. Star Recordings, Box 1055, El Paso, Texas 79946.

EXCLUSIVE! NORELCO CONFERENCE 'CARRY-CORDER'. Four hour recording on C-120 cassette. Unique accessories. Free data: Security Electronics-PER, 15, East 43 Street, New York, N.Y. 10017.

TAPEMATES makes available to you **ALL 4-TRACK STEREO TAPES—ALL LABELS**—postpaid to your door—at tremendous savings. For free brochure write: **TAPEMATES**, 5727 W. Jefferson Blvd., Los Angeles, California 90016.

STEREO TAPES, Save 30% and up; no membership or fees required; postpaid anywhere U.S.A. Free 70-page catalog. We discount batteries, recorders, tape/accessories. Beware of slogans, "not undersold", as the discount information you supply our competitor is invariably reported to the factory. **SAXITONE**, 1776 Columbia Road, N.W., Washington, D.C. 20009.

EMPLOYMENT INFORMATION

FOREIGN and **USA** job opportunities available now. Construction, all trades. Earnings to \$3,000.00 monthly. Paid overtime, travel bonuses. Write; Universal Employment, Woodbridge, Conn. 06525.

PERSONALS

MAKE FRIENDS WORLDWIDE through international correspondence. Illustrated brochure free. Hermes, Berlin 11, Germany.

LEMURIAN VIEWPOINT—Meaningful discussions of Cosmic Truth: the purpose of human life, reincarnation, man's place in a Higher Plan, and subjects from the Lemurian Philosophy. Send for **FREE** copy. Lemurian Fellowship, Dept. 906, Box 397, Ramona, Calif. 92065.

INVESTIGATORS, LATEST ELECTRONIC AIDS. FREE LITERATURE. **CLIFTON**, 11500-K NW 7th AVE., MIAMI, FLORIDA 33168.

SECRET plans revealed. Free brochure. Audiotronix EI, 156 Fifth Avenue, New York, N.Y. 10010.

INVENTIONS WANTED

INVENTIONS wanted. Patented; unpatented. Global Marketing Service, 2420-P 77th, Oakland, Calif. 94605.

PATENT Searches including Maximum speed, full airmail report and closest patent copies, \$6.00. Quality searches expertly administered. Complete secrecy guaranteed. Free Invention Protection forms and "Patent Information." Write Dept. 9, Washington Patent Office Search Bureau, 711 14th Street, N.W., Washington, D.C. 20005.

QUALITY Patent Searches! Preferred by Professional Inventors, Lawyers, Manufacturers. "Confidential Report" Including related United States patent copies "Airmailed Certified." **FREE** information! United States Inventors Service Company, 501-H Thirteenth Street, N.W., Washington, D.C. 20005.

INVENTORS. We will develop, help sell your idea or invention, patented or unpatented. Our national manufacturer clients are urgently seeking new items for outright cash sale or royalties. Financial assistance available. 10 years proven performances. For free information, write Dept. 41, Wall Street Invention Brokerage, 79 Wall Street, New York N.Y. 10005.

CLASSIFIED ADVERTISING ORDER FORM

Please refer to heading on first page of this section for complete data concerning terms, frequency discounts, closing dates, etc.

1	2	3	4	5
6	7	8	9	10
11	12	13	14	15
16	17	18	19	20
21	22	23	24	25
26	27	28	29	30
31	32	33	34	35

_____ Words { @ 70¢ (Reader Rate) } = \$ _____
 { @ \$1.15 (Commercial Rate) }

Insert _____ time(s) Total Enclosed \$ _____

NAME _____

ADDRESS _____

CITY _____ STATE _____ ZIP _____

Signature _____

WORD COUNT: Include name and address. Name of city (Des Moines) or of state (New York) counts as one word each. Zip Code numbers not counted. (Publisher reserves right to omit Zip Code if space does not permit.) Count each abbreviation, initial, single figure or group of figures or letters as a word. Symbols such as 35mm, COD, PO, AC, etc., count as one word. Hyphenated words count as two words.

PE-169

INVENTORS! OUR FREE EXPERT ANALYSIS of your invention can save valuable time, help you realize full sale value. Strictly confidential. **FREE INVENTION CERTIFICATE.** Write today: Pioneer Invention Service, Dept. 35, 150 Broadway, New York, N.Y. 10038.

INVENTORS! Sell your invention for cash or royalties! Our client manufacturers eagerly seek new items. Patented. Unpatented. Financial assistance if needed. 25 years proven performances. For free information, write Dept. 20, Gilbert Adams, Invention Broker, 80 Wall St., New York, N.Y. 10005.

FREE "Directory of 500 Corporations Seeking New Products." For information regarding development, sale, licensing of your patented/unpatented invention. Write: Raymond Lee Organization, 230-GR Park Avenue, New York City 10017.

PATENT SEARCHES, including copies of related United States Patents. Inventors, attorneys, manufacturers use our "World-Wide" Airmail service! Free: "Invention Record" form and "Information Every Inventor Needs", Hayward Company, 1029HR Vermont, Washington, D.C. 20005.

GOVERNMENT SURPLUS

GOVERNMENT Surplus How and Where to Buy in Your Area. Send \$1.00 to: Surplus Information PE, Headquarters Building, Washington, D.C. 20036.

JEEPS Typically From \$53.90 . . . Trucks From \$78.40 . . . Boats, Typewriters, Airplanes, Multimeters, Oscilloscopes, Transceivers, Electronics Equipment, Used. 100,000 Bid Bargains Direct From Government Nationwide. Complete Sales Directory and Surplus Catalog \$1.00 (Deductible First \$10.00 Order). Surplus Service, Box 820-J, Holland, Michigan 49423.

BOOKS

FREE catalog 950 aviation/electronic/space books. Aero Publishers, 329PE Aviation Road, Fallbrook, California 92028.

UNUSUAL Books! Catalog free! International, Box 7798 (PE), Atlanta, Georgia 30309.

FREE Book Prophet Elijah Coming Before Christ. Wonderful Bible Evidence. PE Megiddo Mission, Rochester, New York 14619.

FREE CATALOG. BOOKS FOR ADULTS. CATALOG, 2217 LACKLAND, ST. LOUIS, MISSOURI 63114.

AMAZING self help books. Write Lynn, Box 1573, Waco, Texas 76703.

PUBLISH your book! Join our successful authors: publicity, advertising, promotion, beautiful books. All subjects invited. Send for free appraisal and detailed booklet. Carlton Press, Dept. ZDM, 84 Fifth Avenue, New York 10011.

AUTHORS' SERVICES

AUTHORS! Learn how to have your book published, promoted, distributed. **FREE** booklet "ZD," Vantage, 120 West 31 St., New York 10001.

MUSIC

POEMS wanted for new songs. Nashville Music Institute, Box 532-E, Nashville, Tennessee 37202.

MUSICAL INSTRUMENTS

ACCORDIONS, GUITARS, AND INSTRUMENTS! Save to 50%. Terms. Trades. Free Trial. Free catalog. Mention instrument. Music Mart, 5535-PE Belmont, Chicago 60641.

HYPNOTISM

FREE Hypnotism, Self-Hypnosis, Sleep Learning Catalog! Drawer H400, Ruidoso, New Mexico 88345.

"MALE-FEMALE HYPNOTISM" EXPOSED, EXPLAINED! "SECRET METHOD"—THEY NEVER KNOW! \$2, RUSHED. GUARANTEED! ISABELLA HALL, SILVER SPRINGS, FLORIDA 32688.

AMAZING HYPNOTIC record kit releases fantastic mental power! Free offer expires soon. Write: Forum, Studio A41, 333 North Michigan, Chicago 60601.

January, 1969

Buy 10 PAKS & CHOOSE 1 FREE

<input type="checkbox"/> \$25 SURPRISE PAK: transistors, rect, diodes, etc. . .	\$1
<input type="checkbox"/> 50 MICA CONDENSERS, to 1mf silvered tool . . .	\$1
<input type="checkbox"/> 10 KODAK LENSES, convex, plano, etc. Hobby must	\$1
<input type="checkbox"/> 50 GERMANIUM GLASS DIODES, 1N31, 1N48 no test	\$1
<input type="checkbox"/> 40 TOP HAT SILICON RECTIFIERS, no test/asst values	\$1
<input type="checkbox"/> 25 EPOXY RECTIFIERS, silicon asst, no test . . .	\$1
<input type="checkbox"/> 40 PRECISION RESISTORS, 1/2W 1% asst values . .	\$1
<input type="checkbox"/> 30 TRANSISTORS, rf, if, audio, use, no test . . .	\$1
<input type="checkbox"/> 60 TUBULAR CONDENSERS, to .5mf to 1KV, asst . .	\$1
<input type="checkbox"/> 50 DISC CONDENSERS, to .05mf npo, temp coef, asst	\$1
<input type="checkbox"/> 60 TUBE SOCKETS, receptacles, plugs, audio, etc. .	\$1
<input type="checkbox"/> 30 POWER RESISTORS, to 25 watts, to 24K ohms . .	\$1
<input type="checkbox"/> 60 CERAMIC CONDENSERS, discs, npos, to .05 . . .	\$1
<input type="checkbox"/> 40 "MICRO" RESISTORS, for transistor circuitry . .	\$1
<input type="checkbox"/> 10 VOLUME CONTROLS, to 1 meg, switch too! . . .	\$1
<input type="checkbox"/> 10 ELECTROLYTICS, to 100mf, tubulars too, asst . .	\$1
<input type="checkbox"/> 50 RADIO & TV KNOBS, asstd colors & styles . . .	\$1
<input type="checkbox"/> 10 TRANSFORMER ELECTROLYTICS, to 100mf, asst values	\$1
<input type="checkbox"/> 50 COILS AND CHOKES, if, rf, ant, osc, peaking, etc	\$1
<input type="checkbox"/> 65 HALF WATTERS, to 1 meg, % popular values too	\$1
<input type="checkbox"/> 60 HI-QUALITY RESISTORS, 1/2, 1, 2W asst values . .	\$1
<input type="checkbox"/> 10 RCA PHONO PLUGS & JACK SETS, tuners, etc. . .	\$1
<input type="checkbox"/> 35 TWO WATTERS, asst incl. A.B., 5% tool . . .	\$1
<input type="checkbox"/> 2-PC INFRA-RED DETECTOR & FILTER SET science/proj	\$1
<input type="checkbox"/> 2 FIELD EFFECT TRANSISTORS, n channel, hobby . .	\$1
<input type="checkbox"/> 50 TERMINAL STRIPS, 1 to 8 lug types . . .	\$1
<input type="checkbox"/> 3 PHOTO ELECTRIC CELLS, hi, imp., schematic . . .	\$1
<input type="checkbox"/> 3 TRANSFORMER AMPLIFIER, WIRE, 3x2x3/4" schematic	\$1
<input type="checkbox"/> 10 PRINTED CIRCUIT BOARDS, copper clad, 100 uses	\$1
<input type="checkbox"/> 10 TRANSISTOR SOCKETS, for pnp & npn types . . .	\$1
<input type="checkbox"/> 10 PANEL SWITCHES, toggle, slide, micro, rotary . .	\$1
<input type="checkbox"/> 5 "SUN" BATTERIES, for 100's of lite sens proj's . .	\$1
<input type="checkbox"/> 20 NE 2 BULBS, GE, for 100's proj's Hobby must	\$1
<input type="checkbox"/> 30 MOLDED COND'S, mylar, pore, black beauty . . .	\$1
<input type="checkbox"/> 6 "IBM" COMPUTER BOARDS, many trans, diodes . .	\$1
<input type="checkbox"/> 40 "MICRO" CONDENSERS, for transistor circuitry . .	\$1
<input type="checkbox"/> 40 CORNING "LOW NOISE" resistors, asst.	\$1
<input type="checkbox"/> 2- CLAIREX "DISC" PHOTO ELECTRIC CELLS, . . .	\$1

ADD POSTAGE, avg. wgt. 1/2 lb. CATALOG 10c

POLY PAKS

P.O. BOX 942E
LYNNFIELD, MASS.
01940

CIRCLE NO. 24 ON READER SERVICE PAGE

SECRET techniques of professional hypnotists revealed. **HYPNOTIZE ANY SUBJECT, EVEN AGAINST WILL! \$1.00. SUCCESS OR MONEY BACK.** R.J. Graham, 171 East Bank, Fond du Lac, Wisconsin 54935. **HYPNOTIZE SUCCESSFULLY! RESULTS ABSOLUTELY GUARANTEED! ONLY RESULTS COUNT—RIGHT?** Complete illustrated course—including "SECRET NERVE METHOD". They never know! \$2.00. H. Fowler, Box 4396, Woodbury, N.J. 08096.

COINS

FREE U.S. large cent from catalog. 10¢. Allen's, 5674-Z Beacor, Pittsburgh, Pennsylvania 15217.

MAGNETS

MAGNETS. All types. Special—20 disc magnets, or 2 stick magnets, or 10 small bar magnets, or 8 assorted magnets, \$1.00 Maryland Magnet Company, 5412-H Gist, Baltimore, Maryland 21215.

PHOTOGRAPHY—FILM, EQUIPMENT, SERVICES

MEDICAL Film—Adults Only—"Childbirth"—1 reel 8mm \$7.50—16mm \$14.95. International-E, Greendale, L.I., New York 11548.

SCIENCE Bargains Request Free Giant Catalog "CJ"—148 pages—Astronomical Telescopes, Microphones, Lenses, Binoculars, Kits, Parts. War surplus bargains. Edmund Scientific Co., Barrington, New Jersey 08007.

EDUCATIONAL OPPORTUNITIES

LEARN WHILE ASLEEP. Miraculously build Mind Power, achieve Self-Confidence, improve Health, gain Success. Method 92% effective. Details free. ASR Foundation, Box 7021EG Henry Clay, Sta., Lexington, Kentucky 40502.

RECORDS

SPECIAL INTEREST RECORDS AVAILABLE, PRODUCED BY THE EDITORS OF THE WORLD'S LEADING SPECIAL INTEREST MAGAZINES. SEND FOR FREE CATALOG. RECORD CATALOG-PE ZIFF-DAVIS PUBLISHING COMPANY, ONE PARK AVENUE, NEW YORK, N.Y. 10016.

OLDIES 45RPM. Original Hits. Over 1500 available. Catalog 25¢ C & S Record Sales, Box 197, Wampsville, N.Y. 13163.

19¢ RECORDS from your tapes. Write Concert Recording, Lynwood, California 90262.

INSTRUCTION

LEARN While Asleep, hypnotize with your recorder, phonograph. Astonishing details, sensational catalog free! Sleep-learning Association, Box 24-ZD, Olympia, Wash. 98501.

LEARN ELECTRONIC ORGAN SERVICING at home all makes including transistor. Experimental kit—trouble-shooting. Accredited NHSC. Free Booklet. **NILES BRYANT SCHOOL**, 3631 Stockton, Dept. A, Sacramento, Calif. 95820.

ASSOCIATE Degree in Electronics Engineering earned through combination correspondence-classroom educational program. Free brochure. Grantham Technical Institute, 1505 N. Western Ave., Hollywood, Calif. 90027.

HIGHLY EFFECTIVE home study course in Electronics Engineering Mathematics with circuit application. Earn your Associate in Science Degree. Free Literature. Cook's Institute of Electronics Engineering, P.O. Box 36185, Houston, Texas 77036. (Established 1945.)

FCC First Class License in six weeks—nation's highest success rate—approved for Veterans Training. Write Elkins Institute, 2603B Inwood Road, Dallas, Texas 75235.

R.E.I.'s famous (5) week course for the First Class Radio Telephone License is the shortest, most effective course in the nation. Over 98% of R.E.I. graduates pass F.C.C. exams for 1st class license. Total tuition \$350.00. Job placement free. Write for brochure. Radio Engineering Incorporated Schools, 1336 Main Street, Sarasota, Florida 33577—or 3123 Gillham Road, Kansas City, Missouri 64109—or 809 Caroline Street, Fredericksburg, Virginia—22401—or 625 E. Colorado Street, Glendale, California 91205.

PRINTING

THERMOGRAPHED business cards, \$3.49—1,000, free samples. Gables—405A Clifton, Glenshaw, Pa. 15116.

FREE LITERATURE: Address labels, business cards, printing, Rubber Stamps. **JORDAN'S**, 552 West O'Connor, Lima, Ohio 45801.

BUSINESS OPPORTUNITIES

INVESTIGATE ACCIDENTS: Earn to \$1000 monthly. Men urgently needed. Car furnished. Business expenses paid. No selling. No College education necessary. Pick own job location. Investigate full time or earn to \$8 hour spare time. Write for **FREE** information. No obligation. Universal Schools, CZ-1, 6801 Hillcrest, Dallas, Texas 75205.

RAISE Rabbits for us on \$500 month plan. Free details. White's Rabbitry, Mt. Vernon, Ohio 43050.

FREE CATALOGS. Repair air conditioning, refrigeration. Tools, supplies, full instructions. Doolin, 2016 Canton, Dallas, Texas 75201.

PIANO TUNING learned quickly at home. Tremendous field! Musical knowledge unnecessary. GI Approved. Free Information. Empire School, Miami, Florida 33145.

FREE Book "990 Successful little-known Businesses." Work home. Plymouth 345R, Brooklyn, N.Y. 11218.

ELECTROPLATING Equipment and supplies. All types for home workshops and industrial. Send \$1.00 (refundable) for equipment guide formulas, operating data, catalog. HBS Equipment Division 90, 3543 East 16th, Los Angeles, California 90023.

I MADE \$40,000.00 Year by Mailorder! Helped others make money! Start with \$10.00—Free Proof. Torrey, Box 318-N, Ypsilanti, Michigan 48197.

\$200.00 DAILY In Your Mailbox! Your opportunity to do what mail-order experts do. Free details. Associates, Box 136-J, Holland, Michigan 49423.

SELL HERTEL BIBLES—Part Time. Finest reference Bible available. Demonstrator and supplies furnished. Excellent commissions, Write International Book, Dept. PE, Box 118, Wichita, Kansas 67201.

MAILORDER . . . Stop Looking! Start Your own Business! Methods, 1410-F.D., Lafayette Hill, Pennsylvania 19444.

HOW AND WHERE to get capital. Free details. 1001 sources. Cut red-tape. Counselor-48, Harlingen, Texas 78550.

ADDRESSERS, COMMISSION mailers Wanted. Rush 12¢ stamps for details. Smyre's, 953-ZD, Newark, N.J. 07101.

CHRONICLE magazine profitable opportunities. Sample 40¢. McPlastens, PEM1432 First, San Diego, Calif. 92101.

EARN \$240.00 a month at home, spare time, doing only two \$5.00 Invisable Mending jobs a day. Big money paid for service that makes cuts, tears disappear from fabrics. Steady demand. Details free. **FABRICON**, 1572 Howard, Chicago 60626.

STAMPS

50 FREE stamps with approvals. Marc Bacharach, 662 Foxcroft Road, Elkins Park, Penna. 19117.

REPAIRS AND SERVICES

TV Tuners rebuilt and aligned per manufacturers specification. Only \$9.50. Any make UHF or VHF. Ninety day written guarantee. Ship complete with tubes or write for free mailing kit and dealer brochure. **JW Electronics**, Box 51C, Bloomington, Indiana 47401.

SPEAKER REPAIR. Hi-Fi, guitar, organ speakers reconed good as new at fraction of new speaker price. For details and reconing center in your area write: Waldom Electronics, Inc., Dept PE, 4625 W. 53rd St., Chicago, Ill. 60632.

CHASSIS: All types and sizes. Will build to your specifications. Phone 307-532-5752. A & T Manufacturing, Inc., 1902 West C., Torrington, Wyoming 82240.

REAL ESTATE

FREE . . . New Spring 1969 CATALOG! Describes and pictures hundreds of farms, ranches, town and country homes, businesses coast to coast! Specify type property and location preferred. Zip code, please. **UNITED FARM AGENCY**, 612-EP West 47th St., Kansas City, Mo. 64112.

400,000,000 ACRES government public land located in 25 states. Low as \$1.00 acre detailed 1969 report. Send \$1.00. Land Information 422-PE1, Washington Building, Washington, D.C. 20005.

MISCELLANEOUS

WINEMAKERS: Free illustrated catalog of yeasts, equipment. Semplex, Box 7208, Minneapolis, Minn. 55412.

BILLS PAID WITHOUT BORROWING—Nobody refused up to \$18,000.00. Bad credit no problem—Not a Loan Company. Write for **FREE** application—**INTERNATIONAL ACCEPTANCE**, Dept. 50A, Phoenix, Arizona 85012—711 14th St., N.W., Washington, D.C. 20005—507 Carondelet St., New Orleans, La. 70130.

STOP BURGLARS THE EASY WAY!! Affix authentic "Protected by Electronic Sentry Alarm" Decals to auto windows, door & windows of home, retail stores, vending machines, etc. Whether you have an alarm or not—thieves stay away! Only \$1.00 each set of two. J. Ross, 80-34 Kent St., Jamaica, N.Y. 11432. Dept. PE.

WINEMAKERS: complete catalog—\$1.00. (Refundable). Box 3812-E, Rochester, New York 14618.

KNIVES—101 imported novelty knives. Catalogue (50¢). Friedmar Imports, Box 533, Montebello, Calif. 90640.

"ADULT" BOOKS. Magazines . . . Free illustrated catalogue. Clifton's, Box 1068-E3, Saugus, Calif. 91350.

BEERS, PEACH BRANDY, WINES—Strongest Formulas, \$3.00. Complete brew supplies hydrometers catalog included—Research Enterprises, 29-D Samoset, Woburn, Mass. 01801.

LONG RANGE TV RECEPTION EASY! Booklet outlines methods to receive distant TV stations using inexpensive materials. \$1.50 post-paid. **PRACTICAL PLANS**, Box 56-D, Killteen, Texas 76541.

STAMMER — Stutter — No more. (Dr. Young.) Write Gaucho, Box 9309-E8, Chicago 60690.

POPULAR ELECTRONICS
JANUARY 1969
ADVERTISERS INDEX

READER SERVICE NO.	ADVERTISER	PAGE NO.
1	Accurate Instrument Co. Inc	17
2	Allied Radio	25
3	Argos Products Company	110
34	B & K	9
	Bell & Howell Schools	88, 89, 90, 91
4	Beltronix Systems Inc.	97
5	Burstein-Applebee Co	117
	CREI, Home Study Division, McGraw-Hill Book Company	106, 107, 108, 109
7	Career Academy	113
6	Caringella Electronics, Inc	116
8	Cleveland Institute of Electronics	18, 19, 20, 21
9	Cleveland Institute of Electronics Conar	112
10	Courier Communications, Inc	11
11	EICO Electronic Instrument Co., Inc	FOURTH COVER
12	Edmund Scientific Co	98
13	Electro-Voice, Inc	6
14	Garrard	8
15	GONSET Div. of Aerotron Grantham School of Electronics	114 7
16	Graymark Enterprises, Incorporated	10
17	Heath Company	12, 13
18	Jensen Manufacturing Division	116
19	Lafayette Radio Electronics	110
20	Mosley Electronics, Inc National Radio Institute	124 SECOND COVER, 1, 2, 3
	National Technical Schools	62, 63, 64, 65
21	Olson Electronics	102
23	Pearce-Simpson, Inc	111
24	Poly Paks	121
25	Port Arthur College	101
22	RCA Electronic Components and Devices	THIRD COVER
	RCA Institutes, Inc	36, 37, 38, 39
	Radio Television & Training Association	5
33	Sams & Co., Inc., Howard W	23
26	Schober Organ Corporation, The	105
27	Scott, Inc., H.H.	14
28	Sonar Radio Corporation Sonic Devices	103 101
30	Squires-Sanders, Inc	26
31	United Audio Products, Inc Valparaiso Technical Institute	16 104
32	Vanguard Electronics	99

CLASSIFIED ADVERTISING 118, 119, 120, 121, 122



Winter 1968 ELECTRONIC EXPERIMENTER'S HANDBOOK

Special 10th Anniversary Issue! Complete schematics, illustrations, parts lists and easy-to-follow instructions that guarantee you perfect finished products.

Spring 1968 ELECTRONIC EXPERIMENTER'S HANDBOOK

Another big package containing over 30 of the most challenging, fun-to-build electronics projects ever! Be sure to order this one today!

1968 STEREO/HI-FI DIRECTORY

A giant 182-page buyer's guide to virtually every new audio component on the market today. **Over 1600 products in all!** Includes valuable "what to look for—how to buy" advice!

6 Vital Components

*For Knowledge...
 For Profit... For Sheer
 Electronics Enjoyment!*

ONLY \$1.25 EACH



1968 TAPE RECORDER ANNUAL

Contains over 130 pages, 19 complete features, covering every aspect of tape recording. PLUS complete directories of machines and accessories!

1968 COMMUNICATIONS HANDBOOK

For the ham, CB'er, SWL'er or business radio operator. 150 pages of "how to do it better" information. Directories of ham and CB gear!

1968 ELECTRONICS INSTALLATION & SERVICING HANDBOOK

Now, get the tricks of the trade for servicing everything. A 140-page "encyclopedia" that's a **must** for every serviceman and serious hobbyist!

ZIFF-DAVIS SERVICE DIVISION • Dept. W
 595 Broadway, New York, N.Y. 10012

Please send me the annuals I've checked below:

- Winter 1968 Electronic Experimenter's Handbook
- Spring 1968 Electronic Experimenter's Handbook
- 1968 Stereo/HI-FI Directory
- 1968 Tape Recorder Annual
- 1968 Communications Handbook
- 1968 Electronics Installation & Servicing Handbook

\$1.25 each. In U.S.A., add 15c each for shipping and handling. Outside U.S.A., add 50c each.

TOTAL ENCLOSED \$ _____

print name _____

address _____

city _____ PE.19

state _____ zip _____

PAYMENT MUST BE ENCLOSED WITH ORDER

MOSLEY GOES.....

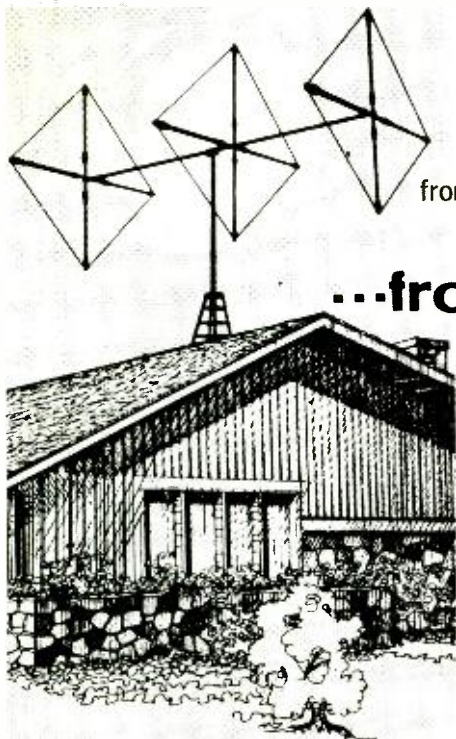

from Quad Configuration to Miniaturization

...from one extreme

If the quad is your choice, consider the Mosley Cubical Quad (Model MCO-27). No less than 145 years of Mosley engineering know-how has gone into its development to assure you of exceptional all-around performance and heavy-duty construction. One of many features is an accessory for switching polarization from vertical to horizontal. Since individual needs differ, Mosley has made this device optional - - the only quad manufacturer to do so. For full electrical and mechanical details, write factory direct, Dept. 175A. Or see your nearest authorized Mosley dealer.

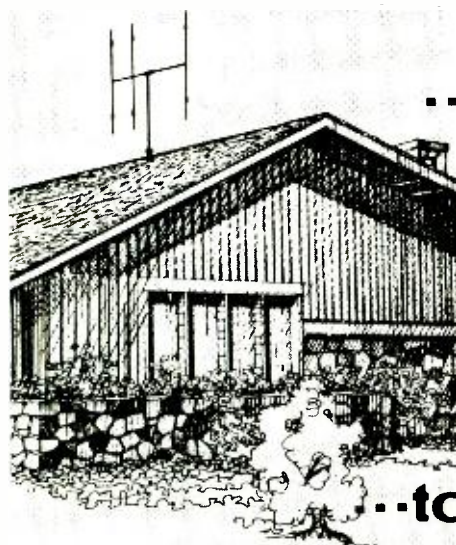

...to the other

CB'ers! Economy-minded? Cramped for space? Consider the unique Mini-Beam - - Mosley's Gamma 323 (Model GA-3). This miniaturized 3-element beam is designed to deliver big beam performance with the economy and size of an efficient TV antenna. One of the many advantages of its modest size is inexpensive installation with low-cost TV antenna mount and rotor. Write factory direct, Dept. 175B, for detailed brochure. Or see your nearest authorized Mosley dealer.

..to serve your **CB** antenna needs.

Mosley Electronics Inc.

4610 N. Lindbergh Blvd., Bridgeton, Mo. 63042

CIRCLE NO. 20 ON READER SERVICE PAGE

Printed in U.S.A.

VIEW

The RCA WO-33A Super-Portable 3-Inch Oscilloscope helps solve virtually any electronics servicing problem, inside or outside the shop. Its combination of exceptionally low cost and high performance have already made it popular as a monitoring and trouble shooting 'scope in black and white and color TV broadcasting studios, and in professional service. And why not? Here's a 3-inch 'scope that meets your requirements for gain, bandwidth, transient response, accuracy, versatility, and portability. AND IT'S ONLY \$139.00.* Also available in an easy to assemble kit, WO-33A (K).

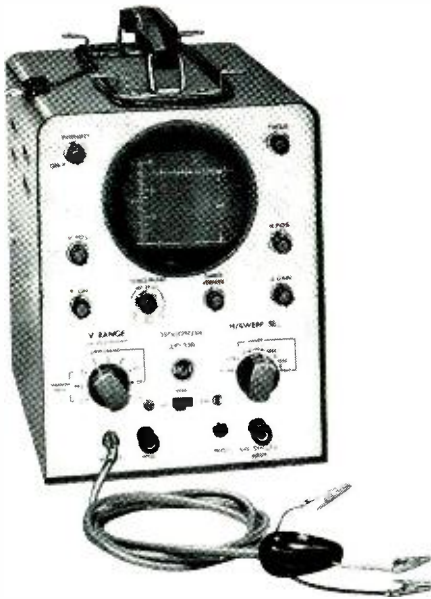

The RCA WO-91C 5-inch Dual Band Oscilloscope is a reliable, heavy-duty, precision 'scope in use in thousands of installations from classrooms to TV distribution systems...from service benches to broadcast stations. You probably can't find a better value. Applications include waveform analysis, peak-to-peak voltage measurement, square-wave testing, and observation of circuit characteristics. A front-panel switch gives you an easy choice of wide-band or narrow-band (high sensitivity) operation. It's easily portable, AND IT'S ONLY \$269.00.* The WO-91C-V1 is available for 240V operation, no increase in price.



*Optional Distributor resale price. Prices may be slightly higher in Alaska, Hawaii, and the West.

Write for a catalog with complete descriptions and specifications for all RCA test equipment: RCA Electronic Components, Commercial Engineering, Department No. A133W, Harrison, N. J. 07029

LOOK TO RCA FOR INSTRUMENTS TO TEST/MEASURE/VIEW/MONITOR/GENERATE

CIRCLE NO. 22 ON READER SERVICE PAGE

RCA

EICO Makes It Possible

Uncompromising engineering—for value does it!
You save up to 50% with Eico Kits and Wired Equipment.



Cortina Stereo

THE VERDICT IS IN. High fidelity authorities agree:

Cortina's engineering excellence, 100% capability, and compact dramatic esthetics all add up to Total Stereo Performance at lowest cost.

NEW



A Silicon Solid State 70-Watt Stereo Amplifier for \$99.95 kit, \$139.95 wired, including cabinet. Cortina 3070

NEW

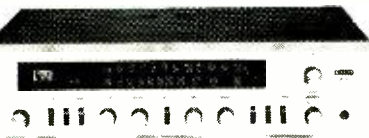

A Solid-State FM Stereo Tuner for \$99.95 kit, \$139.95 wired, including cabinet. Cortina 3200.

A 70-Watt Solid-State FM Stereo Receiver for \$169.95 kit, \$259.95 wired, including cabinet. Cortina 3570.

NEW Silicon Solid State 150-Watt Stereo Amplifier designed for audio perfectionists. Less than 0.1% harmonic distortion, 1M distortion. Less than 0.6% at full output. Controls and inputs for every music source. \$149.95 kit, \$225.00 wired including cabinet. Cortina 3150.

NEW 70-Watt Solid State AM/FM Stereo Receiver for \$189.95 kit, \$279.95 wired including cabinet. Cortina 3770.

Eicocraft The newest excitement in kits.

100% solid-state and professional.

Fun to build and use. Expandable, interconnectable. Great as "jiffy" projects and as introductions to electronics. No technical experience needed. Finest parts, pre-drilled etched printed circuit boards, step-by-step instructions.

EC-100 Electronic Siren \$4.95, EC-101 Electronic Burglar Alarm \$6.95, EC-102 Electronic Fire Alarm \$6.95, EC-200 Electronic Intercom \$5.95, EC-300 Audio Power Amplifier \$5.95, EC-400 Electronic Metronome \$3.95, EC-500 Tremolo \$9.95, EC-600 Electronic Light Flasher \$3.95, EC-700 Electronic "Mystifier" \$4.95, EC-800 Photo Cell Nite Lite \$4.95, EC-900 Power Supply \$8.95, EC-1000 Code Oscillator \$2.50, EC-1100 FM Wireless Mike \$9.95, EC-1200 AM Wireless Mike \$9.95, EC-1300 Electronic VOX \$8.95, EC-1400 Solid State FM Radio \$9.95, EC-1500 Solid State AM Radio \$8.95, EC-1600 Electronic Bongos \$7.95



6 EXCITING NEW PROJECTS

EC-1700 Ham/CB Vox \$8.95,
EC-1800 Electronic "TOX" \$8.95,
EC-1900 "Treasure Finder" \$9.95,
EC-2000 Electronic Organ \$9.95,
EC-2100 Electronic "Eye" \$9.95,
EC-2200 Electronic Touch Switch \$8.95

Color n' Sound



Add a new dimension to your music system. Introducing the first inexpensive solid-state electronic system which provides true synchronization of color with sound. Watch the music you love spring to life as a vibrant, ever shifting interplay of colors.

Simply connect to speaker leads of your Hi-Fi system (or radio). Kit can be assembled in several hours — no technical knowledge or experience necessary. Kit \$49.95, Wired \$79.95.

Automotive

EICO 888—Car/Boat Engine Analyzer.

For all 6V/12V systems; 4, 6, 8-cyl. engines.

Now you can keep your car or boat engine in tip-top shape with this solid-state, portable, self-powered universal engine analyzer. Completely tests your total ignition/electrical system.

Complete with a Tune-up & Trouble-shooting Manual. Model 888; \$49.95 kit, \$69.95 wired.

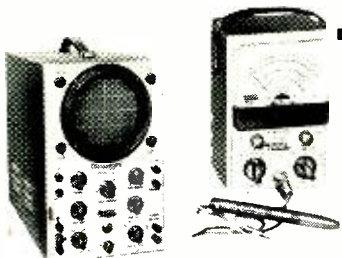

Test Equipment **EICO**

100 best buys to choose from.

"The Professionals" —laboratory precision at lowest cost.

Model 460 Wideband Direct-Coupled 5" Oscilloscope. DC-4.5mc for color and B&W TV service and lab use. Push-pull DC vertical amp., bal. or unbal. input. Automatic sync limiter and amp. \$99.95 kit, \$149.95 wired.

Model 232 Peak-to-Peak VTVM. A must for color or B&W TV and industrial use. 7 non-skip ranges on all 4 functions. With exclusive Uni-Probe.® \$34.95 kit, \$49.95 wired.

FREE 1969 CATALOG

PE-1

EICO Electronic Instrument Co., Inc.
283 Malta Street, Brooklyn, N.Y. 11207

Send me FREE catalog describing the full EICO line of 200 best buys, and name of nearest dealer.

Name _____

Address _____

City _____

State _____ Zip _____

CIRCLE NO. 11 ON READER SERVICE PAGE