

POPULAR ELECTRONICS

AUGUST
1968

50
CENTS

BUILD TELEPHONE MEMORY

BUILD SUPPLY FOR IC EXPERIMENTS

WHAT'S WHAT IN CB ANTENNAS

ALARM REPLACES
IDIOT LIGHTS

BUILD A.C.
LINE MONITOR

1969 HAM RADIO
GEAR REVIEW





firsts

make learning
Electronics at home
fast and fascinating—
give you priceless
confidence.

Some NRI **firsts** in training equipment

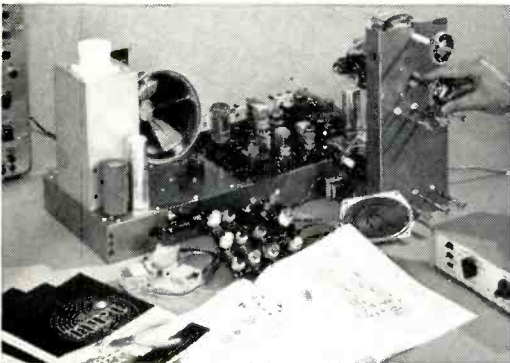

first to give you Color Television training equipment engineered specifically for education—built to fit NRI instructional material, *not* a do-it-yourself hobby kit. The end product is a superb Color TV receiver that will give you and your family years of pleasure. You “open up and explore” the functions of each color circuit as you build.

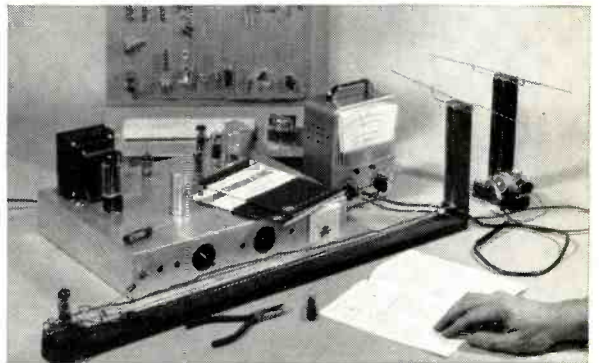

first to give you transmission lines and antenna systems that include experiments not otherwise attempted outside of college physics laboratories. The experience gained with this kind of Communications training equipment is matched only by months—sometimes years—of on-the-job experience.

NRI's "discovery" method is the result of over half a century of leadership simplifying and dramatizing training at home

The FIRSTS described below are typical of NRI's half century of leadership in Electronics home training. When you enroll as an NRI student, you can be sure of gaining the in-demand technical knowledge and the priceless confidence of "hands-on" experience sought by employers in Communications, Television-Radio Servicing and Industrial and Military Electronics. Everything about NRI training is designed for your education . . . from the much-copied, educator-acclaimed Achievement Kit sent the day you enroll, to "bite-size" well-illustrated, easy to read texts programmed with designed-for-learning training equipment.

YOU GET YOUR FCC LICENSE OR YOUR MONEY BACK

There is no end of opportunity for the trained man in Electronics. You can earn \$6 or more an hour in spare time, have a business of your own or qualify quickly for career positions in business, industry, government. And if you enroll for any of five NRI courses in Communications, NRI prepares you for your FCC License exams. *You must pass* or NRI refunds your tuition in full. No school offers a more liberal money-back agreement. The full story about NRI leadership in Electronics training is in the new NRI Catalog. Mail postage-free card today. No salesman is going to call.
NATIONAL RADIO INSTITUTE, Washington, D.C. 20016

APPROVED UNDER NEW GI BILL If you have served since January 31, 1955, or are in service, check GI line on postage-free card.

designed from chassis up for your education

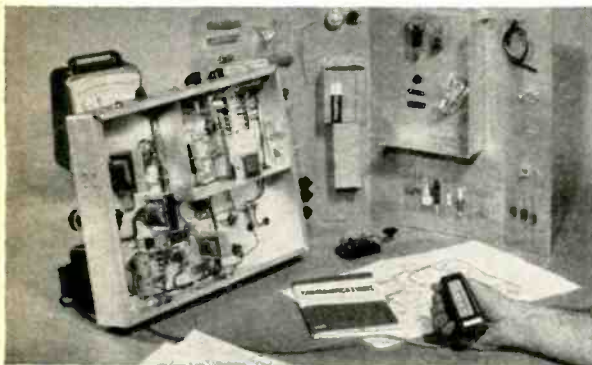

first to give you true-to-life experiences as a communications technician. Every fascinating step you take in NRI Communications training, including circuit analysis of your own 25-watt, phone/cw transmitter, is engineered to help you prove theory and later apply it on the job. Studio equipment operation and troubleshooting become a matter of easily remembered logic.



first to give you completely specialized training kits engineered for business, industrial and military Electronics. Shown above is your own training center in solid state motor control and analog computer servo-mechanisms. Telemetering circuits, solid-state multi-vibrators, and problem-solving digital computer circuits are also included in your course.

POPULAR ELECTRONICS

VOLUME 29 NUMBER 2

AUGUST, 1968

WORLD'S
LARGEST-SELLING
ELECTRONICS
MAGAZINE

SPECIAL ON AMATEUR RADIO

AMATEUR RADIO EQUIPMENT

Review of trends, with specs and prices

67 HERB S. BRIER, W9EGQ

SPECIAL ON CB EQUIPMENT

ANNUAL CATALOG OF 5-WATT CB EQUIPMENT

A guide for selecting from what's available

41 STAFF

TOUCH BASE WITH CB ANTENNAS

Ways to get better performance

58 FOREST H. BELT

FEATURE ARTICLES

IC EXPERIMENTERS' 3.6-VOLT POWER SUPPLY

Indispensable for today's projects

27 FRANK H. TOOKER

WHILE YOU WERE OUT

Next best thing to an answering service

31 H. ST. LAURENT

WHO LEFT THE CAR LIGHTS ON?

Solutions to an old problem

34 RONALD L. IVES

POPULAR ELECOMICS

BUILD THE AUTOMOBILE OMNI-ALARM

It supplements the warning lights

40

51 JOHN S. SIMONTON, JR.

HOW'S YOUR TV Q?

54 VIC BELL

BUILD 117-VOLT PLM

Monitor the power-line voltage

55

F. FORMAN AND E. NAWRACA

THE PRODUCT GALLERY

Knight-Kit KG-372 Ignition system

Petersen RM2-4 Monitor Receiver

74

INFORMATION CENTRAL

76 CHARLES J. SCHAUERS, W6QLV

UNIQUE DUAL-FET AMPLIFIER

Audio amplifier with gain of 500

78 B. W. BLACHFORD

METERS: LET'S FACE THEM

How to use what you have

79 JESS W. SPEER, W6EJ

AMATEUR RADIO

Changes in FCC regulations

83 HERB S. BRIER, W9EGQ

SOLID STATE

84 LOU GARNER

ON THE CITIZENS BAND

86 MATT P. SPINELLO, KHC2060

SHORT-WAVE LISTENING

92 HANK BENNETT, W2PNA

ENGLISH-LANGUAGE BROADCASTS TO NORTH AMERICA

94 ROGER LEGGE

DEPARTMENTS

LETTERS FROM OUR READERS

10

OUT OF TUNE

14

Soncon Continuity Tester

READER SERVICE PAGE

15, 115

NEW LITERATURE

16

NEW PRODUCTS

22

TIPS & TECHNIQUES

96

OPERATION ASSIST

124

POPULAR ELECTRONICS is indexed
in the Readers' Guide
to Periodical Literature

Copyright © 1968 by ZIFF-DAVIS PUBLISHING COMPANY. All rights reserved.

This month's cover photo by
BRUCE PENDELTON

POPULAR ELECTRONICS, August 1968, Volume 29, Number 2. Published monthly at 307 North Michigan Avenue, Chicago, Illinois 60601. One year subscription rate for U.S., U.S. Possessions and Canada, \$5.00; all other countries, \$6.00. Second class postage paid at Chicago, Illinois and at additional mailing offices. Authorized as second class mail by the Post Office Department, Ottawa, Canada and for payment of postage in cash. Subscription service and Form 3579: Portland Place, Boulder, Colorado 80302. Editorial offices for manuscript contributions, reader inquiries, etc.: One Park Ave., New York, N.Y. 10016.

SOUNDTRACKS THE GRADUATE Songs Performed by Simon & Garfunkel 	THE PHILADELPHIA ORCHESTRA'S GREATEST HITS Vol. 3 EUGENE ORMANDY Conductor 	WES MONTGOMERY DOWN HERE ON THE GROUND Plus: Wind Song • 8 MORE 	DAVE BRUBECK QUARTET JACKPOT Plus: Ace in the Hole (RECORDED) 8 MORE 	JOHNNY MATHIS LOVE IS BLUE Plus: The Time I Got To Phoenix 8 MORE 	SPANKY AND OUR GANG LIKE TO GET TO KNOW YOU 	BILL COSEY to ruse! • I brother, whom I slept with 		
HERBIE MANN Glory Of Love Plus: Unclean My heart 	CLAUDINE LONGET LOVE IS BLUE Plus: When I Look in Your Eyes 8 MORE 	MAHLER Symphony No. 1 ("Titan") Leonard Bernstein Conductor NEW YORK PHILHARMONIC 	RAY CONNIF It Must Be Him 	PETULA CLARK The Other Man's Grass Is Always Greener Plus: The Cat in the Window Smile • The Last Waltz (WARNERS) 8 MORE 	AUL MAURIAT and No. 2 Blooming Hits Love Is Blue Prissy Love 8 MORE 	THE BEAT OF THE BRASS HERE! HERE! THE TULANA BRASS 		
6313. Composed and performed by Simon and Garfunkel 6152. Comedian's Galop, Anitra's Dance, etc. 6489. Plus: Up And At It, Georgia On My Mind, 10 in all 6153. Also: Chicago, You Go To My Head, Out Of Nowhere, etc. 6343. Also: I Say A Little Prayer, Walk On By, etc. 6475. Plus: Stardust, Sunday Mornin', Gode, My Bill, 12 in all	6093. Also: House Of The Risin' Sun, The Letter, etc. 6420. Also: Happy Talk, Falling In Love Again, Holiday, etc. 6062. Most often played of all Mahler's works. 6108. Plus: A Man And A Woman, Release Me, etc. 6333. Also: Ballad Of A Sad Young Man, The Last Waltz, etc. 6157. Also: Mama, Somethin' Stupid, 10 in all	BEETHOVEN Moonlight Appassionata Pathétique SONATAS Glenn Gould piano (CANTOPHONE) 	CHARLIE BYRD Sketches of Brazil THE MUSIC OF VILA-LOBOS (COLUMBIA) 	ANDY WILLIAMS Love, Andy Somethin' Stupid Holly 8 MORE (COLUMBIA) 	HENSON CARGILL SKIP A ROPE Plus: It's Over (COLUMBIA) 8 MORE 	BARBRA STREISAND Simply Streisand 	MENDELSSOHN SYMPHONY (No. 4) SCHUBERT "UNFINISHED" SYMPHONY (No. 8) LEONARD BERNSTEIN Conductor PHILADELPHIA ORCHESTRA 	6479. This Guy's In Love With You, Panama, Caeser, etc. 6494. Top drawer performances of favorite standard symphonies
(ORIGINAL SOUNDTRACK) CAMELOT 	JOHNNY CASH AT FOLSOM PRISON JACKSON IS MORE (COLUMBIA) 	PAUL MAURIAT MORE MAURIAT Lora's Theme 8 MORE PHILIPS 	FRANK SINATRA Strangers in the Night Plus: DOWNTOWN CALL ME 7 More (RECORDED) 	BLUE CHEER VINCENTE ERUPTUM Summertime Blues PHILIPS 8 MORE 	DEAN MARTIN Welcome to My World Plus: Little One Who Dreamed, Me In The Chapel With The Angels (APRISS) 	Mrs. Robinson BOOKENDS SIMON & GARFUNKEL 		
5840. "An all-time great stereo musical" - Variety 6415. Plus: The Long Black Veil, Cocaine Blues, The Wall, etc. 5607. Includes: Black Is Black, Bang Bang, Guantánamera, etc. 2673. Also: On A Clear Day, All Or Nothing At All, etc. 6312. Plus: Rock Me Baby, Second Time Around, etc. 5548. Also: Pride, Wallpaper Roses, Turn To Me, 10 in all	SMOKEY ROBINSON & THE MIRACLES' GREATEST HITS, Vol. 2 The Tracks of My Tears I Second That Emotion 10 MORE (TAMLA) 	TWIN-PACKS Twice the music—yet each counts as one selection 	GERSHWIN SHAPSOBY IN BLUE Special Record Concerto Warner Concerto 3 MORE COLUMBIA RECORD CLUB 	Diana Ross and the Supremes Greatest Hits 	FREE — if you join now REVOLUTIONARY SELF-THREADING TAKE-UP REEL <p>Just drop the end of the tape over this reel, start your recorder, and watch it thread itself! Unique Scotch® process automatically threads up tape of any thickness, releases freely on rewind.</p>	6366. Includes: Old Friends, The Zoo, Fakin' It, etc.		

Columbia Stereo Tape Club

now offers you

ANY 5 STEREO TAPES FREE

JUST LOOK AT THE FANTASTIC SELECTION of best-sellers the Columbia Stereo Tape Club is now offering new members! The greatest stars . . . the biggest hits . . . and all available in the incomparable stereo fidelity of 4-track reel-to-reel tape! To introduce you to the Columbia Stereo Tape Club, you may select any 5 of the FREE stereo tapes shown here, and we'll send them to you FREE! That's right . . . 5 FREE STEREO TAPES, and all you need do is purchase one tape now at the regular Club price, and agree to purchase as few as five more tapes during the coming year. In short, at the end of a year, you'll have at least eleven brand-new stereo tapes, and you'll have paid for only six!

HOW THE CLUB OPERATES: Each month you'll receive your free copy of the Club's magazine which describes and displays tapes for many different listening interests and from many different manufacturers. You may accept the regular selection for the field of music in which you are primarily interested, or take any of the scores of other tapes offered you, or take no tape at all that month.

YOUR OWN CHARGE ACCOUNT! Upon enrollment, the Club will open a charge account in your name. You'll pay for the tapes you want only after you've received them and are enjoying them. The tapes you want will be mailed and billed to you at the regular Club price of \$7.95 (occasional Original Cast recordings somewhat higher), plus a small mailing and handling charge.

YOU GET MORE FREE TAPES! Once you've completed your enrollment agreement, you'll get a stereo tape of your choice FREE for every two tapes you purchase! **SEND NO MONEY NOW!** Just fill in and mail the coupon today!

Note: All tapes offered by the Club must be played back on 1-track stereo equipment.
 APO, FPO addresses: write for special offer
COLUMBIA STEREO TAPE CLUB • Terre Haute, Indiana

SEND NO MONEY—JUST MAIL COUPON

COLUMBIA STEREO TAPE CLUB
 Terre Haute, Indiana 47808

Please enroll me as a member of the Club. I've indicated at the right the five tapes I wish to receive FREE. I've also indicated the tape I am buying now as my first selection, for which I am to be billed \$7.95, plus postage and handling. Include the self-threading take-up reel FREE. My main musical interest is (check one):

CLASSICAL POPULAR

In addition to the first selection I am buying now, I agree to purchase five additional selections during the coming year . . . and I may cancel membership at any time thereafter. If I continue, I am to receive a stereo tape of my choice FREE for every two additional selections I accept.

Name (Please Print) _____ First Name _____ Initial _____ Last Name _____
 Address _____
 City _____ State _____ Zip _____

I AM BUYING THIS TAPE NOW (fill in number)

ALSO SEND THESE 5 TAPES — FREE!

432-5/49
 © 1968 CBS Direct Marketing Services T-108/F68

LET THE BUYER BEWARE!

CAVEAT EMPTOR

The Roman phrase "Caveat Emptor" cautions the purchaser to examine the article he is buying, and act on his own judgment, and at his own risk! We print it here as a reminder to you, hopefully a happy owner of a Shure Stereo Dynetic® cartridge, that the superior performance of all Shure cartridges depends upon the Shure Stereo Dynetic Stylus assembly—and alas, there are indeed imitations.

May we caution you that an inferior replacement stylus can audibly detract from and significantly reduce the cartridge's performance, and increase record wear. Obviously, if an imitation Stereo Dynetic stylus is used, we cannot guarantee that the cartridge will perform to published specifications. Accept no substitute.

LOOK FOR THIS WORDING
ON THE BACK OF PACKAGE

THIS DYNETIC
STYLUS IS PRECISION
MANUFACTURED BY
SHURE BROTHERS, INC.

It is your assurance that the stylus you buy will enable your cartridge to perform up to Shure standards . . . incomparable Shure standards, that is.

INSIST ON

SHURE

REPLACEMENT STYLUS

SHURE BROTHERS, INC.

222 Hartrey Ave., Evanston, Illinois 60204

Manufactured Under One or More of the Following U. S. Patents and Other Patents Pending. 2,963,516, 3,055,988, 3,077,521, 3,077,522, D 183,366, D 185,168, D 187,229, D 187,230, D 189,144, D 193,006, D 193,007, D 193,954, D 193,934.

CIRCLE NO. 33 ON READER SERVICE PAGE

POPULAR ELECTRONICS

PHILLIP T. HEFFERNAN
Publisher

OLIVER P. FERRELL
Editor

LESLIE SOLOMON
Technical Editor

JOHN R. RIGGS
Managing Editor

EDWARD I. BUXBAUM
Art Director

ALEXANDER W. BURAWA
Associate Editor

ANDRE DUZANT
Technical Illustrator

PATTI MORGAN
Assistant Editor

AURORA NARDOZZI
Editorial Assistant

H. BENNETT, W2PNA

H. S. BRIER W9EGG

L. E. GARNER, JR.

CHARLES J. SCHAUERS, W6QLV

M. P. SPINELLO, KH2060
Contributing Editors

LAWRENCE SPORN
Advertising Sales Manager

ARDYS C. MORAN
Advertising Service Manager

ZIFF-DAVIS PUBLISHING COMPANY

Editorial and Executive Offices

One Park Avenue, New York, New York 10016
212 679-7200

Eastern Advertising Manager, RICHARD J. HALPERN

Midwestern Office

307 North Michigan Avenue, Chicago, Illinois 60601
312 726-0892

Midwestern Advertising Manager, JAMES WEAKLEY
GERALD L. TAYLOR

Western Office

9025 Wilshire Boulevard, Beverly Hills, California 90211
213 CResview 4-0265; BRadshaw 2-1161

Western Advertising Manager, BUD DEAN

Japan: James Yagi

Ishikawa Mansion

4, Sakuragaoka

Shibuya-ku, Tokyo

462-2911-3

Circulation Office

Portland Place

Boulder, Colorado 80302

William B. Ziff, Chairman of the Board (1946-1953)

William Ziff, President

W. Bradford Briggs, Executive Vice President

Hershel B. Sarbin, Senior Vice President

Phillip Sine, Financial Vice President

Walter S. Mills, Jr., Vice President, Circulation

Stanley R. Greenfield, Vice President, Marketing

Phillip T. Heffernan, Vice President, Electronics Division

Frank Pomerantz, Vice President, Creative Services

Arthur W. Butzow, Vice President, Production

Edward D. Muhlfield, Vice President, Aviation Division

Irwin Robinson, Vice President, Travel Division

Furman Hebb, Administrative Vice President

Ziff-Davis also publishes Airline Management and Marketing, Boating, Business & Commercial Aviation, Car and Driver, Cycle, Electronics World, Flying, HiFi/Stereo Review, Modern Bride, Popular Photography, Skiing, Skiing Area News, and Skiing Trade News. (Travel Weekly is published by Robinson Publications, Inc. a subsidiary of Ziff-Davis Publishing Company.)

Forms 3579 and all subscription correspondence should be addressed to POPULAR ELECTRONICS, Circulation Department, Portland Place, Boulder, Colorado 80302. Please allow at least six weeks for change of address. Include your old address, as well as new—enclosing if possible an address label from a recent issue.

EDITORIAL CONTRIBUTIONS must be accompanied by return postage and will be handled with reasonable care; however, publisher assumes no responsibility for return or safety of art work, photographs or manuscripts.



Member Audit Bureau
of Circulations

POPULAR ELECTRONICS

Introducing the world's first 5-channel, solid state, Citizens Band Radio with a Class B push-pull audio amplifier, super-sensitive receiver, and full-powered transmitter, that comes with either palm microphone or telephone handset at no extra cost: The Sentry II, by Pearce-Simpson.

Total weight, 3 pounds. Total price, \$99.90.

At \$99.90, Pearce-Simpson introduces a remarkable new CB Radio.

How remarkable? This remarkable:

It features no close range blocking.

A greatly improved noise limiting circuit which virtually eliminates ignition and alternator noise.

Its specifications include 4.0-watt power output, 0.5 uv to open squelch, adjacent channel 50 db down, and cross modulation 80 db down. And it carries a full one year warranty.

Conclusion:

Nobody can make a better radio for \$99.90. Not even Pearce-Simpson.



The Sentry II

At \$139.90 you'd probably call The Sentry II a bargain. At \$99.90 there's no question about it.

How can anyone put so much radio into so little space without cutting corners? Anyone can't. Pearce-Simpson can.

And at \$139.90, Pearce-Simpson introduces the brand new solid state Companion IV, featuring 10 channels plus P.A.

Plus:

Both front and bottom speakers. An innovation which guarantees unobstructed, distortion-free sound no matter where the radio is mounted.



Touch-tap tuning. Which allows you to change channels just like that.

No close range blocking.

A greatly improved noise limiting circuit.

Plus:

It comes with a choice of either palm microphone or telephone handset at no extra cost.

It weighs only 3¾ pounds. And it carries a full one year warranty.

Conclusion:

Dollar for dollar, there are more features in a Pearce-Simpson CB Radio than any other CB Radio in the world.

Write us.

We'll tell you where to find them.

F.C.C. type acceptance pending

Pearce-Simpson, Inc./P.O. Box 800	
Biscayne Annex, Miami, Florida 33152	
PE8-68	
Gentlemen: Please send complete information on your new CB Radios and a list of dealers nearest me.	
Name	
Address	
City	
State	Zip

Overseas military personnel may write for special price list.
CIRCLE NO. 28 ON READER SERVICE PAGE

You Can Always Depend On Heath...

NOW, THE TUNER AND AMPLIFIER OF THE FAMOUS HEATH AR-15 RECEIVER ARE AVAILABLE AS SEPARATE COMPONENTS

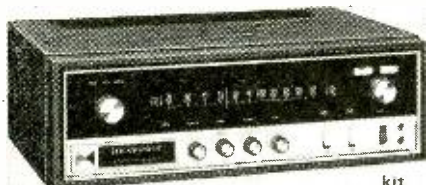

NEW kit
AJ-15
\$189.95*



NEW kit
AA-15
\$169.95*

NEW
kit
AA-18
\$19.95

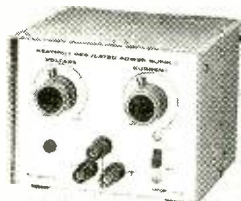

NEW
kit
IP-18
\$19.95

NEW
kit
IT-18
\$24.95



Look What's New

HEATHKIT AJ-15 Deluxe Stereo Tuner

For the man who already owns a fine stereo amplifier, and in response to many requests, Heath now offers the superb FM stereo tuner section of the renowned AR-15 receiver as a separate unit. The new AJ-15 FM Stereo Tuner has the exclusive design I.F.I. FM tuner for remarkable sensitivity, the exclusive Crystal Filters in the IF strip for perfect response curve and no alignment; Integrated Circuits in the IF for high gain, best limiting; elaborate Noise-Operated Squelch; Stereo-Threshold Switch; Stereo-Only Switch; Adjustable Multiplex Phase, two Tuning Meters; two variable output Stereo Phone jacks; one pair variable outputs plus two fixed outputs for amps., recorders, etc.; front panel mounted controls; "Black Magic" panel lighting, 120-240 VAC operation, 18 lbs. Walnut cabinet AE-18, \$19.95.

HEATHKIT AA-15 Deluxe Stereo Amplifier

For the man who already owns a fine stereo tuner, Heath now offers the famous amplifier section of the AR-15 receiver as a separate unit. The new AA-15 Stereo Amplifier has the same superb features: 150 watts Music Power; Ultra-Low Harmonic & IM Distortion (less than 0.5% at full output); Ultra-Wide Frequency Response (-1 dB, 8 to 40,000 Hz at 1 watt); Ultra-Wide Dynamic Range Preamp (98 dB); Tone-Flat Switch; Front Panel Input Level Controls; Transformerless Amplifier; Capacitor Coupled Outputs; Massive Power Supply; All-Silicon Transistor Circuit; Positive Circuit Protection; "Black Magic" Panel Lighting; new second system Remote Speaker Switch; 120-240 VAC, 26 lbs. Walnut cabinet AI-18, \$19.95.

HEATHKIT Solid-State Utility Monophonic Amplifier

This amazing little amplifier accepts ceramic phono cartridges, AM tuners, FM tuners, tape recorders, etc., and delivers a solid 4 watts of music power from 20 Hz to over 100 kHz at a low 1.5% THD. Drives high efficiency speakers of 4 to 16 ohms. Ideal for small music system or testing amp. for service shops. Circuit board construction is simple; just 5 short hookup wires and 6 cable. Single knob tone control; Headphone Jack; Pilot lamp. Transformer operated, 120-240 VAC, 50-60 Hz.

HEATHKIT 1-15 VDC Regulated Power Supply

Labs, service shops, hams, home experimenters... anybody working with transistor circuitry can use this handy new Heathkit All-Silicon Transistor Power Supply... use it in place of conventional battery power supply. Voltage regulated (less than 50 mV variation no-load to full-load; less than 50 mV change in output with input change from 105-125 VAC). Current limiting; adjustable from 10-500 mA. Ripple and noise less than 0.1 mV. Transient response 25 uS. Output impedance 0.5 ohm or less to 100 kHz. AC or DC programming (3 mA driving current on DC). Circuit board construction. Operates 105-125 or 210-250 VAC, 50-60 Hz, 6 lbs.

HEATHKIT In-Circuit Transistor Tester

At last, a realistic price for in-circuit testing of transistors! The new Heathkit IT-18 Tester has the facilities you need and it costs a lot less. It measures DC Beta in-or-out-of-circuit in 2 ranges from 2 to 1000 (the spec. commonly used by mfrs. and schematics to determine transistor gain). It tests diodes in-or-out-of-circuit for forward and reverse current to indicate opens or shorts. Measures transistors out-of-circuit for ICFO and ICBO leakage on leakage current scale of 0 to 5,000 uA. Identifies NPN or PNP devices, anode and cathode of unmarked diodes; matches transistors of the same type or opposite types. Cannot damage device or circuit even if connected incorrectly. Big 4 1/2" 200 uA meter, 10-turn calibrate control. Completely portable, powered by "D" cell (long battery life). Front panel socket for lower power devices. Attached 3' test leads. Rugged polypropylene case with attached cover. Build in 2 hours, 4 lbs.

For Unsurpassed Value and Quality

Deluxe "295" Color TV ... \$479⁹⁵

(less cabinet)

Big, Bold, Beautiful ... With Advanced Features and Exclusive Heathkit Self-Servicing. Top quality, American brand color tube ... 295 sq. inch viewing area. The built-in dot generator and full color photos and simple instructions let you set-up, converge and maintain the best color pictures at all times. Add to this the detailed trouble-shooting chart in the manual and you put an end to costly TV service calls for periodic picture convergence and minor repairs.

New improved phosphors and low voltage supply with boosted B- for maximum color fidelity and operation • automatic degaussing • exclusive Heath Magna-Shield • ACC and AGC assures color purity, flutter-free pictures under all conditions • preassembled IF with 3 stages instead of the usual 2 • deluxe VHF turret tuner with "memory" fine tuning • choice of installation — wall, custom or optional Heath factory assembled cabinets • Easy to assemble.

kit GR-295, (everything except cabinet), 131 lbs. ... \$479.95

GRA-295-4, Mediterranean cabinet (shown), 90 lbs. ... \$112.50

no money dn., \$11 mo. ... \$112.50

Other cabinets from \$62.95

Deluxe "227" Color TV ... \$419⁹⁵

(less cabinet)

Has same high performance features and built-in servicing facilities as the GR-295, except for 227 sq. inch viewing area. The vertical swing-out chassis makes for fast, easy servicing and installation. The dynamic convergence control board can be placed so that it is easily accessible anytime you wish to "touch-up" the picture.

kit GR-227 (everything except cabinet) ... \$419.95

GRA-227-1, Walnut Cabinet (shown) no money dn., \$6 mo. ... \$59.95

GRA-227-2, Mediterranean Oak Cabinet ... no money dn., \$10 mo. ... \$94.50

Deluxe "180" Color TV ... \$349⁹⁵

(less cabinet)

Same high performance features and exclusive self-servicing facilities as the GR-295 except for 180 sq. inch viewing area. Feature for feature the Heathkit "180" is your best buy in deluxe color TV viewing ... tubes alone list for over \$245. For extra savings, extra beauty and convenience, add the table model cabinet and mobile cart.

kit GR-180 (everything except cabinet), 102 lbs. ... \$349.95

GRA-180-5, table model cabinet and mobile cart ... (shown), 57 lbs. ... no money dn., \$5 mo. ... \$39.95

Other cabinets from \$24.95

Heathkit Color TV Remote Control

Now change VHF channels and turn your Heathkit color TV on and off from the comfort of your armchair with this remote control kit. The heavy-duty switch contacts are silver-plated to assure long life and trouble-free service. Use with Heathkit GR-295, GR-227 and GR-180 color TVs. Includes 20' cable.

kit GRA-27, 4 lbs. ... \$19.95

3 HEATHKIT® COLOR TV'S
NOW! ALL WITH 2-YEAR
WARRANTY ON PICTURE TUBE



kit GR-295



kit GR-227



kit GR-180

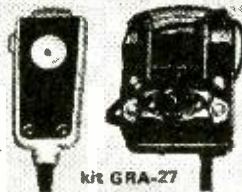

kit GRA-27

FREE! World's Largest Electronic Kit Catalog

Shows these and over 300 other easy-to-build kits that save up to 50% ... Electronic Organs, Stereo, Marine, CB, Ham Radio, Test, Photography, Educational for home & hobby. No skills or experience needed. Send for your free copy today. Mail coupon or write Heath Co., Benton Harbor, Mich. 49022.

HEATH COMPANY, Dept. 10-B
Benton Harbor, Michigan 49022
In Canada, Daystrom Ltd.

Enclosed is \$ _____ plus shipping.

Please send model: s
 Please send FREE Heathkit Catalog
 Please send Credit Application.

Name _____

Address _____

City _____

State _____

Zip _____

Prices & specifications subject to change without notice

EL-331

CIRCLE NO. 22 ON READER SERVICE PAGE

Weller®

**makes first class
soldering the easiest
part of any job**



The original Dual Heat Soldering Guns

Preferred by technicians for their fast heating copper tips, exclusive trigger-controlled dual heat, and high soldering efficiency. Available in 3 watt-age sizes, each with spotlight.

100/140-watt Model 8200, 145/210-watt Model D-440, and 240/325-watt Model D-550. Also in complete kits:

Dependable MARKSMAN Irons in a size for every job



Ideal for deep chassis work and continuous-duty soldering. Marksmann irons outperform others of comparable size and weight. All five feature long-reach stainless steel barrels and replaceable tips.

- 25-watt, 1¾-oz. Model SP-23 with ¼" tip (In kit with extra tips, soldering aid, solder—Model SP-23K)
- 40-watt, 2-oz. Model SP-40 with ¼" tip
- 80-watt, 4-oz. Model SP-80 with ⅜" tip
- 120-watt, 10-oz. Model SP-120 with ½" tip
- 175-watt, 16-oz. Model SP-175 with ⅝" tip

25-watt Technician's Iron for intricate circuit work



Industrial rated pencil iron weighs only 1¾ ounces, yet delivers tip temperatures to 860°F. Cool, impact-resistant handle. All parts readily replaceable. Model W-PS with ⅝-inch tapered tip.

Also available: A new Battery Operated Iron for use with 12 volt battery or 12-24 volt AC/DC source. Complete with 12 ft. cord and battery clips. Model TCP-12.

Complete Weller Line at your Electronic Parts Distributor.

WELLER ELECTRIC CORPORATION, Easton, Pa.

WORLD LEADER IN SOLDERING TOOLS

CIRCLE NO. 38 ON READER SERVICE PAGE

letters

FROM OUR READERS

QUALITY IN EVERY PHASE OF PRODUCTION

In POPULAR ELECTRONICS' "Operation Assist" there never fails to be at least one request for parts or circuit diagrams of Atwater-Kent radio receivers. Why is there still such a great interest in this particular brand of radio as opposed to other makes of the same era? Were these radios made in large quantities, or were they just particularly well made and nice looking? However, the most important question is: Why are Atwater-Kent radios the classic of old radios?

KEN GREENBERG
CHICAGO, ILL.

As you have probably surmised, Atwater-Kent radio receivers were made in large quantities to meet the growing demands of the consumer public. In 1927-1928 alone, about 900,000 Atwater-Kent radios were sold. But A. Atwater-Kent, founder of the Atwater-Kent Manufacturing Company, did not sacrifice excellent performance, beautiful finish, and fine workmanship for large-scale production. Kent took personal interest in the appearance of his radios, insisting on perfection at every step. In testimony of the pains he took, knowledgeable antique radio buffs hold Atwater-Kent radios in very high regard. It was only after cheap (in more ways than one) table-model radios became more and more in demand that competition forced Kent to close down production in 1936. But there can be little doubt that, had production continued until today, superior quality and workmanship would set Atwater-Kent radios in a class by themselves.

FLAME AMPLIFIER ON PARADE

When I read your "Flame Amplification" article (May, 1968) I was quite startled since I had just entered a flame loudspeaker in my school's science fair and won Honorable Mention. (I conceived my idea from the news report in the NEW YORK TIMES.) I used a Bunsen burner, nichrome wire electrodes, a 40-watt p.a. amplifier fed by an AM tuner, and a high-voltage supply. While experimenting with different d.c. voltages, I found that 900 volts worked best.

After hammering the bottom electrode flat and forming it into a trough, it became an effective holder for the potassium nitrate crystals I used to "seed" the flame. To suppress arc noises between the electrodes—a problem at first—I inserted a 5000-ohm current limiter in series with one of the elec-

(Continued on page 12)

CIRCLE NO. 12 ON READER SERVICE PAGE →
POPULAR ELECTRONICS

The "total reliability" CB rig.

Guaranteed for 10 years!

The magnificently styled 23-channel Courier Classic offers you a new dimension in solid-state CB. So reliable — *we guarantee it for 10 years!* Start with Classic's super efficient transmitter designed to help pierce "skip." Silicon transistors throughout. Military spec. fiberglass epoxy bonded circuit board — every part clearly labeled with value, symbol and part number; every adjustment labeled and keyed off to

alignment procedure and schematic. 100% modulation. Exclusive zener diode "Safety Circuit" to protect against mismatched antenna, incorrect polarity, and overload. Illuminated channel selector and S meter, auxiliary speaker jack, modulation indicator, PA system. Adjustable push-pull noise limiter. Heavy-duty microphone connector conveniently located on front panel. Compact — weighs only 4½ lbs.



Just \$199

Complete with crystals
for all 23 channels.



COURIER COMMUNICATIONS, INC.
439 Frelinghuysen Avenue, Newark, N.J. 07114
a subsidiary of Whistler Corporation

Yes! Tell me all about the "total reliability"
CB rig with the 10 year guarantee!

Name _____

19-88

Address _____

City _____

County _____

State _____

Zip _____

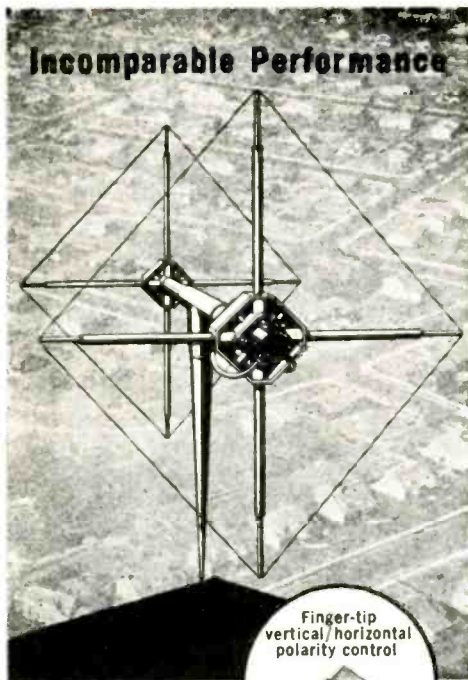

avanti
PDLTM
 Patent Pending
ANTENNA

(Polar diversity loop beam antenna)

No other antenna can match the Avanti PDL-27 A's outstanding long distance, interference-free performance. Its rifle-like signal directivity is combined with a unique ability to transmit or receive on either vertical or horizontal signal polarity. Contact mobiles on the vertical — switch instantly to horizontal for clear contact with other bases. Switching to horizontal adds another channel that can minimize interference from other CB'ers as much as 25 db.

- 11 db gain
- only 13 lbs.
- 30 db front-to-back
- 1.2:1 VSWR
- up to 1000 watts power
- 100 mph wind survival

Write for complete information

avanti

research and development, inc.

Dept. G, 45 West Fullerton Ave., Addison, Ill. 60101

CIRCLE NO. 6 ON READER SERVICE PAGE

LETTERS (Continued from page 10)

trodes. This setup worked fine, and the volume obtainable, though not excessive, was satisfactory.

JACK BOSTELMAN
 TENAFLY, N.J.

After reading your "Flame Amplification" article, I decided to duplicate the experiment, enlisting the aid of my chemistry and electronics teachers and two friends. For the electrodes, we used graphite rods, and the "seeding" material we decided on, after some trial and error, was potassium nitrate. Since we had trouble securing an output transformer, we used a power transformer which sacrificed fidelity but worked just the same. We were able to move the electrodes about 6" apart in our oxy-acetylene flame and still produce good quality sound. A lot of experimenting went into our effort, but the results were impressive not only to us, but to many of the teachers and students in our school.

THOMAS A. HOLLOWAY
 NORTH WOODMERE, N.Y.

The results we obtained from our "Flame Amplification" experiment, performed in our high school, prompt a friend and I to encourage others to try it. The experiment was really amazing.

RICHARD SIMMERMAN
 DAYTON, OHIO

I rigged the same type of experimental arrangement described by the inventors of the "Flame Loudspeaker" ("Flame Amplification," May, 1968). It works just as they said it would. I used a Bogen 60-watt p.a. amplifier and a 400-volt d.c. power supply.

JIMMY BRADSHAW
 Fort Valley, Ga.

MOTOROLA IC SUPPLIER

I would like to build the binary counter ("Want To Build An Integrated Circuit Binary Counter?" December, 1966), but I am having trouble obtaining the μ L914 and μ L923 IC's. The minimum order from Motorola, the manufacturer of these IC's, is \$50 for each type since the two cannot be mixed. Is there any way of obtaining these integrated circuits in small quantities?

STEPHEN WILLIAMS
 VERMILLION, S.D.

Both the μ L914 and μ L923 are available, singly or in multiples, from Robert A. Glassman, 20 Hampton Rd., Massapequa, N.Y. 11758. Also available are specifications for these and other Motorola IC's and transistors.

FOREIGN RADIO DID LOSE ITS POPULARITY

As one who has frequently found radio listening to be a more stimulating medium for drama than television, I was interested in Larry Lisle's article and list of stations ("Tired Of TV? Try Radio Drama," April, 1968). However, I would like to correct Mr.

(Continued on page 14)

only hallicrafters...

offers precision engineered radio receivers, transmitters and two-way transceivers covering every known amateur, professional and entertainment frequency in the world. Which do you want to enjoy next?



Model SR-2000 transceiver

Amateur Equipment

Amateur equipment—High-performance, equipment in every price range, from the great SR-42A and SR-46A VHF transceivers to the incomparable SR-2000 full-coverage kilowatt transceiver.



Citizens 2-way Radio

Model CB-24, 23-channel transceiver

Citizens Two-way Radio—Complete line of "REACTOR" solid-state transceivers featuring new advanced "Dual Noise Suppression" that drastically reduces mobile interference.



Model SR-240 five-band receiver

General Coverage Receivers—Communications-type SWL/FM/AM receivers from \$59.95 to \$395. All the professional features such as BFO, slide-rule dials, electrical bandspread or new S-P-R-E-A-D tuning.



Special Frequency Receivers

Model CR-44 five-band portable

Multi-band portables—Outstanding new multi-band portables covering marine, aviation, police, fire, civil defense, etc., plus FM/AM. Some with "DIRECTION FINDER" capability.



Model CR-3000 FM/AM Short Wave

High-Fidelity—with Short Wave! New Hallicrafters engineering triumph—superb high fidelity reception on FM stereo, AM plus three short wave bands.



Monitor Receivers

Model CRX-102 (144-174 MHz) pocket portable

Special-frequency receivers—New high-performance pocket portable and table model receivers for aviation and industrial/public service frequencies.



Write for complete specifications today!

hallicrafters

A SUBSIDIARY OF NORTHROP CORPORATION

600 Hicks Road,
Rolling Meadows, Illinois 60008

LETTERS (Continued from page 12)

Lisle's statement that in foreign countries radio drama never lost its popularity. When TV programming came on the scene, the effects abroad were similar to those in the U.S.—radio dramas lost more of their audiences to TV. But since most foreign broadcasting is financed by direct annual levies on radio and TV receivers, or state grants, and on advertising, these countries are able to program for minority (in numbers) tastes. Avid listeners are sticking to radio plays, and this is why the radio medium has been retained—not because the majority of listeners supported it. Both here and abroad, as people get over the novelty of TV, perhaps they discover or rediscover the assets of radio, particularly as a drama medium.

THOMAS HOUSE, VE7BHN/WO
Denver, Colo.

QUIRP-NOUN-VERB

It might interest Los Angeles area readers to know that there is a radio station in their area that continually sends you "Quirp-Noun-Verb" in CW. It operates on 10 megahertz from 6:30 p.m. to 7:00 p.m., Pacific Standard Time. Does anyone know anything about this station and the curious transmissions?

AL LARSEN
HERMOSA BEACH, CALIF.

This is news to us. So, we ask the same question: Does anyone out there know what this is all about? Let's say we're curious.

BATTERY OPERATION NOT PRACTICAL

I have two questions concerning the "Pulse Command Responder" (ELECTRONICS EXPERIMENTER'S HANDBOOK, Spring, 1968). First, is it possible to substitute a 6-volt battery for the power supply shown in the schematic drawing on page 49? Then, I would like to know if there is a 6- or 12-volt model stepping relay available to replace the 117-volt a.c. relay, K5.

D. BARON
MASSAPEQUA, N.Y.

Converting the "Pulse Command Responder" to battery operation is impractical because of the high current drawn by the circuit. The smallest size battery we could recommend, if the conversion was possible, is an expensive, bulky automobile battery. Then, too, the only 6- or 12-volt stepping relays we know of are of the continuous-rotation type which are not suitable for the electrical reset operation desirable in this project. —30—

OUT OF TUNE

"SONCON" CONTINUITY TESTER (April, 1968, Fig. 1, page 62). Reverse the connections shown for zener diode D2 in the schematic diagram. The cathode goes to the positive and the anode to the negative terminal of the "Sonalert" module. —30—

New Turner CB mike. 300-3000 CPS response: \$1500

List Price

The Turner 360 is $\frac{3}{4}$ size. It's tube/transistor compatible, provides -54dB output and comes with relay or electronic switching. Your dealer has it now.

TURNER

909—17th Street, N.E.
Cedar Rapids, Iowa 52402.



POPULAR ELECTRONICS READER SERVICE PAGE

free information service:

Here's an easy and convenient way for you to get additional information about products advertised or mentioned editorially (if it has a "Reader Service Number") in this issue. Just follow the directions below...and the material will be sent to you promptly and free of charge.

1. Print or type your name and address on the lines indicated. Circle the number(s) on the coupon below that corresponds to the key number(s) at the bottom of the advertisement or editorial mention(s) that interest you. (Key numbers for advertised products also appear in the Advertisers' Index.)

2. Cut out the coupon and mail it to the address indicated below.

3. This address is for our product "Free Information Service" only. Editorial inquiries should be directed to POPULAR ELECTRONICS, One Park Avenue, New York 10016; circulation inquiries to Portland Place, Boulder, Colorado 80302.

**POPULAR
ELECTRONICS**

VOID AFTER SEPTEMBER 30, 1968

P.O. BOX 8391
PHILADELPHIA, PA. 19101

1 2 3 4 5 6 7 8 9 10 11 12 13 14 15 16 17 18 19 20
21 22 23 24 25 26 27 28 29 30 31 32 33 34 35 36 37 38 39 40
41 42 43 44 45 46 47 48 49 50 51 52 53 54 55 56 57 58 59 60
61 62 63 64 65 66 67 68 69 70 71 72 73 74 75 76 77 78 79 80
81 82 83 84 85 86 87 88 89 90 91 92 93 94 95 96 97 98 99 100

NAME (Print clearly) _____

ADDRESS _____

CITY _____ STATE _____ ZIP CODE _____

8Na

**Get on the
sideband wagon!**

TRAM[®] TITAN II

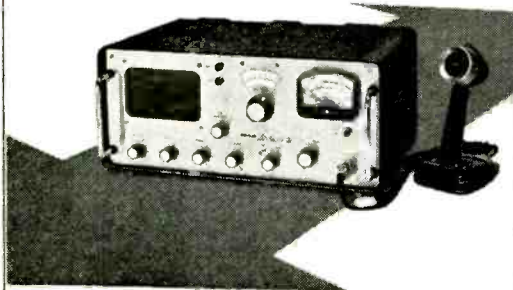

STANDARD AM AND DOUBLE SIDEBAND SUPRESSED CARRIER

The Tram Titan II is two CB rigs wrapped into one: focuses more talk-power with much greater range, virtual immunity from pulse-type and skip interference, plus a choice of either upper or lower sideband reception or standard AM tuning. Completely compatible with AM, DSBRC, DSBSC and SSB.

With multi-function "S" meter, power meter, Collins mechanical filter for super-sharp selectivity, multi-stage R.F. gain control, built-in low pass filter for minimum T.V.I., S.W.R. bridge and unique transmit monitor.

Titan II, the most exciting thing to happen to radio since Marconi threw the switch. \$482. Complete.



For full details write:

TRAM CORPORATION

Dept. No. E-1, Lower Bay Road, P.O. Box 187
Winnisquam, N. H. • Phone 603-524-0622

All use must conform with Part 95 F.C.C. regulations.
Hobby type communications or aimless small talk prohibited.

CIRCLE NO. 36 ON READER SERVICE PAGE

TAKE ONE



new literature

To obtain a copy of any of the catalogs or leaflets described below, simply fill in and mail the coupon on pages 15 or 115.

More than 4000 bargain-priced items are featured in *Edmund Scientific's* Catalog #685. Among the many items are "Show and Tell" educational kits containing a variety of items related to nature, science, math, and physics, a dry copying machine, 9'-diameter hot-air balloons, and an electronic strobe light designed for psychedelic shows and motion freezing. Telescopes, telescope kits, sky and earth globes, cameras, lenses, arts and crafts items, and a whole array of other interesting items are also featured.

Circle No. 86 on Reader Service Pages 15 and 115

New hand-size VOM's and a solid-state VOM with a 7" scale and features of a VTVM are highlighted, along with the entire line of *Simpson Electric Company's* regular line of VOM's and VTVM's in "Test Equipment Catalog," Bulletin 2078. This 16-page catalog also describes accessory equipment, general-purpose and specialized test leads and probes, carrying and utility cases, and an oscilloscope probe kit.

Circle No. 87 on Reader Service Pages 15 and 115

A new color brightener selector chart and an updated selector chart for monochrome TV picture tubes is now available from *Perma-Power Company*. The Color Brightener Selector chart is designated CSG-68, and the Tu-Brite Selector Chart is designated LPB68. The selector chart for color brighteners identifies the 13 round-type color tube numbers (small shell neodiheptal) and 37 rectangular tube numbers (small button diheptar), and indicates the proper brightener for each tube. The Tu-Brite Selector Chart lists 845 different monochrome picture tubes and the proper brightener for each.

Circle No. 88 on Reader Service Pages 15 and 115

The audio experimenter and hi-fi stereo buff are shown the differences between home hi-fi components and those used by professional engineers in *Altec Lansing's* publication No. AL-1365, entitled "Professional Audio Controls." This 12-page brochure, written by recognized professionals in the sound engineering field, explains the merits of fixed-gain amplifiers, passive control devices, and low-impedance transmission circuits.

Circle No. 89 on Reader Service Pages 15 and 115

POPULAR ELECTRONICS

There has never been a better color-bar generator than the RCA WR-64B...

until now!



The RCA WR-502A CHRO-BAR color-bar generator is all solid-state, battery operated... Provides color bars, dots, crosshatch, vertical lines, horizontal lines, blank raster... has rock-solid stability. It's the greatest yet. The CHRO-BAR. \$168.00*.

RCA Electronic Components, Harrison, N. J.

*Optional Distributor resale price. Prices may be slightly higher in Alaska, Hawaii and the West.

RCA

CIRCLE NO. 30 ON READER SERVICE PAGE

August, 1968

17

**“He’s a good worker.
I’d promote him
right now if he had
more education
in electronics.”**



Could they be talking about you?

You'll miss a lot of opportunities if you try to get along in the electronics industry without an advanced education. Many doors will be closed to you, and no amount of hard work will open them.

But you can build a rewarding career if you supplement your experience with specialized knowledge of one of the key areas of electronics. As a specialist, you will enjoy security, excellent pay, and the kind of future you want for yourself and your family.

Going back to school isn't easy for a man with a

full-time job and family obligations. But CREI Home Study Programs make it possible for you to get the additional education you need without attending classes. You study at home, at your own pace, on your own schedule. You study with the assurance that what you learn can be applied to the job immediately.

CREI Programs cover all important areas of electronics including communications, radar and sonar, even missile and spacecraft guidance. You're sure to find a program that fits your career objectives.



You're eligible for a CREI Program if you work in electronics and have a high school education. Our FREE book gives complete information. Airmail postpaid card for your copy. If card is detached, use coupon at right or write: CREI, Dept. 1208G, 3224 16th St., N.W., Washington, D.C. 20010.

Founded 1927



Accredited Member of the National Home Study Council



CREI, Home Study Division
McGraw-Hill Book Company
 Dept. 1208G, 3224 Sixteenth Street, N.W.
 Washington, D.C. 20010

Please send me FREE book describing CREI Programs. I am employed in electronics and have a high school education.

NAME _____ AGE _____

ADDRESS _____

CITY _____ STATE _____ ZIP CODE _____

EMPLOYED BY _____

TYPE OF PRESENT WORK _____ G.I. BILL

- I am interested in Electronic Engineering Technology
 Space Electronics Nuclear Engineering Technology
 Industrial Electronics for Automation
 Computer Systems Technology

APPROVED FOR TRAINING UNDER NEW G.I. BILL



NEW PRODUCTS

Additional information on products covered in this section is available from the manufacturers. Each new product is identified by a code number. To obtain further details on any of them, simply fill in and mail the coupon on page 15 or 95.

COLOR BAR GENERATOR

Crystal-calibrated, solid-state circuits in *RCA Electronic Components'* WR-502A "CHRO-BAR" color-bar generator is designed to provide stable test patterns for color and monochrome TV receiver adjustment.

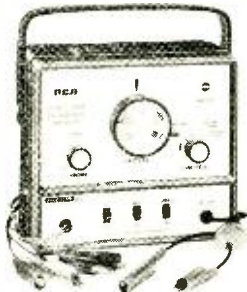

The patterns include color bars, dots, crosshatch, vertical and horizontal lines, and a blank raster for purity and color temperature adjustments. Gun killers, ten individual color bars (including

R-Y, B-Y and Q signals), each separated by a brightness pulse for checking registration and color signals, and a crystal-controlled 1.5-MHz sound carrier are also featured. Crystal-controlled r.f. output is provided on channel 3 for direct feed to the antenna input terminals of the TV receiver. The color bar generator is powered by a 4.2-volt mercury battery, and a facility is provided for an alternate battery that can be switched in as needed. A meter on the front panel indicates the condition of the batteries.

Circle No. 75 on Reader Service Pages 15 and 115

PUSHBUTTON-TUNED STEREO RECEIVER

The *Fisher Radio* Model 160-T 40-watt FM stereo receiver, featuring "TUNE-O-MATIC" pushbutton tuning with five separate FM dials, incorporates advanced solid-state circuitry and a full complement of controls for



tape and phono playback. Each of the five dials can be set to a favorite FM station, allowing you to select the one you want, at the touch of a button. Diode tuning, coupled with

a.f.c., electronically locks onto the desired station. The tuner section features IC's and FET's, a stereo beacon, 2.2- μ V sensitivity, and 45-dB adjacent channel rejection. The 40-watt (IHF) amplifier section features a three-way speaker selector, loudness contour switch, bass, treble, and balance controls, and Fisher's "Transist-O-Gard" overload protection circuit.

Circle No. 76 on Reader Service Pages 15 and 115

4- AND 8-TRACK CARTRIDGE RECORDERS

Said to be the first of its kind, *Kinematix's* Models KX-899 and KX-900 cartridge recorders make it possible to record from almost any electronic source onto the popular 4- and 8-track continuous-loop tape cartridges. The Model KX-899 incorporates only the recording electronics, while the Model KX-900 incorporates both record and playback electronics for use with an external power amplifier. The recorders will come to a stop when they contact the sensing foil featured on 8-track (and which can be added to 4-track) cartridge tapes, thus eliminating the need for a stopwatch to prevent over-recording the same track. The recorders are equipped with VU meters for monitoring recording level. Designed to operate from a 117-volt a.c. source, a quick conversation allows the recorders to be used with 12-volt d.c.



Circle No. 77 on Reader Service Pages 15 and 115

SOLID-STATE POST MARKER GENERATOR

Fifteen switch-selectable, crystal-controlled markers are featured in the *Heath Company's* Model IG-14 post marker generator.

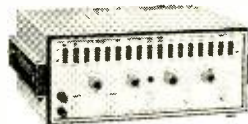

Trace and marker amplitude controls are included in the IG-14. Four marker frequencies are available to set TV color bandpass, one marker is for TV

sound, eight i.f. markers are spotted between 39.75 and 47.25 MHz, and markers are provided for TV channels 4 and 10. Up to six markers can be used simultaneously. For FM alignment, there are markers at 10.7 MHz and 100 kHz on each side of the center frequency. Also provided is a variable bias supply (0-15 volts d.c.) for selection of either positive or negative test bias. The IG-14 is housed in Heath's "new look" stackable cabinets.

Circle No. 78 on Reader Service Pages 15 and 115

LOW-COST RECORDING MICROPHONES

A new high-quality, low-cost microphone for tape recording and public address is being introduced by the *Turner Company*. The Model 2800 is a dynamic, high-impedance, omnidirectional microphone, featuring 70-

MORE POWER! MORE PUNCH! MORE RANGE!

only \$169.95



COBRA 23

23 Channel Solid State CB

Our latest and best! Ready to operate on all 23 channels. Solid state throughout—23 silicon transistors and 9 diodes! 100% modulation means greater power output, more punch, increased range. It's a B&K breakthrough... at a breakthrough price... only \$169.95.



COBRA V
Famous "Punchy Galore"
5 channel solid state CB.
The "hot one"! \$99.95



CAM 88
A proven 23 channel CB
performer. Extra range
and power. \$214.95



A Division of Dynascan

1801 W. Belle Plaine Avenue, Chicago, Ill. 60613
Where Electronic Innovation Is A Way Of Life

Send for CB catalog.
Canada: Atlas Radio Corp., Ontario
Export: Empire Exporters, 123 Grand St., New York 13, U.S.A.

CIRCLE NO. 7 ON READER SERVICE PAGE

PRODUCTS (Continued from page 22)

15,000 Hz frequency response and a -63 dB output level. A pair of matched 2800 microphones (called Model 2804) includes a convenient carrying case. The 2800-series is sold with a 12'-long cable, phone plug, desk stand, lavalier, and a one-year guarantee.

Circle No. 79 on Reader Service Pages 15 and 115

POLICE AND FIRE MONITOR RECEIVERS

To meet the growing interest in monitoring police, fire, and other Public Service broadcasts, *Regency Electronics* is making available two new monitor radios. The Model MR-10D is designed to receive in the 152-174 MHz band, while the Model MR-33D



is designed to receive in the 30-50 MHz band. Both VHF receivers have only three controls—volume, squelch, and tuning—for simplified operation. The slide-rule dial on each receiver features a graphic presentation of frequencies commonly assigned to the various services. Both models are designed to operate from 117-volt a.c. sources.

Circle No. 80 on Reader Service Pages 15 and 115

SNAP-ON VOLT-AMMETER

Accurate current measurement without interruption of the equipment under test is possible with *A.W. Sperry Instruments'* SNAP-5 snap-on volt-ammeter. The SNAP-5 features a new jaw mechanism that is designed to open wide, a positive-action range selector switch, and solid-state circuits. Readings have a 3% accuracy. The a.c. voltage ranges provided are 0 to 150, 300, and 600 volts on all models, and current ranges include 0 to 10/50 amperes, 0 to 30/150 amperes, and 0 to 60/300 amperes, depending on the model chosen. The SNAP-5 also features a dust-proof meter compartment that snaps into any one of five positions so that the meter scale is always pointing toward the user.

Circle No. 81 on Reader Service Pages 15 and 115

FM STEREO TUNER

Silicon integrated circuits are used in the *Sherwood Electronic Laboratories* Model S-3300 FM stereo tuner. Distortion-reducing IC's are used in the i.f. amplifier and Sherwood's "Snychro-phase" FM limiter/detector.



This feature also improves noise rejection and reception under multipath FM receiving conditions. The tuner features noise-threshold-gated automatic stereo/mono switching, zero-center tuning meter, interchannel "hush," front-panel output level control, and a stereo noise

filter that does not affect frequency response. Specifications for the Model S-3300 are: 1.8- μ V sensitivity; 2-dB capture ratio; 55 dB AM rejection; -95 dB cross modulation hum and noise level; 20-20,000 Hz, ± 0.5 dB, mono and 20-15,000 Hz, ± 0.5 dB, stereo frequency response; and 35 dB stereo separation.

Circle No. 82 on Reader Service Pages 15 and 115

AUTOMATIC ANTENNA ROTOR SYSTEM

Designed to take the guesswork out of TV antenna positioning, *Cornell-Dubilier Electronics'* Model AR33 "Autorotor" system incorporates both a 360° compass-dial position control and five separate positioning switches. Each of the switches can be pre-programmed to automatically aim the antenna in the best direction for the most-used TV channels and/or FM stations. The position accuracy of the "Autorotor" is $\pm 1^\circ$. Solid-state circuitry is used in the control console. The system includes the contemporary styled "Autorotor" console and CDE's heavy-duty "Bell" rotor.



Circle No. 83 on Reader Service Pages 15 and 115

AUTOMATIC REVERSE/REPLAY TAPE DECK

Automatic reversing and replay, simplified threading, sound-with-sound, and tape monitoring are some of the features you will find incorporated into *AmpeX Corporation's* Model 1450 stereo tape deck. The tape deck uses four tape heads to facilitate sound-with-sound recording and tape monitoring. The deck includes separate preamplifiers. The Model 1450's automatic replay feature permits a tape to be programmed to repeat itself indefinitely. Optional features include a walnut base and smoked-glass dust cover.

Circle No. 84 on Reader Service Pages 15 and 115

MICROWAVE ALARM

With the Model SS-101 Radar Sentry Alarm made by *Radar Devices Manufacturing Corp.*, intruders and fires can be detected before they do extensive damage. The Radar Sentry Alarm operates in the UHF spectrum with solid-state circuits. The harmless 400-MHz radiation can detect human motion in the area it protects. As soon as an



intruder enters the area, lights are switched on, and 30 seconds later, an ear-splitting police-type siren sounds.

The system can be connected directly to police headquarters through a rented phone line. No one can enter a Radar Sentry protected area without setting off the alarm, since the slightest movement is enough to sound the alarm.

Circle No. 85 on Reader Service Pages 15 and 115

SHIP SHAPE

The Squires-Sanders Citizens Band Fleet is shipping out . . . in top shape. All over the country the message is coming in loud and clear . . . "NOW HEAR THIS—this is the ADMIRAL speaking" . . . "ATTENTION MEN—this is your SKIPPER". It is time for you to put your station in command—with an ADMIRAL to run your base . . . and a SKIPPER to pilot your mobile. Haul in to your dealer today.



THE ADMIRAL • *The SKIPPER*

The ADMIRAL: luxurious new all solid state 23 channel CB base station • highly sensitive receiver • Pulse Eliminator • 5 watt transmitter • Speech Compression • +2 mike • dual antenna • HiLo sensitivity • Public Address • Delta Tune • adjustable squelch • ON-THE-AIR light • illuminated S meter • digital panel clock • ear-phone jack • regulated AC power supply • 9 lbs: 5¼ x 13¾ x 10¾"

\$329.95

The SKIPPER: new low priced solid state 23 channel CB transceiver • superb dual conversion FET/IC no-overload receiver • advanced design noise limiting • illuminated S meter and channel • solid state T/R switching • Speech Clipping • 100% modulation • P.T.T. mike • Local/Distant sensitivity • external speaker jack • Public Address • Exclusive "All Position" Safety Breakaway Mount • only 3 lbs: 1¾ x 6 x 8"

\$159.95

Squires  Sanders

SQUIRES-SANDERS, INC., Box A, Martinsville Road, Liberty Corner, New Jersey 07938 U.S.A.

CIRCLE NO. 35 ON READER SERVICE PAGE

Why every CB emergency team should own a Scanner:

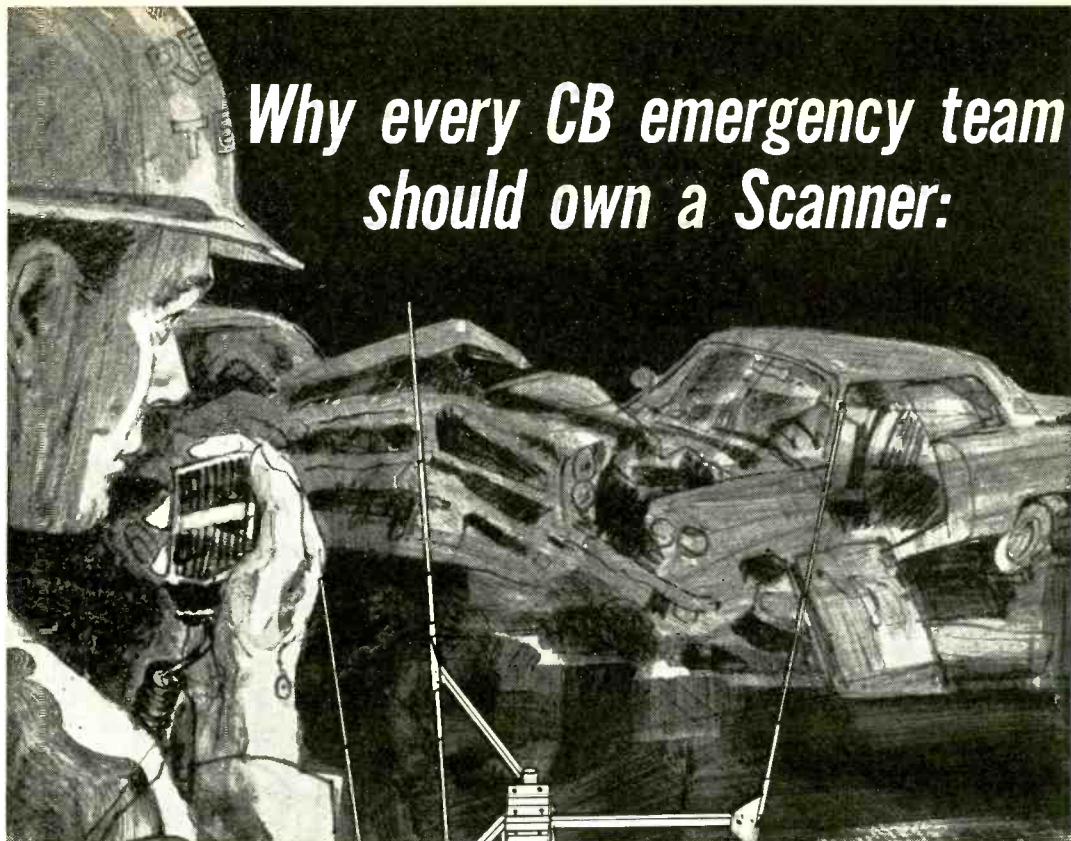

When a life may depend on your ability to communicate, there can be no compromise with the performance of your total system. Regardless of your transceiver, the *big difference* in effective range is up top, at the antenna. *Nothing ever designed can match the instant response pinpoint capability and reach power of the incomparable SCANNER.*

the incomparable

Scanner

Model M-119 electronic sector-phased omni-beam antenna

the antenna specialists co.

12435 Euclid Ave., Cleveland, Ohio 44106

A Division of Anzac Industries, Inc.

"Stripes of Quality"



Export: 64-14 Woodside Ave.
Woodside, N.Y. 11377

CIRCLE NO. 4 ON READER SERVICE PAGE

POPULAR ELECTRONICS



Scan Control Unit, with indicator lights, instantly changes signal direction — just flip the switch.

- Electronic focus and beam rotation—zero in on your mobiles instantaneously with a tremendous 7.75 db directional gain.

- Change signal direction in a split second—control many mobiles, guide ambulances, etc., with maximum gain on each.

- Unmatched 23 db front-to-back ratio—significantly rejects skip and local interference off the backside, assuring maximum effectiveness of your forward signals.

- Compact — 17½-foot vertical elements, total radius only 3 feet. Exceptionally rugged—withstands 100-mile winds.

- All the value of a beam antenna with more flexibility. Priced 30% under conventional beam arrays employing mechanical rotation.

IC EXPERIMENTERS' 3.6-VOLT POWER SUPPLY

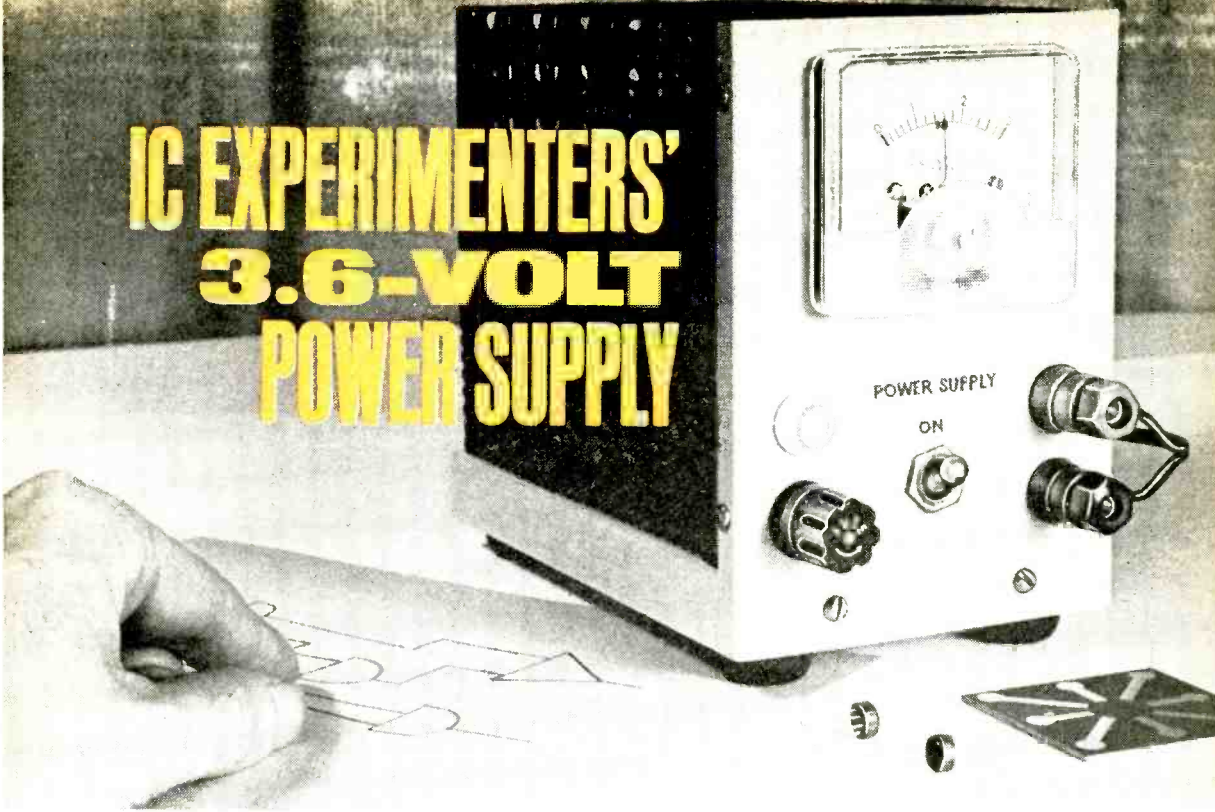

JUST THE THING FOR THOSE IC PROJECTS

By Philip J. Taylor

LOW-COST integrated circuits are being used in an increasing number of home-built projects. For such applications, the experimenter needs a stable, low-cost, high-current 3.6-volt power supply. This voltage (3.6 volts) is the level required to operate most commonly available IC's.

The power supply described here will deliver up to 1.5 A at 3.6 V \pm 150 mV continuously. The combined hum and noise at maximum output is 120 mV and the supply will run cool, even with 24-hour-a-day operation. A built-in ammeter indicates the current being drawn by the circuit under test.

Construction. The components shown within the dashed box of Fig. 1 are mounted on a printed circuit board, such as that shown actual size in Fig. 2. A $\frac{3}{8}$ " hole must be drilled in the board for potentiometer R3. Once the PC board is made, install the components as shown in Fig. 3. After mounting all the parts,

fit the radial heat sink over transistor Q1.

The rectangular heat sink that supports power transistor Q2 and rectifier diodes D1 and D2 is drilled as shown in Fig. 4. When mounting the semiconductors on the heat sink, use mica insulating wafers—liberally coated with silicone grease on both sides—to insulate the semiconductors from the metal heat sink. Don't forget to use insulated mounting hardware for the transistor. The cathodes of the rectifier diodes, and the leads of the transistor should protrude through the flat side of the heat sink.

Connect the required PC board terminals to the semiconductors as shown in the schematic. Then secure the board to the flat side of the heat sink using four long insulated standoffs and the necessary hardware.

The author used a block of smooth wood for the base. This simplifies the mounting of the heat sink (using a pair

Fig. 1. Double zener diode regulation accounts for stability of power supply. Output voltage and current are ideal for experiments with various integrated circuits.

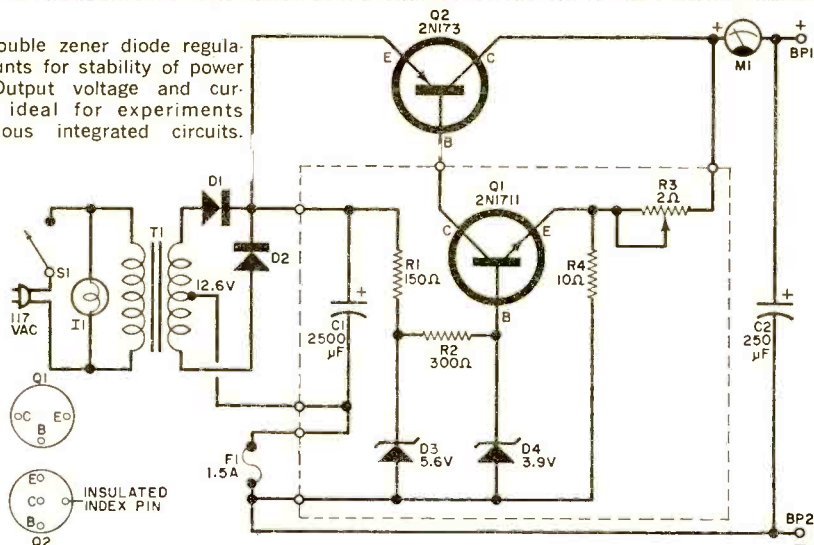

PARTS LIST

BP1, BP2—5-way binding posts, one red and one black
 C1—2500- μ F, 10-volt computer-grade electrolytic capacitor
 C2—250- μ F, 6-volt electrolytic capacitor
 D1, D2—2-ampere silicon rectifier diodes*
 D3—5.6-volt, $\frac{1}{4}$ -watt zener diode
 D4—3.9-volt, $\frac{1}{4}$ -watt zener diode
 F1—1.5-ampere, 3AG fuse
 M1—D.c. ammeter, 1.5 amperes minimum
 I1—117-volt neon lamp and resistor assembly (Leecraft 32-2117 or similar), or 117-volt lamp
 Q1—2N1711 power transistor
 Q2—2N173 power transistor
 R1—150-ohm, $\frac{1}{2}$ -watt resistor
 R2—300-ohm, $\frac{1}{2}$ -watt resistor

R3—2-ohm, 5-watt wire-wound potentiometer
 R4—10-ohm, 10-watt wire-wound resistor
 S1—S.p.s.t. switch
 T1—Filament transformer; secondary 12.6-volts @ 2 amperes C.T.
 Misc.—Rectangular heat sink 3" x 3 $\frac{3}{8}$ "*, fuse holder for 3AG fuse, 5-ohm, 10-watt resistor for calibration, wood for base, metal for front panel and heat sink brackets, silicone grease, heavy-duty screen, radial heat sink for Q1, line cord, rubber feet (4), insulated spacers (4), screws, wire, solder, etc.
 *Several mail-order suppliers are selling a heat sink with four silicon rectifiers (including mounting hardware) for about \$2.00. Look in your latest catalog for this bargain. It is sometimes called "Battery Charger Kit."

of brackets) and the affixing of both the front panel and the enclosing cage.

The front panel can be layed out as desired to accommodate meter M1, the two output binding posts BP1 and BP2, pow-

er ON-OFF switch S1, and indicator lamp I1. It is suggested that a red binding post be used for the positive voltage output (BP1) and a black one for the negative voltage output (BP2). Both binding

HOW IT WORKS

The power supply is a series-regulator circuit using a zener diode as the voltage reference. In a supply of this kind (see Fig. 1), when potentiometer R3 is set for minimum resistance, the output voltage of the supply is equal to the voltage drop across the reference zener diode (D4) minus the emitter-to-base voltage drop of control transistor Q1. In this case, as the voltage across D4 is 3.9 volts and the drop of Q1 is 0.6 volts, the output voltage of the supply will be 3.9-0.6=3.3 volts.

At breakdown voltage levels below approximately six volts, the dynamic resistance of a zener diode tends to increase. The higher dynamic resistance reduced the regulation accuracy and decreases the filtering efficiency unless steps are

taken to prevent or reduce such efforts. In this design, to reduce D4's maximum load current (maximum base current of Q1) to less than 10% of its steady-state value at zero output from the supply, the gain product of the Q1-Q2 combination has been made high. In addition, the voltage from the rectifiers and filter (D1, D2, and C1) is pre-regulated by R1 and zener diode D3 before it is applied to the D4-Q1 combination. Thus, D3 actually provides the greater part of the regulation, reducing the load on D4. Without D3, the wide voltage swing (about 2 volts) at the output of the rectifiers due to the variations in load requirements would result in a higher dynamic resistance in D4.

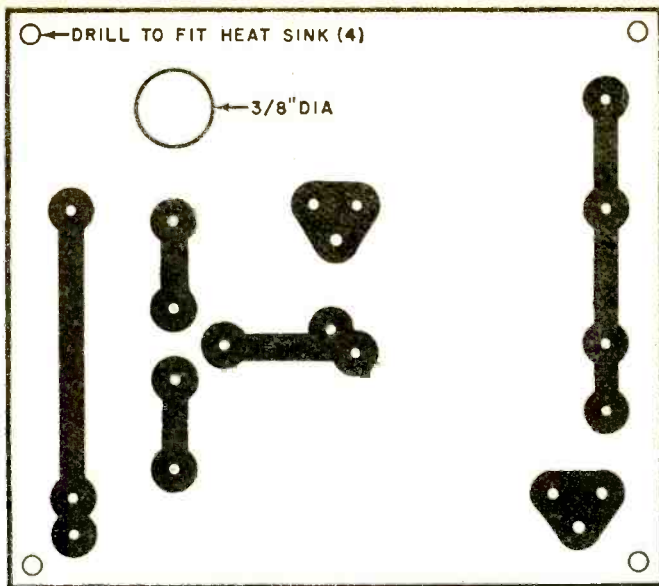

Fig. 2. Actual-size printed circuit board used to simplify wiring of the power supply. A slight change was made in this board compared to the one below in the photo. In this board zener diodes D3 and D4 are fed to individual holes, but in the board below the two diodes are inserted in the same hole. The 3/8"-diameter hole is to mount potentiometer R3. Board is mounted to—but spaced from—the heat sink as shown in Fig. 4.

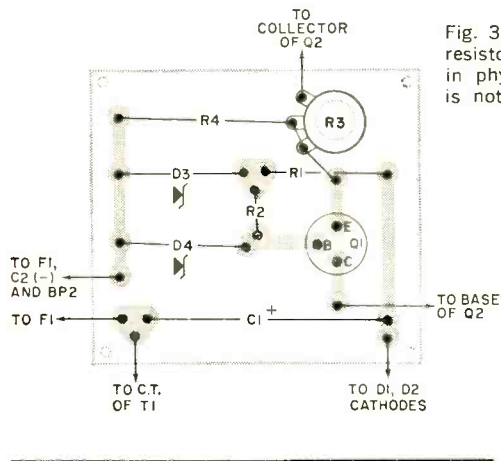
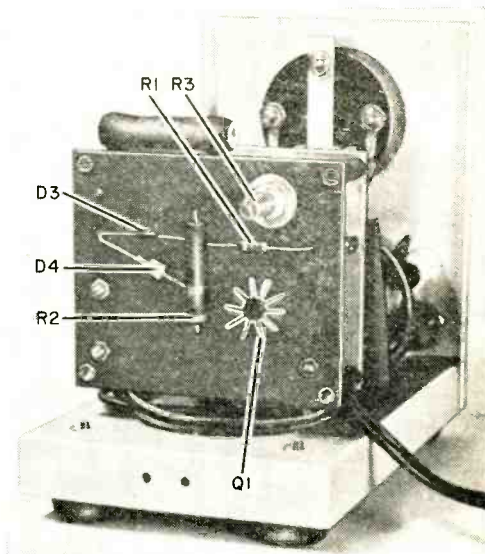
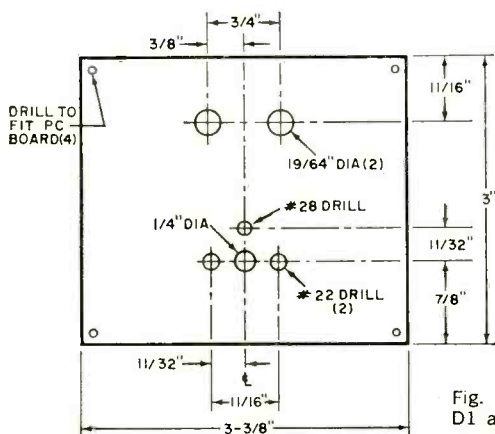
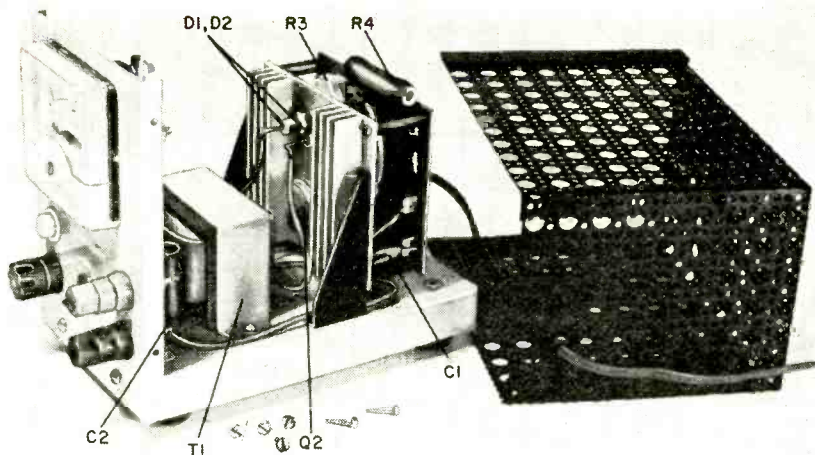

Fig. 3. Parts layout on the PC board. The 10-watt resistor R4 is suspended by its leads and is not in physical contact with the board. This resistor is not called out in photo, but is clearly visible.



Rear view of author's prototype. A piece of hard wood was used for the base to simplify mounting.

Fig. 4. Drilling instruction for heat sink. Diodes D1 and D2 mount in top holes, Q2 in holes below.



Protective screen was shaped by the author out of stock aluminum available at many hardware stores. Note the position of the 10-watt resistor R3 suspended above PC board.

posts are insulated from the metal front panel.

The enclosure can be almost any type as long as it provides sufficient ventilation for the heat sink. The author used a piece of perforated aluminum screen.

Operation. Once all wiring has been completed, and checked over for any possible errors, connect a 5-ohm, 10-watt resistor across the output-voltage binding posts. Then connect a 5-volt d.c. volt-

meter across this resistor. Turn on *S1* and observe that the front-panel indicator lamp (*I1*) comes on. Observe the voltmeter indication, and adjust potentiometer *R3* to obtain a 3.6-volt indication. Turn off the power, and remove both the 5-ohm resistor and the voltmeter from the output terminals.

The power supply will now deliver 3.6 volts for any load up to 1.5 amperes with exceedingly good regulation and very low ripple.

-30-

IN THIS MONTH'S COVER PHOTOGRAPH

The representative equipment shown in the full-color cover photograph pertain to the communications fields of Citizens Radio, Amateur Radio, and short-wave listening. In panel A is a Hallicrafters CB-24 transceiver. Short-wave listeners may be interested in the Lafayette "Explor-Air Mark VI" appearing in panel B. (Details on a variety of SWL receivers will appear in the September issue.) A new receiver for the radio amateur, the Hammarlund HQ-215, is seen in panel C. At D and E are CB transceivers, the Knight-Kit "Safari IV" and Amphenol "777", respectively. At the bottom of the illustration are two glamorous base station CB transceivers, the Courier "Royale" in panel F and the Squires-Sanders new "Admiral" in panel G.

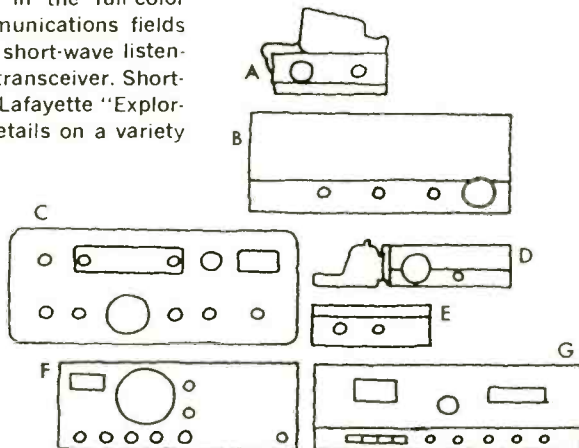



**While
you
were
out...**

*TELEPHONE
MONITOR
TELLS IF
SOMEONE
CALLED*

BY H. St. LAURENT

ONE OF THE drawbacks of the conventional telephone is that you have to be aware that it is ringing. This may present a problem if you are hard of hearing or are out of earshot when it rings. On the other hand, if you run a small business and want to know if anyone calls during your absence, you could use a device that would turn on a lamp when the phone rings. Then when you return to your shop, if the light is on, you know that you should call the answering service to get the message.

The Phonoalarm described in this article (and shown schematically in Fig. 1) is a relatively simple electronic device that does not make direct connection to the phone, but operates by induction. Whenever the phone rings, it energizes a remote bell or buzzer or a conventional 117-volt light in step with

the phone's ringing. At the flip of a switch, the alarm can be changed so that the external circuit remains energized after the phone stops ringing. In this mode, a manual reset switch is used to turn the device off.

Construction. The Phonoalarm is built into a shallow non-metallic tray, just large enough to accommodate the base of the phone being used. The top cover of the tray (supporting the phone) *must* be non-metallic to allow the phone ringer's magnetic field to penetrate the alarm.

Except for the location of the pick-up coil, component arrangement is not critical. In the author's version, shown in Fig. 2, the phone-operated indicator lamp *I1* and the manual reset pushbutton switch *S1* are on the front of the

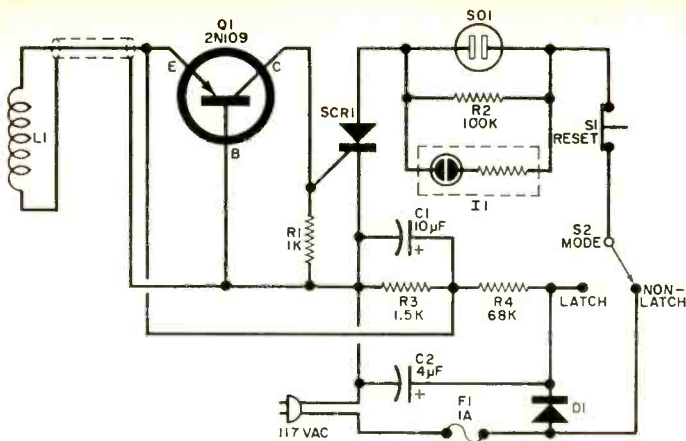

PARTS LIST

- C1—10- μ F, 10-volt electrolytic capacitor
 C2—1- μ F, 150-volt electrolytic capacitor
 D1—1-ampere, 400-PIV silicon rectifier
 F1—1-ampere fuse
 I1—Neon pilot lamp assembly with series resistor for 117-volt operation
 L1—Telephone pickup coil (Aat type)
 Q1—2N109 transistor*
 R1—1000-ohm*
 R2—100,000-ohm
 R3—1500-ohm
 R4—68,000-ohm

all resistors
 1/2-watt

- S1—Normally-closed miniature pushbutton switch
 S2—S.p.d.t. switch
 SCR1—1-ampere silicon-control rectifier* (GE C106-B1 or similar)
 SO1—117-volt chassis mounting socket
 Misc.—Shallow non-metallic tray to fit telephone base, non-metallic cover to fit tray, cement, rubber feet (4), power cord, wire, fuse holder, solder, hardware.
 *A kit of parts including Q1, R1, and SCR encapsulated in a single module is available as P.A-110 from Lectromek, P.O. Box 824, Warwick, R.I. 02888 for \$5.

Fig. 1. Telephone pickup coil L1 detects the magnetic field of the telephone ringer. The current developed is amplified by the transistor and used to trigger the SCR. This in turn applies power to the indicator light and the external circuit through chassis socket SO1.

tray; the power input line and power outlet socket SO1 are on the back. Transistor Q1, resistor R1 and the SCR must be mounted very close to each other to avoid electrical noise pickup that may cause false triggering. The author's version did not include the optional "Mode" switch S2. If this switch is used, it can be mounted on either the front or rear wall. Secure the electronic components within the case, but do not mount induction

coil L1. This coil must be provided with a length of shielded single-conductor cable so that it can be moved about during the following test.

To determine the proper location for L1 (which depends on the type of phone used), place the phone upside down on a pillow, making sure that the handset is firmly in place. Put the cover of the Phonoalarm tray in position so that it fits the base of the phone. With power ap-

HOW IT WORKS

When the phone rings, the alternating magnetic field set up by the ringer coil is picked up by induction coil L1. This signal is amplified by Q1 and applied to the gate of SCR, which is in series with the 117-volt a.c. power and outlet SO1. When the SCR is on, power is applied to SO1 and neon indicator I1 also turns on.

With switch S2 in the NON-LATCH position, the SCR is automatically shut off and power is removed from SO1 when the gate signal is removed. When S2 is in the LATCH position, input power to the SCR is rectified by diode D1 so that the SCR will not turn off when the gate signal is removed, and SO1 is continuously supplied with power until reset switch S1 is depressed, opening the circuit.

The rectifier-filter combination of D1 and C2 also supplies d.c. power for Q1 through R3, R4, and C1.

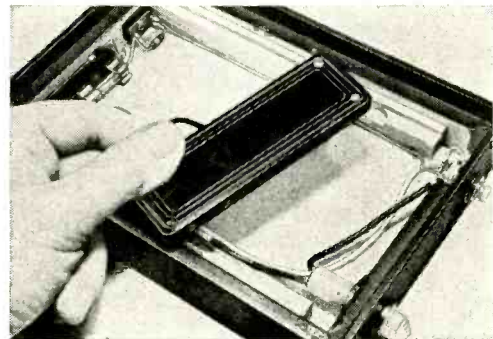

Do not permanently mount the telephone pickup coil until you have found the proper axis and position.

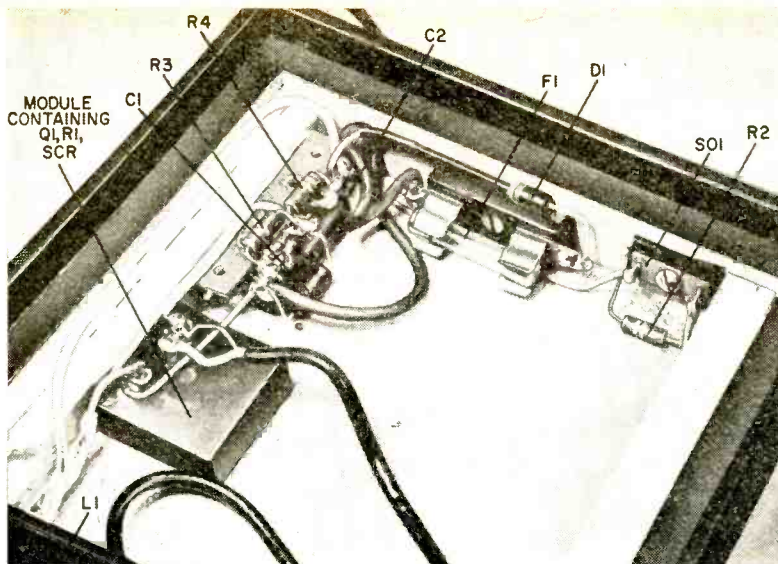

Fig. 2. This is the simplified parts arrangement in the tray under the telephone used by the author. The module is available from Lectromek for \$5, postpaid.

plied to the alarm, have someone call your telephone number. As the phone rings, slide *L1* around the cover until indicator lamp *I1* comes on, and 117-volt power is available at the outlet *SO1*. Mark this position of *L1* and cement the coil in place. In some rare installations, it may be necessary to mount *L1* on the top of the cover under and between the

four cushioned feet of the phone.

If "Mode" switch *S2* is in the NON-LATCH position, the indicator lamp (and the outlet power) will go on and off in step with the ringing of the phone. If *S2* is in the LATCH position, *I1* and *SO1* will be energized with the first ring and will remain on when the phone stops ringing. Push *S1* to reset the system. -30-

REACT GOES ALL OUT!!

In a surprise, but welcome move, REACT has announced a plan to double emergency communications capability by January 1969, and double it again before 1970! In the past six years, REACT (Radio Emergency Associated Citizens Teams), has been the one major bright spot in the CB picture. Organized by the Hallicrafters Company, REACT has quietly compiled an impressive record of supplying necessary volunteer radio communications in times of local, county, or statewide emergency. About 1300 REACT teams have been organized and are monitoring CB channel 9.

Information concerning the REACT expansion is now being distributed throughout the country. In its three-objective approach, REACT will not only double the number of teams available for emergency communications, but will also attempt to establish contact with the thousand or more CB groups that provide similar, but uncoordinated, services. A nationwide publicity program and direct contacts with local and state police and other law enforcement agencies will be instituted. A third objective will be to strengthen the important talents and operational techniques of the individual REACT teams.

If you are interested in this worthwhile effort to improve the public image of CB, we urge you to write National REACT Headquarters, 5th & Kostner Avenues, Chicago, Ill. 60624.

-30-

WHO LEFT THE CAR LIGHTS ON



Simple solutions to a common problem

ONE OF LIFE'S bleakest moments occurs when you dash out of the house some wintry morning, hop into the car, turn the key, and—click, click—the battery is dead. It seems that when you came home the night before, instead of turning your car lights off completely, you inadvertently left the barely visible parking lights glowing all night.

Many methods of alerting the driver to this problem have been proposed; the most popular being some form of solid-state circuit. One system of this type produces a bleep-bleep tone when the lights are on and the ignition is off. Unfortunately, these systems are not always rugged enough to withstand the day-after-day vibrations to which most cars are subjected. What is needed is a system that is mechanically and electrically reliable and has as few parts as possible that can go wrong. There are three approaches that meet these conditions.

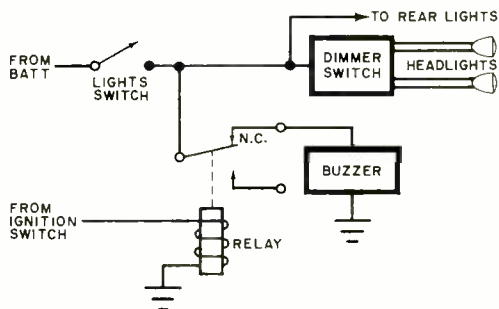

Fig. 1. This simple warning system may be easily installed in most cars. The relay coil and buzzer are matched to the battery voltage—12-volt coil and buzzer for a 12-volt battery. Disadvantage of this system is two-fold: driver frequently chooses to ignore the buzzing and the relay bounces when the car is being driven over a very rough road.

Relay Alarm. Perhaps the simplest system is shown schematically in Fig. 1. It requires only a relay and a buzzer (or any other alarm device) that can operate on the car's battery.

The buzzer circuit would be energized whenever the lights are on, but the cir-

cuit is opened by the relay contact when the ignition switch is on. Consequently, the buzzer sounds only when the lights are on and the ignition is off.

Since no high voltages, high currents, or high frequencies are involved and the system is not temperature sensitive, it has high reliability and long life (particularly if both components are protected within a sealed metal box). The relay can be any type—the author used a 12-volt Potter and Brumfield MR-5-A.

Transistorized Alarm. The circuit shown in Fig. 2 is similar to the relay alarm except that a power transistor is used as a switching element instead of the relay. This reduces the possibility of the relay's making accidental contact and sounding the buzzer when the car is jolted on a rough road. There is also a saving in size. Although the circuit in Fig. 2 is for a negative-ground system with a 2N307A transistor, the arrangement is essentially the same for a positive-ground system except that a 2N1490 would be substituted.

Note that the transistor must be mounted so that the case and the collector are not grounded. Depending on the type of buzzer used, it may also be necessary to insulate it from ground. Although

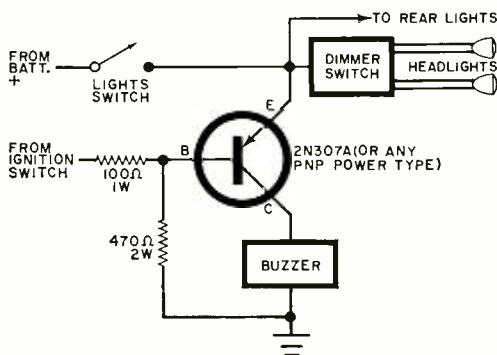

Fig. 2. Power transistor may be substituted for relay shown in Fig. 1. This design is for cars with negative-ground 12-volt systems. Text tells of transistor substitution for positive ground.

a transistor heat sink is not required for occasional operation, a 3" x 3" x 1/16" piece of copper can be used to take care of overheating when the circuit is energized for any length of time. The life of the circuit is limited only by the life of the buzzer, which may be quite a long time—probably the life of the car.

Relay Control of Lights. Both of the circuits discussed above produce an audible alarm whenever the lights are on and the ignition is off. The circuit shown in Fig. 3 uses a relay with a relatively high

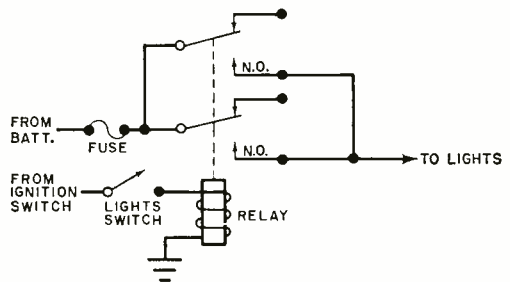

Fig. 3. Some drivers may prefer this system which automatically removes the human element—turning off the ignition switch always turns off the lights.

contact rating to control the lights themselves. The driving lights are energized through two normally open contacts connected in parallel to divide the load. The relay coil is connected to the ignition-switch circuit through the car's light switch (which must be rewired), and the lights go on *only* when the ignition switch and the light switch are on.

The relay used in this circuit should have the same coil voltage rating as the car battery and the contacts must be capable of carrying the steady current drawn by the lights as well as the high-amperage surge when they are turned on. A Potter and Brumfield PR-110DY was used for this circuit on the author's Jeep. The relay should be housed to protect it from dust and water. The wiring for the coil circuit can use any size wire that will carry the coil current.

You can earn more money if you get an FCC License

...and here's our famous CIE warranty that you will get your license if you study with us at home

NOT SATISFIED with your present income? The most practical thing you can do about it is "bone up" on your electronics, pass the FCC exam, and get your Government license.

The demand for licensed men is enormous. Ten years ago there were about 100,000 licensed communications stations, including those for police and fire departments, airlines, the merchant marine, pipelines, telephone companies, taxicabs, railroads, trucking firms, delivery services, and so on.

Today there are over a million such stations on the air, and the number is growing constantly. And according to Federal law, no one is permitted to operate or service such equipment without a Commercial FCC License or without being under the direct supervision of a licensed operator.

This has resulted in a gold mine of new business for licensed service technicians. A typical mobile radio service contract pays an average of about \$100 a month. It's possible for one trained technician to maintain eight to ten such mobile systems. Some men cover as many as fifteen systems, each with perhaps a dozen units.

Coming Impact of UHF

This demand for licensed operators and service technicians will be boosted again in the next 5 years by the mushrooming of UHF television. To the 500 or so VHF television stations now in operation, several times that many UHF stations may be added by the licensing of UHF channels and the sale of 10 million all-channel sets per year.

Opportunities in Plants

And there are other exciting opportunities in aerospace industries, electronics manufacturers, telephone companies, and plants operated by electronic automation. Inside industrial plants like these, it's the licensed technician who is always considered first for promotion and in-plant training programs. The reason is simple. Passing the Federal government's FCC exam and get-

ting your license is widely accepted proof that you know the fundamentals of electronics.

So why doesn't everybody who "tinkers" with electronic components get an FCC License and start cleaning up?

The answer: it's not that simple. The government's licensing exam is tough. In fact, an average of two out of every three men who take the FCC exam fail.

There is one way, however, of being pretty certain that you will pass the FCC exam. And that is to take one of the FCC home study courses offered by the Cleveland Institute of Electronics.

CIE courses are so effective that better than 9 out of every 10 CIE-trained men who take the exam pass it... on their very first try! That's why we can afford to back our courses with the iron-clad Warranty shown on the facing page: you get your FCC License or your money back.

There's a reason for this remarkable record. From the beginning, CIE has specialized in electronics courses designed for home study. We have developed techniques that make learning at home easy, even if you've had trouble studying before.

In a Class by Yourself

Your CIE instructor gives his undivided personal attention to the lessons and questions you send in. It's like being the only student in his "class." He not only grades your work, he analyzes it. And he mails back his corrections and comments the same day he receives your assignment, so you can read his notations while everything is still fresh in your mind.

Mail Card for Two Free Books

Want to know more? The postpaid reply card bound-in here will bring you free copies of our school catalog describing opportunities in electronics, our teaching methods, and our courses, together with our special booklet, "How to Get a Commercial FCC License." If card has been removed, just send your name and address to us.

Matt Stuczynski,
Senior Transmitter
Operator, Radio
Station WBOE



"I give Cleveland Institute credit for my First Class Commercial FCC License. Even though I had only six weeks of high school algebra, CIE's AUTO-PROGRAMMED™ lessons make electronics theory and fundamentals easy. After completing my CIE Course, I took and passed the 1st Class FCC Exam. I now have a good job in studio operation, transmitting, proof of performance, equipment servicing."

Chuck Hawkins,
Chief Radio
Technician, Division
12, Ohio Dept.
of Highways



"My CIE Course enabled me to pass both the 2nd and 1st Class License Exams on my first attempt... I had no prior electronics training either. (Many of the others who took the exam with me were trying to pass for the eighth or ninth time!) I'm now in charge of Division Communications. It's an interesting, challenging and rewarding job. And incidentally, I got it through CIE's Job Placement Service."

Glenn Horning,
Local Equipment
Supervisor, Western
Reserve Telephone
Company



"There's no doubt about it. I owe my 2nd Class FCC License to Cleveland Institute. Their FCC License Course really teaches you theory and fundamentals and is particularly strong on transistors, mobile radio, troubleshooting and math. Do I use this knowledge? You bet. We're installing more sophisticated electronic gear all the time and what I learned from CIE sure helps."

 **CIE Cleveland Institute of Electronics**
1776 E. 17th St., Dept. PE-69, Cleveland, Ohio 44114

Accredited by the Accrediting Commission of the National Home Study Council, and the only home study school to provide complete coverage of electronics fundamentals plus such up-to-date applications as: Microminiaturization • Laser Theory and Application • Suppressed Carrier Modulation • Single Sideband Techniques • Logical Troubleshooting • Boolean Algebra • Pulse Theory • Timebase Generators...and many more.



Cleveland Institute of Electronics

WARRANTY

of success in obtaining a
Government FCC License

The Cleveland Institute of Electronics hereby warrants that upon completion of the Electronics Technology, Broadcast Engineering, or First-Class FCC License course, you will be able to pass the FCC examination for a First Class Commercial Radio Telephone License (with Radar Endorsement);

OR upon completion of the Electronic Communications course you will be able to pass the FCC examination for a Second Class Commercial Radio Telephone License;

AND in the event that you are unable to pass the FCC test for the course you select, on the very first try, you will receive a FULL REFUND of all tuition payments.

This warranty is valid for the entire period of the completion time allowed for the course selected.

G. O. Allen

G. O. Allen
President

✠
**POPULAR
 ELEComics**
 ✠



Look, dear, it's a 7.6 megohm, 5% rainbow!



Neither my wife or kids understand me and because I'm a CB'er, the FCC doesn't understand me either.

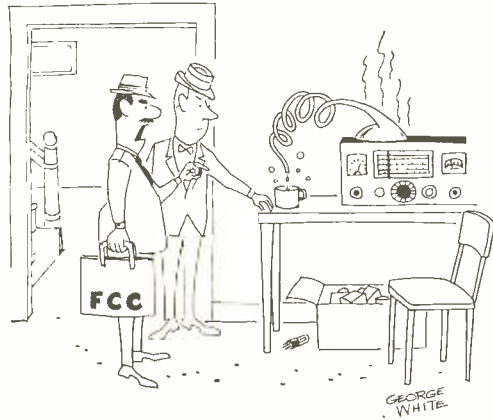

Yep, this is a bootleg transmitter.

But, Barney Collier, fixing this little radio receiver isn't all that impossible.



ANNUAL CATALOG *of* 5-Watt CB Equipment

Prepared by the Staff of POPULAR ELECTRONICS

THE FOLLOWING PAGES show in tabular form all of the principal characteristics of those Citizens Radio Service (CB) transceivers which meet the 5-watt input requirements of Part 95 of the FCC Rules and Regulations. To our knowledge, the Tables list every CB transceiver that is commonly available. Practically every manufacturer will be pleased to send you more, or detailed, information on any unit in this table.

Type of Signal: Although the overwhelming majority of CB transceivers broadcast a straight amplitude-modulated (AM) signal, several models reduce the strength of the carrier and pack slightly more power into the sidebands—which contain the all-important modulation components. The latter signals are referred to in the Table starting on the next page as “DSB” (double-sideband with reduced carrier). Several manufacturers are offering a single-sideband suppressed-carrier transceiver and the emis-

sion is referred to as “SSB.” A few transceivers are capable of receiving SSB signals, but not capable of radiating a true single-sideband signal. In general, most CB transceivers cannot convert a SSB signal into readable modulation. On those transceivers, the SSB signal sounds like Donald Duck chatter.

No. of Transmitting Channels: All Class D stations have permission to operate on any one of 23 channels in the CB 11-meter band. Transmissions must be crystal-controlled and the tolerances of the crystals must be better than 0.005% in frequency deviation. Although most transceivers are driven directly by crystals that resonate at one-half or one-third the transmitted frequency, a system of frequency synthesis is quite common. This system permits generation of all 23 channels through the use of from 6 to 10 crystals. This can be done in well-designed equipment with no

(Continued on page 50)

Clean-cut functional design is evident in the Johnson “Messenger 223” (below). This unit is for base station use. Mobile transceivers similar to the Mark “Invader-23” (right, above) or the Squires-Sanders “Skipper” feature rugged construction and flat pancake-like symmetry.

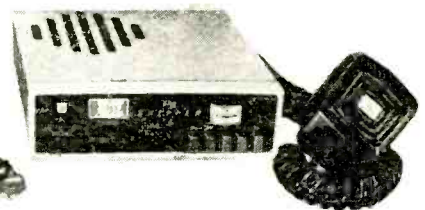
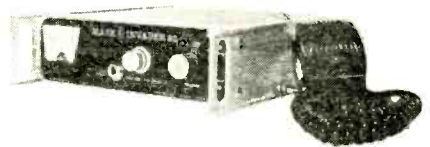
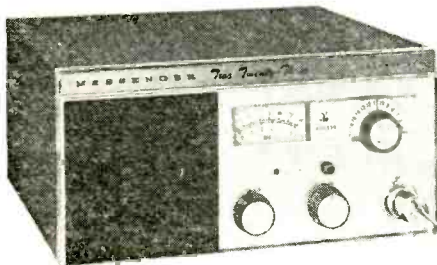

Manufacturer	Model	Type of Signal	No. of Transmit Channels	No. of Receive Channels	Tunable Receiver	Power Supply (Volts)	Receiver	Circuit	Notes	Price
Allied Radio Corp. 100 N. Western Ave. Chicago, Ill. 60680	A-2530	AM	10	10	yes	117 and 12	double superhet	solid-state	3,4,7,8,11,12	\$109.95
	A-2567	AM	23	23	yes	117 and 12	double superhet	tubes	1,2,3,7,8	\$179.95
	A-2569	AM	23	23	no	12	double superhet	solid-state	1,2,3,7,12	\$149.95
	Safari II Safari III	AM AM	5 23	5 23	no yes	12 12	superhet superhet	solid-state solid-state	10,11 7,10,11,23	\$ 69.95 (K) \$ 89.95 (K)
Amphenol Corporation 2875 S. 25th Ave. Broadview, Ill. 60153	675	AM	10	10	no	12	double superhet	solid-state	3,5,11	\$159.95
	725	AM	8	8	no	12	superhet	solid-state	10,11	\$109.95
	750	AM	6	6	no	12	superhet	solid-state	11	\$ 79.95
	777	AM	23	23	no	12	double superhet	solid-state	1,3,7,8,10,23	\$169.95
B & K, Dynascan Corp. 1801 W. Belle Plaine Chicago, Ill. 60613	Cobra V	AM	5	5	no	12	superhet	solid-state	2,11,23	\$ 99.95
	Cobra 23	AM	23	23	no	12	superhet	solid-state	1,2,7,8,23	\$169.95
	CAM 88	AM	23	23	yes	117 and 12	double superhet	tubes	1,2,3,7,8,12	\$214.95
Browning Labs., Inc. 1269 Union Ave. Laconia, N. H. 03246	Eagle	AM	23	23	yes	117	double superhet	tubes	2,4,7,8,9	\$395.00
	Eaglette	AM	23	23	no	12	double superhet	solid-state	1,2,3,7,12,23	\$209.50
Burstein-Applebee Co. 3199 Mercer St. Kansas City, Mo. 64111	BA23X	AM	23	23	yes	117 and 12	double superhet	tubes	4,7,8	\$119.95
Courier Communications, Inc. 439 Frelinghuysen Ave. Newark, N.J. 07114	Courier 12	AM	12	23	yes	117 and 12	superhet	tubes	3,4,7,8,11,12	\$110.00
	Courier 23	AM	23	23	yes	117 and 12	double superhet	tubes	1,3,7,8,12	\$169.00
	Courier 23 Plus	AM	23	23	yes	117 and 12	double superhet	tubes	1,3,7,8,9,12	\$189.00

Courier Classic	AM	23	23	yes	12	double superhet	solid-state	1,3,7,12,23	\$189.00
Courier Royale	AM	23	23	yes	117 and 12	double superhet	tubes	1,2,3,7,8,9,12,15	\$249.00
Courier TR5	AM	5	5	no	12	superhet	solid-state	5,10,11,12,22,23	\$ 99.00
Courier Traveller	AM	23	23	yes	12	superhet	solid-state	1,2,7,22,23	\$149.00

Demco Electronics
Bristol, Ind. 46507

Chalet	AM	6	6	no	12	superhet	solid-state	10,11,23	\$139.50
Ravelle	AM	6	6	yes	117 and 12	superhet	tubes	3,7,11,12	\$139.50
Ravelle 23	AM	23	23	yes	117 and 12	double superhet	tubes	1,3,7,12	\$249.50
Satellite	AM	23	23	yes	117	double superhet	tubes	1,2,7,8,9,10,13	\$450.00

EICO Electronic Instrument Co., Inc.
283 Malta St.
Brooklyn, N.Y. 11207

7923	AM	23	23	yes	12	superhet	solid-state	1,7,8,12,23	\$189.95
779A	AM	23	23	yes	117 and 12	double superhet	tubes	1,2,3,7,8	\$169.95

General Radiotelephone Co.
3501 W. Burbank Blvd.
Burbank, Calif. 91505

Super MC-8	AM	23	23	no	117 and 12	double superhet	tubes	1,2,3,6,7,8,12,15	\$199.50
Super MC-11	AM	23	23	no	117 and 12	double superhet	tubes	2,3,7,9,15,20	\$259.50
VS-6	AM	5	5	no	117 and 12	superhet	tubes	3,6,11,12,15	\$ 99.50

NOTES

- 1—Incorporates frequency synthesis circuit
- 2—Transmitter circuitry includes a system of speech clipping or modulation percentage boosting
- 3—Can be switched to "Public Address" from front panel
- 4—"Spotting" switch on front panel
- 5—Transmit crystal socket on front panel
- 6—Transceiver has socket connections to use manufacturer's selective calling system
- 7—Meter on front panel reads "S-units"
- 8—Meter on front panel reads approximate power output

- 9—Receiver features low-noise Nuvistor front end
- 10—This description fits basic unit—see manufacturer's catalog for numerous optional accessories
- 11—Transceiver requires 2 extra crystals per channel
- 12—Rear skirt provision for remote speaker (paging)
- 13—Transceiver features dual antenna (switched) connections
- 14—Transceiver has power switching to reduce transmitter input to 100 milliwatts
- 15—Receiver features front panel r.f. sensitivity switch or control

- 16—Transceiver may be tuned to either sideband for SSB mode of operation
- 17—Main body of transceiver is mounted in trunk and operated from driver's position by remote control
- 18—Walkie-talkie
- 19—Transceiver feeds received signal to car radio; no complete receiver in this package
- 20—Requires only 1 crystal per controlled channel (transmit/receive)
- 21—Doubles as wired intercom system
- 22—Receiver features i.f. noise blanking
- 23—A.C. power pack available

Manufacturer	Model	Type of Signal	No. of Transmit Channels	No. of Receive Channels	Tunable Receiver	Power Supply (Volts)	Receiver	Circuit	Notes	Price
Hallcrafters 5th & Kostner Ave. Chicago, Ill. 60624	CB-17	AM	6	6	no	117 and 12	superhet	tubes	10,11	\$ 99.95
	CB-20	AM	5	5	no	12	superhet	solid-state	10,11,23	\$ 99.95
	CB-21	AM	8	8	no	12	double superhet	solid-state	3,10,11,23	\$139.95
	CB-24	AM	23	23	yes	12	double superhet	solid-state	1,2,3,7,8,10,23	\$199.95
Hammarlund Mfg. Co. 73-88 Hammarlund Drive Mars Hill, N.C. 28754	HQ-205	AM	6	6	yes	117	superhet	tubes	4,5,7,11,15	\$259.95
Harmon Electronics, Inc. Grain Valley, Mo.	HCB-100	AM	6	6	no	12	superhet	solid-state	3,6,10,11,23	\$ 95.50
Heath Company Benton Harbor, Mich. 49023	GW-14	AM	23	23	yes	12	superhet	solid-state	7,8,10,11	\$ 76.95 (K) \$124.95 (W)
	GW-22A	AM	5	5	no	117	superhet	tubes	10	\$ 47.95 (K)
	GW-22D	AM	5	5	no	12	superhet	tubes	10	\$ 49.95 (K)
International Crystal Mfg. Co., Inc. 18 N. Lee Oklahoma City, Okla. 73102	MO-23	AM	23	23	yes	12	double superhet	hybrid	1,2,17	\$245.00
E. F. Johnson Company Waseca, Minn.	Messenger I	AM	5	5	no	117 and 12	superhet	tubes	6,10,11	\$114.95
	Messenger II	AM	10	10	yes	117 and 12	superhet	tubes	6,10,11	\$159.95
	Messenger III	AM	11	11	no	12	double superhet	solid-state	2,3,6,10,11,23	\$159.95
	Messenger 100	AM	6	6	no	12	superhet	solid-state	2,3,6,10,11,23	\$129.95
	Messenger 110	AM	5	5	no	12	superhet	solid-state	2,6,10,11,23	\$ 99.95
	Messenger 223	AM	23	23	yes	117	double superhet	solid-state	1,2,7,8,10,23	\$214.95
Messenger 300	AM	12	12	no	12	double superhet	solid-state	2,3,6,10,11,12,23	\$189.95	

Messenger 320 AM 23 23 12 superhet tubes 1,2,7,8,10 \$199.50
 Messenger 323 AM 23 23 12 double solid-state 1,2,3,6,7,8,10,12,23 \$229.95
 Messenger 350 SSB 4 4 12 superhet solid-state 3,6,10,11,12,16 \$229.95

Kaar Electronics Corp.
 1203 West St. Georges St.
 Linden, N.J. 07036

Skyark I AM 11 11 12 superhet solid-state 3,10,12,23 \$179.95
 Skyark II AM 23 23 12 superhet solid-state 3,10,12,23 \$229.95

Lafayette Radio Electronics Corp.
 111 Jericho Tnpk.
 Syosset, L.I., N.Y. 11791

Dyna-Com 5 AM 3 3 12 superhet solid-state 2,8,10,11,13,18 \$ 99.95
 Dyna-Com 6 AM 6 6 12 superhet solid-state 2,8,10,11,13,18 \$ 99.95
 HB-525C AM 23 23 12 double solid-state 1,2,3,6,7,10,12,23 \$149.95
 HB-625 AM 23 23 12 double solid-state 1,2,3,6,7,10,12,22,23 \$189.95
 Comstat-19 AM 9 9 117 superhet tubes 10,11,14 \$ 59.95
 Comstat-23 AM 23 23 117 double tubes 2,3,6,7,8,10 \$114.95
 Comstat-25A AM 23 23 117 and 12 double tubes 1,2,3,6,7,8 \$139.95
 HB-23 AM 23 23 12 superhet solid-state 1,6,7,10,12,20,23 \$ 99.95
 HB-600 AM 23 23 117 and 12 double solid-state 1,2,3,6,7,10,12,22 \$219.95
 HE-20T AM 12 12 117 and 12 superhet solid-state 3,6,7,8,11 \$ 89.95
 Telsat 23 AM 23 23 117 and 12 double superhet solid-state 1,2,3,6,7,8 \$159.95

NOTES

- 1—Incorporates frequency synthesis circuitry
- 2—Transmitter circuitry includes a system of speech clipping or modulation percentage boosting.
- 3—Can be switched to "Public Address" from front panel
- 4—Unit has a "Spotting" switch on front panel
- 5—Unit has a transmit crystal socket on front panel
- 6—Transceiver has socket connections to use manufacturer's selective calling system
- 7—Meter on front panel reads "S-units"
- 8—Meter on front panel reads approximate power output
- 9—Receiver features low-noise Nuovistor front end
- 10—This description fits basic unit—see manufacturer's catalog for numerous optional accessories
- 11—Transceiver requires 2 extra crystals per channel
- 12—Rear skirt provision for remote speaker (paging)
- 13—Transceiver features dual antenna (switched) connections
- 14—Transceiver has power switching to reduce transmitter input to 100 milliwatts
- 15—Receiver features front panel r.f. sensitivity switch or control
- 16—Transceiver may be tuned to either sideband for SSB mode of operation
- 17—Main body of transceiver is mounted in trunk and operated from driver's position by remote control
- 18—Walkie-talkie
- 19—Transceiver feeds received signal to car radio; no complete receiver in this package
- 20—Requires only 1 crystal per controlled channel (transmit/receive)
- 21—Doubles as wired intercom system
- 22—Receiver features i.f. noise blanking
- 23—A.C. power pack available

Manufacturer	Model	Type of Signal	No. of Transmit Channels	No. of Receive Channels	Tunable Receiver	Power Supply (Volts)	Receiver	Circuit	Notes	Price
Mark Products Co. 5439 West Fargo Ave. Skokie, Ill. 60076	Invader-23	AM	23	23	no	12	double superhet	solid-state	1,3,7,8,12	\$169.95
Midland International Corp. 1909 Vernon Street North Kansas City, Mo. 64116	13-150	AM	8	8	no	12	superhet	solid-state	8,23	\$ 89.95
	13-865	AM	23	23	no	12	double superhet	solid-state	1,2,3,7,8	\$119.95
	13-870	AM	23	23	no	12	double superhet	solid-state	1,2,3,7,8 12,23	\$149.95
	13-875	AM	23	23	no	117 and 12	double superhet	solid-state	1,2,3,7,8 12	\$169.95
Multi-Elmac Co. 21470 Coolidge Oak Park, Mich. 48237	Citi-Fone II	AM	2	2	yes	12	superhet	solid-state	19	\$ 49.95
	Citi-Fone 99	AM	8	8	no	117 and 12	superhet	tubes	7,8,11	\$ 99.95
	Citi-Fone SS	AM	23	23	yes	117 and 12	superhet	tubes	1,7,8	\$169.50
Olson Electronics, Inc. 260 S. Forge St. Akron, Ohio 44308	CB-8	AM	8	8	no	12	superhet	solid-state	11,23	\$ 59.99
	CB-12	AM	12	12	no	12	superhet	solid-state	3,11,23	\$ 99.99
	CB-88	AM	23	23	no	12	superhet	solid-state	1,2,3,7,12,22	\$149.98
Pace Communications Corp. 24049 S. Frampton Ave. Harbor City, Calif. 90710	Pace 100	AM	6	6	no	12	double superhet	solid-state	6,7,10,11	\$129.95
	Pace 200	AM	12	12	no	12	double superhet	solid-state	3,6,7,10,11,12	\$159.95

Pearce-Simpson, Inc.
 Box 800
 Biscayne Annex
 Miami, Fla. 33152

Pace "Plus 23"	AM	23	23	no	12	double superhet	solid-state	3,7,8,10,11	\$199.95
Pace 2300	AM	23	23	no	12	double superhet	solid-state	3,6,7,8,10,11,12	\$200.00
Pace-Mate	AM	3	3	no	12	double superhet	solid-state	6,10,18	\$ 99.95

Companion II	AM	5	5	yes	117 and 12	superhet	tubes	5,11,12	\$159.90
Companion IV	AM	10	10	no	12	superhet	solid-state	3,11,12,23	\$139.90
Director 23	AM	23	23	no	12	double superhet	solid-state	1,7,12,23	\$269.90
Guardian 23 (B)	AM	23	23	no	117 and 12	double superhet	tubes	1,7,8,9,12,15	\$269.90
Sentry II	AM	5	5	no	12	superhet	solid-state	11,12,23	\$99.90

J.C. Penny Co., Inc.
 1301 Avenue of the Americas
 New York, N.Y. 10019

Pinto 23	AM	23	23	no	12	double superhet	solid-state	1,3,7,8	\$129.00
----------	----	----	----	----	----	--------------------	-------------	---------	----------

Polytronics Communications
 Allied Research Associates
 Box 536
 Baltimore, Md. 21203

Poly-Beaver	AM	23	23	no	12	double superhet	solid-state	6,7,10,12,23	\$199.95
Poly-Pup	AM	7	7	no	12	superhet	solid-state	6,10,11,12,23	\$129.50
Poly-Otter	AM	7	7	no	12	superhet	solid-state	10,11,12,23	\$199.50
Poly-Comm 23	AM	23	23	yes	117 and 12	double superhet	tubes	1,3,6,7,8,9,10,12,14	\$329.50

NOTES

- 1—Incorporates frequency synthesis circuitry
- 2—Transmitter circuitry includes a system of speech clipping or modulation percentage boosting
- 3—Can be switched to "Public Address" from front panel
- 4—Unit has a "Spotting" switch on front panel
- 5—Unit has a transmit crystal socket on front panel
- 6—Transceiver has socket connections to use manufacturer's selective calling system
- 7—Meter on front panel reads "S-units"
- 8—Meter on front panel reads approximate power output
- 9—Receiver features low-noise Nuvistor front end
- 10—This description fits basic unit—see manufacturer's catalog for numerous optional accessories
- 11—Transceiver requires 2 extra crystals per channel
- 12—Rear skirt provision for remote speaker (paging) connections.
- 13—Transceiver features dual antenna (switched)
- 14—Transceiver has power switching to reduce transmitter input to 100 milliwatts
- 15—Receiver features front panel r.f. sensitivity switch or control
- 16—Transceiver may be tuned to either sideband for SSB mode of operation
- 17—Main body of transceiver is mounted in trunk and operated from driver's position by remote control
- 18—Walkie-talkie
- 19—Transceiver feeds received signal to car radio; no complete receiver in this package
- 20—Requires only 1 crystal per controlled channel (transmit/receive)
- 21—Doubles as wired intercom system
- 22—Receiver features i.f. noise blanking
- 23—A.C. power pack available

Manufacturer	Model	Type of Signal	No. of Transmit Channels	No. of Receive Channels	Tunable Receiver	Power Supply (Volts)	Receiver	Circuit	Notes	Price
Radio Shack Corp. 730 Commonwealth Ave. Boston, Mass. 02215	TRC-18	AM	12	12	no	12	double superhet	solid-state	3,7,8,20	\$ 99.95
	TRC-24	AM	23	23	no	12	double superhet	solid-state	1,3,7,8,12,23	\$139.95
Ray-Tel by Raytheon 213 E. Grand Ave. S. San Francisco, Calif. 94080	TWR-7	AM	5	5	no	12	superhet	solid-state	3,11	\$129.95
	TWR-9	AM	6	6	no	117	superhet	solid-state	11,21	\$ 99.95
	TWR-11T	AM	9	9	yes	12	superhet	solid-state	3,6,10,11,12	\$169.95
Regency Electronics, Inc. 7900 Pendleton Pike Indianapolis, Ind. 46226	Charger	AM	12	12	no	12	superhet	solid-state	3,11,12	\$110.00
	Imperial	DSB	23	46	yes	117 and 12	double superhet	tubes	7,8,12,16	\$329.95
	Pacer II	AM	11	23	yes	117 and 12	superhet	tubes	2,4,5,7	\$110.00
	Range Gain II	DSB	23	23	yes	117 and 12	double superhet	tubes	1,7,8	\$269.95
Sears, Roebuck and Company 3245 W. Arthington Chicago, Ill. 60607	Model 6556	AM	5	5	no	12	superhet	solid-state	2,10,11,23	\$ 99.95
	Model 6558	AM	12	12	no	12	double superhet	solid-state	2,6,10,11,23	\$134.95
	Model 6562	AM	23	23	yes	12	double superhet	solid-state	1,2,3,6,7,8,10,12,23	\$199.95

Sonar Radio Corp.
73 Wortman Ave.
Brooklyn, N.Y. 11207

Model E	8	8	yes	117 and 12	superhet	tubes	6,10,11,12	\$179.50
Model FS-23	23	23	yes	117 and 12	double superhet	tubes	1,6,7,8,9,10,11,12	\$239.95
Model G	8	8	yes	117 and 12	double superhet	tubes	4,6,7,8,10,11,12	\$229.50
Model H	8	8	no	117 and 12	superhet	tubes	6,10,11,12	\$159.95
Model J-23	23	23	no	12	double superhet	solid-state	1,3,6,10,12,23	\$239.95

Squires-Sanders, Inc.
Martinsville Rd.
Millington, N.J. 07946

Admiral	23	23	no	117	double superhet	solid-state	1,2,3,7,12,13,15,22	\$329.95
Commodore	23	23	no	12	double superhet	solid-state	1,12,22,23	\$199.95
Skipper	23	23	no	12	double superhet	solid-state	1,2,3,7,12,15,22	\$159.95

Tram Electronics, Inc.
Lower Bsy Rd.
Box 187
Winnisquam, N.H. 03289

Titan II	23	46	yes	117	double superhet	tubes	2,7,8,12,15,16	\$482.00
----------	----	----	-----	-----	-----------------	-------	----------------	----------

NOTES

- 1—Incorporates frequency synthesis circuitry
- 2—Transmitter circuitry includes a system of speech clipping or modulation percentage boosting
- 3—Can be switched to "Public Address" from front panel
- 4—Unit has a "Spotting" switch on front panel
- 5—Unit has a transmit crystal socket on front panel
- 6—Transceiver has socket connections to use manufacturer's selective calling system
- 7—Meter on front panel reads "\$-units"
- 8—Meter on front panel reads approximate power output
- 9—Receiver features low-noise Nuvistor front end
- 10—This description fits basic unit—see manufacturer's catalog for numerous optional accessories
- 11—Transceiver requires 2 extra crystals per channel
- 12—Rear skirt provision for remote speaker (paging)
- 13—Transceiver features dual antenna (switched) connections.
- 14—Transceiver has power switching to reduce transmitter input to 100 milliwatts
- 15—Receiver features front panel r.f. sensitivity switch or control
- 16—Transceiver may be tuned to either sideband for SSB mode of operation
- 17—Main body of transceiver is mounted in trunk and operated from driver's position by remote control
- 18—Walkie-talkie
- 19—Transceiver feeds received signal to car radio; no complete receiver in this package
- 20—Requires only 1 crystal per controlled channel (transmit/receive)
- 21—Doubles as wired intercom system
- 22—Receiver features i.f. noise blanking
- 23—A.C. power pack available

CB EQUIPMENT CATALOG

(Continued from page 41)

loss in stability or deviation above or below the true carrier frequency.

No. of Xtal Receive Channels: A majority of CB transceivers incorporate some crystal-controlled receiving channels—although alternative “spotting” methods are just as satisfactory. Transceivers with frequency synthesis automatically provide the identical number of transmitting and receiving channels—all crystal-controlled. If the numeral in this column is followed by a “plus” sign and the “Notes” column contains the figure “5,” the transceiver has an additional transmitting crystal socket on the front panel.

Tunable Receiver: A means of keeping the cost of a CB transceiver down while adding convenience is to make the receiver tunable (rather than crystal-controlled) with a modest number of crystal-controlled transmitting channels. This arrangement permits cross-channel operation when the base and mobile are transmitting and receiving on different channels. In this column in the Table on the following pages, all frequency synthesis transceivers are considered to be *not* tunable, although strictly speaking the circuit will permit reception on any one of the 23 CB channels. Bandsread tuning of a receiver with this circuitry is limited and is generally crystal-controlled—meaning that the i.f. channel can be tuned 2.5 kHz above or 2.5 kHz below the nominal channel frequency. In some transceivers such tuning has been given the name “Delta.” Unless otherwise indicated, the reader may assume that some sort of “bandsread” tuning has been included in the frequency-synthesis circuit.

Power Supply: In this Table the household a.c. line voltage has been “standardized” at 117 volts. Various manufacturers use 110, 115, or 117 volts in their literature, but we have stuck with the latter since it is closer to the true

line voltage throughout most of North America. Many transceivers use circuits that will permit operation from 12-volt automobile batteries, and a few can be powered from 6-volt batteries. In the Table, the expression “and” means that the transceiver contains some sort of universal power supply permitting operation from any of the input voltages shown. The expression “or” means that the transceiver contains one power supply and that the supply itself can be changed to switch from base station (117 volts) to mobile (12 or 6 volts).

Receiver: There are only two types of receiver circuits now appearing in CB transceivers. They are related and are either straight superheterodynes, or double (sometimes called “dual”) conversion superhets. The latter is generally more selective and able to cope with interference from adjacent channels or other CB’ers with transceivers operating within one-quarter to one-half mile away. Attention should be paid to the possibility that a simple superhet circuit may include a crystal or mechanical filter to provide selectivity comparable to that of a double superhet.

Circuit: Transceivers can use all “Tubes” or some tubes and some transistors—“Hybrid.” A unit with transistors and diodes only is called “Solid-State.”

Notes: A detailed breakdown of the coding numerals for this column appears at the foot of each odd-numbered page. These numerals refer to specialized features that are not common to all CB transceivers.

Price: No attempt has been made to differentiate between so-called “list” prices and the usual CB’er “net” prices in the Table. Many manufacturers supplied list prices for inclusion in this Buyer’s Guide, leaving the discounting of price to the individual dealer and purchaser. Readers are urged to shop around and compare prices after selecting transceivers that best suit their individual requirements. The letter K identifies the transceiver as being a kit. If the price is immediately followed by a second price, assume that the second price is that of a comparable wired unit.

—30—



BUILD THE AUTOMOBILE

OMNI- ALARM

IF AN ENGINE TELLTALE
LIGHT COMES ON,
THIS ALARM WILL NOT
LET YOU IGNORE IT

BY JOHN S. SIMONTON, JR.

THE MAJOR PROBLEM with automobile warning lights (commonly called "idiot lights") is that you seldom look at them because they are almost always dark, or they are so dim that you can't see them in daylight. If one should turn on some sunny day while you are concentrating on the road ahead, it may not be long before the car comes to a stop with smoke pouring from its innards.

It was to rectify this problem that the "Omni-Alarm" was created. As a bonus, the alarm not only urgently calls a driver's attention to a trouble warning signal with its insistent acoustical beeping, but also alerts the driver to the fact that he may have shut off the ignition but failed to turn off his parking (or head)lights.

Although the "Omni-Alarm" was designed for a 12-volt negative-ground system, satisfactory results can be obtained with a 6-volt negative-ground system *without* circuit modification. If you want to use the alarm in a positive-ground vehicle, it can be very easily modified—no extra parts are needed.

Construction. The circuitry for the "Omni-Alarm" (Fig. 1) can be assembled

using any available construction technique. However, because mobile equipment is subject to vibration and jolting, a printed circuit board is recommended. An actual-size PC board appears in Fig. 2, which also shows how the various components are installed on the board for a negative-ground vehicle.

When installing the components, pay particular attention to the polarity of *C1*, *Q1*, and the six diodes. Also, because the "Omni-Alarm" is susceptible to variations in load, it is recommended that a speaker no larger than 2½" to 3" be employed.

For a positive-ground vehicle, diodes *D1* through *D6* must be reversed, and *Q1* should be a 2N107.

The author mounted his alarm in a 2¾" x 3½" x 1½" metal box with the speaker pop-riveted on one wall. A commercial multi-contact jack makes the various electrical contacts (see photo at top of this page).

To test the circuit, apply the positive terminal of a 12-volt battery to pin 5 or 6 (see Fig. 1) and the negative terminal to each of pins 1 through 4. Do not perform this test with the speaker opening

Fig. 1. Basic Omni-Alarm circuit is a "squegging" oscillator turned on by applying correct direct current.

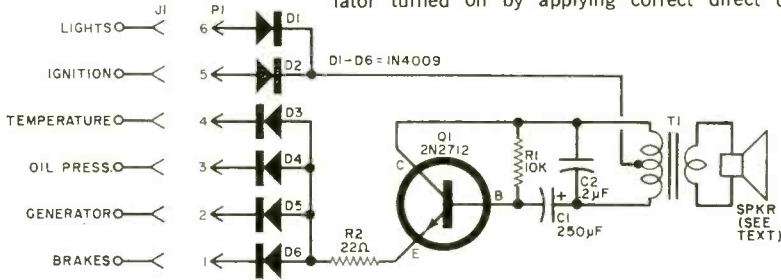

PARTS LIST

C1—250- μ F, 6-volt electrolytic capacitor

C2—0.2- μ F capacitor

D1, D2, D3, D4, D5, D6—1N4009 diode

J1—Optional multi-contact plug to suit *P1*
(Cinch-Jones P308-AB or similar)

P1—Optional multi-contact socket (Cinch-Jones
S308-CCT or similar)

Q1—2N2712 transistor—see text

R1—10,000-ohm, $\frac{1}{2}$ -watt resistor

R2—22-ohm, $\frac{1}{2}$ -watt resistor

SPKR—2 $\frac{1}{2}$ " , 8-ohm speaker—see text

T1—Transistor output transformer: primary, 500
ohms CT; secondary, 8 ohms (Midland 25-634
or similar)

Note: An etched and drilled PC board is avail-
able from PAIA Electronics, Inc., P.O. Box
14359, Oklahoma City, Okla. 73114, for \$3.00.

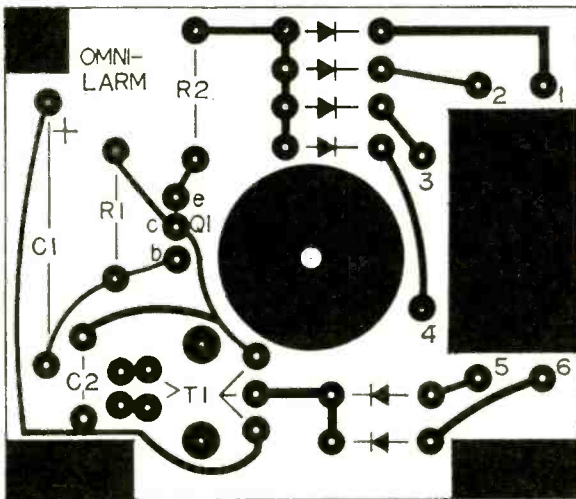

Fig. 2. Actual-size printed circuit board layout. This view also shows how the components are arranged on the non-foil surface. Note in the photo of the completed project on the preceding page that there must be a rectangular hole cut in the side of the metal cabinet to reduce speaker loading.

HOW IT WORKS

The "Omni-Alarm" circuit is a modified Hartley oscillator designed to turn itself on and off every half second or so. This switching action is a result of using a large value capacitor for *C1*. When the oscillator is activated, positive feedback via *T1* produces oscillation.

During the positive half cycle of each period, the base-to-emitter junction of *Q1* is forward-biased, with the result that capacitor *C1* causes the base of *Q1* to go negative with respect to the transformer side of the capacitor. During a portion of the negative half cycle, the base-emitter junction of *Q1* becomes reverse-biased, and the only discharge path for *C1* is through *R1* and the primary of *T1*. Because of the large time

constant involved, there is still some residual charge left at the beginning of the next positive half cycle. (If *C1* had a small value, all of the charge accumulated during the positive half cycle would leak off.)

After each complete cycle, the total accumulated charge is slightly greater than that of the preceding cycle. Eventually, the point is reached at which the potential difference caused by the charge on *C1* is great enough to drive *Q1* completely to cutoff and cause oscillation to stop. With the transistor base-emitter junction reverse-biased, *C1* discharges through *R1* and *T1*. After a short time, *C1* discharges to a point where *Q1* can once again begin to oscillate.

flush against a flat surface; stand the box on one of its sides.

If the unit does not work, check the diodes for opens and polarity, and also check the transistor. If the alarm creates a tone, but does not turn itself on and off at about half-second intervals, check the values of capacitor *C1* and resistor *R1*; you may have to adjust the value of *R1*.

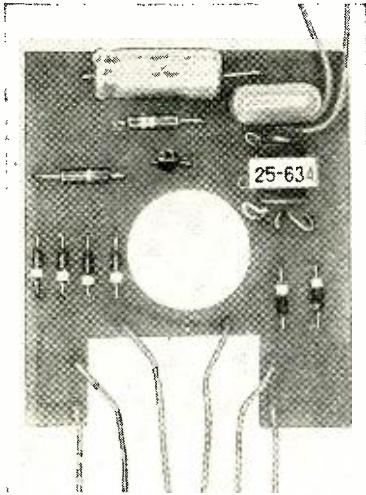

Top view of the finished PC board shows the neat appearance possible. The speaker magnet protrudes through the round hole in the center of the board, while the cutout at the bottom fits around the connector socket.

Installation. The wiring of the warning lights in most American cars is illustrated in Fig. 3. When the ignition switch is closed, it connects one side of the warning lights to the positive side of the battery. The other side of each warning light goes to the "senders" at the points being monitored. The "senders" are simple on-off switches that complete the circuit to the car ground in the event of a fault.

Operation of the "Omni-Alarm" depends upon the interaction of the ignition switch, headlight switch, and the various senders. When the car is not in use, both the ignition switch and the headlight switch should be off. Because the "Omni-Alarm" is not connected directly to the battery, it cannot turn on.

When the ignition is first turned on, the circuit to the positive side of the battery (via pin 5) is completed; and because the engine is not yet running, the various senders are closed. In this
(Continued on page 105)

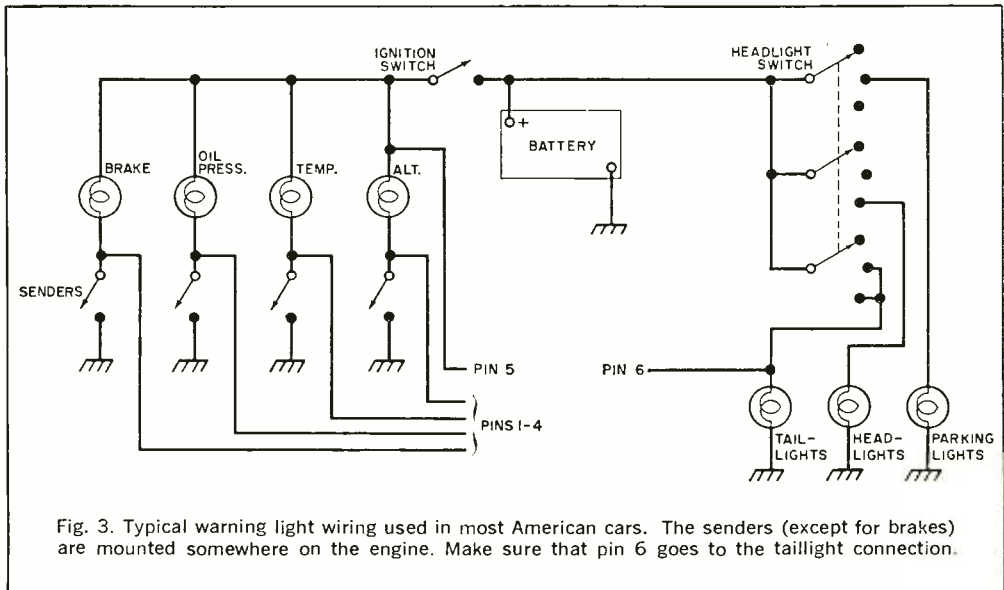

Fig. 3. Typical warning light wiring used in most American cars. The senders (except for brakes) are mounted somewhere on the engine. Make sure that pin 6 goes to the taillight connection.

How's Your TV Q?

DO YOU REALLY KNOW THE SCORE
OR ARE YOU JUST ANOTHER "FIXIT"?

BY VIC BELL

(Answers on page 110)

- 1 The plate of the horizontal output tube may glow red if the high-voltage rectifier is shorted. TRUE _____ FALSE _____
- 2 A shorted tube in the tuner may cause sync troubles in an otherwise normal set. TRUE _____ FALSE _____
- 3 A picture tube malfunction will never cause sync troubles. TRUE _____ FALSE _____
- 4 VDR stands for Variable Damped Resistor. TRUE _____ FALSE _____
- 5 SWR means Sync Width Recovery. TRUE _____ FALSE _____
- 6 The numerals at the beginning of a picture tube number signify picture tube filament voltage. TRUE _____ FALSE _____
- 7 A tuning gang is sometimes called a Varicap. TRUE _____ FALSE _____
- 8 The three phosphors used in color picture tubes are red, green, and violet. TRUE _____ FALSE _____
- 9 Installing a cold horizontal oscillator tube in a warmed-up TV receiver may cause trouble. TRUE _____ FALSE _____
- 10 A noise gate in a TV set is used to reduce man-made picture interference. TRUE _____ FALSE _____
- 11 If a filament in the R-Y amplifier of a color TV receiver opens, the black-and-white picture will not be affected. TRUE _____ FALSE _____
- 12 A sync signal is not needed for the color TV signal because it is crystal-controlled in the set. TRUE _____ FALSE _____
- 13 The first integrated circuits used in commercial TV receivers were video amplifiers. TRUE _____ FALSE _____
- 14 Transistors have no heaters and give off no heat when operating normally. TRUE _____ FALSE _____
- 15 A color circuit breakthrough in 1962 made color TV receivers with quality pictures available at a reasonable consumer price the following year. TRUE _____ FALSE _____
- 16 A water-damaged TV receiver can be dried out quickly with carbon tetrachloride. TRUE _____ FALSE _____
- 17 Remote control of UHF channel selection is impractical because the selector is usually continuously variable. TRUE _____ FALSE _____
- 18 Ignoring line losses, if a TV antenna receives a 50-microvolt signal when mounted on a 50-foot tower, it will receive a 100-microvolt signal if raised to 100 feet. TRUE _____ FALSE _____
- 19 All TV picture tubes must have safety glass mounted on their faces or be mounted in a cabinet with a safety glass in front of the picture tube. TRUE _____ FALSE _____
- 20 Pincushion magnets are sometimes used on wide-angle deflection color CRT's. TRUE _____ FALSE _____



BUILD 117-Volt PLM

BY F. FORMAN
AND
E. NAWRACAJ

Power Line Monitor uses expanded scale for a.c. house voltage read-out

WHEN YOUR a.c. line power is used to supply critically balanced test equipment, some erroneous results can be blamed on variations in the line voltage. While most of us rely on the power company to keep the voltage at a nominal 117 volts, it should be monitored because variations of -15 volts and $+10$ volts are not uncommon.

To check the voltage, it is always possible to use a standard VOM, but trying to read 117 volts on a cramped multi-scale meter is often difficult. A solution is to build a 117-volt PLM, the expanded scale voltmeter that indicates only between 90 and 130 volts, eliminating interpolation between the fine divisions on a VOM meter scale. All you need to make this device is a 0-1 milliammeter and a few spare parts.

The schematic for the voltmeter is shown in Fig. 1. Basically, it consists of a half-wave rectifier with filter ($D1$ and $C1$) and a bridge circuit with the milliammeter in the middle of the bridge. One leg of the bridge is a zener diode, $D2$, which maintains a constant voltage drop of 33 volts. Potentiometer $R4$ in a second leg is adjusted so that with a 90-volt line input, the drop across $R4$ is just 33 volts to match the drop across the zener diode. In this case there is no flow through the meter.

When the line voltage goes up, the drop across $R4$ increases while the drop across $D2$ stays constant. Thus, current flows through the meter and it indicates a voltage higher than 90 volts. Potentiometer $R5$ is adjusted to limit the maximum (130-volt) reading on the meter. Diode

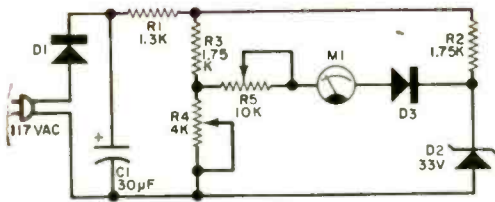
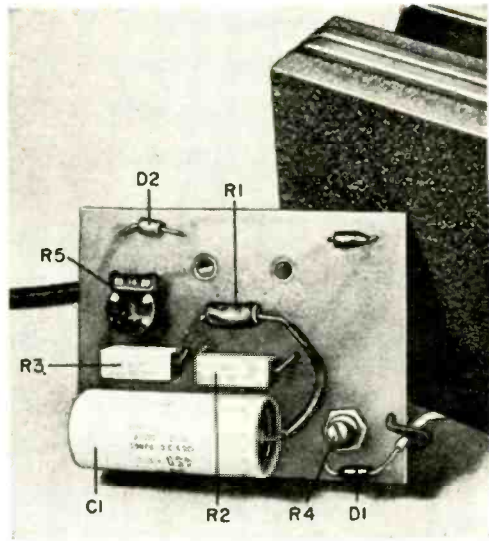

Fig. 1. The circuit is a voltage-sensitive bridge with one leg a zener diode stable reference source.

PARTS LIST

- C1*—30- μ F, 200-volt electrolytic capacitor
D1, D3—Silicon rectifier diode, 1-ampere, 200-volts PIV
D2—Zener diode, 33-volts, 1-watt
M1—0-1 mA meter
R1—1300-ohm, 5-watt resistor
R2, R3—1750-ohm, 5-watt resistor
R4—4000-ohm, 5-watt potentiometer
R5—10,000-ohm, $\frac{1}{4}$ -watt potentiometer (printed circuit type)
Misc.—Meter housing, line cord, new meter scale (see text), miscellaneous hardware.

The printed board is available etched and drilled for \$2.00 from Edward Nawracaj, 3914 West 47th St., Chicago, Illinois



Every component is mounted on PC board and then the board is attached to the meter by the meter lugs.

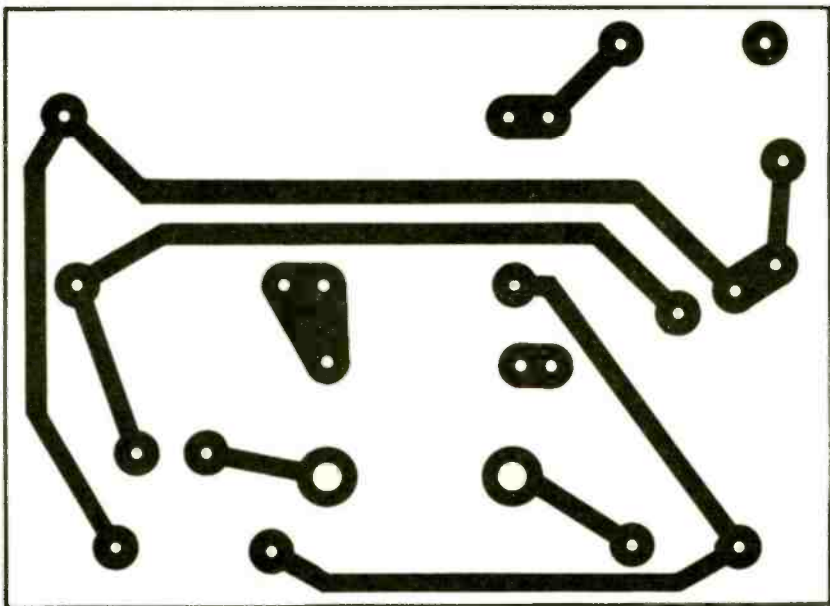

Fig. 2. Full-size drawing of the PC board designed by the authors. Component arrangement can be seen in the photo above and in Fig. 3. The diameter of the large holes should be adjusted to suit the milliammeter lugs used in your project. Some meter lugs are this diameter, but others are somewhat larger.

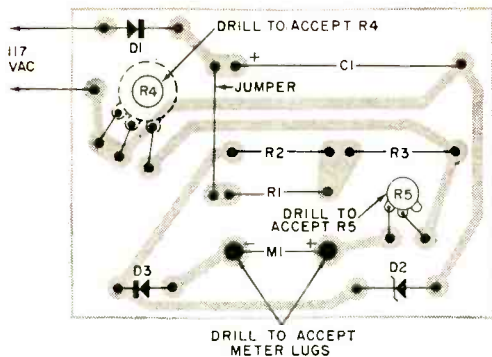
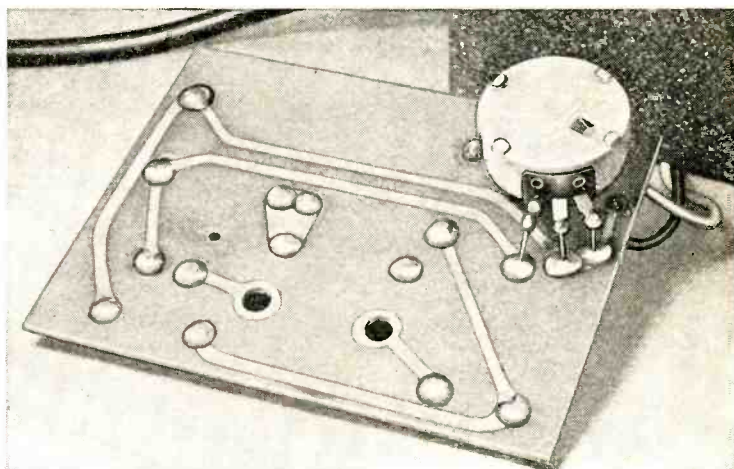

Fig. 3. Component installation on the PC board. A wire jumper connects R1 and the positive side of capacitor C1. This jumper is visible in the photo on the facing page. Alter the diameter of the holes for the meter lugs and potentiometers to fit snug.

Method of mounting potentiometer R4 is seen in this photo. Two shaft nuts enable the potentiometer to stand away from the foil side of the board. Short lengths of bare wire connect the potentiometer lugs to PC board copper foil.



D3 prevents a reverse flow through the meter.

Construction. The complete 117-v PLM circuit is assembled on a printed circuit board, shown full size in Fig. 2. After the board has been fabricated and drilled, mount the components as shown in Fig. 3. The next step is to alter the meter face.

Gently remove the meter scale and either repaint it or make up a new one. Divide the scale into four equal segments marked 90 (old zero on the meter), 100, 110 (center), 120, and 130 (full scale). If desired, the major segments can be marked off into 10 equally spaced minor segments to indicate one volt increments. Mark the 117-volt reading in red.

After the meter is reassembled and the circuit has been calibrated, the printed circuit board can be mounted and supported by the meter lugs.

Calibration. Make a temporary connection between the meter lugs and the appropriate terminals on the PC board. To calibrate the device, you will need a Variac and an accurate a.c. voltmeter covering the range between 90 and 130 volts.

Set the Variac to exactly 100 volts and gradually adjust potentiometer R4 until the meter indicates 100 volts. Increase the Variac input to 130 volts and adjust R5 until the meter reads 130. Repeat the process until the meter reads exactly the same as the Variac over the entire range between 90 and 130 volts.

After calibration, cement the potentiometer shafts in place to prevent them from being accidentally disturbed. Remove the Variac source from the input and remove the temporary wiring on M1. Secure the PC board to the meter lugs using the nuts provided with the meter.

TOUGHENING BASE WITH CB ANTENNAS

WAYS AND MEANS OF GETTING
BETTER PERFORMANCE AT
YOUR BASE STATION

BY FOREST H. BELT

THE USEFULNESS of any wireless communication system depends on how well radio energy gets from the transmitter to the antenna and into the atmosphere (or ionosphere). Sometimes a communications system must use very high power, sometimes the frequency is changed hourly, and sometimes the only answer is an extremely sensitive receiver. In the Citizens Radio Service, limited as it is in both frequency, power, and receiver sensitivity, there is only one factor the user can improve or alter—the antenna.

The greatest area for improvement in CB communications is the high-gain base-station antenna. Souped-up receivers are near their ultimate in sensitivity and FCC Rules directly limit the power output of transmitters. But nothing in the Rules says you can't increase your effective radiated power (ERP), or capture more signal for your receiver, by using an efficient base station antenna.

Road to Power. CB is no baby; it's been around for ten years. Inevitably there have been equipment improvements, but only lately has considerable effort gone into getting more power "into (and out of) the air." The results are startling. You now read advertisements that boast (legitimately): "30 watts of talk-power." The gimmick is in the antenna.

Some CB base antennas build up signal power by beaming the radiated energy. Directors and reflectors in front and behind the active element concentrate the power of the transmitted signal in one direction. This method is useful if the stations you talk to are in one direction; but, if you communicate with mobile stations, excessive directionality can be a hindrance.

Other CB antennas achieve efficiency without giving up the advantage of being omnidirectional. Special radiating elements, plus unusual skirts, ground planes, or other parasitic elements, contribute to increasing your ERP. If you still use the old-fashioned $\frac{1}{4}$ -wave ground-plane CB antenna, you are in for a surprise.

The sought-after quality in any antenna is power buildup—called *gain*. And, the antenna that transmits efficiently also receives just as efficiently. The term *power gain* compares the effectiveness of one antenna with some reference.

For CB antennas, two references are common. Vertical antennas are rated with reference to a $\frac{1}{4}$ -wave ground-plane antenna. Beams and most other configurations are referred to an *isotropic* source (a *point* in free space, from which r.f. is assumed to emanate). Antenna gain is usually called out as so many decibels (dB) over zero decibels (0 dB)—with 0 dB being the amount of power the reference source would radiate.

To understand what X number of decibels of gain can accomplish, consider an example—but non-existent—beam antenna. This antenna is claimed to have 12.5 dB of gain. That's equivalent to a power multiplication of 17 (see Table 1). In other words, this antenna can radiate a signal 17 times as powerful as a reference antenna, fed the same r.f. power.

Stated the way some CB antenna advertisements print gain ratings, it could be assumed that an ordinary CB transmitter feeding this antenna will produce a radiated signal just as powerful as a

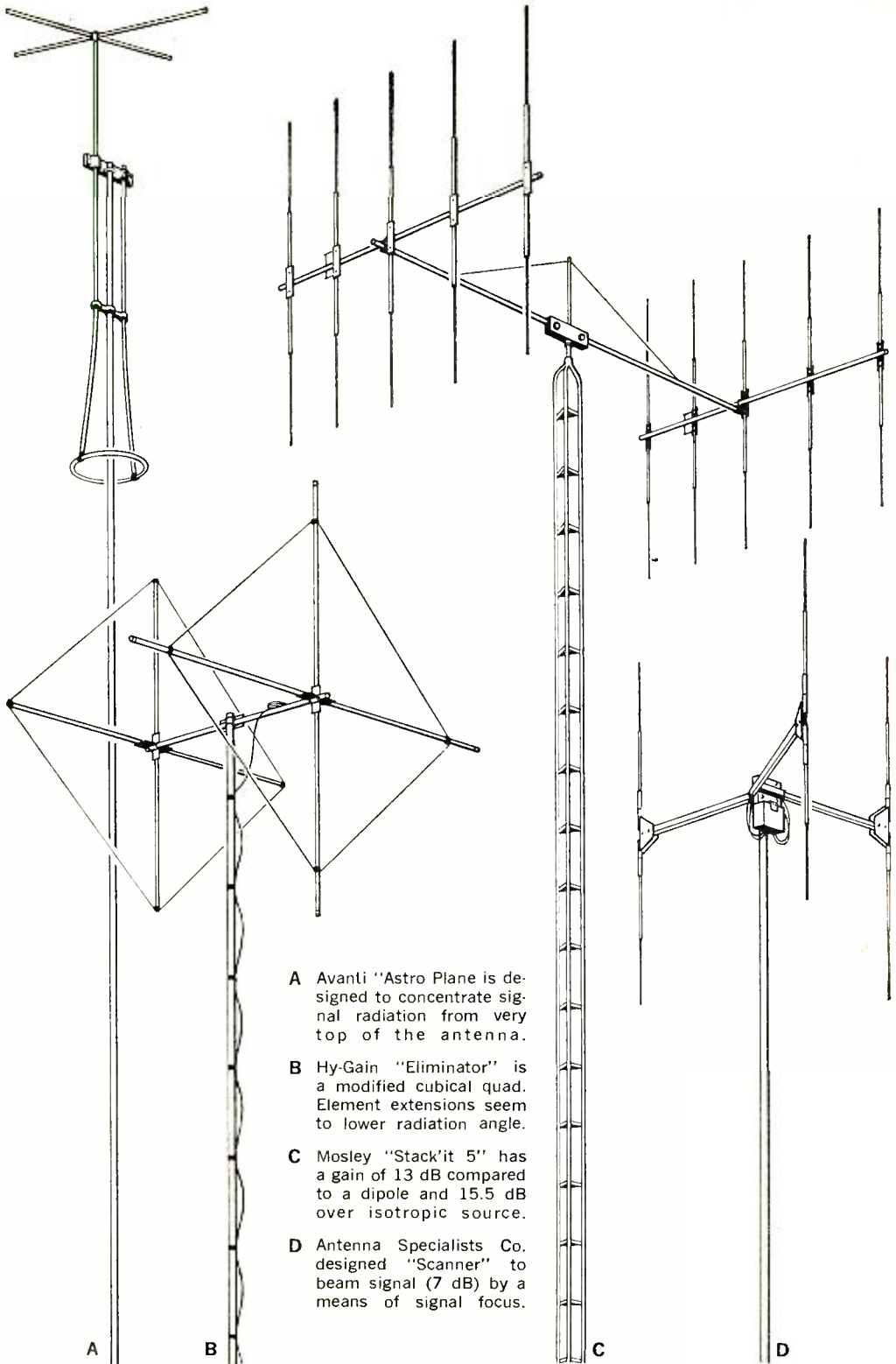

A Avanti "Astro Plane" is designed to concentrate signal radiation from very top of the antenna.

B Hy-Gain "Eliminator" is a modified cubical quad. Element extensions seem to lower radiation angle.

C Mosley "Stack'it 5" has a gain of 13 dB compared to a dipole and 15.5 dB over isotropic source.

D Antenna Specialists Co. designed "Scanner" to beam signal (7 dB) by a means of signal focus.

A

B

C

D

transmitter with 17 times that much power. The manufacturer's specs for our example antenna might imply it could produce "effective power" of 85 watts—17 times the CB transceiver input power.

Unfortunately, this is not true since the r.f. power actually being radiated by the antenna is *not* the 5 watts input of the transceiver, but the actual power output

Table 1 Antenna Ratings vs ERP

dB Gain	Power Multiplier	Typical* CB ERP (watts)	Equivalent Power** (watts)
0	1.0	3.0	5.0
1	1.2	3.6	6.0
2	1.6	4.8	8.0
3	1.9	5.7	9.5
4	2.5	7.5	12.5
5	3.1	9.3	15.5
6	3.9	11.7	19.5
7	5.0	15.0	25.0
8	6.3	18.9	31.5
9	7.9	23.7	39.5
10	10.0	30.0	50.0
11	12.6	37.8	63.0
12	15.8	47.4	79.0
13	19.9	59.7	99.5
14	25.1	75.3	125.5
15	31.6	94.8	158.0
16	39.8	119.4	199.0

*Based on 3.5 watts r.f. output at transmitter and considering normal lead-line and radiation losses.

**Transmitter d.c. power needed to produce equivalent signal from reference radiator. This is the power rating used by many CB antenna manufacturers.

—which according to FCC Rules should not be more than 4.0 watts—with 3.0-3.5 watts being closer to the fact of the matter. Thus, the antenna with a gain of 17 doesn't really radiate 85 watts, but something closer to 55-60 watts.

Either method of expressing gain—actual power multiplier or dB—is perfectly acceptable, but the buyer should understand that he needs to know the reference point for comparison purposes and what you're really talking about is ERP.

Besides Power. When you buy a CB base-station antenna, it's natural that gain is your main concern. But there are other things to think about, too. Probably the most important (besides price) are size and weight. The antenna must

be supported and if you select a beam, you'll need a way to rotate it, unless all communication is to be in one direction.

One CB beam antenna has two booms 20 feet long and the cross-boom between the two arrays is 24 feet long! The vertical elements themselves are almost 19 feet tall from tip to tip. That's a lot of antenna, and it needs lots of room to swing. The whole antenna weighs over 60 lb and the wind loading is in the hundreds of pounds so it requires a sturdy installation. A cheap antenna rotor may have trouble handling such a gigantic array.

If you don't have room for a giant antenna, or don't want to spend so much for the installation, you can get a smaller beam—or try a fixed beam that doesn't require turning. You must balance antenna size and weight against your need for a more powerful signal.

Most CB base antennas are rated to withstand winds to about 75 mph. In windy country, you may need a wind-load rating over 100 mph. If you live where snow is a big factor, the rating should be even higher; ice makes the wind load even worse.

Unusual Shapes and Sizes. The search for greater gain in smaller and lighter designs has produced some strange looking antennas. There are $\frac{5}{8}$ -wavelength collinears that resemble the familiar ground-plane, except that they're taller and often have oddly shaped ground planes (that aren't really ground planes at all). There are special multidirectional types that act like beams but need no rotor. Lately, a batch of cubical quad-type antennas has appeared—an odd-looking group if you aren't acquainted with quads.

One of the most unorthodox looking is the Avanti *Astro Plane*. It is short (12 feet tall) and lightweight (3½ lb), with a wind-load rating of 120 mph. Look at the drawing to visualize its unique structure and to understand its operation.

The feed-line to the *Astro Plane* connects near the top of the double section. Insulation keeps this end of the driven element separated from the support mast. The driven element resembles a conically-flared folded-monopole, mounted upside down with the feed point at the top. The element starts at the feed point,

extends down past a support insulator to the loading ring at the bottom. The ring keeps the lower end of this odd monopole isolated from the grounded support mast both mechanically and electrically. The monopole continues upward from the other side of the ring, past the support insulator to the main support hub. There it's grounded to the mast.

The top portion is a short monopole, loaded to a $\frac{1}{4}$ -wavelength at 27 MHz by the 2-foot top-hat. The strongest radiation points on the *Astro Plane*, the points where maximum r.f. current develops, are just below the feed point and above and below the ground point at the support hub. The parasitic top element helps to keep the radiation angle low.

Power gain compares with that of a $\frac{5}{8}$ -wavelength collinear CB antenna, which we will discuss later. The *Astro Plane* is rated for 4 dB gain, referred to a $\frac{1}{4}$ -wave ground-plane antenna.

Multiple Polarity. The cubical quad is a design that has been around for years, but was only recently adapted for CB. Each element of a quad antenna is shaped like a big square, standing upright on one corner. With two elements—the driven element and a reflector—its outline resembles a cube.

The quad is very directional, concentrating a beam forward from the driven element (in the direction the mounting boom points). Quads seem to have the beam-forming quality of the so-called beam antennas, and offer just about as much gain as some 3- or 4-element parasitic beams. Although a quad can be large, it's surprisingly lightweight, due mainly to its simplicity. One popular quad weighs only 15 lb, and needs a turn-

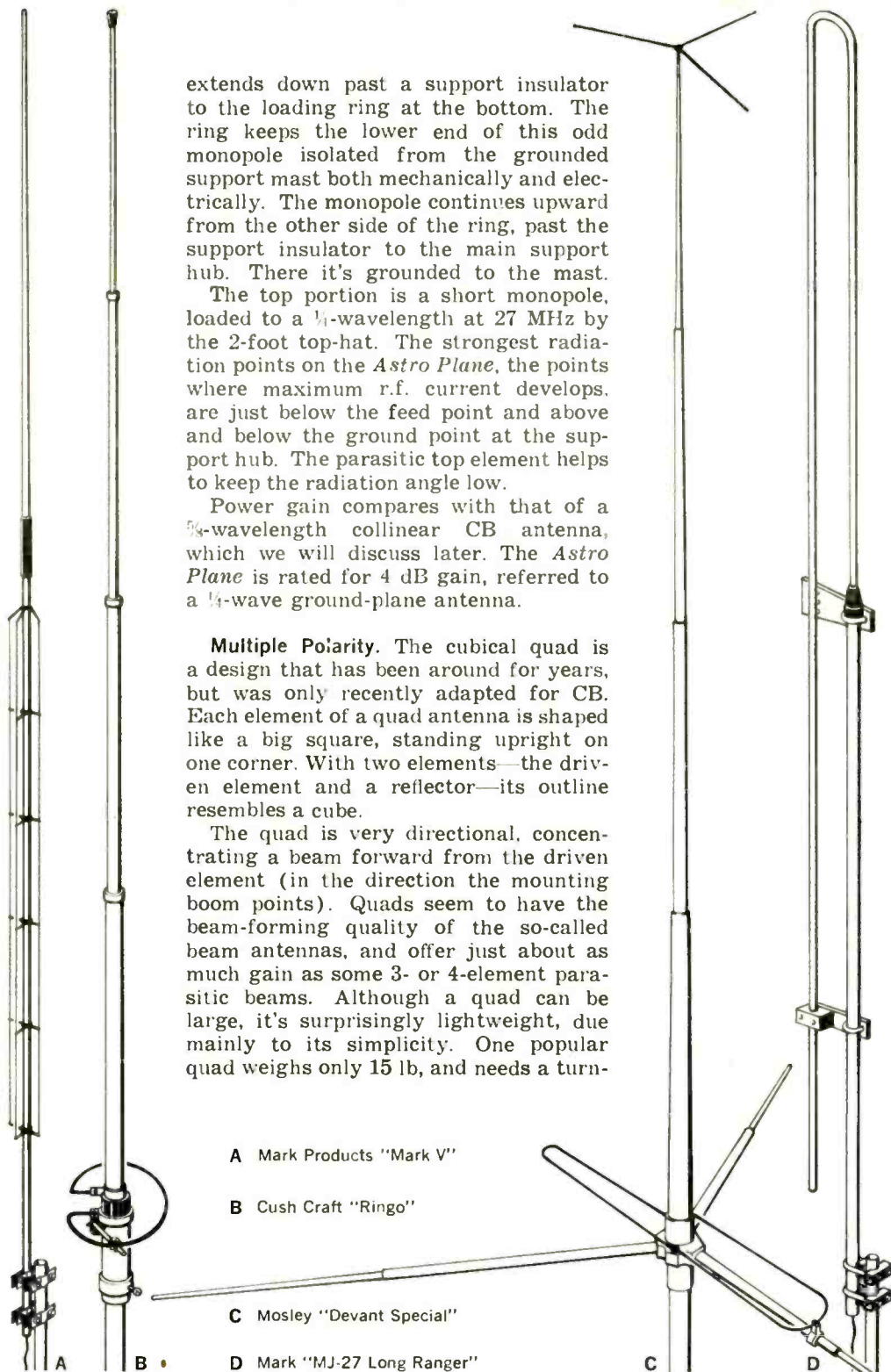

A Mark Products "Mark V"

B Cush Craft "Ringo"

C Mosley "Devant Special"

D Mark "MJ-27 Long Ranger"

Confused by all the ads for home training in electronics?

find out what it's really all about from the leader...

With RCA Institutes Home Training Programs you get:

- As many as 24 valuable kits at no extra cost.
- The AUTOTEXT programmed method of learning electronics faster, easier, almost automatically.
- A unique easy-pay Tuition Plan.

CLASSROOM TRAINING ALSO AVAILABLE. For special catalog and full information, simply check the appropriate box on the attached card.

All courses approved under the new G.I. Bill.
Accredited Member National Home Study Council.

RCA INSTITUTES,
320 West 31st Street, New York, N. Y. 10001

RCA

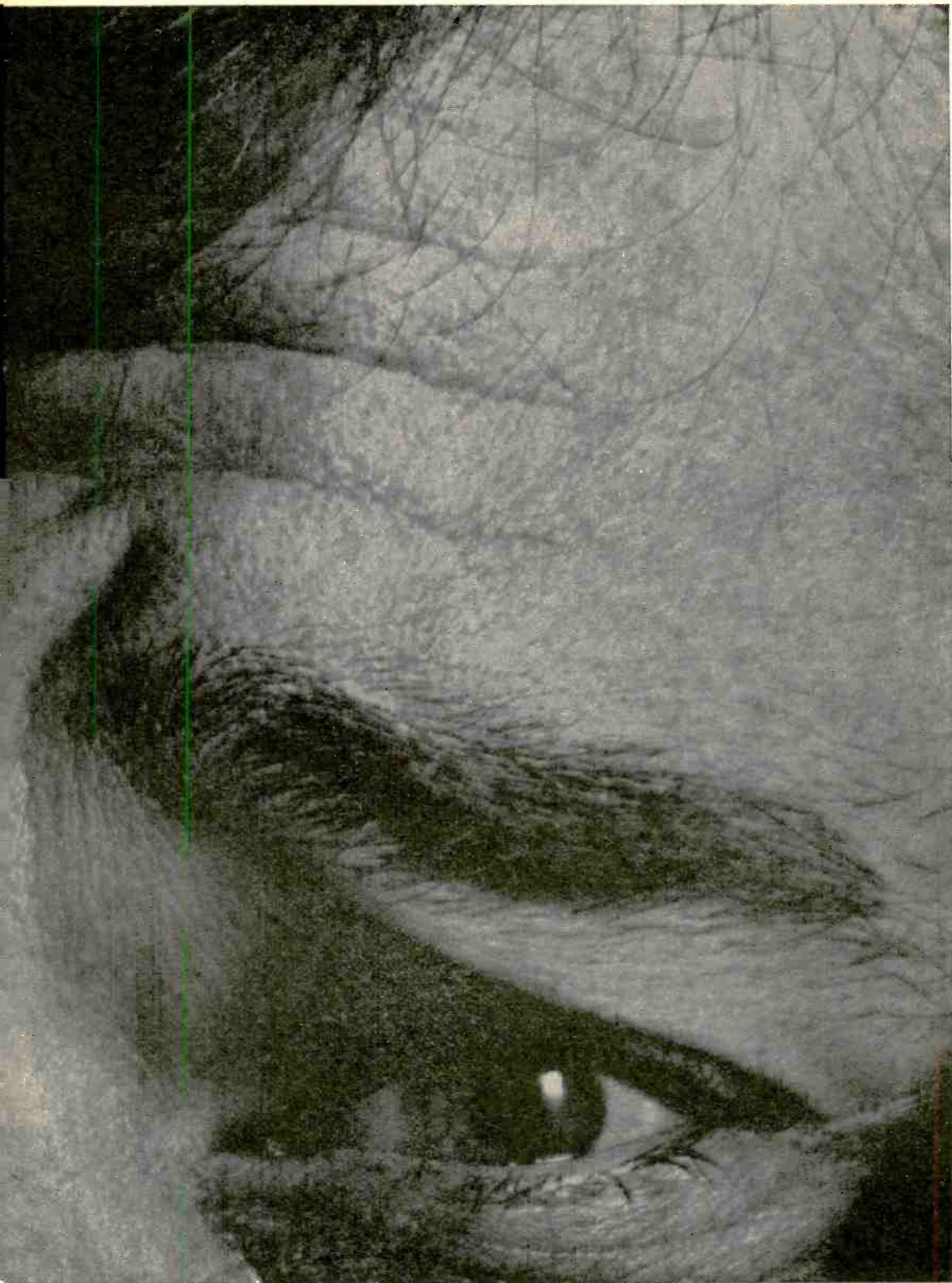

ing radius of about 7 feet. A quad beam, because of the long boom that isolates the two arrays, needs only 16 feet of turning radius and weighs but 35 lb.

The quad used in short-wave broadcasting and by radio hams was $\frac{1}{4}$ -wavelength along each side of the square, and was fed at the bottom corner. One type of CB quad is not fed at the bottom, but is a complete square of wire all the way around. Whereas in older quads the crossed supporting spreaders were insulated from the square, in this case, they are not. In fact, the spreaders are an important part of the radiating element.

Vertical or horizontal polarization is obtained by feeding r.f. to the center of either a vertical or a horizontal spreader, respectively. For diversity, both spreaders can be used with the r.f. switched from one to the other.

Diversity polarization, as this trick is called, has advantages. Only a few CB base stations use horizontally polarized antennas or beams. With this quad, the CB operator can work either polarization. And, two base stations with horizontal polarization can usually cut through interference from co-channel vertically polarized signals.

The quad array can develop a gain of 7 to 10 dB (isotropic reference) in either mode. A stacked pair can approach 15 dB of gain.

One cubical quad, made by Avanti, is called a *Polar Diversity Loop*, or just *PDL*. The matching devices at the center of the spreader dipoles are small transformers wound perpendicular to each other on ferrite cores. They match the odd impedance of the triple elements to 50-ohm coaxial leadline.

The quad made by Hy-Gain Electronics Corp. is called the *Eliminator*. The vertical and horizontal separator dipoles are longer than needed, extending out beyond the corners of the square. This further concentrates the beam with accompanying improvement in gain. It makes the antenna larger; the driven spreaders are nearly 18 feet from tip to tip.

Impedance is matched in the *Eliminator* by a $\frac{1}{4}$ -wavelength Q-section of 93-ohm coax; it matches the 125-ohm element impedance to the 50-ohm feedline. The two matching sections are coiled up and taped to the mounting boom.

Another quad, the *CBQ-2 Poly CB Quad*, is made by Polygon Plastic Co.

Shaped Directional Patterns. Directionality is what gives the quad antennas their gain. With at least two other base station antennas, the CB operator can change the direction of his beam pattern without actually rotating the antenna.

One beam antenna produced by The Antenna Specialists Co. has been around for some time. It's called the *Scanner* and consists of three vertical $\frac{1}{2}$ -wave dipoles clustered at 120-degree intervals around a mounting hub. A special multi-conductor lead-in cable connects the three dipoles to a control box. A switch and matching elements inside the box allow the operator to select which element is active while the other two elements become reflectors. The resulting beam of r.f. energy achieves more than 7 dB gain, and can be aimed in either of three directions. The beam spreads about 90 degrees, which provides some overlap.

Hy-Gain makes a little "black" box, called the *Co-Phaser*, that turns two of its CLR-2 vertical antennas into a directional array. The two verticals are mounted 9 feet apart, and feedlines are run from both to the *Co-Phaser* control box. Inside the box, a four-deck switch selects various combinations of delay lines and matching coils to phase the two antennas and produce different radiation patterns.

The two antennas can generate a cardioid pattern, aimed off either end of the array. Even though the shape of the beam is wide—about 120 degrees—it combines the gain advantages of both antennas. For instance, if two CLR-2 4-dB verticals are used, the gain is 8 dB.

The *Co-Phaser* can also radiate a figure-8 pattern broadside to the array. Gain in this pattern is about 6-7 dB. Intermediate positions of the directional switch shift the pattern all the way around the compass. Beam width varies with direction, but the gain is always 6-7 dB or more. Thus the *Co-Phaser* "rotates" the signal beam without physically moving the antennas.

Directional Beams. This was the first approach to achieving gain in CB antennas. Mounting a dipole driven element
(Continued on page 99)

Amateur Radio Equipment

1968
A Review

BY HERB S. BRIER
W9EGQ

MANUFACTURERS
DROP SENSATIONALISM
AND CONCENTRATE
ON DOLLAR VALUE

IF AMATEUR RADIO activity were restricted to one frequency band and there were only one class of license, an editorial review of amateur radio equipment would consist of mentioning how the various manufacturers achieve the same goal. Now that there are six classes of ham licenses and eight very active amateur bands, the possibilities for product distinctiveness is seemingly endless. Fortunately, in 1968-69 a review of equipment is not too complex. The trend is to improve tried-and-true designs—as opposed to adding a new piece of chrome to the 1967-68 model and proclaiming a revolutionary advance (particularly in the price).

An example of the current trend to upgrade amateur radio equipment is the new version of the Collins 75S-3B receiver. By the most reasonable count, at least 90 changes have been made in this receiver in the past 12 months. Although none of these changes is in itself drastic, together they make the 1968-69 Collins 75S-3B receiver appreciably better than it was in 1967-68. Similar evolutions can be seen in the product lines of various other manufacturers.

SSB/CW Transceivers. There is a continuing de-emphasis in the use of AM below 30 MHz. This is reflected in the popularity of SSB/CW transceivers. Most of the 1968-69 transceivers are easy to operate, compact, and offer good value at economic prices. These factors stem from the fact that many components in the transceiver are used in both reception and transmission.

Transceivers come in all power ratings—from a few watts up to the amateur radio legal maximum of 1000 watts (2000 watts peak envelope power on SSB). Hams now recognize that for best results they must choose a transceiver with the highest power output consistent with other desirable features. Doubling up on the use of the transceiver is now in vogue. Many amateurs select a transceiver for both mobile and fixed-

station operation. Thus, their automotive electrical system does not groan under the load of a high-power transceiver—a linear amplifier being used for higher power output in the base or home station.

Licensed Novice operators constitute a strong market for manufacturers of transceivers with power ratings up to 250 watts. Almost all of the present-day transceivers can be cranked down to 75 watts for operation in the 80-, 40-, and 15-meter Novice bands.

A large number of amateurs use the Collins KWM-2 transceiver as the standard against which all other SSB/CW transceivers must be compared. The KWM-2 is also one of the most expensive (\$1150, less power supply or speaker) transceivers on the market. A full line of accessories for the KWM-2 readily adds another \$600 to outfitting a ham station. In return for these prices, the KWM-2 delivers a 180-watt signal on any amateur frequency between 3.5 and 29.7 MHz. Receiver selectivity is 2.1 kHz and the sensitivity is better than 0.5 μ V. In both transmitting and receiving functions, the stability, dial calibration, and smoothness of operation of the KWM-2 is traditional.

At a price of about one-fourth of the KWM-2 you can pick up a Sideband Engineers SBE-34. This is a hybrid transceiver with 23 transistors in all of the low-power functions and 3 vacuum tubes in the transmitter output stages. The SBE-34 is rated at 135 watts on four bands (80, 40, 20, and 15). Unlike the Collins, you simply plug in a microphone, connect your antenna and use either house current or 12 volts d.c. to get on the air. One nice feature about the SBE-34 is the "incremental tuning" for listening in a few kilohertz either side of your transmitting frequency.

At another giant step down in price, the World Radio Laboratories "Duo-Bander 84" sells for about \$160, plus \$80 for the matching a.c.

power supply, or \$100 for the 12-volt d.c. supply. The Duo-Bander 84 has been upgraded to deliver a peak power input of 400 watts. You can use the Duo-Bander 84 on either 75- or 40-meter phone. The receiver has a 2.7-kHz selectivity and 1.0- μ V sensitivity.

For the fellow who still likes to build his own, the **Heath Company** has a good variety of SSB/CW transceivers in kit packaging. At the bottom of the price scale are the single-band units represented by the HW-12A (75 meters at \$100), the HW-22A (40 meters at \$105), and the HW-32A (20 meters at \$105). All kits are less power supply. Almost, but not quite in this group is the just-announced HW-18-3 for the 160-meter band (\$110). For these nominal prices, the purchaser gets 200 watts of "talk power" and a receiver with 2.7-kHz selectivity. The HW-18-3 differs from the other units in this group since it is crystal controlled on both transmit and receive and can be used to transmit straight AM phone signals at a 25-watt level. Matching power supplies are \$50 for the 117-volt a.c. model and \$70 for the 12-volt d.c. mobile model.

Very new in the Heathkit SSB line is the HW-100. It will sell for about \$240 and uses a field-effect transistor in the variable-frequency oscillator circuit. The receiver is said to have a 0.5- μ V sensitivity and a 2.1-kHz selectivity.

Top of the Heathkit line is the SB-101 with coverage from 3.5 to 29.7 MHz at \$370. This model is rated at 180 watts input PEP and features a built-in side-tone oscillator for monitoring CW keying. There is a provision for an optional 400-hertz CW filter and the SB-101 may be used in conjunction with the SB-640 VFO (\$99) for split-channel operation. Incidentally, the SB-101 is one of the limited number of Heathkit transceivers available in a wired model (\$540). The SB-110 is a somewhat similar model selling for about \$300 and designed solely for operation on 6 meters.

By redesigning to take advantage of the new General Electric 6LE5 tubes, **Galaxy Electronics** has been able to upgrade its Galaxy-V to 500 watts PEP. The new model, called the Mark III, still sells for about \$420 and the a.c. power supply is available for about \$80 and the d.c. power supply for \$100. Numerous accessories are offered for this 5-band transceiver. Due to be released within the next 60 days is a new 400-watt PEP rig from **Hammarlund**. Possibly bearing the title PTR-1, this transceiver will feature plug-in modules and a digital counter readout. The circuit will be hybrid and the selling price is forecast as being "under \$400".

Hallicrafters, long a name to be reckoned with in ham equipment, has two 5-band SSB/CW transceivers in its 1968-69 lineup. They are the SR-400 and the SR-2000 "Hurricane." Each transceiver features better than 0.5- μ V receiver sensitivity and 2.1-kHz selectivity. Receiver incremental tuning is included, as well as a built-in noise blanker, VOX, crystal calibrator, and side-tone CW monitoring. In addition, the SR-400 contains a built-in T-notch filter for eliminating heterodyne interference. The SR-400 is priced at \$780, plus \$120 for the a.c. power supply or \$150 for the 12-volt d.c. supply. The SR-2000 is selling at \$1095, plus \$450 for the a.c. power supply/speaker console.

A little company that is rapidly making a name for itself is **R. L. Drake**. They believe that everything possible should be in one medium-size package and are offering the TR-4 SSB/CW/AM transceiver. Ratings are 300 watts PEP and 260 watts on AM phone and CW. Built-in features include a crystal calibrator, VOX, and side-tone monitoring. A complete TR-4 goes for just under \$720. Also available is the RV-4 remote VFO for split-channel operation.

The top unit at **Swan Electronics** is the Swan 500C SSB/CW/AM transceiver with a PEP-rated input of 520 watts. The price for this model is about \$520, less power supply. A notable improvement made recently in the Swan 500C was a shift in the intermediate frequency. Power supplies go for \$95 and \$130, 117 volts and 12 volts, respectively. An external VFO is \$95 and a plug-in VOX is \$35.

For those who want the 5-band performance of the 500C, less some of the frills, Swan now offers the 350C for \$420. Power supplies and optional accessories are interchangeable between these two transceivers. The Swan 250C extends operation to the 6-meter band. Rated input of the 250C is 240 watts PEP, 75 watts on AM and 150 watts on CW.

More SSB/SW Transceivers. The National 200, 5-band transceiver is still available at about \$360. Matching power supply is \$75. Power rating of the National 200 is 200 watts PEP, 150 watts on CW and 50 watts on AM phone. . . . Imported by **Spectronics** is the Yaesu FTdx-400 transceiver, a hybrid combining 18 tubes, 9 transistors and 33 diodes in a 500-watt PEP transceiver. At \$600, the FTdx-400 features incremental tuning, side-tone monitoring and a dual-frequency crystal calibrator.

For 2-meter operation, the only commercially-available SSB transceiver brought to our attention was the **Gonset-II**. Sold for about \$260 (complete) the Gonset-II is rated at 20 watts PEP and is a hybrid. The Gonset-VI is the 50-MHz twin of the Gonset-II.

While SSB has largely replaced AM in the low-frequency amateur bands, AM has advantages for low-power local communications on frequencies where interference is not a major problem. One of the prime advantages is that low-power AM equipment is less expensive than low-power SSB gear. An example of this philosophy is the **Lafayette Radio Electronics HA-410** AM transceiver with its rated input of 20 watts, complete with built-in VFO and dual power supplies. The HA-410 sells for about \$150.

VHF and Above Transceivers. The popularity of AM on the 50- and 144-MHz bands is not to be denied. There is a wide variety of transceiver kits and wired models available at moderate prices to get the VHF enthusiasts going on either of these bands.

E. T. Clegg Associates is now back in business having been sold by Squires-Sanders. The popular "66'er" and "22'er" are 20-watt AM transceivers priced at \$250 each—ready to go on the air. . . . **Allied Radio** is offering two matched 15-watt AM transceivers in kit form. The TR-106 tunes the first 2 MHz of 6 meters and sells for about \$120. The TR-108 tunes the full 2-



GALAXY V Mk3



HALLICRAFTERS SR-400



R.L. DRAKE T-4XB



NATIONAL 200

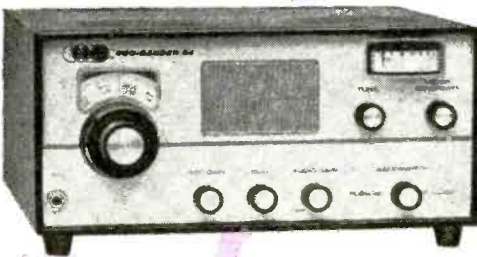

WRL DUO-BANDER 84

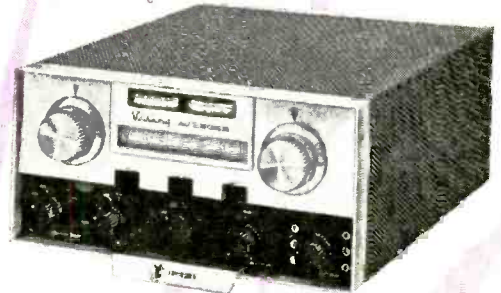

E. F. JOHNSON VIKING AVENGER



HEATHKIT HW-100



COLLINS KWM-2

meter band and goes for \$125. These prices include the power supplies and microphones. . . . Lafayette Radio Electronics has several companions to the HA-410 mentioned above. The HA-460 is an identical twin of the HA-410 except for frequency coverage. The HA-460 is on the 6-meter band. Also for 50 MHz, Lafayette is offering the HA-750, all solid-state, 5-watt-input transceiver.

The Hallicrafters 50- and 144-MHz twins are the SR-46A and SR-42A. These AM transceivers are rated at 12 watts and include built-in a.c. and d.c. power supplies. Each transceiver has four transmitting crystal positions and provision for an auxiliary external VFO. The SR-46A sells for about \$200, the SR-42A for \$220, and the matching HA-26 VFO is \$60.

The Heath Company's "Twoer" and "Sixer" 5-watt AM transceiver kits probably started more radio amateurs operating on VHF than any other piece of gear. These units are still around for \$45 and although not the greatest thing in terms of selectivity, they are useful for local rag chews. The built-in power supply is for 117 volts a.c., but an external 12-volt d.c. supply is available for \$18. The Heath Company has also just announced the HW-17, a 20-watt hybrid, 2-meter AM transceiver that will sell for about \$130 with power supply. The HW-17 will feature a pre-wired and pre-aligned FET receiver front end. This is a hybrid transceiver with four crystal-transmitting positions, plus provision for operating from the Heathkit HG-10B VFO. A matching 12-volt d.c. power supply will be available for \$25.

A modest 6-meter, 5-watt transceiver is available from World Radio Laboratories as its model TC-6A. This unit sells for \$40 in a kit package, less power supply.

Transverters. This is an area where, in 1968-69, radio amateurs can expect to see quite a bit of sensational activity. Swan Electronics is very enthusiastic about its new TV-2, 144-MHz transverter. This unit—when connected to the Swan 250, 350C, 500C, or similar transceiver—will transmit and receive on the 144-MHz band. Rated power is 250 watts PEP, depending on the input signal. The input frequency of the TV-2 is in the 14-MHz band; however, it can be ordered from Swan for use with 21-, 28- or 50-MHz excitation. Power is supposedly derived from the exciting or driving transceiver. Price is said to be about \$265.

The Collins 62S-1 transverter is rated at 65 watts PEP minimum output. This transverter receives and transmits on either the 50- or 144-MHz band when used in conjunction with 14-MHz transceiver for excitation. As usual, the price is high, and figures out to be just a few dollars under \$900.

Communications Receivers. Although transceivers in the ham shack are becoming more and more common, probably 95% of all radio amateurs have some sort of communications receiver. The present-day ham now tends to shy away from general coverage receivers and is more likely to be interested in "amateur-band-only" receivers. Generally speaking, the "only" receivers are remarkably stable and generally crystal-controlled to the extent that the

bands are linear and the received frequencies may be read-out in terms of ± 1 kHz. A brand new entry in the "only" family is the Hammarlund HQ-215. This is a solid-state receiver (41 semiconductors) that tunes the ham bands in 200-kHz segments. The nominal selectivity is 2.1 kHz, although there are provisions for additional filters with 200 Hz and 6 kHz selectivity curves. The HQ-215 sells for \$530 (matching speaker—\$25) and may be operated on 117 volts a.c. or 12 volts d.c. Hammarlund is continuing to manufacture its tube-type receivers including the HQ-110A (\$345), HQ-145A (\$310), HQ-180A (\$480), and the SB-600 family (\$1400, and up).

Two receivers are offered by R. L. Drake for specific ham-band coverage. Top of the Drake line is the R-4B which tunes 80, 40, 20, 15, and 10 meters with crystal-controlled accuracy. Like the HQ-215 mentioned above, the Drake R-4B has provisions for adding accessory crystal-controlled tuning ranges for operation on 160 meters, MARS, etc. If you don't care to spend \$430 for the R-4B, you should find the model 2-C, selling for only \$229, of particular interest. The 2-C offers the basic features of the R-4B, less some of the frills.

Keeping up with the high-ticketed items, the Collins 75S-3B and 75S-3C are basically identical receivers, the sole exception being that the "C" model has provisions for tuning fourteen 500-kHz segments outside the amateur bands. . . . Not yet seen, but being advertised, is the Galaxy R-530, another all solid-state receiver, but one that features continuous tuning from 5 kHz to 30 MHz, in 500-kHz "bites." Priced at \$695, the R-530 includes a 2.1-kHz filter and built-in noise blanker. Numerous additional filters and other options are available in both the Collins and the Galaxy receivers.

Hallicrafters has two receivers with slide-rule bandspread dials covering the five principal ham bands. The Hallicrafters SX-146 goes for \$295 and is intended to be a companion to the HT-46. The SX-130 might be construed as a general-coverage receiver, although a look at the slide rule dial mechanism obviously ranks this receiver as a product for radio-amateur usage.

A brand new transceiver that may set the trend for things to come is the E. F. Johnson "Viking Avenger." This is a hybrid transceiver covering the five major amateur bands with a variety of special features. To our knowledge, it is the only transceiver on the market which contains two built-in VFO's permitting the operator the option of "locked-frequency" transceiver operation or split-channel operation. There is a receiver noise blanker and a 30 dB dynamic range speech compressor. The power rating is 250 watts and the voice operation system is called VLX for "voice latch transmit." At writing, a firm price had not been established, but including power supply we expect the Avenger to sell for around \$1100-plus.

Rather rare on the American scene, but available to the amateur radio operator who likes his receiver in full dress, is the Squires-Sanders deluxe model SS-1R and the Eddystone EA12. The SS-1R is very similar to the IBS receiver (see September issue) with the exception that the tuning ranges are all of the ham bands between



R.L. DRAKE 2-C

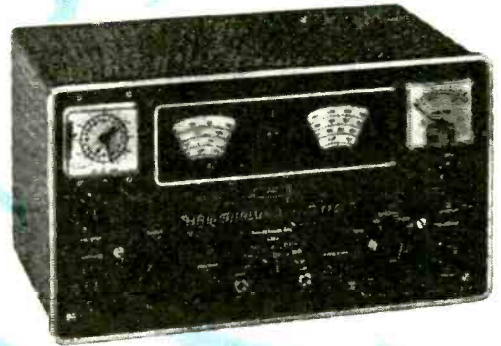

HAMMARLUND HQ-110A



HALLCRAFTERS SX-130



HEATHKIT SB-301

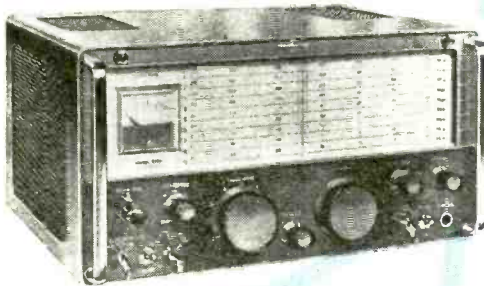

EDDYSTONE EA12



HEATHKIT HW-17

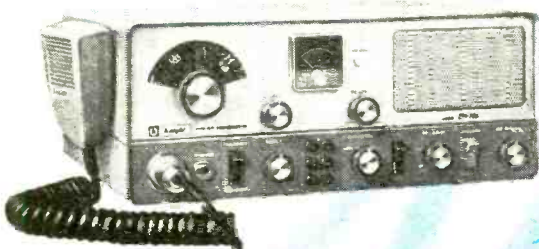

KNIGHT-KIT TR-106



CLEGG 22'er

3.5 and 30 MHz. The Eddystone EA-12 tunes down to 1.8 MHz and features continuously variable selectivity from 6 kHz to the almost unbelievable sharpness of 50 Hz. Price wise, the SS-1R of the order of \$1000 and the Eddystone EA12 around \$550.

For the kit builder that wants performance at a very reasonable price, the **Heath Company** is offering its SB-301. This \$260 kit includes a 2.1-kHz filter as standard equipment and has provisions to mount two more filters (400 Hz and 3.75 kHz). The SB-301 can be matched to the SB-401 transmitter to make a bargain-priced transceiver.

Also available is the **Lafayette Radio Electronics** new HA-600, solid-state, amateur and SWL receiver which includes bandspread tuning on the ham bands from 75 through 10 meters. This receiver goes for about \$110. . . . Some hams have taken a liking to the **Radio Shack** "Realistic DX-150" receiver which is another solid-state item tuning all the bands down to 10 meters. An editorial review of the DX-150 receiver appeared in the December, 1967 issue of **POPULAR ELECTRONICS**.

Miscellaneous Equipment. The Novice amateur operator who is just getting his feet wet should take a look at **Ameco's** AC-1, 15-watt, CW transmitter which sells for just over \$20 (kit, crystal extra). The pi-network output tank circuit allows matching this transmitter to a variety of antennas. . . . The **CONAR** Division of the National Radio Institute is marketing its

Model 400 3-band CW transmitter as a companion to its Model 500 receiver. The transmitter has a 25-watt input and is sold as a kit for about \$33.

Heathkit has long been a producer of favorite equipment for the Novice and is currently offering its model DX-60B which is rated at 90 watts input on all ham bands from 3.5 through 28 MHz. The Novice can reduce the power input to 75 watts. . . . Another Novice transmitter worth noting is the **R. L. Drake** model 2-NT which is rated at 100 watts input. Here, too, the power can be reduced to the 75-watt Novice limitation. The model 2-NT contains a built-in side-tone oscillator, antenna changeover relay, low-pass filter, and sells for about \$130.

Lack of space prevents describing in detail the dozens of other pieces of amateur radio equipment now being offered by various manufacturers. Converters, electronic keyers and linear amplifiers are all popular items. In fact, it may be surprising to those that keep reporting that CW is dead, that at least eight manufacturers have a lively market for electronic keyers. Prices range from \$35-\$100 and manufacturers in this field include: **Heath, Hallicrafters, Omega, M & M Electronics, Palomar Engineers, Pickering Radio, and Walters Manufacturing Company.**

In this quick summary, an effort has been made to counteract the rumors that amateur radio may soon die out. If that is so, it is surprising to find the number of manufacturers and the astonishing dollar volume of equipment sales being made each year in this best of all hobbies.

-30-

ADDRESSES OF MANUFACTURERS MENTIONED IN THIS ARTICLE

(Each manufacturer will be pleased to send you more information. Mention that you saw the product discussed by Herb S. Brier, W9EGQ, in the August **POPULAR ELECTRONICS**)

Allied Radio Corp., 100 N. Western Ave.,
Chicago, Ill. 60680

Ameco. Div. of Aerotron, Inc., P.O.
Box 6527, Raleigh, N.C. 27608

E.T. Clegg Associates, Inc., Box 376
Morris Plains, N.J. 07950

Collins Radio Co., Cedar Rapids, Iowa 52406

Conar, Div. of National Radio Institute,
Washington, D.C. 20016

R.L. Drake Co., 430 Richard St., Miamis-
burg, Ohio 45342

Eddystone, Div. of Marconi Instruments,
111 Cedar Lane, Englewood, N.J. 07231

Galaxy Electronics, 10 S. 34th St., Coun-
cil Bluffs, Iowa 51501

Gonset, Div. of Aerotron, P.O. Box 6527,
Raleigh, N.C. 27608

Hallicrafters, 600 Hicks Road, Rolling
Meadows, Ill. 60008

Hammarlund Mfg. Co., Inc., 73-88 Hammar-
lund Dr., Mars Hill, N.C. 28754

Heath Co., Benton Harbor, Mich. 49023

E.F. Johnson Co., Waseca, Minn. 56093

Lafayette Radio Electronics Corp., 111
Jericho Tpke., Syosset, L.I., N.Y. 11791

M & M Electronics, 6835 Sunnybrook, N.E.
Atlanta, Georgia 30328

National Radio Co., Inc., 37 Washington
St., Melrose, Mass. 02176

Omega Electronics Co., 10463 Roselle St.,
San Diego, Calif. 92121

Palomar Engineers, Box 455, Escondido,
Calif. 92025

Pickering Radio Co., P.O. Box 29, Ports-
mouth, R.I. 02871

Radio Shack Corp., 730 Commonwealth Ave.,
Boston, Mass. 02215

Sideband Engineers, 213 E. Grand Ave.,
South San Francisco, Calif. 94080

Spectronics, Box 356, Los Alamos, Calif. 97020

Squires-Sanders, Inc., Martinsville Rd.,
Liberty Corner, N.J. 07938

Swan Electronics Corp., Oceanside, Calif. 92054

Waters Mfg. Co., Wayland, Mass. 01778

World Radio Laboratories, Inc., 3415 W.
Broadway, Council Bluffs, Iowa 51501

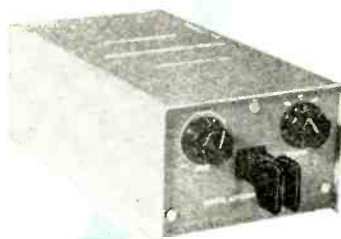
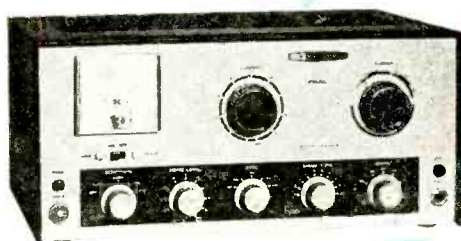
A**B****C****D****E****F****G**

A Electronic keyer from Palomar using integrated circuits. B Digital computer techniques are used in the Omega electronic keyer. C The Lafayette 6-meter transceiver is all solid-state. D Conar is offering this low-cost transmitter to the Novice. E Hallicrafters Model HA-20 dual-receive VFO. F Heathkit Model 60B phone & CW transmitter. G National high power linear amplifier Model NCL-2000.

the product gallery

REVIEWS AND COMMENTARY ON ELECTRONIC GEAR AND COMPONENTS

ELECTRONIC IGNITION SYSTEM (Knight-kit KG-372)

Some day an enterprising author will sit down and write a fascinating story about transistorized electronic ignition systems. When electronic ignition burst upon the American motorist about six years ago, it appeared (if you read all of the advertisements) as though the performance of every automobile could be "upped" by at least 20%. Because many motorists want to experience what they are told, the claims for transistorized ignition defied belief. It wasn't long before disillusionment set in and thousands of motorists were left stranded along the highways as power transistors and zener diodes failed.

Oddly enough, the purpose of transistorized ignition is perfectly valid. The desired objectives are very admirable, but the high-turns ratio ignition coil circuits were not the way to improve automobile performance. It was fortunate that an alternative method of generating high spark voltages for high speed driving was being quietly developed. Unlike the popular "cold" coil system, the circuit that would really work was being pushed aside because it was simply too costly to manufacture. This expensive system used a capacitive-discharge circuit. At one time, electronic ignition systems using this circuit were sold for between \$100-\$125.

From the all-time high of 65 separate manufacturers, you can now count all of the active manufacturers of electronic ignition systems on the fingers of one hand. Half of those people in business only produce the capacitive-discharge system. This is a system that works and the proof of the pudding is in the simple fact that the capacitive-discharge system survived while the others sank out of sight and were never heard from again.

Allied Radio Corporation—after taking a long hard look at electronic ignition systems—has introduced its Knight-Kit KG-372 kit selling for only \$29.95. The KG-372 is obviously related to the popular Delta "Mark Ten" system and must therefore be considered a product of considerable integrity. Your reviewer took his time assembling a KG-372 kit and still had the job done in just about two hours. The kit is well-fabri-

cated and our only admonition is to exercise some care during the printed circuit card wiring so that you don't mix up the 15-ohm resistors. Two different resistor wattage ratings are supplied in the kit and the "size" of the silk-screened outline on the PC board is the tip-off as to which resistor should be used. Don't use the 1-watt resistor on the low voltage board (we did).

Unlike the ignition systems of 1963, the capacitive discharge circuit does not necessitate a change in your ignition coil. To wire the KG-372 to your automobile, you simply pick a good mounting spot under the hood, take off the two wires to the ignition coil, mount the special terminals from the KG-372, reconnect the wires and you're in business.

Does the KG-372 improve car performance? If you drive long distances at 70-80 miles per hour, if you ever find it necessary to start your car in bitter cold weather, if you would like somewhat better gas mileage and somewhat quieter idling, or if you ever find yourself in a "jam" and must kick the accelerator "down" to get out of trouble, the answer is YES.

Circle No. 90 on Reader Service Pages 15 or 115

MONITOR RECEIVER (Petersen RM2-4)

Something new in a monitor receiver has just been introduced by the Petersen Radio Co., Inc. Dubbed the "RM2-4", this monitor receiver is the logical extension of the philosophy governing the design of fixed-tuned short-wave and VHF receivers. The RM2-4 can be easily set up on any four frequencies within the range extending from 2 to 200 MHz. It is a relatively low-cost receiver, 100% solid-state, and may be operated from either 117-volts a.c. or 12-volts d.c. The RM2-4 is a very small compact package with good styling.

Your reviewer used one of the RM2-4 receivers for several weeks and was pleasantly surprised by the sensitivity and selectivity in such a small package. The frequencies chosen for our test included CHU on 7.335 MHz and WWV on 10.0 MHz. The New York City weather broadcaster on 162.55

(Continued on page 104)



KNIGHT-KIT C-D IGNITION SYSTEM

Popular electronics ignition system is unlike so-called "transistorized ignition" circuits of the early 1960's. The KG-372 kit can be assembled in about 2 hours. Metal housing protects two circuit boards that slide into the box as shown in photo (below left). Housing doubles as heat sink for two power transistors. Circuit boards are individually wired and then interconnected before being inserted in housing. Circular object is special transformer. Capacitive-discharge circuit is foolproof since it does not require a change of ignition coil.

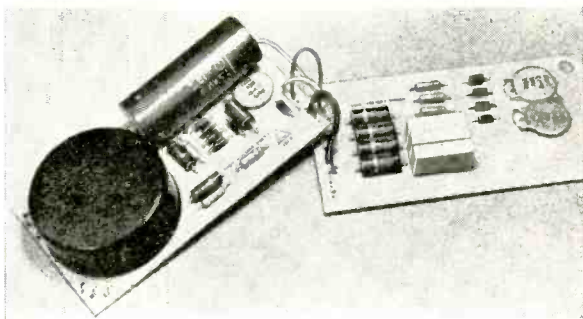
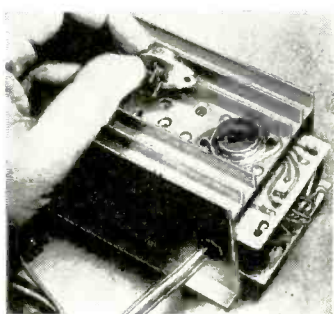

FOUR-CHANNEL MONITOR RECEIVER

New approach to fixed-tuned monitor receiver is revealed in Petersen Radio Company RM2-4. All solid-state, this monitor receiver will operate on any frequency between 2 and 200 MHz. Selected channel is crystal-controlled and may be either AM or narrow-band FM. This receiver has built-in 117-volt a.c. power supply, but may be operated from 12-volt d.c. supply. Speaker is inside metal cabinet and faces out through top.

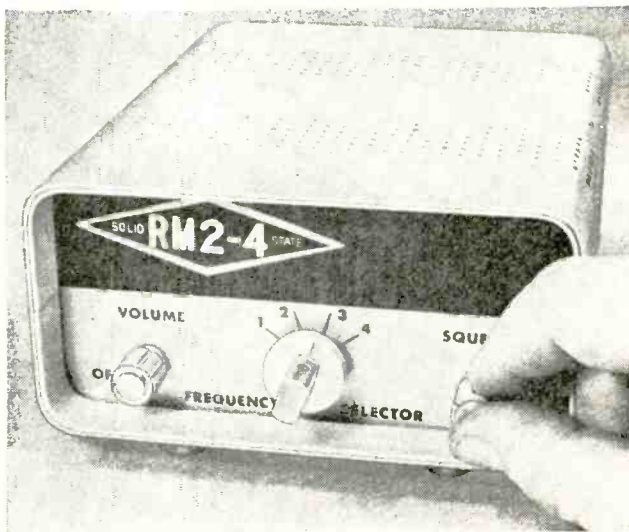



INFORMATION CENTRAL

By CHARLES J. SCHAUERS, W6QLV

More on FM Wireless Mikes. W. Hill of Harvard University points out (very capably) that our answer to the problem of dual operation of FM wireless mikes in the February, 1968, issue missed a main point of FM receiver theory. He argues that the real solution to the problem is to defeat the limiting action of the tuner used in connection with the mikes by modifying the a.g.c. so that the i.f. amplifier signal is never strong enough to limit the last stage. He says, "Although this would result in erratic discriminator operation, it might be useful for two or more voice signals." We agree, but we insist that the two mikes must be on the same frequency via *crystal control* (not difficult) and that there must be enough antenna available for the two mikes to produce an average *signal* regardless of a.f.c., i.f. limiting action, etc.

Receiver Monitor. *I'm a technically capable SWL and my receiver is an all-band tube job. I would like to know where and how I can connect my scope to observe a received signal.*

In the i.f. (plate) circuit through a demodulator probe. It is wise to use the i.f.

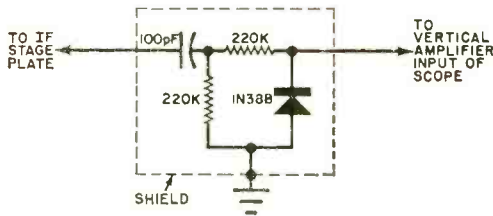

stage just before the detector in your set. A demodulator probe you can use is diagrammed here.

SB-34 Transceiver Changes. *Some time ago I bought an SB-34 transceiver and it worked fine until I connected a popular linear amplifier to it. When I did, the linear amplifier switching transistor (Q23) and the transmit/receive keying transistors (Q16 and Q17) went out. I replaced all of them, but a week later the transistors went out again. What could be wrong and what should I do?*

When the keying relays provided in certain linear amplifiers (connected to the SB-34) produce a transient on the output of J3,

they can not only cause the breakdown of Q23 but the Q16 and Q17 transistors as well. In current SB-34 models, Q23 has been changed from a 2N2926 to a 2N3642; and, in addition, a 1N2071 diode is now connected from the emitter of Q23 to ground. A 0.01- μ F, 500-volt disc ceramic capacitor has also

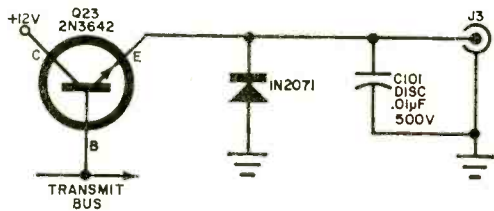

been added and is connected from the emitter of Q23 to ground. See diagram. The parts needed for the various changes are available from most radio distributors.

Electric Fence Noise. *My neighbor's electric fence really messes up reception on the ham bands for me, especially on 80 meters. I have tried power line filters, but the interference seems to be radiated. Is there anything I can do?*

The fence should not radiate, but it can happen if there is leakage to ground, and especially in wet weather. Because the leakage resistance is not constant, an "arcing effect" takes place. One cure is to connect both ends of the fence wire (which should be well-insulated) to ground through a 2-megohm resistor—these resistors will not affect operation of the fence too much. An a.c. line filter at the fence unit and *not* at your receiver may do the trick. You might also try a coaxial feed-through capacitor in series with the high-voltage fence lead.

Tower Choice. *Being new at ham radio, I know very little about selecting an antenna tower. I must choose between three types: tilt-over, crank-up, or conventional. I plan to use a three-element beam antenna on the tower. What do you advise?*

Choose either the crank-up or tilt-over type (at least 40 feet high). Each has its peculiar advantages over the conventional tower. Climbing a fixed tower at any time (especially during the winter months) is not a pleasant task. I like the tilt-over type be-

cause it makes beam element adjustment easy. The crank-up type is less conspicuous when cranked down.

H.F. RDF Bearing Accuracy. *What are the factors that influence the accuracy of radio direction finding bearings in the high-frequency radio band, and what is the difference between a "fix" and "bearing"?*

High-frequency RDF accuracy depends on: type of equipment used; type and location of RDF site; frequency; range and signal strength of the transmitting station; ionospheric conditions, especially diurnal variations; amount of interference; number of bearings taken; and the skill of the operator.

A "fix" is composed of two or more bearings taken from different RDF stations at different RDF sites or mobile locations. The more bearings taken from different RDF stations at different locations, the higher the accuracy of the fix. Bearings are plotted on maps to obtain a fix or pinpoint location.

Dummy Standard Antenna. *I need a dummy "standard" antenna, which will cover 540 to 22,000 KHz or so, for introducing a signal into a radio receiver. The dummy will be fed with a signal generator. Can you help?*

See the diagram below. This is a standard dummy used for receiver tests. The signal

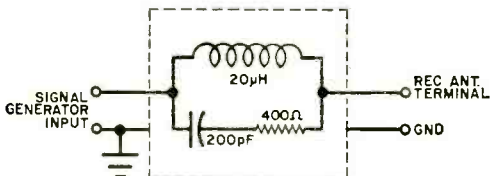

generator used should have the impedance of a typical antenna. If it does not, then a series impedance should be added so that it and the internal impedance of the generator will match the receiver input.

Trap Burnout. *I bought a popular trap beam antenna and installed it. The spec sheet stated that it was rated for 2 kW PEP. I get out fine on 10 meters, but the 15- and 20-meter bands are now practically unworkable. I ran full power to this beam for about six months before it stopped working on the two bands. I have checked the elements and all seem okay. Is there a possibility that the trap coils for 15 and 20 meters are gone?*

Could be. Remember that an accumulation of water in an undrained trap can cause trouble, especially if you are running high power. If you can, try to observe your an-

tenna at night while another ham is operating your rig, and see if you can detect any arcing—this might mean some tower climbing. If you use an SWR meter, however, you will be able to detect the trouble pronto. New traps are indicated.

Audio Q-Multiplier. *There are Q-multipliers to increase the r.f. selectivity of a receiver. Is there such a thing as an audio-frequency Q-multiplier for selective tuning between two closely spaced audio tones?*

One such circuit is shown below. The selective frequency of this circuit is dependent on the value of capacitors and resistors in the feedback circuit between the collector

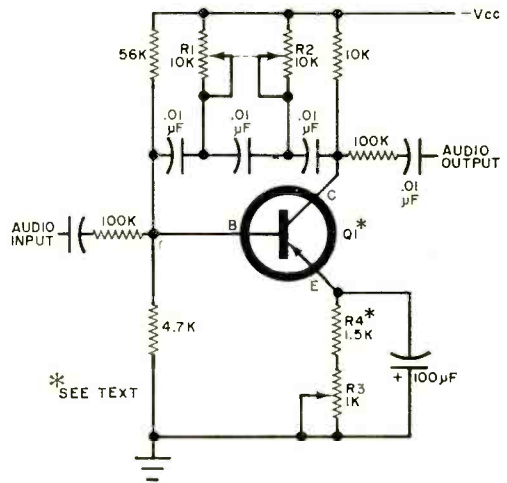

and base of *Q1*. With the values shown, the frequency can be "tuned" a hundred cycles or so around 650 Hz. Other values will produce a different tuning range. Make sure that *R1* and *R2* are ganged. Emitter potentiometer *R3* determines the sharpness of response curve. Any transistor having a beta greater than 50 can be used. Select a value for *R4* so that the circuit will not oscillate when *R3* is set for minimum bandwidth (sharpest tuning).

Your Editors are sorry to report that "Chuck" Schauers has requested that he be temporarily relieved of his duties relating to INFORMATION CENTRAL. On his doctor's advice, Chuck has decided to "take it easy" and plans on vacationing for the next 6 to 12 months. As many readers are aware, Chuck has been writing INFORMATION CENTRAL and other Q & A columns similar to it for about 10 years.

We will miss the service of such a valuable contributor, but INFORMATION CENTRAL will be continued.

UNIQUE DUAL-FET Amplifier

AUDIO STAGE HAS
500 GAIN FIGURE

by B. W. Blachford

A CONVENTIONAL FET audio voltage-amplifier stage using a 22,000-ohm drain load resistor and a d.c. power supply of 15 volts provides a typical signal voltage gain of about 18 times—or the approximate equivalent of that obtained from a triode vacuum tube. Remove the 22,000-ohm resistor and replace it with an electronic load resistor (as shown in the wiring diagram), and the voltage gain goes up to about 500 times—the approximate equivalent of that obtained with a pentode.

How It Works. In the schematic diagram, FET *Q1* is the audio amplification transistor while FET *Q2* is the active element of the electronic load resistance. Potentiometer *R_s* in the source circuit of *Q1* is initially adjusted to make the d.c. potential at the drain of *Q1* equal to one-half of the supply voltage.

The electronic load resistance may be thought of as a resistance which changes its value in a direction opposite to that of a change in source-to-drain resistance of the amplifier FET to which it is connected. When the gate of *Q1* is driven positive by a signal, its source-to-drain resistance decreases. Consequently, its drain electrode voltage goes in a negative direction (closer to ground potential). The gate of *Q2* is connected to the drain of *Q1*. Thus, when the drain of *Q1* goes in a negative direction, the gate of *Q2* does likewise, and, as a consequence, the source-to-drain resistance of *Q2* (which is actually the drain load resistance of *Q1*) increases. This makes the voltage at the drain of *Q1* go much closer to ground potential than would be the case if *Q2* were replaced with a conventional fixed-resistor load.

Similarly, when the gate of *Q1* is driven in a negative direction by a signal, the source-to-drain resistance of *Q1* increases, that of *Q2* decreases, and the drain electrode of *Q1* goes much closer to the value of the supply potential than it could if *Q2* were not in the circuit. This wide swing in the drain potential of *Q1* is, in fact, amplification. In the circuit when a sine-wave signal of 6 millivolts is applied to the gate of *Q1*, a 3-volt sine-wave signal appears at the output. Effective signal voltage gain is about 500 times.

If maximum voltage gain is to be realized, the output of the amplifier must be connected into a high-resistance load. In the author's test setup, this resistance was 1.0 megohms. Thus, a following FET stage will be quite satisfactory. Although this dual-FET stage is quite stable (despite the high gain) lead length should be kept to a minimum, and output leads should be dressed well away from the input leads.

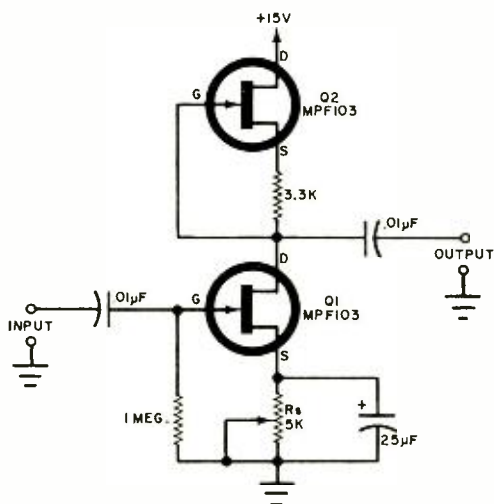

Using a second FET as an electronic load resistance creates a high input impedance, high-gain amplifier.

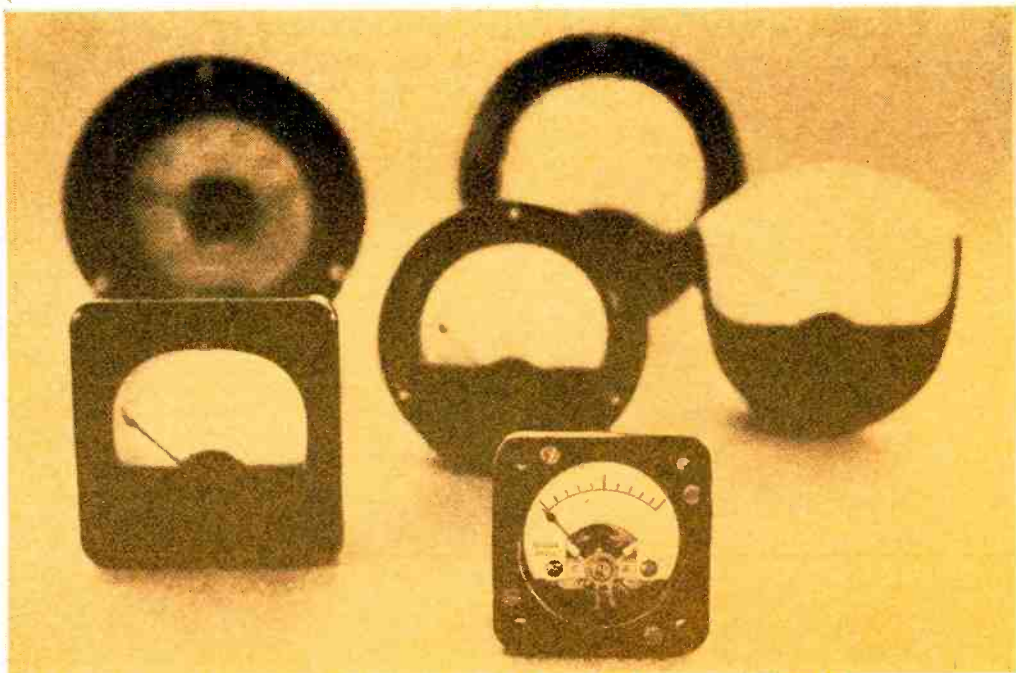

METERS: Let's Face Them

Why waste a meter, when all it may need is a brand-new face

BY JESS W. SPEER, W6ELJ

HAVE YOU EVER started to build a project but had to stop because you needed a meter with a range you didn't have handy? If you're an average experimenter, situations like this probably crop up with annoying regularity. However, any technician, ham, or experimenter worthy of the name should be able to extricate himself from a simple meter problem.

Almost any D'Arsonval meter movement can be converted to suit virtually any current or voltage measuring requirement. The conversion described below is simple, inexpensive, and leaves the meter looking "made-to-order" for your projects. Just two steps are required: adding a multiplier or shunt to the basic meter movement, and reworking the meter scale to conform with the range needed. The whole job shouldn't take more than a

couple of hours, even if you're a beginner at this sort of thing.

Meter Theory. All meters—regardless of how they are eventually used—are basically current-measuring devices. Generally, they are very sensitive, and if used to measure large currents, they must be shunted by a low-value resistor. The low-value shunt resistor will divert the greater part of the current away from the delicate low-current meter movement, thus altering the meter's current-indication range and protecting the movement.

Similarly, the voltage-measuring capability of a meter movement can be expanded many times if a suitably high-value multiplier resistor is connected in series with one of the meter's leads. The higher the resistance value of the mul-

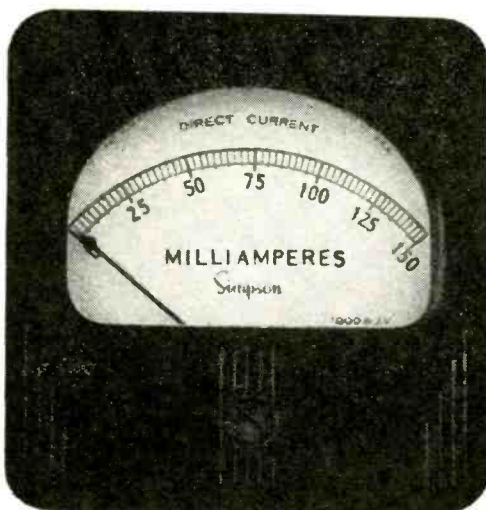
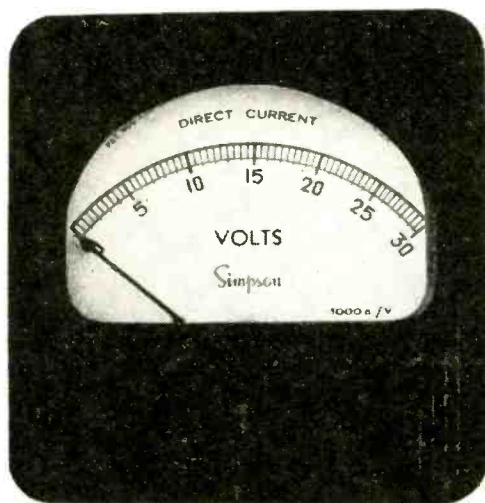

In the photo at the left, the meter is shown before refacing it for the example explained in the text. The "after" view (right) shows the same meter refaced to a 0-150 mA current range.

multiplier, the greater will be the voltage-measuring range of the meter. Then, when the meter is connected to the circuit under test, the meter will indicate only the voltage drop caused by its own internal resistance.

Current measuring meters are always connected in *series* with the circuit under test. Conversely, a voltmeter is connected in *parallel* with the test circuit.

The accuracy of any meter measurement depends on the sensitivity and accuracy of the movement and the tolerance of the shunt or multiplier resistors. In some cases (such as vacuum-tube grid circuits where current flow is very small), a very high-input-impedance voltmeter is required to prevent loading down the circuit and causing inaccurate readings. However, most experimental circuits do not require a high-impedance voltmeter, nor must the readings be exact. For this reason, meters capable of making many useful measurements can be improvised without resorting to complicated mathematics.

Reworking the Meter Scale. Take a hypothetical case where a 0-150 mA meter is needed but the only meter available is calibrated for 0-30 volts d.c. This is a

fortunate accident since the meter scale is divided into six major divisions, each separated by ten minor increments (see photos). Thus each individual increment will divide the desired range into 2.5-mA steps, with the major divisions indicating, 25, 50, 75, 100, 125, and 150 mA, respectively. The major divisions simplify scalar readings.

To rework the scale, carefully remove the movement from its case and the two screws that anchor the scale plate in place. Then delicately slide the plate from under the meter pointer, taking care to avoid bending the pointer. Set the movement aside, and place the scale plate on a clean, flat surface.

Next, remove the original numbers and the word VOLTS from the plate with an ordinary typewriter eraser (or carefully scrape them away with a sharp knife if you can't get good results with the eraser), but leave the divided scale intact.

When all traces of the numerals and letters are removed, use a suitable size "Letraset" or "Prestype" lettering kit to renumber the major scale divisions as shown. When transferring the characters from the lettering sheet, place the sheet of type over the scale with the

characters oriented as they would normally be read. Also, keep the numbers equidistant to lend a professional appearance to the job. For example, with two-digit numbers, the scale mark should separate the two numbers; with three-digit numbers, the central numeral should align with the scale mark.

After renumbering the scale, transfer the word MILLIAMPERES or the symbol mA to the position from which you removed the word VOLTS. Now, remove the multiplier resistor that may be connected to the meter terminals, anchor the scale plate back in place, and reassemble the meter.

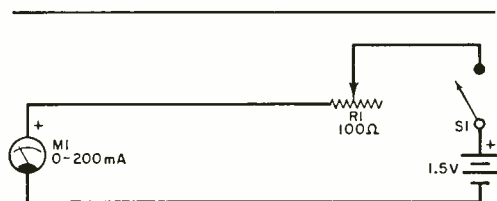

Fig. 1. Simple current-limiter test setup is essential to finding value of shunt resistance needed.

The Meter Shunt. The resistance of the shunt needed for a current-measuring meter can be determined mathematically if you know the internal resistance of the movement. However, a simple trial-and-error technique is usually a lot quicker and just as accurate.

First, breadboard a circuit like that shown schematically in Fig. 1. Meter *M1* in the diagram is a basic 200-mA movement, or it can be a VOM set to read current on a range nearest (but above) 150 mA for our hypothetical example. Set potentiometer *R1* for maximum resistance, and close *S1*. Then adjust *R1* so that *M1* reads exactly 150 mA. Open *S1*, and remove *M1* from the circuit, but be careful not to disturb the setting of *R1*.

Since a trial-and-error technique of arriving at the value of the shunt is to be employed, an arbitrary length of magnet wire should be selected. If you use #24 or #22 wire, start with a 24" length. Be sure the wire size you select is capable

of handling the current it must shunt away from the meter. For example, use #24 wire for shunts that must handle 500 mA or less. For up to 900 mA, #22 wire can be used but for greater current-handling capability, a larger size wire must be selected from the "Copper Wire Table" in the *Radio Amateur's Handbook*. When selecting the wire to use, restrict yourself to high quality "Formvar" or "Nylcad" enameled wire.

After cutting the wire to its arbitrary length, scrape away 1" of insulation from each end, and connect the bared ends to the terminals of the meter you are converting. Insert the meter in place of *M1* in the circuit, and close *S1*. If the pointer deflects less than full-scale, a longer wire is needed; if the pointer swings off the upper end of the scale, use a shorter wire.

Mentally calculate the final length of wire needed for the shunt, using the meter indication as a gauge. For example, if the 24" length of wire produces only a 2/3-scale deflection, the final length should be about 36" (plus about 6" to allow for trimming purposes). The process is a bit tricky if the pointer has moved beyond the upper limit of the scale. In this case, snip away about an inch of wire at a time until the pointer swings slightly beyond the full-scale deflection point. (Remember, when using this cut-and-try technique, *S1* must be open at all times when the shunt wire is not connected to the meter terminals.)

Now, double the wire in the center, and wind it over the body of a 500,000-ohm (or larger), 1-watt resistor, as shown in Fig. 2. The two ends of the



Fig. 2. Correct method of winding a noninductive shunt, winding from center to ends, is shown here.

wire, wound in the same direction as shown, will make the shunt non-inductive. But if the inductance of the shunt is unimportant, just wind the wire in one direction from end to end. (In cases where bulk winding of the wire is large,

glue $\frac{1}{2}$ "- $\frac{3}{4}$ " diameter pieces of cardboard or plastic on each side of the resistor body to prevent the wire from slipping off.) Affix solder lugs to the resistor leads as shown, but don't solder the shunt wire in place.

Connect the shunt to the meter's terminals, close *S1*, and use the trial-and-error technique until the wire yields an exact 150-mA deflection of the meter pointer. (Do not readjust *R1*.) Finally, to check linearity, insert the converted meter in a circuit like that shown in Fig. 3. Meter *M1* is the converted meter, and *M2* is any other meter capable of measuring 150 mA or more. Potentiometer *R1* should have a value of 100 ohms or greater.

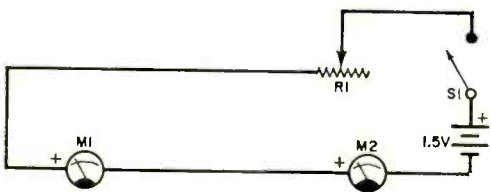

Fig. 3. When checking linearity of converted meter, pointers of both meters should move proportionally.

Close *S1* and vary the setting of *R1* while observing the meters. Both meters should indicate essentially the same reading, point-for-point, over the entire range of the converted meter. After this is done, solder the shunt wire's ends to the resistor leads.

Voltmeter Range Multipliers. Most meter sensitivities—either in microamperes, milliamperes, or ohms/volt—are stamped somewhere on the meter. However, if a meter's basic sensitivity is not indicated, the circuit shown in Fig. 3 can be used to determine it. The process used is comparison, in which case, *M1* should be a basic 1- or 2-mA meter, and the value of *R1* should be increased accordingly.

If a meter's sensitivity is expressed as 1000 ohms/volt, the movement has a full scale sensitivity of 1 mA (determined by Ohm's law where $I = E/R =$

$1/1000 = 1\text{mA}$). Once the approximate voltage level to be measured and the current required for full-scale meter deflection are known, the multiplier resistance value can be determined by dividing the meter sensitivity in amperes into the desired full-scale voltage (in volts) range.

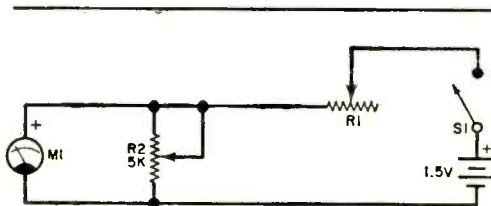

Fig. 4. This circuit is used to determine the internal resistance of any unknown meter movement.

Assuming that a 0-1 mA movement is to be used to measure 100 volts, the multiplier resistor would be 100,000 ohms. The multiplier resistor is then connected in series with one of the meter's terminals.

For very accurate measurements, the internal resistance of the meter must be determined, then subtracted from the value calculated for the multiplier resistor. (Use the circuit in Fig. 4 to determine the internal resistance of the meter. Potentiometer *R1* is 100 ohms. Simply adjust *R1*—with *R2* disconnected—until *M1* indicates exactly full scale. Connect *R2* and adjust it until *M1* indicates exactly half-scale. Disconnect the power from the circuit, remove *R2* without upsetting its setting, and measure the resistance of *R2*. This measured resistance is equal to the internal resistance of the meter.)

For accuracy, precision wire-wound resistors of 1% tolerance or better should be used. However, in most cases, resistors with a 5% tolerance will suffice.

With the conversion techniques described in the foregoing, it is easy to see that almost any meter can be reworked to suit your needs. Both the techniques employed and equipment needed are simple enough to understand and use even by a novice to electronics—much less to someone with extensive experience in fabricating projects. —30—



AMATEUR RADIO

By **HERB S. BRIER**, W9EGQ
Amateur Radio Editor

MORE POWER AND FREQUENCIES ON 160

EFFECTIVE July 1, 1968, the Federal Communications Commission reopened the entire 1.8-MHz (160-meter) band for radio amateur use. The Commission also increased maximum authorized power on the band to 1000 W. Since World War II, amateurs have shared "160" with the LORAN navigation system. Depending upon their location with reference to the LORAN transmitters, amateurs have been crowded into one to four 25-kHz segments of the band and restricted to a power of 25 to 200 W.

Cooperative studies by several government departments revealed that amateur 160-meter band privileges could be increased without jeopardizing the LORAN network.

And why not? Every amateur avoids the raucous LORAN signals as much as possible.

The 160-meter band is now divided into eight 25-kHz segments. There is still a geographic allocation regarding power so check your local FCC office for further details. Listen in—you may find 160 a great place to ragchew.

Also from the FCC. On April 10, the Commission released an order suspending the General Class license of Brad Welton, WA1FTI, for six months. WA1FTI is alleged to have transmitted music and modu-
(Continued on page 111)

AMATEUR STATION OF THE MONTH



Al La Vorgna, WA2OQJ, Hicksville, N.Y., had a Technician Class license for about ten years. He worked 2 meters using a Heathkit Pawnee transceiver and came up with a 12 State DX total. Last year, Al obtained a General Class license and some new equipment—including a Hammarlund HQ-145 and EICO 753 transceiver. Most of his operating time is now spent on CW. We are sending WA2OQJ a one-year subscription to Popular Electronics for his winning picture in the Amateur Station of the Month contest. You can enter this contest by sending me a clear photo of your station—with you at the controls—c/o Amateur Radio Photo Contest, Herb Brier, P.O. Box 678, Gary, In. 46401. Sorry, but it is impossible for me to return photos.



SOLID STATE

By LOU GARNER, Semiconductor Editor

A NUMBER of technical conferences and conventions are held across the nation each year. Most are sponsored by professional engineering societies, national industrial or trade associations, or regional technical groups. Some are open to the public, while others are restricted to members of the sponsoring groups and their invited guests, but almost all share one feature—they are used by manufacturers as backdrops for the announcement of new products or engineering developments.

Among the interesting new items introduced at shows and conventions thus far this year are:

- A solid-state television tuner developed by Standard Kollsman Industries, Inc. (Syosset, N.Y.) and introduced at the IEEE Convention. The new unit is more than just a transistorized version of a conventional tuner—rather, it employs voltage-variable capacitor diodes (varactors) as tuning elements, eliminating the need for r.f. signal bandswitching and mechanical tuning.

In operation, the r.f., oscillator and mixer circuits are tuned by varying the d.c. bias applied to shunt varactors, thus changing their effective internal capacitances. Other diodes, under forward biasing, short out part of the coils for bandswitching. With only d.c. levels handled by the tuning poten-

tiometers and band-switch, the control(s) need not be an integral part of the tuner, as in conventional designs, and the tuner itself may be located for best electrical layout. Service problems caused by dirty switch contacts are eliminated and, in addition, both a.f.c. and remote tuning circuitry are simplified. You'll probably find this new tuner in a number of the TV sets introduced this fall.

- An ultra-compact color-TV camera—claimed to be the smallest in the world—developed by the North American Philips Company, Inc. and shown at both the NAB Convention and the AFCEA Convention. Still experimental, the new unit is no larger than a 16-mm movie camera and weighs 6½ pounds, compared to 92 pounds for studio cameras and 25 pounds for the portable "Little Shaver" color cameras used at the political conventions. Its small size and light weight are due to solid-state circuitry in conjunction with 5/8" diameter, 5" long Plumbicon camera tubes.

- A broad line of experimenter and hobbyist components—covering 85% to 90% of all hobbyist needs (except for tubes and semiconductors)—introduced by the Calectro Division of GC Electronics Company at the NEW Show. The line includes transistorized audio amplifier modules, photocells, and a low-cost etched circuit kit as well as many familiar items such as resistors, potentiom-

From left to right are shown the newly developed compact varactor-diode solid-state TV tuner and modern and early models of vacuum-tube tuners. One of the distinguishing features of the varactor-diode tuner is the complete absence of a tuning control shaft.

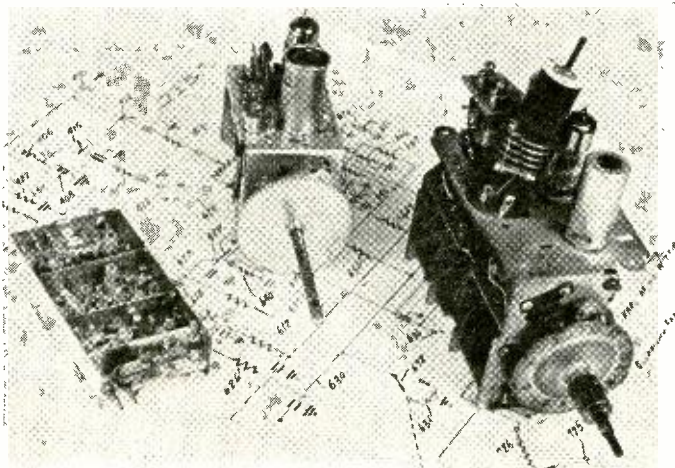

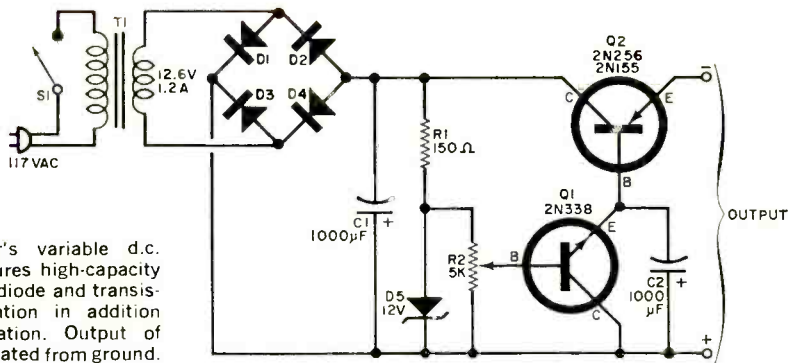

Fig. 1. Bill Lahr's variable d.c. power supply features high-capacity filtering and zener-diode and transistor voltage regulation in addition to bridge rectification. Output of power supply is isolated from ground.

eters, switches, capacitors, etc.

● The "Solid-State Hobby Circuits Manual," a valuable new book introduced by RCA at the NEW Show. All of the circuits in the manual feature RCA's SCR and IC Experimenter Kits as well as a number of their "SK Series" transistors.

There are many other new items, of course, but space limitations prohibit our discussion of these at this time.

Reader's Circuit. A variable output d.c. power supply is virtually a necessity when testing new circuit designs or servicing solid-state equipment. Reader William Lahr (514 W. Bennett St., Compton, Calif. 90220), decided to work up his own circuit as shown in Fig. 1. Suitable for all but "high-power" requirements, the circuit can be assembled in a single evening and, according to Bill, is capable of supplying up to 12 volts, regulated, at currents up to 300 mA.

Referring to the schematic, Bill uses a zener-controlled series regulator with a conventional full-wave d.c. power source. In operation, line voltage is stepped down by transformer *T1*, rectified by a full-wave bridge made up of diodes *D1* through *D4*, while capacitor *C1* serves as a ripple filter. A reference d.c. voltage is established by zener diode *D5* in conjunction with series resistor *R1*. A portion of the reference voltage, as determined by *R2*, is applied as bias to control amplifier *Q1* which, in turn, controls the base bias applied to series regulator *Q2*. Capacitor *C2* provides additional filtering for *Q2*'s bias.

Conventional components are used. Transformer *T1* has a secondary rating of 12.6-volts at 1.2 amperes, *D1* through *D4* are 50-PIV, 1-ampere silicon rectifier diodes, while *C1* is rated at 25 volts, and *C2* at 15 volts. Zener diode *D5* is 12 volts, 1 watt, *R1* is a half-watt resistor, and *R2* is a 5000-ohm linear taper potentiometer. Transistor *Q1* is a 2N338 npn transistor (or equivalent), while *Q2* is a low-cost general purpose pnp

power transistor similar to types 2N155 or 2N256.

In common with most power supply circuits, neither layout nor lead dress is critical. The circuit may be assembled on a small chassis or perf board, and mounted in a metal or plastic instrument case, depending on individual needs. If the unit is to be used at near maximum capacity for long periods, *Q2* should be heat-sinked.

Manufacturer's Circuit. Suitable for use in hi-fi systems, musical-instrument amplifiers, phonographs, tape players, p.a. equipment, or other types of audio amplifiers, the treble and bass tone-control circuits illustrated in Figs. 2 and 3 respectively, were abstracted from *Integrated Circuits Application Note No. 91-508*, published by Westinghouse's Molecular Electronics Division (Box 7377, Elkridge, Md., 21227). The circuits were developed to illustrate potential applications for an IC operational amplifier, the Westinghouse type WC161.

Referring first to Fig. 2, the treble control circuit shown can provide a boost of up to 21 dB, or a cut of as much as 22 dB
(Continued on page 102)

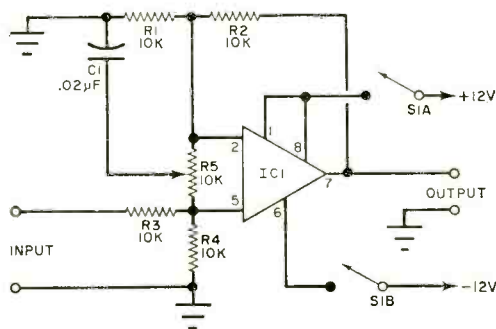

Fig. 2. Potentiometer *R5* is adjusted to control the high-frequency gain in this IC amplifier circuit.



ON THE CITIZENS BAND

By MATT P. SPINELLO, KHC2060, CB Editor

COLORADO REVISITED

EARLIER THIS YEAR your CB Editor activated the POPULAR ELECTRONICS Monitour (*monitoring tour*) Project from Denver, Colorado. The project, which enables your CB Editor to see at first hand CB activities in various parts of the country through on-location, in-person monitoring, will cover at least a dozen areas before the year ends. The Monitour Project has been conducted in seven cities to date.

Our recent return to Colorado was prompted by an invitation to attend "8th Interski," (International Congress of Ski Instruction), dubbed "The Olympics of professional ski instruction." Approximately 3000 professional skiers, skiing buffs, members of the press, and others, assembled for the ten-day program in Aspen, Colorado, 8th Interski headquarters.

Most of the action took place at Tourtelotte Park, at an altitude of 11,000', on Ajax Mountain, high above Aspen. Ski teams from twenty-one nations participated in daily events involving the techniques of skiing, ski instruction, equipment and other aspects of skiing.

A TV production team was on hand from the Ampex Video Institute to videotape daily ski events on the mountain. Tapes were then hand-carried down the mountain on a chair lift and played back each evening for the participants and buffs in attendance at Paepke Auditorium in Aspen.

CB radio solved a communications problem for the TV technicians who spent two days prior to the first skiing events digging trenches in the snow to bury TV camera cable beneath ski trails. CB walkie-talkies were used to provide a communication link between the VTR control center housed in Gretl's Restaurant in Tourtelotte Park and two TV cameras, one 1000 yards to the south of the control point, the other 800 yards to the east. The hand-held transceivers put TV team members in touch with personnel riding the chair lifts, on board Ski Cats (snow tractors), and in automobiles in Aspen at the bottom of the mountain.

From the standpoint of monitoring, interference was nil, intelligibility was excellent, and the temporary system deemed highly

effective. Most other calls placed in the area were made by visiting CB'ers providing directions to their lodges, handling road information, and planning the next day's meeting point on the mountain. Skip transmissions were virtually nil, and violations by area residents amounted mainly to frivolous chit-chat and transmissions that could have been handled by telephone.

In addition to the spectacular and colorful performances executed by Interski attendees, we will never forget our first chair-lift ride to 11,000' and the fact that no one flies out of Aspen, Colorado unless there is a hole in the clouds big enough to fit the nose of a DC-3 through. Even then the mountains are so close you could drag your feet through the snow caps if you were riding on the wing.

When you *can* fly out of Aspen, you arrive in Denver in less than an hour. During our short layover to board a jet to the mid-west, we monitored 37 CB calls in the Den-



Jim Peterson, Technical Supervisor, Ampex Video Institute, makes last minute checks prior to taping skiing events by Interski teams. Unit on his belt is CB receiver; transceiver is between recorders.



Your CB Editor's XYL, Peggy Spinello, chats with Commodore & Mrs. Gugenheim, dockside at The Abbey, Fontana, Wisconsin. Messenger "300" transceiver carried by Peggy is used by CB Editor for monitoring purposes on jaunts around United States.

ver area. Statistics: 7 skip transmissions; 4 downright illegal; 26 clean, necessary, and with call-signs. Although our declaration may set us up with another letter from our friend in Arvada, Colorado (see June issue), our statistics still hold Denver in first place as the cleanest operating area we have visited to date on our Monitour.

Fontana, Wisconsin Following a fast jet trip to Chicago's O'Hare International Airport, we headed north with the XYL to attend the 5th anniversary celebration of The Abbey, a \$6,000,000 resort located on the west edge of Lake Geneva. With thanks to KHR2525, Sharon, Wisconsin, and Leroy, KHD3284, Williams Bay, Wisconsin, we were put on the right road following an attempt at shortcutting on the wrong backroad.

During an extended weekend we learned that The Abbey maintenance and service section has used CB radio for a number of years to dispatch personnel to any of the hotel's rooms, restaurants, lounges, recreation and entertainment areas, and the Harbour House, where more than 400 cabin cruisers are docked. We learned as well, that a number of the guests' boats are CB-equipped and may reach The Abbey's base station from anywhere on Lake Geneva. One cruiser captain admitted that his CB gear saved the day last summer when storm warnings were announced and he ran out of gas in the middle of the lake.

Monitour statistics for the area: All channels surprisingly quiet during daylight hours; early evening chit-chat mixed with skip

transmissions, but no code names used. There is, however, a linear amplifier being used either in Janesville, Wisconsin or Roscoe, Illinois, blotting out surrounding transmissions and the operator is working without call-signs, generally boasting about his output. Someone should check this station out!

Next month: Monitour reports from Oklahoma City, Los Angeles, and San Francisco, California.

I'll CB'ing you.
-Matt, KHC2060

1968 OTCB JAMBOREE CALENDAR

The jamborees, campouts and get-togethers listed below have been scheduled by CB clubs in various parts of the country. Licensed CB'ers, electronics buffs, and those simply interested in knowing what it's all about, are invited to contact the clubs or club representatives at the addresses given.

St. Paul, Minnesota August 3-4
Event: 1st CB Jamboree and Campout. Location: Sunrise Park, Lino Lakes, Minn., 10 miles north of St. Paul. Sponsor: Northwest CB Association. Contact: C. B. McLellan, KRF0725, 1556 Sherwood Ave., St. Paul, Minn. 55106

Nova Scotia, Canada August 16-18
Event: Annual Nova Scotia CB Jamboree. Location: Cameron Lake. Sponsor: Kingfisher CB Radio Club, Inc. Contact: Doug Corkun, 30 Joyce Ave., Sprayfield, Nova Scotia, Canada.

Denver, Colorado August 17-18
Event: Metro CB Jamboree. Location: Jefferson County Fairgrounds. Sponsor: Metropolitan Denver CB Radio Club. Monitor: Channel 9.

Lexington, North Carolina August 17-18
Event: First CB Jamboree. Location: Davidson County Fairgrounds. Sponsor: Pioneer CB Club. Contact: Virginia Athay, KOK3171, 11 Hawthorne Lane, Lexington, N.C. 27292.

Clementon, New Jersey August 18
Event: UCBRC 2nd Annual Jamboree. Location: Clementon Lake Park, N.J. Sponsor: United Citizens Band Radio Club, Inc. Contact: UCBRC, P.O. Box 58, Stratford, N.J. 08084.

Richmond, Virginia August 24-25
Event: 9th Annual Convention & Trade Show. Location: Jefferson Hotel. Sponsor: Virginia State Citizens Band Radio Assn. Contact: Convention '68, Helen Resnick, P.O. Box 7032, Richmond, Va. 23221.

Silver Springs, Maryland August 25
Event: CB-Orama. Location: Silver Spring Boys Club. Sponsor: Channel Busters CB Radio Club. Contact: CB Committee, P.O. Box 1634, Hyattsville, Md.

Concord, New Hampshire August 25
Event: Third Annual Jamboree. Location: Highway Hotel Convention Hall. Sponsors: Central N.Y. 5 Watters CB Club and Capital City CB Club, Inc. Contact: Jamboree, P.O. Box 181, Concord, N.H.

Huntsville, Alabama September 14-15
Event: Fall Festival CB Jamboree. Sponsor: Emergency Citizens Band Monitors, Inc. Contact: ECBM, P.O. Box 1542, Huntsville, Ala. 35807.

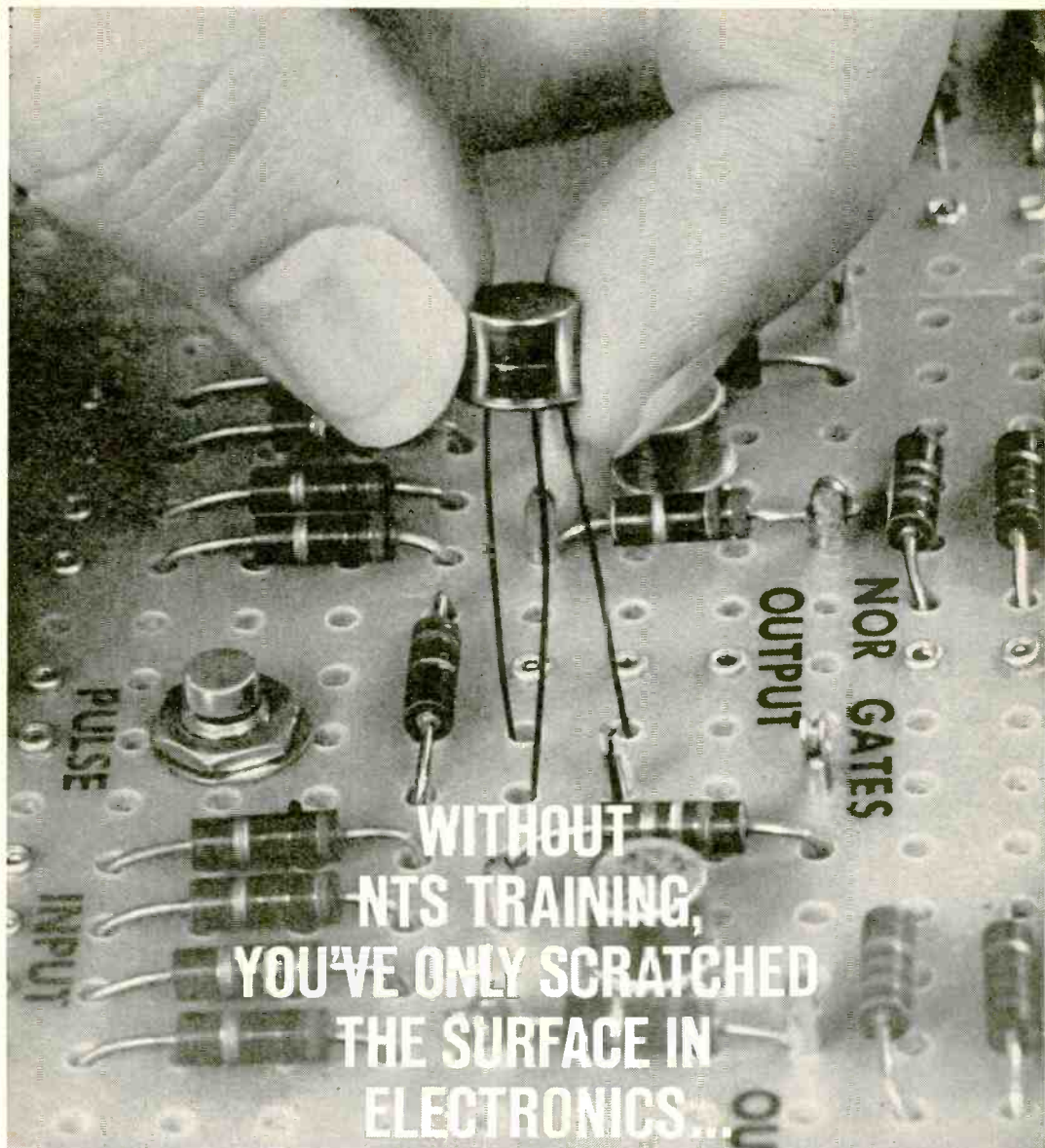

Only NTS penetrates below the surface. Digs deeper. Example? Take the above close-up of the first transistorized digital computer trainer ever offered by a home study school.

It's called The Compu-Trainer®—an NTS exclusive. Fascinating to assemble, it introduces you to the exciting world of computer electronics. Its design includes advanced solid-state NOR circuitry,

flip-flops, astable multivibrators and reset circuits. Plus two zener and transistorized voltage-regulated power supplies. The NTS Compu-Trainer® is capable of performing 50,000 operations per second.

Sound fantastic? *It is!* And at that, it's only one of many *ultra-advanced* kits that National Technical Schools offers to give you incomparable, in-depth career training.

PROVE IT YOURSELF. SEND FOR OUR NEW CATALOG. SEE THE LATEST, MOST ADVANCED KITS AND COURSES EVER OFFERED BY A HOME STUDY SCHOOL.

NTS...THE FIRST HOME STUDY SCHOOL TO OFFER LIVE EXPERIMENTS WITH INTEGRATED CIRCUIT KITS

You build a computer sub-system using the new, revolutionary integrated circuits. Each one, smaller than a dime, contains the equivalent of 15 resistors and 27 transistors.

And your kits come to you at no extra cost. These kits are the foundation of the exclusive *Project-Method* home study system...developed in our giant resident school and proven effective for thousands of men like yourself.

With Project-Method, all your kits are carefully integrated with lesson material. Our servicing and communication kits are *real* equipment—not school-designed versions for training only. As you work on each of the projects, you soon realize that even the most complicated circuits and components are easy to understand. You learn *how* they work. You learn *why* they work.

NTS Project-Method is a practical-experience approach to learning. The approach that works *best!* An all-theory training program can be hard to understand — difficult to remember. More than ever before you need the practical experience that comes from working with real circuits and components to make your training stick.

NTS SENDS YOU KITS TO BUILD THESE IMPORTANT ELECTRONICS UNITS!

- ◆ 25" COLOR TV
- ◆ 21" BLACK & WHITE TV
- ◆ SOLID-STATE RADIO
- ◆ AM-SW TWIN-SPEAKER RADIO
- ◆ TUBE-TESTER
- ◆ TRANSCEIVER
- ◆ COMPU-TRAINER®
- ◆ VTVM
- ◆ SIGNAL GENERATOR

See them all illustrated in
the new NTS Color Catalog.

CLASSROOM TRAINING AT LOS ANGELES: You can take classroom training at Los Angeles in sunny Southern California. NTS occupies a city block with over a million dollars in facilities devoted exclusively to technical training. Check box in coupon.

NATIONAL TECHNICAL SCHOOLS

WORLD-WIDE TRAINING SINCE 1905
4000 So. Figueroa Street, Los Angeles, Calif. 90037

APPROVED FOR VETERANS

Accredited Member: National Home Study Council
Accredited Member: National Association of
Trade and Technical Schools



COMMUNICATIONS

This transceiver is included in Communications courses. You build it. With it, you easily prepare for the F.C.C. license exam. You become a fully-trained man in communications, where career opportunities are unlimited.

25" COLOR TV ▼

Included in Color TV Servicing Courses. With it you advance yourself into this profitable field of servicing work. Color is the future of television, you can be in on it with NTS training.

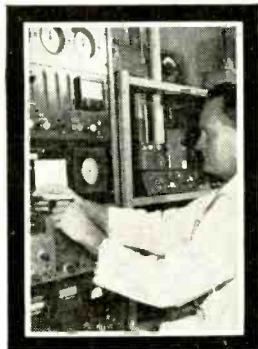
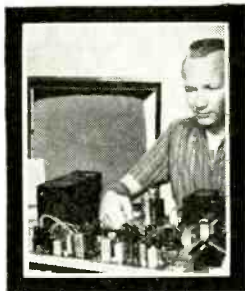

YOUR OPPORTUNITY IS NOW

New ideas, new inventions, are opening whole new fields of opportunity. The electronic industry is still the fastest growing field in the U.S. There's a bigger, better place in it for the man who trains today. So, whatever your goals are — advanced color TV servicing, broadcasting, F.C.C. license, computers, or industrial controls, NTS has a highly professional course to meet your needs.

GET THE FACTS! SEE ALL NEW COURSES AND KITS OFFERED IN THE NEW NTS COLOR CATALOG. SEND THE CARD OR COUPON TODAY!

There's no obligation. You enroll by mail only. No salesman will call.

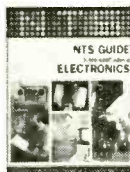

DEPT. 205-88

NATIONAL TECHNICAL SCHOOLS

4000 S. Figueroa St., Los Angeles, Calif. 90037

Please rush Free Color Catalog and Sample Lesson, plus information on field checked below. No obligation.

- | | |
|---|--|
| <input type="checkbox"/> MASTER COURSE IN COLOR TV SERVICING | <input type="checkbox"/> PRACTICAL TV & RADIO SERVICING |
| <input type="checkbox"/> COLOR TV SERVICING | <input type="checkbox"/> FCC LICENSE COURSE |
| <input type="checkbox"/> MASTER COURSE IN TV & RADIO SERVICING | <input type="checkbox"/> INDUSTRIAL & COMPUTER ELECTRONICS |
| <input type="checkbox"/> MASTER COURSE IN ELECTRONIC COMMUNICATIONS | <input type="checkbox"/> STEREO, HI FI & SOUND SYSTEMS |
| | <input type="checkbox"/> BASIC ELECTRONICS |

NAME _____ AGE _____

ADDRESS _____

CITY _____ STATE _____ ZIP _____

- Check if interested in Veteran Training under new G. I. Bill.
 Check if interested ONLY in Classroom Training at Los Angeles.



SHORT-WAVE LISTENING

By HANK BENNETT, W2PJA/WPE2FT
Short-Wave Editor

RANDOM NOTES FROM HERE AND THERE

International Correspondence Chief Jose Diny's of *R. Aparecida*, Brazil (see photo in Jan. 1968 issue) is interested in receiving tape recordings of the *R. Aparecida* on 9635 kHz. Such reports must be of at least 5 minutes duration, and the voice of the station's announcer must be heard on the tape. Satisfactory reports will be awarded a special diploma. If four IRCs accompany your tape recording, the diploma will be sent via airmail in a special envelope.

An overseas monitor has received word that the new medium wave station on St. Helena Island is known officially as *St. Helena Government Broadcasting Station*. Located at Jamestown, it operates on 1511 kHz with 1000 watts on Fridays at 0945-1100 for schools, Saturdays at 1700-1800 and Sundays at 1200-1300 and 1700-1800. Sometime in 1969, a new "powerhouse" is to go on the air, replacing the present low-powered station. Broadcasting time will be increased and there will be, in addition, a

BBC relay station. The station has verification cards ready for distribution to those who submit correct reception reports.

An attractive Listeners' Club Certificate and a badge are being offered by *Radio Australia* until the end of 1968. To qualify, you must send 12 reception reports—two each month for a six-month period. While this item was received too late for inclusion in an earlier issue, it might still be worth your time and effort to send *Radio Australia* a dozen reports within the time remaining.

Reception reports and letters from foreign listeners are being answered by YSS, *R. Nacional de El Salvador*, San Salvador, 6010 and 9555 kHz, in a program called "Reportes del Mundo" on Tuesday at 0245 and 0445, and on Sunday at 2330. Your columnist hasn't logged this program but assumes it is in Spanish.







A letter has been received from the Department of Information, P. O. Box 353,
(Continued on page 114)



Using only the telescoping antenna in his Grundig TR1000 receiver, Harvey Straus, WPE2QJB, Great Neck, N.Y. has logged over 50 countries. More than 20 countries and 25 states have been verified. On the wall behind Harvey are some of the colorful QSL cards and membership certificates he has received.



Ben and Delores Messersmith, WPE7CLQ, Ogden, Utah, use either a DX-150 or Hallicrafters S-118 for monitoring the short-wave bands. Also visible in this photo is a CB transceiver, police monitor receiver, and a variety of useful test equipment. The Messersmiths have jointly logged over 100 countries.

M-11  Solid State Units All Silicon Transistor VHF-FM Pre-amplifier — 20 dB, 300 ohm In — 75 ohm Out	M-19  Solid State Units All Silicon Transistor FM Pre-amplifier — 20 dB, 75 ohm In — 75 ohm Out	M-116  Solid State Units 82-channel solid state — 25 dB Dist. Amplifier Separate UHF and VHF 75 ohm inputs.	M-118  Solid State Units All Silicon Transistor VHF-UHF Home Amplifier — Four 75 ohm Outputs	M-108  Solid State Units All Silicon Transistor VHF 40 dB Distribution Amplifier	M-403  Solid State Units UHF to VHF Crystal Controlled Converter
--	---	---	--	--	--

FINCO

MATV EQUIPMENT

...THE COMPLETE LINE

M-170  Solid State Units Single Channel Strip Amplifier 40 dB Gain	M-248  82-Channel Antenna Mounted Transformer — Die-Cast Housing
M-22  Solid State Units 82-Channel Mast Mounted Pre-amplifier 15 dB	M-261  Four-Way Back Match 82-Channel Splitter indoor
M-206  Four-Way Back Match Splitter indoor	M-210  Eight-Way Back Match Splitter

from the largest
broad-band or single-channel
strip amplifier...
to the smallest
connector
or any one of
over 200 items!

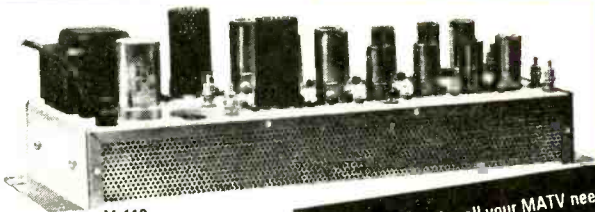







M-110
1 Volt per Channel on 9 Channels, 60 dB Distribution Amplifier

M-304
Dual Output Plate 75 ohm outlet TV 300 ohm outlet FM



- A single source for all your MATV needs.
- Silicon solid state design.
- Built to the highest standards.
- Free MATV layout service.
- Heavy duty 75 ohm MATV Antennas.

M-214  Matched Line Drop Tap — Outdoor Cast Housing	M-213  Matched Line Drop Tap indoor	M-526  Hi-Q Single Carrier Trap, 60 dB Attenuation	M-300  Single 300 Ohm output Wall Outlet Plate — VHF	M-552  Variable Attenuator 0 to 82 dB in 1 dB Steps	M-550  Transistorized Field Strength Meter VHF
--	---	--	--	---	---

Illustrations represent a cross section of over 200 MATV items

USE FINCO MATV ANTENNA SYSTEMS FOR HOTELS • MOTELS • SCHOOLS
HOSPITALS • STORES • OFFICE BUILDINGS • APARTMENTS • HOMES



THE FINNEY COMPANY
FINCO is the maker of the world famous Color Spectrum Antennas

Send for FINCO'S FREE 45-page illustrated MATV catalogue and layout information forms.
THE FINNEY COMPANY
34 W. Interstate Street • Dept. PE-8
Bedford, Ohio 44146

ENGLISH-LANGUAGE BROADCASTS TO NORTH AMERICA FOR THE MONTH OF AUGUST,

Prepared by **ROGER LEGGE**

TO EASTERN AND CENTRAL NORTH AMERICA		TO WESTERN NORTH AMERICA	
TIME—EDT	STATION AND LOCATION	TIME—PDT	STATION AND LOCATION
	FREQUENCIES (MHz)		FREQUENCIES (MHz)
7:00 a.m.	Stockholm, Sweden	8:00 a.m.	Tokyo, Japan
7:15 a.m.	Melbourne, Australia	7:00 p.m.	Melbourne, Australia
8:15 a.m.	Montreal, Canada		Taipei, China
8:45 a.m.	Copenhagen, Denmark		Tokyo, Japan
7:00 p.m.	Helsinki, Finland	7:30 p.m.	Johannesburg, South Africa
	London, England	8:00 p.m.	London, England
	Montreal, Canada		Madrid, Spain
7:45 p.m.	Tokyo, Japan		Peking, China
8:00 p.m.	Moscow, U.S.S.R.		Seoul, Korea
	Sofia, Bulgaria	8:30 p.m.	Berlin, Germany
8:30 p.m.	Budapest, Hungary		Bonaire, Neth. Antilles
	Johannesburg, South Africa		Prague, Czechoslovakia
	Kiev, U.S.S.R. (Mon., Thu., Sat.)		Stockholm, Sweden
	Oslo, Norway (Sun.)	9:00 p.m.	Havana, Cuba
	Stockholm, Sweden		Lisbon, Portugal
8:50 p.m.	Vatican City		Moscow, U.S.S.R. (via Khabarovsk)
9:00 p.m.	Berlin, Germany		Peking, China
	Havana, Cuba		Sofia, Bulgaria
	Madrid, Spain	9:30 p.m.	Bucharest, Rumania
	Peking, China		Budapest, Hungary
	Prague, Czechoslovakia		Kiev, U.S.S.R. (Mon., Thu., Sat.)
	Rome, Italy		Oslo, Norway (Sun.)
9:30 p.m.	Berne, Switzerland	9:45 p.m.	Berlin, Germany
	Bucharest, Rumania		Cologne, Germany
	Cologne, Germany	10:00 p.m.	Havana, Cuba
	Hilversum, Holland		Tokyo, Japan
	Tirana, Albania	10:15 p.m.	Berne, Switzerland
10:00 p.m.	Cairo, Egypt	11:00 p.m.	Moscow, U.S.S.R. (via Khabarovsk)
	Lisbon, Portugal	11:30 p.m.	Havana, Cuba
	London, England		
	Melbourne, Australia		
	Moscow, U.S.S.R.		
	Stockholm, Sweden		

FREE!

1969
CATALOG
No. 690

JUST OFF THE PRESS!!
SEND FOR YOUR EXCITING COPY NOW!



**BIGGER
& BETTER
THAN EVER**
OVER **500** PAGES!

**YOUR 1st GUIDE TO
EVERYTHING IN
ELECTRONICS**

- ★ CITIZENS BAND 2-WAY RADIO
- ★ STEREO/HI-FI COMPONENTS
- ★ MUSICAL INSTRUMENTS AND AMPLIFIERS
- ★ PUBLIC ADDRESS
- ★ AMATEUR RADIO
- ★ TEST EQUIPMENT
- ★ PARTS
- ★ PORTABLE AND TABLE RADIOS
- ★ PHOTO EQUIPMENT
- ★ TOOLS
- ★ AUTO ACCESSORIES
- ★ EDUCATIONAL AND OPTICAL
- ★ TV AND ANTENNAS
- ★ BOOKS

LAFAYETTE Radio ELECTRONICS
Dept. 21, P.O. Box 10
Syosset, L.I., N.Y. 11791

Mail This Coupon Today
For Your 1969 Catalog
No. 690.

Please send the FREE 1969 LAFAYETTE Catalog 690

21

Name

Address

City State

Zip

(please include your Zip Code No.)

CIRCLE NO. 24 ON READER SERVICE PAGE

WHO WAS THAT MASKED MAN?

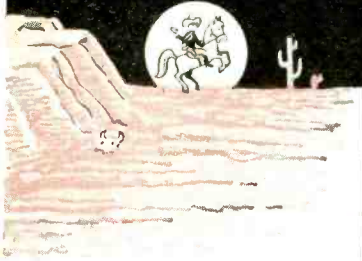

That was no masked man, that was a

Long Ranger

fiberglass CB antenna from Shakespeare . . . the 176 "Big Stick" (18'6") antenna to be specific. The antenna that gives you maximum wind and weather protection. It's another performance-proven No. 1 Shakespeare fiberglass product.

You won't get a shining light, fancy gain claim, gizmo or a silver bullet. We let the antenna do the talking. With a "Big Stick" you don't have to shout. Speak softly.



C/P CORPORATION

R.F.D. 3, Columbia, S. C. 29205
Phone (803) 787-8710

a subsidiary of

Shakespeare



CIRCLE NO. 9 ON READER SERVICE PAGE

PARTS/METHODS/IDEAS/GADGETS/DEVICES

tips & techniques

CALIBRATED POTS AID EXPERIMENTING

There is nothing new about using potentiometers to determine the optimum value of a resistance in an experimental circuit. You simply connect a pot temporarily in the circuit and adjust for the correct results. Then you remove the pot and measure its effective resistance with an ohmmeter. This is a time-consuming, inefficient process. You can do the job faster if you attach a heavy cardboard disk (about 1½" to 2" in diameter) to the pot's shank with two control nuts and a lockwasher. Then calibrate the pot, using an ohmmeter to determine the settings of the major resistance marks. Linear-taper potentiometers are best for this operation, and the major settings depend on the total resistance value of the pot. Several calibrated pots with the most commonly used resistance ranges will cover most needs. Finally, secure a pointer knob to the shaft of the pot.

—Robert E. Kelland

MAKE VECTOR-PIN INSERTER TOOL

You can make a Vector-pin inserter from a 3"-long soft aluminum rod. Drill a 0.111" hole about 5/8" deep in one end of the rod. After drilling the hole, slowly and carefully squeeze the drilled end in a vise. You should be able to slide the Vector pin into the hole easily but the tool should hold the pin firmly once it is in place. The blunt end of the inserter can also be used to remove pins from Vector board without damaging either the board or pins.

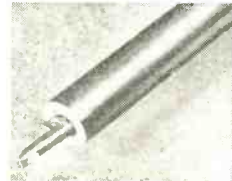

—Stephen E. Maziarz

INTERCOM SPEAKER SUBSTITUTE

Since good buys on 45-ohm loudspeakers are rare, it is sometimes more economical to use a 4- or 8-ohm speaker when making replacements in equipment calling for 45-ohm speakers. To make this substitution, you will need an impedance-matching transformer (Lafayette Radio Electronics stock 33H8578 at \$1.75, or similar) with a nominal primary impedance of 45 ohms and a secondary impedance to match the new speaker. The fact that many of these transformers are designed for use in transistor circuits does not bar

twenty dollars less.



The world's finest CB mobile radiophone is now \$20 less than it used to be. Pace 2300 was \$220. It's now \$200. You get the savings we've been able to make through manufacturing efficiencies. See your Pace dealer or send for descriptive spec sheet.

We'll also include literature on our complete line of CB units, including our exclusive new solid state Base Station—the first base station that's complete in itself, with no extra meters to buy.

PACE COMMUNICATIONS CORP. ((P))
A NOVATECH CO.

24049 S. Frampton Ave., Harbor City, California 90710
ENGINEERED WITH THE ENGINEER IN MIND



not by a long shot it isn't !!

There's certainly nothing top secret about Popular Electronics' classified pages. They're wide open to every buyer in the market for the product or service he knows can be found in Electronics Market Place.

More than 400,000 buyers of Popular Electronics, largest readership of any electronics magazine in the world, guarantee that your ad is being read by people constantly looking for and buying electronics products. It is these people to whom you MUST direct YOUR advertising as do the many key advertisers appearing in this issue and in each issue throughout the year.

No doubt about it—there's a vast market of buyers searching the classified advertising pages of Popular Electronics and it's important that your ad be exposed to them. Prove to yourself that the leading electronics magazine MUST ALSO be the leader in sales responses to the many classified ads presently enhancing its pages—it makes a great deal of sense—give it a try.

See classified section for rate information or write to HAL CYMES, *Classified Advertising Manager*
ZIFF-DAVIS PUBLISHING COMPANY
One Park Avenue, New York, N. Y. 10016

TIPS

(Continued from page 96)

their use in vacuum tube circuits. Power rating of the transformer does not have to be as great as the capability of the speaker as long as volume level is maintained below the power-handling capability of the transformer.

—Robert L. Brown

QUICK-CHANGE PROBE CONNECTOR

Quick-change capability can be built into a VTVM or other test equipment that uses a microphone connector for attaching test cables. Replace the mike connector with BNC coaxial cable fitting. The BNC fittings are shielded, assure positive electrical contact, and can be disconnected with a simple quarter-turn motion. To make the substitution remove the old mike connector and re-

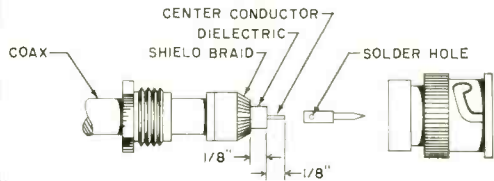

place it with a UG-1094A/U BNC connector. Replace the fitting on the test cable with a UG-88/U BNC connector (see drawing). Since the shorting switch in some VTVM probes can be erratic on the low resistance range, it is a good idea to make a straight-through test cable for this function, using a UG-88/U BNC connector, a length of RG-58A/U, and two alligator clips.

—Robert N. Tellefsen, W0KMF

SAFE CONNECTIONS FOR TRANSISTORS

Home-made J-clamps can save the day when you need a means of safely connecting the large pins of a TO-8 transistor or SCR into a circuit. The clamps can be easily fabricated from thin brass or copper-shim stock as

shown in the photo. For TO-8 pins, cut the shim stock to $\frac{3}{16}$ " x $\frac{1}{4}$ ", fold over $\frac{1}{4}$ " from one end (use the transistor or SCR pin to obtain the correct fold radius), and drill a $\#42$ hole through

both tabs $\frac{3}{16}$ " from the fold. Then drill another much smaller hole through the tab opposite the fold. Finally, secure the clamps to the transistor pins with $\#2-56$ hardware, and solder the hookup wires to the tabs, passing the wires through the small holes. Be sure the hardware holds the clamps firmly in place. If desired, you can also slip a length of heat-shrinkable tubing over the clamps to keep them insulated from the surrounding circuit.

—Frank H. Tooker

POPULAR ELECTRONICS



SAVE BIG MONEY ON ELECTRONICS

Buy from RADIO SHACK, America's biggest nationwide electronics store chain. Send now for your free copy of our new 1968 bargain-packed electronics catalog, available soon . . . plus a year of special bargain bulletins. Write to —

RADIO SHACK®

2727 West 7th St., Dept. VV
Fort Worth, Texas 76107

FREE CATALOG AND BARGAIN BULLETINS

Name

Address

City State Zip

Radio Shack Corporation — subsidiary of Tandy Corp. • Over 190 stores coast to coast

CIRCLE NO. 44 ON READER SERVICE PAGE



CB ANTENNAS

(Continued from page 66)

ment on a boom with several directors and reflectors—Yagi fashion—dates back many years before CB. The elements in beam antennas for CB use are usually vertical. The element arrangement concentrates the signal energy into a fairly narrow beam.

Since beam antennas are so common, most manufacturers include them in their CB antenna catalogs. The most popular sizes are 3-element and 5-element beams. The gain of a 3-element is about 8 dB; for a 5-element, about 10. Some gain figures are higher, but you must know the reference; beams are occasionally rated against a free-air dipole instead of an isotropic source, or $\frac{1}{4}$ -wave ground-plane monopole. Side-by-side beams are also common and 5-and-5 stack can have a gain of 15 dB, and a 3-and-3, about 12 dB.

Verticals and Verticals. Probably the most popular CB base station antennas are the monopoles. These antennas are

usually $\frac{1}{2}$ - and $\frac{5}{8}$ -wave vertical radiators, some with contrivances at the base of the radiator that take the place of ground planes. These monopoles are technically called *collinear* antennas because they are, in effect, two driven elements "in line."

Dominating the vertical collinears are the $\frac{5}{8}$ -wavelength antennas. The gain of this type of antenna is usually referred to as a $\frac{1}{4}$ -wave monopole, and ranges from 3.4 to 4 dB. All are omnidirectional. Among them, however, there are many recognizable differences.

The Antenna Specialists' *Super Magnum*, for example, has a double circle on top which looks almost like a sphere. Its purpose is to avoid a sharp vertical point which can accumulate static charges that contribute to receiver noise. The "sphere" also has the effect of a top-hat somewhat lowering the radiation angle.

The odd wavelength relationship of $\frac{5}{8}$ -type monopoles gives them a peculiar impedance at the feed point, which is usually near the bottom of the antenna in spite of whatever parasitic elements take the place of the conventional ground

Add LIFE to your color TV, stereo radio and electronic equipment

 DELWYN™

Whisper Fan®

- Made especially for cooling transistors, tubes and other heat generating components
- Helps guard against part failure
- Ensures trouble-free life — peak performance
- Costs only a few pennies to operate — saves dollars in repair bills
- So quiet and noise-free, you have to feel the breeze to know it is at work
- Quickly and easily installed



Only
\$14.85
Complete!

Ask your dealer to demonstrate how the Delwyn Whisper Fan will pay for itself in savings on just one heat-caused repair bill.

 DELWYN

BOX 195 B, Route 26
Kingston, New York 12401

CIRCLE NO. 14 ON READER SERVICE PAGE

		<h2>CB ANTENNAS</h2>											
<p>NEW <i>Ringo</i></p> <p>Now an improved model of the famous CR-1. Make Ringo your performance choice today!</p>		<p>3.75 db GAIN BASE STATION VERTICAL MODEL CR-1 \$18.95</p>											
		<p>BALANCED BEAMS</p> <table border="0"> <tr><td>3 ELEMENT</td><td>\$29.50</td></tr> <tr><td>4 ELEMENT</td><td>39.50</td></tr> <tr><td>5 ELEMENT</td><td>59.50</td></tr> <tr><td>6 ELEMENT DUAL</td><td>99.50</td></tr> <tr><td>8 ELEMENT DUAL</td><td>119.50</td></tr> </table>		3 ELEMENT	\$29.50	4 ELEMENT	39.50	5 ELEMENT	59.50	6 ELEMENT DUAL	99.50	8 ELEMENT DUAL	119.50
3 ELEMENT	\$29.50												
4 ELEMENT	39.50												
5 ELEMENT	59.50												
6 ELEMENT DUAL	99.50												
8 ELEMENT DUAL	119.50												
<p>TRIK STIK ALL PURPOSE Universal Antenna Citizens Band•Monitor• Ham•CD•FM•TV•Air- craft•SWL•Business Radio •Universal Mount</p>		<p>MODEL TS-1</p>  <p>\$6.45</p>											
<p>PROTECT YOUR EQUIPMENT</p> 		<p>BLITZ BUG COAXIAL LIGHTNING ARRESTER over 250,000 in use MODEL LAC-1 \$3.95 MODEL LAC-2 \$4.45</p>											
<p>U. S. PATENT #2,922,913</p> 		<p>621 HAYWARD STREET MANCHESTER, N. H. 03103</p>											

CIRCLE NO. 13 ON READER SERVICE PAGE







FREE

Fill in coupon for a **FREE** One Year Subscription to **OLSON ELECTRONICS' Fantastic Value Packed Catalog—Unheard of LOW, LOW PRICES on Brand Name Speakers, Changers, Tubes, Tools, Stereo Amps, Tuners, CB, and other Values. Credit plan available.**

NAME _____

ADDRESS _____

CITY _____ STATE _____

GIVE ZIP CODE _____

If you have a friend interested in electronics send his name and address for a **FREE** subscription also.

OLSON ELECTRONICS
INCORPORATED

923 S. Forge Street, Akron, Ohio 44308

CIRCLE NO. 42 ON READER SERVICE PAGE

plane. The *Super Magnum*, though, does have a conventional ground plane, with four $\frac{1}{4}$ -wave radials. To match its feed-point impedance to 50-ohm coax, a small coil is built into the antenna base.

The Hy-Gain *CLR2* includes a conventional top-hat with three tiny radials at the tip of the radiating element. The ground plane consists of three $\frac{1}{4}$ -wave radials.

Impedance is matched in this antenna by moving the ground point—where the ground-plane radials attach—several inches above the bottom of the radiating element.

The *Devant 1* and *Devant Special*, made by Mosley Electronics, Inc., are alike except for a small top-hat on the *Special*, giving it a small gain advantage. Both are $\frac{5}{8}$ -wave radiators, with three-radial ground planes at the bottom. The *Devants* have an unusual matching device at the bottom—a loop resembling a trombone that extends along one radial and around the radiator; the device is called *Induct-O-Match*.

Webster Mfg. Co. (Division of Raytheon), has a straightforward rugged $\frac{5}{8}$ -wave collinear with four ground-plane radials and a matching section at the base. Its model number is *BCL-1*. A tiny three-element capacity loading top-hat concentrates the pattern lower on the horizon.

At least two $\frac{5}{8}$ -wave collinear CB base station antennas are of the coaxial type. That is, a metal "skirt" surrounds (and is insulated from) the base section of the antenna while serving the usual purpose of a ground plane. Coaxial antennas are usually fed at the "center"—the juncture between the skirt and the upper radiating element. Typical of this breed is the *Webster BCX-1*.

On the Mark Products coaxial model—the *Mark V*—three long, thin, wire-like elements form the coaxial skirt. They are placed 120 degrees apart, surrounding the support mast and are insulated from it.

An unusual $\frac{1}{2}$ -wave vertical monopole is the Cush Craft *Ringo*. Its tall radiator is surrounded at the bottom by an aluminum ring, about 10 inches in diameter, which is in series with the radiating element. There are no ground-plane radials. One end of the open ring is attached about 9 inches up from the very

POPULAR ELECTRONICS

end of the monopole. The ring encircles the monopole, and the other end is grounded to the support pipe. The 9 inches of monopole below the ring is down inside (but insulated from) the support. This unique arrangement loads the bottom of the monopole inductively, matching impedance for the drive point and producing some of the same effects on the radiated beam as the capacitive top-hat does in other antennas.

The effects of precipitation static—electrical noise generated by wind, humidity, and nearby thunderclouds—are cut down in the Mark Products' *Super Beacon* by a coating of extruded vinyl over the entire $\frac{1}{2}$ -wave radiating element. There are no radials or other ground-plane elements; impedance matching is through a special section of coaxial cable. The overall length of the *Super Beacon* approaches that of most $\frac{3}{4}$ -wavelength monopoles (nearly 20 feet), but the interval feed point makes it resonate as a $\frac{1}{2}$ -wave radiator.

A couple of special verticals can be classified in the $\frac{1}{2}$ -wave category: the Mark Products *Long Ranger* and the Hy-Gain *Goldenrod*. Both are new and have distinctive features.

The *Long Ranger* is a vertical unipole radiating element (half a folded dipole) that is only the top half of the antenna. The grounded side of the unipole, opposite the feed point, extends downward a $\frac{1}{4}$ -wavelength—to act as a parasitic element.

On the side where the unipole is fed, a grounded coaxial "skirt" extends downward a little more than $\frac{1}{4}$ -wavelength. It is mainly an impedance matching section, but also is a mounting support.

The distinctive feature of the *Goldenrod* is its short curved radials that act as a ground plane. There are three of them, curved like a pinwheel requiring little mounting space.

Conclusion. With so many new and unusual designs to choose from, picking your base antenna may be a chore. Aside from the gain you feel you need, you should check sturdiness, size, weight, beam width, and directionality. Balance one requirement against another until you come up with the combination that best suits your location, your uses, and your pocketbook.

NOW OFFERED FOR THE FIRST TIME TO THE PUBLIC

GRAYMARK

ELECTRONICS PROJECTS

Hobbyist / Experimenter / Student

For years, teachers have used Graymark classroom projects to provide (1) the basics of electronics theory and (2) valuable and workable end products. Now, for the first time, Graymark offers certain of these projects to the public. You can now embark on an exciting, step-by-step journey toward the building of your own highly professional, eight-transistor or five-tube radio . . . besides learning a great deal about electronics. Each project comes complete with all parts and easy-to-follow instructional manual. All parts fully warranted.



"COMACHO" EIGHT-TRANSISTOR RADIO. Project provides basics of superheterodyne transistor theory operation. Builds into an attractive printed circuit-board radio, mounted in plastic case. Compares favorably with more expensive units. Earphone included. \$19.95 each.

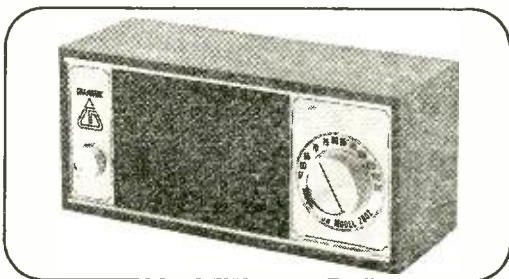

"SCALLON" FIVE-TUBE RADIO. Easy-to-understand project approach to superheterodyne circuitry. Assembles into a distinctive table-type radio. Tubes, contemporary walnut cabinet included. \$21.95 each.

 Send order today to:
GRAYMARK Enterprises, Incorporated
Dept. 101, P.O. Box 54343, Ter. Annex, Los Angeles, Calif. 90054

- Send Projects Checked
 COMACHO (\$19.95 ea.) SCALLON (\$21.95 ea.)
 Send Postpaid. Enclosed find check/money order for full amount. (Calif. Res. add 5% to total purchase)
 Send C.O.D. I will pay full amount, plus postage.

Name _____

Address _____

City & State _____ Zip _____

CIRCLE NO. 19 ON READER SERVICE PAGE

NEW Mosley CB STACK'IT Beam

Extra gain for nearly 1/2 the previous cost of stacking Mosley beams.

4610 N. Lindbergh Blvd.
Mosley Electronics Inc. Bridgeton Missouri 63042

Please send me FREE of charge and obligation, literature on the STACK'IT beams.

Name _____

Address _____

City/State _____

Zip Code No. _____

Mosley Electronics Inc. #108

4610 N. Lindbergh Blvd. Bridgeton Mo. 63042

CIRCLE NO. 25 ON READER SERVICE PAGE

The serious shortwave listener needs Hammarlund quality

The sensitivity and selectivity needed for commercial and military circuits are built into every Hammarlund receiver. "Off the shelf" Hammarlund receivers are in use 24 hours a day, 7 days a week, everywhere in the world. When you buy Hammarlund, you buy the best.

Write for free full specifications of World famous Hammarlund Receivers.

SHORTWAVE LISTENING GUIDE

Tells how to get the most out of shortwave listening. Get yours by sending 25¢ today.

THE
HAMMARLUND
MANUFACTURING COMPANY, INC.

73-88 HAMMARLUND DRIVE, MARS HILL, NORTH CAROLINA 28754

CIRCLE NO. 21 ON READER SERVICE PAGE

102

SOLID STATE

(Continued on page 85)

at 10 kHz with less than a 2-dB change at 200 Hz, while at 20 kHz it can provide up to 29-dB boost, or a 26-dB cut. Distortion is less than 0.7% at 1-volt output.

The IC is a limited-gain, frequency-sensitive amplifier with basic stage gain established at two by voltage-divider $R1-R2$ in the negative feedback loop. Another voltage-divider ($R3-R4$) at the input reduces overall gain to unity. In operation, potentiometer $R5$ works in conjunction with shunt capacitor $C1$ to vary the circuit's overall frequency response. As $R5$'s center arm is moved towards pin 2, the higher frequencies in the feedback are shunted to ground, increasing the amplifier's effective gain at these frequencies. Adjusting $R5$ towards the other end of its range (pin 5) shunts the higher frequencies to ground at the input, thus decreasing gain at these values.

The bass control circuit in Fig. 3 can provide a boost of 15 dB, or a cut down to 23 dB at 20 Hz, with less than a 1-dB change at 2 kHz. At 10 Hz, boosts of as much as 20 dB, or cuts down to 25 dB are possible. Distortion is less than 0.7% with an output of 1 volt.

In general sense, the bass control circuit's operation is almost identical to that of the treble control, except that the shunt capacitor has been replaced by an inductive reactance, $L1$, and resistor values have been changed to adjust the turn-over frequency.

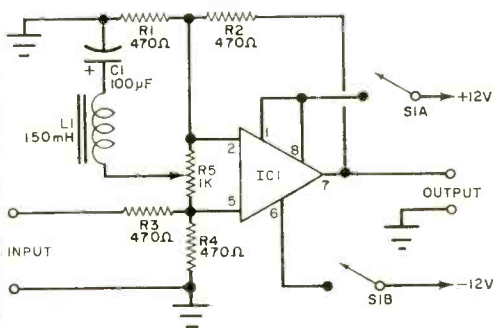

Fig. 3. In the bass control circuit, an inductor is used in conjunction with $R5$ to provide a turn-over frequency of 500 Hz. Treble turn-over is at 1 kHz.

In Fig. 3, $C1$ is used only to maintain d.c. gain at unity—and is therefore not a functional part of the circuit.

POPULAR ELECTRONICS

From a design viewpoint, the turn-over frequency in either circuit is a function of the parallel combination of the reactive element, *C1* in Fig. 2 and *L1* in Fig. 3, and the various resistance values. With the values specified, the treble control has a turn-over at 1 kHz, the bass circuit at 500 Hz.

Except for *IC1*, a Westinghouse type WC161 operational amplifier, conventional components are used in both circuits. All resistors are half-watt types. *C1* is a ceramic or paper capacitor in the treble control, and a 15-volt electrolytic in the bass circuit, while *L1* is a 150-mH inductor.

The circuits may be assembled on perf board or on a suitable etched-circuit board, as preferred. The IC lead numbers refer to pin positions on the WC161. Although not essential to circuit operation, Westinghouse recommends that 0.01- μ F capacitors be connected from pins 9 and 10 to ground in both circuits for maximum stability—either ceramic or paper types may be used.

New Devices. A new dual preamplifier IC, designed for the amplification of low-level stereo signals, has been announced by Motorola Semiconductor Products, Inc. (P.O. Box 13408, Phoenix, Ariz. 85002). Identified as type MC1303P, the monolithic device features a unique design for maximum protection against accidental shorts during test or installation. Its output leads can be connected together during operation without damage to the device. In use, the MC1303P provides a channel separation on 60 dB minimum at 10 kHz with less than 0.1% total harmonic distortion at its minimum rated output voltage swing at 4.5 volts, r.m.s. It can furnish a minimum open-loop voltage gain of 8000. A detailed data sheet on this new IC is available from Motorola distributors or direct from the manufacturer.

Texas Instruments, Inc. (P.O. Box 5012, Dallas, Texas 75222) has introduced a number of new devices, including a series of five single-diffused *npn* silicon power transistors and a trio of avalanche photodiodes.

The five new TI transistors, types 2N3055, 2N3713, 2N3714, 2N3715, and 2N3716, have maximum current ratings of 10 amperes and power dissipation values up to 150 watts. All are furnished in hermetically sealed TO-3 metal cases. Breakdown voltage ratings range from 60 to 80 V, with *beta* values at 1 A from 25-75 and 50-150. Suitable for applications in high-power audio systems, servo amplifiers, and similar consumer and industrial circuits, the new units are available through authorized Texas Instruments distributors.

More power to you—until next month.

—Lou

When You're Ready To Step Up . . . see POLYTRONICS Two-Way CB Radios



POLY-COMM 23-DELUXE BASE STATION.

. . . most sensitive receiver on the market. Teflon covered wiring; weather-proof speaker;

hand-wired, metal plug-in microphone; delta tuning; variable depth noise limiter; professional metering system; public address capability, optional built in selective call. Both 12 volt DC and 117 volt AC. \$299.50

POLY-BEAVER MOBILE OR BASE STATION.

First solid state CB so sensitive that .00000015 volt signal strength can produce 3 watts audio at speaker with minimum of 50 db adjacent channel



rejection. Double-conversion superheterodyne receiver, modulation indicator, signal strength meter, illuminated channel selector, custom colored trim (green, red, blue, beige). \$199.50 with mounting bracket, microphone, crystals for 23 channels. 12 volt DC; optional AC power supply.

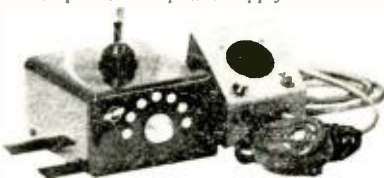

POLY-OTTER—World's first motorcycle and tractor CB radio. Weatherproof, all solid state, 7 channels, complete with remote control head for handlebars and built-on antenna. Two models, one top mounted for luggage rack installation, other for side mount (saddle bag) installation. Remote control head controls push-to-talk, off-on, volume, and squelch. Full 5 watt power, excellent range. \$164.95 with remote control head, antenna . . . ready to go!

Also 1.5 to 3 watt walkie-talkies; Poly-Call Tone Alerts; full range of accessories.

POLYTRONICS COMMUNICATIONS

Baltimore Division of
Allied Research Associates, Inc.
Box 536, Baltimore, Maryland 21203

Please send me information on:

Poly-Comm 23 Poly-Beaver Poly-Otter

Name

Address

City State Zip

DEALER INQUIRIES INVITED

PE 8-68

UNUSUAL BARGAINS

... MANY U. S. GOV'T SURPLUS

AMERICAN-MADE 7x50 BINOCULARS

Big savings! Brand new! Crystal-clear viewing — 7 power. Every optical element is coated. An excellent night glass—the size recommended for satellite viewing. Individual eye focus. Exit pupil 7 mm. Approx. field at 1,000 yds. is 376 ft. Carrying Case included. American 7 x 50's normally cost \$274.50. Terrific bargain.



Stock No. 1544AV \$74.80 Ppd.
 Stock No. 963AV (American Made 6x30's) \$40.00 Ppd.

3" ASTRONOMICAL TELESCOPE



See the stars, moon, phases of Venus, planets close up, 60 to 180 power. Aluminized and over-coated 3" diameter f 10 primary mirror, ventilated cell. Equatorial mount with locks on both axes. Equipped with 60X eyepiece and mounted Barlow lens. 3X finder telescope, hardwood tripod. Included FREE: "STAR CHART" 272-986 "HANDBOOK OF HEAVENS"; "HOW TO USE YOUR TELESCOPE" book.

Stock No. 85.050AV \$29.95 Ppd.
 Stock No. 85.105AV 4 1/4" REFLECTOR \$84.50 FOB
 Stock No. 85.086AV 6" REFLECTOR \$199.50 FOB

Order by Stock No.—Check or M.O.—Money-Back Guarantee
EDMUND SCIENTIFIC CO., 300 EDSORP BUILDING
 BARRINGTON, NEW JERSEY 08007

GIANT FREE CATALOG "AV"

Completely new 1968 edition. New items, categories, illustrations. 148 easy-to-read pages packed with 4000 unusual items. Dozens of electrical and electronic parts, accessories. Enormous selection of Astronomical Telescopes, Microscopes, Binoculars, Magnifiers, Magnets, Lenses, Prisms. Many war surplus items; for hobbyists, experimenters, workshops, factories. Write for catalog "AV", include Zip.



ORDER BY STOCK NUMBER • MICROCHIPS OR MONEY ORDER • MONEY-BACK GUARANTEE
EDMUND SCIENTIFIC CO., 300 EDSORP BUILDING
 BARRINGTON, NEW JERSEY 08007
CIRCLE NO. 18 ON READER SERVICE PAGE

FOR \$14.95

THIS BUG WILL TELL YOU EVERYTHING IT HEARS



For Business!—Pleasure!—Intrigue!

Concealed inside this decorative insect's innocent exterior is a miniature microphone and radio transmitter, which broadcasts a strong signal to any FM radio within 200 feet.

Simply switch this intercom on, and have anyone you choose tune to 88-90 mc on their FM. Normal conversations will be picked up loud and clear (remember FM is static-free). There are no wires. We're sure you can think of dozens of fun ways to use the bug, but here are a few thought starters:

Play with it at your next party, with the guys at the office. Use it as an intercom with your secretary or to the kids' room. You can even tape record what you hear for posterity.

The sophisticated electronic components were designed by Continental, America's leading specialist in security equipment. Get the bug. For yourself. For friends. For fun.

BUY 2 ONLY \$28.00

SPECIAL: Complete 1968 security and crime deterrent catalog. ONLY \$2.35. Send check or money order.



ELECTRONICS MANUFACTURING COMPANY D-M
 47 East 131st Street New York, N.Y. 10043
 Telephone: 674-2494 674-2480-1
 DIVISION OF PHONOMATIC

Dealer Inquiries Also Invited

CIRCLE NO. 27 ON READER SERVICE PAGE

THE PRODUCT GALLERY

(Continued from page 74)

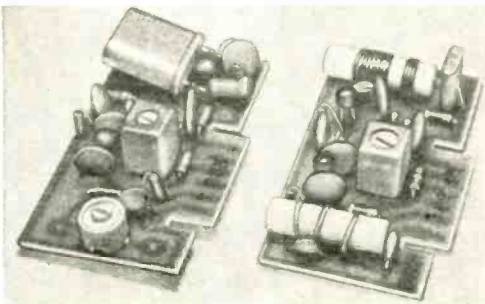

Plug-in printed circuit "cards" contain the r.f. circuits fixed-tuned to various frequencies. Card at left is set for CHU on 7.335 MHz and the card at right is tuned to the weather 162.55-MHz channel.

MHz was our next selection followed by a local police frequency of 155.37 MHz. A 40-foot long wire antenna was used to pick up signals on all four frequencies.

Because of the detector characteristics in the RM2-4, both AM and FM signals can be received with equal clarity. Reception on the long wire was good on the lower frequencies and very adequate on the weather station, but the police signal would have been stronger if a resonant antenna had been employed. Nevertheless, we rate the RM2-4 a good receiver for fixed-tuned monitoring.

Circle 91 on Reader Service pages 15 or 115

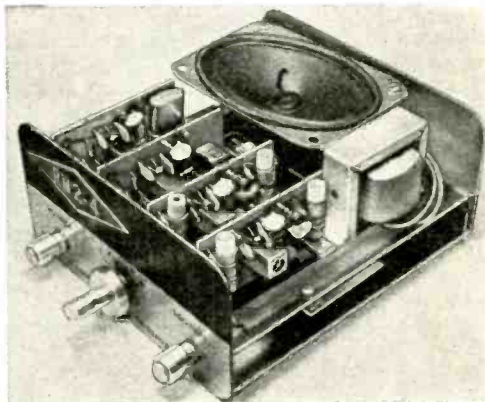

Not visible in this closeup photo are the i.f. and audio stages under the miniature speaker. Transformer is for 117-volt a.c. supply, but receiver may be operated from a 12-volt d.c. car battery.

OMNI-ALARM

(Continued from page 53)

condition, a ground is completed from pins 1 through 4 through the senders. The alarm sounds and assures the driver that it is in working order.

Once the engine has started, all of the sender switches should open. This action removes the ground from the alarm and the audio signal stops. If one sender should close while the car is being operated, the ground will be completed, and the alarm will sound. The operator can then check his indicator lamps for the fault. When the ignition is turned off, the alarm will not sound, since the ignition switch opens before any of the warning senders close (with the possible exception of the alternator sender).

With the headlights on, and the ignition off, the alarm is activated because it is connected to the battery positive via the taillight connection. *Do not* use the brake light connection. The taillight is used because it is on whether you select headlight operation or parking light operation of the headlight switch.

A length of multiconductor ± 22 gauge color-coded wire cable connects the alarm to the various sections of the car wiring. Each of the telltale lights on the dashboard can be examined to determine which lead goes to its associated sender. Remove a small section of insulation from this lead, and splice one lead of the multiconductor cable to the bared portion (soldering is preferred). The joint must be protected with a coating of electrical tape. The lead to the taillight can be run separately.

Make sure that all of this extra wiring does not interfere with the car's regular wiring—tape the multiconductor cable to other existing cables so that it doesn't droop. The order of identification of pins 1 through 4 is not important, as all the diodes are in parallel at their anode ends. Pin 5 must be connected to a point that receives 12 volts positive when the ignition switch is closed.

The completed "Omni-Alarm" can be mounted at any convenient point within the car, but make sure that it is close enough to the driver so that he can hear the alarm.

now there are 3 time & tool-saving double duty sets

New PS88 all-screwdriver set rounds out Xcelite's popular, compact convertible tool set line. Handy midgets do double duty when slipped into remarkable hollow "piggyback" torque amplifier handle which provides the grip, reach and power of standard drivers. Each set in a slim, trim, see-thru plastic pocket case, also usable as bench stand.

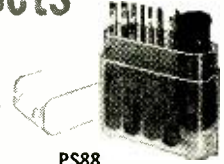

PS88
5 slot tip,
3 Phillips
screwdrivers

PS7
2 slot tip,
2 Phillips
screwdrivers,
2 nutdrivers

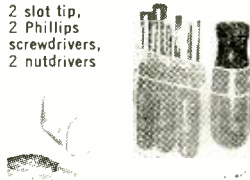

PS120
10 color
coded nutdrivers

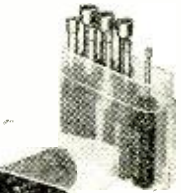

XCELITE®

XCELITE INC. • 20 BANK ST., ORCHARD PARK, N. Y.
Please send free literature N563.

name _____

address _____

city _____

state & zone _____

CIRCLE NO. 40 ON READER SERVICE PAGE

*the
Best
thing in
Electronics
is*

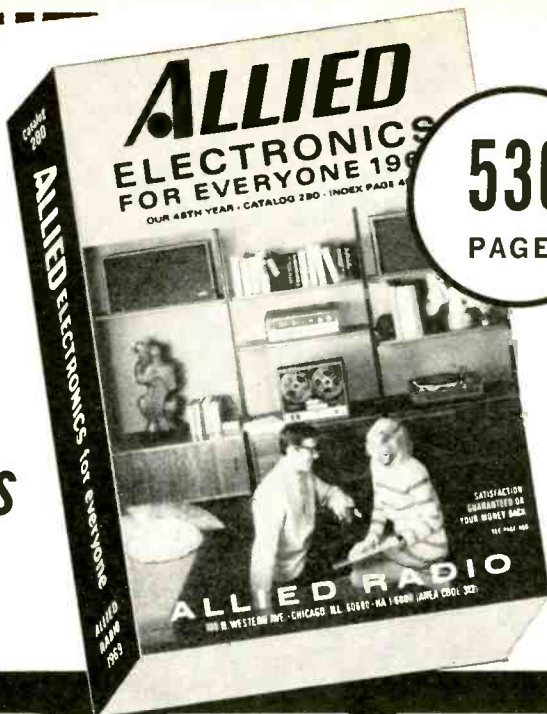

FREE

1969 *ALLIED* CATALOG

Brand new! Fresh off the press! Allied's 1969 Catalog...536 fascinating pages jam-packed with the very latest in Hi Fi, Tape Recorders, CB, Kits, Radios, Tools, Electronic Parts, Books. Probably nowhere else on earth will you find such a complete selection of everything electronic...and virtually all new as tomorrow! Literally thousands of items...many of them never shown before. Allied's all new 1969 Catalog makes wonderful reading...and it's yours absolutely FREE! Tear off the card...mail it in today...and we'll rush you your own personal copy of the newest and most complete book of what's new in electronics...Allied's 1969 Catalog!

TEAR OUT AND MAIL CARD AT RIGHT...OR WRITE

ALLIED RADIO P.O. BOX 4398
CHICAGO, ILLINOIS 60680
CIRCLE NO. 2 ON READER SERVICE PAGE

the most popular books from ALLIED'S vast collection of Electronic Information...



ORDER DIRECT FROM THIS AD!



Complete 14-Volume Set, Allied's Electronic Library Only \$6.25, Postpaid SAVE \$3.00

\$9.25 If Purchased Separately

Fourteen expertly written, illustrated authoritative books—an extremely useful library developed especially for you by Allied's Electronic Experts. An incomparable value. **ELECTRONIC BOOKS FOR HOBBY, SCHOOL, OR HOME STUDY!** Easy to read... use... understand.

Dictionary of Electronic Terms: \$100



Defines over 4800 electronic terms in general usage. Knowing the language of electronics makes it easy to describe, explain, and discuss ideas and equipment. 112 pages. 6x9".

Electronics Data Handbook: \$100



Revised and enlarged 5th edition. Contains formulas, symbols, standards, tables, and charts. Includes: math, constants, symbols and algebraic formulas. 112 pages. 6x9".

Encyclopedia of Electronics Components: \$100



Up-to-date book lists over 350 of the most used electronic components in use today. Each component is listed in alphabetical order with a concise and easily understood description. 128 pages. 5½ x 8½".

GETTING STARTED IN ELECTRONICS: Excellent introduction to basic radio theory in simple language. Includes projects such as building a crystal set, walkie-talkie, transistor radio set. 112 pages. 5½ x 8½". **.50**

UNDERSTANDING AND USING YOUR OSCILLOSCOPE: Tests, measurements, basic principles. 128 pages. 5½ x 8½". **.75**

USING YOUR TAPE RECORDER: Helpful hints on every phase of recording. 96 pages. 5½ x 8½". **.50**

ALL ABOUT HIGH-FIDELITY AND STEREO: Helps you to select stereo components. 96 pages. 5½ x 8½". **.50**

INTEGRATED CIRCUITS FUNDAMENTALS AND PROJECTS: An introduction to integrated circuits in easy-to-follow, non-technical language. 112 pages. 5½ x 8½". **.75**

UNDERSTANDING SCHEMATIC DIAGRAMS: Easy to understand. Detailed explanations. Up-to-date. 112 pages. 5½ x 8½". **.75**

UNDERSTANDING TRANSISTORS AND TRANSISTOR PROJECTS: Transistor applications, characteristics and construction projects. 112 pages. 5½ x 8½". **.75**

UNDERSTANDING AND USING CITIZENS BAND RADIO: Obtaining your license, choosing equipment, on the air operating procedures. 112 pages. 5½ x 8½". **.50**

HOW TO BUILD ELECTRONIC KITS: How to identify parts and components; installing and connecting. 96 pages. 5½ x 8½". **.50**

BEST WAYS TO USE YOUR VOM-VTVM: Explains methods for testing components. 96 pages. 5½ x 8½". **.50**

BUILT-IN STEREO HI-FI MUSIC SYSTEMS: Helps you make a custom hi-fi system installation and get the most from your components. 16 pages. 8½ x 11". **.25**

ALLIED BOOK ORDER FORM

- | | |
|--|---|
| <input type="checkbox"/> 14-Volume Allied Electronic Library (complete set) 23 PA 7409 EP...\$6.25 | <input type="checkbox"/> Using Your Tape Recorder 23 PA 7730 EP..... .50 |
| <input type="checkbox"/> Encyclopedia of Electronic Components 23 PA 7930 EP..... \$1.00 | <input type="checkbox"/> Dictionary of Electronic Terms 23 PA 7756 EP.....\$1.00 |
| <input type="checkbox"/> Understanding Schematic Diagrams 23 PA 7931 EP..... .75 | <input type="checkbox"/> Understanding and Using Citizens Band Radio 23 PA 7701 EP..... .50 |
| <input type="checkbox"/> Understanding and Using Your Oscilloscope 23 PA 7932 EP..... .75 | <input type="checkbox"/> How To Build Electronic Kits 23 PA 7066 EP..... .50 |
| <input type="checkbox"/> Electronics Data Handbook 23 PA 7398 EP..... \$1.00 | <input type="checkbox"/> Best Ways To Use Your VOM-VTVM 23 PA 7067 EP..... .50 |
| <input type="checkbox"/> Understanding Transistors and Transistor Projects 23 PA 7602 EP..... .75 | <input type="checkbox"/> All About High-Fidelity and Stereo 23 PA 7699 EP..... .50 |
| <input type="checkbox"/> Getting Started In Electronics 23 PA 7705 EP..... .50 | <input type="checkbox"/> Built In Stereo Hi-Fi Music System 23 PA 7603 EP..... .25 |
| | <input type="checkbox"/> Integrated Circuits Fundamentals and Projects 23 PA 7625 EP... .75 |

Fill out coupon below, enclose check or money order for exact amount, mail to ALLIED RADIO, P. O. Box 4469, Chicago, Illinois 60680. All Books Postpaid.
(please print)

NAME First Middle Last

ADDRESS

CITY

STATE ZIP

CIRCLE NO. 3 ON READER SERVICE PAGE

DEMCO

— the ultimate in CB radios!



Satellite Base station with 23 channels, instant "ON," ground plane to beam switch, C.A.P. oscillator, voice tone control, dual conversion, delta tuning, auto/manual A.N.L., mode lights, Power Modulator/Speaker — many other features and options.

Ravelle 23



23 channels, dual conversion, electronic switching, mode lights, P.A. switch on front, speaker jack, DC or AC — many other features. Also 6-channel model available.

DEMCO ELECTRONICS • BRISTOL, IND. 46507
Please send information about CB Radios

Name _____
Address _____
City _____
State _____ Zip _____

CIRCLE NO. 15 ON READER SERVICE PAGE

**POLICE • FIRE • MARINE
AIRCRAFT • AMATEUR CALLS**

NEW TUNAVERTER® X!

CRYSTAL & TUNABLE=VERSATILITY & USABILITY



Tunable plus Crystal controlled (selectable with switch) solid state converters to change your auto and home radios into excellent, sensitive, selective, calibrated VHF receivers!

**THE BEST —CALIBRATED 6-1 TUNING—
PLUS —DRIFT FREE CRYSTAL CONTROL—
PLUS —COMPLETE INTERCHANGEABLE
CRYSTALS WITHIN BAND!!!**

- 9 volt btry powered
- Includes coax & mount
- New PET transistor oscil.
- 1 year guarantee
- Size—2 1/2" x 3 1/2" x 4 1/2"
- American Made

MODELS FOR AM & FM	TUNABLE & CRYSTAL	COVERS	OUTPUT	PRICE
CB & 10 M	273 X	26.9-30 mc	1500 kc	\$32.95 ppd. Each
6 meters	504 X	50-54 mc	1500 kc	
2 meters	1450 X	144-150 mc	1500 kc	Less Crystal
Police, fire, Marine	348 X	33-48 mc	1500 kc	
Aircraft	1564 X	150-164 mc	1500 kc	
Models for AM & FM	1828 X	118-128 mc	1500 kc	
Marine	Marine	2.0-2.85 mc	550 kc	\$19.95 ppd.
SW & WWV	SWL	9.5-16 mc	1500 kc	\$19.95 ppd.

Coupling Loop & Ext. Antenna for use with home and Transistor Radios \$3.95 ppd.
Mobile Battery Eliminator 12V to 9V \$4.95 ppd.
Crystals—State Exact Listening Freq. \$5.10 ppd.
See Dealer or Order from: AIR MAIL add \$.85 ea.

HERBERT SALCH & CO. Marketing Division of
Woodsboro PEX, Texas 78393 Tompkins Radio Products

CIRCLE NO. 31 ON READER SERVICE PAGE

TV Q QUIZ ANSWERS

(Quiz appears on page 54)

- 1 TRUE Although this trouble is rare in black-and-white TV receivers, it occurs frequently in color TV receivers.
- 2 TRUE Any a.c. impressed on the video, even in the r.f. section, can cause picture bends or sync trouble.
- 3 FALSE Some early TV sync circuits were indirectly connected to picture tube elements which could create poor sync.
- 4 FALSE The VDR is a Voltage Dependent Resistor frequently found in vertical circuits of TV receivers.
- 5 FALSE SWR means standing wave ratio. Mismatch in the antenna feed-line system may set up an unfavorable standing wave ratio that reduces signal strength.
- 6 FALSE The first numerals on a CRT represent a physical picture tube measurement.
- 7 FALSE A Varicap or varactor is a diode that changes capacitance as the voltage across it is changed.
- 8 FALSE The phosphors are red, green, and blue.
- 9 TRUE Several manufacturers warn against installing a cold oscillator tube in a warmed-up receiver. This practice can lead to premature output tube failure and even intermittent output tube trouble.
- 10 FALSE A noise gate operates during sync time to deactivate the sync separator when noise is present.
- 11 FALSE When a color amplifier is inoperative, B+ is increased and the CRT may draw sufficient current to black out.
- 12 FALSE A color burst is transmitted with the horizontal signal to maintain accurate phase with the receiver's color signal local oscillator.
- 13 FALSE The first integrated circuits employed in commercial TV were in the sound section.
- 14 FALSE Although transistors have no heaters, they do give off heat. Power transistors may normally be uncomfortable to touch.
- 15 FALSE No single or earth-shaking circuit breakthroughs have occurred in receiver design to substantially reduce prices or improve quality.
- 16 TRUE If you use carbon tetrachloride to dry out a wet circuit, however, do it outside your home. Carbon tet fumes are highly toxic.
- 17 FALSE Remote UHF control is an accomplished fact. Local stations can be pretuned similar to the VHF programming system.
- 18 TRUE This is a rule-of-thumb but will hold true in most cases: double the height and double the signal.
- 19 FALSE The Kimcode or metal "banded" tube requires no safety glass. Many compact and light portables use this CRT.
- 20 FALSE Magnets near the CRT would seriously affect the color reproduction. Pincushion correction is accomplished electrically.

AMATEUR RADIO

(Continued from page 83)

lated-code signals in the 75-meter phone band, made unidentified transmissions, used a false call sign, and kept an inaccurate station log. . . . James R. Van Der Maaten, WB6QZL, also received a six-month suspension of his General Class license for allegedly operating an unlicensed transmitter on the VHF police frequencies!

Speaking at the annual ARRL Pacific Division meeting in Oakland, California, Ney Landry, W6UDU, Engineer-in-Charge of the San Francisco FCC office, reported that during the first quarter of 1967, his office administered 137 General Class and nine Extra Class amateur examinations. In the first quarter of 1968 (less a week)—after the new "incentive" licensing regulations were announced—144 General Class, 165 Advanced Class, and 47 Extra Class examinations were given.

Indiana QSO Party. The Indiana QSO Party begins at 2300 GMT (6:00 p.m., CDT), August 17, and ends 24 hours later. Indiana amateurs work the world, and the world works Indiana. Each Indiana amateur sends a contest serial number, call letters, and the name of his county to each station worked. Amateurs outside of Indiana substitute the names of their states, provinces, or countries for the county names. All bands and modes may be used. The same station may be worked once per band and mode. Indiana stations compute their score by multiplying the number of contacts by the number of states, provinces, and countries worked. Other stations multiply contact points by the number of Indiana counties worked. Plaques and certificates will be awarded to high scores in and out of the state. Send your score and a state-



Greg Rainwater, WN7JEG, Everett, Wash., has used his Morrow MBS-60 transmitter and MBR-5 receiver to very good advantage. Morrow equipment was popular in the 1950's, but is not manufactured today.

ment that you obeyed the contest rules to Robert A. Lyles, K9HYV, 706 Spring St., Michigan City, Ind. 43630 (deadline September 15). Include a stamped return envelope for a list of the winners. Incidentally, Indiana amateurs sending the letters "HFA" followed by a number after their county name count extra points towards the Hoosier 500 Award described in this column in March 1968.

Beer Can Vertical—ZL Style. A 40-meter vertical antenna can be constructed by soldering 82 beer cans end to end. Properly guyed, the antenna is surprisingly strong. Getting it into the vertical position can be something of a problem, however, because the soldered joints tend to pull apart under the strain. H. Burton, ZL2APC, President of the New Zealand Amateur Radio Transmitters, suggested a neat solution to this problem in the December 1967 issue of *Break In* (Auckland).

PROFESSIONAL TYPE MOBILE MONITOR RECEIVER

Solid State FM / Crystal Controlled / 6 Channels \$99⁹⁵
LESS CRYSTALS



SEND
FOR FREE LITERATURE



This expertly engineered, all solid-state, crystal controlled FM receiver provides instant monitoring of the VHF frequencies between 39 and 46 mcs or 153 to 157 mcs. Outdating all of the bulky tube-type monitors which take up needed space under dashboards, the compact Ameco Model MRT-6 high band or MRT-7 low band unit measures only 2-1/8" high by 5-5/16" wide by 7-7/8" deep. It's a professional type receiver with latest double conversion superheterodyne circuitry providing 3/4 microvolt sensitivity for 20 db quieting. Has built-in speaker and mobile mounting bracket. Optional AC power supply available.

DIVISION OF AEROTRON / BOX 6527 / RALEIGH, N. C. 27608

CIRCLE NO. 1 ON READER SERVICE PAGE

NEW **ROOF SHATTERING POWER!** Thunder Columns

Never before has a sound reproduction device been designed to handle enormous power with such effortless ease and fidelity! Thunder Columns are scientifically-designed true component perfectly

- 200 and 300 watt models •
- True focused sound for the serious musician •
- Fuse protected against accidental power overloads •
- Hidden steel grille crash protects speakers •
- Rugged upholstery grade vinyl finish •
- Heavy duty electronic instrument speakers

Argos
PRODUCTS COMPANY

600 So. Sycamore, Genoa, Ill. 60135



CIRCLE NO. 5 ON READER SERVICE PAGE

Valuable SAMS BOOKS

Handbook of Electronic Tables & Formulas (New 3rd Ed.)

Enlarged and updated—the complete reference source for all charts, math tables, formulas and laws, symbols, constants, and standards. Special 6-page color insert shows latest FCC frequency spectrum assignments.
Order 20648, only \$4.95

TRANSISTOR FUNDAMENTALS SERIES. A complete 4-volume study and reference work with programmed text. Starts with a description of transistors and how they work; later volumes explain their application in a wide variety of circuits.

- Vol. 1. Basic Semiconductor and Circuit Principles
Order 20641, only \$4.50
- Vol. 2. Basic Transistor Circuits
Order 20642, only \$4.50
- Vol. 3. Electronic Equipment Circuits
Order 20643, only \$4.50
- Vol. 4. Digital and Special Circuits
Order 20644, only \$4.50
- 4-Vol. Set in slipcase, order 20645, only \$15.95

- Second-Class Radiotelephone License Handbook, 20316 \$5.75
- How to Read Schematic Diagrams, 20568 \$3.50
- ABC's of Citizens Band Radio, 3rd Ed. 20019 2.50
- Stereo/FM Know-How & Buying Guide, 50012 1.25
- So You Want to Be a Ham, 4th Ed. 20607 4.50
- Modern Dictionary of Electronics, 3rd Ed. 20600 9.95
- TV Tube Symptoms & Troubles, 20476 2.50

These and over 300 other SAMS books are available from your local Electronic Parts Distributor

HOWARD W. SAMS & CO., INC.

4300 W. 62nd St., Indianapolis, Ind. 46268

CIRCLE NO. 32 ON READER SERVICE PAGE

In condensed form, ZL2APC suggests: Cut two hardwood (or metal) discs slightly larger than the diameter of the cans. Drill a pair of matching holes through each disc and the top and bottom of each can. Next, cut two 35-ft. lengths of galvanized guy wires and, working on a flat surface, thread a disc, all the cans, and the remaining disc on the wires. Twist the wires at each end to pull the cans together tightly. Align the cans in a straight line and solder them together using a husky soldering iron.

Give the assembled antenna a couple of coats of protective paint, tie three light nylon ropes approximately one-third and two-thirds of the way up from the bottom to guy the antenna, set the bottom on a husky bowl—such as a small mixing bowl—for an insulator. Feed power into the antenna with any conventional vertical antenna feed system and start making contacts.

Public Service Activities. Recent public service activities of the West Coast Amateur Radio Service net which monitors 7255 kHz all day, every day, include a "phone patch" made between W7ACF/MM on the Texaco Tanker "California," and WA6BBG, to the tanker's San Francisco office when an unidentified boat jammed the regular marine frequencies. . . . WA6TYR, WB6DBS, and KH6PQ, with the aid of the Hawaiian police, got an emergency message from a mother through to her son in Hawaii in 75 minutes after the commercial services and the American Red Cross had failed because of a faulty address.

When an aircraft evacuating missionaries from Laos was damaged in a tornado, WB6RPK, WA6WHP, and WA6YMG combined to get W6MP at the Missionary Aviation Fellowship headquarters in contact with XW8AQ to get the necessary repair parts shipped to Laos. Of course, other services and other amateurs besides members of WCARS were involved in these and similar incidents; the important thing is that amateurs involved were all ready, willing, and able to use their hobby for public service when they were needed.

Hamfesters 34th Annual Hamfest, August 11.

About 8000 amateurs, their families, and friends attended last year's Hamfesters Amateur Radio Club Hamfest at Santa Fe Park, 91st and Wold Road, Willow Springs, Ill. Plan to attend this year at the same place. The gates open at 9:00 a.m., CDT. Get tickets, further information, and a map to the park from Charles Borkowski, WA9TWA, 1851 West 21st St., Chicago, Ill. 60608. Price of tickets was not included in the hamfest announcement; our guess would be \$2.50.

POPULAR ELECTRONICS



This happy fellow, Joe Lewis, WB6WLH, has just about everything needed to operate AM/CW/SSB, or even FM on appropriate ham bands between 160 and 2 meters. Outside are several different antennas.

Canada. Canadian amateurs are protesting vigorously the recent increase in license fees from \$2.50 to \$10.00 a year. Under the new Canadian fee schedule, license modifications cost \$6.00.

NEWS AND VIEWS

Brian D. Bowers, P.O. Box 1754, El Dorado, Ark. 71730, who is studying for his amateur license, sent your columnist an article, "Women Now," by Dorothy Roe, which appeared in the El Dorado, Ark., *Daily News* on March 20. In the article, Miss Roe humorously warned women what to expect when their husbands become "hams"—always in the shack talking a language no one else can understand, seldom leaving the house for fear of missing an important contact, etc. But what really angered Brian was her statement that an amateur station disrupts television reception of all the neighbors for blocks around. As Brian told Miss Roe in a long letter defending radio amateurs, although amateurs are usually *blamed* for all television interference in the neighborhood, they are seldom the real culprits. . . . If you are bothered by complaints of real or imaginary television interference (TVI) **Al Smith, WA2TAQ**, Public Relations Chairman, Rockaway Amateur Radio Club, P.O. Box 205, Rockaway Park, N.Y. 11694, will send you a copy of the club's TVI folder for a dime or a stamped return envelope. Incidentally, Al says the club is still getting requests for the official-looking, tongue-in-cheek "Notice to All Visitors" certificate we mentioned 13 months ago. The 50-cent donation goes to the club's treasury. . . . **Marty O'Hara, WA0RWW**, 306 Pine St., Millard, Nebr. 68137, worked all states, all continents, and 106 countries on SSB his first eight months on the air. He still needs 24 cards for his DX Century Club (DXCC) certificate. Marty has been helping the boys at WA0AGI at Boys Town, Nebraska, to work some DX. In spite of having an antenna only 20 ft. high next to a 70 ft. high steel building, WA0AGI worked 17 countries one weekend, but Marty is trying to "promote" a 70-ft. antenna tower for the boys. The Boys Town Board of Directors have okayed the project; so all Marty has to do now is find the tower!

David J. Ciba, WA1JDR, 563 Hailes Hill Road, Swansea, Mass. 02777, uses a Lafayette HA-460, 6-meter transceiver to drive a 5-element, Cush-Craft rotary beam when he is not SWL'ing or

August, 1968

NEW!

FREE

1968-69 EDITION— The ONLY CB Catalog of its KIND!

The Most COMPLETE
Catalog for CBers
ever put together!

Everything in equip-
ment and accessories
for CBers at World
Radio Lab's Amazing
LOW PRICES!

Anything in the
book on easy
credit terms,
TOO!

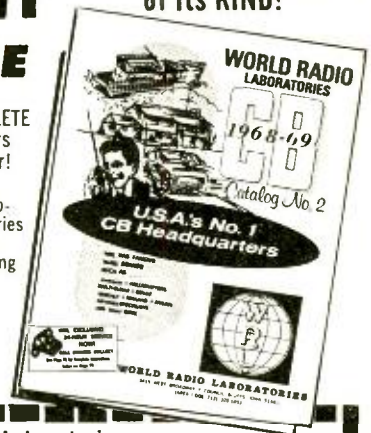

World Radio Laboratories
3415 West Broadway
Council Bluffs, Iowa 51501

Dept. PE-k8

- Please rush me your FREE 1968-69 CB Catalog.
 I am interested in becoming a CB Dealer. At-
tached is my business letterhead. Send Dealer
Price List.

Name _____

Address _____

City _____

State _____

Zip _____

CIRCLE NO. 39 ON READER SERVICE PAGE

BREAKTHROUGH



IN ELECTRONICS CALCULATING

Still plodding through math and electronics problems the slow pencil-and-paper way? Smash the paperwork barrier with this new Electronics Slide Rule.

Even if you've never used a slide rule before, you can whiz through resonant frequency calculations and inductive or capacitive reactance problems. You can find reciprocals for resistance formulas instantly. You can even locate tricky decimal points in a jiffy.

You can also work regular math problems in a flash: multiplication...division...square roots...logarithms...trigonometry.

Anyone can use this sturdy 12-inch, all-metal slide rule. We show you how with our complete 4-lesson instruction course, Slide rule, course, and handsome leather carrying case deliberately priced low as our way of making friends with men in Electronics. FREE booklet gives full details. Mail coupon below today.

MAIL THIS COUPON FOR FREE BOOKLET

CIE Cleveland Institute of Electronics
1776 East 17th Street, Cleveland, Ohio 44114

Please send me your FREE booklet describing the Electronics Slide Rule and 4-lesson instruction course. Also FREE if I act at once—a handy pocket-sized Electronics Data Guide.

Name _____ (PLEASE PRINT)

Address _____

City _____

State _____ Zip _____

PE-147

CIRCLE NO. 11 ON READER SERVICE PAGE

studying for his General Class ticket. Dave's dad is also "studying like mad" for his first amateur license. . . **Andrew D. Leckart, WN11SH**, 30 Elm St., Taunton, Mass. 02780, has not wasted much of his five months as a Novice. Twenty-four countries and 42 states worked proved that A Knightkit T-60 transmitter driving either a 2-element beam on 15 meters or a Hy-Gain 18V vertical antenna on 40 meters, plus a Lafayette HA-350 receiver are his tools. . . If you hear **WA4BR5/R3** on the U. S. Coast Guard Cutter "Bering Strait," FPO. San Francisco, Calif. 96601, the operator is **Paul F. Folmsbee, RM1, USCG**. Paul uses a Collins KWM-2 transmitter and a Heathkit SB-200 amplifier to feed a Hy-Gain vertical antenna, and is the only link with home for the 150-member crew of the "Bering Strait" during its patrols to Ocean Station Victor, a weather-aircraft checkpoint in the North Pacific. Paul reports that his amateur experience was a big help when he joined the Coast Guard four years ago.

Ricky Miller, WN0UAY, R.R. 3. Sumner, Iowa 50674, started his amateur career with a homebrew, 15-W transmitter. Helped by a Heathkit HR-10B receiver and 40-meter dipole antenna, Ricky worked seven states his first five days on the air. . . **Fred Wasielewski, WN2VJL/WA2VJL**, 379 Wyoming Ave., Buffalo, N.Y. 14215, has verified contacts in 20 states and two Canadian provinces after four months on the air. Fred has two transmitters—a Heathkit DX-60 and an EICO 720—both running 75 W (one at a time) to feed a 40-meter dipole. A Hammarlund HQ-110AC is used for receiving. Although Fred can work 6 meters, he prefers to stick to 40-meter CW, at least until he gets his General ticket.

Greg Rainwater, WN7JEG, 12 W. Intercity Av., Everett, Wash. 98201, has spent his first three months as a Novice on 80 meters. He did not mention how many states he had worked, but I counted a couple of dozen QSL cards from many western states in the picture of his radio room. Greg uses a Morrow MBS-60 transmitter (60 W) and a Morrow MBR-5 receiver. . . **Roger Dixon, WB4GPC**, 3015 Vogue Ave., Louisville, Ky. 40220, says the mismatch (SWR) on the feedline of his 40-meter dipole is about 100:1 when he works 20 meters; nevertheless, he has worked some DX—including England—there. But 40-meter CW and AM phone occupy most of his on-the-air time. With a homebrew 50-W transmitter controlled by an ancient Heathkit VF-1 VFO, a homebrew modulator, and a National NC-155 receiver, he has obtained QSL cards from over 40 states.

We solicit your "News and Views," pictures (black and white are best), club papers, general news, and announcements for your column. Send all to: Herb S. Brier, W9EGQ, Amateur Radio Editor, POPULAR ELECTRONICS, P. O. Box 678, Gary, Ind. 46401.

73, Herb, W9EGQ.

SHORT-WAVE LISTENING

(Continued from page 92)

Mesuru, Lesotho, which reads in part, "We do not as yet have a verification card. You may be interested to know that our transmitters are located approximately 5 miles from our studios in Mesuru, at a height of 6020 feet. Our transmitter is a Marconi, 660 watts . . . the antenna is a 300-foot mast radiator . . . it is our hope to increase our power to 2000 watts in the near future. At the present time we are carrying a transmission which is more in the nature of a test program."

CURRENT STATION REPORTS

The following is a resume of current reports. At time of compilation all reports were as accurate as possible, but stations change frequency and/or schedule with little or no advance notice. All times shown are Greenwich Mean Time (GMT) and the 24-hour system is used. Reports should be sent to Short-Wave Listening, P. O. Box 333, Cherry Hill, N. J. 08034, in time to reach Your Short-Wave Editor by the fifth of each month; be sure to include your WPE identification and the make and model number of your receiver.

Bolivia—A press-time receipt of a letter from CP75, *La Cruz del Sur*, La Paz, says they will move from 4985 kHz to 5025 kHz for an indefinite period. They are requesting reports on the new frequency. . . **R. Norte**, Montero, has moved again, now to 4870 kHz and is good at times after 2300. . . CP77, *R. Saravenda*, Camiri, is fair at times on 4887 kHz with Latin American pop tunes and all Spanish anmts until 0300 s/off. IDs from this station are infrequent.

Canada—The new schedule from *R. Canada*, Montreal, shows service to N. A. and the Antilles in English at 1217-1313 on 11,720 and 9625 kHz and in French at 1315-1343 on 1,720 kHz. Service to the Caribbean and Latin American areas is in English at 2258-2330, Portuguese 2330-0000 and Spanish 0000-0046, all on 17,720, 15,190 and 9625 kHz.

Canal Zone—If you can copy Morse code and need a verification from this country, tune for NBA, a U. S. Navy coastal station in Balboa. On 12,883 kHz with 4 kW power, this station will verify correct reports sent to U. S. Naval Communications Station, Balboa, Canal Zone. Listen evenings (your local time) for their "CQ" tape. It was coming in at good level when we wrote this.



DIRECT FREQUENCY DIALING

International Short-Wave Broadcast RECEIVER

No more guesswork in identifying stations. Set dial at a station's frequency and if conditions permit you'll hear it everytime . . .

- Ultra-precision tuning dial accuracy, SW and standard AM Broadcast
- Crystal lattice filter for adjacent station rejection and good AF response
- Dual conversion • Solid state AF output • S-meter • Preselector gives superior sensitivity by peaking antenna and RF stages • Crystal-controlled H. F. Oscillator stability • Amplified AVC constant AF output • Price \$289.00

Write for free Brochure No. 18

R. L. DRAKE COMPANY • Miamisburg, Ohio 45342

CIRCLE NO. 16 ON READER SERVICE PAGE

POPULAR ELECTRONICS READER SERVICE PAGE

free information service:

Here's an easy and convenient way for you to get additional information about products advertised or mentioned editorially (if it has a "Reader Service Number") in this issue. Just follow the directions below... and the material will be sent to you promptly and free of charge.

1. Print or type your name and address on the lines indicated. Circle the number(s) on the coupon below that corresponds to the key number(s) at the bottom of the advertisement or editorial mention(s) that interest you. (Key numbers for advertised products also appear in the Advertisers' Index.)

2. Cut out the coupon and mail it to the address indicated below.

3. This address is for our product "Free Information Service" only. Editorial inquiries should be directed to POPULAR ELECTRONICS, One Park Avenue, New York 10016; circulation inquiries to Portland Place, Boulder, Colorado 80302.

**POPULAR
ELECTRONICS**

VOID AFTER SEPTEMBER, 1968

P.O. BOX 8391
PHILADELPHIA, PA. 19101

1 2 3 4 5 6 7 8 9 10 11 12 13 14 15 16 17 18 19 20
21 22 23 24 25 26 27 28 29 30 31 32 33 34 35 36 37 38 39 40
41 42 43 44 45 46 47 48 49 50 51 52 53 54 55 56 57 58 59 60
61 62 63 64 65 66 67 68 69 70 71 72 73 74 75 76 77 78 79 80
81 82 83 84 85 86 87 88 89 90 91 92 93 94 95 96 97 98 99 100

NAME (Print clearly) _____

ADDRESS _____

CITY _____ STATE _____ ZIP CODE _____

8Nb

THE ELECTRONIC INDUSTRY'S
MOST CURRENT 1969 CATALOG

FREE!



BA's ALL NEW 228 PAGE
VALUE PACKED FALL AND WINTER
ELECTRONICS CATALOG



**YOUR BUYING
GUIDE FOR:**

- Stereo & Hi-Fi Systems & Components
- Tape Recorders
- Phonos, Radios & TV's
- Cameras & Film
- PA
- Ham Gear
- Test Instruments & Kits
- Citizens Band
- Electronic Parts, Tubes & Tools

SEND FOR YOURS TODAY!

MAIL TODAY TO

BURSTEIN-APPLEBEE

DEPT. PET, 3199 MERCIER, KANSAS CITY, MO. 64111

Name _____
Address _____
City _____
State _____ Zip Code _____

CIRCLE NO. 8 ON READER SERVICE PAGE

IT COSTS ONLY
1/100 OF 1¢ MORE
PER SOLDER JOINT
TO KNOW YOU ARE USING THE
WORLD'S FINEST CORED SOLDER

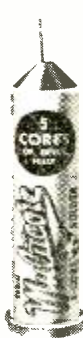

New Easy
Dispenser
Pak
60/40
18 S.W.G.



Latest PC
(Printed
Circuit) Pak
60/40 Extra Thin
22 S.W.G.—.028"

each only 69¢ per package at your dealer

ERSIN



**FIVE-CORE
SOLDER**

MULTICORE SALES CORP., WESTBURY, N.Y. 11590
CIRCLE NO. 26 ON READER SERVICE PAGE

Costa Rica—TIRICA, *La Voz de la Victor*, San Jose, is often good to excellent on its medium wave channel of 625 kHz from 0000-0600 s/off. With little news, but lots of American and Latin American music (some English lyrics), the program is basically Spanish.

Curacao—Another marine coastal station that will verify is Morse station PJC, Willemstad, on 4334 kHz, frequently noted around 0730. Reports go to Mr. C. J. Mol, Director of Government Radio and Telegraph Administration.

Czechoslovakia—R. Prague has a new schedule to N. A.: 1330-1400 in Czech and Slovak followed at 1400-1500 in English (both on Sun. only) on 15.448, 17.840 and 21.450 kHz.; daily 0100-0200 in English, 0300-0330 in Czech and Slovak, and 0330-0430 in English, all on 7345, 9540, 9630, 11.990 and 15.365 kHz. The 0100 xmsn is also on 17.840 kHz.

Dominican Republic—The new international service from HISS, mentioned last month, is being widely reported in Eng. from 2200-0250 on 9505 and 6090 kHz.

Ecuador—HCJB, Quito, has a new Home Service xmsn in Spanish at 2230-2330 on 11.915 kHz. . . . HCJP1, R. *Jesus del Gran Poder*, Quito, is heard at times until 0130 on 5070 kHz with religious talks in Spanish. . . . HCVC3, R. *Sentinela del Sur*, Loja, listed for 5035 kHz where they have never been, has moved up from 5024 kHz to 5120 kHz and noted after 0200 with listeners request music and infrequent IDs.

Egypt—R. Cairo, 9475 kHz, has French to N.A. at 0100-0145. English is still carried from 0200-0330; listeners mail is answered on Sunday. English to Europe is aired on 9475 and 12.005 kHz at 2145-2300 with a newscast being given at 2200.

Ethiopia—A new schedule from ETLF, Addis Ababa, shows English as follows: (Xmtr I) 0530-0555 to W. Africa on 11,890 kHz; 1330-1345 to India on 15.315 kHz; 1655-1710 to Ethiopia on 6065 kHz; and 1900-1945 to W. Africa on 15.425 kHz. Then (Xmtr II) 0400-0425 to E. Africa on 7125 kHz; 1330-1400 to India on 15.400 kHz; 1700-1715 to E. Africa on 9695 kHz; and 1800-1815 to S. Africa on 9705 kHz.

France—Paris has an English newscast ending at 1930 s/off on 15.380 kHz.

Germany (West)—The 1st Program of *Der Sud-deutsche Rundfunk*, Postfach 3000, Stuttgart, is transmitted on 6030 kHz beamed north-south. They are requesting reception reports.

Guyana—R. Demerara, Georgetown, has been noted on 3265 kHz at 0230 Saturdays.

Holland—R. Nederland, Hilversum, has English to N. A. on Tuesdays and Fridays at 1430-1445 on 21.540 kHz; 1530-1545 and 1700-1715 on 21.570 and 21.540 kHz and 2030-2050 on 21.540 and 17.810 kHz. Sundays at 1855-2020 on 15.425 and 11.730 kHz ("Happy Station Program"), weekdays at 2055-2150 on 17.810 and 11.730 kHz and daily via Bonaire at 0125-0220 on 9590 kHz.

Honduras—A letter from Ron Youngs, Program Director of HRVC, *La Voz Evangelica de Honduras*, lists operations on 4820 kHz at 1100-1500 and 1800-0300 in Spanish and 1500-1600 and 0300-0400 in English. Reports go to Apartado 27, Tegucigalpa.

India—All India Radio, Delhi, has English on 15.265 kHz at 0915 and on 15.335 kHz with an ID at 1200 and news at 1455.

Indonesia—The Council of Churches on Jawa has started R. *Oikoumene*; operations on 4087 kHz are at 0730-0930, 1500-1700 and 1930-2200. . . . *The Voice of Indonesia*, Djakarta, now has English to Europe at 1900-2000 on 15.110 kHz.

Italy—Rome noted with a "local quality" signal in the Midwest at 1840-1905 on 21.560 kHz in their West Indies and Central America beam. The 15.110 kHz channel has been heard at 0300 in Italian. English was logged on 9575 kHz at 0100-0120; news at 0100.

Korea (South)—Test xmsns from the *Voice of Hope* are on 6170 kHz at 0815-0845 and 1200-1230

POPULAR ELECTRONICS

with Korean pop music and anmts in Korean and English. It also has a home service from 0700-0815 and 1230-1600 in all Korean. Reports go to Republic of Korea Army Broadcasting Station, *Voice of Hope*, Seoul, Korea.

Kuwait—*Kuwait Broadcasting and Television Service*, P. O. Box 193, Kuwait, has English at 0400-0600 and 1600-1900. It has been heard at 1830 in language on 15.155 kHz. Other channels reportedly in use include 9520 and 4967.5 kHz.

Luxembourg—*R. Luxembourg*, 15.350 kHz, has French news at 2200 followed by pop music with a good signal into mid-USA.

Macau—*Radio Club de Macau* has deleted the 5050 kHz outlet. Listeners are advised to tune in to medium-wave stations on 900 and 1200 kHz.

Malaysia—*BBC Far Eastern Station*, Tebrau, has English news at 0900, "Radio Newsreel" at 0015; World Service close at 0030 followed by "English By Radio" to s/off at 0045. Logged on 11.725 kHz, dual channels are 17.880, 15.425, 11.955, 9725 and 9570 kHz.

Mexico—*XETRA*, 690 kHz., formerly known as *Extra News* has changed to *Extra Music*. The ID as given is Tijuana, Mexico, but studios are in Los Angeles. This 50 kW station operates continuously except for the period 0900-1200 Mondays. . . . XEJN, *Sistema Educativa*, Huayacoatlé, Veracruz, 2390 kHz., has arithmetic lessons following an ID at 0215.

Morocco—Rabat has been found on a new frequency of 15.360 kHz with some pop music, some Arabic music until 0000 s/off.

Nigeria—*Voice of Nigeria*, Lagos, has a new English schedule: 0545-0730 to Europe on 15.155 kHz; 1445-1600 to Europe on 15.330 kHz; W. Africa on 7275 kHz; Central Africa on 11.715 kHz and E. Africa on 15.255 kHz; at 1700-1900 to Europe on 15.255 kHz; W. Africa on 7275 kHz; E. Africa on 15.255 kHz and W. Europe on 11.715 kHz; and 2100-2200 to W. Europe on 11.900 kHz; N. A. on 15.120 kHz; W. Africa on 7275 kHz; and Europe on 11.715 kHz. Another outlet, 4990 kHz, was heard from 2245-2305 with political and Red Cross anmts; this outlet closes Sundays at 2200.

Norway—*R. Norway* has a new xmsn to the Americas and Pacific Ocean areas at 0100-0230 on 11.735, 11.850 and 15.345 kHz. Reports requested.

Pakistan—*R. Pakistan*, Karachi, is being heard in English at 2015-2030 s/off on 15.345 kHz, 0210-0230 or later on 15.335 kHz with news at 0210 and from 2010-2030 s/off on 15.240 kHz.

Peru—According to a press dispatch, *R. Nacional del Peru* will broadcast with 150 kW at 1100-0500 on 9560, 11.915, 15.150, 17.890 and 21.600 kHz. . . . OAX7C, *R. Tacantinsuyo*, Cuzco, wandering for 10 years between 6200-6250 kHz, is now on 4910 kHz where Conakry (Guinea) blots it out after 0400. . . . OEX7H, *R. Ondas del Titicaca*, Puno, 4921 kHz, is best heard after 0300. Do not confuse with an Ecuadorian on 4923 kHz. . . . OAX5Q, *R. Abancay*,

Abancay, 4997 kHz, has request music to around 0330 closing.

Poland—A new schedule from *R. Warsaw* shows English at 0730-0800 on 15.275, 11.840, 9675 and 9570 kHz; 1830-1857 on 7125 and 6135 kHz; 1930-2000 on 7125, 6135 and 6005 kHz; 2030-2100 on 9675 and 5970 kHz; 2130-2155 on 7285, 7125 and 6135 kHz; and for the medium wave DX'ers at 2130-2155 on 1502 kHz and 2303-2330 on 818 kHz.

South Africa—English from *R. RSA*, according to a new schedule, reads: 0415-0427 to E. Africa on 31 and 41 meters; 0430-0442 to Middle East Africa on 31 and 41 meters; 0500-0512 to Central Africa on 60 and 75 meters; 0515-0527 to N. Africa on 31 and 41 meters; 0645-0657 and 2100-2150 to W. Africa on 19 and 25 meters; 1100-1150 to Africa (General) on 13 and 16 meters; 1300-1450 to Africa (General) on 19 and 25 meters; 1600-1650 to Central Africa on 31 and 41 meters; 1700-1750 to N. Africa on 16 and 19 meters; 1800-1850 to E. Africa on 19 and 25 meters; 1900-1950 to United Kingdom and Ireland on 16 and 49 meters; 1000-1050 to New Zealand on 13, 16 and 19 meters; 1200-1250 to Australia on 16, 19 and 25 meters; and 2330-0020, 0030-0120, 0130-0220 and 0230-0320 on 25, 31, 41 and 49 meters. Frequencies used include 25,820 and 25,790 kHz (11 meters), 21,535 and 21,500 kHz (13 meters); 17,790 and 17,805 kHz (16 meters); 15,360, 15,245 and 15,220 kHz (19 meters); 11,900, 11,875 and 11,785 kHz (25 meters); 9720, 9705, 9570 and 9525 kHz (3 meters); 7270 and 7185 kHz (41 meters); 6075, 5990 and 5980 kHz (49 meters); 4895 kHz (60 meters) and 3997 kHz (75 meters). Your Editor finds the actual channels in use to N. A. are 11,875, 9705, 9530 and 6075 kHz., with 7270 kHz in service to the Atlantic Islands.

Sudan—According to schedule, *R. Omdurman* currently broadcasts its Arabic Home Service at 0400-1300 and 1400-2200 and on Fridays at 0400-2200. Daily except Friday there is also a local program for Southern Sudan at 1300-1340 followed by a European program at 1340-1400. Frequencies include 4994, 7200 and 9508 kHz.

Surinam—Paramaribo has definitely returned to the air. Noted originally and briefly on 15.100 kHz, it now operates on 15.450 kHz and is heard at various times between 2330-0330; English religious programs are heard around 2340; request music at

SHORT-WAVE ABBREVIATIONS

anmt—announcement	kHz—kilohertz
BBC—British Broadcasting Corp.	kW—kilowatts
GMT—Greenwich Mean Time	L.A.—Latin America
ID—identification (call or slogan)	N.A.—North America
IS—Interval Signal	R.—radio
iani—interference	s/off—sign-off
	s/on—sign-on
	xm-n—transmission
	xmtr—transmitter

ALL SILICON TRANSISTOR • SOLID STATE



J-23 CITIZENS BAND RADIO

BUILT FOR RUGGED USE—Uses Military type printed circuits

Start with masterful engineering, select the finest components available, entrust them to skilled engineers . . . the end result can only be the superiority that characterizes every CB bearing the SONAR name. Because we never compromise with quality the J-23 may cost a bit more . . . but you get a lot more for your money. Featuring: Positive or Negative ground, 12 high Q circuits plus dual conversion provides receiver with top performance, extra sensitive receiver, automatic gated noise limiter, noise free adjustable squelch, built-in P.A. and external speaker jack plus many other superior features.

COMPLETE WITH 23 CRYSTALS
Receives and transmits
on 1 crystal per channel

\$239⁹⁵

mike, bracket & fused DC
cable for protection, 12 VDC only.

SONAR RADIO CORP. 73 Wortman Ave., Brooklyn, N. Y. 11207

Please send me complete information on CB Radio—J-23

Name Dept. 635

Address

City State

CIRCLE NO. 34 ON READER SERVICE PAGE

POPULAR ELECTRONICS SUBSCRIBER SERVICE

Please include an address label when writing about your subscription to help us serve you promptly. Write to: Portland Place, Boulder, Colo. 80302

CHANGE OF ADDRESS:

Please let us know you are moving at least four to six weeks in advance. Affix magazine address label in space to the right and print new address below. If you have a question about your subscription, attach address label to your letter.

TO SUBSCRIBE:

Check boxes below.

- New Renewal
 5 years \$20
 3 years \$13
 1 year \$5

SPECIFY:

- Payment enclosed
 —You get 1 extra issue per year as a BONUS!
 Bill me later.

← AFFIX LABEL →

If you have no label handy, print OLD address here.

name
please print

address

city

state

zip-code

[Add'l postage: \$1 per year outside U.S., its possessions & Canada.]

name please print 0285

address

city

state zip-code

GET INTO ELECTRONICS



V.T.I. training leads to success as technicians, field engineers, specialists in communications, guided missiles, computers, radar, automation. Basic & advanced courses. Electronic Engineering Technology and Electronic Technology curricula both available. Associate degree in 29 months. B.S. obtainable. G.I. approved. Start September. February. Terms, campus. High school graduate or equivalent. Catalog.

VALPARAISO TECHNICAL INSTITUTE
 DEPARTMENT PE, VALPARAISO, INDIANA 46383

DIAL TELEPHONES



5.50

less bell

With bell \$8.45. If plug is required add \$2.00. Factory reconditioned. Guaranteed. Many other phones available. write for free list. All shipments FOB Waymart, Pa.

SURPLUS SAVING CENTER

Dept. PE-8

Waymart, Penna. 18472

0000-0030 and English language news at 0200.

Sweden—The most recent schedule from *R. Sweden*, Horby, show xmsns to East Coast N. A. at 0000-0230 on 15,275 kHz; 1100-1215 on 15,240 kHz and 1400-1530 on 17,760 kHz; and to West Coast N. A. at 0300-0430 on 11,705 kHz and 1600-1700 on 15,310 kHz.

USSR—*R. Kiev's* latest English schedule to N. A. shows xmsns at 0030-0100 (Monday, Thursday and Saturday) on 17,770, 17,750, 17,720, 15,270, 12,000, 9610 and 9510 kHz; 0430-0500 on 15,470, 15,270, 15,100, 11,890 and 11,850 kHz; and English to Europe at 1900 on 11,830, 11,710 and 9560 kHz. . . . The press-time English schedule to N. A. from *R. Moscow* appears on page TK.

Clandestine—A station identifying itself as *The Voice of Free France* has been heard broadcasting in English, French and Spanish on 13,700, 27,000 and 27,560 kHz. The station, which sometimes abruptly terminates its transmissions, was heard by a listener in Miami, Fla. Further details requested.

-30-

SHORT-WAVE CONTRIBUTORS

Bill Smith (WPE1FZ), Uxbridge, Mass.
 Stan Mayo (WPE1GMF), Portland, Maine
 Dave Rose (WPE1HEF), East Hampton, Conn.
 Russell Edington (WPE1HGR), Middleboro, Mass.
 Eric Linden (WPE2JTY), Jackson Heights, N. Y.
 Peter Malvasi (WPE2NWH), Paramus, N. J.
 Jeffrey Star (WPE2OZD), Franklin Square, N. Y.
 Bernie Lansing (WPE2PBA), Rochester, N. Y.
 Andrew Jezioro (WPE2PCB), Buffalo, N. Y.
 John Burton (WPE2QAX), Valhalla, N. Y.
 Larry Weintraub (WPE2QHK), Cambria Heights, N. Y.
 Robert Nagle (WPE3DIX), Allentown, Pa.
 James Wasson (WPE3HOW), Bethel Park, Pa.
 James Wilson (WPE3HPO), Norristown, Pa.
 Grady Ferguson (WPE4BC), Charlotte, N. C.
 Lee Bogusz (WPE4JLC), Atlanta, Ga.
 Douglas Anderson (WPE4JSE), Tampa, Fla.
 Ray Bacon (WPE5BFU), New Orleans, La.
 Mike Kamp (WPE5EPY), Irving, Texas
 Carlton Blake (WPE5ETX), Fort Smith, Ark.
 Stewart Mac Kenzie (WPE6AA), Huntington Beach, Cal.

Dave Frandin, Jr. (WPE6GTC), San Diego, Cal.
 Arthur Blair (WPE6GXV), San Francisco, Cal.
 Dave Gillooly (WPE6HCB), Los Gatos, Cal.
 Ron Reimers (WPE6HCZ), Cupertino, Cal.
 Bill Kickrich (WPE8JJI), Newark, Ohio
 Mrs. Elaine Walton (WPE8JLR), Bedford, Ohio
 Dwight Denison (WPE8JWG), Canfield, Ohio
 Ken Celmer (WPE8IWO), Harper Woods, Mich.
 John Gomochak (WPE8KE), Youngstown, Ohio
 John Arendt (WPE9DN), Aurora, Ill.
 Richard Pistek (WPE9HOA), Chicago, Ill.
 Richard Doering (WPE9IXG), Hinsdale, Ill.
 Gary Bullinger (WPE9JCZ), Aurora, Ill.
 John Batt (WPE9JFV), Aurora, Ill.
 Keith Powers (WPE9JGO), Milwaukee, Wis.
 Norman Wright (WPE9JHB), Milwaukee, Wis.
 Fred Lynch (WPE9JHD), Girard, Ill.
 A. R. Niblack (WPE9KM), Vincennes, Ind.
 John Beaver, Sr. (WPE0AE), Pueblo, Colo.
 Thomas Rohrs (WPE0EYV), San Francisco, Cal.
 Clair Claiborne (WPE0FEC), Fredonia, Kansas
 Steve Opydke (WPE0FEW), Salina, Kansas
 Jack Perolo (PY2PE1C), Sao Paulo, Brazil
 Terrence Craig (VE3PE2KT), Ottawa, Ont.
 Kenneth Ford (VE7PE1DR), West Vancouver, B. C.
 David Alpert, Morton Grove, Ill.
 John Boland, Ottawa, Ont.
 Steve London, Eggertsville, N. Y.
 Patrick Hector, Canoga Park, Cal.
 Glenn Kraus, Chicago, Ill.
 Bill Mullerbeck, Toronto, Ont.
 David Potter, Key West, Fla.
 Thomas Roach, Shaw Air Force Base, S. C.
 Tim Sullivan, Minneapolis, Minn.
 W. N. Turner, Grayslake, Ill.
 ETLF, Addis Ababa, Ethiopia
 HRVC, Tegucigalpa, Honduras
R. Canada, Montreal, Que.
R. Prague, Prague, Czechoslovakia
R. Sweden, Stockholm, Sweden
Sweden Calling DX'ers Bulletin, Stockholm Sweden

ELECTRONICS MARKET PLACE

COMMERCIAL RATE: For firms or individuals offering commercial products or services. \$1.00 per word (including name and address). Minimum order \$10.00. Payment must accompany copy except when ads are placed by accredited advertising agencies. Frequency discount: 5% for 6 months; 10% for 12 months paid in advance.

READER RATE: For individuals with a personal item to buy or sell. 60c per word (including name and address). No Minimum! Payment must accompany copy.

FOR SALE

FREE! Giant bargain catalog on transistors, diodes, rectifiers, SCR's, zeners, parts. Poly Paks, P.O. Box 942, Lynnfield, Mass. 01940.

GOVERNMENT Surplus Receivers, Transmitters, Snooperscopes, Radios, Parts, Picture Catalog 25¢. Meshna, Nahant, Mass. 02908.

R.F. CONVERTERS. World's largest selection. Also CCTV cameras, etc. Lowest factory prices. Catalog 10¢. Vanguard 196-23 Jamaica Ave., Hollis, N.Y. 11423.

TELEPHONE VOICE SWITCH: (LS-500). ACTUATES AUTOMATICALLY AND UNATTENDED ANY TAPE OR WIRE RECORDER. PICTORIAL INSTALLATION INSTRUCTIONS INCLUDED. \$23.75. POST PAID USA, WJS ELECTRONICS, P.O. BOX 1508, LAS VEGAS, NEVADA 89101.

INVESTIGATORS: KEEP IN STEP WITH ADVANCEMENTS IN THE ART OF ELECTRONICS FOR THE PROFESSIONAL. SEND \$1.00 FOR EQUIPMENT BROCHURE. WJS ELECTRONICS, P.O. BOX 1508, LAS VEGAS, NEVADA 89101.

BUG DETECTOR: WILL DETECT AND LOCATE SURREPTITIOUS TRANSMITTING DEVICES IN CONFERENCE ROOMS, HOME AND OFFICES, ETC. WRITE FOR DETAILS. WJS ELECTRONICS, 737 NORTH SEWARD, HOLLYWOOD, CALIF. 90038.

ROCKETS: Ideal for miniature transmitter tests. New illustrated catalog, 25¢. Single and multistage kits, cones, engines, launchers, trackers, rocket aerial cameras, technical information. Fast service. Estes Industries, Dept. 18, Penrose, Colorado 81240.

LOWEST Prices Electronic Parts. Confidential Catalog Free. KNAPP, 3174 8th Ave. S.W., Largo, Fla. 33540.

CRYSTALS . . . largest selection in United States at lowest prices. 48 hr. delivery. Thousands of frequencies in stock. Types include HC6/U, HC18/U, FT-241, FT-243, FT-171, etc. Send 10c for catalog with oscillator circuits. Refunded on first order. Jan Crystals, 2400F Crystal Dr., Fort Myers, Fla. 33901.

SURVEILLANCE EQUIPMENT—NEW HIGH PERFORMANCE SUBMINIATURE MODELS. ELECTRONIC COUNTERMEASURE DEVICES TO PROTECT PRIVACY. FREE DATA: SECURITY ELECTRONICS-PE, 15 EAST 43RD STREET, NEW YORK, N.Y. 10017.

FREE ELECTRONICS (new and surplus) parts catalog. We repair multimeters. Bigelow Electronics, Bluffton, Ohio 45817.

TREASURE Hunters! Prospectors! Relco's new instruments detect buried gold, silver, coins. Kits, assembled models. Transistorized. Weighs 3 pounds. \$19.95 up. Free catalog. Relco-A33, Box 10836, Houston, Texas 77018.

DIAGRAMS—Radios \$1.50. Television \$3.00. Give make and model. Diagram Service, Box 1151PE, Manchester, Conn. 06042.

EUROPEAN and Japanese bargain catalogs. \$1 each. Dee, 10639E Riverside, North Hollywood, Calif. 91602.

INVESTIGATORS, FREE BROCHURE, LATEST SUBMINIATURE ELECTRONICS SURVEILLANCE EQUIPMENT, ACE ELECTRONICS, 11500-L NW 7TH AVE., MIAMI, FLA. 33168.

TRANSISTORIZED CONVERTER KITS: Two models, converts car radio. Receive 30-50mc or 100-200mc (one mc tuning) \$5.00 with simple instructions. Crystal \$2.50. Meshna, No. Reading, Mass. 01864.

MECHANICAL, Electronic devices catalog 10¢. Greatest Values—Lowest Prices. Fertik's, 5249 'D', Philadelphia, Pa. 19120.

SURVEILLANCE EQUIPMENT, latest devices, also construction plans, free catalog. FISHER ELECTRONICS, Box 350, N. Miami Beach, Florida 33160.

GENERAL INFORMATION: First word in all ads set in bold caps at no extra charge. Additional words may be set in bold caps at 10c extra per word. All copy subject to publisher's approval. Closing Date: 1st of the 2nd preceding month (for example, March issue closes January 1st). Send order and remittance to: Hal Cymes, POPULAR ELECTRONICS, One Park Avenue, New York, New York 10016.

MUSIC LOVERS, CONTINUOUS, UNINTERRUPTED BACKGROUND MUSIC FROM YOUR FM RADIO, USING NEW INEXPENSIVE ADAPTOR. FREE LITERATURE. ELECTRONICS, 11500-Z NW 7th AVE., MIAMI, FLORIDA 33168.

LINEAR AMPLIFIERS: "Hornet"—50 watts output—\$98.50; "Raider"—100 watts—\$139.95; "Maverick-250"—250 watts—\$244.95. For AM and SSB. "BANDIT II"—12 V. mobile amplifier—\$169.95. Frequency range 20-35 megacycles (illegal for Class D 11 meters.) **NEW LINE—6 meter linears. Dealer inquiries invited. D & A Manufacturing Co., 1217 Avenue C, Scottsbluff, Nebraska 69361.**

JAPANESE or EUROPEAN DIRECTORY 200 firms \$1.00. SURVEILLANCE EQUIPMENT, Catalog 25¢. Wireless SNOOPERMIKE \$25.00. SUBMINIATURE 3/8 x 3/8 x 3/16 \$4.00. SIERRATRONICS, Box 7497, Las Vegas, Nev. 89101.

WE SELL CONSTRUCTION PLANS. TELEPHONE: Answering Machine, Speakerphone, Carphone, Phoning, Legal Connector, Auto Dialer, Central Dial System. **TELEVISION:** \$35.00 Color Converter, Tape Recorder, 3DTV, \$25.00 Camera. **DETECTIVE:** Infinity Transmitter, Tail Transmitter, Police Radar Detector. **HOBBYIST:** Electron Microscope, 96 Hour Tape Music System, Ultrasonic Dishwasher, Radar-Oven, Electronic Tranquilizer. Plans \$4.95 each. **COURSES:** Telephone Engineering \$39.50, Detective Electronics \$22.50. Anti-Detective Electronics \$27.50. **SUPER HOBBY CATALOG 25¢.** Don Britton Enterprises, 7906 Santa Monica Blvd., Hollywood, Calif. 90046.

CIRCUIT Boards, Parts for "Poptronics" projects. Free catalog. S.W. Technical, Box 16297, San Antonio, Texas 78216.

SURVEILLANCE COUNTERMEASURES BROCHURE \$1.00. ENGINEERING LABORATORIES, BOX 1036, ANDERSON, INDIANA 46015.

WEBBER LAB's. Police & Fire Converters. Catalog 10¢. 72 Cottage Street, Lynn, Mass. 01905.

ELECTRONIC Ignition, various types. Free literature. Anderson Engineering, Epsom, N.H. 03239.

PROXIMITY switch. Detects nearness of human body! Free information. Claremont Products, 860 Reed, Claremont North, Calif. 91711.

NEW Sensitive Treasure Metal Detectors. New low prices. Professional models from \$29.95 to \$129.50. Write for free catalog today. Jetco Electronics, Box 132-E, Huntsville, Texas 77340.

RADIO—T.V. Tubes—33¢ each. Send for free catalog. Cornell, 4213 University, San Diego, Calif. 92105.

SONAR Monitor Receivers unsurpassed. Fire, police, ambulance taxi, highway patrol communications. exceptional values. Griffin's, 322 West State, Ithaca, N.Y. 14850.

MOBILE SW LISTENING with transistorized converter for your car radio. 10 push-button controlled bands. Send for free brochure: Mercator Company, Box 473, Allentown, Pa. 18105.

RELAYS Telephone Type. Write: Don Verhaus, 424 West Ave., Grand Island, Neb. 68801.

TELEPHONE RECORDER-ACTUATOR (TWI-007). SOLID STATE MODULE AUTOMATICALLY TURNS TAPE RECORDER, INDICATOR, ON WHEN TELEPHONE IN USE, \$22.85. FM TELEPHONE BUG (TWI-004) transmits to FM RADIO \$29.95. Connected anywhere on line. SIMPLE INSTALLATION INSTRUCTIONS. Surveillance RECORDERS (TWI-1000), (TWI-1010). TWILIGHT ELECTRONICS, BOX 11595-Z, St. Louis, Missouri 63105.

"A GUIDE TO OVER 500 ELECTRONIC CONSTRUCTION PROJECTS!" 4 years in the making; covers every project-type imaginable! \$3.95. BEL ENTERPRISES, P.O. Box 381-E2, Bellflower, Calif. 90706.

SIXTY WATTS ON CB; Booklet tells Legal Way. \$2.00. Box 1818, Laurinburg, N.C. 28352.

UNIVERSAL ALARM MULTIPLE USES, FIRE, BURGLARY, WATER TEMP ETC. OPERATES FULL YEAR ON ORDINARY BATTERIES. \$7.95, FREE CATALOG. 3 STAR, BOX 8, BROOKLYN, NY 11236.

REGULATED Power Supply Range 3.6V to 18V 5A short circuit protection with schematic \$9.95. 115VAC 1000W photocell units \$4.95. Alphatronics, 14251 East Colfax, Aurora, Colorado 80010.

WHOLESALE COMPONENTS: Manufacturers and distributors only. Request free catalog on business letterhead. **WESCOM**, Box 2536, El Cajon, California 92021.

CONVERT any television to sensitive, big-screen oscilloscope. Only minor changes required. No electronic experience necessary. Illustrated plans, \$2.00. Relco-A33, Box 10563, Houston, Texas 77018.

POLICE AND FIRE RADIO DIRECTORIES. Frequencies, call signs! Send stamp, catalog. Communications, Box 56-PE, Commack, N.Y. 11725.

TELEVISION CAMERA KITS! Wide selection tube and transistor models. Starter kits, \$18.95 up. Complete kits \$149.50 up. Plans available separately; tube camera \$3.00, transistor camera \$5.00, TV station \$1.00. ATV literature anthology \$2.50. Catalog **FREE**. **ATV RESEARCH**, 13th & Broadway, Dakota City, Nebraska 68731.

THOUSANDS and thousands of types of electronic parts, tubes, transistors, instruments, etc. Send for Free Catalog. Arcturus Electronics Corp., MPE, 502-22nd St., Union City, N.J. 07087.

INTEGRATED CIRCUITS PROJECTS—Audio Amplifier, Code practice Osc., Receiver, Wireless Mic, f.s. meter, Audio generator, Signal tracer, Light flasher, Electronic organ, Square wave generator, etc. Catalog 25¢, Plans \$1.00 each. Catalog free with order. One IC and printed circuit board builds all. \$5.00. Hal's Electronics, P.O. Box 137, Milpitas, Calif. 95035.

DETECTIVES! Precision Surveillance Devices. New Catalog. Free when writing on letterhead. Otherwise \$1.00 refundable with first purchase. **SILMAR ELECTRONICS**, 3476 N. W. 7th Street, Miami, Florida 33125.

PLANS AND KITS

BEGINNERS Allwave \$5.00, Two Band \$5.00, F-M Tuner Chassis \$10.00, Headset \$2.50. Two Band Wired \$10.00. Ekeradio, Box 131, Temple City, Calif. 91780.

UNIVERSITY LEVEL LOGIC KITS with training manuals written by professors. Indiana Instruments, Inc., P. O. Box 8368, St. Petersburg, Florida 33738.

CONNECT EXTENSION TELEPHONE(S), maintain (or insert) ring—undetectable, inexpensive. Detailed plans \$1.95. Ellin, 161 Bonad, Chestnut Hill, Mass. 02167.

"RADIO WORKBENCH TIPS" Handbook—50¢. Experimenter. Beginner's information Catalog—25¢, refundable. Laboratories, 12041-L Sheridan, Garden Grove, California 92640.

BURGLAR ALARM PLANS. Easily constructed, commonly available materials. Includes window stickers—\$1.00. D&S Photo, Box 938, Rantoul, Illinois 61866.

SHORT PROOF power supply—0.1 ohm ohmmeter—power diode curves. Use your Battery Eliminator/Charger and new **E/I CONTROLLER!** Plans \$3.50. Kits. **ALSYNCO**, Dept. PE-81, 171 S. Main, Natick, Mass. 01760.

RADIO jammer plans \$1.50. T.V. jammer plans \$1.50. Catalog of unusual plans, kits, 20¢. Franks Scientific Co., P.O. Box 156, Martelle, Iowa 52305.

BUILD POLICE CALL RECEIVER! UHF-VHF. SCHEMATICS, ALIGNMENT AND CONSTRUCTION DETAILS! \$2.00, ELECTROWEST, BOX 56086, HARWOOD HEIGHTS, ILLINOIS 60656.

INTEGRATED CIRCUIT KITS; COMPUTER CIRCUIT KITS; Others. New catalog free. **KAYE ENGINEERING**, Box 3932-A, Long Beach, California 90803.

LINEAR INTEGRATED CIRCUITS! High Gain Amp. to 300 KC—\$1.50 ea; High Gain Video Amp. to 30 MC—\$1.50 ea; 1½ Volt High Gain Audio Amp—\$1.50 ea. Guaranteed functional. Circuit diagrams included. **AMERICAN INTEGRATED CIRCUITS**, 261 Vista Ave., San Jose, Calif. 95127.

BUILD-IT-YOURSELF. Save big dollars. Transistor stereo amplifiers. Color organs. Speakers. Write Workshop, Box 87, Bethpage, New York 11714.

SHORTWAVE LISTENING

POLICE—FIRE—AIRCRAFT—MARINE—AMATEUR CALLS on your broadcast radio with **TUNAVERTER!** Tunable and crystal in one! Guaranteed! Free catalog. Saich Co., Woodsboro-PEC, Texas 78393. **SHORTWAVE** Listeners DX Guide \$1.75. Limited offer. SWLDXG, P. O. Box 385, Berwick, Penna. 18603.

HIGH FIDELITY

FREE! Send for money saving stereo catalog #P8E and lowest quotations on your individual component, tape recorder, or system requirements. Electronic Values, Inc., 200 W. 20th St., New York, N.Y. 10011.

HI-FI Components, Tape Recorders, at guaranteed "We Will Not Be Undersold" prices. 15-day money-back guarantee. Two-year warranty. No Catalog. Quotations Free. Hi-Fidelity Center, 239 (P) East 149th Street, New York 10451.

LOW, Low quotes: all components and recorders. HiFi, Roslyn, Penna. 19001.

TAPE RECORDERS, Hi-Fi, components, Sleep Learning Equipment, tapes. Unusual Values Free Catalog. Dressner, 1523R, Jericho Turnpike, New Hyde Park, N.Y. 11040.

WANTED

CASH Paid! Unused tubes, electronic equipment. Barry, 512 Broadway, NYC 10012.

QUICKSILVER, Platinum, Silver, Gold, Ores Analyzed. Free Circular. Mercury Terminal, Norwood, Mass. 02062.

TUBES

TUBES "Oldies", latest. Lists free. Steinmetz, 7519 Maplewood, Hammond, Indiana 46324.

RECEIVING & INDUSTRIAL TUBES, TRANSISTORS. All Brands—Biggest Discounts. Technicians, Hobbyists, Experimenters—Request **FREE** Giant Catalog and **SAVE!** ZALYTRON, 469 Jericho Turnpike, Mineola, N.Y. 11501.

TUBE Headquarters of World! Send 10¢ for Catalog (tubes, electronic equipment) Barry. 512 Broadway, N.Y.C. 10012.

RADIO & T.V. Tubes—33¢ each. Send for free list. Cornell, 4213 University, San Diego, Calif. 92105.

DON'T BUY TUBES—Radios TV-Xmitting, special-purpose types until you get our price list! Lowest prices in U.S.A. 5,000 types—Guaranteed Brand New. Send postcard for TV-Special Purpose Price List. **UNITED RADIO COMPANY, P.O. BOX 1000, NEWARK, N.J. 07101.**

TAPE AND RECORDERS

BEFORE Renting Stereo Tapes try us. Postpaid both ways—no deposit—immediate delivery. Quality—Dependability—Service—Satisfaction—prevail here. If you've been dissatisfied in the past, your initial order will prove this is no idle boast. Free Catalog. Gold Coast Tape Library, Box 2262, Palm Village Station, Hialeah, Fla. 33012.

AUTOMATIC telephone connection for Concord and other transistorized recorders. **SURVEILLANCE** and Privacy Protection Devices. Free Data: Security Electronics-PER, 15 East 43rd Street, New York, N.Y. 10017.

HI-FI Components, Tape Recorders, at guaranteed "We Will Not Be Undersold" prices. 15-day money-back guarantee. Two-year warranty. No Catalog. Quotations Free. HiFidelity Center, 239 (PT) East 149th Street, New York 10451.

SCOTCH Recording Tapes. Tape Recorders. Catalog 10¢. Tower, Lafayette Hill, Pa. 19444.

RENT STEREO TAPES—75¢ WEEK. CATALOG. ART'S TAPE SERVICE, 1613½ North Mariposa Ave., Hollywood, Calif. 90027.

TAPE transport. NAB recording studio quality. Build yourself for amazingly low cost. Detailed plans \$5.00. Free particulars. Pepke Laboratories, 309-B West 19 Street, New York, N.Y. 10011.

TAPEMATES makes available to you **ALL 4-TRACK STEREO TAPES—ALL LABELS—**topped to your door—at tremendous savings. For free brochure write: **TAPEMATES**, 5727 W. Jefferson Blvd., Los Angeles, California 90016.

WHOLESALE—4-8 track **STEREOTAPES**—Car, Home **PLAYERS**—**CB**, Recorders. **MUSICO**, Box 2705, Montgomery, Alabama 36105

RENT 4-Track open reel tapes—all major labels—3,000 different—free brochure. Stereo-Parti, 55 St. James Drive, Santa Rosa, Ca. 95401.

STEREO TAPES, Save 30% and up; no membership or fees required; postpaid anywhere U.S.A. Free 70-page catalog. We discount batteries, recorders, tape/accessories. Beware of slogans, "not under sold", as the discount information you supply our competitor is invariably reported to the factory. **SAKITONE**, 1776 Columbia Road, N.W., Washington, D.C. 20009.

SCOTCH RECORDING TAPE, lowest prices **TAPE CENTER**, Box 4305, Washington, D.C. 20012.

TAPE RECORDER SALE. Brand new nationally advertised brands, \$10.00 above cost. Amazing discounts on stereo components. **Arkay Electronics**, 1028-C Commonwealth Avenue, Boston, Mass. 02215.

REPAIRS AND SERVICES

TV Tuners rebuilt and aligned per manufacturers specification. Only \$9.50. Any make UHF or VHF. Ninety day written guarantee. Ship complete with tubes or write for free mailing kit and dealer brochure. **JW Electronics**, Box 51C, Bloomington, Indiana 47401.

SPEAKER REPAIR. Hi-Fi, guitar, organ speakers reconed good as new at fraction of new speaker price. For details and reconing center in your area write: **Waldom Electronics, Inc.**, Dept PE, 4625 W. 53rd St., Chicago, Ill. 60632.

PINS, BUSHINGS, SCREWS Made To Order. 21225 Vandike, Warren, Michigan 48089.

CHASSIS: All types and sizes. Will build to your specifications. Phone 307-532-5752. **A & T Manufacturing, Inc.**, 1902 West C., Torrington, Wyoming 82240.

CRYSTALS: Precision made to customer's specifications. **X-Tron Electronics Inc.**, 1869 National Avenue, Hayward, California 94545.

TV AID SEND SYMPTOMS, MAKE, MODEL, CHASSIS NUMBER, INDIVIDUAL DIAGNOSIS. \$5.00. **TELAID**, BOX 16, MIDDLETOWN, DE. 19709.

ELECTRICAL ENGINEERS WILL DESIGN CIRCUITS. Send description and \$3.00. We send Schematic. **Wray**, 514 Aberdeen, Kettering, Ohio 45419.

PERSONALS

INVESTIGATORS, FREE BROCHURE, LATEST SUBMINIATURE ELECTRONIC SURVEILLANCE EQUIPMENT. **ACE ELECTRONICS**, 11500-K NW 7th AVE., MIAMI, FLA. 33168.

MAKE FRIENDS WORLDWIDE through international correspondence. Illustrated brochure free. **Hermes**, Berlin 11, Germany.

BILL PROBLEMS? Poor credit no trouble. Not a loan company. Send for free application. **Nationwide Plan**, Dept. PE, 318 Broadway Blvd., Reno, Nevada 89502 or 307 Pocasset Ave., Providence, R.I. 02909.

SPEECH diagnosis including **Craig Recorder**, \$48; **Communications Research**, Cortez, Florida 33522.

PROPAGANDA! Challenge! Modern Logic! Free Details. **Aubrey Center**—PE, Middletown, New Jersey 07748.

FREE Catalog low priced, high performance subminiature listen-in devices direct from manufacturer. Dealers welcome. **Audiotronix-E**, 156 Fifth Avenue, New York, N.Y. 10010.

INSTRUCTION

LEARN While Asleep, hypnotize with your recorder, phonograph. Astonishing details, sensational catalog free! **Sleep-Learning Association**, Box 24-ZD, Olympia, Wash. 98501.

LEARN ELECTRONIC ORGAN SERVICING at home all makes including transistor. Experimental kit—trouble-shooting. Accredited **NHSC**. Free Booklet. **NILES BRYANT SCHOOL**, 3631 Stockton, Dept. A, Sacramento, Calif. 95820.

ASSOCIATE Degree in Electronics Engineering earned through combination correspondence-classroom educational program. Free brochure. **Grantham Technical Institute**, 1505 N. Western Ave., Hollywood, Calif. 90027.

FCC First Class License in six weeks—nation's highest success rate—approved for Veterans Training. Write **Elkins Institute**, 2603B Inwood Road, Dallas, Texas 75235.

HIGHLY EFFECTIVE home study course in Electronics Engineering Mathematics with circuit application. Earn your Associate in Science Degree. Free Literature. **Cook's Institute of Electronics Engineering**, P.O. Box 36185, Houston, Texas 77036. (Established 1945.)

LEARN TECHNICAL WRITING—at home. High paying prestige careers not requiring college. Growing demand, all industries for tech writers now. Low monthly tuition. Easy to understand. **FREE** career book, sample lesson. **APPROVED FOR VETERANS**. **American Technical Writing Schools**, Dept. PEC-88, 5512 Hollywood Blvd., Hollywood, Calif. 90028.

R. E. I.'s famous (5) week course for the first class radio telephone license is the shortest, most effective course in the nation. Over 98% of R.E.I. graduates pass F.C.C. exams for 1st class license. Total tuition \$350.00. Job placement free. Write for brochure **Radio Engineering Incorporated Schools**, 1336 Main Street, Sarasota, Florida 33577—or 3123 Gilham Road, Kansas City, Missouri 64109—or 809 Caroline Street, Fredericksburg, Virginia 22401.

FCC First or Second Class Radiotelephone license in four to six weeks. Guaranteed. Day or night classes. Write **ELECTRONICS INSTITUTE**, 2202 W. Erwin, Tyler, Texas 75701 or call 214-593-0807.

FCC LICENSE THROUGH TAPE RECORDED LESSONS. Radio License Training, 1060D Duncan, Manhattan Beach, Calif. 90266.

RADIO AND TELEVISION REPAIR COURSE. BASIC EQUIPMENT AND INSTRUCTION NECESSARY TO START A PROFITABLE BUSINESS FURNISHED. WRITE HOOSIER TECHNICAL INSTITUTE, BOX 88401, INDIANAPOLIS, INDIANA 46208.

INVENTIONS WANTED

PATENT Searches including Maximum speed, full airmail report and closest patent copies, \$6.00. Quality searches expertly administered. Complete secrecy guaranteed. Free Invention Protection forms and "Patent Information." Write Dept. 9, **Washington Patent Office Search Bureau**, 711 14th Street, N.W., Washington, D.C. 20005.

INVENTORS. We will develop, help sell your idea or invention, patented or unpatented. Our national manufacturer clients are urgently seeking new items for outright cash sale or royalties. Financial assistance available. 10 years proven performances. For free information, write Dept. 41, **Wall Street Invention Brokerage**, 79 Wall Street, New York N.Y. 10005.

INVENTORS! Outright cash sale or royalties for your inventions. Patented. Unpatented. Active demand from our client manufacturers. Financial assistance available. Write Dept. 35, **United States Invention Brokerage**, 78 Wall Street, New York, N.Y. 10005.

INVENTIONS wanted. Patented; unpatented. **Global Marketing Service**, 2420-P 77th, Oakland, Calif. 94605.

PATENT SEARCHES \$15.00! FREE "INVENTION RECORD"/Information. **Hayward Company**, 1029HR Vermont, District of Columbia 20005.

INVENTORS! OUR FREE EXPERT ANALYSIS of your invention can save valuable time, help you realize full sale value. Strictly confidential. **FREE INVENTION CERTIFICATE**. Write today: **Pioneer Invention Service**, Dept. 35, 150 Broadway, New York, N.Y. 10038.

INVENTORS! Sell your invention for cash or royalties! Our client manufacturers eagerly seek new items. Patented. Unpatented. Financial assistance if needed. 25 years proven performances. For free information, write Dept. 20, **Gilbert Adams, Invention Broker**, 80 Wall St., New York, N.Y. 10005.

INVENTORS! Don't sell your invention, patented or unpatented, until you receive our offer. **Eagle Development Company**, Dept. P, 79 Wall Street, N.Y., N.Y. 10005.

MANUFACTURERS NEED NEW ITEMS! Many million-dollar corporations have authorized us to locate new products. Free details regarding development, sale, licensing of your invention. **RAYMOND LEE ORGANIZATION**, 230-GR Park Avenue, New York City 10017. Member: **UNITED STATES CHAMBER COMMERCE**.

QUALITY Patent Searches \$15.00! Preferred by Professional Inventors, Lawyers, Manufacturers. "Confidential Report" Including related United States patent copies "Airmailed Certified." **FREE** information! **United States Inventors Service Company**, 501-H Thirtieth Street, N.W., Washington, D.C. 20005.

GOVERNMENT SURPLUS

GOVERNMENT Surplus How and Where to Buy in Your Area. Send \$1.00 to: **Surplus Information PE**, Headquarters Building, Washington, D.C. 20036.

BUY GOVERNMENT SURPLUS Direct. Complete Detailed Booklet With Addresses—\$1.00. Anything—Anywhere. Crider Block and Tile, Box 368. Portsmouth, Ohio 45662. Satisfaction Guaranteed.

JEEPS Typically From \$53.90 . . . Trucks From \$78.40 . . . Boats, Typewriters, Airplanes, Multimeters, Oscilloscopes, Transceivers, Electronics Equipment, Used. 100,000 Bid Bargains Direct From Government Nationwide. Complete Sales Directory and Surplus Catalog \$1.00 (Deductible First \$10.00 Order). Surplus Service, Box 820-J, Holland, Michigan 49423.

BOOKS

FREE catalog 950 aviation/electronic/space books. Aero Publishers, 329PE Aviation Road, Fallbrook, California 92028.

UNUSUAL Books! Catalog free! International, Box 7798(PE), Atlanta, Georgia 30309.

FREE Book. Prophet Elijah Coming Before Christ. Wonderful Bible Evidence. PE Megiddo Mission, Rochester, New York 14619.

AUTHORS' SERVICES

AUTHORS! Learn how to have your book published, promoted, distributed. **FREE** booklet "2D," Vantage, 120 West 31 St., New York 10001

POEMS WANTED for new song hits and recordings by America's most popular studio. Tin Pan Alley, 1650-2D Broadway, New York 10019.

MUSIC

POEMS wanted for new songs. Nashville Music Institute, Box 532-E, Nashville, Tennessee 37202.

MUSICAL INSTRUMENTS

ACCORDIONS, GUITARS, BAND INSTRUMENTS! Save to 50%. Terms Trades. Free Trial. Free catalog. Mention instrument. Music Mart. 5535-PE Belmont, Chicago 60641.

REMAILING SERVICE

GREENUP POSTMARK, 25¢. Burgage, 89 Ohio River Road, Greenup, Ky. 41144.

HYPNOTISM

FREE Hypnotism, Self-Hypnosis, Sleep Learning Catalog! Drawer H400, Ruidoso, New Mexico 88345.

"MALE-FEMALE HYPNOTISM" EXPOSED, EXPLAINED! "SECRET METHOD"—THEY NEVER KNOW! \$2, RUSHED. GUARANTEED! ISABELLA HALL, SILVER SPRINGS, FLORIDA 32688.

SELF-HYPNOSIS for self-improvement. Safe, effective! Free literature. McKinley, Dept. T-4, Box 3038, San Bernardino, California 92404.

HYPNOTIZE SUCCESSFULLY—or money refunded! Complete illustrated course—including Self-Hypnosis \$1.00. Arthur Fowler, Box 4396, Woodbury, New Jersey 08096.

HYPNOTIZE SUCCESSFULLY! "Instantaneous—One Word—Against Will!" Methods Exposed! Complete illustrated course including "Secret Nerve Pressure Technique—Self-Hypnosis"—10" Hypo-Disk. \$2.00. **RESULTS ABSOLUTELY GUARANTEED.** Fowler, Box 4396, Woodbury, N.J. 08096.

RUBBER STAMPS

RUBBER ADDRESS STAMP \$1.50. SIGNATURE \$3.50. FREE CATALOG. JACKSON, BOX 443-G, FRANKLIN PARK, ILL. 60131.

PHOTOGRAPHY—FILM, EQUIPMENT, SERVICES

MEDICAL Film—Adults Only—"Childbirth"—1 reel 8mm \$7.50—16mm \$14.95. International-E. Greenvale, L.I., New York 11548.

SCIENCE Bargains—Request Free Giant Catalog "CJ"—148 pages—Astronomical Telescopes, Microscopes, Lenses, Binoculars, Kits, Parts. War surplus bargains. Edmund Scientific Co., Barrington, New Jersey 08007.

RECORDS

SPECIAL INTEREST RECORDS AVAILABLE, PRODUCED BY THE EDITORS OF THE WORLD'S LEADING SPECIAL INTEREST MAGAZINES. SEND FOR FREE CATALOG. RECORD CATALOG-PE, ZIFF-DAVIS PUBLISHING COMPANY, ONE PARK AVENUE, NEW YORK, N.Y. 10016.

CLASSIFIED ADVERTISING ORDER FORM

Please refer to heading on first page of this section for complete data concerning terms, frequency discounts, closing dates, etc.

1	2	3	4	5
6	7	8	9	10
11	12	13	14	15
16	17	18	19	20
21	22	23	24	25
26	27	28	29	30
31	32	33	34	35

Words { @ 60¢ (Reader Rate) }
 { @ \$1.00 (Commercial Rate) }

Insert _____ time(s)

Total Enclosed

\$ _____

\$ _____

NAME _____

ADDRESS _____

CITY _____ STATE _____ ZIP _____

Signature _____

WORD COUNT: Include name and address. Name of city (Des Moines) or of state (New York) counts as one word each. Zip Code numbers not counted. (Publisher reserves right to omit Zip Code if space does not permit.) Count each abbreviation, initial, single figure or group of figures or letters as a word. Symbols such as 35mm, COD, PO, AC, etc., count as one word. Hyphenated words count as two words.

PE-868

RECORDS!!! 45rpm—15¢; LP'S \$1.00. Details \$2.00. Records, 129 Carol Avenue, Aberdeen, Maryland 21001.

OLDIES 45RPM. Original Hits. Over 1500 available. Catalog 25¢ C & S Record Sales, Box 197, Wampsville, N.Y. 13163.

PLASTICS

CASTOLITE Liquid Plastic pours like water and hardens like glass without heat. Clear, Colors. Embed real flowers, butterflies, photos, coins. Also new molding formulas for perfect reproductions. Illustrated booklet shows **HOW**. Send 25¢—Dept. 68-108J. **CASTOLITE**, Woodstock, Ill. 60098.

EDUCATIONAL OPPORTUNITIES

LEARN WHILE ASLEEP. Miraculously build Mind Power, achieve Self-Confidence, improve Health, gain Success. Method 92% effective. Details free. ASR Foundation, Box 7021EG Henry Clay Sta., Lexington, Kentucky 40502.

PRINTING

FREE LITERATURE: 1000 Address Labels \$1.00. 1000 Business Cards \$4.95. Printing, Rubber Stamps. Jordan's, 552 West O'Connor, Lima, Ohio 45801.

POSTPAID Specials: 1,000 8½ x 11 Offset—\$5.75. Mimeoprinting; 500—\$3.75. Electronic Stencils: \$1.00. Free brochures. **SEAVIEW**, 9115-PE Ave., "L," Bklyn, N.Y. 11236.

THERMOGRAPHED business cards, \$3.49—1,000, free samples. Gables-405B Clifton, Glenshaw, Pa. 15116.

REAL ESTATE

FREE . . . New **FALL-WINTER CATALOG!** Over 2,300 actual photos! Farms, ranches, town and country homes, businesses in 31 states coast to coast! Specify type of property and location preferred. Zip code, please. **UNITED FARM AGENCY**, 612-EP West 47th St., Kansas City, Mo. 64112.

BUSINESS OPPORTUNITIES

INVESTIGATE ACCIDENTS: Earn to \$1000 monthly. Men urgently needed. Car furnished. Business expenses paid. No selling. No college education necessary. Pick own job location. Investigate full time or earn to \$8 hour spare time. Write for **FREE** information. No obligation. Universal Schools, CZ-8, 6801 Hillcrest, Dallas, Texas 75205.

RAISE Rabbits for us on \$500 month plan. Free details. White's Rabbitry, Mt. Vernon, Ohio 43050.

FREE CATALOGS. Repair air conditioning, refrigeration. Tools, supplies, full instructions. Doolin, 2016 Canton, Dallas, Texas 75201.

PIANO TUNING learned quickly at home. Tremendous field! Musical knowledge unnecessary. GI Approved. Information free. Empire School, Miami, Florida 33145.

ELECTROPLATING Equipment and supplies. All types for home workshops and industrial. Send \$1.00 (refundable) for equipment guide formulas, operating data, catalog. HBS Equipment Division 90, 3543 East 16th, Los Angeles, California 90023.

I MADE \$40,000.00 Year by Mailorder! Helped others make money! Start with \$10.00—Free Proof. Torrey, Box 318-N, Ypsilanti, Michigan 48197.

\$200.00 DAILY In Your Mailbox! Your opportunity to do what mail-order experts do. Free details. Associates, Box 136-J, Holland, Michigan 49423.

BIG EARNINGS selling Hertel Bibles. New 3-dimension cover, finest reference edition sells fast. Demonstrator furnished. Big commissions. International Book, Dept. PE, Box 118, Wichita, Kansas 67201.

FREE Book "990 Successful little-known Businesses." Work home. Plymouth 245H, Brooklyn, N.Y. 11218.

EMPLOYMENT INFORMATION

OVERSEAS Jobs all trades and professions. Free information write: National Employment Service, Box 2235 A.M.F., Miami, Florida 33159.

BODMING AUSTRALIA pays travel allowance to get You! Good jobs, Adventure. Latest factual Handbook describing allowances, entry requirements, advantages, opportunities \$1.00, Buckeye, Box 1032TN, Fairborn, Ohio 45324.

STAMPS

RUSSIA HIGH-VALUE COLLECTION. 32 different Russia—some over 50 years old! Commemoratives, Czarist Issues, Airmails. Catalog price \$2.99. Special Get-Acquainted Offer—all for only 10¢! H.E. Harris, Dept. GG-13, Boston, Mass. 02117.

WOW! 110 All Different Germany 10¢. Commemoratives, Airmails, High Values, Big catalog, Bargain lists also, fine stamps from our approval service, which you may return without purchases and cancel service at any time. Jamestown Stamp, Dept. A88EG, Jamestown, N.Y. 14701.

WANTED

CASH for terminal—red, blue, yellow. **HALCAP**, Box 19183, Houston, Texas 77024.

MISCELLANEOUS

WINEMAKERS: Free illustrated catalog of yeasts, equipment. Simplex, Box 7208, Minneapolis, Minn. 55412.

BILLS PAID WITHOUT BORROWING—Nobody refused up to \$18,000.00. Bad credit no problem—Not a Loan Company. Write for **FREE** application—**INTERNATIONAL ACCEPTANCE**, Dept. 50A, Phoenix, Arizona 85012—711 14th St., N.W., Washington, D.C. 20005—507 Carondelet St., New Orleans, La. 70130.

EMPLOYMENT Resumes. Get a better job & earn more! Send only \$2.00 for expert, complete Resume Writing Instructions. J. Ross, 80-34 Kent St., Jamaica, N.Y. 11432, Dept. PE.

STOP BURGLARS THE EASY WAY!! Affix authentic "Protected by Electronic Sentry Alarm" Decals to auto windows, doors & windows of home, retail stores, vending machines, etc. Whether you have an alarm or not—thieves stay away! Only \$1.00 each set of two. J. Ross, 80-34 Kent St., Jamaica, N.Y. 11432 Dept. PE.

WATCHES AND CHRONOGRAPHS—Import from Switzerland, save 50%. Color catalog. DFI, West Dennis, Massachusetts 02670.

STAMMER—Stutter—No More. (Dr. Young.) Write Gaucho, Box 9309-E8, Chicago 60690.

TEN Winemaking Recipes and Winemaking supplies catalog 10¢. Country Winemaker, Box 191E, RFD 1, Mattapoisett, Mass. 02739.

MAIL ORDER OPPORTUNITIES WAITING FOR YOU!

Classified Advertisers find more outlets for their product and service advertising in Ziff-Davis Electronics Publications than in any other media.

Whether in a monthly publication: **POPULAR ELECTRONICS**, **ELECTRONICS WORLD**, **HiFi/STEREO REVIEW** . . . or in an annual: **COMMUNICATIONS HANDBOOK**, **ELECTRONIC EXPERIMENTER'S HANDBOOKS**, **ELECTRONICS INSTALLATION AND SERVICING HANDBOOK**, or **TAPE RECORDER ANNUAL**—Classified Advertising is responded to regularly by an affluent audience of active electronics enthusiasts.

Prove to yourself the effectiveness of Classified Advertising in Ziff-Davis Electronics Publications. Write today for information, assistance or sample copies to:

Hal Cymes, Classified Advertising Manager
Ziff-Davis Publishing Company
One Park Avenue, New York, N. Y. 10016

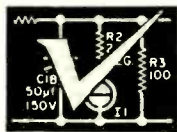

OPERATION ASSIST

Through this column we try to make it possible for readers needing information on outdated, obscure, and unusual radio-electronics gear to get help from other P.E. readers. Here's how it works: Check the list below. If you can help anyone with a schematic or other information, write him directly—he'll appreciate it. If you need help, send a postcard to Operation Assist, POPULAR ELECTRONICS, One Park Avenue, New York, N.Y. 10016. Give maker's name and model number of the unit. If you don't know both the maker's name and the model number, give year of manufacture, bands covered, tubes used, etc. State specifically what you want, i.e., schematic, source for parts, etc. Be sure to print or type everything legibly, including your name and address. Because we get so many inquiries, none of them can be acknowledged. POPULAR ELECTRONICS reserves the right to publish only those items not available from normal sources.

Howard Model 909 receiver. Schematic and operating manual needed. (R. Quillen, 106 Jeff Davis Ave., Biloxi, Miss. 39530)

Feiler Model TS7 oscilloscope. Schematic and operating instructions needed. (James Wenzlaff, Wenona, Ill. 61377)

Hallicrafters Model S-40B. Schematic, operating manual, and alignment data needed. (Michael Hopkins, Box 3, Bradshaw, Neb. 68319)

Zenith Model 27 t.r.f. radio. 1926. Instruction book and UX-199 tubes needed. (John Wolkonowicz, 11 Hartford Rd., Worcester, Mass. 01606)

Delco Model R117 receiver, circa 1939. Schematic and/or manual needed. (Jay Dresser, 15740 Spaulding, Markham, Ill. 60426)

Airline Model 64BR 2701A receiver. Schematic needed. (Mark Murphy, 5700 Hinman Rd., Lockport, N.Y. 14094)

Silvertone Model R-705B receiver, circa 1911. Schematic and source of parts needed. (John Fritz, RD #3, Glen Rock, Penna. 17327)

Hickok Model 305 oscillograph. Manual and schematic needed. (Frank B. Brown, 51 Farnham St., Portland, Me. 04103)

Radiola RS regenerative receiver and amplifier. Schematic, battery voltages, headphones, and source for WD-11 tubes needed. (Frank Jones, 205 Roskie Hall, Bozeman, Mont. 59715)

Zenith Model 6-S-229 and Model 5-S-228 "Long Distance" circa 1936. Schematic needed. (Burlleigh Cooper, 310 Wilson Rd., Oaklands, Newark, De. 19711)

Westinghouse Model H-800 color-TV converter. Schematic and operating instructions needed. (Mearl Ashby, 1026 35 St., Parkersburg, W. Va. 26101)

RCA 115A oscillograph. Schematic and power transformer needed. (S. Risio, 16 City Terr. N., Newburgh, N.Y. 12550)

RCA Model 5Q55 receiver, circa 1937. Schematic and source for parts needed. (Elliot Bernstein, 11 Larch Ln., Scarsdale, N.Y. 10583)

Philco Model 50 broadcast receiver, circa late 1930's. Schematic and parts list needed. (Richard Flack, 2500 NE 201 St., Troutdale, Ore. 97060)

POPULAR ELECTRONICS

AUGUST 1968

ADVERTISERS INDEX

ADVERTISER

READER SERVICE NO.	ADVERTISER	PAGE NO.
1	AMECO, Division of Aerotron, Inc	111
2	Allied Radio	106, 107, 108
3	Allied Radio	109
4	Antenna Specialists Co., The	26
5	Argos Products Company	112
6	Avanti Research and Development, Inc	12
7	B & K	23
	Bell & Howell Schools	125, 126
8	Burstein-Applebee	116
9	C/P Corporation	96
	CREI, Home Study Division, McGraw-Hill Book Company	18, 19, 20, 21
10	Cleveland Institute of Electronics	36, 37, 38, 39
11	Cleveland Institute of Electronics	113
	Columbia Stereo Tape Club	5
12	Courier Communications, Inc	11
13	Cush Craft	100
14	Delwyn	99
15	Demco Electronics	110
16	Drake Company, R.L.	114
18	Edmund Scientific Co	104
17	Electro-Voice, Inc	FOURTH COVER
43	Finney Company, The	93
19	Graymark Enterprises, Incorporated	101
20	Hallicrafters	13
21	Hammarlund Manufacturing Company	102
22	Heath Company	8, 9
23	Johnson Company, E.F.	THIRD COVER
24	Lafayette Radio Electronics	95
25	Mosley Electronics, Inc	102
26	Multicore Sales Corp	116
	National Radio Institute	SECOND COVER, 1, 2, 3
	National Technical Schools	88, 89, 90, 91
42	Olson Electronics Incorporated	100
41	Pace Communications Corp	97
27	Pathé Electronics Manufacturing Company	104
28	Pearce-Simpson, Inc	7
29	Polytronics Communications	103
30	RCA Electronic Components and Devices	17
	RCA Institutes	62, 63, 64, 65
44	Radio Shack	98
31	Salch & Co., Herbert	110
32	Sams & Co., Inc., Howard W	112
33	Shure Brothers, Inc	6
34	Sonar Radio Corp	117
35	Squires-Sanders, Inc	25
	Surplus Savings Center	118
36	Tram Corporation	16
37	Turner	14
	Valparaiso Technical Institute	118
38	Weller Electric Corporation	10
39	World Radio Laboratories	113
40	Xcelite Inc	105

CLASSIFIED ADVERTISING 119, 120, 121, 122, 123

You don't have to be a genius to make it in electronics.

All you need is ambition, a good mind and...this coupon!

You didn't go to college?

Education is not a beautiful campus with ivy-covered walls. It is learning. Period. Your own home can be a fine "university", in which you study electronics at your own pace, under the guidance of respected authorities in the field. Or you can get the know-how you need—day or evening—in one of our resident schools in Chicago, Phoenix or Canada. You'll learn by *doing*. For example, in our home study courses, you'll actually build an oscilloscope, and a transistorized portable electronic meter ... and you'll keep them. You'll earn a diploma worth many thousands of dollars in future income.

TURN PAGE FOR POSTAGE-FREE REPLY CARD...

DE VRY INSTITUTE OF TECHNOLOGY

 **BELL & HOWELL SCHOOLS**

DEPT. PE8Y-A

Please send me your two free booklets. "Pocket Guide to Real Earnings," and "Electronics in Space Travel;" also include details on careers in Electronics. I am interested in the following fields (check one or more):

- | | |
|--|---|
| <input type="checkbox"/> Space & Missile Electronics | <input type="checkbox"/> Communications |
| <input type="checkbox"/> Television and Radio | <input type="checkbox"/> Computers |
| <input type="checkbox"/> Microwaves | <input type="checkbox"/> Broadcasting |
| <input type="checkbox"/> Radar | <input type="checkbox"/> Industrial Electronics |
| <input type="checkbox"/> Automation Electronics | <input type="checkbox"/> Electronic Control |

NAME _____ AGE _____

ADDRESS _____ APT. _____

CITY _____

STATE _____ ZIP _____
CCODE _____

Veterans: Check here. If you were discharged after Jan. 31, 1955, the "G.I. Bill" may cover the entire cost of your tuition.

102R

**If you have what it takes,
this postcard can be your ticket
to everything you want
in electronics.**

**Send it now,
and make something happen!**

Don't expect a miracle. If you don't have *some* ability, or if you don't have the desire to learn, we can't help you. And we'll tell you so, frankly. But if you have a good mind, we can give you the expert knowledge and practical experience you need to make it in this spectacular field. Fast!

How about jobs? We know that's what you really want from us. So Bell & Howell gives you just what you need to qualify for just the kind of job you want. More than that, we'll help you *get* the job. We've done it before... *thousands* of times! And our highly successful job placement service is yours when you graduate... and from then on.

How can you start? By making up your mind to do something. Now. Take the first step. Fill in the postcard. Send it in, and make something happen!

DE VRY INSTITUTE OF TECHNOLOGY
4141 BELMONT AVE., CHICAGO, ILL. 60641

 **BELL & HOWELL SCHOOLS**

Accredited Member, National Home Study Council

Postage
Will Be Paid
by
Addressee

BUSINESS REPLY MAIL
No Postage Stamp Necessary If Mailed in the United States

DE VRY INSTITUTE OF TECHNOLOGY



BELL & HOWELL SCHOOLS

4141 BELMONT AVENUE

CHICAGO, ILLINOIS 60641

First
Class
Permit
No. 4148,
Chicago,
Illinois

NEW ...a 23 channel
base station offering
the best of Johnson's
experience!

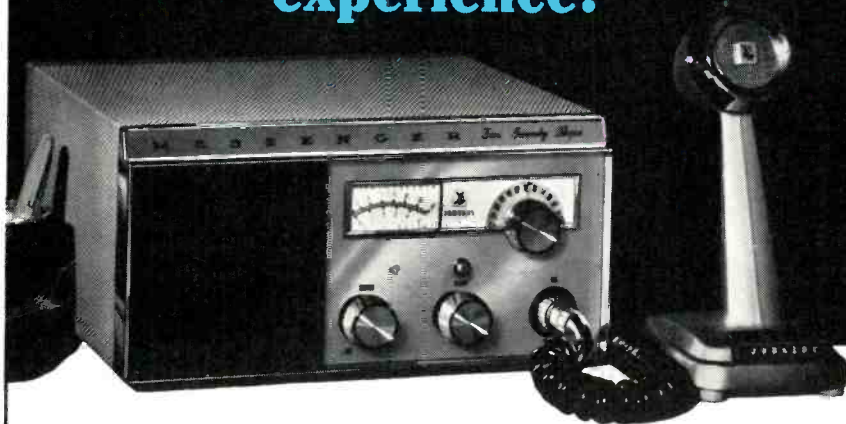

Brought to you by the same engineering team that designed the famous Messengers "I" and "Two", the Messenger 223 has the same rugged circuitry and even greater "Talk Power" capability. With at least 15 db more audio gain than the "I" and "Two", the "223" punches out a clear, penetrating signal . . . outperforming any other radio on the market.

Ten tubes, eight diodes and six transistors form a rugged base station transceiver that can't be beat for reliable day-in, day-out performance. A built-in illuminated "S" meter /power meter measures input strength of RF signals and relative power output of the transmitter. Ready to go on all 23 channels, the Messenger 223 is FCC Type Accepted and DOT Approved.

See your Johnson dealer today for complete details!

E. F. JOHNSON COMPANY

2474 Tenth Ave. S.W., Waseca, Minnesota 56093

Providing nearly a half-century of communications leadership



CIRCLE NO. 23 ON READER SERVICE PAGE



When we put this
four layer voice coil
in the new E-V FIVE-A
we knew it would
sound better...



we never dreamed it
would lower your cost
of stereo by \$94.00, too!

Ⓔ The voice coil is the heart of any speaker. A coil of wire. It moves the cone that makes the music. And in most speakers, that's all it does. But in the new E-V FIVE-A we've found a way to make this little coil of wire much more useful. Instead of one or two layers of wire, we wind the E-V FIVE-A woofer coil *four* layers deep.

Voila!

Now the coil actually lowers the natural resonance of the 10" E-V FIVE-A woofer. And lower resonance means deeper bass with any acoustic suspension system.

In addition, with more turns of wire in the magnetic field, efficiency goes up. But it goes up faster for middle frequencies than for lows. This means we must reduce the amount of expensive magnet if we are to maintain flat response.

It's an ingenious approach to woofer design, and it works. E-V engineers point out that their efforts not only resulted in better sound, but also cut \$47.00 from the price of the E-V FIVE-A.

So now you can compare the \$88.00 E-V FIVE-A with speakers costing up to \$135.00 ... and come out \$94.00 ahead in the bargain for a stereo pair! The difference can buy a lot of Tchaikovsky, or Vivaldi, or even Stan Getz. And after all, more music for your money is at the heart of high fidelity!

Hear the E-V FIVE-A at leading audio showrooms everywhere. Or write for your free copy of the complete Electro-Voice high fidelity catalog. It is filled with unusual values in speakers, systems, and solid-state electronics.

P.S. If you think the E-V FIVE-A woofer is advanced—you should hear the tweeter. But that's another story.

ELECTRO-VOICE, INC., Dept. 884P, 630 Cecil Street, Buchanan, Michigan 49107

Electro-Voice

high fidelity systems and speakers • tuners, amplifiers, receivers • public address loudspeakers • microphones • phonograph needles and cartridges • organs • space and defense electronics

CIRCLE NO. 17 ON READER SERVICE PAGE

www.americanradiohistory.com