

ROAD RALLY TIME-SIGNAL RECEIVER

POPULAR ELECTRONICS

JULY
1968

50
CENTS

BEST WAY TO TUNE YOUR BASS REFLEX

NEW APPROACH TO COLOR TV SERVICING

TRANSISTOR TESTING WITH YOUR VTVM

NOVEL CW MONITOR—\$2 STEREO PHONES

TEST POINTS FOR PREVENTIVE MAINTENANCE

Monitor Your Heart Action
and Blood Flow

(see page 27)

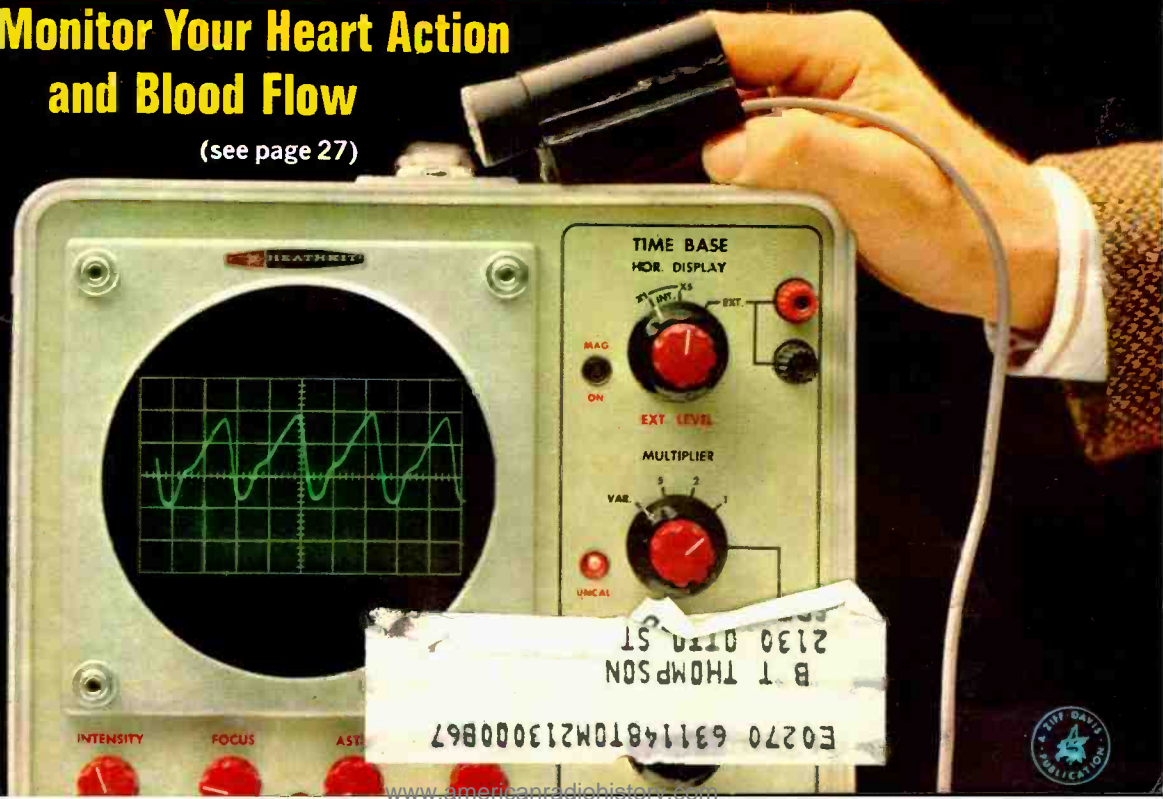

You get more for your money from NRI—

America's oldest and largest Electronic, Radio-Television home-study school

Compare. You'll find—as have so many thousands of others—NRI training can't be beat. From the delivery of your first lessons in the remarkable, new Achievement Kit, to "bite size," easily-read texts and carefully designed training equipment . . . NRI gives you more value.

Shown below is a dramatic, pictorial example of training materials in *just one* NRI Course. Everything you see below is included in low-cost NRI training. Other major NRI courses are equally complete. Text for text, kit for kit, dollar for dollar—your best home-study buy is NRI.

All this is yours—from Achievement Kit to the only Color TV specifically designed for training—when you enroll for NRI's TV-Radio Servicing course. Other courses are equally complete. But NRI training is more than kits and "bite-size" texts. It's also personal services which have made NRI a 50 year leader in the home-study field. Mail the postage-free card today.

Approved under GI BILL

If you served since Jan. 31, 1955, or are in service, check GI line in postage-free card.



GET A FASTER START WITH NRI'S NEW EXCLUSIVE ACHIEVEMENT KIT

The day your enrollment is received your Achievement Kit will be on its way to you. It contains everything you need to make an easy, fast start in the Electronics training of your choice. This attractive, new starter kit is an outstanding, logical way to introduce you to home-study the way NRI teaches it . . . backed by a dedicated staff and the personal attention you should expect of a home-study school. It is your first special training aid . . . designed to make your adventure into Electronics absorbing, meaningful. Your Achievement Kit contains your first group of lesson texts; rich vinyl desk folder to hold study material; the industry's most complete Radio-TV Electronics Dictionary; valuable reference texts; lesson answer sheets; envelopes; pencils, pen; engineer's ruler—even postage. No other school has anything like it.

OVER 50 YEARS OF LEADERSHIP



LEARNING BECOMES AN ABSORBING ADVENTURE WITH NRI TRAINING KITS

What better way to learn than by doing? NRI pioneered and perfected the "home lab" technique of learning at home in your spare time. You get your hands on actual parts and use them to build, experiment, explore, discover. Electronics come alive! NRI invites comparison with training equipment offered by any other school. Begin NOW this exciting, practical program. It's the best way to understand the skills of the finest technicians—and make their techniques your own. Whatever your reason for wanting to increase your knowledge of Electronics . . . whatever your field of interest . . . whatever your education . . . there's an NRI instruction plan for you, at low tuition rates to fit your budget. Get all the facts about NRI training plans, NRI training equipment. Fill in and mail the attached postage-free card today.

**NATIONAL RADIO INSTITUTE, Wash-
ington, D.C. 20016.**

IN ELECTRONICS TRAINING

Accredited by the Accrediting Commission of the National Home Study Council

NEW COLOR TV



POPULAR ELECTRONICS

VOLUME 29 NUMBER 1

JULY, 1968

WORLD'S
LARGEST-SELLING
ELECTRONICS
MAGAZINE

SPECIAL CONSTRUCTION FEATURE

- YOUR OWN LITTLE PHOTOPLETHYSMOGRAPH 27** ROBERT E. DEVINE
Unique device displays blood flow

FEATURE ARTICLES

- MARGARET MAGNA (1918-1968) 16**
- STEREO—AT 99¢ PER EAR 34** DAVID B. WEEMS
- CIRCUIT DESIGNERS' QUIZ 35** ROBERT P. BALIN
- BATTERYLESS CW MONITOR 40** GERALD L. VOGWILL
- BUILD THE ACCURATIME 41** GEORGE WHALEN
Converter tunes CHU or WWV while on the road
- TUNE UP YOUR BASS REFLEX 47** DAVID B. WEEMS
How it is done by the experts
- THE SUPER-SENSITIVE SUPER-SIMPLE SUPER-REGEN 52** LARRY LISLE
Still one of the HOT receiver circuits
- TRANSISTOR TEST ADAPTER FOR YOUR VTVM 55** A.A. MANGIERI
Use to measure the important parameters
- SYSTEMS APPROACH TO TV SERVICING 59** FOREST M. BELT
Successful production line TV repair
- SIMPLIFY WITH TEST POINTS 62** JIM ASHE
- INFORMATION CENTRAL 66** CHARLES J. SCHAUERS, W6QLV
- ENGLISH-LANGUAGE BROADCASTS TO NORTH AMERICA 74** ROGER LEGGE
- SHORT-WAVE LISTENING 75** HANK BENNETT, W2PNA
Verifying those Latin Americans
- AMATEUR RADIO 77** HERB S. BRIER, W9EGQ
Places and people in ham radio
- ON THE CITIZENS BAND 79** MATT P. SPINELLO, KHC2060
- SOLID-STATE 80** LOU GARNER
- ## DEPARTMENTS
- LETTERS FROM OUR READERS 8**
- READER SERVICE PAGE 15**
- NEW PRODUCTS 22**
- OPERATION ASSIST 83**
- TIPS & TECHNIQUES 85**
- OUT OF TUNE 86**
M/M/M Instrument Amplifier
- ELECTRONICS LIBRARY 87**
- READER SERVICE PAGE 95**

POPULAR ELECTRONICS is indexed
in the Readers' Guide
to Periodical Literature

Copyright © 1968 by ZIFF-DAVIS PUBLISHING COMPANY. All rights reserved.

POPULAR ELECTRONICS, July 1968, Volume 29, Number 1. Published monthly at 507 North Michigan Avenue, Chicago, Illinois 60601. One year subscription rate for U.S., U.S. Possessions and Canada, \$5.00; all other countries, \$6.00. Second class postage paid at Chicago, Illinois and at additional mailing offices. Authorized as second class mail by the Post Office Department, Ottawa, Canada and for payment of postage in cash. Subscription service and Forms 3579: Portland Place, Boulder, Colorado 80302. Editorial offices for manuscript contributions, reader inquiries, etc.: One Park Ave., New York, N.Y. 10016.

This month's cover photo by
BRUCE PENDLETON

Could you make it in electronics?

Why not...

Because you're not a genius? So What? All you need is a good mind and the desire to learn. We can help you learn what you need to know to get the kind of job you want. And we can help you land the job, too. We've done it before. *Thousands* of times.

Because you can't quit your job? Keep it. If you can't come to our resident schools, we'll come to you, by mail. Take the courses you need, at home. In our schools or at home, you'll get an excellent, practical education in electronics.

Because you think it's too tough? Too slow? Too expensive? Because you're afraid maybe we can't help you get a good job? Fill in the coupon, and *make us prove it!*

DEVRY INSTITUTE OF TECHNOLOGY
4141 BELMONT AVE., CHICAGO, ILL. 60641

 **BELL & HOWELL SCHOOLS**

 ACCREDITED MEMBER, NATIONAL HOME STUDY COUNCIL

DEVRY INSTITUTE OF TECHNOLOGY Dept. 104-Y
4141 BELMONT AVE., CHICAGO, ILL. 60641



BELL & HOWELL SCHOOLS

Please send me your two free booklets, "Pocket Guide to Real Earnings," and "Electronics in Space Travel;" also include information about preparing for careers in Electronics. I am interested in the following opportunity fields (check one or more):

- | | |
|--|---|
| <input type="checkbox"/> Space & Missile Electronics | <input type="checkbox"/> Communications |
| <input type="checkbox"/> Television and Radio | <input type="checkbox"/> Computers |
| <input type="checkbox"/> Microwaves | <input type="checkbox"/> Broadcasting |
| <input type="checkbox"/> Radar | <input type="checkbox"/> Industrial Electronics |
| <input type="checkbox"/> Automation Electronics | <input type="checkbox"/> Electronic Control |

Name _____ Age _____

Address _____ Apt. _____

City _____

State _____ Zip Code _____

Veterans: Check here. If you were discharged after Jan. 31, 1955, the "G.I. Bill" may cover the entire cost of your tuition.

106

FULLY EQUIPPED FOR
IMMEDIATE OPERATION
ON ALL **23** CHANNELS



**23-CHANNEL CB
mobile and base station
AM TRANSCEIVER**

GREATER RANGE POWER with the exclusive new DYNA-BOOST circuit that intensifies speech signals and extends the signal range.

The new Cobra CAM-88 is rugged, handsome and field proven. Compare it, feature for feature, with other CB equipment and you'll be convinced that the Cobra CAM-88 is by far the best.

Outstanding Features

- Fully-Equipped for Immediate 23-channel Transmit and Receive
- Double Conversion Superheterodyne Receiver
- Transistorized 117V AC/12V DC Power Supply
- Speech Compression with Switch
- Delta-Tune Fine Tuning
- Squelch Control and Standby Switch
- Illuminated Dual-Purpose Meter
Power-in (Receive)-Power-out (Transmit)
- Modulation Indicator
- Detachable Press-to-talk Microphone
- Convertible to a Public Address Amplifier

Carefully engineered design makes the Cobra completely reliable and easy to operate. Completely self-contained. *No additional crystals needed.* \$21495



DIVISION OF DYNASCAN CORPORATION
1801 W. BELLE PLAINE AVE. • CHICAGO, ILL. 60613

Made in U.S.A.

Export: Empire Exporters, 123 Grand St., New York 13, U.S.A. Also available in Canada

CIRCLE NO. 5 ON READER SERVICE PAGE

POPULAR ELECTRONICS

PHILLIP T. HEFFERNAN
Publisher

OLIVER P. FERRELL
Editor

LESLIE SOLOMON
Technical Editor

MARGARET MAGNA
Managing Editor

EDWARD I. BUXBAUM
Art Director

ALEXANDER W. BURAWA
Associate Editor

ANDRE DUZANT
Technical Illustrator

PATTI MORGAN
Assistant Editor

AURORA NARDOZZI
Editorial Assistant

H. BENNETT, W2PNA

H. S. BRIER W9EQG

L. E. GARNER, JR.

CHARLES J. SCHAUERS, W6QLV

M. P. SPINELLO, KH2060
Contributing Editors

LAWRENCE SPORN

Advertising Sales Manager

ARDYS C. MORAN

Advertising Service Manager

ZIFF-DAVIS PUBLISHING COMPANY

Editorial and Executive Offices
One Park Avenue, New York, New York 10016
212 679-7200

Eastern Advertising Manager, RICHARD J. HALPERN

Midwestern Office

307 North Michigan Avenue, Chicago, Illinois 60601

312 726-0892

Midwestern Advertising Manager, JAMES WEAKLEY

GERALD L. TAYLOR

Western Office

9025 Wilshire Boulevard, Beverly Hills, California 90211

213 Crestview 4-0265; Bradshaw 2-1161

Western Advertising Manager, BUD DEAN

Japan: James Yagi

Ishikawa Mansion

#4, Sakuragaoka

Shibuya-ku, Tokyo

462-2911-3

Circulation Office

Portland Place

Boulder, Colorado 80302

William B. Ziff, Chairman of the Board (1946-1953)

William Ziff, President

W. Bradford Briggs, Executive Vice President

Hershel B. Sarbin, Senior Vice President

Philip Sine, Financial Vice President

Walter S. Mills, Jr., Vice President, Circulation

Stanley R. Greenfield, Vice President, Marketing

Phillip T. Heffernan, Vice President, Electronics Division

Frank Pomerantz, Vice President, Creative Services

Arthur W. Butzow, Vice President, Production

Edward D. Muhlfeld, Vice President, Aviation Division

Irwin Robinson, Vice President, Travel Division

Ziff-Davis also publishes Airline Management and Marketing, Boating, Business & Commercial Aviation, Car and Driver, Cycle, Electronics World, Flying, HiFi/Stereo Review, Modern Bride, Popular Photography, Skiing, Skiing Area News, and Skiing Trade News. (Travel Weekly is published by Robinson Publications, Inc. a subsidiary of Ziff-Davis Publishing Company.)

Forms 3579 and all subscription correspondence should be addressed to POPULAR ELECTRONICS, Circulation Department, Portland Place, Boulder, Colorado 80302. Please allow at least six weeks for change of address. Include your old address, as well as new—enclosing if possible an address label from a recent issue.

EDITORIAL CONTRIBUTIONS must be accompanied by return postage and will be handled with reasonable care; however, publisher assumes no responsibility for return or safety of art work. Photographs or manuscripts.



Member Audit Bureau
of Circulations

POPULAR ELECTRONICS

\$379 starts you on a career in crime prevention

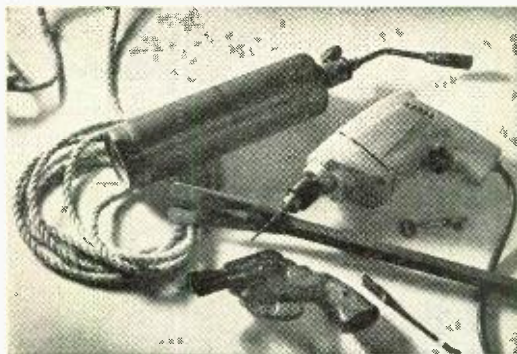

A burglar uses a blowtorch, a jimmy, a skeleton key, a flashlight, a rope, an electric drill. The total cost of his equipment could run as high as \$1000.

For only \$379, on the other hand, you can get into a much more profitable career—with no risks involved. The profession: Crime prevention with Radar Sentry Burglar Alarms.

For only \$379, you buy your first Radar Sentry Burglar Alarm demonstrator unit. That's all the investment you have to make. *There's no franchising fee, no overhead!*

EARN \$3180 A MONTH

Selling Radar Sentry Burglar Alarms is the most profitable new business opportunity to come along in years. Sell one a week and earn as much as \$16,000 a year. Sell five Radar Sentry Alarms a week—earn \$46,000 a year!

You can start selling Radar Sentry Alarms full time or part time. No experience, no special background is necessary, although your electronic know-how gives you a big edge in closing big sales.

TWO-HUNDRED MILLION CUSTOMERS

Your customers are everyone who's been hit by a crime, and everyone else who's worried that the next robbery may be at his business or home. That's almost everyone. A boom market!

And with Radar Sentry Alarms, you've got the best crime-stopper in the world. What a golden opportunity for you! What's more, we supply you with everything you need to find customers, make sales, and build a substantial income. Our advertising produces thousands of sales leads which are forwarded to Radar Sentry Alarm

dealers. A complete kit of sales aids helps you close sales. We back you all the way.

FOOLPROOF, SOLID-STATE BURGLAR TRAP

When we say you're selling the best burglar trap in the business—we mean business. Radar Sentry Burglar Alarms saturate an area of 5000 square feet from wall to wall, floor to ceiling with invisible microwaves. Any human movement will set off an ear-piercing alarm.

All Radar Sentry Alarm units are solid-state, and quality engineered. Installation is simple—no test equipment or special tools required.

Maintenance is just as easy. Thanks to solid-state circuitry, the heart of the Radar Sentry Alarm's electronics is on a single printed circuit module. If a problem develops, the complete module is pulled out, and a new one plugged in. Instant repair, and no lapse in security.

BREAK INTO THE BURGLARY BUSINESS TODAY

Whether you're a TV service technician, student, engineer, draftsman...selling Radar Sentry Burglar Alarms will increase your income dramatically. Or launch you on a brand new career.

And, remember, you can start part-time and work your way up to a full-time career as a Radar Sentry dealer.

But now is the time to act—while you can still get in on the ground floor of a booming business. And while there are still choice Radar Sentry Alarm territories available.

Act now. There's no time to lose. Fill in the coupon below.

—Break into the Burglary Business Today—

RADAR DEVICES MFG. CORP. PE-7
22003 Harper Avenue, St. Clair Shores, Michigan 48080
Please tell me how I can have a business of my own distributing Radar Sentry Alarm Systems. I understand there is no obligation.

Name _____

Address _____

City _____

State _____ Zip _____

CIRCLE NO. 23 ON READER SERVICE PAGE

THE ELECTRONIC INDUSTRY'S
MOST CURRENT 1968 CATALOG

FREE!



ALL NEW...
SPRING AND SUMMER
ELECTRONIC CATALOG

**YOUR BUYING
GUIDE FOR:**

- Stereo & Hi-Fi Systems & Components • Tape Recorders • Phonos, Radios & TV's • Cameras & Film
 - PA • Ham Gear • Test Instruments & Kits • Citizens Band • Electronic Parts, Tubes & Tools.
- SEND FOR YOURS TODAY!



MAIL TODAY TO...

BURSTEIN-APPLEBEE

DEPT. PES, 3199 MERCIER, KANSAS CITY, MO. 64111

Name _____
Address _____
City _____
State _____ Zip Code _____

CIRCLE NO. 6 ON READER SERVICE PAGE

IT COSTS ONLY
1/100 OF 1¢ MORE
PER SOLDER JOINT
TO KNOW YOU ARE USING THE
WORLD'S FINEST CORED SOLDER



New Easy
Dispenser
Pak
60/40
18 S.W.G.

Latest PC
(Printed
Circuit) Pak
60/40 Extra Thin
22 S.W.G.—.028"

each only 69¢ per package at your dealer



MULTICORE SALES CORP., WESTBURY, N.Y. 11590
CIRCLE NO. 18 ON READER SERVICE PAGE

Letters

FROM OUR READERS

WIPER PROJECT CAN CAUSE SHORT CIRCUIT

Although your variable-speed windshield wiper ("Slow Kick Your Windshield Wipers," March, 1968) seems to work fine on most cars, certain Chrysler Motors cars use a wiper system that reverses the wiper when the wiper switch is turned off. This is called the "off-normal-park" and allows the wiper blades to settle away from their normal run-

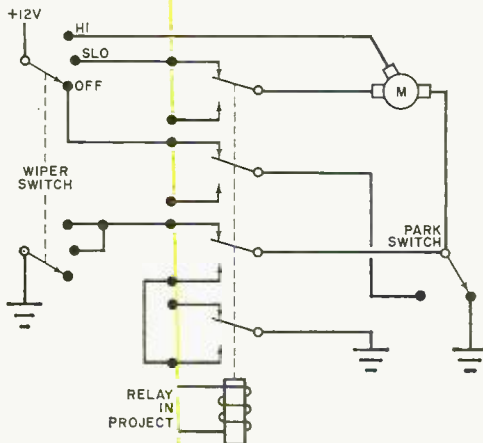

ning position. Your system can introduce a short circuit in this type of car if the project is operated while the car's wiper switch is in the "off" position. I have modified your schematic diagram to alleviate this problem.

ARTHUR E. FURY
Auburn, N.Y.

If any readers own a Chrysler Motors car and have been having trouble with our windshield wiper project, this modification is the answer to your problem.

STIRRING UP A HORNET'S NEST

In regard to Lawrence Hardiman's letter ("Letters From Our Readers," March, 1968) concerning "Equal Rights, Equal Responsibilities," I feel he is being too hasty about women not being able to fulfill their responsibilities as hams. Every YL I have ever known has stayed within the rules of ham radio and fulfilled her responsibilities as a ham. And for Mr. Hardiman to state that a woman wanting special privileges may never have seen a soldering iron, much less ever

THIS MIC MAINTAINS MAX MODULATION



- NEW! VARIABLE OUTPUT LEVEL
- TRANSISTORIZED

Built-in two-transistor preamplifier and volume control enables you to attain, and maintain 100% modulation — provides additional audio gain! Even compensates for equipment that lacks sufficient gain to attain 100% modulation. Ultra-reliable Controlled Magnetic element with specially tailored response insures highest "talk power". Adjustable height, super-rugged "Armo-Dur" case. For AM, FM, Sideband, CB. Only \$29.70 net.



SHURE 444T
VARIABLE OUTPUT MICROPHONE

Shure Brothers, Inc., 222 Hartrey Avenue, Evanston, Illinois 60204

CIRCLE NO. 26 ON READER SERVICE PAGE

© 1967 Shure Brothers, Inc.

CB'ers

Consider Your Capabilities-

Then Consider ...
The DELTA-5!

by **Mosley**

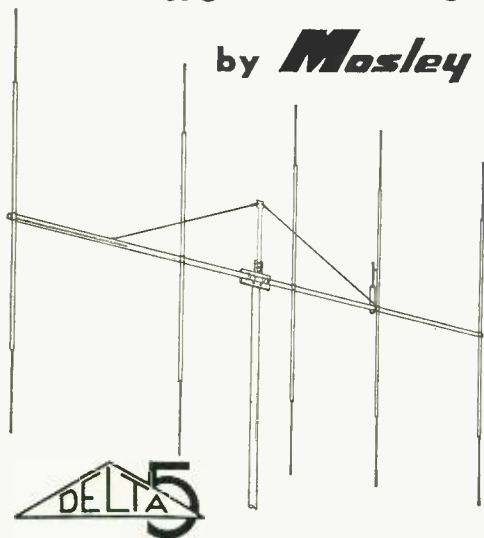

The New-Improved DELTA-5 (model SA-511-S) five element base station antenna, was designed and engineered for greater boom-end support while maintaining a perfect uni-directional pattern. Boom sag or droop (prevalent in this type of antenna) is now eliminated! The DELTA-5 — a new look of rugged strength and graceful beauty, mounted vertically or horizontally — insures superior, dependable all-weather performance.

For more information on the DELTA-5, or to convert your A-511-S to the new DELTA-5, see your nearest authorized Mosley dealer or write Dept. 164.

MOSLEY ELECTRONICS INC.
4610 N. Lindbergh Blvd. Bridgeton, Mo. 63042

Please rush me FREE detailed brochure on the DELTA-5 and A-511-S Conversion Kits Dept. 164

Name _____
Address _____
City/State _____ Zip _____

CIRCLE NO. 16 ON READER SERVICE PAGE

LETTERS

(Continued from page 8)

have used one, is ridiculous. I know many women studying for their Advanced class ham license who have built most of their equipment and many POPULAR ELECTRONICS projects.

EDWARD O'CONNOR
Englewood, N.J.

I don't like the idea of the sentence: "And if she has any home-built equipment in her shack, chances are her OM built it for her" in Mr. Hardiman's letter. I am 13 years old and female, and I am nuts about electronics. I can do as well as—or better than—any 13-year-old boy. I don't think it's fair for the majority of men to be so darned prejudiced against women.

JULIA LOBUR
New Kensington, Pa.

Well, it appears as though Tom Hardiman's letter that opposed the idea of special privileges for ladies ("Why Not A Ham License Just For Ladies," December, 1967) has stirred up a hornet's nest of indignation from both sexes. Julia's letter is particularly interesting because it almost appears like a challenge to prove her wrong—which, if accepted, we have no doubt she would win. As for your editor, I have known a few lady hams who would literally put many so-called more knowledgeable male hams to shame when it comes to fabricating electronic gear.

HIGH-IMPEDANCE INPUT FOR "L'IL TIGER"

As pointed out in the "L'il Tiger Stereo Power Amplifier" article (December, 1967), the input impedance is too low (5000 ohms) for use with most vacuum-tube preamplifiers. Since this was the use to which I intended to

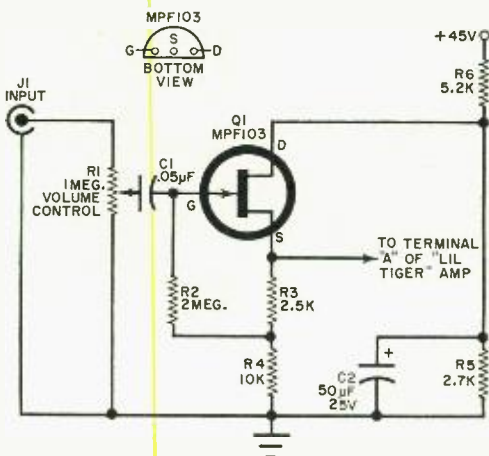

put my L'il Tiger, I built an adapter input circuit (see schematic diagram) to provide the necessary impedance transformation without loss in fidelity. All the components can be mounted on a 6-lug terminal strip which, in

CIRCLE NO. 10 ON READER SERVICE PAGE →

The "total reliability" CB rig.

Guaranteed for 10 years!

The magnificently styled 23-channel Courier Classic offers you a new dimension in solid-state CB. So reliable — *we guarantee it for 10 years!* Start with Classic's super efficient transmitter designed to help pierce "skip." Silicon transistors throughout. Military spec. fiberglass epoxy bonded circuit board — every part clearly labeled with value, symbol and part number; every adjustment labeled and keyed off to

alignment procedure and schematic. 100% modulation. Exclusive zener diode "Safety Circuit" to protect against mismatched antenna, incorrect polarity, and overload. Illuminated channel selector and S meter, auxiliary speaker jack, modulation indicator, PA system. Adjustable push-pull noise limiter. Heavy-duty microphone connector conveniently located on front panel. Compact — weighs only 4½ lbs.

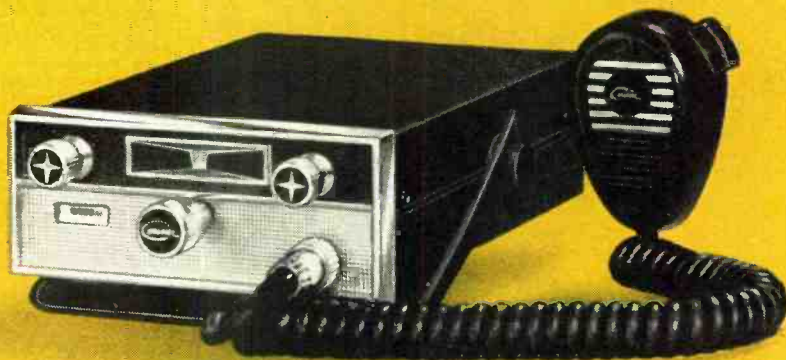

Just \$199

Complete with crystals
for all 23 channels.



**COURIER
COMMUNICATIONS, INC.**

439 Frelinghuysen Avenue, Newark, N.J. 07114

a subsidiary of **Whittaker** corporation

Yes! Tell me all about the "total reliability"
CB rig with the 10 year guarantee!

Name

PE-87

Address

City

County

State

Zip

Look What's New



NEW
Kit
IT-18
\$24.95

NEW
Kit
IP-18
\$19.95

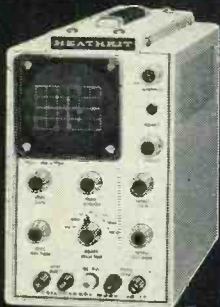

NEW
Kit
IO-17
\$79.95



NEW
Kit
IM-17
\$21.95

NEW
System Kit
GD-47
\$219.95



NEW HEATHKIT In-Circuit Transistor Tester

At last, a realistic price for in-circuit testing of transistors! The new Heathkit IT-18 Tester has the facilities you need and it costs a lot less. It measures DC Beta in-or-out-of-circuit in 2 ranges from 2 to 1000 (the spec. commonly used by mfrs. and schematics to determine transistor gain). It tests diodes in-or-out-of-circuit for forward and reverse current to indicate opens or shorts. Measures transistors out-of-circuit for ICEO and ICBO leakage on leakage current scale of 0 to 5,000 μ A. Identifies NPN or PNP devices, anode and cathode of unmarked diodes; matches transistors of the same type or opposite types. Cannot damage device or circuit even if connected incorrectly. Big $4\frac{1}{2}$ " 200 μ A meter. 10-turn calibrate control. Completely portable, powered by "D" cell (long battery life). Front panel socket for lower power devices. Attached 3' test leads. Rugged polypropylene case with attached cover. Build in 2 hours. 4 lbs.

NEW HEATHKIT I-15 VDC Regulated Power Supply

Labs, service shops, hams, home experimenters . . . anybody working with transistor circuitry can use this handy new Heathkit All-Silicon Transistor Power Supply. Voltage regulated (less than 40 mV variation no-load to full-load; less than 0.05% change in output with input change from 105-125 VAC). Current limiting; adjustable from 10-500 mA. Ripple and noise less than 0.1 mV. Transient response 25 μ s. Output impedance 0.5 ohm or less to 100 kHz. AC or DC programming (3 mA driving current on DC). Circuit board construction. Operates 105-125 or 210-250 VAC, 50/60 Hz. 6 lbs.

NEW HEATHKIT Low-Cost 5 MHz 3" 'Scope

Here is the wideband response, extra sensitivity and utility you need, all at low cost. The Heathkit IO-17 features vertical response of 5 Hz to 5 MHz; 30 mv Peak-to-Peak sensitivity; vertical gain control with pull-out X50 attenuator; front panel 1 volt Peak-to-Peak reference voltage; horizontal sweep from internal generator, 60 Hz line, or external source; wide range automatic sync; plastic graticule with 4 major vertical divisions & 6 major horizontal; front mounted controls; completely nickel-alloy shielded 3" CRT; solid-state high & low voltage power supplies for 115/230 VAC, 50-60 Hz; Zener diode regulators minimize trace bounce from line voltage variations; new professional Heath instrument styling with removable cabinet shells; beige & black color; just $9\frac{1}{2}$ " H. x $5\frac{1}{2}$ " W. x $14\frac{1}{2}$ " L.; circuit board construction, shipping wt. 17 lbs.

NEW HEATHKIT Solid-State Portable Volt-Ohm Meter

There's never been a better buy in meters. Solid-state circuit has FET input, 4 silicon transistors (2 used as diodes), and 1 silicon diode. 11 megohm input on DC, 1 megohm on AC. 4 DC volt ranges, 0-1000 v, with $\pm 3\%$ accuracy; 4 AC volt ranges, 0-1000 v. with $\pm 5\%$ accuracy. 4 resistance ranges, 10 ohms center scale x1, x100, x10K, x1M, measures from 0.1 ohm to 1000 megohms. $4\frac{1}{2}$ ", 200 μ A meter with multicolored scales. Operates on "C" cell and 8.4 v. mercury cell (not included). Housed in rugged black polypropylene case with molded-in cover and handle and plenty of space for the three built-in test leads. An extra jack is provided for connecting accessory probes to extend basic ranges. Controls include zero-adjust, ohms-adjust, DC polarity reversing switch, continuous rotation 12-position function switch. Easy-to-build circuit board construction completes in 3-4 hours. 4 lbs.

NEW HEATHKIT/Kraft 5-Channel Digital

Proportional System with Variable Capacitor Servos

This Heathkit version of the internationally famous Kraft system saves you over \$200. The system includes solid-state transmitter with built-in charger and rechargeable battery, solid-state receiver, receiver rechargeable battery, four variable capacitor servos, and all cables. Servos feature sealed variable capacitor feedback to eliminate failure due to dirty contacts, vibration, etc.; three outputs; two linear shafts travel $\frac{1}{8}$ " in simultaneous opposite directions plus rotary wheel. Specify freq.: 26.995, 27.045, 27.095, 27.145, 27.195 MHz.

From Heath

NEW HEATHKIT AJ-15 Deluxe Stereo Tuner

For the man who already owns a fine stereo amplifier, and in response to many requests, Heath now offers the superb FM stereo tuner section of the renowned AR-15 receiver as a separate unit. The new AJ-15 FM Stereo Tuner has the exclusive design FET FM tuner for remarkable sensitivity, the exclusive Crystal Filters in the IF strip for perfect response curve and no alignment; integrated Circuits in the IF for high gain, best limiting; elaborate Noise-Operated Squelch; Stereo-Threshold Switch; Stereo-Only Switch; Adjustable Multiplex Phase, two Tuning Meters; two variable output Stereo Phone jacks; one pair variable outputs plus two fixed outputs for amps, recorders, etc.; front panel mounted controls; "Black Magic" panel lighting; 120/240 VAC operation. 18 lbs. *Walnut cabinet AE-18, \$19.95.

NEW HEATHKIT AA-15 Deluxe Stereo Amplifier

For the man who already owns a fine stereo tuner, Heath now offers the famous amplifier section of the AR-15 receiver as a separate unit. The new AA-15 Stereo Amplifier has the same superb features: 150 watts Music Power; Ultra-Low Harmonic & IM Distortion (less than 0.5% at full output); Ultra-Wide Frequency Response (± 1 dB, 8 to 40,000 Hz at 1 watt); Ultra-Wide Dynamic Range Preamp (98 dB); Tone-Flat Switch; Front Panel Input Level Controls; Transformerless Amplifier; Capacitor Coupled Outputs; Massive Power Supply; All-Silicon Transistor Circuit; Positive Circuit Protection; "Black Magic" Panel Lighting; new second system Remote Speaker Switch; 120/240 VAC. 26 lbs. *Walnut cabinet AE-18, \$19.95.

NEW HEATHKIT 2-Meter AM Amateur Transceiver

2-Meters at low cost. And the HW-17 Transceiver has 143.2 to 148.2 MHz extended coverage to include MARS, CAP, and Coast Guard Auxiliary operation. Output power of tube-type transmitter is 8 to 10 watts, AM, 4 crystal sockets plus VFO input. Relayless PTT operation. Double conversion solid-state superhct. Receiver has 1 μ V sensitivity with prebuilt, aligned FET tuner. ANL, Squelch, "Spot" function, and lighted dial. Signal-strength/relative power-output meter. Battery saver switch for low current drain during receiving only. 15 transistor, 18 diode, 3 tube circuit on two boards builds in about 20 hours. Built-in 120/240 VAC, 50-60 Hz power supply and 3" x 5" speaker; low profile aluminum cabinet in Heath gray-green; ceramic mic. and gimbal mount included. 17 lbs. *Optional DC mobile supply, HWA-17-1, \$24.95.

NEW HEATHKIT Home Protection System

Customize your own system with these new Heathkit units to guard the safety of your home and family. Warns of smoke, fire, intruders, freezing, cooling, thawing, pressure, water, almost any change you want to be warned about. Your house is already wired for this system, just plug units into AC outlets. Exclusive "loading" design of transmitters generates unusual signal which is detected by the Receiver/Alarm. Solid-state circuitry with fail-safe features warns if components of system have failed. Any number of units may be used in system. Receiver/Alarm has built-in 2800 Hz alarm and rechargeable battery to signal if power line fails (built-in charger keeps battery in peak condition). Receiver accepts external 117 VAC bells or horns. Smoke/Heat Detector-Transmitter senses smoke and 133°F. heat (extra heat sensors may be added to it). Utility Transmitter has several contacts to accept any type switch or thermostat to guard against any hazard except smoke. All units feature circuit board construction and each builds in 3-4 hours. All are small and finished in beige and brown velvet finish. Operating cost similar to that of electric clocks. Invest in safety now with this unique new low-cost Heathkit system.

NOW, THE TUNER AND AMPLIFIER OF THE FAMOUS HEATH AR-15 RECEIVER ARE AVAILABLE AS SEPARATE COMPONENTS



NEW Kit
AJ-15
\$189.95*



NEW Kit
AA-15
\$169.95*



NEW Kit
HW-17
\$129.95*



GD-77
Receiver /
Alarm
\$39.95



NEW
GD-87
Smoke / Heat
Detector-
Transmitter
\$49.95

GD-97
Utility
Transmitter
\$34.95

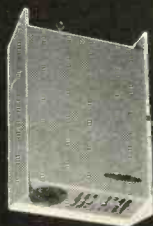

NEW
FREE 1968 CATALOG!
Now with more kits, more color. Fully describes these along with over 300 kits for stereo, hi-fi, color TV, electronic organs, electric guitar & amplifier, amateur radio, marine, educational, CB, home & hobby. Mail coupon or write Heath Company, Benton Harbor, Michigan 49022.

HEATH COMPANY, Dept. 10-7
Benton Harbor, Michigan 49022
In Canada, Daystrom Ltd.

Enclosed is \$ _____, plus shipping.

Please send model (s)
 Please send FREE Heathkit Catalog.
 Please send Credit Application.

Name _____

Address _____

City _____

State _____

Zip _____

Prices & specifications subject to change without notice.

CL-328R

Olson



*** FREE**

Fill in coupon for a **FREE One Year Subscription** to **OLSON ELECTRONICS' Fantastic Value Packed Catalog—Unheard of LOW, LOW PRICES on Brand Name Speakers, Changers, Tubes, Tools, Stereo Amps, Tuners, CB, and other Values. Credit plan available.**

NAME _____
ADDRESS _____
CITY _____ STATE _____
GIVE ZIP CODE _____

If you have a friend interested in electronics send his name and address for a **FREE** subscription also.

OLSON ELECTRONICS
INCORPORATED

903 S. Forge Street, Akron, Ohio 44308

CIRCLE NO. 19 ON READER SERVICE PAGE

FIVE COURSES FOR TECHNICIANS WITH EXTENSIVE LABORATORY TRAINING!



ALL Courses approved for Veterans' training

Electronics Technician eight, 10-week sessions
Electronics Mechanic six, 10-week sessions
Broadcast Engineer six, 10-week sessions
Radiotelegraph Operator five, 10-week sessions
Radio-TV Servicing four, 10-week sessions

1968 dates: September 3 and November 11

1969 dates: January 20, March 31, June 9,
September 2, and November 10

PORT ARTHUR COLLEGE

1500 Procter, Box 310, Port Arthur, Texas 77640

FREE BROCHURE

CIRCLE NO. 21 ON READER SERVICE PAGE

LETTERS (Continued from page 10)

turn, could be attached to one corner of the power amplifier terminal board. The source and drain of $Q1$ are interchangeable. Since this is a source-follower circuit, the source is at a positive potential with respect to ground and it is necessary to reverse the polarity of the input capacitor ($C1$) in the L'il Tiger. Volume control $R1$ in the adapter circuit is optional and if desired may be left out. With the adapter circuit, the L'il Tiger works beautifully with a vacuum-tube preamplifier or from crystal or ceramic phono cartridges.

RICHARD O. MARWIN
Santa Clara, Calif.

CHARACTER-TO-CODE CONVERTER WANTED

I would like to challenge you to develop a construction project that would eliminate the key normally used by radio amateurs in transmitting code. The operator would just press a push-button for each character or symbol and the appropriate *dits* and *dahs* would go out. Possibly an old electric typewriter could be converted to do the job in the mechanical portion and some IC's take care of the electronics.

ED PETERSEN
Petaluma, Calif.

We've looked into the possibility of such a project for publication in POPULAR ELECTRONICS. In fact, one of our authors has built a prototype of a character-to-code converter that we have tested. Unfortunately, such a device has two important drawbacks. First, the device we saw was much too complex. Secondly, it would be very expensive to duplicate. The electronics alone might cost \$100. A teleprinter would be the only practical mechanical keyboard assembly you could use—and this is expensive. On the whole, we feel the complexity and cost of such a device is prohibitive for all but a minute portion of our readers. But if a break-through should happen along, feel confident we will publish a character-to-code converter.

MANY THANKS

I would like to thank you for publishing my letter in your "Letters From Our Readers" column (page 99, January, 1968) about my difficulty in obtaining electronics parts. Experimenters from all over the United States and Canada have written to me offering a variety of components. I was really very moved by the large response I received.

RA'AD SADIQ JALAL
Baghdad, Iraq

I wish to thank you for the great service your "Help Promote International Friendship" column (December, 1967) has done for me. I was overwhelmed by the number of letters I received.

JOE HOM AidAN
Accra, Ghana

POPULAR ELECTRONICS

POPULAR ELECTRONICS READER SERVICE PAGE

free information service:

Here's an easy and convenient way for you to get additional information about products advertised or mentioned editorially (if it has a "Reader Service Number") in this issue. Just follow the directions below... and the material will be sent to you promptly and free of charge.

1. Print or type your name and address on the lines indicated. Circle the number(s) on the coupon below that corresponds to the key number(s) at the bottom of the advertisement or editorial mention(s) that interest you. (Key numbers for advertised products also appear in the Advertisers' Index.)

2. Cut out the coupon and mail it to the address indicated below.

3. This address is for our product "Free Information Service" only. Editorial inquiries should be directed to POPULAR ELECTRONICS, One Park Avenue, New York 10016; circulation inquiries to Portland Place, Boulder, Colorado 80302.

**POPULAR
ELECTRONICS**

P.O. BOX 8391
PHILADELPHIA, PA. 19101

VOID AFTER AUGUST 31, 1968

1 2 3 4 5 6 7 8 9 10 11 12 13 14 15 16 17 18 19 20
21 22 23 24 25 26 27 28 29 30 31 32 33 34 35 36 37 38 39 40
41 42 43 44 45 46 47 48 49 50 51 52 53 54 55 56 57 58 59 60
61 62 63 64 65 66 67 68 69 70 71 72 73 74 75 76 77 78 79 80
81 82 83 84 85 86 87 88 89 90 91 92 93 94 95 96 97 98 99 100

NAME (Print clearly) _____

ADDRESS _____

CITY _____ STATE _____ ZIP CODE _____

7 a



SAVE BIG MONEY ON ELECTRONICS

Buy from RADIO SHACK, America's biggest nationwide electronics store chain. Send now for your free copy of our new 1968 bargain-packed electronics catalog, available soon . . . plus a year of special bargain bulletins. Write to—

RADIO SHACK®

2727 West 7th St., Dept. YO
Fort Worth, Texas 76107

FREE CATALOG AND BARGAIN BULLETINS

Name

Address

City State Zip

Radio Shack Corporation — subsidiary of
Tandy Corp. • Over 190 stores coast to coast

CIRCLE NO. 24 ON READER SERVICE PAGE



MARGARET MAGNA
(1918-1968)

Behind the scenes of every magazine is a group of devoted people whose workaday efforts prepare the pages you are now reading. The names of these people appear on the magazine masthead (page 6), but as individuals the reader rarely knows of their existence. Such an editor was Margaret Magna who served as Associate and then Managing Editor of POPULAR ELECTRONICS throughout the past 13 years.

Margie "Maggie" Magna was the Editor's right arm and her unexpected death on Wednesday, April 17, 1968 was a severe blow to all of those editors and writers who had worked with and/or for her during those years.

A wonderful person, Maggie, contributed much and asked little in return. The part she played in developing POPULAR ELECTRONICS will not be forgotten.

Are you too young to know?



Nobody's too young . . . or too old . . . to know one basic fact of electronic life: The indispensability of Mueller clips . . . as familiar on test benches as are shoelaces on shoes. *World's largest and only complete line of electric clips and insulators . . . Since 1908.*

At Jobbers everywhere.

Write factory for FREE sample clips and catalog.

Mueller Electric Co.

1600V East 31st Street • Cleveland, Ohio 44114
CIRCLE NO. 17 ON READER SERVICE PAGE

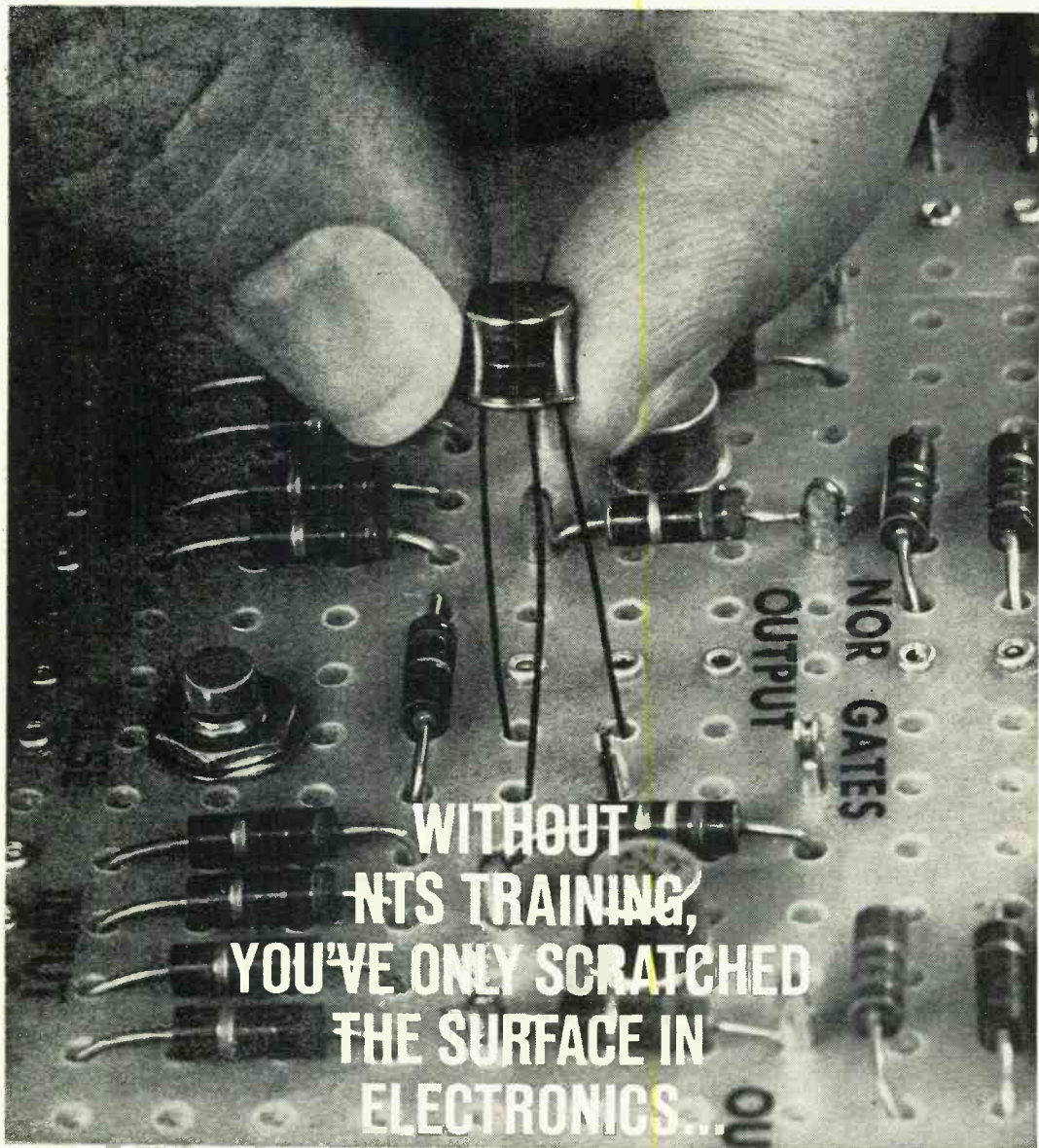

Only NTS penetrates below the surface. Digs deeper. Example? Take the above close-up of the first transistorized digital computer trainer ever offered by a home study school.

It's called The Compu-Trainer®—an NTS exclusive. Fascinating to assemble, it introduces you to the exciting world of computer electronics. Its design includes advanced solid-state NOR circuitry,

flip-flops, astable multivibrators and reset circuits. Plus two zener and transistorized voltage-regulated power supplies. The NTS Compu-Trainer® is capable of performing 50,000 operations per second.

Sound fantastic? *It is!* And at that, it's only one of many *ultra-advanced* kits that National Technical Schools offers to give you incomparable, in-depth career training.

PROVE IT YOURSELF. SEND FOR OUR NEW CATALOG. SEE THE LATEST, MOST ADVANCED KITS AND COURSES EVER OFFERED BY A HOME STUDY SCHOOL.

NTS...THE FIRST HOME STUDY SCHOOL TO OFFER LIVE EXPERIMENTS WITH INTEGRATED CIRCUIT KITS

You build a computer sub-system using the new, revolutionary integrated circuits. Each one, smaller than a dime, contains the equivalent of 15 resistors and 27 transistors.

And your kits come to you at no extra cost. These kits are the foundation of the exclusive *Project-Method* home study system...developed in our giant resident school and proven effective for thousands of men like yourself.

With Project-Method, all your kits are carefully integrated with lesson material. Our servicing and communication kits are *real* equipment—not school-designed versions for training only. As you work on each of the projects, you soon realize that even the most complicated circuits and components are easy to understand. You learn *how* they work. You learn *why* they work.

NTS Project-Method is a practical-experience approach to learning. The approach that works *best!* An all-theory training program can be hard to understand — difficult to remember. More than ever before you need the practical experience that comes from working with real circuits and components to make your training stick.

NTS SENDS YOU KITS TO BUILD THESE IMPORTANT ELECTRONICS UNITS!

- ◆ 25" COLOR TV
- ◆ 21" BLACK & WHITE TV
- ◆ SOLID-STATE RADIO
- ◆ AM-SW TWIN-SPEAKER RADIO
- ◆ TUBE-TESTER
- ◆ TRANSCEIVER
- ◆ COMPU-TRAINER®
- ◆ VTVM
- ◆ SIGNAL GENERATOR

See them all illustrated in
the new NTS Color Catalog.

CLASSROOM TRAINING AT LOS ANGELES: You can take classroom training at Los Angeles in sunny Southern California. NTS occupies a city block with over a million dollars in facilities devoted exclusively to technical training. Check box in coupon.

NATIONAL TECHNICAL SCHOOLS

WORLD-WIDE TRAINING SINCE 1905
4000 So. Figueroa Street, Los Angeles, Calif. 90037

APPROVED FOR VETERANS

Accredited Member: National Home Study Council
Accredited Member: National Association of
Trade and Technical Schools



COMMUNICATIONS

This transceiver is included in Communications courses. You build it. With it, you easily prepare for the F.C.C. license exam. You become a fully-trained man in communications, where career opportunities are unlimited.

25" COLOR TV

Included in Color TV Servicing Courses. With it you advance yourself into this profitable field of servicing work. Color is the future of television, you can be in on it with NTS training.



YOUR OPPORTUNITY IS NOW

New ideas, new inventions, are opening whole new fields of opportunity. The electronic industry is still the fastest growing field in the U.S. There's a bigger, better place in it for the man who trains today. So, whatever your goals are — advanced color TV servicing, broadcasting, F.C.C. license, computers, or industrial controls, NTS has a highly professional course to meet your needs.

GET THE FACTS! SEE ALL NEW COURSES AND KITS OFFERED IN THE NEW NTS COLOR CATALOG. SEND THE CARD OR COUPON TODAY!

There's no obligation. You enroll by mail only. No salesman will call.



NATIONAL TECHNICAL SCHOOLS

4000 S. Figueroa St., Los Angeles, Calif. 90037
Please rush Free Color Catalog and Sample Lesson, plus information on field checked below. No obligation.

- | | |
|---|--|
| <input type="checkbox"/> MASTER COURSE IN COLOR TV SERVICING | <input type="checkbox"/> PRACTICAL TV & RADIO SERVICING |
| <input type="checkbox"/> COLOR TV SERVICING | <input type="checkbox"/> FCC LICENSE COURSE |
| <input type="checkbox"/> MASTER COURSE IN TV & RADIO SERVICING | <input type="checkbox"/> INDUSTRIAL & COMPUTER ELECTRONICS |
| <input type="checkbox"/> MASTER COURSE IN ELECTRONIC COMMUNICATIONS | <input type="checkbox"/> STEREO, HI FI & SOUND SYSTEMS |
| | <input type="checkbox"/> BASIC ELECTRONICS |

NAME _____ AGE _____

ADDRESS _____

CITY _____ STATE _____ ZIP _____

- Check if interested in Veteran Training under new G.I. Bill.
 Check if interested ONLY in Classroom Training at Los Angeles.



NEW PRODUCTS

Additional information on products covered in this section is available from the manufacturers. Each new product is identified by a code number. To obtain further details on any of them, simply fill in and mail the coupon on page 15 or 95.

DIRECT/REFLECTING SPEAKER SYSTEM

The *Bose Corporation* Model 901 stereo speaker system employs a unique approach to reproducing stereo hi-fi sound. Each speaker enclosure contains nine relatively small speakers—eight speakers aimed at a wall behind the enclosure, one speaker supplying the direct-to-listener sound. All speakers are high compliance with a long voice coil excursion. Careful design smooths out the individual speaker resonant frequencies. The entire system is fed from an "active equalizer" that permits the listener to choose a response curve to suit his room acoustics. No crossover networks are used and the stereo "hole-in-the-middle" is eliminated by reflecting 89% of the sound from the wall behind the speakers.



Circle No. 75 on Reader Service Pages 15 or 95

MOBILE PUBLIC ADDRESS SYSTEM

The Model TM-30 30-watt mobile public address system available from *Bell P/A Products* is just the thing for sports events, political rallies, fire and police duty, etc. The system consists of an amplifier, microphone, twin loudspeakers, and a quick-fastening car-top mounting assembly. You can plug the power supply cable of the dash-mounted amplifier into the cigarette lighter socket. Or, it can be connected to the 12-volt car battery for permanent installation. The amplifier has separate microphone and phono/auxiliary controls to enable mixing of voice and music. It can be equipped with a plug-in, high power electronic siren.

Circle No. 76 on Reader Service Pages 15 or 95

SOLID-STATE TAPE DECKS

Tape decks with two heads (TD-2) and three heads (TD-3) have been introduced by *Herman-Kardon*. Both models are compact in

design, less than 12" long, and come in hand-crafted oiled wood cabinets. Inside, the precise mechanism is mounted on a heavy die-cast metal chassis, assuring maintenance of critical alignment of components, and permitting the recorder to be operated in either an upright or lying position. The play-back head in the TD-3 (shown in the photo) has a gap of only one micron. Frequency response of these "professional" tape decks goes up to 20,000 Hz (TD-2) and 22,000 Hz (TD-3).

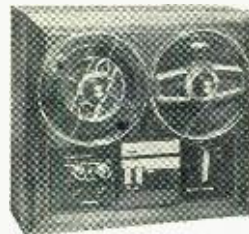

Circle No. 77 on Reader Service Pages 15 or 95

SOLID-STATE UHF CONVERTER

You can listen in on the new police and business band frequencies between 450-470 MHz using the *Ameco* "CGU" converter. Crystal-controlled, the "CGU" converter is proximity coupled to a standard AM broadcast band receiver. No connections are required between converter and receiver. Either AM or FM signals can be received. The "CGU" is flashlight-battery powered and is similar in size and operation to the manufacturer's model "CG" used for VHF reception.

Circle No. 78 on Reader Service Pages 15 or 95

AM-FM MULTIPLEX RECEIVER

A compact solid-state stereo receiver has been announced by *CLARICON Products*. The AM-FM Multiplex Model 36-220 has slide rule tuning, a.f.c. stereo FM indicator, built-in a.g.c., and three i.f. stages; and provision is

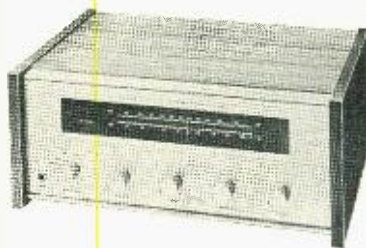

made for record changer, auxiliary input, and headphones. Enclosed in a walnut-finished wood cabinet, with an illuminated brushed aluminum panel, the receiver is also available as Model 36-225 with two matching wide-range speaker systems.

Circle No. 79 on Reader Service Pages 15 or 95

PUSH-BUTTON SOLID-STATE MULTIMETER

Push-button function switches and a high-impedance FET input circuit are featured in the *Triplet* Model 601 solid-state VOM. The Model 601 has 11 megohms input impedance

Some mikes have to take a beating



But your worries are over if it's an RCA STARMAKER. They're designed for whispers or shouts. A mike for every broadcast or recording application. From \$8.00 to \$50.00.*

For complete information on RCA STARMAKER mikes, call RCA, Microphone Merchandising at 201-485-3900, Ext. 2678. Or write RCA Electronic Components, Microphone Department, Section G 133 ZC, Harrison, N. J. 07029. *Optional User Price

CIRCLE NO. 30 ON READER SERVICE PAGE

RCA

PRODUCTS (Continued from page 22)

on all a.c. and d.c. ranges, a "low power ohms" function that will permit the operator to make safe IC measurements, and a choice of 52-range selections. The a.c. measurements are accurate to within 3% and the frequency response is 50 Hz to 50 kHz. Accuracy on d.c. is 2%. The lowest full-scale a.c. range is 0-0.01 volts; the lowest d.c. range is 0-0.1 volt. Other features include a very low current-measuring capability, a battery check switch position, zero-center voltage scale for precise null adjustments, and a shielded universal test probe. Handy push-button function switches select +d.c. volts/ohms; -d.c. volts/ohms; low power ohms; and a.c. volts.

Circle No. 80 on Reader Service Pages 15 or 95

SOLID-STATE FM MONITOR RECEIVER

Operating from either a 12-volt d.c. or 117/230-volt a.c. power source, the *Kaar Electronics Corp.* Model QJ75 FM monitor receiver can be fixed-tuned to any six crystal-controlled channels within any 1-MHz segment of the 137.5-174 MHz range. This all-solid-state unit can be mounted under



der the dash for mobile use or on a table top or a shelf for fixed locations.

Circle No. 81 on Reader Service Pages 15 or 95

82-CHANNEL TV ANTENNA

The vertical beam phasing system in *Winegard's* Model SC-1000 "Super Colortron" TV antenna eliminates stray signal pickup from above and below the antenna on all channels in the VHF TV band. This system is also said to eliminate ghosts, while increasing the VHF capture area and power gain of the antenna. A constant focus UHF parabolic screen reflector ensures maximum UHF TV signal pickup. The SC-1000 has a built-in cartridge housing that accepts *Winegard* solid-state cartridge pre-amplifiers, color spectrum filters, etc. Impedance "correlators" provide perfect 300-ohm matching of antenna elements to feedline. *Winegard* sells their "Super Colortron" with a two-year replacement warranty.



Circle No. 82 on Reader Service Pages 15 or 95

CB TRANSCEIVER KIT

Allied Radio's Knight-Kit "Safari IV" can be quickly mounted in a car, truck, or boat, or it can be used as a portable or base station.

A solid-state transceiver measuring 2½" x 6⅞" x 8½", the "Safari IV" is a 12-channel,

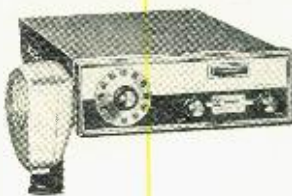

5-watt unit. Features include a sensitive superhet receiver with a just adjustable squelch, all-silicon transistors, and a built-in series

gate noise limiter. Easy to put together, the kit is supplied with a factory-assembled and aligned transmitter section, step-by-step instructions, and crystals for channel 9. Available accessories are a factory-assembled a.c. power supply and charger, a lightweight assembled battery pack, and a mobile mounting bracket.

Circle No. 83 on Reader Service Pages 15 or 95

LOW-COST TAPE DECK

Concert hall fidelity at a budget price is the claim of *Martel Electronics* for the UHER Model 7000 tape deck. The two-speed (7½ and 3¾ in/sec) transport mechanism is the proven system used in most UHER professional recorders. Frequency response is said to be 40-18,000 Hz at 7½ in/sec and 40-15,000 Hz at 3¾ in/sec. With a metallic leader, the Model 7000 can be made to feature automatic shut-off. The tape counter is 4 digit and the level of each channel can be set with the aid of a built-in VU meter. The model 7000 is mounted in a walnut base.



Circle No. 84 on Reader Service Pages 15 or 95

COMPUTER-TACHOMETER KIT

Combining a computer with a tachometer for precise measurement of engine r.p.m., *Delta Products' "Computach"* features voltage and temperature stabilization under virtually all operating conditions. The zero-parallax meter is equipped with variable-intensity internal illumination, wide-angle pointer sweep, and adjustable-set pointer. The electronic computer consists of solid-state, precision components designed to produce a highly accurate, trouble-free system. "Computach" features a 0-8000 r.p.m. range, applicable to almost all 12-volt car power systems. Also supplied with the tachometer kit is a "Computester" which permits the user to calibrate his tach to laboratory standards prior to installation.

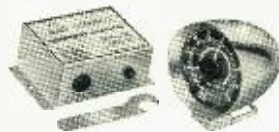

Circle No. 85 on Reader Service Pages 15 or 95

SHIP SHAPE

The Squires-Sanders Citizens Band Fleet is shipping out . . . in top shape. All over the country the message is coming in loud and clear . . . "NOW HEAR THIS—this is the ADMIRAL speaking" . . . "ATTENTION MEN—this is your SKIPPER". It is time for you to put your station in command—with an ADMIRAL to run your base . . . and a SKIPPER to pilot your mobile. Haul in to your dealer today.



THE ADMIRAL • *The* SKIPPER

The ADMIRAL: luxurious new all solid state 23 channel CB base station • highly sensitive receiver • Pulse Eliminator • 5 watt transmitter • Speech Compression • +2 mike • dual antenna • HiLo sensitivity • Public Address • Delta Tune • adjustable squelch • ON-THE-AIR light • illuminated S meter • digital panel clock • ear-phone jack • regulated AC power supply • 9 lbs: 5¼ x 13¾ x 10¾"

\$329.95

The SKIPPER: new low priced solid state 23 channel CB transceiver • superb dual conversion FET/IC no-overload receiver • advanced design noise limiting • illuminated S meter and channel • solid state T/R switching • Speech Clipping • 100% modulation • P.T.T. mike • Local/Distant sensitivity • external speaker jack • Public Address • Exclusive "All Position" Safety Breakaway Mount • only 3 lbs: 1¾ x 6 x 8"

\$159.95

Squires  Sanders

SQUIRES-SANDERS, INC., Box A, Martinsville Road, Liberty Corner, New Jersey 07938 U.S.A.
CIRCLE NO. 29 ON READER SERVICE PAGE

your own little PHOTOPLETHYSMOGRAPH

Unusual project shows heart action and blood flow

Hundreds of times each day, in the leading hospitals of the world, surgeons perform miraculous feats of surgery made possible by daring innovations in technique and an array of the finest equipment money can buy. An important member of the surgical team is the anesthetist. He leans heavily on modern medical electronic instrumentation, and can now keep his full attention on the unconscious form before him while the important heart data is supplied to him aurally. This information comes in the form of a soft rhythmic "bleep" emanating from an electronic monitor. If the *bleep* should falter, the signal can be

switched from an audible to a visual presentation. The anesthetist would then be able to study the heartbeat waveform displayed on the face of his small, battery-operated oscilloscope.

This heartbeat signal originates in a photocell transducer that has been slipped over one of the patient's fingers. It has the rather formidable name of photoplethysmograph, usually abbreviated to PPG. The "plethysmo" portion of the word is derived from the Greek "plethore," meaning "to be full." Basically, the transducer measures the blood volume flow in the finger to which it is attached. This is an excellent indication

BY ROBERT E. DEVINE

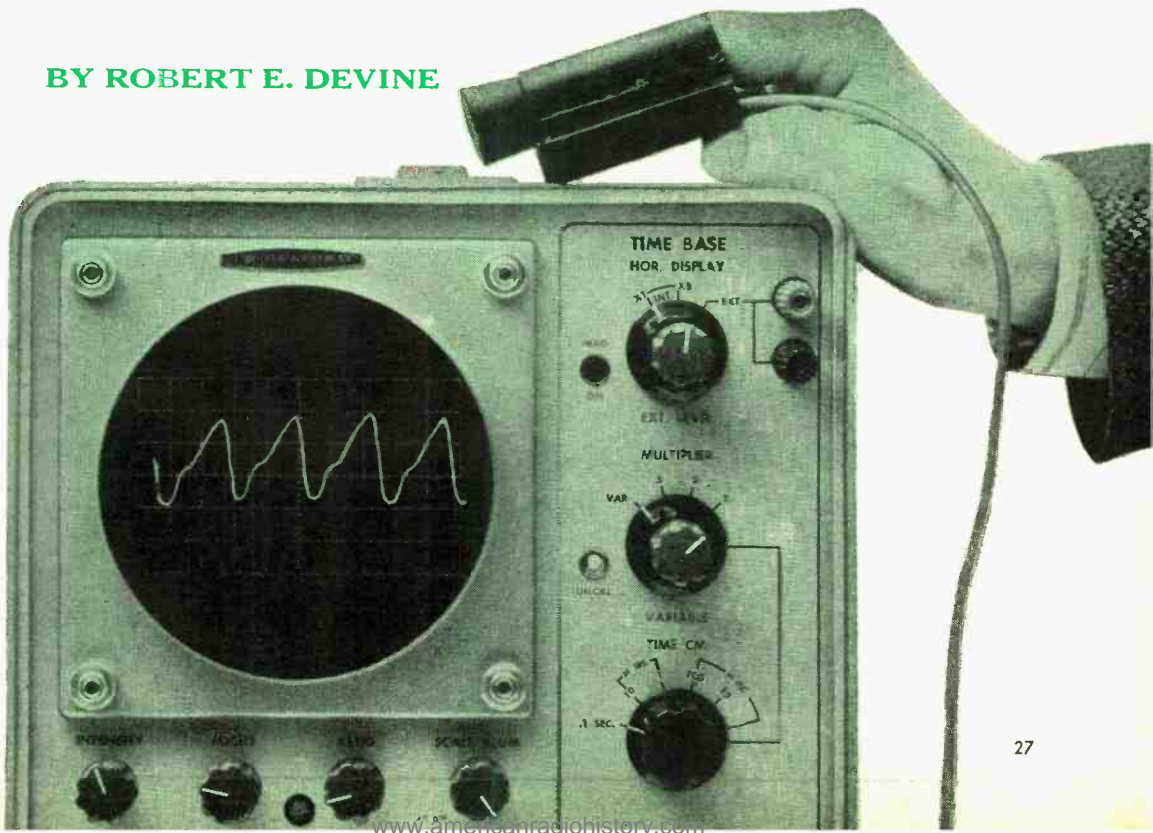

PARTS LIST

B1—22.5-volt battery
 B2—1.5-volt battery
 I1—Pilot bulb ≈ 222 , or "grain-of-wheat" bulb
 J1—Three contact polarized socket
 P1—Three contact polarized plug
 PC1—Photocell sensitive to approximately 7350 Angstroms (Clairex CL903L or similar)
 R1—5600-ohm, $\frac{1}{2}$ -watt resistor
 R2, R3—10,000-ohm, $\frac{1}{2}$ -watt resistor
 S1—D.p.s.t. switch
 Misc.—Block of wood or opaque plastic approximately $2\frac{1}{2}$ " x $1\frac{1}{2}$ " x $\frac{1}{2}$ ", thin metal plate, battery holders, length of 2-conductor flexible shielded cable with three-pin polarized plug

Fig. 1. The PPG circuit is a simple bridge with photocell PC1 as the variable arm. The plate bleeds off static electricity. The shield of the transducer cable is the common ground lead and is connected to pin 1 of P1. The output cable is a shielded single-lead microphone cable.

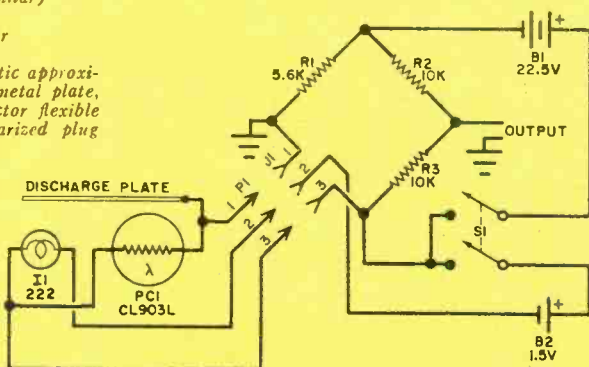

(from transducer to bridge), length of phono cable with two-pin polarized plug (from bridge to preamp or scope), finger support (see text), connector for scope or preamplifier (optional), 25,000-ohm potentiometer (optional, see text), terminal strips, hardware, etc.

of how efficiently the heart is working. If the patient's condition warrants it, this pressure pulse monitor will accompany the patient to the recovery room. The PPG is also used in intensive care hospital rooms. Its signal can be carried by cable to a central observation point where it may be monitored continuously by either visual display or an audible signal. The electronic vigil will watch-and-warn for that critical 200 seconds—the period between the instant the heart ceases to pump, and death. The heart must be restarted during this critical interval to save the patient's life.

The actual waveform generated by the

pressure pulse has a frequency of only one or two hertz—much too low to be heard by the human ear. In an aural setup this signal triggers an electronic tone generator whose frequency has arbitrarily been selected to be something "easy to listen to." The important information conveyed by the *bleep* is the tempo and regularity of the heartbeat. On the other hand—when the waveform is displayed on an oscilloscope, all the above information, plus other physiologically significant events, can be extracted from a visual observation of the waveform.

If you have a good oscilloscope, you

PARTS LIST

B1—22.5-volt battery
 C1—12- μ F, 20-volt tantalum capacitor
 C2—75- μ F, 6-volt electrolytic capacitor
 J1—Two contact polarized socket
 Q1—N-channel FET (Motorola MPF103 or similar)
 R1, R4—2-megohm } all resistors
 R2—470-ohm } $\frac{1}{2}$ -watt
 R3—7500-ohm }
 S1—S.p.s.t. switch
 S2—S.p.s.t. momentary contact switch
 Misc.—Metal case 4" x $2\frac{1}{4}$ " x $2\frac{1}{4}$ ", transistor socket, battery holder, length of shielded flexible cable (from amplifier to scope), terminal strips, hardware, etc.

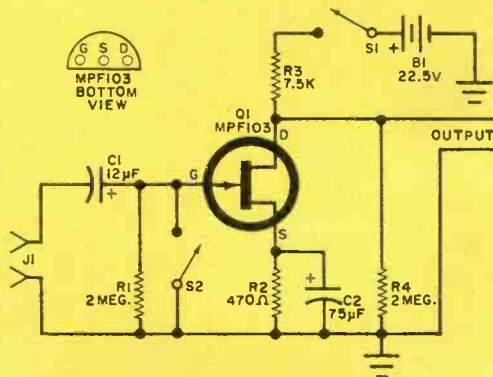

Fig. 2. Output level of the bridge is very low and this special pre-amplifier may be required. Capacitor C1 is made of tantalum foil.

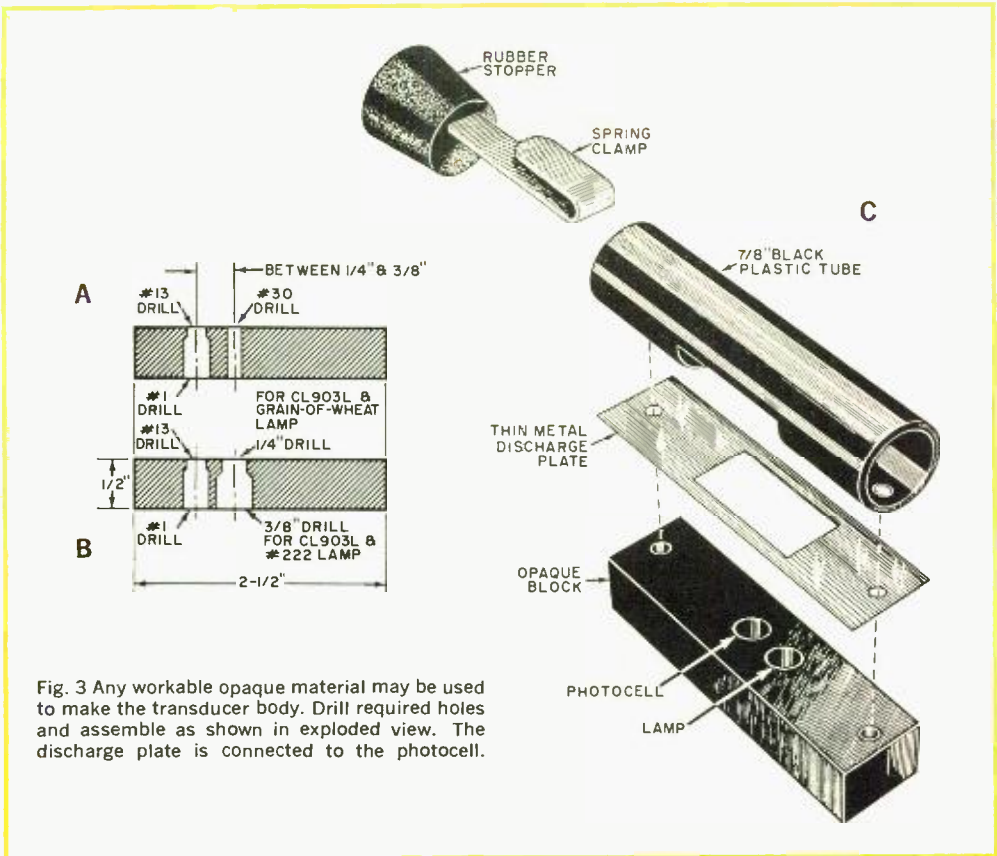

Fig. 3 Any workable opaque material may be used to make the transducer body. Drill required holes and assemble as shown in exploded view. The discharge plate is connected to the photocell.

can reduce the cost of building your own PPG to approximately six dollars. Construction time should be just a few hours.

Construction. The PPG is divided into three cable-connected sections: the finger-mounted transducer assembly, the measuring bridge, and a FET signal preamplifier (optional). The circuit for the transducer and bridge is shown in Fig. 1 and the schematic for the FET preamplifier is shown in Fig. 2.

To make a transducer, a piece of opaque plastic or wood approximately $2\frac{1}{2}'' \times 1\frac{1}{2}'' \times \frac{1}{2}''$ is drilled to accept the photocell and lamp as shown in Fig. 3. There are two methods of drilling the holes for the light source. Fig. 3(a) shows the drilling requirements for a grain-of-wheat lamp, while Fig. 3(b) shows the drilling for a #222 lamp. In both cases, the hole for the photocell remains the same size. Each unit should be submerged within the opaque block so that they do not "see" each other unless

HOW IT WORKS

The PPG takes advantage of the fact that tissues of the human body are relatively transparent to the red part of the light spectrum (near infrared region from 7000 to 8000 Angstroms), while the blood is not.

When you place your finger across the gap separating the reddish light source and the photocell, your flesh will provide a path for the light rays to reach the photocell from light source. With each systole, or contraction of the heart muscles, the amount of blood in your peripheral extremities increases as the blood vessels momentarily dilate. Since blood is opaque to the red light, this reduces the amount of light reaching the photocell during the pressure pulses. The change in light causes the photocell to change its resistance with each pulse.

The photocell is connected in a bridge circuit (see Fig. 1) with R_1 being its opposite bridge element. Equal value resistors R_2 and R_3 provide a mid-point pickoff for the output signal. Each time the photoresistor changes its resistance value, an output signal is generated by the bridge.

Because the bridge output is a low-level, low-frequency signal, the FET preamplifier shown in Fig. 2 may be used to increase the signal level to a point usable by some scopes. This preamplifier is a conventional FET stage having the required very high input impedance so as not to reduce the low-frequency coupling (C_1) at these one-to-two-Hz subaudible frequencies.

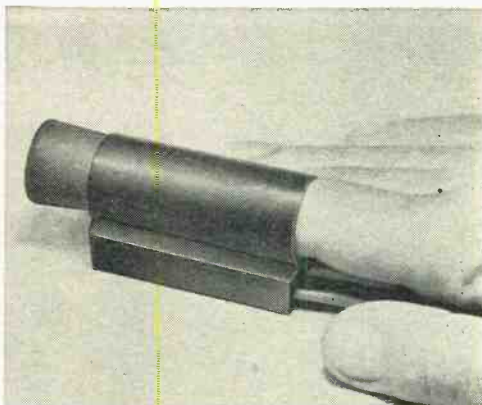
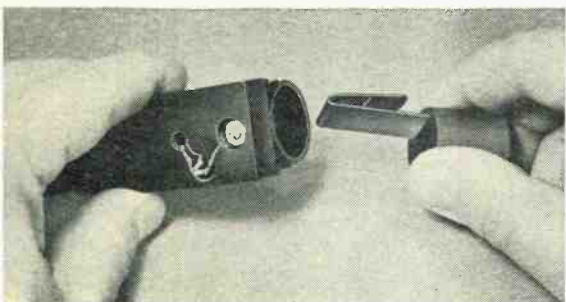
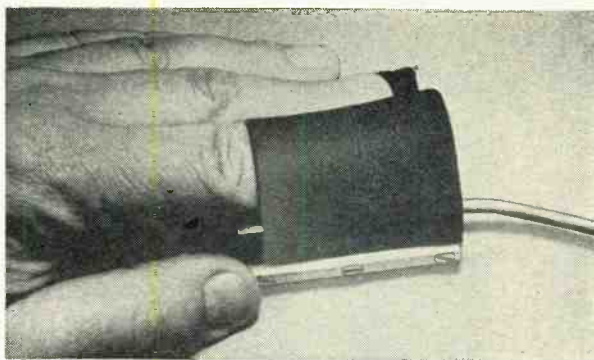
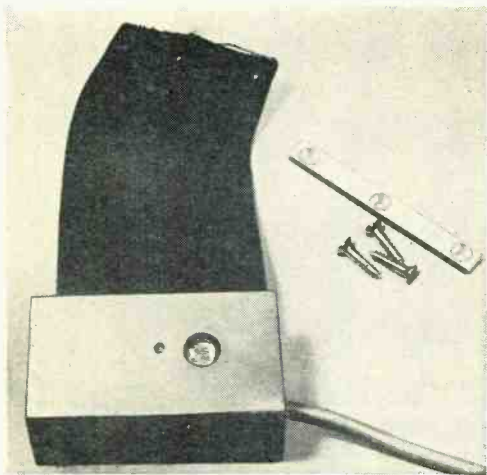

Fig. 4. Two preferred methods of assembling a transducer are shown. In the upper two photos, an elastic cloth has been used to secure the finger and block off outside light. The photocell and light source are visible through the holes in the metal plate. The two lower photos show tube transducer.

a finger is so placed as to make a reflective bridge between photocell and lamp.

To remove any static electricity charge, a thin metal plate covers the top of the opaque block with a cutout over the lamp and photocell holes. This is shown in Fig. 3(c). The metal plate is connected to the ground lead of the transducer-bridge cable.

A light shield surrounding the finger and the photocell is recommended. Use a black (opaque) plastic tube that can be bolted to the opaque block, with a cutout as shown in Fig. 3(c). To make sure that the finger correctly bridges the *I1-PC1* gap, make up a clamp using a rubber stopper and a home-made spring. The stopper should be a tight fit in the end of the plastic tube. The spring clamp is inserted so that when a finger is placed in the tube (fingernail up), the clamp will force the finger down to bridge the

I1-PC1 gap. An alternative construction method is to use a piece of opaque, elasticized cloth attached to both sides of the opaque block. This cloth forms both a finger support and a light shield. Figure 4 illustrates both types of finger transducers.

The photocell, lamp, and ground plate are wired to a short length (three feet) of two-conductor shielded cable. This cable is terminated in a polarized three-pin plug.

Building The Bridge. The author built his bridge circuit in a 5" x 4" x 2" metal box, as shown in Fig. 5, although any other similar container would suffice. The bridge elements (*R1*, *R2*, and *R3*) are supported on a pair of three-terminal strip assemblies. The two batteries are mounted on the sides of the box, the on-off switch (*S1*) is on the upper surface of the box, and the three-pin polarized

connector to accept the output from the transducer is mounted on one end of the box. All wiring is point to point. The bridge output is taken via a length of phono cable, with the center lead going to the bridge, and the braid connected to the ground. This cable is terminated in a two-pin polarized plug for connection either to an oscilloscope or to the FET amplifier.

If the output of the bridge is used to feed a d.c. scope, the d.c. component of the bridge output can be removed by replacing R_2 and R_3 with a 25,000-ohm potentiometer. The output is then taken from the arm of the potentiometer which is adjusted to produce a zero voltage output (to ground) with no signal to the photocell.

Preamplifier. The approximate bridge output amplitude of a PPG signal is 0.05-volt peak to peak. Your scope should have a vertical sensitivity of at least 10 mV per cm (25 mV per inch) at one to two Hz. However, if your scope does not have this sensitivity, the FET preamplifier (schematic in Fig. 2) should be built.

This amplifier has two characteristics that may cause you some trouble. The first is that the tantalum input capacitor (C_1) acts somewhat like a diode—it has a high resistance in one direction and a low resistance in the other. The second is the very long time constant of RIC_1 . Although this is a nuisance, it is important in passing the very low frequencies required by the PPG.

When using the PPG the output is at a d.c. level, transducer modulated about 25 mV in both directions. It is important that C_1 present its high-resistance side to this d.c. voltage, otherwise C_1 will bias the gate of Q_1 enough to make the amplifier inoperative. If you get no output from the amplifier (with an input signal from the bridge), reverse the capacitor end-for-end or reverse the battery powering the bridge. **DO NOT** reverse the battery supplying power to the FET.

The aggravating long RIC_1 time constant means that it may take anywhere from ten to fifteen seconds to charge C_1 . During this interval, the charging current passing through R_1 can bias the FET to pinchoff—the equivalent of cut-

off in a bipolar transistor or vacuum tube. Therefore, after placing your finger in the transducer, you might have to wait fifteen seconds before the amplifier commences functioning and the signal appears on the CRT. To partially eliminate this delay, a momentary-contact switch (S_2 in Fig. 2) is connected across R_1 . With this switch closed, C_1 will charge in a fraction of a second. When you release this switch, the amplifier should function immediately.

The amplifier is built in a 4" x 2¼" x 2¼" metal box as shown in Fig. 6. Short leads should be used, as excessive capacitance between the output and input leads may lead to instability. Also, a good quality transistor socket is used to mount Q_1 . Since the signal of interest is in the millivolt range, the circuit should be shielded and good r.f. wiring techniques should be used to keep stray 60-Hz a.c. to a minimum. The input two-pin connector must match the plug coming from the bridge circuit, making sure that like leads are in contact—that is, hot lead to hot input, and ground braid to ground. The output of the preamplifier is a length of shielded microphone cable, with a termination plug suitable for attaching to your scope.

Using the PPG. Connect the transducer to the bridge, the bridge to the FET

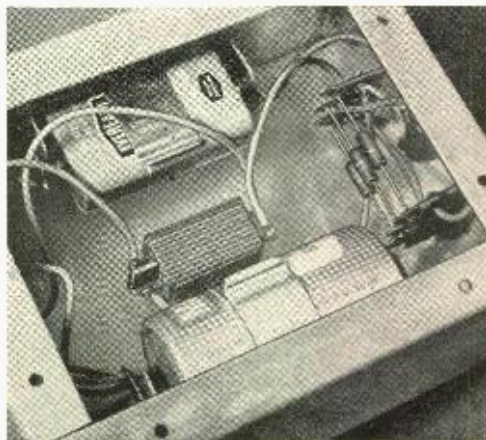

Fig. 5. The bridge circuit—excluding photocell and light source—is assembled with point-to-point wiring.

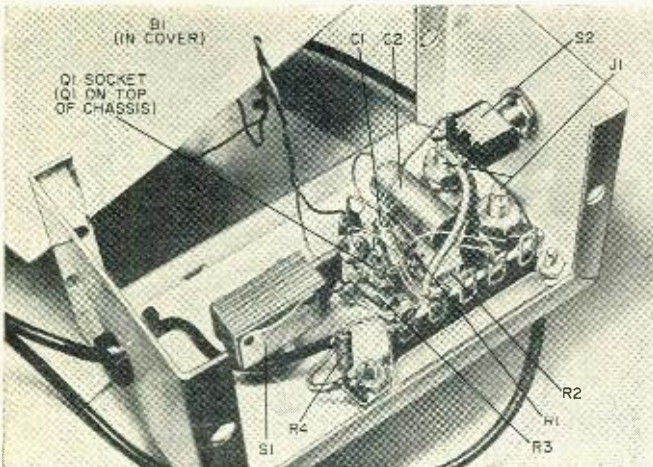

Fig. 6. Use point-to-point wiring when assembling the FET preamplifier. The circuit must be shielded to avoid electrical noise pick-up. Author mounted capacitor loading switch S2 on end plate of metal box and power switch S1 on top panel.

WHAT DOES THE PPG DISPLAY?

The photoplethysmograph (PPG) when connected to an appropriate oscilloscope displays pulsations of blood in the vascular system. These pulsations originate in the action of the heart and the PPG shows their amplitude, frequency and waveform.

Blood pressure (PPG amplitude) is displayed in three phases: "systolic," during contraction of the heart when arterial pressure is maximum; "diastolic," when the heart is expanding and pressure is low; and "mid-point," or mean, which occurs between the two extremes and is called the pulse pressure.

There is no normal PPG amplitude although there is a direct correlation between blood pressure and the peak response displayed by the PPG. Blood pressure of the subject varies according to age, physical condition, emotional state, etc. It also varies in different parts of the vascular system. The large arteries have higher pressure while the capillaries at the finger tips have a moderately low pressure.

The frequency rate of the pulse display is also variable—from an abnormal low of 50 pulses per minute to a high of 150, or more, pulses per minute. The velocity of the pulse wave through the vascular system is about 7 meters per second, although the actual blood flow is around 0.5 meters per second. If you attempt to correlate the actual heart beat and the PPG display, you will see a displacement due to the time lag in the flow of the blood through the arteries.

Because of the many variables, a strict interpretation of the PPG display is best left to the professional. However, as indicated in the article text, the PPG offers an opportunity to examine blood flow in the human body and the reaction of the heart to stress or emotional upset and physical exertion.

preamp (if used), and the preamp to the d.c. scope vertical input. If the preamp is not used, connect the bridge output directly to the oscilloscope. Make sure that the polarity of each signal lead is correct. Turn on the scope and adjust for a very slow horizontal sweep rate—one every two seconds is a good place to start—otherwise, set the sweep to as slow a rate as possible with your particular scope. If your scope has provisions for hooking an external capacitor to the horizontal sweep circuit, select a capacitor that produces a sweep time between one and 10 seconds. Capacitance values depend on the particular scope.

Set the scope vertical gain high, as the signal to be observed will be of low amplitude. Turn the bridge on-off switch *on* and check that the transducer light bulb goes on simultaneously. One interesting aspect of the transducer is that the brightest light source does not necessarily produce the strongest output signal. Some commercial PPG's use a rheostat in series with the light bulb so that light intensity can be controlled. Starting with maximum brightness, the lamp is gradually dimmed until a point is reached where the amplitude of the output signal peaks. The explanation for this behavior becomes clear when you recall that the PPG photocell is most sensitive in the *red* region of the visible light spectrum. A light bulb at full brilliance is putting too much of its energy in the blue spectrum, where the cadmium selenide photocell used in this project is "blind." This is why the *I1* is

operated at approximately half voltage.

Insert a finger into the transducer light shield so that the ball of your fingertip rests comfortably across the two holes containing the light bulb and photocell. If you use either the spring clip or elastic band finger retainer, make sure that it does not push down too hard on your finger, as this will cut off the blood flow to the fingertip and reduce the output signal.

If you are using the FET preamplifier, close the capacitor switch for a couple of seconds, and adjust the scope vertical position until the trace is centered on the screen.

Do not wiggle your finger while making PPG measurements, as this will cause the trace to dart up and down the scope face.



Fig. 7. Typical PPG displayed waveform. The trace shows fuzziness due to electrical noise pick-up.

After the trace settles down, you will see it assume a waveform similar to that shown in Fig. 7. (The waveform seen on the scope face on the cover is an approximate three-second time exposure.) The upward trace (downward if you have reversed the battery in the bridge circuit) is caused by an increase in blood volume due to a momentary dilation of the blood vessels. This in turn is caused by a pressure wave originating in the heart with each heart beat. This sharp contraction of the heart is called "systole" in medical terms. Naturally, the upward pulse trace will occur somewhere between 60 and 120 times each minute, corresponding to your heart rate. Variations in rate or amplitude, which represent an increase or decrease in blood

volume, are easily seen.

To observe the action of the heart, stand up, hold your hand at heart level, and observe the trace. Then raise your hand as high as you can (wait for the trace to settle if it should flick off the scope face), and note the difference in the amplitude of the pressure wave. You can also lie down, with the transducer at heart level, note the waveform, then raise the hand as high as possible.

While observing the waveform, grasp the wrist of the hand attached to the transducer and start squeezing—gently at first, then more firmly. The amount of pressure required to flatten the scope trace will depend on your blood pressure. A pneumatic cuff and mercury manometer may be used with the PPG to determine your actual blood pressure.

You know that the tempo of your heartbeat will increase with exercise (such as a few quick, deep-knee bends), but what happens to the shape of the waveform? Try it and see. Also, try holding your breath after inhaling deeply—you might find that your pulse rate will accelerate at first, then decelerate, then speed back up again. There will be surprising changes in the amplitude of the pulse wave.

Emotions also have a powerful effect on blood circulation. If you experience stress, anger, or fear, your peripheral blood vessels will constrict and lessen the blood flow. It is difficult to duplicate these strong emotions under artificial conditions. However, be alert and you may note changes in the PPG waveforms that correspond to changes in the subject's emotional state.

Other, more practical uses, can also be demonstrated. The PPG can be used as an indicator of whether or not blood flow has been cut off in an arm while practicing with a tourniquet or using "pressure points" in practicing first-aid procedures. You can even apply the PPG transducer to a leg (connect the transducer to a toe) and check for the proper application of pressure points used to stop leg bleeding.

Cigarette smoking causes cutaneous vasoconstriction—reduction of blood flow in the skin. Smokers may observe this effect by taking a few deep "drags" on a cigarette while monitoring a PPG scope trace.

STEREO- at 99¢ per ear

BY DAVID B. WEEMS



To make the headset comfortable, the funnel edge should be padded with foam rubber or plastic foam. Cement in place after making the necessary cutout. Headset is very light in weight.

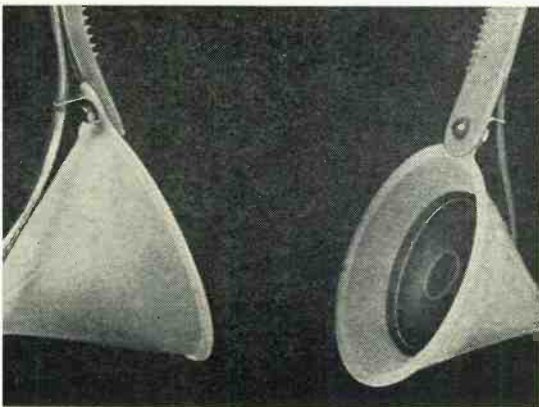

HERE'S A CUTE IDEA for a project that is fun to assemble and is very useful in the bargain. For about 99¢ per ear, you can put together a set of stereo headphones using ordinary household materials. Try it one evening and see.

The necessary parts—shown in the photo at the top of this page—consist of a pair of two-inch diameter PM speakers, two 2-oz. plastic funnels, a plastic headband, nuts, bolts and wire. Prepare the funnels by cutting the stem down to a length of $\frac{1}{4}$ ". Attach the funnels to the headband (see bottom photo) with #6 hardware and bend a solder lug to make a wiring support. Solder connecting wires to speakers and bring the wires out funnel neck through solder lugs. Wire speakers in phase and fasten connecting lead to headband with silicone cement. Wad a piece of fiberglass stuffing into the funnel behind each speaker and apply a bead of silicone cement around the edge of the speaker basket to hold them in place. Then press the speakers into the funnels and allow the cement to dry. Of course, attach the appropriate connector at the end of the headset cable.

If you connect this stereo headset to the speaker terminals of your hi-fi, it is a good idea to install a 100-ohm resistor in series with each speaker. This will prevent blasting. Edge each of the funnels with a piece of foam rubber or plastic foam for comfort. —50—

Speakers are wired in phase so that terminals with red dot go to hot side of amplifier output. Other speaker connections go to amplifier ground. Note use of the solder lug.

POPULAR ELECTRONICS

Circuit Designers' Quiz

Many common electronic circuits bear the name of their inventors. To test your knowledge of these men and their inventions, match the diagrams (A-J) to the names (1-10). Answers are given on page 98.

BY ROBERT P. BALIN

3-G

10-A

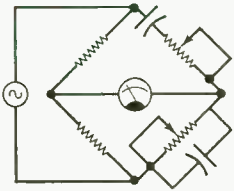

- 1 Clapp
- 2 Cockcroft-Walton
- 3 Darlington
- 4 Eccles-Jordan
- 5 Foster-Seeley
- 6 Heising
- 7 Kelvin
- 8 Pierce
- 9 Schmitt
- 10 Wein

B
D
C
H
J
K
E
A

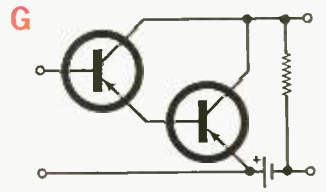

1-B

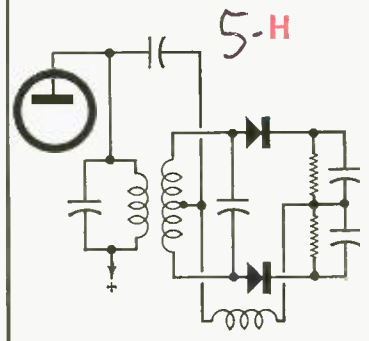
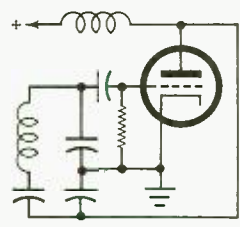

4-C

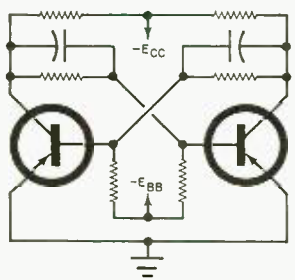

E 9-E

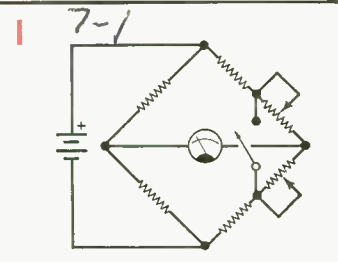
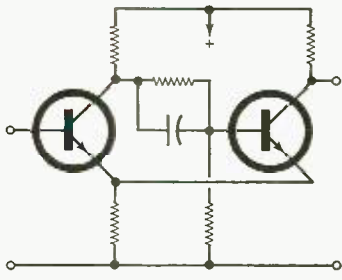

2-D

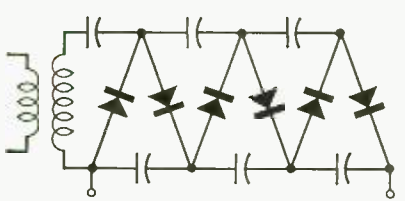

F 8-F

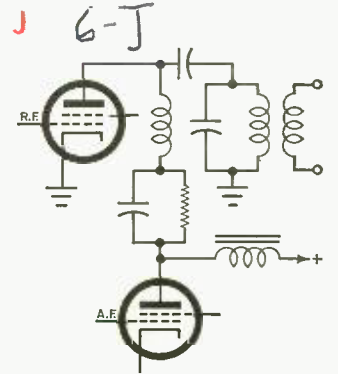
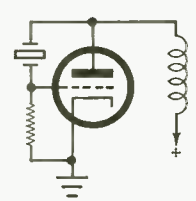

**“Get more
education
or
get out of
electronics
...that’s my advice.”**



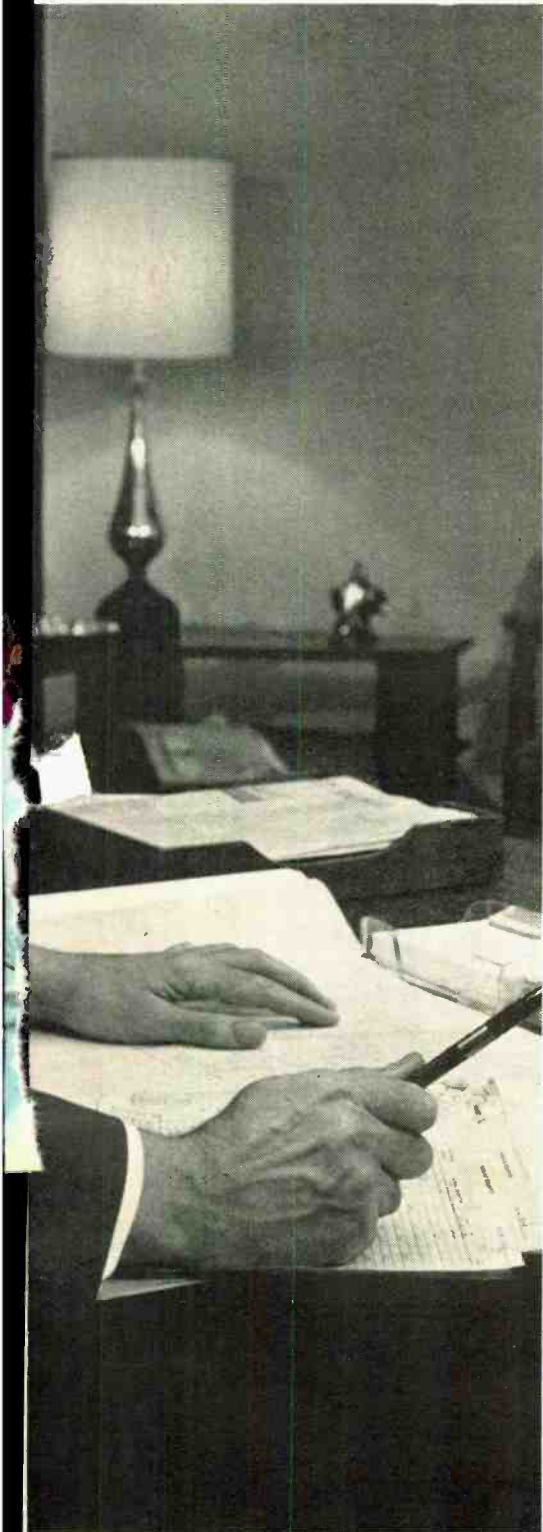

Ask any man who really knows the electronics industry.

Opportunities are few for men without advanced technical education. If you stay on that level, you'll never make much money. And you'll be among the first to go in a layoff.

But, if you supplement your experience with more education in electronics, you can become a specialist. You'll enjoy good income and excellent security. You won't have to worry about automation or advances in technology putting you out of a job.

How can you get the additional education you must have to protect your future—and the future of those who depend on you? Going back to school isn't easy for a man with a job and family obligations.

CREI Home Study Programs offer you a practical way to get more education without going back to school. You study at home, at your own pace, on your own schedule. And you study with the assurance that what you learn can be applied on the job immediately to make you worth more money to your employer.

You're eligible for a CREI Program if you work in electronics and have a high school education. Our FREE book gives complete information. Airmail postpaid card for your copy. If card is detached, use coupon below or write: CREI, Dept. 1207G, 3224 Sixteenth Street, N.W., Washington, D.C. 20010.

Founded 1927



**CREI, Home Study Division
McGraw-Hill Book Company
Dept. 1207G, 3224 Sixteenth Street, N.W.
Washington, D.C. 20010**

Please send me FREE book describing CREI Programs. I am employed in electronics and have a high school education.

NAME _____ AGE _____

ADDRESS _____

CITY _____ STATE _____ ZIP CODE _____

EMPLOYED BY _____

TYPE OF PRESENT WORK _____ G.I. BILL

I am interested in Electronic Engineering Technology
 Space Electronics Nuclear Engineering Technology
 Industrial Electronics for Automation
 Computer Systems Technology

APPROVED FOR TRAINING UNDER NEW G.I. BILL

BATTERYLESS CW Monitor

BY GERALD L. VOGWILL, K3SKP

MUD MODULE DOES THE TRICK

THE RADIO AMATEUR working CW can either transmit "blind," or desensitize his receiver to use it for a monitor. Another possibility is to use an onboard tone generator coupled to the key.

A cheap "mud module" code-practice oscillator makes an ideal battery-less monitor. The only circuit requirement is that the transmitter use both cathode bias and cathode keying. The only modification is a change in the cathode bias resistor to accommodate the CPO.

Wiring It Up. Determine the lowest voltage that will reliably activate the CPO. Because the CPO will be keyed by the voltage supply, short the module's key leads, connect the loudspeaker to the module and apply a variable d.c. voltage to the input leads. Gradually reduce the applied voltage to the lowest level that will insure proper CPO operation. Record this value.

Next measure the voltage developed across the cathode resistor of the keyed transmitter stage. In most cases, this will be far in excess of that required for proper operation of the CPO

module. Therefore, the cathode resistor (R_K) is divided into two resistors chosen so that the CPO operating voltage will be generated across resistor $R1$.

Use Ohm's Law to calculate the current (I_K) flowing through the cathode resistor with the key down. Knowing this current, and the voltage required by the CPO, resistor $R1$ can be determined. Now calculate $R2$ by subtracting the value of $R1$ from the value of the previous single resistor.

Operation. After installation, check the r.f. output of the transmitter. If it is not the same as before the CPO installation, check the grid bias (E_G). If this bias has changed (it may be slightly less), increase the value of $R1$ a few ohms, and use a slightly larger value of $R2$ until the grid bias and output are back to normal.

In operation, the CPO will sound off each time the key is pressed. If the CPO is not wanted, an on/off switch located in the positive feed may be included. This switch is necessary if the rig is also to be used for phone operation. —30—

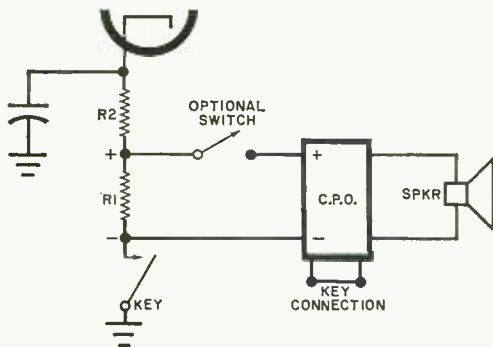

To operate CPO, a suitably low voltage is developed across resistance network in cathode of transmitter.

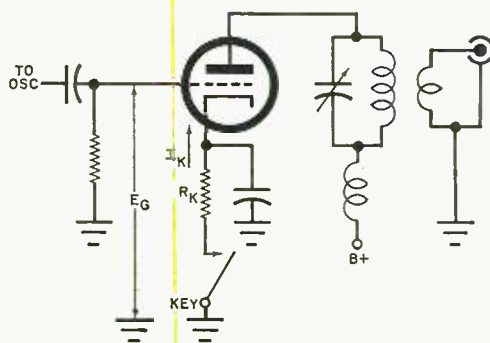

Basic requirement for this type of monitor is that the transmitter use cathode bias and cathode keying.

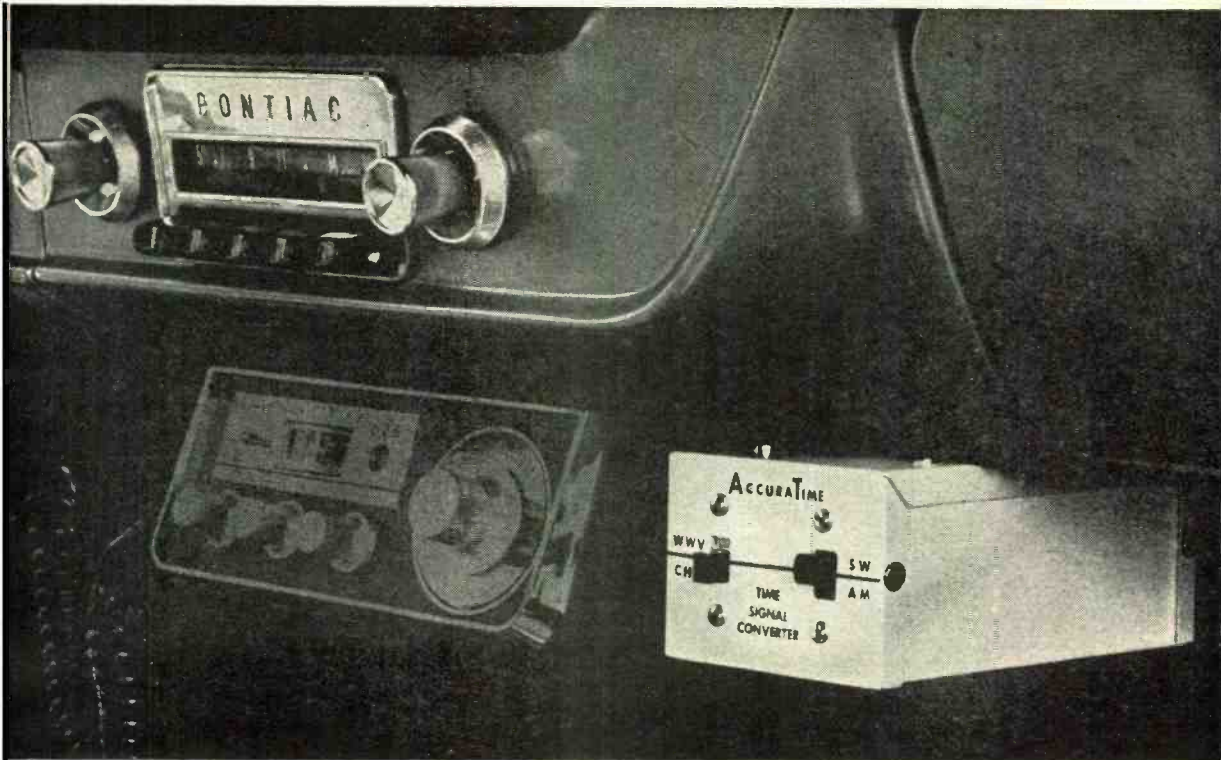

BUILD the ACCURATIME

BY GEORGE J. WHALEN

*CONVERT YOUR CAR RADIO
INTO THE WORLD'S
MOST ACCURATE TIMEPIECE*

HOW WOULD YOU like an "electronic" clock with an accuracy far better than one second per year? This "electronic" clock announces the time each minute in English and French and will also tell you about such weird things as whether or not there have been any solar flares in the last 24 hours. If that isn't enough, this ubiquitous device will also let you listen in on standard frequency audio tones, or even the 41- and 31-meter international broadcasting bands.

If you have a friend that drives in sports car rallies, he is going to want you to build him one of these "electronic" clocks—so be prepared.

Outside of building the device, the only other thing you need is either an automobile AM or transistor AM radio. Named the "AccuraTime," this fixed-

tuned little crystal-controlled short-wave converter receives the National Bureau of Standards station WWV on 10 MHz, or the Canadian Dominion Observatory station CHU on 7.335 MHz. At a flick of a panel switch, you can select either station, giving you the choice of CHU's one-second "beeps" plus voice time announcements in English and French each minute or the broad range of time, frequency, and propagation announcements made over WWV. Because of the geographical separation between these two stations, propagation effects are always different. Consequently, if propagation conditions cause one station to drop out, you can switch to the other for uninterrupted time keeping.

The "AccuraTime" converter is assembled on a small printed circuit board,

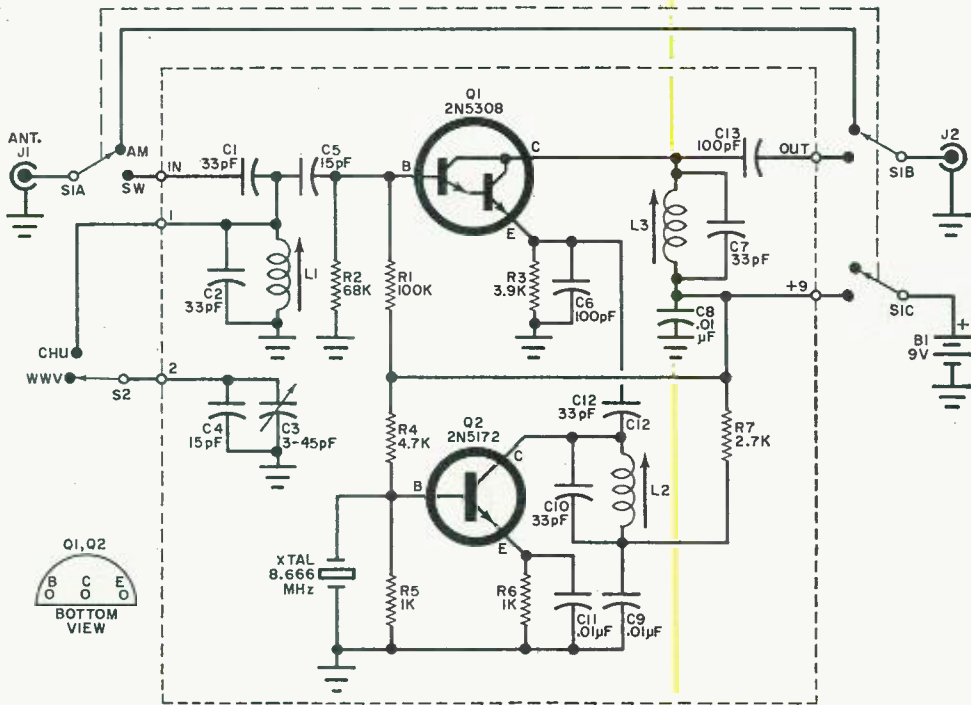

PARTS LIST

- B1—9-volt battery
 C1, C2, C7, C10, C12—33-pF, disc ceramic capacitor
 C3—7-45-pF trimmer (Centralab S22-BN or similar)
 C4, C5—15-pF disc ceramic capacitor
 C6, C13—100-pF disc ceramic capacitor
 C8, C9, C11—0.01-μF, disc capacitor
 J1, J2—Motorola-type auto radio jack (H. H. Smith 1207, or similar)
 L1, L2—2.4-4.1-μH adjustable printed circuit coil (J. W. Miller 23A336RPC or similar)
 L3—160-275-μH adjustable printed circuit coil (J. W. Miller 23A224RPC, or similar)
 P1, P2—Motorola-type auto radio plug (H. H. Smith 1200, or similar)
 Q1—2N5308 transistor (Also known as the General Electric D16P4)*
 Q2—2N5172 transistor*
 R1—100,000 ohms
 R2—68,000 ohms
 R3—3900 ohms
 R4—4700 ohms
 R5, R6—1000 ohms
 R7—2700 ohms
 S1—3-p.d.t. slide switch
 S2—S.p.s.t. slide switch
 XTAL—8666 kHz quartz crystal (similar to Petersen Radio type Z-9C; specify frequency and order from Allied Radio Corp., stock number 12B9404CS)
- } all resistors
 } ½-watt and
 } 5% tolerance

Fig. 1. The circuit is a basic high-efficiency short-wave converter using the latest in available transistors. Having an i.f. output of 1.33 MHz, it converts any car radio into a double-conversion superhet. With its tunable i.f. (the car radio), selectivity and sensitivity are both excellent.

Misc.—Printed circuit board,* battery clip, spring and lugs for battery hold-down, metal case 5¼" x 2½" x 3", 1-inch tapped standoffs (4), low-capacitance shielded cable, hook-up wire, solder, hardware, etc.

*Kit of semiconductors \$1.50, etched and drilled PC board \$2.50; both postpaid from the G. J. Whalen Co., P.O. Box 16, E. White Plains, N.Y. 10604. (New York State residents add 2% sales tax.)

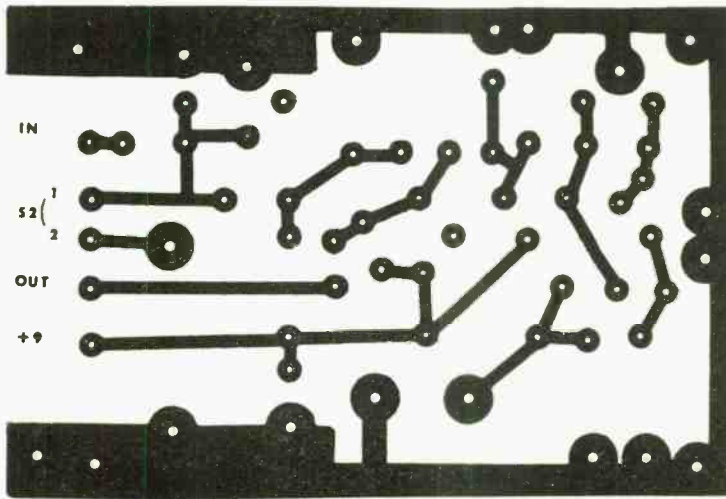

Fig. 2. Actual-size printed board is easy to duplicate (or it can be purchased). Terminal identification is the same as shown on the schematic.

HOW IT WORKS

The "AccuraTime" is a crystal-controlled r.f. converter tuned to either of two desired short-wave frequencies. The converter output is an i.f. that falls within the standard AM broadcast band. The BCB radio receiver provides i.f. gain and selectivity, detection, and audio amplification.

Separate mixer and local-oscillator stages are used (see Fig. 1) for best conversion efficiency and freedom from spurious responses. The mixer transistor (*Q1*) is a monolithic Darlington device having a very high input impedance and excellent gain.

Local oscillator *Q2* is crystal-controlled at 8.666 MHz in a tuned-base, tuned-collector configuration. This frequency is halfway between the 10.0 MHz frequency of WWV and the 7.335 MHz frequency of CHU, and produces a resultant i.f. close to 1330 kHz. Tuning the converter to either WWV or CHU is accomplished by changing the resonant frequency of the mixer tuned circuit *L1-C2*, by inserting trimmer capacitor *C3* in the circuit through selector switch *S2*.

The converter oscillator signal is injected into the mixer via *C12*. This signal modulates the r.f. current through *Q1*, varying the non-linear impedance of the emitter-base junction of the first transistor of the Darlington. The incoming r.f. signals selected by *S2* are mixed with the local oscillator signal at this point, thus developing the sum and difference signals. These signals appear across the output tuned circuit (*L3-C7*) which is made to resonate at 1330 kHz. The difference signal is fed to the output jack (*J2*).

Switch *S1* is provided to bypass the short-wave converter when only BCB listening is required. This switch simultaneously removes power from the converter through the *S1(c)* section.

which provides parts support, speeds assembly, and makes exact duplication of the author's layout and wiring a cinch! Packaging combinations are limited only by your imagination. For example, you can attach the converter to a spare AM transistor radio receiver, or even repackage the transistor radio and the "AccuraTime" printed circuit board in a single metal case to make a standard time and frequency receiver.

Construction. The circuit appearing in Fig. 1 may be assembled on a printed circuit board, similar to that shown actual-size in Fig. 2. Once the board is made (or purchased), the components are installed on the board in the locations shown in Fig. 3. Note that capacitor *C4*

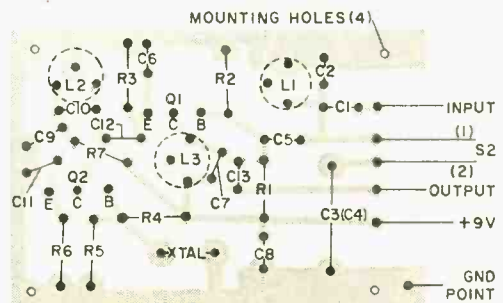

Fig. 3. Parts installation on the upper side of the board. Note that all coils have three support lugs.

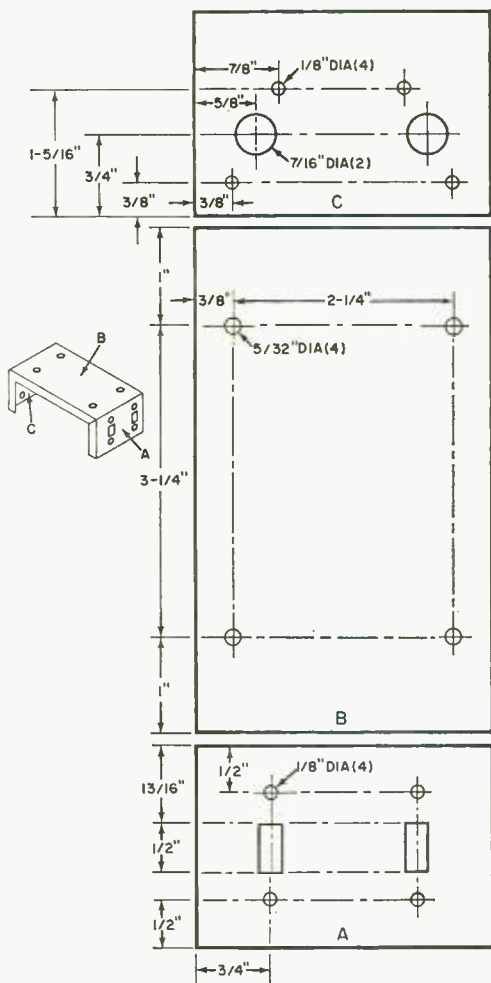

Fig. 4. All components will fit in aluminum metal box. Author used Premier aluminum box AMC-1006.

is soldered across the terminals of trimmer *C3* on the foil side of the PC board. After all components have been installed, recheck that the correct parts are in the correct holes and make sure that both transistors have been properly installed.

Before installing the crystal (XTAL), lightly sand the pins of the crystal holder to prepare them for soldering. Place the crystal in position on the board and carefully solder it into place. Make sure that you do not prolong the soldering operation. Excessive heat can fracture the crystal. Note also that coils *L1*, *L2*, and *L3* have three mounting pins arranged in a triangular configuration. Pin 2 of each coil is not connected into the circuit

but is only soldered to the foil side of the board for increased coil support.

When all the PC board components have been soldered in place, the board should be mounted in a metal case, using a short standoff insulator at each corner of the board. The plan of the author's metal case is shown in Fig. 4. The board is then wired to the two switches (*S2*, the s.p.s.t. "WWV-CHU" selector, and *S1*, the 3p.d.t. "AM-SW" selector). As shown in the photograph, the two switches are mounted on the front of the metal case, while the two Motorola-type r.f. connectors are mounted on the rear wall. Battery *B1* is supported by a spring within the metal case (see photo).

Connection to Radio. To connect the assembled "AccuraTime" converter to a car radio, you will need a shielded r.f. cable fitted with Motorola male auto radio connectors at each end. The low-capacitance shielded antenna cable from an old car radio is ideal for this purpose. However, for short runs (up to 20 inches), ordinary coaxial cable such as RG-59/U may be used. This cable is connected between the output of the "AccuraTime" (*J2*) and the antenna input of the car radio. The car radio antenna is plugged into the input receptacle, *J1*. With the "AM-SW" switch in the "AM" position, the car radio will operate as usual.

If you want to use the "AccuraTime" with a conventional transistor AM radio, you must add a coupling coil to the radio receiver's ferrite antenna bar as

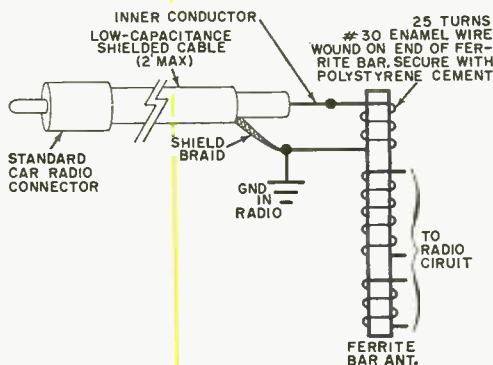

Fig. 5. Make this modification if you use the converter with a transistor radio. Make sure that the radio is shielded to eliminate the unwanted CBB signals.

shown in Fig. 5. This coupling coil consists of 25 turns of #30 enamelled wire wound at one end of the ferrite bar. Attach a low-capacitance coax cable to the new coil and solder a Motorola auto radio connector at the other end. This plug mates with *J2* on the converter. Pass the cable through a hole drilled in the radio case.

If you want to make a WWV-CHU laboratory-type time signal receiver, remove the AM transistor radio receiver from its case and mount it with the

"AccuraTime" PC board in a metal case. Wind the coupling coil (Fig. 5) around the ferrite antenna bar of the transistor radio, ground one end of the coil and connect the other end to capacitor *C13* on the converter board. Shield the entire converter/receiver combination, making some provision to gain access to the tuning and volume control on-off switch of the transistor radio. The same 9-volt battery can be used for the receiver and converter, and switch *S1* is not required.

View of the "C" side of the chassis showing placement of the two Motorola-type jacks, and method of mounting the 9-volt battery.

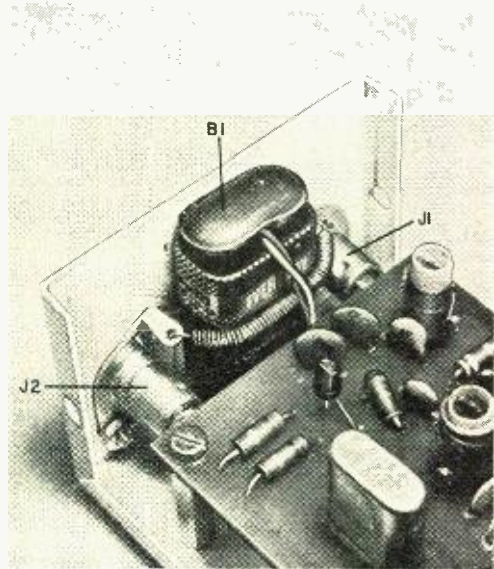

The finished converter within its chassis. After final tune-up, secure each coil slug using a little cement or putty. This prevents them from moving and detuning during any vehicle vibration.

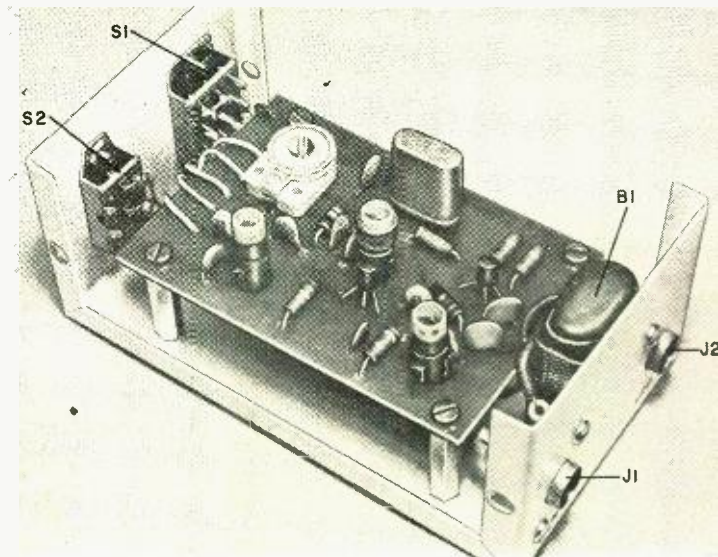

WWV—National Bureau of Standards, Ft. Collins, Colorado, 10 MHz. The signal from this station is complex and serves many functions besides time keeping. Identification may be made by the "time tick" that occurs each second (omitted at the 59th second) and a double tick at the exact minute. These ticks, and all other modulation, are removed during the period between 45 and 49 minutes before the hour.

At the start of each five-minute interval, 600- and 440-Hz standard audio tones are alternated and last for two minutes. The tone is followed by a special computer time code lasting for one minute and sounding like a coarse "buzz." There is one exception to this progression: the 600-Hz tone that starts the hour lasts three minutes and there is no computer code.

The last 30 seconds of each five-minute interval consists of an announcement, both in English and in slow-speed, tone-modulated Morse code, of the station call letters and location and the exact time. Special "Geoalerts" and time correction signals are transmitted between the 18th and 19th minute past the hour.

Alignment. With the car radio antenna connected to the converter and the converter output connected to the car radio as previously described, extend the car radio antenna to about 40", turn on the car radio, and place the converter "AM-SW" switch (*S1*) in the "SW" position and the "WWV-CHU" switch (*S2*) in the "WWV" position. Tune the car radio to 1330 kHz and peak its antenna trimmer for maximum noise hiss or signal pickup. On some car radios, the antenna trimmer is located next to the antenna input jack, while on other receivers it is accessible either through the bottom or side of the chassis. Some car radios conceal it behind the tuning knob.

Once the car radio trimmer has been peaked, use a plastic hexagonal alignment tool to peak up the coils in the converter. Adjust converter oscillator coil *L2* until the receiver noise level rises

CHU—Dominion Observatory, Ottawa, Ontario, Canada, 7.335 MHz. This time-signal-only station can easily be identified by the tone-modulated "time ticks" that occur each second with the exact minute tick 2½-times longer, and the exact hour tick 5-times longer. The 29th tick is omitted, as is the 51st through 59th. During this latter period, time announcements of the hour and minute are made in English and French. Also, the first through tenth ticks are omitted at the beginning of each hour.

indicating that the oscillator is working properly. Peak output coil *L3* for maximum noise level in the receiver. Then peak mixer coil *L1* for maximum noise. Rock the car radio tuning dial back and forth around 1330 kHz (1.33 MHz) until you tune in the clock ticks or tone transmission of WWV. Once you locate WWV, touch up coil *L1* for maximum signal strength. Set the "WWV-CHU" switch to the "CHU" position and tune down the radio dial very slightly until you hear the distinctive one-second "beeps" of CHU, or the English and French time an-

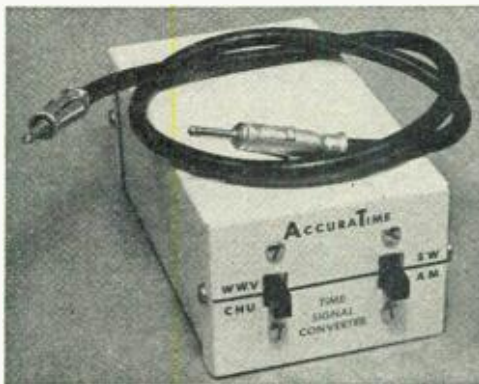

The completed "AccuraTime" converter makes a neat package, is self powered, and does not change operation of the radio to which it is connected.

nouncements. Peak CHU by adjusting trimmer capacitor *C3*.

With the converter set to receive CHU, tuning the car radio between 1300 and 1600 kHz (1.3 to 1.6 MHz) enables partial coverage of the 40-meter ham and 41-meter broadcast bands. With the converter set to receive WWV, tuning the car radio between 830 kHz and 1100 kHz covers most of the 31-meter international broadcast band.

When used with a transistor radio, connect an outdoor antenna to *J1* of the converter, connect the converter to the coax cable feeding the radio antenna, and turn on both converter and receiver. Set the radio to 1330 kHz, put the "AM-SW" switch (*S1*) of the converter on "SW," and the "WWV-CHU" switch (*S2*) on "WWV"; then follow the same alignment procedures described above for car radio installation.

—30—

BY DAVID B. WEEMS

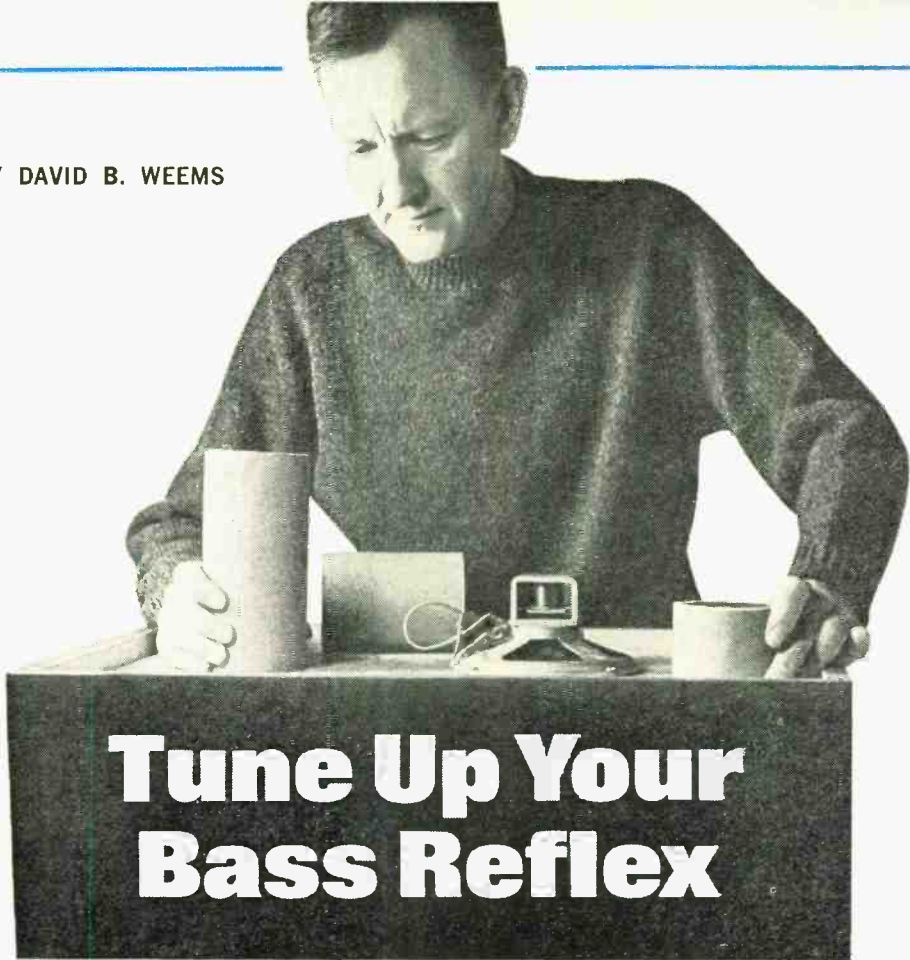

Tune Up Your Bass Reflex

Smooth out that bass response by matching the enclosure to the speaker

WHAT IS THE weakest link in any stereo system? Chances are in favor of it being the speakers. Fortunately, you can optimize this important hi-fi component by making some simple speaker enclosure refinements. One of the most rewarding investments is the small amount of time needed to “fine tune” a bass reflex enclosure to match its particular speaker.

About the “Boom Box.” The primary purpose of any enclosure is to prevent the out-of-phase back wave of the speaker from cancelling the sound wave at the front of the speaker. A tuned bass reflex does this and more. It inverts the

phase of the low frequencies over a broad audio band and the radiation from the port reinforces the sound from the front of the speaker cone. A properly tuned condition exists when the resonant frequency of the box occurs at the same point as the resonant frequency of the speaker. This point will dampen speaker motion and knock down the resonant peak. The result is a speaker system of high efficiency and extended low-frequency range. Mis-tuned enclosures generally sound awful—hence the name “boom box.” If you know what test results to look for, or even how to listen carefully, you can expect to realize a better-sounding system.

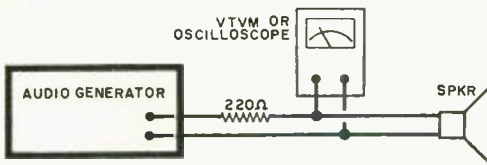

Fig. 1. Resonant frequency of speaker in free air is indicated by peak VTVM or oscilloscope reading.

The first step in matching an enclosure to a specific speaker is to find the free air resonance of the speaker. A "no equipment" method will be explained later, but typically, an audio generator and an a.c. voltmeter (any VTVM) wired as shown in Fig. 1 are used. The output of a glide-tone frequency test record fed through a hi-fi amplifier may be substituted for the audio generator. A run from 200 Hz down to 20 Hz will locate speaker resonance by a peak in the voltage across the voice coil. (See Fig. 2.) Let's call this frequency " f_r " to identify it.

After finding f_r , you have a choice of several procedures. The traditional approach is to adjust the area size of the port or the length of the duct—if one is

used—to produce equal peaks in the impedance curve of the mounted speaker (see Fig. 2). The theory of the equal double hump is all right, but trying to obtain it may give you problems the textbooks don't mention. Usually when the trough of the impedance curve is centered on f_r , the amplitude of the humps will not be equal. Some reference books suggest that the peaks should be equally distant from f_r . Test curves sometimes show the trough at f_r , but the lower peak may be closer to f_r than the upper peak.

One test by the author resulted in reference-produced tuned box frequencies of 40, 58 and 85 Hz. The "distances" of 18 Hz (58 minus 40 Hz) and 27 Hz (85 minus 58 Hz) were clearly unequal, but the ratio of 58:40 (1.45:1) was approximately equal to the ratio of 85:58 (1.47:1). A double check of authoritative texts uncovered one expert who mentioned equal ratios rather than equal distances! Which expert do we believe? The author's enclosure produced the equal ratio condition when the trough was centered at f_r and seemingly confirmed the equal ratio theory.

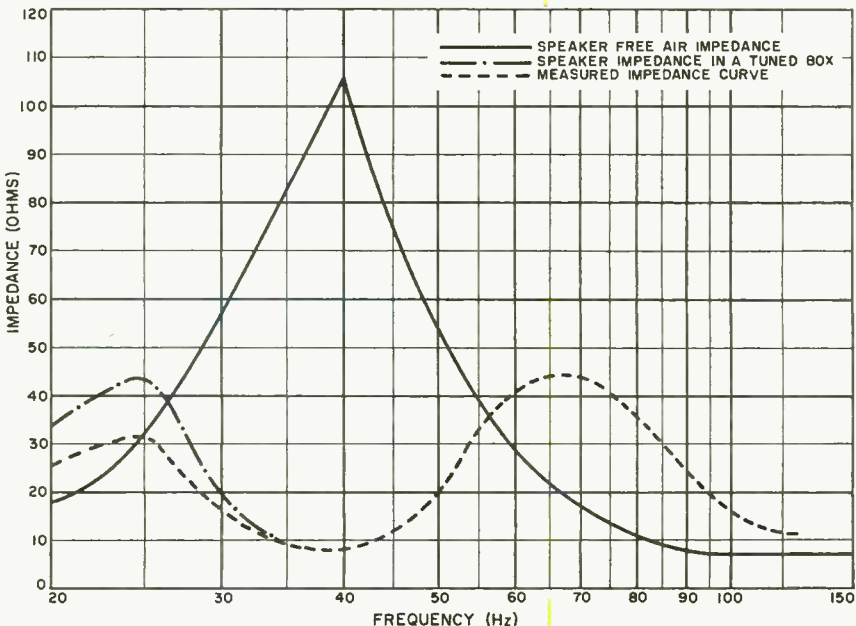

Fig. 2. Experimental results with speaker having free air resonance of 40 Hz. Enclosure was tuned to provide peaks at 66 and 24 Hz. Ratio 66:40 and 40:24 is important.

The Easy Way. There once was an easy way to tune a bass reflex enclosure. You followed the dimensions shown in a published chart that was based on speaker size. Perhaps speakers were more uniform in those days, but hi-fi enthusiasts would have probably done better if they had tuned by ear. Which brings us to the highlight of this story. You can actually tune a bass reflex by ear with the proper technique. The method is especially useful for enclosures in the construction stage. All you need is a test record.

First, locate the free air resonance (f_r) of your speaker. If you don't have a VTVM, you can probably hear the rise in audible output at resonance. Or sprinkle a little talcum powder on the cone and watch for maximum vibration. If you are using an audio generator, you can read the frequency directly. If you use a frequency test record, locate the point of resonance by a stopwatch or the sweep second hand on a wristwatch, counting the seconds from a frequency mark on the record.

When you construct your bass reflex enclosure, cut a hole that will hold the tuning duct (if it is a compact box) and cut various lengths of tubes to try. However, before making your speaker cut-out, drill a $\frac{3}{16}$ -inch hole in the center of the proposed speaker location. Mount the front panel and install the back in your enclosure, giving particular attention to see that both are sealed against air leakage. Mount a small 5 or 6-inch speaker (any functional small speaker) over the $\frac{3}{16}$ -inch hole (see Fig. 3). The gasket of the speaker should make firm contact with the panel, and the screws should be tightened uniformly to seal the gasket without deforming the speaker.

Now, using the same glide-tone source, feed the output from your amplifier, tape recorder, or audio generator to the small speaker. By listening carefully at the port, you will hear an increased output at the resonant frequency of the enclosure. Insert tubes of varying lengths and note the resonant frequency with each tube. Each tube should be inserted in the hole at least far enough to be flush with the inside of the front panel. If the desired resonance (f_r) happens to be located between those obtained

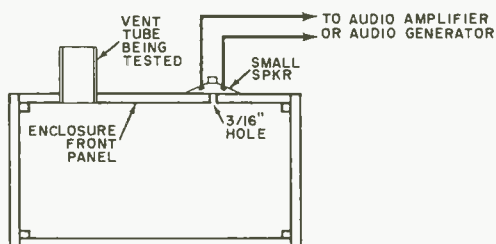

Fig. 3. To tune enclosure, fasten a speaker over small hole and vary length of cardboard vent tube.

with two tubes, you can cut off the longer tube a little at a time until f_r is reached.

Note that you do not have to have an accurately calibrated audio generator for this method. In fact, you don't even have to know the value of f_r .

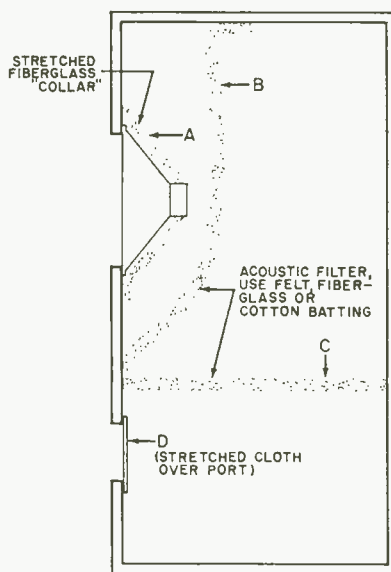

Fig. 4. Acoustic filter material may be added to the enclosure to provide sufficient damping. Top, bottom, and at least one side should be padded.

Does It Work? Skeptics may see some discrepancies, such as the possibility that the duct and the small speaker located outside the enclosure will give different results to those obtained later when the duct and a large speaker are mounted inside the enclosure.

To investigate these questions, an enclosure with a cubic volume of 2.5 cu. ft. was tuned to a 12-inch speaker with a free-air resonance of 38 Hz. After con-

BASS REFLEX TROUBLE SHOOTING CHART

SYMPTOM	POSSIBLE CAUSE	PROBABLE CURE
Numerous impedance peaks	Panel vibration	Brace enclosure walls with 1" x 2" wood strips. Glue and screw strips to walls. Or, glue sheets of Celotex to panels
Tuning peaks move unpredictably with each change in port area size or duct length	Air leak	Use more screws to hold back and front panels perfectly rigid. If necessary, add gasket. Check other enclosure joints and caulk if in doubt
Peaks in impedance curve are not equal when trough of curve is at speaker free air resonance	Test equipment defect	Use ratio method of fine tuning enclosure
Values in Design Chart produce enclosure resonance significantly above speaker free air resonance	Mistaken measurement. Double check enclosure measurements. Wrong enclosure shape	Double check for panel (front or rear) vibration or air leaks. Decrease port area or try longer tube on ducted enclosure
Enclosure resonance is well below speaker free air resonance	Double check chart, or re-check measurement	Increase port area or shorten length of tube on ducted enclosures. If port area must be increased above maximum (see Speaker Data table) the enclosure can be partially filled with solid material (bricks, sand bags, etc.)

SIMPLIFIED DESIGN CHART FOR BASS REFLEX ENCLOSURES

VOLUME	A			B			C			A			B			C			A			B			C		
	A	B	C	A	B	C	A	B	C	A	B	C	A	B	C	A	B	C	A	B	C	A	B	C			
6 cu. ft.	9	12	25	12	18	32	20	28	36	28	40		56	75													
5 cu. ft.	7	9	20	10	14	28	15	20	24	20	30	40	36	50													
4 cu. ft.	¾		2	7	10	20	11	15	20	14	20	24	26	36		45	80										
3½ cu. ft.	1		¾	¾		1½	8	11	16	12	16	20	20	28		32	45										
3 cu. ft.	2		4	¾		2	5	8	12	9	12	18	15	22		26	36		40	80							
2½ cu. ft.	2		5	2		4	¾		2	5	8	12	12	16		20	28		30	40							
2 cu. ft.	4		8	2		5	1		¾	¾		2	7	10		12	18		18	25							
1½ cu. ft.	7		10	4		8	3		5	2		4	¾		2	8	11		14	20							
1 cu. ft.							6		8	4		7	2		4	1		2	5	10							
	35			40			45			50			60			70			80								
FREE AIR RESONANCE OF SPEAKER (f_r)																											
<p>A — Approximate port area in square inches for rectangular port (length to width ratio—4:1)</p> <p>B — Approximate port area in square inches for square or circular port</p> <p>C — Maximum port area in square inches for increased bass output. This tunes enclosure above speaker resonant frequency, but is permissible if resonance is below 50 Hz</p>																											

To use the design chart shown directly above, find f_r as described in the text, and determine the volume of the enclosure (use inside dimensions). Locate the intersection of the row and column that appropriately describe volume and f_r to determine length of tubing needed for the port. Then tune the enclosure.

sulting a design chart, three 3-inch diameter tubes were cut to lengths of 2½, 5 and 7½ inches. The cabinet was prepared in the prescribed manner and tests run. The resonant frequencies of the empty enclosure were:

2½" tube	37-38 Hz
5" tube	33 Hz
7½" tube	27 Hz

These results were about as expected, the two longer tubes had been selected for use in the event of an upward shift of resonance. Next, the front panel was cut out for the 12-inch speaker and the speaker was installed. The 2½-inch duct was installed inside the enclosure. An impedance curve showed:

Upper peak	78 Hz
Center of trough	39 Hz
Lower peak	20 Hz

Both the position of the trough and the ratios of the upper peak:trough, and trough:lower peak, indicated that the tuning was successful. The shift of resonance from the empty box condition was insignificant.

Some speaker systems may show detuning effects more than the one tested. Remember that any change in tuning due to speaker volume will result in an enclosure tuned to a frequency slightly above f_r . This is a condition recommended by some hi-fi experts, particularly for systems that resonate below 50 Hz. It results in smooth bass with increased

output at the usually needed bass frequencies. Conversely, tuning the box to a frequency below f_r can extend the frequency range downward but at the expense of increased bass distortion and lower output above f_r .

Other Problems. There are some factors that have more effect upon sound quality than minor errors in tuning. The amplitude of the upper impedance peak often presents a danger zone, even in a well tuned enclosure. Increased output there may produce boom unless sufficient damping material (felt, fiberglass or cotton batting) is added to the interior. The most efficient use of such material is to suspend it in the air behind the speaker (see B, C, Fig. 4), or stretch it tightly over the speaker (A, Fig. 4). If necessary, damping may also be applied at the port by stretching a layer of cloth across the opening (D, Fig. 4). A final check of damping may be made by connecting a 1.5 V flashlight battery to the speaker terminals via a s.p.s.t. switch. When the "bong" of the undamped enclosure changes to a "click" at the "make" or "break" of the circuit, the system is damped. Padding also reduces the reflection of mid-range frequencies from the cabinet back to the cone.

Another danger is panel vibration, which shows up on an impedance curve as multiple peaks and robs you of true bass response. All except the smallest enclosures should be constructed of ¾-inch plywood fastened together by glue
(Continued on page 97)

After mounting speaker inside its enclosure, again connect a VTVM or oscilloscope and an audio generator to it to determine whether or not the enclosure is correctly tuned.



The

By LARRY LISLE, K9KZT

SUPER-SENSITIVE SUPER-SIMPLE SUPER-REGEN

Just for kicks, try your hand experimenting with this famous VHF receiver circuit out of the past

BACK IN THE THIRTIES, when most VHF gear was home-brewed, the super-regenerative receiver was the mainstay of amateur and SWL activity above 30 MHz.

Since then much progress has been made in receiver design, the super-regen has been given less and less attention, and many of today's electronics hobbyists are unaware of how useful this type of receiver can be when it is properly adjusted.

While a one-tube receiver won't make you the local DX champ, you can probably hear a surprising number of sta-

tions. And, a super-regen can't be beaten for monitoring a local VHF net.

The beginner will find that since only a handful of parts are required and no test equipment is needed, the super-regenerative detector is a good choice for a first electronics project.

How The Super-Regen Works. The super-regenerative receiver achieves its amazing sensitivity by a unique quirk. It is basically an r.f. oscillator thrown into and out of oscillation at a super fast (ultrasonic) rate known as the quench frequency. In the basic circuit illustrated

Author fed super-regen output into audio of All-American 5 to make monitor receiver.

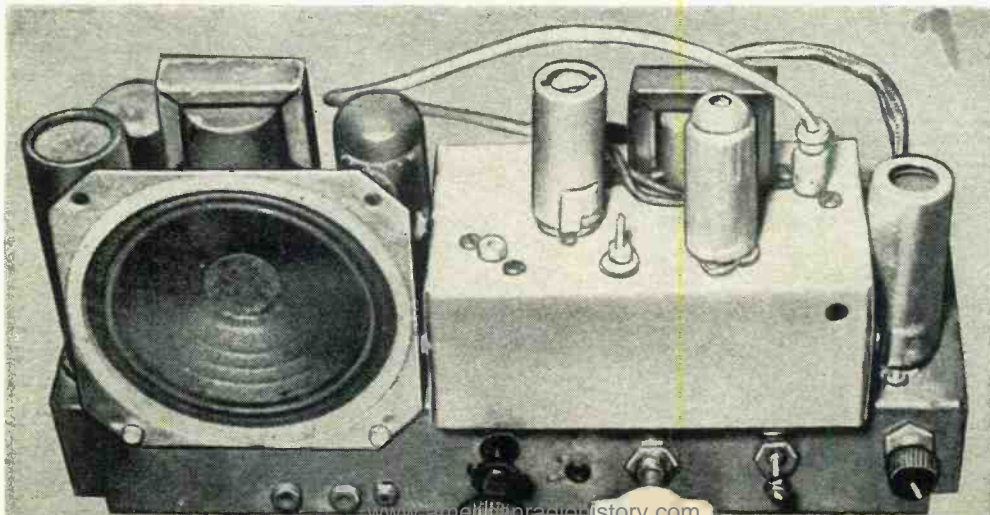

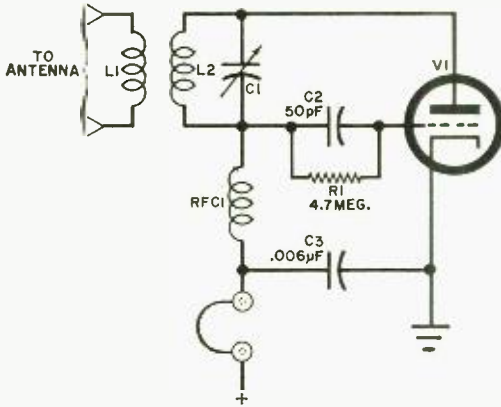

Fig. 1. Operation of this basic super-regenerative circuit is described in the text paragraph below.

in Fig. 1, with no signal present at the input, the oscillations are first initiated by the thermal agitation always present in a tuned circuit. Because the grid capacitor ($C2$) and grid leak ($R1$) have a long time constant, a negative bias is built up on the grid of $V1$ which eventually becomes great enough to block the tube (self-quenching). The electrons then flow off the grid through $R1$ and the cycle repeats. Each period of oscillations causes a pulse of plate current to flow through the headphones. Since thermal agitation starts the oscillations at random intervals, the plate current pulses flow at random and this produces a characteristic super-regen hissing or rushing noise in the headphones.

When $C1$ and $L2$ are tuned to an unmodulated v.h.f. carrier, the oscillations are no longer random, but equally spaced, and the plate current is unvarying. The audible hiss quiets down or nearly disappears.

If the received carrier is modulated, the voltage across the tuned circuit changes at an audio rate. When the signal is strong, the oscillations decay less before they are reinitiated, and, consequently, there are more periods of oscillation and more pulses of plate current. The average plate current is therefore greater when the signal voltage is strong and is dependent upon the level of modulation. In the self-quenched super-regen, the output is proportional to the logarithm of the input. This causes noticeable distortion when modulation peaks are above 80 percent, but this effect is

also responsible for the desirable automatic volume control action inherent in this type of receiver.

Because the super-regen responds to the received signal only during the times that oscillations are being initiated, ignition impulse type of noise does not appear in the output. This makes the super-regenerative detector especially useful as a receiver in an automobile.

Typical Adjustments. The gain of a super-regen receiver is related *directly* to the square of the quench frequency, and *inversely* to the amplitude of the oscillations. Means of controlling these parameters are included in the receiver illustrated in Fig. 2.

Variable capacitor $C1$ controls the amount of r.f. signal energy transferred from the antenna to the detector and also the flow of r.f. energy generated by the detector to the antenna, and, consequently, the amplitude of oscillations in the tuned circuit. Capacitor $C1$ is the primary regeneration control in this type of super-regen circuit. To set the *amplitude* of the oscillations, slowly increase $C1$ from its minimum value until the hiss is at its loudest in the headphones (no signal being received).

Potentiometer $R2$ controls the quench frequency. While adjusting the antenna coupling ($C1$), $R2$ should be set at maximum. After $C1$ is peaked, slowly decrease $R2$ until the background hiss becomes loudest.

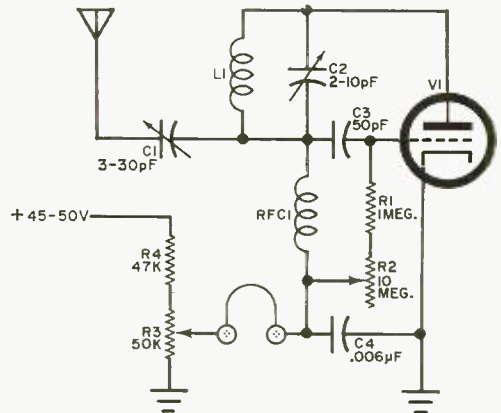
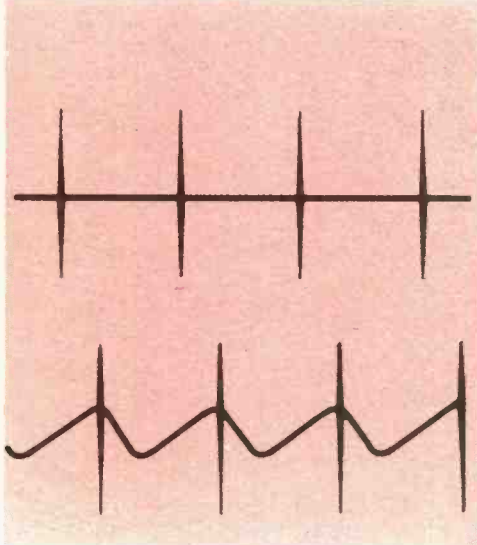

Fig. 2. Each of these four controls contribute toward making the super-regen extremely sensitive.

EXPERIMENTAL COIL VALUES FOR L1

TURNS OF B & W 3011 OR AIR DUX 616	FREQUENCY (MHz) C2 AT 4.5 pF
23	28
21	30
19	32
17	34
15	36.5
13	38.5
11	43
9	48
7	57
5	71
3	100
2	125
1	170

A little known feature of the super-regenerative detector may be observed by decreasing $R2$ slightly past this point of maximum gain. When the quench frequency becomes high enough, insufficient time will be available for the oscillations to die out completely before the next cycle is begun. Therefore, this new period of oscillations is initiated by the decaying oscillations of the previous period, and since they are initiated from a con-



Oscillograms of the r.f. pulse waveforms in L1 (top) and superimposed on grid of V1 (bottom).

stant voltage level, the normal background hiss will be eliminated completely. Powerful signals above this level will be heard, but weak signals will not be heard. This is called the *coherent* state, and may be used as a sort of squelch circuit.

Note that the grid leak ($R1$ and $R2$) is returned to B+ instead of to ground, as this permits the electrons stored on the grid capacitor ($C3$) to flow off more rapidly, increasing the quench frequency.

Potentiometer $R3$ forms part of a voltage divider used to adjust the plate voltage (usually about 50 volts) of V1. It should be used to establish the best compromise between tube noise and gain, and once set it will not require further adjustment. Plate voltage variation should *not* be used as a regeneration control because decreasing voltage also lowers the gain of the tube. If desired, plate voltage may be supplied by a 45-volt "B" battery since the usual current drain is only about 1 mA. In this case, the voltage divider may be omitted.

All the controls of a super-regen interact somewhat; $C1$ affects the quench frequency, $R2$ can change the amplitude of the oscillations, and $R3$ disturbs both. Even the setting of $C2$ can cause the circuit gain to vary. By following the procedure outlined above, these interactions can be minimized and after a little practice, ignored.

At ultra high frequencies, better results can be obtained by connecting $RFC1$ to the center of $L1$ instead of to the grid end; and it may help to isolate the cathode and filament of V1 from ground with small-valued r.f. chokes.

Almost any v.h.f. triode tube is suitable for use as a super-regenerative detector. Typical examples are the 6AF4, 6C4, and the 12AT7. For UHF service, the 6AF4 is the best of the three.

A few construction hints may help the newcomer to the very high frequencies. Mount the tuning capacitor, $C2$, close to the tube socket, connect bypass capacitor $C4$ directly to the cathode terminal of V1 and keep all leads reasonably short and direct.

The super-regenerative receiver is a valuable addition to the arsenal of techniques available to the VHF enthusiast. No other circuit so simple is capable of sensitivity approaching this veteran performer's.

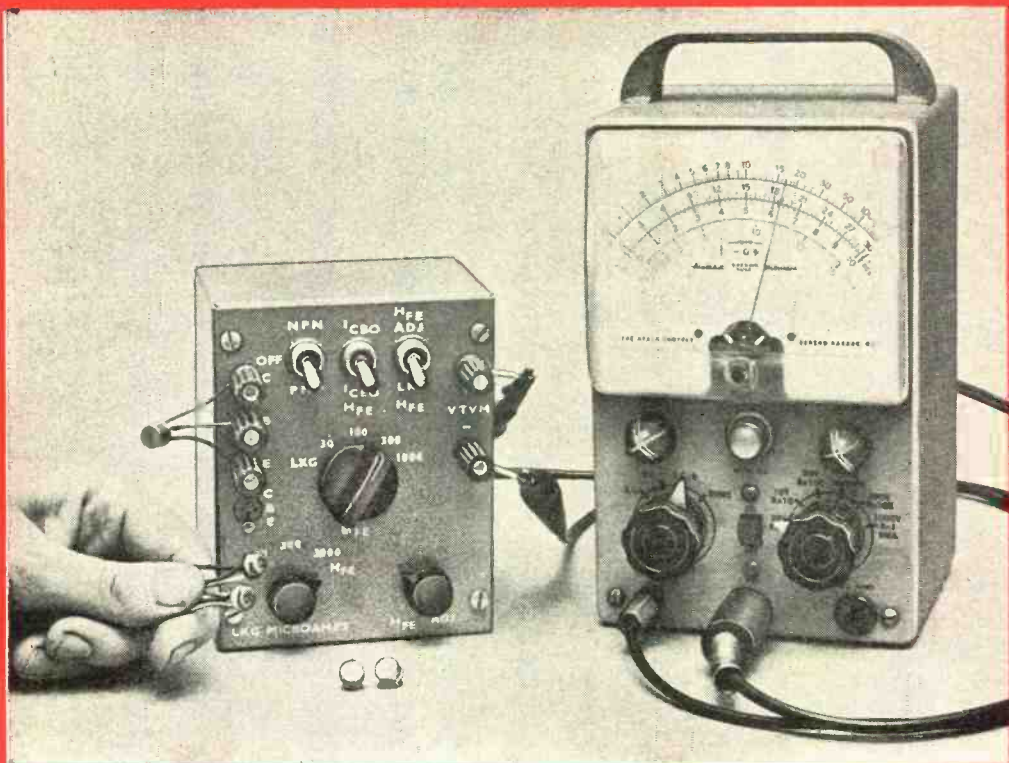

Transistor Test Adapter for your VTVM

MAKE ACCURATE CHECKS OF IMPORTANT TRANSISTOR PARAMETERS
OR, HOW TO TELL THE BAD FROM THE GOOD

BY A.A. MANGIERI

WHILE a transistor tester is a desirable addition to any modern experimenter's test bench, it isn't necessary to invest a lot of money to obtain a good one. If you already own an 11-megohm-input vacuum-tube voltmeter that has a 1.5- or 3-volt d.c. range, you can build an adapter that will temporarily convert the meter into a transistor tester.

The VTVM/tester adapter combination will do the checking job just as well as—with an accuracy the equal of—most medium-priced full-fledged transistor testers. Yet the difference in price be-

tween the adapter (it costs about \$6 to build) and a commercially available tester can represent a savings of \$50 or more.

When the adapter is attached to your VTVM, you can measure the d.c. *beta* (h_{FE}) and leakage currents (I_{CBO} and I_{CEO}) of almost any transistor available. The power supplied by the adapter to the transistors under test is maintained at a safe 4.5-volt level.

Construction. The entire adapter circuit can be conveniently housed inside a

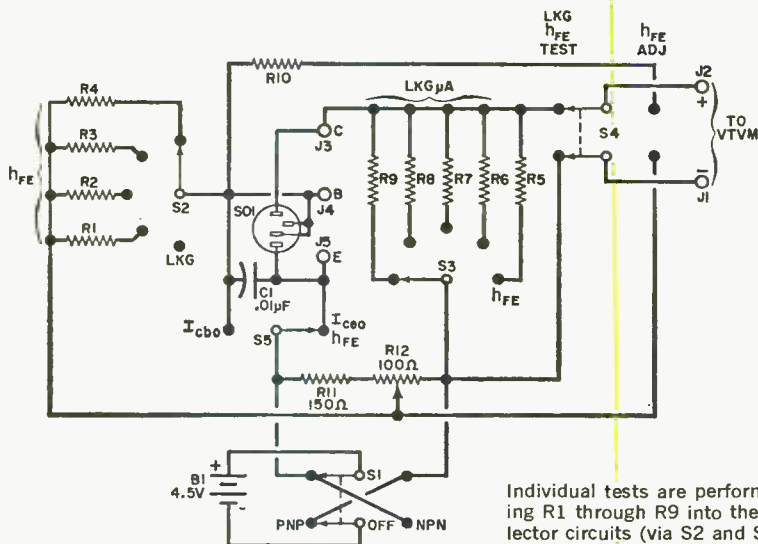

Individual tests are performed by switching R1 through R9 into the base and collector circuits (via S2 and S3) as needed.

ABOUT THE CIRCUIT

The circuit of the transistor test adapter simulates the most desirable forward and reverse biasing conditions for testing almost any transistor—whether it is *npn* or *pnp*. Range switch S2 selects one of the base resistors (R1 through R4) for proper base current during h_{FE} gain tests. Range switch S3 selects from among resistors R5 through R9 to provide direct gain and leakage readings on a VTVM when connected to J1 and J2. The values of R1 through R10 must be chosen on the basis of the range of the VTVM. The respective values have been computed and are shown in the Range Resistance Table on page 58.

Potentiometer R12 is used during the tests to adjust base current to the correct level, taking

into account normal battery aging. Switch S1 applies battery power in the proper polarity during the tests, and S5 is the test mode switch.

Switch S4 is, in effect, a test-calibration switch; in the left position, it sets the adapter up for TEST, while in the right position it permits calibration (via R12) of base current.

Capacitor C1 bypasses any stray a.c. induced into the base circuit of the transistor being tested. Resistor R10 prevents battery short circuit in the event J1 is shorted to J2. (For the 1.5-volt d.c. range, R10, which is equal to the input resistance of conventional VTVM's, reduces the meter's sensitivity by half when base current is adjusted. The sensitivity of the VTVM remains unaffected on the 3-volt range.)

PARTS LIST

B1—Three 1.5-volt "D" cell batteries
 C1—0.01- μ F, 200-volt disc capacitor
 J1-J5—Insulated five-way binding post or banana jack
 R1-R10— $\frac{1}{2}$ -watt, 5% resistor—see Range Resistance Table for values
 R11—150-ohm, $\frac{1}{2}$ -watt, 10% resistor
 R12—100-ohm wire-wound potentiometer
 S1, S4—D.p.d.t., center OFF, toggle or slide switch

S2, S3—Single-pole, five-position rotary switch
 S5—S.p.d.t. toggle or slide switch
 SO1—Elco No. 05-3301 saddle-mounting transistor socket
 1—5" x 4" x 3" utility box
 1—Keystone No. 175 single "D" cell battery holder
 1—Keystone No. 176 dual "D" cell battery holder
 Misc.—Knobs, hookup wire, solder, hardware

5" x 4" x 3" metal utility box if you follow the layout in Figs. 1 and 2. Start construction by fabricating the front panel, with the mounting holes sized according to the parts you use. Mount the parts in their respective holes. Then carefully label the positions of the controls, control designations, and the jacks. Take particular care to label S2 and S3 (" h_{FE} " and "LKG" range switches) so that they correspond to the ranges in the "Range Resistance Table" for your meter.

Wire the capacitor and resistors into the circuit, using Fig. 1 and the schematic diagram as guides. (You parallel a 10,000- and a 15,000-ohm resistor to obtain 6000 ohms; parallel 100,000- and 150,000-ohm resistors to obtain 60,000 ohms; and series-connect a 270,000- and a 39,000-ohm resistor to obtain approximately 308,000 ohms as needed.) Use insulating spaghetti on all resistor leads to prevent accidental short circuits. Then solder all connections.

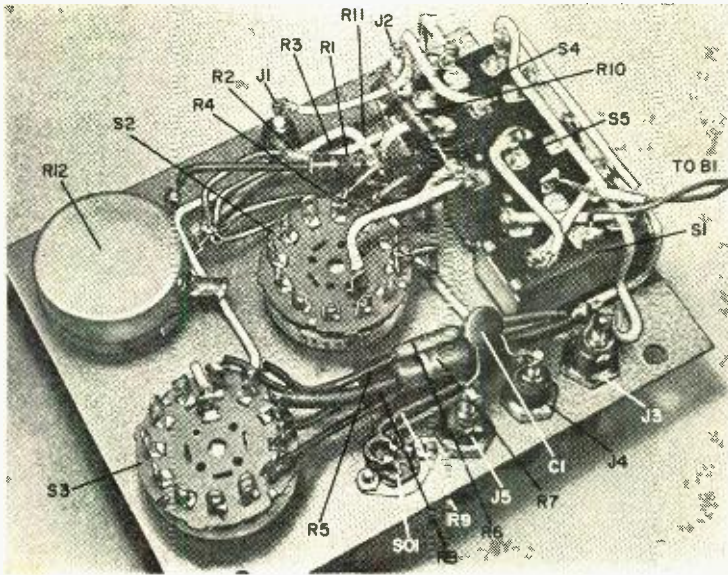

Fig. 1. All parts except batteries and holders should be mounted on the front panel of the metal box.

It will be necessary to nibble or file away parts of the bent-over edges on the body of the utility box (see Fig. 2) to allow the front panel to properly mate with the sides. Mount the battery holders on the rear of the box as shown, and solder hookup wires from *S1* ("NPN-OFF-PNP" switch) to the holders. Finally, insert the batteries in the holders, and secure the front panel in place.

Using the Adapter. Connect test cables from *J1* and *J2* on the adapter to the ap-

propriate input jacks on the VTVM (see schematic diagram). Set the meter's **FUNCTION** switch to "plus d.c. volts" and the **RANGE** switch to either 1.5 or 3 volts—whichever your adapter is designed for. Then plug a test transistor into *SO1*, or connect its leads to *J3*, *J4*, and *J5* (collector, base, and emitter jacks or binding posts, respectively).

First, measure leakage currents I_{CBO} and I_{CEO} . (If you measure gain first, the meter reading obtained may be due to excessive leakage instead of base current.)

Fig. 2. It is necessary to nibble or file away portions of the bent-over edges on the body of the metal box to permit front panel and sides of box to mate properly.

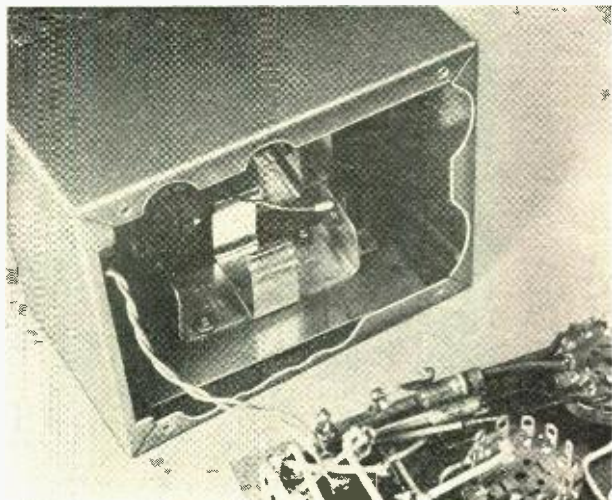

RANGE RESISTANCE TABLE				
FUNCTION	1.5-VOLT D.C. RANGE		3-VOLT D.C. RANGE	
	Resistance (in ohms)	h_{FE} Range Full Scale	Resistance (in ohms)	h_{FE} Range Full Scale
R1	10,000	50	6000*	30
R2	30,000	150	20,000	100
R3	100,000	500	60,000*	300
R4	300,000	1500	200,000	1000
R5	100		200	
LKG	Leakage Range (μA)		Leakage Range (μA)	
R6	300	5000	1000	3000
R7	3000	500	10,000	300
R8	30,000	50	100,000	30
R9	308,000*	5	1,100,000	3
R10	11,000,000		1000	

*See text

Table reflects differences in gain and leakage range multiplier resistors needed for 1.5- and 3-volt d.c. VTVM ranges. To obtain non-standard resistance values, connect two or more standard value resistors in parallel by following instructions given in the text.

To measure collector-to-base leakage current, set $S5$ to " I_{CBO} ," $S2$ and $S4$ to "LKG," and $S3$ to the lowest range. Move $S1$ to "NPN" if the test transistor is *npn* ("PNP" if *pnp*-type). The meter pointer will now indicate I_{CBO} in microamperes.

Next, determine the collector-to-emitter leakage current. To do this, set $S5$ to " I_{CEO} ," $S2$ and $S4$ to "LKG," and $S3$ to any position that will give a good meter reading when $S1$ is set to the appropriate

position as determined by the type of transistor under test. Now, read I_{CEO} in microamperes on your meter.

Most low-power germanium transistors will show between 1 and 5 μA I_{CBO} , while I_{CEO} may be as high as 200 μA , depending on the gain of the transistor. Silicon transistors, on the other hand, have exceptionally low leakages and will often test out at less than 0.1 μA . In any case, check the readings you obtain against the figures given for that particular transistor in a transistor manual. If the readings obtained are higher than those listed, the leakage is excessive, and the transistor should be discarded.

To measure d.c. *beta*, set $S3$ and $S5$ to " h_{FE} " and $S2$ to a mid-range—say, 300. Move $S1$ to the appropriate position as described for leakage tests, set $S4$ to " h_{FE} ADJ.," and adjust $R12$ for full-scale deflection of the meter's pointer. (If you are unable to obtain full-scale deflection, the battery is weak and should be replaced). Now move $S4$ to its alternate position, and read the transistor's gain on your VTVM.

Next, open-circuit the base of the transistor by moving $S2$ to "LKG." The meter pointer should drop to—or very near—zero if the transistor is good.

You may be able to measure gain on several different ranges, and the readings obtained may not agree with each other. Such discrepancies are normal and are due to the variations in tolerance among the resistors and to transistor nonlinearity.

-50-

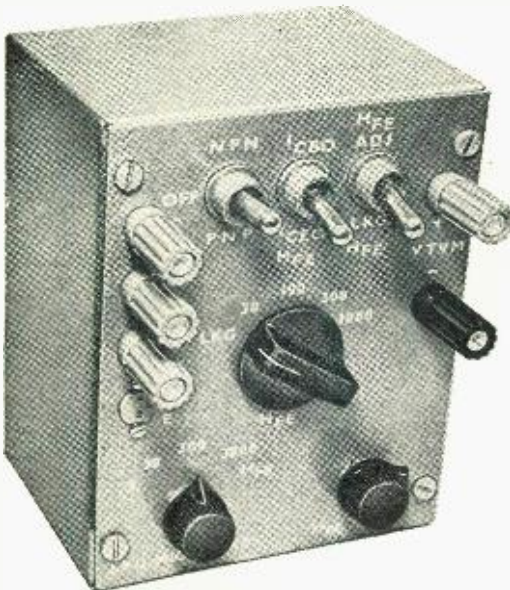

The finished transistor test adapter unit is compact and conveniently independent of line power.

Systems Approach to TV Servicing



Production line technique builds TV repair shop efficiency

BY FOREST M. BELT

IN MANY AREAS of the country, capable TV repair technicians are scarce. Some owners, especially of color-TV receivers, wait days for someone to come look at the set, and then more days—sometimes even weeks—while the set is repaired in the service shop. Then, to cap it all, many owners find that their TV receivers once repaired still fail to work properly.

Reasons for these delays vary—depending on who you ask. Service shops blame manufacturers for making TV receivers hard to service and parts harder to find. TV set manufacturers accuse service technicians of incompetency, carelessness, and indifference. One thing, however, on which both camps agree: there are not enough qualified technicians to go around.

An obvious remedy is to improve the

efficiency of the trained manpower now available. This suggestion of relief is the basis for something new in TV servicing—a “systems approach” that enables a qualified technician to repair more sets in a day, and repair them better. Repair facilities using this idea are appearing in certain areas throughout the country. Shop owners who have tried it report encouraging results, both in time saved and in quality of the finished service jobs.

A System at Work. The systems approach is two-faceted. One involves a fixed, logical trouble-diagnosis procedure, the same procedure for every TV receiver. This systematized troubleshooting has proven speedier and more accurate than most conventional methods. The other facet features production-

Customer brings TV receiver to Diagnostic Center and assists receptionist in writing up report on faults and/or symptoms.



line work flow in the shop. By careful division of labor, this systematic handling enables skilled technicians to turn out more competently repaired receivers in a day's time.

The most successful system seems to be one patterned after the "diagnostic clinic" idea that has become so popular in the automotive repair business. With a diagnosis procedure and patterned work flow, the clinic approach to television servicing is highly efficient.

The set owner brings the TV receiver to the diagnostic clinic; only a few clinics offer pickup and delivery services. The receptionist writes customer information on a special form; pictures on the form help the customer describe the faults or symptoms. A shop helper puts the set on a rollabout cart and starts it immediately through the diagnosis lane.

At the first "island," the back is removed and dust is vacuumed out of the chassis. The picture tube face and cabinet are cleaned. At the second island, an apprentice technician tests the tubes and temporarily replaces any that are defective or exhibit symptoms of impending failure. He turns the set on and checks controls and adjustments, sometimes adjusting them, sometimes cleaning them with control lubricant. Many obvious failures are remedied at this island.

However, even if the set seems to be fixed, the procedure does not stop here.

The receiver is then rolled up to a diagnostic island with a comprehensive array of test equipment (scope, sweep generator, transistor tester, vacuum-tube voltmeter, TV Analyst, color-bar generator, bias supplies, power-line Variac, etc.)—everything needed to make a quick and accurate diagnosis of whatever troubles might remain.

At this diagnostic island, the skilled master technician takes over. The chassis is subjected to a number of specific tests. The nature and number depends on the brand, model, and type of set, but each test reveals the operation of a particular section. The technician monitors key test points throughout the chassis, tabulating test results. He now knows not only the cause of the major trouble that still exists, but also the condition of all the other circuits. Time involved is about 30 minutes.

The technician fills out a report to inform the customer of the total diagnosis. The report identifies the major trouble and the cost to repair it, and calls attention to any minor troubles that exist and the cost to repair them. The customer then elects to: have the major repair made and ignore the minor ones (no guarantee), authorize the complete repair job (90 day guarantee), or take the



An apprentice technician removes the back panel and dusts out the interior of the TV receiver. The picture tube face and cabinet are cleaned and all tubes are tested. Weak or bad tubes are temporarily replaced.



Each diagnostic island includes all the test equipment required by a top-grade technician to find out what's wrong with the ailing TV receiver. The receivers are placed on rollabout carts for mobility.

report and the set elsewhere to have the repairs made. The very few who choose the last course pay the flat diagnosis fee (portables \$3.50, consoles \$4.50, color \$5.50); the set is returned, cleaned and reassembled, but with the old tubes back in their sockets.

If the customer decides to have the repairs made, the set is rolled to a repair island. An apprentice technician installs the parts indicated by the master technician's report, makes all necessary adjustments, and sends the set back to the first island for reassembly. The finished set is moved to a "cooking out" area to run awhile and await pickup by the customer. Repairs take a little longer than the diagnosis, but often less than an hour.

The Measure of Success. The clinic idea for TV is successfully used by Tele-Quick Corporation, Fort Wayne, Ind. Five Tele-Quick Centers are in opera-



The technician writes up a report and estimates the cost of repairs. The customer can have the repair work done immediately or take the receiver to a shop of his own choice. Customer pays diagnostic charge.

tion: a parent-owned pilot Center in Fort Wayne and franchised Centers in Indianapolis, Ind., Nashville, Tenn., Clearwater, Fla., and Gulfport, Miss. Other Centers will open shortly in Denver, Colo., and in southern California.

Tele-Quick Centers are the brainchild of a young electronics engineer, Royce Evans, who acquired a TV repair shop a few years ago. He set out immediately to make it efficient and profitable. What evolved was the diagnostic clinic idea and a philosophy of troubleshooting that is best described as systematic and thorough. TV receivers *stay* fixed and the recall rate is lower than the national average. Marginal receiver operation is uncovered and this often heads off expensive breakdowns.

Television star Pat Boone found the idea very much to his liking, and became a stockholder, director, and booster of Tele-Quick. Evans—who is now president of the parent corporation—opened the first Diagnostic Center in February 1967. The new idea really began to catch on when the four franchised Centers opened. (Pat Boone owns the franchised Center in Nashville.)

(Continued on page 94)



Developer of the systems approach to mass TV repair, Royce Evans, used engineering program concepts to convert a run-of-the-mill TV repair shop to an efficient establishment. More centers will open.



SIMPLIFY with TEST POINTS

BY JIM ASHE, W2DXH

PREVENTIVE MAINTENANCE IS SO MUCH EASIER WHEN YOU BUILD IN TEST AND CHECK POINTS

TEST POINT (test point), *n.* A place or position in an electronic circuit where a suitable measurement by an instrument external to the circuit may be made.

TEST POINTS are rarely found in home-built gear, apparently because nobody thinks about them. Yet every technician admits that they are great time-savers. Voltage or current measurements made at conveniently placed test points may tell you when, and when not, to tear down your gear. Or they may warn of a slowly developing fault before its effects become catastrophic.

Add some test points to your next construction project. They will make debugging easier and simplify servicing.

Overall Design Considerations. The simplest test points are connected directly to, or into, the circuit. Be careful, for they can add parasitic capacitance to detune circuits, reduce frequency response, and introduce unwanted feedback. Direct connections are accident-prone, too, since they offer a chance of open or short circuits or may carry high voltages out to accessible locations.

Four factors should be considered when designing any test point arrangement:

(1) What will happen if the test point is shorted to ground?

(2) What will happen if the test point is opened, particularly in a series circuit?

(3) If you are well grounded and make good contact with the test point, will you get hurt?

(4) Will the hum and noise picked up by body capacitance or the test instrument upset the circuit?

Plan to use a VTVM for reading test point voltages. Its 11-megohm typical input impedance minimizes voltage and signal loss through series resistors in the test circuit. And the VTVM will introduce little noise into a circuit. One of its low ranges should be sufficiently sensitive for all test work.

Typical Test Point Circuits. Resistance and capacitance values for test point takeoff circuits should be chosen after determining the electronic circuit's natural impedance level. Think about frequencies, too, and test gear characteristics. Component values at test point takeoffs are not critical. Resistors are generally 100,000 ohms (except for circuits such as those shown in Figs. 4, 7, and 10, later in this article, where 50-500 ohm values are appropriate). Capacitors can be 0.1 μF for hi-fi circuits; 0.01 μF for audio and i.f. circuits; 0.001 μF for r.f.

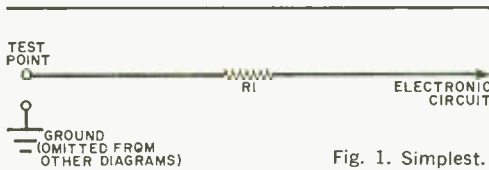

Fig. 1. Simplest.

circuits and 100 pF for high frequency r.f. circuits.

The simplest test point circuit is shown in Fig. 1. This is used for d.c. circuit and signal voltage measurements at audio and low radio frequencies. At high radio frequencies, the signal will be attenuated by unavoidable circuit capacitances. To minimize possible unwanted capacitance, $R1$ is placed very close to the electronic circuit.

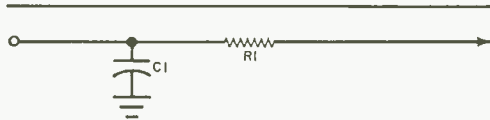

Fig. 2. D.c. only.

Although the signal at the output side of $R1$ will be smaller than the electronic circuit signal, it may still be strong enough to cause trouble. If only the d.c. part of the signal is of interest (with some averaging required), add a capacitor as shown in Fig. 2. Its capacitance value is not critical, but the capacitor should be near the electronic circuit and returned to the circuit ground.

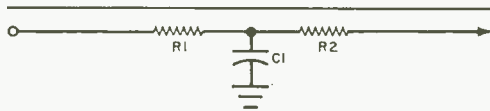

Fig. 3. D.c. drop.

The two resistors and capacitor arrangement of Fig. 3 will be generally superior to Fig. 2, since it offers greater attenuation to signals traveling either way through the network. Choice of values for $R1$, $R2$, and $C1$ is complicated by considerations of circuit impedance level, required signal attenuation, and output loss due to voltage divider effect from the test circuit through the meter.

This is the preferred direct-coupled test point arrangement, however.

Easy ways for measuring current without breaking into the circuit are generally not available to the amateur and experimenter. A test instrument must still be somehow placed in series with the circuit. The simplest method, a shorting jack, does not pass the design requirements suggested previously, because

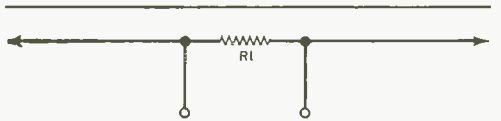

Fig. 4. Current.

opening the jack breaks the circuit. Also, whatever d.c. voltage the electronic circuit carries will appear at the test point. These objections may be partially overcome by adding a small series resistor to the circuit, as in Fig. 4, and measuring the voltage appearing across it. Ohm's law converts the voltage measurement to a current reading.

If the d.c. voltage is of no interest, a parallel-connected transformer can be used to reduce the signal amplitude and provide a safe output (see Fig. 5).

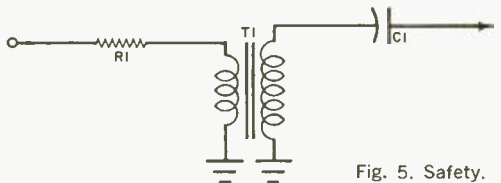

Fig. 5. Safety.

When the test terminal is shorted to ground, $R1$ is reflected through the square of the transformer-turns-ratio into the primary and may be seen by the circuit as a large value. There is no signal power loss in this arrangement, as there must be with a resistor attenuator. Capacitor $C1$ keeps circuit d.c. from the transformer, and its reactance at signal frequencies should be low compared to the reflected value of $R1$. In Fig. 6, $C1$ is eliminated by returning the transformer primary to d.c. rather than to ground.

A transformer can be placed in series,

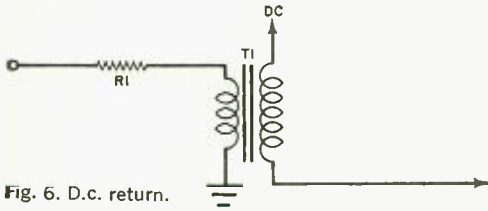

Fig. 6. D.c. return.

rather than in parallel (see Fig. 7), with a circuit to pick off a current measurement. The primary is a turn or a few turns of wire, or the low-impedance side of an output transformer. Resistor $R1$ (typically, a few hundred to 10,000 ohms) now appears across the output, rather than in series with the output, so that the transformer never "sees" an open secondary circuit.

For checking low-level r.f. voltages, the common VTVM probe circuit of Fig. 8, built into the chassis, can be used. Resistor $R1$ is not critical since its value is typically much greater than common transmission line or link impedances. The diode pump circuit of Fig. 9 offers improved sensitivity to very small r.f. voltages.

For higher r.f. voltages and low circuit impedances, a resistive voltage divider will work well (see Fig. 10) into the 300-MHz range. The sum of $R3$ and $R4$, probably a few hundred ohms, should

Fig. 7. Pickoff.

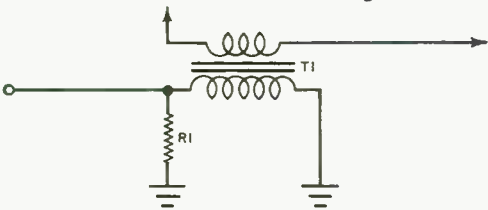

not upset the circuit impedance levels. By making $R2$ small, large voltages can be measured.

Sometimes you'll want to determine whether an a.c. voltage exceeds a certain value. This is a useful measurement at all audio and radio frequencies, and the diode pickoff circuit of Fig. 11 is appropriate. A stable voltage provided by a

potentiometer or a resistance divider reverse-biases the diode. There is no output until the input voltage swings above the predetermined bias voltage. Unlike the other test point circuits given

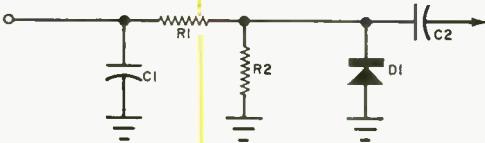
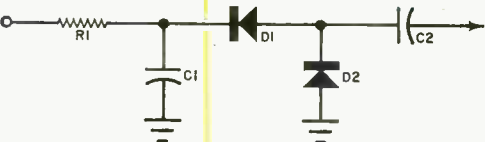

Fig. 8. Probe.

here, this one provides an a.c. output. A d.c. output may be obtained by adding one of the preceding circuits to rectify the a.c.

If you use a thermistor, the test point may tell you something about the temperature of an inaccessible location (see Fig. 12). You might be interested in the temperature of a transformer, or curious about conditions inside an insulated or distant oscillator enclosure. Or you might need to know if a water pipe is about to freeze, or require an automotive radiator temperature measurement. By substituting a photoresistive cell, this circuit will

Fig. 9. Pump.



indicate light levels. And interchanging $R2$ and $R3$ results in a test circuit that will put out a falling voltage for rising temperature or light level.

Fig. 10. Divider.

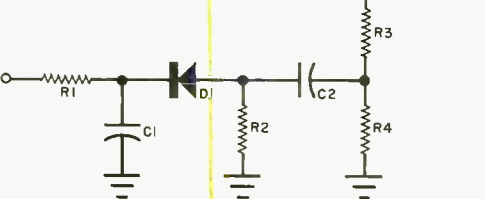

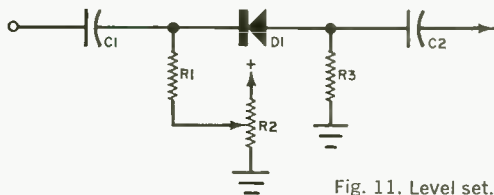

Fig. 11. Level set.

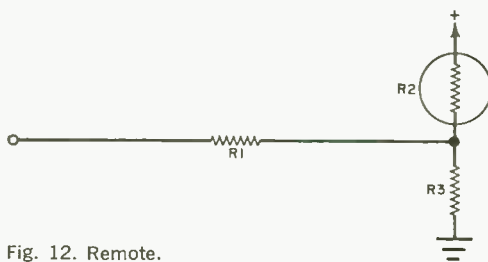

Fig. 12. Remote.

Mechanical Details. Test point mechanical arrangements should not be compromised, except for purposes of safety. A row of tip jack sockets is suitable for most purposes; and if some jacks carry dangerous voltages, a plastic bar with 1/4-inch diameter holes, installed over the jacks, will offer protection.

Tube sockets make fine test point assemblies, and the points are not prone to accidental contact. If some of the test points carry signals, capacitive transfer of signal from one point to another may cause unwanted feedback. A grounded point between the two offending points, with careful location of wiring, will stabilize very high gain circuits. Octal tube sockets are preferred, and

there are similar special sockets available that carry up to 12 or 20 points.

For printed circuit work, Vector's T9.4 and T28 lugs are easily inserted and angular enough to avoid a skidding probe when you look up at the instrument. Place them in a neat line along the edge of the board.

Although test points are convenient if arranged in a systematic pattern described in an equipment manual, labels are better. A word or two is sufficient, and they can be applied with a marking pen. One of the many marking tapes now on the market will also make an attractive label.

-30-

MORE QRM? Over-the-horizon radar systems for spotting rocket booster takeoffs are expected to use HF and VHF communications channels. Will these super-high power transmitters become new sources of interference and QRM in the radio amateur and International Broadcast bands? Operating frequencies are expected to be variable, but must be those most appropriate for long-distance communications. And, here we were thinking that things on the SW bands were bad enough.

ELECTROPHONIC HEARING The U.S. Army is experimenting with a new method for coupling low frequency radio signals directly into the listener's head. This is said to enable a listener to hear weak signals under extremely noisy conditions. The method may be of interest to hi-fi enthusiasts since the frequency response is essentially flat from 10 through 20,000 H. The technique applies a capacitively-coupled low-power AM broadcast signal to the head in a region in front of the ears. Broadcast frequencies being tested are between 36 kHz and 100 kHz.

SUPER Q FROM SUPER COLD Superconductivity, the remarkable zero-resistance property of some materials at temperatures near absolute zero, has been very useful in research work. Now it may be applied to selectivity and r.f. interference problems. Researchers have been able to obtain unloaded Q's in properly designed LC circuits as high as 2.2 million at 20 MHz. A working model tuner that was supercooled reduced susceptibility to intermodulation by about 40 dB.

ed.) Use aluminum foil and shield the back of the meter. Make certain the shield does not short out the meter terminals. Ground the foil. If this does not do the job, connect a 2½ millihenry choke in series with the meter on the "hot" side. Another trick is to place a piece of grounded copper window screen so that it covers the meter face. As a last resort, obtain a *shielded* meter.

Transistor Advantages. *I note the increased trend toward the use of transistors and IC's. The vacuum tube seems to have had its day. Can you tell me why semiconductors are now preferred in radio, TV, hi-fi, and other electronic equipment?*

This is a question we are asked every week. Transistors have a much longer life than tubes. Transistors are less likely to change characteristics, are lower in price (except for special types), and occupy less space. Except in the higher power r.f. circuits—1000 watts or more—transistors do as well as vacuum tubes. Westinghouse developed an all-transistorized 1000-watt transmitter for the U.S. Air Force, but there is still a long way to go to "beat" tubes in high-power applications. The transistor is not very heat tolerant and "suffers" from non-linearity in certain applications. Properly designed transistor circuits can, in fact, last forever.

Dual Meter SWR. *I have a dual-meter SWR indicator wired into my antenna transmission line. One meter reads relative power and the other the VSWR. Why does the VSWR meter reading go up when I modulate the transceiver?*

You may have a higher SWR than you think. Remember that most two-meter SWR-power indicators provide a "level set" potentiometer, and, if this is not adjusted properly for your transceiver, you can obtain deceptively low SWR readings.

Paralleling Electrolytics. *Why are resistors connected in parallel with series-connected electrolytic capacitors which have the same capacitance and voltage ratings?*

The slight differences in capacitance values of electrolytics create a voltage division problem. The resistors help provide voltage equalization and also act as bleeders. Paralleled capacitors are usually found in the power supplies of SSB transmitters which require supplies having good dynamic characteristics.

HW-32 Receiving Intermittent. *I have used a Heath HW-32 20-meter transceiver for a long time, and it has given me good service; but now it has suddenly developed a receiver intermittent. The tubes check out*

all right. The transceiver operates fine for about 5 minutes, then cuts off. Turning the function switch off and on a couple of times restores operation for another 5 minutes or so. What is your diagnosis?

First, clean every switch and relay contact with a good contact cleaner and then try the transceiver again. If the trouble persists, suspect the coupling capacitors between stages. One intermittent in this model was traced to the two coupling capacitors C-110 and C-124 feeding V12B and V12A.

Negative and Positive Ground Systems. *I own a foreign sports car with a positive ground electrical system. The CB radio I have will work only on a negative ground. Is it possible to change over the car's electrical system to a negative ground? Adding another battery is no problem, but how do I charge it?*

Changing over a car's electrical system is not simple. Adding a second battery

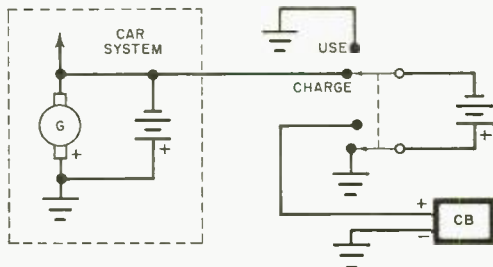

which can be switched in and out of the charging circuit is an expedient (but not the best) answer to your problem. The system above will work with a solid-state transceiver that draws only a few watts.

QM and Knight-Kit R-55A. *I have a Knight-Kit R-55A for SWL'ing. I also have a Heath QM-multiplier which I used with another receiver. Can the Heath QM be used with my R-55A?*

No. The i.f. of the R-55A is 1650 kHz, and the Heath QM operates around 455 kHz.

VFO for CB. *Instead of using crystals, I'd like to add a good VFO to my CB transmitter base station to cover all channels. Is this possible?*

Possible but not legal. Crystal control on the 11-meter CB band is mandatory.

Valiant II for SSB. *I am a new ham and have acquired a second-hand Valiant II transmitter that I want to use for SSB. What do you suggest as an SSB exciter (new or used)?*

I recommend shopping around for the Johnson SSB adapter which will "fit" your

transmitter without modification. These, as well as the good old SB-10 Heath SSB adapter, are available on the used market.

DVM Accuracy. *What determines the accuracy of a digital voltmeter?*

Noise, digital count ambiguity, effects of temperature over a period of time on parts causing them to change or drift in value, line voltage variations and transients, and design of the analog-to-digital conversion circuitry.

Code-Practice Oscillator. *I'd like to build a code-practice oscillator. I want an inexpensive unit (one or two transistors). Can you help?*

The circuit shown in the diagram is very low in cost and works fine.

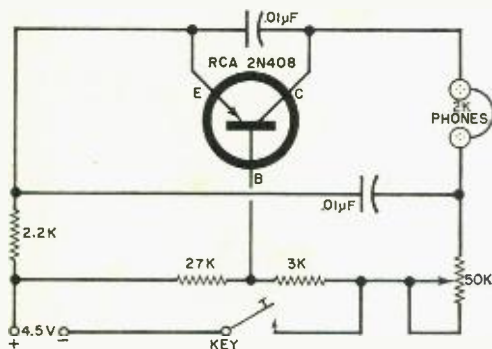

BCI With Intercoms. *I recently bought three vacuum-tube intercoms. They work very well except that a local broadcast station comes through loud and clear. What can I do? The BC station is on 800 kHz.*

Connect a 75,000-ohm resistor in series with each first stage (mike amplifier) grid and bypass the resistor to ground with a .001-µF ceramic capacitor. This will stop the grid rectification.

Heath DX-60 Intermittent. *My Heath DX-60 worked fine except that lately it has been exhibiting a tendency to "jump out of control." The normal plate current goes from 150 to 250 mA when I am operating on 40 meters (crystal controlled). What is happening?*

It sounds like intermittent drive. Check key contacts, crystal, oscillator, and driver tube.

Knight T-60 Output. *During the last year, the output of my transmitter seems to have dropped off in r.f. power. The tubes were checked on an emission-type tube checker and seem to be all right. What do you think is happening?*

Check your antenna connections first.

Next, try some tube substitutions. An emission checker does *not* always show up bad tubes.

SP-600 VLF 31 Receiver Conversion. *One of my receivers for SWL work is a Hammarlund SP-600 VLF 31 which I would like to convert for all-band operation. How do I do this?*

Only by using a converter; any other modification would be impractical.

Unknown Parts. *I have a garage door opener which works very well, and I would like to build another transmitter unit for my second car. Checking the diagram and parts list, I find that the manufacturer has used his own (non-standard) identification of the parts. What do you suggest I do?*

Look over the parts actually used in the transmitter unit you have and try to identify or measure the values. Maybe the manufacturer will sell you a diagram.

RFI and EMC. *I hear a lot about radio-frequency interference (RFI) and electro-magnetic compatibility (EMC). I would like to know how RFI and EMC are related and what is being done about both of them.*

With EMC there is no RFI. EMC means that systems within systems do not interfere with each other. To put it simply, a receiver that receives only what it should receive is *compatible*. If the receiver does not, then RFI exists, and this may be from any one of a thousand or more sources. Every technically advanced country in the world has EMC-RFI research programs. RFI can send rockets off course, make for unintelligible communications, disrupt radar and navigational aids, and lower the efficiency of data handling systems, etc.

RFI comes from a large number of sources where radio or electrical devices are found. Manufacturers are aware of the RFI problem and many are doing something about it.

Preamplifier With RIAA Equalization. *I need a tube-type preamplifier for magnetic phono pickup use. It should have a gain of 140, or so. Can you help me? RIAA equalization is a must.*

An excellent circuit is shown in the RCA Receiving Tube Manual Technical Series RC-25.

BC-348 Improvements. *I, like many other hams and SWL's, have purchased a surplus BC-348. Can you refer me to published articles in any magazine which will help me to get the most out of this receiver?*

Check *CQ* magazine for the issues of: May, 1959, March 1959, Feb. 1959, July 1958,

Sept. 1956, Nov. 1950, July 1949, April 1949, Dec. 1948, Oct. 1948, and April 1948. Reprints of BC-348 articles are \$1 from CQ. Also, QST for Nov. 1948, June 1948, April 1948 contained some interesting articles. No reprints are available.

Time Delay Circuit. *I need a circuit which will turn a relay on and off at given intervals. The time constant must be adjustable up to about 5 seconds. Can you help?*

See the diagram below. The circuit can use a 2N1671, 2N1671A, 2N1671B, or 2N2160 unijunction transistor. The relay can have a coil resistance of 150 ohms or less. The pot

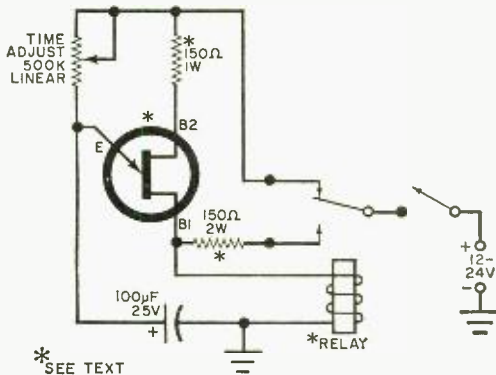

* SEE TEXT

must be linear and *not* logarithmic. Supply voltages from 12 to 24 volts may be used for the circuit. The two 150-ohm resistors shown should be replaced with 330-ohm resistors if a 24-volt supply is used.

One set of contacts on the relay are used to hold the relay closed, the other set for control purposes. The pot sets the time constant. Each 10,000 ohms of pot resistance produces a holding time close to 1 second.

VHF Rhombic For TV. *I live in a TV fringe area and was wondering if a VHF rhombic antenna would be worthwhile installing. The antenna would be mounted on a flat roof and fed with 300-ohm twinlead. Any advice? I presently use a Yagi and receive two stations with a lot of snow. I tried a booster and this helped a bit.*

Try a rhombic antenna 3 wavelengths long on each leg mounted off the roof with 10-foot poles. A counterpoise system under the antenna will raise the signal about 2 dB. Rhombics are easy to construct and install for the VHF bands if you have the space. Proper antenna-to-line matching is a must.

IC Power Limits. *Why are present day integrated circuits so limited in their power dissipation ranges?*

The problem is getting rid of generated

heat. The materials used in the IC headers are not good heat dissipators. However, some new audio IC's have reached slightly above 2 watts dissipation. In r.f. pulse operation IC's can be phased for increased power output without an appreciable increase in dissipation of the individual IC's involved. Also, by operating IC's (amplifiers) in the class-B region, it is possible to boost power and limit dissipation.

Vertical Matching Indicator. *I have adapted a commercially available, motor-driven coil to tune my vertical antenna from the shack. What I would like to know is the best way of determining when proper tuning has been accomplished. The motor has no "readback" feature, so all I do is watch the final plate meter of my rig for maximum loading. Is this all right?*

An in-line SWR meter would be of great help, but your method of tuning is fine as long as adjustments are made quickly so that you do not cause too much QRM. You can also use a simple diode-type field strength meter, which will give you relative loading information.

Rate Servo. *What is a rate servo and what does it do?*

A rate servo is one that controls the rate, or speed, of a load instead of controlling the load position. It varies the rate at which the load moves in response to an external rate order. A typical example of a rate servo is found in radar antenna systems where a rheostat is often used to vary the field voltage, which decreases or increases the speed of a motor—thus the antenna is turned slower or faster.

One kHz Test Oscillator. *I need a one or two transistor audio tone generator with a 1 kHz output and level of between 0.005 and 0.01 volts. Can you supply a diagram?*

See the circuit diagram. This is an excellent circuit, and the transistor used may be

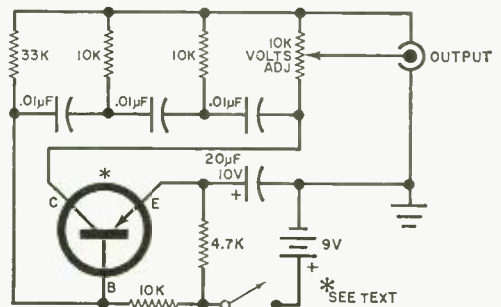

* SEE TEXT

a 2N383, 2N397, 2N417, 2N508A, 2N609, SK3004, GE-2, 2N1274, or 2N59A.

Join "THE TROUBLESHOOTERS"

They get paid top salaries
for keeping today's
electronic world running

Suddenly the whole world is going electronic! And behind the microwave towers, push-button phones, computers, mobile radio, television equipment, guided missiles, etc., stand **THE TROUBLESHOOTERS**—the men needed to inspect, install, and service these modern miracles. They enjoy their work, and get well paid for it. Here's how you can join their privileged ranks—without having to quit your job or go to college in order to get the necessary training.

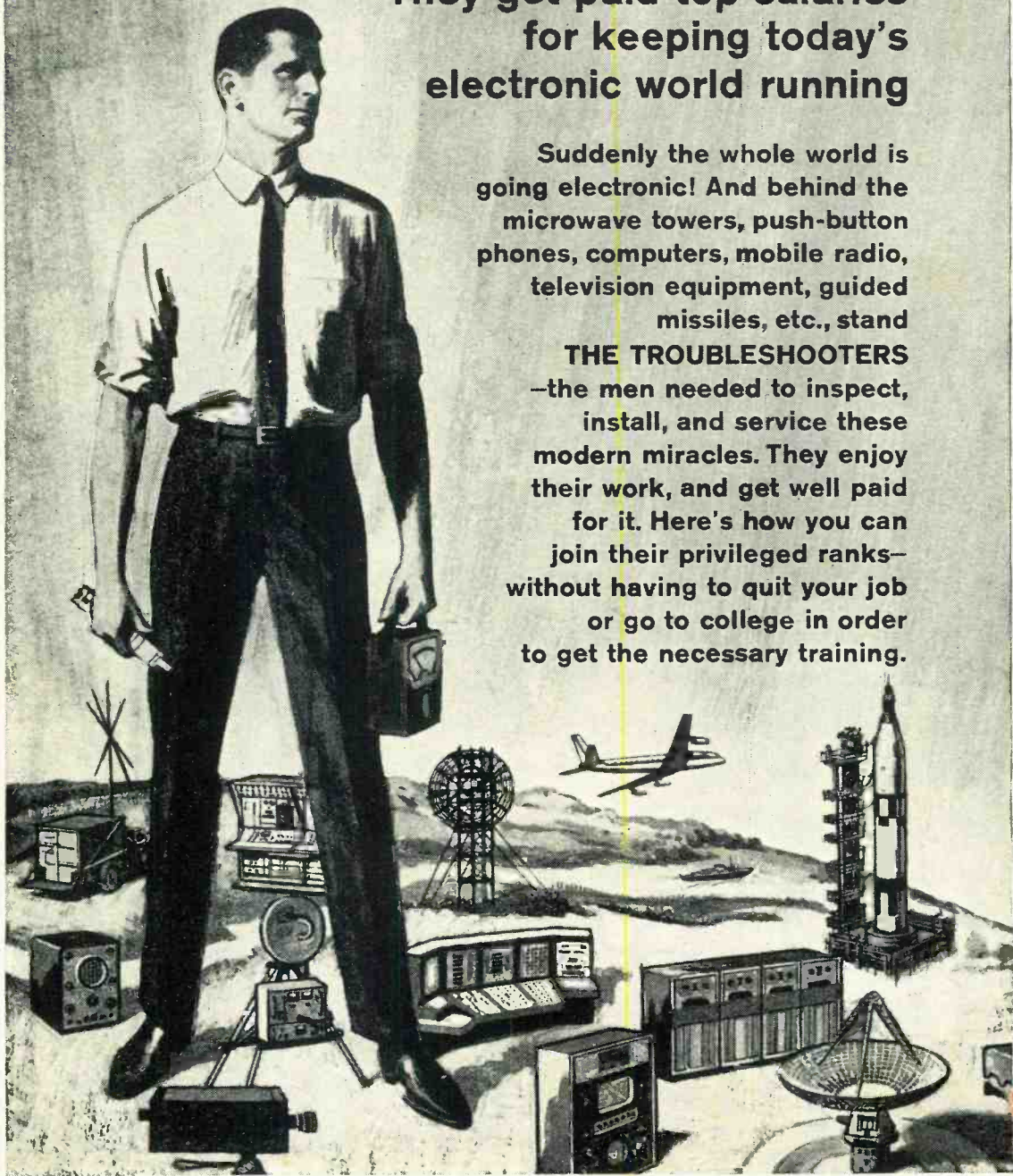

JUST THINK HOW MUCH in demand you would be if you could prevent a TV station from going off the air by repairing a transmitter...keep a whole assembly line moving by fixing automated production controls...prevent a bank, an airline, or your government from making serious mistakes by repairing a computer.

Today, whole industries depend on electronics. When breakdowns or emergencies occur, someone has got to move in, take over, and keep things running. That calls for one of a new breed of technicians—The Troubleshooters.

Because they prevent expensive mistakes or delays, they get top pay—and a title to match. At Xerox and Philco, they're called Technical Representatives. At IBM they're Customer Engineers. In radio or TV, they're the Broadcast Engineers.

What do you need to break into the ranks of The Troubleshooters? You might think you need a college diploma, but you don't. What you need is know-how—the kind a good TV service technician has—only lots more.

Think With Your Head, Not Your Hands

The service technician, you see, "thinks with his hands." He learns his trade by taking apart and putting together, and often can only fix things he's already familiar with.

But as one of The Troubleshooters, you may be called upon to service complicated equipment that you've never seen before or *can't* take apart. This means you have to be able to take things apart "in your head." You have to know enough electronics to understand the engineering specs, read the wiring diagrams, and calculate how a circuit should test at any given point.

Now learning all this can be much simpler than you think. In fact, you can master it without setting foot in a classroom and without giving up your job!

AUTO-PROGRAMMED™ Lessons Show You How

For over 30 years, the Cleveland Institute of Electronics has specialized in teaching electronics at home. We've developed special techniques that make learning easy, even if you've had trouble studying before.

For one thing, our AUTO-PROGRAMMED™ lessons build your knowledge as you'd build a brick wall—one brick at a time. Each piece rests securely on the one that came before it.

ENROLL UNDER NEW G.I. BILL

All CIE courses are available under the new G.I. Bill. If you served on active duty since January 31, 1955, or are in service now, check box on reply card for G.I. Bill information.

In addition, our instruction is personal. When your teacher goes over your assignment, no one else competes for his attention. You are the only person in his class. He not only grades your work, he analyzes it to make sure you are thinking correctly. And he returns it the day it's received so that you can read his comments and corrections while everything is fresh in your mind.

Always Up-To-Date

To keep up with the latest developments, our courses are constantly being revised. This year CIE students are getting new lessons in Laser Theory and Application, Microminiaturization, Single Sideband Techniques, Pulse Theory and Application, and Boolean Algebra.

In addition, there is complete material on the latest troubleshooting techniques including Tandem System, Localizing through Bracketing, Equal Likelihood and Half-Split Division, and In-circuit Transistor Checking. There are special lessons on servicing two-way mobile equipment, a lucrative field in which many of our students have set up their own businesses.

Your FCC License—or Your Money Back!

Two-way mobile work and many other types of troubleshooting call for a Government FCC License, and our training is designed to get it for you. But even if your work doesn't require a license, it's a good idea to get one. Your FCC License will be accepted anywhere as proof of good electronics training.

And no wonder. The licensing exam is so tough that two out of three non-CIE men who take it fail. But CIE training is so effective that 9 out of 10 of our graduates pass. That's why we can offer this warranty with confidence: *If you complete one of our license preparation courses, you'll get your license—or your money back.*

Mail Card for 2 Free Books

Want to know more? Mail the postage-paid reply card bound here. We'll send our 40-page catalog describing our courses and the latest opportunities in Electronics. We'll also send a special book on how to get a Commercial FCC License. Both are free. If the card is missing, just send us your name and address.



CIE

Cleveland Institute of Electronics

1776 E. 17th St., Dept. PE-68, Cleveland, Ohio 44114

Accredited Member National Home Study Council
A Leader in Electronics Training... Since 1934



CIRCLE NO. 7 ON READER SERVICE PAGE

ENGLISH-LANGUAGE BROADCASTS TO NORTH AMERICA FOR THE MONTH OF JULY

Prepared by ROGER LEGGE

TO EASTERN AND CENTRAL NORTH AMERICA		TO WESTERN NORTH AMERICA	
TIME—EDT	STATION AND LOCATION	TIME—PDT	STATION AND LOCATION
	FREQUENCIES (MHz)		FREQUENCIES (MHz)
7:00 a.m.	Stockholm, Sweden	8:00 a.m.	Tokyo, Japan
7:15 a.m.	Melbourne, Australia	7:00 p.m.	Melbourne, Australia
8:15 a.m.	Montreal, Canada		Taipei, China
8:45 a.m.	Copenhagen, Denmark		Tokyo, Japan
7:00 p.m.	Helsinki, Finland	7:30 p.m.	Johannesburg, South Africa
	London, England	8:00 p.m.	London, England
	Montreal, Canada		Madrid, Spain
7:45 p.m.	Tokyo, Japan		Peking, China
8:00 p.m.	Moscow, U.S.S.R.		Seoul, Korea
	Sofia, Bulgaria	8:30 p.m.	Bonaire, Neth. Antilles
8:30 p.m.	Budapest, Hungary		Prague, Czechoslovakia
	Johannesburg, South Africa		Stockholm, Sweden
	Kiev, U.S.S.R. (Mon., Thu., Fri.)	8:45 p.m.	Berlin, Germany
	Stockholm, Sweden	9:00 p.m.	Havana, Cuba
8:50 p.m.	Vatican City		Lisbon, Portugal
9:00 p.m.	Berlin, Germany		Moscow, U.S.S.R. (via Khabarovsk)
	Havana, Cuba		Peking, China
	Madrid, Spain		Sofia, Bulgaria
	Peking, China	9:15 p.m.	Bangkok, Thailand
	Prague, Czechoslovakia	9:30 p.m.	Bucharest, Rumania
	Rome, Italy		Budapest, Hungary
9:30 p.m.	Berne, Switzerland		Kiev, U.S.S.R. (Mon., Thu., Fri.)
	Bucharest, Rumania	9:45 p.m.	Berlin, Germany
	Cologne, Germany		Cologne, Germany
	Hilversum, Holland	10:00 p.m.	Havana, Cuba
	Tirana, Albania		Tokyo, Japan
9:45 p.m.	Copenhagen, Denmark	10:15 p.m.	Berne, Switzerland
10:00 p.m.	Cairo, Egypt	11:00 p.m.	Moscow, U.S.S.R. (via Khabarovsk)
	Lisbon, Portugal	11:30 p.m.	Havana, Cuba
	London, England		
	Melbourne, Australia		
	Moscow, U.S.S.R.		
	Stockholm, Sweden		



SHORT-WAVE LISTENING

By HANK BENNETT, W2PNA/WPE2FT
Short-Wave Editor

VERIFYING THOSE LATIN AMERICANS

MANY of our readers have expressed the sentiment that short-wave stations in Central and South America do not verify reports—even good reports—in a ratio proportionate to the number of stations on the air. Several possible reasons have been offered, one being the language barrier. It is not easy for SWL's to compose and intelligently translate a report from their native English into virtually unknown (to them) Spanish or Portuguese. Still, they should be just familiar enough with either of the two languages in spoken form to be able to filter out the ID, and to be sure, beyond any shadow of a doubt, that they have logged the station in question. But how do you get a QSL?

Joseph Hueter, Sr., Philadelphia, Pa., one of the East Coast's veteran DX'ers (with over 150 countries verified) has found the ratio of replies can be greatly increased when a reception report—written in English if you wish—is accompanied by an actual tape recording of the time segment being reported. SWL Hueter has found this to be at least a partial answer to the problem of the "non-verifier." Many of the stations in Central and South America do not keep logs of

their broadcasts, or very badly kept ones at best. If you want to convince the station that you really did hear them, make a tape recording which includes not only the ID and/or interval signal, but those portions of the program when commercials or local spot announcements were given. A tape also eliminates the need of reporting in detail the quality, fading, signal strength and interference. It is also reported that a station receiving a tape is more inclined to include some additional favors with its QSL; perhaps a pennant, seal, badge, or picture postcards.

In any event, don't forget to include the vital information: date and time, frequency, a brief description of your receiving equipment and antenna, tape speed, and return postage in the form of mint stamps, or an IRC or two, especially if you wish to have your tape returned. Many stations will return your tape with new material recorded on it; folk music or other musical items.

Convention Time. The Association of North American Radio Clubs (ANARC) will hold their yearly convention on August 16, 17 and 18 in Omaha, Nebr. SWL's in-



Ethel Fogleson (Mrs.), WPE8JEA, Cleveland, Ohio, is seen here in a Listening Post sporting three receivers. To the left of the Panasonic tape recorder is a Drake SW-4. To the right of the recorder are two Zenith receivers: M660A and Trans-Oceanic 3000-1. A Monitor Award acknowledges 50 countries verified.



Located in Lewistown, Pa., Robert A. Fleck, WPE3DXZ, has received about 65 countries on his Zenith Trans-Oceanic portable receiver. A "Courier-25" CB transceiver and Aiwa TP-1001 stereo tape recorder round out this comfortable Listening Post. At this writing Bob has received 28 country veri's and QSL cards.

terested in attending or obtaining further particulars should write to Ernest Wesolowski, 1416 Pasadena Ave., Omaha, Nebr. 68107.

Finland Still Going. Information previously released by the Foreign Relations Department of the Finnish Broadcasting Co., Ltd., Helsinki, was in error. A new release reads in part, "None of our English transmissions, either those produced by the station or by the Finlands DX Club, are to be discontinued. Some changes have been made . . . we broadcast to Europe weekdays 1800-1830 and Sun. 1615-1630 on 9550, 11,805 and 15,185 kHz, and to N. A. daily at 2300-2330 on 15,155 kHz."

Random Notes. HISD, *Radio Television Dominicana*, Santo Domingo, is to introduce *Radio Quisqueya International*, a new international service in several languages. The present channels of 3215, 6090 & 9505 kHz are to be used; tentative transmission time is 1500-0300. Press time listening indicates that this station is airing English language recorded programs at 2315-0200 on 6090 and 9505 kHz. Use of the third channel is being announced, but QRN has not enabled your Editor to get a positive ID. Reports go to Av. Dr. Tejada Florentino No. 8, Santo Domingo.

The Peruvian Government has granted a short-wave license to *Radio Del Pacifico* after 3 years of negotiations. The station will operate a 5000-watt transmitter on the tropical band frequency of 4975 kHz.

Don't forget to listen for those tests to be conducted by the *International Committee of the Red Cross* on July 22, 24 and 26 at 0600-0700, 1130-1230, 1700-1800 and 2300-0000 on 7210 kHz. Reports go to the *ICRC* at 7 Avenue de la Paix, Geneva, Switzerland.

CURRENT STATION REPORTS

The following is a resume of current reports. At time of compilation all reports were as accurate as possible, but stations change frequency and/or schedule with little or no advance notice. All times shown are Greenwich Mean Time (GMT) and the 24-hour system is used. Reports should be sent to Short-Wave Listening, P. O. Box 333, Cherry Hill, N. J. 08034, in time to reach your Short-Wave Editor by the fifth of each month; be sure to include your WPE identification and the make and model number of your receiver.

Bolivia—CP90, *R. Juan XXIII*, Santa Cruz, is a new station apparently operated by a religious group according to the pattern of programming. On 4951 kHz, it is noted in Spanish around 0000 and later. CP87, *R. San Rafael*, Cochabamba, is irregularly on 5055 kHz with messages for listeners in the interior at 0200.

Burma—*R. Rangoon*, 4795 kHz, has been heard at 1300 in an Oriental language program. DX'ers on the West Coast are reporting this one.

Cameroon—Yaounde, 4972.5 kHz, is excellent at times from 2200 with French music and pops; an ID in French and English is given at 2230 s/off.

Canada—*Voice of the Arctic*, Pond Inlet, is an unlicensed station of 100 watts on 3750 kHz. About 85% of the programs are in Eskimo. The owner, "Dutchman" Joe Sanders, is fighting for a DOT license. (Editor's Note: Pond Inlet is in Northwest Territories, about 1700 miles north of Ottawa, on the north shore of Baffin Island. A nice catch—but has anyone heard it?)

Costa Rica—*La Voz de la Victor*, San Jose, is being reported on 9615 kHz from 2330-0500 s/off with NA and LA pop music and frequent IDs in Spanish. We've had no trouble hearing this one. *R. Alajuela* (formerly *R. Progreso*) is on 1300 kHz. They operate a 10-watt studio-xmtr link on 27,540 kHz. We've also logged this country the hard way: look for TIOS, *R. Titania*, on 825 kHz with pop LA tunes; in Spanish, they have a sharp, clear ID. This was noted often 0300-0315.

Cyprus—BBC Relay noted on 15,370 kHz at 0200 with English news and commentary; this xmsn closes at 0215.

Czechoslovakia—*R. Prague* is usually good at 0100 and 0400 on 11,990 kHz, and 0140-0200 on 7345 kHz, both in English. Spanish heard on 9560 kHz at 2330, and Portuguese to Brazil on 9540 kHz to 0100, then changes to English until 0155.

Dahomey—Cotonou, 4870 kHz, good to closing at 2300 Sat. in French with pop records. An English language lesson is aired at 0607-0613 and news in French 0616-0635.

Ecuador—HCMV5, *R. Popular*, Cuenca, is on 4807 kHz and noted with frequent time checks around 0100. HCGH1, *R. Tarqui*, Quito, is on 4972 kHz around 0200 with all Spanish programming and rarely-given IDs.

Egypt—Cairo has been logged on 21,440 kHz at 2100 with "English by Radio"; on 9780 kHz at 2220 with Arabic news, and 9475 kHz at 0235 with answers to listener's mail.

Estonia—*Eesti Raadio Tallinn*, 6085 kHz, has confirmed a tentative logging at 2000-2030. Also noted with chimes IS at 2104 but mixing badly with *Bayerischer Rundfunk*, Germany.

France—Paris has English to Africa and Madagascar at 0515-0530 on 15,445 and 11,725 kHz, at 0615-0630 on 9730, 5970, 4795 and 3232 kHz, at 1100-1115 on 21,650, 17,850, 15,445 and 11,970 kHz, and at 1915-1930 on 15,190, 11,930, 9730, 7105, 5970 & 3232 kHz. To Far East and Africa at 1300-1330 on 21,580, 21,500, 17,740, 15,245 and 15,190 kHz.

Germany (East)—*R. Berlin International* is heard on 15,100 kHz in Arabic at 1857-1959, on 15,445 kHz at 2315 in Portuguese to Brazil. On 21,475 kHz in an African language with news and music at 1715-1728 and from 1729 in French.

Guyana—*R. Demerara*, Georgetown, 5980 kHz, has been logged at 0935-0955, 1030, and to 1115 in English with news at 1115. Time checks are 3 hours, 45 minutes behind GMT.

Haiti—4VHW, *R. Haiti*, Port-au-Prince, has returned to the air on 6195 kHz and is good at 2300-0000 in French with light music. 4VEH, Cap Haitien, has been testing with 100 watts on 15,274 kHz around 0230.

Holland—*R. Nederland*, Hilversum, is good on 17,880 kHz, dual with 15,320 kHz at 2305-2330 in Dutch & English to the West Indies.

India—*All India Radio*, Delhi, is good on 15,260 kHz from 0055-0115 s/off; news is given at 0100 and this xmsn is all English.

Indonesia—*R. Angkatan Udara Republik Indonesia* (Indonesian Air Force Radio) has been logged on 11,903 kHz with s/off at 1158 weekdays, but running to 1313 fadeout on Sun. with news at 1300. Programming is primarily Indonesian pop music.

Italy—West Coast loggings show Rome to be heard on 15,340 kHz at 1930 with IS but quickly jammed. Again at 2050 with IS and on 21,560 kHz to Latin America in Italian at 1840-1905 and 1910-1945.

(Continued on page 99)



AMATEUR RADIO

By HERB S. BRIER, W9EGQ
Amateur Radio Editor

PLACES AND PEOPLE IN HAM RADIO

Pontiac, Washington: A few months ago, Larry England, K8GMO, told the story of Sally Harrington, age 5 years, on 75-meter phone. Sally was in the Saint Joseph Hospital, Pontiac, Michigan, with acute aplastic anemia. She was receiving daily blood transfusions, and her doctors estimated that she would need 600 to 700 pints of blood in the next 12 weeks to stay alive. And, Sally already owed the blood bank 400 pints of blood!

Larry reported that anyone who wished could donate blood in Sally's name at any blood bank in the United States. The information was relayed from amateur net to amateur net. Within hours, amateurs, men at military posts, and others who had been alerted to Sally's need by amateur radio started appearing at blood banks from coast to coast to offer their blood.

In two days, Sally's 400-pint debt to the blood bank had been repaid and all her foreseeable needs were satisfied. As this is being written, Sally is cheerful and doing well. We are informed that CB groups also helped publicize her needs in Pontiac.

Washington, D.C.: New FCC regulations regarding permanent changes of amateur station location specify that the station owner must apply for a modification of the station license within four months of the change of address and before operating from the new location. Once the application for modification has been made, however, he can operate as a portable from the new location until the FCC returns the modified license—provided that he sends a notice of such portable operation to the Engineer in Charge of the FCC district in which the station is located.

The January 1968 Federal Communications Commission Reports announced a three-month suspension of the Advanced Class license of Arthur H. Jones, Jr., W3IRL, Baltimore, Md., for fraudulently certifying that an applicant had passed the 5-wpm code test for a Technician license. Witnesses testified that the applicant could identify only five letters of the alphabet in code.

The Commission announced that the light penalty for a serious breach of trust—which, if it became widespread, could destroy the

AMATEUR STATION OF THE MONTH



Combination radio amateur, short-wave listener and radio/TV repair technician keeps Alberto Merino Sotero, OA4NFH, Bellavista, Callao, Peru pretty busy. On the ham radio side, Alberto uses an ancient Harvey-Wells transmitter and a nearly modern Hallicrafters S-38E receiver. His 40-meter dipole antenna works on both 40 and 15. In whatever spare time is available, Alberto works on his home study TV and radio course. For sending us a description of his station, Alberto will receive a free one-year subscription to POPULAR ELECTRONICS. This was the winning entry in our Monthly Amateur Station Photo Contest. To enter, simply send a clear photo of your station with you at the controls (and equipment details) to Amateur Radio Photo Contest, c/o Herb Brier, Box 678, Gary, Ind. 46401.



Dayton Johnson, WN8YST, Rochester, Mich., sports a Johnson (no relation) Viking transmitter and Mosley 15-meter beam. Also visible in this photo is a Hammarlund HQ-180 and Heathkit HR-10. Dayton likes to ragchew on 80.

entire volunteer examiner system—reflected some mitigating circumstances in Mr. Jones's behalf.

Your columnist has heard that the FCC's action has prompted a few amateurs to decline to act as volunteer examiners for fear of getting into trouble. These fears are groundless, if the examiner conducts his examinations honestly, and promptly returns all examination papers to the FCC. The latter includes returning unopened the examination envelope of any applicant who fails to take his examination.

London, England: If you are in Great Britain between July 8 and 20, look in on the City of London Festival. The Radio Society of Great Britain (RSGB) will present an amateur radio exhibit and operate GB2LO during the festival. Get full details from the RSGB, 28 Little Russell St., London WC1, England. If you do not make the scene, keep an ear open to work GB2LO.

Vancouver, Canada: Last summer, Canadian amateurs set up a network across Canada to carry the communications involved in organizing and holding the Pan-American Paraplegic Games in Winnipeg. Sydney E. G. Lashley, VE4SD, Winnipeg, was net control station, and Harry W. Beardsdell, VE7ZQ, 2648 East 6th Ave., Vancouver 12, B.C., held down the Vancouver end of the circuit.

In September, the first Canadian National Wheelchair games were held in Montreal, and the National Wheelchair Athletic Association was formed to hold these games in a Canadian city each year and to send a Canadian wheelchair team to future international paraplegic games. VE7ZQ, who is a Canadian-Pacific airline pilot, was appointed Communications and Transport Manager of the group.

This year's wheelchair games will be held in Edmonton, Alberta, during the last week

of August. The amateur net meets each Friday at 1600 GMT on 14160 kHz to handle details. VE6RD, located in the Rehabilitation Centre in the University of Alberta, Edmonton, is the NCS.

As an outgrowth of the above activities, the Canadian National Handicappers Net meets on 14160 kHz at 2000 GMT each Wednesday and now has 15 regular members. And that's not all. Harry, VE7ZQ, and fellow members of the Canadian Pacific Amateur Radio Club are teaching amateur radio to nine patients in the polio ward of the Pearson Hospital in Vancouver. All students are making excellent progress, and by the time you read this, it is expected that at least three of them will have qualified for their licenses, and the club will have set up a complete amateur station at the hospital.

New York, N.Y.: At the spring Electronics Industries Association meeting in New York, Irving Strauber, W4KXD, Amateur Product Manager of the Hammarlund Manufacturing Company, Mars Hill, N.C., suggested simplifying the Novice examination to increase the applicants for Novice licenses.

This columnist believes that in view of the FCC's unhappy experiences with no-exam CB licenses, the chances of simplifying the Novice examinations are virtually nil. And really the basic problem is not the difficulty of the Novice examination; it isn't that hard! For example, I recently gave the test to an 11-year-old, fifth-grade girl, who passed it with flying colors.

The problem is lack of encouragement. Unfortunately, too many amateurs recite (and almost believe) the fairy tale, "Let the newcomers do as I did when I wanted to become a ham. No one helped me. I got a 'License Manual' and studied by myself until I passed the examination."

(Continued on page 92)



ON THE CITIZENS BAND

By MATT P. SPINELLO, KHC2060, CB Editor

WITH THE EXCEPTION of hundreds of CB Jamborees held throughout the U.S. and Canada, CB club activity normally drops off this time of the year. Vacations and outdoor activities take precedent, leaving most clubs with no alternative but to close up shop until the fall, keeping only emergency communications and first aid teams on standby alert.

For your columnist this has been a welcomed opportunity to answer his mail. Some of the questions are pretty interesting and are reprinted below.

Replacement Crystals. *"My rig is 5 years old and I need crystals for new channels. Where can I get replacement information?"*

There are many places, but since you didn't mention your rig type, write to Bomar Crystal Co., 737 Lincoln Blvd., Middlesex, N.J. 08846 for a catalog. You can also get help from CTS Knights, Inc., Sandwich, Ill. and possibly Shepherd Industries, 7900 Pendleton Pike, Indianapolis, Ind.

Make Walkie-Talkies Handy. *"Why not a walkie-talkie with a short antenna and shoulder-mounted speaker? It looks silly walking around with a 5-foot antenna sticking out of a pack of cigarettes."*

Good point and we hope that some of the CB manufacturers take note. Antenna Specialists Co. (12435 Euclid Ave., Cleveland, Ohio 44106) does sell a shortened whip for walkie-talkies. It is called the WT-1. The shoulder speaker came and went years ago. The Morrow VP100 is one of the few units I remember that had such an arrangement.

Think Positive. *"Why isn't something done about getting more of the public on the side of the CB'ers? After all CB does a lot of good work."*

The Electronics Industry Association is doing something. About 30 CB equipment manufacturers have banded together in an attempt to educate the public about the advantages of CB two-way radio. Magazine ads (see Popular Electronics, June, 1968) have started to appear and these will be followed by a campaign on TV and AM radio. The EIA also hopes to better the understanding between CB'ers and governmental and public service organizations.

(Continued on page 94)

OTCB JAMBOREE CALENDAR

At press time the following get-togethers, banquets, or jamborees had been brought to our attention. For more details, contact the clubs or representatives at addresses given.

Glens Falls, New York July 13-14
Event: Glens Falls Area CB'ers Jamboree. Location: Washington County Fairgrounds, Rt. 29 between Schuylerville and Greenwich, N.Y. Contact: Jamboree Chairman, P.O. Box 251, Hudson Falls, N.Y. 12839.

Bethlehem, Connecticut July 14
Event: Naugatuck Valley CB'ers Jamboree. Location: Bethlehem Fair Grounds. Contact: Mrs. Lorraine Seeley, Fairview Circle, Watertown, Conn. 06795.

Watertown, New York July 20-21
Event: MCEU 8th Annual National Convention. Location: Watertown, N.Y. Contact: National MCEU Headquarters, P.O. Box 38, Syracuse, N.Y. 13201.

Wheeling, West Virginia July 21
Event: Sixth Annual CB Picnic. Location: White Palace, Wheeling Park, Wheeling. Sponsor: Fort Henry CB Radio Club. Contact: CB Picnic, P.O. Box 1127, Wheeling, W. Va. 26003.

Lockport, New York July 26-28
Event: Second Annual Campout & CB Roundup. Location: Niagara County Farm & Home Center, Rt. 78, Lockport, N.Y. Contact: N.A.C.O.M., P.O. Box 281, Lockport, N.Y. 14094.

Painesville, Ohio July 27-28
Event: Fourth Annual CB Jamboree & Campout. Location: Lake County Fairgrounds, Rt. 20. Sponsor: 5 Watters of Lake County.

Lowell, Massachusetts July 28
Event: Sixth Annual Massachusetts State Jamboree. Location: Tyngboro Country Club, Rt. 113, Tyngboro. Contact: Jamboree Chairman, 5 Watt Whips, Box 201, Lowell, Mass. 01851.

Louisville, Kentucky July 28
Event: Third Annual Jamboree. Location: Funland Amusement Park. Contact: Ronald Zibart, 111 Juneau Dr., Middleton, Ky. 40043.

Nova Scotia, Canada August 16-18
Event: Annual GRS/CB Jamboree. Location: Cameron Lake. Sponsor: Kingfisher CB Radio Club. Contact: Doug Corkum, 30 Joyce Ave., Spryfield, Nova Scotia, Canada.

Denver, Colorado August 17-18
Event: Metro CB Jamboree. Location: Jefferson County Fairgrounds. Sponsor: Metropolitan Denver CB Club. Monitor: Channel 9.

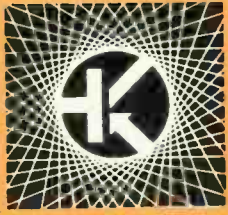

SOLID STATE

By LOU GARNER, Semiconductor Editor

PERHAPS NOT THIS YEAR, or next, but a pocket-sized radar set is likely to come along in the not too distant future. Engineers have successfully compressed all the circuitry of a microwave transmitter, receiver, and antenna system into a unit small enough to hold in the palm of your hand (see photo).

Designed by engineers at Texas Instruments, Inc. (Semiconductor Components Division, P.O. Box 5012, Dallas, Texas 75222) using components developed under the U.S. Air Force's MERA (molecular electronics for radar applications) program, the mini-radar module measures only 3" by 1" by 0.5" overall. It is part of a new experimental airborne solid-state radar system. In practice, 604 of these modules are assembled into an antenna array measuring about 27 inches in diameter which uses electronic, rather than failure-prone mechanical, scanning techniques.

Instead of physically moving a single large antenna along horizontal and vertical

planes, a compact digital computer precisely adjusts the phase of the pulse signals radiated by each module in the array. For example, when the array scans to the left, the modules on the right side begin emitting pulses with phase angles slightly ahead of the pulses radiated by modules on the left. The phase relationships shift according to a programmed sequence, simulating electronically, the mechanical rotation of the antenna, and eliminating the need for motors, servos, power control circuits, gear trains, and scores of other complex electro-mechanical parts.

Although hundreds of the modules are used in the present system, each module is—in itself—a complete and virtually independent microwave transmitter, receiver, and antenna system. This insures an unusually high degree of reliability, for the system will continue to function adequately even with as many as 10% of its elements knocked out.

Potentially, the individual modules could be modified for use as pocket-sized micro-

Solid-state microwave radar module (right) includes transmitter, receiver and antenna. Texas Instruments uses 604 modules to make airborne phased antenna radar array (below).

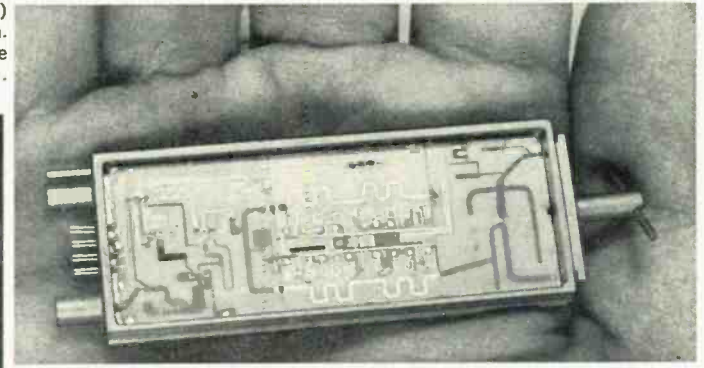

wave transmitter/receivers, with possible future applications in milling machine controls, surveying equipment, point-to-point communications, highway (automobile) anti-collision equipment, liquid level gauges, and even in remote controls for TV sets and household appliances. Although understandably expensive at present, module prices within the \$50 range are anticipated as mass production techniques are refined.

Reader's Circuit. A prospective Novice can be "on the air" even before he qualifies for his ticket if he assembles the circuit illustrated in Fig. 1, using it in conjunction with a conventional broadcast band receiver. Essentially a home broadcaster (see last month's column) modified by the addition of a built-in tone modulator, the project was submitted by reader, Alan Brookstone (17401 N.W. 19 Ave., Miami, Fla. 33054), who feels that wireless code practice is not only more realistic than that obtained with a conventional code-practice oscillator (CPO), but a lot more fun. The unit has a limited range, in keeping with FCC requirements, but is adequate for room-to-room practice.

Referring to the schematic diagram, *pn*p transistor *Q1* is used in the common-emitter configuration as a tickler-feedback audio oscillator, with transformer *T1* providing the collector-to-base feedback needed to start and sustain oscillation. Potentiometer *R1* controls feedback current, thus permitting an adjustment for optimum performance. The r.f. oscillator (*Q2*) is an *n*pn unit used in a modified Hartley arrangement. Base bias is supplied through *R2*, bypassed by *C2*, while the circuit's operating frequency is determined by tuned circuit *C1-L1*, with the coil tapped to provide the feedback needed for oscillation. Emitter modulation is used, applied through impedance matching transformer *T2*.

Alan's circuit is unique in that he keys *only* the tone source permitting the r.f. oscillator to operate continuously. This technique minimizes frequency shift that can occur as an r.f. oscillator is switched on and off.

Readily available, low-cost parts are used in the project: *Q1* is type 2N107, and *Q2* 2N170; *T1* and *T2* are miniature 1200:3.2-ohm output transformers; *C1* is a 360-pF tuning capacitor or adjustable padder, while *L1* is a tapped broadcast band ferri-loop-stick antenna coil.

Neither parts layout nor wiring dress are critical, and the circuit may be assembled on a small chassis or on a perf or etched circuit board. Alan writes that he assembled his original model on perf board, mounting the unit in a small plastic box. The antenna

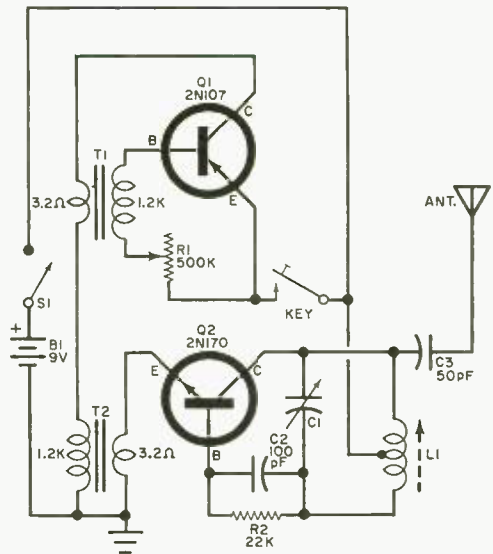

Fig. 1. This wireless CPO, suggested by Alan Brookstone, is a very low power transmitter tuned to the AM BCB. Good for room-to-room CW practice.

can be either a short length of hook-up wire or a short vertical whip.

In operation, the unit's (r.f.) output frequency should be adjusted so that its signal is picked up at a "dead" spot (*i.e.*, where no local stations are received) on a nearby AM receiver. This is accomplished by adjusting either *C1* or *L1*. Afterwards, *R1* is adjusted for the best compromise between tone quality and volume. If you are unable to obtain an audio tone, try reversing *T1*'s primary or secondary (not both) lead connections.

Manufacturer's Circuit. One of the dozens of projects illustrated in General Electric's interesting *Transistor Manual*, the circuit shown in Fig. 2 can be used as the basis for an inexpensive, but extremely useful, multi-station signalling system suitable for an office, shop, school, or home. With a minimum of parts needed, the circuit can be assembled, and—in most cases—installed in a single evening.

Note that an unijunction transistor (UJT) is used as a relaxation oscillator to drive a PM loudspeaker. Base-2 bias is supplied through *R5*, while the loudspeaker's voice coil serves as an output load. The circuit's repetition rate (frequency) is determined by the *RC* time constant in the UJT's emitter circuit, and hence by emitter return resistor *R4*, capacitor *C1*, and the particular charging resistor (*R1*, *R2*, or *R3*) chosen as the appropriate push-button switch (*S1*, *S2*, or *S3*) is closed. In operation, *C1* is charged

slowly by the d.c. source (*B1*) through *R1*, *R2*, or *R3*, and discharges through the UJT's emitter-base-1 junction and the loudspeaker's voice coil when *C1*'s voltage forward biases the emitter junction, overcoming the internal reverse bias established by *R5*. The action repeats as long as a charging voltage is applied to *C1*, developing an harmonic-rich output signal.

Standard components are used in duplicating this project. All resistors are half-watt types; *C1* is a 25-volt capacitor, the UJT is type 2N2646, *S1*, *S2*, and *S3* are normally-open momentary contact s.p.s.t. push-button switches, and *S4* is an optional power switch, which can be any s.p.s.t. type, as preferred. Loudspeaker size and voice-coil impedance are not critical—4-, 6-, 8-, or even 16-ohm units may be used. The 25-30-volt d.c. power source (*B1*) may be a line-operated power supply, or three series-connected 9-volt batteries.

With neither lead dress nor parts arrangement critical, the basic device may be assembled using your favorite technique—point-to-point wiring, perf board, etched circuitry, or terminal strip construction. It may be housed in the loudspeaker's baffle, in a separate case, or even in a standard outlet box.

The system's final installation is a straightforward job comparable to that of wiring the familiar doorbell circuit. The loudspeaker is placed in a central location with remote speakers (if needed) connected in parallel with the main unit. Two, three, or more speakers may be used without changing the basic circuit. The individual control push-buttons are installed at the desired signalling points. Typically, *S1* might

be installed by the front door, *S2* at the rear door, and *S3* at a side entrance. Each switch, when depressed, sounds a different and distinctive tone, thus identifying its location. Switch and remote loudspeaker (if used) connections to the oscillator circuit can be made using bell wire, conventional hook-up wire, or twin-conductor line cord.

Device News. A family of linear integrated circuits designed for low-cost entertainment applications has been introduced by the *P. R. Mallory & Co., Inc.* (3029 E. Washington St., Indianapolis, Ind. 46206). Available in both in-line and TO-type packages at prices ranging as low as 80 cents each in production quantities, the new line includes signal (type MIC 0101) and dual (type MIC 0103) preamps designed for use with magnetic transducer inputs, and driver amplifiers (type MIC 0201) designed for use with class-A single ended *pnp* power stages. All units are of silicon monolithic construction.

An inexpensive integrated circuit voltage regulator is now available through *Westinghouse* semiconductor distributors. Identified as type WC109T, the new IC unit contains seven transistors, two zeners, three diodes, one SCR, and ten resistors. It can regulate currents up to 150 mA over the range of from 4 to 15 volts, maintaining regulation at the desired voltage level within 1% regardless of line, load, or temperature variations. With built-in overload protection, the new device is packaged in a 12-pin transistor can and sells for slightly under \$5 each in small quantities.

The first silicon *pnp* large-signal, high-frequency power transistor has been announced by *Motorola Semiconductor Products, Inc.* (P.O. Box 13408, Phoenix, Ariz. 85002). Designated as type 2N5160, the new unit is designed as a complement for *nnp* type 2N3866 in VHF and UHF circuit applications, and is the forerunner of a series of complementary *pnp* units. Fabricated using a multiple emitter overlay geometry and packaged in a TO-39 case, the 2N5160 is suitable for use in class-A, -B, or -C output, driver, or oscillator applications at frequencies up to 800 MHz. Detailed specifications are available from the manufacturer.

Transitips. Attending a club picnic meeting recently, your columnist had the opportunity to examine a dozen or so hobbyist-assembled projects. The units ranged from simple 2-transistor circuits to fairly complex instruments. Some were assembled from kits, others on commercially etched circuit boards, and a few on rough breadboards. All were wired correctly with new parts
(Continued on page 96)

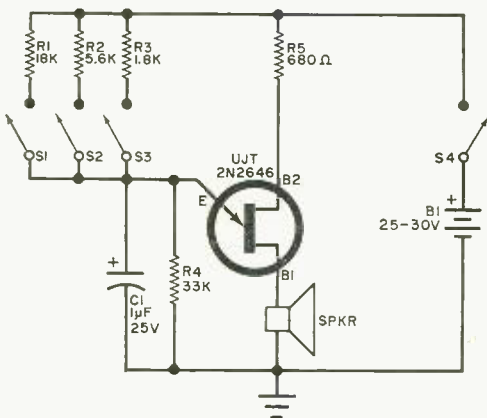

Fig. 2. Three, or more, distinctive tone signals can be generated by this electronic doorbell developed by General Electric. Each pushbutton feeds different value resistor (*R1*, *R2*, *R3*) to create tone note.



OPERATION ASSIST

Through this column we try to make it possible for readers needing information on outdated, obscure, and unusual radio-electronics gear to get help from other P.E. readers. Here's how it works: Check the list below. If you can help anyone with a schematic or other information, write him directly—he'll appreciate it. If you need help, send a postcard to Operation Assist, POPULAR ELECTRONICS, One Park Avenue, New York, N.Y. 10016. Give maker's name and model number of the unit. If you don't know both the maker's name and the model number, give year of manufacture, bands covered, tubes used, etc. State specifically what you want, i.e., schematic, source for parts, etc. Be sure to print or type everything legibly, including your name and address. Because we get so many inquiries, none of them can be acknowledged. POPULAR ELECTRONICS reserves the right to publish only those items not available from normal sources.

Meissner Model EX "Signal Shifter" transmitter.
Browning-Drake Model 5-R receiver. Any available information wanted. (A. Christopher Wilson, 15 Bracebridge Rd., Newton Centre, Mass. 02159)

Detrola Radio multiband radio receiver, 1937; chassis 155E. Transformer identification needed. (Eric Mersall, 860 40 St., Wyoming, Mich.)

Oral Model TR-700 tape recorder. Instruction manual, source for parts, and schematic needed. (Howard S. Cohen, 949 Ascan St., Valley Stream, N.Y. 11580)

GE Model EF-150 short-wave receiver, 1961. Instruction manual and schematic needed. (Edward Stone, 9613 Bristol Ave., Silver Spring, Md. 20901)

Supreme Model 502 tube tester. Tube list booklet, schematic, and source for NE-1W neon lamp needed.

Hickok Model 533 mutual conductance tube tester. Up-to-date tube list and source for panel meter needed. (Jim Gianacos, 8537 S. 115 Place, Seattle, Wash. 98179)

Hallcrafters Model S-53A AM/SW receiver. Tuning dial, schematic, and tuning alignment instructions needed. (L.A.C. Galbaransingh, C.F.B. Greenwood, Nova Scotia, Canada)

RCA Model C8-15 radio receiver. Schematic needed. (Bernard Borglum, RD #4, Pre-emption Rd., Penn Yan, N.Y. 14527)

Airline Model 62-357 radio receiver. Schematic and 17A35 coil needed. (Marion Strang, RD #2, Smethport, Pa. 16749)

Meissner Model 9-1065 record cutter. Astatic X-26 crystal cutting cartridge needed. (Fred Rice, 1933 Greymont St., Philadelphia, Pa. 19116)

GE Model F-96 superhet SW/BCB receiver. Schematic and tubes needed. (Steve Jacobsmeier, 917 S. Hi-Lusi, Mt. Prospect, Ill. 60056)

Eveready Model 2 BCB receiver, circa 1929. Schematic needed. **RCA** "Radiola 18" BCB receiver. Values of power supply resistors needed. (James L. Bochantin, Rte. 1, Box 54, DuBois, Ill. 62831)

RCA Model MI-12875 magnetic wire recorder. Microphone and wire cartridge needed. (Fred Van Pala, 70-64 45 Ave., Woodside, N.Y. 11377)

Airline Model 4130 TV receiver; UHF-VHF portable. Output transformer part #R2684 needed. (Leo Stratman, 106 W. Maryland St., Evansville, Ind.)

Weathers Industries hi-fi turntable. StereoRamic cartridge with five thin pins for connections needed. (Scott Arrowsmith, 307 Hayden, E. Quad, Ann Arbor, Mich. 48104)

Knight Model KN-400B stereo amplifier. Assembly manual, schematic, and parts source needed. (David Teegarden, 1233 N. Denver Ave., Tulsa, Okla. 74106)

Fada neodyne receiver, circa 1927; #175-A. Schematic needed. (Vernon Wood, 1800 Corbett, Las Cruces, N.M. 88001)

Times Model 9R-301A transistor radio. Schematic and source of parts needed. (A. Seroko, 723 Pritchard Ave., Winnipeg 4, Manitoba, Canada)

Weston Model 695 power level indicator/voltmeter, #3A CV-22195. Schematic and instruction manual needed. (Robert W. Conway, 5511A Guadalupe, Austin, Texas 78751)

RCA Model U-2 UHF converter. Instruction manual and/or schematic needed. (Geoffrey Marcus, 46 Deepdale Dr., Great Neck, N.Y. 11021)

RCA-Victor 8T superhet receiver, circa 1930. Schematic and parts source needed. (Kevin E. Mather, 10161 McCallum Ave., N.E. Alliance, Ohio 44601)

Gilbert Davis Instrument Model 214 dwell tachometer tester. Schematic instruction manual, and parts list needed. (Maurice P. Stannard, 747 Boulevard Rd., Olympia, Wash. 98501)

Hallcrafters Model S-53 receiver. Instruction manual and schematic needed. (W.L. Crutcher, 3709 43 St., Lubbock, Texas)

RCA Model 85E superhet receiver, circa 1937. Schematic, operating manual, and source of parts needed. (Jim Provines, RR #3, Auburn, Ind. 46706)

Radio City Products Model 411 "Superstester." Schematic needed. (Lon M. Rose, Rte. 1, Box 6S1, Marion, Ark. 72364)

Packard Bell Model 5R1 radio receiver. Schematic needed. (Jose Grajeda, 3232 Granada St., Los Angeles, Calif.)

Ford Model O4BT truck AM receiver, made by Bendix, circa 1961. Source for audio output transformer, Bendix part N2090849-2, needed. (Gus A. Green, 12692 Green St., Boron, Calif. 93516)

ATR Model EL10 rectifier power supply, type 120C. Schematic and terminal information needed. (A.W. Small, 500 N. First St., Burbank, Calif. 91502)

Superior channel analyzer, circa 1940. Operating manual needed. (George Feser, 219-14 94 Ave., Queens Village, N.Y. 11428)

Graybar Model 300 receiver, circa 1927. Schematic needed. (Steven Grau, 927 Denison, Manhattan, Kan. 66502)

National Model NC109 short-wave receiver. XCU-109 crystal and NFM 83-50 adapter needed. (Alan Goldstein, 1334 Virginia St., Far Rockaway, N.Y. 11691)

Westinghouse Model WR-8 BCB receiver, made by RCA, circa 1930. Schematic needed. (Bill Valentine, 139 E. Grove Ave., Mesa, Arizona 85201)

Arkay Model VT-10 vacuum-tube voltmeter. Schematic and operating manual needed. (G.A. Varnum, RA 17614741, HQ Co., USA Avn., Maint. Center, APO, New York 09028)

New York Transistor Corp. Model BE-102 receiver. Schematic, parts list, and alignment instructions needed. (Arthur H. Steinberg, P.O. Box 48, New Ulm, Minn. 56073)

Telectro Model 300 tape recorder. Belts needed. (Dave Hamilton, 522 River Rd., Rte. 1, Paw Paw, Mich. 49079)

Hickok Model 539A mutual conductance tube tester, circa 1953. Operating manual and schematic needed. (Douglas Hively, 4476 Dove Dr., Beale AFB, Calif. 95903)

Hallcrafters Model SX-24 receiver, circa 1945. Schematic and operating manual needed. (Jack Segal, 6240 Zelzah Ave., Reseda, Calif. 91335)

Precision Apparatus Series 912 "Electronic" tube tester, circa 1948. Schematic, operating manual, and latest roll chart needed. (Carlos F. Arredondo, Condominios "Constitution," Edificio #12, Depto. #6, Monterrey, N.L., Mexico)

Wurlitzer Model 506 amplifier. Schematic and information on phono jacks labeled "muting switch" and "aux amp" needed. (Bill Laughlin, 1504 S. 93 Ave., Omaha, Nebr. 68124)

Lafayette Model LT325. Alignment instructions needed. (Alan Turof, 150 Gates Manor Dr., Rochester, N.Y. 14606)

Tele-Tone Model TV149B, circa 1948. Schematic and servicing data needed. (Joseph E. Mastrolanni, 10 Maple St., Indian Head, Md. 20640)

EICO Model 470K 7" oscilloscope. Parts needed. **EICO Model 488 K** electronic switch. Schematic needed. (Billy K. Hart, 32 Best Dr., Saraland, Ala. 36571)

Rogers Majestic "Jacques Cartier" receiver; type 58. Schematic and alignment data needed. (Max Schumann, 339 King St., Oshawa, Ont., Canada)

Metz Model 3501 DK TV-radio-phono combination, made in West Germany. Schematic and tubes needed. (Capt. D.E. Woodruff, Box 719, Montauk, N.Y. 11954)

Electronics, Inc. Model P38 d.c. power supply. Schematic needed. **B & K Model 1000 TV** generator. Schematic and instruction manual needed. (Max Wymore, Anderson, Spangler & Wymore, 1700 Broadway, Denver, Colo. 80202)

Viking Universal radio receiver; made by Dominion Electrohome Industries; tunes broadcast band, 19, 25, 31, and 49 meters. Tube basing diagram and schematic needed. (Lyle C. Fahiman, 54 Bayview Dr., Transcona 25, Manitoba, Canada)

John Meck Industries, Inc. Model T60-1 radio telephone/telegraph transmitter. Instruction manual or schematic needed. (Roy A. Hyikema, 41 Darlingside Dr., West Hill, Ont., Canada)

RCA Model 151 cathode-ray oscillograph, circa 1945. Operating manual and/or schematic needed. (Mark Feller, Box 97, E. Bernard, Texas 77435)

Hallicrafters Model S-20R receiver. S-meter needed. (Larry Wallman, 203 Winifred Ave., Lansing, Mich. 48917)

Superior Model TW 11 tube tester. Schematic and operating instructions needed. (Abe Morgan, 54 3rd St., New Aberdeen, Glace Bay, Nova Scotia)

Stromberg-Carlson Model CCT-46104 radio receiver. Schematic needed. (James Salzein, 600 Isle of Palms, Ft. Lauderdale, Fla. 33301)

Bell Model 360 stereo recorder and copier. Operating manual needed. (W. Portische, 354 E. Sonora St., San Bernardino, Calif. 92404)

Triumph Model 3279 motor-generator set, type B-7. Ampere output rating of generator and date of manufacture wanted. (Mike Martin, 710 Colorado, Louisville, Ky. 40208)

Link Type 2240 FM transmitter and Type 1905 FM receiver. Schematics and servicing information needed. (John Aughey, 134 W. 2nd St., Hobart, Ind. 46342)

Kolster Class 42000 radio chassis and Class 47000 amplifier and power supply chassis. Sources of parts, tubes, and speaker needed. Also schematic and tube replacement chart. (Jeff Bush, 5 Deane Way, Red Bank, N.J. 07701)

Atwater Kent Model 55 receiver. Schematic, parts list, source for parts, and instructions needed. (Les Tucker, 2628 Chatam St., N.W. Roanoke, Va. 24012)

Philco radio/phono combination, chassis 70SA. Schematic and any available information wanted. (Harry Rodd, 373 Ontario St., Toronto, Ont., Canada)

Diamond Model 1139 stereo tape player. Wiring diagram and parts list needed. (A.E. Green, 416 E. 27 St., Hialeah, Fla. 33013)

Accurate Instrument Model AT 162 dwell-tachometer. Schematic and instruction manual needed. (R.L. Gagnon, 84 Hampshire St., Holyoke, Mass. 01040)

Precise Model 630 marker generator. Operating manual needed. (Dennis Cochia, 604 Hambrick, Dallas, Texas 75218)

National Model NC-46 receiver. Schematic and manual needed. (Rex Moore, RR 1, Cochrane, Wis. 54622)

Montgomery Ward Model 04BR 729A short wave AM radio receiver. Schematic, parts list, and operators manual needed. (David Graham, R.F.D. 4, Box 160, Bluefield, W. Va. 24701)

RCA AM-FM phono combination; chassis RC-613A. Information on type of speaker and how to hook up needed. (A. Moxness, 1969 Stanford, St. Paul, Minn. 55105)

Fisher Research Laboratory Model Shipmate F marine radio receiver, circa 1940. Schematic and alignment instructions needed. (Roy C. Vornell, Jr., 4137 Collin St., Ft. Worth, Texas 76119)

Grundig Model TK-820 tape recorder. Schematic needed. (Thomas Holloway, 522 Hungry Harbor Rd., N. Woodmere, N.Y. 11581)

Hallicrafters Model SX-28. Operation manual and alignment data needed. (Wilbert Stenzel, 386 Fletcher St., Tonowanda, N.Y. 14150)

Remler, Model 10 five-tube receiver, circa 1930. Schematic needed. (Steven Benham, Rt. 1, Box 1526, Brenton, Wash. 98310)

Chevy Model C-360 auto radio. Schematic needed. (Edward Kozacic, 501 156 St., Calumet City, Ill. 60409)

Super Air Castle Model 922/2050 receiver. Schematic, operating and service data, and source for parts needed. (Robert E. Douglas, 34 Benjamin St., Meriden, Conn. 06450)

RCA Model VHR-307. Schematic, operating manual, and repair data needed. (Ted Larson, 560 Central Ave. S., Milaco, Minn. 56353)

RCA Model 18T 8-tube radio; chassis 540423. Schematic needed. (Paul H. Hayden, Rt. 2, Box 262, Wentzville, Mo. 63385)

Fairchild SM-1 stereo phono cartridge. Diamond needle needed. (Mark Fountain, 1432 W. Roberta, Fullerton, Calif. 92633)

Heath SG-6 signal generator. Construction manual needed. (Tom Dornbach, 19W167 21st, Lombard, Ill.)

Philco Model 40-95 battery radio receiver. Speaker and service diagram needed. (W. Hoyt Poston, Rt. 2, Box 156, Pamplico, S.C. 29583)

Philco Model 41-608 radio-phono combination. Schematic needed. (Robert J. Galligan, Box 326, Niantic, Conn. 06357)

Dectron Model DG-2 geiger counter. Schematic and instruction manual needed. (Randy Gill, 6912 E. Pasadena, Scottsdale, Ariz. 85251)

Splitdorf Model R-582 neutrodyne receiver, circa 1922. (Darrell Loeffler, 82 Lincoln Ave., Dover, N.J. 07801)

Superior Model 450 tube tester. Schematic and instruction manual needed. (Everett Olin, 113A Ganesvoort Rd., S. Glens Falls, N.Y.)

Paco Model S-50 oscilloscope. Assembly manual, chassis, and transformer needed. (Robert Ayres, 264 Lauren Ave., Pacifica, Calif. 94044)

Globe Chief 90A transmitter, circa 1959. Schematic needed. (Richard Mahler, 3111 Brian Ct., Arcata, Calif. 95521)

RME Model 6900. Manual and schematic needed. (Robert D. Randall, 122 Nahdrette, Durand, Mich. 48429)

Silvertone radio, circa 1939-40; has eight tubes; covers 0.55 MHz to 18 MHz; has a beat oscillator. Schematic and service information needed. (Kipp Kramer, III, 100 Pine Lake Dr., Elizabeth City, N.C. 27909)

Recordio, General Ind., RCA or any other disc, record cutting unit wanted and/or parts. Must be manufactured before 1954. (Mark Wozniak, 4174 S. Taylor Ave., Milwaukee, Wisc. 53207)

Reiner Electronic's Model 550-A oscilloscope. Schematic needed. (Edwin Halvorsen, 2610 N.W. 22 Ave., Miami, Fla. 33142)

Stromberg Carlson radio; has 10 tubes; 1929 model. Two UX245 or CX345 (or equivalent) tubes needed. (James M. Yorke, 612 Greenland Dr., Fayetteville, N.C. 28305)

SOURCES OF INFORMATION

"Operation Assist" is published as a service to the readers of POPULAR ELECTRONICS who cannot find schematics, parts, etc., for old or no-longer-manufactured equipment. Military—or Government surplus—equipment is not itemized in this column, since schematics and copies of Tech Manuals for military equipment can be obtained from a variety of independent sources: Slep Electronics, Drawer 178, Ellenton, Florida 33532; Quaker Electronics, P.O. Box 215, Hunlock Creek, Pa. 18621; etc. Unusual or difficult-to-find schematics and servicing information can frequently be obtained from Supreme Publications, 1760 Balsam Rd., Highland Park, Ill., for a slight charge.

tips & techniques

PERMANENT MAGNET SERVES AS BULK ERASER

Need a bulk eraser for your recording tapes? If you do, but can't justify the cost since you will use it only occasionally, try doing the job with a small permanent magnet. To erase a magnetic tape with the permanent magnet,



thread the tape on your recorder as you normally would if you were going to record or play back, and hold the magnet as close as possible to (but not touching) the tape. Then activate the "fast-forward" or "rewind" control, and the magnet will erase all tracks.

—Fred Blechman

MAKE INEXPENSIVE FEEDTHROUGH INSULATORS AND HERMETIC TERMINATIONS

Defunct "top hat" diodes can be converted for use as feedthrough insulators and/or hermetic terminations for your projects. To prepare such a diode, you remove the flange cap by carefully filing it until the welded joint parts (see photo). Then use pliers to round out the pin on the crown of the diode case, and remove the wire lead from the pin. This leaves the glass-to-metal —Kovar—seal intact. Now, drill a hole (the same diameter as that



of the crown of the diode case) in your chassis, insert the case in the hole, and solder the flange to the chassis. If you need a feedthrough insulator, just slide the wire through

the pin in the crown of the diode case; for a hermetic termination, strip about $\frac{3}{8}$ " of insulation from the terminal wire, slide the wire into the pin, and crimp the pin for a firm joint.

—H. St. Laurent

PROTECT MOSFET FROM ELECTROSTATIC DESTRUCTION

The very high input resistance of a MOSFET is due to a microscopically-thin film of glass deposited between the transistor chip and metal gate electrode. This film is so delicate that friction-produced electrostatic charges built up by allowing the MOSFET to slide around inside a plastic box—or even handling —without proper precautions will puncture the film. To protect a MOSFET from electrostatic destruction, the leads must be kept shorted together at all times except when the unit is in a circuit. Press the MOSFET leads between the coils of a small-diameter spring—while keeping the leads twisted or shorted together. It may be necessary to stretch the spring slightly, but the spacing of the turns must be kept less than the diameter of the MOSFET's leads to insure a short circuit. Then pass a length of copper wire through the spring, bending the ends at right angles as shown, to hold the MOSFET in place.



—Frank H. Tooker

TWIN-LEAD ANTENNA CABLE DOUBLES AS DURABLE SHOULDER STRAP

Ever need to replace broken shoulder straps on your portable tape recorder, CB transceiver, or camera case? If you have this problem, a length of flat 300-ohm twin-lead antenna cable can come to the rescue. Simply cut away the leather or plastic strap from the securing hardware, pass the ends of the twin-lead through the hardware, and staple each end securely. Good-quality twin-lead won't stiffen up and crack in cold weather, and chances are it will be a lot more durable than the original strap that came with the equipment.

—James E. Arconati



IDENTIFYING SPACE AGE RESISTORS

Anyone who has visited his local surplus parts supplier recently has probably come across precision "Space Age" or MIL type resistors. If precision metal film, these resistors can be identified by the curious coding stamped on them (such as, RN6049R9F). Unless you know how to interpret this code, you have to buy blind. However, it is relatively

TIPS

(Continued from page 85)

simple to identify some of these resistors. The first four digits in the code tell you the power rating—RN60, RN65, RN70, RN75, and RN80 indicate $\frac{1}{8}$ -, $\frac{1}{4}$ -, $\frac{1}{2}$ -, 1-, and 2-watt units, respectively. Of the next four digits, the first three are the significant figures of the resistance value, and the fourth indicates the number of zeros. Insertion of the letter "R" in the midst of these four digits locates the decimal point for values less than 100 ohms. The last letter, "F," indicates that the resistor has a 1% tolerance. In the above example, the code is read: $\frac{1}{8}$ watt, 49.9 ohms, and 1%.

—Herman W. Frisch

SUBMINIATURE CONNECTORS FOR PROJECTS AND EQUIPMENT

You can make inexpensive subminiature connectors from 6-, 8-, or 10-pin TO-5 integrated circuit sockets. A socket with the wires from the circuit soldered to the pins serves as the female connector. The male connector must be prepared by carefully melting a small amount of solder into each of the IC socket's holes. Then cut the required number of lengths of wire (transistor or IC leads make a perfect fit) to $\frac{1}{4}$ " or $\frac{3}{8}$ ". Heat the pins of the IC socket, and drop in the lengths of wire. Then solder the wires to the appropriate pins on the male connector. Finally, slip a 1" length of heat-shrinkable tubing over each connector, and shrink it in place.

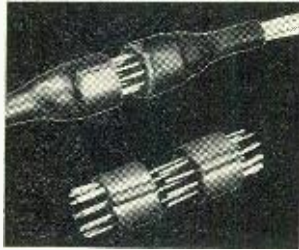

—C. A. Schieszer

TRANSISTOR HEAT RADIATOR EXTENDS NUVISTOR TUBE LIFE

If a Nuvistor tube could be operated at a lower ambient temperature its life might be extended. With this in mind,

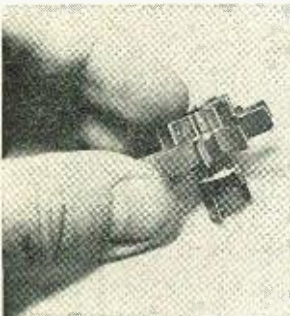

attach a transistor heat radiator to the top of the Nuvistor's envelope as shown in the photo. The fins will provide a larger radiating surface, thus increasing heat radiation efficiency. Any heat radiator that will fit snugly over the Nuvistor will serve.

—Richard Mollentins, WAØKKC

METAL BRACKETS PUT AN END TO SNARLING POWER CORDS

When storing Heathkit test equipment, it is often difficult to keep the power cord from sprawling all over the place. To solve this problem, you can drill two holes about half way through each end of the carrying handle and secure L brackets to the ends with self-tapping screws, or you can secure double-L brackets under the handle, anchoring them in place with the handle's mounting screws. To prevent the sharp edges of the brackets from chafing through the insulation of the power cord, slip some heat-shrinkable tubing over the brackets and shrink the tubing for a snug fit. Finally, wind the power cord around the handle as shown in the photo.



—Stephen LaFleur

INEXPENSIVE PILOT LAMP ASSEMBLIES

Looking for a low-cost, easy-to-mount indicator lamp assembly for your projects? Well, you can't get much less expensive than making an assembly from an NE-2 lamp, clear plastic cable clamp, and a two-lug terminal strip. The first thing you do is decide where



you want to mount the lamp assembly; then drill a $\frac{1}{4}$ " hole through the panel in that location. Next, slide the lamp inside the cable clamp, and place the assembly against the panel to determine where to drill the mounting hole. Then, after drilling the second hole,

place the mounting lug of the terminal strip between the cable clamp and panel, and secure them in place with appropriate hardware. The terminal strip provides a convenient mount for the series dropping resistor needed for the lamp. For colored lamps, use colored plastic tape, placing a $\frac{1}{2}$ " length over the hole on the inside of the panel.

—Donald R. Hicke

OUT OF TUNE

M/M/M INSTRUMENT AMPLIFIER, Part I (April, 1968, page 44). Change the type numbers for Q1 and Q3 to read MM3005 and for Q2 to read MM4005. The same applies to the Parts List.

—50—

ELECTRONICS library

QUIET

SOLID-STATE ELECTRONICS: A BASIC COURSE FOR ENGINEERS AND TECHNICIANS

by Robert G. Hibberd

Written by the Manager of Advanced Technical Communication, Texas Instruments Inc., this is an excellent "first" book for those electronics technicians (with a high-school background) who want a good, easy-to-read, yet thorough introduction to solid-state devices. With no math, the reader is led through the details of semiconductors and their properties, how a junction diode works, transistors and their circuits. The author briefly discusses FET's, varactors, tunnel diodes, SCR's, unijunctions, photodiodes, etc., and concludes with an introduction to integrated circuits.

Published by McGraw-Hill Book Company, 330 W. 42 St., New York, N.Y. 10036. Hard cover. 180 pages. \$8.95.

SERVICING DIGITAL DEVICES

by Jim Kyle

As our way of living becomes more dependent on digital computers, we're going to need a much larger force of computer servicemen. If you're thinking of becoming a computer serviceman, this book can help you on your way. It starts with a discussion of the basics of digital computation, and proceeds to explain many of the circuits used in computers. This is followed by a discussion of digital systems, what they are, and how they work. The test equipment essential to computer maintenance and its use are also discussed.

Published by Howard W. Sams & Co., 4300 West 62 St., Indianapolis, Ind. 46206. Soft cover. 144 pages. \$3.25.

HANDBOOK OF SEMICONDUCTOR CIRCUITS

This is a handy hard-cover edition of MIL-HBBK-215 with the title "Military Standardization Handbook, Selected Semiconductor Circuits." The book is divided into subheadings dealing with direct-coupled amplifiers, low-frequency amplifiers, high-frequency amplifiers, oscillators, switching circuits, logic circuits, and various types of power supplies and power converters. Each subheading contains material on design philosophy and a list of selected circuits—generally contributed by engineers working in industry with solid-state devices.

Published by Tab Books, Blue Ridge Summit, Pa. 17214. Hard cover. 448 pages. \$7.95.

July, 1968



New

Patio outdoor speaker in timeless redwood

\$14.95 Audiofile net

- Silicone-treated speaker.
- 10-watt, full-range, 8-ohms.
- Handy, built-in volume control.
- Weather-resistant cane grille.
- 14" x 10½" x 3½" fits in any sheltered space.

Write for

FREE

CATALOG

Argos

COMPANY

Dept. C, 630 So. Sycamore St., Genoa, Illinois 60135
CIRCLE NO. 4 ON READER SERVICE PAGE

Live Better Electronically With

LAFAYETTE RADIO ELECTRONICS

1968 Catalog 680 **FREE!**



Now OFF PRESS
BETTER THAN EVER
Over 500 Pages

Stereo Hi-Fi • Citizens
Band • Ham Gear • Tape
Recorders • Test Equip-
ment • TV and Radio Tubes
and Parts • Cameras •
Auto Accessories • Musical
Instruments • Tools • Books

Featuring Everything in Electronics for
• HOME • INDUSTRY • LABORATORY
from the "World's Hi-Fi & Electronics Center"

LAFAYETTE Radio ELECTRONICS
Dept. 1G-8 P.O. Box 10
Syosset, L.I., N.Y. 11791

Send me the FREE 1968 LAFAYETTE Catalog 680 1G-8

Name

Address

CityState.....

Zip

(Please Give Your Zip Code No.)

CIRCLE NO. 15 ON READER SERVICE PAGE

**This is the least you'll get
out of RCA Institutes
Home Training in electronics.**



Sure you'll build, and keep, a lot of expensive equipment up to 25 kits. But the thing you'll value most, is AUTOTEXT the new and easy training method that really prepares you for a rewarding career in electronics.

AUTOTEXT MAKES IT EASY

RCA's exclusive AUTOTEXT method lets you learn and retain in fast, easy steps. Problems in math, and circuitry melt away. You wonder why such things ever seemed difficult.

There's no wasted effort in these home study career programs. You quickly realize that everything you're learning can be used in the field you have chosen.

THESE ARE THE CAREER PROGRAMS NOW OPEN TO YOU: ■ Television Servicing ■ FCC License Preparation ■ Automation Electronics ■ Automatic Controls ■ Digital Techniques ■ Telecommunications ■ Industrial Electronics ■ Nuclear Instrumentation ■ Solid State Electronics ■ Electronics Drafting

Separate courses are available which include all subjects from Electronics Fundamentals to Computer Programming.

All courses approved for student government loans.

UNIQUE TUITION PLAN

With the RCA Institutes, just as you learn at your own pace, so do you pay. There are no long term contracts to sign. No staggering down-payment to lose if you stop. No badgering for bills—honest. You pay for lessons only as you order them.

CLASSROOM TRAINING ALSO AVAILABLE

Classroom and laboratory training is offered in day or evening sessions. Coeducational classes start four times a year. Students are drawn from all over the world. Placement Service at no extra cost. Just check "Classroom Training" on the attached card for more details.

Veterans: GI Bill benefits available.

Accredited Member National Home Study Council.

For complete information, send attached postage paid card today. No obligation. No salesman will visit you.

RCA INSTITUTES, Inc.,
320 West 31st St., New York, N. Y. 10001



RCA

Included with your kits is the all-important Oscilloscope at no extra charge!

POPULAR ELECTRONICS SUBSCRIBER SERVICE

Please include an address label when writing about your subscription to help us serve you promptly. Write to: Portland Place, Boulder, Colo. 80302

CHANGE OF ADDRESS:

Please let us know you are moving at least four to six weeks in advance. Affix magazine address label in space to the right and print new address below. If you have a question about your subscription, attach address label to your letter.

TO SUBSCRIBE:

Check boxes below.

- New Renewal
 5 years \$20
 3 years \$13
 1 year \$5

SPECIFY:

- Payment enclosed
 —You get 1 extra issue per year as a BONUS!
 Bill me later.

← AFFIX LABEL →

If you have no label handy, print OLD address here.

name
please print

address

city

state

zip-code

[Add'l postage: \$1 per year outside U.S., its possessions & Canada.]

name please print 0284

address

city

state zip-code

COMMUNICATIONS HANDBOOK

World's most complete guide to communications. 148 fact packed pages of features by experts in each category.

1968....\$1.25....#53

1967....\$1.25....#47

Order by number from

Ziff-Davis Service Div., 595 Broadway, New York, N.Y. 10012. Enclose add'l 15¢ per copy for shipping and handling (50¢ for orders outside U.S.A.)

GET INTO ELECTRONICS

V.T.I. training leads to success as technicians, field engineers, specialists in communications, guided missiles, computers, radar, automation. Basic & advanced courses. Electronic Engineering Technology and Electronic Technology curricula both available. Associate degree in 29 months. B.S. obtainable. G.I. approved. Start September, February. Dorms, campus. High school graduate or equivalent. Catalog.

VALPARAISO TECHNICAL INSTITUTE
 DEPARTMENT PE, VALPARAISO, INDIANA 46363



AMATEUR RADIO

(Continued from page 78)

It's no wonder that many potential amateurs gravitate to a friendly CB club after a chilly brush-off by some ham. And the semi-official attitude of many CB clubs is that most amateurs are finks—best left alone—exactly the same attitude that many amateur clubs hold towards CB'ers. This mutual distrust is indicated by the meager results on both sides of the American Radio Relay League's recent campaign for increased co-operation between the two groups at the local club level.

Yet the fact remains that many CB'ers would become amateurs if they were given a little encouragement, and there are many amateurs who are willing to give that help. If you are one of the latter, don't wait for your club to start a class or make a big deal of it. Let it be known by word of mouth, an item in your community newspaper, or an announcement over your local AM radio station public-service program that you are available.

San Antonio, Texas: When you visit the HemisFair '68 World's Fair this summer in San Antonio, drop in on the amateur station WSSC. The station is located near the Tower of the Americas and is on the air from 2300 GMT until 0400 GMT, weekdays, and from 1800 GMT on Saturday and Sunday. Special HemisFair '68 QSL cards will be sent to contacts.

NEWS AND VIEWS

Allan Schoeneberg, WN5TRH, Route 1, Box 165, Weimar, Texas 78962, lashed a Heathkit DX-60B transmitter. **Lafayette HA-350** receiver, and a 15-meter dipole together to work 28 states his first three weeks on the air. His record is now 44 states and 8 countries. Russia, Australia, and Ascension Island look the biggest on his DX list. Allan is building a 4-element, 15-meter beam, and he sports Rag Chewer and Amateur Radio Emergency Corps certificates on the shack wall. . . . **Tom Eyring, WN41ZU**, 15001 SW 81st Ave., Miami, Fla. 33158, also prefers 15 meters. It took Tom only a week to roll up 28 states and Puerto Rico. A Drake 2-NT transmitter with a Hallicrafters S-120 receiver and Heathkit Q-Multiplier do the inside work. He has the choice between a vertical or horizontal antenna. Incidentally, Tom is not a fanatic about 15 meters; he will operate on 40 meters. . . . **Andy Binkerd, WN6BLZ**, 10643 Hamden Ave., Stanton, Calif. 90680, suspects that when his General or Advanced license comes through, he will be a WC6, because there are few WB6 calls left. He usually works 40 meters with a Knightkit T-60 transmitter, Heathkit HR-10 receiver, and either a 1/2-wave horizontal dipole antenna or a Hy-Gain 18-V vertical. So far, Andy has 15 states and 3 countries worked. He is interested in handling traffic.

Steve Fredericks, WA7HTA, 3730 Harrison, Corvallis, Oregon 97330, started out as a Novice with a



George Watson, WA8HDQ, trustee, and members of the Howland Junior High School Radio Club, Warren, Ohio. Four of the club members have Novice tickets and 6 more are well on their way to getting licensed. The club equipment includes an EICO 720, Drake 2B receiver and Heathkit Two-er transceiver. The school club call sign is WA8ODB.

Heathkit DX-60A transmitter and HR-10 to which he added a Heathkit HG-10 VFO when his General ticket arrived. He still uses these units on CW and AM phone. A recently-acquired Galaxy-300 transceiver is used on SSB. Although Steve claims his inverted-V antenna really is not designed for DX chasing, he chases DX, nevertheless. His total with his non-DX antenna is 41 states and 9 countries. . . . **Bill Babian, WB2QDF**, 6 Lent St., Peekskill, N. Y. 10566, has two complete stations in the same ham shack. Station #1 has a Johnson Ranger-II transmitter driving a P and H amplifier plus a Hammarlund HQ-110 receiver. It is usually used on CW, including a couple of hours per week in the 40-meter Novice band. Station #2 is a Hallcrafters SR-2000 transceiver on SSB, single-sideband. Bill likes to ragchew and to chase DX; a Rag Chewers' Club certificate and 49 states and 60 countries worked indicate that he is proficient in both activities. . . . **George Watson, WA8HDQ**, Trustee of the Howland Junior High School Radio Club Station, WA8ODB, 8100 South Street S. E., Warren, Ohio 44484, reports that the club is proud to have 4 licensed members; **Greg, WN8WTP**; **Don, WN8VOI**; **Chuck, WN8WRD**; and **Bill, WN8VZP**. In addition, it has four others studying for their tickets. The club owns an EICO 720 transmitter, Drake 2B receiver, and a Heathkit "Twoer."

Tom Treszow, VE3FWQ, 101 Cameron Ave., Toronto 15, Ontario, Canada, is another of those who start their amateur careers in overdrive. In eight days, he worked 27 states and 10 countries on 40- and 15-meters. An Italian Geloso transmitter running 80 watts, a Lafayette HA-225 receiver and two antennas—one a 40-meter dipole, and the other a home-built, 15-meter cubical quad—did the work. The "Quad" is only 12 feet high. . . . **Paul Gauvin, WA1FNI**, 18 Hurlburt Dr., East Haven, Conn. 06512, qualified for his Conditional license two years ago while he was in the hospital. In fact, he operated for two months while encased in a body cast from his chest to his toes. Paul feeds a homebrew, 20-meter Quad antenna 60 feet high with a Heathkit HW-32 transceiver and has worked 45 states and 53 countries. . . . **Dave Repogle, WN9VID**, 509 Lake Drive, Elkhart, Ind. 46514, may have his General ticket before this item is in print. Dave operates

Valuable SAMS BOOKS

NEW AND RECENTLY PUBLISHED

Bench Servicing Made Easy. 2nd. Ed. Presents the most practical technique for fast, effective TV troubleshooting; shows you step-by-step how to locate defective components in any circuit; based on proved work-bench experience. Order 20658, only \$3.95

Advanced & Extra-Class License Handbook. Here is all you need to know to obtain the top amateur radio licenses. Covers license requirements, building up code speed, knowledge of advanced data required, including information on principles and equipment. Includes sample questions for each exam. Order 20649, only \$3.95

Electrical & Electronic Signs & Symbols. Not only describes the technical symbols used in schematics, abstract diagrams, graphs, and mathematical formulas, but explains how the symbols are constructed, and how they are used to convey meaning. Order 20633, only . . \$3.95

- Second-Class Radiotelephone License Handbook. 20316 \$5.75
- How to Read Schematic Diagrams. 20568 \$3.50
- ABC's of Citizens Band Radio. 3rd Ed. 20019 2.50
- Stereo/FM Know-How & Buying Guide. 50012 1.25
- So You Want to Be a Ham. 4th Ed. 20607 4.50
- Modern Dictionary of Electronics. 3rd Ed. 20600 9.95
- TV Tube Symptoms & Troubles. 20476 2.50
- Solving TV Tough-Dogs. 20403 3.95
- ABC's of Computers. 2nd Ed. 20012 2.95

These and over 300 other SAMS books are available from your local Electronic Parts Distributor

HOWARD W. SAMS & CO., INC.
4300 W. 62nd St., Indianapolis, Ind. 46268

CIRCLE NO. 25 ON READER SERVICE PAGE



LOOK! A NEW ELECTRONICS SLIDE RULE WITH COMPLETE INSTRUCTION COURSE

Professional 10" all-metal Electronics Slide Rule. Designed specifically for technicians, engineers, students, hobbyists. Has special scales not found on any other rule. Enables you to solve electronics problems quickly, accurately. Made to our rigid specs by Pickett, Inc. Slide Rule plus four lesson AUTO-PROGRAMMED Instruction Course with grading service, and top-grain leather carrying case . . . a \$50 value for less than \$25! Send coupon for FREE booklet. Cleveland Institute of Electronics, Dept. PE-146, 1776 E. 17th St., Cleveland, Ohio 44114.

SEND COUPON FOR FREE BOOKLET

Cleveland Institute of Electronics
1776 E. 17th St., Dept. PE-146,
Cleveland, Ohio 44114



Please send FREE Electronics Slide Rule Booklet. SPECIAL BONUS: Mail coupon promptly and get FREE Pocket Electronics Data Guide, too!

GET THIS FREE!

NAME _____ (Please Print)
ADDRESS _____ COUNTY _____
CITY _____ STATE _____ ZIP _____

A leader in Electronics Training . . . since 1934

CIRCLE NO. 8 ON READER SERVICE PAGE

a Heathkit-equipped station. Possibly the fact that his dad, Chet, K9DGO, works for Heath might have something to do with this fact. At any rate, the equipment includes an SB-301 receiver, DX-60B transmitter, HW-16 Novice transceiver, and a Heathkit electronic keyer. A 3-band trap antenna and a homebrew, 21-MHz beam complete the station, which has worked 15 countries, 6 Canadian provinces, and 39 states . . . **Dayton K. Johnson, WN8SYT**, 1590 Walton Blvd., Rochester, Mich. 48063, has a Mosley 15-meter beam on a home-built 35-foot tower, but he spends most of his time rag-chewing on 80 meters! He has worked 30 states and Argentina.

We close with the reminder that your "News and Views," pictures, and suggestions are important parts of your column. And keep your club papers and bulletins coming. Address your mail to: Herb S. Brier, W9EGQ, Amateur Radio Editor, POPULAR ELECTRONICS, P. O. Box 678, Gary, Indiana 46401.

73, Herb, W9EGQ.

TV SERVICING

(Continued from page 61)

Customer reaction is one measure of how successful an idea like this may be. A random sample, picked by POPULAR ELECTRONICS, voiced almost unanimous approval. They were satisfied with the repairs that had been made; they felt (with one exception) that the charges were fair; they liked the quick service; and they were impressed with the apparent professionalism of the technicians.

TV-service companies have tried before to improve efficiency by shop rearrangement or using untrained help for unskilled tasks. They have succeeded in varying degrees. Unfortunately, most of them lacked a carefully thought out *fixed* testing/analysis procedure and operating capital. Insufficient money to do the job right is responsible for many

failures in *all* businesses, and it's especially common in the TV servicing business. To open a five-island, five-man Tele-Quick Center requires at least \$30,000; after the Center is open, there is an additional need for operating capital until income reaches a breakeven point—usually within three to six months. —30—

ON THE CITIZENS BAND

(Continued from page 79)

Simultaneously, the manufacturers will contact present CB user groups toward improving operating procedures and techniques.

CB Calls. "I've been told that when I renew my license I keep my old call."

That's correct, as of January 3rd, applications for renewal of CB licenses that have not been suspended, revoked, or have lapsed, will be granted the same call for another five-year period. We suggest that you play it safe by applying for renewal of your license at least 60 days prior to the expiration date. Better check that you use the very latest Form 505 when applying for a renewal. As of this writing, the optimum Form 505 is dated August 1966. The FCC sends each new licensee and renewal a copy of the 42-page booklet "How To Use CB Radio" (SS Bulletin 1001a, November 1967). Newcomers and veteran CB'ers should read this informative guide.

Help From Shell. "Club members are talking about the HELP program going coast to coast with the assistance of the Shell Oil Co. Is this so?"

To our knowledge the Shell Oil Co. has equipped only 16 gasoline service stations with CB gear. These stations are spotted along a 200-mile stretch of Interstate Highway 70 between St. Louis and Kansas City,

NEW SOLID STATE 5-BAND RECEIVER

SEND FOR FREE LITERATURE

MODEL R-5



- Continuous Coverage .54 to 54 mc
- Variable beat frequency oscillator
- Includes 6-meter ham band
- And the 30 to 50 mc police bands
- Fully transistorized — Bandsread
- Noise limiter — Optional battery pack

WIRED AND TESTED \$89.95

AMECO

DIVISION OF AEROTRON



BOX 6527, RALEIGH, N. C. 27608

CIRCLE NO. 1 ON READER SERVICE PAGE

POPULAR ELECTRONICS

POPULAR ELECTRONICS READER SERVICE PAGE

free information service:

Here's an easy and convenient way for you to get additional information about products advertised or mentioned editorially (if it has a "Reader Service Number") in this issue. Just follow the directions below... and the material will be sent to you promptly and free of charge.

1. Print or type your name and address on the lines indicated. Circle the number(s) on the coupon below that corresponds to the key number(s) at the bottom of the advertisement or editorial mention(s) that interest you. (Key numbers for advertised products also appear in the Advertisers' Index.)

2. Cut out the coupon and mail it to the address indicated below.

3. This address is for our product "Free Information Service" only. Editorial inquiries should be directed to POPULAR ELECTRONICS, One Park Avenue, New York 10016; circulation inquiries to Portland Place, Boulder, Colorado 80302.

**POPULAR
ELECTRONICS**

P.O. BOX 8391
PHILADELPHIA, PA. 19101

VOID AFTER AUGUST 31, 1968

1 2 3 4 5 6 7 8 9 10 11 12 13 14 15 16 17 18 19 20
21 22 23 24 25 26 27 28 29 30 31 32 33 34 35 36 37 38 39 40
41 42 43 44 45 46 47 48 49 50 51 52 53 54 55 56 57 58 59 60
61 62 63 64 65 66 67 68 69 70 71 72 73 74 75 76 77 78 79 80
81 82 83 84 85 86 87 88 89 90 91 92 93 94 95 96 97 98 99 100

NAME (Print clearly) _____

ADDRESS _____

CITY _____ STATE _____ ZIP CODE _____

7 b

SAVE \$3⁰⁰

ON ALLIED ELECTRONIC LIBRARY

Complete 14 Volume

Set only \$6²⁵

(\$9.25 if purchased separately)

Fourteen expertly written, authoritative books—an extremely useful library developed especially for you by Allied's Electronic Experts.

- All About Hi-Fi & Stereo
- Built-In Stereo Hi-Fi System
- Your Tape Recorder
- Electronics Handbook
- Dictionary Of Electronic Terms
- Encyclopedia Of Electronic Components
- Using The Oscilloscope
- Best Ways To Use VOM VTVM
- Getting Started In Electronics
- How To Build Electronic Kits
- Transistors
- Schematic Diagrams
- Integrated Circuits
- Citizens Band Radio

ELECTRONIC BOOKS FOR HOBBY, SCHOOL, OR HOME STUDY!

RUSH ME THE SET! ALLIED ELECTRONIC LIBRARY

Fill out coupon below, enclose check or money order for \$6.25, and mail to

ALLIED RADIO, P.O. Box 4469, Chicago, Ill. 60680 Post Paid
(please print) 23 PC 7409EP

NAME _____
First Middle Last

ADDRESS _____

CITY _____

STATE _____ ZIP _____

CIRCLE NO. 2 ON READER SERVICE PAGE

FOR \$14.95

THIS BUG WILL TELL YOU EVERYTHING IT HEARS



For Business!—Pleasure!—Intrigue!

Concealed inside this decorative insect's innocent exterior is a miniature microphone and radio transmitter, which broadcasts a strong signal to any FM radio within 200 feet.

Simply switch this intercom on, and have anyone you choose tune to 88-90 mc on their FM. Normal conversations will be picked up loud and clear (remember FM is static-free). There are no wires. We're sure you can think of dozens of fun ways to use the bug, but here are a few thought starters:

Play with it at your next party, with the guys at the office. Use it as an intercom with your secretary or to the kids' room. You can even tape record what you hear for posterity.

The sophisticated electronic components were designed by Continental, America's leading specialist in security equipment. Get the bug. For yourself. For friends. For fun.

BUY 2 ONLY \$28.00

SPECIAL: Complete 1968 security and crime deterrent catalog. ONLY \$2.35. Send check or money order.

Pathe



ELECTRONICS MANUFACTURING COMPANY 8-N
47 East 19th Street New York, N.Y. 10003
Telephones: 674-2494 674-2480-1
DIVISION OF PHONOMATIC

Dealer Inquiries Also Invited

CIRCLE NO. 20 ON READER SERVICE PAGE

Mo. This appears to be a test project and we understand that similar projects will be established along the east and west coasts.

More Tech Knowledge. "Some of our club members don't know the difference between a transformer and a piece of insulating spaghetti. Is there a dictionary or a guide for the needy?"

There sure is and we recommend the Allied Radio Corp. (100 N. Western Ave., Chicago, Ill. 60680) dollar booklet called "Encyclopedia of Electronics Components." In fact, Allied has quite a library of cheap booklets your members might find interesting. Take a look at the latest Allied Radio catalog.

I'll CB'ing you.

—Matt, KHC2060

SOLID STATE

(Continued from page 82)

using proven circuit designs—and all had one common characteristic—they didn't work!

Upon close examination and after a series of simple tests, it was found that all the defects were the result of a single cause—poor soldering techniques.

In some cases, excessive heat had damaged the semiconductors. In others, a seemingly "good" connection was found to have a high-resistance film of rosin between the solder and a component lead (or conductor strip). In a few cases, the builder had used rosin paste flux (all knew that acid flux is prohibited) on circuit boards, leaving a thin, greasy film which established leakage paths between adjacent conductors.

This experience emphasizes the importance of good work habits and the acquisition—and maintenance—of basic skills. Some of the builders, for example, had considerable training, but had simply become "lazy" and allowed their soldering techniques to deteriorate.

Our "tip" this month, then, is the suggestion that you recheck your soldering methods. Examine recent projects, inspecting each connection to make sure you've done good work. A fine-pointed metal tool can be used to clean the flux residue from the space between adjacent soldered contacts and a dry toothbrush will clean away all debris. In this way, all contacts will stand out alone. If you aren't completely satisfied with your skill, practice soldering using discarded parts and scrap wire.

After all—*practice makes perfect.*

Until next month, then, happy summer!

—Lou

POPULAR ELECTRONICS

TUNE BASS REFLEX

(Continued from page 51)

and screws. Large panels should be braced by 1" x 2" cleats. It is also recommended that large panels be sandwiched to some other material (such as Celotex) to provide extra sturdiness and remove any tendency to vibrate or resonate.

A more subtle problem is air leaks. A few loose screws in the back of a large enclosure will not only allow vibration of the back panel, but also fail to seal it airtight. Generous use of screws plus a gasket of felt or thin foam rubber will insure proper sealing and tuning.

Of course, if you are starting out to design your own enclosure, you have other decisions, such as size and shape. Before stereo, most enclosures were large, and the dimensions shown on design charts were based on a port area equal to the effective cone area of the speaker. Almost any volume can be tuned to any reasonable resonant frequency, but in a compact enclosure the port area cannot possibly equal the cone area of a 12-inch speaker. A reduced port area means reduced port output, so while we can tune a compact enclosure to match a large woofer, it will produce less bass than a larger enclosure with a larger port. In fact, the optimum volume for the 1968 speaker is likely to be a moderate size enclosure. If in tuning you find that the port area must be greater than the effective cone area of your

speaker, your cabinet is too large.

The shape of your enclosure and the location and shape of the port can also affect performance. Avoid "extreme" enclosures, such as a cube where all three dimensions favor a single frequency. Also avoid a long shape where the long dimension is equal to $\frac{1}{4}$ any reproducible frequency or as much as three times as long as the shortest side. Very shallow enclosures should be used only where

SPEAKER DATA

ADVERTISED SPEAKER SIZE	APPROXIMATE EFFECTIVE DIAMETER	APPROXIMATE CONE AREA
15"	13"	130 sq. in.
12"	10"	80 sq. in.
10"	8"	50 sq. in.
8"	6"	30 sq. in.
6"	5"	20 sq. in.

Port area is never greater than speaker cone area.

demanding by lack of space. Typical depth:width:height dimension ratios are 1:1.42:2 or 1:1.5:2.5.

Don't be afraid to experiment. The easy tuning method is a perfect way to begin. Finally, believe your ears if they prefer a different size port or duct. And you don't have to feel guilty about it because hi-fi history tells us that in conflicts between ears and instruments, later improvements in our measuring methods have usually vindicated the ear. -30-

KEEP IN TOUCH WITH THE ACTION!

SONARCOM
VHF-FM 2 WAY
TRANSCEIVER
(132-174 MHz)

FCC TYPE
ACCEPTED
for parts 89,91,93 and
part 21 telephone use
*optional

\$375 with
1 pair
of crystals and
penlite batteries



INSTANT 2 Way Communications To All Points!

**YOU ALWAYS GET THROUGH . . . OPERATES ANYWHERE!
INDOORS, OUTDOORS, IN STEEL BUILDINGS**

More performance and features than much higher priced units • engineered with space age techniques and military type components for high reliability, superior performance and long life • Provides instant voice contact with base stations, mobile units and other portable transceivers • compatible with all VHF narrowband systems • exclusive "Push-to-Talk" mike • Full frequency range for all public safety, industrial and land transportation services • single or split channel operation • 1.6 watts output.

SONAR RADIO CORP., 73 Wortman Ave., Brooklyn, N.Y. 11207
Please send information on Model 2301—the SONARCOM.
Dept. 667

Firm Name _____ Title _____
Address _____ Phone _____
City _____ State _____ Zip _____

CIRCLE NO. 28 ON READER SERVICE PAGE

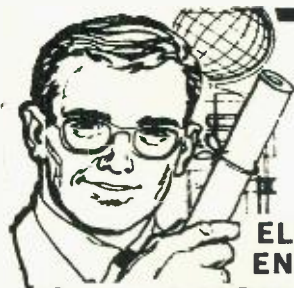

Earn Your Degree ELECTRONICS ENGINEERING

through HOME STUDY

HIGHLY EFFECTIVE HOME STUDY COURSES IN:
• ELECTRONICS ENGINEERING TECHNOLOGY
• ELECTRONICS ENGINEERING MATHEMATICS

Earn your Associate in Science Degree in Electronics Engineering and upgrade your status and pay to the engineering level. Complete college level courses in Electronics Engineering. We're a forward looking school. Outstanding lesson material—thorough and easy to understand. Engineering taught on the basis of application and understanding rather than on the basis of memorization. Up to date in every respect. Acquire the knowledge and ability that means the difference between a low paying technician job and a high paying engineering position. Low tuition cost with low monthly payments. Free engineering placement service for our graduates. Write for free descriptive literature. Ask for bulletin G, no salesman will call on you.

COOK'S INSTITUTE of Electronics Engineering



Northeast Regional Office

P.O. Box 1085

Buffalo, N.Y. 14240

Established 1945

Formerly Cook's School of Electronics

CIRCLE NO. 9 ON READER SERVICE PAGE

UNUSUAL BARGAINS

... MANY U. S. GOV'T SURPLUS

TOP-QUALITY LOW-COST STROBE

Create spectacular psychedelic lighting effects with this genuine electronic strobe. Terrific for parties, special occasions, experiments... Perfect for combos, night clubs, dances, exhibitions. Adjusts from 1 to 10 short-duration flashes per second—not a make-shift mechanical device. Amaze friends with old-time movie effects. Best party ice-breaker ever—"freeze" the action and "unfreeze" your guests. Practical too-check action of moderate-speed machinery. Xenon lamp gives one million flashes. 6 1/2" diam. reflector. Uses reg. 110-120 volt A.C. current. Handsome solid walnut cabinet 9 1/2"x9 1/2"x4". Send for Bulletin #75—describes other startlingly new unique lighting effects.

Stock No. 70,989 AV \$79.95 Ppd.



NEW SURPLUS NI-CD BATTERIES

Save more than 50%! Long life—accept 300 charge and discharge cycles. 1.25 Volts per cell—750 milliampere hours capacity. Excel. charge retention. Hermetically sealed. Indefinite storage life. Multiple cells welded in series—easily cut. Low-cost charger separate.

Order #	Cells	DC Volt.	Price Ppd.
Stock Number 40,986AV	1	1.25	\$ 1.50
Stock Number 60,633AV	3	3.75	3.60
Stock Number 60,634AV	4	5.00	4.80
Stock Number 60,703AV	(Battery Charger) \$3.25		

Order by Stock No.—Check or M.O.—Money-Back Guarantee
EDMUND SCIENTIFIC CO., 300 EDCORP BUILDING
BARRINGTON, NEW JERSEY 08007

GIANT FREE CATALOG "AV"

Completely new 1968 edition. New items, categories, illustrations. 148 easy-to-read pages packed with 4000 unusual items. Dozens of electrical and electro-magnetic parts, accessories. Enormous selection of Astronomical Telescopes, Microscopes, Binoculars, Manifolds, Magnets, Lenses, Prisms. Many war surplus items: for hobbyists, experimenters, workshops, factory. Write for catalog "AV". Include Zip.



ORDER BY STOCK NUMBER • WHEN CHECK OR MONEY ORDER • MONEY-BACK GUARANTEE
EDMUND SCIENTIFIC CO. 300 EDCORP BUILDING
BARRINGTON, NEW JERSEY 08007
CIRCLE NO. 12 ON READER SERVICE PAGE

DESIGNERS' QUIZ ANSWERS

(Quiz appears on page 35)

- 1 — B The CLAPP oscillator designed by J.K. Clapp is a series-tuned variant of the Colpitts oscillator. The Clapp circuit is noted for its low-drift characteristics.
- 2 — D The COCKCROFT-WALTON high voltage circuit was developed by J.D. Cockcroft and E.T. Walton. It is used in nuclear particle accelerators.
- 3 — G A direct-coupled transistor pair is called a DARLINGTON amplifier. The designer was Sidney Darlington. This circuit increases the input impedance and offers a current gain approximately equal to the product of the separate transistor current gains.
- 4 — C The ECCLES-JORDAN multivibrator is a bistable circuit designed by William H. Eccles and F.W. Jordan. The circuit is used to subdivide the frequency of incoming pulses by a factor of two.
- 5 — H To convert frequency-modulated r.f. carriers into an amplitude-modulated audio signal, D.F. Foster and Stuart W. Seeley developed the FOSTER-SEELEY FM discriminator.
- 6 — J The HEISING modulation circuit designed by Raymond A. Heising is a constant-current form of plate modulation in transmitters.
- 7 — I Lord Kelvin (William Thompson) developed the KELVIN bridge to measure small values of resistance.
- 8 — F The PIERCE oscillator designed by George W. Pierce is a crystal-controlled version of the Colpitts oscillator circuit.
- 9 — E The SCHMITT trigger was designed by Otto H. Schmitt as a cathode-coupled bistable multivibrator. It is used in squaring circuits.
- 10 — A Originally, the WIEN bridge designed by Max Wien was used to measure capacitance in terms of a standard capacitor, or inductance in terms of a standard inductor. Recently, the Wien bridge is seen more frequently in audio oscillators.

SHORT-WAVE LISTENING

(Continued from page 76)

Japan—R. Japan, Tokyo, has replaced 15,135 kHz with 21,640 kHz at 0300-0400 to N.A., L.A. and Hawaii in English. This channel is also noted from 0200 in English. Other English xmsns tuned at 0203-0255 on 17,830 kHz and 0815-0816 on 9505 kHz.

POPULAR ELECTRONICS



A Hallicrafters SX-130 and a Roberts 1719 tape recorder are the DX'ing tools of Gary Lane, Lewis-town, Pa. Otherwise known as WPE3CJX, Gary has a total of 54 countries logged, 22 verified.

Lebanon—Beirut now has English to N.A. at 0230-0300, French at 0130, Arabic at 0200, and Spanish from 0300-0400, all on 15.440 kHz. The 17,715 kHz outlet is fair to good at 2300 s/on in Arabic.

New Zealand—Wellington has been found on 9755 kHz at 0730-0830. Is this a new frequency? (*Editor's Note:* It is new and in use at 1700-1945 and 0600-0845 dual with 11,780 kHz to Pacific Islands daily except Sunday when closed, according to schedule, "between 0800 and 0900".)

Nicaragua—YNRG, *R. Zelaya*, Bluefields, 5950 kHz, was logged at 0000-0100 with ads, dance music, and annms in all Spanish. This one isn't easy as your Editor can attest. YNRP, *R. Mar*, Puerto Cabezas, reports that their 9580 kHz outlet is 1 kw. They have commercials & pop tunes around 2200 and a very weak signal.

Pakistan—*R. Pakistan*, Karachi, is being heard well at 0210 on 15,335 kHz and 17,945 kHz at 1332-1350, both segments with English news. According to an announcement by the station, the broadcasting service of this country will order two medium wave xmtrs of 1000 kw each for Dacca and Islamabad plus two short-wave units, 100 kw for Dacca and 200 kw for Islamabad.

Papua—The last of the new stations for this area is VL8AS, *R. Milne Bay*, Samarni, testing with 250 watts on 3235 kHz at 0900-1030.

Peru—OBX4E, *R. Andahuaylas*, is on the air at 4840 kHz with best listening time 0000 and later in all Spanish programming.

Seychelles—*The Far East Broadcasting Corp.* plans to set up a transmitting site according to an interview program portion of a religious news broadcast over the *Australian Broadcasting Corp.*, Perth. No frequencies, schedules or target dates were given.

South Africa—*R. RSA*, Johannesburg, now operates to Eastern Canada and U.S. at 2330-0020 on 17,785, 15,220, 11,875 and 7270 kHz. The xmtns to Central, Mountain & Pacific areas of N.A., running to 0320, are broadcast on 11,875, 9705, 7270 & 6075 kHz. The 6075 kHz outlet is heard with piano setting-up exercises at 0445-0455, pop music to 0459, news to 0510, weather, and into more pop music. *Radio South Africa* (not *R. RSA*) is good at times on 3250 kHz in a commercial service noted from 2330-0240.

Surinam—Presstime listening reveals a possibility of *Stitching Radio Omroep Suriname*, Paramaribo, having returned to the air on 15,100 kHz. We haven't even had the chance to check it out ourselves; look for it in English with pop records, time checks and commercials until reported 0030 closing time.

July, 1968

When you write for our condensed high fidelity SPEAKER, ELECTRONICS or MICROPHONE catalogs...

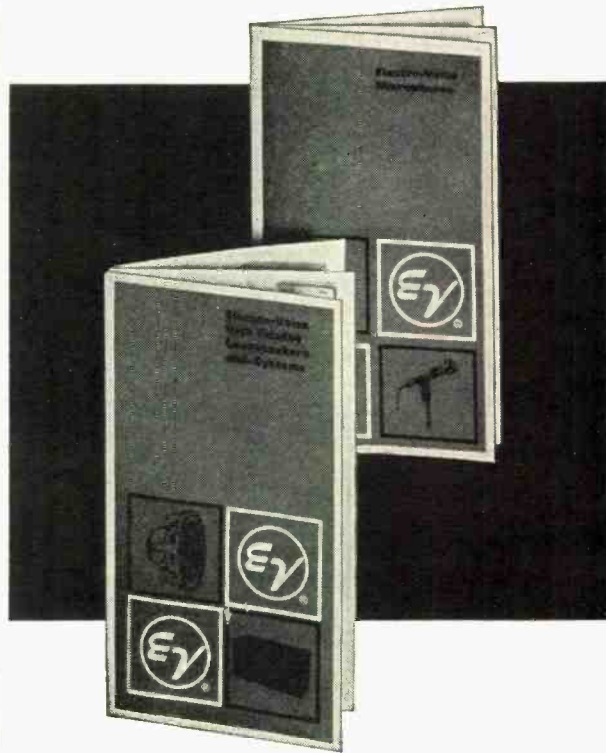

you really get a brief progress report on the state of the art in sound.

Both FREE for the asking, of course.



ELECTRO-VOICE, INC., Dept. 783P
630 Cecil Street, Buchanan, Michigan 49107

Please send me the latest word on

E-V high fidelity E-V microphones

I am particularly interested in E-V Model _____

Name _____

Address _____

City _____ State _____ Zip _____

CIRCLE NO. 13 ON READER SERVICE PAGE

POPULAR ELECTRONICS

JULY 1968

ADVERTISERS INDEX

ADVERTISER

READER

SERVICE NO.	ADVERTISER	PAGE NO.
1	AMECO, Division of Aerotron, Inc	94
2	Allied Radio	96
	American Basic Science Club	106
3	Arcturus Electronics Corp	103
4	Argos Products Company	87
5	B & K	6
	Bell & Howell Schools	5
6	Burstein-Applebee	8
	CREI, Home Study Division, McGraw-Hill Book Company	36, 37, 38, 39
7	Cleveland Institute of Electronics	70, 71, 72, 73
8	Cleveland Institute of Electronics	93
9	Cook's Institute of Electronics Engineering	98
10	Courler Communications, Inc	11
11	EICO Electronic Instrument Co., Inc	FOURTH COVER
12	Edmund Scientific Co	98
13	Electro-Voice, Inc	99
14	Heath Company	12, 13
15	Lafayette Radio Electronics	87
16	Mosley Electronics Inc	10
17	Mueller Electric Co	16
18	Multicore Sales Corp	8
	National Radio Institute	SECOND COVER, 1, 2, 3
	National Technical Schools	18, 19, 20, 21
19	Olson Electronics Incorporated	14
20	Pathé Electronics Manufacturing Company	96
21	Port Arthur College	14
22	RCA Electronic Components and Devices	17
23	RCA Electronic Components and Devices	23
	RCA Electronic Components and Devices	THIRD COVER
	RCA Institutes, Inc	88, 89, 90, 91
23	Radar Devices Mfg. Corp	7
24	Radio Shack	16
25	Sams & Co., Inc., Howard W	93
26	Shure Brothers, Inc	9
27	Solid State Sales	104
28	Sonar Radio Corp	97
29	Squires-Sanders, Inc	26
	Valparaiso Technical Institute	92

CLASSIFIED ADVERTISING 101, 102, 103, 104, 105

Sweden—R. Sweden, Stockholm, has English to the Far East at 1300, then into language. English to S. Africa at 1900-1930; both xmsns are on 21,675 kHz.

U.S.A.—The North American Broadcasting Corp. has announced that it will build a \$2.5 million short-wave station. Will be on the air 18 hours daily, programs to originate from the new NABC Center in Monterey, Calif.

Venezuela—YVKR, R. Caracas, has moved to 4980 kHz as noted at 0324 with all Spanish programming and frequent IDs.

Vietnam (North)—R. Hanoi has English news on 4713 kHz at 1320 according to West Coast sources. The station goes into Vietnamese at 1330.

Clandestine—R. Euzkadi, E. P. 59, Poste Centrale, 17-Paris (16) France, announces that it is a mobile station broadcasting in Spanish and Basque at 2030 on 13,250 & 15,032 kHz, and at 2130 on 15,290 kHz. A QSL card has been received by a West German DX'er in which the power is listed as 80 kw. Waiting time for the QSL was 3 months. —50—

SHORT-WAVE CONTRIBUTORS

Chris Lobdell (WPE1GCI), Reading, Mass.
 Stan Mayo (WPE1GMF), Portland, Maine
 John Kiernan (WPE2EMN), New York, N. Y.
 Floyd Hale (WPE2HGN), Chittanooga, N. Y.
 Eric Lebowitz (WPE2JJI), Jackson Heights, N. Y.
 William Graham (WPE2LMU), Binghamton, N. Y.
 Peter Macinta (WPE2ORB), Kearny, N. J.
 Larry Stransky (WPE2OIJ), Bellerose, N. Y.
 John Banta (WPE2PHU), Bay Shore, N. Y.
 Michael Flamm (WPE2QDE), New York, N. Y.
 Marc Kiddle (WPE3HGG), Williamsport, Pa.
 Joel Dennis (WPE3HII), Shickshinny, Pa.
 Robert Newhart (WPE3BKA), Philadelphia, Pa.
 Robert Ridgely (WPE3HOJ), Towson, Md.
 Marvin Barrash (WPE3HOU), Pikesville, Md.
 Jim Ippolito (WPE3HPO), Dover, Del.
 James Wilson (WPE3HPQ), Norristown, Pa.
 Grady Ferguson (WPE4BC), Charlotte, N. C.
 John Ethridge (WPE4JHC), Martin, Tenn.
 John Hagey (WPE4JNP), Bristol, Tenn.
 Patrick Donahue (WPE4JRM), Cape Coral, Fla.
 Ray Bacon (WPE5BFU), Baton Rouge, La.
 Clifford Davis (WPE5EPN), Grand Prairie, Texas
 Robert Beck (WPE5ET), Miami, Fla.
 Steve Kamp (WPE5EUT), Irving, Texas
 Charles Juncker III (WPE5EVG), New Orleans, La.
 Stewart MacKenzie (WPE6AA), Huntington Beach, Calif.
 Jim Young (WPE6ENA), Wrightwood, Calif.
 W. W. Mosby (WPE6EXA), San Jose, Calif.
 Trevor Clegg (WPE6FAF), Santa Cruz, Calif.
 Bruce Brolsma (WPE6GMD), Northridge, Calif.
 Paul Farmanian (WPE6GVG), Glendale, Calif.
 Walter Dick (WPE6HAX), Santa Monica, Calif.
 Fr. John Peiza (WPE6HCP), Ojai, Calif.
 Bill Migley (WPE6JEL), Lancaster, Ohio
 William Shaw (WPE6JMX), Wheeling, W. Va.
 Patrick Buckley (WPE6JXQ), Ferndale, Mich.
 J. P. Arendt (WPE6JDN), Aurora, Ill.
 Richard Pistek (WPE6HOA), Chicago, Ill.
 James Bochantin (WPE6IDA), Du Bois, Ill.
 A. R. Niblack (WPE6KMI), Vincennes, Ind.
 John Beaver, Sr. (WPE6OZE), Pueblo, Colo.
 Marshall Reece (WPE6OZZL), Overland Park, Kan.
 Leslie Prus (WPE6PFGG), Manhattan, Kan.
 Philip Wanat (E44PE1B), APO, New York, N. Y.
 Jack Perolo (PY2PE1C), Sao Paulo, Brazil
 Bert Pestor (VE3PE9L), Sudbury, Ont.
 Dean Frey (VE6PE7N), Fort Saskatchewan, Alta.
 Leo Alster, Rahway, N. J.
 Leonard Anderson, Sun Valley, Calif.
 Mrs. Eva Collier, Lima, Ohio
 Erik Corey, Sepulveda, Calif.
 Marty Eggers, Avoca, Iowa
 Roger Giannini, Honolulu, Hawaii
 James Gill, Danville, Ill.
 N. Greco, Pittsburgh, Pa.
 Steve Jacobsmeyer, Mt. Prospect, Ill.
 John Janowiak, Detroit, Mich.
 Leslie Marcus, Eugene, Ore.
 Jose Robat, Liege, Belgium
 Tom Shultz, Cherry Hill, N. J.
 Radio New York Worldwide, New York, N. Y.
 Sweden Calling DX'ers Bulletin, Stockholm, Sweden

ELECTRONICS MARKET PLACE

COMMERCIAL RATE: For firms or individuals offering commercial products or services. \$1.00 per word (including name and address). Minimum order \$10.00. Payment must accompany copy except when ads are placed by accredited advertising agencies. Frequency discount: 5% for 6 months; 10% for 12 months paid in advance.

READER RATE: For individuals with a personal item to buy or sell. 60¢ per word (including name and address). No Minimum! Payment must accompany copy.

FOR SALE

FREE! Giant bargain catalog on transistors, diodes, rectifiers, SCR's, zeners, parts. Poly Paks, P.O. Box 942, Lynnfield, Mass. 01940.

GOVERNMENT Surplus Receivers, Transmitters, Snooperscopes, Radios, Parts, Picture Catalog 25¢. Meshna, Nahant, Mass. 02908.

R.F. CONVERTERS. World's largest selection. Also CCTV cameras, etc. Lowest factory prices. Catalog 10¢. Vanguard 196-23 Jamaica Ave., Hollis, N.Y. 11423.

TELEPHONE VOICE SWITCH: (LS-500). ACTUATES AUTOMATICALLY AND UNATTENDED ANY TAPE OR WIRE RECORDER. PICTORIAL INSTALLATION INSTRUCTIONS INCLUDED. \$23.75. POST PAID USA, WJS ELECTRONICS, P.O. BOX 1508, LAS VEGAS, NEVADA 89101.

INVESTIGATORS: KEEP IN STEP WITH ADVANCEMENTS IN THE ART OF ELECTRONICS FOR THE PROFESSIONAL. SEND \$1.00 FOR EQUIPMENT BROCHURE. WJS ELECTRONICS, P.O. BOX 1508, LAS VEGAS, NEVADA 89101.

BUG DETECTOR: WILL DETECT AND LOCATE SURREPTITIOUS TRANSMITTING DEVICES IN CONFERENCE ROOMS, HOME AND OFFICES, ETC. WRITE FOR DETAILS. WJS ELECTRONICS, 737 NORTH SEWARD, HOLLYWOOD, CALIF. 90038.

ROCKETS: Ideal for miniature transmitter tests. New illustrated catalog, 25¢. Single and multistage kits, cones, engines, launchers, trackers, rocket aerial cameras, technical information. Fast service. Estes Industries, Dept. 18, Penrose, Colorado 81240.

LOWEST Prices Electronic Parts. Confidential Catalog Free. **KNAPP**, 3174 8th Ave. S.W., Largo, Fla. 33540.

CONVERT any television to sensitive, big-screen oscilloscope. Only minor changes required. No electronic experience necessary. Illustrated plans, \$2.00. **Relco-A33**, Box 10563, Houston, Texas 77018.

CRYSTALS . . . largest selection in United States at lowest prices. 48 hr. delivery. Thousands of frequencies in stock. Types include HC6/U, HC18/U, FT-241, FT-243, FT-171, etc. Send 10¢ for catalog with oscillator circuits. Refunded on first order. **Jan Crystals**, 2400F Crystal Dr., Fort Myers, Fla. 33901.

SURVEILLANCE EQUIPMENT—NEW HIGH PERFORMANCE SUBMINIATURE MODELS. ELECTRONIC COUNTERMEASURE DEVICES TO PROTECT PRIVACY. FREE DATA: SECURITY ELECTRONICS-PE, 15 EAST 43RD STREET, NEW YORK, N.Y. 10017.

FREE ELECTRONICS (new and surplus) parts catalog. We repair multimeters. **Bigelow Electronics**, Bluffton, Ohio 45817.

TREASURE Hunters! Prospectors! Relco's new instruments detect buried gold, silver, coins. Kits, assembled models. Transistorized. Weighs 3 pounds. \$19.95 up. Free catalog. **Relco-A33**, Box 10836, Houston, Texas 77018.

RECTIFIERS, transistors, other components. Catalog free. **Electronic Components Co.**, Box 2902C, Baton Rouge, La. 70821.

DIAGRAMS—Radios \$1.50, Television \$3.00. Give make and model. **Diagram Service**, Box 1151PE, Manchester, Conn. 06042.

EUROPEAN and Japanese bargain catalogs. \$1 each. **Dee**, 10639E Riverside, North Hollywood, Calif. 91602.

INVESTIGATORS, FREE BROCHURE, LATEST SUBMINIATURE ELECTRONICS SURVEILLANCE EQUIPMENT, ACE ELECTRONICS, 11500-L NW 7TH AVE., MIAMI, FLA. 33168.

TRANSISTORIZED CONVERTER KITS: Two models, converts car radio. Receive 30-50mc or 100-200mc (one mc tuning) \$5.00 with simple instructions. **Crystal \$2.50**. Meshna, No. Reading, Mass. 01864.

GENERAL INFORMATION: First word in all ads set in bold caps at no extra charge. Additional words may be set in bold caps at 10¢ extra per word. All copy subject to publisher's approval. Closing Date: 1st of the 2nd preceding month (for example, March issue closes January 1st). Send order and remittance to: Hal Cymes, **POPULAR ELECTRONICS**, One Park Avenue, New York, New York 10016.

MECHANICAL, Electronic devices catalog 10¢. Greatest Values—Lowest Prices. **Fertik's**, 5249 'D', Philadelphia, Pa. 19120.

MUSIC LOVERS, CONTINUOUS, UNINTERRUPTED BACKGROUND MUSIC FROM YOUR FM RADIO, USING NEW INEXPENSIVE ADAPTOR. FREE LITERATURE. ELECTRONICS, 11500-Z NW 7th AVE., MIAMI, FLORIDA 33168.

LINEAR AMPLIFIERS: "Hornet"—50 watts output—\$98.50; "Raider"—100 watts—\$139.95; "Maverick-250"—250 watts—\$244.95. For AM and SSB. "BANDIT II"—12 V. mobile amplifier, 100 watts output—\$169.95. Frequency range 20-35 megacycles (illegal for Class D 11 meters.) Dealer inquires invited. **D & A Manufacturing Co.**, 1217 Avenue C, Scottsbluff, Nebraska 69361.

JAPANESE or EUROPEAN DIRECTORY 200 firms \$1.00. **SURVEILLANCE EQUIPMENT**, Catalog 25¢. Wireless **SNOOPERMIKE** \$25.00. **SUBMINIAMIKE** $\frac{3}{8}$ x $\frac{3}{8}$ x $\frac{3}{16}$ \$4.00. **SIERRATRONICS**, Box 7497, Las Vegas, Nev. 89101.

WE SELL CONSTRUCTION PLANS. TELEPHONE: Answering Machine, Speakerphone, Carphone, Phonevision, Legal Connector, Auto Dialer, Central Dial System. **TELEVISION:** \$35.00 Color Converter, Tape Recorder, 3DTV, \$25.00 Camera. **DETECTIVE:** Infinity Transmitter, Tail Transmitter, Police Radar Detector. **HOBBYIST:** Electron Microscope, 96 Hour Tape Music System, Ultrasonic Dishwasher, Radar-Oven, Electronic Tranquillizer. Plans \$4.95 each. **COURSES:** Telephone Engineering \$39.50, Detective Electronics \$22.50, Anti-Detective Electronics \$27.50. **SUPER HOBBY CATALOG** 25¢. Don Britton Enterprises, 7906 Santa Monica Blvd., Hollywood, Calif. 90046.

CIRCUIT Boards, Parts for "Poptronics" projects. Free catalog. **S.W. Technical**, Box 16297, San Antonio, Texas 78216.

SURVEILLANCE COUNTERMEASURES BROCHURE \$1.00. ENGINEERING LABORATORIES, BOX 1036, ANDERSON, INDIANA 46015.

WEBBER LAB'S. Police & Fire Converters. Catalog 10¢. 72 Cottage Street, Lynn, Mass. 01905.

ELECTRONIC Ignition, various types. Free literature. **Anderson Engineering**, Epsom, N.H. 03239.

PROXIMITY switch. Detects nearness of human body! Free information. **Claremont Products**, 860 Reed, Claremont North, Calif. 91711.

SURVEILLANCE EQUIPMENT, latest devices, also construction plans, free catalog. **FISHER ELECTRONICS**, Box 350, N. Miami Beach, Florida 33160.

EDUCATIONAL FUN KITS: Germanium diode radio \$1.95, AC-DC radio (with tubes) \$12.95. 20-in-1 electronics kit \$15.95. Kits include simple instructions. **Meshna**, North Reading, Mass. 01864.

NEW Sensitive Treasure Metal Detectors. New low prices. Professional models from \$29.95 to \$129.50. Write for free catalog today. **Jetco Electronics**, Box 132-E, Huntsville, Texas 77340.

RADIO—T.V. Tubes—33¢ each. Send for free catalog. **Cornell**, 4213 University, San Diego, Calif. 92105.

SONAR Monitor Receivers unsurpassed. Fire, police, ambulance, taxi, highway patrol communications, exceptional values. **Griffin's**, 322 West State, Ithaca, N.Y. 14850.

DETECTIVES! Precision Surveillance Devices. New Catalog. Free when writing on letterhead. Otherwise \$1.00 refundable with first purchase. **SILMAR ELECTRONICS**, 3476 N. W. 7th Street, Miami, Florida 33125.

CABINETS for Poptronics projects, free literature. **SPECTRUM**, 13946 Blackstone, Detroit, Mich. 48223.

ELECTROSHOCK MODULE. Produces 1200 volt shock from 6 volts. No battery drain until touched. Non-lethal. Protects property for months on lantern battery. \$4.95. Catalog of interesting projects, plans, kits, 20¢. Franks Scientific Co., P. O. Box 156, Martelle, Iowa 52305.

DIAGRAMS, Service Manuals, Radio, TV, HiFi. \$1.00. Technical Services Associates, Box 1167, Berkeley, Calif. 94701.

INTEGRATED CIRCUITS PROJECTS—Audio amplifier, code practice osc., receiver, wireless mic, f.s. meter, audio generator, signal tracer, light flasher, electronic organ, square wave generator, etc. Catalog 25¢, plans \$1.00 each, catalog free with order. One IC and printed circuit board builds all. \$5.00. Hal's Electronics, P. O. Box 137, Milpitas, Calif. 95035.

INVESTIGATORS EXPENDABLE EQUIPMENT. Surplus Tail Transmitters \$39.50, Bug-Taps \$23.50. Don Britton Enterprises, P. O. Box G, Waikiki, Hawaii 96815.

LOOKING FOR SURVEILLANCE EQUIPMENT? Informative Directory of Manufacturers and Distributors. \$2.00. **T & G PUBLICATIONS, BOX 28658, MEMPHIS, TENNESSEE 38128.**

PC boards. Popular Electronics artwork. XXXP \$2.50. Polyester \$3.50. Epoxy \$4.50. Send check or money order. Phoenix Electronix, 3604 Motor Avenue, Palms, Calif. 90034.

DISPLAY Music on color TV . . . Easy, inexpensive and compatible . . . complete instructions \$2.00 . . . Box 1854, Station A, Canton, Ohio 44705.

FREE LISTINGS: new and used hi fi and other electronic gear—excellent prices. **GIM UNLIMITED.** Box 123, Hicksville, N.Y. 11801.

LASER Rod Material catalog 55¢. Moynihan, 107 North Brighton, Atlantic City, New Jersey 08401.

SAVE 50% on printed circuits. Conduct-A-Tape. The tape you solder to! Sampler kit \$3.00. Full kit \$7.50. CAC, 2573 4th W., Seattle, Wash. 98119. No COD.

RESISTORS: Free catalog of high-quality values. Kimberly-James, Inc., 1422 Chestnut, Philadelphia, Pa. 19102.

TELEVISION CAMERA KITS! Wide selection tube and transistor models. Starter kits, \$18.95 up. Complete kits \$149.50 up. Plans available separately; tube camera \$3.00, transistor camera \$5.00, TV station \$1.00, ATV literature anthology \$2.50. Catalog FREE. **ATV RESEARCH,** 13th & Broadway, Dakota City, Nebraska 68731.

PLANS AND KITS

BEGINNERS Allwave \$5.00, Two Band \$5.00, F-M Tuner Chassis \$10.00, Headset \$2.50, Two Band Wired \$10.00. Ekeradio, Box 131, Temple City, Calif. 91780.

ELECTRONIC HOBBYIST POSTAL CLUB enables exchange of schematics, ideas, components, equipment with other members. Write, now! Associates, Box 58113, Houston, Texas 77058.

UNIVERSITY LEVEL LOGIC KITS with training manuals written by professors. Indiana Instruments, Inc., P. O. Box 8368, St. Petersburg, Florida 33738.

10 TESTED TRANSISTOR plans—25¢. "Coil Winding" Handbook—50¢. Catalog. Laboratories, 12041-L Sheridan, Garden Grove, Calif. 92640.

CONNECT Extension Telephones, maintain (or insert) ring—161 Bonad, Chestnut Hill, Mass. 02167.

SEND 10¢ for brochure on multi-purpose relay system. Applications include remote control, burglar alarm, call monitor, & vox. Michael Spielzinger, 87-10 204 St., Hollis, N. Y. 11423

CIRCUIT ANALYZER—Voltage-continuity checker, audio generator, battery eliminator-charger, variable voltage. Plans \$2.50. Gibson, Box 5153, Buena Park, Calif. 90620.

INTEGRATED CIRCUIT KITS; COMPUTER LOGIC; IC's; others. Catalog free. **KAYE ENGINEERING,** Box 3932-A, Long Beach, California 90803.

BLACK or WHITE fluorescent light. Low cost, battery operated. Use to find fluorescent minerals or as a camper light. Free construction article. Enclose self-addressed stamped envelope. Milwaukee Electromagnetics, Box 4476, Dept. B, Milwaukee, Wis. 53207.

SUB-CARRIER MUSIC ADAPTER for uninterrupted commercial-free music. Transistorized, easily connects to any FM tuner. Inexpensive and easy to build. Complete plans and etched circuit board \$4.50. Wallace Enterprise, 83-15 98th Street, Woodhaven, N. Y. 11421.

SHORTWAVE LISTENING

POLICE—FIRE—AIRCRAFT—MARINE—AMATEUR CALLS on your broadcast radio with **TUNAVERTER!** Tunable and crystal in one! Guaranteed! Free catalog. Salch Co., Woodsboro-PEC, Texas 78393.

SUMMER SUPPLEMENT—World Radio Handbook, \$2.75 PPD. New items in catalog—indoor and outdoor SWL antennas, receiver discounts, etc. **GILFER ASSOC., INC.,** Box 239, Park Ridge, New Jersey 07656.

HIGH FIDELITY

FREE! Send for money saving stereo catalog #P7E and lowest quotations on your individual component, tape recorder, or system requirements. Electronic Values, Inc., 200 W. 20th St., New York, N.Y. 10011.

Hi-Fi Components, Tape Recorders, at guaranteed "We Will Not Be Undersold" prices. 15-day money-back guarantee. Two-year warranty. No Catalog. Quotations Free. Hi-Fidelity Center, 239 (P) East 149th Street, New York 10451.

LOW, Low quotes: all components and recorders. HiFi, Roslyn, Penna. 19001.

TAPE RECORDERS, Hi-Fi, components, Sleep Learning Equipment, tapes. Unusual Values Free Catalog. Dressner, 1523R, Jericho Turnpike, New Hyde Park, N.Y. 11040.

WANTED

CASH Paid! Unused tubes, electronic equipment. Barry, 512 Broadway, NYC 10012.

QUICKSILVER, Platinum, Silver, Gold, Ores Analyzed. Free Circular. Mercury Terminal, Norwood, Mass. 02062.

TUBES

TUBES "Oldies", latest. Lists free. Steinmetz, 7519 Maplewood, Hammond, Indiana 46324.

RECEIVING & INDUSTRIAL TUBES, TRANSISTORS. All Brands—Biggest Discounts. Technicians, Hobbyists, Experimenters—Request **FREE** Giant Catalog and **SAVE!** **ZALYTRON,** 469 Jericho Turnpike, Mineola, N.Y. 11501.

TUBE Headquarters of World! Send 10¢ for Catalog (tubes, electronic equipment) Barry, 512 Broadway, N.Y.C. 10012.

RADIO & T.V. Tubes—33¢ each. Send for free list. Cornell, 4213 University, San Diego, Calif. 92105.

TAPE AND RECORDERS

BEFORE Renting Stereo Tapes try us. Postpaid both ways—no deposit—immediate delivery. Quality—Dependability—Service—Satisfaction—prevail here. If you've been dissatisfied in the past, your initial order will prove this is no idle boast. Free Catalog. Gold Coast Tape Library, Box 2262, Palm Village Station, Hialeah, Fla. 33012.

AUTOMATIC telephone connection for Concord and other transistorized recorders. **SURVEILLANCE** and Privacy Protection Devices. Free Data: Security Electronics-PER, 15 East 43rd Street, New York, N.Y. 10017.

Hi-Fi Components, Tape Recorders, at guaranteed "We Will Not Be Undersold" prices. 15-day money-back guarantee. Two-year warranty. No Catalog. Quotations Free. Hi-Fidelity Center, 239 (PT) East 149th Street, New York 10451.

SCOTCH Recording Tapes. Tape Recorders. Catalog 10¢. Tower, Lafayette Hill, Pa. 19444.

RENT STEREO TAPES—75¢ WEEK. CATALOG. ART'S TAPE SERVICE, 1613½ North Mariposa Ave., Hollywood, Calif. 90027.

TAPE transport. NAB recording studio quality. Build yourself for amazingly low cost. Detailed plans \$5.00. Free particulars. Pepke Laboratories, 309-B West 19 Street, New York, N.Y. 10011.

TAPEMATES makes available to you ALL 4-TRACK STEREO TAPES—ALL LABELS—postpaid to your door—at tremendous savings. For free brochure write: **TAPEMATES,** 5727 W. Jefferson Blvd., Los Angeles, California 90016.

TAPE RECORDER SALE. Brand new, nationally advertised brands. \$10.00 above cost. Special prices on Hi-Fi Components and color television. Arkay Sales, 1028C Commonwealth Avenue, Boston, Mass. 02215.

STEREO TAPES. Save 30% and up; no membership or fees required; postpaid anywhere U.S.A. Free 70-page catalog. We discount batteries, recorders, tape/accessories. Beware of slogans, "not under-sold", as the discount information you supply our competitor is invariably reported to the factory. **SAXITONE**, 1776 Columbia Road, N.W., Washington, D.C. 20009.

WHOLESALE—4-8 track STEREOTAPES—Car, Home PLAYERS—CB, Recorders. MUSICO, Box 2705, Montgomery, Alabama 36105.

RENT 4-Track open reel tapes—all major labels—3,000 different—free brochure. Stereo-Parti, 55 St. James Drive, Santa Rosa, Ca. 95401.

SCOTCH RECORDING TAPE, lowest prices **TAPE CENTER**, Box 4305, Washington, D.C. 20012.

THE Tape Library—Postage Paid Rentals—Scotch Tape discounted. Catalog. Box 8146, D.C. 20024.

RENT STEREO TAPES \$1.00 week, postage paid. Scotch tape discounted. The Tape Library, Box 8146, D.C. 20024.

VIDEOTAPE 1/2", 2400 Ft, \$8.80. Moynihan, 107 North Brighton, Atlantic City, New Jersey 08401.

REPAIRS AND SERVICES

TV Tuners rebuilt and aligned per manufacturers specification. Only \$9.50. Any make UHF or VHF. Ninety day written guarantee. Ship complete with tubes or write for free mailing kit and dealer brochure. **JW Electronics**, Box 51C, Bloomington, Indiana 47401.

SPEAKER REPAIR. Hi-Fi, guitar, organ speakers reconed good as new at fraction of new speaker price. For details and reconing center in your area write: **Waldom Electronics, Inc.**, Dept PE, 4625 W. 53rd St., Chicago, Ill. 60632.

DESIGN SERVICES. Special designs to your requirements. Quotation guides 25¢. **Anderson Associates**, Box 1464, Mountain View, California 94040.

TV AID send symptoms, make, model chassis number. Individual diagnosis \$5.00. **TELAID**, Box 16, Middletown, DE. 19709.

PERSONALS

INVESTIGATORS, FREE BROCHURE, LATEST SUBMINIATURE ELECTRONIC SURVEILLANCE EQUIPMENT. ACE ELECTRONICS, 11500-K NW 7th AVE., MIAMI, FLA. 33168.

MAKE FRIENDS WORLDWIDE through international correspondence. Illustrated brochure free. **Hermes**, Berlin 11, Germany.

BILL PROBLEMS? Poor credit no trouble. Not a loan company. Send for free application. **Nationwide Plan**, Dept. PE, 318 Broadway Blvd., Reno, Nevada 89502 or 307 Pocasset Ave., Providence, R.I. 02909.

INSTRUCTION

LEARN While Asleep, hypnotize with your recorder, phonograph. Astonishing details, sensational catalog free! **Sleep-Learning Association**, Box 24-ZD, Olympia, Wash. 98501.

LEARN ELECTRONIC ORGAN SERVICING at home all makes including transistor. Experimental kit—trouble-shooting. Accredited NHSC, Free Booklet. **NILES BRYANT SCHOOL**, 3631 Stockton, Dept. A, Sacramento, Calif. 95820.

ASSOCIATE Degree in Electronics Engineering earned through combination correspondence-classroom educational program. Free brochure. **Grantham Technical Institute**, 1505 N. Western Ave., Hollywood, Calif. 90027.

HIGHLY EFFECTIVE home study course in Electronics Engineering Mathematics with circuit application. Earn your Associate in Science Degree. Free Literature. **Cook's Institute of Electronics Engineering**, P.O. Box 36185, Houston, Texas 77036. (Established 1945.)

FCC First Class License in six weeks—nation's highest success rate—approved for Veterans Training. Write **Elkins Institute**, 2603B Inwood Road, Dallas, Texas 75235.

"ARCTURUS" SALE

• **Tube Bareains, to name just a few:**
 #6146\$2.95 #5725/GA56 79c; 3 for \$2.00 #6AQ561c
 #6360 3.50 #5842/417A 2.50 #6BQ794c
 #6688 3.50 #5847/404A 2.50 #6CG759c
 #6939 3.50 #1AX249c; 5 for 2.00 #6J649c
 #702559 #6K739c; 3 for 1.00 #6T888c
 #7788 3.75 #12BN659c; 3 for 1.49 #6U878c
 #ZD2149 #25L659c; 3 for 1.49 #12AU759c

• **Tube Cartons:** 6AU6 etc. size, \$1.95 per 100. 6SN7 etc. size, \$2.35 per 100. 5U4GB size, \$2.75 per 100. 5U4G size, .03c each.
 • **Obsolete Tubes:** #UX200, \$1.69; #80, \$1.20; #10Y, 69c.

• **7 inch 90 degree TV bench test Picture Tube with adapter.** No lon trap needed. Cat. #7BP7, \$7.99.

• **Silicon Rectifier** octal-based long-range replacement for 5U4, 5Y3, 5AS4, 5AW4, 5T4, 5V4, 5Z4. With diagram. Cat. #Rect 1, 99c each.

• **Silicon Rectifier** replacement, octal based, for 024. Cat. #Rect 2, 99c each.

• **10 Flangeless Rectifiers**, 1 amp. 400 to 1000 p.i.v. Cat. #RS10, \$2.98.

• **10 Silicon Rectifiers**, 750 MA. 50 to 300 p.i.v. Cat. #330F, 99c each.

• **RCA—110 degree flyback transformer**, latest type. Produces 18 KV. Includes schematic diagram application for any TV. Cat. #BR-1 \$2.99.

• **5 transistor circuit boards** containing up to 6 transistors, plus diodes, resistors, capacitors, etc. Cat. #TB10, 99c.

• **Needs:** values such as #AS22 Sapphire, 39c; Diamond, 99c.
 • **Color Yokes**, 70 Degree for all around color CRT's. Cat. #XRC70, \$12.95. 90 degree for all rectangular 19 to 25 inch color CRT's. Cat. #XRC90, \$12.95.

• **Transistorized U.H.F. Tuners** used in 1965 to 1967 TV sets made by Admiral, RCA, Motorola, etc. Removable gearing may vary from one make to another. Need only 12 volts d.c. to function. No filament voltage needed. Easy replacement units. Cat. #U.H.F. 567, \$4.95.

• **Flyback Transformer** in original carton. Made by Merit or Todd. Most with schematic drawing of unit. Please do not request specific type. Cat. #506, 99c each.

• **Kit of 30 tested Germanium Diodes.** Cat. #100, 99c.

Send for our Free Catalog listing thousands of similar best buys in tubes, parts, kits, transistors, rectifiers, etc. Order under \$5.00, add 50c handling charge. Include 4% of dollar value of order for postage.

Canadian Postage \$1.00 extra.

ARCTURUS ELECTRONICS CORP.

Phone: 201-UN 4-5568

502-22nd St., Union City, N.J. 07087 Dept. MPE
 CIRCLE NO. 3 ON READER SERVICE PAGE

LEARN TECHNICAL WRITING—at home. High paying prestige careers not requiring college. Growing demand, all industries for tech writers now. Low monthly tuition. Easy to understand. **FREE** career book, sample lesson. **APPROVED FOR VETERANS.** American Technical Writing Schools, Dept. PEC-78, 5512 Hollywood Blvd., Hollywood, Calif. 90028.

R. E. I.'s famous (5) week course for the first class radio telephone license is the shortest, most effective course in the nation. Over 98% of R.E.I. graduates pass F.C.C. exams for 1st class license. Total tuition \$350.00. Job placement free. Write for brochure **Radio Engineering Incorporated Schools**, 1336 Main Street, Sarasota, Florida 33577—or 3123 Gillham Road, Kansas City, Missouri 64109—or 809 Caroline Street, Fredericksburg, Virginia 22401.

ART TALENT? Make money right away. A course may not be necessary. Free Brochure. **Famous American Studios**, Spring Park, Minnesota 55384.

FCC FIRST CLASS PHONE license in five weeks guaranteed. Day or Night classes. Write **Electronics Institute**, 2202 West Erwin, Tyler, Texas 75701.

FCC LICENSE THROUGH TAPE RECORDED INSTRUCTION. Radio License Training, 1060D Duncan, Manhattan Beach, Calif. 90266.

PLASTICS

CASTOLITE Liquid Plastic pours like water and hardens like glass without heat. Clear, Colors. Embed real flowers, butterflies, photos, coins. Also new molding formulas for perfect reproductions. Illustrated booklet shows **HOW**. Send 25¢—Dept. 68-108H. **CASTOLITE**, Woodstock, Ill. 60098.

REMAILING SERVICE

GEORGIA Remails. Your secret address. Entersulf, Box 206E, Forsyth, Georgia 31029.



LINEAR CIRCUITS

FM IF Amplifier.....\$2.00
 702C Wide Band DC Ampl.....\$4.50
 709C Operational Ampl.....\$4.50
 710C Hi Sped Diff.
 Comparator.....\$5.00
 711C Dual Comparator.....\$5.50

DIGITAL CIRCUITS

SR Flip Flop.....\$.90
 SR Clocked Flip Flop.....\$1.15
 8 Input NAND Nor Gate.....\$1.00
 Dual NAND Nor Gate.....\$1.00
 Dual and Gate.....\$1.00
 OR Expander.....\$1.00

SILICON CONTROL RECTIFIER

PRV	3A	7A	20A	70A
50	.35	.45	.70	
100	.50	.65	1.00	4.00
200	.70	.95	1.30	8.00
300	.90	1.25	1.70	
400	1.20	1.60	2.10	12.00
500	1.50	2.00	2.50	
600	1.80	2.40	3.00	16.00
700	2.20	2.80		
1000			5.00	24.00

Silicon Power Rectifiers

PRV	3A	12A	20A	40A
100	.09	.30	.40	.75
200	.16	.50	.60	1.25
400	.20	.70	.80	1.50
600	.30	.00	1.20	1.80
800	.40	1.25	1.50	
1000	.55	1.50	1.80	

Avalanche Mode Transistors, used for Triggering SCR's. .3/\$1.00

UNIJUNCTIONS!

Similar to 2N2419. RBB of 5-7, stand off ratio of .6 and Ip of 12, with data sheet. \$1.50

TRIACS TO-66 5 AMP

PRV	
100	.90
200	1.40
300	1.75
400	2.25
500	2.60

Terms: FOB Cambridge, Mass. Send check or Money Order. Include Postage. Average Wt. per package 1/2 lb. NO C.O.D.'s. MIN. ORDER \$3.00.

SEND FOR OUR SPRING CATALOGUE

POST OFFICE BOX 74F
 SOMERVILLE, MASS. 02143

Featuring transistors, rectifiers
 Business Address: 325 Elm St.
 Cambridge, Mass.



CIRCLE NO. 27 ON READER SERVICE PAGE

GOVERNMENT SURPLUS

KEEPS TYPICALLY FROM \$53.90 . . . Trucks From \$78.40 . . . Boats, Typewriters, Airplanes, Electronics Equipment, Photographic Equipment, used. 100,000 Bargains Direct From Government. Complete Sales Directory and Surplus Catalog \$1.00 (Deductible First \$10.00 Order). Surplus Service, Box 820-J, Holland, Mich. 49423.

GOVERNMENT Surplus How and Where to Buy in Your Area. Send \$1.00 to: Surplus Information PE, Headquarters Building, Washington, D.C. 20036.

BOOKS

FREE catalog 950 aviation/electronic/space books. Aero Publishers, 329PE Aviation Road, Fallbrook, California 92028.

UNUSUAL Books! Catalog free! International, Box 7798(PE), Atlanta, Georgia 30309.

FREE Book. Prophet Elijah Coming Before Christ. Wonderful Bible Evidence. PE Megiddo Mission, Rochester, New York 14619.

TERRIFIC, new army written book, Basic Theory and Application of Transistors. \$1.40 postpaid. Devices, Box 136E, Bronx, New York 10463.

AUTHORS' SERVICES

AUTHORS! Learn how to have your book published, promoted, distributed. FREE booklet "ZD," Vantage, 120 West 31 St., New York 10001

POEMS WANTED for new song hits and recordings by America's most popular studio. Tin Pan Alley, 1650-ZD Broadway, New York 10019.

MUSIC

POEMS wanted for new songs. Nashville Music Institute, Box 532-E, Nashville, Tennessee 37202.

INVENTIONS WANTED

PATENT Searches including Maximum speed, full airmail report and closest patent copies, \$6.00. Quality searches expertly administered. Complete secrecy guaranteed. Free Invention Protection forms and "Patent Information." Write Dept. 9, Washington Patent Office Search Bureau, 711 14th Street, N.W., Washington, D.C. 20005.

INVENTORS. We will develop, help sell your idea or invention, patented or unpatented. Our national manufacturer clients are urgently seeking new items for outright cash sale or royalties. Financial assistance available. 10 years proven performances. For free information, write Dept. 41, Wall Street Invention Brokerage, 79 Wall Street, New York N.Y. 10005.

INVENTORS! Outright cash sale or royalties for your inventions. Patented. Unpatented. Active demand from our client manufacturers. Financial assistance available. Write Dept. 35, United States Invention Brokerage, 78 Wall Street, New York, N.Y. 10005.

INVENTIONS wanted. Patented; unpatented. Global Marketing Service, 2420-P 77th, Oakland, Calif. 94605.

PATENT SEARCHES \$15.00! FREE "INVENTIDN RECORD"/Information. Hayward Company, 1029HR Vermont, District of Columbia 20005.

INVENTORS! OUR FREE EXPERT ANALYSIS of your invention can save valuable time, help you realize full sale value. Strictly confidential. FREE INVENTION CERTIFICATE. Write today: Pioneer Invention Service, Dept. 35, 150 Broadway, New York, N.Y. 10038.

INVENTORS! Sell your invention for cash or royalties! Our client manufacturers eagerly seek new items. Patented. Unpatented. Financial assistance if needed. 25 years proven performances. For free information, write Dept. 20, Gilbert Adams, Invention Broker, 80 Wall St., New York, N.Y. 10005.

INVENTORS! Don't sell your invention, patented or unpatented, until you receive our offer. Eagle Development Company, Dept. P, 79 Wall Street, N.Y., N.Y. 10005.

MANUFACTURERS NEED NEW ITEMS! Many million-dollar corporations have authorized us to locate new products. Free details regarding development, sale, licensing of your invention. RAYMOND LEE ORGANIZATION, 230-GR Park Avenue, New York City 10017. Member: UNITED STATES CHAMBER COMMERCE.

QUALITY Patent Searches \$15.00! Preferred by Professional Inventors, Lawyers, Manufacturers. "Confidential Report" Including related United States patent copies "Airmailed Certified." FREE information! United States Inventors Service Company, 501-H Thirteenth Street, N.W., Washington, D.C. 20005.

MUSICAL INSTRUMENTS

ACCORDIONS, GUITARS, BAND INSTRUMENTS! Save to 50%. Terms Trades. Free Trial. Free catalog. Mention instrument. Music Mart, 5535-PE Belmont, Chicago 60641.

HYPNOTISM

FREE Hypnotism, Self-Hypnosis, Sleep Learning Catalog! Drawer H400, Ruidoso, New Mexico 88345.

"MALE-FEMALE HYPNOTISM" EXPOSED, EXPLAINED! "SECRET METHOD"—THEY NEVER KNOW! \$2, RUSHED. GUARANTEED! ISABELLA HALL, SILVER SPRINGS, FLORIDA 32688.

SELF-HYPNOSIS for self-improvement. Safe, effective! Free literature. McKinley, Dept. T-4, Box 3038, San Bernardino, California 92404.

HYPNOTIZE SUCCESSFULLY—or money refunded! Complete illustrated course—including Self-Hypnosis \$1.00. Arthur Fowler, Box 4396, Woodbury, New Jersey 08096.

HYPNOTIZE MALES, FEMALES!—Unnoticed! Quickly! Nerves! Exciting! \$2.25. Research Enterprises, 29-SN21 Samoset, Woburn, Mass. 01801.

FEMALE, MALE HYPNOTISM!! Easily! Instantly! Secret Nerve Centers! \$2.20. Brugenheimer, Box 158-E30, Lexington, Mass. 02173.

MAGNETS

MAGNETS. All types. Special—20 disc magnets, or 2 stick magnets, or 10 small bar magnets, or 8 assorted magnets, \$1.00. Maryland Magnet Company, 5412-H Gist, Baltimore, Maryland 21215.

RUBBER STAMPS

RUBBER ADDRESS STAMP \$1.50. SIGNATURE \$3.50. FREE CATALOG. JACKSON, BOX 443-G, FRANKLIN PARK, ILL. 60131.

PHOTOGRAPHY—FILM, EQUIPMENT, SERVICES

MEDICAL Film—Adults Only—"Childbirth"—1 reel 8mm \$7.50—16mm \$14.95. International-E, Greenvale, L.I., New York 11548.

SCIENCE Bargains—Request Free Giant Catalog "CJ"—148 pages—Astronomical Telescopes, Microscopes, Lenses, Binoculars, Kits, Parts. War surplus bargains. Edmund Scientific Co., Barrington, New Jersey 08007.

RECORDS

SPECIAL INTEREST RECORDS AVAILABLE, PRODUCED BY THE EDITORS OF THE WORLD'S LEADING SPECIAL INTEREST MAGAZINES. SEND FOR FREE CATALOG. RECORD CATALOG-PE, ZIFF-DAVIS PUBLISHING COMPANY, ONE PARK AVENUE, NEW YORK, N.Y. 10016.

!!! RECORDS !!! Assorted, \$25.00—20 LP's. \$5.00, 30—45 rpm. 129 Carol Avenue, Aberdeen, Maryland 21001.

EDUCATIONAL OPPORTUNITIES

LEARN WHILE ASLEEP. Miraculously build Mind Power, achieve Self-Confidence, improve Health, gain Success. Method 92% effective. Details free. ASR Foundation, Box 7021EG Henry Clay Sta., Lexington, Kentucky 40502.

PRINTING

FREE LITERATURE: 1000 Address Labels \$1.00, 1000 Business Cards \$4.95. Printing, Rubber Stamps. Jordan's, 552 West O'Connor, Lima, Ohio 45801.

POSTPAID Specials: 1,000 8½ x 11 Offset—\$5.75. Mimeoprinting: 500—\$3.75. Electronic Stencils: \$1.00. Free brochures. SEAVIEW, 9115-PE Ave., "L." Bklyn. N.Y. 11236.

THERMOGRAPHED business cards, \$3.49—1,000, free samples. Gables—405B Clifton, Glenshaw, Pa. 15116.

BUSINESS OPPORTUNITIES

INVESTIGATE ACCIDENTS: Earn to \$1000 monthly. Men urgently needed. Car furnished. Business expenses paid. No selling. No college education necessary. Pick own job location. Investigate full time or earn to \$8 hour spare time. Write for FREE information. No obligation. Universal Schools, CZ-7, 6801 Hillcrest, Dallas, Texas 75205.

RAISE Rabbits for us on \$500 month plan. Free details. White's Rabbitry, Mt. Vernon, Ohio 43050.

FREE CATALOGS. Repair air conditioning, refrigeration. Tools, supplies, full instructions. Ooolin, 2016 Canton, Dallas, Texas 75201.

PIANO TUNING learned quickly at home. Tremendous field! Musical knowledge unnecessary. GI Approved. Information free. Empire School, Miami, Florida 33145.

ELECTROPLATING Equipment and supplies. All types for home workshops and industrial. Send \$1.00 (refundable) for equipment guide formulas, operating data, catalog. HBS Equipment Division 90, 3543 East 16th, Los Angeles, California 90023.

I MADE \$40,000.00 Year by Mailorder! Helped others make money! Start with \$10.00—Free Proof. Torrey, Box 318-N, Ypsilanti, Michigan 48197.

\$200.00 DAILY In Your Mailbox! Your opportunity to do what mail-order experts do. Free details. Associates, Box 136-J, Holland, Michigan 49423.

SELL HERTEL BIBLES—Part Time. Finest reference Bible available. Demonstrator and supplies furnished. Excellent commission. Write: International Book, Dept. PE, Box 118, Wichita, Kansas 67201.

EMPLOYMENT INFORMATION

OVERSEAS Jobs all trades and professions. Free information write: National Employment Service, Box 2235 A.M.F., Miami, Florida 33159.

AUSTRALIA. Opportunity. Adventure. Jobs. New Life. Government Shares Passage. Information \$1. Pacifico, Box 43485-R, Los Angeles, Calif. 90043.

REAL ESTATE

FREE . . . SUMMER CATALOG! Over 2,300 actual photos! 2,080 properties . . . farms, ranches, town and country homes, businesses in 31 states coast to coast! Specify type property and location preferred. Zip code, please. UNITED FARM AGENCY, 612-EP West 47th St., Kansas City, Mo. 64112.

400,000,000 ACRES GOVERNMENT PUBLIC LAND located 25 states. Low as \$1.00 acre. Detailed 1968 report—send \$1.00. Land Information, 422-PE7 Washington Building, Washington, D. C. 20005.

MISCELLANEOUS

WINEMAKERS: Free illustrated catalog of yeasts, equipment. Semplex, Box 7208, Minneapolis, Minn. 55412.

BILLS PAID WITHOUT BORROWING—Nobody refused up to \$18,000.00. Bad credit no problem—Not a Loan Company. Write for FREE application—INTERNATIONAL ACCEPTANCE, Dept. 50A, Phoenix, Arizona 85012—711 14th St., N.W., Washington, D.C. 20005—507 Carondelet St., New Orleans, La. 70130.

EMPLOYMENT Resumes. Get a better job & earn more! Send only \$2.00 for expert, complete Resume Writing Instructions. J. Ross, 80-34 Kent St., Jamaica, N.Y. 11432, Dept. PE.

STOP BURGLARS THE EASY WAY!! Affix authentic "Protected by Electronic Sentry Alarm" Decals to auto windows, doors & windows of home, retail stores, vending machines, etc. Whether you have an alarm or not—thieves stay away! Only \$1.00 each set of two. J. Ross, 80-34 Kent St., Jamaica, N.Y. 11432 Dept. PE.

WATCHES AND CHRONOGRAPHS—Import from Switzerland, save 50%. Color catalog. DFI, West Dennis, Massachusetts 02670.

BEERS, PEACH BRANDY, WINES Strongest Formulas, \$2.25. (complete brew supplies, hydrometers, catalog included)—Research Enterprises, 29-D Samoset, Woburn, Mass. 01801.

STAMMER — Stutter — No more. (Dr. Young.) Write Gaucho, Box 9309-E8, Chicago 60690.

MAIL ORDER OPPORTUNITIES WAITING FOR YOU!

Classified Advertisers find more outlets for their product and service advertising in Ziff-Oavis Electronics Publications than in any other media.

Whether in a monthly publication: POPULAR ELECTRONICS, ELECTRONICS WORLD, HiFi/STEREO REVIEW . . . or in an annual: COMMUNICATIONS HANDBOOK, ELECTRONIC EXPERIMENTER'S HANDBOOKS, ELECTRONICS INSTALLATION AND SERVICING HANDBOOK, or TAPE RECORDER ANNUAL—Classified Advertising is responded to regularly by an affluent audience of active electronics enthusiasts.

Prove to yourself the effectiveness of Classified Advertising in Ziff-Davis Electronics Publications. Write today for information, assistance or sample copies to:

Hal Cymes, Classified Advertising Manager
Ziff-Davis Publishing Company
One Park Avenue, New York, N. Y. 10016

AMERICA'S GREATEST VALUES IN SCIENCE LABS AND COURSES!

Now! Space Age Science for Everyone

AMAZING KIT-A-MONTH CLUB

You get **ALL** the following in **nine** monthly kits!



ELECTRICAL LAB

All the equipment for basic electrical experiments with **Whetstone Bridge** (measures resistance), **Magnell** and **D-magnetizer**, **Thermocouple**, **Mystery Shock Box**, **Continuity Tester**, **Extinction Voltmeter**, **Solenoid Coin Toss**, **Electromagnetic Relay**, **Neon Lamp**, **Galvanometer**, **Induction Coil**, **Resistors**, **Chemicals** and **Electrodes** for **Plating** and **Electrolysis**. **FOR SAFETY** a step-down **Isolation Transformer** provides **reduced current**.



RADIO LAB AND COURSE

YOU BUILD A **SHORTWAVE AND BROADCAST RADIO**. 3-tube regenerative circuit. Uses 115V AC. **CARBON MICROPHONE** for code or voice. **RADIO TRANSMITTER** for code or voice. **RIPPLE TANK WAVE GENERATOR** with variable frequency. Invaluable in the understanding of wave theory. **CODE PRACTICE OSCILLATOR** with manual. "Steps to a Ham License." All you need to pass the FCC Ham License Exam.



ATOMIC ENERGY LAB

ATOMIC CLOUD CHAMBER WITH PROJECTOR ILLUMINATOR. See the vapor trails of alpha and beta particles, and of cosmic rays. **SPINTHARISCOPE**. Shows exploding atoms. **ELECTROSCOPE**—metal housed with **Scale** and **Magnifying Viewer**. Measures background radiation and tests sample sources. **SAFE RADIOACTIVE MATERIALS**. Alpha Source in handy container and **Lithium Ore**. Full instructions and explanations open up the fascinating field of nuclear physics.

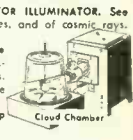

STROBE LIGHT

A **Neon Lamp** that flashes at intervals you can synchronize with the speed of rotating or vibrating objects in order to "freeze" their motion in permit close study and checking frequencies and RPM. Flashes are timed by a variable frequency oscillator with a range of 20 to 600 cycles per second.

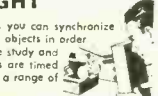

RADIO SERVICING TOOLS

SIGNAL TRACER. A valuable "double shooting" tool which permits you to "listen in" as you trace through a faulty circuit until you find the trouble spot. **CONTINUITY TESTER**. Pinpoints open circuits and test voltages. The use of both pieces fully described in accompanying manual. "Simplified Radio and TV Servicing."



SPECTROSCOPE

Analyze spectra of glowing gases. See and identify the Fraunhofer Lines. A quality instrument featuring an **easy-to-read built-in scale** and a powerful **condensing system** for a bright spectrum. Equipment includes **Alcohol Burner** and a **2 Watt Neon Spectral Lamp**. Full instructions cover theory and use.

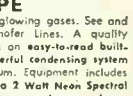

PHOTOELECTRIC RELAY

Crystal PhotoCell, **Electronic Amplifier**, **Relay**, **large Condensing Lens** in **Cabinet Mount**. Features automatic on-off or holding circuit operation. **Sensitivity Control**. Plug-in **Outlet** for controlled circuit. Use for alarms, counters, etc. Operates on 115V AC. A basic unit for many exciting experiments.

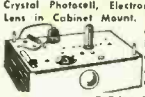

DC POWER SUPPLY

Changes regular 110-120V AC to the direct current required for electronic projects and experimenting. Consists of a **Power Transformer**, **Vacuum Tube Rectifier**, **20/10 MFD Capacitor Filter Circuit**, and a **potentiometer Voltage Selector**. A **Safe Isolated Power Supply** eliminates the need of expensive multi-volt batteries.



ULTRAVIOLET LAMP

140 watt filter type UV LAMP. Heavy metal cabinet. **6 Foot Cord**, **Rotary Switch**. Produces dazzling color effects with invisible black light. Has many uses in the fields of **Mineralogy**, **Crime Detection** and **Science**. Accessories include **Invisible Ink**, **Tracer Powder**, **Fluorescent Crayons**.



ANALOG COMPUTER

Electronic Computer multiplies, divides, calculates powers, roots. Set up the problem on the scales of two potentiometers and find the answer on the scale of third potentiometer as indicated by a sensitive meter. **Instruction Manual** covers computer theory and practical use. Over 150 sample problems and answers demonstrate use with fractions, trigonometry, logarithms, physics formulas, ballistics, etc.



MICROCAST LAB

Microprojector shows microscopic subjects enlarged with brilliant detail on wall or screen. Has sturdy **Steel Cabinet**, **large Condensing Lens** for extra brightness, and a **GE Projection Lamp**. **Microscope** features **Romiden Eye-piece** for wide field viewing. **Substage Light** and **Polarizing Filters**. **Magnifies up to 200X**. Includes: **Slides**, **Cover Glasses** and **Microscopy Manual**.



SURVEYOR'S TRANSIT

A practical **Transit**. **6X erect image telescope** with **Range Finder**. **Reticle** for measuring remote distances and heights. **Yerrier** reading for both horizontal and vertical scales. **Leveling Head** with **Thumb Screw Adjustment** and **Spirit Level**. **Clamps** under head hold wooden legs of Tripod. **Legs** not included. **Instructions** cover elementary surveying, range-finding.



LIGHT AND OPTICS LAB

Exciting optical projects for the study of light. Equipment includes: **Five Precision Lenses**, **Prism**, **Polarizing Filters**, **Diffraction Grating**, **Mirror**, **Telescoping Tubing**, **Lens Mounts**, **Tube Holders** and **Brackets**. All the parts and instructions to build a **Camera Obscura**, **Camera Lucida**, **Polariscope**, and many other optical devices.

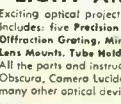

PHOTOMICROGRAPHY CAMERA

Photographs subjects mounted on microscopic slides. Enlarges up to 100X. Takes clear, sharp pictures of specimens too small to be seen with the naked eye. A fully self-contained unit — no microscope required. Uses standard roll film, either 120 or 35mm, black and white or color. Make a photographic record of your projects with microscopic subjects.



TELESCOPE AND MOUNT

30X erect image. Extends to 30" length. **Five ground and polished lenses**. **Romiden Eyepiece**. **Sturdy Equatorial Mount** makes it easy to follow the movement of heavenly bodies. **Mount** has fittings for wooden legs that complete the tripod (legs are regular 1x2 lumber not included).



PHOTOGRAPHY LAB

A **PRECISION 35MM ENLARGER**... horizontal type with twin condensing lenses and 3" **F1L projection lens**. Produces quality enlargements up to 8" x 10". **Contact Print Frame** takes negatives up to 3 1/2" x 4 1/4". **3 Plastic Developing Trays**, **Neon Safelight**, **Trey Thermometer**, **Film Clips**, **Developing Chemicals**. **Printing and Enlarging Paper** and **Orderform Handbook**. Make quality enlargements for 6c. Make prints for only 2c. Full instructions.



LIGHT TRANSMITTER-RECEIVER

The **TRANSMITTER** consists of a **Light Source**, a **Modulating Reflector Diaphragm** and an **Optical Projection System**. The **RECEIVER** is a **Two-Stage Audio Amplifier**, controlled by a **Photo-electric Cell** that catches the projected light beam and causes the original sound waves to be reproduced in the headphone.



WEATHER STATION

A **REMOTE READING ANEMOMETER AND WIND VANE**... **Flashing Neon Lights** on indoor indicator board show wind speed and direction. **Safety Power Cord** makes all connections safe. **100 ft. of Lead-in Wire**. Plus—**Air Tank Barometer** with 4ft. indicator column. **Sling psychrometer** measures relative humidity. **Rain Gauge** measures rainfall to 1/100 inch. **ALSO Cloud Chart**, **Weather Map** and **Forecasting Manual**—a complete set-up for amateur meteorology.



You get **ALL** the equipment for **ALL** the above in **nine** monthly kits

SEND ONLY \$1.00 TO ENROLL PAY ONLY \$4.75 FOR EACH KIT THAT YOU RECEIVE

Take as few as you wish—or get all nine... it's up to you!

SOME QUESTIONS ANSWERED

- Q. How is it possible? It seems incredible to be able to get all the equipment shown above in just nine kits — at only \$4.75 per kit!
- A. The low overhead of the membership plan is just part of the answer. The real key to this amazing program is ABSClub's especially designed multi-use equipment. For example: the Microprojector quickly and easily converts into the Spectroscopy, Photo Enlarger and Cloud Chamber Illuminator. Similarly, the Transit Head doubles as a Telescope Mount. Such multi-purpose design makes possible this all-science program at a price everyone can afford.
- Q. May members choose the order in which they receive their kits?
- A. Yes. With the first kit members receive a list of the equipment and projects contained in each of the remaining eight kits. With this information they are able to choose the kit sequence that best suits their particular interest.
- Q. Can members get their kits all at once instead of one-a-month?
- A. Yes. At any time members can have the balance of their kits sent in one shipment. We recommend that you start on the kit-a-month plan because the monthly spacing will give you time to get the full measure of knowledge and enjoyment that each kit has to offer.

NO OBLIGATION—NO RISK!

- ★ You take only as many kits as you wish.
- ★ All kits on 2 weeks approval.
- ★ You may return any kit for full refund.

Send coupon today—get your first kit on its way!

MEMBERSHIP COUPON

I wish to try the Kit-a-Month Program:

- I enclose \$1.00 to enroll and \$4.75 for the first kit postpaid.
- I enclose \$1.00 to enroll. Send first kit COD. I'll pay COD fee.

I understand if I am not satisfied with the first kit I may return it for a complete refund including the \$1.00 membership fee.

NAME _____

ADDRESS _____

CITY AND STATE _____ (PLEASE PRINT) ZIP CODE _____

AMERICAN BASIC SCIENCE CLUB, INC.
104 Heiman, San Antonio, Texas 78205

NO EXPERIENCE NECESSARY — IT'S FUN! IT'S EASY!

We can't leave well-enough alone...

...so we decided to redesign the RCA-6GF7A vertical deflection tube to practically eliminate low-line top-picture compression, high-line top picture stretch in color TV receivers.

We developed a cathode material that improves the tube's ability to provide uniform and consistent performance as a high-perveance, low- μ triode unit for vertical-deflection amplifier applications. A better grid-wire plating technique virtually eliminates cathode poisoning and grid emission problems. Linearity is 100% controlled. And for vertical-

deflection-oscillator applications, we test for grid leakage at higher plate and grid voltages than would normally be found in TV applications so the picture won't creep up the screen as the vertical deflection tube warms up.

Innovations and improvements that make your service operation more reliable, efficient, and profitable are our constant aim. See your Authorized RCA Tube Distributor for quality RCA receiving tubes.

RCA Electronic Components, Harrison, New Jersey.

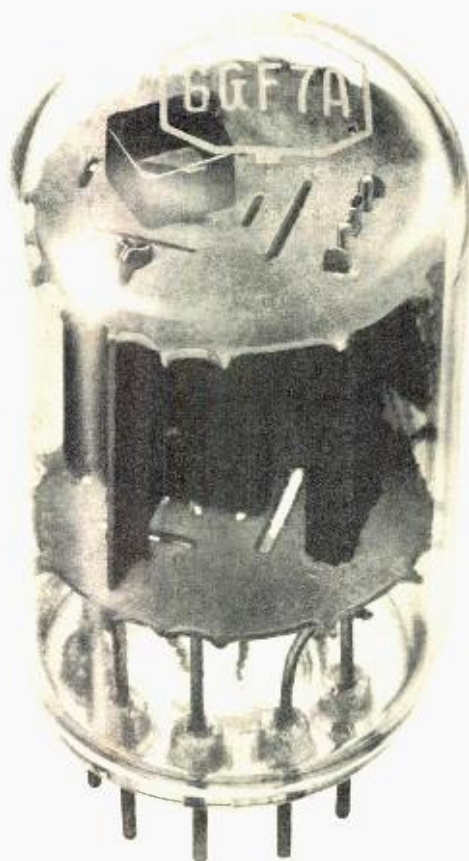

RCA

EICO Makes It Possible

Uncompromising engineering—for value does it!
You save up to 50% with Eico Kits and Wired Equipment.



Cortina Stereo

Engineering excellence, 100% capability, striking esthetics, the industry's only **TOTAL PERFORMANCE STEREO** at lowest cost.

A Silicon Solid-State 70 Watt Stereo Amplifier for \$99.95 kit, \$139.95 wired, including cabinet. Cortina 3070.

A Solid-State FM Stereo Tuner for \$99.95 kit, \$139.95 wired, including cabinet. Cortina 3200.

A 70-Watt Solid-State FM Stereo Receiver for \$169.95 kit, \$259.95 wired, including cabinet. Cortina 3570.



Eicocraft

The newest excitement in kits.

100% solid-state and professional. Fun to build and use. Expandable, interconnectable. Great as "jiffy" projects and as introductions to electronics. No technical experience needed. Finest parts, pre-drilled etched printed circuit boards, step-by-step instructions.



Electronic Siren \$4.95, Burglar Alarm \$6.95, Fire Alarm \$6.95, Intermom \$3.95, Audio Power Amplifier \$4.95, Metronome \$3.95, Tremolo \$8.95, Light Flasher \$3.95, Electronic "Mystifier" \$4.95, Photo Cell Nite Lite \$4.95, Power Supply \$7.95, Code Oscillator \$2.50, FM Wireless Mike \$9.95, AM Wireless Mike \$9.95, Electronic VOX \$7.95, FM Radio \$9.95, AM Radio \$7.95, Electronic Bongos \$7.95.



Two years ahead! Model 7923
All Solid-State 23-Channel 5W Transceiver. 4 exclusives: dual-crystal lattice filter for razor-sharp selectivity; efficient up-converter frequency synthesizer for advanced stability; precision series-mode fundamental crystals; Small: only 3"H, 8"W, 8 1/4"D. \$189.95 wired only.

The best buy in tube-type CB—"Sentinel-Pro" 23-channel dual conversion 5W Transceiver \$169.95 wired only.

Citizen's Band



EICO Trans/Match (Model 715) is a professional test set designed for complete checking of ham and CB equipment. Kit \$39.95, Wired \$59.95.

Truohm

Professional Portable Multimeters by EICO. The industry's greatest V-O-M values. Designed, made to Eico's high standards of professionalism. Each complete with batteries & test leads. Backed 100% by famous EICO warranty.

Model 100A4, 100,000 Ω /V, \$34.95.
Model 30A4, 30,000 Ω /V, \$19.95.
Model 30A3, 30,000 Ω /V, \$15.95.
Model 20A3, 20,000 Ω /V, \$12.95.
Model 4A3, 4,000 Ω /V, \$9.95.
Model 1A1, 1,000 Ω /V, \$5.95.



Automotive

EICO 888—Car/Boat Engine Analyzer.

For all 6V/12V systems; 4, 6, 8-cyl. engines.

Now you can keep your car or boat engine in tip-top shape with this solid-state, portable, self-powered universal engine analyzer. Completely tests your total ignition/electrical system.

Complete with a Tune-up & Trouble-shooting Manual. Model 888; \$49.95 kit, \$69.95 wired.



Model 232 Peak-to-Peak VTVM. A must for color or B&W TV and industrial use. 7 non-skip ranges on all 4 functions. With exclusive Uni-Probe.® \$34.95 kit, \$49.95 wired.

Test Equipment EICO®

100 best buys to choose from.

"The Professionals"
—laboratory precision at lowest cost.

Model 460 Wideband Direct-Coupled 5" Oscilloscope. DC-4.5mc for color and B&W TV service and lab use. Push-pull DC vertical amp., bal. or unbal. input. Automatic sync limiter and amp. \$109.95 kit, \$149.95 wired.

FREE 1968 CATALOG

PE-7

EICO Electronic Instrument Co., Inc.
283 Malta Street, Brooklyn, N.Y. 11207
 Send me FREE catalog describing the full EICO line of 200 best buys, and name of nearest dealer.

Name _____

Address _____

City _____

State _____ Zip _____

CIRCLE NO. 11 ON READER SERVICE PAGE