

Build \$2 IC Square-Wave Generator

# POPULAR ELECTRONICS

JANUARY  
1968

50  
CENTS



Build Adapter for Hi-Fi Reverb ● Using  
The SCR ● Pro's of Transistorized VOM's  
● SW Broadcasts from South America ●  
Report on Sub-Strata Communications  
● Cutting PC Boards ● Heathkit AR-15  
Reviewed ● Measure Watts with VOM

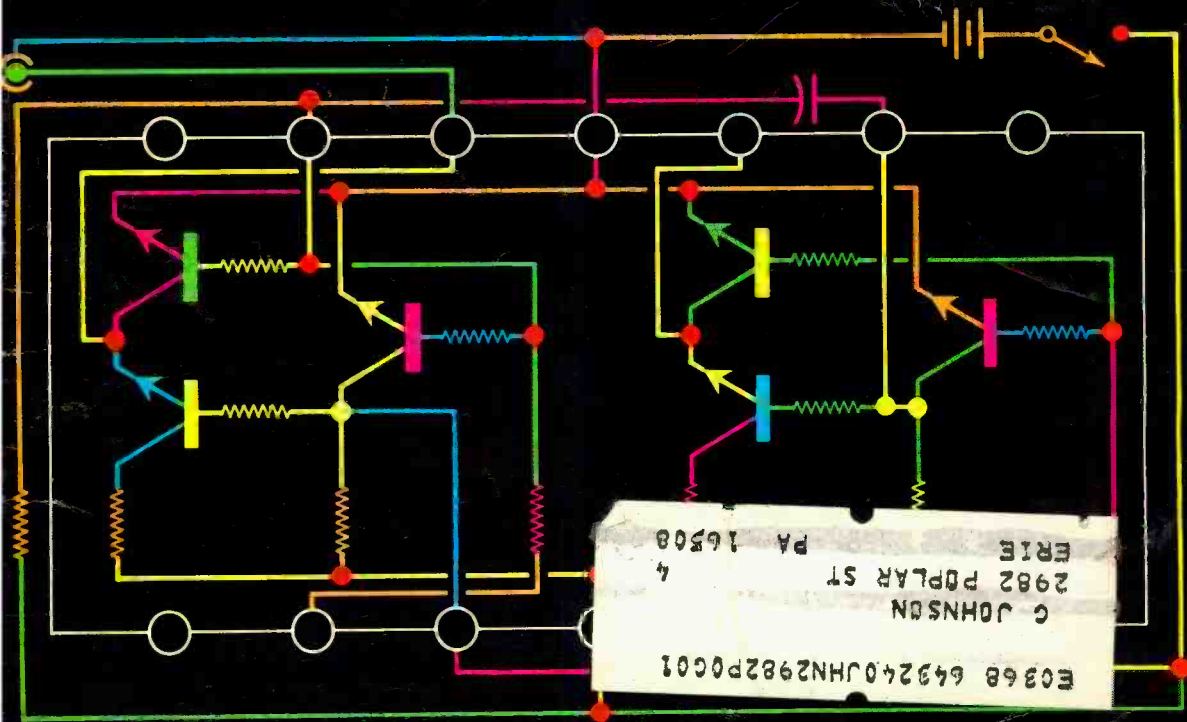

# You get more for your money from NRI—

## America's oldest and largest Electronic, Radio-Television home-study school

Compare. You'll find—as have so many thousands of others—NRI training can't be beat. From the delivery of your first lessons in the remarkable, new Achievement Kit, to "bite size," easily-read texts and carefully designed training equipment . . . NRI gives you more value.

Shown below is a dramatic, pictorial example of training materials in *just one* NRI Course. Everything you see below is included in low-cost NRI training. Other major NRI courses are equally complete. Text for text, kit for kit, dollar for dollar—you best home-study buy is NRI.

All this is yours—from Achievement Kit to the only Color TV specifically designed for training—when you enroll for NRI's TV-Radio Servicing course. Other courses are equally complete. But NRI training is more than kits and "bite-size" texts. It's also personal services which have made NRI a 50 year leader in the home-study field. Mail the postage-free card today.

### Approved under GI BILL

If you served since Jan. 31, 1955, or are in service, check GI line in postage-free card.





## **GET A FASTER START WITH NRI'S NEW EXCLUSIVE ACHIEVEMENT KIT**

The day your enrollment is received your Achievement Kit will be on its way to you. It contains everything you need to make an easy, fast start in the Electronics training of your choice. This attractive, new starter kit is an outstanding, logical way to introduce you to home-study the way NRI teaches it . . . backed by a dedicated staff and the personal attention you should expect of a home-study school. It is your first special training aid . . . designed to make your adventure into Electronics absorbing, meaningful. Your Achievement Kit contains your first group of lesson texts; rich vinyl desk folder to hold study material; the industry's most complete Radio-TV Electronics Dictionary; valuable reference texts; lesson answer sheets; envelopes; pencils, pen; engineer's ruler—even postage. No other school has anything like it.

**OVER 50 YEARS OF LEADERSHIP**

## **LEARNING BECOMES AN ABSORBING ADVENTURE WITH NRI TRAINING KITS**

What better way to learn than by doing? NRI pioneered and perfected the "home lab" technique of learning at home in your spare time. You get your hands on actual parts and use them to build, experiment, explore, discover. Electronics come alive! NRI invites comparison with training equipment offered by any other school. Begin NOW this exciting, practical program. It's the best way to understand the skills of the finest technicians—and make their techniques your own. Whatever your reason for wanting to increase your knowledge of Electronics . . . whatever your field of interest . . . whatever your education . . . there's an NRI instruction plan for you, at low tuition rates to fit your budget. Get all the facts about NRI training plans, NRI training equipment. Fill in and mail the attached postage-free card today.  
NATIONAL RADIO INSTITUTE, Washington, D.C. 20016.



**IN ELECTRONICS TRAINING**

**Accredited by the Accrediting Commission of the National Home Study Council**

**NEW  
COLOR TV**



# POPULAR ELECTRONICS

VOLUME 28 NUMBER 1

JANUARY, 1968

WORLD'S  
LARGEST-SELLING  
ELECTRONICS  
MAGAZINE

## SPECIAL TEST EQUIPMENT REPORT

**THE CASE FOR THE TRANSISTORIZED MULTIMETER**  
*New breed of test gear has all-around versatility*

30 LESLIE SOLOMON

## FEATURE ARTICLES

### BUILD AN IC 'TESTONE'

*Square-wave generator in a miniature package*

27 DON LANCASTER

### STILL AKIHABARA—STILL GOING STRONG

### BUILD AN ELECTRONIC REVERB-B-B ADAPTER

*Add pleasing echo effects to your hi-fi*

40 JACKSON M. GARROTT

41 DANIEL MEYER

### SUBSTRATA COMMUNICATIONS

*Still misunderstood, but being used every day*

45 RUSSELL E. ADAMS, JR.

### HOW TO USE GROUND COMMUNICATIONS

### "THAT OLD REGENERATIVE SET OF MINE"

49  
50 FRED E. EBEL

### POPULAR ELECOMICS

### WHO'S AFRAID OF THE SCR?

*The semiconductor with something extra*

52  
53 A. A. MANGIERI

### UNIQUE PATENTS

*Process for extracting metal from living bodies*

56

### CUTTING, PUNCHING AND DRILLING OF

### PRINTED CIRCUIT BOARDS

*Professional tricks for the home experimenter*

57 ALF ADEL, W9CDB

### A BAFFLING QUIZ

### MEASURE A.C. AMPS & WATTS WITH YOUR VOM

*It's all done with a filament transformer*

60 ROBERT P. BALIN

61 NEIL JOHNSON

### THROW TOGETHER A "QUINTUPLER"

### SLAVE DRIVER

64 FRANK H. TOOKER

65 A. J. LOWE

### THE PRODUCT GALLERY

*Comments on Heathkit AR-15 stereo receiver, Lafayette HB-625 CB transceiver, AMECO R-5 all-wave receiver, and Omega-T "Noise Bridge"*

68

### INFORMATION CENTRAL

### AMATEUR RADIO

*EXPO '67 shenanigans, contest and other news*

72 CHARLES J. SCHAUERS, W6QLV

75 HERB S. BRIER, W9EGQ

### SOLID STATE

### LET'S LISTEN TO CENTRAL AND SOUTH AMERICA

### SHORT-WAVE LISTENING

*Harmonic DX'ing*

77 LOU GARNER

80 ROGER LEGGE

81 HANK BENNETT, W2PNA

### ENGLISH-LANGUAGE BROADCASTS TO NORTH AMERICA

### ON THE CITIZENS BAND

*Operation Phantom II*

82 ROGER LEGGE

83 MATT P. SPINELLO, KHC2060

## DEPARTMENTS

LETTERS FROM OUR READERS 8

READER SERVICE PAGE 15

ELECTRONICS LIBRARY 16

NEW PRODUCTS 22

TIPS & TECHNIQUES 90

OPERATION ASSIST 92

NEW LITERATURE 111

POPULAR ELECTRONICS is Indexed  
in the Readers' Guide  
to Periodical Literature

Copyright © 1967 by ZIFF-DAVIS PUBLISHING COMPANY. All rights reserved.

POPULAR ELECTRONICS, January 1968, Volume 28, Number 1. Published monthly at 307 North Michigan Avenue, Chicago, Illinois 60601. One year subscription rate for U.S., U.S. Possessions and Canada, \$5.00; all other countries, \$6.00. Second class postage paid at Chicago, Illinois and at additional mailing offices. Authorized as second class mail by the Post Office Department, Ottawa, Canada and for payment of postage in cash. Subscription service: Portland Place, Boulder, Colorado 80302. Editorial offices for manuscript contributions, reader inquiries, etc.: One Park Ave., New York, N.Y. 10016.

This month's cover designed by  
Edward I. Buxbaum



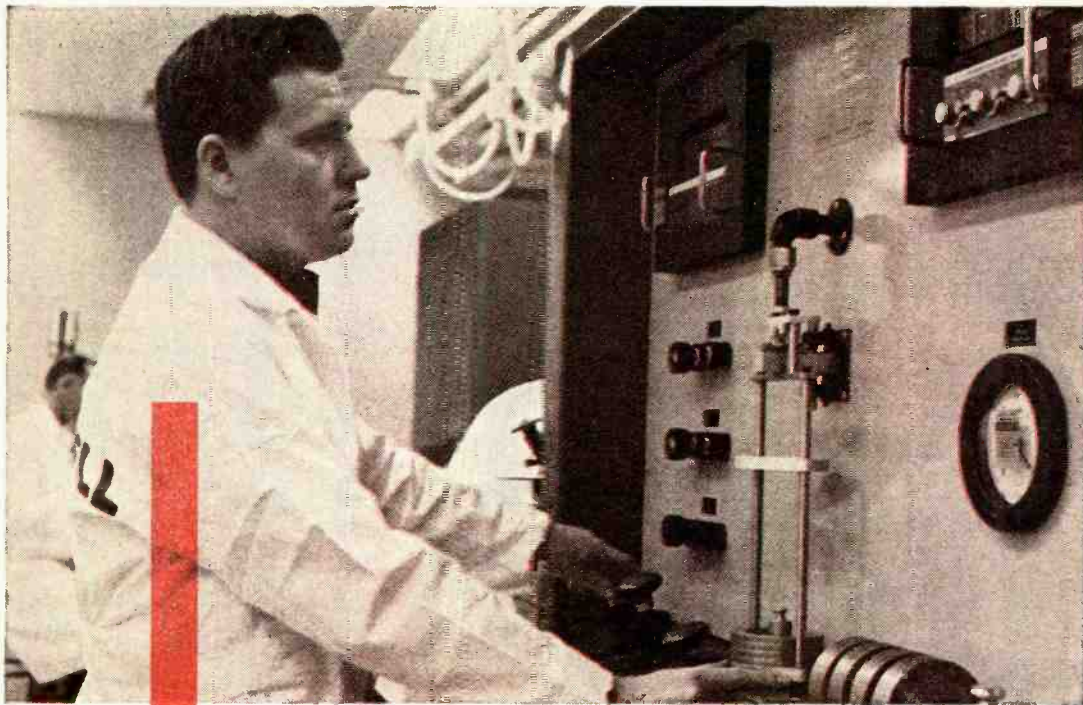

## DeVry Not Only Trained Me... But Helped Me Get a Good Job in Electronics

"One of the luckiest days of my life was when I sent for DeVry Tech's informative booklets on Electronics. It was my start toward a wonderful future," says William L. Hudson, originally from Pennsylvania.

"I attended DeVry's Resident School. Upon graduation, without added cost, their Employment Service helped me get a job. Like other graduates of their Resident School and Home Study programs, I am entitled to career-long placement service whenever I need it. That's a wonderful feeling!" concluded Hudson, who is shown above at his job as a laboratory electronics technician for a prominent manufacturer in the space program.

If you are between 17 and 45 years of age, send the coupon now for free details. See how DeVry

may prepare you at home in your spare time — or in day or evening classes at one of its three resident schools in Chicago, Phoenix or Canada. If you enroll in resident school, we help you find a part-time job to defray some of your expenses, if you wish.

Start to make the big switch now toward a bright, profitable future. The first step is to fill in and mail the coupon below.

*Approved for Veterans*

A SUBSIDIARY OF  **BELL-HOWELL**

**DeVRY INSTITUTE of TECHNOLOGY**  
**4141 Belmont Avenue, Chicago, Ill. 60641, Dept. PE-1-Y**

Please give me your two free booklets, "Pocket Guide to Real Earnings," and Electronics in Space Travel"; also include details on how to prepare for a career in Electronics. I am interested in the following opportunity fields (check one or more):

- |  |   |
|--|---|
| <input type="checkbox"/> Space & Missile Electronics | <input type="checkbox"/> Communications         |
| <input type="checkbox"/> Television and Radio        | <input type="checkbox"/> Computers              |
| <input type="checkbox"/> Microwaves                  | <input type="checkbox"/> Broadcasting           |
| <input type="checkbox"/> Radar                       | <input type="checkbox"/> Industrial Electronics |
| <input type="checkbox"/> Automation Electronics      | <input type="checkbox"/> Electronic Control     |

### Send for Full Facts!

Get two FREE booklets with facts on how a DeVry educational program may prepare you to enter the big field of electronics.



ACCREDITED MEMBER, NATIONAL HOME STUDY COUNCIL

**DeVRY INSTITUTE of TECHNOLOGY**

4141 BELMONT AVENUE, CHICAGO, ILLINOIS 60641

Name \_\_\_\_\_ Age \_\_\_\_\_  
 Address \_\_\_\_\_ Apt. \_\_\_\_\_  
 City \_\_\_\_\_ State or Province \_\_\_\_\_ Zone or Zip Code \_\_\_\_\_

Check here if you are under 16 years of age.

**HOME STUDY AND RESIDENT SCHOOL PROGRAMS**  
 AVAILABLE IN CANADA. SEND FOR DETAILS.

2107

# put a price on your equipment!



\$14.95

## Then add this one, and stop heat from robbing you of component life.

The Hi Fi Boxer fan can return its cost 10 times or more by increasing the life of the average color TV or Hi Fi set. Save money with fewer service calls, fewer replacements and better performance.

This unit, made by the company that produces airmovers for computers, broadcasting equipment, and the Minuteman missile is now available in the new long-life Grand Prix model at no extra cost.

Avoid plastic substitutes, get the real Grand Prix from your nearest Hi Fi dealer or write:

IMC Magnetics Corp   
New Hampshire Division, Route 16B,  
Rochester, New Hampshire 03867

CIRCLE NO. 15 ON READER SERVICE PAGE

# POPULAR ELECTRONICS

**PHILLIP T. HEFFERNAN**  
*Publisher*

**OLIVER P. FERRELL**  
*Editor*

**LESLIE SOLOMON**  
*Technical Editor*

**MARGARET MAGNA**  
*Managing Editor*

**EDWARD I. BUXBAUM**  
*Art Director*

**ALEXANDER W. BURAWA**  
*Associate Editor*

**ANDRE DUZANT**  
*Technical Illustrator*

**PATTI MORGAN**  
*Assistant Editor*

**AURORA NARDOZZI**  
*Editorial Assistant*

**H. BENNETT, W2PNA**  
**H. S. BRIER W9EGQ**

**L. E. GARNER, JR.**  
**CHARLES J. SCHAUERS, W6QLV**  
**M. P. SPINELLO, KHC2060**  
*Contributing Editors*

**LAWRENCE SPORN**  
*Advertising Sales Manager*

**ARDYS C. MORAN**  
*Advertising Service Manager*

## ZIFF-DAVIS PUBLISHING COMPANY

Editorial and Executive Offices  
One Park Avenue, New York, New York 10016  
212 679-7200

Eastern Advertising Manager, RICHARD J. HALPERN  
Midwestern Office  
307 North Michigan Avenue, Chicago, Illinois 60601  
312 726-0892

Midwestern Advertising Manager, JAMES WEAKLEY  
ROBERT J. UR

Western Office  
9025 Wilshire Boulevard, Beverly Hills, California 90211  
213 CRestview 4-0265; BRadshaw 2-1161  
Western Advertising Manager, BUD DEAN

Japan: James Yagi  
Ishikawa Mansion  
#4, Sakuragaoka  
Shibuya-ku, Tokyo  
462-2911-3

Circulation Office  
Portland Place  
Boulder, Colorado 80302

William B. Ziff, Chairman of the Board (1946-1953)  
William Ziff, President

W. Bradford Briggs, Executive Vice President  
Hershel B. Sorbin, Senior Vice President

Philip Sine, Financial Vice President

Walter S. Mills, Jr., Vice President, Circulation

Stanley R. Greenfield, Vice President, Marketing

Phillip T. Heffernan, Vice President, Electronics Division

Frank Pomerantz, Vice President, Creative Services

Arthur W. Butzow, Vice President, Production

Edward D. Muhlfeld, Vice President, Aviation Division

Irwin Robinson, Vice President, Travel Division

Ziff-Davis also publishes Airline Management and Marketing, Boating, Business & Commercial Aviation, Car and Driver, Cycle, Electronics World, Flying, HiFi/Stereo Review, Modern Bride, Popular Photography, Skiing, Skiing Area News, and Skiing Trade News. (Travel Weekly is published by Robinson Publications, Inc. a subsidiary of Ziff-Davis Publishing Company.)

All subscription correspondence should be addressed to POPULAR ELECTRONICS, Circulation Department, Portland Place, Boulder, Colorado 80302. Please allow at least six weeks for change of address. Include your old address, as well as new—enclosing if possible an address label from a recent issue.

EDITORIAL CONTRIBUTIONS must be accompanied by return postage and will be handled with reasonable care; however, publisher assumes no responsibility for return or safety of art work, photographs or manuscripts.



Member Audit Bureau  
of Circulations

POPULAR ELECTRONICS





**POLAROID SWINGER**  
Regular Price \$19.95  
Club Member's Price \$14.25



**POLAROID COLOR CAMERA**  
Regular Price \$50.00  
Club Member's Price \$37.88

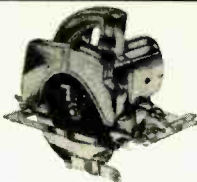

**MANNING BOWMAN POWER SAW**  
Regular Price \$28.00  
Club Member's Price \$16.65



**MANNING BOWMAN ELEC. DRILL**  
Regular Price \$14.95  
Club Member's Price \$7.40

**INFORMATION ON HOW TO BUY**

**BRAND NEW CARS**

Any Make or Model—Full Warranty

**SAVE UP TO \$1,000.00**



**SCHICK ELEC. RAZOR**  
Regular Price \$19.95  
Club Member's Price \$9.88

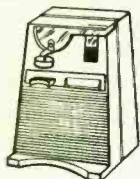

**ROTO-BROIL ELEC. CAN OPENER**  
Regular Price \$19.95  
Club Member's Price \$5.40



**1st QUALITY FIRESTONE TIRES**  
Regular Price \$25.00  
Club Member's Price \$12.00



**STOCKINGS—First Quality,**  
400 needle, 15 denier seamless,  
100% nylon.  
Reg. Price \$9.50 per dozen pair  
Club Member's Price  
\$2.90 per dozen pair

Also, information on where to buy  
reconditioned fleet cars  
like these:



**1966 FORDS AND DODGES**  
\$595.00

**1967 FORDS AND PLYMOUTHS**  
\$995.00



# Now You Can Save Up To 75% On Everything You Buy!!!

## EVERYTHING BRAND NEW, TOP QUALITY, FULLY GUARANTEED! MANY BELOW WHOLESALE!

**THOUSANDS OF ITEMS!** Appliances, TV sets, automobiles, watches, jewelry, radios, stereo sets, furniture, gift items, housewares, toys, furs, hosiery, clothing, shoes, and much, much more—such great names as General Electric, Westinghouse, Dormeyer, Polaroid, Gruen, Presto, Kodak, Remington, Firestone, Shick, Webcor, Sunbeam, International Silver, and many, many more!

**HOW DO YOU GET IN ON THIS FABULOUS DEAL?** It's easy! All you do is join the Wholesale-Discount Buyers Club. 100,000 folks have already joined and are receiving all the Club benefits.

**HOW MUCH DOES IT COST TO JOIN THE CLUB?** You pay only \$3.00 for a full year's membership! There are no other costs or charges of any kind whatsoever! And your \$3.00 fee will be refunded to you in full at any time if you are not completely satisfied!

**WHAT ELSE DOES THE CLUB DO?** As a Club member you immediately receive a huge color catalog with pictures and descriptions of hundreds of items at lowest, low Club member's prices! You also get the automobile catalog with information on where you can get late model Fords, Dodges, Chevrolets and Plymouths as low as \$595.00. Pictures, descriptions, and prices of the cars are included! And Club members get special free gifts, too!

**MAIL THIS COUPON TODAY**

**WHOLESALE DISCOUNT BUYERS CLUB**  
Dept. 659-1 • 333 Old Tarrytown Road • White Plains, New York 10603

I enclose \$3.00 payment in full for a year's membership in the Wholesale-Discount Buyers Club. Please send full information on merchandise and automobiles, immediately. Also put me on the list to receive the regular special mailings. I understand that I am not obligated to buy anything and that I will receive a full refund of the \$3.00 membership fee at any time, with no questions asked.

NAME \_\_\_\_\_

ADDRESS \_\_\_\_\_

CITY \_\_\_\_\_ STATE \_\_\_\_\_ ZIP CODE \_\_\_\_\_

**MONEY BACK  
GUARANTEE**

We're so certain that you'll be thrilled as a Club member, we'll return your \$3.00 fee at anytime, for any reason, with no questions asked! You have nothing to lose and everything to gain.

If you want to order anything in this ad at the prices shown, you may do so at the same time you send your \$3.00 membership fee.

**CIRCLE NO. 27 ON READER SERVICE PAGE**



*The professionals  
have been turning  
their records  
this way for years.*

*Now it's your turn.*



Meet Garrard's newest and finest automatic transcription turntable, the SL 95...so advanced that even its motor sets new standards in record reproduction! The SL 95 is powered by Garrard's revolutionary new SYNCHRO-LAB MOTOR™, that gives you absolutely constant speed—*synchronous speed*—plus instant induction starting power and freedom from rumble and distortion.

Synchronous speed—you find it on the professional turntables used for broadcasting and record cutting. It means that no matter how many appliances you (or your neighbors) use, and regardless of changes in record load, stylus pressure or temperature, the speed will not vary to affect the sound of your records. Note, too, the ultra low-mass tone arm, the adjustable counterweight for dynamic balancing, the gyroscopically gimbaled pivoting, the built-in cueing, anti-skating and stylus pressure controls.

So significant an advancement is Synchro-Lab power that it has been incorporated in four new SYNCHRO-LAB SERIES™ automatic turntables, from \$59.50 to \$129.50 (less base and cartridge) for the magnificent new SL 95. A 20-page Comparator Guide, just published, describes all the new models in full color. For a complimentary copy, write: Garrard, Dept. AA-13, Westbury, N.Y. 11590.

**Garrard**®  
World's Finest

British Industries Corp., a division of Avnet, Inc.

**CIRCLE NO. 12 ON READER SERVICE PAGE**

# letters

FROM OUR READERS

Address correspondence for this department to:  
Letters Editor, POPULAR ELECTRONICS  
One Park Avenue, New York, N. Y. 10016

## DELUXE VERSION OF FET VOM ADAPTER

I built your FET voltmeter adapter ("VOM + FET = TVM," July, 1967) but incorporated a few changes that gives my unit "deluxe" features. For better linearity, I added a 2N3906 transistor and 4700-ohm resistor between the drain lead of Q1 and the battery. I mounted the rectifier circuit on the circuit board with the other components instead of in the probe. In my unit, a three-position, two-pole switch is used to reverse the polarity of the d.c. tests and select the a.c. test position. A ten-position,



three-pole switch selects the a.c. and d.c. voltage ranges and turns the unit on and off.

My deluxe TVM works like a charm. Its accuracy is very good considering that 5% tolerance resistors were used. The case for my adapter holds my VOM in a tilted-back position for easy reading, and I can remove the VOM for separate use whenever I wish.

BROOKS HILL  
Santa Barbara, Calif.

## OLD ENOUGH TO BECOME A HAM?

What is the lower age limit—if there is any—for a person to become an amateur radio operator? I am just 13 years old, and I would like to apply for a Novice license.

MICHAEL N. WILKE  
Fraser, Mich.

*Michael, there is no age limit—either lower or higher. In the U.S., amateur radio operator*

*(Continued on page 12)*

POPULAR ELECTRONICS

Be the man who's always  
first to say: "I've got  
the answer right here!"



START USING THIS REMARKABLE

# ELECTRONICS SLIDE RULE

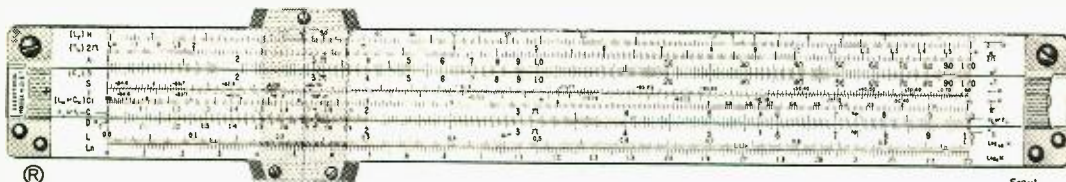

Front

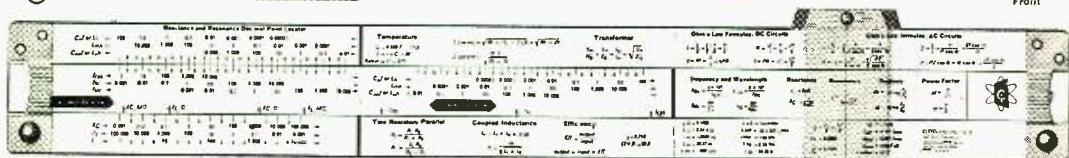

Back

**S**OME DAY EVERYONE in electronics may have a slide rule like this. Till then, the man who uses one will seem like a wizard as he solves reactance and resonance problems in 12 to 20 seconds—without pencil and paper.

This is a professional slide rule in every detail, a full 10" long, made exclusively for Cleveland Institute of Electronics, to our rigid specifications, by Pickett, Inc. It can be used for conventional computation as well as special electronics calculations. All-metal construction assures smooth operation regardless of climate.

Handsome top-grain leather carrying case has heavy-duty plastic liner to protect slide rule; removable belt loop for convenient carrying. "Quick-flip" cover makes it easy to get rule in and out of case.

You also get four full-length AUTO-PROGRAMMED™ Lessons, which teach you how to use the special electronics scales on the slide rule. These lessons have been carefully designed to meet the same high educational standards as the electronics career courses for which our school is famous. Even if you've never used a slide rule before, you'll soon whiz through the toughest problems with this CIE rule.

Deliberately underpriced. Many men in electronics have told us that this unique slide rule, leather case, and 4-lesson course easily add up to a \$50 value. But we have deliberately underpriced it at less than \$25. Why? Our reason is simple: we are looking for men in electronics who are ambitious to improve their skills...who know that this will require more training. If we can attract you with the low price of our slide rule and course—and impress you with its quality—you are more

likely to consider CIE when you decide you could use more electronics training.

Send for free booklet. See for yourself why this amazing slide rule and course have made such a big hit with busy electronics men everywhere. No obligation, of course—just an opportunity to get in on the best offer ever made to people in electronics. Just mail coupon, or write Cleveland Institute of Electronics, Dept. PE-140, 1776 East 17th St., Cleveland, Ohio 44114.

**CIE** Cleveland Institute of Electronics  
1776 East 17th Street, Cleveland, Ohio 44114

MAIL THIS COUPON FOR **FREE BOOKLET**

Cleveland Institute of Electronics  
1776 East 17th Street Cleveland, Ohio 44114  
Please send me without charge or obligation your booklet describing CIE Electronics Slide Rule and Instruction Course. ALSO FREE if I act at once: a handy pocket-size Electronics Data Guide.



Name \_\_\_\_\_ (please print)

Address \_\_\_\_\_

City \_\_\_\_\_ State \_\_\_\_\_ Zip \_\_\_\_\_



Accredited Member National Home Study Council  
A Leader in Electronics Training... Since 1934

PE-140

CIRCLE NO. 7 ON READER SERVICE PAGE



*the finest* CB Base Station  
transceiver...first all solid state design  
with professional 2 way features!



**THE ADMIRAL** . . . The luxurious new 23 channel CB base station transceiver from Squires-Sanders . . . features normally only found in professional two way communications equipment: highest power transmitter with Speech Compression • matching +2 microphone with built in transistor pre-amplifier • exclusive Space Spanner receiver with adjustable Pulse Eliminator • dual antenna switch • Hi/Lo sensitivity control • Public Address function • separate PA volume control • sharp Delta Tuning • receiver volume independent of power switch • adjustable squelch • ON-THE-AIR light • illuminated S meter and channel readout • digital panel clock • earphone jack • electronically regulated AC power supply • rich olive homespun vinyl cabinet, natural teakwood panel, gold trim

Made in U.S.A.—\$329.95

Squires  Sanders

See your distributor or write today for details. SQUIRES SANDERS, INC., Box A, Liberty Corner, N. J. 07938



*the smallest* 23 channel,  
all solid state, full 5 watt CB transceiver  
with ultra modern FET and IC circuits!

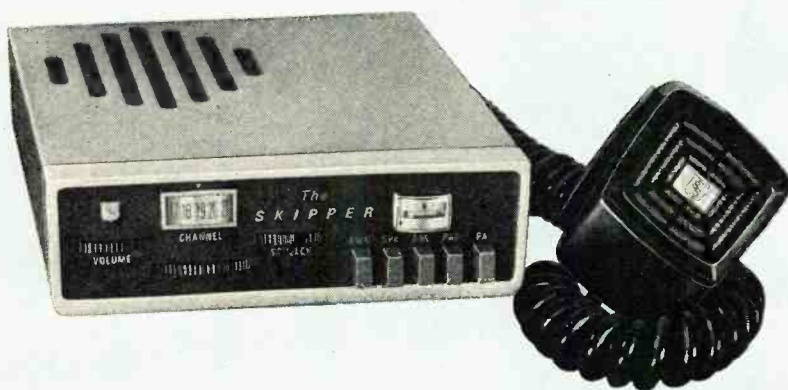

*The SKIPPER* . . . A fabulous new 23 channel transceiver from Squires-Sanders . . . at a new low price . . . with features not found in other units irrespective of price. New design innovations give you: • superb no overload receiver with space age dual conversion FET and IC circuit design • advanced design noise limiting • illuminated S meter and channel readout • solid state T/R switching • new Speech Compression • 100% modulation • new American P.T.T. mike • Local/Distant sensitivity control • provision for external speaker • switchable Public Address • positive push button switches • safety breakaway mount with exclusive "All-Position" operation • recessed controls • satin chrome die-cast panel • only 3 lbs.; 1-3/4" x 6" x 7-7/8".

Made in U.S.A.— \$159.95

Squires  Sanders

See your distributor or write today for details. SQUIRES SANDERS, INC., Box A, Liberty Corner, N. J. 07938

CIRCLE NO. 26 ON READER SERVICE PAGE

# NEW ALLIED 1968 CATALOG & BUYING GUIDE

# FREE

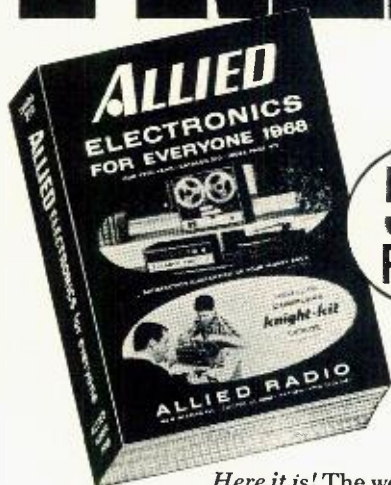

518  
PAGES

Here it is! The world's most famous catalog of electronic equipment featuring hundreds of new and exclusive items and special Allied values.

518 pages—including the complete Knight-Kit Catalog — picturing, describing, and pricing thousands upon thousands of items. The most complete inventory ever assembled of Hi-Fi, Radios, Tape Recorders, CB, Electronic Equipment, Parts and Tools... all at money-saving low prices.

**NO MONEY DOWN—UP TO 2 YEARS TO PAY!**

**BIG SAVINGS ON THE BEST IN ELECTRONICS FOR EVERYONE**

- Stereo Hi-Fi • Famous Knight-Kits® • Tape Recorders & Tape
- CB 2-Way Radios • Walkie-Talkies • FM-AM & AM Radios
- Shortwave Receivers • Portable TV • Phonographs • Transistors
- Intercoms & PA • Automotive Electronics • Test Instruments
- TV Antennas & Tubes • Power Tools, Hardware
- Amateur Equipment • Tubes • Parts, Batteries, Books



**WRITE FOR YOUR COPY TODAY!**

**ALLIED RADIO, Dept. 3A**  
**P.O. Box 4398, Chicago, Ill. 60680**

**Send me your free catalog for 1968**

NAME Please Print

ADDRESS

CITY

STATE ZIP CODE

**CIRCLE NO. 1 ON READER SERVICE PAGE**

## LETTERS (Continued from page 8)

licenses are issued only to citizens of this country—regardless of age or physical condition. To prepare for a Novice exam, you will have to study code and theory. When you are ready to take the test, you write to the Federal Communications Commission office nearest you and request application Form 610. For complete information on ham licensing, read the 1968 Edition of the COMMUNICATIONS HANDBOOK (put out by POPULAR ELECTRONICS), which should hit the newsstands about December 19.

### IN DEFENSE OF CB AND SWL ARTICLES

I object to Robert Walker's statement ("Letters From Our Readers," February, 1967) that articles concerning the Citizens Band and short-wave radio are useless and should be left out of POPULAR ELECTRONICS. If these articles did not appear in your magazine, I would probably not buy it. For Mr. Walker's information, CB'ing and SWL'ing



are a lot more important than just leisure time hobbies. During all sorts of emergencies—forest fires, floods, hurricanes, for example—CB clubs have been a great help to stricken communities. As for SWL'ing, such stations as *Radio Moscow*, *Radio Peking*, *Voice of America*, and *Radio Free Europe*—all broadcast their versions of the truth in the news, and you can learn a lot about other countries by listening on the short-wave bands.

GEORGE PEARSON, WPE6GVS  
Gardena, Calif.

### PARTS SUBSTITUTIONS, ONCE AGAIN

In spite of the explanations which have appeared in these pages in the past, I fail to see why POPULAR ELECTRONICS projects don't use commonly available components. The "Theremin" ("Music à la Theremin," November, 1967) is a case in point. Why such rare transistors? Are you people in cahoots with certain manufacturers?

M.M. BEHRENS  
Brooklyn, N.Y.

We'll try again. First of all, projects published in this magazine are designed with one purpose in mind—they must operate in the best possible manner. Most readers tend to ignore the hours that an author spends developing a project which "works." Frequently,

Introducing the world's first 5-channel, solid state, Citizens Band Radio with a Class B push-pull audio amplifier, super-sensitive receiver, and full-powered transmitter, that comes with either palm microphone or telephone handset at no extra cost: **The Sentry II, by Pearce-Simpson.**

**Total weight, 3 pounds. Total price, \$99.90.**

At \$99.90, Pearce-Simpson introduces a remarkable new CB Radio.

How remarkable? This remarkable:

It features no close range blocking.

A greatly improved noise limiting circuit which virtually eliminates ignition and alternator noise.

Its specifications include 4.0-watt power output, 0.5 uv to open squelch, adjacent channel 50 db down, and cross modulation 80 db down. And it carries a full one year warranty.

**Conclusion:**

Nobody can make a better radio for \$99.90. Not even Pearce-Simpson.



The Sentry II

**At \$139.90 you'd probably call The Sentry II a bargain.**  
**At \$99.90 there's no question about it.**

How can anyone put so much radio into so little space without cutting corners? Anyone can't. Pearce-Simpson can.

And at \$139.90, Pearce-Simpson introduces the brand new solid state Companion IV, featuring 10 channels plus P.A.

Plus:

Both front and bottom speakers. An innovation which guarantees unobstructed, distortion-free sound no matter where the radio is mounted.



Touch-tap tuning. Which allows you to change channels just like that.

No close range blocking.

A greatly improved noise limiting circuit.

Plus:

It comes with a choice of either palm microphone or telephone handset at no extra cost.

It weighs only 3¾ pounds. And it carries a full one year warranty.

**Conclusion:**

Dollar for dollar, there are more features in a Pearce-Simpson CB Radio than any other CB Radio in the world.

Write us.

We'll tell you where to find them.

F.C.C. type acceptance pending

Pearce-Simpson, Inc./P.O. Box 800  
 Biscayne Annex, Miami, Florida 33152 PE-168

Gentlemen: Please send complete information on your new CB Radios and a list of dealers nearest me.

Name

Address

City

State

Zip

Overseas military personnel may write for special price list.

**CIRCLE NO. 20 ON READER SERVICE PAGE**



## LETTERS (Continued from page 12)

such projects involve the use of specific components.

Possibly substitutions could be made in the "Theremin," but in the design submitted by the author, the components called out in the Parts List made the project work as claimed. If a particular component is difficult to get, POPULAR ELECTRONICS makes an arrangement whereby that component can be purchased at a very low cost. But what is a "commonly available component"? It has been our experience, specifically where transistors are concerned, that there just isn't any such animal.

### DCEV DOUBLES AS A MICROAMMETER

The DCEV ("Low-Cost, High-Quality Electronic Voltmeter," November, 1967) can be used as a 10- $\mu$ A full-scale electronic microammeter by making one simple change in the original circuit. Instead of a 10,000-ohm, 10% tolerance resistor for  $R_L$ , substitute a resistor having an accurately selected value of 16,000 ohms. This slight change will not affect the original accuracy of the DCEV as an electronic voltmeter.

Make a 3- to 4-foot test cable, connecting a phono plug at one end and a prod or alligator clip at the other end. Plug the cable into the probe input (J1) of the voltmeter, and another ordinary test lead into the BLACK in-

put jack (J3). Set the Balance and Zero controls as described in the article, but leave the Range switch set to its 0 position.

With this setup, accurate measurements as low as 1  $\mu$ A can be easily made, simply by dividing the meter reading by 5. The d.c. voltage drop across the microammeter input is only 0.15 volt at full-scale deflection, and power consumption from the circuit under test is only 1.5 microwatts!

FRANK H. TOOKER  
Pine Beach, N.J.

### REPUBLIC OF PANAMA HAS 60-HZ POWER

In your "Information Central" column (August, 1967), it is stated under "Worldwide Voltage And Frequency" that the Republic of Panama uses 25 Hz a.c. line power. Panama has never used 25 Hz power. The Panama Canal Zone once did use 25 Hz power, but that was so long ago that nobody seems to remember when the switch to 60 Hz power was made. At the present time, both the Republic of Panama and the Canal Zone have 60 Hz power.

C.A. ROA  
Panama, Republic of Panama

### FOOT-SWITCH-OPERATED "FUZZBOX"

Instead of installing a hand-operated push-button switch in the "Fuzzbox" (January, (Continued on page 99))

**STOP  
LOOK, LISTEN!** Everyone's talking about Mosley's new 1968 Catalog of Citizens Band Antennas. Send for your Free copy. Dept. 119A.

**Mosley Electronics, Inc.**  
4610 N. Lindbergh Blvd. Bridgeton Mo. 63042

CIRCLE NO. 17 ON READER SERVICE PAGE

# POPULAR ELECTRONICS READER SERVICE PAGE

## free information service:

Here's an easy and convenient way for you to get additional information about products advertised or mentioned editorially (if it has a "Reader Service Number") in this issue. Just follow the directions below... and the material will be sent to you promptly and free of charge.

**1.** Print or type your name and address on the lines indicated. Circle the number(s) on the coupon below that corresponds to the key number(s) at the bottom of the advertisement or editorial mention(s) that interest you. (Key numbers for advertised products also appear in the Advertisers' Index.)

**2.** Cut out the coupon and mail it to the address indicated below.

**3.** This address is for our product "Free Information Service" only. Editorial inquiries should be directed to POPULAR ELECTRONICS, One Park Avenue, New York 10016; circulation inquiries to Portland Place, Boulder, Colorado 80302.

**POPULAR  
ELECTRONICS**

VOID AFTER FEBRUARY 29, 1968

P.O. BOX 8391  
PHILADELPHIA, PA. 19101

1 2 3 4 5 6 7 8 9 10 11 12 13 14 15 16 17 18 19 20  
21 22 23 24 25 26 27 28 29 30 31 32 33 34 35 36 37 38 39 40  
41 42 43 44 45 46 47 48 49 50 51 52 53 54 55 56 57 58 59 60  
61 62 63 64 65 66 67 68 69 70 71 72 73 74 75 76 77 78 79 80  
81 82 83 84 85 86 87 88 89 90 91 92 93 94 95 96 97 98 99 100

NAME (Print clearly) \_\_\_\_\_

ADDRESS \_\_\_\_\_

CITY \_\_\_\_\_ STATE \_\_\_\_\_ ZIP CODE \_\_\_\_\_

# Move up to 30 watt Courier Business Band.

## \$219.50!



FCC TYPE ACCEPTED

FLEET COURIER 30B. Powered for the business and commercial operator. Lowest price unit of its kind (FCC Type Accepted). Big power input (30 watts) and output. Greater range. Reduced interference. Increased antenna height. If you use CB for business communications — move up to Fleet Courier 30B!

### COURIER COMMUNICATIONS, INC.

56 Hamilton Ave.,  
White Plains, N. Y. 10601

**Whittaker**  
CORPORATION  
a subsidiary of

Yes! Tell me all about FLEET COURIER 30B.

Name \_\_\_\_\_

PE-81

Address \_\_\_\_\_

City \_\_\_\_\_

County \_\_\_\_\_

State \_\_\_\_\_

Zip \_\_\_\_\_

CIRCLE NO. 28 ON READER SERVICE PAGE

PROVIDES HIGH GAIN ACROSS THE  
ENTIRE UHF BAND

for UHF  
Reception  
at its VERY  
BEST!



Revolutionary  
MODEL UPW  
UHF PASSIVE WAVE ANTENNA

Excellent color reception assured.  
Write for literature.

## S & A ELECTRONICS INC.

Manufacturers of the TARGET ANTENNA

228 W. FLORENCE STREET

TOLEDO, OHIO 43605

CIRCLE NO. 23 ON READER SERVICE PAGE

# ELECTRONICS library

QUIET

## ELECTRONICS MATHEMATICS

by Gregory J. Nunz and William L. Shaw

Sandwiched between the covers of "Electronics Mathematics" is an all-inclusive course in mathematics, running the entire gamut from elementary arithmetic to differential and integral calculus. This book is divided into two sections: "Arithmetic and Algebra" and "Algebra, Trigonometry, and Calculus." Every problem given is solved in step-by-step fashion and, where applicable, problems are directly linked to electronics. The refreshingly easy-to-understand style the authors exhibit in their presentation of the material makes the learning of mathematics an easy process. "Electronics Mathematics" belongs in every hobbyist's library.

Published by McGraw-Hill Book Co., 330 West 42 St., New York, N.Y. 10036. Hard cover. 418 pages. \$9.95.

## MAHLIN LOOMIS—INVENTOR OF RADIO

by Thomas Appleby

This book describes the world's first invention of radio and the man who invented it. It is a storehouse of information not only on Dr. Loomis' invention of radio, but on many of his other inventions as well. Written by a retired U.S. Naval Reserve Commander, *Mahlon Loomis—Inventor of Radio* contains 37 illustrations and a 19-page detailed index covering the various things a historian, writer, or student might like to know about Dr. Loomis.

Published by Loomis Publications, P.O. Box 6318, Washington, D.C. 20015. Soft cover. 164 pages. \$3.25.

## TAPE RECORDING FOR THE HOBBYIST, Second Edition

by Art Zuckerman

If you own a tape recorder, or are planning to buy one soon, the revised *Tape Recording for The Hobbyist* is a "must-read" book. It covers a multitude of uses for tape recorders, and tells you how to make many different types of recordings. Pointers are given on sound effects, tape editing, programming, and tape and recorder maintenance. A complete section is devoted to home video recording.

Published by Howard W. Sams & Co., Inc., 4300 West 62 St., Indianapolis, Ind. 46206. Soft cover. 160 pages. \$3.25.

—50—

POPULAR ELECTRONICS



No dealer  
stocks  
everything.

No salesman  
knows  
everything.

But the  
**1968 STEREO/HI-FI DIRECTORY** does!

It's a giant 182-page buyer's guide to virtually every new audio component on the market today. Over 1600 products in all! From amplifiers to complete hi-fi systems to tape cartridge recorders and players for your home, car and boat. All the latest offerings from 176 manufacturers are fully detailed and illustrated for your "shop-at-home" convenience.

Every technical specification, dimension, special feature, optional accessory, price and model number is at your fingertips—to help you compare similar items, feature for feature, dollar for dollar and decide which is best

for you. Before you buy!

Forget the guesswork, costly mistakes, store-to-store treks and "after-you-get-it-home" disappointments. With the 1968 STEREO/HI-FI DIRECTORY as your guide, you'll zero-in on the equipment you want, buy it with confidence—and know you're getting the greatest value for your money.

The price for this valuable "encyclopedia" of hi-fi information? Just \$1.25. A small investment, indeed, for such an essential component of your listening enjoyment. So don't delay. Use the coupon below to order your copy of the 1968 STEREO/HI-FI DIRECTORY today!



CONTENTS INCLUDE

Special 8-page section on:

- How to choose components
- How to compare prices, features, specifications
- Exclusive state-of-the-art report on componentry
- PLUS an incisive analysis of the controversial 8 track, 4 track and cassette tape cartridges. . . . Comments and clues on which design holds the most promise for the future.

Individual directories for amplifiers / changers / turntables / cartridges and tonearms / receivers / tuners / tape machines (including video recorders and cartridge units) / speakers / integrated systems / antennas / microphones / cabinets.

GET THE DELUXE LEATHER-FLEX-BOUND EDITION for just \$3 POSTPAID!

The 1968 STEREO/HI-FI DIRECTORY is also available in a splendid deluxe edition. Rugged Leatherflex cover provides lasting protection yet is softly textured and gold-embossed for the look of elegance. A collector's item—a superb addition to your permanent hi-fi reference library. And it's yours, for just \$3 postpaid, when you check the appropriate box on the order form.



ZIFF-DAVIS SERVICE DIVISION • DEPT. SD • 595 Broadway • New York, N. Y. 10012

YES: Send me the new 1968 STEREO/HI-FI DIRECTORY as checked below:

- \$1.25 enclosed, plus 15c for shipping and handling. Send me the regular edition. (\$1.75 for orders outside the U.S.A.)
- \$3.00 enclosed. Send me the Deluxe Leatherflex-bound edition, postpaid. (\$3.75 for orders outside the U.S.A.) Allow three additional weeks for delivery.

name \_\_\_\_\_ please print \_\_\_\_\_

address \_\_\_\_\_

city \_\_\_\_\_

state \_\_\_\_\_ zip code \_\_\_\_\_

PAYMENT MUST BE ENCLOSED WITH ORDER

# Join "THE TROUBLESHOOTERS"

They get paid top salaries  
for keeping today's  
electronic world running

Suddenly the whole world is going electronic! And behind the microwave towers, push-button phones, computers, mobile radio, television equipment, guided missiles, etc., stand

**THE TROUBLESHOOTERS**  
—the men needed to inspect, install, and service these modern miracles. They enjoy their work, and get well paid for it. Here's how you can join their privileged ranks—without having to quit your job or go to college in order to get the necessary training.





**J**UST THINK HOW MUCH in demand you would be if you could prevent a TV station from going off the air by repairing a transmitter...keep a whole assembly line moving by fixing automated production controls...prevent a bank, an airline, or your government from making serious mistakes by repairing a computer.

Today, whole industries depend on electronics. When breakdowns or emergencies occur, someone has got to move in, take over, and keep things running. That calls for one of a new breed of technicians—The Troubleshooters.

Because they prevent expensive mistakes or delays, they get top pay—and a title to match. At Xerox and Philco, they're called Technical Representatives. At IBM they're Customer Engineers. In radio or TV, they're the Broadcast Engineers.

What do you need to break into the ranks of The Troubleshooters? You might think you need a college diploma, but you don't. What you need is know-how—the kind a good TV service technician has—only lots more.

### Think With Your Head, Not Your Hands

The service technician, you see, "thinks with his hands." He learns his trade by taking apart and putting together, and often can only fix things he's already familiar with.

But as one of The Troubleshooters, you may be called upon to service complicated equipment that you've never seen before or *can't* take apart. This means you have to be able to take things apart "in your head." You have to know enough electronics to understand the engineering specs, read the wiring diagrams, and calculate how a circuit should test at any given point.

Now learning all this can be much simpler than you think. In fact, you can master it without setting foot in a classroom and without giving up your job!

### AUTO-PROGRAMMED™ Lessons Show You How

For over 30 years, the Cleveland Institute of Electronics has specialized in teaching electronics at home. We've developed special techniques that make learning easy, even if you've had trouble studying before.

For one thing, our AUTO-PROGRAMMED™ lessons build your knowledge as you'd build a brick wall—one brick at a time. Each piece rests securely on the one that came before it.

#### ENROLL UNDER NEW G.I. BILL

All CIE courses are available under the new G.I. Bill. If you served on active duty since January 31, 1955, or are in service now, check box on reply card for G.I. Bill information.

In addition, our instruction is personal. When your teacher goes over your assignment, no one else competes for his attention. You are the **only** person in his class. He not only grades your work, he analyzes it to make sure you are thinking correctly. And he returns it the day it's received so that you can read his comments and corrections while everything is fresh in your mind.

### Always Up-To-Date

To keep up with the latest developments, our courses are constantly being revised. This year CIE students are getting new lessons in Laser Theory and Application, Microminiaturization, Single Sideband Techniques, Pulse Theory and Application, and Boolean Algebra.

In addition, there is complete material on the latest troubleshooting techniques including Tandem System, Localizing through Bracketing, Equal Likelihood and Half-Split Division, and In-circuit Transistor Checking. There are special lessons on servicing two-way mobile equipment, a lucrative field in which many of our students have set up their own businesses.

### Your FCC License—or Your Money Back!

Two-way mobile work and many other types of troubleshooting call for a Government FCC License, and our training is designed to get it for you. But even if your work doesn't require a license, it's a good idea to get one. Your FCC License will be accepted anywhere as proof of good electronics training.

And no wonder. The licensing exam is so tough that two out of three non-CIE men who take it fail. But CIE training is so effective that 9 out of 10 of our graduates pass. That's why we can offer this warranty with confidence: *If you complete one of our license preparation courses, you'll get your license—or your money back.*

### Mail Card for 2 Free Books

Want to know more? Mail the postage-paid reply card bound here. We'll send our 40-page catalog describing our courses and the latest opportunities in Electronics. We'll also send a special book on how to get a Commercial FCC License. Both are free. If the card is missing, just send us your name and address.

  
**CIE**

**Cleveland Institute of Electronics**

1776 E. 17th St., Dept. PE-62, Cleveland, Ohio 44114

Accredited Member National Home Study Council  
A Leader in Electronics Training... Since 1934



CIRCLE NO. 8 ON READER SERVICE PAGE





## NEW PRODUCTS

Additional information on products covered in this section is available from the manufacturers. Each new product is identified by a code number. To obtain further details on any of them, simply fill in and mail the coupon on page 15.

### DIGITAL IC COLOR GENERATOR

Another first! *Conar Instruments'* Model 680 color generator is said to be the first on the market to employ *digital* integrated circuits and use *four* crystal-controlled oscillators. It can generate a wide range of test patterns (only one horizontal raster line thick), and a standard ten-bar color pattern. The oscillators include a 189-kHz timing generator, 3.56-MHz offset color subcarrier, 4.5-MHz sound carrier, and 55.25- or 61.25-MHz r.f. carrier (channel 2 or 3 optional). The Model 680 can be operated from a.c. line power or dry-cell batteries and is scheduled to be available on January 1 in kit and wired form.



Circle No. 75 on Reader Service Page 15

### SINGLE-BAND COMMUNICATIONS RECEIVERS

Integrated circuits are featured in the critical i.f. stages of *Lafayette Radio's* Model PF-30 (30 to 50 MHz) shown in the photograph and Model PF-60 (152 to 174 MHz) communications receivers. These fully solid-state superhet receivers can be operated on crystals or tuned manually. Front panel squelch controls can be set for receiver quieting under no-signal conditions. Both receivers are imported and designed to operate from either a 12-volt d.c. or a 117-volt a.c. source.



Circle No. 76 on Reader Service Page 15

### THREE NEW SOLID-STATE KITS

*EICO's* low-cost "Eicocraft" solid-state kit line now includes two new radio receivers and electronic bongo drums. The radio kits, designated as Models EC-1400 and EC-1500, are for the FM and AM broadcast bands, respectively. Both are tunable personal radios

(earphone supplied) which can be used as tuners or wireless intercoms. The electronic bongo drum kit, Model EC-1600, employs two "ringing" oscillators and a preamplifier. When touch plates are tapped, the percussive sounds of bongo drums, tom-toms, etc., are electronically reproduced. It can feed any guitar amplifier, hi-fi system, etc. All three units are battery-powered.

Circle No. 77 on Reader Service Page 15

### "COOL" UTILITY BOXES

"Mini-Cool" utility boxes made by *Sarex Corporation* are "cool" in more ways than one. Consisting of extruded aircraft alloy aluminum, these miniature boxes were designed with the hobbyist in mind. A clever lock joint at each corner allows an entire box to be disassembled down to six sides (including top and bottom), which facilitates machining, assembly, and servicing of a circuit built inside. When the corner screws are installed, the lock joints tighten and hold the box shape—

even under three tons of pressure! "Mini-Cool" boxes come in 21 sizes with either plain or finned walls—the latter act as heat sinks for solid-state devices.



Circle No. 78 on Reader Service Page 15

### STEREO CASSETTE TAPE DECK

Designed for use with almost any hi-fi system, the Model F-105 four-track cassette deck by *Concord Electronics* lets the listener create a music library of stereo or mono recordings from off-the-air, records, or another tape source. This tape deck contains solid-state preamplifiers, a precision tape transport mechanism, Concord's exclusive flux field tape heads, capstan drive, and two VU meters. Controls are recording level, cassette ejector, instant fast forward and reverse.



Circle No. 79 on Reader Service Page 15

### HOLLOW-SHAFT NUTDRIVER SET

Locknut/slotted screw adjustments can be speeded up by means of a unique handle in *Xcelite's* Model HSC-1 hollow-shaft nutdriver set. Passing an 8-inch or longer screwdriver through the center of the hollow handle and nutdriver shank allows quick and easy settings of the screw-locknut combinations found on many electronic controls. Eight hol-

Ziff-Davis Service Division, Dept. ISH  
595 Broadway, New York, N. Y. 10012

Please send my copy of the 1968 ELECTRONICS INSTALLATION & SERVICING HANDBOOK as checked below:

- I am enclosing \$1.25 plus 15c for shipping and handling for the Regular Edition. (\$1.75 for orders outside U.S.A.)
- I am enclosing \$3.00. Please send me, postpaid, the Leatherflex-covered Deluxe Edition, (\$3.75 for orders outside U.S.A.) (Please allow 3 additional weeks for delivery of the Deluxe Edition.)

print name \_\_\_\_\_ PE-1

address \_\_\_\_\_

city \_\_\_\_\_ state \_\_\_\_\_ zip code \_\_\_\_\_

**HERE'S THE MOST IMPORTANT JOB TICKET YOU'LL WRITE UP THIS YEAR!**

NOW—GET THE TRICKS OF THE TRADE FOR SERVICING EVERYTHING . . . FROM TV TO AM/FM . . . FROM CITIZEN'S BAND TO PUBLIC ADDRESS . . . FROM HOME INTERCOM TO TAPE CARTRIDGE UNITS. THEY'RE ALL IN THE NEW, 1968 ELECTRONICS INSTALLATION AND SERVICING HANDBOOK.

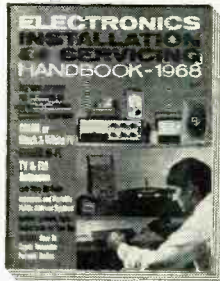

You'll find the latest, most comprehensive technique advice, equipment information and step-by-step "how-to-do-it" hints that will aid you in your servicing (or save you costly outside repairs).

This 140-page "encyclopedia" of electronics servicing knowledge contains a special, full-color section on color TV maintenance . . . model numbers and prices of replacement parts . . . recommended tools for every operation . . . accessory information to help you turn an extra dollar. Plus up-to-the-minute reports from hundreds of manufacturers.

Whether you're a professional serviceman, weekend home hobbyist or spare time "Mr. Fixit," the 1968 ELECTRONICS INSTALLATION AND SERVICING HANDBOOK is essential for you. Essential for your profit, fun or both.

GET THE HANDSOME LEATHERFLEX-COVERED EDITION FOR \$3 POSTPAID!

The 1968 ELECTRONICS INSTALLATION & SERVICING HANDBOOK is also available in a splendid deluxe edition. Rugged Leatherflex cover provides lasting protection yet is softly textured and gold-embossed for the look of elegance. A collector's item—a superb addition to your electronics library. And it's yours, for just \$3 postpaid, when you check the appropriate box on the order form.



**ORDER YOUR COPY TODAY!**

**Thinking of college and a space age career?**



Send for this booklet on **ENGINEERING TECHNOLOGY AND ENGINEERING**

Learn how you can prepare for a dynamic career as an electrical or mechanical engineering technician or engineer in such exciting, growing fields as avionics, missiles, reliability control, fluid mechanics, data processing, metallurgy, microelectronics, and advanced aerospace research.

MSOE offers residence study programs leading to these degrees in engineering technology and engineering:

- 2 years — Associate in Applied Science
- 4 years — Bachelor of Science

Also get facts about scholarships and financial aids, job placement and other student services, plus photographs of MSOE technical laboratories and student activities. Courses approved for veteran training.

For your copy, just mail the coupon — no obligation.

**MSOE**

Milwaukee, Wisconsin 53201

Milwaukee School of Engineering  
Dept. PE-168, 1025 N. Milwaukee Street  
Milwaukee, Wisconsin 53201

Please send the "Your Career" booklet. I'm interested in

- Electrical fields       Mechanical fields

Name.....Age.....

Address.....

City.....State.....ZIP.....

CIRCLE NO. 31 ON READER SERVICE PAGE

MS-284



## PRODUCTS (Continued from page 22)

low, interchangeable hexnut shafts—with openings ranging from 3/16" to 9/16"—and the shockproof, breakproof plastic handle make up the set. A spring mechanism in the handle holds the shafts firmly in place.

Circle No. 80 on Reader Service Page 15

### PASSIVE RADIATOR SPEAKER SYSTEM

The "Estoril" speaker system by *University Sound* introduces the "passive radiator" concept to hi-fi sound reproduction. Actually a

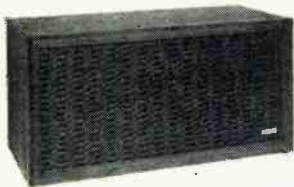

speaker that is driven by the acoustic energy inside the enclosure rather than by the electrical power of an amplifier, this passive radiator is said to enhance

the bass and give distortion-free sound. The hand-rubbed enclosure is a precisely matched acoustic chamber, balanced to load the electroacoustic components. Frequency response is 25 to 40,000 Hz; power-handling ability, 35 watts music power.

Circle No. 81 on Reader Service Page 15

### POLICE/FIRE MOBILE RECEIVERS

Six crystal-controlled police and fire mobile FM receivers make up the "HA Series" recently introduced by *Lafayette Radio*. Four receivers in the 39- to 47-MHz low band cover a range of 1 MHz each, and two receivers in the high band (153 to 157 MHz) each cover a 2-MHz range.



All feature six crystal-controlled channels, high sensitivity, dual-conversion superhet circuitry, built-in

speaker, and variable squelch. High-performance mesa transistors are used in the critical circuits of the 19-transistor, 6-diode units. Each operates from a 12-volt d.c. source, negative or positive ground, but can also operate from line power with an optional power supply. Imported.

Circle No. 82 on Reader Service Page 15

### TRANSISTORIZED CB/MOBILE MICROPHONE

Want to replace your carbon-type microphone with a dynamic unit? The Model "+350" transistorized dynamic mike introduced by the *Turner Microphone Company* can be used as a replacement for most carbon-type units. This new microphone has a built-in solid-state preamplifier that reduces distortion and background noise for better transmission quality. Frequency response of the "+350" is voice-tailored to the 350 to 4000

Hz audio range. Output level is -38 dB below 1 V/dyne/cm<sup>2</sup>.

Circle No. 83 on Reader Service Page 15

### VARIABLE-SPEED SABRE/JIG SAW

Continuously variable cutting speeds from 0 to 2800 one-inch strokes per minute are made by a thumb-operated speed control on *Wen's* Model 521, 1/2-horsepower sabre/jig saw. The natural downward pressure of the operator's thumb when gripping the handle of the saw automatically sets the "Mind-Reader" switch to apply the proper speed and torque for the job. In addition, the Model 521 saw can start its own hole for inside cuts and perform intricate scroll and close-pattern cuts. The metal shoe plate can be tilted up to 45° for angle cuts. Seven blades are supplied for cutting a variety of materials—among them, plastic, wood, and metal.



Circle No. 84 on Reader Service Page 15

### SOLID-STATE SWL RECEIVER

Designated as Model SWL-4, *AMECO'S* new short-wave receiver provides continuous tuning from 540 kHz to 23 MHz in four switch-selectable bands, including the standard AM and foreign broadcast bands, and the ham bands from 160 through 15 meters. The receiver features a built-in speaker, illuminated dial, earphone jack for private listening, and a bandspread tuning control. Since the Model SWL-4 is all solid-state, no warm-up is required.



Circle No. 85 on Reader Service Page 15

### FOUR-CHANNEL MIXER/PREAMPLIFIER

Up to four individual signal sources can be fed through a single amplifier or tape recorder input channel with *Bogen's* line-operated, solid-state Model MX6A-T mixer/preamplifier. The four mixer inputs can handle high- and low-impedance microphones or electric guitars—two will accept tuner or crystal-cartridge signals. Each mixer channel has its own volume control for perfect mixing. The output of the MX6A-T will drive any "packaged" amplifier through its auxiliary input, and power amplifiers with 5-volt or better sensitivity.



Circle No. 86 on Reader Service Page 15

# Introducing Power Steering!

for the most powerful  
CB signal under the sun

With a Hy-Gain Duo-Beam you can concentrate the entire output of your CB transceiver into a single narrow beam and direct it with pinpoint accuracy exactly where you want it. That's Power Steering!

In addition to low VSWR on all 23 channels, the Hy-Gain Duo-Beams with Power Steering give you a tremendous power multiplication. In short, with a Duo-Beam you just plain communicate better and farther than you ever dreamed possible.

Power Steering gets you through traffic and congestion with the most powerful CB signal under the sun.

The <sup>new</sup> Hy-Gain Duo-Beams are big and ruggedly-built, yet they lend themselves to quick and easy installation, whether it be on rooftop or towers.

Three Super Duo-Beam models to choose from:

Models	No. of Elements	PMF* (Power Multiplication Factor)
SDB-4	4	7
SDB-6	6	13
SDB-10	10	20

\*In terms of your own application, the actual power available to you in watts is equal to the output power of your transceiver times the PMF.

Get Power Steering, from your Hy-Gain dealer. Hy-Gain Electronics Corporation, Dept. BA-1, N.E. Highway 6, Lincoln, Nebraska 68501.

## Hy-Gain's New Duo-Beams

HY-GAIN ANTENNAS, FOR THE MOST POWERFUL SIGNAL UNDER THE SUN  
CIRCLE NO. 14 ON READER SERVICE PAGE



# Cobra

new power!  
new punch!  
new performance!

This is CB's hottest line of performance-proven radios! Models for homes, offices, cars, trucks, boats. Perfect for business, professional people, farms, hobbyists. Makes work more efficient; makes life more fun. Full 5 watt input power and exclusive Dyna-Boost speech compression for 100% modulation—puts more sock in your talk!

## Cobra the "big 3" in CB!



**1. Cobra CAM-88.** Nothing finer. Double-conversion superhet receiver for extra sensitivity, greater selectivity. Completely self-contained; operates on all 23 channels. Dual-purpose S/Rf meter measures signal in, power out. Converts to 3 watt PA system. Works on 117 VAC and 12 VDC. \$214.95



**2. Cobra V.** All solid-state. Miniature size, walnut grained cabinet. Outstanding talk-power gets the message across. 5 crystal-controlled channels. All-weather performance through a wide temperature range. Operates on 12 VDC, negative ground.\* Includes mountings, manual, FCC license application, high-impact ceramic microphone. \$99.95



and introducing...

**3. Cobra 23.** All 23 channels with no extras to buy. All solid-state, including antenna switching—no relay contact failures. S/Rf meter measures signal in, power out. Top performance from Twin Pi output network. Handsome walnut-grain panel. Maximum talk-power; rugged dependability. Operates on 12 VDC, negative ground.\* With all accessories, \$169.95

\*OPTIONAL: PAC5 desk-top power supply converts Cobra V and Cobra 23 to 117 VAC, for base station service. \$29.95

Hear the difference know-how makes!  
Write for the name of a Cobra distributor near you.



Division of Dynascan Corporation  
1801 W. Belle Plaine, Chicago, Illinois 60613  
Where Electronic Innovation Is A Way Of Life

CIRCLE NO. 5 ON READER SERVICE PAGE

POPULAR ELECTRONICS



## *Build an IC 'Testone'*

UTILITY SQUARE-WAVE GENERATOR

FEATURES HIGH OUTPUT AND LOW COST

BY DON LANCASTER

**H**ERE'S A LOW-COST IC audio signal source powerful enough to directly drive a speaker, yet so tiny it fits easily into the palm of your hand. The "Testone" puts out a 1-kHz square wave of 2.5 volts amplitude, runs on two internal AA penlight cells for 50 hours or more, and has a special buffered output stage that can drive any impedance load—and even be short-circuited—without stalling.

The "Testone" is handy for audio, p.a., and hi-fi service work, particularly in checking out cables, speaker lines, and anywhere else where a physically larger audio oscillator unit would become an awkward burden. It tucks away in the smallest tool kit or tube caddy. In conjunction with an oscilloscope, the "Tes-

tone" will help you obtain approximate quality checks on a hi-fi system—frequency response, distortion, etc. The sharp-rise output square wave has harmonics well out into the MHz region, making the "Testone" an ideal signal injector whose thousands of harmonics can be most useful for AM radio and other high-frequency service work. Add a key and a speaker, and you have a low-cost CPO or signaling system.

A breadboard version of this circuit could cost you less than \$2 (the price tag on IC1 is only \$1.08), while a fancier, boxed version will go from \$3 to \$5, depending upon your taste in enclosures. A professional dialplate is available, and all parts are easy to get.

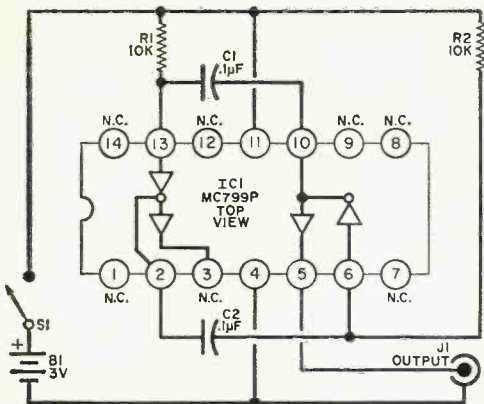

Fig. 1. Although the IC contains two sets of inverting buffers, not all of the internal circuits are used. The output can drive any load impedance—even down to a short circuit.

### PARTS LIST

- B1—"AA" penlight cell, 1.5 volts (2 needed)  
 C1, C2—0.1-µF, 10-volt miniature ceramic capacitor (Centralab UK-10-104 or similar)  
 IC1—Motorola MC799P dual buffer (Allied Radio #50-E-26-MC799P-MOT)  
 R1, R2—10,000-ohm, ¼-watt resistor  
 S1—S.p.s.t. slide switch  
 J1—RCA phono jack  
 1—Small enclosure (Bud CU-2100A, Davies #220 plastic case, Zero Z-32-40A-24 box, or similar)  
 1— $\frac{1}{16}$ " x 1" x  $1\frac{3}{4}$ " single-sided printed circuit board  
 1—Dialplate (optional)\*  
 Misc.—Holder for 2 "AA" penlight cells (Keystone #140); chassis (optional—see text); pop rivets (4) optional; threaded rivet-type spacers (5) optional; #6 x  $\frac{1}{4}$ " binder-head plastic screws, optional; wire, solder, etc.

\*Metalphoto hard anodized aluminum dialplate is available from Reill's Photo Finishing, 4627 N. 11 St., Phoenix, Arizona 85014, in black and white for \$1, red or copper for \$1.25, postpaid in U.S.A.

### HOW IT WORKS

The heart of the "Testone" is an integrated circuit (IC1) containing two inverting buffers, each having a high- and low-power output. The low-level outputs are coupled to the opposite inputs by C1 and C2, thus forming an astable multivibrator. Recharging resistors R1 and R2, together with the capacitors, determine the waveform symmetry and operating frequency. Values of the resistors and capacitors have been selected to produce an approximate 1-kHz operating frequency. The signal output is taken from one high-level output (at pin 5), and routed to the output jack.

The IC contains 6 transistors and 12 resistors, divided equally into two identical circuits. Transistors Q1 and Q4 form the active part of the astable multivibrator, while Q5 and Q6 provide a push-pull output stage for load drive and isolation. Transistors Q2 and Q3, and a pair of 1000-ohm resistors (all within the IC), are not used.

**Construction.** Figure 1 is the schematic for the "Testone" and Fig. 2 shows the equivalent circuit of the IC. An actual-size printed circuit board appears in Fig. 3, while Fig. 4 gives you the layout and drilling details. You can make the PC board from a  $1\frac{3}{4}$ " x 1" x  $\frac{1}{16}$ " scrap of printed circuit material.

Component layout is shown in Fig. 5. Note that IC1 is identified by a dot and code notch and that all pin connections are shown from the top. Use a small soldering iron and fine solder to mount the components. While not required, three PC terminals (one for each lead coming off the PC board) add a professional touch and aid in making circuit interconnections.

You can use any enclosure you wish—

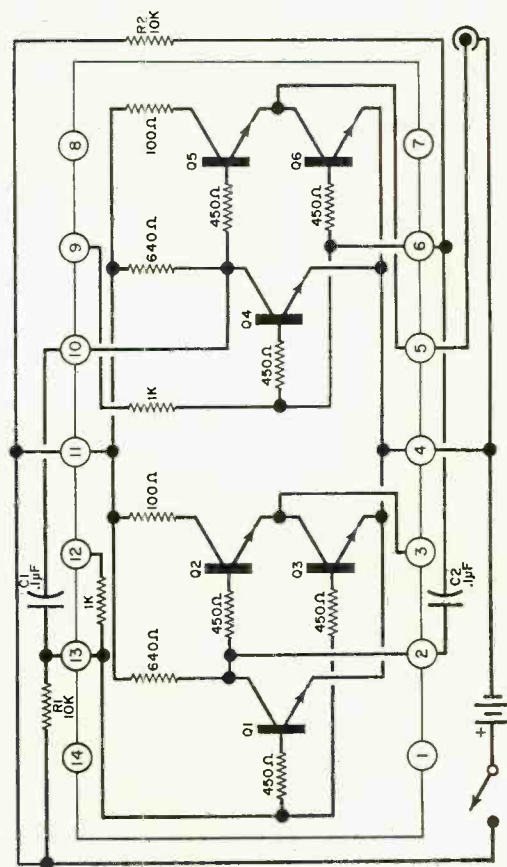

Fig. 2. The IC contains six transistors and 12 resistors, all diffused on a tiny piece of silicon, and packaged in a dual in-line, injection-molded 0.75" x 0.3" plastic case.



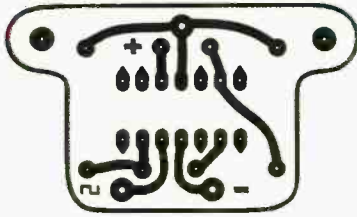

Fig. 3. Use this actual-size printed board if you want to make the "Testone" as small as possible.

a small metal box, a small plastic instrument case, or a deep-drawn aluminum box. Inside case dimensions should be greater than  $1\frac{3}{8}'' \times 1\frac{7}{8}'' \times 2\frac{3}{8}''$  to allow enough room for the battery holder and the IC. Some enclosures may call for a small aluminum chassis, particularly if a dialplate is being used.

In the prototype "Testone," rivet-type standoffs secure the PC board to the chassis, while S1 and the battery holder are pop-riveted in place. If you're using a dialplate, be sure to dimple the chassis or case so the dialplate will lie flush and

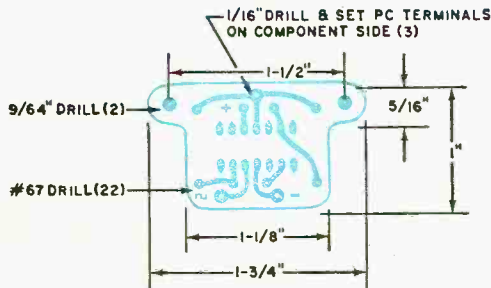

Fig. 4. Drilling information for the PC board. Use of PC terminals makes a professional-looking job.

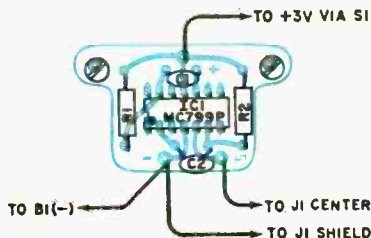
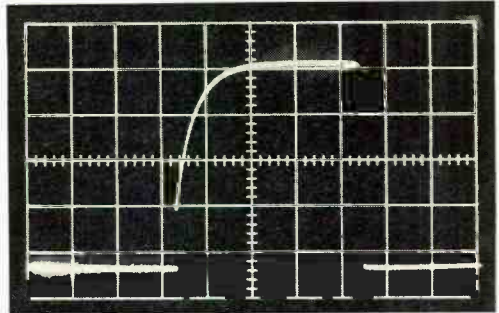

Fig. 5. Component layout. Note that the IC carries both a coding dot and notch for proper positioning.

hide the switch hardware. The dialplate is secured with the hardware on S1. If #6 plastic binder head screws are used, their heads can double as no-mar cabinet feet for the complete instrument. Be sure to observe polarity when you install the penlight cells.

**Operating Hints.** To use the "Testone," just connect it to a speaker or an amplifier input, switch to ON—and away you



Abrupt trailing edge of the output waveform of the Testone produces harmonics out to the MHz region.

go. Although the "Testone" has a small d.c. output offset current, its value is safely within that of even the smallest speaker, and no harm will be done.

**DO NOT** apply any voltage to the "Testone" output terminal or use the "Testone" on any live circuit carrying

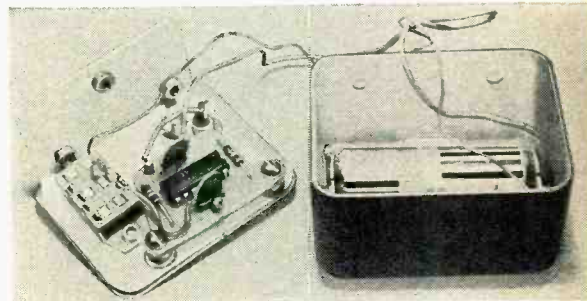

Author's prototype shows PC board mounting, location of on/off switch, batteries, and output jack.

d.c. without adding a coupling capacitor. For AM radio service and signal injecting, use a 500-pF mica coupling capacitor which will permit only the high frequency leading and trailing edges of the "Testone's" output waveform to be injected into the circuit under test. -30-

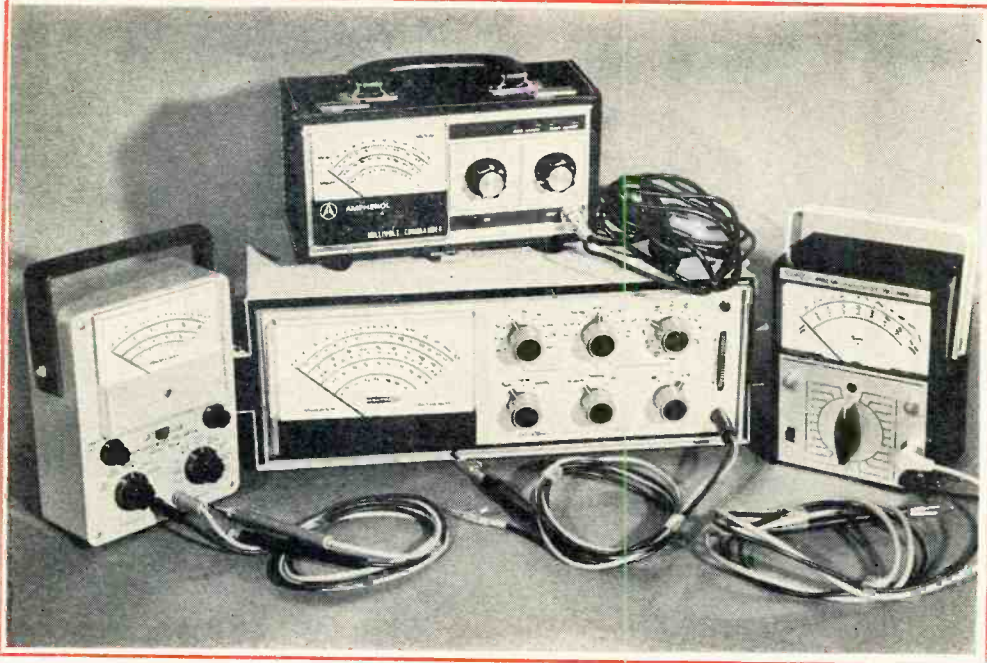

# ***The Case for the Transistorized Multimeter***

PRO'S AND CON'S OF NEW TYPE OF TEST EQUIPMENT

BY LESLIE SOLOMON TECHNICAL EDITOR

**T**HE ever-increasing use of transistors and IC's in electronic circuitry has produced new problems for experimenters. Because the voltage levels for proper operation of solid-state circuits are usually very small—as a look at any solid-state circuit will show—any change, even slight, in these voltage values can produce improper circuit operation. The problems start when you try to measure these low-level voltages.

Using a conventional VOM (volt-ohm-milliammeter) is usually a poor way to make these measurements. Why? Take a close look at the electrical characteris-

tics of some typical VOM's. In many cases, the input resistance (in ohms-per-volt usually found on the meter face in one of the corners) on the lowest voltage range is sufficiently low to cause serious changes in the measured voltage level.

What does this have to do with measuring voltage? If you recall Ohm's law, you will remember that when two resistors are connected in parallel, the resulting equivalent resistance is found by  $(R1 \times R2)/(R1 + R2)$ . For example, if you assume that a pair of 1000-ohm resistors are connected in parallel, the resulting equivalent resistance is 500



ohms. (We usually remember this equation when we parallel actual resistors to produce some desired lower value, but we seem to forget it when we connect a voltmeter into a circuit!)

Now, if you assume that one of the 1000-ohm resistors is a 1000-ohms-per-volt VOM on the one-volt range, and the other 1000-ohm resistor is in a circuit that should measure one volt, the resultant 500-ohm equivalent resistance produces a meter indication of only 0.5 volt—50% off the circuit value required. In cases where the 1000-ohm resistor determines current flow in the circuit, reducing its value to 500 ohms may produce enough current flow to damage a semiconductor. This is why your VOM probably doesn't give you the voltage level indicated by the manufacturer, and it is also why some of your semiconductors may have been damaged for unknown reasons.

What about VTVM's? Don't they usually have input impedances measured in megohms, making them almost non-loading? True, they do have this characteristic—but they also have several small drawbacks. First, until very recently, most VTVM's had 1.5-volts full-scale as their lowest range. This meant that the very low voltages (below 0.25 volt) found in many solid-state circuits were indicated at the bottom end of the meter scale, where, in most cases, they were difficult to read and slight changes to interpolate were necessary. Second, they required connection to a.c. power, thus limiting their use to the bench. Third, most VTVM's use vacuum tubes (that's why they're called VTVM's), and vacuum-tube circuits often require recalibration as the tubes age.

**VOM + VTVM = TVM.** Recent VTVM's have overcome some of their disadvantages by utilizing pre-aged tubes, and incorporating 0.5-volt full-scale ranges. However, these changes still did not eliminate the need for another voltage measuring instrument having the total portability of the VOM, the non-loading of the VTVM, full-scale ranges of 0.5 volt or less, and requiring a minimum of recalibration.

Two developments helped bring such an instrument into being—the FET with its very high input resistance, and the

## THE BOOTSTRAP CIRCUIT

The major reason that a bipolar transistor circuit is a low-impedance circuit is the fact that the input signal "sees" a parallel combination of the transistor base bias resistors, the input resistance of the transistor, and the leakage resistance of the transistor. When the resulting equivalent resistance is calculated, it will be found to be a low figure.

The input resistance of a transistor is determined by multiplying the emitter resistor value (if it has one) by the *beta* ( $\beta$ ) of the transistor. Therefore, with any reasonable value of resistor, and *beta*, the input resistance will be high. This is the reason why emitter-follower circuits are said to be high input resistance circuits.

With the introduction of improved manufacturing processes, the leakage current of a good transistor will be very low, thus making the leakage resistance a high value. The remaining resistance, the parallel combination of the base bias resistors, unfortunately remains with us, and it is this value that has the greatest effect on input resistance.

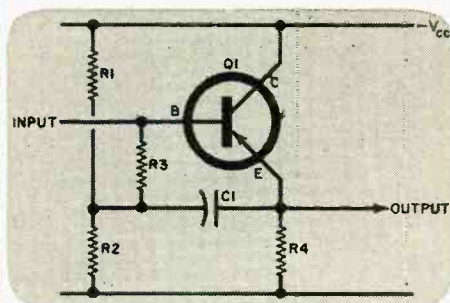

As shown in the schematic of a bootstrap circuit (above),  $R_1$  and  $R_2$  form the base bias voltage-divider network, while  $R_3$  is an isolating resistor connected between the base of the transistor and the  $R_1$ - $R_2$  junction. The signal input is fed to the base of the transistor and the output is taken across emitter resistor  $R_4$  and also coupled to  $R_3$  via capacitor  $C_1$ .

When a signal appears at the top end of  $R_3$  and the base, it also appears at the emitter in the same phase—and for all practical purposes at the same amplitude. Thus, an identical signal voltage appears at both ends of  $R_3$  and no signal (a.c.) current flows in this resistor. Resistor  $R_3$  then represents an infinitely high resistance to signal (a.c.) current, thus effectively isolating the base bias resistors. Since  $R_3$  has no effect at d.c., however, the base bias is unchanged. The circuit literally lifts its impedance by its own "bootstraps," hence its name.

In practice, the signal voltage at the emitter is slightly less than on the base, thus limiting the effective value of  $R_3$ . If, for example, the emitter follower voltage gain is 0.99, and the value of  $R_3$  is 100,000 ohms, the effective resistance of  $R_3$  is raised to 10 megohms, an increase in value by a factor of 100 times. Dependent upon the  $\beta$  (*beta*) of the transistor in use, and the leakage value of that particular transistor, the input impedance of the circuit will be a value not too much less than 10 megohms.

Triplet's Model 600 requires two "AA" cells, one "D" cell, and one conventional 9-volt transistor radio battery. Note clean appearance of interior.

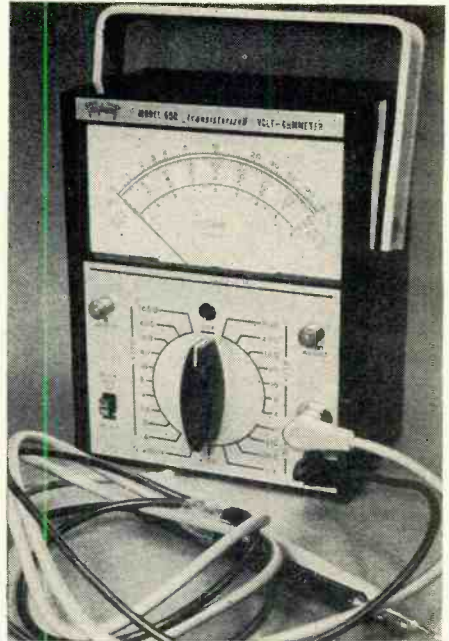
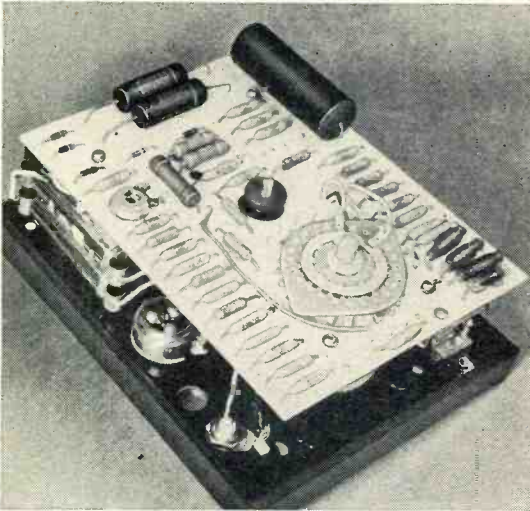

bipolar transistor "bootstrap" circuit in which a novel approach makes an ordinary low-impedance transistor circuit look like a very high impedance circuit. The use of semiconductors meant that batteries could be employed as the power source, providing portability; and the fact that semiconductor devices require no "aging" removed the last electronic barrier. The creation of a low-voltage range is only a component change in the input voltage-divider circuit. Thus, the stage was set for the introduction of the transistor volt-ohm-milliammeter or TVM.

#### TVM GRAND-DADDY?

In August, 1963, POPULAR ELECTRONICS reported on the first commercial transistor volt-meter—the De Vry TRVM. Still available, it comes as a kit (\$64.50), or wired unit (\$89.50), and features a.c. ranges from 5 to 1000 volts, d.c. ranges from 1 to 1000 volts, and current measurements from 50  $\mu$ A to 50 mA. External shunts permit current measurement from 500 mA to 5 amperes, and a conventional ohmmeter range is provided. Input impedance on a.c. is 650,000 ohms on the 5-volt range and approximately 2 megohms on the others. The d.c. input resistance is 10 megohms on all scales except the 1-volt range, where it is about 1 megohm. The device operates from three "D" cells and one "C" cell.

As new TVM's are appearing on the market with regularity, the four units discussed on these pages represent only a small sampling. However, there are sufficient differences among them to illustrate some trends in TVM's.

**Power Sources.** As one of the major reasons for the existence of the TVM is portability, most units are powered only by batteries. There are exceptions—the Heath IM-25, for example, is powered either by an internal battery supply or by the commercial power line, with selection made by a front-panel control. When the a.c. power cord is not in use, it is stored on the rear of the cabinet. TVM's having this feature can be employed both on the bench and in the field.

Types of batteries used by the various TVM's range from "AA," "C," and "D" cells, through conventional 9-volt transistor radio batteries. All units have several batteries, often in various combinations as required by the respective circuit, and, with all, battery replacement is easy. One unit (the Amphenol "Millivolt Commander") has a provision on its function selector switch for testing its internal battery, and its meter scale is marked accordingly. The others have special, easy-to-perform test procedures



included in their operating manuals to simplify battery testing.

**D.C. Voltage Measurements.** As TVM's were designed with solid-state circuit voltage measurement in mind, all are provided with at least a 0.5-volt range, and most also incorporate a 0.15-volt range. The remainder of the voltage ranges are as found on VTVM's, ranging in 5 to 7 steps to about 1500 volts. Of course, all TVM's have switch provisions for measuring either positive or negative volts.

D.C. full-scale accuracy for all TVM's is between  $\pm 2$  and 3%. There is a greater variation in input resistance, however. The Heath and Amphenol units have about 11 megohms input resistance on all ranges; the Triplett Model 600 has 2.75 megohms on its 0.4-volt range, 5.5 megohms on its 0.8-volt range, and 11 megohms on all other ranges; while the Aul TVM-4 has 500,000 ohms on its 0.15-volt range, 1.5 megohms on the 0.5-volt range, 5 megohms on the 1.5-volt range, 17 megohms on the 5-volt range, and 36 megohms on all other ranges.

**A.C. Voltage Measurements.** As it is seldom necessary to measure low-level a.c.

voltages, many TVM's do not make provisions for such measurement below the usual 1.5 volts. However, there are exceptions—the Heath unit measures down to 0.15 volt, while the Amphenol unit goes down to 0.1 volt.

A.C. full-scale accuracy is not quite as good—ranging from 3 to 5%. Input impedance once again varies widely, ranging from 10 megohms for the Heath and Amphenol units, to 750,000 ohms for the Triplett, down to 250,000 ohms for the Aul TVM. The frequency response of the a.c. measurement circuit also shows wide variation. The Heath unit is flat from 10 Hz to 100 kHz, the Amphenol from 50 Hz to 50 kHz, and the Triplett from 15 Hz to 2 MHz. Voltage measurements outside these limits may be in error.

**D.C. Current Measurement.** This seems to be an area of disagreement. While some manufacturers provide for d.c. measurement—in the case of Heath from 0.015 to 1.5 A (ampere), and Aul from 0.15 to 1.5 A—others do not include this measurement facility.

Since the TVM is a voltage-sensitive device, the inclusion of a series voltage-dropping resistor in its current measure-

#### The RCA TVM Entry

As this issue goes to press, we have learned that RCA has introduced the Model WV-500A solid-state Volt-Ohmyst. Resistance can be measured from 0.2 ohm to 1000 megohms; d.c. voltage measurement is from 0.2 to 1500 volts; and a.c. (r.m.s.) measurement is from 0.1 to 1500 volts, complex waveforms to 4200 volts. Input resistance on all d.c. ranges is 11 megohms. Price, \$75.00.

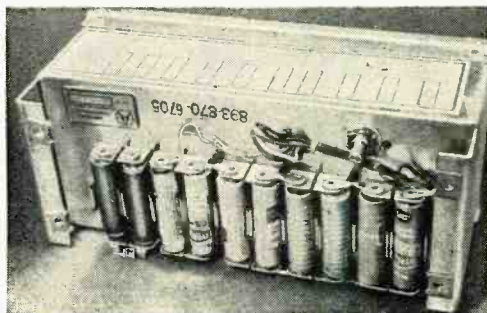

Amphenol's "Millivolt Commander" automatically shuts itself off when the cover is closed. The detachable cover also contains storage space for the test leads. Ten "AA" cells are required to power this test set.

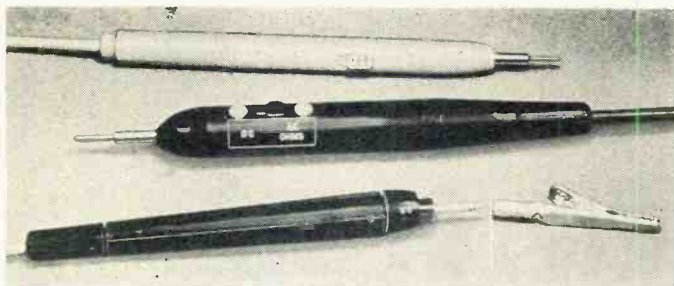

The probe for the Heath unit (bottom) has a rotatable end to select either a.c./ohms or d.c. function, and an optional screw-on alligator clamp test terminal. Plastic probes used by Amphenol and Triplett (center and top) both use fingertip-operated function switches.

ment circuit may produce external circuit problems. For example, the insertion resistance of the Heath unit is 10,000 ohms for the 0.015-A range. When measuring current in a circuit, the user should be aware of the presence of this unseen series resistance, as in many cases it may curtail certain circuit operations.

**A.C. Current Measurements.** Measurement of low-level a.c. current flow is seldom required in any service work, and only one unit discussed here (Heath) makes provision for it. In this case, the a.c. current range duplicates the d.c. range (0.015 to 1.5 A), and the same problem of insertion resistance exists as discussed above.

**Resistance Measurements.** As in VOM's and VTVM's, TVM's are provided with the usual ohmmeter ranges. Where Aul and Triplett are content to go to  $R \times 100K$  as the upper end of their units, Heath and Amphenol provide an  $R \times 1M$  setting.

Three of the representative units have the usual "Zero Adjust" and "Ohms Adjust" controls; Heath uses a "Zero" control which is common for all functions. Like conventional ohmmeters, the TVM's use "10" as the center scale indication.

**Probe Design.** Test leads have also undergone a design evolution during the past few years. Gone are the days of the unshielded length of wire supplying the "hot" meter input with a signal. Today,

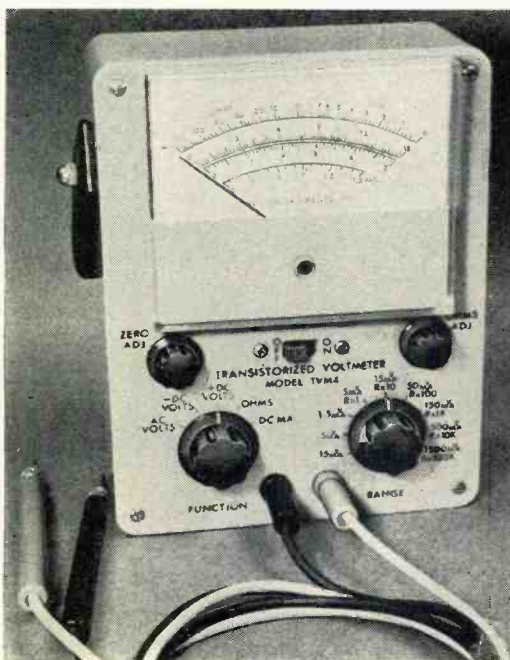

Exterior and interior views of the Aul TVM-4. Although labeled a transistorized voltmeter, the instrument is actually a transistorized multimeter. It uses one "C" cell and six "AA" cells.

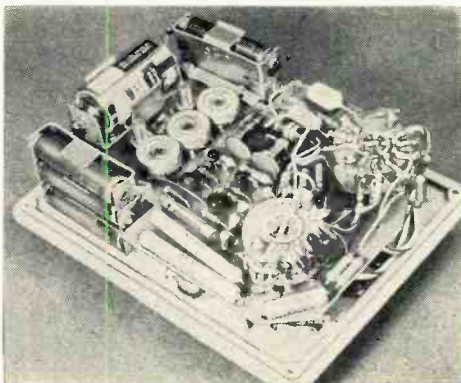



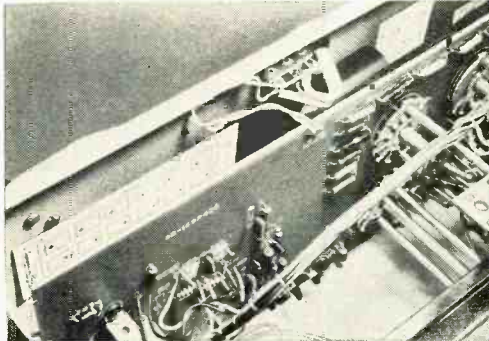
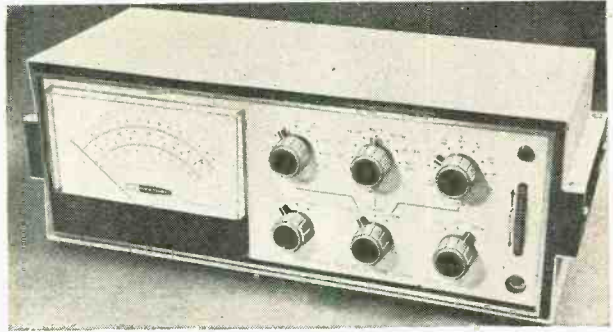

Heath's IM-25 uses 14 "C" cells, two for the ohmmeter function, and the other 12 for battery operation, installed as shown at left. The IM-25 can also be operated from a commercial power line if necessary.

with very high input impedance VTVM's, and now TVM's with their very low full-scale voltage ranges, stray pickup on the test leads can lead to erroneous indications. The trend is toward a length of shielded wire terminated in a plastic probe having some form of fingertip switching between the d.c. and a.c./ohms functions.

While all probes are terminated with a reasonably sharp metal tip, many are also provided with a friction-fit alligator clip that can be slipped over the metal tip. Heath, on the other hand, uses a threaded metal tip so that the screw-on alligator clip forms an integral part of the tip.

**Physical Design.** The modern TVM has that "uncluttered" look. Meters are large, clearly printed, very easy to read, and range in width up to six inches. Although the familiar box-on-end packaging is still in vogue for VTVM's and VOM's, TVM's are starting new style trends.

Amphenol, for example, encloses its "Millivolt Commander" in a simulated leather case with carrying handle, with test lead storage space provided in the cover. A tilting "foot" at the rear of the unit permits standing it at any easy viewing angle. Another Amphenol novelty is the use of a rocker-type on/off switch so arranged that when the cover is installed and closed, a rubber bumper on the cover will automatically switch the unit off if the operator forgets to do so.

Heath is following its latest approach  
(Continued on page 101)

CURRENTLY AVAILABLE TVM's		
Company	Model	Price
Amphenol	"Millivolt Commander" (Model 870)	\$99.95
Aul	TVM-4	\$69.85
	TVOM-4	\$55.00
	TVOM-3	\$44.00
DeVry	TVRM	\$64.50 (kit)
		\$89.50 (wired)
Heath	IM-16	\$44.95 (kit)
	IM-25	\$80.00 (kit)
	IMW-25	\$115.00 (wired IM-25)
Triplett	Model 600	\$78.00

# SOMEONE SHOULD DEVELOP AN EASY WAY TO LEARN ELECTRONICS AT HOME

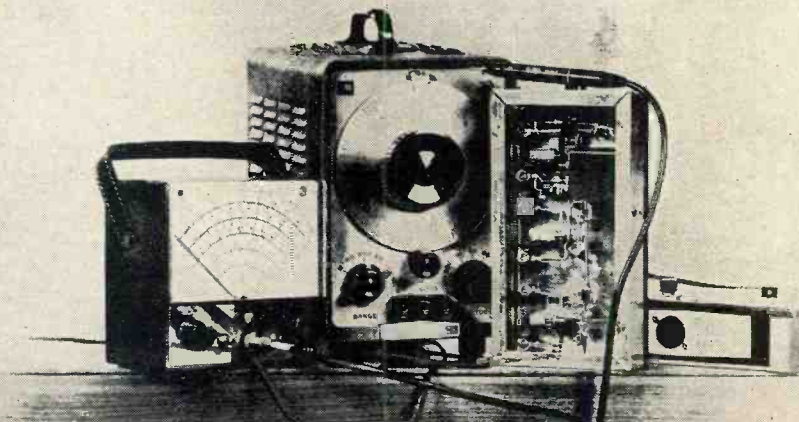

## RCA INSTITUTES DID!

Here is a whole new approach to learning electronics at home! RCA Institutes, one of the nations' largest schools devoted to electronics, has developed a faster, easier way for you to gain the skills and the knowledge you need for the career of your choice. Here for the first time, is a student-proved, scientifically designed way to learn. If you have had any doubts in the past about home training in electronics—if you have hesitated because you thought you might not be able to keep up—or that electronics was too complicated to learn—here is your answer! Read how RCA Institutes has revolutionized its entire home training ideas!

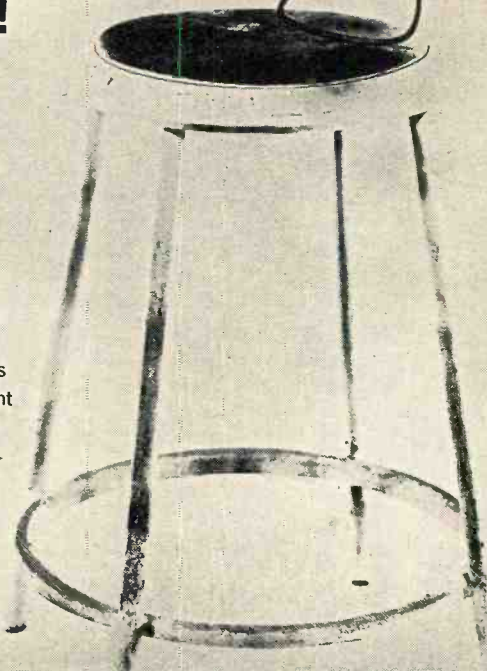



## NEW CAREER PROGRAMS BEGIN WITH "AUTOTEXT" INSTRUCTION METHOD!

**Start to learn the field of your choice immediately!**

**No previous training or experience in electronics needed!**

With this new revolutionized method of home training you pick the career of your choice—and RCA Institutes trains you for it. RCA's Career Programs assure you that everything you learn will help you go directly to the field that you have chosen! No wasted time learning things you'll never use on the job! The Career Program you choose is especially designed to get you into that career in the fastest, easiest possible way!

And each Career Program starts with the amazing "AUTOTEXT" Programmed Instruction Method—the new, faster way to learn that's almost automatic! "AUTOTEXT" helps even those who have had trouble with conventional home training methods in the past. This is the "Space Age" way to learn everything you need to know with the least amount of time and effort.

### CHOOSE A CAREER PROGRAM NOW

Your next step may be the job of your choice. Each one of these RCA Institutes Career Programs is a complete unit. It contains the know-how you need to step into a profitable career. Here are the names of the programs and the kinds of jobs they train you for. Which one is for you?

**Television Servicing.** Prepares you for a career as a TV Technician/Service Man; Master Antenna Systems Technician; TV Laboratory Technician; Educational TV Technician.

**FCC License Preparation.** For those who want to become TV Station Engineers, Communications Laboratory Technicians, or Field Engineers.

**Automation Electronics.** Gets you ready to be an Automation Electronics Technician; Manufacturer's Representative; Industrial Electronics Technician.

**Automatic Controls.** Prepares you to be an Automatic Controls Electronics Technician; Industrial Laboratory Technician; Maintenance Technician; Field Engineer.

**Digital Techniques.** For a career as a Digital Techniques Electronics Technician; Industrial Electronics Technician; Industrial Laboratory Technician.

**Telecommunications.** For a job as TV Station Engineer, Mobile Communications Technician, Marine Radio Technician.

**Industrial Electronics.** For jobs as Industrial Electronics Technicians; Field Engineers; Maintenance Technicians; Industrial Laboratory Technicians.

**Nuclear Instrumentation.** For those who want careers as Nuclear Instrumentation Electronics Technicians; Industrial Laboratory Technicians; Industrial Electronics Technicians.

**Solid State Electronics.** Become a specialist in the Semiconductor Field.

**Electronics Drafting.** Junior Draftsman, Junior Technical Illustrator; Parts Inspector; Design Draftsman Trainee Chartist.

### SEPARATE COURSES

In addition, in order to meet specific needs, RCA Institutes offers a wide variety of separate courses which may be taken independently of the Career Programs, on all subjects from Electronics Fundamentals to Computer Programming. Complete information will be sent with your other materials.

### LIBERAL TUITION PLAN

RCA offers you a unique Liberal Tuition Plan—your most economical way to learn. You pay for lessons only as you order them. No long term contracts. If you wish to stop your training for any reason, you may do so and not owe one cent until you resume the course.

### VALUABLE EQUIPMENT

You receive valuable equipment to keep and use on the job—and you never have to take apart one piece to build another. **New—Programmed Electronics Breadboard.** You now will receive a scientifically programmed electronic bread-

board with your study material. This breadboard provides limitless experimentation with basic electrical and electronic circuits involving vacuum tubes and transistors and includes the construction of a working signal generator and superheterodyne AM Receiver.

**Bonus From RCA—Multimeter and Oscilloscope Kits.** At no additional cost, you will receive with every RCA Institutes Career Program the instruments and kit material you need to build a multimeter and oscilloscope. The inclusion of both these kits is an RCA extra.

### CLASSROOM TRAINING ALSO AVAILABLE

RCA Institutes maintains one of the largest schools of its kind in New York City where classroom and laboratory training is available in day or evening sessions. You may be admitted without any previous technical training; preparatory courses are available if you haven't completed high school. Coeducational classes start four times a year.

### JOB PLACEMENT SERVICE, TOO!

Companies like IBM, Bell Telephone Labs, GE, RCA, Xerox, Honeywell, Grumman, Westinghouse, and major Radio and TV Networks have regularly employed graduates through RCA Institutes' own placement service.

SEND ATTACHED POSTAGE PAID CARD FOR COMPLETE INFORMATION. NO OBLIGATION. NO SALESMAN WILL CALL.

ALL RCA INSTITUTES COURSES  
AVAILABLE UNDER NEW GI BILL.

ACCREDITED MEMBER  
National Home Study Council



**The Most Trusted Name in Electronics**

**RCA INSTITUTES, Inc., Dept. PE-18**  
A Service of Radio Corporation of America  
320 West 31st Street, New York, N.Y. 10001



Large billboard in Akihabara area advertises color TV sets made by Toshiba, one of Japan's largest manufacturers.

## Still Akihabara-- Still Going Strong

**A**LTHOUGH I was born and raised in Japan, I had never heard of Akihabara until May, 1966.\* When I went home for a visit a few months ago, my curiosity immediately led me to this by-now-famous spot.

A local electronics "bug" served as my guide and he took me not to the street level stores, full of bargains as they are, but instead to the subway station building itself. The trains run on what would be considered the third floor level and in the space between the trains and the street are three low-ceiling floors crammed with electronics goodies.

I was disappointed in the hi-fi speakers; you can get speakers that are just as good at better prices from Lafayette, McGee, Olson, and Radio Shack. But, otherwise, everything lived up to my expectation. For example, in the maze of aisles and tiny shops, I found high-quality stereo tape heads for \$2.22. And there were what seemed like thousands of surplus and distress items, ranging

from oscilloscopes to two-transistor radio receivers.

The greatest single experimenter's item that I saw was uncased portable AM radios. These units had been pulled from production lines due to some small fault. Even 10-transistor FM/AM/short-wave radios were being sold for between \$2 and \$3.

The bargains aren't quite worth the round-trip price, but don't pass through Tokyo without visiting Akihabara.

—Jackson M. Garrott



Most of the shops in Akihabara specialize. This one sells known and unknown brand tape recorders.

\*"Akihabara, Tokyo's Radio Row," POPULAR ELECTRONICS, May 1966, p. 54.





HOW HOW WOULD WOULD YOU YOU LIKE LIKE  
 TO TO INCORPORATE INCORPORATE A A CONTROLLABLE  
 CONTROLLABLE ECHO ECHO IN IN YOUR  
 YOUR AUDIO AUDIO SYSTEM SYSTEM? ?

BY DANIEL MEYER

**T**HE ADDITION of electronically generated reverberation to any audio system adds a new dimension to the reproduction of music. By adjustment of the amplitude and decay time of reverb (really an echo), speech, guitar music, or even simple recorded sounds can be made to seem as though you were hearing them in a huge concert hall. When electronic reverb is used with electronic musical instruments, the artist can create a variety of new sounds—ranging from a simple echo to a playing-in-a-barrel effect\*.

Most low-cost reverb units can be purchased over the counter at various electronics supply houses. However, you cannot simply connect one between the signal source and the amplifier and expect it to work. The reverb unit must have a driver and an output amplifier, in addition to a resistive mixing circuit needed to combine the straight-through and the reverb sound. The complete re-

verb adapter described in this article contains all of these electronic elements and is designed to be connected between a conventional preamplifier and power amplifier, either vacuum-tube or transistor types. It is particularly useful with POPULAR ELECTRONICS' "Brute-70" (February, 1967) or the "L'il Tiger" (December, 1967) power amplifiers.

**Construction.** Putting the reverb adapter (Fig. 1) together is simplified by using the printed-circuit board shown actual size in Fig. 2. Install the components on the PC board in accordance with Fig. 3. The usual PC board construction techniques should be observed—all parts should be mounted close to the board; use rosin-core solder, do not overheat when soldering, and do not form solder bridges across the foil sections. Clip all component leads close to the solder.

The adapter can be mounted on a small metal chassis as shown in Fig. 4. Four small standoffs (approximately 1/4") and associated hardware secure the PC board to the base of the chassis, potentiometer R13 is mounted on the front panel,

\*Don't confuse reverb and tremolo and Leslie effects. Reverb is an echo, tremolo an amplitude variation, and Leslie a warble—as though the sound were changing point source of direction.

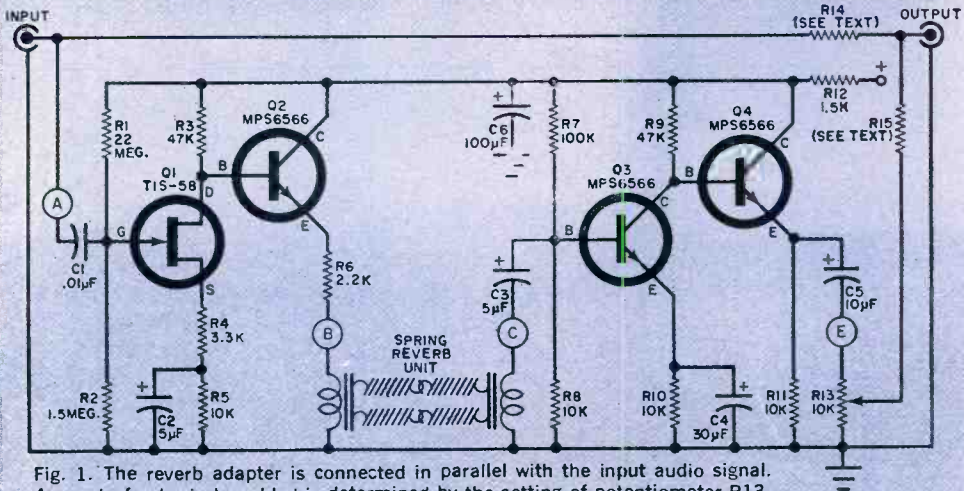

Fig. 1. The reverb adapter is connected in parallel with the input audio signal. Amount of echo to be added is determined by the setting of potentiometer R13.

### PARTS LIST

- C1—0.01- $\mu$ F capacitor
  - C2, C3—5- $\mu$ F, 15-volt capacitor
  - C4—30- $\mu$ F, 6-volt capacitor
  - C5—10- $\mu$ F, 25-volt capacitor
  - C6—100- $\mu$ F, 50-volt capacitor
  - Q1—Texas Instruments TIS-58 field effect transistor
  - Q2, Q3, Q4—Motorola MPS-6566 transistor
  - R1—22 megohms
  - R2—1.5 megohms
  - R3, R9—47,000 ohms
  - R4—3300 ohms
  - R5, R8, R10, R11—10,000 ohms
  - R6—2200 ohms
  - R7—100,000 ohms
  - R12—1500 ohms—see text
- All resistors  
1/2 watt,  $\pm$  10%

- R13—10,000-ohm linear potentiometer
- R14, R15—See text
- 1—Spring reverberation unit (Gibbs IV-C, Hammond Organ)
- 1—Printed circuit board\*
- Misc.—Phono jacks (4), single-hole mounting type; chassis—see text; wire, solder, spacers, bolts, nuts, etc.

\*A kit of the circuit board, chassis, and electronic parts used in the driver amplifier is available from Southwest Technical Products Corp., 219 W. Rhapsody, San Antonio, Texas. 78216, for \$8.75 postpaid (#CA-139); the IV-C reverberation unit for \$10 plus 2 lb. postage; the circuit board alone for \$2 postpaid.

### HOW IT WORKS

The heart of the reverb adapter is the spring reverberation unit: the electromechanical device that produces the delay and echo effects. Basically, it consists of a pair of contraround springs (it could be only one spring) suspended between a pair of transducers. When the input transducer is supplied with an audio current, it causes the springs to twist in step. The twisting motion travels down the springs and excites the output transducer, generating an output voltage. Two simultaneous actions occur—there is a slight time delay of the signal in traversing the springs (approximately 25 milliseconds); and because of coupling inefficiencies, some of the signal “bounces” back and forth from transducer to transducer a couple of times, producing an “echo.” As each mechanical reflection produces a weaker and weaker signal in the output transducer, multiple weakening of acoustic signals in a “live” room is simulated.

Because the typical loss in the spring reverb system is about 40 dB, an input amplifier (Q1) is used. This stage employs a FET to produce a high input impedance (about 1 megohm), which allows the reverb adapter to be used with almost any type of input equipment without loading problems. An emitter follower (Q2) matches the input amplifier to the approximately 2000-ohm input impedance of the spring unit.

The electrical output of the spring unit is coupled to amplifier Q3, which raises the signal level back to the same level as was applied at the adapter input. Emitter follower Q4 isolates Q3 from any loading effects introduced by the external audio power amplifier. Potentiometer R13 acts as the “reverb level” control and is used to set the desired amount of reverberation. The input audio signal is directly coupled to the output via R14, while the reverb is introduced through R15.

while the four phono jacks are mounted along the rear apron. Connect short pieces of insulated wire between points A, B, C, and E of the PC board and their respective phono jacks (see Fig. 1).

The value of resistors R14 and R15 will depend on what type of audio system

the reverb adapter is to be used with. With vacuum-tube equipment, these two resistors should be between 47,000 and 100,000 ohms, with the exact value determined by test. Start with 47,000-ohm units, and remember that some signal loss will be encountered through the use



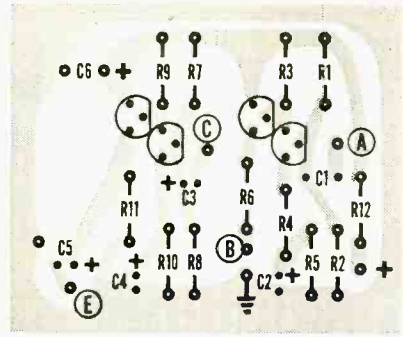
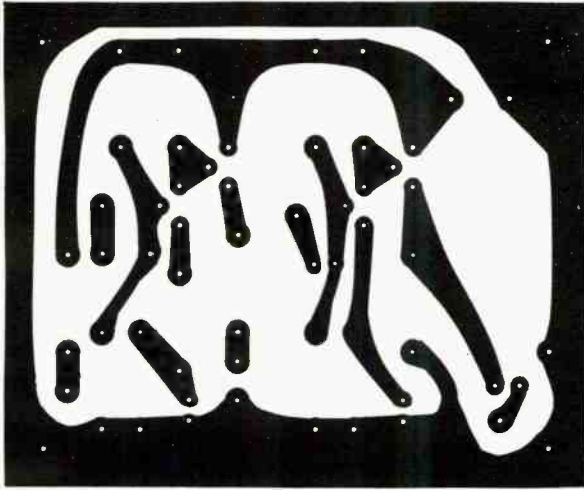

Fig. 2 (left). Actual-size printed board.

Fig. 3 (above). Component installation. Resistors R14 and R15, with potentiometer R13, are installed on the chassis.

of these two resistors. With transistor audio equipment, resistors *R14* and *R15* will be in the range from 1000 to 4700 ohms, again with the best value determined by experimentation. A good compromise is 2200 ohms.

On transistor amplifiers, such as the "Brute 70" and "L'il Tiger," the reverb adapter can be added without a loss in gain by utilizing the present input resistor as one of the mixing resistors (*R14*). Figure 5 shows how this is done. Simply,

*R14* in the reverb adapter is omitted and the input resistor of the amplifier is used in its place. In this case, the value of *R15* should be about the same as the input resistor of the amplifier. The value would be about 82,000 ohms with the "Brute 70" and about 4700 ohms with the "L'il Tiger." The "L'il Tiger" was designed with an extra input jack just for this purpose.

Power for the reverb adapter can be obtained from the power supply of

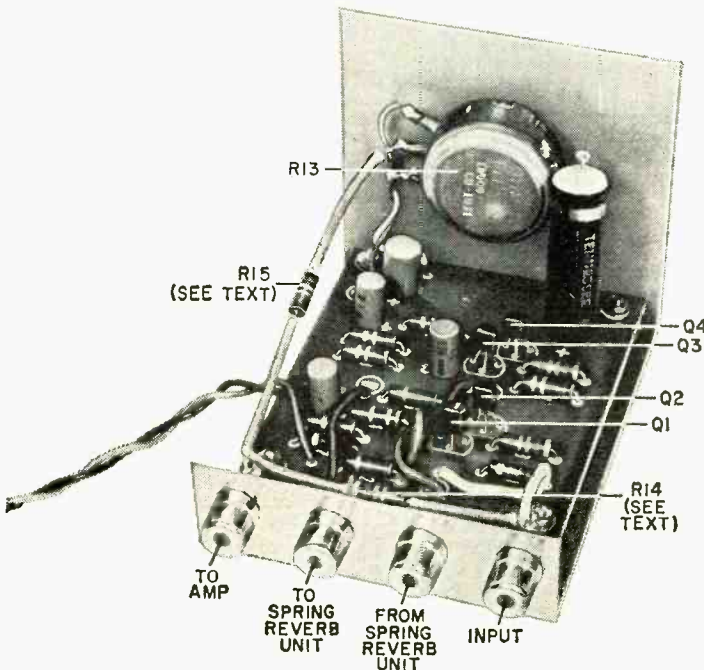

Fig. 4. The finished board can be mounted on a metal chassis with the external connections completed as shown here. Short spacers isolate board from chassis.

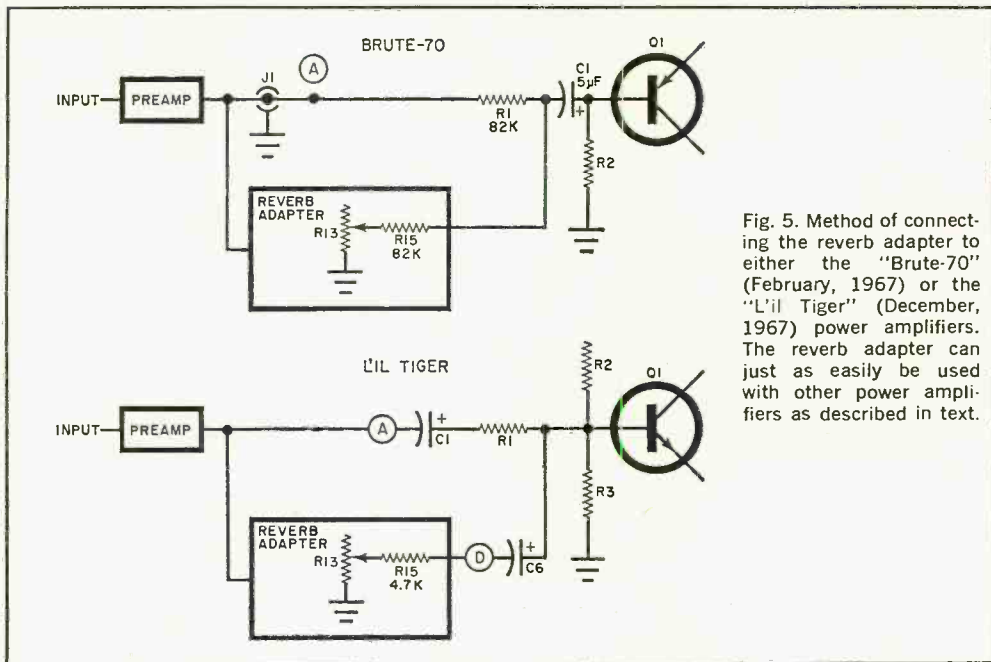

Fig. 5. Method of connecting the reverb adapter to either the "Brute-70" (February, 1967) or the "L'il Tiger" (December, 1967) power amplifiers. The reverb adapter can just as easily be used with other power amplifiers as described in text.

either the "Brute 70" or "L'il Tiger." The value of  $R12$  shown in Fig. 1 is correct for use with power supplies between 40 and 50 volts. For higher voltage sources, such as are found in vacuum-tube equipment, the value of  $R12$  will have to be increased to a value that delivers the approximately 30 volts required by the reverb adapter, as shown in Fig. 6.

**Installation and Use.** On instrument amplifiers, the reverb adapter can be connected either between the instrument and its amplifier, or it can be inserted into the circuit between the preamplifier and the power amplifier stages. If you do not want to "go into" the amplifier, the first approach is the safest—but possibly not the best—as there is a possibility of hum pickup at these low-level stages.

The reverb spring unit is shock-mounted, but the long springs make it sensitive to any undue bouncing, which will produce a "boing"-like sound. Also, the magnetic pickups on the output end of the springs are sensitive to stray magnetic fields and will easily pick up any induction hum from an unshielded—or partially shielded—power transformer in the vicinity. Therefore, always mount the spring unit as far from power transformers as possible, and protect it from

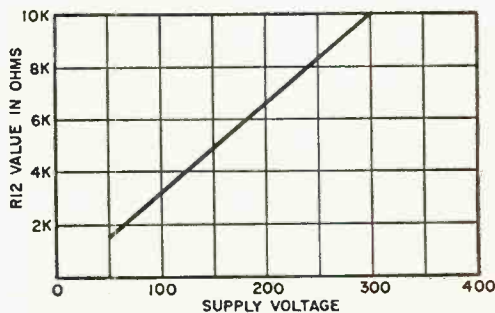

Fig. 6. To determine value of  $R12$  at high voltages, draw a vertical line from the voltage to the reference line, then go horizontally to locate the value.

any mechanical shocks. In some cases, it may be necessary to wrap the reverb spring unit in fiberglass, or build a cover over it, to prevent acoustic feedback from a nearby speaker.

To obtain reverberation, rotate potentiometer  $R13$  for the desired amount. When full reverb is used, it may have a "barrel" effect on voices. Some compromise will have to be made, as the best "sound" with music generally causes more echo on voice than most people like. And remember that too much reverberation can be disturbing, unless you are trying for novelty rather than realism. —30—



THE MYSTERY  
OF RADIO WAVES  
THAT  
TRAVEL ALONG  
OR  
BENEATH  
THE SURFACE  
OF  
THE EARTH

---

BY RUSSELL E. ADAMS, JR.

---

SUB-  
STRATA  
COMMUNICATIONS

**A**LTHOUGH it is not common knowledge, the history of electrical communications goes way back to 1748—predating Samuel Morse's invention of the telegraph by almost a hundred years. The actual credit for the first electrical communications system can go to Benjamin Franklin.

On a spring-like day in late April, 1748, Benjamin Franklin held a picnic along one bank of the Schuylkill River in Philadelphia. The guests present were entertained with a series of electrical demonstrations, the first of which was the firing of several guns—using an electric spark to ignite the charges. This was followed by the electric-shock-slaughtering of the turkeys for the picnic. The turkeys were, in turn, roasted over fires that had been kindled with another electric spark.

As the afternoon drew to a close, Benjamin Franklin requested a volunteer from among his guests. The volunteer was asked to place a hand on each of two metal plates that had been nailed to the top of a table. A wire, connected to each plate, terminated in the waters of the river.

Benjamin Franklin told his guests that an assistant was stationed on the opposite bank of the river with a similar apparatus, and that when a signal was given, the assistant would momentarily place a charged Leyden jar across the plates on his apparatus. The signal was given, and the volunteer immediately jumped away from the table—he had received a mild electric shock. The electric charge had traveled from one bank to the other solely through the medium of water.

This was the first demonstration of “ground communications,” but unfortunately, Benjamin Franklin did not realize the full implications of his discovery.

It was not until many years later that ground communications was to become known and successfully utilized.

**Ground communications**, as demonstrated by Benjamin Franklin, depends on a physical flow of current (termed "ionic charge carriers") through a conducting medium between the "transmitter" and the "receiver." A continuous conductive medium is required, so that the atmosphere—a non-conductive medium, to say the least—cannot be utilized to establish point-to-point ground communications.

Among the first experimenters with the ground communications phenomenon was Samuel F.B. Morse. On December 16, 1842, he transmitted code messages from one side of a river to the other without connecting wires. The diagram of his apparatus is shown below; note the similarity between the diagram and the description of Franklin's setup. Instead of a Leyden jar and human contact with the "receiver" side, Morse used batteries (*P* and *N* denoting positive and negative) and headphones, denoted by *E*.

Perhaps the earliest documented use



In diagram drawn by Samuel Morse, AB and CD represent opposite banks of a river; f, g, h, and i are copper plates (antenna); w indicates wires; and PN and E are batteries and headphones respectively.

of ground communications for transmitting *voice* messages dates back to 1902. In that year, Nathan Stubblefield, an inventor from Kentucky, broadcasted voice messages from the steamer *Bartoldi* to members of Congress on the shore of the Potomac River—a distance of about a half-mile.

**The military history** of ground communications had its beginning in the

early part of World War I. A French unit, trapped in the Argonne Forest by a strong encircling force of Germans, was running low on ammunition and needed reinforcements. But the encirclement was so complete that heavy losses would be the price the main body of French troops would have to pay to mount a rescue. The trapped unit, however, was in a position to observe the enemy forces. If up-to-the-minute and steady communications could be established, it could turn the tide of battle.

Fortunately, a signalman with the trapped unit had heard of ground communications. He constructed a "transmitter," using the field telegraph set and two bayonets driven into the ground about six feet apart. A runner was sent through the German lines with instructions for the French army to assemble a simple "receiver," consisting of two bayonets and a pair of headphones. The subsequent flow of tactical information coming from the trapped unit turned a nearly impossible situation into victory as the French army suddenly broke through the enemy lines.

When the audion tube was invented, the French learned that they could also use ground communications techniques to intercept German telephone messages. At that time, the German telephone system employed a single wire strung from station to station, with the earth as the return current path to complete the circuit. Two bayonets again became a pick-up antenna, and an audion amplifier and headphones were the receiver. The grounded connections at the German telephone stations served as the transmitting antenna electrodes.

Between World War I and about the mid-1950's, very little military research into ground communications was conducted. But private and government research was stimulated. During World War II, ground communications was utilized to a limited extent by radio amateurs who had been forced off the air to make the spectrum space available for military operations. The American Radio Relay League (ARRL), an amateur radio organization, conducted experiments with ground communications. The ARRL concluded, however, that ground communications was much less efficient than radio.



Then, in 1948, the U.S. Bureau of Mines began to experiment with ground communications transceivers in coal, iron, and salt mines. Primary communications were still relegated to the field telephone, but in cave-ins, where phone lines were often cut by falling rock, ground communications was intended to provide contact between rescue teams and the trapped workers. A great deal of success was achieved with this system.

Perhaps the first serious attempt by the U.S. Department of Defense to utilize ground communications began with the introduction of the nuclear submarine. Since the new submarines were designed and built for long-term, deep-water cruising, it was evident that the then current 50-foot maximum penetration depth of VLF communications systems would be inadequate. For a nuclear submarine to communicate via VLF, it would have to practically surface or release a floating antenna to receive radio signals, putting the submarine in a vulnerable position.

The Navy's first ground communications experiments with submarines were held at the Naval Air Station in Lakehurst, New Jersey. A dirigible was equipped with a ground communications transceiver. Antenna electrodes were affixed to the transceiver and dirigible in such a manner that they could be lowered into the water. The submarines were equipped with similar equipment.

In the beginning, the tests indicated that greater-than-fifty-foot depths could be achieved, but the transmission range was limited to a few miles—not enough to satisfy the Navy's needs. However, enough progress was made each year to keep the Navy interested. Whether such a system is operational at the present time is not known.

Two accidental discoveries were made by the Navy during this research. It was found that high-energy electrons oscillating from pole to pole generated about a 10-Hz signal that could be detected by the ground communications equipment, suggesting the possibility of using ground communications as a means of detecting atmospheric tests of nuclear weapons. It was also discovered that the system could be utilized to detect cruising submarines. (The electrolytic action of the sea water on the propeller and hull creates a d.c. field around the submarine, and as the propeller turns, the lubricant on the shaft produces an intermittent circuit. The resulting fluctuations in the d.c. field were easily detected.) While the situation that caused detection could easily be remedied, the potential of ground communications as an anti-submarine warfare weapon was demonstrated.

The Air Force became interested in ground communications techniques in 1958, during the height of the nuclear arms race. The ICBM's designed for de-

Radio waves from underground launch control center transmitter travel along earth's surface. Some of the energy is reabsorbed into the earth and picked up by underground launch site's receiving antenna.

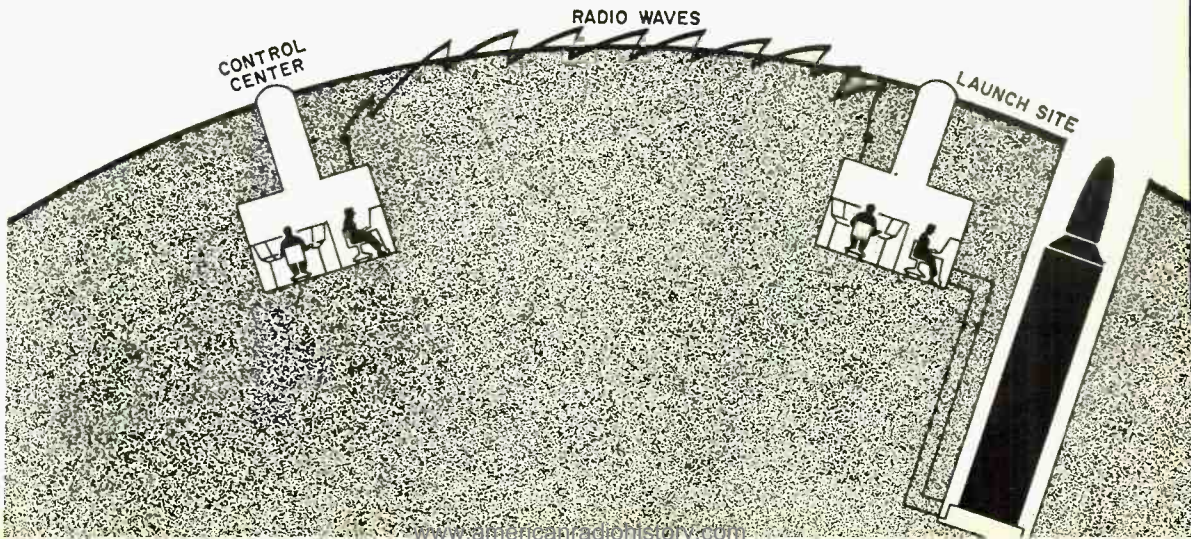

livering nuclear warheads to the targets had to be protected against destruction, so they were housed in "hardened" silos deep in the earth. This deep-earth silo setup gave rise to another problem—that of jam-proof communications.

In July, 1958, Space Electronics Corporation (now Space-General Corporation, a division of Aero-Jet General) was formed in California to investigate ground communications for the Air Force. Instead of ionic charge carriers, low-frequency radio waves were used to transmit the information from site to site. The system was based on a special application of the wave equations formulated by Drs. A. Sommerfield and J. Zenneck, wherein the angle of refraction of a radio wave can be controlled by the proper selection of frequency.

Space Electronics Corporation utilized this principle in its experiments at Newport Harbor, and later across the Glendale Grand Central Airport, both in California. The transmitter and receiver dipole antennas were buried less than 50 meters below the surface of the earth (the silo centers were much deeper). Radio waves from the transmitting antenna traveled toward the surface of the earth. The r.f. energy that was not reflected back passed through the earth/air interface, or barrier, and continued along the surface. As the wave front moved along the surface, it was constantly attenuated, and some of the energy was reabsorbed into the earth to be intercepted by the receiving antenna.

The system developed for the Air Force employed the "up-over-down" (UOD) technique. Signals generated by the transmitter were detected by VLF receivers placed only a few feet above the ground. The operating frequencies used for the tests were less than 200 kHz, and the maximum distance achieved was less than 50 miles.

In February of 1961, the UOD system was adopted by the Air Force as a means of providing underground communications between missile silos and launch control centers. At the present time, this system is employed at all Minuteman missile bases, reportedly saving some \$300,000 per missile.

**Another method** of ground communications, differing from the UOD system

in that radio signals are transmitted directly through the earth instead of along the surface, was developed next. Normally, a through-the-earth system would have a very limited range (less than a few hundred feet). If the antenna were placed only a few meters below the earth's surface as in the UOD system, the relatively high conductivity of the earth's crust would act like the metal shield of a coaxial cable, rapidly attenu-

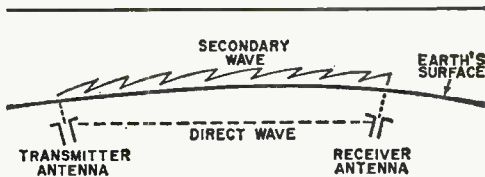

In the "up-over-down" system (above), the secondary wave is the primary transmission path. The direct wave, attenuated by the earth through which it passes, does not propagate very far. Drawing below shows details of UOD transmitting dipole antenna.

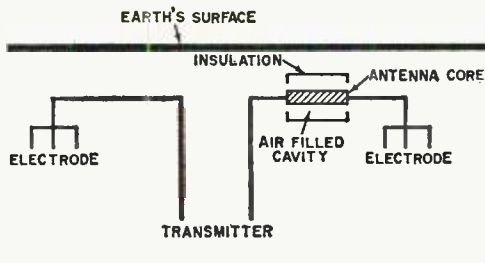

ating the signal. However, the companies involved (among them Raytheon and International Telephone and Telegraph) in the development of the new system employed the wave guide principle. The geological structure of the earth itself was used as a natural wave guide.

This geological structure has certain electrical properties that are quite similar to those in man-made wave guides. From the earth's surface to a depth of between 700 and 1700 feet, the "crust" of the earth is a relatively good conductor. Below this "crust" is a rocky layer (mostly non-conducting granite) that forms a part of the Precambrian "basement complex," the thickness of which varies between 3500 and 6500 feet. A third layer that forms a part of the earth's "core" and extends to a depth of  
(Continued on page 100)

# HOW TO USE GROUND COMMUNICATIONS\*

**I**F YOU WOULD LIKE to experiment with ground communications, the following explanation will guide you in setting up a transmit-receive system. Such a system can be of great help if you are practicing code with a friend while studying for your ham license. You can even tie in with other prospective hams and form a "Voices From The Earth" net.

The materials you'll need for a complete station are an audio amplifier (ten or more watts output), audio oscillator, CW key, microphone (optional), headphones, and a few grounding rods and wire. It may also be necessary to obtain an impedance-matching transformer, depending on the ground conditions in your locality.

Start off by rigging up your "transmitter." The ground electrodes should be placed as far apart as possible (100 feet or more is best, but if this isn't possible, the results will normally be acceptable anyway). The first ground should be a water pipe; connect a heavy cable to it via a suitable metal strap. The other ground connector should consist of as much metal as possible, buried as deep as possible, to provide optimum ground conditions.

Several grounding rods, connected in common, are better than one for the second ground electrode. Some sheet metal, buried

terminating the resistance, the output of your amplifier must be matched to the ground resistance. For example, the 16-ohm output tap will work fine for a 20-ohm ground. But if you have some odd value ground resistance, you might have to use an impedance-matching transformer as shown in the dashed-line box within the diagram. Almost any transformer with the proper turns ratio will do.

If, for example, your measured ground resistance is 24 ohms and your amplifier has only an 8-ohm tap, a 1 to 3 step-up transformer is needed. An old power transformer with a 360-volt secondary can be connected to the grounding rods; the 117-volt primary connected to the output of the amplifier will provide the proper impedance match. (When improvising matching transformers, check the actual power developed by the amplifier across the load. Measure the a.c. voltage across the grounds while the key is closed; then apply Ohm's law—voltage squared divided by resistance measured across the ground connections is equal to the power developed.)

The "receiver" grounding rods need not be as elaborate as those used for the "transmitter." Ten-foot-long rods, driven about 8' into the earth will suffice. Almost any type of headphones can then be connected from one "receiver" grounding rod to the other. Don't

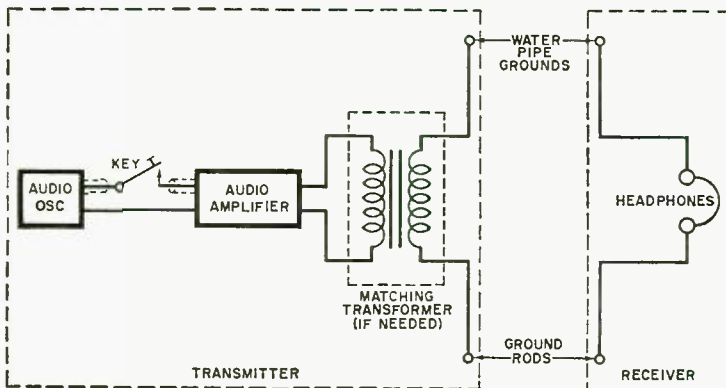

Matching transformer is needed only if difference between ground resistance and amplifier output impedance is more than 4 or 5 ohms. A microphone can be substituted for the audio oscillator if voice transmissions are desired.

with the grounding rods, will help. (Do not use the water pipes of two different houses for the grounds since they are shorted together by the neutral power line circuit.)

Use an ohmmeter to determine the resistance of your grounding system. When measuring the resistance, be sure to switch the meter leads and take the average of the two readings obtained.

After installing the ground system and de-

use the same ground rods for both the "transmitter" and "receiver."

By connecting a microphone to the input of your amplifier instead of an audio generator, you can transmit voice messages. The range of such a setup is very limited, and a high power amplifier will be required if you want to transmit over a few city blocks. In any case, try the microphone; if it works adequately, it will give you a means of checking your code practice sessions without having to trot back and forth with voice messages.

\*Based on "Communicating Through The Earth" by J. C. Fischesser (POPULAR ELECTRONICS, July, 1960).



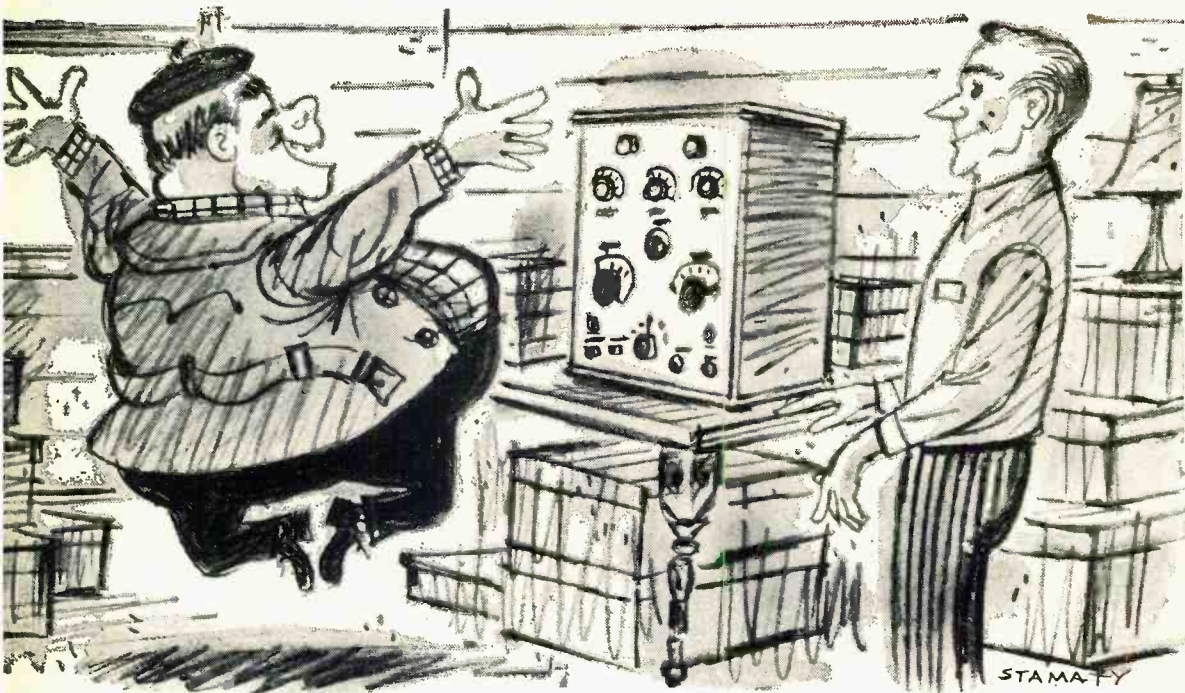

# *“That Old Regenerative Set of Mine”*

---

OR, NEVER THROW  
ANYTHING AWAY,  
IF YOU CAN HELP IT

---

BY FRED E. EBEL

**I**T WAS pure coincidence. I was hunting for a power transformer in the storeroom when I came across my old regenerative receiver. What fond memories of the 500-kHz band it evoked. I

just had to hook it up to see if the old squealer still worked.

I rummaged around, found the old “B” battery eliminator. In another corner of the room was an old storage battery I’d used for the filaments.

Ten minutes later, I turned on the switch, and—Happy Day!—it worked. The heterodyne squeals were sweeter than hi-fi to my nostalgic ears. Even the spill-over feedback howls were a delight—and that’s when fate conspired to change my way of life.

The windows were open—since it was a warm Saturday afternoon—and the set had just finished an unearthly howl. At this moment I heard the squealing of brakes outside, a thump-thump like a

lumbering elephant, then door chimes.

When I opened the door, I beheld a blimp of a man. Atop the blimp was a bright red beret. Behind the blimp, in the street, was a fire-engine red sports car.

The blimp spoke excitedly, "I must have it! I must have it!"

I looked around for some suitable weapon. "Just what is it you must have?" I asked.

"That beautiful bloodcurdling sound. I must have it for my picture."

"Your picture?"

"Yes, my picture. Don't you know me? I'm Franz Von Schloggen, the movie director."

**Von Schloggen, the movie director!** Of course I'd heard of him. Who hasn't? It was the great Von Schloggen who directed the spine-chilling *The Slime That Oozed In the Night*. And it was the fabulous Von Schloggen who made the country shudder with *Doctor Weirido's Garden of Ghouls*. Now this genius, this wizard of horror and science-fiction movies, was talking to me—an ordinary guy whose hobby was electronics.

I unlatched the door and he barged in.

"Where is it?" he demanded. "It will be just the sound for *Son of Transistor Man*."

But when I showed him the regenerative receiver, his face fell. Pointing a stubby finger at the relic, he queried in disbelief, "This old thing made that bloodcurdling sound?"

I nodded. "It's a regenerative receiver I made about 30 years ago. You see, a part of the voltage in the plate circuit is fed back to the grid. I can get more feedback by varying this tickler coil. If I get enough feedback, the set oscillates. Then I zero-beat the incoming signal and—" I stopped as I noted his disappointed look. "I suppose your sound specialists have more sophisticated equipment."

"I want to hear that sound," he said. "That *yowl-l-l-l!*"

I threw the set into the feedback howl that had captured his interest.

The effect was magical. "That's it! That's it!" he shouted. "I know just where to put it. When the son of Transistor Man is born, the doctor slaps his rear chassis and the baby makes this sound."

He jumped up and down. "It'll make the picture. I must have it. How much?" He extracted a wallet that looked like a portable Fort Knox.

I looked at the roll of bills, coughed. "Would—would ten dollars be too much?"

"Here," he said, peeling off a hundred dollar bill. "Bring it to Monster Studios Monday morning. Be there at six, ready to work."

"Ready to work?"

"Of course. You know this equipment best. You must operate it."

"But I have a—"

He held up a pudgy hand. "Whatever you're making now, we'll double it."

**And that's how I became** Special Sound Effects Man at Monster Studios. Maybe you've heard some of my work.

There was *A Man Called H2O* in which I had a watery monster talk like water if water could talk. What I did was make a recording of bubbling water, and I modulated the water sound track with a human voice.

And then there was *The Transistorized Werewolf*. I made a recording of a wolf howl and mixed it with the howl of my regenerative set. The result scared even me. Movie critics acclaimed it as "the sound that gave America insomnia."

I was most proud of *The Five Headed Monster from Planet Beta*. This was a real challenge. But I solved it, thanks to CB radio. What sounds like five heads talking at once? QRM, of course? I simply mixed five voices, threw in a handful of CB heterodynes, and I had it.

And Von Schloggen is greater than ever. Good man that he is, he attributes much of his fame to my sound effects. But I think he goes overboard so far as my old regenerative receiver is concerned. He insists that an armed guard place it in the vault every night. -50-



# POPULAR ELEComics



"Sorry, Mac . . .  
that machine's on the blink"



"Horace! . . . I told you to stay away  
from that CB crowd."

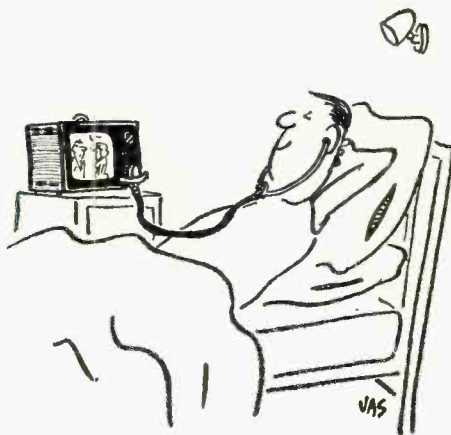

# Who's Afraid of the SCR?

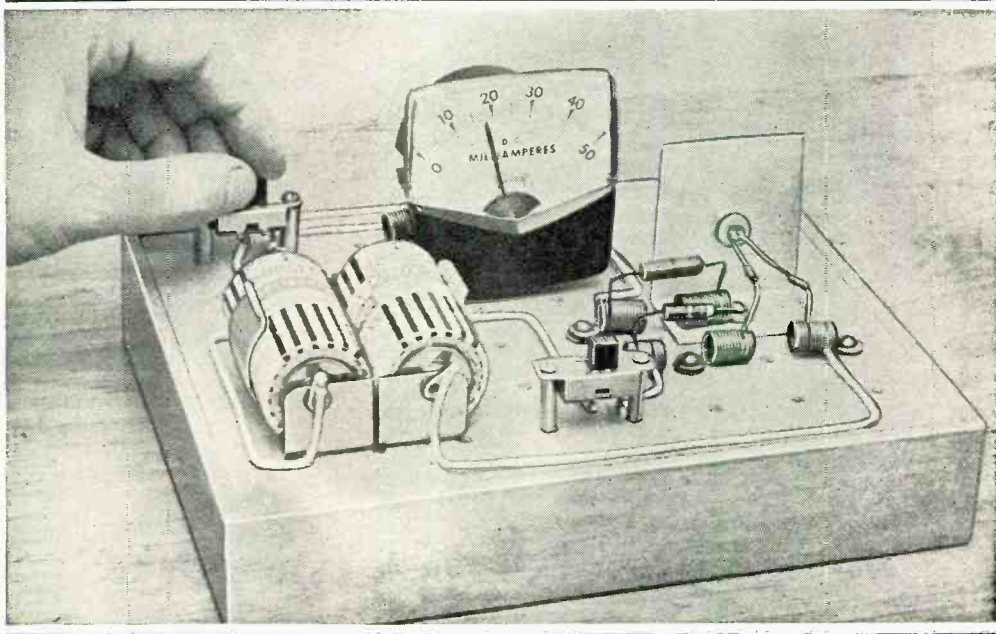

## AN APPRECIATION OF THE UBIQUITOUS SILICON-CONTROLLED RECTIFIER

BY A.A. MANGIERI

**T**HE silicon-controlled rectifier (SCR) is rapidly becoming one of the most useful of semiconductors. Why? Because the SCR can efficiently and smoothly control relatively large amounts of a.c. power required by a load without wasting any power within itself. This makes the SCR ideal for controlling motor speed, light dimming, etc., as the amount of electronic circuitry required to operate the SCR (plus the SCR itself) is usually far smaller than for any other type of power reducer.

You may possibly have built one or more projects containing an SCR, but you may not know exactly how an SCR works. This article will present some basic facts about SCR's together with a test circuit and some measurements that will help you to become familiar with their actions and usage.

**SCR Basics.** The SCR is a *pnpn* semiconductor based on silicon technology (germanium has been used in some ex-

perimental SCR's, but these are not yet commercially available) having an anode, cathode, and gate as shown in Fig. 1. This illustration also shows a conventional *pn* rectifier diode. Both are rectifiers that can convert a.c. to d.c. However, the SCR has one unique characteristic—it will only pass current when its gate is pulsed, and will cease conduction only when its anode voltage drops to zero. Once conducting, the gate no longer has any control over current flow.

In a way, the SCR is like a special type of *on-off* switch. When *off*, the SCR prevents current flow in *both* directions. When *on* or *fired*, the SCR passes current only in the forward direction (like any other diode).

How is the SCR switched *on*? Simply by applying a relatively low-level gate triggering voltage (or current) that is positive-going with respect to the SCR cathode. Even a momentary voltage pulse will do it, because once the SCR fires, it stays *on*.

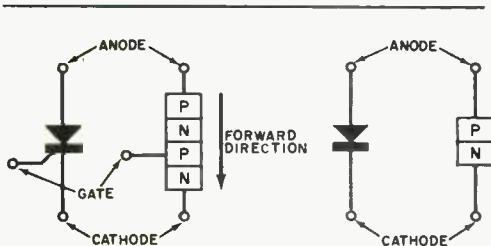

Fig. 1. Circuit and semiconductor diagrams of SCR (left) and ordinary diode (right). Both rectify.

How, then, is the SCR switched off? This occurs automatically whenever the SCR anode voltage is reduced to zero (as it would be on each sine wave of a.c. power), or when its anode is supplied with a negative voltage (like the negative half-cycle of each a.c. waveform). It will also snap itself off whenever the load current is interrupted or reduced to some very low level even for an instant.

(The above explanation should sound familiar to vacuum-tube enthusiasts, because this is exactly the way a thyatron works. All you do is substitute "control grid" for "gate.")

Turn-on and turn-off time is very fast. For example, a typical SCR will switch on in half a microsecond (half a millionth of a second), while switch-off time is about 12 microseconds.

How does the SCR simultaneously rec-

tify the a.c. to d.c., and permit variation in the amount of current reaching the load? The secret is to use a gate voltage supply circuit which not only turns on the SCR during each and every positive-going cycle of the applied a.c. voltage, but also permits *varying* the exact moment of turn-on within each positive half cycle.

**Test Circuit.** You can put together the test circuit shown in Fig. 2 using any SCR rated at one-half ampere or more, and having a reverse breakdown voltage rating of at least 250 volts. Although an oscilloscope is required to observe the waveforms within the circuits, Fig. 3 will serve as a substitute for the purposes of this article. Use a 1:1 line isolating

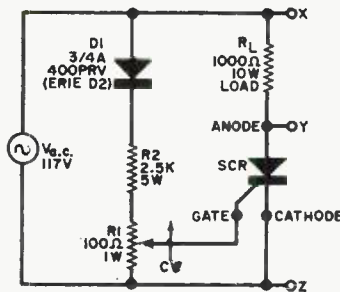

Fig. 2. This elementary half-wave test circuit can be used to demonstrate basic operation of an SCR.

### ADVANCED SCR INFO

As shown in the SCR voltage-current characteristic curve at right, a narrow, elongated portion (A to B) acts as a voltage barrier, preventing current flow through the SCR. The forward voltage at point B is called the forward breakover voltage ( $V_{FOM}$ ). This value is larger than the reverse breakdown voltage rating ( $V_{ROM}$ ) at point C.

To prevent damage to the SCR, the peak value of applied voltage must not exceed the reverse voltage breakdown rating. With the SCR off, the elongated voltage barrier acts as a block to the forward voltage applied to the SCR anode, while the reverse characteristic of the semiconductor acts to block the negative voltage, just like a conventional rectifier diode. No current can pass through the SCR in either direction.

When a positive voltage is applied to the gate of the SCR, the elongated portion (A-B) is removed and the positive half-cycle gets through the SCR. Turn-off is automatic when the current flow through the device drops below point X—the "hold current" value.

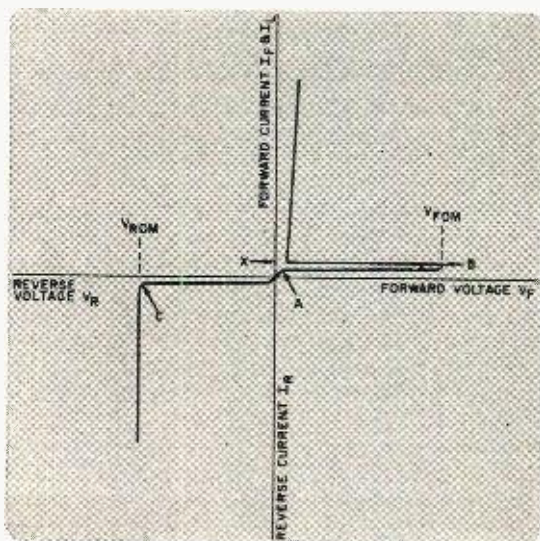



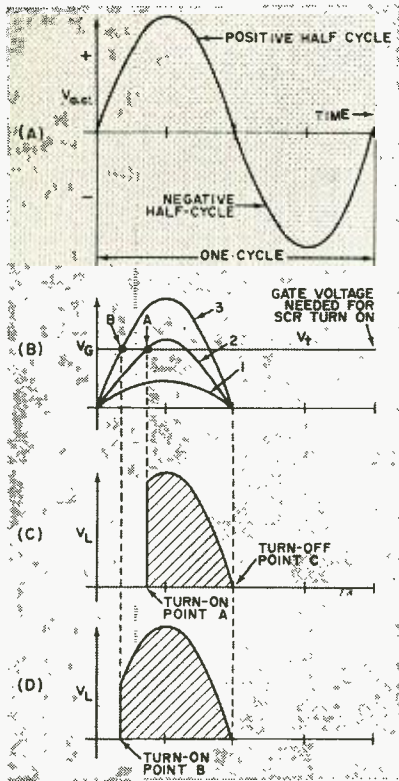

Fig. 3. These waveforms should be seen on an oscilloscope connected to the test circuit. See text for explanation of A - D.

transformer to obtain the 117 volts a.c. required for the test circuit.

Connect a VOM or VTVM (on the 100-volt or more d.c. range) across terminals "X" and "Y." If you wish, a conventional 117-volt, 15-watt (approx.) light bulb can be used in place of the meter for visual indication of the output voltage.

Connect the scope ground lead to point "X," and the scope vertical input lead to point "Z." With power applied to the test circuit, adjust the scope sweep and sync controls to display two to four stationary cycles on the screen. Then shift the scope vertical input lead to point "Y."

Adjust potentiometer *R1* to set the gate voltage at zero (completely counter-clockwise). Observe that both the scope and the output indicating device show no load current and voltage. The SCR is completely off.

Gate circuit diode *D1* rectifies the applied a.c. voltage and produces a half-wave d.c. voltage across resistor *R2* and potentiometer *R1*. A waveform similar to waveform 3 in Fig. 3(b) should be seen between the junction of *R1* and *R2* and point "Z." The waveform (and voltage) at the rotor of *R1* is zero, and, as the rotor is moved towards the *R1-R2* junction, the waveform and voltage increase as shown in waveforms 1 and 2 of Fig. 3(b). In Fig. 3(b), the voltage level marked *V<sub>t</sub>* is that voltage required to turn on the gate of the SCR. As *R1* is advanced, the a.c. first reaches point "A." At this point, the SCR fires (turns on) and the output waveform then looks like Fig. 3(c). Note that the SCR turns itself off when the applied a.c. waveform reaches zero on its cycle.

When *R1* is advanced further, the SCR is turned on earlier in the cycle (reaches point "B") and the resulting waveform remains on longer as shown in Fig. 3(d). Observe then, that the earlier the SCR is turned on during each cycle the more power is available at the output. This is shown by an increase in the meter reading (or brightening of the bulb), and a larger area of the sine wave as seen on the scope.

**Measurements.** The triggering voltage and current required to turn on a SCR can be measured using the circuit shown in Fig. 4. In this circuit, a d.c. source

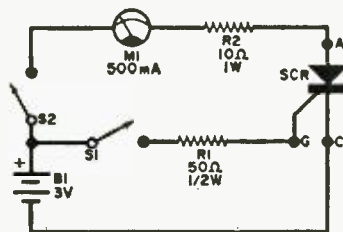
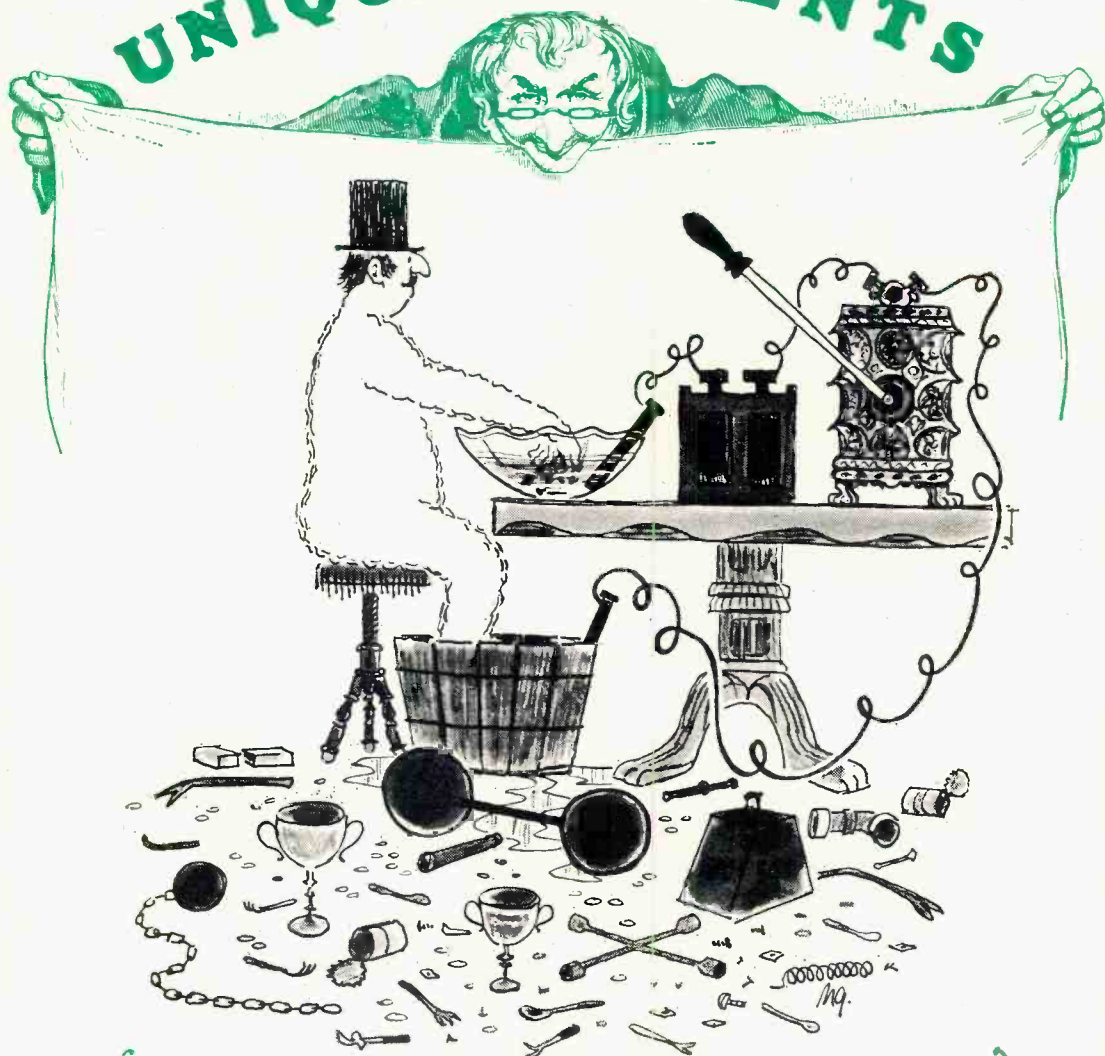

Fig. 4. D.c. test circuit that is used to determine amount of gate voltage required to trigger an SCR.

(*B1*) is substituted for the a.c. source used previously. Open both *S1* and *S2*, then close *S2*. The SCR will be off and *M1* should not indicate any current flow. Now close *S1*. The SCR will snap on and meter *M1* will indicate about 100 to 200  
(Continued on page 98)

# UNIQUE PATENTS



## Process For Extracting Metal From Living Bodies

Invented by Thomas M. Clague

Patented Jan. 5, 1915—No. 1,123,683

Do you have to be degaussed before watching color TV? Do you have iron-rich blood, or do compass needles point at you, and has the hardware store owner refused to let you in the door? If so, this invention might be worth a try. The apparatus consists of two pails of briny water, a 20-volt d.c. source, two electrodes, and a rheostat. Place your bare feet in the pail of water on the positive side of the battery, your hands in the other. Adjust the rheostat to obtain desired effects and carefully examine the pail on the negative side of the battery for metallic poisons.



Fig. 1. A nibbling tool trims, notches, or cuts up to 18-gauge steel, 1/16" aluminum, and all types of plastic PC boards.

# CUTTING, PUNCHING and DRILLING of Printed Circuit Boards

WORDS OF ADVICE  
FROM A PROFESSIONAL  
TOOLMAKER, SO YOU  
WON'T BOTCH THE JOB

BY ALF ADEL, W9CDB\*

\*Adel Tool Co., 4640 Ronald St., Chicago, Ill.

January, 1968

ONE OF THE BIGGEST headaches for most electronic experimenters is the cutting and drilling of printed circuit boards, or other similar sheet plastic materials. Most PC boards are fabricated from a paper-base, thermosetting phenolic resin, making them soft and brittle, and therefore susceptible to cracking and tearing unless handled properly. However, such problems can be reduced, or even eliminated, by the use of proper tools and techniques.

The following paragraphs will tell you what tools are best to use for cutting, drilling, and punching PC boards, and which tools should NOT be used for these purposes.

**Cutting.** Sheet metal snips should NEVER be used to cut PC boards. Their shear angle is too great, and the use of this tool would only result in rough, ragged edges, and possible damaging or cracking of the board.

Most sheet metal power shears will cut PC boards. However, any excessive angle of the shear blade will rip the material along the cut edge. This happens because the shear blade bends the material downward at the shear point, literally



tearing the two segments apart. If you want to use power shears, the cutting angle **MUST** be corrected first. If this does not do the trick, try heating the PC board slightly before attempting to shear it. Do **NOT** try to shear thermoplastics, such as polystyrene, acrylics, etc., as they will *always* crack.

ground for cutting metal and usually will dig in and rip through the bottom of the hole when you're drilling through plastic. This is due to the rake angle at the cutting edge (lip) of the drill. See Fig. 2(a).

You can modify a few twist drills for drilling plastics by flattening out the rake angle. This will destroy the twist drill's

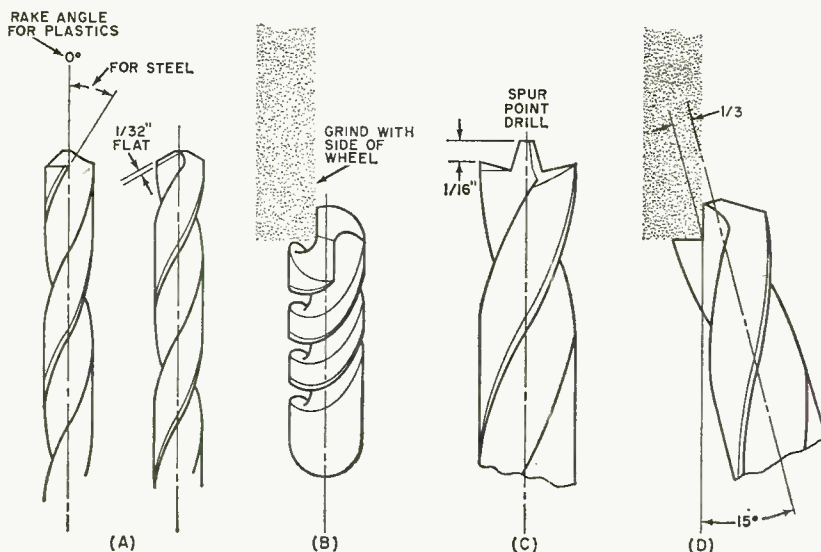

Fig. 2. Drilling neat holes in plastic is simplified if you modify some commonly used metal twist drills as shown here and explained in the text. You can reduce the rake angle of a drill to zero by grinding a  $\frac{1}{32}$ " flat (a) across the cutting edge on both sides as shown in (b). A spur-point drill (c) can be made from a conventional metal drill as shown in (d). These drills cannot be used on metal once they are modified.

Although a saber saw, or hacksaw, is **NOT** recommended for cutting a PC board, a metal-cutting bandsaw having at least 18 teeth per inch can be used. The copper foil side of the PC board should be up during the cutting operation or the foil may peel away from the base during the cutting.

Probably the best way to cut a printed board is with a nibbling tool. Nibbling is a punch-and-die method of taking small "bites" out of the plastic, thus eliminating the possibility of fracture (cracking) of the board while the punch takes the small bites. This method, shown in Fig. 1, also prevents the copper foil from peeling away from the phenolic base.

**Drilling.** Using a conventional twist drill to make holes in any type of plastic material (including PC boards) can be a problem. An ordinary twist drill is

usefulness for drilling metal, but the advantage gained in clean drilling through plastic will more than compensate for the investment of a few drills.

To flatten the rake angle, you'll need a high-speed grinding wheel. Clamp the twist drill so that the cutting edge can be very carefully pushed in toward the right-hand side of the grinding wheel as shown in Fig. 2(b). Grind a  $\frac{1}{32}$ " flat across the sharp cutting edge—in other words, reduce the rake angle from about 15 degrees to zero degrees (parallel to the long axis of the twist drill). Be sure to flatten both cutting edges.

To drill holes in PC boards larger than  $\frac{3}{8}$ ", a spur-point twist drill is called for. These drills are not too common, but you can modify an ordinary twist drill to do the same job. Here, again, a high-speed grinding wheel is needed. In this case, the tip of the ordinary twist drill

will be cut away to create a spur-point drill as shown in Fig. 2 (c). You do this by clamping the twist drill at an angle of about 15 degrees to the grinding wheel, with the cutting edge in line with the horizontal axis of the wheel. See Fig. 2(d).

Hold the drill against the wheel and grind away the old cutting edge, except for the one-third center part, to form a spur. Do the same thing on the other side of the drill, making sure that the same amount is removed from each side of the center. The center will extend about  $\frac{1}{16}$ " above the spurs, and becomes the pilot that will guide the drill. If the pilot is not exactly in the center of the drill, gently grind the high side down using the side of the grinding wheel.

To sharpen this drill, hold it exactly in the same manner used to make it originally. With the grinding wheel operating, rotate the drill clockwise about 30 degrees as you gently grind. Start each grind with the cutting edge horizontal and lift upward as you rotate. This will provide about 10 degrees of clearance at the rear of the cutting edge and the pilot.

You now have an excellent sheet-metal drill. To make it useful for plastics, grind a flat on the spurs as shown in Fig. 2(b).

**Punching.** Printed circuit boards can be cleanly punched by using a punch and a backup plate with matching punch/plate-hole diameters. If the hole in the backup plate is larger in diameter than the punch, many break lines, cracks, and splits will appear, as shown in Fig. 3(a). When the punch and plate hole have the same diameter, the break is clean and vertical through the material, the board will not crack, and a clean slug of material the same size as the hole will be punched out. See Fig. 3(b). This is the principle of the nibbling tool shown in Fig. 3(c).

A useful punch plate can be made as shown in Fig. 3(d). The lower plate acts as a back-up plate (die) for the material. A spacer and a couple of nuts and bolts secure the two plates together and keep them aligned. Drill various size holes through the two plates to accommodate a variety of punch sizes.

When using a punch, keep the tool at least one punch diameter away from the edge of the material.

Whenever cutting, drilling, or punching plastic materials, always use a *sharp* cutting tool to reduce friction heating—one of the main causes of cracking and tearing.

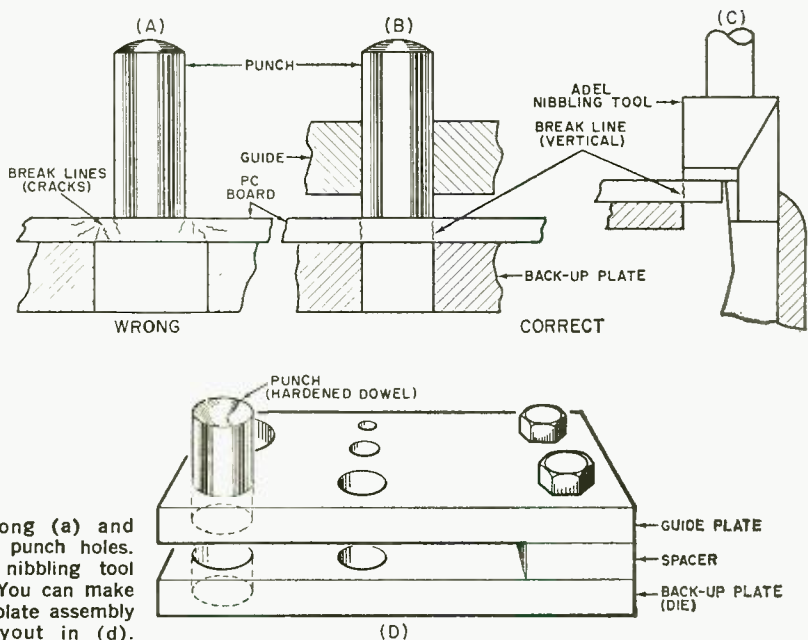

Fig. 3. The wrong (a) and right (b) way to punch holes. Operation of a nibbling tool is shown in (c). You can make your own punch plate assembly by following layout in (d).





# A Baffling Quiz

BY ROBERT P. BALIN

Speaker enclosure designs differ mainly in the way they employ baffles, ports, tubes, columns, ducts, and horns to control the sound radiated from the front and back of the speaker. To see how much you are baffled

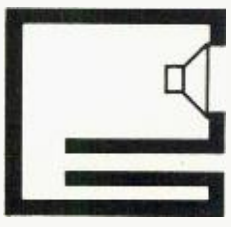
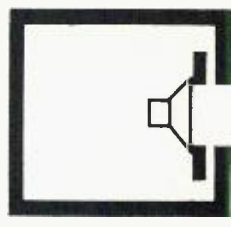
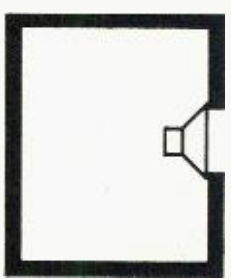
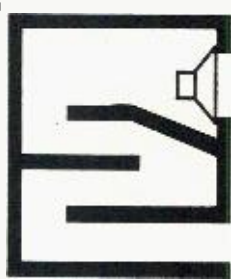
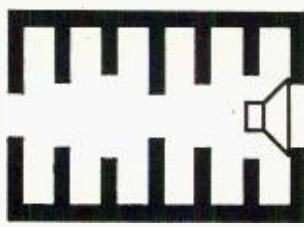
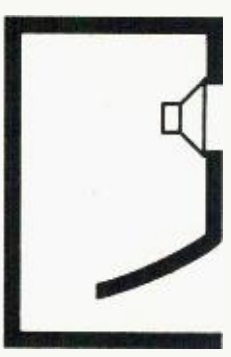
by enclosures, try matching the cross-section drawings (A-J) of commonly used enclosures with the names by which they are known (1-10).

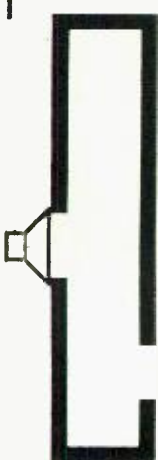
(Answers on page 116)

<p><b>A</b></p> 	<p><b>B</b></p> 	<ol style="list-style-type: none"> <li>1 Acoustic labyrinth _____</li> <li>2 Air coupler _____</li> <li>3 Baffle _____</li> <li>4 Ducted-port phase inverter _____</li> <li>5 Folded horn _____</li> <li>6 Helmholtz resonator _____</li> <li>7 Horn-loaded reflex _____</li> <li>8 Infinite baffle _____</li> <li>9 Klipschorn _____</li> <li>10 Resonant column _____</li> </ol>	
<p><b>C</b></p> 	<p><b>D</b></p> 	<p><b>G</b></p> 	
<p><b>E</b></p> 	<p><b>F</b></p> 	<p><b>I</b></p> 	<p><b>J</b></p> 
<p><b>H</b></p> 			



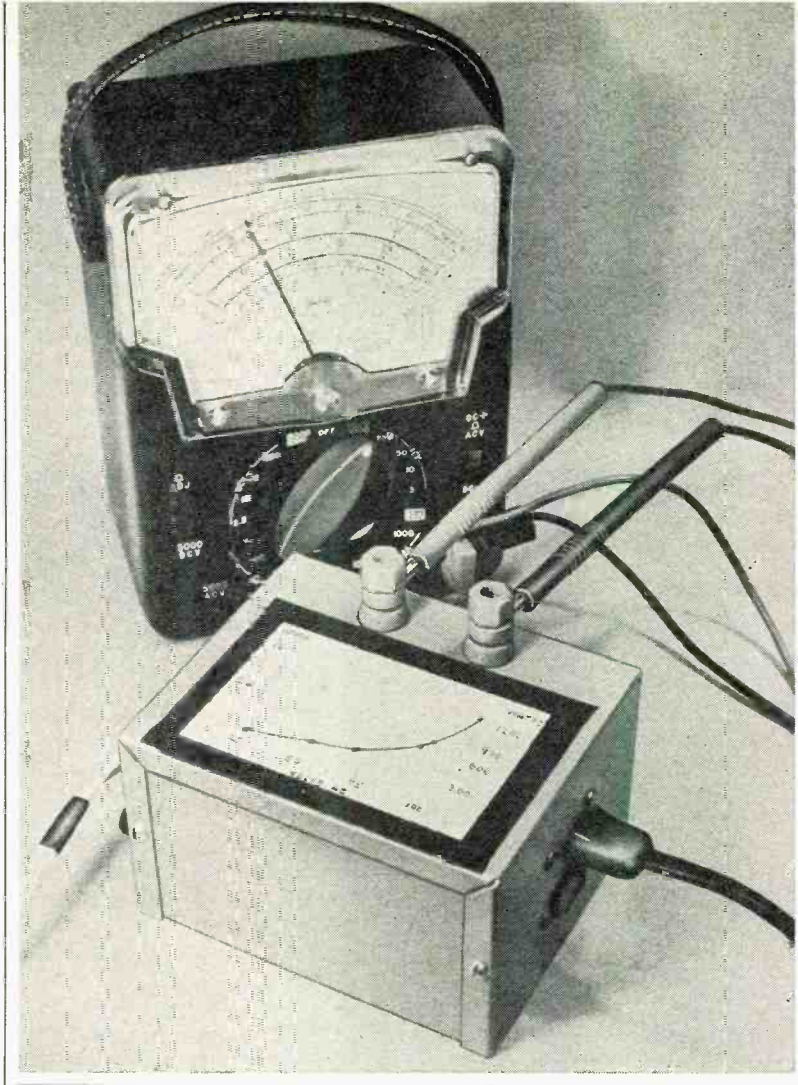

## ***Measure A.C. Amps & Watts with Your VOM***

BY NEIL JOHNSON

YOU CAN USE ANY  
FILAMENT TRANSFORMER  
IN MAKING LOW-COST  
1200-WATT ADAPTER

**F**EW EXPERIMENTERS have facilities to measure the wattage or alternating current drawn by a piece of electrical or electronic equipment. The question of how many watts a certain piece of gear draws during operation goes unanswered. The main reason for this situation is that a broad-range a.c. ammeter or wattmeter is expensive.

However, most experimenters own a multimeter—VOM or VTVM. With the

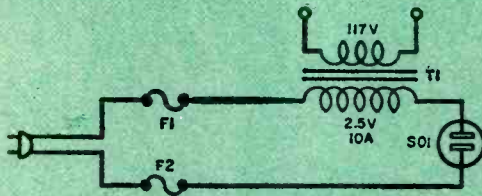

Fig. 1. Don't let simplicity of circuit fool you; it does a good job. Almost any filament transformer can be used as explained in text.

### PARTS LIST

- F1, F2—10-ampere fuse*  
*SO1—A.C. outlet*  
*T1—Filament transformer: primary, 117 volts; secondary 2.5 volts, 10 amperes (Allied Radio 54 B 3711 or similar—see text)*  
*Misc.—A.C. line cord with plug, feedthrough grommet, binding posts (2), fuse holders (2), suitable chassis, test jig—see text*

addition of a low-cost filament transformer, and a few other parts, you can convert your VOM into an a.c. ammeter or wattmeter. The ammeter adapter to be described here will enable your VOM to measure from an ampere, or so, to over 10 amperes a.c., or from a couple of watts to over 1000 watts.

**Construction.** Although the transformer specified in the Parts List for the adapter has a 2.5-volt, 10-ampere sec-

### HOW IT WORKS

The heart of the adapter is a conventional filament transformer booked up "backward." When a piece of gear is plugged into *SO1*, current proportional to the wattage of the load will be drawn through the low-resistance, low-voltage winding. This will induce in the 117-volt winding of the transformer a voltage that can be easily measured. The higher the voltage, the greater the current being drawn by the load.

There is a bonus with this type of current measurement. As the load applied to *SO1* is increased, there will come a point where the transformer core will saturate. This effect produces nonlinear output readings with the result that a larger meter scale differential exists between currents at the low end of the scale, and smaller at the high end. For example, a 1-ampere change at the 2-ampere point will move the multimeter needle a greater distance than a 1-ampere change at the 8-ampere point. This is desirable because, in the first case, the change is a significant 50%, while in the second case, the change is only 12½%. In essence, this is a form of "expanded scale" metering.

ondary winding, you can use almost any filament transformer you happen to have at hand provided that the low-voltage winding can carry the current range you want to measure. For example, a 5-volt, 6-ampere filament transformer can be used if the load current being measured does not exceed six amperes (at 117-volt nominal line voltage, this amounts to about 702 watts). The only requirement, other than current-carrying capability, is that the filament winding have a low

Fig. 2. Actual-size graph that can be copied (without the sample curve) and glued to your metal cabinet. The calibration curve for the transformer you use can then be plotted and drawn in for future reference.

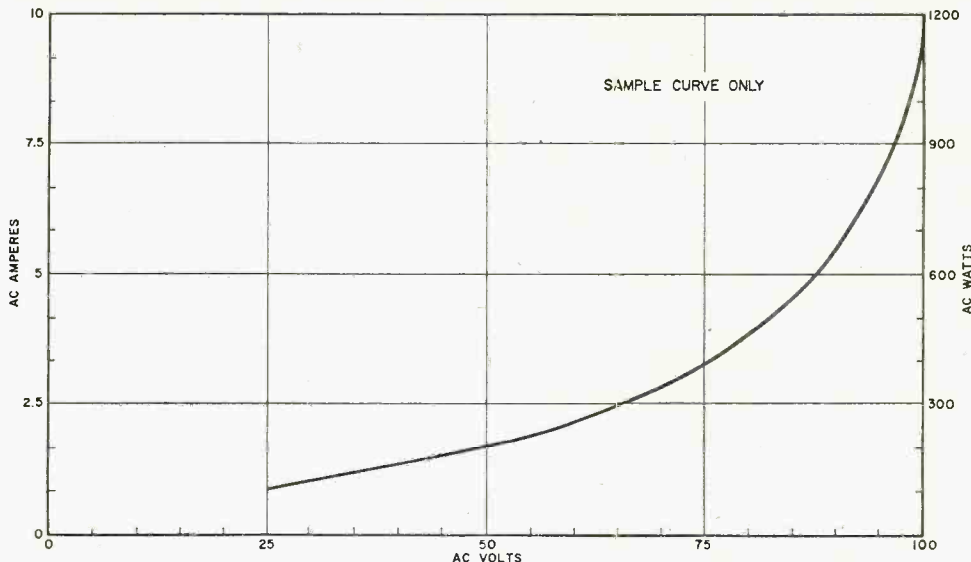

voltage rating so as not to introduce an excessive voltage drop and distort the true wattage reading.

The schematic in Fig. 1 and the photo show one method of construction. (Almost any method will do.) Transformer *T1* is mounted within the metal box, the two input fuses (*F1* and *F2*) and a.c. line cord protrude from one end, while the a.c. outlet (*SO1*) is mounted on the other end. The multimeter binding posts,

trical screw-in candelabra lamp sockets. Wire these sockets in parallel to a length of ordinary lamp wire terminated with a conventional electrical plug. Mate this plug with *SO1* on the ammeter adapter, then connect your VOM (set to its highest a.c. range) to the binding posts. Plug the adapter into the power line.

Start the calibration by inserting a low-wattage lamp into one of the sockets on the test jig. Adjust the VOM a.c.

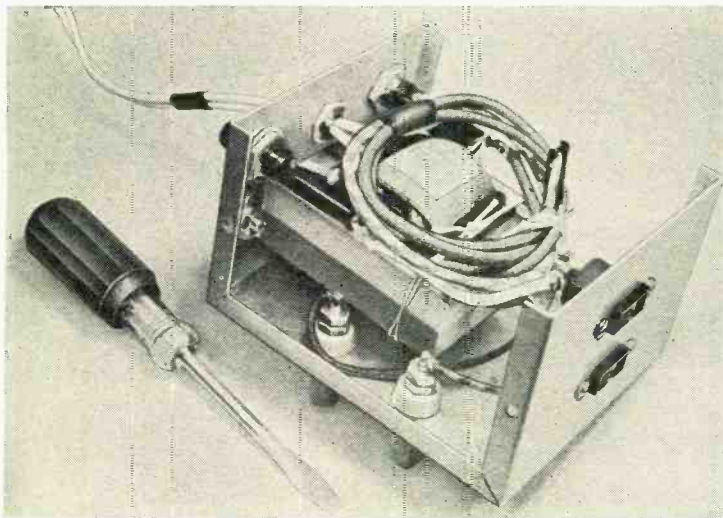

In the author's version, the filament transformer, two fuse holders, and the line cord grommet are on one wall, the output binding posts are on the middle wall, while a pair of a.c. sockets are mounted on the third chassis wall. Layout is not critical; any other will do as well.

and the meter calibration graph, are affixed to the top of the box.

**Calibration.** Temporarily make up a test jig consisting of four conventional elec-

Bulbs of various wattages are used to create a wide load variation. Be careful of exposed line wiring.

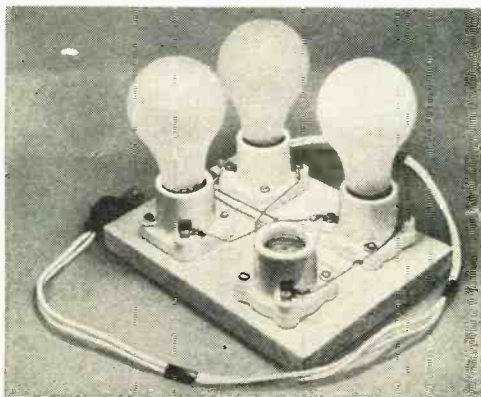

range switch until an easy-to-read indication is found on the meter scale. Record this value and the wattage of the bulb. Various wattage lamps, or combinations of lamps, can be inserted into the sockets of the test jig to produce a range of wattages.

As necessary, change the a.c. voltage range switch on the VOM. The wattages that produce the meter indications should be recorded. If electrical appliances are used for the very high wattages, remove the test jig plug from the adapter, and insert the appliance plug. These appliances usually have a nameplate calling out their wattages.

**Calibration Curve.** After a sufficient number of readings have been recorded, make up a calibration curve as shown in the graph (Fig. 2). To convert wattage

(Continued on page 100)



# Throw Together A "Quintupler"

SHUNT  
UPS RANGE  
OF  
YOUR  
MILLIAMMETER

BY FRANK H. TOOKER

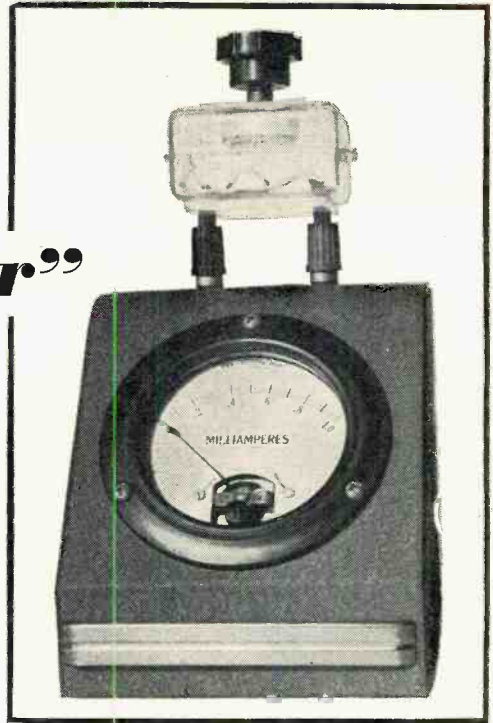

**H**OW OFTEN has the pointer of your milliammeter been deflected off scale because the current through the meter was slightly too high? What did you do? Change meters or give up because you didn't have a suitable meter at hand? If your measurements can tolerate a modest inaccuracy, you need a "Quintupler."

The "Quintupler" is nothing more than a simple variable shunt that you temporarily place across the milliammeter. The shunt is made up of two resistances: a potentiometer ( $R1$ ) equal to, or slightly greater in value than, the internal resistance of the meter movement; and a fixed resistor ( $R2$ ) with a value of about 10-15% of the potentiometer's resistance.

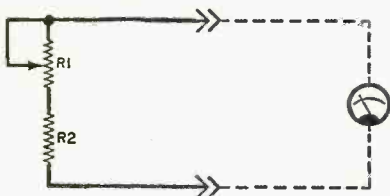

Values of potentiometer  $R1$  and resistor  $R2$  depend on the internal resistance of the meter movement.

For example, if the meter has an internal resistance of 100 ohms, the potentiometer should also be 100 ohms, and the resistor between 10 and 15 ohms.

The following discussion assumes that your meter is a 0-to-1 mA unit; however, the same procedure applies to all current-measuring meters. Before using the variable shunt, adjust the current amplitude through the meter movement only for full-scale deflection. Plug the shunt into the meter's inputs, leaving the power connected. Now adjust the potentiometer so that the meter pointer deflects to 0.5 mA to obtain an  $X2$  range. For the  $X3$ ,  $X4$ , and  $X5$  ranges, adjust the potentiometer so that the meter pointer deflects to 0.33 mA, 0.25 mA, and 0.20 mA, respectively. The  $X1$  range is obtained with the variable shunt out of the circuit. Record pot position for each range.

This setup allows you to measure up to 5-mA current amplitudes with only a 0-to-1 mA meter movement. Using a greater than five times multiplication factor for any given meter movement is not recommended since beyond this point the adjustment of the potentiometer is too critical.

-30-

# Slave Driver

LIGHT-ACTIVATED  
DEVICE ADDS  
A NEW DIMENSION  
TO AMATEUR  
PHOTOGRAPHY

BY A.J. LOWE



**A**MATEUR PHOTOGRAPHERS frequently rely on a single flash gun or strobe light to provide adequate lighting for their home photo sessions. Professional photographers, on the other hand, often employ a multiple flash technique to "fill in" and obtain more uniform lighting. One or more slave flash units are wired or interconnected to a master flash (camera-shutter-controlled) unit, and the master and slave units must be synchronized with the camera's shutter. This is usually done via long dangling cables, but if you build the "Slave Driver," you will eliminate the need for interconnecting cables between the master and the slaves.

When you trip the shutter on your camera, the master flash unit fires and the bright flash in turn triggers the slave or slaves—through the light-sensitive circuit of the "Slave Driver." Flash guns and strobe lights can be used compati-

bly (except for color balance) in your photo sessions since the reaction time of the Slave Driver is in milliseconds. The Slave Driver consists of five small parts that can be housed in a compact, lightweight container. A single hour of construction time is all you need to build this unit and give your photos that professional look.

**Construction.** Parts layout is not critical except that the light-sensitive end of *LDR1* (see Fig. 1) must be in the open so that it can "see" the master flash unit. The prototype was built into a 2½"-long by 1½"-diameter plastic container with twist-on cap. A piece of phenolic board, cut to fit across the center of the container, divides the interior of the container into two compartments. One compartment is for AA cell *B1*, the other for the remaining parts.

Small bolts provide mechanical sup-

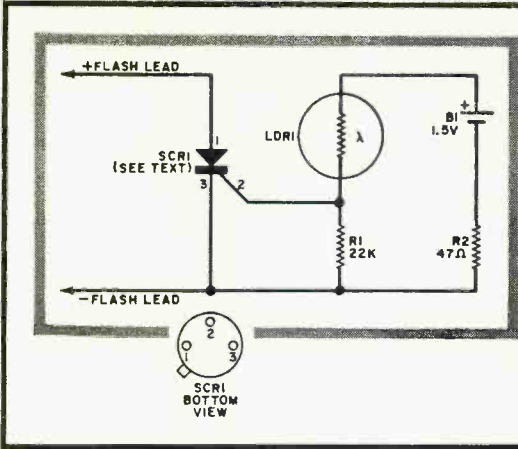

### PARTS LIST

- B1—1.5-volt battery (AA cell)
- LDR1—Light-dependent resistor (Clairex CL605-L, or similar)
- R1—22,000-ohm, 1/2-watt resistor—see text
- R2—47-ohm, 1/2-watt resistor
- SCR1—Silicon-controlled rectifier (GE C106, or similar)
- 1—2 1/8" long x 1 1/8" diameter plastic container with twist-on cap
- Misc.—Phenolic board, strobe light cable, small bolts and nuts, brass strap, solder, etc.

Sensitivity of slave control unit depends on value of gate bias resistor R1 and how close to master flash the "Slave Driver" is located.

port for LDR1, R1, R2, and SCR1, and conduct current from the battery side of the board to the component side. Clips fabricated from brass strap (you can substitute metal cable clamps) can be used to anchor LDR1 and SCR1 at opposite ends of the board as shown. The dome, or light-sensitive end, of LDR1 should protrude about 3/8" over the edge of the board. (A Mullard ORP-61 and a 2N2325 SCR were used in the prototype for LDR1 and SCR1 respectively; but for economy, a Clairex CL605-L photocell and a GE C106 SCR can be substituted, as indicated in the Parts List.)

Fashion the battery contacts from brass strap, bend them to shape, and

bolt them to the board, using the hardware marked BI+ and BI- as shown in Figs. 1 and 2. Cut the camera-end connector off a flash gun cable, drill a small hole in the cap of the slave flash container, and pass the cut end of the cable through this hole. Strip away some insulation, and connect the positive lead of the cable to the anode of SCR1; the negative lead goes to the cathode. Solder all connections.

Now clip the battery in place, and slide the completed board into the container. Finally, drill a hole in the bottom of the container (directly in line with the light-sensitive end of LDR1), and screw on the cap.

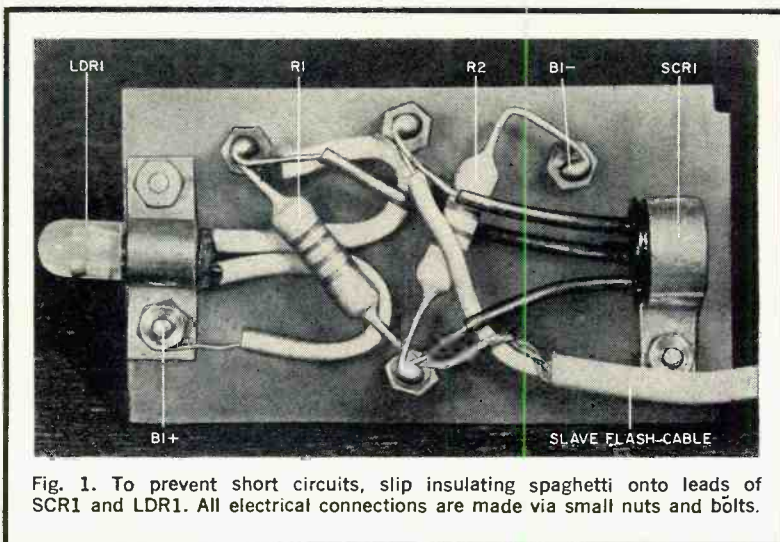

Fig. 1. To prevent short circuits, slip insulating spaghetti onto leads of SCR1 and LDR1. All electrical connections are made via small nuts and bolts.



## HOW IT WORKS

The Slave Driver is essentially a light-activated electronic switch and strobe light (or flash gun) combination. Switching action is accomplished by triggering on silicon-controlled rectifier *SCR1*. The triggering current is supplied by battery *B1* via a voltage divider circuit formed by light-dependent resistor *LDR1* and resistor *R1*.

Normally, very little light strikes the light-dependent resistor, so *LDR1* has a very high characteristic resistance, and *SCR1* acts as an open circuit. However, when a brilliant light—such as that from a camera-controlled flash gun—strikes *LDR1*, the resistance suddenly decreases, applying enough current to the gate to trigger *SCR1* on. As a result, *SCR1* fires, in turn firing the slave strobe light. Resistor *R2* limits gate current in the event a flash is fired very close to *LDR1*.

lighting effect you want. Then operate the shutter of your camera.

Both the master and slave should fire simultaneously. If they do not, check cable connections, battery polarity, *SCR1*, and *LDR1*. (Temporarily connect a wire from pin 2 of *SCR1* to the positive side of *B1*; if *SCR1* and *B1* are good, the slave will fire. Disconnect one side of *LDR1* and measure its "light" and "dark" resistance—it should be less than 100 ohms and about 10 megohms, respectively.) If the components and cable connections are all okay, increasing the value of resistor *R1* will increase the sensitivity of the "Slave Driver." —30—

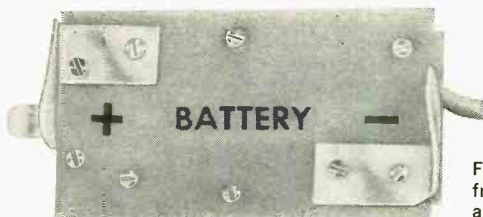

Fig. 2. Battery clips are fabricated from brass strips. Bolt clips to board and bend ends for tight battery fit.

To keep the project as simple as possible, no switch is provided for disconnecting the battery from the Slave Driver circuit when the unit is not in use. (With the battery in the circuit at all times, current drain is only a few microamperes.) To disconnect the battery, just unscrew the cap and remove it from the container—a few seconds work at most.

**Using the Slave Driver.** As mentioned previously, the light-dependent resistor must be positioned to catch the light from the master flash unit. Sensitivity of the Slave Driver is determined by how far apart the master and slave units are.

Set up your camera and master flash as usual. Plug the cable from the Slave Driver into a second flash or strobe unit, and position the slave setup to give the



Fig. 3. Light-sensitive end of light-dependent resistor should protrude from one end of plastic container as shown here.

# the product gallery

## REVIEWS AND COMMENTARY ON ELECTRONIC GEAR AND COMPONENTS

### HEATHKIT STEREO RECEIVER (Model AR-15)

At a time when electronic project and kit building are being made simpler and simpler, the Heath Company (Benton Harbor, Mich. 49022) manages to flaunt this general trend very successfully. Several times each year, Heath announces the release of a new kit that invariably looks more difficult than the last to assemble. Of course, it is difficult, but it does go together, it does work, and the builder is left with the feeling that it wasn't such a hard job after all.

When your reviewer first saw the 1½-lb assembly manual for the AR-15 stereo receiver kit, he was convinced that the Heath Company had gone too far this time. Was it within the realm of reason to expect any kit builder to assemble a stereo receiver as complex as the AR-15, with its 69 transistors, 43 diodes, and 2 IC's?

Obviously, the AR-15 can be—and is being—assembled. In fact, it has even been built by hi-fi'ers with minimal kit assembly experience! How? With the help of a series of "checkout" steps that eliminate the chance of a wiring error. These steps include visual inspection, resistance checks, voltage checks, and hum injection tests. None of these may sound unusual, but in the AR-15, the assembly manual explains how these checks are made through temporary connections using the internal AM/FM signal strength meter. Thus, no test equipment is required by the builder; and since the tests are made before final wiring, there is maximum protection for the individual circuit components at all times.

Assembling the Heathkit AR-15 is still not an easy task. And, because of its complexity, there is probably no hard average wiring and assembly time. However, the three kits that have been built by friends of your reviewer all took not less than 27 hours and not more than 35 hours to put together. This time element appears to be reflected in the dollar difference between the kit and wired version sold by Heath (\$329.95 for the kit and \$499.50 for a wired and tested unit).

The technical specifications of the AR-15 are so impressive that some of them are worth repeating. Continuous power output per channel exceeds 50 watts (equal to 75 watts music power) at 8 ohms. Both harmonic and IM distortion at this power level are approximately 0.5%; or, to phrase it an-

other way, power bandwidth for 0.5% THD is 6 Hz to 30 kHz. The FM tuner sensitivity has been independently measured as being under 1.5  $\mu$ V. Phono hum and noise (at the 10-millivolt reference point) is better than -60 dB. The hi-fi journals that make a habit of verifying manufacturing claims all agree that the AR-15 is somewhat *better* than Heath is saying it is. Check Heath's latest catalog for a complete listing of the operating characteristics of this state-of-the-art hi-fi receiver.

The AR-15 is one of those kits for which reams of paper would be necessary to describe all of its interesting and unusual features. Here is a sampling of 10 of them: (1) FM stereo phase adjustment for maximum separation between channels; (2) stereo threshold adjustment to establish minimum signal strength for adequate FM stereo reception; (3) FM squelch (just as in CB); (4) high-temperature protection circuit breakers; (5) flat tone control switch; (6) FET FM tuner (prealigned); (7) input level controls; (8) dual FM tuning meters; (9) crystal-lattice i.f. filters to curb adjacent channel FM interference; and (10) thorough SCA filtering.

In tests at POPULAR ELECTRONICS, the AR-15 was compared with a hi-fi component tuner-amplifier system (also solid-state) that is popularly priced at about \$350-375. Although it might be expected that audible differences between the two systems would be indistinguishable, your reviewer found just the opposite to be true. The AR-15—in the low end—lacked the boominess, or hangover, of the other system. The highs—particularly with reference to transients—were crystal-clear, lacking the blurring overshoot common to amplifiers with inadequate high-frequency response. And, of particular note, off-the-air tape recordings of FM stereo material were clean and whistle-free!

There is no doubt in your reviewer's mind that the AR-15 is a remarkable musical instrument. If you are harboring any suspicion that, after all, a kit is still a kit, be assured that kit building has reached an apogee with the AR-15.

### LAFAYETTE CB TRANSCEIVER (Model HB-625)

In case you haven't read about it in the advertisements, integrated circuits are now being used in CB transceivers. And, what



# HEATHKIT AR-15 STEREO RECEIVER



Density of components can be readily seen in partial above-chassis view of the AR-15 at right; in the upper left corner view of the left channel amplifier, at lower left is the power supply, and at right a portion of the multiplex board. Behind the drop panel in the photo below are the special controls, including stereo FM threshold, FM squelch, and stereo FM phase. Recessed in the back of this compartment are 10 level controls.

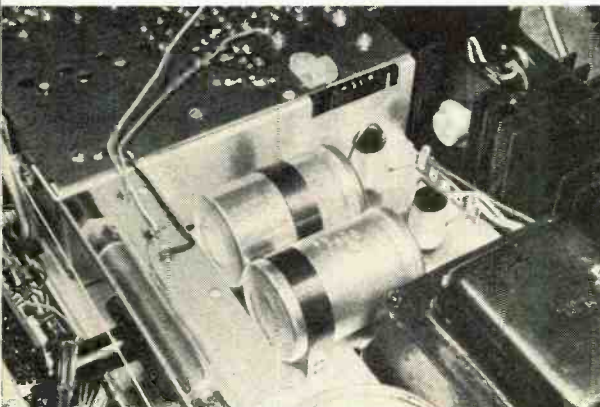
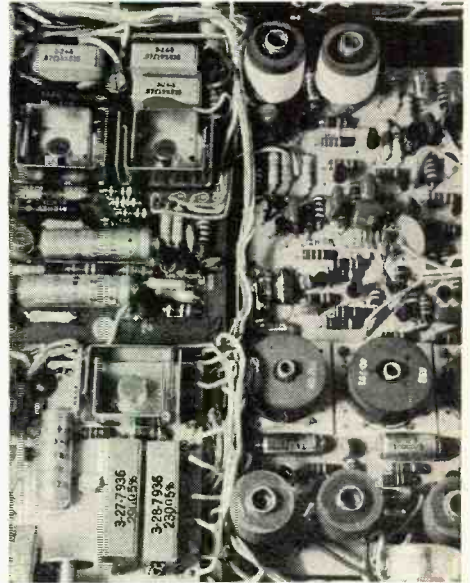

A unique feature of the AR-15 kit is the use of the internal AM/FM signal strength meter for voltage and resistance checks. Assembly manual (below) details test points and meter readings. To the left are the 4000- $\mu$ F capacitors in the speaker circuit.

VOLTAGE CHECKS		TROUBLESHOOTING CHART
Test Point	Normal Meter Reading	Area Of Trouble (See Figures 6-3 and 6-4)
Emitter of Q105L	1.2 to 1.1 0.00000	Transistor Q105L, Q105R, Q104L or Q104R.
Collector of Q103L or Q103R	1.2 to 1.1 0.00000	Transistor Q103L or Q103R.
Collector of Q101L or Q101R	1.2 to 1.1 0.00000	Transistor Q101L, Q101R, Q102L, Q102R, C105 (C106), C107 (C108), C111 and/or faulty.



could be more logical than for Lafayette Radio Electronics (111 Jericho Turnpike, Syosett, L.I., N.Y.) to use them in the replacement for its HB-600. Lafayette is one of two manufacturers employing r.f. noise silencing in top-line CB units. The HB-600 (also solid-state) was popular, but somewhat cumbersome, so a redesign was called for. The HB-625 is similar, much smaller, and even cheaper—\$189.95 (a cut of \$30.00).

If you think all mobile CB transceivers are pretty much alike, you haven't used one with r.f. noise silencing. This is the system of noise elimination where noise pulses are fed down a separate i.f. channel, amplified, and then dumped back into the second mixer to momentarily cut off reception, hence eliminating the noise pulse altogether. It's a complex business and calls for quite a bit more circuitry. Thus, IC's are a natural in an application like r.f. noise silencing.

The HB-625 actually uses three separate IC's. One (an RCA CA3020) is in the audio stages, the second is a multi-stage 455-kHz amplifier, and the third (an RCA CA3011) is the noise amplifier. There are about 30 more miscellaneous semiconductors scattered around the innards of the HB-625.

Frequency synthesis is used in the HB-625 to permit 23-channel operation. The receiver is a dual-conversion unit and the transmitter has "full-time" Range Boost modulation. An interior wiring change (it takes about three minutes) allows operation with either negative or positive chassis grounding.

For the price and flexibility, the HB-625 is a stiff contender to beat.

### AMECO ALL-WAVE RECEIVER (Model R-5)

Continuing the move toward a greater use of solid-state components in communication-style receivers, AMECO (Division of Aero-tron, Box 6527, Raleigh, N.C. 27608) has introduced the Model R-5. This receiver is tunable from 540 kHz to 54.0 MHz—an unusually wide span for a product selling for \$79.95.

Featuring a carefully designed 11-transistor circuit, the Model R-5 has a stabilized

local oscillator, two i.f. stages (one is cascaded), separate a.g.c. amplifier, r.f. gain control on the front panel, and noise limiter. The BFO is adequate for clean SSB and CW reception.

Practically all communications receivers limit frequency coverage to about 32 MHz.\* The Model R-5 represents a departure from this practice; the tuning bands are divided into the following segments: 540-1350 kHz; 1350-3500 kHz; 3.5-9.0 MHz; 9.0-23.0 MHz; and 23.0-54.0 MHz.

In tests at POPULAR ELECTRONICS, the Model R-5 demonstrated adequate sensitivity on all bands. Selectivity was fair and band-spread tuning sufficient for casual tuning. For listening to stations above 30 MHz, an external speaker may be required—to reduce acoustic feedback. The Model R-5 should make a good second receiver for the experienced SWL, or just about the right package for the beginner who wants to tune in a little of everything.

### OMEGA-T NOISE BRIDGE (Model TE7-01)

Every once in awhile someone pops up with a really new idea—simple, useful, uncomplicated, and frequently dirt cheap. Well, just such an idea is being offered by Omega-T Systems, Inc. (516 W. Belt Line Rd., Richardson, Texas 75080) in its "Noise Bridge."

The Bridge is housed in a small plastic box and contains a diode noise generator with a wideband r.f. amplifier. The bridge is inserted in the coax line between a receiver and antenna. A calibrated dial on the Bridge reads out the antenna resonant impedance according to the noise-null on the receiver's S-meter. So, if you've stuck up a new antenna and are wondering if it's resonant and what the coaxial line is "seeing," the Model TE7-01 Noise Bridge will tell you in a few seconds.

The manufacturer claims that the Bridge is good from 150 MHz down to 1 MHz. Impedance can be measured from about 10 to 100 ohms. The whole Noise Bridge circuit is contained within the plastic box and is driven by a single 9-volt battery.

Our first test of the Noise Bridge at POPULAR ELECTRONICS was in conjunction with a Cush Craft "Ringo" antenna. The results were accurate, but somewhat disappointing, since CB equipment does have the

*(Continued on page 95)*

\*Using a tuning capacitor/coil value that will sweep from 540 to 1700 kHz—the usual first band on most all-wave receivers, the remaining spectrum can be broken up into several segments—generally putting the upper frequency limit around 32 MHz.

## LAFAYETTE HB-625 CB TRANSCEIVER



Lafayette's HB-625, sitting atop predecessor HB-600, shows size reduction achieved through use of tighter construction and integrated circuits. Control functions on the HB-625 have been simplified and include channel selector switch, volume, squelch, 1.8-kHz delta tuning, and noise silencer switch.

## AMECO R-5 ALL-WAVE RECEIVER



AMECO's Model R-5 is one of the few solid-state communications-style receivers designed for 117-volt a.c. operation. Unusual segmenting of the tuning ranges permits the Model R-5 to cover up to 54 MHz and thus tune low-band VHF police signals.



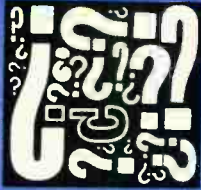

# INFORMATION CENTRAL

By CHARLES J. SCHAUERS, W6QLV

**A**CCORDING to recent reports, the average U.S. housewife has a great deal of difficulty obtaining rapid and competent home appliance repair service. Because of this situation, more and more husbands are buying do-it-yourself repair books and repairing their own appliances, and also their automobiles. Are they successful? Well, many are—but many are not.

Most appliances used in the home are electrically operated and unless you have studied enough to become familiar with electric motors, switches, fuses, circuit breakers, transformers, etc., you may have a difficult time. Replacing a fuse is simple, but troubleshooting without the proper instruments often turns out to be an impossible job. The mechanical sections of an appliance are easier to repair because a mechanical defect is easier to see than an electrical defect. Television (especially color) or radio set repair requires more than just a few tubes, although these do account for most set outages.

To answer a question that has been asked by many readers as to what tools a do-it-yourself repairman needs to repair his home appliances, we suggest that you first invest in some good books on repair or even take a home-study course on the subject—the money you can save by doing so is worth the effort. In addition to the usual hand tools found in nearly every home, a home repairman needs a multimeter for a.c. and d.c. voltage, and resistance measurements. A good medium-weight soldering iron is a must, as is a selection of screwdrivers of various sizes and types.

Blindly tackling an inoperative electrical appliance without knowing what you are doing may endanger your life, and is a sure way to run a repair bill up, for sometimes major damage can result from blind tinkering. Finding repair parts can be a headache, but most parts can be obtained from distributors—not dealers.

You can save money by repairing your own appliances if you know what you are doing. If you have an appliance (electrically operated) repair problem that is stumping you, shoot a question in to us on a postcard.

**12-Volt Power Supply.** *I have a transceiver that requires 12 volts supplied by 8 dry batteries. Can you provide a diagram for a*

*117-volt a.c. to 12-volt d.c. power supply? The current drain on transmit is around 100 mA.*

See the diagram below. The transformer can be any unit which has a secondary capable of delivering 16 volts up to 500 mA. For stability (if required), a 12-volt, 2-watt

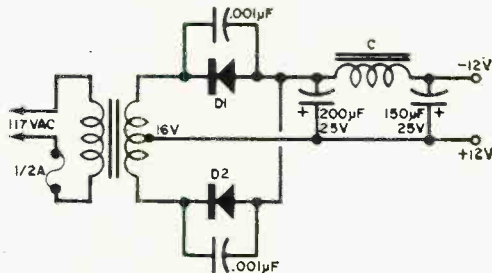

zener diode can be connected across the output connections. Any 500-mA rectifier diode can be used for *D1* and *D2*.

**Crystal Calibrator Output.** *My homemade crystal calibrator does not have enough output at 30 MHz—I can hear the signal, but it is very weak. The calibrator uses a 6C4 tube having 65 volts on its plate. What do you suggest?*

Increase the plate voltage to 150 volts and you will note a big difference.

**TV Antennas.** *I live 6 miles east of Philadelphia and would like to receive both Philly and New York. Can I connect two antennas (pointed in different directions) together to receive both areas?*

You are going to run into a complex impedance problem if you do—possibly resulting in worse reception of both areas. Your best bet is to use two different antennas.

**Color TV and Recorder Noise.** *I have a Heathkit GR-53 color TV set and an EICO RP-100 tape deck. Each unit performs very well by itself, but when I try to record from the TV using its special hi-fi output, I get a hum. Is there any way I can get rid of this hum?*

Make sure that both the TV and the recorder have a common ground and that the lead from the recorder to the TV is shielded. Try reversing your line plugs, too; this may make a difference.



This version of the electronic lock uses rotary switches and a 5-2-5-3 opening combination. Lock at bottom of page incorporates N.O. push buttons and has a 5-7-14 combination.

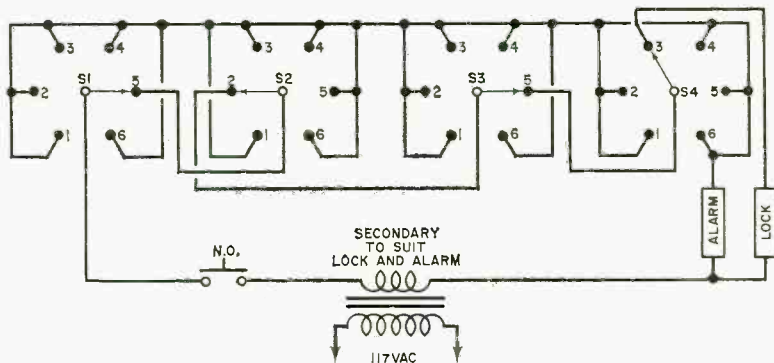

**Improved Electronic Locks.** The electronic lock circuit (*Information Central*, October, 1967) drew much reader mail. Of the 1296 possible combinations, 17 will open the lock, and, therefore, there is no single unique combination. An improved version of the lock is shown above. This arrangement will sound an alarm if one or more switches are set to the wrong number, and there is only one unique combination which will unlock it. The household disable switch in the original unit has been replaced by a simple push button, permitting you to dial in the correct numbers without sounding the alarm. Be sure *not* to leave the combination on after opening the door, but rearrange the combination to thwart any intruder.

Another improved electronic lock is shown below. Note that 16 push-button switches are arranged in a square matrix here, although other arrangements of a different number of switches can be used. With the configuration shown, the lock will open if you depress switches 5, 7, and 14 with your thumb and first two fingers. Depressing any other switch will actuate the alarm. When this lock is open, it does not display to others what the combination digits are. This circuit does not require a household disable switch either.

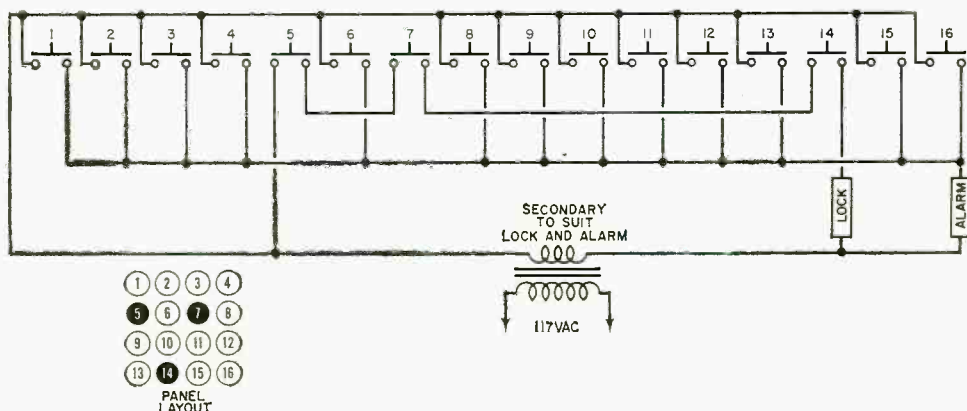

Although both of the circuits show the lock in the external wiring, it could be located at various places within the switch circuits. Thanks to R. E. Lovejoy of 5815 Compass Dr., Los Angeles, Calif. for these two *better* electronic lock circuits, as well as to those who submitted other, more complicated circuits.

**Garage Door Opener.** *My garage door opener (radio-activated) seems to stick half-way open and I have to push it up by hand. Do you have any idea what could be wrong?*

First check the mechanical linkage coupled to the opening motor to see that it is not binding. Make sure that there is sufficient grease on the door rollers as well as on the opening cam (if one is used in your system). If these are all right, then check to make sure that the motor starting relay stays closed for a complete opening cycle.

**Down-Modulation.** *I get reports of down-modulation when I use my CB rig. What does this mean, and how can anyone tell when it occurs?*

Down-modulation in an AM transmitter can be caused by several faults: insufficient excitation or grid bias of the final amplifier; improper loading; poorly regulated

power supply; too high a d.c. voltage to the final; low cathode emission of the final; and in plate-and-screen modulated pentodes or tetrodes, insufficient screen modulation. A receiver S-meter indicates down-modulation by a decreased reading on modulation of the carrier, and so does the final r.f. stage plate current meter in the transmitter.

**Simple Noise Generator.** *Can you come up with a simple diode noise generator which will not bankrupt me? I would like to use it for some receiver experiments.*

See the diagram below; the diode is a 1N82 or similar UHF diode. A noise gen-

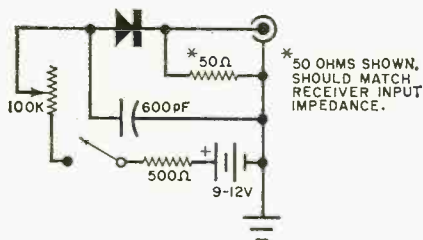

erator is useful in adjusting a receiver "front end" for best noise figure. In many cases, it is even better than a conventional signal generator.

**Beam Detuning.** *My 2-element CB beam mounted on an ungrounded corrugated metal roof works very well, but when the wind blows, the final plate current meter varies as much as 5 mA or so, without modulation. Is this anything to worry about?*

No, but I would suggest that you ground the roof and make sure that the ground on your set is a good one. Also, check the coax line connection at the antenna, and the mechanical stability of the antenna.

**Convertible Car Top Closer.** *Where can I buy a convertible top closer that will close my car's top when the first few drops of rain fall? It should operate electronically and be easy to install.*

Write to Eastern Electronics, 28 Weymouth St., Albany, N.Y. 12205, Att: G. E. Molson. This company makes one for 6 or 12 volts, all solid-state and easy to install.

**Mono-Phono BC Pickup.** *What can I do about a mono-phono amplifier that picks up AM signals from a station over a mile away? Neither the people at the store where I got the amplifier nor the radio station personnel have a solution.*

If the set is a tube model, try putting a 68,000-ohm resistor in series with the input tube control grid and bypass this resistor to ground (on the grid side) with a 0.001- $\mu$ F

ceramic capacitor. If your set is transistorized but a.c.-supplied, bypass each side of the a.c. line lead to ground. Next, (if you still have the interference), try a 2.5-mH r.f. choke in series with each speaker lead and bypass the speaker leads with two 0.005- $\mu$ F capacitors in series (center-tap grounded). You may have to shield and ground your amplifier.

**Alternator Noise.** *I use a Lafayette HB-525A transceiver in my alternator-equipped 1963 Chevrolet. Noise-suppression measures have been taken, but a loud whine still comes through. How can this be cured?*

Try inserting a coaxial capacitor, 0.1  $\mu$ F or greater, in series with the alternator output lead. If there is still some whine left, try bridging the battery with a 1000- $\mu$ F, 20-volt electrolytic capacitor.

**Guitar Amplifier Impedance.** *What is the standard impedance of a guitar amplifier input circuit?*

Most guitar amplifiers have both high- and low-input impedances: high is 50,000 ohms and up, and low is 250 ohms or less. There is no "standard" input impedance. Most "electronic" guitars use two pickups, but four-pickup models are available.

**Low-Z Stereo Phones To High.** *How can I use my low-impedance stereo headphones with my high-output-impedance tape deck?*

By using transformers that will match the high impedance of the deck to the low impedance of your phones. For high tonal quality, make sure you use good transformers.

**Tape Recorder in Car.** *I have a tape recorder that will operate from either 117 volts a.c. or 9 volts d.c. I'd like to use it in my car which has a 12-volt system. What should I do?*

If you plan to use the recorder while the car is moving (engine running), you will have a bad voltage regulation problem. If you want to use the recorder when the engine is not running, insert a series voltage-dropping resistor whose value can be calculated by measuring the current the recorder takes at 9 volts and provide for the 3-volt drop ( $R = E/I$ ).

**Troubleshooting a Scope.** *A friend gave me a scope which does not work. How do I go about troubleshooting it? I have test instruments.*

First, check all tubes (leave the cathode-ray tube until last), and replace any bad ones. Before turning on the scope, take it out of its cabinet and look for burned resistors, broken connections, bad switch con-

(Continued on page 102)

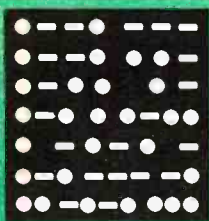

# AMATEUR RADIO

By **HERB S. BRIER, W9EQO**  
Amateur Radio Editor

## EXPO '67 SHENANIGANS, CONTEST AND OTHER NEWS

**W**ANT to hear the inside story about why there was so little publicity (advance or otherwise) on VE2XPO, the amateur station at EXPO '67 in Montreal? Word has it that the Montreal amateur radio clubs were ready to sponsor and man an amateur station at the exposition, and various amateur equipment manufacturers were ready to equip it. But the EXPO "brass" would not give their okay because the Japanese Government wanted to install an amateur station equipped solely with Japanese equipment in their exhibition pavilion. As soon as the Japanese station was set up, the EXPO officials authorized the Montreal hams to install VE2XPO in a 6' by 18' corner of the Youth Pavilion.

Station VE2XPO was equipped with Drake, Hallicrafters, Heath, and other manufacturers' gear which fed a Hy-Gain



A young amateur radio operator visiting EXPO '67 in Montreal, Canada, experiences the thrill of operating the VE2XPO ham station. The station was set up in a corner of the Youth Center at the Fair, and licensed hams who came to EXPO '67 were invited to operate the station. In just a few hours, they could work from 25 to 30 countries. (Photo by W9QKE)

## AMATEUR STATION OF THE MONTH

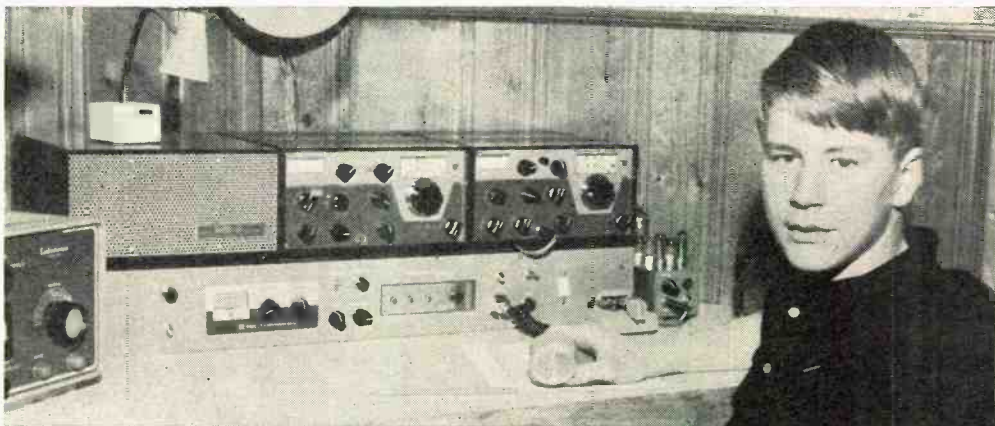

Herbert Rippe, Jr., WA8DCH, of Cincinnati, Ohio, was a Novice seven years ago at the age of nine. He is now a DX man with more than 200 countries worked. His current gear consists of a Drake T-4X transmitter and a home-brew 1000-watt amplifier (dubbed the "Loudenboomer") feeding a wide-spaced 65-foot high Telrex beam antenna. He uses a Drake R-4A for receiving. Herb works strictly on 20 meters, except during contests when he operates on all bands; the "Loudenboomer" amplifier (partially shown at far left in photo) is then used on 80 and 40 meters. WA8DCH will receive a one-year subscription for submitting the winning entry for January in our Amateur Station of the Month Photo Contest. To enter the contest, send a clear photo of your station with you at the controls and some details about the equipment you use and your ham radio career to Amateur Radio Photo Contest, c/o Herb S. Brier, Amateur Radio Editor, Box 678, Gary, Ind. 46401.





Robert Nichols, WN4DWI, has worked 37 states and a half-dozen countries with his Hallicrafters HT-40 transmitter and Hammarlund HQ-100-AC receiver. He keeps extra crystals on top of the transmitter for shifting frequency.

TH-6DX, 10-, 15-, and 20-meter rotary beam, and 40- and 80-meter dipole antennas. Fortunately, the troubles faced in getting VE2XPO set up did not extend to its operation. It put out an excellent signal all over the world and visitors could work 25 to 30 countries in a few hours of operation.

**Third Annual Louisiana QSO Party.** The party starts at 1800 GMT, Saturday, January 27, 1968, and ends at 2200 GMT, Sunday, January 28. Amateurs outside of Louisiana work Louisiana stations and multiply the number of Louisiana parishes worked for their score. Louisiana amateurs work the world, including other Louisiana stations; their scores are the number of contacts multiplied by the number of Louisiana parishes, U.S. states, Canadian provinces, and other countries worked. Contestants may work the same station once per band and mode.

Contest exchanges include QSO number, signal report, and name of parish, state, province, or country. Suggested operating frequencies are: 3.6, 3.91, 7.075, 7.26, 14.075, 14.3, 21.075, 21.4, 28.7 and 29.1 MHz. Certificates will be awarded to the highest scorers in each area (minimum score of 50 points). Scores should be mailed to the Lafayette Amateur Radio Club, 308 Karen Dr., Lafayette, La. 70501. Include a stamped return envelope if you want a tabulation of contest rules.

**160-Meter DX Tests.** The annual transatlantic 160-meter DX tests conducted every year since 1932 (war years excepted) will be held on Sundays—December 17 and 31, January 14, and February 4 and 18—from 0500 to 0730 GMT (midnight to 2:30 a.m., EST). W's and VE's call "CQ DX Test" for five minutes starting precisely at

0500 and listen for DX for the next five minutes. These 5-minute call-and-listen periods continue throughout the tests—except when DX contacts are actually in progress. Transpacific tests will be held on December 16 and 30, January 13, and February 3 and  
(Continued on page 114)



Although Ron Weaver, WA6CZH, is shown grasping a microphone (above), he really prefers CW to phone. Les Lehrman, WA3ENE, (below), splits his on-the-air time between CW and phone. See P. 115.



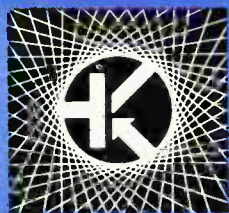

# SOLID STATE

By LOU GARNER, Semiconductor Editor

**J**ANUARY, and, once again, World Series time—not baseball, but the annual crystal ball game between yours truly and the electronics industry. Before we venture out on the proverbial limb, however, let's check our batting average for last year. In January, 1967, we predicted . . .

● *A transistorized color TV set in the "under \$200" price range.* Strikeout! We were optimistic, as usual, but not realistic, for we didn't allow for the high cost of the color picture tube. However, as the famous "bums" used to say, wait 'til next year!

● *Widespread use of IC's in automobiles.* Home run! No less a giant than General Motors has introduced IC voltage regulators in its 1968 Pontiac line. And IC's are being used in auto receivers, stereo tape players, and even mobile CB gear.

● *The use of triacs in place of SCR's in consumer products.* Double! Although triacs haven't replaced SCR's in all applications, they are being widely used in a variety of consumer products, including portable electric tools, light dimmers, and even some home appliances.

● *The production of a radically new semiconductor device.* Home run—with bases loaded! Amperex introduced its BiFET, a unique device with the high input impedance of a FET coupled with the ruggedness of a bipolar transistor. General Electric has started producing a Darlington photoamp, a low-cost, high-gain, silicon phototransistor. Westinghouse has introduced the resonant-gate transistor, a frequency-selective amplifying device which permits the assembly of tuned amplifiers without using inductors. And RCA's dual-gate MOSFET is making news in the receiver design field.

● *The introduction of receivers featuring electronic tuning.* Another homer! Fisher, Audio Dynamics, and Matsushita have all introduced electronically tuned receivers. In all three cases, the "tuner" includes varactor diodes shunted across an inductor, with different frequencies selected by varying the d.c. bias applied to the diodes.

● *The development of a new type of solid-state electronic musical instrument.* Score a hit—Motorola developed the "Storachord" electronic organ, a unique solid-state combo

instrument featuring integrated circuits and, for the first time in any musical instrument, an electronic memory bank.

● *The production of large-screen, solid-state TV receivers.* Score another homer. Motorola's new line of color-TV receivers is all solid-state (except for the picture tube, of course), and Montgomery Ward features a 172-sq. in. solid-state B/W TV receiver in its latest catalog.

● *The introduction of an "Experimenter's Integrated Circuit" kit.* Home run! Both TI and Fairchild offer moderately priced IC breadboarding kits for circuit development, student and experimental use; and Lafayette has introduced a low-cost (\$6.95, plus postage) IC Experimenter's Kit which features a pair of Fairchild IC's.

● *The development of a solid-state automobile "safety-check" system.* Another hit. Bisset-Berman has developed a dashboard-mounted solid-state computer which warns the driver when engine service is needed. Au-



Low-cost experimenter's IC kits have been introduced by Texas Instruments, Fairchild, Lafayette, and Kaye Engineering. The TI kit is shown here.

toscan and Allen Electric both have developed solid-state analytical instruments for checking automobile performance. Finally, several major auto manufacturers have developed experimental systems which warn the driver, automatically, when dangerous or critical situations develop. The majority of these new units check engine

water temperature, lights, battery, and oil pressure, while a few also check air pressure and brakes and warn if the car's doors are unlocked or seat belts unfastened.

Of the sixty-nine annual predictions made by your columnist since 1960, sixty have scored as "hits" in the year in which they were made. Others "scored," but later. In baseball terms, our batting average, to date, is 0.870. How about that!

**Things To Come.** In 1968, watch for: the use of IC's and SCR's in toys—high power FET's—a portable (battery/line) solid-state color TV receiver—development of a new type of semiconductor transducer—a solid-state video recorder at a price competitive with better quality audio tape recorders—*a.c. control devices (SCR's or triac's) with integral triggering elements*—an inexpensive solid-state oscilloscope kit—a drop in the cost of medium- to high-power high-frequency transistors, making them generally competitive with tubes for ham and communications applications—the introduction of project kits featuring IC's as their main circuit elements—*IC's featuring FET's (current types use conventional bipolar transistors)*—and, the development of a radically new type of semiconductor manufacturing process.

**Reader's Circuit.** Easily assembled in a single evening, the project in Fig. 1 is the result of joint efforts by engineer Jim DeYoung, who designed the basic circuit, and reader Peter C. Hanson, K2MPG/8 (1001

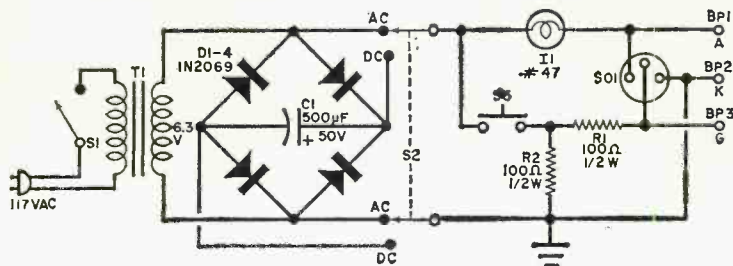

Fig. 1. Simple SCR tester developed by Jim DeYoung and Peter Hanson can check proper operation of an SCR using either a.c. or d.c. supplies.

Tabor Ave., Dayton, Ohio 45420), who assembled and tested a working model. An inexpensive "SCR tester," the instrument could be a valuable addition to the home workshop or electronics laboratory.

Jim and Pete have provided for both a.c. and d.c. tests. Step-down transformer *T1*, controlled by s.p.s.t. switch *S1*, serves as the a.c. voltage source, while d.c. is provided by a full-wave bridge rectifier (*D1*, *D2*, *D3*, and *D4*) and a filter capacitor (*C1*). The desired test voltage is selected by d.p.d.t. switch *S2*. An incandescent lamp, *II*, acts as a test indicator. An s.p.s.t. momentary con-

tact switch, *S3*, serves to apply gate bias through current-limiting resistor *R1*, while *R2* acts as a gate-to-cathode bleeder.

Low-cost, readily available components are used in the instrument: *T1* is a 6-volt, 1-ampere filament transformer, *R1* and *R2* are half-watt resistors, and *C1* is a 500- $\mu$ F, 50-volt electrolytic. Reader Hanson used 1N2069 diodes in the rectifier circuit but these can be replaced, if preferred, by a single bridge rectifier such as Motorola MDA920-1 assembly. Although *S1* and *S2* can be toggle, slide, or rotary switches, a normally-open push-button switch is preferred for *S3*. The test indicator, lamp *II*, is a #47 pilot lamp. Standard hardware is used for the lamp mounting, for the transistor socket (*SO1*), and for the test lead binding posts (*BP1*, *BP2*, and *BP3*).

Tester operation is a relatively simple procedure. You insert the SCR in socket *SO1* or, if it's a large unit, connect its leads to the appropriate anode (A), cathode (K), and gate (G) binding posts. With *S2* in its "a.c." position, close *S1*. If *II* lights, the SCR is either excessively leaky or shorted. If the lamp remains dark, depress and release *S3*. If the SCR is responding normally, *II* should light while *S3* is depressed, but not to full brightness, and should go dark when *S3* is released.

After completing the a.c. test, switch *S2* to its "d.c." position—*II* should remain dark until *S3* is depressed and released. With low-to-medium-current SCR's, *II* will light to full brightness when *S3* is closed and will remain lighted when the switch is released

—until the power source is interrupted by opening *S1* or switching *S2* to its "a.c." position.

**IC Kits.** If you want to learn more about IC's, and a little more about computer logic at the same time, drop a line to Kaye Engineering, P.O. Box 3932, Long Beach, Calif. 90803 and ask them for a catalogue. This firm puts out a series of low-cost IC projects, individual IC's, and a series of digital computer type projects. The complete IC kits are low-cost units—\$6.95 is the price of the basic experimenter's kit.



**Manufacturer's Circuits.** The circuits illustrated in Figs. 2 and 3 especially appropriate at this time in view of the increasing interest in IC devices and their applications. Both circuits feature "stock" IC assemblies and both can be duplicated quite easily in the average home workshop. In each case, the schematic symbol for a linear amplifier (a triangle) is used to represent the IC device. The lead numbers refer to corresponding pin connections on each device.

Designed for use with 500- to 600-ohm headsets, the headphone amplifier circuit illustrated in Fig. 2 has an overall gain of 100 and can provide up to 50 mW output with less than 0.2% distortion over the audio frequency spectrum. It is one of several applications for the  $\mu A716$  linear amplifier described in a technical applications bulletin published by Fairchild Semiconductor.

The IC assembly itself contains 14 transistors, 2 diodes, and 18 resistor elements. The external components needed for operation in this application include a volume control,  $R1$ , input and output coupling capacitors  $C1$  and  $C3$ , respectively, stabilization capacitor  $C4$ , and gain control bypass capacitor  $C2$ . Power is supplied by  $B1$ .

Except for the IC, all parts are conventional components. Potentiometer  $R1$  has an audio taper;  $C2$  and  $C3$  are 25-volt electrolytics, while  $C4$  is a small ceramic capacitor. A 20- to 24-volt d.c. source (either battery or line-operated power supply) is used for  $B1$ . Finally, either binding post ( $BP1$ ,  $BP2$ , etc.) or jack-type connectors can be used.

If you wish, you can assemble a duplicate circuit breadboard-fashion for experimental tests or as a Science Fair project. However, for general lab applications, the amplifier should be assembled in a small case, with a perforated board or etched circuit board "chassis" used to hold the IC and accessory components. Layout and lead dress are not overly critical.

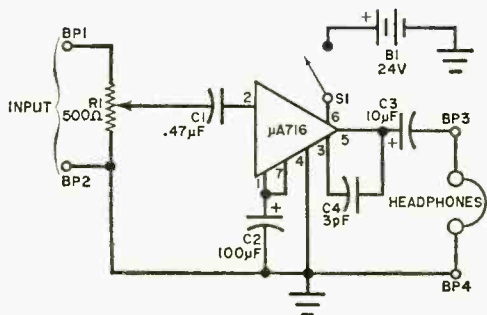

Fig. 2. Suggested by Fairchild Semiconductor, this circuit makes a good, high-output (50-mW), low-distortion, general-purpose headphone amplifier.

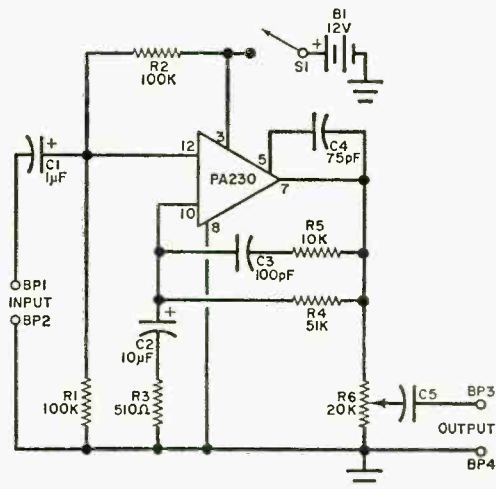

Fig. 3. Suggested by General Electric, this circuit uses a PA230 integrated circuit as a general-purpose low-level audio amplifier having a gain of 100.

With a rated gain of 100, and a frequency response essentially flat from 30 Hz to 30 kHz, the preamp circuit illustrated in Fig. 3 is designed for use with conventional power amplifiers. It is one of the circuits described in GE's specification sheet for its PA230 IC device.

A general-purpose, low-level, audio amplifier, the PA230 is encapsulated in an 8-lead, dual in-line, plastic package. It features output short-circuit protection, high gain and low noise, and includes 8 transistors, 3 diodes, a zener diode, and 15 resistor elements.

In the preamp circuit,  $C1$  and  $C5$  serve as the input and output coupling capacitors, respectively. Input bias is established by voltage divider  $R1$ - $R2$ , while volume control  $R6$  serves as the output load. The remaining components ( $C2$ ,  $C3$ ,  $C4$ ,  $R3$ ,  $R4$ , and  $R5$ ) provide feedback to establish the circuit's overall gain and frequency response characteristics, while operating power is furnished by  $B1$ .

In practice,  $C5$ 's value is determined by the input impedance of the power amplifier with which the preamp is used. Values as low as 0.1  $\mu F$  may be used with high-impedance amplifiers, or as high as 5 to 10  $\mu F$  where moderate to low impedances are encountered. Capacitor  $C1$  is a Mylar or polystyrene plastic film unit,  $C2$  a 15-volt electrolytic, and  $C3$  and  $C4$  ceramic types. Except for volume control  $R6$ , an audio taper potentiometer, all resistors are half-watt units. Switch  $S1$  can be a separate toggle or slide switch, or a rotary control switch mounted on  $R6$ , as preferred. A 12-volt d.c.

(Continued on page 112)

# LET'S LISTEN TO CENTRAL AND SOUTH AMERICA

Prepared by **ROGER LEGGE**

*Most of the short-wave broadcasts by stations in South America, Central America, and the West Indies are intended for reception within the country in which the broadcasts originate. These stations operate with lower power than most international broadcasting stations and generally use non-directional antennas. However, stations in most of these countries can be heard if you know where and when to tune for them. Here are the best times for listening.*

COUNTRY	STATION AND LOCATION	TIMES (GMT)	FREQUENCY (MHz)	LANGUAGES
ARGENTINA	R. Splendid, Buenos Aires	0000-0200	5.985	Spanish
	R. Nacional, Buenos Aires	1400-1700	15.345	Spanish
BOLIVIA	R. Altiplano, La Paz	0200-0600	5.045	Spanish
BRAZIL	R. Globo, Rio de Janeiro	0000-0400	6.035	Portuguese
	R. Nacional, Rio de Janeiro	2300-0200	6.145	Portuguese
	R. Cultura do Bahia, Salvador	0000-0400	9.595	Portuguese
	R. Tupi, Sao Paulo	0000-0400	11.765	Portuguese
	R. Cultura, Sao Paulo	2200-0100	17.815	Portuguese
BRITISH HONDURAS	R. Belize, Belize	0030-0400	3.30	English
CHILE	R. Pres. Balmaceda, Santiago	0300-0430	9.60	Spanish
	R. Nuevo Mundo, Santiago	0100-0430	11.742	Spanish
COLOMBIA	R. Sutatenza, Sutatenza	0000-0315, 1015-1300	5.095	Spanish
	La Voz de Tolima, Ibague	0000-0400, 1100-1300	6.04	Spanish
	Em. Nueva Granada, Bogota	0000-0600, 1100-1300	6.16	Spanish
COSTA RICA	R. Reloj, San Jose	0000-0600, 1200-1300	6.21	Spanish
	La Voz de la Victor, San Jose	1200-1400	9.615	Spanish
DOMINICAN REPUBLIC	R. Dominicana, Santo Domingo	0000-0500, 1100-1300	6.09	Spanish
		1100-1400	9.505	Spanish
ECUADOR	R. Nacional Espejo, Quito	0300-0600	4.885	Spanish
	R. Quito, Quito	0000-0600	4.922	Spanish
EL SALVADOR	R. Nacional, San Salvador	2200-0400, 1200-1400	9.552	Spanish
FRENCH GUIANA	R.T.F., Cayenne	0000-0300	4.892	French
GUATEMALA	R. Neuvo Mundo, Guatemala City	1100-1300	5.99	Spanish
	R. Nacional, Guatemala City	0000-0600, 1200-1400	6.18	Spanish
GUYANA	Voice of Guyana, Georgetown	0915-1100	5.98	English
HAITI	R. Haiti, Port-au-Prince	0100-0300, 1100-1300	6.195	French
	4VEH, Cap Haitien	1000-1500, 1700-0300	11.835	English/ French
HONDURAS	R. Evangelica, Tegucigalpa	0000-0400	4.82	Spanish
	La Voz de Honduras, Tegucigalpa	0000-0400, 1200-1300	5.875	Spanish
MARTINIQUE	R.T.F., Fort de France	1015-1200	4.895	French
MEXICO	XEWW, Mexico City	1145-1600, 2200-0600	9.515	Spanish
	XEHH, Mexico City	1200-1800, 2200-0600	11.88	Spanish
NICARAGUA	R. Mundial, Managua	0100-0500	5.965	Spanish
PANAMA	La Voz del Barú, David	1100-1200	6.045	Spanish
PARAGUAY	R. Encarnacion, Encarnacion	2200-2400	11.947	Spanish
PERU	R. Nacional, Lima	1100-1300	9.562	Spanish
URUGUAY	El Espectador, Montevideo	0300-0500	11.835	Spanish
VENEZUELA	R. Bolivar, Ciudad Bolivar	0000-0300	4.77	Spanish
	R. Nacional Caracas	0000-0330, 1100-1300	6.17	Spanish
	R. Barquisimeto, Barquisimeto	1100-1300	9.51	Spanish
WINDWARD ISLANDS	Windward Is. B/C Service, Grenada	0000-0230	11.975	English



# SHORT-WAVE LISTENING

By **HANK BENNETT**, W2PNA/WPE2FT  
Short-Wave Editor

## HARMONIC DX'ING

**D**uring the past several months, there has been an increase in the number of DX reports of "harmonics." Although some of these reports are obviously legitimate and of great interest to SWL's, the situation regarding harmonic DX'ing is far from clear.

Possibly Bob Padula, writing on this subject in a recent issue of *Australian DX News*, best stated the case when he observed that reports of harmonic reception have (sometimes) been due to an inability on the part of the listener to recognize receiver fault conditions—faults which can easily give the impression that an SWL is tuned to a station broadcasting on a much higher frequency than is actually being utilized.

Les Solomon, the Technical Editor of *POPULAR ELECTRONICS*, has listed for me several common faults which create the impression that received signals are harmonics. They include:

- (1) Receiver front-end overload (particularly vulnerable are VHF receivers near FM or TV broadcasters).
- (2) Heterodyning from oscillators in nearby receivers (this frequently makes "harmonics" appear above 25 MHz).
- (3) I.f. stage regeneration.
- (4) Unannounced test broadcasts or clandestine "rebroadcasters."

Your Short-Wave Editor urges all monitors to be extremely cautious when report-

ing reception of stations that are apparently operating on harmonic frequencies. Some are real, but at best these signals should be very weak—many are not.

**WRTH Price Increases.** First copies of the 1968 *World Radio TV Handbook* were to be mailed in early December. The pre-publication price of this valuable listing of

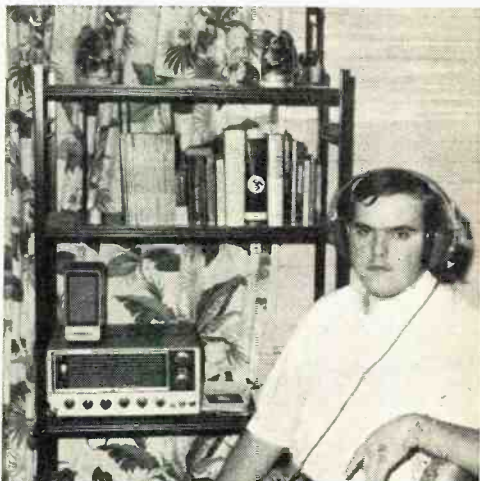

John Rhodes, WPE4JHJ, of La Fayette, Ga., is a member of the DX Clubs of Radio Portugal, Radio Canada, Radio RSA, and Radio New York Worldwide. He DX'es with a Lafayette (as you might expect, considering where he lives) Model HA-230 receiver. To date, John has 31 countries verified.



Jose Diny's, of Aparecida, Brazil, handles a very large volume of station correspondence as Chief of Correspondence for Radio Aparecida. This broadcaster has outlets on 1600 kHz (ZYR44 with 250 watts out); 3285 kHz (ZYR89, 1 kilowatt); and 9635 kHz (ZYR83, 7.5 kilowatts).

all short-wave broadcasters was \$4.95. It is being increased to \$5.95 before the end of December. If you have not ordered your copy, you'll want to do so immediately. As usual, Gilfer Associates, Inc., P.O. Box 239, Park Ridge, N.J., has the new edition in stock.

**A Thank You.** In this, the last issue of the year, your Short-Wave Editor would like to thank the many monitors who, with patience and diligence—shown by their reports, helped us prepare this column during 1967.

(Continued on page 108)



# ENGLISH-LANGUAGE BROADCASTS TO NORTH AMERICA

## FOR THE MONTH OF JANUARY

Prepared by **ROGER LEGGE**

### TO EASTERN AND CENTRAL NORTH AMERICA

TIME—EST	TIME—GMT	STATION AND LOCATION	FREQUENCIES (MHz)
6:15 a.m.	1115	Melbourne, Australia	9.58, 11.71
7 a.m.	1200	Tokyo, Japan	9.505
7:15 a.m.	1215	Montreal, Canada	5.97, 11.72
7:45 a.m.	1245	Copenhagen, Denmark	15.165
9 a.m.	1400	Stockholm, Sweden	21.585
6 p.m.	2300	London, England	6.11, 9.58, 11.78
		Moscow, U.S.S.R.	7.29, 9.665, 9.685
7 p.m.	0000	Peking, China	15.06, 17.68
		Sofia, Bulgaria	9.70
		Tirana, Albania	7.263
7:30 p.m.	0030	Budapest, Hungary	6.235, 9.833, 11.91
		Johannesburg, South Africa	11.875, 15.22
		Kiev, U.S.S.R. (Mon., Thurs., Fri.)	7.29, 9.685
		Stockholm, Sweden	5.99
7:50 p.m.	0050	Vatican City	6.145, 9.69, 11.76
8 p.m.	0100	Berlin, Germany	9.675, 9.73
		Madrid, Spain	6.13, 9.76
		Melbourne, Australia	15.32, 17.84
		Prague, Czechoslovakia	5.93, 7.345, 9.55, 11.99
		Rome, Italy	9.575, 11.81
8:30 p.m.	0130	Berne, Switzerland	6.12, 9.535, 11.715
		Cairo, U.A.R.	9.475
		Cologne, Germany	9.64, 11.945
		Hilversum, Holland	9.59 (Bonaire relay)
9 p.m.	0200	Helsinki, Finland	9.585
		Lisbon, Portugal	6.025, 9.68, 11.935
		London, England	6.11, 7.13, 9.58
		Moscow, U.S.S.R.	7.205, 9.665, 9.685
		Stockholm, Sweden	5.99
9:30 p.m.	0230	Beirut, Lebanon	11.925

### TO WESTERN NORTH AMERICA

TIME—PST	TIME—GMT	STATION AND LOCATION	FREQUENCIES (MHz)
8 a.m.	1600	Tokyo, Japan	9.505
6 p.m.	0200	Melbourne, Australia	15.32, 17.84
		Taipei, China	15.125, 15.345, 17.72
		Tokyo, Japan	15.135, 15.235, 17.825
6:30 p.m.	0230	Johannesburg, South Africa	9.705, 11.875
7 p.m.	0300	Madrid, Spain	6.13, 9.76
		Peking, China	9.457, 11.82, 15.095
		Seoul, Korea	15.43
7:20 p.m.	0320	Yerevan, U.S.S.R. (Tues., Wed., Fri., Sat.)	11.85, 15.18
7:30 p.m.	0330	Prague, Czechoslovakia	5.93, 7.345, 9.55, 11.99
		Stockholm, Sweden	11.705
7:45 p.m.	0345	Berlin, Germany	9.56, 9.65
8 p.m.	0400	Lisbon, Portugal	6.025, 9.68, 11.935
		Moscow, U.S.S.R. (via Khabarovsk)	9.735, 11.85, 15.18
		Sofia, Bulgaria	9.70
8:30 p.m.	0430	Bucharest, Rumania	6.15, 9.51, 11.94
		Budapest, Hungary	6.235, 9.833
		Kiev, U.S.S.R. (Mon., Thurs., Sat.)	7.29, 9.685
8:45 p.m.	0445	Cologne, Germany	9.735, 11.945
9:15 p.m.	0515	Berne, Switzerland	6.12, 9.695
10:30 p.m.	0630	Havana, Cuba	9.655



# ON THE CITIZENS BAND

By MATT P. SPINELLO, KHC2060, CB Editor

IN the December CB column, AVERT, the Association of Volunteer Emergency Radio Teams, was listed on the final OTCB Club Roster for 1967. As a follow-up, AVERT coordinator Chuck Brown, KOI2103, has forwarded some interesting details on the association's activities—including the part it played in *Operation Phantom II*.

Headquartered in Springfield, Va., AVERT is a CB service organization with members located throughout the United States. They include CB'ers from REACT teams, search and rescue groups, CB clubs, and individuals too remotely located to participate in regular club functions. AVERT is basically interested in supplying emergency monitoring on channel 9 to aid CB mobile units or base stations that may require help or information. Members volunteer for specific monitoring hours, on a monthly basis. The group's ultimate objective is nationwide 24-hour monitoring.

On September 16, 1967, the District of Columbia Medical Society sponsored and conducted *Operation Phantom II* in the Washington, D.C., metropolitan area. The exercise was a test of metropolitan area readiness for the hospitalization and medical evacuation needs resulting from a major disaster. *Phantom II* gave 166 CB'ers

from 15 CB organizations an opportunity to demonstrate CB radio effectiveness, and experience in network operations and message handling between various disaster control points. And AVERT provided the initial planning for CB participation in *Operation Phantom II*, hosting an orientation meeting of liaison representatives from the 15 CB organizations involved.

Communications networks during the exercise became a joint effort by CB'ers, hams, the Military Affiliated Radio Service (MARS), and the Civil Air Patrol. Other participants included the medical and administrative personnel of 20 hospitals, the staff and personnel of the D.C. Medical Society, and personnel and equipment to transport 2500 "casualty-played" persons through the metropolitan area by bus, helicopter, and boat. Five thousand additional minor casualties were assembled but not casualty-played by volunteers.

The CB radio net control and relay capabilities were generated by the RAMCO CB Radio Club at the Montgomery County CD/CB station, Rockville, Md.; by the Channel Busters CB Radio Club at Silver Spring, Md.; and by the operation of the Springfield REACT team, Alexandria, Va. Valuable assistance was also given by the Northern Virginia CB Club, Herdon REACT team, Fairfax REACT team, D.C. REACT team, S.E. REACT CB Radio Club, ARFAC CB Radio Club, Maryland H.E.L.P.

Volunteers made up as "casualties" to take part in OPERATION PHANTOM II exercise are shown as they arrived at one of the 20 hospitals participating in the disaster drill. Radio escorts for the "casualties" included CB'ers from the Maryland H.E.L.P. CB Radio Club and the Capitol Area Rescue Squad.





During OPERATION PHANTOM II, Bernard Hartley, KCG2277, of the RAMCO CB Radio Club, operated the Civil Defense CB station at the Emergency Operations Center in Montgomery County. The transceiver used at the station is a Browning "Eagle."

CB Radio Club, Metropolitan Area Radio Club, Capitol Area Rescue Squad, Prince George CB Radio Club, and the Citizens Band Radio Emergency Corps.

Overall CB coordinator for *Operation Phantom II*, AVERT's Chuck Brown wrote an editorial in the association's newsletter about the disaster exercise. In it, he stated that probably the most important accomplishment of the exercise was the creation of an effective plan whereby any town or community in the U.S. can utilize the Citizens Radio Service as an emergency radio communications network.

The CB portion of the disaster exercise was considered successful. In action, the network stretched across parts of Washington, D.C., Maryland, and Virginia, with radio communications provided to 20 hospitals, Red Cross offices, Civil Defense and other agencies.

The Association of Volunteer Emergency Radio Teams took special pride in having initiated the concept and planning stages for CB participation in *Operation Phantom II*, and AVERT extends thanks publicly to all the CB'ers and organizations that contributed their time and efforts to the project. Organizations that would like further information on the association are invited to write to: AVERT, Dept. 18, 7430 Hastings St., Springfield, Va. 22150.

**Canadian Corner.** According to Harold Merton, XM44042, publisher of *SCOPE*, Canada's GRS Journal, the release of the Department of Transport's new 51-page General Radio Service Handbook is a milestone in GRS history.

The original idea for the handbook was delivered to DOT officials in Ottawa by the resolutions committee of the Annual GRS

Convention almost two years ago. Somehow, a misunderstanding arose. The DOT had been under the impression that the cost of printing such a handbook was to be borne by GRS, while GRS representatives thought they were to prepare the editorial copy and that the DOT would publish the book. The plan was tabled until the following year when it was again presented to the DOT, this time with a request that the DOT assume the costs of publishing the handbook. The book was prepared and has been distributed to regional DOT offices throughout Canada, in English and French editions.

Harold Merton maintains that the important part of the whole project is that the DOT produced the handbook strictly on the recommendation of Canada's GRS users. He feels that it was an accomplishment for the resolutions committee to be granted a meeting with top officials of the DOT, a further compliment to have been invited to return the following year, and a good sign of understanding and rapport between the governing body and the GRS to have the DOT authorize the expense of such a volume.

The completeness of the handbook in its handling of regulations, licensing, installa-



tion and servicing, communications, and procedures, makes the volume a must for all GRS newcomers and veteran operators as well. It is our understanding that copies may be obtained by request at any regional office, and that clubs may secure sufficient quantities for their members by writing the DOT.

**CB Jamborees.** It is unfortunate that many CB Jamborees have missed mention in this column over the last five years. There  
(Continued on page 103)











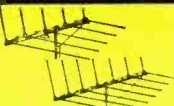
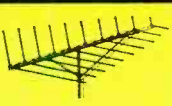







# NEW FINCO® COLOR SPECTRUM™ antennas are "signal customized" for better color reception...

"the ANTENNA that captures the RAINBOW"

FINCO has developed the Color Spectrum Series of antennas—"Signal Customized"—to exactly fit the requirements of any given area. There is a model scientifically designed and engineered for your area.

Check this chart for the FINCO "Signal Customized" Antenna best suited for your area.

STRENGTH OF UHF SIGNAL AT RECEIVING ANTENNA LOCATION ↓	Strength of VHF Signal at Receiving Antenna Location				
	NO VHF ↓	VHF SIGNAL STRONG ↓	VHF SIGNAL MODERATE ↓	VHF SIGNAL WEAK ↓	VHF SIGNAL VERY WEAK ↓
NO UHF →		 CS-V3 \$10.95	 CS-V5 \$17.50 CS-V7 \$24.95	 CS-V10 \$35.95	 CS-V15 \$48.50 CS-V18 \$56.50
UHF SIGNAL STRONG →	 CS-U1 \$9.95	 CS-A1 \$18.95	 CS-B1 \$29.95	 CS-C1 \$43.95	 CS-C1 \$43.95
UHF SIGNAL WEAK →	 CS-U2 \$14.95	 CS-A2 \$22.95	 CS-B3 \$49.95	 CS-C3 \$59.95	 CS-D3 \$69.95
UHF SIGNAL VERY WEAK →	 CS-U3 \$21.95	 CS-A3 \$30.95	 CS-B3 \$49.95	 CS-C3 \$59.95	 CS-D3 \$69.95

NOTE: In addition to the regular 300 ohm models (above), each model is available in a 75 ohm coaxial cable download where this type of installation is preferable. These models, designated "XCS", each come complete with a compact behind-the-set 75 ohm to 300 ohm balun-splitter to match the antenna system to the proper set terminals.



**THE FINNEY COMPANY**  
34 West Interstate Street  
Dept. PE • Bedford, Ohio 44146

Send for free brochure

Name \_\_\_\_\_

Address \_\_\_\_\_

City \_\_\_\_\_ State \_\_\_\_\_ Zip \_\_\_\_\_

CIRCLE NO. 30 ON READER SERVICE PAGE

# NTS PUTS YOU WHERE THE MONEY IS ... FAST!

NTS Home-Study training is for men in a hurry to move up! NTS Electronics Courses are geared to the needs of the electronics industry. This is up-to-date training. As modern as tomorrow.

Our close working relationship with electronics companies all over the country is the key. They tell us what you need to know to be a top-flight technician. They

keep us informed of new, exciting career opportunities. With this information, we constantly revise our courses to keep our home-study students one step ahead. In an industry that moves so rapidly, advancement comes quickly to the man with NTS training.

Since 1905, NTS has been leading ambitious men to where the money is. Join them.

## EXCLUSIVE! ONLY FROM NTS! ALL NEW KITS... MAKE IT FUN TO LEARN, EASIER TO EARN.

For the first time! The greatest lineup of electronics kits ever offered to train you for the space-age. Only NTS has them. Designed for tomorrow... each has all

the latest electronics advances built in. NTS trains you better. NTS makes it fun to learn, easier to earn more, TODAY.

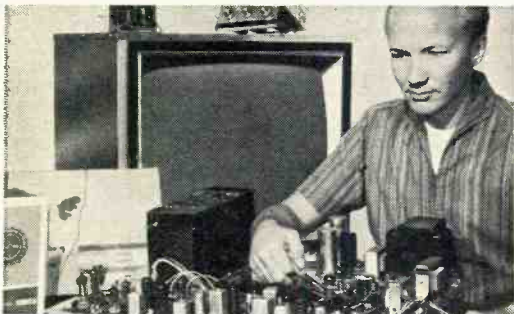

**25" COLOR TV:** Included in Color TV servicing courses ...to prepare you for the big demand for qualified service technicians. This is where the big money is. More than 16 million homes will have color TV by the end of this year. You can cash in on the boom. You can take a giant step ahead with professional training from NTS.



**COMMUNICATIONS:** Transceiver included in Communications Courses. This modern equipment is an important element in communications. You get it, you build it. With it you easily prepare for the F.C.C. License Exam. You become a fully trained man in communications, where career opportunities are unlimited.

**ALL  
NEW KITS!  
ALL NEW  
COURSES!**

**DESK-TOP COMPUTER:** Professionally designed exclusively for NTS. Included with your Industrial and Computer Electronics Course. You can't get this computer kit, or anything like it, anywhere else. The special

computer and integrated circuitry of the training kits prepare you for a big career in this giant industry. These are the first kits offered by any school which include actual integrated circuits.



## LEARN MORE, EARN MORE—IN ELECTRONICS

**SIGNAL GENERATOR, VTVM, AND TUBE CHECKER INCLUDED WITH NTS ELECTRONICS COURSES.** These are invaluable instruments for all kinds of Electronic and TV-radio servicing work. You learn to use them early in your training. Begin trouble-shooting work to earn money even before you've completed your course. Many of our students have more than paid for their NTS home-training this way—even before they graduated!

With these professional instruments, you are well-equipped to go into a business of your own. They're all you need to pinpoint most of the trouble spots in TV, Radio, or other electronic components. You get them at no extra cost—as part of your NTS training.

### YOUR OWN BUSINESS

The big jobs belong to the men who prepare for them. You can earn money—learn how to start a business of your own—with NTS home training.

NTS starts you out right with the exclusive **Project Method Career Kit**. Contains everything you need to make your training easy. Keeps you organized. You learn faster. You move ahead that much sooner.

You can get all the details on the many advantages of NTS **Project Method** home training. It's all in the NTS catalog, along with pictures and information on all the equipment and exciting kits you receive and keep. Tells you all you need to know to get started.

### CLASSROOM TRAINING AT LOS ANGELES:

You can take classroom training at Los Angeles in sunny Southern California. NTS occupies a city block with over a million dollars in facilities devoted exclusively to technical training. Check special box in coupon.



### HIGH SCHOOL AT HOME

National offers accredited high school programs. Take only subjects you need. Study at your own pace. Everything included at one low tuition. Check special high school box in coupon for full information and **FREE** catalog.

### MAIL REPLY CARD OR COUPON FOR NEW COLOR CATALOG & SAMPLE LESSON. **THEY'RE FREE!**

We Have No Salesman:  
This Means Lower Tuition For You.



## NATIONAL TECHNICAL SCHOOLS

WORLD-WIDE TRAINING SINCE 1905

4000 So. Figueroa St., Los Angeles, Calif. 90037

Accredited Member National Home Study Council  
Accredited Member National Association of Trade & Technical Schools

9  
TRAINING  
PROGRAMS

## NATIONAL TECHNICAL SCHOOLS

4000 S. Figueroa St., Los Angeles, California 90037

APPROVED  
FOR  
VETERANS

Please rush Free Color Catalog and Sample Lesson, plus detailed information on field checked below. No obligation.

- Master Course in Color TV Servicing
- Color TV Servicing for Qualified Technicians
- Master Course in TV & Radio Servicing
- Practical TV & Radio Servicing
- Master Course in Electronic Communications
- FCC License Course
- Industrial & Computer Electronics
- Stereo, Hi-Fi & Sound Systems
- Basic Electronics     High School at Home

NAME \_\_\_\_\_ AGE \_\_\_\_\_

ADDRESS \_\_\_\_\_

CITY \_\_\_\_\_ STATE \_\_\_\_\_

Please fill in Zip Code for fast service

- Check if interested in Veteran Training under new G. I. Bill. (Dept. 205-18)
- Check if interested **ONLY** in Classroom Training at Los Angeles.



# tips & techniques

## CONTROL THREE RELAYS IN A FIVE-WAY MODE

"On-line" relay control is one of the more popular methods for controlling electrical devices from remote locations. Normally, such a system would require a separate pair of conductors and a separate switch. However, only three conductors and a single five-

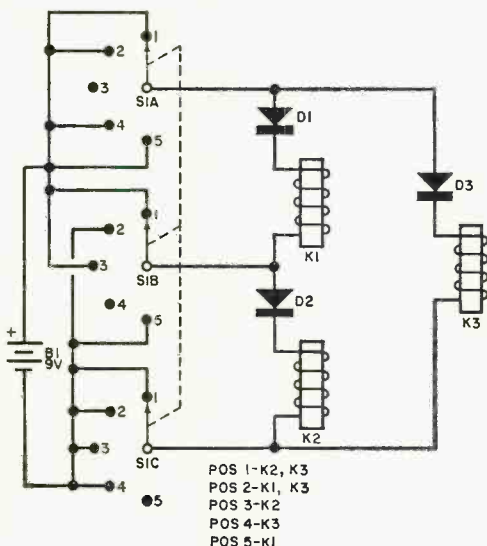

position rotary switch will allow you to control up to three relays. The secret is in the proper use of diodes ( $D1$ ,  $D2$ , and  $D3$  in schematic) in series with the relay windings. The various positions of switch  $S1$  control power to relays  $K1$ ,  $K2$  and  $K3$  as indicated in the listing below the schematic. Power is provided by  $B1$ , a 9-volt battery; and  $D1$ ,  $D2$ , and  $D3$  are 1N34 diodes. Relays  $K1$ ,  $K2$ , and  $K3$  should be low-current (5 to 15 mA) 6-volt units.

—Mahaveerchand Bhandari

## MAKE YOUR OWN MINIATURE MERCURY SWITCH

If you have an old thermometer and a miniature NE-2 neon lamp, you have the makings of a mercury switch for compact projects. The glass tip of the lamp must first be carefully ground down until you have about a 1/32" diameter hole in the envelope. Insert a sewing needle through this hole and bend the

electrodes as far apart as possible (see drawing). Break the thermometer in half, and heat the bulb end to extract a 1/10" to 1/8" bead of mercury. Use a medicine dropper to force the bead of mercury through the hole in the lamp's envelope. Now check the make-and-break action of your home-made mercury switch using a continuity checker; inter-



mittent "make" action means that more mercury must be added, and improper "break" action indicates that some of the mercury must be removed. Finally, seal the hole in the lamp's envelope with plastic cement.

—Frederic W. Chesson

## CABLE CONNECTORS SAVE TIME AND EFFORT

Still fumbling with a screwdriver to disconnect the antennas from your TV set and FM and short-wave receivers whenever the sets have to be moved? If so, you can save a lot of time and effort with a couple of twin-line antenna cable connectors. These Mosley 301 and 311 connectors can be fitted between the set's antenna input terminals and the 300-ohm twin-line cable in short order. Connect

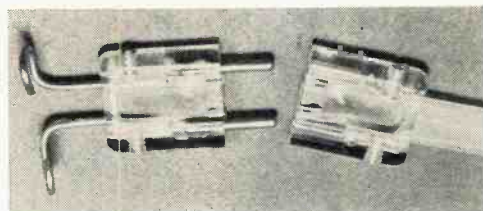

the lead-in cable to the female connector as needed. Then fit a pair of heavy bare wires into the male connector and bend the wires as shown in the photo. Finally, mount the male connector—via the bent wires—to the antenna input terminals on your set, and snap the two sections of the connector together. When you have to remove the antenna for any reason, simply reach behind the set and unplug it—total time, about 2 seconds

—Steven Koons

## USE PERMANENT MARKER PEN TO LAY OUT ETCH PATTERN

The most time-consuming part of building a project that incorporates a printed circuit board is the laying down of the resist pattern. You've probably struggled along with messy liquid resist or resist tape, strips, and dots. An easier way to lay out the etch pattern is to use a felt- or nylon-tipped permanent marker. (The ink in such markers has the properties of regular etch resist solutions.) The marker

tips can be shaped with a knife for the desired foil pattern width. Draw the resist pattern directly on the foil side of the board, making large dots where holes are to be drilled. Two or more coats of ink are generally needed for good resistance to the etching solution. To etch the board, immerse it in a concentrated solution of hot ferric chloride (without additives).  
—Bert Thiel

### IMPROVE BASS RESPONSE OF INEXPENSIVE SPEAKERS

Many inexpensive 8" and 10" PM speakers have an annoying tendency to resonate in the upper bass region of the audio spectrum, causing the notes below this point to drop off sharply. The result is restricted and irregular response. However, you can improve the speaker's compliance, which will push the resonance effect into the lower bass region for a more uniform frequency response in the mid- and upper bass ranges. All you need is a fine-grit abrasive paper or a disposable emery board. Carefully file (sand) the circumference of the cone along the corrugated surround as shown in the photo. Don't file too long in one spot or you will go right through the cone. You will soon notice that the cone moves more freely—freer cone movement means higher compliance and increased bass response.

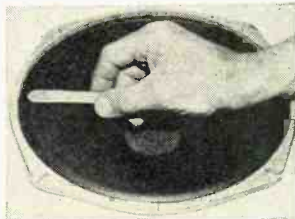

—Art Trauffer

### OPERATE BATTERY-POWERED CLOCK FROM A.C. LINE POWER

Many people who have battery-powered clocks often find that replacing worn batteries is too much of a bother. You can quickly assemble a simple power supply, as shown below, to convert the clock to a.c. power and eliminate the need for batteries. Because power is required only once in about 5 min-

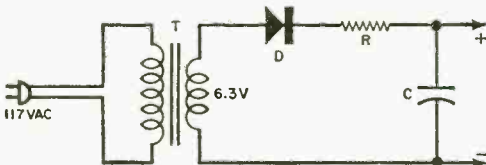

utes (to turn a motor that, in turn, winds a conventional mechanical clock mechanism), the resistance value should be selected to yield an RC time constant of approximately 5 minutes when connected to the 1000- $\mu$ F capacitor. A 6-volt, 1-ampere (at least) filament transformer, and a 1N1115 silicon diode are the only other parts you need. When connecting the power supply to the clock, be sure to observe the correct polarity.  
—Tom Li

January, 1968

# HAMS! CBERS! E-V PUTS THE WORLD AT YOUR FINGER TIPS!

\$1.00



NEW  
4th Edition  
"SECOND OP"

Essential DX operating aid, provides vital data like: beam headings; list of world QSL bureaus; includes logging space. See needed prefixes at a glance, increase your odds of a QSO because you have full information instantly.

\$1.00



NEW "Q" DIAL

A must for every active operator, ham or C.B. Over a dozen vital information tables including: Q-signals, 10-signals, abbreviations, all U.S. radio districts and prefixes, time conversion, logging space for CW-SSB-CB. Saves time for efficient operation.

At your E-V microphone headquarters, or send coupon.

**ElectroVoice®**

Dept. 183P, 630 Cecil Street, Buchanan, Michigan 49107  
Please send \_\_\_\_\_ Second Op, \_\_\_\_\_ Q Dial. I enclose \$1.00 for each item ordered.

Name \_\_\_\_\_  
Address \_\_\_\_\_  
City \_\_\_\_\_  
State \_\_\_\_\_ Zip \_\_\_\_\_



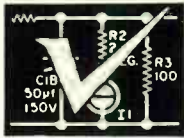

## OPERATION ASSIST

*Through this column we try to make it possible for readers needing information on outdated, obscure, and unusual radio-electronics gear to get help from other P.E. readers. Here's how it works: Check the list below. If you can help anyone with a schematic or other information, write him directly—he'll appreciate it. If you need help, send a postcard to Operation Assist, POPULAR ELECTRONICS, One Park Avenue, New York, N.Y. 10016. Give maker's name, model number, year of manufacture, bands covered, tubes used, etc. State specifically what you want, i.e., schematic, source for parts, etc. Be sure to print or type everything legibly, including your name and address. Because we get so many inquiries, none of them can be acknowledged. POPULAR ELECTRONICS reserves the right to publish only those items not available from normal sources.*

**Supreme Model 85** tube tester. Tube chart, instruction manual, and schematic needed. (Bill Simmons, 2223 Culver Rd., Rochester, N.Y. 14609)

**E. H. Scott Model SLRM** receiver, circa 1942; has 4 bands, 11 tubes, and "magic eye." Schematic and tuning alignment instructions needed. (Michael Bishop, 208 Water St., Chardon, Ohio 44024)

**Zenith Model 26-235** receiver, ser. S 712948, chassis #1005, circa 1940; tunes 55 to 160 kHz (BCB) and 1.6 to 18 MHz on 2 bands; has 9 tubes and "magic eye." Schematic needed. (Sewim Ablay, 6552 Kingsbury, Dearborn Heights, Mich. 48127)

**Majestic Model 130-A TRF** "Super Screen Grid Receiver" made by Grigsby-Grunow Co., Chicago, circa 1930. Schematic needed. (John Smoroden, 911 Langin Rd., S., Cranbrook, B.C., Canada)

**Zenith Model 6-S-254** receiver, circa 1940; tunes BCB from 55 to 170 kHz and s.w. from 1.8 to 18 MHz; has 3 bands and 6 tubes. Schematic needed. (Thomas Weigand, Willardshire Rd., Orchard Park, N.Y. 14127)

**RCA "Radiola 26"** AM receiver, circa 1925; has 6 tubes. Three #UV-199 tubes needed. (Sam Samuelian, Jr., 7000 Llanfair Rd., Upper Darby, Pa. 19082)

**Fisher Model K2** radio-phonograph, ser. 2120; 16-tube tuner—FM, AM, s.w.—with phono and TV input and 1-tube preamp chassis with 7-tube power amplifier; has 8 push-button station selector and bass and treble tuning control. Schematic and/or servicing information needed; also brass escutcheon plate for push button and control knobs. (Harold Parchment, 160 Stony Hollow Rd., Greenlawn, N.Y. 11740)

**Torotor No. 75P3AG42D** transistorized FM front end, made in Denmark, 1964. Schematic and operating data needed. (Arthur Jesberger, 144 Old Bergen Rd., Jersey City, N.J. 07305)

**Calrad Model STA-330** AM-FM stereo amplifier. Schematic needed. (Steve Gebier, 16809 Hartland Ave., Van Nuys, Calif. 91406)

**Technical Radio Co. Model LRR-5** receiver, ser. 4, 1945; tunes 0.54 to 1.6—2.6—6.5, and 6.5—18 MHz. Schematic and operating manual needed. (John Reinhold, P.O. Box 8055, Reno, Nev.)

**Jewell Electrical Instrument Co. A.C.** tube checker, pattern 210; tests 4-5 pin tubes. Schematic and technical data needed. (Donn Miller, 2391 Werren Rd., Walnut Creek, Calif. 94529)

**Majestic Model 90** AM receiver, ser. 9A-580341; has 7 tubes. Schematic and operating manual needed. Majestic power supply for Model 90 receiver, ser. 9P6-

166393; has 1 tube. Schematic and operating manual needed. (David A. Lengeling, Collins, Iowa 50055)

**Geloso Model G-255-S** tape recorder. Instruction manual, source for parts, and schematic needed. **Stuzzi Type 671 B "Magnetite"** Source for parts and servicing manual needed. (J. C. Howlett, 83 Louisa St., Kitchener, Ont., Canada)

**Phillips BD273U** receiver; circa 1957-8; tunes 4 bands including FM; has 6 tubes. Translation for schematic and alignment data printed in German needed. (James Lambert, 901 J, Aurora, Neb. 68818)

**Hallicrafters Model CA-2** i.f. receiver; has 5 tubes plus 6517 vibrator. Schematic and operating instructions needed. (Marc L. Ferreira, 1216 Rivera St., El Cerrito, Calif. 94530)

**E. H. Scott Model SLR-H** receiver, ser. 4169, 1942; tunes 0.55-16.5 MHz on 3 bands; has 11 tubes. Operating manual and schematic needed. (P. C. McIntyre, 1110 N.E. 52 Ave., Portland, Ore. 97213)

**GE Model 4RMV35B1** FM receiver, type RMV-35B; tunes 30-42 MHz; has 12 tubes; mobile type. Schematic and service manual needed. (John Cunningham, Route 6, Shrub Oak, N.Y. 10588)

**Tray-Ler table model AM a.c.-d.c.** receiver, ser. 297159, N-F-2; has 6 tubes. Schematic needed. (D. Landesberg, 179 Marcy Ave., Brooklyn, N.Y. 11211)

**Truetone Model JD-727** receiver, circa 1920; 550-1600 kHz, 1.8-5.0 MHz. Schematic and source for 8 tubes needed. (Mike Heckrotte, 13932 Burning Tree Dr., Victorville, Calif.)

**National Model HRO-50** receiver; AC-AB-J-H-G-F and SOF-3 Select-O-Ject. Plug-in coil sets needed. (R. D. Wartes, 4402B, Boston Ave., Lubbock, Texas 79413)

**Midwest Instrument Model C.B. 54** Cathode Beamer (kinescope analyzer). Operating manual needed. (John F. Anderson, 478 N. 7th Ave., Canton, Ill. 61520)

**National Model HRO-7R** receiver; has 4 plug-in coils; tunes 1.7 to 30 MHz; has separate power supply. Schematic and operating manual needed. (Tommy Todd, 1300 S.W. 62, Oklahoma City, Okla. 73159)

**Sparton Model 931** receiver, circa 1928; has 10 tubes; tunes AM. Tube layout and schematic needed. (Mark Hansen, 6322 S. Pierce Ave., Whittier, Calif. 90601)

**Hickok Model 292X** signal generator; tunes 125 kHz to 220 MHz. Schematic and instruction manual needed. (A. C. Lewis, Box 100, Humboldt, Tenn. 38343)

**Freed Eisemann Model ND-5** receiver, 1920. Interstage transformer and 5 UV-201A or C-301A tubes needed. (Terry Loving, 613 E. College #5, Carbondale, Ill. 62901)

**RCA Model V-219** Victrola, ser. 041030; has 8 tubes. Schematic needed. (Carl W. Betcher, Jr., R.F.D. #1, Campbell Hall, N.Y. 1916)

**General Motors Model 253** receiver, ser. 6235 S 3 A, circa 1930's; has 10 tubes; tunes 550-1600 kHz. Schematic needed. (George Topuline, 4028 Marathon St., Los Angeles, Calif. 90029)

**RCA UHF transmitter MI-7752**, 1939; has 7 tubes. Schematic and operating manual needed. (Don Merritt, 182 Hawthorn Dr., Painesville, Ohio 44077)

**Hallicrafters Model S-20-R** SW receiver; tunes 540 kHz to 44 MHz on 4 bands; has 9 tubes. Schematic, operating manual, and alignment data needed. (Bobby Horner, 9142 Southwood, Shreveport, La. 71108)

**Heathkit Model T-3** visual-aural signal tracer. Schematic and operating manual needed. (Wallace F. Peterson, R #1, Box 248, Thompson, Conn. 06277)

**RME Model 70** receiver; has 10 tubes; covers 550 kHz to 30 MHz. Schematic and operating manual needed. (Stephen J. Silva, 29 Hillside St., Fall River, Mass. 02720)

**Radio Shack Model CBK-1** CB transceiver; has 5 tubes. **International Crystal "Executive"** Model 100-A CB transceiver; has 9 tubes. Schematics and operating manuals needed. **Northern Electric "Mark II"** tank transceiver, circa 1942; ZA-10175, PC92049C. Schematic, operating manual, and parts source needed. (Paul H. Gorrell, P.O. Box 413, Teaticket, Mass. 02536)

**CWS-52244** radio transmitter, part of homing equipment Model YG-2, circa 1944; U.S. Navy. Schematic and/or manual needed. (D. Blanchard, 216 Carson Way, Henderson, Nev. 89015)

**70-480 pF** mica trimmer capacitor and two 1AC5 sub-miniature transmitting tubes needed. (Robert Kalke, 1820 S. Ashland Ave., Park Ridge, Ill. 60068)



**Heathkit Model GR-91** general-coverage receiver, 1963; tunes 550 kHz to 30 MHz; has 4 tubes. Operating manual needed. (Brad Hart, 1290 S. Quebec Way, Denver, Col. 80222)

**GE E1A transmitter and E3A receiver**, 30-40 MHz and FM, circa 1944. Schematics wanted. (M.C. Stewart, Ashburnham, Mass. 01430)

**RCA 46X11 a.c./d.c. receiver**; has 6 tubes; tunes 3 bands (SW and BC); 540-1600 kHz, 2300-6300 MHz.

**Philco Model 40-115 receiver**, code 121; has 6 tubes; tunes 2 bands (BC and police). Schematics and sources for parts needed. (Charles Kelsor, 615 S. Champion, Columbus, Ohio 43205)

**TM 11-267 Signal Corps technical manual** for tube tester I-177 and MX 949U adapter kit wanted. (C.E. Maass, 37 Haddonfield Rd., Short Hills, N.J. 07078)

**Anchor Model T 401 CRT tester/rejuvenator and Anchor Model UT 450 picture tube test adapter**, circa 1959. Schematics and operating manuals needed. (Wallace F. Peterson, R #1, Box 248, Thompson, Conn. 06277)

**Zenith Model G844 receiver**, chassis 8G21; tunes standard AM and FM broadcast bands. Source for AM dial-plate needed. (Larry Bates, 2155 Airport Blvd., Mobile, Ala. 36606)

**Philco Model 48-472 receiver**; tunes BC and FM; has 7 tubes. Operating manual, schematic, and tube source needed. (Bob Trotter, 75 Edgewater Dr., Blackstone, Mass. 01504)

**Superior Model 670 combination VTVM capacitor-resistor tester. Hallicrafters Model S 380 receiver**; has 5 tubes; tunes BC and SW. Schematics and instruction manuals needed. **Wurlitzer Model 851 amplifier**; 150 watts; has 5 tubes. Schematic and operating instructions, and/or tube chart, and source for speaker and tubes needed. (Jack Westbrooks, 9031 Meridian, Willis, Mich. 48191)

**Airline Model 04BR-513B receiver**; has 5 tubes; tunes AM only. Schematic needed. **Airline Model 62-455 receiver**, ser. 628524, circa 1937. Schematic, parts list, and oscillator coil needed. (George Milton, 34 Ottawa St., Plainfield, Ill. 60544)

**Silvertone TV receiver**, chassis 528-51188. Schematic and parts list needed. (George Robinson, 10550 Edbrooke, Chicago, Ill. 60628)

**Westinghouse Model H162 radio phonograph**; tunes BC, FM (88-108 MHz), and SW (5-18 MHz); has 14 tubes. Operating manual needed. (Jim Childs, RD #4, Kittanning, Pa. 16201)

**Globe HG-303 transmitter**; 80-10 meters, CW. Schematic, parts list, and operating manual needed. (Raymond N. Shwake, 17000 N.E. 6 Ct., N. Miami Beach, Fla. 33162)

**Link Model 1498-T transmitter**, ser. 222. Schematic and operating manual needed. **CW-52063A aircraft radio transmitter**, ser. 4058, circa 1941; part of equipment group GF-12; built for Navy by Western Electric. Schematic, operating manual, and source of tubes needed. (Darryl C. Foyuth, 281 Fieldboro Dr., Trenton, N.J. 08638)

**Panasonic Model RQ 114A battery-operated tape recorder**. Complete a.c. adapter needed, or double-pronged, square plug (from adapter to recorder) to fit jack in recorder. (Jim Currall, 8625 Minnehaha Ln., Kansas City, Mo. 64114)

**Heathkit W-5M Williamson-type amplifier**, 1959; 25 watts; has 5 tubes, including rectifier. Want to buy. (Thomas Clark, Seth Low Mt. Rd., Ridgefield, Conn. 06877)

**Fada OF-1 radio interference locator**, type CFE 60029. Schematic or battery hookup information needed. (Richard Euston, 1205 Lincoln St., The Dalles, Ore.)

**Nuclear Electronics Model DMR FM multiplex receiver**; has 17 tubes. Operating manual and schematic needed. (Keith Allen, 412 Marion Ave., Aurora, Ill. 60505)

**Sylvania tube analyzer**, circa 1925. Schematic and operating manual needed. (F.C. Davis, 43 Rivermont Dr., Newport News, Va. 23601)

**American Measuring Instruments Radiosonde cavity-resonator transmitter T-93B/AMT-4**; has 3 tubes. Schematic and information on power supply needed. (Terry Haster, 300 E. 8 St., Clay City, Ind. 47841)

**Andrea Radio Corp. CND-46156 (Model RAL-7) radio receiver**. Service manual, schematic and power supply information needed. (John S. Rowe, 1055 N.E. 13 Place, Gainesville, Fla. 32601)

(Continued on page 94)

# Popular SAMS BOOKS



## USE THIS HANDY ORDER FORM

### RECENTLY PUBLISHED! TIMELY!

- Modern Dictionary of Electronics. New 3rd Ed.** Now defines more than 16,500 terms; includes special pronunciation guide, most widely used symbols and abbreviations, new terms in latest specialized fields. The most complete authoritative electronics dictionary available. Order 20600, only ..... \$9.95
- 101 Questions & Answers About CB Operations.** Complete answers to the most frequently asked questions about CB radio, including permissible uses, licensing, FCC rules, operating procedures, tips on selecting CB equipment. Order 20604, only ..... \$2.50
- Practical Problems in Number Systems, Logic and Boolean Algebra.** A 62-lesson introduction to the mathematics of digital computers. No special background in mathematics is required for understanding. Order 20609, only ..... \$2.95
- Experimental Earth Sciences.** This fascinating book enables you to learn about the earth and its atmosphere through 60 simple experiments in the subjects of meteorology, astronomy, geology, and oceanography. Order 20601, only ..... \$2.50
- How To Read Schematic Diagrams.** Not only shows you how to read and interpret diagrams, but analyzes each component, its construction, and its circuit purpose and use. Order 20568, only ..... \$2.95
- TV Servicing Guide.** Tells you how to apply proper trouble shooting procedures based on analysis of symptoms, illustrated by picture tube photos. Packed with troubleshooting and servicing hints. Order 20361, only ..... \$2.50
- Color-TV Servicing Made Easy. Vol. 1.** Full explanation of color principles, circuitry, setup adjustments, and servicing of all color-TV sets. Takes the mystery out of servicing color-TV. Order 20135 ..... \$3.25
- ABC's of Citizens Band Radio.** NEWLY REVISED & UPDATED. All you need to know about planning and setting up a CB 2-way radio system. Explains functions, principles, setup and operation, latest rules and regulations. Order 20019 ..... \$2.25
- Transistor Ignition Systems Handbook.** 20238 ..... \$2.95
- TV Tube Symptoms & Troubles.** 20476 ..... 1.95
- Understanding Telemetry Circuits.** 20518 ..... 3.25
- 2nd-Class Radiotelephone License Handbook.** 20316 ..... 4.75
- Modern Dictionary of Electronics.** 20151 ..... 7.95
- Handbook of Electronic Tables & Formulas.** 20230 ..... 3.95
- Color TV Trouble Clogs.** 20120 ..... 1.95
- Solving TV Tough-Dogs.** 20403 ..... 3.25

### FAMOUS ABC'S BOOKS

- Lasers & Masers.** 20262 ..... \$2.25
- Computers.** 20012 ..... \$2.50
- Tape Recording.** 20395 ..... 1.50
- Boolean Algebra.** 20055 ..... 2.25
- Transistors.** 20440 ..... 2.25
- Modern Radio.** 20047 ..... 1.95

## — HOWARD W. SAMS & CO., INC. —

Order from any Electronic Parts Distributor, or mail to Howard W. Sams & Co., Inc., Dept. PE-1 4300 W. 62nd St., Indianapolis, Ind. 46268

Send books checked above. \$ \_\_\_\_\_ enclosed.

Send FREE Sams Book Catalog.

Name \_\_\_\_\_

PLEASE PRINT

Address \_\_\_\_\_

City \_\_\_\_\_ State \_\_\_\_\_ Zip \_\_\_\_\_

CIRCLE NO. 24 ON READER SERVICE PAGE

**GE** "Play-Talk" Model 4SJA1 8" magnetic paper recording disc (cat. no. spm-002) or source needed. (Rick Harman, 4707 48th Ave., N.E., Seattle, Wash. 98105)

**Heathkit** Model AR-2 receiver, circa 1955; tunes 1.5-35 MHz and BC on 4 bands; has 6 tubes. Schematic needed. (Tim Hargrove, 1161 Ravenna Ave., Wilmington, Calif. 90744)

**H.F.L. Super** "Nine in Line" Model 28 BC receiver, circa 1927; uses 8 201's and 1 171. Schematic and operating manual needed. (Stanley Smith, P.O. Box 274, Mt. Berry, Ga. 30149)

**Jewell** 199 radio set analyzer. **Jewell** service test oscillator, pattern 560; uses 2 #30 tubes. Operating or instruction manuals needed. **REMO** radio receiver; 3 tubes; made in Davenport, Iowa. Any available information wanted. (J.N. Clapp, 1516 Elm St., Davenport, Iowa 52803)

**Hallicrafters** Model S-40A receiver; tunes 0.55 to 44 MHz; has 9 tubes. Operating manual needed. (Robert Heilbrunn, 82-74 165 St., Jamaica, N.Y. 11432)

**Gemark** tape recorder, ser. 32700. Schematic and parts list needed. (R. Maurice Boy, 330 S. 7th St., Fernandina Beach, Fla. 32034)

**North American** Model 1010 10-transistor, AM-FM receiver. Schematic and a.f.c. switch needed. (Jack Dornorsek, 552 Thomas St. Ext., Bridgeville, Pa. 15017)

**Crosley** "Ace" socket with ears; **Dayfan** center vernier dial, 5050-7 set; two variometers like Workrite for **REMO** radio (or basket-weave type) needed. (J.N. Clapp, 1516 Elm St., Davenport, Iowa 52803)

**Philco** Model 39-25 receiver; tunes SW (5-18 MHz) and BC on 2 bands; has 5 tubes. Schematic, parts list, and parts source needed. (Louis R. Altazan, Jr., 368 Avenue E, Port Allen, La. 70767)

**Ray Jefferson** Model 483 radio direction finder; ser. 508011. Schematic and parts source needed. (Pablo Alvarez, 413 N.W. 51 St., Miami, Fla. 33127)

**Meissner** phono recorder, chassis No. 9-1065, circa 1948. Schematic needed. (J.A. Domurat, 205 E. Cottage St., Dorchester, Mass. 02125)

**Lumatron** Model 112 sampling oscilloscope. Sampling head, schematic, and manual needed. (Bruce Ashcraft, 16 Mayflower Ave., Williston Park, N.Y. 11596)

**Philco** Model 48-1253 phonograph-radio, circa 1942-47; has 5 tubes. Schematic and parts list needed. (Jim Fribbeno, 29 Glen Oaks, Prescott, Ariz. 86301)

**Meteor** receiver; made by The Radio Shop, Chicago; uses 3 UV-199 tubes. Schematic, audio transformers, and snap-in resistors needed. (James L. Bochantin, Route 1, Box 54, DuBois, Ill. 62831)

**CRV-46148 RBC-3** Navy receiver, circa 1930. Schematic needed. (Mark Bond, 55 Paterson Ave., Newton, N.J. 07860)

**Gonset** Model 3316 CB transceiver; has 8 tubes, 4-channel operation; 117 volts a.c./12 volts d.c. Schematic, operating manual, and complete chassis needed. (Paul H. Gorrell, P.O. Box 228, Mashpee, Mass.)

**Superior Instruments** TV-11 tube tester, circa 1953. Schematic needed. (N. Cope, 5027 18th, N.E., Seattle, Wash. 98105)

**Supreme** Model 189 signal generator. Schematic and instruction manual needed. (Mark H. Doll, 1243 S. 76 St., West Allis, Wis. 53214)

**National** NC-44 receiver; has 7 tubes and tunes 4 bands. Schematic and operating manual needed. (Glenn R. Box, 4805 Pam Dr., Del City, Okla. 73115)

**Hallicrafters** Model S-77 receiver, 1952; tunes 0.55-44 MHz. Schematic and rectifier tube number needed. (Pete Moyle, 934 Emaus Ave., Allentown, Pa. 18103)

**Silvertone** Models 1822, 1825, 1825A, 1828, 1831. Parts needed. (Ronald Propst, Dublin, Pa. 18917)

**Hallicrafters** Model SX-25 communications receiver. Power supply choke coil needed (part number L3 on schematic). (Geoffrey Fleck, 55 West Way, Mt. Kisco, N.Y. 10549)

**R.M.E.** DB-20 preselector; tunes 6 bands. Alignment instruction data needed. (Clarence Cain, Sr., 125 Church St., Bridgeton, N.J. 08302)

**Triplet** signal generator, circa 1950; AM and FM. Operating manual needed. (Ed Langdon, 74 Elm St., Hicksville, N.Y. 11801)

**Westinghouse** Model H-494P4 radio; tunes AM; has 4 tubes. Operating instructions needed. (Richy Tombasco, 793 N. Laurel St., Hazleton, Pa. 18201)

**RCA** Model AR88F receiver, 1946, built for the military; tunes 540 kHz-32 MHz. Schematic and instruction book (TM-11-880) needed. (P. Elford, 304 Kennedy Towers, 10101 Sask Dr., Edmonton, Alberta, Canada)

**Federal** Model 804 signal generator. Instruction manual and schematic needed. (W.G. Emory, Box 55, Union, S.C. 29379)

**Supreme** Model 580 signal generator, ser. 580-511, deluxe series. Schematic and instruction manual needed. (T. McClaskey, 2965 Jarrell St., Huntington, W.Va. 25705)

**RCA** Model A-25 SW receiver, 1932; has 7 tubes. Schematic needed. (Harry Shepherd, 436 Greenwood Dr., Beaconsfield, Quebec, Canada)

**Knight** Model R100RX receiver; tunes 540 kHz-30 MHz on 4 bands. Schematic and operating instructions needed. (G. Orndorff, 5718 Superior St., Chicago, Ill. 60644)

**Philco** Model 60 receiver, code 121; tunes 55-150 kHz, 1.5-4.0 MHz; has 5 tubes. Schematic and dial light needed. (Jim Basinger, R.R. #1, Kenton, Ohio 43326)

**Gonset** Model G-66 mobile receiver. Schematic and/or operating manual needed. (Norman Wearli, P.O. Box 1102, Fort Stockton, Texas 79735)

**Atwater Kent** Model 10 receiver, ser. 4607, type AD. Schematic, service data, and operating instructions needed. (Michael D. Razor, R. 3, Box 894, Burlington, Wis. 53105)

**National** Model SW-3 receiver. Schematic, including power supply, needed. (Oren Holmes, 552 Bridge St., Yuba City, Calif. 95991)

**RCA** Model WV-97A "Senior VoltOhmyst," ser. 21482, code 851. Meter, schematic, a.c.-d.c. probe, and source for parts needed. (Jody Tollison, 540 Huntington St., Augusta, Ga. 30904)

**Serv-U-Center** receiving tube tester, ser. 404AB1. Tube chart needed. (Joseph Elnicky, 3956 N. Vineland, Baldwin Park, Calif.)

**BC-659** FM transceiver; 22-30 MHz. Schematic and power supply information needed. (Allen Windhorn, Rt. 2, Box 8, St. Peter, Minn. 56082)

**Sylvania** 15" color TV receiver, chassis C-73599. Vertical dynamic convergence output transformer, schematic, and instruction manual needed. (Reinhard Metz, 3520 W. Abbott Ave., Milwaukee, Wis. 53221)

**Hallicrafters** Model S-120 receiver, 1964; tunes 1.6-31 MHz. Operating manual needed. (Joseph Catalfama, 35 Franklin Blvd., Somerset, N.J. 08573)

**Radio City Products** Model 662-A Electronic Multitester. Schematic and operating manual needed. (Robert Furrow, 4812 Eastern Lane-203, Suitland, Md. 20023)

**Granco** Model 701U AM-FM table radio receiver; has two 12BA6, one 50C5, 12BE6, 12DT8, and 14G18 tubes. Schematic and operating manual needed. (Samuel Rosan, 970 Van Auker, Palo Alto, Calif. 94303)

**Philco** Model 40-95 receiver; code 121, K1 2095; tunes broadcast band. Schematic and/or type battery (voltage and how connected) needed. (Leslie H. Seymour, 713 Elmwood St., Orange, Calif. 92667)

**Murdock** No. 55 earphones, circa 1918-22. Phone caps and green cord needed. (Art Trauffer, 120 Fourth St., Council Bluffs, Iowa 51501)

**Zenith** 26-235 receiver; has 8 tubes; tunes AM and short-wave bands to 18 MHz. Operating manual needed. (Richard Kessler, 18 West St., Middleboro, Mass. 02346)

**Approved Instruments** Model A-470 TV linearity generator. **Midwest** Model TR-12 AM-FM 3-band SW receiver; has 45 tubes. **Heath** Model SG-8 signal generator, schematics needed. (Robert E. Carlson, 1636 Wilbur, Dallas, Texas 75224)

**Vocaline** Model 400 Class B, 5-watt CB transceiver; tunes 450-460 MHz; has 3 tubes; 117-volt a.c. and 6-volt d.c. power supplies built in. Instructions needed. (Dave Bloch, 20017 Mansfield, Detroit, Mich. 48235)

**Philco** Model 40-180 receiver, code 121; tunes BC and SW; has 7 tubes. Tube #1232 and schematic needed. (Norman Dill, 1025 Powell Ave., Erie, Pa. 16505)

**Philips** HD 464 A radio receiver; FM and SW. Dial (10 3/4" x 2 1/2") needed. (Rex Meurer, 1001 Las Palmas Ave., Sacramento, Calif. 95815)



## THE PRODUCT GALLERY

(Continued from page 70)

tuning range to get a glimpse at off-frequency impedances. However, the second test with an SWL "trap" horizontal antenna was quite surprising. Although the antenna had been purchased and installed as a largely preassembled unit (supposedly resonant on most of the international short-wave broadcast bands), your reviewer found



First test of Omega-T Noise Bridge simply proved that Cush Craft antenna was resonant to entire CB 27-MHz range—hardly surprising. However, when connected between good SWL receiver and 75-ohm trapped dipole antenna, the Noise Bridge disclosed that section lengths were improperly cut and the antenna could not be resonated to important bands.

that resonant points were uniformly lower in frequency than had been expected. An adjustment of the first dipole length quickly solved this problem.

The Noise Bridge is sold for \$24.95 and should be of considerable help to hams and interested SWL's—but not particularly to CB'ers.

-30-

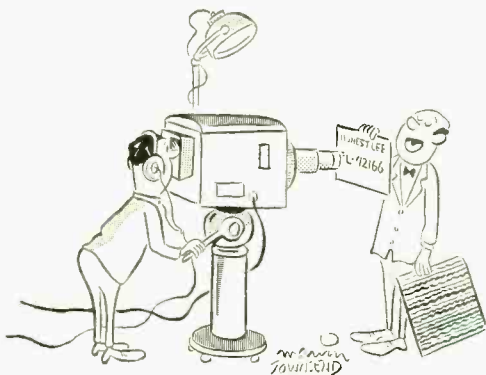

"Now, folks, if any of you had horizontal lines suddenly appear and disappear across your screen—call this number for expert repairs."

January, 1968

The TRUE electronic solution to a major problem of engine operation!

## DELTA'S FABULOUS MARK TEN®



Only \$44.95 ppd.  
In easy-to-build Deltakit®  
Only \$29.95 ppd.

## CAPACITIVE DISCHARGE IGNITION SYSTEM

You've read about The Mark Ten in *Mechanix Illustrated*, *Popular Mechanics*, *Electronics* and other publications!

Now discover for yourself the dramatic improvement in performance of your car, camper, jeep, truck, boat — any vehicle! Delta's remarkable electronic achievement saves on gas, promotes better acceleration, gives your car that zip you've always wanted. Find out why even Detroit has finally come around. In four years of proven reliability, Delta's Mark Ten has set new records of ignition benefits. No re-wiring! Works on literally any type of gasoline engine.

Why settle for less when you can buy the original DELTA Mark Ten, never excelled and so unique that a U.S. Patent has been granted.

### READY FOR THESE BENEFITS?

- ▲ Dramatic increase in performance
- ▲ Fast acceleration
- ▲ More complete combustion
- ▲ Points, Plugs last 3 to 10 times longer
- ▲ Up to 20% Mileage Increase

Literature by Return Mail • BETTER YET — ORDER TODAY!



**DELTA PRODUCTS, INC.** DP 7-14

P.O. Box 1147 PE • Grand Junction, Colo. 81501

Enclosed is \$ \_\_\_\_\_,  Ship ppd.  Ship C.O.D.

Please send:

- Mark Tens (Assembled) @ \$44.95
- Mark Tens (Deltakit®) @ \$29.95

(12 VOLT POSITIVE OR NEGATIVE GROUND ONLY)

- 6 Volt: Negative Ground only.
- 12 Volt: Specify  Positive Ground  Negative Ground

Car Year \_\_\_\_\_ Make \_\_\_\_\_

Name \_\_\_\_\_

Address \_\_\_\_\_

City/State \_\_\_\_\_ Zip \_\_\_\_\_

CIRCLE NO. 10 ON READER SERVICE PAGE



# 12 NEW KITS FROM HEATH...

## For The Whole Family . . .

### New Deluxe "227" Color TV

**Exclusive Heathkit Self-Servicing Features.** Like the famous Heathkit "295" and "180" color TV's, the new Heathkit "227" features a built-in dot generator plus full color photos and simple instructions so you can set-up, converge and maintain the best color pictures at all times. Add to this the detailed trouble-shooting charts in the manual, and you put an end to costly TV service calls for periodic picture convergence and minor repairs. No other brand of color TV has this money-saving self-servicing feature.

**Advanced Features.** Boasts new RCA Perma-Chrome picture tube for 38% brighter pictures . . . 227 sq. in. rectangular viewing area . . . 24,000 v. regulated picture power . . . improved phosphors for brilliant, livelier colors . . . new improved low voltage power supply with boosted B+ for best operation . . . automatic degaussing . . . exclusive Heath Magna-Shield to protect against stray magnetic fields and maintain color purity . . . ACC and AGC to reduce color fade and insure steady, flutter-free pictures under all conditions . . . preassembled & aligned IF with 3 stages instead of the usual 2 . . . preassembled & aligned 2-speed transistor UHF tuner . . . deluxe VHF turret tuner with "memory" fine tuning . . . 300 & 75 ohm VHF antenna inputs . . . two hi-fi sound outputs . . . 4" x 6" 8 ohm speaker . . . choice of installation — wall, custom or optional Heath factory assembled cabinets. Build in 25 hours.

**Kit GR-227**, (everything except cabinet) . . . \$42 dn., as low as \$25 mo. . . 114 lbs. . . . . **\$419.95**

**GRA-227-1**, Walnut cabinet. . . no money dn., \$6 mo. . . . . **\$59.95**

**GRA-227-2**, Mediterranean Oak cabinet (shown above) . . . no money dn., \$10 mo. . . . . **\$94.50**



Kit GR-227  
**\$419.95** (less cabinet) \$25 mo.



Kit GRA-27  
**\$19.95**

### New Remote Control For Heathkit Color TV

Now change channels and turn your Heathkit color TV off and on from the comfort of your armchair with this new remote control kit. Use with Heathkit GR-227, GR-295 and GR-180 color TV's. Includes 20' cable.



Kit GR-295  
**\$479.95** (less cabinet) \$42 mo.



Kit GR-180  
**\$349.95** (less cabinet & cart) \$30 mo.

### Deluxe Heathkit "295" Color TV

Color TV's largest picture . . . 295 sq. in. viewing area. Same features and built-in servicing facilities as new GR-227. Universal main control panel for versatile in-wall installation. 6" x 9" speaker.

**Kit GR-295**, (everything except cabinet), 131 lbs. . . . . \$48 dn., \$42 mo. . . . . **\$479.95**

**GRA-295-1**, Walnut cabinet (shown above), 35 lbs. . . . . no money dn., \$7 mo. . . . . **\$62.95**  
Other cabinets from \$94.50

### Deluxe Heathkit "180" Color TV

Same high performance features and exclusive self-servicing facilities as new GR-227 (above) except for 180 sq. in. viewing area.

**Kit GR-180**, (everything except cabinet), 102 lbs. . . . . \$35 dn., \$30 mo. . . . . **\$349.95**

**GRS-180-5**, table model cabinet & mobile cart (shown above), 57 lbs. . . . no money dn., \$5 mo. . . . . **\$39.95**  
Other cabinets from \$24.95



**FREE** 40-Lesson Record Course With Either Heathkit/Thomas Organ! A \$50 Value! Includes four 33 1/3 rpm records, music book & leatherette album.

Kit TO-67  
**\$995** (including bench) \$200 dn., as low as \$29 mo.

### Heathkit®/Thomas "Paramount" Theatre Organ

Save Up To \$500! Build in 80-100 hours. All Thomas factory-made parts . . . 15 manual, 4 pedal voices; instant-play Color-Glo; all-transistor circuit; 200 watts peak power; 2-speed rotating Leslie plus main speaker system with two 12" speakers; 44-note keyboards; horseshoe console with stop tablets; 28-note chimes; 13-note bass pedals; repeat & attack percussion; reverb; headset outlet; assembled walnut finish hardwood cabinet & bench; and more. 265 lbs. 7", 33 1/3 rpm demonstration record 50c.

### America's Lowest Cost Solid-State Organ

Kit GD-325B  
**\$394.90** \$40 dn., \$34 mo.

Save Up To \$205! Instant-play Color-Glo; 10 voices; 13-note bass pedals; repeat percussion; 37-note keyboards; 75-watt peak power; vibrato; assembled walnut cabinet & bench. 172 lbs. 7", 33 1/3 rpm demonstration record 50c.



### Exclusive Band Box Percussion

Automatically or manually adds 10 percussion voices to any Heathkit/Thomas organ. Build & install in 12 hours.

**Kit TOA-67-1**, no money dn., \$14 mo. . . . . **\$145.00**

### Exclusive Playmate Rhythm Maker

Adds 15 fascinating rhythms to any Heathkit/Thomas Organ. Requires Band Box percussion (above) for operation.

**Kit TOA-67-5**, no money dn., \$18 mo. . . . . **\$189.90**

# USE COUPON TO ORDER NOW!



TO-68  
**\$349.95**  
 \$35 dn., \$30 mo.

## NEW! VOX "Jaguar" Transistor Combo Organ By Heathkit

Save Up To \$150 on the world's most popular combo organ with this new Heathkit version. Features the most distinctive sound of any combo organ. Has a special bass output that gives a brilliant stereo bass effect when played through a separate or multi-channel amplifier, 4 complete octaves, vibrato, percussive effects and reversible bass keys. Includes hand crafted orange and black cabinet, fully plated heavy-duty stand, expression pedal and waterproof carrying cover and case for stand. Requires a bass or combo amplifier like Heathkit TA-17 (opposite page).

Kit TO-68, 80 lbs. . . \$35 dn., \$30 mo. . . . . **\$349.95**

## NEW! Deluxe Solid-State Combo Amplifier & Speaker System . . . Choose Kit Or Factory Assembled

Amplifier Kit TA-17  
**\$175**  
 \$17 mo.  
 (Assembled TAW-17 \$275)

Speaker System Kit TA-17-1  
**\$120**  
 \$11 mo.  
 (Assembled TAW-17-1 \$150)

Special Combination Offer  
 Amplifier & Two Speaker Systems  
 Save \$20  
 Kit TAS-17-2  
**\$395**  
 \$40 dn.  
 \$34 mo.  
 (Assembled TAW-17-2 \$545)



All the "big sound" features every combo wants . . . tremolo, built-in "fuzz", brightness, reverb, separate bass and treble boost and more. Delivers a shattering 120 watts EIA music power (240 watts peak power) through two TA-17-1 speakers . . . or 90 watts through one TA-17-1 speaker. Features 3 independent input channels, each with two inputs. Handles lead or bass guitars, combo organ, accordion, singer's mike, or even a record changer. All front panel controls keep you in full command of all the action.

Speaker system features two 12" woofers, special horn driver and matching black vinyl-covered wood cabinet with casters & handles for easy mobility.



Kit AR-17  
**\$72.95**  
 (less cabinet) \$8 mo.

## NEW! Lowest Cost Solid-State Stereo Receiver

Features wide 18-60,000 Hz response @ ±1 db at full 5 watts RMS power per channel . . . 14 watts music power . . . inputs for phono and auxiliary . . . automatic stereo indicator . . . outputs for 4 thru 16 ohm speakers . . . adjustable phase for best stereo . . . flywheel tuning . . . and compact 9 1/2" D. x 2 1/2" H. x 11 1/2" W. size. 12 lbs. Optional factory assembled cabinets (walnut \$7.95, beige metal \$3.50).

Kit AR-17, (less cab.) 12 lbs. . . no money dn., \$8 mo. . . **\$72.95**  
 Kit AR-17, 7-Watt FM Mono Only Receiver (less cab.) 9 lbs. . . no money dn., \$5 mo. . . . . **\$49.95**

Kit IM-17  
**\$19.95**

## NEW! Solid-State Portable Volt-Ohm-Meter



So Handy, So Low Cost we call it "every man's" meter. Just right for homeowners, hobbyists, boatowners, CBER's, hams . . . it's even sophisticated enough for radio & TV servicing! Features 12 ranges . . . 4 AC & 4 DC volt ranges, 4 ohm ranges; 11 megohm input on DC, 1 megohm input of AC; 4 1/2" 200 uA meter; battery power; rugged polypropylene case and more. Easy 3 or 4 hour kit assembly. Ideal gift for any man! 4 lbs.

**NEW**

**FREE 1968 CATALOG!**

Now with more kits, more color. Fully describes these along with over 300 kits for stereo/hi-fi, color TV, electronic organs, electric guitar & amplifier, amateur radio, marine, educational, CB, home & hobby. Mail coupon or write Heath Company, Benton Harbor, Michigan 49022.



**HEATH COMPANY, Dept. 10-1**  
 Benton Harbor, Michigan 49022  
 In Canada, Daystrom Ltd.

Enclosed is \$ \_\_\_\_\_, including shipping.

Please send model (s) \_\_\_\_\_

Please send FREE Heathkit Catalog.

Please send Credit Application.

Name \_\_\_\_\_

Address \_\_\_\_\_

City \_\_\_\_\_ State \_\_\_\_\_ Zip \_\_\_\_\_

Prices & specifications subject to change without notice.

CL-312R

**POLICE • FIRE • MARINE  
AIRCRAFT • AMATEUR CALLS**

**—TUNABILITY—USABILITY—QUALITY—**



**TUNAVERTERS**

TUNABLE, CALIBRATED solid state converters to change your auto and home radios into excellent, sensitive, selective, calibrated Amateur and VHF receivers!

"Of all of the converters tested by POPULAR ELECTRONICS there is little doubt that the "TRP Tunaverters" is the most versatile."—POPULAR ELECTRONICS, August, 1967.

- 6-1 reduction tuningl
- HF—2 gang tuningl
- VHF—3 gang tuningl
- FREE 24" conn. coaxl
- 2 WEEK MONEY BACK GUARANTEE!
- Plug into auto radiol
- American Model
- 9 volt btry. poweredl
- Size 2 1/4 x 3 1/2 x 4 1/2"

Models for AM & FM

BAND	MODEL	COVERS	OUTPUT	PRICE
Marine	Marine	2.0-2.85 mc	550 kc	\$19.95 ppd
SW & WWV	SWL	9.3-10 mc	550 kc	\$19.95 ppd
CB & 10 M	273	26.9-30 mc	1500 kc	\$29.95 ppd
6 meters	504	50-54 mc	1500 kc	\$29.95 ppd
2 meters	1450	144-150 mc	1500 kc	\$29.95 ppd
Police	308	30-38 mc	1500 kc	\$29.95 ppd
fire, & }	375	37-50 mc	1500 kc	\$29.95 ppd
Marine	1564	150-164 mc	1500 kc	\$29.95 ppd
Aircraft	1828	118-128 mc	1500 kc	\$29.95 ppd

Radiation loop & Ext. Antenna for using with home radios \$ 3.95 ppd  
Order from: Fast AIR MAIL add \$ .85 ea.

**HERBERT SALCH & CO.**

Woodsboro PE-1, Texas 78393

Marketing Division of  
Tompkins Radio Products

**CIRCLE NO. 29 ON READER SERVICE PAGE**

**WHO'S AFRAID OF THE SCR?**

(Continued from page 55)

mA—resistor  $R2$  limits total current to less than 300 mA. Now, if you open  $S1$  to remove the gate voltage—lo-and-behold—the SCR remains on. This proves that an SCR cannot be turned off by removing gate voltage, and since the anode voltage does not go through zero, the SCR remains on. To shut the SCR off, switch  $S2$  has to be opened momentarily.

To measure the amount of voltage required to trigger the SCR on, remove  $R1$  (Fig. 4) and replace it with a potentiometer having sufficient resistance to prevent turn-on even with  $S1$  and  $S2$  closed. Connect a high-impedance voltmeter (preferably a VTVM) across the gate (G) and cathode (C) terminals of the SCR—with the positive test lead to the gate terminal.

With both switches closed, slowly decrease the value of the potentiometer until the SCR fires. Note the gate voltage at this instant. A typical SCR will require 0.7 volt (at 7 mA) to snap it on. Lower-powered SCR's require lower values. Obviously, the gate control circuit must be capable of supplying a trigger voltage in excess of that required to trigger the SCR on.

It is not necessary to use the a.c. line to trigger the SCR on. Almost any type of pulse generator can be used, provided that the pulse applied to the gate is positive-going with respect to the SCR cathode, and has an amplitude greater than that required to trigger the gate. —50—

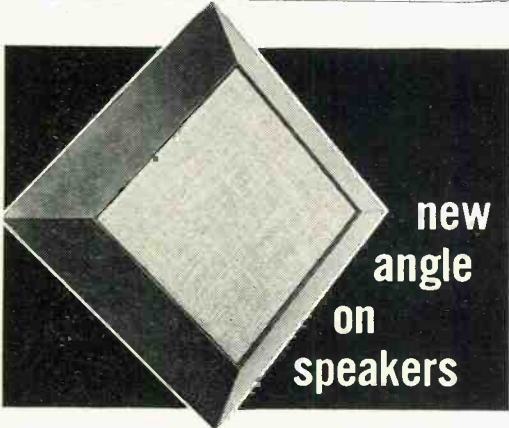

Striking contemporary art frame design in Dusk Walnut or Antique Birch. Mount traditionally or in diamond position. Special 8" dual cone speaker designed exclusively for Argos. Excellent for stereo or as extension speakers. Audiophile net \$13.95

*Troubador* model TSW-8S by

**Argos**  
PRODUCTS COMPANY

Dept. C, 600 Sycamore St., Genoa, Illinois 60135

**CIRCLE NO. 3 ON READER SERVICE PAGE**

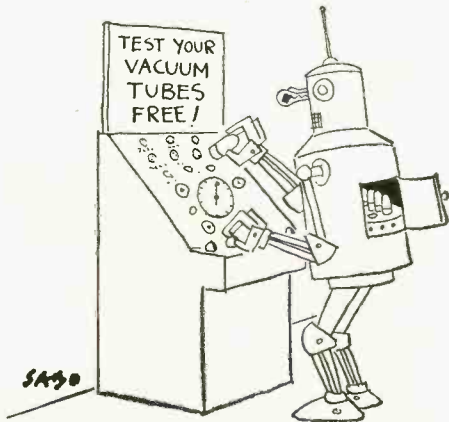

POPULAR ELECTRONICS



## LETTERS *(Continued from page 14)*

1967), I decided to add a relay circuit that can be controlled by a foot switch—leaving my hands free to play my guitar when I want to fuzz the sound. The extra circuit consists of a three-pole, double-throw relay and battery (both 6-volt units). I used a phone plug and jack combination to connect and disconnect the foot switch from the relay circuit. Also, I had to change the position of the capacitor in

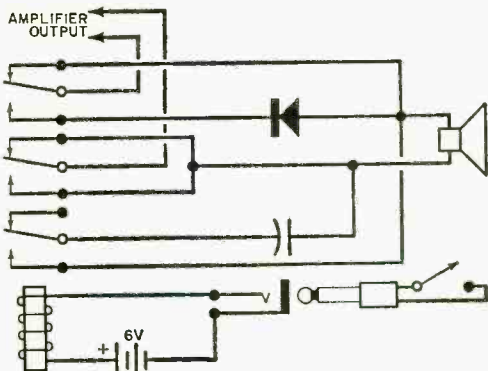

the "Fuzzbox" so that its reactance would not load down my amplifier's output when the "Fuzzbox" was out of the circuit. The entire unit—minus foot switch, cable and jack—is mounted inside the amplifier's enclosure.

JOHN R. WARRICK  
Brown Mills, N.J.

### IGNITION SWITCH INSTEAD OF SSS?

Instead of installing a "Secret Safeguard Switch" on your CB transceiver, or any other equipment. ("Tips & Techniques" August, 1967), substituting a universal ignition switch is a better idea. Then you can lock up the power when you go away, and no one can tamper with your equipment.

RAY DERY  
Winnipeg, Ontario, Canada

*Although your idea is good, Ray, the SSS ("Secret Safeguard Switch") is what most people are looking for. If a universal ignition switch were used, it would be a give-away, and an ambitious person might find a way to jumper the device. An SSS is not likely to be noticed; anyone who decides to tamper with equipment utilizing an SSS will be led to believe that the equipment is faulty.*

### PARTS AND BACK ISSUES WANTED

Here in Iraq it is difficult to obtain such components as FET's, SCR's, relays, etc. When such parts are available, their costs are prohibitively high. I would like to correspond with anyone who would be interested in exchanging parts for Iraqi novelties and/or new and unused stamps.

Since I am a relatively new reader of POPULAR ELECTRONICS, I am interested in obtaining back issues of your magazine, starting from Volume 1, No. 1, and continuing up to December, 1966. I offer the same exchange mentioned above for them.

RAAD SADIQ JALAL  
Karrada Sherkeya, 72/11  
Baghdad, Iraq

The essential components, such as transistors, crystals, electron tubes, and the like, needed for projects in POPULAR ELECTRONICS are extremely difficult to obtain in Singapore. I am prohibited from sending money out of my country except for educational and business purposes. I contacted the local United State Information Service office to inquire about how I could obtain the parts I need, and they advised me that I might get the "penpal" type of assistance that Yusuf Tolkom of Turkey (Letters, September, 1965) obtained.

ALLEN CHIA HOO NGUAN  
19, Lorong Low Koon  
Upper Serangoon Rod.  
Singapore 19

*Raad and Allen, we've printed your full names and addresses so that any readers who are interested can contact you directly. There are undoubtedly many who would like to exchange both parts and ideas.*

-30-

## NEW SOLID STATE 5-BAND RECEIVER

SEND FOR FREE LITERATURE

MODEL R-5



- Continuous Coverage .54 to 54 mc
- Variable beat frequency oscillator
- Includes 6-meter ham band
- And the 30 to 50 mc police bands
- Fully transistorized — Bandspread
- Noise limiter — Optional battery pack

WIRED AND TESTED . . . . . \$79.95

AMECO

DIVISION OF AEROTRON



BOX 6527, RALEIGH, N. C. 27608

CIRCLE NO. 2 ON READER SERVICE PAGE

## MEASURE A.C. AMPS & WATTS

(Continued from page 63)

to amperes, divide the recorded wattage value by the line voltage. For example, if you have 600 watts on a 120-volt line:  $600/120 = 5$  amperes.

With respect to a.c. loads that are predominantly inductive—such as electric motors—the adapter will indicate volt-amperes, not watts. This phenomenon is common to all types of a.c. ammeters. To convert volt-amperes to true watts, multiply by the power factor of the device under test. If the power factor is unknown, use 0.8 as an average value.

Always start voltage measurements with the VOM set to its highest a.c. range, as the starting currents of some devices, particularly electric motors, can be very high. The resultant high voltage surge may damage the meter. —50—

## SUBSTRATA COMMUNICATIONS

(Continued from page 48)

greater than 16,500 feet is characterized by increasing conductivity with increasing depth.

These three layers—crust, basement complex, and core—form a sandwich which is not unlike a wave guide. Between the conducting core and crust, the basement complex can be likened to the non-conducting air space inside a man-made wave guide. Although the sandwich structure of the earth behaves in a manner similar to a man-made wave guide, the non-conducting solid layer dampens signals to a much greater degree than air.

In June, 1952, the Raytheon Corporation began experiments with this "deep rock strata" communications system, in Brewster, Cape Cod. A 300-watt transmitter was used; a narrow-band wave analyzer served as the receiver. Transmission distances up to 1.1 miles were obtained for frequencies up to 10 kHz, but attempts to increase that distance were unsuccessful. An examination of geological formations indicated that long-dis-

tance transmissions were impractical in that region.

Additional experiments were conducted in the Adirondack Mountains, where the formation of the basement complex was more favorable for long-distance transmissions, and deeper holes could be drilled for the long resonant antennas. From these experiments, Raytheon scientists concluded that transmission distances in the tens of miles were practical.

The deep rock strata communications system has one unique advantage over both the ionic charge carrier and UOD systems—the conductive overburden of the crust forms a shield to natural and man-made interference.

In this modern age of communications satellites and lasers, ground communications might seem to be out of place. But it can play an ever-increasing role in solving unusual communications problems. For example, it can provide destruction-proof communications networks for the Department of Defense. Based on ground communications techniques, undersea radar may someday become a reality.

There is also the distinct possibility that ground communications may provide the answer to over-the-horizon communications problems that will plague colonization of the moon. Because the moon's radio horizon is so close, by comparison to that of the earth, plus the absence of a radio-wave-reflective ionosphere, only two alternatives are left for site-to-site communications. Moon-to-earth-to-moon relay and orbiting lunar satellite. If, on the other hand, ground communications techniques can be employed, this potentially vexing problem may be solved. —50—



"Welcome! Welcome!"

## TRANSISTORIZED MULTIMETER

(Continued from page 35)

to clean packaging design with retractable handles mounted on the sides of the unit. The Heath unit, with its multiple functions and large meter, has gone to a horizontal design, making it the largest of the TVM's available at present. The IM-25 is the only unit so far that comes either in kit or factory-wired form.

Triplet features a clean, uncluttered front panel with a single large-size function selector knob and easy-to-read range markings, while the Aul unit is a business-like service instrument compact enough to fit in a tube caddy.

There also seems to be a wide variation in test lead input jack type. Amphenol uses a coaxial screw-on fitting, Heath has a telephone type jack, and the other two representative models use variations of the banana plug fitting.

**Conclusions.** TVM's are here to stay. At the approximate cost of a VTVM, you now can have a voltage-measuring device with the very high input impedance of the VTVM and the portability of the VOM. And, most important, you can now measure down to extremely low levels of voltage and current with excellent accuracy.

Which one to buy? Obviously, if you do a lot of bench work where line power is available, the Heath unit comes to the fore. This is also the most versatile of the TVM's, and can operate from batteries if desired. For greatest all-around portability, the Amphenol unit, contained within its own carrying case and having an automatic on/off power switch, will make a hit with most outside servicemen.

The Triplet unit is a very easy-to-use instrument having the simplest operating controls (only one knob). It also features a combination handle/foot, for portability and viewing convenience, and a leather carrying case for protection. The Aul unit is the most compact of the TVM's covered.

All TVM's are good, and selection should be made based on your needs, present prices, measurement ranges to be used, and personal taste in instrument appearance and brand names. —50—

# FREE!



## BRAND NEW FALL AND WINTER RADIO-TV ELECTRONICS CATALOG



YOUR BUYING GUIDE FOR: • Stereo & Hi-Fi Systems & Components • Tape Recorders • Electronic Parts, Tubes, Tools • Phonos & Records • Ham Gear • Test Instruments & Kits • Cameras & Film • PA • Citizens Band • Radio & TV Sets • Musical Instruments

MAIL TODAY TO:

**BURSTEIN-APPLEBEE**

Dept. PEM 1012 McGee, Kansas City, Mo. 64106

Name \_\_\_\_\_  
Address \_\_\_\_\_  
City \_\_\_\_\_  
State \_\_\_\_\_ Zip Code \_\_\_\_\_

CIRCLE NO. 6 ON READER SERVICE PAGE

## GET INTO ELECTRONICS



V.T.I. training leads to success as technicians, field engineers, specialists in communications, guided missiles, computers, radar, automation. Basic & advanced courses. Electronic Engineering Technology and Electronic Technology curricula both available. Associate degree in 29 months. B.S. obtainable. G.I. approved. Start February, September. Dorms, campus. High school graduate or equivalent. Catalog.

**VALPARAISO TECHNICAL INSTITUTE**  
DEPARTMENT PE, VALPARAISO, INDIANA 46383

WRITE NOW FOR 1968 SENT FREE

# McGEE'S CATALOG

### 1001 BARGAINS IN

SPEAKERS—PARTS—TUBES—HIGH FIDELITY

COMPONENTS—RECORD CHANGERS—

Tape Recorders—Kits—Everything in Electronics

1901 McGee Street, Kansas City, (PE), Missouri 64108

## LEARN Electronics Engineering AT HOME

Fix TV, design automation systems, learn transistors, complete electronics. College level Home Study courses taught so you can understand them. Earn more in the highly paid electronics industry. Computers, Missiles, theory and practical. Kits furnished. Over 30,000 graduates now employed. Resident classes at our Chicago campus if desired. Founded 1934. Catalog. "Vets—write for information about G I Bill Training."

**AMERICAN INSTITUTE OF ENGINEERING & TECHNOLOGY**  
1137 West Fullerton Parkway, Chicago, Illinois 60614



## INFORMATION CENTRAL

(Continued from page 74)

tacts, and see that the proper fuse is inserted. Next, turn it on. If nothing appears on the CRT screen after you adjust the intensity, amplifier and sweep controls, measure all voltages with a VTVM, and compare your measurements with those given in the instruction manual. If the voltages check out all right, you should suspect the CRT. Substitute a new CRT, and you more than likely will be in business.

**SB-34 Hum.** *When I use my SB-34 transceiver in Europe (on 50-Hz current), it exhibits a 50-Hz mechanical hum. Can anything be done about this hum?*

Tighten the transformer holding bolts and all other screws on the chassis. After putting the chassis back in the cabinet, try positioning it for minimum mechanical hum, then tighten the holding bolts.

**BC-610 Transmitter.** *I just received my ham license and I have an opportunity to acquire a surplus BC-610 transmitter for \$125.00. Would this be a bargain?*

It would if the transmitter is TVI'ed and you intend to work on AM or CW. The final of this old set can be converted for linear operation on SSB. Actually, buying the set for parts alone would not be a bad idea.

**Surplus Tube Tester.** *I have an old surplus tube tester that works fine. I recently wrote to the original manufacturer of the set and asked for an up-to-date tube chart, but I received no reply. Do you know of any company that makes up-to-date tube charts for old tube testers?*

No. There have been so many new tubes and tube configurations (nuvistor, compactron, etc.) since your tube tester was built that it would be almost impossible to create a new chart for it.

**R.F. Signal Generator Calibration.** *How can I check the calibration of my old r.f. signal generator which covers 550 kHz to 30 MHz?*

Use a good all-band communications receiver equipped with a crystal calibrator.

**Vox Relay.** *I need a circuit that will enable me to use a crystal mike to actuate a relay with a voice signal. The unit should be small, transistorized, and very simple. I can afford a commercially available amplifier, but the circuit should not call for an expensive relay.*

Most of the popular transistorized ampli-

fiers now available on the market can be effectively used for a voice-operated relay application by connecting the circuit shown below to the output (8 to 11 ohms). The relay is the Lafayette "Little Jewel" unit, priced at \$1.95, which operates on 1.4 mA. If you can find a 10- to 15-ohm relay which

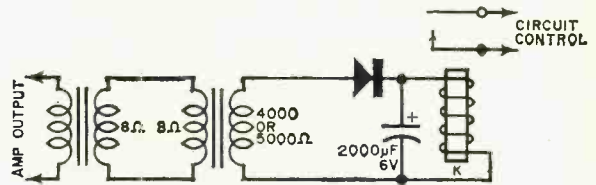

will operate at 2 to 3 mA, you can do away with the transformer. The low-resistance relay is connected in series with the diode and the 8- to 11-ohm output winding. Do not forget to use the capacitor shown, however. The diode is a 1N54 or 1N69.

**VHF/UHF Transistor Amplifier Design.** *Where can I obtain some information on VHF/UHF transistor amplifier design? The data should contain as little math as possible.*

Write to ITT Semiconductors, 3301 Electronics Way, W. Palm Beach, Fla. Ask for the ITT Application Notes (in four parts) on the subject. These notes are the most readable we have seen.

**Fuses.** *Why are there both quick-blow and slow-blow fuses? Are they used for different things?*

Quick-blow fuses are used where practically instantaneous protection of a device is required. Slow-blow fuses are used where the initial starting current may exceed the normal operating load current. Slow-blow fuses are available in a number of current ratings and blow times. For example, the 3AG Slo-Blo<sup>®</sup> fuse, has a blow time of 1 hour at 135% of rating and 5 seconds minimum at 200% of rating.

**Relay Enclosures.** *I bought a number of surplus relays which are all metal-cased and sealed. How can I adjust them?*

The relays you no doubt have cannot be adjusted, for they were designed to be replaced if they failed. An unsealed relay exposed to dust, humidity, etc., has a lifetime of less than one-half that of a sealed unit.

**Paralleling Transistors.** *If a transistor is rated at, say, 1-watt r.f. output, can you parallel two of them for 2 watts output?*

This depends on the frequency and type of transistor involved. At low r.f.'s, transistors can sometimes be paralleled for greater output. At UHF/VHF, making transistors

share a common load is a big problem, as variations in electrical parameters contribute to instability. Emitter degeneration (or impedances in the base) to equalize power flow to each transistor is sometimes used to control gain, end impedance, and efficiency. Push-pull circuits are best for HF work but can cause trouble at VHF and above.

**30L-1 Meter Deflection.** *I just acquired a Collins 30L-1 linear amplifier, and when I key it, the exciter meter deflects to the left. What causes this effect and how can it be cured?*

Replace the 1N252 diode in the metering circuit with a 1N458. The 1N252 is inclined to develop a reverse leakage which permits some of the positive delay bias to appear in the exciter a.l.c. circuit, thus causing the meter needle to swing to the left. -50-

## ON THE CITIZENS BAND

*(Continued from page 84)*

is only one reason we have had to pass up promotional plugs for these hooplas. In every case, information on the jamboree has arrived at our editorial offices too late for publication before the event was to take place. Since the success of these gatherings is dependent upon attendance, we urge groups planning jamborees to forward us complete information well in advance. News of the events will reach nearly half a million readers, halfway around the world.

Here's the first one we've heard about for 1968. The Rock River Valley Citizens Band Radio Club, Rockford, Ill., will hold its fourth Annual RRVCB Jamboree on Sunday, May 19. Club chairman is Lois Coffin, KLL0460. Co-chairman is Pierre LaBounty, KPK3273. Committees are already headed up for display booths, food concessions, ticket sales, publicity, jamboree correspondence, and entertainment. From all indications, the jamboree will again be held at the Rockford Armory, 605 N. Main Street. For more information regarding this outstanding midwest event, contact Pierre LaBounty, KPK3273, 2015 Glenwood, Dept. JM, Rockford, Ill.

Advance planning such as the above has brought this club (and many others across the country) annual attendances from 400 to 10,000. Incidentally, the information on the RRVCBRC '68 Jamboree has been in our hands since last October. We thought perhaps an October announcement might be just a little too early.

I'll be CB'ing you,

-Matt, KHC2060

January, 1968

# GET MORE ACTION WITH

**MULTI-ELMAC  
PRECISION MADE,  
POPULAR PRICED  
CB UNITS!**

CITI-FONE SS

\$16950

**FULL  
23 CHANNEL**

AC-DC Operation,  
Illuminated Meter  
& Channel Selector,  
Triple Tuned RF,  
"Noise Immune"  
Squelch, Double  
Tuned IF's, Ready to Operate

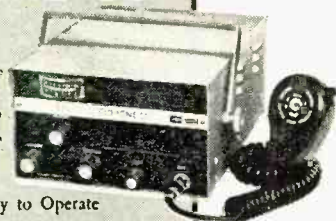

CITI-FONE 99

\$9950

**FULL  
8 CHANNEL**

AC-DC Operation,  
Delayed AVC,  
Electronic Switching,  
2 Stage Pre-Amp  
Illuminated "S"  
Meter, Complete  
with Crystal for 1 Channel



CITI-FONE II

\$4995

**SOLID STATE  
Transmitter-Converter**

Compact 5 3/4 x  
4 3/8 x 1 1/2, 9  
Transistor, 2  
Diodes, 5 Watt  
Input (FCC Max.)  
100% Modulation, 12 VDC  
Operation, Complete with Crystal for  
1 Channel



Please send further information on Citi-Fone SS , 99 , II

**MULTI-ELMAC CO.**

21470 Coolidge • Oak Park, Michigan 48237

NAME \_\_\_\_\_

ADDRESS \_\_\_\_\_

CITY \_\_\_\_\_

STATE \_\_\_\_\_ ZONE \_\_\_\_\_

**CIRCLE NO. 18 ON READER SERVICE PAGE**

103

**“Get more  
education  
or  
get out of  
electronics  
...that’s my advice.”**





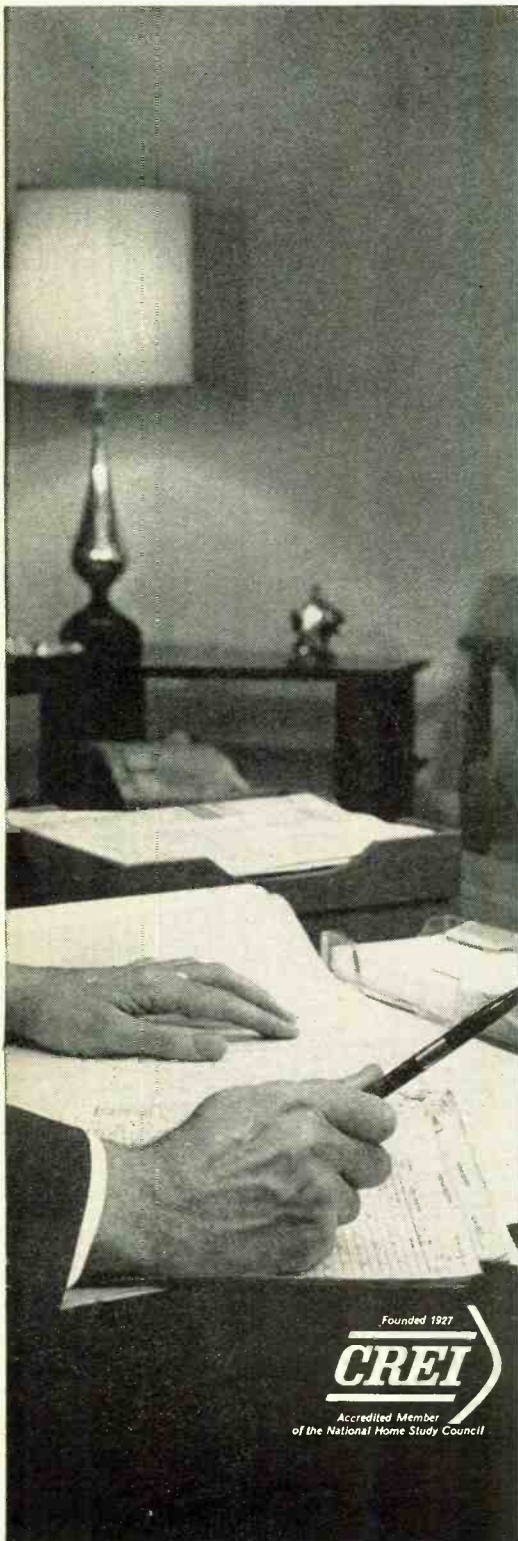

Founded 1927  
**CREI**  
 Accredited Member  
 of the National Home Study Council

**Ask any man who really knows the electronics industry.**

Opportunities are few for men without advanced technical education. If you stay on that level, you'll never make much money. And you'll be among the first to go in a layoff.

But, if you supplement your experience with more education in electronics, you can become a specialist. You'll enjoy good income and excellent security. You won't have to worry about automation or advances in technology putting you out of a job.

How can you get the additional education you must have to protect your future—and the future of those who depend on you? Going back to school isn't easy for a man with a job and family obligations.

CREI Home Study Programs offer you a practical way to get more education without going back to school. You study at home, at your own pace, on your own schedule. And you study with the assurance that what you learn can be applied on the job immediately to make you worth more money to your employer.

You're eligible for a CREI Program if you work in electronics and have a high school education. Our FREE book gives complete information. Airmail post-paid card for your copy. If card is detached, use coupon below or write: CREI, Dept. 1201G, 3224 Sixteenth Street, N.W., Washington, D.C. 20010.



**The Capitol Radio Engineering Institute**

A Division of McGraw-Hill, Inc.  
 Dept. 1201G, 3224 Sixteenth Street, N.W.  
 Washington, D.C. 20010

Please send me FREE book describing CREI Programs. I am employed in electronics and have a high school education.

NAME \_\_\_\_\_ AGE \_\_\_\_\_

ADDRESS \_\_\_\_\_

CITY \_\_\_\_\_ STATE \_\_\_\_\_ ZIP CODE \_\_\_\_\_

EMPLOYED BY \_\_\_\_\_

TYPE OF PRESENT WORK \_\_\_\_\_  G.I. BILL

- I am interested in  Electronic Engineering Technology  
 Space Electronics  Nuclear Engineering Technology  
 Industrial Electronics for Automation  
 Computer Systems Technology

**APPROVED FOR TRAINING UNDER NEW G.I. BILL**

# Olson®



\* **FREE**

Fill in coupon for a **FREE** One Year Subscription to **OLSON ELECTRONICS' Fantastic Value Packed Catalog—Unheard of LOW, LOW PRICES on Brand Name Speakers, Changers, Tubes, Tools, Stereo Amps, Tuners, CB, and other Values. Credit plan available.**

NAME \_\_\_\_\_  
ADDRESS \_\_\_\_\_  
CITY \_\_\_\_\_ STATE \_\_\_\_\_  
GIVE ZIP CODE \_\_\_\_\_

If you have a friend interested in electronics send his name and address for a **FREE** subscription also.

**OLSON ELECTRONICS  
INCORPORATED**

788 S. Forge Street, Akron, Ohio 44308

CIRCLE NO. 19 ON READER SERVICE PAGE

## SHORT-WAVE LISTENING

(Continued from page 81)

### CURRENT STATION REPORTS

The following is a resume of current reports. At time of compilation all reports are as accurate as possible, but stations may change frequency and/or schedule with little or no advance notice. All times shown are Greenwich Mean Time (GMT) and the 24-hour system is used. Reports should be sent to **SHORT-WAVE LISTENING**, P.O. Box 333, Cherry Hill, N.J., 08034, in time to reach your Short-Wave Editor by the fifth of each month; be sure to include your WPE identification, and the make and model number of your receiver. We regret that we are unable to use all the reports received each month, due to space limitations, but we are grateful to everyone who contributes to this column.

**Albania**—A new frequency for *R. Tirana*, 7300 kHz, has been noted. Opening is in Eng. at 0630 with an excellent signal.

**Belgium**—*Radiodiffusion-Television Belge*, Brussels, is noted on 9615 kHz in Dutch and French to South America from 2230 to 2305 with talks and light music; from 2315 to 0000, again in Dutch and French, to N.A. and to Belgian seamen in N.A. waters, with talks, interviews, and light music; to 0100 with music, and news in French at 0005.

**Bolivia**—Station CP75, *La Cruz del Sur*, La Paz, 4985 kHz, often has Strauss waltzes from 0245 to 0300s/off, when ID is given in Spanish and English. *R. Norte*, Montero, Provincia de Santo Esteban, Depto. de Santa Cruz, 4940 kHz, has moved from 4919 kHz, and is heard well in Spanish with Latin American pop tunes and commercials; best listening time is around 2300. Also heard well is CP66. *R. Centenario*, Santa Cruz, 4850 kHz, with a newscast in Spanish at 0300 daily (irregular).

**Brazil**—Station PRAB, *R. Clube de Pernambuco*, Recife, 6015 kHz, has a good signal at 0807-0900 with usual Brazilian music and five minutes of ads before the hour and half hour. Station ZYK21, *R. Tamandare*, Recife, 3265 kHz, can be heard at times under *R. Ribeirao Preto*, using the same channel, with Brazilian pop music, many ads, and an ID every 15 minutes (unverified). On 3295 kHz, there are three stations operating: *R. Cultura de Sergipe*, Rua Simao Dias, 643 Aracaju, Sergipe, waiting assignment of a call-sign, runs dual to ZYM22 on 670 kHz, 10 kW; *R. Educacao Rural*, Rua Ruy Barbosa 877, Campo Grande, Mato Grosso (1 kW), is dual to 1260 kHz; and *R. Educadora de Uberlandia*, ZYV75, Caixa Postal 401, Uberlandia, Minas Gerais, is dual to 780 kHz.

**Cambodia**—*R. Phnom-Penh*, 4995 kHz, has been heard with a fair-to-good signal with local-type music and Southeast Asian language at 1045.

**Cameroon**—*R. Garoua*, 5010 kHz, is heard well with African music at 2150-2200; there are some anmts in French at 2155.

**Canada**—The Ontario Dept. of Lands & Forests operates a station at White River on 3376, 4460, 4520, 4580, 4880, 5170, 5499, and 9172 kHz at 1200-2300 (winter) and 1200-0300 (summer). The power is 300 watts. Look for it around sunrise and sunset.

**Colombia**—Station HJIW, *Voz de Centro*, Espinal (?), 6095 kHz, was noted with two ID's between 0345 and 0348 in Spanish. This spot is usually occupied by a Brazilian.

**Czechoslovakia**—*R. Prague* has been found on 9635 kHz at 0110 with Eng. to N.A., dual to 7345, 11,990, and 15,368 kHz.

**Egypt**—Cairo was noted with an Arabic ID at 0525 on 11,875 kHz—a new frequency—and on 15,290 kHz at 2045 with Eng. news and anti-Israeli propaganda.

POPULAR ELECTRONICS

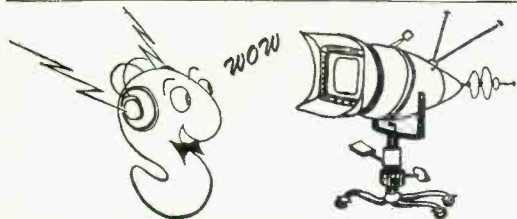

### TELEPHONE ENGINEERING COURSE

basic instruments to long distance circuits.....\$39.50

### DETECTIVE ELECTRONICS COURSE

designed for the professional.....\$22.50

### VIDEO TAPE RECORDERS

package deals below wholesale

### AMAZING CONSTRUCTION PLANS

see our ad in the classified section

### ASTROTAPE

world's finest mylar audio recording tape.....\$1.75/1800'

### SURPLUS ELECTRONIC EQUIPMENT

wild, wild buys in government surplus

**SUPER**

**HOBBY**

**CATALOG 25¢**

**DON BRITTON ENTERPRISES**

PO Drawer G, WAIKIKI, HAWAII 96815

CIRCLE NO. 11 ON READER SERVICE PAGE



**Ethiopia**—Station ETLF, *Radio Voice of the Gospel*, Addis Ababa, 7125 kHz, is excellent from 0330 s/on in Eng. to E. Africa.

**Finland**—Finnish B/C Co., Helsinki, 15,155 kHz, (replacing 15,185 kHz) broadcasts to N.A. at 2300-0000 in Eng. (to 2315) and in Finnish with news, talks, and light music.

**Formosa**—*Voice of Free China* is scheduled in Eng. at 0200-0350 on 7130, 11,825, 15,125, 15,345, 17,720, 17,775, and 17,890 kHz, and at 1800-1900 on 9685, 9765, 11,725, 11,825, 15,125, and 17,890 kHz. The "Dragon Show" is aired at 1030-1100 on 7130, 9655, 9685, 11,825, and 17,890 kHz.

**Germany (West)**—*Deutsche Welle*, Cologne, 9765 kHz, was heard at 2116 with Eng. news. A late schedule shows Eng. and French at 0130-0250 on 9640 and 11,945 kHz. Eng. at 0445-0545 on 9545 and 11,945 kHz, "Newsfeed" at 1045-1055 on 11,905 and 15,315 kHz, and at 1900-1910 on 15,405 and 17,790 kHz.

**Guinea Rep.**—*R. Conakry* was heard on a seldom-noted frequency of 7125 kHz from 2315 to 0000 s/off with news, local music, and ID in French. The 15,305-kHz outlet, new, can be heard from 0600 s/on with IS. ID in French, then native music.

**Guyana**—Georgetown, 5980 kHz, has been heard at 0948 giving time as 6:03 a.m. ID for *R. Demerara*, and programs to follow: 0955, orchestra and local items; 1000, commercial and a religious service. News in Eng. is given at 1018.

**Indonesia**—Although nothing is listed for 7285 kHz, a station is definitely being heard in Indonesian, climbing to a good level by 1130 and going parallel to Ambon, 7140 kHz, at 1200. Sorong, 4872 kHz, is also heard well with Indonesian language at 1115.

**Iran**—Teheran can be heard daily in Eng. at 2030 on 11,730 kHz with news, music and talks. Another outlet is heard on 15,140 kHz from 2030 to past 2058 with talks and music but no English.

**Israel**—*Kol Israel*, Jerusalem, has Eng. to Europe at 2115-2130 on 9009 and 9725 kHz. Eng. to Africa at 2015-2030 on 9009 kHz, and French to Europe at 2045-2115 on 9725 kHz and at 2145-2215 on 9009 kHz.

**Italy**—Infrequently reported on 6050 kHz, Rome was logged here from 0415 s/on in Italian.

**Ivory Coast**—*R. Abidjan*, 6115 kHz, can be heard at 2230-2300 with music, and sportscasts at times.

**Lebanon**—*R. Lebanon*, Beirut, has Eng. to Africa at 1830-1900 on 15,180 kHz. English to N.A. at 0230-0300 on 11,925 kHz is preceded by 30-minute programs at 0130 in French and 0200 in Arabic, followed by Arabic until 0330, and Spanish until 0400. A new frequency, 17,710 kHz, has been noted; opening is in native language at 2300 to South America.

**Malaysia**—*R. Malaysia*, Kuala Lumpur, in Home Service on 4845 kHz, was observed at 1220-1230 with music of S. E. Asia and native language.

**Mexico**—For the medium-wavers, XEG, Monterey, 1050 kHz, is often good during dark hours with many programs of a religious nature. You may experience some QRM from WHO, Des Moines, 1040 kHz; WHN, New York, 1050 kHz; or KYW, Philadelphia, 1060 kHz.

**Mongolia**—Once again being heard is *R. Ulan Bator* on 10,885 kHz from 2257 to 2301 with chimes IS, anthem, and native language programming. No Eng. was noted at this time.

**Netherlands Antilles**—*Trans-World Radio*, Bonaire, has a xmsn in Portuguese beamed to South America from 2300 to 2330 and in German until 2355 on 15,280 kHz, replacing 15,170 kHz.

**New Zealand**—*R. New Zealand*, Wellington, was noted with a sporting event in Eng. at 0250-0300 on a new split-channel frequency, 17,768 kHz, dual to 15,110 kHz. Also heard were the 9520- and 11,780-kHz outlets, after 0700; there was QRM on the former, good reception on the latter.

**Nigeria**—Lagos fades in by 2000 and ID's as *Voice of Nigeria* in native language on 15,120 kHz, a new channel.

**Niue Island**—Good as DX news but unlikely to be heard, except possibly on the West Coast, is 2ZN, Niue, on 550 kHz, with 200 watts. The schedule is Tuesdays, Thursdays and Saturdays at 0530-0730 in Eng. and Nuiclan. Niue time is 11 hours behind GMT.

**Pakistan**—A new outlet for Karachi is 17,830 kHz, tuned at 0200 with native language.

**Portugal**—Here are two new frequencies for *R. Lisboa*: 11,935 kHz in Eng. to N.A. with closing at 0230 (this channel unannounced; the normal outlets on 6185 and 6025 kHz are still best for this xmsn); and 9585 kHz at 2300-0000 with Portuguese to South America (news at 2330).

**Portuguese Guinea**—*Emissora de Guine* is now audible as early as 2330 on 5044 kHz, with s/off following at 0000 after the anthem "A Portuguesa."

**Saudi Arabia**—Djeddah has been noted wandering lately from as low as 15,100 kHz to as high as 15,150 kHz, around 2200, with native music, variety programming, and news in Arabic.

An overseas source states that this country will soon have a new medium-wave xmitr of 1250 kW (1,250,000 watts!) to serve areas in Europe, the Near East, and Africa; no frequency has yet been

### SHORT-WAVE ABBREVIATIONS

Anmt—Announcement	N.A.—North America
B/C—Broadcasting	QRM—Station interference
Eng.—English	R.—Radio
ID—Identification	s/off—Sign-off
IS—Interval signal	s/on—Sign-on
kHz—Kilohertz	xmsn—Transmission
kW—Kilowatts	xmitr—Transmitter

## Sonar SENTRY VHF MONITOR RECEIVERS

With Battery, Earphone, & Carrying strap less Crystals Crystals \$5.00 ea.

**\$39<sup>95</sup>**

Model  
**FR-103** | **FR-106**  
150-175 MHz | 25-50 MHz



### LISTEN TO: POLICE, FIRE, AIRCRAFT & WEATHER REPORTS!

for Industrial, Commercial, Utility & Govt. Use  
2 CHANNELS • BROADCAST BAND • CRYSTAL CONTROLLED

Designed and engineered for simplicity of operation, compact enough to fit a shirt pocket yet powerful enough to deliver a clear clean signal—it's dependable • Operates on two crystal controlled VHF channels plus broadcast band • Completely solid state for long life use • Visible battery indicator to show battery condition at all times • Built in antenna • 5 7/8" H x 2 1/2" W x 1 3/8" D. Wt. 11 oz.

SONAR RADIO CORP., 73 Wortman Ave., Bklyn, N.Y. 11207

Please send information on VHF Monitor Receivers.

Name \_\_\_\_\_ Dept. 584

Address \_\_\_\_\_

City \_\_\_\_\_ State \_\_\_\_\_

CIRCLE NO. 25 ON READER SERVICE PAGE



# POPULAR ELECTRONICS SUBSCRIBER SERVICE

Please include an address label when writing about your subscription to help us serve you promptly. Write to: Portland Place, Boulder, Colo. 80302

**CHANGE OF ADDRESS:** Please let us know you are moving at least four to six weeks in advance. Affix magazine address label in space to the right and print new address below. If you have a question about your subscription, attach address label to your letter.

**TO SUBSCRIBE:**

Check boxes below.

- New  Renewal  
 5 years \$20  
 3 years \$13  
 1 year \$5

**SPECIFY:**

- Payment enclosed  
 —You get 1 extra issue per year as a **BONUS!**  
 Bill me later.

AFFIX LABEL

If you have no label handy, print OLD address here.

state      city      address      name      please print      zip code

[Add'l postage: \$1 per year outside U.S., its possessions & Canada.]

name please print 0261

---

address

---

city

---

state zip code

---

quoted. Compare this power to that of *R. Nederland's* Bonaire outlet on 800 kHz with 525 kW.

**Senegal**—*R. Senegal*, Dakar, has moved a xmttr to 15,115 kHz (another new frequency) where it is heard as early as 1930 in French with news and variety. By 2215, the signal is generally excellent.

**South Africa**—At press time, *R. RSA*, Johannesburg, is operating on 11,875 and 9705 kHz at 2325-0000 to Eastern Canada, including Nova Scotia and Newfoundland. According to a DX program, a new internal short-wave service from this country is planned, using four 100-kW xmttrs.

**Spanish Sahara**—Regarding EAJ103, a new 50-kW station reported recently on 656 kHz, the latest available schedule shows no English. Local lan-

## SHORT-WAVE CONTRIBUTORS

- Thomas Feeney, Jr. (*WPE1GZC*), Newport, R. I.  
 Robert Lazar (*WPE1HHS*), Plainville, Conn.  
 Wayne Rosenfield (*WPE1HHV*), Springfield, Mass.  
 William Graham (*WPE2LMU*), Binghamton, N. Y.  
 Peter Macinta (*WPE2ORB*), Kearny, N. J.  
 John Banta (*WPE2PHU*), Bay Shore, N. Y.  
 Edward Sobota (*WPE2PIR*), Fulton, N. Y.  
 Tom Cardinal (*WPE2PMK*), Astoria, N. Y.  
 Brian McMahon (*WPE2POC*), Fair Haven, N. J.  
 James Rivello (*WPE2POK*), Cherry Hill, N. J.  
 Stanley Benson (*WPE2POH*), Bronx, N. Y.  
 Joel Singer (*WPE2PSU*), Jamaica, N. Y.  
 Mark Kirshner (*WPE2PWH*), East Meadow, N. Y.  
 Bret Schumacher (*WPE2PWI*), Liverpool, N. Y.  
 Edward O'Connor (*WPE2PZA*), Enklewood, N. J.  
 Bob Huber (*WPE3GUN*), Wilmington, Del.  
 Bob Barr (*WPE3HNC*), Willow Grove, Pa.  
 Dan Ferguson (*WPE4AUL*), Coral Gables, Fla.  
 Grady Ferruson (*WPE4BC*), Charlotte, N. C.  
 Dan Henderson (*WPE4GW*), Laurel, Md.  
 Winston Prude (*WPE5ESF*), Amorv, Miss.  
 Trev Clegg (*WPE6FAF*), Santa Cruz, Calif.  
 Tom Burnett (*WPE6GYA*), Reseda, Calif.  
 Thomas Saputo (*WPE6LJI*), Detroit, Mich.  
 Jim Leon (*WPE9JYQ*), Norridge, Ill.  
 A. R. Niblack (*WPE9KM*), Vincennes, Ind.  
 John Beaver, Sr. (*WPE0AE*), Pueblo, Colo.  
 Phil Wanat (*E44PE1B*), APO, Madrid, Spain  
 Jack Perolo (*PY2PE1C*), San Paulo, Brazil  
 Billy Kournikakis (*VEP2E1M1*), Montreal, Quebec, Canada  
 Robert Jones (*VE3PE2W*), Belleville, Ontario, Canada  
 Mike Thompson (*VE7PE1BE*), Vancouver, B. C., Canada  
 Dave Chapman, Upton, N. Y.  
 Thomas Daly, New Hyde Park, N. Y.  
 Russell Dixon, Cherry Hill, N. J.  
 Leslie Marcus, Eugene, Ore.  
 Curtis Phillips, Hellertown, Pa.  
 Richard Sia, Honolulu, Hawaii  
 Sherman Wing, Hanford, Calif.  
*Sweden Calling DX'ers Bulletin*, Stockholm, Sweden

## SURPLUS SATELLITE BATTERIES 6 AMP/HR — 97¢ ea.

(Govmnt. Cost \$11.40 ea.)



These Government surplus storage battery cells are nickel-cadmium sintered plate type used in satellites and missiles due to characteristics not possessed by any other battery, i.e.: Lifetime service, constant voltage during discharge, extreme temperature ranges, discharges in any position, compact, high discharge rates, no corrosive fumes, not harmed by storage, overcharging and freezing. Cells are 1.25 V. each. Combine these cells in series to required voltage for replacement of any battery-operated equipment (within discharge limits—150 amps on this cell), using dry or storage batteries where portability, dependability, constant voltage, high current drains, and ruggedness are requisites. Size 4 1/2" H. x 2 3/8" W. x 1 1/16" T. Wt. per cell 1/2 lb.

- Used, as received from Govmnt. \$ .97 ea.  
 Used, checked for cracks & electrolyte restored \$1.49 ea.  
 Brand new cells \$2.95 ea.

Include postage with order.

We have other cells of greater Amp. Hr. capacities for motor starting, etc. In stock. Send for free list.  
**GUARANTEE:** All checked & new cells are guaranteed or your money back.

**ESSE RADIO COMPANY**

Dept. PE-1 368 S. Meridian St. Indianapolis, Indiana 46225

guages are aired at 0900-1000 and 2000-2055, Spanish at 1000-1300 and 2055-0000. Reports appearing in an overseas publication do not yet include any from N.A. The slogan: *R. Sahara*. The location: El Aaiun.

**Tunisia**—Tunis seems to have stabilized on 6200 kHz, noted by several checks at 0430 s/on in Arabic.

**Venezuela**—*R. Frontera*, a fairly new station, is noted on 4760 kHz, in Spanish, strong, with many ads, a variety of L.A. music, and a 0400 s/off. The ID's are frequent and time checks are given for both Venezuela and Colombia.

**Windward Islands**—The W. I. B/C Service, St. Georges, Grenada, is taking advantage of the better conditions on the higher bands; it was noted at 1930-1055 on 21,690 kHz. The 17,885-kHz channel was also tuned at 2210-2245 with music, program items, and talks. On the lower frequencies, reception continues to improve, with a good signal on 11,970 kHz as early as 0100.

**Yugoslavia**—*R. Belgrade* has Eng. at 1530-1600 on 9505, 11,735, and 15,240 kHz at 1830-1900 on 6100 and 7200 kHz, and at 2200-2215 on 1268, 6100, 7200, and 9505 kHz.

TAKE ONE



# new literature

To obtain a copy of any of the catalogs or leaflets described below, simply fill in and mail the coupon on page 15.

"The Tape Cartridge: How It Began and What It's All About" is the title of a colorfully illustrated booklet published by *Audio Devices*. The 12-page booklet discusses continuous loop and cassette type cartridges, provides "at-a-glance" diagrams to help you understand tape cartridge features, and gives hints on proper handling of cartridges for trouble-free performance.

Circle No. 87 on Reader Service Page 15

Catalog No. 167, just released by the *J. W. Miller Company*, lists more than 2800 coils and chokes (including specifications) in its 156 pages—some 200 of which are new items. And there are over 3000 parts listed in the 98-page cross-reference coil replacement section, said to be the most complete and authoritative coil reference source covering all major brand TV sets and home and car radios.

Circle No. 88 on Reader Service Page 15

Many additions have been made to *Altec Lansing's* line of hi-fi components and speaker systems, as described in this company's new 1968 brochure, No. AL-1368. A variety of furniture equipment cabinets, tastefully designed for any home decor, are discussed and illustrated. Technical specifications are included.

Circle No. 89 on Reader Service Page 15

You can familiarize yourself with the latest technological advancements in color-TV picture tubes by reading "Today's RCA HI-LITE Color Picture Tubes" (ID1304) put out by the *Radio Corporation of America*. The advantages of RCA's new red phosphor, and Perma-Chrome and Unity Current Ratios are all explained in colorful detail in this 12-page (8½" x 11") brochure.

Circle No. 90 on Reader Service Page 15

Eight new HEP semiconductor devices are featured in Motorola's latest catalog covering the complete HEP line. They include: the HEP 240 npn silicon power transistor in TO-66 (small diamond) package; HEP 452 TO-66 mounting kit; HEP n-channel r.f. FET (only \$1.59); and three, Dual In-Line plastic RTL IC's (HEP 570, 571, and 572).

Circle No. 91 on Reader Service Page 15

January, 1968

## Deluxe POPULAR ELECTRONICS MAGAZINE CASES

DESIGNED TO HOLD A FULL YEAR'S COPIES

These decorative cases are just what you've been looking for to keep your copies of Popular Electronics Magazine in easy-to-find order.

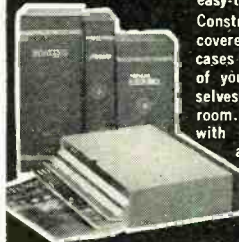

Constructed of reinforced fibreboard and covered in rich leatherette, these durable cases guard against soiling and tearing of your magazines while lending themselves handsomely to the decor of any room. The magazine cases are available with embossed gold lettering in either all black or attractive maroon back with black sides.

\$3.50 ea., 3 for \$10, 6 for \$19

FULLY GUARANTEED!

Ziff-Davis Publishing Co., Dept. SD

1 Park Ave., N.Y., N.Y. 10016

Please send me \_\_\_\_\_ Popular Electronics Magazine

Files as checked below:

- All black, gold embossed
- Maroon back, gold embossed/black sides

NAME \_\_\_\_\_ P.E. 1

ADDRESS \_\_\_\_\_

CITY \_\_\_\_\_

STATE \_\_\_\_\_ ZIP \_\_\_\_\_

Enclosed is \$ \_\_\_\_\_ at \$3.50 per case, 3 for \$10, 6 for \$19 (Quantity prices apply for combination orders of more than one title). Orders outside U.S.A. \$4.50 ea., 3 for \$13, 6 for \$25.

■ ■ ■ (Payment must accompany order) ■ ■ ■

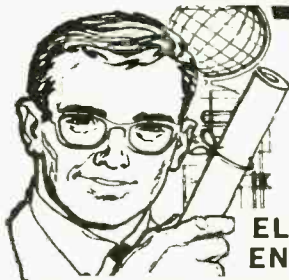

## Earn Your Degree

### ELECTRONICS ENGINEERING

### through HOME STUDY

- HIGHLY EFFECTIVE HOME STUDY COURSES IN:
- ELECTRONICS ENGINEERING TECHNOLOGY
  - ELECTRONICS ENGINEERING MATHEMATICS

Earn your Associate in Science Degree in Electronics Engineering and upgrade your status and pay to the engineering level. Complete college level courses in Electronics Engineering. We're a forward looking school. Outstanding lesson material—thorough and easy to understand. Engineering taught on the basis of application and understanding rather than on the basis of memorization. Up to date in every respect. Acquire the knowledge and ability that means the difference between a low paying technician job and a high paying engineering position. Low tuition cost with low monthly payments. Free engineering placement service for our graduates. Write for free descriptive literature. Ask for bulletin B, no salesman will call on you.

## COOK'S INSTITUTE of Electronics Engineering



Southern Regional Office  
2705 Gallatin Road—P.O. Box 4689  
Nashville, Tenn. 37216

Established 1945

Formerly Cook's School of Electronics

CIRCLE NO. 9 ON READER SERVICE PAGE

## SOLID STATE

(Continued from page 79)

source ( $B1$ ) is needed. As in the circuit of Fig. 2, either binding post ( $BP1$ ,  $BP2$ , etc.) or jack type connectors can be used.

The preamp circuit can be assembled as part of a complete amplifier system or as a separate accessory instrument, depending on individual requirements. Layout is not overly critical. Either etched circuit or perforated board construction techniques can be used.

**Transistors.** In one sense, a bipolar transistor is really two diodes connected "back-to-back." Most experimenters and engineers know that transistors can be used as relatively effective half-wave diode detectors or rectifiers simply by connecting to the base and emitter (or collector) leads, even if the other electrode is "open" internally. Less well known is the fact that—*within limitations—both diode elements may be used at the same time!* Several unusual transistor "diode" applications are illustrated schematically in Figs. 4 to 7. Component values

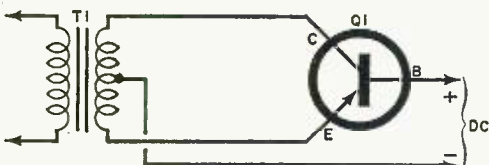

Fig. 4. Low-to-moderate current rectifier circuit.

are not listed, as these will vary with the types of transistors used, circuit voltages, load requirements, and other factors.

A simple full-wave rectifier circuit using a single *pnp* transistor,  $Q1$ , and a center-tapped transformer,  $T1$ , is shown in Fig. 4. If an *npn* transistor is used, the output d.c. polarity is reversed. Low to moderate currents can be obtained with power transistors, but the circuit is not overly efficient, for the emitter-collector area acts as a resistive load on the transformer. Best results are obtained with low-gain, low-leakage transistors.

A full-wave bridge rectifier can be as-

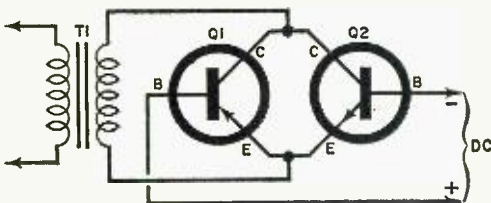

Fig. 5. Bridge rectifier made from two transistors.

sembled by using both *pnp* ( $Q1$ ) and *npn* ( $Q2$ ) types, as shown in Fig. 5. As in the circuit of Fig. 4, efficiencies are low and best results are obtained with low-gain, low-leakage types.

The half-wave rectifier circuit in Fig. 6 uses a single transistor,  $Q1$ , and a "bias" rheostat,  $R1$ , and features an adjustable output. In operation,  $Q1$  conducts *only* on negative half-cycles (when both base and collector are negative with respect to the emitter) and at a level determined by the base's instan-

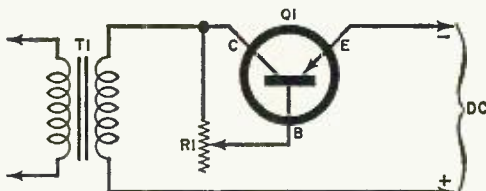

Fig. 6. Half-wave circuit having adjustable output.

taneous bias current which, in turn, is determined by  $R1$ 's value. Here, best results are obtained with high-gain transistors, and overall performance is much more efficient.

A unique circuit in which a transistor serves as an automatic "switch" is shown in Fig. 7. Transistor  $Q1$  is used in conjunction with a battery,  $B1$ , and a line-operated d.c. power supply ( $T1$ ,  $D1$ , and  $C1$ ). The power supply's output voltage is fixed high enough so that the normal load voltage almost equals the battery voltage. Thus, there

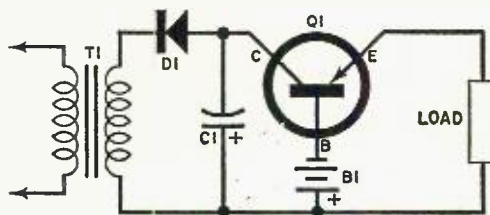

Fig. 7. Automatic switch using a minimum of parts.

is only a *small* base bias current. As long as line power is available, the load current is furnished principally by the d.c. power supply. If line power fails, however, then  $Q1$ 's base-emitter junction, acting as a forward-biased diode, permits  $B1$  to furnish load current. The difference between battery and line power, as far as the load is concerned, is but a small fraction of a volt; hence, there is no noticeable difference in load operation.

**Product News.** Westinghouse (P.O. Box 2278, Pittsburgh, Pa.) has a new resonant-gate transistor that is essentially a modified MOSFET in which the gate electrode is a



subminiature cantilevered beam acting somewhat like a tuning fork. In operation, the input signal is electrostatically coupled to the free end of the gate beam, which is then set in motion above the source and drain electrodes. Maximum deflection and hence maximum output occurs at the beam's resonant frequency. Currently available units have Q's of from 20 to about 200 at frequencies from 3 kHz to 30 kHz, although higher frequencies can be obtained by using an overtone mode of vibration.

Also from Westinghouse comes news of an extremely high power *npn* silicon transistor. Identified as Type 1401, this new unit has a continuous power rating as high as 625 watts at  $V_{ce}$  values up to 140 volts and at currents of up to 250 amperes. A low to moderate gain device, the 1401 has a cutoff frequency of 0.5 MHz.

Texas Instruments (13400 N. Central Expressway, Dallas, Texas) has announced a new series of low-cost plastic transistors with 1.6-watt power dissipation ratings. Both *npn* and *pnp* types are offered in the series, as well as factory-matched complementary pairs. The *npn* types are designated as TIS90 and TIS92, while the *pnp* types are TIS91 and TIS93. With a minimum break-

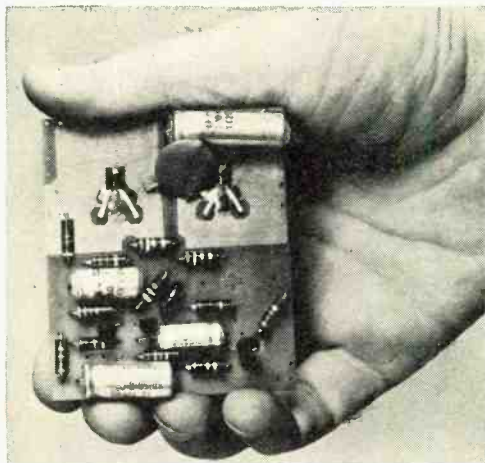

This small handful of amplifier, which utilizes the new Texas Instruments economy plastic transistors, can deliver 2 watts using PC board as a heat sink.

down rating of 40 volts and a maximum collector current rating of 400 mA, the new units are ideally suited to low-cost audio applications. The manufacturer suggests their use in amplifiers in which an area of copper on the face of an etched circuit board serves as a heat sink.

That's it for now—watch out for those wintry winds!

—Lou

Live Better Electronically With

# LAFAYETTE RADIO ELECTRONICS

## 1968 Catalog 680 **FREE!**



**Now OFF PRESS  
BETTER THAN EVER  
Over 500 Pages**

Stereo Hi-Fi • Citizens Band • Ham Gear • Tape Recorders • Test Equipment • TV and Radio Tubes and Parts • Cameras • Auto Accessories • Musical Instruments • Tools • Books

**Featuring Everything in Electronics for**  
**• HOME • INDUSTRY • LABORATORY**  
 from the "World's Hi-Fi & Electronics Center"

**LAFAYETTE Radio ELECTRONICS**  
 Dept. 1A-8 P.O. Box 10  
 Syosset, L.I., N.Y. 11791

---

Send me the FREE 1968 LAFAYETTE Catalog 680 1A-8

Name

Address

City  State

Zip

(Please Give Your Zip Code No.)

CIRCLE NO. 16 ON READER SERVICE PAGE

# SAY YOU SAW IT IN POPULAR ELECTRONICS

**LEARN DRAFTING  
AT HOME**



**ALL 3  
FREE**

U.S. Labor Dept. says "42% more Draftsmen needed next 10 years." Send for FREE "DRAFTING CAREER KIT." No salesman will call.

NAME  AGE

ADDRESS

CITY  STATE  ZIP

NORTH AMERICAN SCHOOL OF DRAFTING, Dept. 1341  
 Accredited National Home Study Council 4500 Campus Drive, Newport, California 92660

## AMATEUR RADIO

(Continued from page 76)

17, from 1330 to 1700 GMT (5:30 to 8 a.m. PST). W's and VE's transmit the first five minutes, DX the next five minutes, as above.

Each year dozens of transatlantic contacts are made in these DX tests. Japan has only recently authorized its amateurs to use 160 meters, but already many W6, W7, VE7 to Japan 160-meter contacts have been made, and U.S. amateurs in other call areas have been heard in Japan. The JA's transmit between 1907.5 and 1912.5 kHz and listen in the U.S. band segments for replies.

**News From Club Papers.** According to Tom, W3AX, writing in *Auto Call*, published by the Foundation for Amateur Radio, Inc., Washington, there are 485 Navy ships (including eight air mobiles) with amateur stations aboard, each with its own call-sign. The aircraft carrier *Franklin D. Roosevelt* has eight amateurs, and the aircraft carrier *America* has nine. Incidentally, at the last count, there were over 7000 amateurs enrolled in the Navy MARS program.

Bob Grodrian, WA9CJR, Editor of the Indiana Radio Club Council, Inc.'s *Bison*, reports that when a South Bend, Ind., TV station photographer pushed the "transmit" button on his mobile transmitter, an explosion in the trunk blew out a panel under the rear window of the car and started a flash fire that did \$1000 in damages to the car. The photographer, who was treated for minor neck and face burns, said that he had been smelling gasoline fumes in the car for some time. This incident is a timely reminder not to operate your mobile equipment while getting gasoline for the car or in the presence of gasoline fumes—a spark-

ing relay may cause you to get out even better than you hope.

Sonny Ketter, WAØBBI, Chairman of the Denver Radio Club TVI committee, reporting in the *DRC Round Table*, said that of the latest 25 TVI complaints referred to the committee by the Denver FCC office, only four were caused by amateur transmitter defects, and they were quickly remedied by the amateurs involved. Eighteen of the other complaints, where there actually was interference to the TV pictures, were cleared up by the installation of high-pass filters at the TV receiver antenna terminals. Two of the complaints were withdrawn, and one was still under investigation.

**W6JBA Commended.** Last September, Harold Samson, W6JBA, Supervisor of the Electronic Data Processing Section of the California Highway Patrol, received an "Outstanding Performance Award" from the Patrol for his work in setting up its Amateur Radio/MARS auxiliary communications system. The system was born as a result of communications interruptions during the 1963 tidal waves and 1964-65 floods. W6CDY, at Patrol Headquarters, is a member of the West Coast 7255-kHz emergency net.

### NEWS AND VIEWS

**Steve Barefoot, WA9SMN**, 3500 South Penn St., Muncie, Ind., worked 44 states and 4U1ITU at the International Telecommunications Union headquarters in Geneva, Switzerland, as a Novice. Now, after a few months as a General, he has worked all states and 22 countries on all continents. Steve uses a Swan 500 SSB/CW transceiver mostly on 20 meters SSB and CW, but he also likes to work South American DX on 40 meters. His Antennas for these bands are dipoles. A Heathkit "Twoer" and a 7-element beam handles two meters . . . **Mike Reininga, WN9VYR**, 1119 South Englewood, Evansville, Ind., worked a VE3 (Canada) for his first contact. In a week, he racked up 25 states and another Canadian province, mostly on 40 meters with a few on 15 meters. Possibly having the top of his Hy-Gain 14-AVQ vertical antenna 75 feet high helps Mike's Heathkit DX-60 do so well. He receives on a Hammarlund HQ-170 . . . **Steve Glickman, WB4HFJ**, 7835 S.W. 133 St., Miami, Fla., had to wait over three months after passing his General exam before he got his ticket. Even worse, he didn't get a counterpart of his Novice call-sign—WN4FFB. Steve drives a vertical antenna with a Johnson "Viking Valiant" on 20-meter CW and 15-meter phone, and he receives on a Drake 2-C. His logbook shows 42 states and 32 countries confirmed.

**Ronald E. Sprague, WA2WVV**, 623 Garson Ave., Rochester, N.Y., has been a ham for six years and has operated from six different locations while in the Air Force, including Newfoundland and the Aleutian Islands. He has made DXCC five times and has worked all states twice at his different portable locations. Now in Rochester, he is on the way again with a Heathkit SB-100 transceiver driving a Mosley TA-33 Jr. tri-bander on a 40-foot tower. When not hamming, Ronald is a Senior Research Aide at Xerox Company . . . Last summer, **Sammy Davis, WA1GQY**, 128 Bainbridge St., Malden, Mass., operated from Camp Bauercrest in Massachusetts and worked 39 states and 12 countries in



If all goes according to plan, Lester Zaviski, WN7HEO, Enumclaw, Wash., will be signing his General Class call when you see this picture.





Robert W. Baker, WB2SCK, Pitman, N.J., uses his Heathkit SB-100 SSB/CW transceiver and two home-built amplifiers mostly on 20 meters (phone and CW) and looking for Hawaii for WAS. Bob also has a Heathkit "Sixer" and Mosley CM-1 receiver.

seven weeks. The equipment used was Sammy's B&W 5100-B transmitter and matching SSB adapter, and a borrowed receiver. At home, using the same transmitter and a Hammarlund HQ-110 receiver, plus a 10-15 meter beam on a 35-foot tower and dipoles for the lower frequencies, he has worked all states and is an ARRL OBS (Official Bulletin Station) . . . Lester V. Lohrman, WAJENE, 2053 Ferry St., Easton, Pa., is a registered pharmacist in his own pharmacy; that and a wife and two young children do not leave too much time for amateur radio—so he says. But Les has a full house of equipment, including a Johnson "Valiant" transmitter, Hallicrafters SX-101A and SX-117 receivers and HT-44 transmitter, and a Heathkit SB-200 linear amplifier, all used in conjunction with a 28-foot vertical antenna. After working six years to make the antenna operate with a very low feedline standing-wave ratio on all bands from 80 through 6 meters, Les discovered that he had "invented" the same vertical antenna described in the "Radio Handbook." Anyway, it works fine on all bands and excites much comment. With it, Les has logged 36 states and 17 countries confirmed. Currently, he spreads his thin operating time over 80-, 40-, 20-, and 15-meter CW, 75-meter AM, and 75- and 20-meter SSB. Oh, yes, Les also likes photography, swimming, bass fishing, trumpet playing, and people watching.

Carl Kratzer, WN3HRV, 7201 Selkirk Dr., Bethesda, Md., brought his code speed up to 15 wpm in three months of operating. As a by-product, he also put 37 states, 5 Canadian provinces, and 11 countries in his logbook. A home-brew transmitter using an 829B tube to feed a 75' end-fed wire 20 feet high does the exhaling, and a Hallicrafters SX-101 receiver does the inhaling on the 80- and 15-meter Novice bands . . . Ronald G. Weaver, WA6CZH, 11970 Grevillea, Apt. "E," Hawthorne, Calif., has just completed 10 years as a ham and enjoys his hobby as much today as he did when he was a Novice. It must be catching, because his wife is WN6VBF, and is studying hard for her General ticket. Living in an apartment limits Ron to a Hy-Gain 14-AVQ antenna on the roof of the building; however, WAS, WAC, and 72 countries worked with his Swan 350 transceiver prove that this is not too much of a handicap. Ron prefers CW but will work SSB if needed and will sked Novices who need a California contact.

Are you going to start out the new year by writing us a letter telling us *your* "News and Views"? And how about sending us a picture of yourself operating the gear that makes you so strong in the other fellow's receiver? Keep your club bulletins coming, too, please. The address, as always, is: Herb S. Brier, W9EGQ, Amateur Radio Editor, POPULAR ELECTRONICS, P.O. Box 678, Gary, Ind. 46401.

73, Herb, W9EGQ

## FIRST WITH

- ★ Digital Integrated Circuits
- ★ 4 Crystal-Controlled Oscillators
- ★ Battery & AC Operation Standard



The New Pace-Setting CONAR Model 680  
**COLOR GENERATOR**  
 KIT \$83.50 WIRED \$114.50

Until now, no commercially available color generator has offered so many quality features in a single instrument at such a low price. Only the CONAR SIGNAL GENERATOR has all these features at any price: exclusive digital integrated circuits; exclusive 4 crystal-controlled oscillators; exclusive AC or battery operation standard; completely solid state; color amplitude control; color phase adjustment; regulated power supply; stability control; TV station sync and blanking pulses; nine patterns; red, blue and green gun killers; compact; lightweight; portable.

For details write Dept. AA8C

## CONAR instruments

DIVISION OF NATIONAL RADIO INSTITUTE  
 3939 Wisconsin Ave., Washington, D.C. 20016

WRITE FOR FREE CONAR CATALOG



## SAVE BIG MONEY ON ELECTRONICS

**FREE**

Buy from RADIO SHACK, America's biggest nationwide electronics store chain. Send now for your free copy of our new 1968 bargain-packed electronics catalog, available soon . . . plus a year of special bargain bulletins. Write to—

**RADIO SHACK®**  
 2727 West 7th St., Dept. WN  
 Fort Worth, Texas 76107

**FREE CATALOG AND BARGAIN BULLETINS**

Name .....

Address .....

City ..... State ..... Zip .....

Radio Shack Corporation — subsidiary of  
 Tandy Corp. • Over 190 stores coast to coast

CIRCLE NO. 22 ON READER SERVICE PAGE



**STATEMENT OF OWNERSHIP, MANAGEMENT AND CIRCULATION** (Act of October 23, 1962; Section 4369, Title 39, United States Code).

1. Date of filing: October 1, 1967.
2. Title of publication: **Popular Electronics**.
3. Frequency of Issue: Monthly.
4. Location of known office of publication: 307 N. Michigan, Chicago, Illinois 60601.
5. Location of the headquarters or general business offices of the publishers: One Park Avenue, New York, New York 10016.
6. Names and addresses of publisher, editor, and managing editor: Publisher, Phillip T. Heffernan, One Park Avenue, New York, New York 10016; Editor, Oliver P. Ferrell, One Park Avenue, New York, New York 10016; Managing Editor, Leslie Solomon, One Park Avenue, New York, New York 10016.
7. Owner (If owned by a corporation, its name and address must be stated and also immediately thereunder the names and addresses of stockholders owning or holding 1 percent or more of total amount of stock. If not owned by a corporation, the names and addresses of the individual owners must be given. If owned by a partnership or other unincorporated firm, its name and address, as well as that of each individual must be given.) Ziff-Davis Publishing Company, One Park Avenue, New York, New York 10016; William B. Ziff, One Park Avenue, New York, New York 10016; Priscilla R. Stafford, One Park Avenue, New York, New York 10016.
8. Known bondholders, mortgagees, and other security holders owning or holding 1 percent or more of total amount of bonds, mortgages or other securities: None.
9. Paragraphs 7 and 8 include, in cases where the stockholder or security holder appears upon the books of the company as trustee or in any other fiduciary relation, the name of the person or corporation for whom such trustee is acting, also the statements in the two paragraphs show the affiant's full knowledge and belief as to the circumstances and conditions under which stockholders and security holders who do not appear upon the books of the company as trustees, hold stock and securities in a capacity other than that of a bona fide owner. Names and addresses of individuals who are stockholders of a corporation which itself is a stockholder or holder of bonds, mortgages or other securities of the publishing corporation have been included in paragraphs 7 and 8 when the interests of such individuals are equivalent to 1 percent or more of the total amount of the stock or securities of the publishing corporation.

10. Extent and nature of circulation

	Average No. Copies Each Issue During Preceding 12 Months	Single Issue Nearest To Filing Date
A. Total No. Copies printed (Net Press Run) .....	479,240	455,160
B. Paid circulation		
1. Sales through dealers and carriers, street vendors and counter sales .....	80,390	72,300
2. Mail subscriptions .....	298,910	293,390
C. Total paid circulation .....	379,300	365,690
D. Free distribution (including samples) by mail, carrier or other means .....	4,600	4,600
E. Total distribution (Sum of C and D) .....	383,900	370,290
F. Office use, left-over, unaccounted, spoiled after printing .....	95,340	84,870
G. Total (Sum of E and F— should equal net press run shown in A) .....	479,240	455,160

I certify that the statements made by me above are correct and complete.

PHILIP SINE, Treasurer

## BAFFLING QUIZ ANSWERS

(Quiz appears on page 60)

- 1 - D An **ACOUSTIC LABYRINTH** is a form of bass-reflex enclosure which uses a folded rear air column designed to be one-quarter wavelength at the low-frequency resonant point of the speaker. The resonant column dampens the resonant peak of the speaker and extends the low-frequency response.
- 2 - I An **AIR COUPLER** is an air column designed to be one-quarter wavelength at the speaker's low-frequency resonance point to minimize the resonant peak and provide improved speaker-to-room (free air) acoustic impedance-matching.
- 3 - G The **BOFFLE**, box baffle, or Hartley-Turner enclosure, uses a series of vented, sound-absorbent baffles to absorb back radiation and minimize back loading.
- 4 - A A **DUCTED-PORT PHASE INVERTER** is a form of bass-reflex enclosure in which a duct provides additional acoustic inductance to resonate with the acoustic capacitance provided by the volume of the enclosure. The reduced acoustic capacitance requirement permits a more compact cabinet for the same speaker resonant frequency.
- 5 - F A **FOLDED HORN** offers the advantages of speaker-to-room acoustical impedance matching in a more compact cabinet than an otherwise impractically large straight horn design.
- 6 - B The **HELMHOLTZ RESONATOR**, or R-J enclosure, is a form of bass-reflex enclosure in which the port, in the form of a narrow, circular slit surrounding the speaker, supplies additional acoustical resistance for improved low-frequency damping of the speaker.
- 7 - E The **HORN-LOADED REFLEX** enclosure is a form of ducted-port phase inverter having the increased radiation resistance and higher efficiency provided by the horn-shaped duct.
- 8 - C An **INFINITE BAFFLE** enclosure is not really infinite in the sense that all of the front radiation will go forward without refraction, but back-enclosed cabinets do prevent the back radiation from interfering with the sound radiated from the front of the speaker and, in that sense, are considered a practical form of infinite baffle.
- 9 - H A **KLIPSCHORN** enclosure is a folded, exponential horn which uses the corner of the room as the final flare of the horn mouth, and thereby, in effect, places the listener within the horn.
- 10 - J A **RESONANT COLUMN** is a cross between an infinite baffle and a tuned pipe coupler that provides the large air volume of an infinite baffle in an enclosure design which requires less floor space.

# ELECTRONICS MARKET PLACE

**COMMERCIAL RATE:** For firms or individuals offering commercial products or services. \$1.00 per word (including name and address). Minimum order \$10.00. Payment must accompany copy except when ads are placed by accredited advertising agencies. Frequency discount: 5% for 6 months; 10% for 12 months paid in advance.

**READER RATE:** For individuals with a personal item to buy or sell. 60¢ per word (including name and address). No Minimum! Payment must accompany copy.

**GENERAL INFORMATION:** First word in all ads set in bold caps at no extra charge. Additional words may be set in bold caps at 10¢ extra per word. All copy subject to publisher's approval. Closing Date: 1st of the 2nd preceding month (for example, March issue closes January 1st). Send order and remittance to: Hal Cymes, POPULAR ELECTRONICS, One Park Avenue, New York, New York 10016.

## FOR SALE

**FREE!** Giant bargain catalog on transistors, diodes, rectifiers, SCR's, zeners, parts. Poly Paks, P.O. Box 942, Lynnfield, Mass. 01940.

**GOVERNMENT Surplus Receivers, Transmitters, Snooper-scopes, Radios, Parts, Picture Catalog 25¢.** Meshna, Nahant, Mass. 01908.

**WEBBER LAB'S POLICE-FIRE KITS \$5.00 ALL SOLID STATE, SPECIFY FREQUENCY. 26-200MC ALWIRED CRYSTAL CONTROLLED LIFE TIME GUARANTEE \$23.00, KIT \$11.00. WRITE FOR METAL LOCATORS, REMOTE READING COMPASS, CATALOG 10¢, 72 COTTAGE STREET, LYNN, MASS. 01905.**

**R.F. CONVERTERS.** World's largest selection. Also CCTV cameras, etc. Lowest factory prices. Catalog 10¢. Vanguard 196-23 Jamaica Ave., Hollis, N.Y. 11423.

**TELEPHONE VOICE SWITCH: (LS-500). ACTUATES AUTOMATICALLY AND UNATTENDED ANY TAPE OR WIRE RECORDER. PICTORIAL INSTALLATION INSTRUCTIONS INCLUDED. \$23.75. POST PAID USA, WJS ELECTRONICS, P.O. BOX 1508, LAS VEGAS, NEVADA 89101.**

**INVESTIGATORS: KEEP IN STEP WITH ADVANCEMENTS IN THE ART OF ELECTRONICS FOR THE PROFESSIONAL. SEND \$1.00 FOR EQUIPMENT BROCHURE. WJS ELECTRONICS, P.O. BOX 1508, LAS VEGAS, NEVADA 89101.**

**BUG DETECTOR: WILL DETECT AND LOCATE SURREPTITIOUS TRANSMITTING DEVICES IN CONFERENCE ROOMS, HOME AND OFFICES, ETC. WRITE FOR DETAILS. WJS ELECTRONICS, 737 NORTH SEWARD, HOLLYWOOD, CALIF. 90038.**

**DETECTIVES! Free Brochures! Electronics Surveillance Devices. SILMAR ELECTRONICS, 3476 N.W. 7th Street, Miami, Fla. 33125.**

**CIRCUIT Boards, Parts for "Poptronics" projects. Free catalog. DEMCO, Box 16297, San Antonio, Texas 78216.**

**ROCKETS:** Ideal for miniature transmitter tests. New illustrated catalog, 25¢. Single and multistage kits, cones, engines, launchers, trackers, rocket aerial cameras, technical information. Fast service. Estes Industries, Dept. 18, Penrose, Colorado 81240.

**LOWEST Prices Electronic Parts. Confidential Catalog Free. KNAPP, 3174 8th Ave. S.W., Largo, Fla. 33540.**

**RADIO-T.V. Tubes - 33¢ each. Send for free catalog. Cornell, 4213 University, San Diego, Calif. 92105.**

**CONVERT any television to sensitive, big-screen oscilloscope. Only minor changes required. No electronic experience necessary. Illustrated plans, \$2.00. Relco-A33, Box 10563, Houston, Texas 77018.**

**CRYSTALS . . . largest selection in United States at lowest prices. 48 hr. delivery. Thousands of frequencies in stock. Types include HC6/U, HC18/U, FT-241, FT-243, FT-171, etc. Send 10¢ for catalog with oscillator circuits. Refunded on first order. Jan Crystals, 2400F Crystal Dr., Fort Myers, Fla. 33901.**

**SURVEILLANCE EQUIPMENT - NEW HIGH PERFORMANCE SUBMINIATURE MODELS. ELECTRONIC COUNTERMEASURE DEVICES TO PROTECT PRIVACY. FREE DATA: SECURITY ELECTRONICS-PE, 15 EAST 43RD STREET, NEW YORK, N.Y. 10017.**

**FREE ELECTRONICS** (new and surplus) parts catalog. We repair multimeters. Bigelow Electronics, Bluffton, Ohio 45817.

**JAPANESE PRODUCTS CATALOG** by air mail \$5, sea \$3. Intercontinental, CPO 1717, Tokyo, Japan.

**TREASURE Hunters! Prospectors! Relco's** new instruments detect buried gold, silver, coins. Kits, assembled models. Transistorized. Weighs 3 pounds. \$19.95 up. Free catalog. Relco-A33, Box 10836, Houston, Texas 77018.

**LINEAR AMPLIFIERS:** "Hornet"—50 watts output—\$98.50; "Raider"—100 watts—\$139.95; "Maverick—250"—250 watts—\$244.95. For AM and SSB. Frequency range 20-35 megacycles (illegal for Class D 11 meters.) Dealer inquiries invited. D & A Manufacturing Co., 1217 Avenue C, Scottsbluff, Nebraska 69361.

**RECTIFIERS, transistors, other components. Catalog free. Electronic Components Co., Box 2902C, Baton Rouge, La. 70821.**

**ELECTRONIC Ignition. Kits, components, systems. Diagrams. Anderson Engineering, Epsom, N.H. 03239.**

**DIAGRAMS—Radios \$1.00, Television \$2.50. Give make and model. Diagram Service, Box 1151PE, Manchester, Conn. 06042.**

**INVESTIGATORS, FREE BROCHURE, LATEST SUBMINIATURE ELECTRONICS SURVEILLANCE EQUIPMENT, ACE ELECTRONICS, 11500-L NW 7TH AVE., MIAMI, FLA. 33168.**

**EUROPEAN and Japanese bargain catalogs. \$1 each. Dee, 10639E Riverside, North Hollywood, Calif. 91602.**

**JAPAN DIRECTORY. Electronics products and parts. General merchandise and Asia trade information. Just \$1.00 today. Ippano Kaisha Ltd., Box 6266, Spokane, Washington 99207.**

**TRANSISTORIZED CONVERTER KITS:** Two models, converts car radio. Receive 30-50mc or 100-200mc (one mc tuning) \$5.00 with simple instructions. Crystal \$2.50. Meshna, No. Reading, Mass. 01864.

**SUPER HOBBY CATALOG 25¢. WE SELL CONSTRUCTION PLANS. TELEPHONE:** Ansaphone, Speakerphone, Legal Connector, Carphone, Central Dial System, Pushbutton Dialer, **TELEVISION:** \$35 all electronic Color Converter, Camera, Recorder, 3DTV. **DETECTIVE:** Tail Transmitter, Wireless Mike, Infinity Transmitter. Plans \$4.95 each. **DYNAMITES ALL Eavesdroppers, silent jammer plans \$8.50. TELEPHONE ENGINEERING COURSE \$39.50. DETECTIVE ELECTRONIC COURSE \$22.50. ANTI-DETECTIVE ELECTRONIC COURSE \$27.50. TELEVISION FCC LICENSE COURSE \$97.50. Don Britton Enterprises, 7906 Santa Monica Blvd., Hollywood, Calif. 90046.**

**FM WIRELESS MIC, Guitar Pickup, bug in case \$9.85, Board only with instructions \$6.75 COD. SCI Manufacturing Co., 3700 First National Bank, Dallas, Texas 75202. SEND FOR FREE CATALOG, featuring rectifiers, zeners, SCR's, triacs, integrated circuits, and other semiconductor devices in large and small quantities. ALL DEVICES ARE CHECKED AND GUARANTEED. Solid State Sales, Box 74F, Somerville, Mass. 02143.**

**JAPANESE or EUROPEAN DIRECTORY 200 firms \$1.00. SURVEILLANCE EQUIPMENT, wireless SNOOPERMIC \$25.00, SUBMINIMIKE 3/8 x 3/8 x 3/16 \$4.00, Brochure 25¢. SIERRATRONICS, Box 7497, Las Vegas, Nev. 89101.**

**METAL**—Treasure Detectors, most sensitive. Lowest priced. Free catalog. Jetco Instruments, Box 2880-E, Huntsville, Texas 77340.

**REVERBERATION Springs**—Data sheets and application information available. Send self addressed envelope to: Southwest Technical Products Corp., 219 W. Rhapsody, San Antonio, Texas 78216.

**SHORTWAVE RECEIVERS AND TRANSCEIVERS—"68" MODELS BY HAMMARLUND, NATIONAL, DRAKE, SWAN. TRADES ACCEPTED ON YOUR TUBES, TEST EQUIPMENT AND GOVERNMENT SURPLUS. WRITE: BILL SLEP, W4FHY, SLEP ELECTRONICS, DRAWER 178-PE, ELLENTON, FLORIDA 33532.**

**TECH MANUALS, SOLD ON MILITARY SURPLUS AND CIVILIAN ELECTRONIC EQUIPMENT. GIVE MAKE, MODEL FOR MANUAL QUOTE. SLEP ELECTRONICS, DRAWER 178-PE, ELLENTON, FLORIDA 33532.**

**AR-4x SPEAKERS**, Oiled Walnut Finish, \$47.00. Acoustic Systems, 101 North Hyland, Ames, Iowa 50010.

**MONITOR** Police, Fire, Emergency or other radio calls you select. Miniverter II converts car or home radio to sensitive receiver. Easy. Inexpensive. Thousands sold. Free brochure. Scientific Associates Corporation, Department E, Box 276, South Glastonbury, Connecticut 06073.

**MUSIC LOVERS, CONTINUOUS, UNINTERRUPTED BACKGROUND MUSIC FROM YOUR FM RADIO, USING NEW INEXPENSIVE ADAPTOR. FREE LITERATURE. ELECTRONICS, 11500-Z NW 7th AVE., MIAMI, FLORIDA 33168.**

**SIGNAL** Tracing Trouble Shooter—Repairs radios, televisions, amplifiers. Money back guarantee, \$595. United, P. O. Box 8690, Washington, D.C. 20011.

**MECHANICAL**, Electronic devices catalog 10¢.  $\frac{1}{16}$  laminated copper clad 2 sides, for printed circuits,  $9\frac{1}{2} \times 4\frac{1}{2}$ , \$1. Fertik's, 5249 "D", Philadelphia, Pa. 19120.

**PROXIMITY** switch. Detects nearness of human body! Free information. Claremont Products, 860 Reed, Claremont North, Calif. 91711.

**DESK** nameplate 2" x 8" plastic, walnut background, white engraving, \$2.95. Print name. Three plastic holders frame and display 60 QSL or post cards \$1.00. Same day shipment. Postpaid and guaranteed. Tepabco, Brown Blvd., Gallatin, Tennessee 37066.

**OUTDOOR TV** antennas below wholesale. Jones, 1115 Rambler, Pottstown, Pa. 19464

**EXPERIMENTERS—SCIENCE STUDENTS** . . . New force sensitive ceramic paint . . . Senses, pressure, vacuum, weight, strain, tension, vibration, heartbeat, blood pressure, pulse . . . 2-ounce size, only \$2.95. H. M. Spitzer, Port Republic, Va. 24471.

**C.B.ers C.T.S. KNIGHT** Crystals guaranteed \$1.85 each (postage pd.)—Write—E & S Sales & Service, Box 463, Winchester, Ind. 47394.

**SURVEILLANCE** Equipment. Latest miniature devices. Free 1968 catalog. Fisher Electronics, Box 350, N. Miami Beach, Florida 33160.

**TV CAMERA KITS!** Televisive live pictures on any TV receiver without modification! Perfect for experimental, educational and industrial applications. Eight tube and transistor models to choose from—\$18.95 up. Plans available separately. **EASY-EDUCATIONAL-ECONOMICAL.** Informative catalog **FREE. ATV RESEARCH**, 13th & Broadway, Dakota City, Nebr. 68731.

**SONAR** monitor Receivers unsurpassed. Fire, police, ambulance, taxi, highway patrol communications. Exceptional values. Griffin's, 322 West State, Ithaca, New York 14850.

**LATEST TELEPHONE BUGGING COUNTERMEASURES: ENGINEERING LABORATORIES, BOX 1036, ANDERSON, INDIANA 46015.**

## PLANS AND KITS

**ALLWAVE RADIO KIT.** Tube, transistor included \$5.00. Headset \$2.50. Ekeradio, Box 131, Temple City, Calif. 91780.

**"COIL WINDING"** Handbook—50¢. Experimenter's catalog includes 250 exclusive items—25¢, refundable. Laboratories, 12041-L Sheridan, Garden Grove, Calif. 92640.

**MICROMINIATURE** laser, recent breakthroughs now make it possible for you to construct a matchbox sized laser. Complete plans \$3.00. Frank Catanzaro, Daniels Hall, Room 209, Worcester Polytechnic Institute, Worcester, Mass. 01609.

**SILENCE TV COMMERCIALS** with flashlight! Complete plans with schematic \$1.00. Vines Electronics, 3425 7th Ave., Port Arthur, Tex. 77640.

**INTEGRATED CIRCUIT KITS; COMPUTER LOGIC;** Parts; others. Catalogue free. **KAYE ENGINEERING**, Box 3932-A, Long Beach, California 90803.

**TESLA COIL—40" SPARKS!** Plans \$5.00. Information 50¢. Huntington Electronics, Box 9-P Huntington Station, Shelton, Conn. 06484.

**INTEGRATED CIRCUIT** digital kit. Contains IC, Mounting board, circuits. \$3.75. Adams, Box 399, Hazelwood, Missouri 63042.

## SHORTWAVE LISTENING

**BUILD 2** Band set, tube and plan \$1.50. Ekeradio, Box 131, Temple City, Calif. 91780.

**OVER 4000 MEMBERS IN 86 COUNTRIES!** . . . they're talking about it from Argentina to Turkey. **SWLs**, businessmen, amateurs and DXers . . . everyone's joining and receiving professionally-printed monthly magazines covering the usual and unusual in the field of international radio. Members receive gold certificate of enrollment and numbered membership card. One year's membership only \$1.00. Write now for free sample Club Magazine. Radio New York Worldwide Listeners Club, 485 Madison Avenue, New York 10022.

**1968 SWL PROGRAM GUIDE**, listings by the hour, \$2.00. Antennas, Antenna Tuners. **BOOKS** for **SWLs**, 218 Gifford, Syracuse, N.Y. 13202.

## EQUIPMENT

**SOLDERLESS TERMINALS:** Kit 101 assorted, \$2.00 postpaid. McCanna, Woodstock, N.Y. 12498.

## WANTED

**CASH Paid!** Unused tubes, electronic equipment. Barry, 512 Broadway, NYC 10012.

**QUICKSILVER**, Platinum, Silver, Gold. Ores Analyzed. Free Circular. Mercury Terminal, Norwood, Mass. 02062.

## TUBES

**TUBES "Oldies"**, latest. Lists free. Steinmetz, 7519 Maplewood, Hammond, Indiana 46324.

**RECEIVING & INDUSTRIAL TUBES, TRANSISTORS.** All Brands—Biggest Discounts. Technicians, Hobbyists, Experimenters—Request **FREE** Giant Catalog and **SAVE!** **ZALYTRON**, 469 Jericho Turnpike, Mineola, N.Y. 11501.

**TUBE** Headquarters of World! Send 10¢ for Catalog (tubes, electronic equipment) Barry, 512 Broadway, N.Y.C. 10012.

**RADIO & T.V. Tubes**—33¢ each. Send for free list. Cornell, 4213 University, San Diego, Calif. 92105.

**FREE** Catalog. Electronic parts, tubes. Wholesale. Thousands of items. Unbeatable prices. Arcturus Electronics ZD, 502-22 St., Union City, N.J. 07087.

**DON'T BUY TUBES**—Radio, TV-Xmitting, special-purpose types until you get our price list! Lowest prices in U.S.A. 5,000 types—Guaranteed Brand New. Send postcard for TV—Special Purpose Price List. **UNITED RADIO COMPANY, P.O. BOX 1000, NEWARK, N.J. 07101.**

## CUSTOM RECORDING

**L.P.** Hi-Fi Records made from any speed tape. Plan sixteen minutes per side. Three identical copies \$19.95. **"RECORDS"**, Box 206, N. Wales, Penna. 19454.



## HIGH FIDELITY

**FREE!** Send for money saving stereo catalog ±PIE and lowest quotations on your individual component, tape recorder, or system requirements. Electronic Values, Inc., 200 W. 20th St., New York, N.Y. 10011.

**HI-FI Components, Tape Recorders, at guaranteed "We Will Not Be Undersold" prices. 15-day money-back guarantee. Two-year warranty. No Catalog. Quotations Free.** Hi-Fidelity Center, 239 (P) East 149th Street, New York 10451.

**"LOW, Low quotes: all components and recorders. HiFi, Roslyn, Penna. 19001.**

**TAPE RECORDERS, Hi-Fi, components, Sleep Learning Equipment, tapes. Unusual Values Free Catalog. Dressner, 1523R, Jericho Turnpike, New Hyde Park, N.Y. 11040.**

## TAPE AND RECORDERS

**BEFORE** Renting Stereo Tapes try us. Postpaid both ways—no deposit—immediate delivery. Quality—Dependability—Service—Satisfaction—prevail here. If you've been dissatisfied in the past, your initial order will prove this is no idle boast. Free Catalog. Gold Coast Tape Library, Box 2262, Palm Village Station, Hialeah, Fla. 33012.

**STEREO TAPES.** Save up to 60% (no membership fees, postpaid anywhere U.S.A.). Free 60 page catalog. We discount batteries, recorders, tape accessories. Beware of slogans "not undersold," as the discount information you supply our competitor is usually reported to the factory. **SAXITONE**, 1776 Columbia Road, Washington, D.C. 20009.

**AUTOMATIC** telephone connection for Concord and other transistorized recorders. **SURVEILLANCE** and Privacy Protection Devices. Free Data: Security Electronics-PER, 15 East 43rd Street, New York, N.Y. 10017.

**HI-FI Components. Tape Recorders, at guaranteed "We Will Not Be Undersold" prices. 15-day money-back guarantee. Two-year warranty. No Catalog. Quotations Free.** Hi-Fidelity Center, 239 (PT) East 149th Street, New York 10451.

**SCOTCH** Recording Tapes. Tape Recorders. Catalog 5¢. Tower, Lafayette Hill, Pa. 19444.

**RENT STEREO TAPES—75¢ WEEK. CATALOG. ART'S TAPE SERVICE, 1613½ North Mariposa Ave., Hollywood, Calif. 90027.**

**TAPE** transport. NAB recording studio quality. Build yourself for amazingly low cost. Detailed plans \$5.00. Free particulars. Pepke Laboratories, 309-B West 19 Street, New York, N.Y. 10011.

**RENT** Stereo Tapes—over 2,500 different—all major labels—free brochure. Stereo—Parti, 1616 PE Terrace Way, Santa Rosa, California 95404.

**4 & 8 TRACK** Stereo Tapes—all labels, artists—**WHOLE-SALE.** Musico, Box 2705, Montgomery, Ala. 36105.

**TAPEMATES** makes available to you **ALL 4-TRACK STEREO TAPES—ALL LABELS**—postpaid to your door—at tremendous savings. For free brochure write: **TAPEMATES** 5727 W. Jefferson Blvd., Los Angeles, California 90016.

**TAPE RECORDER SALE.** Brand new, nationally advertised brands, \$10.00 above cost. Special prices on HI-FI Components and color television. Arkay Sales, 1028C Commonwealth Avenue, Boston, Mass. 02215.

## REPAIRS AND SERVICES

**TV Tuners** rebuilt and aligned per manufacturers specification. Only \$9.50. Any make UHF or VHF. Ninety day written guarantee. Ship complete with tubes or write for free mailing kit and dealer brochure. JW Electronics, Box 51C, Bloomington, Indiana 47401.

**SPEAKER REPAIR.** Hi-Fi, guitar, organ speakers reconed good as new at fraction of new speaker price. For details write: Waldom Electronics, Inc., Dept. PE, 4625 W. 53rd St., Chicago, Ill. 60632.

WORLD'S MOST POPULAR

# \$1 PARTS PAKS

- 5—1 Amp 800 PIV EPOXYs, submini . . . . . \$1
- \$25 SURPRISE PAK: transistors, rect, diodes, etc. \$1
- 40 PRECISION RESISTORS, ½, 1, 2W, 1% values \$1
- 30 TRANSISTORS, rf, if, audio osc-ifs, T05 no test \$1
- 60 TUBULAR CONDENSERS, to .5mf, to 1KV; asst \$1
- 40 DISC CONDENSERS, 27 nmf to .05 mf to 1KV \$1
- 60 TUBE SOCKETS, receptacles, plugs, audio, etc. \$1
- 30 POWER RESISTORS, 5 to 50W, to 24K ohms \$1
- 4—"EPOXY" TRANSISTORS 2N3663, 600 MC, . . . \$1
- 10 VOLUME CONTROLS, to 1 meg, switch too! . . . \$1
- 10 ELECTROLYTICS, to 500mf, asst FP & tubulars \$1
- 50 RADIO & TV KNOBS, assttl, colors & styles . . . \$1
- 10 TRANSISTOR ELECTROLYTICS: 10 mf to 500 mf \$1
- 50 COILS & CHOKES, if, rf, ant, osc, & more . . . \$1
- 4—"EPOXY" TRANSISTORS 2N3643 by Fairchild. . . \$1
- 75 HALF WATTERS, asst incl: A.B., 5% too! . . . \$1
- 60 HI-Q RESISTORS, ½, 1, 2W, 1% & 5% values \$1
- 10 PHONO PLUG & JACK SETS, tuners, amps . . . \$1
- 3 EPOXY TRANSISTORS 2N4265 by Motorola npp \$1
- INFRA-RED PHOTO DETECTOR TRANSDUCER . . . \$1
- INFRA-RED PARABOLIC REFLECTOR & FILTER . . . \$1
- 2 FETS FOR HOBBYIST, EXPERIMENTERS "N" Channel \$1
- 4 TRANSISTOR TRANSFORMERS, asst, worth \$25 \$1
- 4 EPOXY TRANSISTORS 400 HFE by Fairchild . . \$1
- 60 CERAMIC CONDENSERS, discs, npo's, to .05 . . \$1
- 40 "TINY" RESISTORS, 1/10W, 5% too! . . . . . \$1
- 50 TERMINAL STRIPS, 1 to 8 solder lug types . . \$1
- 30 MOLDED COND'S, mylar, porc, black beauty \$1

MICROAMP METER, brand new 100 microamps GE. \$2.70



**2\$1**  
For

**2**  
PHOTO  
CELL  \$1

**10¢ GIANT SPRING CATALOG ON: PARTS REC- TIFIERS TRANSISTORS SCRS ZENERS 10¢**

INCLUDE POSTAGE, AVZ. Wt. per pak 1 lb. CODs 25%

# POLY PAKS

P. O. BOX 942 E  
LYNNFIELD, MASS  
01940

**CIRCLE NO. 21 ON READER SERVICE PAGE**

**TUNERS** FM AM Instruments commercial or kits repaired, realigned. Details: Box 24, Stoneham, Massachusetts 02180.

**ELECTRONICS ENGINEERING CONSULTANT**—We develop your electronic idea into a finished product. Electret Corp., Box 373, Ansonia Station, N.Y.C. 10023.

**MANUFACTURING** under contract, Ferrari Electronics Corporation, 581 Bergen Blvd., Ridgefield, New Jersey 07657. 201-943-8432.

## PERSONALS

**"SLEEP THERAPY"**—Send for free brochure, "What's It All About." Navon, Box 190-PE, Quincy, Massachusetts 02169.

**MAKE FRIENDS WORLDWIDE**, promote international understanding, join Europe's leading correspondence club. Illustrated brochure free. HERMES, Box 17/33, 1 Berlin 11, Germany.

**LEMURIAN VIEWPOINT**—Meaningful discussions of Cosmic Truth: the purpose of human life, reincarnation, man's place in a Higher Plan, and subjects from the Lemurian Philosophy. Send for **FREE** copy. Lemurian Fellowship, Dept. 767, Box 397, Ramona, Calif. 92065.

**INVESTIGATORS, FREE BROCHURE, LATEST SUBMINIATURE ELECTRONIC SURVEILLANCE EQUIPMENT. ACE ELECTRONICS, 11500-K NW 7th AVE., MIAMI, FLA. 33168.**

**BILL PROBLEMS?** Poor credit no trouble. Not a loan company. Send for free application. Automatic Acceptance, 318PE Broadway Blvd., Reno, Nevada 89502 or 307PE Pocasset Ave., Providence, R. I. 02909.

## INSTRUCTION

**LEARN** White Asleep, hypnotize with your recorder, phonograph. Astonishing details, sensational catalog free! Sleep-Learning Association, Box 24-ZD, Olympia, Wash. 98501.

**LEARN ELECTRONIC ORGAN SERVICING** at home all makes including transistors. Experimental kit—trouble-shooting. Accredited NHSC, Free Booklet. **NILES BRYANT SCHOOL**, 3631 Stockton, Dept. A, Sacramento, Calif. 95820.

**ASSOCIATE** Degree in Electronics Engineering earned through combination correspondence-classroom educational program. Free brochure. Grantham Technical Institute, 1505 N. Western Ave., Hollywood, Calif. 90027.

**REI** First Class Radio Telephone License in (5) weeks Guaranteed. Tuition \$295.00. Job placement free. (KANSAS CITY) R.E.I., 3123 Gillham Road, Kansas City, Missouri, Telephone WE1-5444. (SARASOTA) R.E.I., 1336 Main Street, Sarasota, Florida 33577. Telephone 955-6922.

**HIGHLY EFFECTIVE** home study course in Electronics Engineering Mathematics with circuit application. Earn your Associate in Science Degree. Free Literature. Cook's Institute of Electronics Engineering, P.O. Box 36185 Houston Texas 77036. (Established 1945.)

**FCC** First Class License in six weeks—nation's highest success rate—approved for Veterans Training. Write Elkins Institute, 2603B Inwood Road, Dallas, Texas 75235.

**CATHODIC** protection instructions \$1.00. F. F. KNAPP, P. O. Box 854, Scottsdale, Arizona 85252.

**HIGH SCHOOL DIPLOMA** at home. Qualified instructors. Send age, highest grade completed, for free details. No salesman. **SOUTHERN STATES ACADEMY**, Westbury Square Professional Bldg., Dept. 5, Houston, Texas 77035.

## GOVERNMENT SURPLUS

**JEEPS** Typically From \$53.90 . . . Trucks From \$78.40 . . . Boats, Typewriters, Airplanes, Electronics Equipment, Photographic Equipment, used, 100,000 Bargains Direct From Government. Complete Sales Directory and Surplus Catalog \$1.00 (Deductible First \$10.00 Order). Surplus Service, Box 820-J, Holland, Mich. 49423.

**ELECTRONIC COMPONENTS AT FRACTIONS OF ORIGINAL COST. BUY DIRECT FROM GOVERNMENT, USED AND NEW MATERIALS, WALKIE-TALKIES, MULTIMETERS, OSCILLOSCOPES, TRANSCEIVERS, ETC. "HOW-TO" DIRECTORY PLUS APPLICATIONS FOR CONTINUED BULLETINS DIRECTLY FROM GOVERNMENT AGENCIES . . . \$3.00. SURPLUS BROKERS, 209A EAST 56th STREET, NEW YORK, NEW YORK 10022.**

## INVENTIONS WANTED

**PATENT** Searches including Maximum speed, full airmail report and closest patent copies. \$6.00. Quality searches expertly administered. Complete secrecy guaranteed. Free Invention Protection forms and "Patent Information." Write Dept. 9, Washington Patent Office Search Bureau, 711 14th Street, N.W., Washington, D.C. 20005.

**INVENTORS.** We will develop, help sell your idea or invention, patented or unpatented. Our national manufacturer clients are urgently seeking new items for outright cash sale or royalties. Financial assistance available. 10 years proven performances. For free information, write Dept. 41, Wall Street Invention Brokerage, 79 Wall Street, New York, N.Y. 10005.

**INVENTORS!** Outright cash sale or royalties for your inventions. Unpatented. Active demand from our client manufacturers. Financial assistance available. Write Dept. 35, United States Invention Brokerage, 78 Wall Street, New York, N.Y. 10005.

**INVENTIONS** wanted. Patented; unpatented. Global Marketing Service, 2420-P 77th, Oakland, Calif. 94605.

**INVENTIONS—IDEAS** developed: **CASH/ROYALTY SALES.** Member: United States Chamber of Commerce, Raymond Lee, 230-GR PARK AVENUE, NEW YORK CITY 10017.

**PATENT SEARCHES \$6.00! FREE "INVENTION RECORD"/** Information. Miss Hayward, 1029HR Vermont, District of Columbia 20005.

**INVENTORS!** Sell your invention for cash or royalties! Our client manufacturers eagerly seek new items. Patented. Unpatented. Financial assistance if needed. 25 years proven performances. For free information, write Dept. 20, Gilbert Adams, Invention Broker, 80 Wall St., New York, N.Y. 10005.

**INVENTORS!** Don't sell your invention, patented or unpatented, until you receive our offer. Eagle Development Company, Dept. P, 79 Wall Street, N.Y., N.Y. 10005.

**INVENTORS! OUR FREE EXPERT ANALYSIS** of your invention can save valuable time, help you realize full sale value. Strictly confidential. **FREE INVENTION CERTIFICATE.** Write today: Pioneer Invention Service, Dept. 35, 150 Broadway, New York, N.Y. 10038.

## BOOKS

**FREE** catalog 950 aviation/electronic/space books, Aero Publishers, 329PE Aviation Road, Fallbrook, California 92028.

**UNUSUAL** Books! Catalog free! International, Box 7798(PE), Atlanta, Georgia 30309.

**ELECTRONICS,** How-To-Do-It books. Free catalog. **Handyman** Books, Box 52H, Westbury, N.Y. 11590.

**FREE** Book. Prophet Elijah Coming Before Christ. Wonderful Bible Evidence. PE Megiddo Mission, Rochester, New York 14619.

**FREE CATALOG.** Adult Books. **POSTAL PE,** 2217 Lackland, St. Louis, Missouri 63114.

**LEARN TRANSISTORS,** experiment book \$1.50. "Fix Transistor Radios", \$.50. Transistor, Box 774, Devon, Pa. 19333.

## COINS

**1943PDS,** 1954P, 1955S cents, all \$1.00. Free list. Money-saver, Box 666Z, Aptos, Calif. 95003.

**LINCOLNS:** 10¢ each, 1919-S, 1929-D, 1937-S, 1943-D, 1949-S. Bedrin, 250F Fulton, Hempstead, New York 11550.

**INDIAN** Cents—Buffalo nickels, good clear dates (scarce). Buffalos 20 different \$3.95; 100 mixed \$12.95; Indians 20 different \$6.95; 100 mixed \$24.95; 50 mixed foreign coins \$1.95. Van's Coins, 168 Walworth, Wisconsin 53184.

## AUTHORS' SERVICES

**AUTHORS!** Learn how to have your book published, promoted, distributed. **FREE** booklet "ZD," Vantage, 120 West 31 St., New York 10001.

**POEMS WANTED** for new song hits and recordings by America's most popular studio. Tin Pan Alley, 1650-ZD Broadway, New York 10019.

## MUSIC

**POEMS** wanted for new songs. Nashville Music Institute, Box 532-E, Nashville, Tennessee 37202.

## MUSICAL INSTRUMENTS

**ACCORDIONS, GUITARS, BAND INSTRUMENTS!** Save to 50%. Terms. Trades. Free Trial. Free catalog. Mention instrument. Music Mart, 5535-PE Belmont, Chicago 60641.

## RUBBER STAMPS

**RUBBER ADDRESS STAMP \$1.50. SIGNATURE \$3.50. FREE CATALOG. JACKSON, P.O. BOX 443-G, FRANKLIN PARK, ILL. 60131.**

## STAMPS

**SPACEOPHIA?** Monaco Nudes plus 50 different, 10¢ with approvals. BKJ, Astor, Boston, Mass. 02123.

## MOTION PICTURES

**AMUSEMENT . . . ENTERTAINMENT**—New Catalog, 100+ titles, 8/SUPER 8. **SPORTLITE FILMS-PE**, 20 North Wacker Drive, Chicago, Illinois 60606.

## PHOTOGRAPHY—FILM, EQUIPMENT, SERVICES

**MEDICAL Film—Adults Only**—"Childbirth"—1 reel 8mm \$7.50—16mm \$14.95. International-E, Greenvale, L.I., New York 11548.

**SCIENCE Bargains**—Request Free Giant Catalog "CJ"—148 pages—Astronomical Telescopes, Microscopes, Lenses, Binoculars, Kits, Parts. War surplus bargains. Edmund Scientific Co., Barrington, New Jersey 08007.

## EDUCATIONAL OPPORTUNITIES

**WANTED! TV—Radiomen** to learn aircraft electronics servicing. Numerous job openings everywhere. Write: Academy Avionics, Reno/Stead Airport, Reno, Nevada 89506.

**LEARN WHILE ASLEEP.** Miraculously build Mind Power, achieve Self-Confidence, improve Health, gain Success. Method 92% effective. Details free. ASR Foundation. Box 7021EG Henry Clay Sta., Lexington, Kentucky 40502.

## PRINTING

**PRINTING** Presses, Type, Supplies. Lists 5¢. Turnbaugh Service, Mechanicsburg, Pa. 17055.

**OFFSET PRINTING—8 HOUR SERVICE—LOW PRICES** 25 to 5,000 copies. Nationwide Printing, Atlanta, Illinois 61723.

**FREE LITERATURE:** 1000 Address Labels \$1.00, 1000 Business Cards \$4.95. Printing, Rubber Stamps. Jordan's, 552 West O'Connor, Lima, Ohio 45801.

**FREE** Discount printing catalog. Wagner Company, 6200PE Whitewood, Library, Penna. 15129.

**THERMOGRAPHED** business cards, \$3.49—1,000, free samples. Gables—405B Clifton, Glenshaw, Pa. 15116.

## DO-IT-YOURSELF

**SAVE!** Build transistorized treasure finder. Details free! Del Research, Dept. A, West Barnstable, Mass. 02668.

## BUSINESS OPPORTUNITIES

**INVESTIGATE ACCIDENTS!** Earn up to \$1,000 and more a month in your own business. Work spare time with average earnings of \$5 to \$8 per hour. No selling. Send for Free booklet. No obligation. No salesman will call. Write: Universal Schools, CZ-1, 6801 Hillcrest, Dallas, Texas 75205.

**RAISE Rabbits** for us on \$500 month plan. Free details. White's Rabbitry, Mt. Vernon, Ohio 43050.

**FREE CATALOGS.** Repair air conditioning, refrigeration. Tools, supplies, full instructions. Doolin, 2016 Canton, Dallas, Texas 75201.

**PIANO TUNING** learned quickly at home. Tremendous field! Musical knowledge unnecessary. GI Approved. Information free. Empire School, Miami, Florida 33145.

**ELECTROPLATING** Equipment and supplies. All types for home workshops and industrial. Send \$1.00 (refundable) for equipment guide formulas, operating data, catalog. HBS Equipment Division 90, 3543 East 16th, Los Angeles, California 90023.

**I MADE \$40,000.00** Year by Mailorder! Helped others make money! Start with \$10.00—Free Proof. Torrey, Box 318-N, Ypsilanti, Michigan 48197.

**FREE** Book "990 Successful little-known Businesses." Work home. Plymouth 245R, Brooklyn, N.Y. 11218.

**100,000 PRODUCTS Wholesale!** Terrific bargains! Wholesalers, 1265-PP, Broadway, New York, N.Y. 10001.

**SELL HERTEL BIBLES**—Part time. Finest reference Bible available. Demonstrator and supplies furnished. Excellent commissions. Write: International Book, Box 114PE, Wichita, Kansas 67201.

**SELL LIFETIME**, Metal, Social Security Plates. Big profits! Sample and Sales Kit Free. Russell, Box 286-PE, Pulaski, Tennessee 38478.

**NEED Money?** Prosperity letter shows you how to make it. Send 50¢ to: Hargraves, Box 613-P, Miami Beach, Florida 33139.

**FREE "Franchise Profit Letter"** tells how unique NFR service is helping thousands seeking profitable businesses. Write today. National Franchise Reports, PE-528, 333 North Michigan, Chicago 60601.

**EARN \$240.00** a Month at home, spare time, doing only two \$5.00 invisible Mending jobs a day. Big money paid for service that makes cuts, tears disappear from fabrics. Steady demand. Details free. Fabricon, 1572 Howard, Chicago, Ill. 60626.

## REAL ESTATE

**FREE!!!** New Illustrated **SPRING 1968 CATALOG!** Describes hundreds of farms, ranches, town and country homes, businesses, vacation, retirement and waterfront properties coast to coast! Specify type property and location preferred. Zip code, please. **UNITED FARM AGENCY**, 612-EP West 47th St., Kansas City, Mo. 64112.

## MAGNETS

**MAGNETS.** All types. Special—20 disc magnets, or 2 stick magnets, or 10 small bar magnets, or 8 assorted magnets, \$1.00. Maryland Magnet Company, 5412-H Gist, Baltimore, Maryland 21215.

## EMPLOYMENT INFORMATION

**FOREIGN and USA** job opportunities available now. Construction, all trades. Earnings to \$2,000.00 monthly. Paid overtime, travel, bonuses. Write: Universal Employment, Woodbridge, Connecticut 06525.

**HOW to Write Job-Winning Resume.** Instructions, samples: \$2. Executive, Box 246P, Montclair, N.J. 07042.

**FOREIGN EMPLOYMENT.** Construction, other work projects. Good paying overseas jobs with extras, travel expenses. Write only: Foreign Service Bureau, Dept. D, Bradenton Beach, Florida 33510.

**AUSTRALIA** wide-open. Jobs. Opportunity. Government-assisted passage. Information \$1. Pacifico, Box 43485-R, Los Angeles, Calif. 90043.

## HYPNOTISM

**FREE** Hypnotism, Self-Hypnosis, Sleep Learning Catalog! Drawer H400. Ruidoso, New Mexico 88345.

**"FEMALE HYPNOTISM"** Exposed, explained! "Secret Method"—they never know! \$2, rushed. Guaranteed! Isabella Hall, Silver Springs, Florida 32688.

**SELF-HYPNOSIS** for self-improvement. Safe, effective! Free literature. McKinley, Dept. T-4, Box 3038, San Bernardino, California 92404.

**AMAZING HYPNOTIC** record kit releases fantastic mental power! Free offer expires soon. Write: Forum, Studio AA1, 333 North Michigan, Chicago 60601.

**HYPNOTIZE FEMALES!**—Unnoticed! Instantly! Nerves! Exciting! Send \$2.25. Research Enterprises, 29-SN21 Samoset, Woburn, Mass. 01801.

**FEMALE HYPNOTISM!!!** Easily! Instantly! Secret Nerve Centers! \$2.20. Brugenheimer Publishers, Box 158-E30, Lexington, Mass.

**HYPNOTIZE SUCCESSFULLY**—or money refunded! Complete illustrated course—including Self-Hypnosis \$1.00. Arthur Fowler, Box 4396, Woodbury, New Jersey 08096.



**TUBES!** **CORNELL** **TUBES!**

FREE Send For FREE  
**CORNELL'S**  
**New 1968**  
**CATALOG**  
 Many New Items

**30¢** per tube  
**33¢** per tube

**WE SELL**  
**PICTURE**  
**TUBES**

**IN LOTS OF 100**

**4221 UNIVERSITY AVE., SAN DIEGO, CALIF. 92105**

**RECORDS**

SPECIAL INTEREST RECORDS AVAILABLE, PRODUCED BY THE EDITORS OF THE WORLD'S LEADING SPECIAL INTEREST MAGAZINES. SEND FOR FREE CATALOG. RECORD CATALOG-PE, ZIFF-DAVIS PUBLISHING COMPANY, ONE PARK AVENUE, NEW YORK, N.Y. 10016.

**MISCELLANEOUS**

**WINEMAKERS:** Free illustrated catalog of yeasts, equipment. Semplex, Box 7208, Minneapolis, Minn. 55412.

**SPARE TIME OPPORTUNITY—MONEY—WE PAY** at the rate of \$10 hr. for **NOTHING** but your opinions, written from home about our clients' products and publications, sent you free. Nothing to buy, sell, canvass, or learn. **NO SKILL. NO GIMMICKS.** Just honesty. Details from **RESEARCH, ZD2**, Box 669, Mineola, N.Y. 11501.

**BILLS PAID WITHOUT BORROWING—**Nobody refused up to \$18,000.00. Bad credit no problem—Not a Loan Co. Write for **FREE** application—**INTERNATIONAL ACCEPTANCE**, Dept. 50A, 5133 N. Central Ave., Phoenix, Arizona 85012—119 Ann St., Hartford, Conn. 06103—507 Carondelet St., New Orleans, La. 70130—or 504 Victoria Ave., Windsor, Ontario, Canada.

**EMPLOYMENT** Resumes. Get a better job & earn more! Send only \$2.00 for expert, complete Resume Writing Instructions. J. Ross, 80-34 Kent St., Jamaica, N.Y. 11432, Dept. PE.

**TEN** Winemaking Recipes and Winemaking Supplies catalog 10¢. Country Winemaker, Box 243EGA, Lexington, Massachusetts 02173.

**STOP BURGLARS THE EASY WAY!!** Affix authentic "Protected by Electronic Sentry Alarm" Decals to auto windows, doors & windows of home, retail stores, vending machines, etc. Whether you have an alarm or not—thieves stay away! Only \$1.00 each set of two. J. Ross, 80-34 Kent St., Jamaica, N.Y. 11432 Dept. PE.

**STAMMER — Stutter — No More.** (Dr. Young.) Write: Gaucho, Box 9309-E8, Chicago 60690.

**BEERS, PEACH BRANDY, WINES—**Strongest Formulas, \$2.25. (complete brew supplies hydrometers catalog included)—Research Enterprises, 29-D Samoset, Woburn, Mass. 01801.

**VENTRILOQUISM!** Information free! Dummy catalog 25¢. State age. Maher, Studio ZD1, Box 6536, Kensington Station, Detroit, Michigan 48224.

**MAIL ORDER OPPORTUNITIES  
 WAITING FOR YOU!**

Classified Advertisers find more outlets for their product and service advertising in Ziff-Davis Electronics Publications than in any other media.

Whether in a monthly publication: **POPULAR ELECTRONICS, ELECTRONICS WORLD, HiFi/STEREO REVIEW** or in an annual: **COMMUNICATIONS HANDBOOK, ELECTRONIC EXPERIMENTER'S HANDBOOKS, ELECTRONICS INSTALLATION AND SERVICING HANDBOOK, or TAPE RECORDER ANNUAL**—Classified Advertising is responded to regularly by an affluent audience of active electronics enthusiasts.

Prove to yourself the effectiveness of Classified Advertising in Ziff-Davis Electronics Publications. Write today for information, assistance or sample copies to:

**Hal Cymes, Classified Advertising Manager**  
**Ziff-Davis Publishing Company**  
**One Park Avenue, New York, N. Y. 10016**

**POPULAR ELECTRONICS**  
**JANUARY 1968**  
**ADVERTISERS INDEX**

READER SERVICE NO.	ADVERTISER	PAGE NO.
1	Allied Radio .....	12
2	AMECO, Division of Aerotron, Inc .....	99
	American Institute of Engineering & Technology .....	101
4	Amperex Electronic Corporation ..	FOURTH COVER
3	Argos Products Company .....	98
5	B & K .....	26
6	Burstein-Applebee .....	101
	Capitol Radio Engineering Institute, The .....	104, 105, 106, 107
7	Cleveland Institute of Electronics .....	9
8	Cleveland Institute of Electronics ..	18, 19, 20, 21
	Conar .....	115
9	Cook's Institute of Electronics Engineering .....	111
	Cornell Electronics .....	122
28	Courier Communications, Inc. ....	16
10	Delta Products, Inc .....	95
	DeVry Institute of Technology .....	5
11	Don Britton Enterprises .....	108
	Electro-Voice .....	91
	Esse Radio Company .....	110
30	Finney Company, The .....	85
12	Garrard .....	8
13	Heath Company .....	96, 97
14	Hy-Gain Electronics Corporation .....	25
15	IMC Magnetics Corp .....	6
16	Lafayette Radio Electronics .....	113
	McGee .....	101
31	Milwaukee School of Engineering .....	23
17	Mosley Electronics, Inc .....	14
18	Multi-Elmac Co .....	103
	National Radio Institute ..	SECOND COVER, 1, 2, 3
	National Technical Schools .....	86, 87, 88, 89
	North American School of Drafting .....	113
19	Olson Electronics Incorporated .....	108
20	Pearce-Simpson, Inc .....	13
21	Poly Paks .....	119
	RCA Electronic Components and Devices .....	THIRD COVER
	RCA Institutes, Inc .....	36, 37, 38, 39
22	Radio Shack .....	115
23	S & A Electronics Inc .....	16
29	Saich & Co., Herbert .....	98
24	Sams & Co., Inc., Howard W .....	93
25	Sonar Radio Corp .....	109
26	Squires-Sanders, Inc .....	10, 11
	Valparaiso Technical Institute .....	101
27	Vanguard Mailorder Ltd. ....	7

**CLASSIFIED ADVERTISING 117, 118, 119, 120, 121, 122**



Service your Color TV customers with confidence...  
with RCA HI-LITE picture tubes!

Customer satisfaction... and consequently your service reputation... can very often depend on the quality of the replacement parts you use. When it comes to replacement picture tubes, you can depend on an RCA HI-LITE for picture brightness and color fidelity at its finest. Install them and you literally "up-date" your customer's set with the same quality... the same tubes... that go into today's original equipment sets.

Enjoy the confidence of offering the finest. Rely on RCA picture tubes to protect your service reputation. They are designed to protect the biggest reputation in the Color TV industry.

RCA Electronic Components and Devices, Harrison, N. J.



The Most Trusted Name in Electronics





# Now...18 different professional-quality amplifiers, tuners & preamps

- completely assembled...
- solid state, printed circuits...
- priced lower than kits.

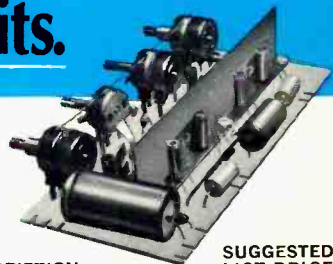

There are so many ways you will use these easy-to-install, printed-circuit assemblies; in hi-fi equipment, ham gear, P.A. and intercom systems, or as guitar and organ amplifiers. Employing the most advanced Complementary-Symmetry transistorized designs, these assemblies provide the ultimate in economical circuitry for reliable audio applications from one watt to twenty. They have already become the design standard for a large group of audio equipment manufacturers, as well as a basic teaching tool in many educational institutions.

TYPE	DESCRIPTION	SUGGESTED LIST PRICE
PCA-1-9	1W, 9V D.C. 4 Transistor Amplifier	\$7.20
PCA-1-14	2W, 14V D.C. 4 Transistor Amplifier	7.00
PCA-2-9	3/4W, 9V D.C. 3 Transistor Amplifier	5.90
PCA-2-14	1W, 14V D.C. 3 Transistor Amplifier	5.90
PCA-3B-18-1	4W/Channel Stereo Amplifier with Bass, Treble, Volume and Balance Controls	19.20
PCA-4-9	1W, 9V D.C. High Gain, 4 Transistor Amplifier for Radio, Ceramic or Crystal Phono Cartridge, etc.	8.30
PCA-4-9A	Same as PCA-4-9 with Tone Control Circuit	9.20
PCA-4-14	2W, 14V D.C. High Gain 4 Transistor Amplifier for Radio, Ceramic or Crystal Phono Cartridge, etc.	8.30
PCA-4-14A	Same as PCA-4-14 with Tone Control Circuit	9.20
PCA-4-18A	3W, High Sensitivity, 4 Transistor Amplifier with Volume and Tone Controls for use as Guitar, Radio or Phono Amplifier	9.52
PCA-5A-14	2W/Channel 14V D.C. Stereo Amplifier with Balance, Tone and Volume Controls	15.80
PCA-6A-25	8-10W/Channel Stereo Amplifier with Preamp for Ceramic Phono Cartridge and Bass, Treble, Balance, and Volume Controls	30.10
PCA-6A-25SCS	Same as PCA-6A-25 with Separate Control Assembly	31.80
PCA-7B-18	Tape Cartridge Stereo Preamp with Level Set Controls	12.00
PCA-7C-18	Same as PCA-7B-18 without Level Sets; 4 Transistor	9.50
PCA-8-36	20W Mono Basic Amplifier	18.85
PCA-9-18	3W/Channel, 10 Transistor Stereo Tape Playback Amplifier with Volume, Tone and Balance Controls	25.30
PCR-1-9	9V 2 Transistor AM Tuner	11.30

For brochure containing complete technical data on all 18 assemblies and for name of distributor nearest you, write: Ampere Electronic Corporation, Distributor Sales Dept., Hicksville, New York 11802.

## Amperex®

TOMORROW'S THINKING IN TODAY'S PRODUCTS

CIRCLE NO. 4 ON READER SERVICE PAGE