

BUILD SPACE-SAVER HI-FI SPEAKER SYSTEM

POPULAR ELECTRONICS

OCTOBER 1967

50 CENTS

▲ 10

Novice Ham 65-Watt Transmitter
Direct Readout Frequency Meter
6 to 12 Volt D.C. "Up-Verter"
Detailed S.W. Broadcast Schedules
We Need More Radio Channels

*Build me, the
MEMO MINDER
and I will call your
attention to notes,
orders, messages, etc.
(page 49)*

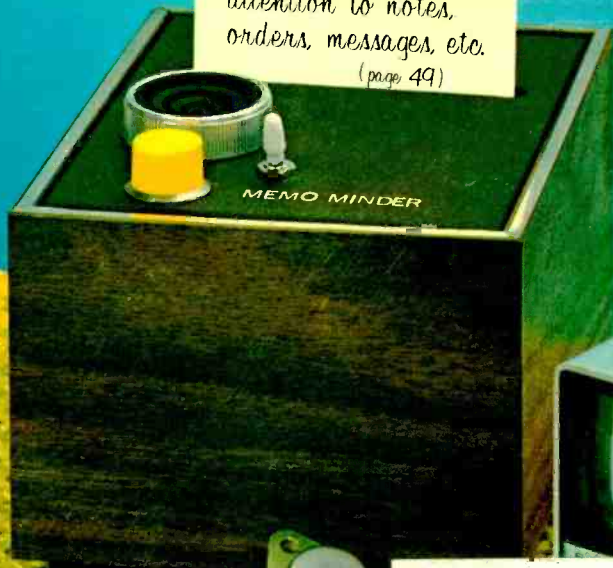

Read About
Coat Pocket TV
(page 31)

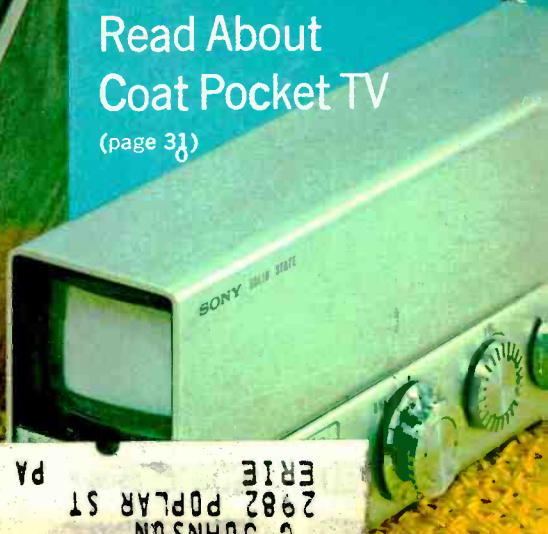

ERIE PA 16508
4
G JOHNSON
2982 POPLAR ST
E0368 643240J0H2982PC09K



You get more for your money from NRI—

America's oldest and largest Electronic, Radio-Television home-study school

Compare. You'll find—as have so many thousands of others—NRI training can't be beat. From the delivery of your first lessons in the remarkable, new Achievement Kit, to "bite size," easily-read texts and carefully designed training equipment . . . NRI gives you more value.

Shown below is a dramatic, pictorial example of training materials in *just one* NRI Course. Everything you see below is included in low-cost NRI training. Other major NRI courses are equally complete. Text for text, kit for kit, dollar for dollar—your best home-study buy is NRI.

All this is yours—from Achievement Kit to the only Color TV specifically designed for training—when you enroll for NRI's TV-Radio Servicing course. Other courses are equally complete. But NRI training is more than kits and "bite-size" texts. It's also personal services which have made NRI a 50 year leader in the home-study field. Mail the postage-free card today.

Approved under GI BILL

If you served since Jan. 31, 1955, or are in service, check GI line in postage-free card.



GET A FASTER START WITH NRI'S NEW EXCLUSIVE ACHIEVEMENT KIT

The day your enrollment is received your Achievement Kit will be on its way to you. It contains everything you need to make an easy, fast start in the Electronics training of your choice. This attractive, new starter kit is an outstanding, logical way to introduce you to home-study the way NRI teaches it . . . backed by a dedicated staff and the personal attention you should expect of a home-study school. It is your first special training aid . . . designed to make your adventure into Electronics absorbing, meaningful. Your Achievement Kit contains your first group of lesson texts; rich vinyl desk folder to hold study material; the industry's most complete Radio-TV Electronics Dictionary; valuable reference texts; lesson answer sheets; envelopes; pencils, pen; engineer's ruler—even postage. No other school has anything like it.

OVER 50 YEARS OF LEADERSHIP



Accredited by the Accrediting Commission of the National Home Study Council

LEARNING BECOMES AN ABSORBING ADVENTURE WITH NRI TRAINING KITS

What better way to learn than by doing? NRI pioneered and perfected the "home lab" technique of learning at home in your spare time. You get your hands on actual parts and use them to build, experiment, explore, discover. Electronics come alive! NRI invites comparison with training equipment offered by any other school. Begin NOW this exciting, practical program. It's the best way to understand the skills of the finest technicians—and make their techniques your own. Whatever your reason for wanting to increase your knowledge of Electronics . . . whatever your field of interest . . . whatever your education . . . there's an NRI instruction plan for you, at low tuition rates to fit your budget. Get all the facts about NRI training plans, NRI training equipment. Fill in and mail the attached postage-free card today.

NATIONAL RADIO INSTITUTE, Wash-
ington, D.C. 20016.

IN ELECTRONICS TRAINING

NEW COLOR TV



POPULAR ELECTRONICS

WORLD'S LARGEST-SELLING ELECTRONICS MAGAZINE

VOLUME 27

OCTOBER, 1967

NUMBER 4

SPECIAL TV FEATURE

- LESLIE SOLOMON **31** **COAT POCKET TV**
TV's are getting smaller . . . where will it end?

SPECIAL CONSTRUCTION FEATURE

- R. PERSING **49** **MEMO MINDER**
Electronic memory slave keeps you posted

FEATURE ARTICLES

- LYMAN E. GREENLEE **40** **'2 + 2' REMOTE VOLUME CONTROL**
- HARTLAND B. SMITH, W8VVD **41** **HART-65 TRANSMITTER**
An excellent starting for the Novice ham
- LESLIE SOLOMON **48** **SIGNAL-POWERED SIGNAL SQUARER**
- ROBERT P. BALIN **52** **ELECTRONIC SWITCHING QUIZ**
- DON LANCASTER **53** **DIRECT READOUT IC FREQ METER**
Automatically calibrated meter makes accurate audio measurements to 1 MHz
- DAVID B. WEEMS **57** **THREE-CORNER SPACE SAVER**
Triangular enclosure gives speaker system true hi-fi sound
- W. P. MITCHELL **66** **TURN INDICATOR FLASHER UNIT**
- BEN RICHARDS **67** **6 TO 12 VOLT 'UP VERTER'**
Sell that extra storage battery—'Up-Verte'r' is here
- RICHARD HUMPHREY **71** **CAN WE STAVE OFF RADIO-FREQUENCY SUPER-SATURATION?**
Congestion is the word for most radio channels
- CHARLES J. SCHAUERS, W6QLV **74** **INFORMATION CENTRAL**
- LOU GARNER **78** **SOLID STATE**
- MATT P. SPINELLO, KHC2060 **81** **ON THE CITIZENS BAND**
APPL CB survey
- HERB S. BRIER, W9EGQ **82** **AMATEUR RADIO**
HC9EP rescued from the Pacific
- HANK BENNETT, W2PNA **84** **SHORT-WAVE LISTENING**
Broadcasting station news around the world
- ROBERT LEGGE **85** **ENGLISH-LANGUAGE BROADCASTS TO WESTERN NORTH AMERICA**
- BILL LEGGE **86** **ENGLISH-LANGUAGE BROADCASTS TO EASTERN NORTH AMERICA**
- 2118** **DX PROVINCES AWARDS PRESENTED**

DEPARTMENTS

- 8** LETTERS FROM OUR READERS
- 15** READER SERVICE PAGE
- 16** ELECTRONICS LIBRARY
- 22** NEW PRODUCTS
- 26** TIPS & TECHNIQUES
- 92** NEW LITERATURE
- 94** OPERATION ASSIST
- 111** OUT OF TUNE



Direct readout freq meter **53**

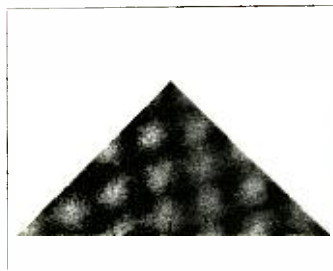

"Three corners" saves space **57**

POPULAR ELECTRONICS is indexed
in the Readers' Guide
to Periodical Literature

This month's cover photo by
Conrad Studios, Inc.

Copyright © 1967 by ZIFF-DAVIS PUBLISHING COMPANY. All rights reserved.

POPULAR ELECTRONICS, October 1967, Volume 27, Number 4, Published monthly at 307 North Michigan Avenue, Chicago, Illinois 60610. One year subscription rate for U.S., U.S. Possessions and Canada, \$5.00; all other countries, \$6.00. Second class postage paid at Chicago, Illinois and at additional mailing offices. Authorized as second class mail by the Post Office Department, Ottawa, Canada and for payment of postage in cash. Subscription service: Portland Place, Boulder, Colorado 80302. Editorial: One Park Ave., New York, N.Y. 10016.

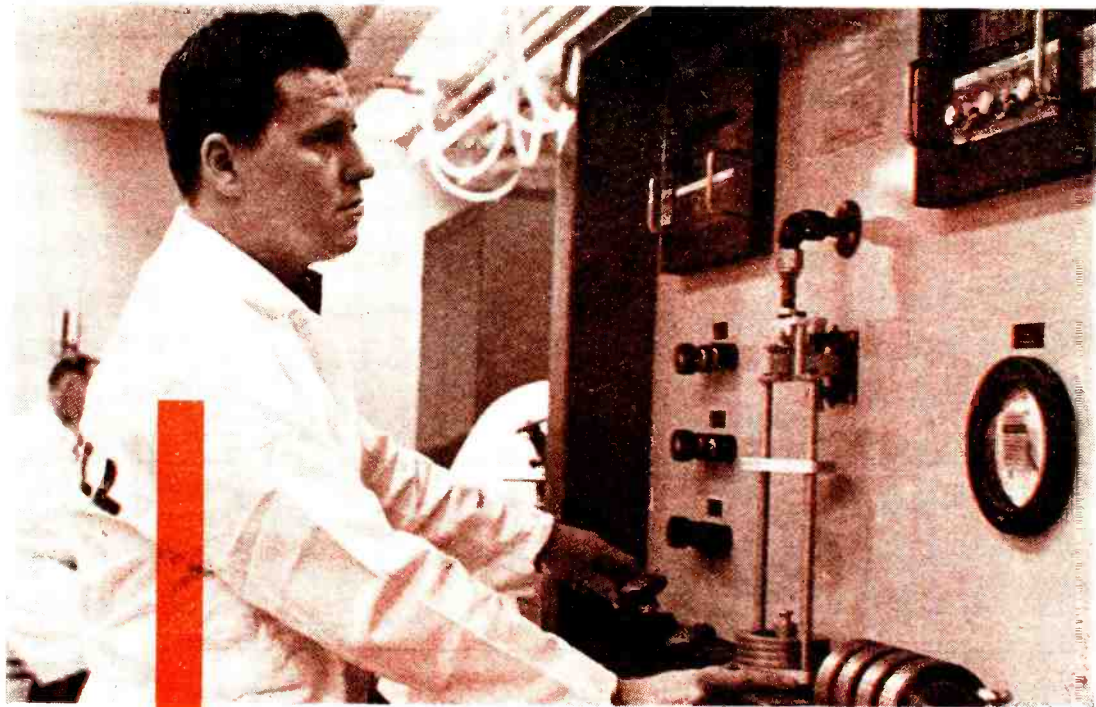

DeVry Not Only Trained Me . . . But Helped Me Get a Good Job in Electronics

"One of the luckiest days of my life was when I sent for DeVry Tech's informative booklets on Electronics. It was my start toward a wonderful future," says William L. Hudson, originally from Pennsylvania.

"I attended DeVry's Resident School. Upon graduation, without added cost, their Employment Service helped me get a job. Like other graduates of their Resident School and Home Study programs, I am entitled to career-long placement service whenever I need it. That's a wonderful feeling!" concluded Hudson, who is shown above at his job as a laboratory electronics technician for a prominent manufacturer in the space program.

If you are between 17 and 45 years of age, send the coupon now for free details. See how DeVry

may prepare you at home in your spare time — or in day or evening classes at one of its three resident schools in Chicago, Phoenix or Canada. If you enroll in resident school, we help you find a part-time job to defray some of your expenses, if you wish.

Start to make the big switch now toward a bright, profitable future. The first step is to fill in and mail the coupon below.

Approved for Veterans

A SUBSIDIARY OF  **BELL-HOWELL**

DeVRY INSTITUTE of TECHNOLOGY
4141 Belmont Avenue, Chicago, Ill. 60641, Dept. PE-10-X

Please give me your two free booklets, "Pocket Guide to Real Earnings," and "Electronics in Space Travel"; also include details on how to prepare for a career in Electronics. I am interested in the following opportunity fields (check one or more):

- | | |
|--|---|
| <input type="checkbox"/> Space & Missile Electronics | <input type="checkbox"/> Communications |
| <input type="checkbox"/> Television and Radio | <input type="checkbox"/> Computers |
| <input type="checkbox"/> Microwaves | <input type="checkbox"/> Broadcasting |
| <input type="checkbox"/> Radar | <input type="checkbox"/> Industrial Electronics |
| <input type="checkbox"/> Automation Electronics | <input type="checkbox"/> Electronic Control |

Name _____ Age _____

Address _____ Apt. _____

City _____ State or Province _____ Zone or Zip Code _____

Check here if you are under 16 years of age.

HOME STUDY AND RESIDENT SCHOOL PROGRAMS
AVAILABLE IN CANADA. SEND FOR DETAILS.

2107

Send for Full Facts!

Get two FREE booklets with facts on how a DeVry educational program may prepare you to enter the big field of electronics.



ACCREDITED MEMBER, NATIONAL HOME STUDY COUNCIL

DeVRY INSTITUTE of TECHNOLOGY

4141 BELMONT AVENUE, CHICAGO, ILLINOIS 60641

Weller®

...the soldering tools professionals depend on



The original Dual Heat Soldering Guns

Preferred by technicians for their fast heating copper tips, exclusive trigger-controlled dual heat, and high soldering efficiency. Available in 3 wattage sizes, each with spotlight.

100/140-watt Model 8200, 145/210-watt Model D-440, and 240/325-watt Model D-550. Also in complete kits:

- **Model 8200PK** includes 100/140 watt gun, extra tips, tip-changing wrench, flux brush, soldering aid and solder
- **Model D-550PK** heavy-duty 240/325 watt gun kit with soldering, cutting and smoothing tips, wrench and solder

Dependable MARKSMAN Irons in a size for every job



Ideal for deep chassis work and continuous-duty soldering, Marksmann irons outperform others of comparable size and weight. All five feature long-reach stainless steel barrels and replaceable tips.

- 25-watt, 1 3/4-oz. Model SP-23 with 1/8" tip (In kit with extra tips, soldering aid, solder—Model SP-23K)
- 40-watt, 2-oz. Model SP-40 with 1/4" tip
- 80-watt, 4-oz. Model SP-80 with 3/8" tip
- 120-watt, 10-oz. Model SP-120 with 1/2" tip
- 175-watt, 16-oz. Model SP-175 with 5/8" tip

NOW a BATTERY OPERATED IRON for field servicing

Use this lightweight service tool for automotive wiring, model planes, or mobile communications. Works from any 12 volt battery or 12-14 volt AC/DC supply. Supplied complete with long-life patented "Temperature Sensing" tip, 12-ft. power cord and terminal clips. Model TCP-12—12 volt; Model TCP-24—24-28 volts.



Complete Weller Line includes replacement tips and solder at your Electronic Parts Distributor

WELLER ELECTRIC CORPORATION

Easton, Pa.

WORLD LEADER IN SOLDERING TECHNOLOGY
CIRCLE NO. 45 ON READER SERVICE PAGE

POPULAR ELECTRONICS

PHILLIP T. HEFFERNAN
Publisher

OLIVER P. FERRELL
Editor

LESLIE SOLOMON
Technical Editor

WILLIAM GALBREATH
Art Director

MARGARET MAGNA
Associate Editor

ALEXANDER W. BURAWA
Assistant Editor

ANDRE DUZANT
Technical Illustrator

PATTI MORGAN
AURORA NARDOZZI
Editorial Assistants

H. BENNETT, W2PNA
H. S. BRIER W9EQG

L. E. GARNER, JR.

CHARLES J. SCHAUERS, W6QLV
M. P. SPINELLO, KHC2060

Contributing Editors

LAWRENCE SPORN
Advertising Sales Manager

ARDYS C. MORAN
Advertising Service Manager

ZIFF-DAVIS PUBLISHING COMPANY

Editorial and Executive Offices
One Park Avenue, New York, New York 10016
212 679-7200

Eastern Advertising Manager, RICHARD J. HALPERN

Midwestern Office

307 North Michigan Avenue, Chicago, Illinois 60601
312 726-0892

Midwestern Advertising Manager, JAMES WEAKLEY

Western Office

9025 Wilshire Boulevard, Beverly Hills, California 90211
213 CRestview 4-0265; BRadshaw 2-1161

Western Advertising Manager, BUD DEAN

Japan: James Yagi
Ishikawa Mansion
#4, Sakuragaoka
Shibuya-ku, Tokyo
462-2911-3

Circulation Office
Portland Place

Boulder, Colorado 80302

William B. Ziff, Chairman of the Board (1946-1953)
William Ziff, President

W. Bradford Briggs, Executive Vice President

Hershel B. Sarbin, Senior Vice President

Philip Sine, Financial Vice President

Walter S. Mills, Jr., Vice President, Circulation

Stanley R. Greenfield, Vice President, Marketing

Phillip T. Heffernan, Vice President, Electronics Division

Frank Pomerantz, Vice President, Creative Services

Arthur W. Butzow, Vice President, Production

Edward D. Muhfeld, Vice President, Aviation Division

Irwin Robinson, Vice President, Travel Division

Ziff-Davis also publishes *Airline Management and Marketing*, *Boating*, *Business & Commercial Aviation*, *Car and Driver*, *Cycle*, *Electronics World*, *Flying*, *HIFI/Stereo Review*, *Modern Bride*, *Popular Aviation*, *Popular Photography*, *Skiing*, *Skiing Area News*, and *Skiing Trade News*. (*Travel Weekly* is published by Robinson Publications, Inc., a subsidiary of Ziff-Davis Publishing Company.)

All subscription correspondence should be addressed to POPULAR ELECTRONICS, Circulation Department, Portland Place, Boulder, Colorado 80302. Please allow at least six weeks for change of address. Include your old address, as well as new-enclosing if possible an address label from a recent issue.

EDITORIAL CONTRIBUTIONS must be accompanied by return postage and will be handled with reasonable care; however, publisher assumes no responsibility for return or safety of art work, photographs or manuscripts.



Member Audit Bureau of Circulations

CIRCLE NO. 20 ON READER SERVICE PAGE →

MORE OBers ARE BUYING Hy-gain's NEW CLR 2 THAN ANY OTHER BASE STATION ANTENNA FOR CITIZENS BANC

*because they
work better*

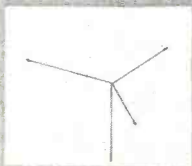

▲ Top Hat originally conceived by Hy-Gain effectively reduces static...offers low wind resistance

19'10½" radiator is maximum legal height... provides maximum signal capture area

▶ Full sized ¼ wavelength radials insure maximum gain through lowering the angle of radiation

*because they're
built better*

Rugged double-grip mast bracket ▶

Taper-swaged seamless aluminum tubing ▼

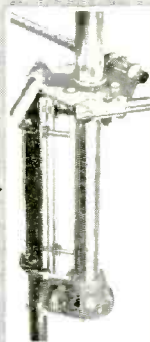

▶ Unique full circumference compression clamp exerts vise-like grip to insure permanent protection against performance killing corrosion and mechanical failure. Hy-Gain exclusive.



▶ Solid State Matcher



AND...WE GUARANTEE 'EM!

HY-GAIN
Dept. BA-10

The Antenna Manufacturer

ELECTRONICS CORPORATION

3458 N.E. Highway 6 - Lincoln, Nebraska

with a Record of Engineering "FIRSTS"

Symbol of a
new era in
record playing
equipment



**Garrard's new
Synchro-Lab™ Motor...
turns records at
perfectly constant
synchronous speed...
"locks in" to your
electric current**

Early evening. Lights and appliances go on all over the area—a heavy drain on the electric supply. No matter, if you're playing your records on a new Garrard Synchro-Lab™ Series Automatic Turntable! Record speed cannot vary with changes in voltage, record load, stylus pressure, or temperature. The new Garrard Synchro-Lab Motor "locks in" to the 60-cycle frequency of the current—yet, unlike old-fashioned synchronous motors, it starts powerfully, accelerates instantly. The secret: two motor sections: an induction element for high torque; a synchronous element that holds speeds absolutely constant.

Consistent engineering leadership helps explain why Garrard builds the world's finest automatic turntables—bought by more owners of component music systems than all other record playing units. Now, with synchronous power, the new Garrard Synchro-Lab Series is the inevitable choice of the critical listener. Four superb models, from \$129.50 to \$59.50, less base and cartridge.

Write for the new edition of the Garrard Comparator Guide. Garrard, Dept. AR-13, Westbury, N.Y. 11590.

British Industries Corp., a division of Avnet, Inc.



Garrard
WORLD'S FINEST
SYNCHRO-LAB SERIES

CIRCLE NO. 17 ON READER SERVICE PAGE

LETTERS

FROM OUR READERS

Address correspondence for this department to:
Letters Editor, POPULAR ELECTRONICS
One Park Avenue, New York, N. Y. 10016

PARTS IDENTIFICATION

Many electronic parts suppliers offer diodes by the bagful at reasonable prices. The low costs of these diodes are attractive, but there is a problem of identification. The only possible identification seems to be the color-code bands on the cathode end. If there is a standard color-code guide available for signal diodes, could you tell me where I can obtain it?

HERMAN W. FRISCH
San Jose, Calif.

Herman, the same color-coding system that applies to resistors also applies to crystal, or signal, diodes. First, drop the "1N" part of the type number. Then use the bands, reading from the cathode end, to find the exact number nomenclature of the diode.

CIRCUIT NOT FAIL-SAFE

Your fail-safe external alarm system ("Ultrasonic Omni-Alarm," April, 1966") fails to ring a bell, or I fail to see the light. If *K1* in Fig. 1 of the article opens, or if wires *F* and *G* (Fig. 8) are cut but not shorted together, there is no possible current path to the bell or the light. To make the circuit work as described, I removed the wire indicated by the

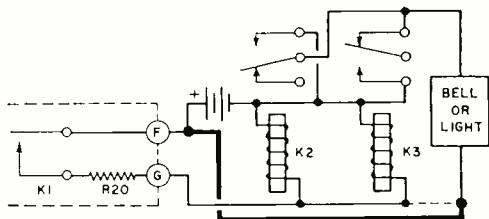

dashed line in the drawing, and I connected the jumper wire indicated by the heavy solid line.

A1C R.D. NOTARI
McConnell AFB, Kan.

Good catch, R.D.. The alarm cannot sound—or the lamp light—if points F and G are opened as in the original schematic drawing. Your slight modification rectifies the problem nicely.

CHANGE TO 350 WVDC

In the "Compac' Solid-State C-D Ignition" system article (November, 1966), I noticed

POPULAR ELECTRONICS

Be the man who's always
first to say: "I've got
the answer right here!"



START USING THIS REMARKABLE

ELECTRONICS SLIDE RULE

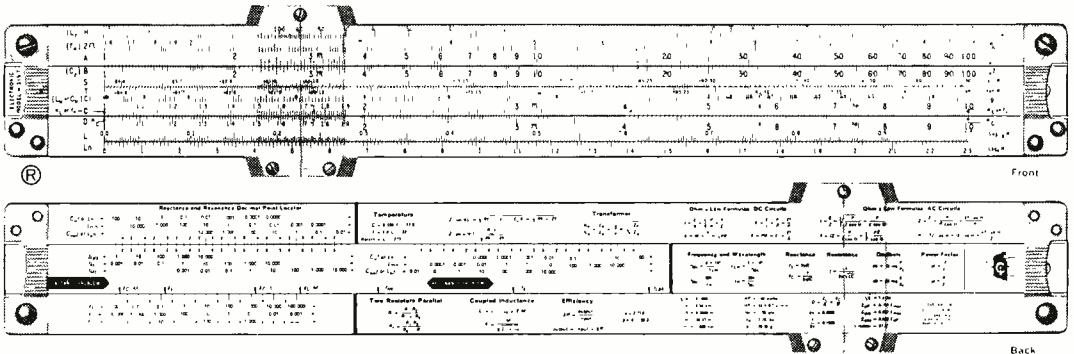

SOME DAY EVERYONE in electronics may have a slide rule like this. Till then, the man who uses one will seem like a wizard as he solves reactance and resonance problems in 12 to 20 seconds—without pencil and paper.

This is a professional slide rule in every detail, a full 10" long, made exclusively for Cleveland Institute of Electronics, to our rigid specifications, by Pickett, Inc. It can be used for conventional computation as well as special electronics calculations. All-metal construction assures smooth operation regardless of climate.

Handsome top-grain leather carrying case has heavy-duty plastic liner to protect slide rule; removable belt loop for convenient carrying. "Quick-flip" cover makes it easy to get rule in and out of case.

You also get four full-length **AUTO-PROGRAMMED™ Lessons**, which teach you how to use the special electronics scales on the slide rule. These lessons have been carefully designed to meet the same high educational standards as the electronics career courses for which our school is famous. Even if you've never used a slide rule before, you'll soon whiz through the toughest problems with this CIE rule.

Deliberately underpriced. Many men in electronics have told us that this unique slide rule, leather case, and 4-lesson course easily add up to a \$50 value. But we have deliberately underpriced it at less than \$25. Why? Our reason is simple: we are looking for men in electronics who are ambitious to improve their skills...who know that this will require more training. If we can *attract* you with the low price of our slide rule and course—and *impress* you with its quality—you are more

likely to consider CIE when you decide you could use more electronics training.

Send for free booklet. See for yourself why this amazing slide rule and course have made such a big hit with busy electronics men everywhere. No obligation, of course—just an opportunity to get in on the best offer ever made to people in electronics. Just mail coupon, or write Cleveland Institute of Electronics, Dept. PE-137, 1776 East 17th St., Cleveland, Ohio 44114.

CIE Cleveland Institute of Electronics
1776 East 17th Street, Cleveland, Ohio 44114

MAIL THIS COUPON FOR **FREE BOOKLET**

Cleveland Institute of Electronics
1776 East 17th Street Cleveland, Ohio 44114

Please send me without charge or obligation your booklet describing CIE Electronics Slide Rule and Instruction Course, **ALSO FREE**, if I act at once: a handy pocket-size Electronics Data Guide.



Name _____ (please print)
Address _____
City _____ State _____ Zip _____



Accredited Member National Home Study Council
A Leader in Electronics Training... Since 1934

PE-137

CIRCLE NO. 7 ON READER SERVICE PAGE

LETTERS *(Continued from page 8)*

that the Parts List specifies a 1.5- μ F, 250-volt capacitor for C5, while the text of the article states that this capacitor "... charges to about 300 volts." Shouldn't the working voltage for this capacitor be between 350 and 400 volts?

JIM ROBBINS
Grand Rapids, Mich.

Jim, the 250 working volts specified in the Parts List for C5 should have read 350 volts. This was a typographical error.

STAY WITH YOUR 3" TAPE REELS

I own a small, inexpensive portable tape recorder that accepts only the small 3"-diameter tape reels. Is there some kind of an adapter that I can use with my recorder so that I can record and play back larger diameter tape reels?

JACK DZIEWIT, JR.
Philadelphia, Pa.

Jack, if you have the popular type of tape recorder that sells for less than \$20, there is nothing you can do. These small recorders are all equipped with a small, low-torque motor which generally operates at near-maximum load with 3"-diameter reels. Any attempt—other than a complete redesign of the

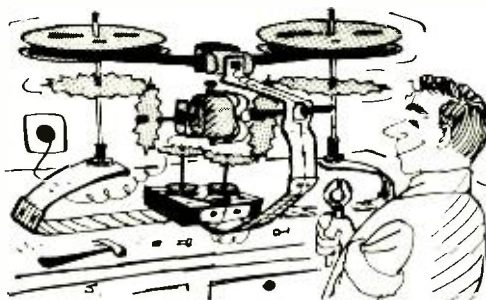

unit—to adapt larger reel sizes will only result in erratic operation, and perhaps no tape movement at all.

VACUUM TUBE TO TRANSISTOR MODIFICATION

I would like to convert my single-tube type phonograph to use a transistor amplifier. However, I find that the heater of the 25EH5 vacuum tube in my present setup is wired in series with the windings of the motor. What ohmic value and power rating resistor should I use in series with the motor for operation from a 117-volt a.c. source?

R.W. LIPPOTH
Mt. Vernon, N.Y.

R.W., the heater of a 25EH5 vacuum tube draws approximately 0.3 ampere at its operating potential of 25 volts; so the size of the



NEW



COMMODORE 23 ... Squires-Sanders new 23 channel, full 5 watt CB transceiver ...
NEW soft color styling ... rich natural walnut panel ... gold accents ...
NEW double conversion receiver ... exclusive Noise Silencer ... crystal filter ...
26 transistors, 7 diodes5 μ v sensitivity ... only \$200. Request literature.

See your distributor or write today for details. SQUIRES-SANDERS, INC., Box 319 A, Millington, New Jersey, 07946

CIRCLE NO. 40 ON READER SERVICE PAGE

CB'ers...

SKIP IS LEGAL

ON THE HAM BANDS...

in fact, Amateur Radio is based on the intelligent use of natural phenomena to achieve distant communications with relatively low power. Increased sun-spot activity in the next couple of years will bring tremendous propagation opportunities — like worldwide contacts on ten meters . . . tropospheric bending (predictable from an ordinary weather map) brings exciting surprises on two meters . . . Sporadic E skip gets you miles and miles and miles with little power on six meters . . . and more! And that is not all that you have going for you . . . there are no time restrictions . . . less crowding . . . more frequency bands . . . more legal power . . . and greater satisfaction because your knowledge of propagation permits you to plan your contacts. It is all out in the open . . . you can give the man your right name and your call without getting a pink ticket for a chaser.

You can get into ham radio easily and quickly (our buck says it will take you only 30 days . . . 45 max.). The technical requirements for a Novice license are *simple*. The test can be administered by a qualified licensee in your own neighborhood. Available licensing booklets lay it all out on a silver platter for you. SURE, we know about the code test, but man, five words — 25 characters — a MINUTE . . . that's less than a minute's worth of notes in a dreamy waltz!

Start it off with a Squires-Sanders 22'er (two-way voice privileges on two meters for Novices) . . . for sixty days we will throw in a free license manual and a code learning record. If you want to go all out, apply for the Technician License . . . a little more complex technical test (you can do it) and the same easy five word code exam . . . permits privileges on other bands — like 6 meter two-way voice. 22'er — 20 watts of high quality two meter AM phone transceiver . . . only \$249.95. 66'er — 22 watts of same for six meters . . . same free manual and record . . . same price.

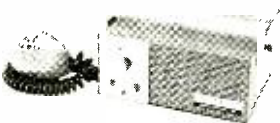
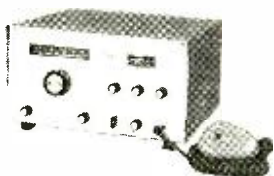

OK, OK . . . so your only interest is highly intelligible local communications for your personal business . . . your truck . . . your boat . . . your car . . . then go buy the 23'er all transistor 23 channel 5 watt CB transceiver for a modest \$235.00 or the 5 channel S5S for \$185.00. But, please, just talk to momma . . . or the office . . . or call H.E.L.P.

Squires  Sanders

See your distributor or write today for details. SQUIRES-SANDERS, INC., Box 319 A, Millington, New Jersey, 07946
CIRCLE NO. 41 ON READER SERVICE PAGE

LETTERS *(Continued from page 10)*

resistor should be about 83.3 ohms and capable of handling at least 7.5 watts. The resistor can be wire-wound or of carbon composition. You may have another problem, however: the filament of the tube may drop more or less voltage than its specified operating voltage when installed in the circuit. If this is the case, perhaps the easiest solution would be to connect a 500-ohm, 10-watt potentiometer in series with the motor instead of a fixed resistance, and then adjust the setting of the potentiometer for the correct motor speed by using a strobe light setup.

MORE VHF ON AM/FM TRANSISTOR RADIOS

I modified my portable radio, using the instructions given in "Get More VHF On AM/FM Transistor Radios" (June, 1967), and the conversion works great!

JOE HUGHART
Sutter, Calif.

I tried to modify my inexpensive portable transistor radio to "Get More VHF On AM/FM Transistor Radios." All that happened was that I detuned the calibration of my radio. The conversion just didn't work with my set.

I don't believe the spreading of the coil and adjustment of the capacitors can give the

results described. The capacitor and coil must be changed to give the band of frequencies desired, in my opinion.

SEYMOUR PAUL
Brooklyn, N.Y.

Opinions and results seem to be divided on this article. Seymour, we modified a unit identical to the one described in the article, and it worked immediately. Although the coil and capacitor values could be changed, the modification serves the same purpose. By spreading the coil, you do alter its reactance so it can be tuned to a different band of frequencies if you adjust the two trimmer capacitors slightly. The modification as described may be physically difficult with some transistor radios. Incidentally, it will work fine with any FM tuner or receiver.

NEVER TOO YOUNG

Electronics fascinates me and I have become interested in it to the point where I am giving it some consideration as a possible choice for a career. I am a high school sophomore and am wondering if it would be too early for me to get at least a minor education in electronics. If you think I am too young, please tell me how old I have to be to start.

KEN PETRON
South Bend, Ind.

(Continued on page 14)

Going nowhere



Unless he's got the skill and background to make it work.

Computers are machines too. Just machines. It takes a programmer to make them work. It takes a programmer to unleash the computer's fantastic power for use in business, science, electronics. You name it.

75,000 programmers are needed right now. Starting salaries are around \$7,000. Experienced programmers get \$10,000-\$15,000 - and more. And there are lots of part-time programmers needed.

The Computer Usage Study Course will train you to be a **computer programmer** - or give you the kind of computer background to let you really go somewhere in your own field. All you need is the equivalent of a high school diploma - and the desire to make it.

Just clip the coupon - and move out!

CUC COMPUTER USAGE
EDUCATION, INC.

51 Madison Ave., Dept. 500
New York, N.Y. 10010

Send me your free COMPUTER PROGRAMMING KIT.
No obligation, no sales representative will call.

Name _____

address _____

occupation _____ age _____

CIRCLE NO. 10 ON READER SERVICE PAGE

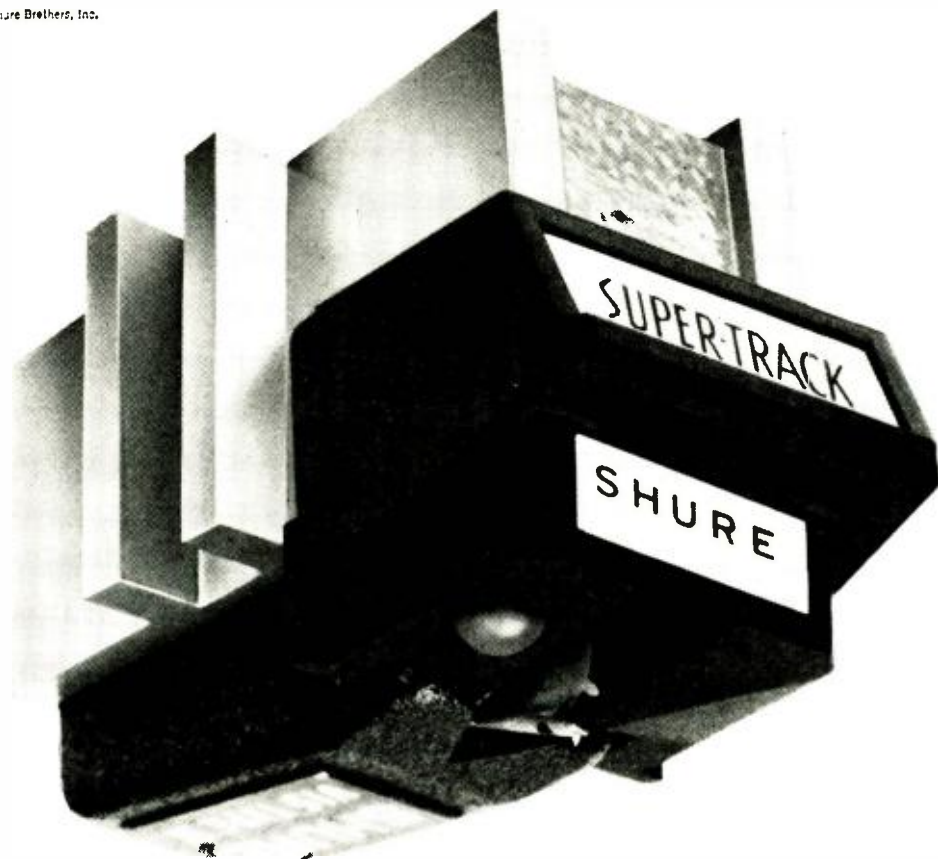

SINGULAR!
in no other way can
\$67.50 create such a
hearable sound improvement

The Shure V-15 Type II costs about \$30.00 more than "second-echelon" (good) cartridges. This same \$30.00 would barely pay for a different finish in loudspeakers; or provide minimal convenience-type improvements in a good quality turntable; and would have virtually no noticeable sound difference if invested in a better amplifier. With the V-15 Type II, you will *HEAR* a difference, always.

World-wide, critics say that all of your recordings will sound better and last longer when played with the revolutionary Shure V-15 Type II Super-Trackability phono cartridge.

Independent testing organizations say it is alone in its ability to track passages which have been cut at a sufficiently high recording velocity to insure precise and definitive intonation, full dynamic range, and optimum signal-to-noise ratio . . . at one gram (or less) force!

WRITE FOR COMPLETE LITERATURE, or send \$3.95 for the definitive Shure trackability test record "An Audio Obstacle Course". (Record is free with a V-15 Type II.) Shure Brothers, Inc., 222 Hartrey Ave., Evanston, Illinois 60204.

CIRCLE NO. 38 ON READER SERVICE PAGE

LETTERS (Continued from page 12)

Ken, you are not too young to learn about electronics. There's no doubt that more electronics teaching could be conducted at the high-school level. You should consult your grade advisor, and if your present school program leaves you with enough time, you might consider a home-study course in electronics. However, don't underestimate the importance of the math, physics and science subjects—included in the academic programs—in your electronics career. Also, active pursuit of an electronics-oriented hobby can be a big stepping-stone for you.

100% PROJECT ISSUE?

Why not have a 100% project issue sometime?

PAUL CARLSON
Tacoma, Wash.

Paul, there are many areas of interest in electronics, some of which have nothing at all to do with project construction. We try to have something for all our readers. But if you're interested in a 100% construction magazine, you can buy the ELECTRONIC EXPERIMENTER'S HANDBOOK that is put out by POPULAR ELECTRONICS, two editions a year. This magazine is devoted solely to construction projects. The Winter, 1968, Edition is

scheduled to hit the newsstands about September 28.

TWO-LOCATION CONTROL

The "Carrier-Current Remote-Control System" described in your January, 1967, issue can be controlled from only one location—the transmitter. However, if the s.p.s.t. power relay (K2 in Fig. 3) is replaced with a s.p.d.t. relay and a s.p.d.t. switch is installed in any

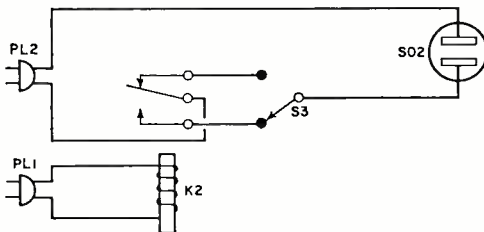

strategic location (see drawing), the receiver can be controlled from two locations.

R.A. D'ARCHE
West Hartford, Conn.

R.A. your switch idea will work fine. But you forgot to mention that the contacts of the switch and new relay must be capable of handling more than the amount of power the load connected to SO2 can reasonably be expected to draw.

-30-

What's best for POL-123...

... is best for KLN-9449

Model ASP-543 130-174 Mc police antenna.

Model M-176 27-Mc citizens band antenna.

Police communicators demand all the things CBers want in their mobile antennas: Maximum range. Ruggedness. Reliability. Long life. That's why 9 out of 10 police vehicles in America use antennas made by The Antenna Specialists.

Antenna Specialists' CB antennas are literally made from the same mold. Except for the length of the whip, they are identical with their professional counterparts. Shouldn't you put John Law's experience to work in your mobile?

More communicators use Antenna Specialists brand antennas—mobile and base—than use the next five brands combined.

the antenna specialists co.

Export: 64-14 Woodside Ave.
Woodside, N.Y. 11377

Div. of Anzac Industries, Inc., 12435 Euclid Ave., Cleveland, Ohio 44106
CIRCLE NO. 2 ON READER SERVICE PAGE



POPULAR ELECTRONICS

READER SERVICE PAGE

free information service:

Here's an easy and convenient way for you to get additional information about products advertised or mentioned editorially (if it has a "Reader Service Number") in this issue. Just follow the directions below... and the material will be sent to you promptly and free of charge.

1. Print or type your name and address on the lines indicated. Circle the number(s) on the coupon below that corresponds to the key number(s) at the bottom of the advertisement or editorial mention(s) that interest you. (Key numbers for advertised products also appear in the Advertisers' Index.)

2. Cut out the coupon and mail it to the address indicated below.

3. This address is for our product "Free Information Service" only. Editorial inquiries should be directed to POPULAR ELECTRONICS, One Park Avenue, New York 10016; circulation inquiries to Portland Place, Boulder, Colorado 80302.

**POPULAR
ELECTRONICS**

VOID AFTER NOVEMBER 30, 1967

P.O. BOX 8391
PHILADELPHIA, PA. 19101

1 2 3 4 5 6 7 8 9 10 11 12 13 14 15 16 17 18 19 20
21 22 23 24 25 26 27 28 29 30 31 32 33 34 35 36 37 38 39 40
41 42 43 44 45 46 47 48 49 50 51 52 53 54 55 56 57 58 59 60
61 62 63 64 65 66 67 68 69 70 71 72 73 74 75 76 77 78 79 80
81 82 83 84 85 86 87 88 89 90 91 92 93 94 95 96 97 98 99 100

NAME (Print clearly) _____

ADDRESS _____

CITY _____ STATE _____ ZIP CODE _____

10

NOW: PACE 2-WAY RADIO IN YOUR \$ 69⁹⁵ CAR



USE THE NEW PACE "AUTOMATE" ALL SOLID STATE 5-WATT TRANSMITTER to call for help when you're in trouble • Receive messages over your AM car radio . . . and get assistance in a hurry • Communicate up to 10 miles even on a weak battery • Just flip on the transmitter switch, tune your car radio to 1505, pick up the microphone, and make a call • Takes no more current than an electric clock • 12 channels available for business or personal use • Write for complete information and the name of your nearest PACE dealer.

((p)) PACE

COMMUNICATIONS CORP.

24049 Frampton Ave., Harbor City, Calif. 90710

Export Div.: 64-14 Woodside Ave., Woodside, N.Y.

Also available in Canada

CIRCLE NO. 29 ON READER SERVICE PAGE

ELECTRONICS LIBRARY

MEASURING HI-FI AMPLIFIERS

by Mannie Horowitz

Whether you are a technician, engineer, or an audiophile interested in electronics for the sake of audio excellence, you'll find *Measuring Hi-Fi Amplifiers* an indispensable book for your library. The author has attempted to clear up the battle of specifications currently being waged among amplifier manufacturers by presenting concrete information on how to go about testing any hi-fi amplifier. The book is devoted mainly to the "how to" phases of the various tests, each of which is supported by an interesting section on the "why's".

Published by Howard W. Sams & Co., Inc., 4300 West 62 St., Indianapolis, Ind., 46206. Soft cover. 160 pages. \$3.25.

ZENER DIODE HANDBOOK

Compiled by the Motorola Applications Engineering Department, this completely new handbook covers applications for temperature-compensated zeners, reference standards, current regulator diodes, and zener transient suppressors, as well as the latest types of zener diodes. All data necessary for the efficient use of zener components is provided, with major emphasis on circuit design.

Published by Motorola Semiconductor Products, Inc. Available from franchised Motorola distributors, or from Motorola's Technical Information Center, Box 13408, Phoenix, Ariz. 85002. Soft cover. 184 pages. \$2.00.

PROBLEMS IN ELECTRONICS WITH SOLUTIONS, Fourth Edition

by F. A. Benson

This book is aimed directly at the undergraduate electronic engineer and is a compilation of some 349 problems gathered by Dr. Benson during his tenure as Reader in Electronics, University of Sheffield, England. Coverage is broad—across the complete spectrum of electronics. The first half of the book is divided into 35 chapters, each on a different area of electronics (several new areas have been added in this expanded edition), and a number of problems, with answers, are presented in each chapter. The second half of the book is keyed to the first half, thoroughly describing the steps necessary to reach each solution.

Published by Associated Book Publishers Ltd., London, England. Distributed in the U.S.A. by Barnes & Noble Inc., 105 Fifth Ave., New York, N. Y. 10003. Soft cover. 298 pages. \$4.25. (Also available in hard cover for \$8.00) —30—

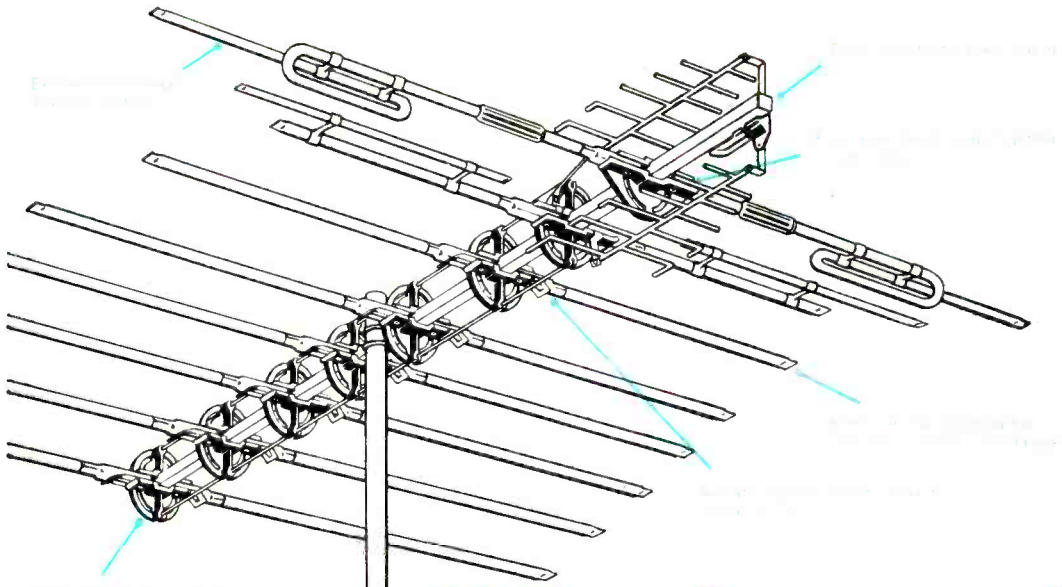

82-channel signal grabber

The Jerrold VUfinder® Antenna. The first 300-ohm UHF-VHF-FM antenna designed—from the ground up—for uncompromising color and black-and-white excellence across the entire TV spectrum. Models available for metropolitan to deepest fringe areas.

- Sharp directivity eliminates color ghosts
- Flat response (± 1 db per channel) for optimum color fidelity
- Exclusive bi-modal director system for extra gain

VUfinders are easy to put together, can't possibly fall apart. The quality that's built in stays in. Quickly convertible to 75-ohm Color-axial performance. VUfinders come in 5 models. Each is supplied with a UHF/VHF frequency splitter. And the list prices range from \$17.95 to \$79.95. There's no better performance per dollar than this—anywhere.

For the most efficient 300-ohm signal grabber in Jerrold's Spectrum '67, see your Jerrold Distributor today about the Jerrold VUfinder antenna.

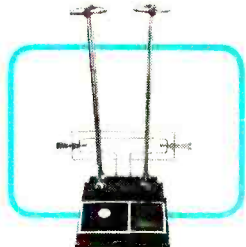

Indoor antennas



Home pre-amplifiers



Distribution equipment



*Focusing on one thing...
better reception*

SOMEONE SHOULD DEVELOP AN EASY WAY TO LEARN ELECTRONICS AT HOME

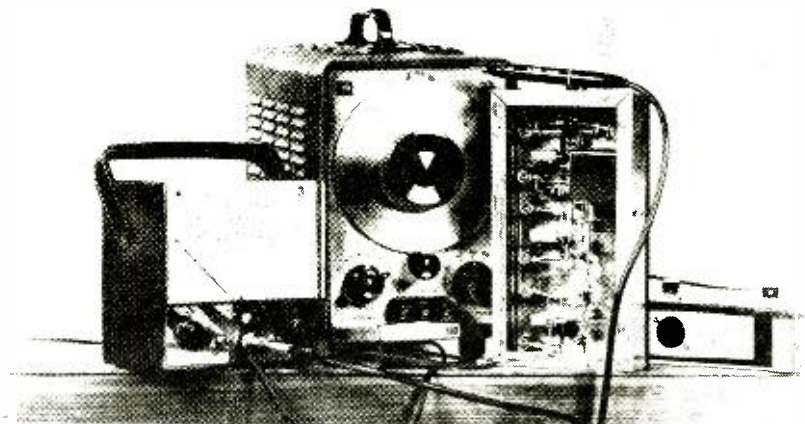

RCA INSTITUTES DID!

Here is a whole new approach to learning electronics at home! RCA Institutes, one of the nations' largest schools devoted to electronics, has developed a faster, easier way for you to gain the skills and the knowledge you need for the career of your choice. Here for the first time, is a student-proved, scientifically designed way to learn. If you have had any doubts in the past about home training in electronics —if you have hesitated because you thought you might not be able to keep up—or that electronics was too complicated to learn—here is your answer! Read how RCA Institutes has revolutionized its entire home training ideas!

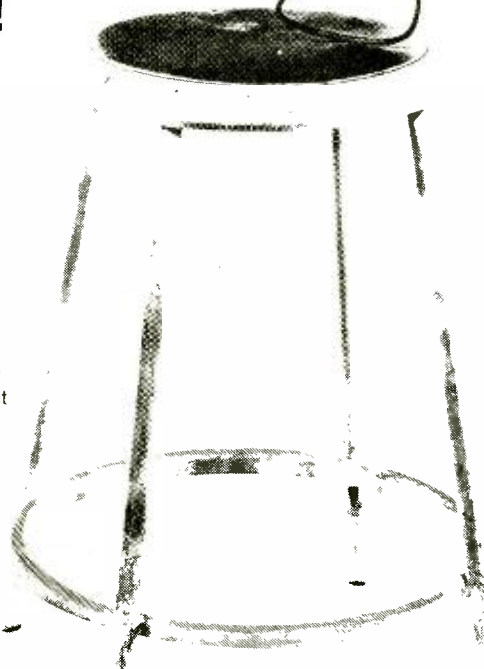

NEW CAREER PROGRAMS BEGIN WITH "AUTOTEXT" INSTRUCTION METHOD!

Start to learn the field of your choice immediately!

No previous training or experience in electronics needed!

With this new revolutionized method of home training you pick the career of your choice—and RCA Institutes trains you for it. RCA's Career Programs assure you that everything you learn will help you go directly to the field that you have chosen! No wasted time learning things you'll never use on the job! The Career Program you choose is especially designed to get you into that career in the fastest, easiest possible way!

And each Career Program starts with the amazing "AUTOTEXT" Programmed Instruction Method—the new, faster way to learn that's almost automatic! "AUTOTEXT" helps even those who have had trouble with conventional home training methods in the past. This is the "Space Age" way to learn everything you need to know with the least amount of time and effort.

CHOOSE A CAREER PROGRAM NOW

Your next step may be the job of your choice. Each one of these RCA Institutes Career Programs is a complete unit. It contains the know-how you need to step into a profitable career. Here are the names of the programs and the kinds of jobs they train you for. Which one is for you?

Television Servicing. Prepares you for a career as a TV Technician/ Serviceman; Master Antenna Systems Technician; TV Laboratory Technician; Educational TV Technician.

FCC License Preparation. For those who want to become TV Station Engineers, Communications Laboratory Technicians, or Field Engineers.

Automation Electronics. Gets you ready to be an Automation Electronics Technician; Manufacturer's Representative; Industrial Electronics Technician.

Automatic Controls. Prepares you to be an Automatic Controls Electronics Technician; Industrial Laboratory Technician; Maintenance Technician; Field Engineer.

Digital Techniques. For a career as a Digital Techniques Electronics Technician; Industrial Electronics Technician; Industrial Laboratory Technician.

Telecommunications. For a job as TV Station Engineer, Mobile Communications Technician, Marine Radio Technician.

Industrial Electronics. For jobs as Industrial Electronics Technicians; Field Engineers; Maintenance Technicians; Industrial Laboratory Technicians.

Nuclear Instrumentation. For those who want careers as Nuclear Instrumentation Electronics Technicians; Industrial Laboratory Technicians; Industrial Electronics Technicians.

Solid State Electronics. Become a specialist in the Semiconductor Field.

Electronics Drafting. Junior Draftsman, Junior Technical Illustrator; Parts Inspector; Design Draftsman Trainee Chartist.

SEPARATE COURSES

In addition, in order to meet specific needs, RCA Institutes offers a wide variety of separate courses which may be taken independently of the Career Programs, on all subjects from Electronics Fundamentals to Computer Programming. Complete information will be sent with your other materials.

LIBERAL TUITION PLAN

RCA offers you a unique Liberal Tuition Plan—your most economical way to learn. You pay for lessons only as you order them. No long term contracts. If you wish to stop your training for any reason, you may do so and not owe one cent until you resume the course.

VALUABLE EQUIPMENT

You receive valuable equipment to keep and use on the job—and you never have to take apart one piece to build another. **New—Programmed Electronics Breadboard.** You now will receive a scientifically programmed electronic bread-

board with your study material. This breadboard provides limitless experimentation with basic electrical and electronic circuits involving vacuum tubes and transistors and includes the construction of a working signal generator and superheterodyne AM Receiver.

Bonus From RCA—Multimeter and Oscilloscope Kits. At no additional cost, you will receive with every RCA Institutes Career Program the instruments and kit material you need to build a multimeter and oscilloscope. The inclusion of both these kits is an RCA extra.

CLASSROOM TRAINING ALSO AVAILABLE

RCA Institutes maintains one of the largest schools of its kind in New York City where classroom and laboratory training is available in day or evening sessions. You may be admitted without any previous technical training; preparatory courses are available if you haven't completed high school. Coeducational classes start four times a year.

FREE PLACEMENT SERVICE

In recent years, 9 out of 10 Resident School students who used the Free Placement Service had their jobs waiting for them when they graduated. And many of these jobs were with top companies in the field—such as IBM, Bell Telephone Labs, General Electric, RCA, and radio and TV stations and other communications systems throughout the world.

SEND ATTACHED POSTAGE PAID CARD FOR COMPLETE INFORMATION, NO OBLIGATION. NO SALESMAN WILL CALL.

**ALL RCA INSTITUTES COURSES
AVAILABLE UNDER NEW GI BILL.**

RCA INSTITUTES, Inc., Dept. PE-07
A Service of Radio Corporation of America
350 West 4th St., New York, N.Y. 10014



The Most Trusted Name in Electronics



NEW PRODUCTS

Additional information on products covered in this section is available from the manufacturers. Each new product is identified by a code number. To obtain further details on any of them, simply fill in and mail the coupon on page 15.

CALL LETTER DOOR/FLOOR MAT

How would you like to personalize your front door or radio shack with a rubber mat containing your name and call letters? *Herbert Salch & Co.* (Marketing Division of *Tompkins Radio Products*) will make one up for you. The 18" x 28", 1/2"-thick mats are available in black, brown, green, or blue, with name and call letters in 2 5/8"-high white lettering across the middle. If your name is a long one, you might want to use your call-sign alone, since the number of characters is limited to 13.

Circle No. 75 on Reader Service Page 15

THREE-WAY HI-FI SPEAKER SYSTEM

A three-way, five-speaker system has been introduced by *Sansui Electronics Corporation*, U.S. marketing arm for *Sansui Electric Company Ltd.* of Tokyo. Called the Model SP-200, it consists of a 12-inch woofer, two 5-inch mid-range speakers, and two 2-inch horn-type tweeters housed in a "pipe-ducted" bass reflex type walnut enclosure with hand-carved speaker grille. Frequency response is 35 to 20,000 Hz, with crossovers at 1500 and 5000 Hz. Maximum input is 45 watts; input impedance, 8 ohms. A specially designed level control has three positions—"natural" for average rooms; "clear" for rooms where the highs are swallowed up and the lows exaggerated; and "soft" for rooms where lows are swallowed up and highs exaggerated.

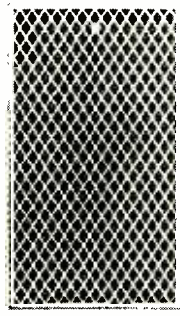

Circle No. 76 on Reader Service Page 15

MOBILE MICROPHONE

Fingertip output control is now available in a mobile microphone—the *Turner M+2/U*—that can be easily wired into ANY transceiver, according to the manufacturer. (The original *Turner M+2* pioneered adjustable mobile-microphone output but could not be

wired into several recently introduced transceiver brands.) The *M+2/U* uses a self-contained preamp to provide clear communications at greater distances than was previously possible. It is especially suitable for the operator who has to vary his distance from the mike.

Circle No. 77 on Reader Service Page 15

MULTI-MULTI TEST INSTRUMENT

Incorporating seven instruments in one compact case, the Model 880 "Stereo Commander" introduced by *Amphenol* provides a complete testing laboratory for audio FM and multi-



plex—for about a third of what it would cost to purchase seven individual pieces. The solid-state portable unit contains four signal sources (audio generator, multiplex simulator, r.f. sweep oscillator, and a "marker" oscillator) and three measuring instruments (inter-

modulation distortion analyzer, impedance bridge, and a high-impedance a.c. voltmeter). Composite output is 5 volts peak-to-peak stereo, with 35 dB channel separation up to 10 kHz; 2.5 volts peak-to-peak L-R; and 3 volts peak-to-peak monaural.

Circle No. 78 on Reader Service Page 15

ELECTRONIC CHANGE-OVER SWITCH

The Model 381B electronic antenna change-over switch for 52-75 ohm coaxial line announced by *Barker & Williamson* permits a transmitter to be continuously connected to an antenna, blocking the antenna circuit to the receiver during "Transmit." There are no switch contacts to arc or burn, and switching is instantaneous. The 381B is said to be ideally suited for break-in operation on CW, SSB, and AM phone. Selectable bandswitching assures full receiver sensitivity.



Circle No. 79 on Reader Service Page 15

ROOFTOP CB ANTENNA

Fiberglass construction is said to make the "Perfect 36" CB antenna immune to problems of moisture, dust, salt air, extreme cold, and other physical hazards. Announced by the *C/P Corporation*, subsidiary of the *Shakespeare Company*, the rugged 36-inch rooftop

We know a man doesn't come by \$539.80 just like that. And parts with it only after carefully deliberating his alternatives.

So we've put together a new illustrated booklet that explains just what you'll be getting into should you decide to spend \$269.90 for our completely hand wired Director 23 mobile radio telephone; just what you'll be getting into should you decide to spend \$269.90 for our matching hand wired Guardian 23 (or 23-B) base station radio telephone. And just what you could be getting into should you decide that \$539.80 is too much to spend for two two-way radios.

Total cost for the booklet? Nothing. But you've got to mail the coupon to let us know you want one, and that'll set you back a nickel.

But just in case you're thinking you'll save the nickel because you already know all about our 23's, you might just as well know that we've redesigned them to include some rather exotic new features. (The all solid state Director 23, for instance, now boasts a final transistor that won't blow—even if you key up and forget to connect the antenna. Plus a tone control. Plus

a front-mounted speaker.)

Plus' features like HetroSync® Circuitry. (Which has all but completely wiped out spurious signals.) And our remarkable Superhet Receiver. (Which is so good that sloppy signals from adjacent channels have virtually become a thing of the past.)

And electronic switching, dual function S-meter, and your choice of two base stations. (The Guardian 23 comes with a conventional palm microphone. The Guardian 23-B, which comes without a microphone, comes with a built-in solid state pre-amplifier which permits the operator to remain from 1 to 1½ feet from a desk microphone and still broadcast at 100% modulation. Costs are identical.)

In short, we think it's well worth the price of a stamp to know exactly what you're getting into before you decide to get into it. So we'd like to send you one of our brand new illustrated booklets that tells you all about all of our new CB radios, and some things about some CB radios that aren't ours.

If you'll just tell us where to send it.



Director 23 (23-channel mobile unit), \$269.90



Guardian 23, 23-B (23-channel base stations), \$269.90

Before you spend \$539.80 for one of Pearce-Simpson's new base stations and matching mobile units, spend 5¢ and find out why you should.

F.C.C. Type Acceptance pending

Pearce-Simpson, Inc. P.O. Box 800/Biscayne Annex, Miami, Florida 33152 Gentlemen: I'd like to receive one of your new booklets. PE-1067	
Name	
Address	
City	
State	Zip

Overseas military personnel may write for special military price list.

CIRCLE NO. 30 ON READER SERVICE PAGE

PRODUCTS (Continued from page 22)

mobile antenna is completely enclosed through the use of a parallel fiber process, and never gets "out of tune." It's a tapered-pitch, 50-ohm impedance, helical load antenna with capacitor matching circuit, a power rating of 50 watts, and a VSWR of less than 2.0 over the 27-MHz band and less than 1.2 at midband.

Circle No. 80 on Reader Service Page 15

STEREO CARTRIDGES

Sonotone has released three new ceramic cartridges designed for replacement purposes in transistorized record players. They have clip-in and clip-out mounting brackets which will fit all two-boss-mount type tone arms, and are equipped with a Sono-Flex® needle

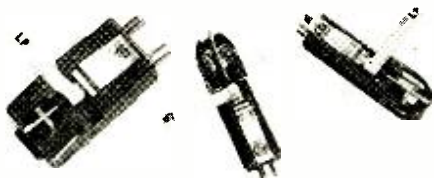

which comes in three different combinations. The Model 31TA (left) has a frequency response of ± 3 dB from 30 to 15,000 Hz; Model 32T (center), 30 to 9,000 Hz; Model 39T (right), 30 to 10,000 Hz. Each model has a tracking force of 4 to 7 grams and a compliance of 3×10^{-6} cm/dyne.

Circle No. 81 on Reader Service Page 15

PALM-SIZED MONITOR RECEIVERS

Three new monitor receivers have been developed by *Hallcrafters* that deliver professional-quality selectivity, sensitivity, and stability using an ordinary 9-volt transistor radio battery. Each is only slightly larger than two packs of cigarettes. Model CRX-100 covers the 27-50 MHz band (Class D Citizens Band, 10-meter amateur band, and part of the Business Radio Service and Public Safety Service); Model CRX-101 covers 108-135 MHz (the VHF aircraft band); and Model CRX-102 covers 144-174 MHz (2-meter amateur band, Civil Air Patrol, and part of the Business Radio Service and the Public Safety Service). A built-in whip antenna in each monitor delivers good reception of local signals, but a jack is provided for an external antenna if one is desired. A built-in jack for external earphone and a.c. adapter is also included.

Circle No. 82 on Reader Service Page 15

MARINE CB ANTENNA

Designed to eliminate the need for radials or other difficult-to-install ground systems, the *Mosley* "Channel Cat" CB antenna is effective even on wood and fiberglass boats. Loading is through a waterproof coil in the

antenna center, and matching via a high-Q transformer in the waterproof base. Feed point impedance is 52 ohms. Eight feet and three-eighths inches high, the antenna has a base hinge of extra heavy duty construction for quick foldover. The whip is made of high grade stainless steel.

Circle No. 83 on Reader Service Page 15

DIAL-LABEL CALL LETTERS

You can permanently mark the exact location of your favorite FM stations directly on the dial of your FM set—with inexpensive DIAL-LABEL pressure-sensitive call letters marketed by *Abigail Enterprises*. You just tune in a station, place the preprinted DIAL-LABEL call letters for that station over the selector needle, rub the back of the transfer sheet with a dull, hard object, then remove the transfer sheet. DIAL-LABEL call letters are available in black or white, and are printed either horizontally (for vertical dials) or vertically (for horizontal dials). At the time this is being written, each set contains 58 station call letters from Santa Barbara to San Diego, California. However, they will soon be available for most U.S. cities—probably by the time you read this item.

Circle No. 84 on Reader Service Page 15

TRIANGULAR CABINET FOR CONTROLS

Featuring all-welded construction with removable front panel and hinged door, the *Bud* "Mark-T" triangular cabinet for controls was planned so that the entire contents



would be visible to the viewer when the door is open. (The truncated triangular cross section of the frame is a replica of the *Bud* Radio insignia.) The Mark-T is available in three widths, all with a vinyl texture charcoal gray body and light gray enamel front panel and rear door.

Circle No. 85 on Reader Service Page 15

LIGHTWEIGHT CARTRIDGE

Weighing only 7 grams, *Ortofon's* new SL-15 cartridge will fit all transcription tone arms and can be mounted in all of the better quality automatic turntables. The features of *Ortofon's* S-15 are also incorporated in the SL-15, including the smallest moving mass (which results in practically non-existent record wear at 1 gram stylus pressure); 15° vertical tracking angle; and an elliptical diamond stylus. Channel separation is 20-30 dB; frequency response, 10-40,000 Hz.

Circle No. 86 on Reader Service Page 15

CIRCLE NO. 33 ON READER SERVICE PAGE →

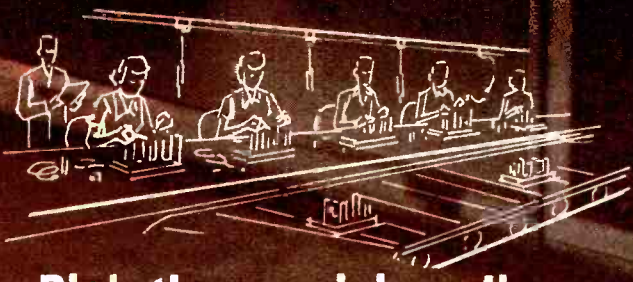

Pick the precision pliers used on electronic assembly lines



"Let your Hands be the judge"

... right for you because they look better, feel better, work better

Why are S-K Wayne small precision pliers preferred for the most accurate and exacting work in such fields as hobbycrafts, watchmaking, and all phases of electronics? For the same reasons you would have for owning them:

An S-K Wayne precision plier is made to *look* better. Each tool is drop forged from fine grain tool steel. Each is individually machined. Tempered. Carefully fitted and adjusted by expert American tool craftsmen. Fully tested. And finally, the head is polished like a fine surgical instrument to a smooth, gleaming finish—the famous S-K Wayne finish recognized as the finest in professional tools.

It's made to *feel* better. Expertly balanced and

shaped to fit the hand, with cross coil springs and Cushion Grip handles to fight fatigue and provide maximum comfort.

It's made to *work* better. Small, slim, polished head design permits easy access to tight work areas—spots other pliers can't reach. With carefully filed cutting edges to assure a perfect cut every time.

Professionals and serious hobbyists like S-K Wayne's broad selection of pliers of every type and size. *You'll* like it, too.

Visit your S-K Wayne dealer and ask to make your own comparison. Then, like the professionals say: "Let your hands be the judge."

S-K WAYNE TOOL COMPANY
332 South Michigan Ave. • Chicago, Ill. 60604



Subsidiary of Symington Wayne Corporation



NO. 90

◀ 5-pc. matched set of precision pliers. Includes diagonal cutting pliers, end cutting nipper, chain nose plier, flat nose plier and round nose/round jaw plier—in zippered case.

S-K Wayne makes a complete line of professional quality tools for home, farm and industry, including: Sockets, ratchets and handles • alloy wrenches • combination and utility pliers • screwdrivers • adjustable wrenches • solid joint pliers • snips • punches and chisels • pipe tools • automotive tools • tool boxes



PARTS
METHODS
IDEAS
GADGETS
DEVICES

TIPS & TECHNIQUES

CONVERT PHONO MOTOR INTO COOLING FAN

Heat build-up is perhaps the most troublesome problem in electronic equipment. Solid-state devices must operate "cool" to prevent thermal runaway in transistors and large heat sinks may be inadequate. Wherever heat build-up may be a potential cause of trouble, a fan or blower should be used. If you have an old phonograph or tape recorder motor you might consider using it as a "fan." The only other thing you need is a suitable fan blade (see page 255 of the Lafayette Radio Electronics 1967 catalog for sizes). Slide the blade onto the motor shaft, tighten the blade setscrew, and mount the assembly where needed. A single fan of this type should provide adequate cooling for almost any electronic device in your home or workshop.

—Joe Riedel

RUBBER BUMPERS LET YOU USE SHOP VISE AS SAFE WORK HOLDER

When you have to use a shop vise as a work holder, you can prevent marring panels and components if the jaws of the vise are faced with some type of cushioning material. Small adhesive-backed rubber bumpers (similar to those made by 3M and sold at most electronics parts stores) are perfect "cushions." When two of these are pressed opposite each other on the steel vise jaws and a part chucked between them as shown in the photo, the part will be held firmly but safely in place. These rubber bumpers have plenty of "give" and surface resistance to prevent slippage of even the smoothest devices that are chucked between them.

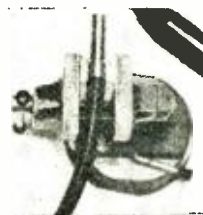

—Byron G. Wels

SELECT—DON'T SETTLE—FROM TWO FILAMENT TRANSFORMERS

No experimenter's workbench is complete without a low-voltage a.c. power supply, but it's not necessary that the supply be continuously variable from 0 to its top voltage. A few

NEW ELECTRONIC PROJECTS!

Electronic education and recreation through Project Kits from **ELECTRO KITS**

A DIVISION OF ELECTRONIC KITS SUPPLY CO.



PACKARD-BELL 5R1 RADIO KIT—Most popular school project, 5 Tube Superhet Radio, hand wired chassis, ivory cabinet. Pre-punched chassis. Lab. manual included. **\$14.95** postpaid



RE-760 TRANSISTOR RADIO KIT A fine radio with 6 transistors, diode, and varistor. Printed circuit panel, large tuning and audio components. Two tone plastic cabinet with handle. Lab. manual and batteries included. **\$14.95** postpaid



SA-12 STEREO AMPLIFIER KIT A radio/phonograph amplifier with output of 3 watts monaural, 1.5 watts stereo. Hand wired circuits, four tubes, pre-punched chassis, steel cabinet, tone control. Lab. manual included. **\$14.95** postpaid

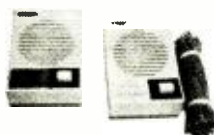

TRANSISTOR INTERCOM HP-30-YT A 3 Transistor Intercom Kit, two stations, battery operated. Lab. manual, printed circuit board construction. **\$11.95** postpaid



RX-12 SHORT WAVE RADIO KIT A new SW radio kit with 3 bands: broadcast, marine, and short wave 4 to 12 mc. Steel cabinet, pre-punched chassis, hand wired circuit, B.F.O. phone jack, 5 tubes 110V. AC/DC operation. Lab. manual included. **\$21.95** postpaid



MULTIMETER KIT YT-63 A fine 2000 ohm per volt VOM Kit. Measures AC and DC voltages, resistance, and DC current. D'Arsonval movement, test leads, battery, lab. manual included. **\$7.95** postpaid

ELECTRONIC KITS SUPPLY CO.

P.O. Box 54660-PE, Terminal Annex, Los Angeles, Calif.

ITEM NO.	PRICE	QUANTITY	TOTAL
_____	\$ _____	_____	\$ _____
_____	\$ _____	_____	\$ _____
_____	\$ _____	_____	\$ _____
_____	\$ _____	_____	\$ _____
_____	\$ _____	_____	\$ _____

School instructors billed in open account. Others enclose check or money order.

NAME _____
SCHOOL _____
ADDRESS _____
CITY _____
STATE _____ ZIP _____

Send complete catalog

CIRCLE NO. 15 ON READER SERVICE PAGE



Put admiration in her eyes!

Raytheon TWR-9 on the kitchen shelf will do the trick.

Then she can talk to you on the way home . . . and have you pick up those little essentials like TV dinners . . . or the laundry.

And when she signs clear with you she'll quickly shift the "niner" to intercom and threaten junior with disaster if his homework isn't done before you arrive home.

She's sure to be extra pleased (and you will be also) with that cordless microphone

feature that is unique with "niner"—and so easy and convenient to use.

She'll admire your foresight even more when she learns that it's simple to divert the output of the C-B receiver section to a remote speaker at poolside so she can still hear your calls from the car even when she relaxes outside. Mighty handy.

So buy her that nifty niner. **Be admired . . .** and for only **99.95!**

5 watts—6 channels—tip touch tab control.

RAYTHEON COMPANY

213 East Grand Ave. South San Francisco, Calif. 94080

RAYTHEON

Write today for descriptive brochure on TWR-9

CIRCLE NO. 31 ON READER SERVICE PAGE

of the most commonly used low voltages will usually be enough. With two low-cost filament transformers and a simple switching arrangement as shown in the schematic, you can obtain 3, 6, 9, 12, 15, and 18 volts (positions 1 through 6 of *S2*, respectively). Build the circuit in any convenient size case. Then plug it into a 117-volt a.c. source, turn the power on, set *S2* to position 6, and measure the voltage from *J1* to *J2*. If the meter reading is approximately 6 volts (it should be about 18 volts),

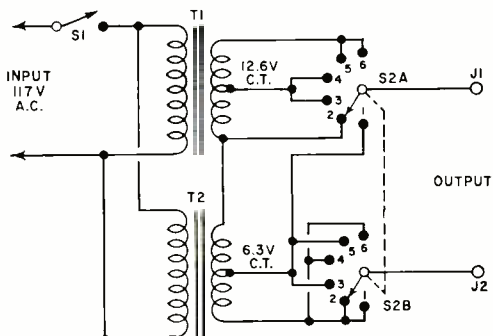

T1 and *T2* are improperly phased. For correct phasing, simply reverse the primary connections of only one of the transformers. When

d.c. voltages are required, the output at *J1* and *J2* can be connected to a rectifier and d.c. filter network. —*Frank H. Tooker*

**MODEL AIRPLANE CEMENT
REDUCES CORROSION AND SHOCK HAZARD**

For use in space, military and industrial electronics, printed circuit boards are often encapsulated in a tough epoxy plastic to protect them from moisture, dirt, grease, etc. While your printed circuit boards are not likely to be subjected to space, marine and corrosive atmospheres, they are susceptible to moisture and dirt and can be a potential shock hazard. After all components have been installed and all soldered connections checked, you can protect your boards against damage and yourself against shock by coating the boards with a film of clear plastic model airplane cement. Apply a coat to one side of the board, let it set, then repeat the process for the other side of the board. Two or more coats may be necessary for boards used in high-voltage circuits.



—*Michael Evangelist*



**... PRESENTS THE ALL NEW SWL-4
ALL SOLID STATE SHORT WAVE RECEIVER**

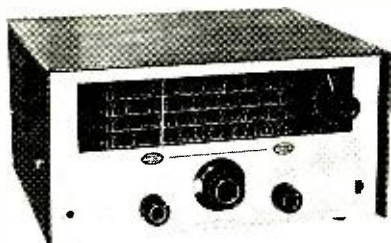

Now, at a price everyone can afford, here's a completely solid state short wave receiver which will enable you to hear news broadcasts from Africa to Asia, hundreds of foreign language stations, ships at sea, Voice of America, Bureau of Standards Time Signals . . . plus the full standard broadcast band. The Ameco SWL-4 covers .54 Mc through 23 Mc in four continuous bands including all amateur phone bands from 160 through 15 meters. Beautifully styled in an all metal Presidential Walnut cabinet, the unit has a built-in permanent magnet speaker, illuminated dial panel, earphone jack for private listening and a smartly designed control panel for easy tuning by anyone. Utilizing the latest communications quality components, the SWL-4 contains only solid state devices . . . no tubes . . . giving instant operation without warmup.

AVAILABLE AT LEADING DEALERS COMPLETE **\$69.95**

Send Now For Free Spec Sheet

AMECO - DIVISION OF AEROTRON

P. O. Box 6527, Raleigh, North Carolina 27608

Manufactured in the Award Winning Aerotron plant

CIRCLE NO. 48 ON READER SERVICE PAGE

cortina®

The most exciting innovation in solid state stereo history.

Engineering excellence, 100% capability, striking esthetics — all at budget prices. We call it the industry's only **TOTAL PERFORMANCE STEREO** at lowest cost.

■ A full capability 70 watt All Silicon Solid State Stereo Amplifier for \$89.95 kit, \$129.95 wired, including cabinet. Cortina 3070.

■ An Automatic FM Stereo Tuner for \$89.95 kit, \$129.95 wired, including cabinet. Cortina 3200.

■ A 70-Watt Solid State FM Stereo Receiver for \$159.95 kit, \$239.95 wired, including cabinet. Cortina 3570.

The most electronics value for your money has been the EICO design philosophy for 22 years. Its successful expression in stereo is the new Cortina Series. In performance, specifications, circuitry, controls, decor — in everything you expect of professional quality stereo, you'll see that

nothing has been sacrificed — except high price. Let yourself in for one of the pleasant surprises in stereo history: hear Cortina, see it, examine it at your local EICO dealer. Compare and judge critically for value. We believe you'll conclude with Popular Science "The EICO Cortina Series are low-cost audio components that look, and sound, like high-cost components."

SIMPLIFIED KIT ASSEMBLY — New EICO exclusive circuitry techniques make kit building easier, faster and more enjoyable. RF, IF and Multiplex circuitry of the tuner and receiver are all supplied completely pre-assembled and pre-aligned. Each channel of the amplifier and receiver uses 3 etched printed-circuit module boards.

NEW ULTRA-COMPACT BOOKSHELF SIZE COMPONENTS

"The compact dimensions and attractive styling appealed

to us. The Cortina 3070 represents a whole new trend away from "overblown" amplifiers which are much larger than need be. In fact, it is one of the very few we have seen which are actually suitable for bookshelf mounting." Hirsch-Houch Labs.

CORTINA TECHNICAL HIGHLIGHTS:

AMPLIFIER — Total Music Power: 70W into 4 ohms; 50W into 8 ohms. Harmonic Distortion: less than 0.6%. IM Distortion: less than 2% at full power. Hum & Noise: 72db below rated output. Frequency Response: ± 1.5 db 5Hz to 100kHz; ± 0.5 db 8Hz to 60kHz. Channel Separation: 40db. Size (HWD) 3 $\frac{1}{2}$ " x 12" x 7 $\frac{1}{2}$ ".

TUNER — Usable Sensitivity 1HF: 2.4 microvolts for 30db quieting. Channel Separation: 40db at 1kHz. Signal-to-Noise Ratio: 60 db. Capture Ratio: 4.5db. Image Rejection: 45db. Selectivity: 45 db. Audio Frequency Response: ± 1 db 20Hz to 15kHz. Size (HWD) 3 $\frac{1}{2}$ " x 12" x 7 $\frac{1}{2}$ ".

RECEIVER — Same as above Cortina Tuner and Amplifier. Size (HWD) 4 $\frac{1}{2}$ " x 16" x 9".



3570 FM Stereo Receiver



3070 70W Stereo Amplifier



3200 FM Stereo Tuner

EICO Electronic Instrument Co., Inc. PE-10
131-01 39th Avenue, Flushing, N. Y. 11352

- Tell me where I can have a free Cortina demonstration
 Send me free 36-page catalog on EICO's 200 "best-buy" products.

Name _____
Address _____
City _____
State _____ Zip _____

Cobra

new power!
new punch!
new performance!

This is CB's hottest line of performance-proven radios! Models for homes, offices, cars, trucks, boats. Perfect for business, professional people, farms, hobbyists. Makes work more efficient; makes life more fun. Full 5 watt input power and exclusive Dyna-Boost speech compression for 100% modulation—puts more sock in your talk!

Cobra
the "big 3" in CB!



1. Cobra CAM-88. Nothing finer. Double-conversion superhet receiver for extra sensitivity, greater selectivity. Completely self-contained; operates on all 23 channels. Dual-purpose S/Rf meter measures signal in, power out. Converts to 3 watt PA system. Works on 117 VAC and 12 VDC. \$214.95



2. Cobra V. All solid-state. Miniature size, walnut grained cabinet. Outstanding talk-power gets the message across. 5 crystal-controlled channels. All-weather performance through a wide temperature range. Operates on 12 VDC, negative ground.* Includes mountings, manual, FCC license application, high-impact ceramic microphone. \$99.95

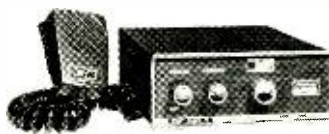

3. Cobra 23. All 23 channels with no extras to buy. All solid-state, including antenna switching—no relay contact failures. S/Rf meter measures signal in, power out. Top performance from Twin Pi output network. Handsome walnut-grain panel. Maximum talk-power; rugged dependability. Operates on 12 VDC, negative ground.* With all accessories, \$169.95

and introducing . . .

*OPTIONAL: PAC5 desk-top power supply converts Cobra V and Cobra 23 to 117 VAC, for base station service. \$29.95

Hear the difference know-how makes!
Write for the name of a Cobra distributor near you.



Division of Dynascan Corporation
1801 W. Belle Plaine, Chicago, Illinois 60613
Where Electronic Innovation Is A Way Of Life

CIRCLE NO. 5 ON READER SERVICE PAGE

COVER STORY TV SETS WITH 1" SCREENS—
OR, WHAT HATH THE IC BROUGHT?

By **LESLIE SOLOMON**
Technical Editor

YES, TV receivers are getting smaller . . . and smaller . . . and smaller. Way back in the post-World War II days of TV, the picture size of available sets was about 5 inches. If you wanted a larger picture, you simply bought a magnifying lens, stuck it in front of the screen, and sat back smugly satisfied. During the next few years, the size of the CRT started to grow and 5's became 7's, 9's became 15's, and 17's grew to 21's and 25's. At one point even a 27-incher was available, and, on top of that, large-screen projection TV came into being. Then, for a good many years, picture tubes stabilized at a nominal 21-inch plateau. However, there always were undercurrents in the set size area, with an occasional 9- or 11-incher (vacuum-tube powered) set breaking the surface—they weren't successful.

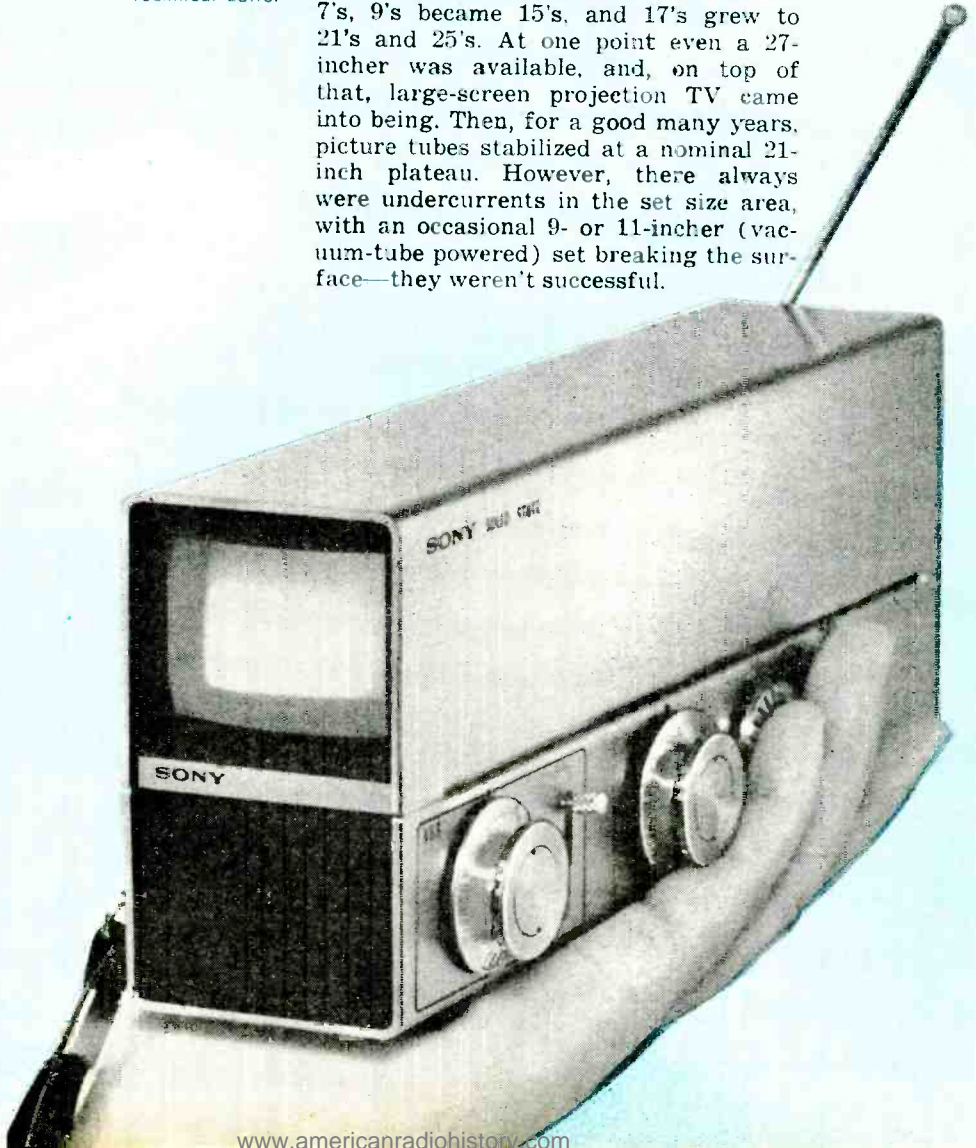

Then the transistor came to TV, the floodgates opened, and the size trend started to reverse. Solid-state circuitry meant portability, and portability necessitated reducing the size and weight of the picture tube. Suddenly, we were in the age of the small set and sizes rapidly dropped to 9", 7", and then down to 4" and 3". We were deluged with imported small-screen eye-strainers as recently as two years back. The circle was complete—but not to the 5" set where it all began. Sony (whose business philosophy has always been "think small") recently announced a 1" TV receiver—complete with magnifying lens!

Sony's Set. Shown on this month's cover, and on p. 31, Sony's 1-inch set is expected to go into production in a year or so and sell at a price estimated to be about \$200, with this price hopefully dropping with demand.

Fig. 1. The Motorola experimental 1" TV set does not use any IC's, yet isn't much larger than a pack of king-size cigarettes. The set has a 1" diameter electrostatic CRT, and the actual receiver occupies only 1.2 cubic inches! Four penlight cells supply necessary power and the earphone lead also acts as the antenna. Don't wait for this set . . . it's not going into production.

The tiny TV weighs almost 2 pounds (with batteries) and has about half the volume of a cigarette carton. The set will operate a couple of hours from an internal nickel-cadmium battery that can be recharged when the set is operated from the power line. The one-inch picture is slightly enlarged by a lens incorporated in a combined retractable hood and on/off switch. Pulling the hood forward automatically turns the set on.

Two tuners, one for VHF and the other for UHF are incorporated. Tuning on VHF is continuous rather than by the usual detent, while a switch alongside the VHF tuning control enables choice of high-or-low-band VHF. A collapsible monopole antenna is used for all reception and a small loudspeaker is mounted below the CRT.

The company declines to divulge any technical information on the set but merely claims the use of an unknown quantity of integrated circuits, with conventional transistors used elsewhere.

Motorola's Set. Sony is not the only company with an eye towards extra small-screen (1-inch) TV sets. Last year, the Advanced Engineering Laboratory of Motorola Consumer Products Division demonstrated its version of a 1-inch TV set, shown in Fig. 1. Although Motorola has no intention of marketing this set, they state that the circuit design has been made available to interested manufacturers.

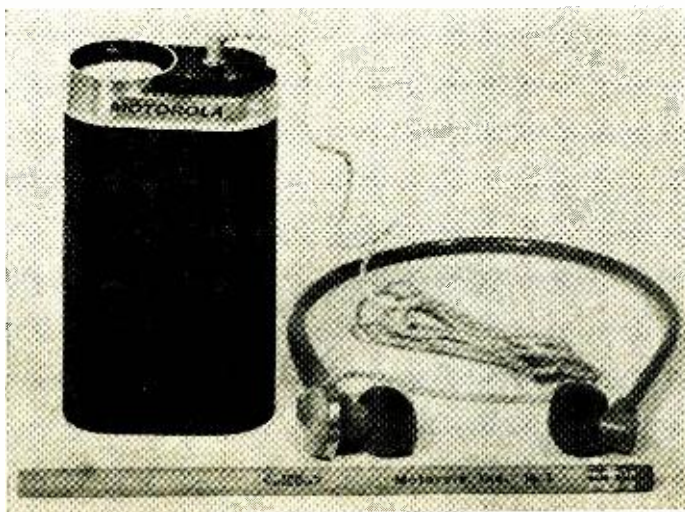

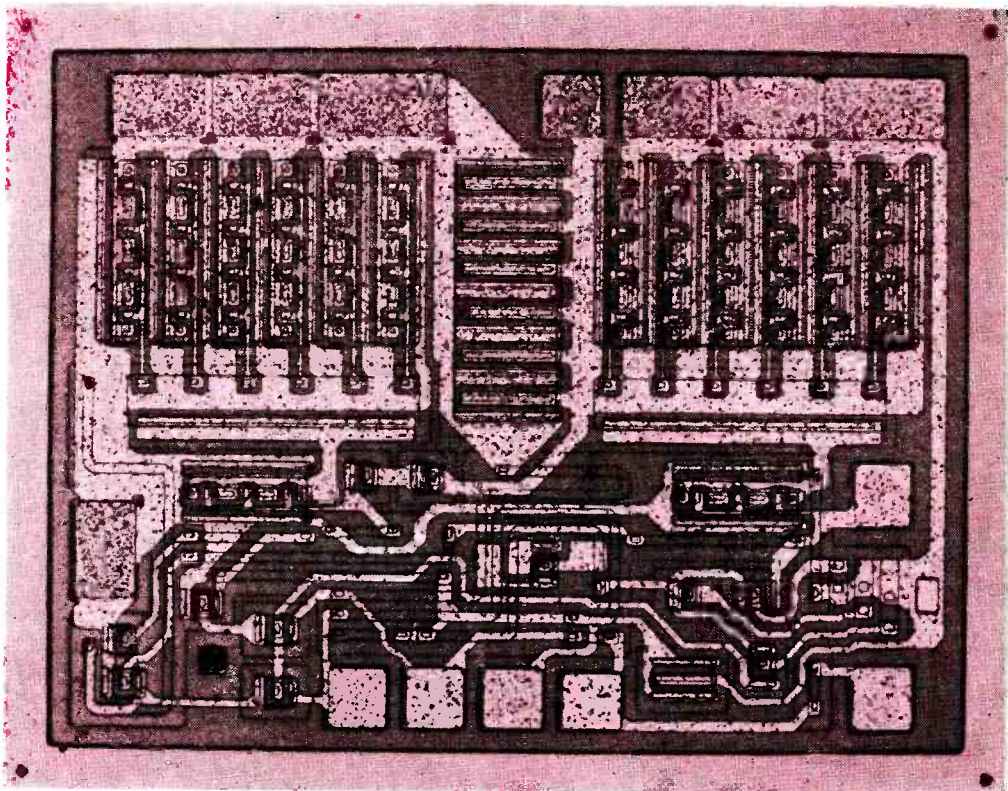

Because this 29-transistor, 14-diode receiver was designed and built in 1964, it does not use integrated circuits. It weighs only 12½ ounces and the entire unit occupies just 13 cubic inches of space.

The receiver circuits are mounted on a three-layer module occupying a total volume of 1.2 cubic inches. About half of the set's internal volume is taken up by the 1½-inch diameter, 4-inch long, electrostatically deflected CRT. One interesting feature of this set is that the ear-phone lead also doubles as the antenna.

Power for this tiny TV comes from four penlight cells driving a d.c.-d.c. converter that delivers the 11, 100, 275, 1200, and 3000 volts required for operation. To minimize any possible interference (caused by switching transients) between the voltage converter and the set's active circuits, the voltage converter switching frequency was made to be very close to the line scanning frequency (15,750 Hz).

These two units demonstrate the feasibility of the so-called "coat-pocket" TV receiver. Although the Motorola receiver

Shown above is a greatly enlarged view of a Motorola MC 1554, 1-watt IC chip. Having 10 transistors, 6 diodes, and 14 resistors, this chip will deliver 1 watt of audio output at 0.4% distortion and is "flat" to 300 kHz.

The rectangles at top right and left are the power output transistors. Oh, yes . . . this chip fits into a TO-5 can (0.3" diameter by 0.18" deep) with room to spare.

is made up entirely of discrete solid-state components, the present state-of-the-art of IC's has improved to the point where miniature TV sets like these can incorporate IC's for the bulk of their circuitry. This broad use of IC's will not make the TV sets any smaller, but it will make them easier—and possibly cheaper—to manufacture.

Integrated Circuits for TV. If you examine the schematic of a typical transistor TV set, you will note that no circuits, with the exception of the video amplifier,

sweep output stages, and possibly the audio amplifier, are required to produce a large voltage or power output.

During the past year, many new and improved linear IC's have made their appearance. Performance-wise, linear IC's do not differ greatly from similar circuits using discrete solid-state components. The major difference is, of course, size—up to 12 transistors, their associated resistors, and sometimes a few diodes, complete with all their interconnections, can be mounted within an ordinary TO-5 transistor can, or in an in-line package about half the size of a postage stamp. If you don't know the

powered from a two-transistor, six-diode voltage regulator. The specs are impressive. Using a 10-volt d.c. input, this IC produces a 4.5-MHz power gain of 75 dB, has an AM rejection of better than 50 dB, and develops about 0.2-volt of audio output.

Another IC manufacturer (Texas Instruments) has taken a different road to making a complete i.f. package. Instead of the monolithic IC system used by RCA and others, TI is making use of thick-film techniques to create its HC-1001 module. This 1/2-inch-square, 0.2-inch-high capsule contains the functional equivalent of 30 individual components

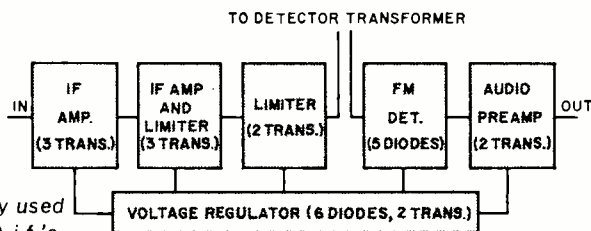

Fig. 2. This RCA IC is presently used in both FM and TV (sound) i.f.'s.

It now becomes possible to have a complete i.f. in a TO-5 can (except for tuned circuits). In the not-too-distant future, it is likely that the entire FM set (and the bulk of the TV set), will be found in one tiny can!

size of a TO-5 can—it is about 0.3-inch in diameter and 0.18-inch high.

Because of the extremely small size of an IC, stray capacitance is greatly reduced, making most linear IC's capable of operation (relatively "flat") from d.c. to the MHz region. All that the designer must do is couple the frequency-selective external components to the IC.

As an example of this compact circuitry, the RCA CA3013/14 IC, as used by several receiver manufacturers in FM i.f. circuitry (radio and TV), incorporates 12 transistors, 9 diodes, 3 diode capacitors, and resistors—all in a TO-5 transistor can. As shown in Fig. 2, this IC contains a three-transistor i.f. amplifier, another three-transistor i.f. amplifier and limiter, a two-transistor limiter, a five-diode FM detector, and a two-transistor audio preamplifier—and the entire IC is

and has an input sensitivity of 300 μ V, and an AM rejection of 35 dB. As shown in Fig. 3, the module contains a four-transistor i.f. amplifier, a two-diode FM detector, and a two-transistor audio pre-amplifier.

Still other IC manufacturers are announcing their entry into the linear IC for broadband amplification field. The two latest are Motorola with the MC1550 IC for video amplification, and General Electric with the PA189 i.f./discriminator, useful for both 4.5 and 10.7 MHz.

IC's In Actual Use. Several radio and TV manufacturers have produced AM and FM radios using IC's, and some are incorporating IC's in their present line of monochrome and color TV sets. At present, these IC's are being employed only in low-voltage input and output i.f. amplifiers (both video and audio), sync separation, a.f.c. circuits, chroma demodulators, etc. This low signal voltage requirement has been imposed because getting power or high-voltage output from an IC has been difficult.

When it is considered that a present-

day electromagnetically-scanned CRT requires several watts of yoke power to sweep both the horizontal and vertical axes, and needs up to 30-40 volts of video to effectively modulate the electron beam, one realizes how limited present IC's are. If electrostatically swept CRT's are considered, IC's simply cannot produce the necessarily large voltage swing to fully deflect the electron beam across the screen.

It is only within the past year or so that several manufacturers have been able to produce linear IC's having a capability of up to one watt output. Typical of these is the Motorola MC 1554 module that includes ten transistors, six diodes, and fourteen resistors in a TO-5 can; the d.c. voltage requirement is only 18

signed for other, non-TV purposes. Such voltage converters can presently be manufactured as small modules for easy insertion into a final cabinet. Although voltage needs may reach as high as 3 kV, current needs are modest (a few mA or so).

The second requirement is the development of small tuners, probably going away from the relatively bulky and complex mechanical detent switching in the larger sets to all-electronic tuning with some form of electronic variable capacitor (such as a varactor).

The Overall Picture. What will the price situation be? That depends on how well the tiny sets sell, plus the declining production cost of turning out the low-cost

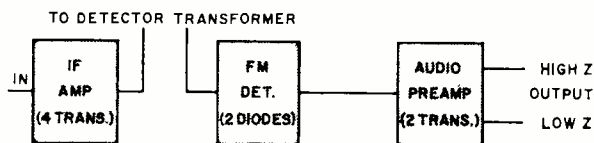

volts. And General Electric has a PA237 that can deliver one watt with a 12-volt d.c. supply, and two watts when the voltage is raised to 24 volts.

Two Requirements. Obviously, the first requirement is the development of a CRT that uses very little heater power. (Remember that heater power is wasted power and may represent over half the set's total consumption.) The CRT also must operate on a low value of yoke current to scan the screen in both the vertical and horizontal directions—this also means a physically smaller yoke, thus saving weight and size while simultaneously reducing the power-handling capability of the IC that would be used as the sweep amplifier. And finally, the CRT must be capable of complete control of the electron beam with only a few volts (peak-to-peak) applied to the beam control element—cathode or control grid, thus reducing the output voltage requirements for an IC used as the video amplifier.

The high voltages needed by a CRT are currently available from d.c.-to-d.c. voltage converters that have been de-

Fig. 3. The internal arrangement of Texas Instruments' thick-film, i.f. IC. It contains the functional equivalent of 30 discrete components in a package only 1/2" square by 0.2" thick! It also requires the use of external tuned circuits at the i.f. frequency.

IC's. As hundreds of IC's are automatically made at a time on a 1-inch diameter slice of silicon, the total yield per slice must be high to keep costs down. At present, the yield leaves a lot to be desired.

The small CRT's must also be reasonably economical to manufacture. Today, most glass factories are producing the big-money items—color TV tubes—and may be loath to create expensive production lines to turn out small CRT's that will frankly be a gamble.

Looking at the overall picture of the super-miniature IC TV set, there seems no doubt that it is destined for the future. If the miniaturization of other components—speakers, batteries, CRT's, controls, and switches—keep pace with the electronics, then the only limit to smallness will be the knobs!

How to get into One of the hottest money-making fields in electronics today— servicing two-way radios!



HE'S FLYING HIGH. Before he got his CIE training and FCC License, Ed Dulaney's only professional skill was as a commercial pilot engaged in crop dusting. Today he has his own two-way radio company, with seven full-time employees. "I am much better off financially, and really enjoy my work," he says. Read here how you can break into this profitable field.

More than 5 million two-way transmitters have skyrocketed the demand for service men and field, system, and R&D engineers. Topnotch licensed experts can earn \$12,000 a year or more. You can be your own boss, build your own company. And you don't need a college education to break in.

HOW WOULD YOU LIKE to start collecting your share of the big money being made in electronics today? To start earning \$5 to \$7 an hour... \$200 to \$300 a week... \$10,000 to \$15,000 a year?

Your best bet today, especially if you

don't have a college education, is probably in the field of two-way radio.

Two-way radio is booming. Today there are more than *five million* two-way transmitters for police cars, fire department vehicles, taxis, trucks, boats, planes, etc. and Citizen's Band uses—

and the number is still growing at the rate of 80,000 new transmitters per month.

This wildfire boom presents a solid gold opportunity for trained two-way radio service experts. Many of them are earning \$5,000 to \$10,000 a year *more* than the average radio-TV repair man.

Why You'll Earn Top Pay

One reason is that the United States Government doesn't permit anyone to service two-way radio systems unless he is *licensed* by the Federal Communications Commission. And there simply aren't enough licensed electronics experts to go around.

Another reason two-way radio men earn so much more than radio-TV service men is that they are needed more often and more desperately. A home radio or television set may need repair only once every year or two, and there's no real emergency when it does. But a two-way radio user must keep those transmitters operating at all times, and *must* have their frequency modulation and plate power input checked at regular intervals by licensed personnel to meet FCC requirements.

This means that the available licensed experts can "write their own ticket" when it comes to earnings. Some work by the hour and usually charge at least \$5.00 per hour, \$7.50 on evenings and Sundays, plus travel expenses. A more common arrangement is to be paid a monthly retainer fee by each customer. Although rates vary widely, this fixed charge might be \$20 a month for the base station and \$7.50 for each mobile station. A survey showed that one man can easily maintain at least 100 stations, averaging 15 base stations and 85 mobiles. This would add up to at least \$12,000 a year.

Be Your Own Boss

There are other advantages too. You can become your own boss—too entirely by yourself or gradually build your own fully staffed service company. Instead of being chained to a workbench, machine, or desk all day, you'll move around, see lots of action, rub shoulders with important police and fire officials and business executives who depend on two-way radio for their daily operations. You may even be tapped for a big job working for one of the two-way radio manufacturers in field service, factory quality control, or laboratory research and development.

How To Get Started

How do you break into the ranks of the big-money earners in two-way radio? This is probably the best way:

1. Without quitting your present job, learn enough about electronics fundamentals to pass the Government FCC Exam and get your Commercial FCC License.
2. Then get a job in a two-way radio service shop and "learn the ropes" of the business.
3. As soon as you've earned a reputation as an expert, there are several ways you can go. You can move *out* and start signing up and servicing your own customers. You might become a franchised service representative of a big manufacturer and then start getting into two-way radio sales, where one sales contract might net you \$5,000. Or you may even be invited to move *up* into a high-prestige



THIS COULD BE YOUR "TICKET" TO A GOOD LIVING. You must have a Commercial FCC License to service two-way radios. Two out of three men who take the FCC exam flunk it... but nine out of ten CIE graduates pass it the first time they try!

salaried job with one of the major manufacturers either in the plant or out in the field.

The first step—mastering the fundamentals of Electronics in your spare time and getting your FCC License—can be easier than you think.

Cleveland Institute of Electronics has been successfully teaching electronics by mail for over thirty years. Right at home, in your spare time, you learn electronics step by step. Our **AUTO-PROGRAMMED™** lessons and coaching by expert instructors make everything clear and easy, even for men who thought they were "poor learners." You'll learn not only the fundamentals that apply to all electronics design and servicing, but also the specific procedures for installing, troubleshooting, and maintaining two-way mobile equipment.

Get Your FCC License... or Your Money Back!

By the time you've finished your CIE course, you'll be able to pass the FCC License Exam with ease. Better than nine out of ten CIE-trained men pass the FCC Exam the first time they try, even though two out of three non-CIE men fail. This startling record of achievement makes possible the famous CIE

warranty: you'll pass the FCC Exam upon completion of your course or your tuition will be refunded in full.

Ed Dulaney is an outstanding example of the success possible through CIE training. Before he studied with CIE, Dulaney was a crop duster. Today he owns the Dulaney Communications Service, with seven people working for him repairing and manufacturing two-way equipment. Says Dulaney: "I found the CIE training thorough and the lessons easy to understand. No question about it—the CIE course was the best investment I ever made."

Find out more about how to get ahead in all fields of electronics, including two-way radio. Mail the bound-in postpaid reply card for two **FREE** books, "How To Get A Commercial FCC License" and "How To Succeed In Electronics." If card has been removed, just send us your name and address on a postcard.

ENROLL UNDER NEW G.I. BILL

All CIE courses are available under the new G.I. Bill. If you served on active duty since January 31, 1955, OR are in service now, check box on reply card for G.I. Bill information.

CIE Cleveland Institute of Electronics
1776 E. 17th St., Dept. PE-59, Cleveland, Ohio 44114

A Leader in Electronics Training... Since 1934 • Accredited Member National Home Study Council

CIRCLE NO. 8 ON READER SERVICE PAGE

BUILD THE "2 + 2" REMOTE VOLUME CONTROL

By LYMAN E. GREENLEE

...AND CONTROL AUDIO DEVICES
FROM UP TO 50 FEET AWAY

DO TV AND RADIO commercials irritate you? If so, you can build a remote volume control that will let you reduce or blank out the sound from up to 50 feet away, and the whole thing will cost about \$2 and require just 2 hours of work. With a remote volume control, you don't have to leave your easy chair or make an extra trip to the TV set when the telephone rings. Simply flip a switch or set a control.

The "2 + 2" remote volume control gets its name from the cost and construction time. Once built, it can be connected to your set in a matter of seconds and can be removed just as quickly. While connected and turned off, it has no detectable effect on the normal operation of the set, nor can it cause any damage or introduce hum.

Light-dependent resistor *LDR1* in the schematic diagram is the heart of the "2 + 2." It is optically close-coupled to a controlled intensity lamp (*I1*) that causes an increase or decrease in the resistance of *LDR1*. The intensity of the light is dependent on the amount of current flowing through *B1*, *R1* and *B2*, and it can be increased or decreased by varying the setting of *R1*. Any increase or decrease in the intensity of the light results in a corresponding decrease or increase in the resistance of *LDR1*.

Although *B1* and *B2* develop a total potential of 3 volts, there is little danger of burning open the 2-volt (#48) lamp since the maximum current through the circuit is limited by the d.c. resistance of the 50'-long twin-line cable connecting *B1* and *B2* to *I1*.

To use the "2 + 2" remote volume

control in your TV set, radio, or phonograph amplifier, simply clip one of the leads from *LDR1* to the wiper lug and the other to the signal ground lug of the set's volume control. With the "2 + 2" turned off, adjust the set's volume control for the desired maximum loudness. Then operating the "2 + 2" will reduce the volume from this point.

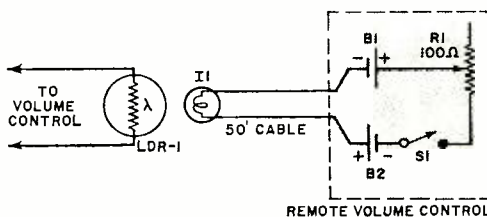

Lamp *I1* and light-dependent resistor *LDR1* must be mounted in light-tight box. Parts in shaded area are contained in separate box at remote location.

The batteries, switch and potentiometer can be mounted in any convenient size box. However, *LDR1* and *I1* should be hooked in a small i.f. transformer can to take up as little space as possible and facilitate easy sealing with tar or pitch to exclude outside light.

The bottom of the transformer can should be cut to make the can about 1 3/8" long, but leave enough metal to provide a pair of 1/4" tabs on opposite sides (bottom) of the can. Mount *LDR1* on a 1" x 3/4" piece of phenolic board, set it at the bottom of the transformer can, and fold the tabs over to hold it in place. If necessary, enlarge the hole in the top of the can, and mount *I1* and a 3/4" rubber grommet here. Finally, seal the can. ~~50-~~

BUILD A

HART-65 TRANSMITTER



CLOSE TO THE
LEGAL LIMIT
NOVICE HAM TRANSMITTER
CAN BE BUILT
FOR 80 AND 40
USING ONLY ONE TUBE

By **HARTLAND B. SMITH**, W8VVD

OVER TWELVE YEARS AGO, the author wrote about a Novice transmitter with an input of 22-26 watts which cost about \$20 to build.* Several months ago a 1967 version of this single-tube transmitter was constructed. Through the use of a modern tube, the power input can be raised to 65 watts—but the construction cost remains just about the same—\$20! Here is a Novice transmitter for 40 or 80 meters that is easy to build and provides just about the “mostest” for the very “leastest” investment.

*POPULAR ELECTRONICS, April, 1955. “The Hart-25,” page 30.

The "HART-65" was carefully constructed to minimize television interference (TVI). All r.f. carrying components, with the exception of the crystal, are shielded within an aluminum box. The key and power leads are bypassed to confine stray r.f. inside the case. A high-C pi-network r.f. plate circuit discriminates against harmonics that want to escape up the antenna feed line. In the unlikely event that a herringbone does appear on your family's favorite TV channel, a coaxial cable and low-pass filter can be connected between the transmitter and the antenna.

How It Works. The transmitter circuit is shown in Fig. 1. The tube, a 6HB5, was designed to be a TV horizontal amplifier, but it is also a highly efficient r.f. generator. A 3.5-MHz crystal is required for 80-meter operation and a 7-MHz crystal for 40-meter work. Pilot lamp *I1* indicates the r.f. current passing through the crystal. The brighter the bulb, the greater the current. Since too much r.f. energy will overheat the crystal, or pos-

sibly fracture it, trimmer *C1* has been included to provide a means of adjusting crystal current to a safe level.

The d.c. voltage to the plate of *V1* passes through an r.f. choke, *RFC2*, and any r.f. is blocked. However, the r.f. is passed by *C4* to *L1* and then on to output connector *J1*. Components *C5*, *L1*, and *C6* form a pi-network load and antenna circuit which can be tuned to the operating frequency. All of *L1* is used for 80 meters, while a portion of the coil is shorted by *S1* when 40-meter operation is desired. The output capacitor, *C6*, is adjusted to match the transmitter to a low impedance feed line. Capacitors *C7* and *C8* can be switched across *C6* to extend its impedance-matching range.

Although a telegraph key could have been wired directly in series with the cathode of *V1*, this arrangement was not used because it would have allowed a very dangerous 700 volts to appear across the exposed key terminals. Instead, 6.3 volts from the power transformer is applied to the coil of relay *K1* by the telegraph key. The relay, in turn, keys the

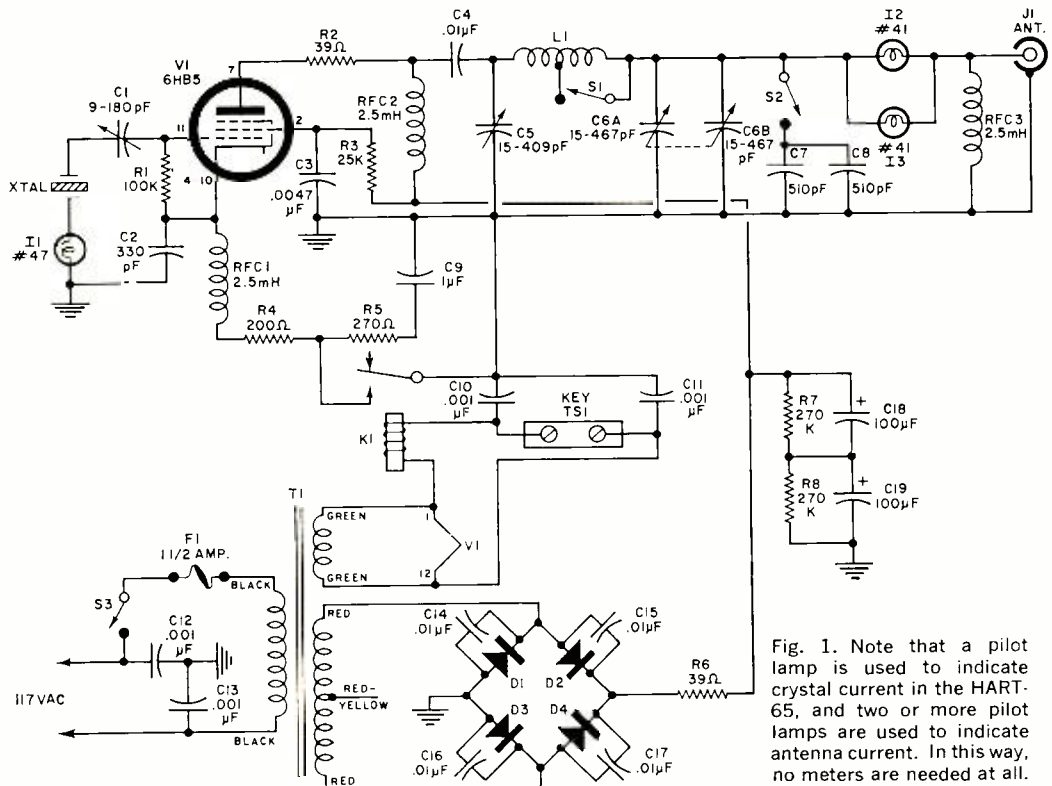

Fig. 1. Note that a pilot lamp is used to indicate crystal current in the HART-65, and two or more pilot lamps are used to indicate antenna current. In this way, no meters are needed at all.

transmitter. This arrangement keeps high voltage inside the transmitter, where it is less likely to attack a careless operator.

A built-in keying filter consisting of R5 and C9 minimizes key clicks to prevent undesirable interference to other fellows operating near your frequency.

Safety is one of the most important features of this unit. When the transmitter is properly buttoned up, there are no exposed high-voltage points to shock the unwary. Even across the key terminals,

a danger spot overlooked in many transmitters, the voltage is only 6.3 volts.

Choke RFC3, connected between J1 and the chassis, provides a d.c. path that will immediately blow the 1½-ampere line fuse, F1, should plate blocking capacitor C4 fail, thus preventing a deadly voltage from ever appearing on the antenna or its feeder.

Since the HART-65 is strictly a CW rig, its power transformer need only supply plate current during the short intervals when the key is depressed. Between dots and dashes, as well as during standby periods, the transformer loafs along, merely furnishing a little heater power to the 6HB5. The intermittent nature of CW operation makes it possible to draw much more than rated transformer current under "key down" conditions without causing the transformer to overheat. Thus, a relatively small, low-cost transformer can be used.

A bridge rectifier utilizing the entire T1 secondary, rather than half, as is the case with an ordinary center-tapped full-wave circuit, doubles the available d.c. voltage. Disc capacitors C14 through C17 in parallel with diodes D1 through D4 absorb stray voltage spikes which might otherwise ride in on the power line and destroy the diodes. In addition, the capacitors also bypass r.f. around the diodes to produce a clean signal in the shack. Without C14 through C17, if you used your receiver as a monitor, the signal would sound disturbingly rough, even though it would be clear as a bell at a distance.

Resistor R6 prevents a high current surge from ruining the diodes at the instant C18 and C19 first charge up when the a.c. power is switched on. Two filter capacitors in series are needed to withstand the "key up" voltage of the power supply. Equalizing resistors R7 and R8 divide the voltage drops across C18 and C19 so that one capacitor is not subjected to a significantly greater voltage than the other. These resistors also serve as bleeders to slowly discharge the capacitors after the power supply is switched off.

No plate meter is included in the transmitter. If the transformer specified in the Parts List is used, the input to V1 will be between 60 and 70 watts, safely below the 75-watt Novice limit, when the

PARTS LIST

- C1—9-180 pF mica trimmer capacitor (Allied Radio 43 A 3513, or similar)
 C2—330-pF mica capacitor
 C3—0.0047-μF disc ceramic capacitor
 C4, C14, C15, C16, C17—0.01-μF, 1000-volt disc ceramic capacitor
 C5—15-409 pF variable capacitor (Allied Radio 43 A 3524, or similar)
 C6—15.5-467.8 pF two-gang variable capacitor (Allied Radio 43 A 3528, or similar)
 C7, C8—510-pF mica capacitor (Aerovox 1404, or similar)
 C9—1-μF, 600-volt paper capacitor
 C10, C11, C12, C13—0.001-μF disc ceramic capacitor
 C18, C19—100-μF, 350-volt electrolytic capacitor
 D1, D2, D3, D4—750-mA, 1200-PIV silicon diode rectifier
 F1—1½-amp fuse (3AG)
 I1—#47 pilot lamp
 I2, I3—#41 pilot lamp
 J1—SO-239 coaxial chassis connector
 K1—S.p.d.t. relay, 6.3-volt a.c. coil (Potter & Brumfield KA5AV-6AC, or similar)
 L1—22¾ turns of #20 wire, 1" diameter, 1¾" long, tapped 7 turns from C6 end (Barker & Williamson 3015 Miniductor, or similar)
 R1—100,000-ohm, ½-watt resistor
 R2, R6—39-ohm, 2-watt carbon resistor
 R3—25,000-ohm, 12-watt wire-wound resistor
 R4—200-ohm, 5-watt wire-wound resistor
 R5—270-ohm, ½-watt resistor
 R7, R8—270,000-ohm, 2-watt resistor
 RFC1, RFC2, RFC3—2.5-mH, 125-mA r.f. choke (National R-50, or similar)
 S1, S2, S3—S.p.s.t. slide switch
 T1—Power transformer: primary, 117 volts, a.c.; secondary, 480 volts, CT @ 70 mA, and 6.3 volts @ 3 amperes (Allied Radio 54 A 1463, or similar)
 TS1—2-screw terminal strip
 V1—6HB5 tube
 XTAL—See text
 1—10" x 6" x 3½" aluminum box (Bud CU-2110A, or similar)
 Misc.—Fuse clip; compactron tube socket (ceramic); 1-terminal insulated tie point; 2-terminal insulated tie strips (3); 4-terminal insulated tie strips (4); crystal socket, 0.095"-diameter pins, 0.487" spacing; ½" spacers for #6 screws (3); ⅜" to ¼" shaft extender (Allied Radio 47 A 1109, or similar); knobs (2); grommets, ½" mounting hole, ⅜" i.d. (6); grommet, ¼" mounting hole, 11/32" o.d.; 4-36 and 6-32 machine screws and nuts; line cord; plug; decals; wire; solder.

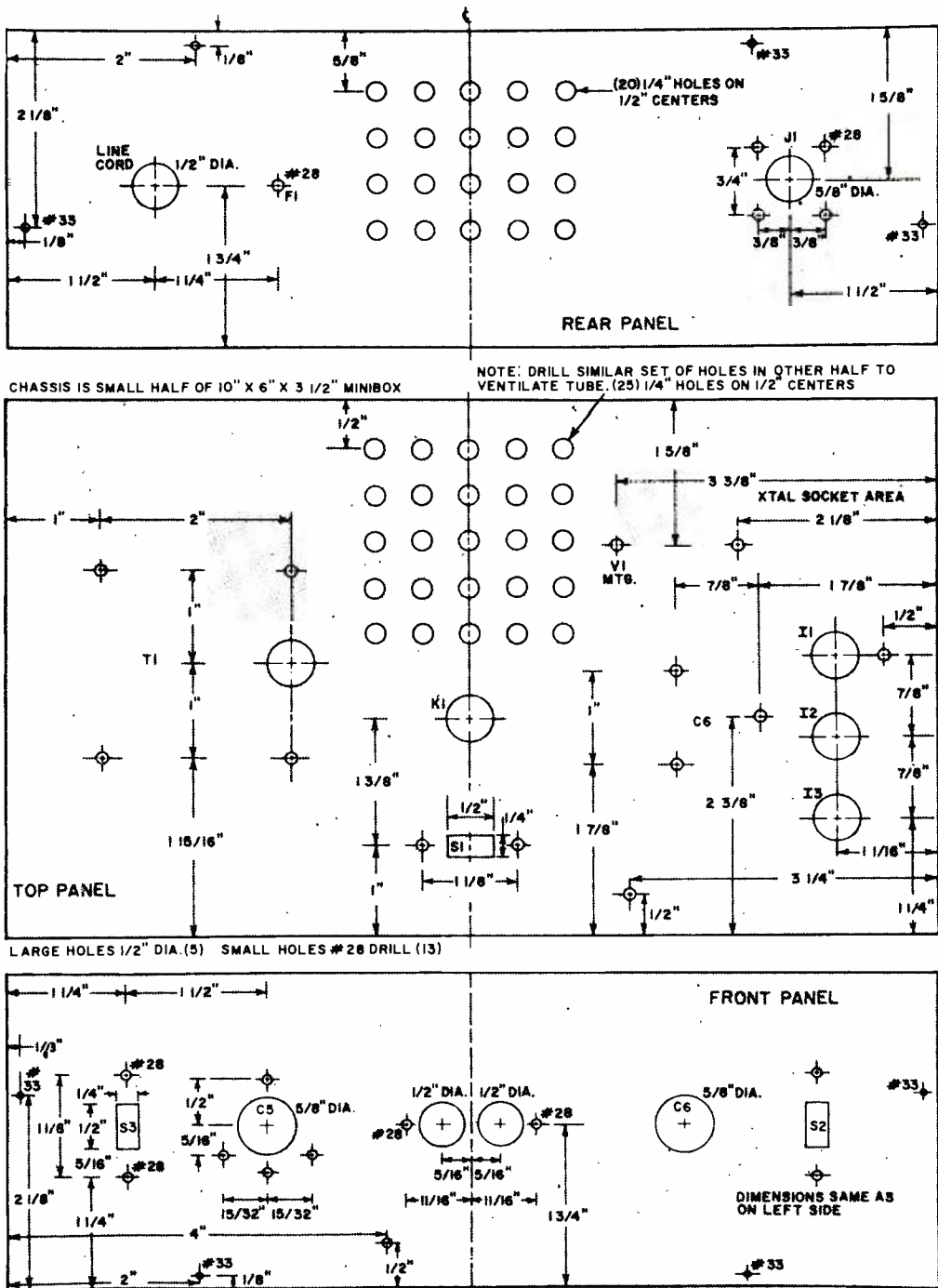

Fig. 2. Drilling specifications for the chassis. The three photos on the opposite page show the various holes and the location of all parts. Don't forget to drill 25 holes in the other half of the chassis, directly opposite the holes on the top panel. Crystal socket holes are drilled as required.

Top view of finished transmitter (right). Visible here are the top and rear panels with mounted components. In this transmitter, only the power transformer and crystal are mounted outside the chassis. Note that the three indicator lamps are mounted in ordinary rubber grommets fitted into drilled holes.

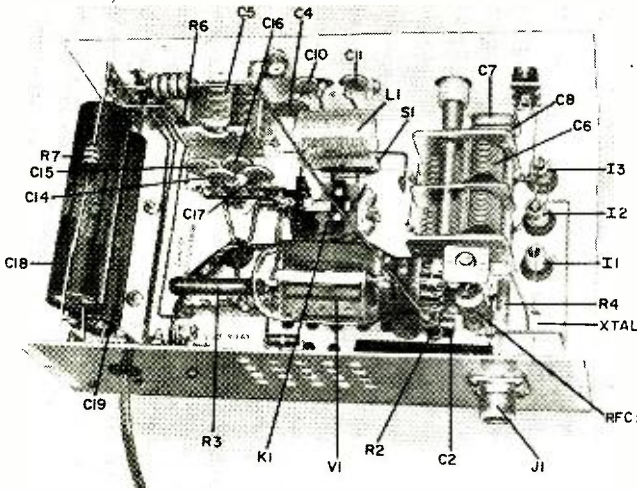
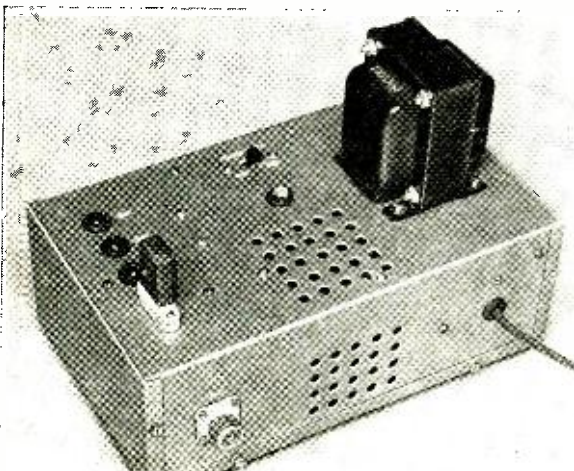
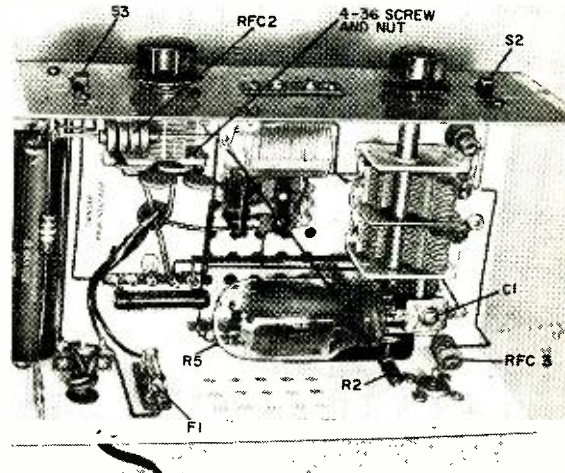

Fig. 3 (left and below). Views of the interior of the transmitter. Mounting details of certain components are shown enlarged on pages 46 and 47. Once the other half of the box is secured in place, the entire transmitter is shielded, and all high voltages are safe from accidental contact.

rig is tuned for maximum output as indicated by *I2* and *I3*.

Construction. A 10" x 6" x 3½" metal box serves as both cabinet and chassis for the transmitter. Major dimensions are shown in Fig. 2, while the photos on p. 41 and below show what the final unit looks like. A few of the small holes required for mounting the insulated tie strips have been omitted from the drawing because their exact positions will depend on the configuration of the mounting holes of the tie strips you buy. The crystal socket holes are also missing for the same reason.

It is very important that you drill all of the ¼"-ventilation holes visible in the



October, 1967

photos and called out in Fig. 2. Otherwise, the considerable amount of heat generated by *V1* will be trapped within the chassis. Four rubber feet, at least ¼" thick, should be fastened to the bottom of the box so that it will clear the operating table sufficiently for air to circulate easily through 25 holes drilled in the bottom directly beneath the tube.

Indicator lamps *I1*, *I2*, and *I3* require no sockets. They are merely pressed into ½" grommets with ⅜" holes just far enough to assure a good friction grip (see photos). Appropriate leads are then soldered to the bases and tips of the bulbs.

Since relay *K1* is rather noisy, shock-mount it to prevent the chassis from act-

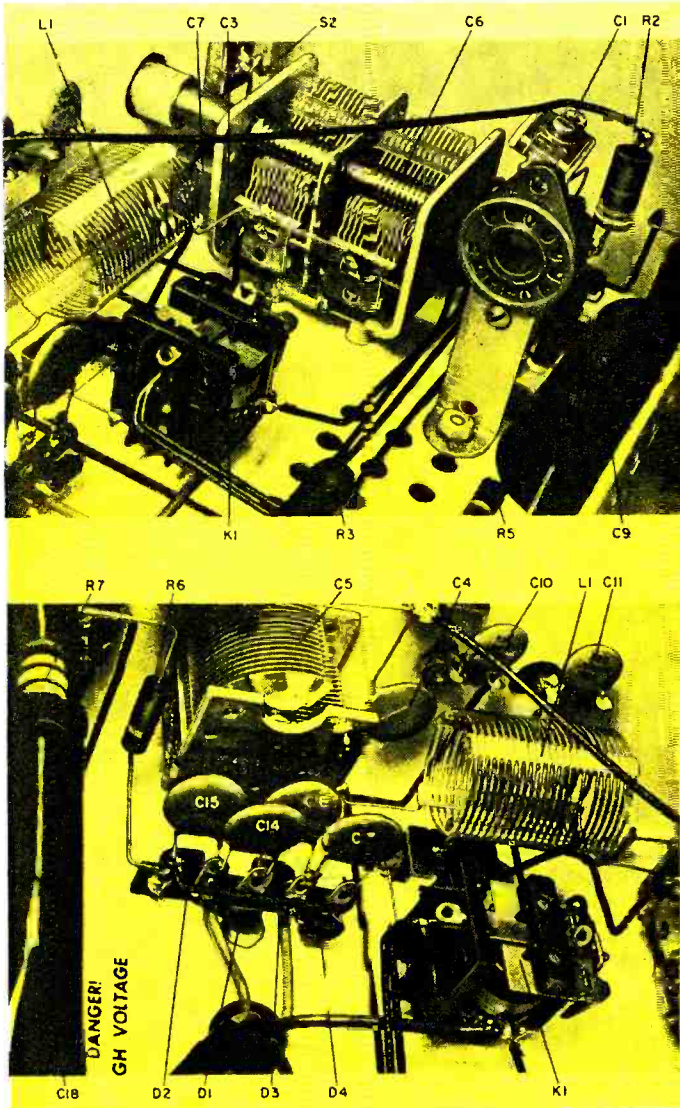

Fig. 4. Details of vacuum tube L-bracket (top) and rectifier and bypass capacitor mounting (bottom). The bracket is a narrow piece of scrap aluminum bent into an L-shape as shown with the vertical section about $1\frac{1}{2}$ " long; mount the socket so that pin 4 faces the chassis. Also clearly shown in lower photo are the 4-36 screw and nut that prevents the rotor of C5 from opening fully to avoid accidental operation on 20 meters. Note method of "countersinking" L1's turns on both sides of tapped turn.

ing as a sounding board. In the prototype, the positioning lug on the base of the relay was cut off. Then, a $\frac{1}{4}$ " grommet was slipped over the 6-32 mounting bolt. This grommet was inserted in the $\frac{3}{8}$ " hole of a $\frac{1}{2}$ " grommet. A washer was placed over the short portion of the mounting bolt protruding above the chassis and the relay was secured in place with a 6-32 nut. These mounting details can be clearly seen in the photos between the *Band Switch* and ventilation holes on the top of the unit. An even quieter mount can be achieved by epoxy-cementing a 1"-square chunk of plastic sponge to the underside of the chassis

and then epoxying the relay to the sponge.

Details of the underside of the chassis are shown in Fig. 3. Before mounting C6, remove and discard the trimmer adjusting screws, mica insulation, and trimmer plates located on the side of the capacitor. Since C6 has a $\frac{3}{8}$ " shaft, a $\frac{3}{8}$ "-to- $\frac{1}{4}$ " shaft extender is required to adapt it for a knob having a $\frac{1}{4}$ " hole. Fasten the capacitor to the chassis using $3\frac{5}{8}$ " long, 6-32 screws that pass through $\frac{1}{2}$ " spacers and then into tapped holes in the bottom of the capacitor frame.

Attach C5 to the front panel with three $\frac{1}{4}$ " x 6-32 screws that have been cut down until they are long enough to hold

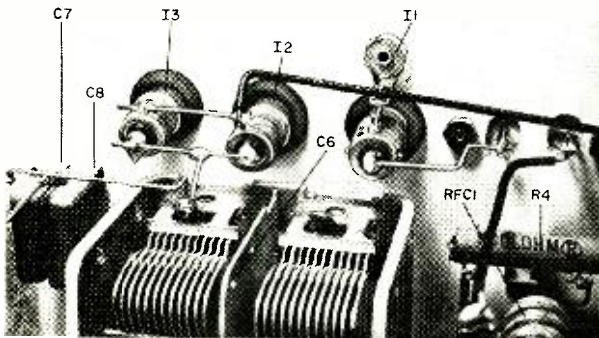

The three bulbs are press-fitted into ordinary rubber grommets. The crystal is mounted adjacent to I1. Note that I2 and I3 are connected in parallel.

the capacitor, but not so long that they extend through the frame far enough to touch the rotor. There are five holes in the rear of C5's frame. Fasten a 4-36 screw in the upper right hole, as shown in Fig. 3, to prevent the rotor from opening fully. This action restricts the tuning range of the capacitor and will prevent you from accidentally resonating the transmitter at 20 meters when you're tuning up on 40.

Support V1's socket on an L-bracket approximately 1½" high, as shown in Fig. 4, with the pin-4 side towards the

chassis. When V1 is plugged into the socket, the envelope of the tube should clear the bottom cover of the chassis by approximately ¼".

Wiring. After mounting the major components, start wiring the power supply section. The red-yellow center tap of T1 is not used. Snip it short and insulate the stub with electrical tape. When soldering diodes D1 through D4, grip their leads with long-nosed pliers to drain away excessive heat.

While wiring K1, TS1 and S1, keep in mind that you must leave room for L1, which will be installed after the balance of the circuit has been completed. Before installing L1, bend the turns on either side of the tapping point inward so that there will be plenty of clearance to prevent a blob of solder from creating an unwanted short.

Cut the leads of R2 very short and solder the resistor directly to pin 7 of V1. A wire about 6" long can then be run diagonally across the chassis from the other end of R2 to a one-terminal tie point supporting the junction of RFC2 and C4. (See Fig. 3.)

Resistor R1 is connected between pin 11 and pin 4 of V1's socket; C2 goes from pin 4 to a ground lug under the mounting nut that holds V1's socket to the L-bracket; C3 runs between pin 2 and the same ground lug; and RFC1 goes from pin 10 to a two-terminal tie strip which also supports R4.

Solder the terminal of C1 which is part of the capacitor's movable plate directly to pin 11. Run a wire from the other end of C1 to the crystal socket.

When you have completed the overall wiring, apply the following words in a prominent spot on the underside of the chassis: "DANGER! HIGH VOLTAGE. CLOSE RELAY. SHORT B PLUS." These will remind you that after pulling the a.c. plug you should close the relay momentarily with an insulated prod to discharge C9 and you should ground the positive end of C18 with a shorting stick or the blade of a screwdriver with an insulated handle before working on any below-chassis component. *Don't neglect these warnings.* The bleeder on C18 and C19 works quite slowly, and C9 can hold a nasty charge for several days!

(Continued on page 99)

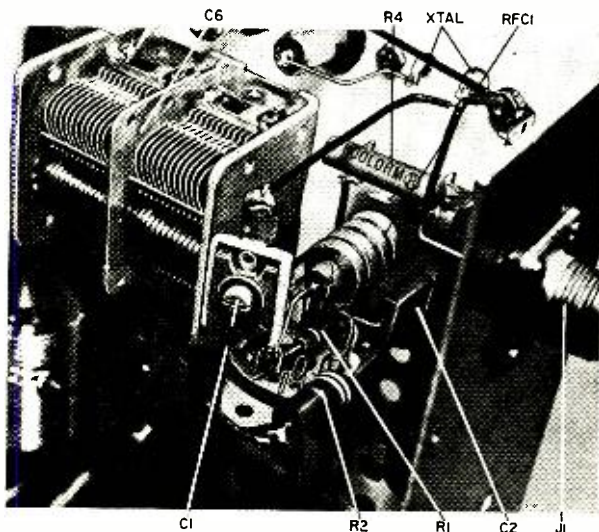

Details of the area around the tube socket. Trimmer C1 adjusts crystal current as indicated on lamp I1. Antenna output connector J1 is on the right panel.

SIGNAL - POWERED SIGNAL SQUARER

THIS INEXPENSIVE ADDITION TO A SINE-WAVE GENERATOR
 PRODUCES FAST RISE-TIME
 SQUARE WAVES OF THE SAME FREQUENCY

By **LESLIE SOLOMON**, Technical Editor

MOST EXPERIMENTERS either have, or have access to, conventional audio frequency sine-wave generators. However, there may come a time when you are finishing some project and the instructions call for the use of a square-wave signal—but you don't have a square-wave generator! After being hit this way a couple of times, the author decided to either buy a composite sine/square wave generator, or cook up some circuit that could be used with an existing sine-wave source. The result is shown in the diagram below.

The circuit is a conventional two-transistor Schmitt trigger having a built-in

power supply with both signal and a.c. power derived from the output signal of the audio generator. Operation of the Schmitt trigger is such that the frequency of the output square wave is the same as the frequency of the incoming sine wave. Unlike a bistable multivibrator, commonly used in squaring circuits, the Schmitt circuit does not divide the frequency by two. Also, rise time is excellent.

Input signal requirements are rather broad. The circuit will accept almost any source of a.c. between 50 and 15,000 Hz. with a voltage level between 0.5 and 10 volts r.m.s. Output signal level is a function of input signal level.

Component values are not critical and may vary broadly from those shown in the schematic. If *n*p*n* transistors are used, reverse the polarity of the rectifier diodes and the electrolytic capacitors. In fact, a little experimentation with various values of resistors and capacitors will teach you a lot about Schmitt trigger operation. The rectifier diodes can be any type, of almost any voltage or current ratings, that you happen to have on hand.

Mounting is up to the builder. Several units have been made, ranging from small PC boards that can be directly plugged into the output jacks of the sine-wave generator to perforated board projects that are mounted within the generator and provided with separate output terminals.

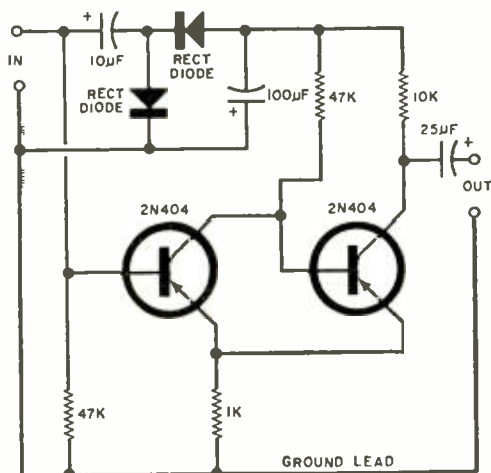

The incoming sine waves play a dual role: they trigger the Schmitt circuit and supply d.c. power.

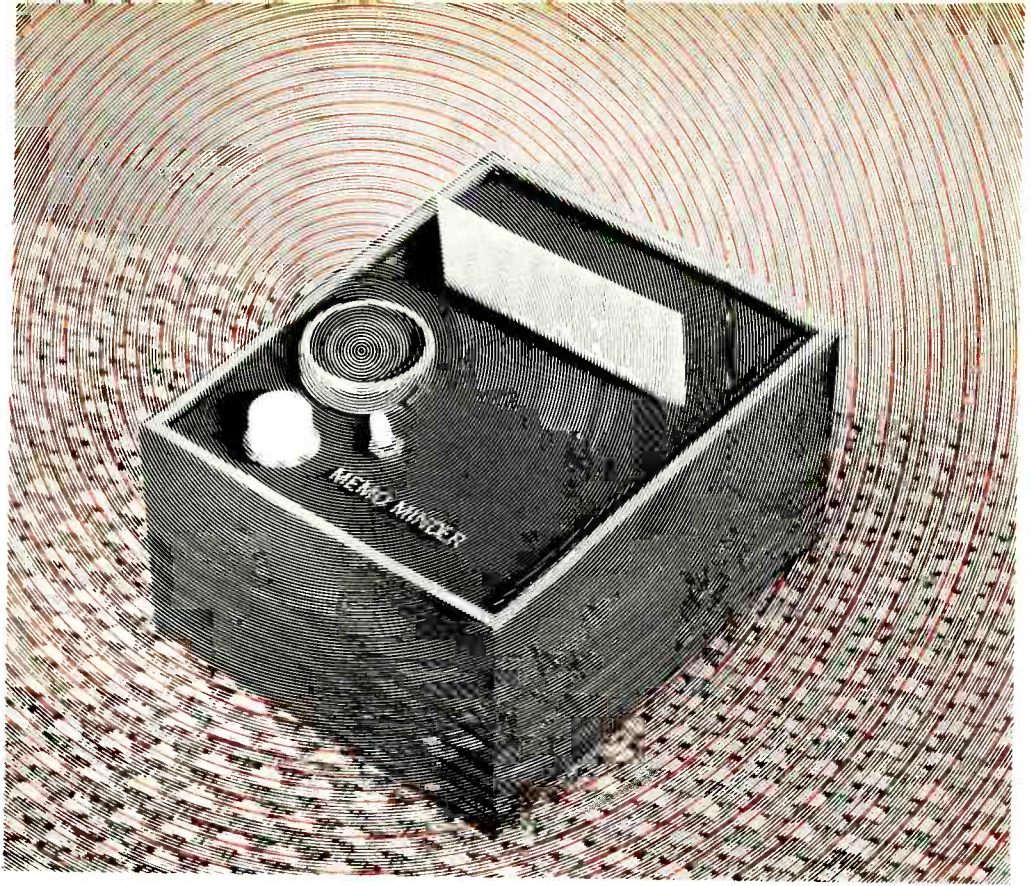

BUILD YOUR OWN **MEMO MINDER**

URGENT NOTES AND TELEPHONE MESSAGES
MAKE THEMSELVES KNOWN

By **R. PERSING***

COVER STORY

WHAT EXCUSE does your wife give when that important phone message—which arrived just after you left—goes unseen and unanswered? Was the message plainly visible, or hidden under some old newspapers? Did your wife forget to hang it on your tackboard or message clip? If you have this problem—and what family doesn't—the "Memo Minder" is for you!

To leave a short written message, simply write it on a 3" x 5" card and drop it into the slot of the Memo Minder. Automatically, the Memo Minder senses the presence of the message and a bright lamp starts flashing at a rate of about once-per-second. The lamp will keep flashing as long as the card is in the message slot, and only when the card is removed will the Memo Minder go back to sleep.

If you're not likely to see the flashing light, the recipient of the message can turn on a Sonalert alarm—its insistent

*RCA Laboratories, Princeton, N. J.

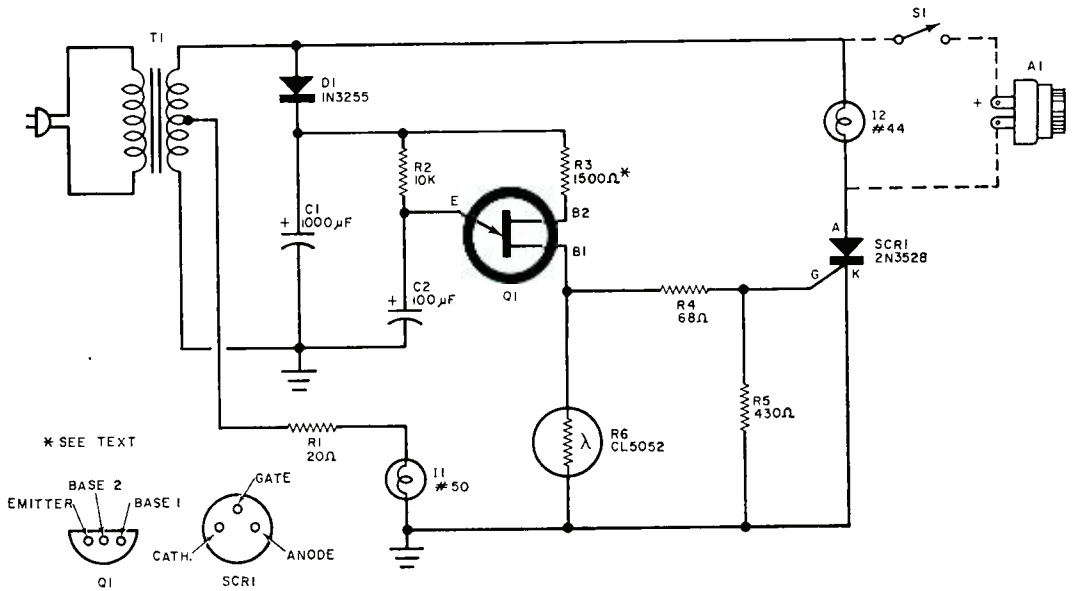

Fig. 1. When R6 is shielded from the light by an opaque card, the unijunction-SCR-bulb I2 circuit operates once per second. Without a message in the slot, the circuit shuts itself off and remains on standby.

beeping is guaranteed to attract your attention. Although the Memo Minder is always plugged into the a.c. power line, its current consumption is negligible.

How It Works. As shown in Fig. 1, the Memo Minder consists of two interlocking circuits: a unijunction transistor oscillator that automatically turns on when a message card is placed in the slot, and produces a one-per-second trigger signal; and an SCR and lamp combination that generates the actual message alert indication.

Unijunction transistor *Q1* is used as a relaxation oscillator. When d.c. power is applied to the circuit, capacitor *C2* charges up through resistor *R2* until it reaches the firing voltage of *Q1*. At this point, the normally reverse-biased emitter junction becomes forward-biased, thus presenting a low impedance between the emitter and base-1. Capacitor *C2* then discharges through the transistor and the series combination of *R4* and *R5*. The positive-going pulse generated at the junction of *R4* and *R5* is applied to the gate of *SCR1* to turn it on.

Once *C2* discharges, the emitter of *Q1* is again reverse-biased, and *C2* begins charging again through *R2*. The time

constant of *C2-R2* is set so that one pulse occurs each second. This eventually becomes the blinking rate for the message alert indicator lamp (*I2*). If a slower rate is desired, the value of *C2* can be increased. Conversely, if you want to speed up the blinking rate, decrease the value of *C2*.

Connected in parallel with the *R4-R5* combination is light-sensitive resistor *R6*. The property of *R6* is such that when its face is illuminated, its resistance drops to a very low value, and conversely,

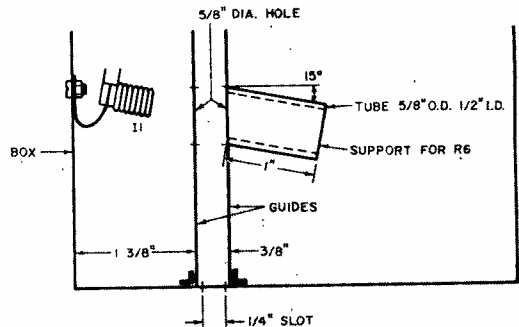

Fig. 2. Construction details for the message detector. The plastic tube for R6 is cemented to one guide, then both guides are cemented to the chassis.

PARTS LIST

A1—Audible alarm such as Mallory Sonalert SC628A (optional)
C1—1000- μ F, 25-volt electrolytic capacitor
C2—100- μ F, 15-volt electrolytic capacitor
D1—1N3255 diode
I1—#50 lamp
I2—#44 lamp
Q1—Unijunction transistor (Texas Instruments T1S43)
R1—20-ohm, $\frac{1}{2}$ -watt resistor
R2—10,000-ohm, $\frac{1}{2}$ -watt resistor
R3—1500-ohm, $\frac{1}{2}$ -watt resistor (nominal value—see text)
R4—68-ohm, $\frac{1}{2}$ -watt resistor
R5—430-ohm, $\frac{1}{2}$ -watt resistor
R6—Photoresistor (Clairx CL505L photocell)
S1—S.p.s.t. switch (optional)
SCR1—2N3528 silicon-controlled rectifier (RCA)
T1—Power transformer; primary, 117 volts; secondary, 12 volts CT
1—3" x 4" x 5" metal box
Misc.—Line cord, $\frac{1}{2}$ " inside-diameter plastic tube, sockets for I1 and I2 (see text), material for paper guides, flat black paint, vector board, screws, glue, etc.

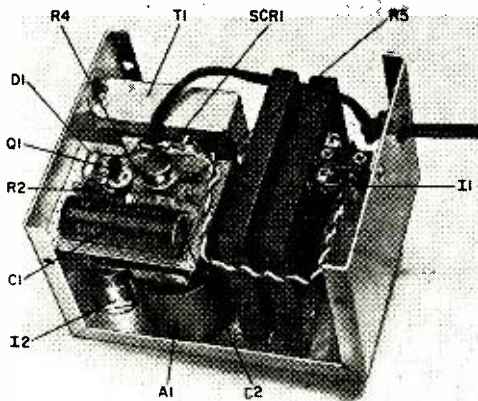

Fig. 3. The perforated circuit board is secured to the side of the chassis with a small L-bracket. Resistor R1 is mounted directly on bulb I1's socket.

when dark, its resistance is very high. When R6 is in the dark, as would be the case when a message card is in the Memo Minder, essentially it does not influence the circuit and the transistor oscillates normally. However, with no message in the Memo Minder, R6 is illuminated by I1, reducing its resistance, and the total base-1 to ground resistance, to a very low value. With the circuit in this state, R2 supplies just enough current to the emitter junction to prevent Q1 from returning to its reverse-biased emitter-base-1 state necessary for continued oscillation.

Resistor R3 in the base-2 leg of Q1

may require a slight alteration in value to compensate the circuit for the particular unijunction transistor and SCR used. This adjustment will be described later.

Lamp I1 is supplied with power through dropping resistor R1, which produces about 4 volts across the normally 7.5-volt bulb. Although the light output is reduced, it is still sufficient to operate R6, and bulb life is greatly extended.

Message indicator lamp I2 is connected in series with SCR1 across the 12-volt a.c. supply. To make the lamp glow, the SCR must be turned on. This is accomplished by supplying the SCR gate electrode with a positive-going pulse (with respect to its cathode) during the part of the a.c. sine wave when the SCR anode is supplied with a positive voltage. The gate is generated, as previously described, across R5.

Once the SCR is gated on, it will remain on until the a.c. waveform on its anode passes through zero (as occurs during each cycle of the power line sine wave). As the gate pulse is longer than the a.c. cycle, the SCR will turn on and off at a 60-Hz rate for the duration of the gate pulse, but this will have no noticeable effect on the bulb operation. When the gate pulse stops, the next time that the anode alternation passes through zero, the SCR automatically shuts itself off, and remains off until the gate pulse is re-introduced.

Construction. Begin construction by preparing two paper guides, which can be made from plastic, metal, or any other suitable material. The author used the cover from a plastic box for each of the guides, with the rim of each cover providing a convenient means for mounting. Although dimensions are not critical, those indicated in Fig. 2 should be adhered to as closely as possible. The plastic tube used to house photoresistor R6 is glued to one paper guide and tilted at an angle of approximately 15 degrees to minimize the effect of stray room light. The photoresistor is very sensitive and any light reflected onto it will cause the flasher to stop even when there is a piece of paper in the slot.

Once the guides are cut to size, holes drilled for bulb I1 and the tube, and provisions made for mounting them in

(Continued on page 102)

ELECTRONIC SWITCHING QUIZ

In the circuits shown below (1-8), the position of each switch can cause all, one or more, or none of the lamps to light. Exactly what happens can be completely specified by selecting one statement (A-L) from each of the four sets of switch positions listed. Lamps are considered as "on" when lit to any degree of brightness. Find the four statements that describe the behavior of each circuit under all switching conditions, and insert the four letters corresponding to the applicable statements in the spaces provided.

By **ROBERT P. BALIN**

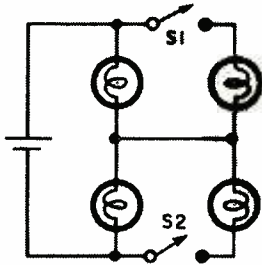

1. _____

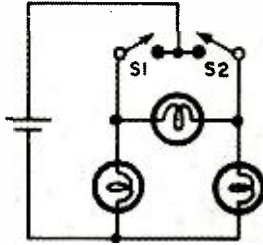

2. _____

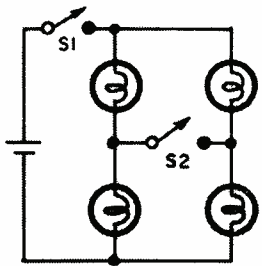

3. _____

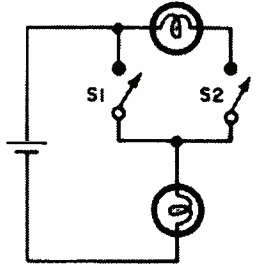

4. _____

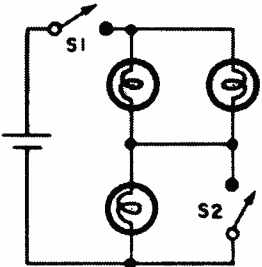

5. _____

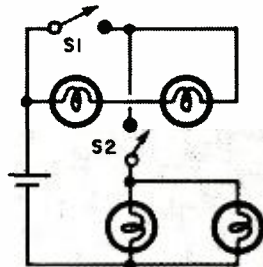

6. _____

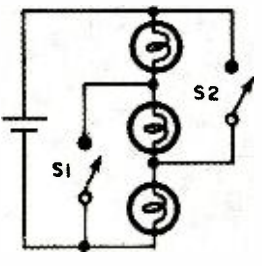

7. _____

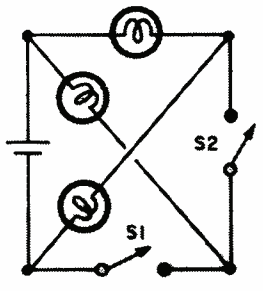

8. _____

S1 OPEN; S2 CLOSED

- A All lamps will light
- B One or more will light
- C No lamps will light

S1 CLOSED; S2 OPEN

- D All lamps will light
- E One or more will light
- F No lamps will light

S1 OPEN; S2 OPEN

- G All lamps will light
- H One or more will light
- I No lamps will light

S1 CLOSED; S2 CLOSED

- J All lamps will light
- K One or more will light
- L No lamps will light

(Answers on page 111)

BUILD **DIRECT
READOUT
IC FREQ
METER**

LOW-COST DIGITAL
LOGIC IC'S
ALLOW EASY CONSTRUCTION
OF 5-RANGE METER
COVERING THE SPECTRUM
FROM 5 HZ TO 1.0 MHZ

By **DON LANCASTER**



EVER DREAM of owning a good frequency counter? The \$500-and-up instruments are tops for all sorts of experimental and industrial work, but the accurate clock and complex decoding circuitry they use puts them well out of reach of most experimenters. But how about a frequency *meter*? About \$12 worth of semiconductors, integrated circuits, and other parts can put you in

command of a five-range, linear scale meter, good from 5 Hz to 1 MHz. It has an input sensitivity of 30 millivolts r.m.s., accepts any waveshape with no loss of accuracy, and automatically calibrates itself simply by borrowing the 60-Hz reference belonging to the local power company. The integrated circuits and a printed board make it a snap to put together.

This frequency meter is perfect for checking the performance of experimental audio oscillators, tone generators, and square-wave signal sources, and is particularly handy if you're working with RTTY, FM multiplex decoders, tone-signaling circuits, or electronic musical instruments. It's a "must have" instrument for working with transistor or SCR power inverters when it comes time to set—and keep—the operating frequency right on 60 Hz, and it's useful for checking out the performance of engine-driven emergency power units.

Add an external oscillator, and the unit becomes an accurate LC bridge for determining the value of an inductance or capacitance. And, finally, you can make the meter count anything you can convert into repetitive electrical pulses by adding a small generator and a photoelectric pickup, or something similar;

then the meter is an accurate, wide-range linear-scale tachometer.

How It Works. The input signals are amplified and inverted by transistor *Q1*, as shown in Fig. 1. This transistor drives a Schmitt trigger circuit (*IC1*) whose output snaps from ground to +3.9 volts the instant the input signal goes positive above a certain threshold level. The rise time of *IC1*'s output (from pin 6) is independent of the *shape* of the input signal, so a rectangular waveform of identical frequency to the input results.

Capacitor *C8* and resistor *R14* differentiate the square wave to produce a positive trigger pulse every time *IC1* snaps on. These pulses trigger *IC2* (a monostable multivibrator), which also snaps on, and stays on for a precise time interval determined by *R8*, *R15*, and a selected range capacitor (from *C9*

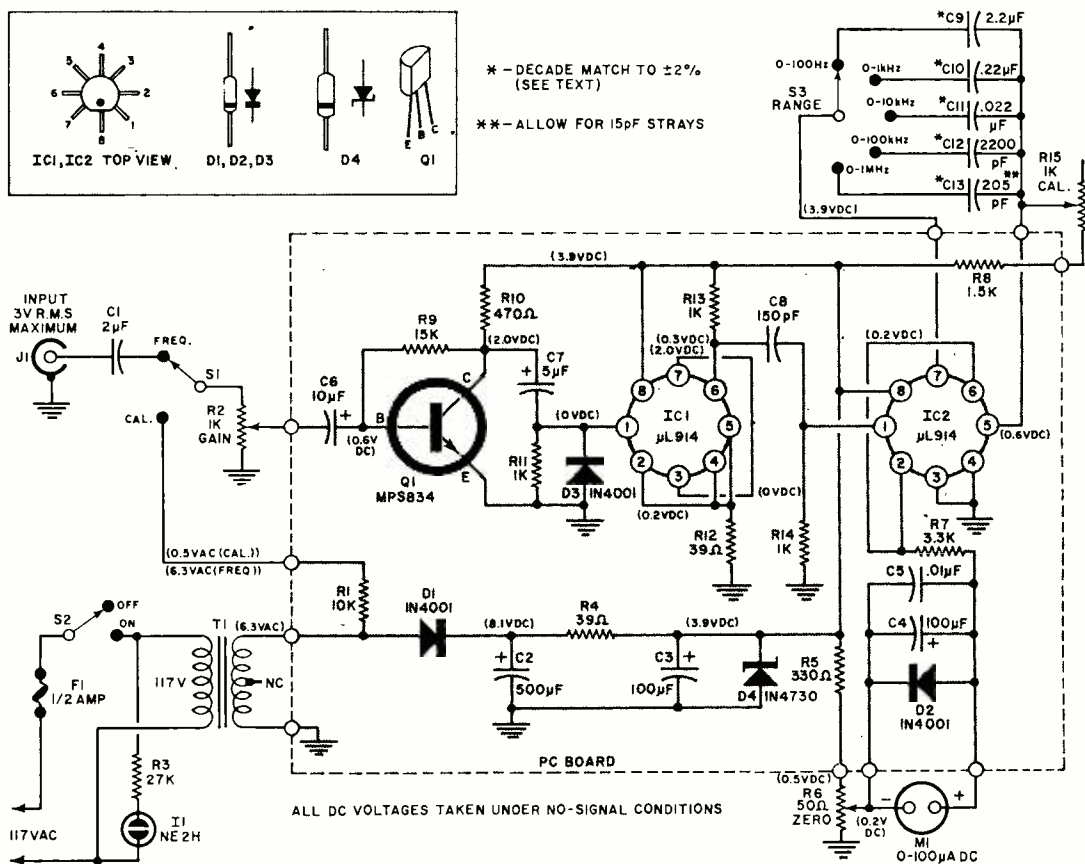

Fig. 1. Although only one transistor is shown, the two IC's contain five transistors and nine resistors. The circuit is self-checking from commercial power line through S1 (calibrate position) and resistor R1.

PARTS LIST

- C1*—2- μ F, 200-volt paper or Mylar capacitor (NOT an electrolytic)
C2—500- μ F, 25-volt electrolytic capacitor
C3—100- μ F, 15-volt electrolytic capacitor
C4—100- μ F, 6-volt electrolytic capacitor
C5—0.01- μ F, 50-volt Mylar or paper capacitor
C6—10- μ F, 10-volt electrolytic capacitor
C7—5- μ F, 10-volt electrolytic capacitor
C8—150-pF mica or disc ceramic capacitor
C9—2.2- μ F, 50-volt Mylar or paper capacitor (NOT an electrolytic)*
C10—0.22- μ F, 50-volt Mylar or paper capacitor*
C11—0.022- μ F, 50-volt Mylar or paper capacitor*
C12—2200-pF Mylar, paper, mica, or disc ceramic capacitor*
C13—205-pF mica or disc ceramic capacitor (allows for 15 pF of stray and circuit capacitance)*
D1, D2, D3—Silicon diode, 200 mA, 50 PIV (1N4001 or similar)**
D4—Zener diode, 3.9 volts, 1 watt (1N4730A or similar)**
F1— $\frac{1}{2}$ -ampere fuse (and fuse holder)
I1—Neon lamp
IC1, IC2— μ L914 epoxy integrated circuit (Fairchild)**
J1—Phono jack
M1—0-100 d.c. microammeter, $\frac{4}{2}$ " rectangular (Knight 52 A 7206, or similar)
Q1—Silicon transistor (Motorola MPS2923 or MPS834)**
R1—10,000-ohm, $\frac{1}{4}$ -watt carbon resistor
R2, R15—1000-ohm, linear-taper carbon potentiometer
R3—27,000-ohm, $\frac{1}{2}$ -watt resistor (may be a part of *I1*)
R4—39-ohm, 1-watt carbon resistor
R5—330-ohm, $\frac{1}{4}$ -watt carbon resistor
R6—50-ohm, linear-taper carbon potentiometer
R7—3300-ohm, $\frac{1}{4}$ -watt carbon resistor
R8—1500-ohm, $\frac{1}{4}$ -watt carbon resistor
R9—15,000-ohm, $\frac{1}{4}$ -watt carbon resistor
R10—470-ohm, $\frac{1}{4}$ -watt carbon resistor
R11, R13, R14—1000-ohm, $\frac{1}{4}$ -watt carbon resistor
R12—39-ohm, $\frac{1}{4}$ -watt carbon resistor
S1—S.p.s.t. slide switch (Wirt G323, or similar)
S2—S.p.d.t. slide switch (Wirt G324, or similar)
S3—Single-pole, five-position, non-shorting selector switch (Mallory 31151, or similar)
T1—Filament transformer, 6.3 volts, 0.6 ampere (Knight 54 A 1416, Stancor P6465, Thordarson 21F21, or similar)
1— $\frac{1}{4}$ " x $2\frac{3}{4}$ " x $3\frac{1}{2}$ " single-sided copper printed circuit board***
1— $3\frac{1}{2}$ " x 6" x 8" aluminum box (Bud CU-2109A, or similar)
Misc.—Line cord and strain reliefs, handle, knobs (4), rubber feet (4), PC terminals (11), mounting hardware for *M1* and *I1*, wire, solder, etc.

* Accuracy of instrument depends directly upon accuracy with which *C10* through *C13* are exact decade submultiples of *C9*.

** A kit of all semiconductors is available from Hamilton Electro of Arizona, 1741 N. 28 St., Phoenix, Ariz. 85009, for \$4.50, postpaid in U.S.A. Stock #ZX-53.

*** The printed board in $\frac{1}{16}$ " etched and drilled G-10 fiberglass is available for \$2.50 from Southwest Technical Products Corp., 219 W. Rhapsody, San Antonio, Texas 78216. Most of the other parts as well as complete kits are also available—write to Southwest Technical for complete list and prices.

through *C13*). Each capacitor provides a time delay ten times that of its neighbor, resulting in five decade frequency ranges. Calibrate control *R15* sets the time delay to a value that causes a 60-Hz input signal to read exactly 60 on the 100-Hz range.

How often *IC2* snaps on is determined by the input frequency, while how long it stays on is determined by the range switch-selected capacitor. The ratio of on time to off time linearly increases with increasing frequency. Resistor *R7* charges up *C4* and *C5* (an integrator) to a voltage whose average value equals the ratio of on to off time. Meter *M1* then indicates this average voltage as frequency.

Zero control *R6* provides a small d.c. voltage to buck out the saturation effect of *IC2*, while *D2* protects the meter from overload if an input frequency higher than full scale is encountered. A conventional zener-regulated +3.9-volt d.c. supply is used. Switch *S1* and resistor *R1* route the 60-Hz power to the input for calibration.

The 100-Hz scale accuracy depends solely upon how closely you can read the meter, while the scale-to-scale accuracy depends upon how closely the range capacitors (*C9* through *C13*) are exact decade multiples. An accuracy of better than $\pm 3\%$ should be easily obtained with a quality meter and careful capacitor selection.

Construction. The two IC's together replace five transistors and nine resistors, which, if bought separately, would cost eight dollars, or well over twice that of the IC's, not counting the extra assembly time and trouble.

Buy (see Parts List), or etch, cut, and drill the printed circuit board and mount the components as shown in Figs. 2, 3, and 5. Watch the polarity on all semiconductors and electrolytic capacitors. On *IC1* and *IC2*, make certain lead 8 (center lead of flat side, having a red dot) goes to the +3.9-volt supply.

Mount the meter, pilot lamp, Range switch *S3*, Gain control *R2*, input jack *J1*, Zero control *R6*, on/off switch *S2*, calibration switch *S1*, and calibration potentiometer *R15* on a suitable front panel as shown in the photo on page 53. Mount the PC board and the remainder of the components within the selected

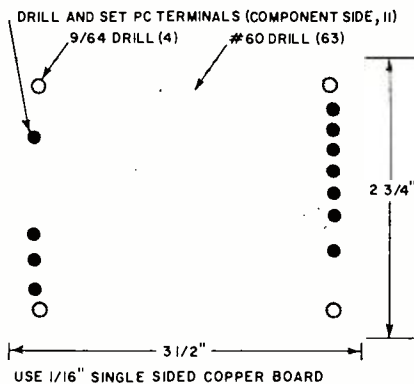

Fig. 2 (above). Drilling details for the printed board. Actual-size board is shown on page 98.

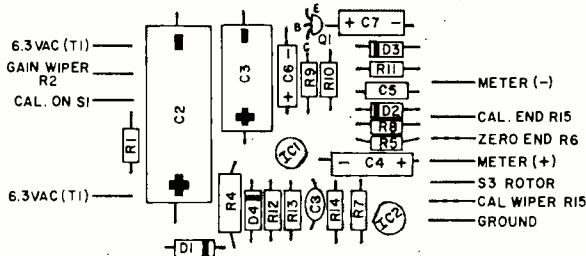

Fig. 3. (above, right). Component location on board, and connections to remainder of circuit.

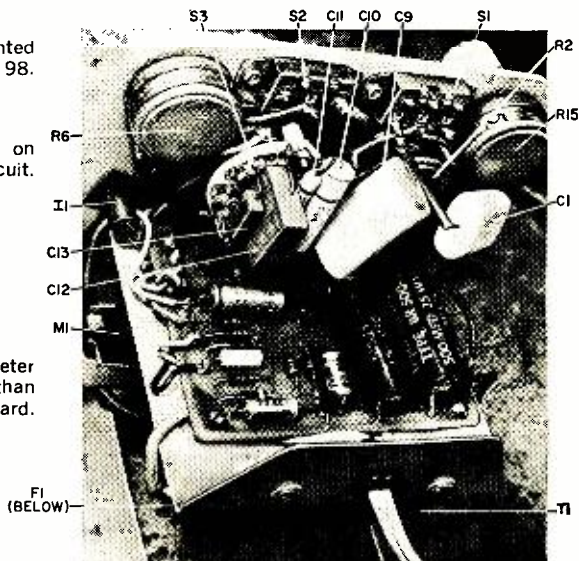

Fig. 4 (right). Interior of the frequency meter showing general location of parts other than those already mounted on the printed board.

metal enclosure. Use Fig. 3 as a guide for interconnecting the PC board with the remainder of the system.

The accuracy of the instrument on the four upper scales depends entirely upon how closely range capacitors *C10* through *C13* are exact decade submultiples of *C9*. One source of matched capacitors is given in the Parts List. Otherwise, by using an LC bridge, a quality oscilloscope, or a good audio oscillator, you can trim the capacitance (and therefore, the *on* time of *IC2*) so that the frequency indication on *M1* has exact scale-to-scale calibration.

When the capacitors are accurate, you'll have a correct frequency reading on *any* scale without having to retouch the *Calibrate* control, and with a power-line calibration, you can rest assured that all scales will be accurate.

Operating Hints. Always turn the gain control fully counterclockwise before you make any measurement or connect the instrument to a live circuit, or you might risk damage to *Q1*. Calibrate the instrument each time you use it by zeroing the meter (with front-panel Zero control *R6*), selecting the 100-Hz range, and setting the *Freq/60 Hz* switch (*S1*) to 60 Hz. Bring the Gain control up a quarter turn and adjust the meter to a steady "60" reading using the *Calibrate* potentiometer. Set the *Freq/60 Hz* switch to *Freq*, and you're all set to measure.

Keep the input amplitude under 3 volts r.m.s. maximum. If you're working with higher signal levels, add a resistive divider to cut the level down. You may safely connect the input to any d.c. level within the breakdown rating of *C1*.

(Continued on page 98)

THREE-CORNER SPACE SAVER

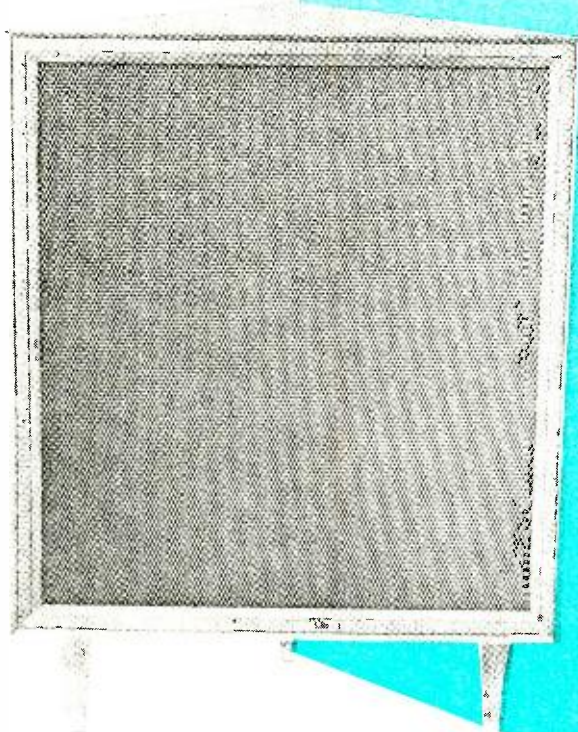

TRIANGULAR ENCLOSURE GIVES
SPEAKER SYSTEM TOP-QUALITY
HI-FI SOUND

By **DAVID B. WEEMS**

UNTIL STEREO SOUND became popular about eight years ago, use of the triangular-shaped corner speaker system was quite common among hi-fi enthusiasts who wanted top-quality sound reproduction. Today, it is a rare home that has a corner speaker system—the triangular enclosure has all but disappeared from the hi-fi scene. Yet this type of enclosure is considered by many speaker system experts to be superior to the limited-volume rectangular or bookshelf designs that have replaced it.

G. A. Briggs of Wharfedale Wireless Works in England, one of the foremost authorities on loudspeakers and speaker system design, rates the triangular enclosure as one of the two best designs (see Enclosure Design Table). According to him, the triangular enclosure insures maximum bass response in the average listening room. This type of enclosure can maximize speaker system efficiency and, if carefully constructed, will occupy little more than a cubic foot of floor space.

ENCLOSURE DESIGN TABLE*

TYPE	ACOUSTIC MERIT
Triangular	10
Hexagon	9
Concrete Column	10
Average Cabinet	7
Circular Pipe	5
Slimline	5
Cube	3
Sphere	1

*From *More About Loudspeakers*, G. A. Briggs, 1965, page 102.

Because the triangular enclosure is so highly rated by Briggs, the author designed the speaker system to be described here. The "Three-Corner Space Saver" is a slightly modified version of the system presented on page 97 of Briggs' book, *More About Loudspeakers*. To avoid compromising sound quality and eliminate the chance of something going wrong with the system, a pair of Wharfedale speakers were used in the enclosure. The speakers selected account for the slight variation in dimensions between Briggs' system and the one presented here.

The "Three-Corner Space Saver" derives its name from its characteristic design and the fact that it requires so little floor space. But any way you slice it, this system will perform as well as, and possibly outperform, many more expensive hi-fi speaker systems on the market today.

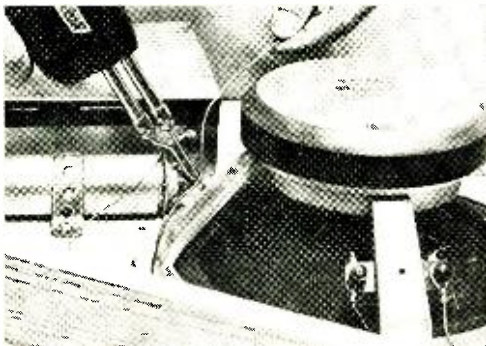

Fig. 1. Full-range "Super 10" speaker has heavy cast aluminum basket to minimize support resonance. Large 7-in magnet extends bass response.

The Speakers. The fullest possible frequency response is obtained from the system through the use of the moderately priced Wharfedale speakers. A Model "Super 10" 10"-diameter full-range speaker reproduces the bass and mid-range frequencies, while a 3" Model "Super 3" tweeter provides more than adequate response in the high frequency range. Paired together in a well-designed enclosure, these two speakers provide a smooth response over virtually the entire audio frequency spectrum.

The "Super 10" shown in Fig. 1 sports a big 7-lb. ceramic magnet, and the speaker has a characteristic free-air resonance of somewhere between 38 and 43 Hz. The "Super 3" tweeter, shown in Fig. 2, also has a large (3-lb.) ceramic magnet; high frequency cutoff is 20 kHz on the average. Both speakers have cast aluminum baskets that reduce the possibility of undesirable support resonance.

Since the tweeter, like the full-range speaker, has an open back, it requires a separate enclosure, designed to reduce diffraction of the high frequencies. This simply means that the front of the tweeter board must be chamfered around the speaker mounting hole. However, the Wharfedale people have eliminated the necessity of fashioning this board since the "Super 3" is shipped mounted to a board that can be used as the front of the tweeter enclosure as shown (left in Fig. 2).

The Enclosure. An almost complete absence of parallel surfaces is perhaps the most favorable feature of the triangular enclosure design. (The top and bottom surfaces, although parallel to each other, are such small areas that they can be disregarded.) Without parallel surfaces to bounce the sound around, standing waves are minimized and the enclosure is less apt to "peak" or favor a given band of frequencies.

The triangular enclosure used for the "Three-Corner Space Saver" speaker system contains a port that tunes the system, providing extended low-frequency response. Since the port is located in the bottom rear of the enclosure, the additional space between the bottom of the enclosure and the floor acts as an expanded port.

Construction of the enclosure is quite simple, as can be seen from the drawings in Fig. 3. However, it is almost a necessity that you have a power saw equipped for making angular cuts to properly mate the speaker board to the front of the enclosure.

To make the cutout for the port (small triangular shape at apex of top view

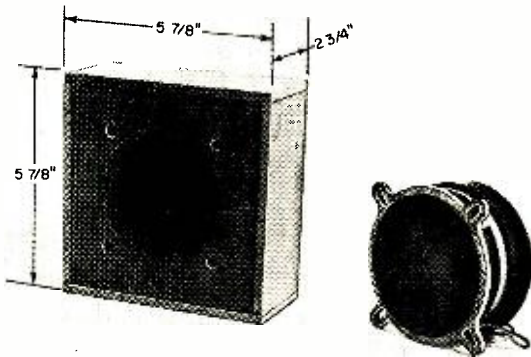

Fig. 2. An enclosure (left) must be used with "Super 3" tweeter (right). Speaker mounting hole should be chamfered to reduce high-frequency diffraction.

drawing), measure $5\frac{3}{4}$ " from the 90° corner along the adjoining sides, draw a straight line connecting the two measurement points, and cut along this line. Discard the small triangular piece, but save the remaining piece of plywood for later use as the bottom of the enclosure.

Glue and nail a side cleat flush with one of the longer edges of each side plate (see Bill of Materials for dimensions). When the glue sets, cut the cleated edges of both side pieces at a 45° angle. To do so, place the saw against the uncleated side, or outer wall, and angle the saw blade toward the edge opposite the cleat.

Except when securing the speaker board and decorative trim to the front of the enclosure, use wood cement liberally between all surfaces to be joined.

Glue and nail the sides together as shown in the top view drawing, and set the side assembly on the bottom plate (plywood board with port cutout), recessing it $\frac{3}{4}$ " in from the front edge of the bottom plate. Glue and nail the sections together.

Invert the bottom-side assembly onto the top plate, and align the right-angle

corners flush with each other (there should be $\frac{3}{4}$ " distance between the front edge of the top plate and the front edges of the sides). Draw the interior outlines of the sides and side cleats on the top plate, and remove the bottom-side assembly.

Cut two pieces of $\frac{3}{4}$ " x $\frac{3}{4}$ " clear pine; one $14\frac{1}{2}$ "-long, the other $13\frac{3}{4}$ "-long. Glue and nail these top cleats in place along the side outlines on the top board. After applying wood cement to the outer surface of the cleats and the top edges of the sides, set the top in place, and drive $1\frac{1}{4}$ "-long wood screws through the top cleats and into the enclosure sides.

Cut the ends of two $2\frac{1}{4}$ " pieces of $\frac{3}{4}$ " x $\frac{3}{4}$ " clear pine at a 45° angle, and glue and nail these to the top and bottom of the enclosure, each end touching opposite side cleats. The outer edges of the cleats should now be $\frac{3}{4}$ " in from the front edges of the top and bottom of the enclosure.

Secure the port wall in place, and mount the legs. The only dimension of the legs that is somewhat critical is their length—6 inches. Otherwise, they can be square, round, tapered, or any other shape that suits your fancy, and they can be located as desired.

Prepare the small sealed enclosure for the "Super 3" tweeter, using the dimensions given in Fig. 2 as a guide. The front of the enclosure will be the board on which the tweeter was shipped to you, as mentioned earlier, and the sides and back should be $\frac{1}{4}$ "-thick plywood or hardwood board. Before mounting the front board, however, drill a small hole through one of the sides of the enclosure, bring out the speaker wires, and line the walls with 1"-thick fiberglass or cotton batting. Then fill the hole around the speaker wires with cement to make an airtight seal. Mount the tweeter and set the assembly aside temporarily.

Prepare the speaker board as shown in Fig. 3, front view. Smooth the front surface and walls of the speaker cutout with medium emery cloth, and apply a coat or two of flat black paint. When the paint dries, glue and nail the front and side braces, orienting them approximately as shown in Fig. 4.

Sand and stain or paint all exterior surfaces of the enclosure.

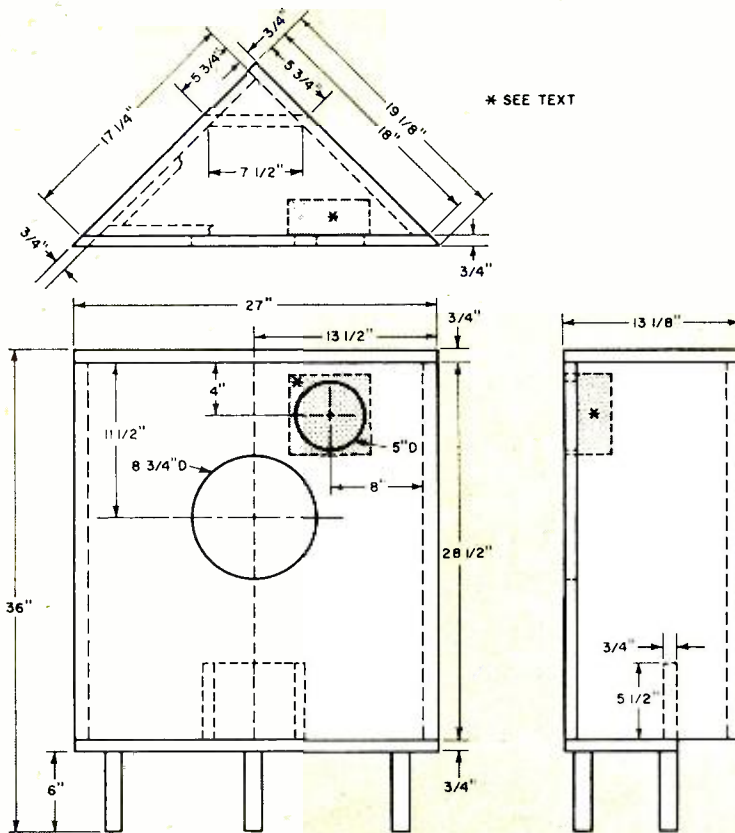

Fig. 3. Mating surfaces between speaker board and sides of enclosure (as well as port front) must be cut at 45° angles to insure proper mating of parts and airtight seal.

BILL OF MATERIALS

- 1—27" x 28 1/2" piece of 3/4" fir plywood for speaker board
- 1—18" x 28 1/2" piece of 3/4" fir plywood for side
- 1—17 1/4" x 28 1/8" piece of 3/4" fir plywood for side
- 1—19 1/8" x 19 1/8" piece of 3/4" fir plywood, cut diagonally, for top and bottom
- 1—5 1/2" x 7 1/2" piece of 3/4" fir plywood for port
- 2—2 1/2" x 5 7/8" pieces of 1/4" plywood for tweeter enclosure top and bottom
- 2—2 1/2" x 5 3/8" pieces of 1/4" plywood for tweeter enclosure sides
- 1—5 7/8" x 5 7/8" piece of 1/4" plywood for tweeter enclosure back
- 2—28 1/2" lengths of 3/4" x 1 5/8" clear pine for side cleats*
- 2—22" lengths of 3/4" x 1 5/8" clear pine for side braces*
- 1—20" length of 3/4" x 1 5/8" clear pine for front brace*
- 1—14 1/2" length of 3/4" x 3/4" clear pine for top cleat**

- 1—13 3/4" length of 3/4" x 3/4" clear pine for top side cleat**
- 2—21 1/4" lengths of 3/4" x 3/4" clear pine for front top and bottom cleats**
- 3—6" long legs—see text
- 1—Wharfedale Model "Super 10" 10-inch full-range speaker (Allied Radio No. 20-8173X, \$47.50)
- 1—Wharfedale Model "Super 3" 3-inch tweeter (Allied Radio No. 20-8185X, \$26.50)
- 1—2-μF paper or oil-filled capacitor
- Misc.—#8 x 1 1/2" flat head wood screws (24), #8 x 3/4" pan-head screws (8), 1 1/2" finishing nails, 1" wire brads, wood cement, grille cloth or expanded aluminum mesh, picture frame molding for decorative trim, open-weave black cloth, felt strips (4), fiberglass or cotton batting, speaker wire, solder, etc.

*Sold as 1" x 2" clear pine

**Sold as 1" x 1" clear pine

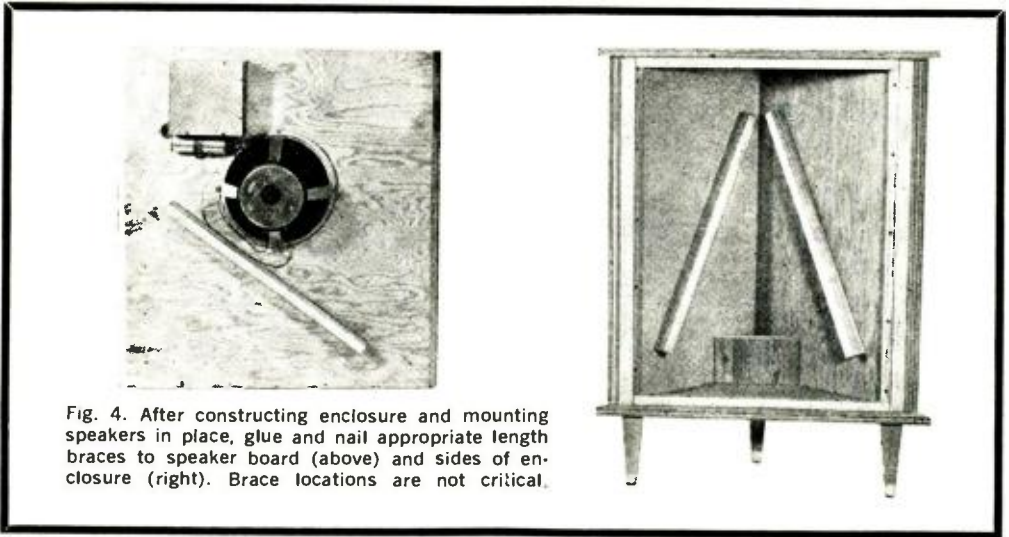

Fig. 4. After constructing enclosure and mounting speakers in place, glue and nail appropriate length braces to speaker board (above) and sides of enclosure (right). Brace locations are not critical.

Mount the Saper 10" full-range speaker over its hole on the speaker board, using $\approx 8 \times \frac{3}{4}$ " pan-head screws. Then symmetrically orient the tweeter assembly over its hole and secure it in place with 1½"-long finishing nails. Use a metal strap to mount the 2- μ F capacitor near the full-range speaker.

Finally, line the entire interior of the enclosure with 1"-thick (or more) damping material, such as cotton batting or fiberglass, and glue a strip of felt to each of the front cleats.

Installation. Wire the speakers and capacitor exactly as shown in the schematic drawing (Fig. 5). The red wire from the tweeter must go to the positive terminal of the full-range speaker for proper phasing.

Set the speaker board in place on the front of the enclosure, and screw it down. The screws should be located 4"

apart around the front, or speaker board, to insure the proper seal.

Cover the entire front surface of the speaker board with open-weave black cloth, and tack the cloth in place. The picture frame molding selected for the decorative trim should be cut to size with mitered corners that can be joined together with glue and only one finishing nail through each corner.

Speaker grille material or expanded aluminum mesh can be used to attractively set off the front trim. Before mounting the grille material, it is necessary to cut the side edges of the trim at a 45° angle. When this is done, tack the grille cloth or aluminum mesh to the trim, and mount the assembly on the front of the enclosure with small wire brads.

Connect the speaker cable to the 8- or 16-ohm output terminals on your amplifier—either tap will do. Set the speaker system in a corner, turn your amplifier on, and start a record spinning. If the bass is too "throaty" or deep, pull the system out from the wall until you are satisfied with the way it sounds. If you want to, you can even set it out in the middle of the room and still get good hi-fi reproduction.

You'll be surprised at the superior quality of sound possible with the "Three-Corner Space Saver" speaker system—so surprised that you'll want two (one for each channel) if you have a stereo system.

Fig. 5. Wire speakers exactly as shown for proper phasing of system. Capacitor serves as a high-pass filter.

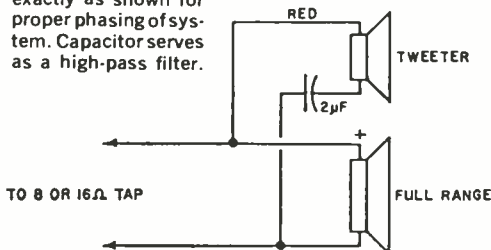

NTS PUTS YOU WHERE THE MONEY IS ... FAST!



NTS Home-Study training is for men in a hurry to move up! NTS Electronics Courses are geared to the needs of the electronics industry. This is up-to-date training. As modern as tomorrow.

Our close working relationship with electronics companies all over the country is the key. They tell us what you need to know to be a top-flight technician. They

keep us informed of new, exciting career opportunities. With this information, we constantly revise our courses to keep our home-study students one step ahead. In an industry that moves so rapidly, advancement comes quickly to the man with NTS training.

Since 1905, NTS has been leading ambitious men to where the money is. Join them.

EXCLUSIVE! ONLY FROM NTS! ALL NEW KITS... MAKE IT FUN TO LEARN, EASIER TO EARN.

For the first time! The greatest lineup of electronics kits ever offered to train you for the space-age. Only NTS has them. Designed for tomorrow... each has all

the latest electronics advances built in. NTS trains you better. NTS makes it fun to learn, easier to earn more, TODAY.



25" COLOR TV: Included in Color TV servicing courses ...to prepare you for the big demand for qualified service technicians. This is where the big money is. More than 16 million homes will have color TV by the end of this year. You can cash in on the boom. You can take a giant step ahead with professional training from NTS.



COMMUNICATIONS: Transceiver included in Communications Courses. This modern equipment is an important element in communications. You get it, you build it. With it you easily prepare for the F.C.C. License Exam. You become a fully trained man in communications, where career opportunities are unlimited.

**ALL
NEW KITS!
ALL NEW
COURSES!**

DESK-TOP COMPUTER: Professionally designed exclusively for NTS. Included with your Industrial and Computer Electronics Course. You can't get this computer kit, or anything like it, anywhere else. The special

computer and integrated circuitry of the training kits prepare you for a big career in this giant industry. These are the first kits offered by any school which include actual integrated circuits.

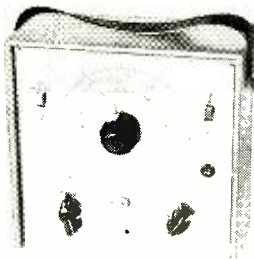

LEARN MORE, EARN MORE—IN ELECTRONICS

SIGNAL GENERATOR, VTVM, AND TUBE CHECKER INCLUDED WITH NTS ELECTRONICS COURSES. These are invaluable instruments for all kinds of Electronic and TV-radio servicing work. You learn to use them early in your training. Begin trouble-shooting work to earn money even before you've completed your course. Many of our students have more than paid for their NTS home-training this way—even before they graduated!

With these professional instruments, you are well-equipped to go into a business of your own. They're all you need to pinpoint most of the trouble spots in TV, Radio, or other electronic components. You get them at no extra cost—as part of your NTS training.

YOUR OWN BUSINESS

The big jobs belong to the men who prepare for them. You can earn money—learn how to start a business of your own—with NTS home training.

NTS starts you out right with the exclusive **Project Method Career Kit**. Contains everything you need to make your training easy. Keeps you organized. You learn faster. You move ahead that much sooner.

You can get all the details on the many advantages of NTS **Project Method** home training. It's all in the NTS catalog, along with pictures and information on all the equipment and exciting kits you receive and keep. Tells you all you need to know to get started.

CLASSROOM TRAINING AT LOS ANGELES:

You can take classroom training at Los Angeles in sunny Southern California. NTS occupies a city block with over a million dollars in facilities devoted exclusively to technical training. Check special box in coupon.

HIGH SCHOOL AT HOME



National offers accredited high school programs. Take only subjects you need. Study at your own pace. Everything included at one low tuition. Check special high school box in coupon for full information and **FREE** catalog.

MAIL REPLY CARD OR COUPON FOR NEW COLOR CATALOG & SAMPLE LESSON. THEY'RE FREE!

We Have No Salesman!
This Means Lower Tuition For You.



Accredited Member National Home Study Council
Member: National Association of Trade & Technical Schools

NATIONAL TECHNICAL SCHOOLS

WORLD WIDE TRAINING SINCE 1905

4000 So. Figueroa St., Los Angeles, Calif. 90037

9
TRAINING
PROGRAMS

NATIONAL TECHNICAL SCHOOLS

4000 S. Figueroa St., Los Angeles, California 90037

APPROVED
FOR
VETERANS

Please rush Free Color Catalog and Sample Lesson, plus detailed information on field checked below. No obligation.

- Master Course in Color TV Servicing
- Color TV Servicing for Qualified Technicians
- Master Course in TV & Radio Servicing
- Practical TV & Radio Servicing
- Master Course in Electronic Communications
- FCC License Course
- Industrial & Computer Electronics
- Stereo, Hi-Fi & Sound Systems
- Basic Electronics High School at Home

NAME _____ AGE _____

ADDRESS _____

CITY _____ STATE _____

Please fill in Zip Code for fast service

Check if interested in Veteran Training under new G. I. Bill. (Dept. 205-107)

Check if interested ONLY in Classroom Training at Los Angeles.

TURN INDICATOR FLASHER UNIT

By W. P. MITCHELL

... IS INDEPENDENT
OF CURRENT
THROUGH THE CIRCUIT
TO PROVIDE
GREATER ROAD SAFETY

THE CONVENTIONAL flasher unit that controls the turn-signal lights in your car is a temperature-operated device. It employs a bi-metallic strip (two dissimilar metals bonded together) that serves as the moving contact of an s.p.s.t. thermal switch. Current flowing through the bi-metallic switch causes the strip to heat and expand, but one metal expands faster than the other, flexing the strip to open the contacts. As the contacts open, and the bi-metallic strip immediately begins to cool and unflex until it again makes contact.

This open-and-close cycle repeats itself at the same rate as long as power is applied and the current through the circuit is maintained at a constant level. Any change in the current through the bi-metallic strip affects only the "close" cycle; no matter what the current through the circuit, the bi-metallic strip cools at essentially the same rate. Con-

sequently, if the current drawn by extra lamps—as when a trailer is connected to your car's turn-signal system—is increased sufficiently, the "on" cycle may be so short in duration that the signal lights will produce only a feeble glow.

With a simple RC -time constant relay type flasher, you can make the flash rate independent of the current flowing through the turn-signal system. The modification can be accomplished at only nominal cost, but there is a big payoff: greater safety on the road.

The schematic diagram of the modified and improved current-independent flasher unit is shown below. Only three parts are required: a large capacitor, a power resistor, and a miniature relay. The entire assembly can be housed in a plug-in container a little larger than the thermal flasher it is to replace. If wired to an appropriate socket, it can also plug into the circuit in the same way.

The values of R and C should be selected to yield an open-and-close cycle of between 3 flashes/second and 1 flash every $1\frac{1}{2}$ seconds. Use the RC time constant formula ($T = RC$) to arrive at the values for R and C needed, but in no case should the value of R exceed one-half the resistive value of the relay's solenoid windings.

For a 2-per-second flash rate, a 2000- μ F, 15-volt capacitor and a 100-ohm, 3-watt wire-wound resistor can be connected to a s.p.d.t., 12-volt d.c. relay (Potter and Brumfield No. KUP5D15 miniature relay, or similar). If your car has a 6-volt electrical system, use a 6-volt relay.

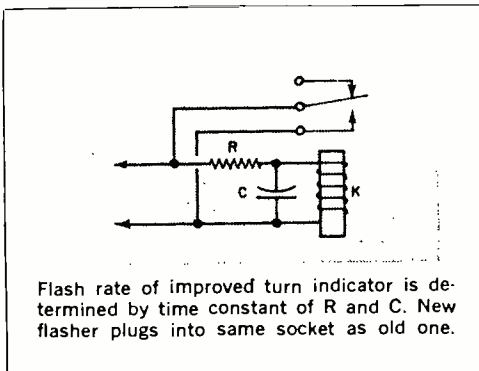

MAKE YOUR OWN **6 to 12 VOLT "UP-VERTER"**

JOIN THE 12-VOLT CROWD—
THE VOLTAGE IS FINE

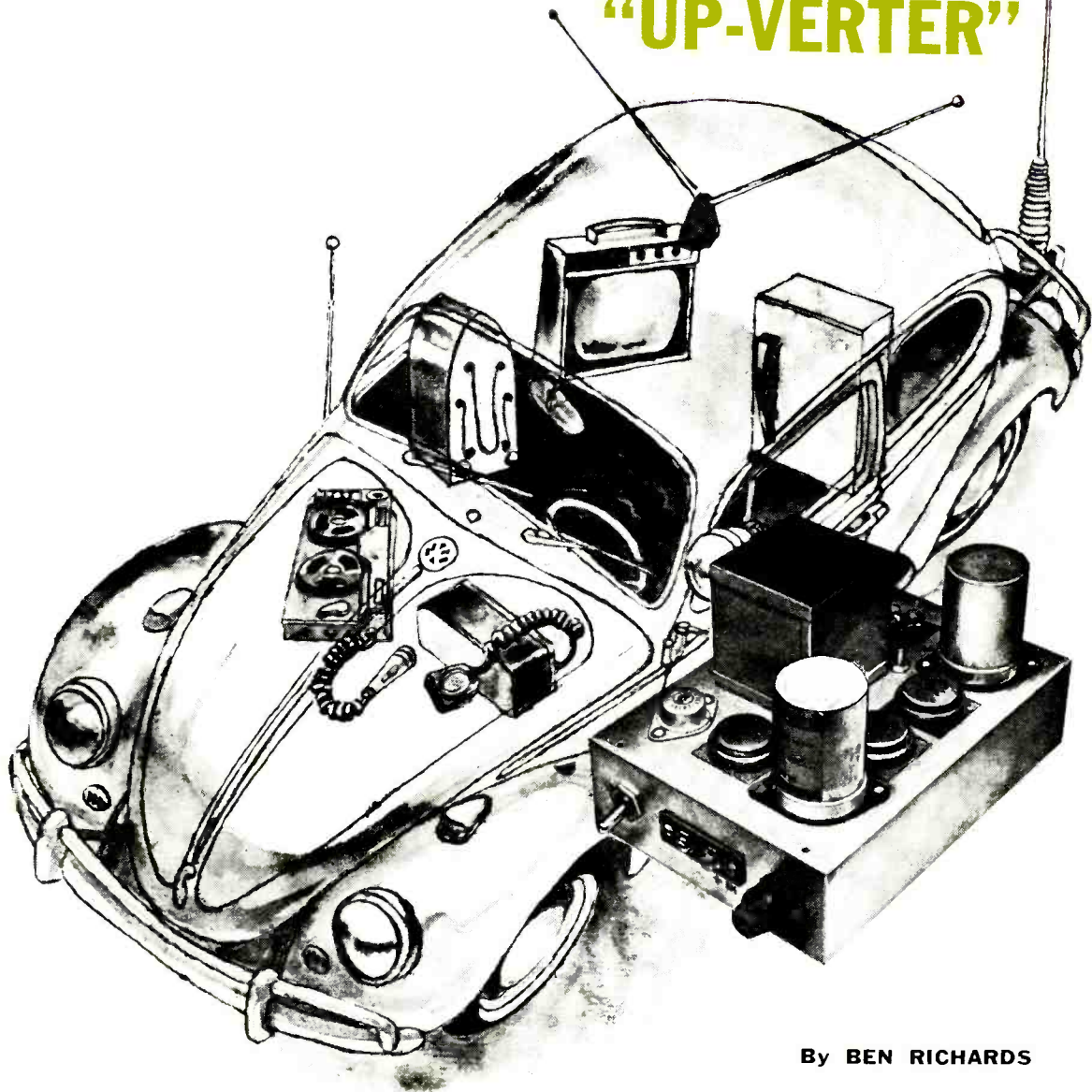

By **BEN RICHARDS**

ONE OF THE major problems with a car having a 6-volt electrical system is that almost all mobile electronic equipment is now designed for use in 12-volt cars. Out of desperation, some car owners have resorted to using two 6-volt

batteries in series, with elaborate schemes to keep both batteries charged. If you are one of these poor souls, read on—relief is at hand.

For about \$20, or approximately the cost of that extra 6-volt battery, you can

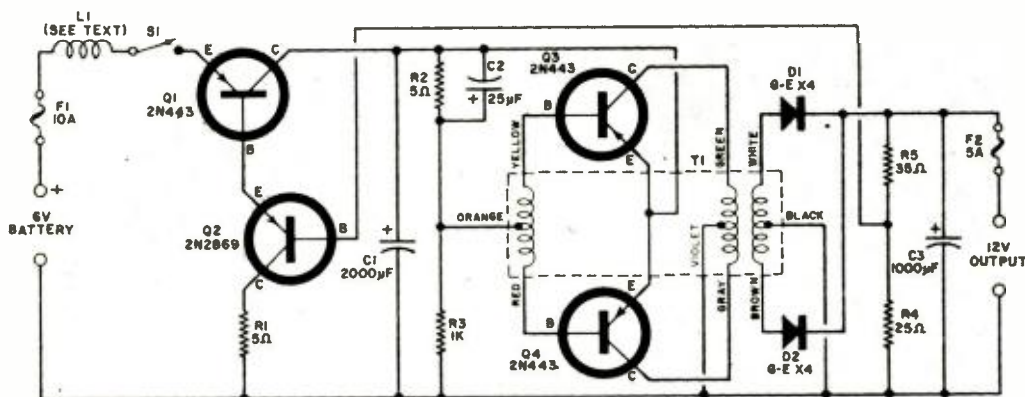

Fig. 1. While Q3 and Q4 are oscillating to create 12 volts from the incoming 6 volts, the output is monitored by Q2, which, in turn, controls Q1 to maintain output voltage at exactly twice the input.

PARTS LIST

- C1—2000- μ F, 15-volt electrolytic capacitor (Sprague TVL-116S, or similar)
 C2—25- μ F, 50-volt electrolytic capacitor
 C3—1000- μ F, 25-volt electrolytic capacitor (Sprague TVL-1230, or similar)
 D1, D2—GE type X4 rectifier (20 amperes, 200 PIV)
 F1—10-ampere 3AG fuse
 F2—5-ampere 3AG fuse
 L1—See text
 Q1, Q3, Q4—2N443 transistor
 Q2—2N2869 transistor
 R1, R2—5-ohm, 5-watt wire-wound resistor
 R3—1000-ohm, 2-watt resistor
 R4—25-ohm, 5-watt wire-wound resistor
 R5—35-ohm, 5-watt wire-wound resistor
 S1—S.p.s.t. switch (optional remote power switch)
 T1—Type EC-0401-1C saturable transformer (available from Milwaukee Electromagnetics, P. O. Box 4476, Milwaukee, Wis. 53207, for \$10.95, postpaid)
 Misc: 2" x 5" x 7" chassis and cover plate, terminals, fuse holders, silicone heat sink grease, etc.

and D2, and filtered by C3 to produce a relatively smooth d.c. output.

To maintain a constant d.c. output level (at twice the input voltage), Q1 and Q2 are used in a conventional series regulator circuit with a portion of the output voltage (selected by the ratio of R4 to R5) as the reference. If the d.c. output voltage tends to rise, the feedback to the base of Q2 causes Q1 to increase its series resistance, thus lowering the voltage fed to the oscillator. This, in turn, reduces

build this 6-to-12-volt converter which can handle up to 40 watts. This is more than enough power to cope with most CB transceivers, tape players, and other 12-volt car accessories.

How It Works. The circuit, shown in Fig. 1, uses transistors Q3 and Q4 in conjunction with transformer T1 in a feedback-type power-oscillator circuit. This circuit accepts a d.c. input, and, as a result of the oscillation, produces an a.c. output across the secondary of T1 whose amplitude is a function of the level of the d.c. voltage applied to the oscillator. The a.c. output is then rectified by D1

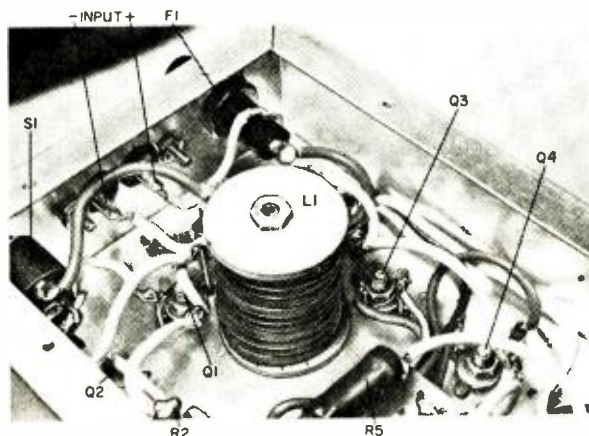

Underchassis view of input end of the "Up-Verter" showing the general placement of components. Other underchassis views appear on following page.

the available output voltage. Conversely, if the output voltage is dropping, the feedback loop causes $Q1$ to reduce its resistance, supplying more voltage to the oscillator, and raising the available output voltage.

Inductor $L1$ and capacitor $C1$ make up a "hash" filter to keep generator noise out of the system.

Construction. Mount all components on the chassis first, in roughly the arrangement shown in the photographs. Install the transistors *after* all the drilling and filing is done.

Use the insulating fiber mounting plates supplied with the electrolytic capacitors, because the converter chassis is electrically isolated from the circuit and serves as a passive shield when it is ultimately grounded to the automobile. The converter chassis will not be conducting any of the heavy supply current in the event that separate leads are run to *both* the + and - input terminals (as in the case of the cigarette lighter input connection).

It is permissible, of course, to ground the negative input terminal of the converter at the point at which the chassis of the converter is attached to the car, and to run only one wire to the positive terminal of the battery. Note that switch $S1$ can be mounted on the chassis as shown, or can be connected as an external switch under the dash.

Take great care in mounting the transistors and diodes so that they all are electrically insulated from the chassis. Use the mounting kits furnished with transistors $Q1$, $Q3$, and $Q4$. Transistor $Q2$, and diodes $D1$ and $D2$ do not come with a mounting kit, so install them as shown in Fig. 2. Be sure to employ silicone grease on the transistor and diode mounting surfaces and on both sides of the mica or celluloid insulators so that heat can be transferred efficiently from the semiconductors to the chassis.

Check to make certain that the transistors, diodes, and capacitors are isolated from the chassis with an ohmmeter or flashlight battery and bulb; this should be done *after all* the components are

Fig. 2. Method of mounting transistor $Q2$ and the two rectifier diodes ($D1$ and $D2$) to insulate them from the common chassis.



Output side of the chassis showing diode installation, power output terminals, filter capacitor $C3$, and output fuse $F2$.

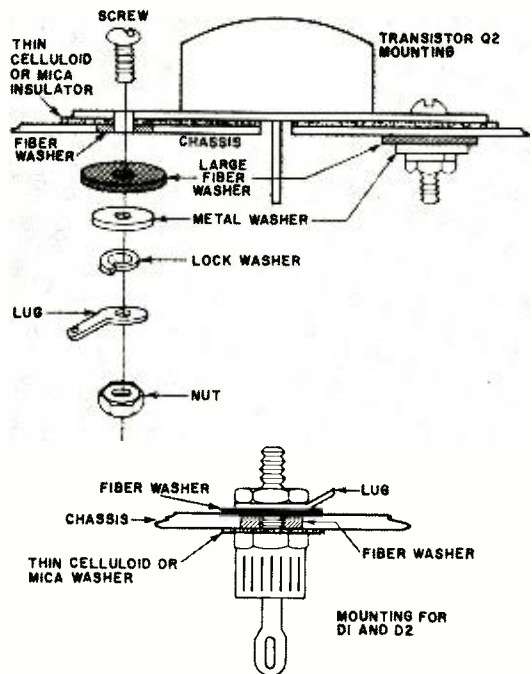

In this view of the input end, the wall-mounting of R2 can be seen. You don't have to follow this chassis arrangement exactly; almost any layout will suffice.

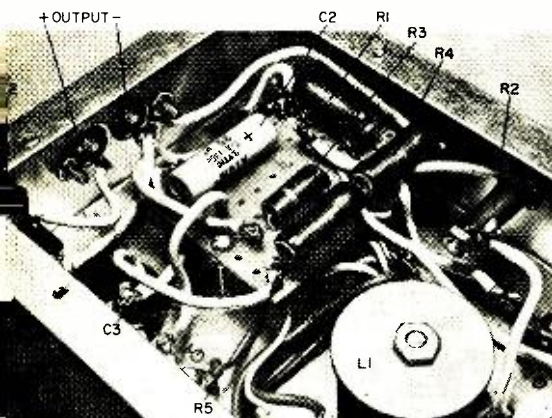
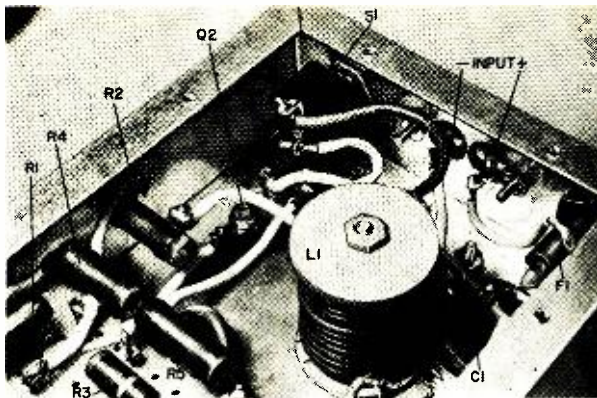

The output end of the "Up-Verter" chassis. Note location of the circuit board and the remainder of the components not visible in the other photos.

mounted on the chassis. Use #14 insulated stranded wire for all connections, except for the transformer—which has several thinner leads.

With the exception of R2 and L1, which should be mounted on the chassis with

bolts, the remaining components can be wired point-to-point or on a small circuit board. Incidentally, L1 is "home-brewed" by close-winding 21 turns (about 7-3/4 feet) of #14 insulated solid or stranded wire in two layers on a wood bobbin as shown in Fig. 3.

Connections to the transistor pins and the diode anodes can be made by direct soldering. Take care not to damage the semiconductors with excessive heat; use a pair of long-nose pliers as a heat sink between the point of soldering and the transistor or diode case. If the small amount of sound produced by the unit is disturbing, use a cover lined with foam rubber or styrofoam, or any other acoustic absorbent material. A bottom cover plate on the chassis will partially suppress r.f. noise.

Testing and Use. Double-check the wiring and make sure that the chassis is electrically isolated from the input and output terminals. Apply 6 volts d.c. with the proper polarity to the input terminals. No-load current drain should be about 2 amperes. No-load output voltage should be 2.1 times the voltage measured across the input terminals. Remember to use heavy wire, at least #14, for connections to the battery, load, and remote on/off switch (S1) if one is used.

Output loading can be approximately 3 amperes continuously (about 35-40 watts), and higher on an intermittent basis. However, do not load so heavily as to cause the output voltage to drop below 1.8 times the input voltage. Full load drain on a 6-volt battery is typically 10 amperes.

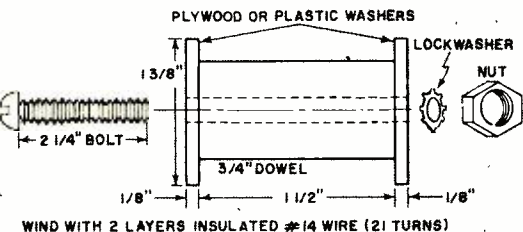

Fig. 3. Construction details for "hash" coil L1. Close-wind 21 turns of #14 insulated wire in two layers. The bolt secures the coil to the chassis.



CAN WE STAVE OFF RADIO-FREQUENCY SUPER-SATURATION?

NORTH AMERICA IS RAPIDLY RUNNING OUT OF USABLE RADIO FREQUENCIES—HOW DID IT HAPPEN?

By RICHARD HUMPHREY

USERS of two-way radio communications facilities have looked with horror upon the congestion and glut on the 23 Citizens Band channels. Many users take the viewpoint that this congestion may be a warning of things to come on all two-way radio channels. It is becoming increasingly apparent that there are a lot of people using two-way radio and just as many wanting to get on the air as soon as they can.

Radio users in North America are not the only ones concerned. Two-way radio usage in Europe and South America is increasing at an astonishing rate. All users are being made to face up to the fact

that the radio frequency spectrum is fast approaching the super-saturation point.

In New York City, a really concern was forced to give up its two-way radio communications system because, "We could never get through to each other due to the congestion." The U.S. Coast Guard says that the marine calling and distress frequency (2182 kHz) is almost useless at certain times of the year because of the congestion and interference.

Much of the two-way land mobile radio communications is now—out of sheer desperation—migrating to the more expensive (from an equipment viewpoint) UHF channels. CB'ers are making desul-

tory moves toward a plan wherein they could acquire operating privileges in a portion of the 10-meter amateur radio band. Actually, rumors abound that the FCC may eventually give CB'ers some portion of the 6-meter band.

Law enforcement agencies, emergency services, fire departments, etc., are all pleading for more two-way radio frequencies. The major metropolitan areas (New York City, Los Angeles, etc.) must have more radio space or be strangled within the next few years by lack of radio communications. The aeronautical service is caught in a fantastic air traffic explosion, with more planes, more airline flights, more airports, etc., all demanding radio frequencies.

The Federal Communications Commission is toying with the idea of channel splitting in the VHF/FM business band, which would effectively double the number of available frequencies, but is encountering opposition. Some halving of channel space is already afoot in England, however.

"Land mobile radio in Britain," said J. R. Brinkley of Pye Telecommunications, Ltd., "is now embarking on the changeover to 12.5-kHz channel spacing."

A few years ago the FCC attempted to break the communications log jam in the 2-3 MHz marine band through the creation of several channels in the VHF/FM band. As this is being written, channel-splitting in this new VHF band is expected to take place in a few months.

Too Many Services. Many people aren't aware of the number and variety of FCC regulated radio communications services that are fighting for channel space. Each service has its own particular set of woes. How many of the following radio services did you suspect even existed?

Motion Pictures	Relay Press
Forest Products	Public Utilities
Taxicabs	Petroleum and Gas Pipeline
Motor Carriers	Auto Emergency Vehicles
Railroads	Telephone Maintenance
Manufacturers	One-Way Signalling
Forestry	Local Government
Conservation	Highway Maintenance
Fire Department	Municipal Police
Rural Radio	
(a telephone service)	
Special emergency	
(ambulances, school buses, etc.)	
Special Industrial	
(highway construction and others)	

Most of the services just listed are crowded into the VHF spectrum where they share (proportionately) a miniscule amount of frequency space in relation to the spectrum allocated for FM and TV broadcasting.

The largest property owner in the radio frequency spectrum is the broadcast industry. It has the right to 82% of all non-government radio frequency allocations below 1000 MHz. In a span of only seven years (1958-1965), the number of licenses to broadcasting stations increased 60%.

Television broadcasting is a real frequency user. Each TV channel extends over a bandwidth of 6 MHz. Since the AM broadcasting band extends from, roughly, 550 to 1600 kHz, this means that each TV channel could contain almost six commercial AM broadcast bands!

The Frequency Grabber. Although broadcasting appears to hold a disproportionate share of radio frequencies, the greatest frequency grabber is the U.S. Government! Roughly speaking, just about 47% of the radio frequency spectrum below 40,000 MHz is allocated to the U.S. Government! And only about 34% is placed under the control of the FCC for non-government use.

Although the Government can find valid and sometimes justifiable reasons for some of its exceptional frequency allocation, the fact remains that somewhere along the line there must have been terrible mismanagement. When you tune from 2 to 50 MHz on any general-coverage communications receiver, you will find a lot of wasteland—vacant channels, misused channels and even redundant channels.

To put it bluntly, the U.S. Government is nothing but a gigantic frequency hog! Although, privately, many Government officials admit that the situation is bad, few if any Government services want to give up—even temporarily—their radio channels.

What Went Wrong? Most two-way radio communications users are unaware that more than 80% of our present facilities came into being after the close of World War II. From the 722 AM broadcast band stations on the air in 1939, and the 919 in 1945, the total now has reached



an astonishing level of 4153! Commercial FM broadcasting stations grew from only 46 transmitters in 1945 to a grand total of 1744 in 1966.

Radio station authorizations in the other radio services saw the same enormous growth:

Amateur Service	
1939 - 53,558	1955 - 142,387
1945 - 60,000	1965 - 280,343
Aeronautical Services	
1939 - 1824	1955 - 43,855
1945 - 3793	1965 - 109,897
Marine Service	
1939 - 4036	1955 - 50,714
1945 - 8676	1965 - 114,075
Land Transportation And Industrial Services	
<small>(no land transportation service existed until 1946)</small>	
1939 - 307	1955 - 44,856
1945 - 576	1965 - 156,995

It is no small wonder, considering the number of transmitters in operation, that in 1964 the Joint Technical Advisory Committee of the IEEE told all those who would listen that all of our radio frequency space is in use and any major change would be difficult to make because of the great amount of money that has been invested.

What Is Going To Happen? A few years ago, Irving Brownstein of the FCC staff said that communications is a world "where frequency cannibalism may be a

major means of survival." In other words, if a radio service doesn't make sufficient and efficient use of their radio frequency allocations, they may wake up some morning and find that their channel is gone. Or, in a nutshell—"use it or lose it!"

Right now might be a good time for all radio amateurs to take a look at their total frequency allocations. How many hams are using those 220-MHz-and-up bands? It is doubtful that the ham is in a very secure position as far as the *use or lose* philosophy is concerned.

Powerful commercial interests are positive that they will secure frequency relief within the foreseeable future. The influential AT&T has asked for 78 channels for a public correspondence service; so far they have received only a piddling 18. The Ford Foundation has proposed a TV satellite relay system which might help pay for educational TV; although everyone admits that the idea is worthy, it's being opposed on the grounds that there's no frequency space available. And what might happen if the CB'ers ever did get organized and presented a united front to the FCC for more frequency space?

Somewhere there is a solution to this problem of frequency strangulation. Whether it will be in the extension of the radio frequency spectrum or getting

(Continued on page 97)



INFORMATION CENTRAL

By CHARLES J. SCHAUERS, W6QLY

ALTHOUGH THIS COLUMN is devoted to assisting readers with their technical problems, there are some areas in which we cannot be of service. For example, your columnist cannot give you legal advice, we cannot intercede with manufacturers or distributors on your behalf, nor can we engage in equipment modification design work—or design equipment to special order.

Although your columnist will occasionally certify a manufacturer's claims for the operation of a specific piece of equipment, we are not in the position to recommend components that we have not field-tested. Obviously, your columnist cannot test every piece of ham gear, or every CB rig, hi-fi system, etc., unless someone develops a 48-hour day.

The questions that are chosen to be answered in this column are those which we feel will be of interest to a majority of our readers. Once again, we request that you do not attempt to engage us in lengthy correspondence and, where possible, confine your inquiry to a simple post card.

Identifying Surplus Gear. *Can you identify some war surplus electronic components if I furnish the part number, coloration, and other markings?*

Sorry, but this task would be practically impossible. Although the major pieces of equipment are easy to identify, values of unmarked transformers, capacitors, etc., can only be guessed at—and only if you have the appropriate wiring schematic.

Series Relays. *I have purchased two identical relays with 6-volt coils. Is there any reason why I can't use these relays on 12 volts if I put the two coils in series?*

No reason why not, provided that your power source has the current to handle the relay coil drain.

"Turn-Signal" Noise. *Although I have managed to take most of the electrical noise out of my mobile CB installation, I still have loud annoying clicks from the turn signal indicator. Is there any way to eliminate this interference?*

It is surprising that you are experiencing any interference, but if you have the opportunity to "get at" your turn signal indica-

tor, try placing a 10-ohm resistor in series with a 0.01- μ F tubular capacitor across the relay contacts. The noise is coming from contact arcing.

SSB Product Detector. *I have a popular low-priced short-wave receiver which is nothing to brag about so far as receiving SSB signals is concerned. It has a BFO, but the weaker SSB signals are unintelligible. Can I add an outboard SSB detector?*

You should be able to get good SSB reception using the very simple product detector diagrammed below. I would suggest re-

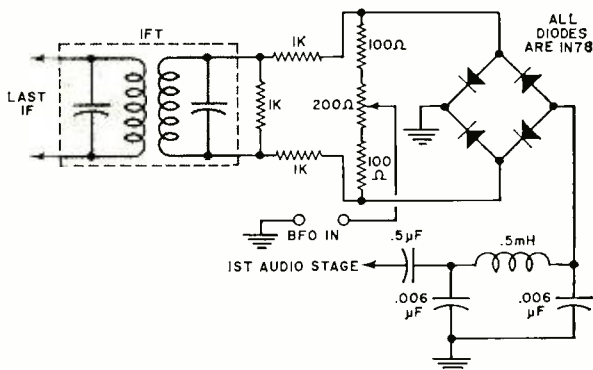

wiring the receiver detector circuit so that the regular AM detector can be switched out and the SSB product detector switched into the circuit. You must make sure that the BFO signal is stable and, in all probability, the high voltage to the BFO will need to be regulated.

Power Supplies In Series? *Is there some way whereby I can take two 300-volt d.c. power supplies (which I bought at a surplus store) and connect them in series to get 500-600 volts output?*

There's an outside chance that this can be done, but it certainly isn't an advisable practice. One power supply would need to be "floated" above ground, and that could be lethal.

Ignition TVI. *Is there a filter that I can install at my TV receiver to eliminate interference from passing trucks and gasoline engine lawn mowers?*

No. This sort of TVI must be cured at the source. Your best bet would be to use a coaxial feeder between the antenna and TV set, and try to locate the antenna as far from the electrical noise sources as possible.

Tube Hum. *My receiver has developed a peculiar hum, and although I have checked all of the power supply components and the tubes, the hum persists. In fact, it increases in intensity as the receiver warms up. Any ideas as to what's going on?*

Sounds like a bad tube with a heater-to-cathode intermittent short. The short occurs as the tube heats up. A good tube tester should indicate this fault.

Conduit Size. *What diameter of conduit pipe should I use to route some electric wires? I would like to put in a separate power line to my shack using three #6 wires.*

Check to see if your local electric code will permit you to do this yourself without inspection. The 1" conduit pipe is the one specified by the National Electric Code, 1965 Edition, Table 1, p. 70-390.

Neons for Voltage Regulation. *I am satisfied with the 1000-volt transistorized power supply that I built to operate my surplus Geiger counter. However, I want to stabilize the voltage at about 900 and was wondering if there was an inexpensive method of doing so?*

Yes, there is, and it is simply using ten NE-2E neon bulbs in series across the power supply output circuit. These neon bulbs will fire at about 90 volts and ten of them should give you a fairly regulated voltage at about 910 volts.

Telephone Extension. *Bargain dial telephones are appearing in the surplus stores and I would like to know if I can connect one of these phones to my present phone line?*

You can if you want to make your local telephone company very angry. There are certain exceptions to the general rules about telephone extension lines, but the way the telephone company sees this practice is that it is the same as bridging your electric watt-hour meter.

Bad Crystal. *Why is it that I have to tap my CB Channel 9 crystal to make it oscillate?*

Initially suspect that your crystal has gone sour or has dirty pin contacts. There might also be a broken or partially unsoldered lead coming into one of the pins. Re-pairing CB crystals is impractical and I suggest buying a new one. By the way, does this always happen, and what effect did an oscillator tube replacement have on keeping the crystal active?

Dynamic Mike Replacement. *My new transceiver specifies the use of a high-impedance microphone. Unfortunately, the only microphones that I have at hand are of the low-impedance variety. How can I use these mikes in a high-impedance circuit?*

The simplest method would be to use an in-line low-to-high-impedance transformer. These transformers are commonly available, but cost between \$8.00 and \$10.00. The circuit shown in the diagram below will do approximately the same job, however. If

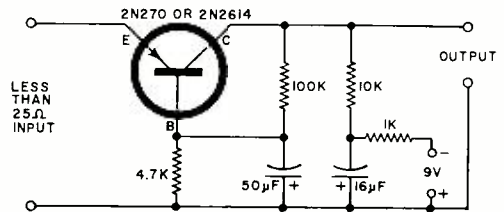

you do make this impedance converter/pre-amplifier, make sure that the input and output leads are carefully shielded and isolated from one another. Just about any good low noise audio transistor will work in this circuit. Make sure to wire up the mike switch so as to prolong the life of the mercury cell.

Mobile Vertical Antenna Tuning. *How do I adjust my 75-meter mobile vertical antenna (center-loaded) for maximum radiation? I am using a Swan SSB transceiver.*

Most commercially available 75-meter mobile antennas really don't need to be peaked up unless they are sold with a rotary or tapped coil. You can adjust your antenna to one frequency by increasing or decreasing the number of turns on the loading coil, or increasing or decreasing the length of the top section of the whip antenna. To determine the resonant frequency of the antenna, wind a 3-turn coil (about 1½" in diameter) of #18 insulated wire. Connect this coil to the coaxial cable plug that would normally be feeding your transceiver, and find the resonant frequency with a grid-dip meter. If the resonant point is too low, use either less coil or less whip; if the resonant frequency is too high, use more coil or more whip. It is sometimes easier to lengthen the top section of the whip by merely clipping two inches or more of ± 12 stiff copper wire to the top end of the whip.

Cascode FET Preamp. *Where can I obtain some up-to-the-minute information on the construction of a 144-MHz cascode pre-amplifier using field effect transistors?*

Try writing to Union Carbide Electronics, 365 Middlefield Rd., Mountain View, Calif.

94041, and asking for a copy of Applications Note AN-9. On p. 14 of this Application Note, you will find a diagram for a 100-MHz cascode amplifier, which can be tuned up on 144 MHz by simply changing capacitor and coil values.

Heater D.C. Supply. *I am building my own hi-fi gear and would like to eliminate all the possibilities of encountering a.c. hum problems by supplying d.c. to the heaters of the preamplifier tubes. These tubes take 6 volts apiece. Do you have a diagram of such a supply?*

The d.c. filament (heater) supply shown in the diagram below should solve your problem. The output of this transistorized sup-

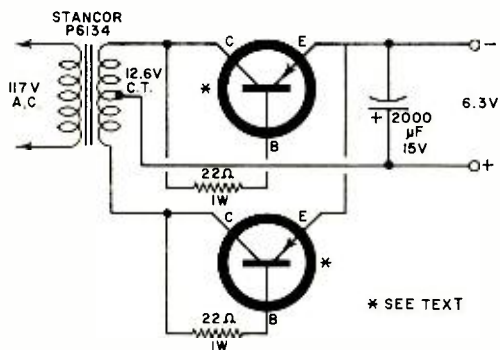

ply is around 9 volts with no load and 6.3 volts under load. If you have a fairly good sized heat sink, any of the following transistors can be used in this circuit: 2N235A, 2N251, 2N307A, 2N376A, or GE-3.

Fresh Batteries. *When I buy a dry cell battery, how can I tell whether or not it is fresh? There must be some way to test them.*

Yes, there are ways and means of testing dry cell batteries, but you won't find such test instruments on dealers' store counters. Your best bet would be to read the article "Build a Combination Battery Charger and Tester" in our August, 1967, issue. Besides testing batteries, this unit will also recharge them if they are not too far gone.

I.F. Transformer Replacement. *I have an old Globe Model CB-100 transceiver and one of the i.f. transformers has shorted. According to the schematic diagram, the i.f. strip was tuned up on 1680 kHz. The manufacturer doesn't have any replacement parts available, but I thought you might be able to suggest one.*

Yes, the J. W. Miller Model 1732 i.f. transformer should tune to 1680 kHz. Try a little capacitive padding if you can't reach your i.f. on the first try.

Remote Control. *I am looking for a simple device that will enable me to turn on a radio in another part of the house by remote control. I am sure that someone must sell these things, because they would be pretty handy.*

If you want to use your 117-volt a.c. house lines, I suggest that you try the Lafayette Radio Electronics wireless remote control—catalog number 99 G 9118. This unit uses the a.c. lines for control signals and will turn electric appliances on and off up to a rating of 500 watts.

NCX-5 Selectivity. *I would like to increase the reception selectivity of my NCX-5 transceiver. Is there a Q-multiplier or a mechanical filter that I could adapt for use in the NCX-5 circuit?*

Because of the very high i.f. in the NCX-5, a Q-multiplier would be impractical. In fact, the upper frequency limit for good Q-multiplier operation is around 1500 kHz. Mechanical filters are just not commonly available for frequencies other than those around 455 kHz. Outside of completely re-vamping the receiver section of this transceiver, there is very little you can do.

Vertical Antenna Installation. *I would like to mount my Hy-Gain 18V on the top of the house, but running those suggested four 33' radials has me perplexed. Can I run the radials down the corners of the house, or must they be underneath the ground?*

Although running the radials in the fashion suggested may be unorthodox, I would certainly try draping the radials down the corners of your house and if at all possible terminating each radial at ground level with a good grounding rod. I have used an antenna installed in a similar manner with good results.

Got a Bug? *Although I live in an apartment building, I have better than average FM reception—possibly due to my top-quality FM receiver. But I can hear voices around 106 MHz. These voices seem conversational and are certainly not part of any radio program. Is there any explanation for them?*

From your description, it sounds as if someone in your apartment building has planted a "bug."

CCTV Radiation. *My closed-circuit TV camera is used to monitor the bedroom of my smaller children. It works fine, but when anyone else in my neighborhood tunes to Channel 6, they can receive my "telecast." Isn't there some way I can prevent this reception?*

Your letter didn't indicate if the signal from the TV camera is fed to your own TV

receiver via a coaxial line. If it is, you should have no radiation problem. However, some CCTV users attempt to connect the camera output to the TV receiver while the receiver is still connected to an outdoor or master antenna system. Obviously, if you connect the camera output to an outdoor antenna, you have a miniature broadcasting station. Make sure that your TV receiver inputs are isolated and that there is no leakage from the CCTV camera to your outdoor antenna.

Electric Combination Lock. Please publish a schematic diagram for a simple electric door lock using rotary tap switches. I would want the switches to set the combination to open a solenoid door lock and a buzzer should sound if the switches are tampered with.

See the diagram below which is a simple combination lock that I built for my own amusement. The four rotary tap switches can be installed in a small metal box. The wires leading from the box cannot be shorted to activate the solenoid lock. You can choose

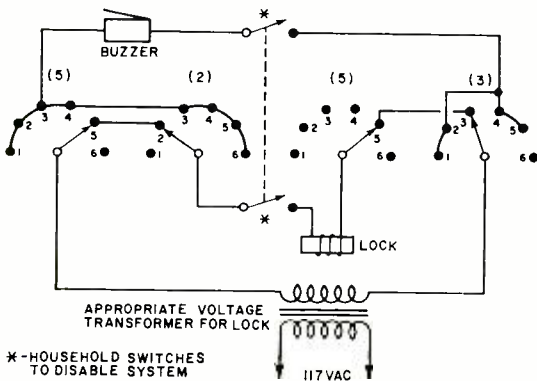

your own combination. The combination shown in the diagram is 5-2-5-3. Arrange the switches so that only the knobs are accessible to the user.

Broadband R.F. Preamplifier. Is it possible to build an r.f. preamplifier (whether tube or transistor type is immaterial) to cover the whole spectrum from 1.6 MHz to 30 MHz without bandswitching? I would like a preamplifier that has at least 10-12 dB gain.

Such preamplifiers have been built successfully; however, none has been seen on the commercial market. The reason is possibly that the necessary very high quality, low-noise transistors make the amplifier very expensive. It is much cheaper to build a tunable, bandswitched r.f. stage directly into the set. In this way, you have the gain where you need it (on the frequency you are listening

to), and yet don't have the possible problem of cross-modulation that might occur with broadband amplification.

VR Tube Firing. If a gaseous voltage regulator tube does not fire so that I can see the purplish glow, is it working? If there is no glow and one is required, what should I do?

A VR tube will fire when it has the proper firing voltage applied across the tube electrodes—generally through appropriate dropping resistors. It is also necessary to be sure that the load is not open. Check the voltages across the VR tube and see if they are—according to the tube manuals—adequate to fire the VR. If the voltages are okay, I would suggest replacing the tube, since it has apparently gone bad.

SWL Problem. I want to listen to the BBC in London, but my Hallicrafters "Sky Buddy" receiver doesn't seem to be selective enough to hear the BBC plainly. Is there anything I can do about it?

This is a pretty old receiver and there is a chance that the alignment is so broad that what little i.f. selectivity you have is almost nonexistent. The short-wave broadcasting bands are very crowded, and it takes a good receiver to hear even the strongest stations. However, a preselector might help and certainly any improvement in the selectivity—such as adding an outboard Q-multiplier—would vastly improve your reception possibilities.

Can You Help? Your Information Central department continues to receive a number of "urgent" information requests for circuit details not in our library. One of these concerns the development of a solid-state circuit that will convert 220 volts at 50 hz to 110 volts at 60 hz. This would permit the operation of U.S.-made tape recorders in parts of Europe. No ideas concerning rotary converters are desired.

How about a method that would eliminate a.c. line hum from a tape recording made under adverse conditions? Supposedly, a bridge-T filter could be constructed to weed out the hum signal, but this might adversely affect the low frequencies also recorded on the tape. It would seem possible that there are other and more sophisticated ways of accomplishing this end result. Does anyone have any ideas?

Your columnist has received dozens of questions on TV servicing and practically all of these questions pertain to "tough dog" TV receivers that no one seems to be able to fix. Your columnist doesn't qualify as a TV repair expert, but feels that there must be some other "answering service" for problems of this nature.

SOLID STATE

By LOU GARNER, Semiconductor Editor

THERE ARE all the signs that a major battle is shaping up between the semiconductor manufacturers. The weapons: low-cost linear integrated circuits suitable for use in TV receivers and other consumer products. The objective: the billion dollar consumer products manufacturers' market. The strategy: the time-honored technique of "being there fustest with the mostest."

Regardless of which manufacturer gains the advantage or reaps the lion's share of sales, the eventual winner will be the general public, who will be able to buy better products at lower prices. In addition, hobbyists and experimenters will benefit from the availability of low-cost "surplus" linear IC's suitable for a wide range of projects.

Motorola, RCA, Philco-Ford and General Electric are basing their strategy on the development of monolithic IC's, while Texas Instruments plans to introduce low-cost monolithic IC's later and at present is moving on a series of new hybrid circuits. A hybrid IC is made up of both monolithic and discrete component elements assembled on a common base (substrate) using thick-film techniques.

At this writing, the battle is nip and tuck. Motorola has gained an early lead with the introduction of IC's suitable for color-TV sets. Its broad line of linear IC devices includes a video i.f. amplifier which may sell

for about 50 cents in very large quantities.

Radio Corporation of America, marketing a broad and versatile line of monolithic IC's, was the first firm to use an IC in a production black-and-white TV receiver, and has recently introduced an IC audio preamplifier which is designed to be mounted under the "belly" of a ceramic phonograph cartridge. The combination permits the ceramic cartridge to be used with low-impedance (transistor) audio amplifiers and, according to early reports, offers a performance comparable to that of more expensive magnetic cartridges.

Several new consumer products featuring IC devices have been introduced by Philco-Ford, including a color-TV receiver with IC's in the video amplifier section, a stereo hi-fi system featuring an IC in the FM receiver, and a remote-control system for home entertainment centers that can control a phonograph as well as a TV set. The R/C system uses an IC in the transmitter.

General Electric, one of the first manufacturers to produce an IC table model radio receiver, introduced three new low-cost IC circuits at the Chicago Parts Show last June, including a 2-watt audio amplifier, an audio preamp, and an i.f. amplifier/discriminator stage. All three circuits are housed in plastic dual-in-line packages and sell for under \$4 each in small quantities.

Texas Instruments' HC-1001 hybrid IC (right) contains complete i.f. strip (A, below) except for tuned circuits. See block diagram at (B). Either high or low impedance audio output is available.

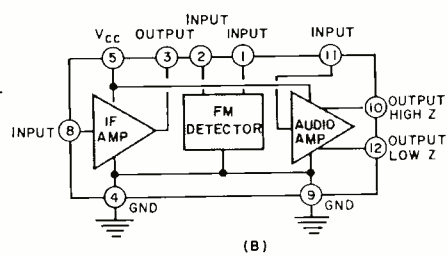
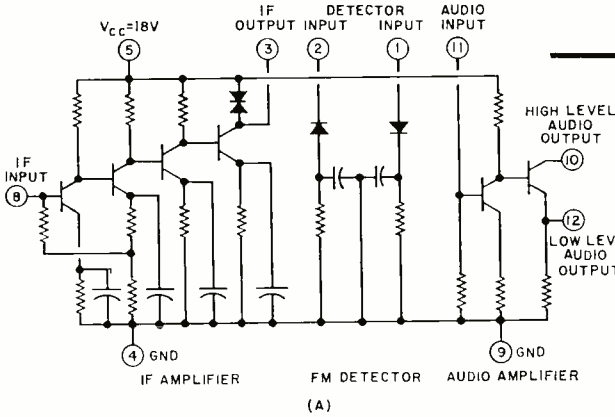

Meanwhile, back at the ranch, Texas Instruments is a strong contender with a line of five new hybrid IC's designed for TV, radio, and phonograph applications. The new items include an FM sound system module and four audio-output modules delivering from 300 mW to 1 watt. Pricing—in large quantities—is in the two-dollar bracket, making the hybrid IC's directly competitive with conventional discrete component circuitry.

Typical of TI's new line, the HC-1001 FM/audio module is dwarfed by a half-dollar (see photo), yet combines the functional equivalent of 30 individual components, as shown by its schematic diagram. Featuring both high- and low-impedance outputs to permit its use in both transistorized and tube circuits, the HC-1001 includes three separate stage functions in a single module: a 4.5-MHz wideband i.f. amplifier, an FM detector, and an audio preamplifier. It is made up of glass-coated transistor, diode, and capacitor semiconductor chips mounted on a ceramic substrate which serves as a base for the chips as well as the thick-film resistors and conductors.

The future? With the battle still raging, the outcome is anyone's guess. But one thing is certain. The switch to IC's is on—and in a BIG way!

Reader's Circuit. Ingenuity is not an exclusive attribute of any one age group. Our mail contains just as many "pet circuits" from teen-agers as from older readers, and there is a good sprinkling of circuits from retired senior citizens. John Ramsey (361 Washington Ave., Kenmore, N. Y. 14217), who submitted the electronic siren circuit illustrated in Fig. 1, is only 14 years old—and a technician at an electronics supply house to boot!

Employing low-cost, non-critical components, the electronic siren can be used in place of a bell or horn on a bicycle, as an attention-getter at parties, as a unique door bell, as part of a science fair project, or as a "just for fun" device.

In his circuit, John has used *pnp* (*Q1*) and *nnp* (*Q2*) transistors in a complementary direct-coupled relaxation oscillator. The loud-speaker serves as *Q1*'s collector load. Transistor *Q2* is direct-coupled to *Q1*, serving as *Q1*'s base bias source, while interstage feedback coupling is provided by *C1*. Base bias for *Q2* is established by voltage divider *R1-R2* and obtained from *C2*'s charge.

In operation, first *S2* is closed to apply power to the circuit. When *S1* is closed, *C2* begins to charge and causes the oscillator to start, and its frequency to increase slowly. If *S1* is released, *C2* starts to discharge, causing the oscillator frequency to decrease. If a push-button switch is used for *S1*, it is possible to effectively simulate a siren.

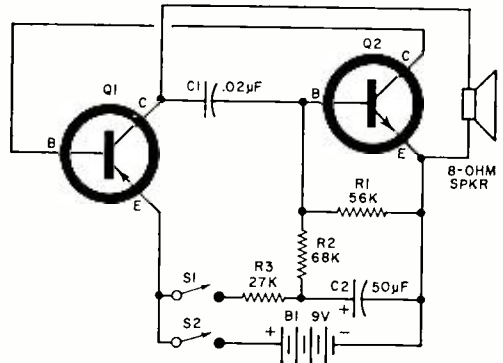

Fig. 1. In John Ramsey's siren, *S1* is a push-button type switch. This circuit makes an ideal electronic substitute for those bicycle-wheel-operated sirens.

Any general-purpose *pnp* power transistor—typically, types 2N155, 2N301 and 2N554—can be used at *Q1*. A low-power *nnp* type, such as IR's TR-09 or Workman's AA2, is at *Q2*.

Manufacturer's Circuit. Suitable for use in an electronic stethoscope, signal tracer, or long-range listening device, the high-gain, low-noise audio amplifier circuit in Fig. 2 was developed by Texas Instruments to demonstrate its premium-quality 2N2586 audio transistors. Overall voltage gain is 1000 (60 dB); input impedance is 340,000 ohms, and output impedance is 12,000 ohms.

This amplifier employs three common-emitter stages, with *nnp* transistors used throughout. Base bias of *Q1* is established by voltage-divider *R1-R2* in conjunction with emitter resistors *R4* and *R5*, with the latter bypassed by *C2*. Resistor *R3* is *Q1*'s collector load, with direct-coupling to the second stage, *Q2*. Thus, *Q1* serves as *Q2*'s base-bias source, in conjunction with emitter resistors *R8* and *R9*, the latter bypassed by *C5*. Resistor *R7* is *Q2*'s collector load, with circuit stabilizing and frequency compensation feedback provided by network *R6-C3*.

The second stage is capacitively coupled to the last stage (*Q3*) through *C4*. Base bias here is established by voltage-divider *R11-R13* in conjunction with emitter resistor *R15*, bypassed by *C7*. Resistor *R14* serves as *Q3*'s collector load, with feedback to the second stage provided by network *R10, R12* and *C6*. A potentiometer (*R12*) in the feedback network is the gain control.

As is common with high-gain circuits, both layout and lead dress are somewhat critical, and reasonable care should be exercised when assembling a duplicate circuit. Although any of a variety of construction methods can be employed—chassis, perforated board, or etched circuitry—all signal leads should be

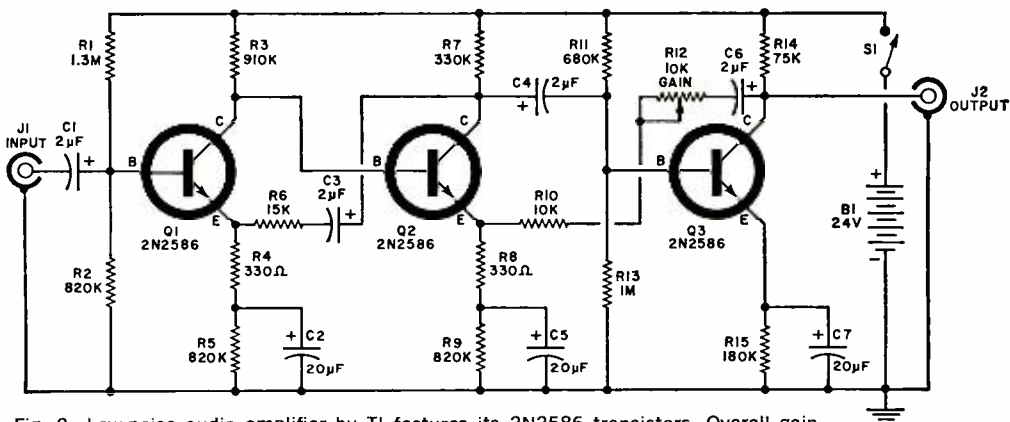

Fig. 2. Low-noise audio amplifier by TI features its 2N2586 transistors. Overall gain is 60 dB, input impedance is 340,000 ohms, and output impedance is 12,000 ohms.

kept short and direct, with adequate spacing provided between the input and output stages. A metal case is preferred as a housing to minimize hum and noise pickup.

Since the amplifier has a moderately high output impedance, best results are obtained if it is used with a power amplifier having a high input impedance or with crystal headphones.

New Devices. Semiconductor manufacturers continue to introduce new and interesting products on an almost day-to-day basis. Although a majority are conventional transistors, diodes, and SCR's with familiar characteristics, a few are unique. The "big news" today lies in two areas: the production of UHF solid-state devices which can compete with exotic vacuum tubes; and the introduction of multiple section and multi-electrode devices using IC construction techniques.

In the UHF field, Texas Instruments has introduced a pair of low-noise, high-gain germanium planar transistors designed to compete with traveling-wave tubes (TWT's) selling in the several-thousand-dollar price range. Identified as Types TIXM105 and TIXM106, the units are assembled in packages ideally suited for UHF circuitry. They can be used at frequencies up to 4 GHz and both have maximum noise figures of only 4.5 dB at 2.25 GHz. As might be expected, they are relatively expensive, but still cost only a fraction of the price of a TWT of comparable performance.

General Electric (Semiconductor Products Department, Syracuse, N. Y.) is now offering a series of low-cost, epoxy-cased devices which features gains from 2000 to 20,000, or more. Identified as Types D16P1 to D16P4, the units are manufactured using monolithic IC construction methods, with each consisting of a pair of planar epitaxial passivated npn silicon transistors in a Darlington con-

figuration, as illustrated by the equivalent circuit in Fig. 3 (a). Used as emitter followers, they can provide input impedances as high as several megohms. Although each device consists of two internally cascaded transistors, in practice each is used as if it were a single high-gain transistor.

Another manufacturer, Amperex Electronic Corporation (Slatersville, R. I. 02876), is offering a multiple device called a "BiFET." Identified as Type TAA-320, the unit consists of a MOSFET input stage direct-coupled to a bipolar transistor amplifier on a single silicon semiconductor chip mounted in a TO-18 case. The BiFET's internal circuitry is shown schematically in Fig. 3 (b). These units feature a minimum transconductance of 40,000 μ mho and a typical gate-to-source im-

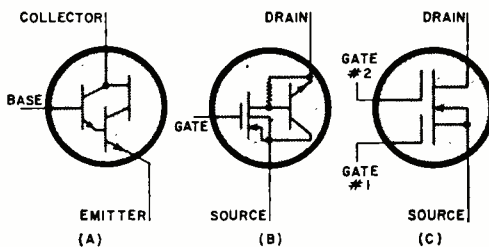

Fig. 3. Some of the latest semiconductor devices: (A) GE's Darlington pair, (B) Amperex's BiFET, (C) RCA's dual-gate, n-channel silicon MOSFET unit.

pedance of—hold your breath—10,000 megohms! Priced at less than \$3 each in small quantities, the BiFET is relatively insensitive to voltage transients as compared to conventional MOSFET devices.

With an eye on multigrad tube applications, RCA (Electronic Components and Devices, Harrison, N. J.) has developed a dual-
(Continued on page 110)



ON THE CITIZENS BAND

By MATT SPINELLO, KHC2060, CB Editor

THE American Radio Relay League, founded in 1914 as the national organization of radio amateurs, has expressed the belief that a closer relationship between Citizens Band and amateur radio operators can and should be developed. In a letter directed to its affiliated clubs, the ARRL said that they had completed a study of the ways in which amateurs could work more

ARRL CB SURVEY

closely with CB'ers, primarily to encourage qualified CB'ers to seek amateur licenses. The organization noted that a worthwhile program must be adopted on a local level, but that such a program would work only if hams and amateur clubs are willing to support it actively. Affiliated ARRL clubs were asked to comment on (1) their willingness to cooperate with CB clubs; (2) their interest in participating in a program locally; and (3) their desire to work with local CB clubs in providing guest speakers, setting up joint meetings, establishing a code course, etc.

In a similar mailing, the ARRL informed CB radio clubs (from a list made available to them by POPULAR ELECTRONICS) of the proposal made to the amateur groups and asked them to enter their comments on a *CB/Amateur Radio Planning Survey* questionnaire. The statistics derived from the returns will help the ARRL launch a constructive program.

Your CB Editor would like to encourage CB licensees and clubs to get behind this

movement, especially those hundreds of readers who have written requesting information on how they might learn more about electronic theory, operating procedures, code, club activities, emergency communications networks, etc. A rapport between the amateur and CB groups would be of immeasurable value on a local, state-wide, and even on a national basis. CB'ers and hams have proven this theory in the past by joining forces to give assistance during tornadoes, hurricanes, and earthquakes.

Indianapolis Crime Alert. More than 300 CB operators recently attended a briefing held by the Indianapolis Police Department, the Marion County Sheriff's Department, and the Indiana State Police, to encourage CB'ers to participate in a community-wide "Crime Alert" program. Law officers provided each CB'er with a Crime Alert card and folder explaining how to describe a suspect. Speakers discussed do's and don't's for observing and reporting crime suspects, and how CB'ers could be of valuable assistance in combating crime.

An Indianapolis CB equipment dealer, John Stiles, told the group that police officials had volunteered to conduct additional meetings for CB'ers in an effort to expand two-way radio participation in the Indianapolis fight against crime. He urged the group to draft a written proposal to the police department describing how the CB'ers would organize themselves to obtain maximum efficiency and results.

(Continued on page 103)



Hundreds of CB'ers were encouraged to participate in the Crime Alert program that was initiated recently in Indianapolis, Ind., by police officials. They are shown here being briefed by Captain Frank Campbell.

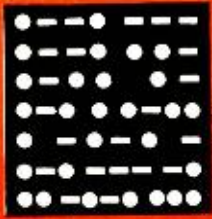

AMATEUR RADIO

By **HERB S. BRIER, W9EGQ**
Amateur Radio Editor

HC9EP RESCUED FROM THE PACIFIC

IN DECEMBER, 1966, *Expedicion Pacifica* left Ecuador. It consisted of three adventurers, Vital Azar, Manalo Camino, and Mack Modena, aboard a primitive raft constructed of 11 large balsa logs. They hoped to drift to Australia—just as prehistoric South American sailors were supposed to have done. The raft was equipped with a gasoline-powered, 20-meter transceiver with the call-sign of HC9EP. With this rig, they kept in contact with the Expedition Control Station, XE1EEI, operated by Rafael Corcura, Guadalajara, Mexico.

By March 12 the raft had only drifted 800 miles west of Panama, but it was so waterlogged that there were eight inches of water over its "deck." Moving the transceiver to the roof of the cabin, the crew advised XE1EEI that waves were breaking over the raft, sharks were circling about them, and that they might be able to stay afloat another three or four days.

XE1EEI contacted Julio Erento, W6ZOM, San Diego, Calif., who immediately alerted the U. S. State Department in Washington, D.C., and the Air-Sea Rescue Group in the Panama Canal Zone via amateur radio,

Coast Guard Communications, and MARS. On March 14, HC9EP contacted W6ZOM (apparently the only station that could read the raft) to report worsening conditions and to request immediate rescue. HP1JC in Panama reported that the rescue plane would arrive the next morning.

At 6 a.m., W6ZOM, again the only station that could read the raft, heard HC9EP continually repeating its position, and reporting heavy seas, a 3000' ceiling, and visibility of one mile. By 10:20 a.m., the rescue aircraft had a radar fix on the raft and was in radio contact with the crew. The raftsmen could hear the plane overhead, but neither party could see the other through the clouds.

At last the plane found a hole in the clouds several miles away from the raft, and the plane and the raft saw each other for the first time. Simultaneously, the plane saw a German ship disappearing in the distance. Upon being alerted, the ship swung around and plucked the three men from the sinking raft at 1 p.m.

Amateurs from seven countries, the U.S. Coast Guard, the Air-Sea Rescue Service,

Donald Quelch, WB2EXP, of Neptune City, N.J., has been an amateur for three years. His Drake TR-3 transceiver—feeding a Telrex beam on 15 meters and simple antennas for the other bands—has worked all states, all continents, and 58 countries. Don is a member of Navy MARS and holds a 25-wpm code certificate. He will receive a free one-year subscription for submitting the winner for October in our Amateur Station of the Month photo contest. If you would like to enter the contest, send a clear photo of your station showing you at the controls and some details on your ham career and the equipment you use to: Amateur Photo Contest, c/o Herb S. Brier, W9EGQ, P.O. Box 678, Gary, Ind. 46401.

AMATEUR STATION OF THE MONTH





This is the balsa raft on which Vital Azar, Manalo Camino, and Mack Modena, put to sea late last year. They were rescued some three months later 800 miles west of Panama after calling for help via amateur radio station HC9EP.

Navy MARS, the Mexican Emergency Net, the West Coast Amateur Radio Service Net, and the YL International SSB Communications System cooperated in this rescue operation. Our thanks to Ed Gribi, WB6IZF, one of those involved, for the information from which this account was written.

FCC News. The Federal Communications Commission has added nine questions and deleted one from its Novice Study Guide, making a total of 50 questions in the Guide. The new questions—and answers—are included in the latest edition of the American Radio Relay League "License Manual;" so if you are studying for the Novice exam, we strongly advise getting the latest manual. The new questions are no more difficult than the old but they touch on new fields, such as the use of diodes and transistors.

The FCC has denied another petition to

eliminate code from amateur license examinations. This petition was from Robert B. Bose, Ormond Beach, Fla., who wanted the code test removed from the Technician exam. In its denial of the petition, the FCC again cited Article 41 of the International Radio Regulations (Geneva, 1959) which requires all applicants for amateur licenses to demonstrate the ability to send and receive the International Morse code.

Speaking of the code and Technician licenses, the ARRL is considering recommending to the FCC that Technician Class amateurs be allowed to operate code in the 80-, 40-, and 15-meter Novice bands with power up to 75 watts. It sounds like a sensible suggestion to POPULAR ELECTRONICS.

According to an FCC Public Notice, via the Amateur Radio News Service *Bulletin*, an unlicensed station using the call letters of WBBH was broadcasting classical music
(Continued on page 112)

A. R. Friesen, VE3GLF, Arnprior, Ontario, Canada, works 80 through 10 meters with a home-brew, 100-watt transmitter feeding a Gotham V-80 vertical antenna, and a Hallicrafters S-77A receiver. Rag-chewing on 80 and 40 CW is VE3GLF's favorite pastime.

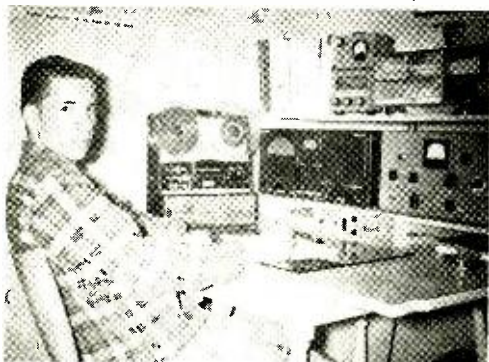

As a Novice, Mark Kustwan, WN1HEC, Indian Orchard, Mass., used a Knight-Kit T-60 transmitter to make 450 contacts in 15 countries. When he became a General, he obtained a Johnson "Valiant."



SHORT-WAVE LISTENING

By HANK BENNETT, W2PNA/WPE2FT
Short-Wave Editor

BROADCASTING STATION NEWS AROUND THE WORLD

IN THE AUGUST ISSUE, we mentioned in this column that the *Voice of America* had discontinued sending verification cards to U. S. listeners. Last month we said that one of our reporters had written to the VOA for a further explanation of its policy, and had, in return, received a QSL for the Tangier relay on which he had reported earlier. At press time we've learned that the VOA has now reversed its earlier decision.

A statement from a VOA official reads: "After a detailed view of the situation, we are reinstating the mailing of QSL cards. If again you hear a *Voice of America* transmitter and provide us with sufficient information, we will issue the verification."

The Near East. During the June Near East crisis, there was good-to-excellent reception of the following stations in Europe and the U.S.: Cairo on 11,915 and 11,940 kHz with Arabic services and on 9475 and 12,005 kHz with a European service; *Kol Israel*, Jerusalem, on 9009, 9625, and 9725 kHz; *R. Amman*, Jordan, on 11,810 kHz, days, and on 9530 kHz at night; *R. Baghdad*, Iraq, on 7180 kHz, days, and on 6030 and 6095 kHz, nights; *R. Damascus*, Syria, on 9555 kHz, days, and on 15,165 kHz, nights; *R. Algier*, Algeria, on 11,835 kHz, days, in French, and on 9685 kHz in the Kabyl language. These are all good frequencies to monitor. (The "day" and "night" listings given above are in GMT.)

Albania. *Radio New York Worldwide* reports that *R. Tirana* has begun a daily program in Indonesian for Indonesians living in Europe! Since it is broadcast only on the medium waves, 1088 kHz, at 2030-2100, DX'ers in North America stand virtually no chance of hearing it. But this is the first time, to our knowledge, that a European station is broadcasting a daily program on the medium waves for an Asian country that has citizens living in Europe. Wonder how many listeners the station has to this particular program?

Australia. According to *Telecoms Journal*, an Australian publication, the new booster

station of *R. Australia* will be located at Cox Peninsula near Darwin, and will be in operation in mid-1968. Programs from Shepparton will be rebroadcast to give better reception in Asian areas. Initially, the new station will provide up to three simultaneous transmissions in various languages with a power output of 250 kW each.

The antenna system is from Italy, the radio link circuits were manufactured in the U. S., and receiving equipment items are products of the United Kingdom and Australia. A system of so-called "broad-band vertically-polarized logarithmically-periodic transmission antennas" will be used, each of which is suitable for operation at any frequency between 7 and 26 MHz.

(Continued on page 115)



Irvin Knorr, VE3PE2HM, of St. Jacobs, Ontario, Canada, has 41 countries, 29 states, and all Canadian provinces verified. His equipment includes a Heathkit "Comanche" MR-1 with a Trio preselector, and a Webster all-band antenna, 25 feet high.

Eddie Williams, WPE4JGM, a resident of Rockmart, Ga., uses a Hallicrafters S-130 receiver most of the time but there are two other units in standby service. Eddie has 15 countries confirmed so far.

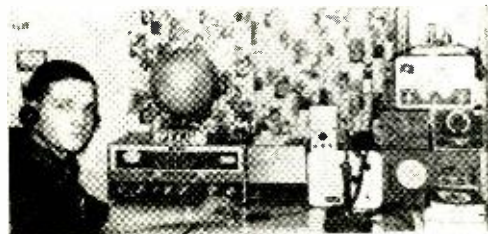

ENGLISH-LANGUAGE BROADCASTS TO WESTERN NORTH AMERICA FOR THE MONTH OF OCTOBER

Prepared by **ROBERT LEGGE**

A number of Western listeners have requested the listing of more broadcasts beamed to that area. We have therefore expanded the Western North America section to a full page for this issue, to permit inclusion of *all* broadcasts announced for Western North America (except some of the 24 hourly Tokyo broadcasts), some "North American" broadcasts that are scheduled at a more suitable time for Western than Eastern listeners, and a few additional broadcasts not announced for North America but receivable in the Western area. The latter are marked with an asterisk. Comments by Western listeners as to whether or not you would like to have this expanded schedule continued will be appreciated.

TIME—PST	TIME—GMT	STATION AND LOCATION	FREQUENCIES (MHz)
7 a.m.	1500	*Djakarta, Indonesia	9.865
		*Melbourne, Australia Tokyo, Japan	7.22, 9.58 9.505
7:30 a.m.	1530	*Hanoi, North Vietnam	9.76, 11.76
8 a.m.	1600	Stockholm, Sweden	15.24
6 p.m.	0200	Melbourne, Australia	15.32, 17.84
		Taipei, China Tokyo, Japan	15.125, 17.72, 17.89 15.135, 15.235, 17.825
6:30 p.m.	0230	Johannesburg, South Africa	9.705, 11.97
7 p.m.	0300	Madrid, Spain	6.13, 9.76
		Peking, China	9.457, 11.82, 15.095
		Seoul, Korea	15.43
7:20 p.m.	0320	Yerevan, U.S.S.R.	15.14, 17.775 (Tues., Wed., Fri., Sat.)
7:30 p.m.	0330	Prague, Czechoslovakia	5.93, 7.345, 11.99
		Stockholm, Sweden	11.705
7:45 p.m.	0345	Berlin, Germany	9.56, 9.65
8 p.m.	0400	Havana, Cuba	6.135, 6.17
		Lisbon, Portugal	6.025, 6.185, 9.68
		Moscow, U.S.S.R. (via Khabarovsk)	15.14, 17.775, 17.88
		Peking, China	9.457, 11.82, 15.095
		Quito, Ecuador	9.745, 11.915, 15.115
		Sofia, Bulgaria	9.70
8:15 p.m.	0415	Bangkok, Thailand	11.91
8:30 p.m.	0430	Bucharest, Rumania	9.57, 11.94, 15.25
		Budapest, Hungary	9.833, 11.91
		Kiev, U.S.S.R.	9.61, 9.685, 11.755 (Mon., Thurs., Sat.)
8:45 p.m.	0445	Berlin, Germany	9.56, 9.65
		Cologne, Germany	9.735, 11.945
9 p.m.	0500	Havana, Cuba	6.135, 6.17
		Moscow, U.S.S.R.	9.665, 9.685, 11.755
9:15 p.m.	0515	Berne, Switzerland	6.12, 9.695
10 p.m.	0600	Buenos Aires, Argentina	9.69 (Mon.-Fri.)
		Moscow, U.S.S.R. (via Khabarovsk)	15.14, 15.18, 17.88
		Tokyo, Japan	15.105
10:30 p.m.	0630	Havana, Cuba	9.655

ENGLISH-LANGUAGE BROADCASTS TO EASTERN NORTH AMERICA

FOR THE MONTH OF OCTOBER

Prepared by **BILL LEGGE**











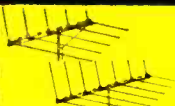
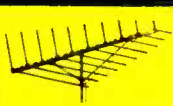
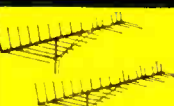
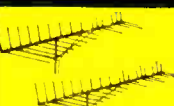
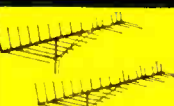

TIME—EST	TIME—GMT	STATION AND LOCATION	FREQUENCIES (MHz)
6:15 a.m.	1115	Melbourne, Australia	11.71
7 a.m.	1200	Bonaire, Neth. Antilles	11.82
7:15 a.m.	1215	Montreal, Canada	9.625, 11.72
7:45 a.m.	1245	Copenhagen, Denmark	15.165
9 a.m.	1400	Prague, Czechoslovakia	15.448, 17.705, 21.45 (Sun.)
		Quito, Ecuador	15.115, 17.89
		Stockholm, Sweden	17.84
9:30 a.m.	1430	London, England	21.61
3 p.m.	2000	Accra, Ghana	9.76, 11.85
3:15 p.m.	2015	Stockholm, Sweden	11.705
4 p.m.	2100	Hilversum, Holland	11.73, 15.425 (exc. Sun.)
4:15 p.m.	2115	London, England	11.78, 15.26
5 p.m.	2200	Moscow, U.S.S.R.	9.665, 9.685, 11.755
5:30 p.m.	2230	Vilnius, U.S.S.R.	9.53, 9.665 (Fri., Sun.)
6 p.m.	2300	London, England	9.58, 11.78, 15.26
6:30 p.m.	2330	Johannesburg, South Africa	9.705, 11.97
6:45 p.m.	2345	Tokyo, Japan	15.135, 17.825
7 p.m.	0000	London, England	7.13, 9.58, 11.78
		Moscow, U.S.S.R.	9.665, 9.685, 11.755
		Peking, China	15.06, 17.68
		Sofia, Bulgaria	9.70
		Tirana, Albania	7.263
7:30 p.m.	0030	Bonaire, Neth. Antilles	11.815
		Budapest, Hungary	9.833, 11.91
		Kiev, U.S.S.R.	9.685, 11.755
			(Mon., Thurs., Sat.)
		Stockholm, Sweden	11.805
7:50 p.m.	0050	Vatican City	7.27, 9.69, 11.76
8 p.m.	0100	Berlin, Germany	9.73, 11.89
		Havana, Cuba	6.17
		Madrid, Spain	6.13, 9.76
		Melbourne, Australia	15.32, 17.84
		Prague, Czechoslovakia	5.93, 7.345, 11.99
		Rome, Italy	9.63, 11.81
8:30 p.m.	0130	Berne, Switzerland	6.12, 9.535, 11.715
		Bucharest, Rumania	11.94, 15.25
		Cairo, U.A.R.	9.475
		Cologne, Germany	9.64, 11.945
		Hilversum, Holland	9.59 (Bonaire relay)
		Johannesburg, South Africa	9.705, 11.97
8:45 p.m.	0145	Copenhagen, Denmark	9.52
9 p.m.	0200	Lisbon, Portugal	6.025, 6.185, 9.68
		London, England	7.13, 9.58, 11.78
		Moscow, U.S.S.R.	9.665, 9.685, 11.755
		Peking, China	15.06, 17.68
		Stockholm, Sweden	11.805
9:30 p.m.	0230	Beirut, Lebanon	11.785
		Berlin, Germany	9.73, 11.89
10 p.m.	0300	Budapest, Hungary	9.833, 11.91
		Buenos Aires, Argentina	9.69 (Mon.-Fri.)
		Lisbon, Portugal	5.985

NEW FINCO[®] COLOR SPECTRUM[™] antennas are "signal customized" for better color reception...

"the ANTENNA that captures the RAINBOW"

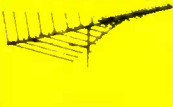
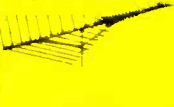
FINCO has developed the Color Spectrum Series of antennas— "Signal Customized" — to exactly fit the requirements of any given area. There is a model scientifically designed and engineered for your area.

Check this chart for the FINCO "Signal Customized" Antenna best suited for your area.

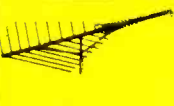
STRENGTH OF UHF SIGNAL AT RECEIVING ANTENNA LOCATION	Strength of VHF Signal at Receiving Antenna Location						
	NO VHF	VHF SIGNAL STRONG	VHF SIGNAL MODERATE	VHF SIGNAL WEAK	VHF SIGNAL VERY WEAK		
NO UHF →		 CS-V3 \$10.95	 CS-V5 \$17.50	 CS-V7 \$24.95	 CS-V10 \$35.95	 CS-V15 \$48.50	 CS-V18 \$56.50
UHF SIGNAL STRONG →	 CS-U1 \$9.95	 CS-A1 \$18.95	 CS-B1 \$29.95	 CS-C1 \$43.95	 CS-E1 \$43.95		
UHF SIGNAL WEAK →	 CS-U2 \$14.95	 CS-A2 \$22.95	 CS-B3 \$49.95	 CS-C3 \$59.95	 CS-D3 \$69.95		
UHF SIGNAL VERY WEAK →	 CS-U3 \$21.95	 CS-A3 \$30.95	 CS-B3 \$49.95	 CS-C3 \$59.95	 CS-D3 \$69.95		

NOTE: In addition to the regular 300 ohm models (above), each model is available in a 75 ohm coaxial cable downlead where this type of installation is preferable. These models, designated "XCS", each come complete with a compact behind-the-set 75 ohm to 300 ohm balun-splitter to match the antenna system to the proper set terminals.



THE FINNEY COMPANY
34 West Interstate Street
Dept. PE • Bedford, Ohio 44146

Send for free brochure

Name _____
Address _____
City _____ State _____ Zip _____

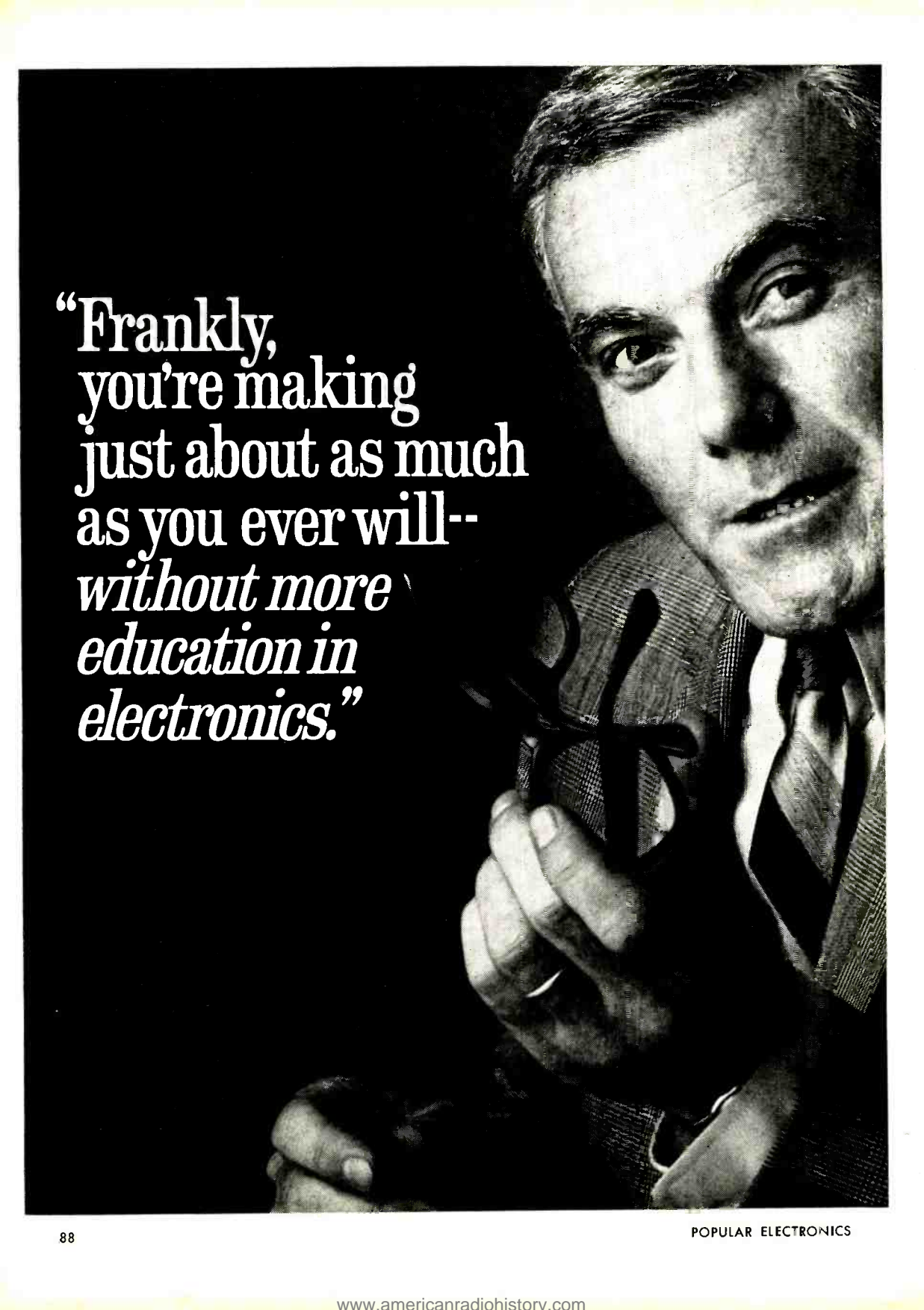

“Frankly,
you’re making
just about as much
as you ever will--
*without more
education in
electronics.*”

Ask any man who really knows the electronics industry.

Opportunities are few for men without advanced technical education. If you stay on that level, you'll never make much money. And you'll be among the first to go in a layoff.

But, if you supplement your experience with more education in electronics, you can become a specialist. You'll enjoy good income and excellent security. You won't have to worry about automation or advances in technology putting you out of a job.

How can you get the additional education you must have to protect your future—and the future of those who depend on you? Going back to school isn't easy for a man with a job and family obligations.

CREI Home Study Programs offer you a practical way to get more education without going back to school. You study at home, at your own pace, on your own schedule. And you study with the assurance that what you learn can be applied on the job immediately to make you worth more money to your employer.

You're eligible for a CREI Program if you work in electronics and have a high school education. Our FREE book gives complete information. Air-mail postpaid card for your copy. If card is detached, use coupon below or write: CREI, Dept. 1210E, 3224 Sixteenth Street, N.W., Washington, D.C. 20010.



40
Years
Progress

The Capitol Radio Engineering Institute

A Division of McGraw-Hill, Inc.

Dept. 1210E, 3224 Sixteenth Street, N.W.

Washington, D.C. 20010

Please send me FREE book describing CREI Programs. I am employed in electronics and have a high school education.

NAME _____ AGE _____

ADDRESS _____

CITY _____ STATE _____ ZIP CODE _____

EMPLOYED BY _____

TYPE OF PRESENT WORK _____ G.I. BILL

- I am interested in Electronic Engineering Technology
 Space Electronics Nuclear Engineering Technology
 Industrial Electronics for Automation
 Computer Systems Technology

APPROVED FOR TRAINING UNDER NEW G.I. BILL

Founded 1927

CREI

Accredited Member
of the National Home Study Council

Move up to 30 watt Courier Business Band.

\$219.50!



FCC TYPE ACCEPTED

FLEET COURIER 30B. Powered for the business and commercial operator. Lowest price unit of its kind (FCC Type Accepted). Big power input (30 watts) and output. Greater range. Reduced interference. Increased antenna height. If you use CB for business communications — move up to Fleet Courier 30B!

COURIER COMMUNICATIONS, INC.

56 Hamilton Ave.,
White Plains, N. Y. 10601

Whittaker
CORPORATION
a subsidiary of

Yes! Tell me all about FLEET COURIER 30B.

Name _____ PE-710

Address _____

City _____ County _____

State _____ Zip _____

CIRCLE NO. 12 ON READER SERVICE PAGE

Argos' new speaker technology creates a genuine price breakthrough in two-way system design.



The new Argos TX-200 is a totally new dimension in high fidelity sound reproduction systems — a superb instrument offering fine-furniture construction, big-system performance and compactness for maximum versatility. The TX-200 matches a specially-designed high compliance, low-resonance woofer with a new high-compression horn-loaded driver component to produce distortion-free response from 30 Hz to the inaudibles at 18,000 Hz.

Specifications

Cabinet: Select walnut, Belgian linen grille. Size: 18 $\frac{3}{8}$ " x 11 $\frac{1}{8}$ " x 7 $\frac{7}{8}$ ".
Price: Audiophile net \$45.00.

Argos
Products Company
Genoa, Illinois 60135

CIRCLE NO. 3 ON READER SERVICE PAGE

NEW LITERATURE

To obtain a copy of any of the catalogs or leaflets described below, simply fill in and mail the coupon on page 15.

Edmund Scientific has a brand-new catalog — its third this year — jam-packed with almost 4000 unusual and stimulating items. Highlighted are: psychedelic art plaques, an accurately calibrated giant (4") rule, an atomic energy lab and cloud chamber, and "Flexi-light" — a gadget that pipes light around corners and illuminates hidden areas.

Circle No. 87 on Reader Service Page 15

Improved CB communications is the stated aim of a brochure released by the Antenna Division of *Avanti Research and Development, Inc.* The brochure discusses the Avanti approach to this end by utilizing horizontal as well as vertical transmission to almost double channel capacity, and taking advantage of the signal directivity found in beam antennas to minimize interference.

Circle No. 88 on Reader Service Page 15

Practical hints on the proper use of electrical tapes in electronic servicing are presented in a new 32-page illustrated booklet published by the *3M Company*. Among the 21 topics covered are: how to protect power input connections, wiring harnessing, circuit isolation protection, and antenna protection.

Circle No. 89 on Reader Service Page 15

A 12-page catalog detailing the frequency control crystals manufactured by *Texas Crystals* is now available. Engineering data, crystal holder description, and military specifications are given.

Circle No. 90 on Reader Service Page 15

Included in the color TV capacitor replacement guide compiled by *Cornell-Dubilier Electronics* are all the electrolytic capacitors used in color chassis made by 32 different set manufacturers. The booklet indicates the recommended Color-Lytic® replacement by cross reference to the OEM number, and also direct reference to rating capacity/voltage.

Circle No. 91 on Reader Service Page 15

Another color-TV cross-reference guide recently announced is a 4-pager by the *J. W. Miller Company* for eight new color-TV sweep, linearity, and convergence coils. Over 200 exact replacements are provided by the eight coils.

Circle No. 92 on Reader Service Page 15

FREE!

Live Better Electronically With

LAFAYETTE RADIO ELECTRONICS

NOW OFF PRESS!

Latest Electronics Buying Guide

1968 CATALOG 680

Over 500 Pages



New!
23 Channel 2-Way
CB Radio
All Solid State
with IC's



New!
Solid State Stereo
Tape Recorders
with Automatic Reverse



New!
Solid State FM-AM
Receivers
with "IC" & FET's

*A complete buying guide to HI-FI, CB, Amateur gear,
Optics, Musical Instruments, Tools, and Auto Accessories*



LAFAYETTE Radio ELECTRONICS
Dept. 11-7 P.O. Box 10
Syosset, L.I., N.Y. 11791



**SEND
FOR YOUR
FREE
COPY
TODAY!**

Send me the Free 1968 Lafayette Catalog 680

11-7

Name _____

Address _____

City _____ State _____ Zip _____

(Please Give Your Zip Code No.)

CIRCLE NO. 24 ON READER SERVICE PAGE

UNUSUAL BARGAINS

... MANY U. S. GOV'T SURPLUS

GIANT WEATHER BALLOONS

"Balls of fun" for kids, traffic stoppers for stores, terrific for amateur meteorologists. Create a neighborhood sensation. Great backyard fun. Exciting beach attraction. Made of heavy duty neoprene. Inflate with vacuum cleaner or auto air hose; or locally available helium for high rise.



Order Stock Number 60,568AV... (8' diam).... \$2 Ppd.
Order Stock Number 60,632AV... (16' diam).... \$7 Ppd.

NEW SURPLUS NI-CD BATTERIES



Save more than 50%! Long life—accept 300 charge and discharge cycles, 1.25 Volts per cell—750 milliampere hours capacity. Excel. charge retention. Hermetically sealed, indefinite storage life. Multiple cells welded in series—easily up. Combine to form btry. 3/8" dia. x 1 1/8" high. Spec. price for 100 up. Low-cost charger separate.

Order #	Cells	DC Volt.	Price Ppd.
Stock Number 40,986AV	1	1.25	\$ 1.50
Stock Number 40,987AV	2	2.50	2.75
Stock Number 60,633AV	3	3.75	3.60
Stock Number 60,634AV	4	5.00	4.80
Stock Number 70,812AV	Trickle Charger (1-10 cells)		10.95

Order by Stock No.—Check or M.O. Money-Back Guarantee
EDMUND SCIENTIFIC CO., Barrington, N.J. 08007

GIANT FREE CATALOG "AV"

Completely new 1968 edition. New items, categories, illustrations. 148 easy-to-read pages packed with nearly 4000 unusual items. Dozens of electrical and electromagnetic parts, accessories. Enormous selection of Astronomical Telescopes, Microscopes, Binoculars, Magnifiers, Magnets, Lenses, Prisms. Many war surplus items; for hobbyists, experimenters, workshops, factory. Write for catalog "AV". Please include your Zip Code.



ORDER BY STOCK NUMBER • SEND CHECK OR MONEY ORDER • MONEY BACK GUARANTEE
EDMUND SCIENTIFIC CO., BARRINGTON, NEW JERSEY 08007
CIRCLE NO. 14 ON READER SERVICE PAGE

Audio-Color

Lets you see your music

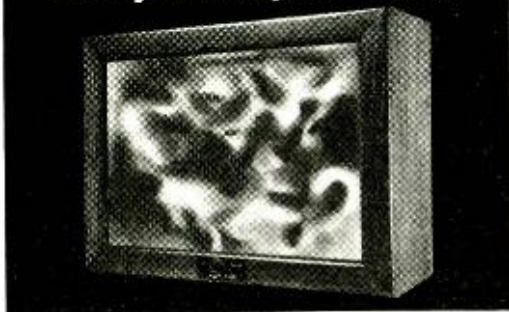

ASSEMBLED \$54.95 **KIT FORM \$44.95**

\$5 DOWN — \$5 MONTH

Walnut finished cabinet included / Shipped REA Collect
Easy to build, easy to install. All transistor AUDIO-COLOR adds a visual dimension to musical enjoyment. A brilliantly moving panorama of color casts dancing images on a soft frosted screen, reflecting rising and falling volume with each beat of the music. Here's a truly unique and exciting new musical experience. Make check or money order to CONAR.

SEND FOR FREE CONAR CATALOG

CONAR

Division of National Radio Institute,
Dept. KA7C 3939 Wisconsin Ave.,
Washington, D.C. 20016



OPERATION ASSIST

Through this column we try to make it possible for readers needing information on outdated, obscure, and unusual radio-electronics gear to get help from other P.E. readers. Here's how it works: Check the list below. If you can help anyone with a schematic or other information, write him directly—he'll appreciate it. If you need help, send a postcard to Operation Assist, POPULAR ELECTRONICS, One Park Avenue, New York, N.Y. 10016. Give maker's name, model number, year of manufacture, bands covered, tubes used, etc. State specifically what you want, i.e., schematic, source for parts, etc. Be sure to print or type everything legibly, including your name and address. Because we get so many inquiries, none of them can be acknowledged. POPULAR ELECTRONICS reserves the right to publish only those items not available from normal sources.

Pierson Model KE-93 receiver: tunes ECB, 160 to 10 meters. Instruction manual needed. (E.W. Brown, 6030 Sixth Ave., Los Angeles, Calif. 90043)

Precise Model 315K oscilloscope. Schematic and assembly instructions needed. (R.F. Quick, 33 Stephen Place, Rockaway, N.J. 07866)

American Bosch Magneto radio. 1928 model. =215-31X tube needed. (Richard Haug, Brentwood Public School, Brentwood, N.Y.)

Stromberg-Carlson Model 130-M receiver, ser. 1301331; has 7 tubes; circa 1930. Schematic and parts list needed. (Brian Cullen, 980 50th Ave., Montreal 32, P.Q., Canada)

General Electric Model K-66-M receiver; tunes 0.55-3 MHz on 2 bands. Schematic and/or parts list needed. (Kenny Logsdon, 615 Edith Rd., Louisville, Ky. 40206)

Abbott Instruments Model DK-3 s.w. transceiver. Schematic or tube and power supply information needed. **Philco BC-1066-B receiver;** has 3 tubes; 2 bands. Technical manual needed. (Charles Welte, 146 Linden Ave., Kearny, N.J. 07032)

RCA battery receiver; tunes ECB; has 6 tubes; ser. 318119 on cabinet; contained in Brunswick radiophono-graph Model BR-160; circa 1924. Schematic and source of tubes needed. (Walter H. Smartt, M.D., 3020 Bay-view Dr., Manhattan Beach, Calif. 90266)

Webster-Chicago Model 80-1 wire recorder. Schematic and servicing information needed. (Ron Wilhelm, R.D. 1, Leetonia, Ohio 41431)

Precision Apparatus Model 858 "Multi-Master," ser. 4257. Schematic and operating manual needed. (D.O. Terraicciano, 85-47 Little Neck Pkwy, Floral Park, N.Y. 11011)

AJA Electronic Co. (W. Germany) AJA Type 5812 receiver. Schematic needed. **Weston Model 686 vacuum tube tester,** type 10 A. Schematic and operating manual needed. (Arthur Hall, Jr., 603 Glenpark Ct., Nashville, Tenn. 37217)

Superior Instruments Model 670-A voltmeter. Schematic and instruction manual needed. (Keith P. Layel, 3007 E. Long Ave., Gastonia, N.C. 28502)

Oxford Tartak Model CT-400 capacitor analyzer; uses 2 tubes. Operating manual and schematic needed. (William G. Gorlich, 516 Summit Ave., Westville, N.J. 08093)

Hallicrafters Model T541171 TV receiver; circa 1948. 7JP4 tube and schematic needed. (Jim Bellows, 991 Eastman Rd., Midland, Mich. 48610)

(Continued on page 96)

Now There Are 3 Heathkit® Color TV's To Choose From

Introducing The NEW Deluxe Heathkit "227" Color TV

Exclusive Heathkit Self-Servicing Features. Like the famous Heathkit "295" and "180" color TV's, the new Heathkit "227" features a built-in dot generator plus full color photos and simple instructions so you can set-up, converge and maintain the best color pictures at all times. Add to this the detailed trouble-shooting charts in the manual, and you put an end to costly TV service calls for periodic picture convergence and minor repairs. No other brand of color TV has this money-saving self-servicing feature.

Advanced Performance Features. Boasts new RCA Perma-Chrome picture tube with 227 sq. in. rectangular viewing area for 40% brighter pictures . . . 24,000 v. regulated picture power and improved "rare earth" phosphors for more brilliant, livelier colors . . . new improved low voltage power supply with boosted B+ for best operation . . . automatic de-aussing combined with exclusive Heath Magna-Shield that "cleans" the picture every-time you turn the set on from a "cold" start, and keeps colors pure and clean regardless of set movement or placement . . . automatic color control and gated automatic gain control to reduce color fade and insure steady, flutter-free pictures even under adverse conditions . . . preassembled & aligned 3-stage IF . . . preassembled & aligned 2-speed transistor UHF tuner and deluxe VHF turret tuner with "memory" fine tuning . . . 300 & 75 ohm VHF antenna inputs . . . two hi-fi sound outputs . . . 4" x 6" 8 ohm speaker . . . one-piece mask & control panel for simple installation in a wall, your custom cabinet or either optional Heath factory-assembled cabinets. Build in 25 hours.

GRA-227-1, Walnut cabinet **\$59.95**
GRA-227-2, Mediterranean Oak cabinet (shown above) . . . **\$94.50**



Kit GR-227
\$399⁹⁵
 (less cabinet)

Kit GRA-27
\$19⁹⁵



New Remote Control For Heathkit Color TV

Now change channels and turn your Heathkit color TV off and on from the comfort of your armchair with this new remote control kit. Use with Heathkit GR-227, GR-295 and GR-180 color TV's. Includes 20' cable.



Kit GR-295
\$479⁹⁵
 (less cabinet)

Deluxe Heathkit "295" Color TV

Has same high performance features and built-in servicing facilities as new GR-227, except for 295 sq. in. viewing area (industry's largest picture) . . . 25,000 volt picture power . . . universal main control panel for versatile in-wall installation . . . and 6" x 9" speaker.

GRA-295-1, Walnut cabinet (illus. above) **\$62.95**
GRA-295-3, Early American cabinet **\$99.95**
GRA-295-2, Deluxe walnut cabinet **\$94.50**



Kit GR-180
\$349⁹⁵
 (less cabinet)

Deluxe Heathkit "180" Color TV

Same high performance features and exclusive self-servicing facilities as new GR-227 (above) except for 180 sq. in. viewing area.

GRA-180-1, Contemporary walnut cabinet **\$49.95**
GRA-180-2, Early American cabinet **\$75.00**
GRA-180-3, Table model cabinet **\$24.95**
GRA-180-5, Table model cabinet & mobile cart (illus. above) **\$39.95**



NEW FREE 1968 CATALOG!

Now with more kits, more color. Fully describes these along with over 300 kits for stereo/hi-fi, color TV, electronic organs, electric guitar & amplifier, amateur radio, marine, educational, CB, home & hobby. Mail coupon or write Heath Company, Benton Harbor, Michigan 49022.

HEATH COMPANY, Dept. 10-10
 Benton Harbor, Michigan 49022
 In Canada, Daystrom Ltd.

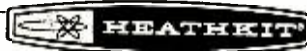

Enclosed is \$ _____, including shipping.

Please send model (s) _____

Please send FREE Heathkit Catalog.

Name _____

Address _____

City _____

State _____

Zip _____

Prices & specifications subject to change without notice.

CL-306

**ENGINEARED
FOR
EXCELLENCE:
TOP-QUALITY
TELEX
HEADSETS**

!
Ham operators, hi-fi fans and audio engineers all endorse famous TELEX headsets; known for top grade performance for more than 25 years.



MAGNA-TWIN—Typifies the quality standards which have made Telex a favorite of hams. Delivers absolute maximum intelligibility under difficult QRM conditions; equipped with super-comfort foam cushions. Rugged, moisture-proof magnetic drivers give excellent sensitivity. Made of tough, high-impact plastic for outstanding durability under hard usage.

MORE THAN 50 DIFFERENT MODELS TO CHOOSE FROM, PRICED TO \$59.95



**TELEX
acoustics**

A DIVISION OF THE
TELEX CORPORATION
3054 EXCELSIOR BOULEVARD
MINNEAPOLIS, MINN. 55416

CIRCLE NO. 42 ON READER SERVICE PAGE

ASSIST

(Continued from page 94)

Bendix Model MN-26LB "Radio Compass" receiver; has 12 tubes; 3 bands (200-410 kHz, 550-1200 kHz, 2-6 MHz); circa 1951. Operating manual and/or schematic needed. (Mark Feldman, 5007 N. Mozart, Chicago, Ill. 60625)

Hickox Model 19-X crystal-controlled microvolt generator, tunes 85 kHz to 144 MHz; has 7 ranges; 100- and 1000-kHz calibration positions. Schematic and operating manual needed. **Osborne Electronics** "Duo-Comm-100" walkie-talkies; 1.5 watts input, 35.160 MHz. Schematic and operating manual needed. (Bob Richards, 902 North Park, Helena, Mont.)

Grunow 10-tube superhet all-wave receiver; chassis 11G; made by General Household Utilities. Parts list and schematic needed. (M. Jackson, 20 Colfax Ave., Midvale, N.J. 07465)

RCA Model 96K2 receiver; tunes 510-1720 kHz, 2300-22,000 kHz. Schematic and part values needed. **Harpers** Model NK727 tape recorder; 7" hi-fi twin speakers. Schematic needed. (Chih K. Wong, 160 Madison St., New York, N.Y. 10002)

Canadian Marconi 95386/4802 transceiver (PN1A transmitter); tunes 3-6 MHz. Schematic, operating manual, and micro-headset 111-516 needed. (Terrence Craig, 1683 Mallard Dr., Ottawa 5, Ont., Canada)

Philco Model 827 BC-band receiver; has 6 tubes. Schematic and source of parts needed. (Jonathan Prigot, 324 Pine St., Westfield, N.J. 07090)

Espey Model 513 AM-FM receiver. Schematic and operating manual needed. (Stan Fidler, 6262 Walker St., Philadelphia, Pa. 19135)

Zenith Model 9H981LP AM-FM phono console; circa 1918. Turntable center post needed. (Gary Davis, 9601 Spruce, Kansas City, Mo. 64137)

Link receiver, type 11 UF Ed 3, ser. 15828. Schematic needed. (Walter E. Nichols, Lake Rd., RR-3, E. Hampton, Conn. 06424)

National NC-101X s.w. receiver; tunes 10-160 meters in 5 bands; has 11 tubes. Schematic and operating manual needed. (Francis A. Rath, 5312 Sharynne Ln. Torrance, Calif. 90505; and James Belanger, 719C Salerno Circle, Fort Devens, Mass. 01433)

E.H. Scott Model RB-CZC-16149 receiver; tunes 0.53 to 15.6 MHz on 3 bands; has 11 tubes; circa 1942. Dial marker, dial plate, and knobs needed. (Paul T. Judkins, 1200 Stuart Rd., Herndon, Va. 22070)

Vico 87 monaural amplifier/dreamplifier, 20 watts; manufactured by Video Instruments. **TEC** S-25 stereo amplifier/preamplifier, 25 watts per channel; manufactured by Transis-Tronics. Schematics needed. (Alan R. Kossack, 128 Bayard Ave., Hamden, Conn. 06518)

Daystrom Model DA-286 AM/FM tuner; circa 1961. Operating manual and schematic needed. (Jeff Walker, Box 167, Wright Quadrangle, Indiana University, Bloomington, Ind. 47401)

E.H. Scott Model SLF-F radio; tunes 80-550 kHz and 1.9-24.0 MHz; ser. 1057. Operating manual and schematic needed. (W. A. Clams, 2509 52 St. S., St. Petersburg, Fla.)

Dumont Model 329A oscilloscope. Schematic and servicing instructions needed. (Dennis Graham, 409 S. Pearl Ave., Compton, Calif. 90221)

Reiner Model 556 cathode-ray oscilloscope, ser. 247. Schematic, service manual, and calibration information needed. (Carl C. Henry, Jr., 308 W. 4th St., Erie, Pa. 16507)

Sonar Model SR-9 2-meter receiver; has 9 tubes; tunes 143.8 to 148.1 MHz. Schematic needed. (John T. Los, 27 Milmohr Ct., Northport, L.I., N.Y. 11768)

Atwater-Kent Model C55 receiver; has 5 tubes. Schematic, parts list, type and source of speaker needed. (William E. Cowles, III, 36 Robbins Rd., Watertown, Mass. 02172)

Heathkit Model QF-1 Q-multiplier. Instructions on hooking up receiver needed. (Kell Corcoran, 3211 Flowertree Rd., Orlando, Fla. 32809)

Jackson Model 103 tube tester. Schematic and/or operating manual needed. (George Mayer, 218 Osborne Rd., Albany, N.Y. 12205)

Superior Model 1130-S signal generator, and **Superior** channel analyzer (no model number); circa 1940. Operating instructions and schematics needed. (Alfred E. Jordan, 897 Vine St., Murray, Utah 84107) —30—

SUPER-SATURATION?

(Continued from page 73)

more out of what we already have is an interesting problem. A possibility—being very seriously discussed—is taking some radio services off the air. More than one “objectively-minded” engineer is aware that radio and TV broadcasting could be carried throughout this country by land coaxial cable or wire lines as well as by radio waves.

One solution, with an eye towards unifying the fight against frequency poverty, is contained in a recent Department of Commerce report by a panel of non-government experts.* This panel recommended the creation of what might be called a “Super FCC.”

First, said the panel, this super-agency would find out who uses two-way radio communications and what they are used for. Then, all users would be ranked as to their importance to the national economy and how much their growth depended upon communications. This agency would judge who was doing the best job all the way down to who was doing the worst job. The Department of Commerce panel says coyly that it is “aware of the magnitude of the difficulties and complexities” facing such a group, but then adds that the agency would need a free hand.

Interestingly enough, the panel also criticized the “radio smog” generated by wireless remote controls, wireless microphones, gadgets and toys, electronic appliances, electronic industrial heaters, and various types of medical equipment.

In the early 1920's, well before these days of radio frequency congestion, glut, and smog, numerous radio experimenters claimed that they had received signals from outer space. There is always a chance that someone out there just might be listening to this mess. What will we do when “they” decide to speak to us by radio? Answer? Or, give them a citation for illegal transmissions? Somehow, this just doesn't seem to be a serious problem. With all the radio frequency congestion, it's doubtful that we'll hear them. —30—

*“Electromagnetic Spectrum Utilization—The Silent Crisis”, Telecommunications Science Panel of the Department of Commerce Technical Board.

color coded nutdriver sets

in new “keep and carry” cases

Sturdy plastic cases keep nutdrivers in order on the workbench. Tight fitting, snap-lock covers protect tools when not in use, permit carrying them on service calls without danger of spilling or becoming lost in tool box.

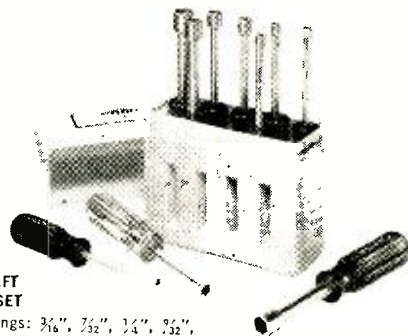

No. HS6-18
HOLLOW SHAFT
NUTDRIVER SET

10 Hex Openings: $\frac{3}{16}$ ", $\frac{7}{32}$ ", $\frac{1}{4}$ ", $\frac{9}{32}$ ",
 $\frac{5}{16}$ ", $\frac{11}{32}$ ", $\frac{3}{8}$ ", $\frac{7}{16}$ ", $\frac{1}{2}$ ", $\frac{9}{16}$ ".
Yellow, slipover cover case.



No. 77
DRILLED SHAFT
NUTDRIVER SET

7 Hex Openings: $\frac{3}{16}$ ", $\frac{7}{32}$ ", $\frac{1}{4}$ ",
 $\frac{9}{32}$ ", $\frac{5}{16}$ ", $\frac{11}{32}$ ", $\frac{3}{8}$ ". Hole depth $\frac{1}{4}$ ".
Black, pebble grain, hinged cover case.

professional quality

Precision fit, case-hardened sockets; polished and plated steel shafts; shockproof, breakproof, color coded plastic (UL) handles.

XCELITE

XCELITE, INC., 20 BANK ST., ORCHARD PARK, N. Y. 14127

Send Bulletin N567 with information on nutdriver sets in “keep and carry” cases.

name _____

address _____

city _____ state & zip _____

CIRCLE NO. 46 ON READER SERVICE PAGE

NEW Mosley

CB STACK'IT Beam

Extra gain for nearly 1/2 the previous cost of stacking Mosley beams.

4610 N. Lindbergh Blvd.

Mosley Electronics Inc. Bridgeton Missouri 63042

Please send me FREE of charge and obligation, literature on the STACK'IT beams.

Name _____

Address _____

City/State _____

Zip Code No. _____

Mosley Electronics Inc. #108

4610 N. Lindbergh Blvd. Bridgeton Mo. 63042

CIRCLE NO. 26 ON READER SERVICE PAGE



SMALL BUT POWERFUL

DON'T BE FOOLED BY IMITATIONS!
Get the ORIGINAL

SYDMUR SOLID STATE "CD" IGNITION SYSTEM!

High Quality Components used throughout. Fiberglass Printed Circuit Board. Unitized Construction. Simplified Kit Assembly.

Construction Article in Nov. 1966 Popular Electronics

Thousands of satisfied customers.

Write for Free Literature TODAY.

COMPAC Assembled . . . \$34.75*

COMPAC KIT 24.95*

*Add 75c for mailing and handling

N.Y. State Residents add Sales Tax.

SYDMUR ELECTRONICS SPECIALTIES

1268 E. 12th St.

Brooklyn, N.Y. 11230

WRITE NOW FOR 1968 SENT FREE

McGEE'S CATALOG

1001 BARGAINS IN

SPEAKERS—PARTS—TUBES—HIGH FIDELITY COMPONENTS—RECORD CHANGERS—

Tape Recorders—Kits—Everything in Electronics

1901 McGee Street, Kansas City, (PE), Missouri 64108

IC FREQ METER

(Continued from page 56)

Avoid pegging the meter by always starting one range *above* the frequency you want to measure. Best operation occurs when the *Gain* control is advanced 1/8th of a turn beyond the point where the meter first produces a steady indication.

For power inverter work, there's a different way to use the frequency meter. Calibrate the instrument against the 60-Hz power line and then plug the frequency meter's power line cord into the in-



Fig. 5. Actual-size layout of PC board. Drill as shown in Fig. 2; mount components as per Fig. 3.

verter, leaving the *Freq/60 Hz* switch in the 60 Hz position. Now, read the frequency directly. The zener-regulated supply automatically takes care of any inverter voltage from 70 to 160 volts, at any frequency from 30 to 1200 Hz.

In cases where you're measuring pulses or other low duty cycle signals, you'll get best results with a narrow, *negative-going* input waveform. -30-

HART-65 TRANSMITTER

(Continued from page 47)

Crystals. Use a 3.5-MHz crystal for the 80-meter band, or a 7-MHz crystal for 40 meters. Although the transmitter will put out a 40-meter signal with an 80-meter crystal if *C5* is inadvertently set near minimum capacitance, NEVER operate the rig in this manner because it will radiate a strong subharmonic at the fundamental frequency.

Use only FT-243 type crystals, which are furnished in Bakelite cases that measure approximately $\frac{3}{16}$ " wide, $1\frac{1}{8}$ " high, and $\frac{7}{16}$ " thick. They are widely available on the surplus market at prices ranging from \$1 to \$1.50. Smaller HC6/U hermetically sealed crystals cannot be used in the HART-65 because they will over-heat, drift, and possibly shatter.

The transmitter will not function satisfactorily on the 20-, 15-, or 10-meter bands. Don't attempt to modify it for such service.

Testing. The power supply delivers up to 700 volts. Consequently, while performing the following tests, you must be sure to keep your fingers out of the works!

After double-checking for wiring errors, plug in the power cord, attach a 100-watt bulb to *J1*, plug in an 80-meter crystal, and connect a telegraph key to *TS1*. Tighten *C1* for maximum capacitance. Set *C5* (*Tune*) and *C6* (*Ant. Loading*) at maximum capacitance, place *Band Switch S1* in the 80M (meter) position, and place the *Pad* switch (*S2*) in the IN (closed) position. Turn on the a.c. power. After a one-minute warm-up, close the key. Relay *K1* should click shut. Slowly reduce the capacitance of *C5* until the 100-watt lamp glows brightest. Mark the position of *C5*'s knob with "80M". In the future, whenever you work 80 meters, *C5* should always be set to approximately this point.

Plug in a 40-meter crystal. Place the *Band Switch* (*S1*) in the 40M (meter) position, and set the *Pad* switch (*S2*) in the OUT (open) position. Adjust *C5* for maximum lamp brilliance, and mark the

TURNER +2 "Best CB Microphone



in the World!"

That's what many +2 owners say, and we're glad they're so enthusiastic. It's the only microphone on the market that actually increases the output of your microphone up to 50 times at the twist of a dial. It makes a world of difference on CB (and amateur), so why in the world don't you get one? List Price \$49.50

THE TURNER MICROPHONE COMPANY
946 17th Street N.E.
Cedar Rapids, Iowa

In Canada: Tri-Tel Associates Ltd.
Export: Ad Auriema, Inc. 85 Broad Street,
New York, N.Y. 10004

NOW! IMMEDIATE DELIVERY EVERYWHERE!

CIRCLE NO. 43 ON READER SERVICE PAGE

NEW ALLIED 1968 CATALOG & BUYING GUIDE

FREE

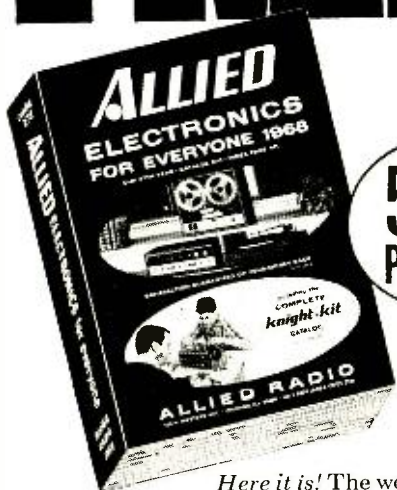

**518
PAGES**

Here it is! The world's most famous catalog of electronic equipment featuring hundreds of new and exclusive items and special Allied values.

518 pages—including the complete Knight-Kit Catalog — picturing, describing, and pricing thousands upon thousands of items. The most complete inventory ever assembled of Hi-Fi, Radios, Tape Recorders, CB, Electronic Equipment, Parts and Tools... all at money-saving low prices.

NO MONEY DOWN — UP TO 2 YEARS TO PAY!
BIG SAVINGS ON THE BEST IN ELECTRONICS FOR EVERYONE
 • Stereo Hi-Fi • Famous Knight-Kits® • Tape Recorders & Tape
 • CB 2-Way Radios • Walkie-Talkies • FM-AM & AM Radios
 • Shortwave Receivers • Portable TV • Phonographs • Transistors
 • Intercoms & PA • Automotive Electronics • Test Instruments
 • TV Antennas & Tubes • Power Tools, Hardware
 • Amateur Equipment • Tubes • Parts, Batteries, Books

WRITE FOR YOUR COPY TODAY!

ALLIED RADIO, Dept. 3K
P.O. Box 4398, Chicago, Ill. 60680
Send me your free catalog for 1968

NAME _____ Please Print

ADDRESS _____

CITY _____

STATE _____ ZIP CODE _____

CIRCLE NO. 1 ON READER SERVICE PAGE

position of the tuning knob with "40M".

Remove the antenna from your ham receiver and tune in the transmitter's signal. Send a series of rapid dots while slowly opening *C1* (reducing capacitance) with an insulated screwdriver. Use only enough capacitance to assure reliable, chirp-free starting of the crystal every time the key is operated. When *C1* is properly adjusted, indicator lamp *I1* (marked *XTAL*) will barely glow. If it lights up brightly, too much current is flowing through the crystal.

Bear in mind, too, that *T1*, *V1*, the r.f. chokes and several resistors are operated above their continuous-duty ratings. Therefore, when you're tuning the rig, never hold the key down for more than 10 seconds at a time. Always allow a 15-second cooling interval before operating the key again.

Antennas. For maximum performance and minimum harmonic radiation, separate center-fed half-wave antennas for 80 and 40 meters are recommended. Do not attempt to get by with a multiband radiator or a random-length wire.

If an 80-meter dipole is too long for your piece of real estate, don't hesitate to bend it around corners, or even droop the ends. Whatever the final arrangement, though, make certain that you have a total of 125' of wire in the air.

Although the antenna itself must be cut to the dimensions given in Fig. 5, the feeder can be of any convenient length. RG-59/U coaxial cable can be used if you want a fancy installation, but Belden 8222 75-ohm receiving-type twin

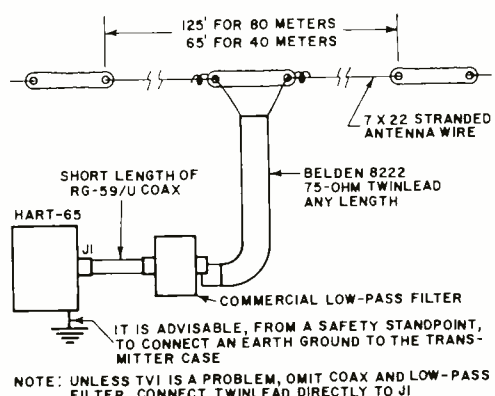

Fig. 5. Suggested antenna system for the HART-65. The commercial TVI filter is an optional feature.

lead, at \$1.65 per hundred feet, will cost a lot less and will perform quite satisfactorily.

On The Air. Plug in the appropriate crystal and antenna. Place the *Band Switch (S1)* in the appropriate position. Set *C5 (Tune)* at the correct band mark, then place the *Pad switch (S2)* in the IN position. Slowly reduce the capacitance of *C6 (Ant. Loading)* while slightly readjusting *C5* for brightest indication on *I2* and *I3* (marked *Line*). On 40 meters, you may find it necessary to place the *Pad switch* in the OUT position to obtain the most power from the transmitter.

If lamps *I2* and *I3* are very dim, or don't glow at all, disconnect one of them. This will double the current through the other and you should then get a usable indication. On the other hand, if the bulbs are very bright, you may find it necessary to add a third—similar—bulb, one in parallel with the other two to prevent them from burning out. Bulb brightness is dependent on feed line length and the amount of standing wave present in your particular installation. Since *I2* and *I3* are relative indicators only, just tune for the best indication and forget about how bright or dim they are at maximum output.

When you've completed the tuning process, the knob of *C5* should be fairly close to the band marked on the panel. If it isn't, your antenna is not properly constructed, the *Band Switch* is in the wrong position, or *C6* has been set at too low a capacitance with the *Pad switch* in the OUT position. In any case, don't work 80 meters with *C5* at less than half capacitance, because the nearer *C5* approaches minimum capacitance, the more likely the transmitter is to put out an unwanted 40-meter harmonic.

While testing the prototype, Novices and Generals were worked throughout the U.S. and Canada on both 80 and 40 meters. The little rig has a click-free pure d.c. note that is a joy to copy. It is rock-steady on 80, and its 40-meter stability compares favorably with that of many low-cost VFO transmitters presently on the market.

If you're looking for an inexpensive way to put out a truly effective signal, the HART-65 is a construction project well worth considering.

-30-

October, 1967

The CB-20 "Reacter" is one of seven solid state CB transceiver brands on the market selling for less than \$100. Even if their specifications were

comparable,*

doesn't it

make

sense

to buy yours

from the company that has built more communications rigs by a country mile than all the others put together?



hallicrafters

A Subsidiary of Northrop Corporation
5th and Kostner Aves.
Chicago, Ill. 60624

*The CB-20's specs are a matter of conservative record: Channels: 5, crystal-controlled. Transistors: 12 plus 8 diodes. Zener voltage regulator. Sensitivity: One microvolt for 10 db S/N ratio. Audio power output: 3 watts. Power supply: 12 V. dc only. Modulation: high order. Microphone: push-to-talk ceramic. Maximum current drain: Receive, 0.75 amp.; Transmit, 1.4 amps. Dimensions: 7" x 6" x 2 1/4" LWH. Weight: 4 lbs. PS 20 AC pedestal power supply available as an accessory.

Export: Int'l. Div. Canada: Gould Sales Co.
CIRCLE NO. 18 ON READER SERVICE PAGE

101

Popular SAMS BOOKS



USE THIS HANDY ORDER FORM

RECENTLY PUBLISHED! TIMELY!

- Transistor Substitution Handbook.** *New 7th edition*—more complete than ever. Lists thousands of direct transistor substitutions—U.S., foreign (including replacements for Japanese types), both home entertainment and industrial. Order 20529, only..... \$1.75
- Slide Rule in Electronics.** How to use the slide rule for quick electronics calculations. Tells how to figure resistance, reactance, impedance, current and voltage relationships, etc. Order 20532, only..... \$4.25
- Troubleshooting with the Oscilloscope.** *Newly revised.* Explains clearly how to isolate electronic circuit troubles through waveform analysis. Covers testing of solid-state devices, use of triggered sweep scopes, etc. Order 20550, only..... \$3.95
- 101 Ways to Use Your Hi-Fi Test Equipment.** *Newly revised.* Explains proper use of these specialized instruments; gives test setups, procedures, and how to evaluate results. Order 20552, only..... \$2.95
- Basic Electricity & An Introduction To Electronics.** *Newly revised.* Clear coverage of electricity fundamentals, followed by an explanation of electronics basics. Ideal for home study. Order 20540, only..... \$3.95
- How To Read Schematic Diagrams.** Not only shows you how to read and interpret diagrams, but analyzes each component, its construction, and its circuit purpose and use. Order 20337, only..... \$2.25
- TV Servicing Guide.** Tells you how to apply proper trouble shooting procedures based on analysis of symptoms, illustrated by picture tube photos. Packed with troubleshooting and servicing hints. Order 20361, only..... \$2.50
- Color-TV Servicing Made Easy, Vol. 1.** Full explanation of color principles, circuitry, setup adjustments, and servicing of all color-TV sets. Takes the mystery out of servicing color-TV. Order 20135..... \$3.25
- ABC's of Citizens Band Radio.** NEWLY REVISED & UPDATED. All you need to know about planning and setting up a CB 2-way radio system. Explains functions, principles, setup and operation, latest rules and regulations. Order 20019..... \$2.25
- Transistor Ignition Systems Handbook, 20238..... \$2.95**
- TV Tube Symptoms & Troubles, 20476..... 1.95**
- Citizens Band Radio Handbook, 20101..... 3.50**
- 2nd-Class Radiotelephone License Handbook, 20316..... 4.75**
- Modern Dictionary of Electronics, 20151..... 7.95**
- Handbook of Electronic Tables & Formulas, 20230..... 3.95**
- Color TV Trouble Clues, 20120..... 1.95**
- Solving TV Tough-Dogs, 20403..... 3.25**

FAMOUS ABC'S BOOKS

- Lasers & Masers, 20262..... \$2.25
- Modern Radio, 20047..... \$1.95
- Electronic Test Probes, 20039..... 2.25
- Transistors, 20440..... 2.25
- Computer Programming, 20123..... 2.25
- Tape Recording, 20395..... 1.50

— HOWARD W. SAMS & CO., INC. —

Order from any Electronic Parts Distributor, or mail to Howard W. Sams & Co., Inc., Dept. PE-10 4300 W. 62nd St., Indianapolis, Ind. 46268

Send books checked above. \$ _____ enclosed.

Send FREE Sams Book Catalog.

Name _____
PLEASE PRINT

Address _____

City _____ State _____ Zip _____

CIRCLE NO. 35 ON READER SERVICE PAGE

MEMO MINDER

(Continued from page 51)

the box, they should be painted with a flat, black paint. Be sure to paint both the inside and outside of the tube.

When the glue and paint have dried, R6 should be inserted in the end of the tube and held in place with a dab of glue. The paper guides should be temporarily mounted in the box and the socket for I1 should be bent and oriented so that it will be in line with the tube housing R6. There should be enough space left in the box to mount the remainder of the components as shown in Fig. 3. The socket for I2 must be an enclosed type so it will not interfere with the proper operation of the photoresistor.

The power supply consists of T1, which has a center tapped 12.6-volt secondary, rectifier D1, and filter capacitor C1.

The circuit can be built on a small piece of vector board or a printed circuit can be made. Sockets for Q1 and SCR1 are not absolutely essential but, if possible, should be used. Layout of the components is not at all critical but be sure to refer to the base diagrams for Q1 and SCR1 when wiring the circuit.

Adjustment. It is advisable to temporarily insert a 5000- to 10,000-ohm potentiometer in place of R3. Turn on the power and adjust the potentiometer until proper operation of I2 is obtained—when a piece of paper is put into the slot, bulb I2 should flash about once a second. Improper operation would be indicated by I2 staying on all of the time, or not flashing at all. When the piece of paper is removed, the light should flash once and then remain off.

While you're making this adjustment, be sure there isn't any bright light shining on the open box since this might adversely affect the proper operation of R6. Once the proper value of R3 has been determined and an equivalent-valued fixed resistor has been wired into the circuit, the Memo Minder is complete. If desired, a Sonalert alarm (A1) and associated on-off switch S1 can be included as shown in Fig. 1.

Plug in the Memo Minder, and when it wants you, it will let you know. —50—

ON THE CITIZENS BAND

(Continued from page 81)

Mr. Stiles informed the audience that his firm was cooperating with Regency Electronics, Inc., a CB transceiver manufacturer, in sponsoring the efforts of CB'ers in Crime Alert. The two companies produced a Crime Alert certificate and window decal for presentation to each two-way radio equipped CB'er attending the meeting.

The get-together ended with a lengthy question-and-answer session. Law enforcement officials, Stiles, and By Crum, Regency Public Relations Director, stated that they were quite enthusiastic about the response at the meeting. They said that they would explore all ways in which CB operators could help become an organized and effective force in the city's crusade against crime.

FCC Readies CB Rule Enforcement. On July 21, Chairman Rosel H. Hyde of the FCC spelled out plans for CB rule enforcement. Appearing before the Senate Appropriations Subcommittee, Chairman Hyde said that CB is one of the Commission's most vexing prob-

lems. Because disregard of the rules has become so widespread, the usefulness of CB to the public has been seriously impaired.

The FCC is proposing that the Congress grant money to initiate a pilot enforcement program that would be concentrated in a specific geographic area. This pilot program would evaluate the effects of increased CB monitoring, investigations, and inspections. If successful, the program would be shifted to other areas as soon as possible.

EIA Recommends Use of Channel 9. The Electronic Industries Association's CB Section has formally recommended to the FCC that channel 9 be set aside for highway emergency communications.

The EIA CB Section is composed of representatives of numerous CB equipment manufacturers. A majority of the manufacturers support the premise that present-day CB transceivers have more potential for providing a communications link between motorists than the side-tracked and kicked-around HELP program.

In acknowledging the EIA resolution, the FCC praised the suggestion as being "most helpful," but did not indicate if formal action would be taken.

Last-Minute Jam-formation. The Bell City Radio Club will hold a CB Jamboree on Oc-



Popular Science Top-Rates Scott's Stereo Tuner Kit

(THERE'S A SOUND REASON.)

Popular Science magazine's reviewer said, "I rate the LT-112-B as one of the finest FM tuners available — in or out of kit form." All of this fabulous tuner's critical circuitry comes pre-wired, pre-tested, and pre-aligned . . . and the full-size, full-color instruction manual makes the rest simple. In just eight hours, you'll have it completed. Again, in the reviewer's words: "Stereo performance is superb, and the set's sensitivity will cope with the deepest fringe area reception conditions . . . drift is non-existent." See your Scott dealer and review the new LT-112B-1 for yourself. Only \$199.95.

© Copyright 1967, H.H. Scott, Inc.



H.H. Scott, Inc., Dept. 520-10, Maynard, Mass. Export: Scott International, Maynard, Mass. 01754

CIRCLE NO. 36 ON READER SERVICE PAGE

October, 1967

103

The TRUE electronic solution to a major problem of engine operation!

DELTA'S FABULOUS

MARK TEN®



Only \$44.95 ppd.
In easy-to-build Deltakit®
Only \$29.95 ppd.

CAPACITIVE DISCHARGE IGNITION SYSTEM

You've read about The Mark Ten in *Mechanix Illustrated*, *Popular Mechanics*, *Electronics* and other publications!

Now discover for yourself the dramatic improvement in performance of your car, camper, jeep, truck, boat — any vehicle! Delta's remarkable electronic achievement saves on gas, promotes better acceleration, gives your car that zip you've always wanted. Find out why even Detroit has finally come around. In four years of proven reliability, Delta's Mark Ten has set new records of ignition benefits. **No re-wiring!** Works on literally any type of gasoline engine.

Why settle for less when you can buy the original DELTA Mark Ten, never excelled and so unique that a U.S. Patent has been granted.

READY FOR THESE BENEFITS?

- ▲ Dramatic increase in performance ▲ Fast acceleration
- ▲ More complete combustion ▲ Points, Plugs last 3 to 10 times longer ▲ Up to 20% Mileage Increase

Literature by Return Mail • BETTER YET — ORDER TODAY!



DELTA PRODUCTS, INC. DP 7-14

P.O. Box 1147 PE • Grand Junction, Colo. 81501

Enclosed is \$_____ Ship ppd. Ship C.O.D.
Please send:

- Mark Tens (Assembled) @ \$44.95
- Mark Tens (Deltakit®) @ \$29.95

(12 VOLT POSITIVE OR NEGATIVE GROUND ONLY)

- 6 Volt: Negative Ground only
- 12 Volt: Specify Positive Ground Negative Ground

Car Year _____ Make _____

Name _____

Address _____

City/State _____ Zip _____

CIRCLE NO. 47 ON READER SERVICE PAGE

tober 1 and 2 at Lake Compounce, Bristol, Conn.; and the Clovis "5" Watters Radio Club of New Mexico, Inc., will sponsor a 2-day CB whiz-bang on October 7-8 at the Curry County Fairgrounds, Clovis, N. M.

1967 OTCB CLUB ROSTER

In order to maintain an accurate annual roster of active CB clubs, we make periodic requests that all associations, old or new, supply us with current statistics at least once a year. Specifically, we would appreciate your membership total, officers' names and call-signs, photographs of activities or groups involved in emergency rescue, sample decal, and your club paper sent on a monthly basis. Address all material to Matt P. Spinello, CB Editor, POPULAR ELECTRONICS, One Park Avenue, New York, N.Y. 10016. The following clubs have recently reported to the OTCB Roster.

Fresno, California—*Central California REACT*. Assigned the use of 100 transmitters under the call KRA0790, this group serves Fresno, and parts of Madera and Kings Counties. Their monthly newspaper is the *REACTOR*. The group works with the Fresno County Sheriff's Search and Rescue Team and all area law enforcement and fire agencies, and is currently enrolled in a training program with the Fresno County Chapter of the American Red Cross Disaster Action Team. Officers: Jim Otto, KPA0221, president; John Downing, KNA4764, vice president; Donna Helmits, KNA3245, secretary; Chuck Stafford, KLA0834, treasurer; John C. Andres, KPA1494; and five additional officers covering communications, membership, programming, ways and means, and newspaper committees.

Quincy, Florida—*Gadsden Emergency Net Trimmers (GENTS Club) of Florida, Inc.* Organized in 1961, and incorporated in 1963, the club meets monthly. Meetings feature supper, a business session, and usually a program or speaker. Current membership: 30. The GENTS organization has been tested by two major hurricanes, and CD drills are held regularly. Club equipment available to members includes a CB rig (KMP0494), complete ham station (W4JGQ), five short-wave receivers (WPE4JGQ), service and test equipment, TV receiver and an 80' portable antenna trailer. Officers: Stuart Eastick, KMP5149, president; Fred Clark, KD10257, vice president; John May, KOP-4152, treasurer; Nick Adams, KD10142, publicity chairman; and two board members.

Batavia, Illinois—*Kane County REACT*. Organized about a year ago, this group serves the Batavia/St. Charles, Ill., area. Membership: 50. Officers are Co-Captains Dan Anderson, KNJ9660, and Mike Rutland, KPK4898; and Lt. Dave Hallow, KNJ2517.

New York, New York—*Empire-Garden States REACT*. The team membership of 15 serves the New York City metropolitan area, its boroughs, and an area of New Jersey within a 15-mile radius. Officers: Al Moskowitz, KMD2945, president; Marge Kern, KOD8124, vice president; and Kenneth Schaffel, KOD1443, secretary/treasurer.

Wellington, New Zealand—*New Zealand CB'ers*. This group publishes a newspaper we've found worth reading from cover to cover. Excellently written, it includes an editorial page, president's page, mail box, gossip page, membership roster, several pages of news and views, and a number of highly technical pages on elementary radio. Officers responsible for the publication are: Allan Scott, WN265, president; Gray Goddard, WN133, editor; Joan Scott, secretary; and George Morgan, WN295, printer.

Cleveland, Ohio—*Cuyahoga County Civil Defense CB Communications*. Membership: 24. This group has assisted during local tornados and provided communications and ambulance service for Boy Scout Camporees. They have four amphibious vehicles and are presently involved with training in

light rescue, basic first aid, traffic and crowd control, and various communications procedures. Team officers include Glen M. Fowler, KLN9458, director, CB communications; and Don Balint, KLN8426, assistant director.

Smithville, Texas—*Fayette County CB Radio Club*. Club has aided authorities on automobile accident scenes and searches for lost children. Current officers: Frank Guenther, president; William Beirsdorfer, vice president; Bea Kinney, secretary/treasurer; plus net, project, publicity, program and refreshment committee officers. Our thanks to this group for an honorary membership.

I'll CB'ing you,

—Matt, KHC2060

OUT OF TUNE

Remote Commander (August, 1967, page 45). Several of the parts in Fig. 5 are numbered incorrectly, and *T1* on the transmitter board is shown improperly oriented. The drawings below contain the necessary corrections for

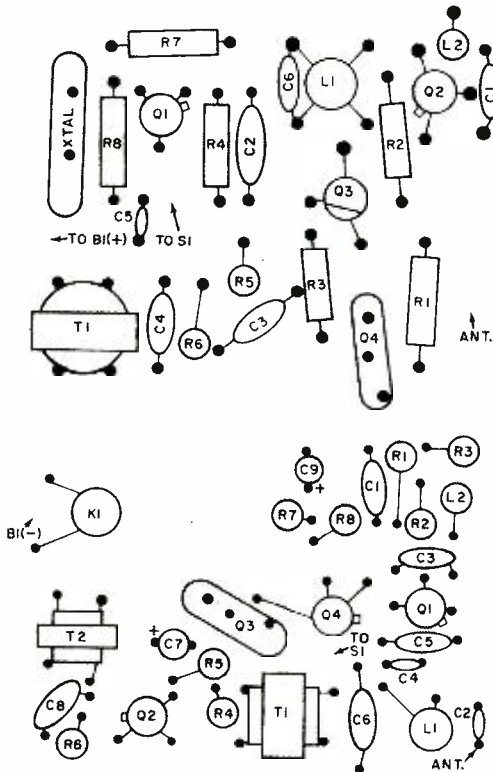

proper operation of this project. Clip out these drawings, and paste them over the ones in your copy of the August issue.

Radio Amateur Equipment Sampler (August, 1967, page 51). The price of the Hammarlund HX-50A was erroneously listed; its present selling price is \$495.00.

—30—

October, 1967

Thinking of college and a space age career?

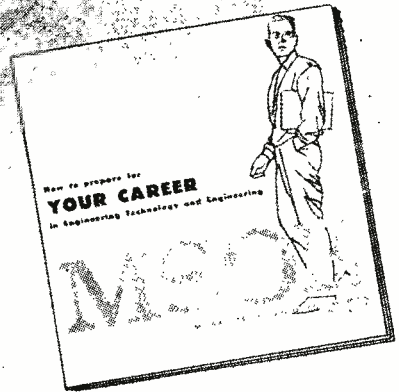

Send for this booklet on ENGINEERING TECHNOLOGY AND ENGINEERING

Learn how you can prepare for a dynamic career as an electrical or mechanical engineering technician or engineer in such exciting, growing fields as avionics, missiles, reliability control, fluid mechanics, data processing, metallurgy, microelectronics, and advanced aerospace research.

MSOE offers residence study programs leading to these degrees in engineering technology and engineering:

2 years — Associate in Applied Science

4 years — Bachelor of Science

Also get facts about scholarships and financial aids, job placement and other student services, plus photographs of MSOE technical laboratories and student activities. Courses approved for veteran training.

For your copy, just mail the coupon — no obligation.

MSOE

Milwaukee, Wisconsin 53201

Milwaukee School of Engineering
Dept. PE-1067, 1025 N. Milwaukee Street
Milwaukee, Wisconsin 53201

Please send the "Your Career" booklet. I'm interested in

Electrical fields Mechanical fields

Name.....Age.....

Address.....

City.....State.....ZIP.....

CIRCLE NO. 25 ON READER SERVICE PAGE

MS-284

Look What's NEW In The

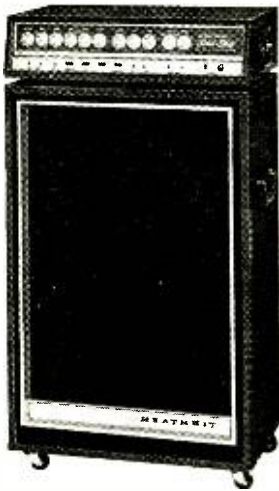

NEW! Deluxe Solid-State Combo Amplifier & Speaker System!

Kit TA-17
Amplifier
\$175⁰⁰
40 lbs.

Kit TA-17-1
Speaker System
\$120⁰⁰
100 lbs.

Special Combo Offer!

Kit TAS-17-2 Amplifier &
2 Speaker Systems
Save \$20.00
\$395⁰⁰
240 lbs.

All the "big sound" features every combo wants . . . tremolo, built-in "fuzz", brightness, reverb, plus a shattering 120 watts of EIA music power. Has 3 independent input channels each with 2 input jacks. Handles lead or bass guitars, combo organ, singer's mike, even a record changer. Speaker system features two special 12" woofers, special horndriver and matching black vinyl-covered wood cabinet.

NEW! Low Cost Single-Channel Solid-State Guitar Amplifier



Kit TA-27
\$89⁹⁵
Assembled
TAW-27
\$134⁹⁵

Boasts 20 watts EIA music power, 40 watts peak power; variable tremolo & reverb; two inputs that handle lead guitars; singer's mike; special heavy-duty 12" speaker; line bypass reversing switch that reduces hum; transformer-operated power supply; and handsome leather-textured, black vinyl covered wood cabinet with extruded aluminum front panel and chrome knobs. 35 lbs.

NOW Available Fully Assembled . . . Heathkit "Starmaker" Dual-Channel Guitar Amplifier



Assembled
TAW-16
\$199⁹⁵
(Kit TA-16
\$134.95)

Features all solid-state circuit; 25 watts EIA, 60 watts peak power; two channels, one for accompaniment, accordion or mike, the other for variable tremolo & reverb; two inputs each channel; two 12" heavy-duty speakers; line bypass reversing switch for hum reduction; leather-textured black vinyl covered wood cabinet with extruded aluminum front panel & chrome knobs. For extra savings, build the kit version in just 15 hours. 52 lbs.

NEW! Low Cost Solid-State FM Stereo Receiver



Kit AR-17
\$72⁹⁵
(less cabinet)

Features complete FM, FM stereo listening; wide 18-60,000 Hz ± 1 db at full 5 watt continuous power per channel; 14 watts music power; inputs for phono & auxiliary; outputs for 4 thru 16 ohm speakers; stereo indicator; adjustable phase for best stereo; and flywheel tuning. 12 lbs. Optional walnut (\$9.95) or beige metal (\$3.95) cabinets.

NEW! Low Cost Solid-State FM Mono Receiver



Kit AR-27
\$49⁹⁵
(less cabinet)

Features all-transistor circuit for cool, instant operation; FM mono listening; 7 watts music power; 5 watts RMS; response 18 to 60,000 Hz ± 1 db; inputs for phono and auxiliary; outputs for 4 thru 16 ohm speaker; flywheel tuning; all front panel controls for easy operation. 9 lbs. Optional walnut (\$9.95) or beige metal (\$3.95) cabinets.

'68 HEATHKIT® Catalog!

NOW Available Fully Assembled . . .
World's Most Advanced Stereo Receiver



Assembled
ARW-15
\$499⁵⁰
(less cab.)
Kit AR-15,
\$329.95

Boasts advanced features like integrated circuits and crystal filters in the IF amplifier; ultra-sensitive FET FM tuner; 150 watts dynamic music power; AM, FM and FM stereo; positive circuit protection; all-silicon transistors; "black magic" panel lighting; stereo only switch; adjustable phase control and many more. 34 lbs. Optional wrap-around walnut cabinet \$19.95

NEW! Professional 10-Band
Shortwave Listener's Receiver

Kit SB-310
\$249⁰⁰
(SB-600 8 ohm
6" x 9" speaker
\$18.95)



Covers 6 shortwave bands (49, 41, 31, 25, 19, & 16 meters) . . . 80, 40 & 20 meter ham bands . . . 11 meter CB. Has 5 kHz crystal filter for AM, SSB and CW; Selectivity that slices stations down to last kHz . . . no more guessing station identities; 11-tube circuit; crystal-controlled front-end; prebuilt & aligned linear oscillator; metal cabinet. Other crystal filters available. 20 lbs.

NEW! Amateur Novice CW
Transceiver



Kit HW-16
\$99⁵⁰

Novices! New Hams! Get on-the-air at lowest cost. Provides CW operation on the first 250 kHz of the 80, 40 & 15 meter bands. 75 watt CW input, up to 90 watts for general class operation. True "break-in" CW operation. Crystal control transmit with VFO receiver tuning. Built-in sidetone. Grid-block keying. Metal cabinet and simple assembly. 25 lbs.

NEW! Deluxe Solid-State Volt-Ohm
Meter

Kit IM-16
\$44⁹⁵

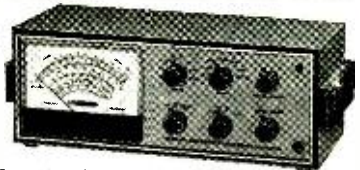

Features 8 DC and 8 AC voltage ranges from 0.5 v to 1500 v full scale; 7 ohmmeter ranges; 11 megohm input resistance on DC ranges; 1 megohm on AC ranges; internal battery or 120/240 v, 50/60 AC power for portable or "in-shop" operation; 6" 100 uA meter; single test probe for all measurements; new Heathkit "unitized" cabinet construction.

NEW! Heathkit Jr.®
Solid-State Port-
able Phonograph

Kit JK-17
\$19⁹⁵

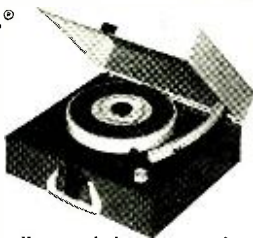

Perfect for the youngster in your family. Plays all 4 speeds, all record sizes. Crystal cartridge with sapphire stylus for all types of records; 4" speaker; built-in 45 rpm adaptor; preassembled turntable and hardboard cabinet. Build in 1 to 2 hours. 117 VAC, 60 Hz operation. 11 lbs.

NEW! Heathkit Soldering Iron

Kit GH-17
\$14⁹⁵



Ideal for kit-building or other electronic soldering jobs. Safe 6 volt, 25 watt GE midget iron with non-corroding tip. 3 heat ranges. Excellent heat recovery time. Quick warm-up . . . iron ready in 2 minutes. Protective metal cage. Build in an hour. 5 lbs.



NEW!
**FREE 1968
CATALOG!**

Now with more kits, more color. Fully describes these along with over 300 kits for stereo, hi-fi, color TV, electronic organs, electric guitar & amplifier, amateur radio, marine, educational, CB, home & hobby. Mail coupon or write Heath Company, Benton Harbor, Michigan 49022.



HEATH COMPANY, Dept. 10-10
Benton Harbor, Michigan 49022
In Canada, Daystrom Ltd.

Enclosed is \$ _____, including shipping.

Please send model (s) _____

Please send FREE Heathkit Catalog.

Name _____

Address _____

City _____

State _____

Zip _____

Prices & specifications subject to change without notice.

CL-304

**Before you buy
a cheap changer,
read about this
inexpensive Dual.**



The new Dual 1010S at \$69.50 is Dual's lowest priced model, yet it is in every respect a precision-engineered automatic turntable.

Its cueing system lowers the tonearm gently on your records instead of just dropping it and possibly damaging both stylus and groove. This is the identical auto/manual system as used on our most expensive models.

The 1010S also shares their feathertouch slide switches and Elevator-Action changer mechanism. Its Hi-Torque motor holds speed constant within 0.1% even when voltage varies $\pm 10\%$, and its low mass tubular tonearm tracks flawlessly at 2 grams.

Precision features like these make the difference between a Dual and a cheap record changer. And make the difference on your records.

United Audio Products, Inc.,
535 Madison Avenue, New York,
N. Y. 10022.

Dual

CIRCLE NO. 44 ON READER SERVICE PAGE

SOLID STATE

(Continued from page 80)

gate *n*-channel silicon MOSFET. Known as Type TA2644, the unit features a series arrangement of two separate channels, with each having an insulated control gate that functions independently. The schematic symbol of the device is shown in Fig. 3 (c). As an r.f. amplifier, the TA2644 can provide a performance comparable to that of two MOSFET triodes connected in a "cascode" arrangement. In addition, with two insulated control gates, it is ideally suited for r.f. mixer, a.g.c. amplifier and similar applications at frequencies up to 300 MHz.

Transitips. Last month we discussed some of the factors affecting battery life in transistorized equipment and passed on a few "Do" and "Don't" tips to insure maximum battery life. But even if you go to special pains to take care of your batteries, they will be of little value if you use the wrong type and size unit in your equipment.

If you use a smaller (electrically, not physically) battery than needed, its life will be considerably shortened, while an excessively large battery is not only more expensive, heavier, and physically larger, but it may have a "shelf" life shorter than its nominal "operating life" in your equipment. In other words, a larger battery may deteriorate long before it is exhausted on the basis of current drain and hours of use vs. its nominal milliampere-hour rating.

Today, there are three basic kinds of primary batteries in common use: zinc-carbon, alkaline cell, and mercury. Although primary batteries are not considered rechargeable—as a general rule—their life can be extended considerably by using "charging techniques" (see Fred Shunaman's article "Can Dry Cells Be Recharged?" in the July, 1967, issue, page 41).

The most familiar kind is the zinc-carbon (flashlight-type) battery. It has a short to moderate shelf life, is readily available, and is the least expensive of the three common types. Alkaline cells cost more than zinc-carbon units, have a somewhat longer shelf life, and can provide from three to eight times the service life of zinc-carbon units, depending on mode of operation. Mercury batteries are the most expensive, but offer the advantages of an almost unlimited shelf life, an operating life up to ten times longer than that of zinc-carbon cells, and the technical advantage of delivering nearly full rated voltage almost to the end of their service life.

However, if you must watch your budget, as is the case with your Semiconductor Edi-

tor, chances are you'll use zinc-carbon batteries in most of your projects. And the chances are equally good that you'll use either penlight or flashlight cells, or one of the popular 9-volt batteries which have become more or less "standard" for transistorized receivers.

The table below lists some 9-volt batteries and the average current drains for maximum life (assuming intermittent operation of a few hours a day). Assembled from engineering data furnished by battery manufacturers, this chart can be used as a guide when you're selecting batteries for your projects.

BATTERY SELECTOR CHART (9-Volt Types)	
AVERAGE CURRENT DRAIN	RECOMMENDED BATTERY TYPES
7 mA	L6, 206, VS337
8 mA	2U6, 216, 222, VS312
9 mA	P6, 226, PM6, VS300
15 mA	2N6, 246, VS305
20 mA	M6, 266, VS322
30 mA	D6, 276, VS306
Above 30 mA	Suggest use of series-connected penlight or flashlight cells (6 for 9 volts)

If you prefer to use series-connected penlight or flashlight cells, you'll obtain optimum service life if you use: Type AAA cells for current drains up to 20 mA; Type AA cells for drains up to 25 mA; Type C cells for drains up to 80 mA; and Type D cells for drains up to 150 mA.

If your equipment (or project) requires much larger average current drains, you may have to use heavy-duty "lantern" batteries or even small storage batteries to obtain a reasonable service life.

And DON'T EVER try to operate a 10-watt audio amplifier on a 2U6 battery!

Until next month. . .

—Lou

SWITCHING QUIZ ANSWERS (Quiz appears on page 52)	
1 B E H J	5 C D I K
2 A D I K	6 A F I K
3 C D I J	7 B E G J
4 A E I K	8 A D H K

**POLICE • FIRE • MARINE
AIRCRAFT • AMATEUR CALLS**
—TUNABILITY—USABILITY—QUALITY—



TUNAVERTERS
TUNABLE, CALIBRATED solid state converters to change your auto and home radios into excellent, sensitive, selective, calibrated Amateur and VHF receivers!

"Of all of the converters tested by POPULAR ELECTRONICS there is little doubt that the "TRP Tunaverters" is the most versatile"—POPULAR ELECTRONICS, August, 1967.

- 6-1 reduction tuning!
- HF—2 gang tuning!
- VHF—3 gang tuning!
- FREE 24" conn. coax!
- Plug into auto radio!
- American Made!
- 9 volt btry. powered!
- Size 2 1/4" x 3 1/2" x 4 1/2" "

• 2 WEEK MONEY BACK GUARANTEE!

MODELS for AM & FM	BAND	MODEL	COVERS	OUTPUT	PRICE
Marine	Marine		2.0-2.85 mc	550 kc	\$19.95 ppd
SW & WWV	SWL		9.3-10 mc	550 kc	\$19.95 ppd
CB & 10 M		273	26.9-30 mc	1500 kc	\$29.95 ppd
6 meters		504	50-54 mc	1500 kc	\$29.95 ppd
2 meters		1450	144-150 mc	1500 kc	\$29.95 ppd
Police		308	30-38 mc	1500 kc	\$29.95 ppd
fire, & Marine		375	37-50 mc	1500 kc	\$29.95 ppd
		1564	150-164 mc	1500 kc	\$29.95 ppd
Aircraft		1828	118-128 mc	1500 kc	\$29.95 ppd
Radiation loop for use with home radios					\$ 1.25 ppd
Order from:			Fast AIR MAIL add		\$.85 ea.

HERBERT SALCH & CO. Marketing Division of Tompkins Radio Products
Woodsboro EHB7, Texas 78393

CIRCLE NO. 34 ON READER SERVICE PAGE

OUR 1968 CATALOG
of precision quartz crystals and electronics for the communications industry is now available.

It will cost you nothing.



Buy The Best

SENTRY MANUFACTURING COMPANY
1634 Linwood Boulevard—Oklahoma City, Oklahoma 73106
PHONE: (405) 232-1120 — (405) 232-3001 — FAX: (405) 232-1129

CIRCLE NO. 37 ON READER SERVICE PAGE

**NOW...there is
another way to
get through**



ANTENNA

POLAR DIVERSITY
LOOP ANTENNA*

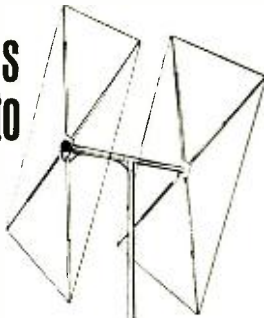

**JUST A
FLICK OF A
SWITCH AWAY**



The new concept in antennas that gets the signal through when others fail

The Avanti PDL-27A is a polar diversity loop antenna that provides for instant switching to transmit or receive horizontal or vertical signals. Commercially available for CB'ers for the first time--the PDL-27A offers the advantages of signal diversity found in military and trans-oceanic communication networks.

HIGH GAIN HORIZ. DIVERSITY GAIN 11 db
VERT. ISOTROPIC

MINIMUM INTERFERENCE--30 db front to back ratio.

LONG LASTING--rugged frame of aluminum and fiberglass.

EASY TO INSTALL--factory measured; cut and drilled for simple mount on pipe mast. Only 13½ lbs.

*Patent Applied For

Write today for complete information.

ANTENNA DIVISION

avanti research & development, inc.

45 W. Fullerton Avenue, Addison, Ill. 60101

Please send full details on Avanti PDL-27A antenna.

NAME _____

ADDRESS _____

CITY _____ STATE _____ ZIP _____

CIRCLE NO. 4 ON READER SERVICE PAGE

AMATEUR RADIO

(Continued from page 83)

on 4970 kHz, and giving a P.O. Box number in New Jersey for correspondence. An FCC engineer found that the post office box was assigned to a teen-age college student who was a licensed amateur, but the student denied any knowledge of WBBH. Within 20 minutes of the time that WBBH came on the air that evening, the engineer had its location pinpointed a few miles away from the college post office. Dropping in on the station, the engineer found a 65-watt transmitter being operated by a teen-ager who said he used his buddy's box number to throw the FCC off the track. The station was closed down, of course.

This TVI complaint really doesn't involve amateur radio, but we'll wager that a ham was blamed for it at first. A Mr. Richard "Red" Skelton complained of severe television interference. Sensing that good TV reception might be important to a man with Mr. Skelton's vocation, the Los Angeles FCC office gave the complaint prompt attention. Analysis of the problem pointed to the distribution amplifier feeding the seven television receivers in the Skelton home--changing the amplifier cured the TVI.

Free QSL Cards. According to *Ham Gab*, of the Hamfesters Radio Club, Inc., and other sources, licensed amateurs can obtain 100 free QSL cards by writing to the Advertising Department, Pontiac Motor Division, General Motors Corporation, 196 Oakland Ave., Pontiac, Mich. 48053, and requesting a QSL card order form.

Sunspot Cycle. Just when most of the propagation experts had come around to the opinion that the peak of the present sunspot cycle would occur this winter, Rex Pay, writing in the June, 1967, edition of *Amateur Radio Facts*, came up with a plausible prediction that the peak will actually occur in the winter of 1968-69. Let's hope he's right, because it would give us another year of excellent DX conditions on 15, 10, and possibly 6 meters.

NEWS AND VIEWS

Joe Rock, Jr., WA3GLP, P. O. Box 162, Knoxville, Md. reports that he has helped many amateurs obtain their Rag-Chewer's Club certificate, which requires the applicant to carry on a contact for at least a half hour with an RCC member. (Applicant and RCC member then each send a postcard containing the date, time, and length of the QSO to the ARRL, 225 Main St., Newington, Conn. 06111, and shortly after receiving both cards, the ARRL mails the applicant his certificate.) Joe works 80 through 10 meters with a Knight T-150 transmitter and a Hallicrafters SX-99 receiver helped along

POPULAR ELECTRONICS

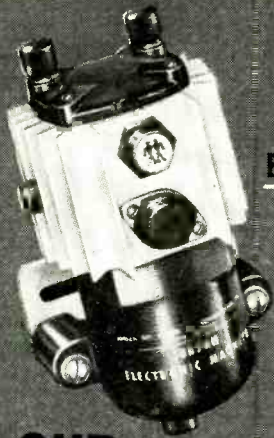

**WE DON'T
CLAIM OUR
ELECTRONIC
IGNITION
SYSTEM
IS BEST.**

**OUR
CUSTOMERS DO!**

WRITE TODAY FOR FREE LITERATURE

JUDSON

RESEARCH AND MFG. CO.
CONSHOHOCKEN, PA. U.S.A.



CIRCLE NO. 22 ON READER SERVICE PAGE

Olson®



***FREE**

Fill in coupon for a **FREE** One Year Subscription to **OLSON ELECTRONICS' Fantastic Value Packed Catalog—Unheard of LOW, LOW PRICES on Brand Name Speakers, Changers, Tubes, Tools, Stereo Amps, Tuners, CB, and other Values.** Credit plan available.

NAME _____
ADDRESS _____
CITY _____ STATE _____
GIVE ZIP CODE _____

If you have a friend interested in electronics send his name and address for a **FREE** subscription also.

**OLSON ELECTRONICS
INCORPORATED**

727 S. Forge Street, Akron, Ohio 44308

CIRCLE NO. 28 ON READER SERVICE PAGE

Another Winner



News Service film crews and 500 mile race movie cameramen used 29 Regency CB radios for fast, reliable communications during the 1967 running of the world famous event. Our Bronco offers you the same low-priced communication reliability and versatility. With optional field-pack, and AC power supply, you can use it effectively for mobile, base or portable operation. And—the attractive price tag is unmatched by any other CB set. Try one today—you'll like the results.

at the
**Indianapolis
500 Mile Race**

the **Regency**
Bronco
only **\$89.95**

5 watts, 8 channels with channel 11 crystals
REGENCY ELECTRONICS, INC.
7900 PENDLETON PIKE
INDIANAPOLIS, INDIANA



The Imperial Range Gain II Ranger Pacer II Charger

CIRCLE NO. 49 ON READER SERVICE PAGE

October, 1967

113

PROVIDES HIGH GAIN ACROSS THE
ENTIRE UHF BAND

for UHF
Reception
at its VERY
BEST!

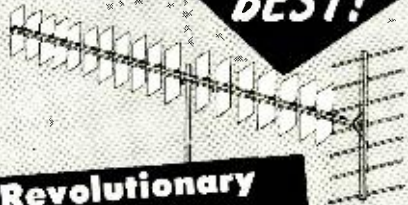

Revolutionary
MODEL UPW
UHF PASSIVE WAVE ANTENNA

Excellent color reception-assured.
Write for literature.

S & A ELECTRONICS INC.

Manufacturers of the TARGET ANTENNA

72 W. FLORENCE STREET

TOLEDO, OHIO 43605

CIRCLE NO. 32 ON READER SERVICE PAGE

GET INTO **ELECTRONICS**

V.T.I. training leads to success as technicians, field engineers, specialists in communications, guided missiles, computers, radar, automation, basic & advanced courses. Electronic Engineering, Technology and Electronic Technology curricula both available. Associate degree in 29 months. H.S. obtainable. G.I. approved. Start February, September. Dorms, campus. High school graduate or equivalent. Catalog.

VALPARAISO TECHNICAL INSTITUTE
DEPARTMENT PE, VALPARAISO, INDIANA



Let **COYNE** Train You
AT HOME
for Big Pay in 

TELEVISION **RADIO**
COLOR TV

MAIL COUPON FOR FREE BOOK

Coyne Electronics Institute Dept. 77-C2
1501 W. Congress Pkwy., Chicago, Ill. 60607
Send FREE Book showing how I can get Coyne
Quality Home Training in TV-Radio at Low
Cost on Easy Terms.

Name.....

Address.....

City..... State..... Zip.....

Phone..... Age.....

Put X here if interested in Resident School for Associate Degree
in Electronics Engineering and Technology, or shorter courses
in Electricity, Radio-TV, Electronics. Approved GI Bill. Spare time
employment and tuition payment plans available.

by a homebrew preselector and a Heathkit Q-multiplier . . . A year or so ago **Mike Czuhajewski, W8BMCQ**, Rte. 3, Paw Paw, Mich., reported working a KZ5 (Panama Canal Zone) on 80 meters one summer evening at 6 p.m. Your Amateur Radio Editor surmised that some "bootlegger" was pulling Mike's leg, because you just don't work the Canal Zone at that time of the day on 80 meters in the summer. Well, Mike now has the QSL card to prove the contact. Guess that shows more than anything else how unpredictable amateur radio is. Mike is a member of the QRP club; running less than 100 watts, he has worked 23 countries on 40 meters, plus an additional five countries on the other bands. He has a selection of seven antennas, all dipoles, to choose from!

M. Grayle Suffern, MD., W6NO/W2NO, 156 North Hill, Pasadena, Calif. really spends a lot of time in and on the air. He jets back and forth between Pasadena, Calif. and Suffern, N.Y., every three days, carrying his Collins 32S3 CW/SSB exciter with him. In California, the exciter runs alone; in New York, it drives a Collins 30S1 1000-watt amplifier (which unfortunately is too heavy to load on the jet). Grayle uses separate Hallicrafters SX-111 receivers at each station. If you are wondering about all the jetting around, W6NO is a Major General in the USAR besides being a busy doctor. He has been a licensed amateur for over 45 years and has held both First Class Commercial Telegraphy and Telephony licenses. For more information on this interesting amateur, see "Who's Who in America" . . . **Larry Soughan, WA9SDP**, 2711 Hobson Rd., Fort Wayne, Ind., works six meters with a Knight-Kit T-150 transmitter modified for plate modulation and CW in the Novice bands with a transmitter he built as part of a correspondence course in radio electronics. A "long-john" beam up 40' on a Rohn tower does the outside work on 6 meters, and a 250-footer handles the lower frequencies. A Hallicrafters SX-28-A, abetted by a nuvistor converter, processes incoming signals . . . **PFC Robert H. Williams, US53435149, WA4DYK**, Battery A, 2133 Arty, 1st Inf. Div., APO San Francisco, Calif., isn't allowed to "ham" in Vietnam, but he listens a lot to 20-meter SSB. U.S. amateurs, especially on the West Coast, really boil in over there. Being the only amateur in his outfit makes him doubly anxious to get back home to do a little humming.

Giffith L. DeGolie, WA0OGD, 3730 St. Mary's Ave., Lincoln, Nebr., started as a Novice a year ago and now likes to rag-chew at 15 to 20 wpm on 40 or 15 meters. He transmits on an EICO 720 and receives on an old National unit which cost him \$20 after some shrewd dickering . . . **Steve Glickman, WN4FFB**, 7835 SW 133 St., Miami, Fla., started out "on the wrong foot." A short in his transmitter blew three fuses and the silicon rectifiers in its power supply. But he recovered fast. In six weeks, he has worked 31 states and three countries on 80 and 15 meters. Tools of his trade include a Knight-Kit T-150A transmitter, Knight-Kit R-100A receiver, and a vertical antenna. . . . **Mark Kustwan, WN1HEC**, 55 Oak St., Indian Orchard, Mass., worked 15 countries in five continents in five months as a Novice using a Knight-Kit T-60 transmitter, a Hallicrafters SX-122 receiver, and a 40-meter dipole antenna. His best DX so far was on 40, where he worked KH6EXJ daily for quite a while . . . **Don Strickler, W6GZUP**, 835 S. Curson Ave., Los Angeles, Calif., waited five months after getting his license before making his first contact. Then he worked 21 states and five countries in a few weeks using an EICO 720 transmitter, a Hy-Gain 14-AVQ vertical antenna, and a Lafayette KT-340 receiver. Don wants to organize a 15-meter Novice net.

Will your picture or "News and Views" be in next month's column? The first step is up to you. We appreciate receiving your club bulletins. Send all material to Herb S. Brier, W9EGQ, Amateur Radio Editor, POPULAR ELECTRONICS, P. O. Box 678, Gary, Ind. 46401.

73. Herb, W9EGQ

SHORT-WAVE LISTENING

(Continued from page 84)

Saudi Arabia. King Faisal recently inaugurated the new building of the Saudi Arabian Ministry of Information in Jeddah. On the same occasion, the Minister of Information stated that their broadcasting facilities are currently among the best in the Middle East. Three years ago, there was only one 50-kW transmitter. Now the combined output of the stations in Jeddah, Riyadh, and Damman has reached 1800 kW, and further units totaling 1000 kW are projected. New stations at Damman and Riyadh will soon be on the air.

More Relay Stations. If newcomers to SWL'ing are confused by the strength of signals and the "odd" times that DX stations are being heard, it's due to the ever-increasing number of relay transmitters. At least five of the major international shortwave broadcasters are using relay transmitters not located in the country of origin of the broadcasts. Included are the BBC, VOA, Radio Netherlands, etc.

Expected on the air within the next few months is the second relay station of *Deutsche Welle* (the first is at Kigali, Rwanda). This one will be in El Salvador and will use two 250-kW transmitters. Presumably the broadcast will be in English and Spanish.

CURRENT STATION REPORTS

The following is a resume of current reports. At time of compilation all reports are as accurate as possible, but stations may change frequency and/or schedule with little or no advance notice. All times shown are Greenwich Mean Time (GMT) and the 24-hour system is used. Reports should be sent to SHORT-WAVE LISTENING, P.O. Box 333, Cherry Hill, N.J., 08034, in time to reach your Short-Wave Editor by the fifth of each month; be sure to include your WPE identification, and the make and model number of your receiver. We regret that we are unable to use all the reports received each month, due to space limitations, but we are grateful to everyone who contributes to this column.

Argentina—Station LRA35, *R. Nacional*, Buenos Aires, has moved up to 11.715 kHz, where it was tuned at 2340 in English.

Australia—Station VLW9/VLX9, Perth, 9610 kHz, was logged at 1009 with news and music; at 1030 with sports highlights, music, weather and shipping reports; and at 1312-1326 with sports news, pop music, time checks, and report of horse race.

Biafra (formerly Eastern Nigeria)—*R. Biafra*, Enugu, is heard well in Eng. at 0430 on 3980 kHz with a program summary and devotional service until 0455.

Brazil—Listed as being "under repair." ZYZ32, *R. Rural Brasileira*, Rio de Janeiro, 15.105 kHz, has been noted testing from 2300 to 2330 s/off with a variety of music and many ID's. Station PRB24, *R. Record*, Sao Paulo, 11.965 kHz, is heard around 2300 with a good deal of native music and frequent commercials. A QSL is in (after five years of trying on the part of the reporter) from ZYD9, *R. Di-*

GET



ACTION WITH

MULTI-ELMAC
PRECISION MADE,
POPULAR PRICED
CB UNITS!

\$16950

FULL 23 CHANNEL

AC-DC Operation,
Illuminated Meter
& Channel Selector,
Triple Tuned RF,
"Noise Immune"
Squelch, Double
Tuned IF's, Ready to Operate.



\$ 9950

FULL 8 CHANNEL

AC-DC Operation,
Delayed AVC,
Electronic Switching,
2 Stage Pre-Amp
Illuminated "S"
Meter, Complete
with Crystal for 1 Channel



\$ 4995

SOLID STATE Transmitter-Converter

Compact 5¼ x
4¾ x 1½, 9
Transistor, 2
Diodes, 5 Watt
Input (FCC Max.)
100% Modulation, 12 VDC
Operation, Complete with Crystal for
1 Channel



Please send further information on Citi-Fone SS 99 II



MULTI-ELMAC CO.

21470 Coolidge • Oak Park, Michigan 48237

NAME _____

ADDRESS _____

CITY _____

STATE _____ ZONE _____

CIRCLE NO. 27 ON READER SERVICE PAGE

FREE!



BRAND NEW FALL AND WINTER RADIO-TV ELECTRONICS CATALOG



YOUR BUYING GUIDE FOR: • Stereo & Hi-Fi systems & Components • Tape Recorders • Electronic Parts, Tubes, Fads • Phonos & Records • Ham Gear • Test Instruments & Kits • Cameras & Film • PA • Citizens Band • Radio & TV Sets • Musical Instruments

MAIL TODAY TO:

BURSTEIN-APPLEBEE

Dept. PEJ 1012 McGee, Kansas City, Mo. 64106

Name _____
Address _____
City _____
State _____ Zip Code _____

CIRCLE NO. 6 ON READER SERVICE PAGE



LEARN TO TAME the GENIE...

• If you are tired of a hum-drum low paid job, train yourself to be an expert electrician—at home in your spare time. Literally a million choices open up to you.

Big pay with extras, pension plans, security. Out door work if that's what you like. Even foreign contract bonus work. Chance for advancement or open your own business. This up-to-the-minute home study course trains you fast. Take your skill anywhere and make a fresh start. We show you how and help you get started.

Send for free complete information today!

INDUSTRIAL TRAINING INSTITUTE Dept. 65137
815 East Rosecrans, Los Angeles 90059

Name _____ Age _____
Street _____
City _____ State _____ Zip _____



LEARN Electronics Engineering AT HOME

Fix TV, design automation systems, learn transistors, complete electronics. College level Home Study courses taught so you can understand them. Earn more in the highly paid electronics industry. Computers, Missiles, theory and practical. Kits furnished. Over 20,000 graduates now employed. Resident classes at our Chicago campus if desired. Founded 1934. Catalog. "Vote - write for information about G. I. Bill Training."

AMERICAN INSTITUTE OF ENGINEERING & TECHNOLOGY
1137 West Fullerton Parkway, Chicago, Illinois 60614

fusora Acreana, Rio Branca, Territorio do Acre, stating the power as 5 kW but "currently less due to technical problems"; try for this station around 0320 on 4885 kHz. Newly reported is ZYR61. *R. Difusora Taubate*, Taubate, 4855 kHz, noted from 0900 to 0917 fade-out in Portuguese.

Cameroon Republic—*R. Yaounde* has been found on 3965 kHz at 1835 with Eng. news.

Canada—*R. Canada*, Montreal, 11.945 kHz, is beamed to the U. S., Caribbean, and Latin America with Eng. home and world news. "Focus." Short-Wave Club, and program anmts. Dual channels are 9625 and 15.190 kHz. All are heard well.

Larry Wilson, Box 103, White River, Ontario, operates a Department of Lands and Forests xmttr from 1300 to 2200 on 4580, 4880, and 9172 kHz with the call XLQ78. He would be grateful for any reception reports.

Cape Verde Islands—*Emissora Nacional*, Praia, has been definitely logged on 21.660 kHz around 1635-1700. Check closely for the "Aqui Praia" ID.

China—*R. Peking* was logged on two new frequencies, to N.A., 17.795 kHz at 0300 and 15.355 kHz at 0155, both in English. The schedule calls for xmsns to "N.A. East" at 0000-0100 in the 19- and 16-meter bands, and at 0100-0200 and 0200-0300 in the 25-, 24-, and 19-meter bands, and to

SHORT-WAVE CONTRIBUTORS

- Bill Smith (*WPE1FZ*), Uxbridge, Mass.
Mike Macken (*WPE1GYR*), Winthrop, Mass.
John Altieri (*WPE1HAG*), Bantam, Conn.
Eric Lebowitz (*WPE2JYJ*), Jackson Heights, N. Y.
William Graham (*WPE2LMU*), Binghamton, N. Y.
Robert Kaplan (*WPE2MUR*), Bronx, N. Y.
Roger Greene (*WPE2NFC*), Bronx, N. Y.
William Snyder (*WPE2ONK*), Levittown, N. Y.
Monte Tremont (*WPE2PKV*), Atlantic City, N. J.
John Linn, Jr. (*WPE2PME*), Manhasset, N. Y.
Mike Poore (*WPE3GHI*), Bethesda, Md.
Bob Huber (*WPE3GLV*), Wilmington, Del.
Rickey Chapman (*WPE3HUK*), New Carrollton, Md.
Richard Collier (*WPE3HIE*), Hyattsville, Md.
Dan Ferguson (*WPE4AUL*), Miami, Fla.
Grady Ferguson (*WPE4BC*), Charlotte, N. C.
Mason Cooper (*WPE4HXK*), Winchester, Va.
David Meisel (*WPE4IRS*), Charlottesville, Va.
Danny Edwards (*WPE4JDI*), Chesapeake, Va.
M. P. Frutchey (*WPE4PC*), Winter Park, Fla.
Eddie Robisheaux (*WPE5DWI*), Corpus Christi, Texas
Don Kenney (*WPE6AET*), Santa Monica, Calif.
Trev Clegg (*WPE6FAF*), Fresno, Calif.
Bruce Fingerhood (*WPE6GPG*), Northridge, Calif.
Jim Richardson (*WPE6GRB*), Fullerton, Calif.
Jon Biemer (*WPE7CKL*), Phoenix, Ariz.
George Schnabel (*WPE8EMO*), Rochester, N. Y.
Mark Ondrejko (*WPE8JQJ*), Maple Heights, Ohio
Bill Rieckich (*WPE8JII*), Newark, Ohio
Robert Mitchell (*WPE8JIZ*), Cleveland, Ohio
Paul Moore (*WPE8JQE*), Cleveland, Ohio
G. L. Beam (*WPE9HUG*), Indianapolis, Ind.
Eugene Kramer (*WPE9IGC*), Freeburg, Ill.
Bill Vogt (*WPE9IND*), Tinley Park, Ill.
Gary Schinski (*WPE9IPH*), Elmwood Park, Ill.
Andrew Pappas (*WPE9ISO*), Chicago, Ill.
Mike Beuckman (*WPE9IYZ*), Bellevue, Ill.
A. R. Niblack (*WPE9KMM*), Vincennes, Ind.
John Beaver, Sr. (*WPE9OAE*), Pueblo, Colo.
Bud Whitlock (*WPE9OCOS*), Augusta, Kan.
Jim Homan (*WPE9OEU*), Florissant, Mo.
Gary Lovegren (*WPE9OFA*), St. Paul, Minn.
Jack Perolo (*WPE9PEIC*), Milwaukee, Wis.
Billy Kournikakis (*VE2PEMI*), Montreal, Que., Canada
Paul Kay (*VE3PE2KM*), Downsview, Ont., Canada
Edward Horne, Alaska Highway, B. C., Canada
Dave Alpert, Morton Grove, Ill.
Leo Alster, Rahway, N. J.
Carlton Blake, Fort Smith, Ark.
Ray Fehringer, Chappell, Neb.
B. L. Manohar, Ludhiana, India
Don Urruth, Halstead, Kan.
David Woody, Columbus, Ohio
Deutsche Welle, Cologne, West Germany
International Short Wave Club, London, England
Radio New York Worldwide, New York, N. Y.
Sweden Calling DXers Bulletin, Stockholm, Sweden

"N.A. West" at 0300-0500 in the 31-, 25- and 19-meter bands.

Costa Rica—*La Voz de la Victor*, San Jose, 9615 kHz. is currently active at 0300-0500 with native music and some U. S. pop tunes, and the language used is Spanish. According to a message from the station, they are building a new *one-million watt* xmitr. Their present test schedule is listed as 1200-0500.

Cuba—*R. Habana* is noted on 15,205 kHz with an Eng. musical program to Europe. S/off is at 2135.

Czechoslovakia—*R. Prague* has Spanish to Central and South America at 2300-0000 with world and home news, commentary, trade talk, documentaries, and folk-dance music. Spanish is also noted at 2345 on 17,840 kHz; this channel has Eng. to N.A. from 0100 which renders *R. Australia's* xmsn at the same time virtually useless.

Dominican Republic—Station *HIRL. R. Exitos*, Santiago, 3365 kHz, is good at 0023-0105 with organ and Latin American music, and Spanish.

Ecuador—A weak station operating on 3308 kHz is, according to an overseas source, *Onidas Quevedanas*, Quevedo, new within the past year. Further details and schedules are requested.

Egypt—Cairo, 9475 kHz, was noted in Eng. from 2212 to 2345 s/off with chanting, news and commentary, and to N.A. from 0130 to past 0200 with news, Arabic military music, and commentaries. Other outlets noted: 7095 kHz in Arabic and 17,760 kHz to Brazil in Portuguese at 2330.

England—The new BBC World Radio Club is aired Saturdays at 0745 on 7150, 7295, 9640, 11,955, 15,070, 17,810, and 21,710 kHz; Sundays at 0245 on 6110, 7130, 9510, 9580, 11,750, 11,780, 11,865, 15,070, 15,140, and 15,260 kHz; Tuesdays at 2100 on 9410, 9580, 11,820, 11,860, 12,095, 15,070, 15,400, 15,435, 17,790, 21,550, and 21,710 kHz; and Thursdays at 1245 on 11,750, 15,070, 15,420, 15,435, 17,705, 17,790, 17,885, 21,470, 21,550, 21,660, 21,710, and 25,650 kHz.

Ethiopia—Station *ETLF. Voice of the Radio Gospel*, Addis Ababa, has religious programs at 0400 on 7245 kHz.

Germany (West)—*Deutsche Welle*, Cologne, has Eng. and French at 0130-0250 on 9640 and 11,945 kHz. Eng. at 0445-0545 on 9735 and 11,945 kHz. at 1045-1055 on 11,905 and 15,315 kHz, and at 1900-1910 on 15,405 and 17,785 kHz. After November 1, Eng. is scheduled for 0130-0250 on 6075 and 9735 kHz and French for 0445-0545 on 6145 and 9735 kHz. All to N.A.

Greece—National Hellenic Broadcasting Institute, Athens, can be heard on 15,345 kHz from 2300 s/on in Greek.

Haiti—*Voz de la Revolucion*, Port-au-Prince, was noted from 0200 on 5950 kHz with French.

Iraq—An Arabic speaker heard around 0435 on 11,785 kHz is definitely Baghdad on a new frequency. You can try for this station around 2130 also, but QRM is heavy at that time.

Lebanon—Beirut's present schedule is as follows:

SHORT-WAVE ABBREVIATIONS

anmt—Announcement	N.A.—North America
BBC—British Broadcast-	QRM—Station interfer-
ing Corporation	ence
B/C—Broadcasting	QSL—Verification
(W)—Morse code	R.—Radio
Eng.—English	s/off—Sign-off
ID—Identification	s/on—Sign-on
IS—Interval signal	VOA—Voice of America
kHz—Kilohertz	xmsn—Transmission
kW—Kilowatts	xmitr—Transmitter

to Africa on 17,750 kHz at 1830 in Eng., at 1900 and 2000 in Arabic; to South America on 17,765 kHz at 2300 in Portuguese, at 2330 in Arabic, and at 0030-0100 in Spanish; to N.A. on 11,965 kHz at 0130 in French, at 0200 and 0300 in Arabic, at 0230 in Eng., and at 0330-0400 in Spanish. Nondirectional xmsns: on 5980 kHz at 0430-0730 and 1625-1820, and on 9545 kHz at 0925-1600.

Malaysia—The BBC Far Eastern Station, Tebrau, 11,955 kHz, relays London in Indonesian at 1055-1115, then has English-language lessons. The Eng. World Service relay is given to Burma and Thailand at 1645-1745, dual to 9580 kHz.

R. Malaysia, Kuala Lumpur, 11,900 kHz, is usually good in western areas at 1115-1215 in Eng. with news, commentary, and excellent music.

Maldiv Islands—Mahe is reportedly operating on a new frequency, 4725 kHz, but the schedule is not known as yet.

Mexico—Southwestern area DX'ers should beware of the second harmonic of XEDX, Ensenada (1010 kHz), which often shows up on 2020 kHz. Few ID's are heard but Tijuana is mentioned often.

Nicaragua—A new station is *R. El Mar*, Puerto Cabezas, noted fading in with usual Latin American programming and pop tunes around 2230 on 9580 kHz.

Nigeria—The External Service from Lagos has Eng. to Europe at 1645-1715, being widely heard in N.A. A test xmsn has been noted on 21,700 kHz from 1840.

Norway—*R. Norway*, Oslo, has been logged on 17,825 kHz at 1800-1820 with a book review and on 11,705 kHz at 2257-2313 with IS, Norwegian news, and weather.

Pakistan—*R. Pakistan* has been heard on 9640 kHz at 2315 with classical music; on 15,315 kHz at 1110-1132 with music, Eng. news, commentary, and anmts in native language; on 21,460 kHz at 1040-1055 in Eng. and on 21,685 kHz with native music at 1145-1200. ID, and native-language news.

Peru—*Radio Eco Eco Eco*, OAX8U, Iquitos, 9665 kHz, signs off at 0455 with ID in Spanish *after* the national anthem. Native music and time checks are featured.

Philippine Islands—The Far East B/C Co., Manila, has the following Eng. schedule to S. E. Asia: 15-

Sonar SENTRY VHF MONITOR RECEIVERS

\$39.95

With Battery, Earphone, & Carrying strap less Crystals \$5.00 ea.

Model		
FR-103	FR-106	AR-107
150-175 MHz	25-50 MHz	Aircraft 108-136 MHz



SOLID STATE

POCKET SIZE

LISTEN TO: POLICE, FIRE, AIRCRAFT & WEATHER REPORTS!

for Industrial, Commercial, Utility & Govt. Use

2 CHANNELS • BROADCAST BAND • CRYSTAL CONTROLLED

Designed and engineered for simplicity of operation, compact enough to fit a shirt pocket yet powerful enough to deliver a clear clean signal—it's dependable • Operates on two crystal controlled VHF channels plus broadcast band • Completely solid state for long life use • Visible battery indicator to show battery condition at all times • Built in antenna • 5 1/2" H x 2 1/2" W x 1 1/8" D. Wt. 11 oz.

SONAR RADIO CORP., 73 Wortman Ave., Bklyn, N.Y. 11207

Please send information on VHF Monitor Receivers.

Name _____ Dept. 563

Address _____

City _____ State _____

CIRCLE NO. 39 ON READER SERVICE PAGE

DX PROVINCES AWARDS PRESENTED

To be eligible for one of the DX Provinces Awards designed for WPE Monitor Certificate holders, you must have verified stations (any frequency or service) in 6, 8, 10, or 12 Canadian provinces. (For these awards, the Yukon Territory and the Northwest Territories are considered as provinces.) The following DX'ers have qualified for and received awards in the categories indicated.

TWELVE PROVINCES VERIFIED

Donald Smith (WPE1HDW), Quincy, Mass.
Jack Winther (WPE8BJD), Moraga, Calif.
Paul Kilroy (WPE3FOB), Washington, D.C.

TEN PROVINCES VERIFIED

Roger Thering (WPE6FUB), Barstow, Calif.
Gary Ligon (WPE4JAX), Cliffside, N. C.

EIGHT PROVINCES VERIFIED

Jorge Batlle (WPE2GI, Skaneateles, N. Y.
Bertram Heiser (WPE8ITB), Ypsilanti, Mich.
Richard Davis (WPE0AKR), Denver, Colo.
John Stevenson (WPE9GNU), Delavan, Wis.
Samuel Gold (WPE6DXA), San Francisco, Calif.
Paul Slater (WPE1FRT), Medford, Mass.
Tom Taggart (WPE8IHL), Lakewood, Ohio
Ronald Hartwig (WPE5ELA), Midland, Texas

SIX PROVINCES VERIFIED

J. R. Miller (WPE7CIA), Tigard, Ore.
Tony Bratton (WPE8FMX), Anderson, Calif.
Bernard Maguire (VE6PE7K), Edmonton, Alta.,
Canada
Leo Blouin (VE2PE1KJ), Quebec, Que., Canada

Gerald Sullivan (WPE1GQY), Concord, Mass.
Don Davis (WPE6FXQ), Monterey Park, Calif.
Andrew Cooper (WPE8JNC), Westland, Mich.
Curt Webber (WPE0BBF), Leavenworth, Kan.
Dennis Eksten (WPE9DT), Loves Park, Ill.
Rick Jemison (WPE9HLZ), Des Plaines, Ill.
Joseph Agrella (WPE4FNS), Fort Lauderdale, Fla.
Kendall Porter (WPE0EVD), Overland Park, Kan.
Denis Frank (WPE8FBQ), Farmington, Mich.
Philip Smith (WPE8IIA), Kettering, Ohio
Kenneth Cohen (WPE2LZJ), Woodbridge, N. J.
Edward Madej (WPE1GEM), Indian Orchard,
Mass.
Robert Brandle (WPE2NQP), Madison, N. J.
John Myers (WPE6GSV), Santa Barbara, Calif.
David Conder (WPE9IHU), Centralia, Ill.
Jim Homan (WPE0EUS), Florissant, Mo.
John Sgrulletta (WPE2MXF), Bedford Hills, N. Y.
Bob Hertzberg (WPE9IHK), Mequon, Wis.
Alan Rhodes (WPE2OQU), Mountaintop, N. J.
Leonard Mack (VE7PE1BI), Vancouver, B. C.,
Canada
Bill Migley (WPE8JEL), Lancaster, Ohio
Timothy Armstrong (WPE6GGJ), Suisun, Calif.
Gordon Meyers (VE6PE6T), Medicine Hat, Alta.,
Canada
Romona Hagerman (WPE2OBV), Delaware, N. J.

300 and 17.810 kHz at 2155-2330; 15.380 and 17.810 kHz at 2330-0100 (17.810 kHz to 2345 only); 15.380 kHz at 0100-0530 (to 0630 on Sundays); 9710, 11,890, 15,300, 15,440, and 17.810 kHz at 0830-0900; 15,440 and 17.810 kHz at 0900-1145; 11,920, 15,300, and 15,440 kHz at 1145-1245; 15,230 and 15,300 kHz at 1245-1400, and 15,230 kHz at 1530-1630. On Sundays there are church services in Eng. at 0300-0400 on 15,440 kHz.

Portugal—A new frequency for Lisbon is 15.315 kHz, noted with news in Portuguese at 2330. Another xmsn in Portuguese, on 11,840 kHz, is aired at 2300-2345 and beamed to Brazil; news is given at 2330.

Reunion—Station ORTF, St. Denis, listed for 2246 kHz, has been reported on 2446 kHz from 0231 to 0300 fade with news and pop music, all-French.

Romania—R. *Bucharest* has been noted on new frequencies, 11.725 kHz from 0300 s/on and 15.225 kHz to 0500 s/off, both in English.

Saudi Arabia—Jeddah, 11.855 kHz, was noted at 2256 with ID. Arabic news to 2304, chanting at 2305-2318, march anthem and s/off at 2319. The ID is *Al Izza Al Arabia Al Saoudia*.

South Africa—R. *RSA*, Johannesburg, is now

beamed to N.A. at 2330-0025, 0030-0125, 0130-0225, and 0230-0325 on 11,970, 9705, and 6075 kHz. Numerous reporters say that the 11,970-kHz xmsn's are hard to read due to heavy QRM on and near the frequency.

Syria—*Hama Dimashk*, Damascus, has rescheduled; they now s/on at 0300 with a brilliant signal, on 17,865 kHz.

U.S.A.—R. *New York Worldwide's* special program for short-wave listeners and DX'ers is now broadcast on Saturdays at 1735 on 15,440, 17,730, 17,845 and 21,530 kHz.

Southern California DX'ers should note that the weak Eng. speaker under CHU, Ottawa (Canada's time station) is the third harmonic of KRLA, Pasadena, whose fundamental frequency is 1110 kHz.

Uruguay—Station CXA13, R. *Carre*, Montevideo, not often reported, is currently fair to good on 6155 kHz at 0230-0245 with rapid Spanish language and commercials.

Vatican City—*Vatican Radio* has a xmsn in Arabic to Asia and Africa on 15.135 kHz, another new frequency.

Venezuela—Station YVLE, R. *Puerto Capello*, Puerto Capello, 3285 kHz, was logged at 0150-0230 with the usual type of musical programs. They QSL promptly.

A new station is YVPP, R. *Frontera*, San Antonio del Tachira. Announced as being on 4770 kHz (actually measured as 4765 kHz) and 11,725 kHz (not yet heard on this channel), the station features Latin American programming around 0200. S/off is at 0400 with full ID and the Venezuelan anthem.

Station YVPA, R. *Yaracuy*, San Felipe, has ceased testing on 4940 kHz, and is now heard nightly to 0400 s/off with Latin American music and frequent ID's. Yaracuy is pronounced "Yaw-ruh-koeee" but it sometimes comes out merely as "Yara"; do not confuse this station with the former occupant of the channel, R. *Lara*. —[30]

DX AWARDS PROGRAM RULES

Here's an easy way to get a copy of the rules and regulations for each of the three phases of the DX Awards Program to date (Countries, States, and Provinces). Just supply a postage stamp or return envelope, and your Short-Wave Editor will send you a leaflet containing the rules for all three phases—plus a copy of the official Countries List for DX Awards. The stamp or envelope, with your request, should go to: DX AWARD RULES, P. O. Box 333, Cherry Hill, N. J. 08034.

ELECTRONICS MARKET PLACE

COMMERCIAL RATE: For firms or individuals offering commercial products or services. \$1.00 per word (including name and address). Minimum order \$10.00. Payment must accompany copy except when ads are placed by accredited advertising agencies. Frequency discount: 5% for 6 months; 10% for 12 months paid in advance.

READER RATE: For individuals with a personal item to buy or sell. 60c per word (including name and address). No Minimum! Payment must accompany copy.

GENERAL INFORMATION: First word in all ads set in bold caps at no extra charge. Additional words may be set in bold caps at 10¢ extra per word. All copy subject to publisher's approval. Closing Date: 1st of the 2nd preceding month (for example, March issue closes January 1st). Send order and remittance to: Hal Cymes, POPULAR ELECTRONICS, One Park Avenue, New York, New York 10016.

FOR SALE

FREE! Giant bargain catalog on transistors, diodes, rectifiers, SCR's, zeners, parts. Poly Paks, P.O. Box 942, Lynnfield, Mass. 01940.

GOVERNMENT Surplus Receivers, Transmitters, Snooper-scopes, Radios, Parts, Picture Catalog 25¢. Meshna, Nahant, Mass. 01908.

INVESTIGATORS. FREE BROCHURE, LATEST SUBMINIATURE ELECTRONICS SURVEILLANCE EQUIPMENT, ACE ELECTRONICS, 11500-L NW 7TH AVE., MIAMI, FLA. 33168.

CB-WPE-QSL CARDS. Same High Quality, Beautiful, Glossy multi-color cards. New **LOW PRICES. SAMPLES, 25¢.** Dick, W8VXK, 19QA0625, Gladwin, Mich. 48624.

R.F. CONVERTERS. World's largest selection. Also CCTV cameras, etc. Lowest factory prices. Catalog 10¢. Vanguard 196-23 Jamaica Ave., Hollis, N.Y. 11423.

TELEPHONE VOICE SWITCH: (LS-500), ACTUATES AUTOMATICALLY AND UNATTENDED ANY TAPE OR WIRE RECORDER. PICTORIAL INSTALLATION INSTRUCTIONS INCLUDED. \$23.75. POST PAID USA, WJS ELECTRONICS, 737 NORTH SEWARD, HOLLYWOOD, CALIF. 90038.

INVESTIGATORS: KEEP IN STEP WITH ADVANCEMENTS IN THE ART OF ELECTRONICS FOR THE PROFESSIONAL. SEND \$1.00 FOR EQUIPMENT BROCHURE. WJS ELECTRONICS, 737 NORTH SEWARD, HOLLYWOOD, CALIF. 90038.

BUG DETECTOR: WILL DETECT AND LOCATE SURREPTITIOUS TRANSMITTING DEVICES IN CONFERENCE ROOMS, HOME AND OFFICES, ETC. WRITE FOR DETAILS. WJS ELECTRONICS, 737 NORTH SEWARD, HOLLYWOOD, CALIF. 90038.

DETECTIVES! Free Brochures! Electronics Surveillance Devices. SILMAR ELECTRONICS, 3476 N.W. 7th Street, Miami, Fla. 33125.

CIRCUIT Boards, Parts for "Poptronics" projects. Free catalog. DEMCO, Box 16297, San Antonio, Texas 78216.

ROCKETS: Ideal for miniature transmitter tests. New illustrated catalog, 25¢. Single and multistage kits, cones, engines, launchers, trackers, rocket aerial cameras, technical information. Fast service. Estes Industries, Penrose 18, Colorado 81240.

LOWEST Prices Electronic Parts. Confidential Catalog Free. KNAPP, 3174 8th Ave. S.W., Largo, Fla. 33540.

RADIO—T.V. Tubes — 33¢ each. Send for free catalog. Cornell, 4213 University, San Diego, Calif. 92105.

CONVERT any television to sensitive, big-screen oscilloscope. Only minor changes required. No electronic experience necessary. Illustrated plans, \$2.00. Relco-A33, Box 10563, Houston, Texas 77018.

SURVEILLANCE EQUIPMENT — NEW HIGH PERFORMANCE SUBMINIATURE MODELS. ELECTRONIC COUNTERMEASURE DEVICES TO PROTECT PRIVACY. FREE DATA: SECURITY ELECTRONICS-PE, 15 EAST 43RD STREET, NEW YORK, N.Y. 10017.

FREE ELECTRONICS (new and surplus) parts catalog. We repair multimeters. Bigelow Electronics, Bluffton, Ohio 45817.

CRYSTALS . . . largest selection in United States at lowest prices. 48 hr. delivery. Thousands of frequencies in stock. Types include HC6/U, HC18/U, FT-241, FT-243, FT-171, etc. Send 10¢ for catalog with oscillator circuits. Refunded on first order. Jan Crystals, 2400F Crystal Dr., Fort Myers, Fla. 33901.

JAPANESE PRODUCTS CATALOG by air mail \$5, sea \$3. Intercontinental, CPO 1717, Tokyo, Japan.

TREASURE Hunters! Prospectors! Relco's new instruments detect buried gold, silver, coins. Kits, assembled models. Transistorized. Weighs 3 pounds. \$19.95 up. Free catalog. Relco-A33, Box 10836, Houston, Texas 77018.

LINEAR AMPLIFIERS: "Hornet"—50 watts output—\$98.50; "Raider"—100 watts—\$139.95; "Maverick—250"—250 watts—\$244.95. For AM and SSB. Frequency range 20-35 megacycles (illegal for Class D 11 meters.) Dealer inquiries invited. D & A Manufacturing Co., 1217 Avenue C, Scottsbluff, Nebraska 69361.

ELECTRONIC PARTS! Components, transistors, diodes, kits, relays, and many special items. Guaranteed. Send 25¢ for 100 page catalog. General Sales Co. P.O. Box 2031 D, Freeport, Texas 77541.

MESHNA'S TRANSISTORIZED CONVERTER KIT. Converts car radio to receive police and fire. 30-50MHz and 100-200 MHz (one MHz Tuning). \$5.00 with easy to follow step instructions. Meshnas, No. Reading, Mass. 01864.

RECTIFIERS, transistors, other components. Catalog free. Electronic Components Co., Box 2902C, Baton Rouge, La. 70821.

ELECTRONIC Ignition. Kits, components, systems. Diagrams. Anderson Engineering, Epsom, N.H. 03239.

DIAGRAMS—Radios \$1.00, Television \$2.50. Give make and model. Diagram Service, Box 1151PE, Manchester, Conn. 06042.

CLOSED CIRCUIT TV CAMERA KITS! \$18.95 (starter) to \$149.50 (complete). Both tube and transistorized models. Step-by-Step instruction manuals. Televisive live pictures on any standard TV receiver without modification. Quality performance! Perfect for industrial, educational and experimenter applications. **FACTORY-DIRECT** prices. Compare before buying. **ATV RESEARCH,** Thirteenth and Broadway, Dakota City, Nebr. 68731.

WEBBER LAB'S POLICE-FIRE KITS \$5.00 ALL SOLID STATE, SPECIFY FREQUENCY. 26-200MC ALWIRED CRYSTAL CONTROLLED LIFE TIME GUARANTEE \$23.00, KIT \$11.00. WRITE FOR METAL LOCATORS, REMOTE READING COMPASS, CATALOG 10¢, 72 COTTAGE STREET, LYNN, MASS.

SEND FOR FREE CATALOG, featuring transistors, rectifiers, zeners, SCR's, Triac and other semiconductor devices in large and small quantities. **ALL DEVICES ARE CHECKED AND GUARANTEED. INTEGRATED CIRCUITS (JK, SR, SRT FLIP FLOPS AND GATES),** with checked inputs and diagrams are available. Solid State Sales, Box 74F, Somerville, Mass. 02143.

TRANSISTORIZED RF OSCILLATOR CIRCUITS, LESS TANK. Transistor, capacitors, resistors are wired, packaged, sealed and tested. Just connect your tank (coil and capacitor) and 6 to 12 vdc as per instructions. Average size ¼ × ¾ × 1 inches. .5 to 6.5 MHz \$2.00. 6.5 to 30 MHz \$2.50. 6.5 to 125 MHz \$3.00. **J. A. DECATOR,** 603 10th Street, Holly Hill, Florida 32017.

COAXIAL Switches, 5 positions. Send \$8.75. Leed's 407-51st St., West New York, N.J. 07093.

POLICE Radio codes. 10, code 1, 11. \$1.50. Reyna, Box 568, S. F., Calif. 94101.

LOWEST prices. LP records. All labels. Harvey's, Box 1402, Newport News, Va. 23601.

ELECTRONIC, mechanical devices catalog 10¢. Transistor boards bonanza \$5.95, **FERTIK'S**, 5249 "D," Phila., Pa. 19120.

MUSIC LOVERS, CONTINUOUS, UNINTERRUPTED BACKGROUND MUSIC FROM YOUR FM RADIO, USING NEW INEXPENSIVE ADAPTOR. FREE LITERATURE. ELECTRONICS, 11500-Z NW 7th AVE., MIAMI, FLORIDA 33168.

CIRCUIT boards for projects. List. Shrive, Box 20017, Cincinnati, Ohio 45220.

SURVEILLANCE Equipment. Latest miniature devices. Free 1968 catalog. Fisher Electronics, Box 350, N. Miami Beach, Florida 33160.

PRINTED circuit boards. Free lists. Dirck Spicer, 11 Ridgeland Road, Wallingford, Connecticut 06492.

AMAZING NEW SUPER HOBBY CATALOG 25¢. Construction plans: **TELEPHONE:** Answering Machines, Speakerphones, Carphones, Automatic Dialers, Central Dial Systems, Voice Scramblers, Legal Connectors. **TELEVISION:** Cameras, 3DTV Converters, Color TV Converters, Video Recorders. **HOBBYIST:** Transistorized Teletypes, Electron Microscopes, Tranquilizers, Wireless Microphones, Private Eye Tail Transmitter. Plans \$4.95 each. **COURSES: TELEPHONE ENGINEERING** \$39.50. Detective Electronics \$22.50. Dynamites Listening Devices plans \$8.50. Don Britton Enterprises, 7906 Santa Monica Blvd., Hollywood, Calif. 90046.

FOR SALE: Antique radio magazines, books, tubes, 10¢ and stamped envelope for list. Joe Rusinko, 1120 W. Lime, Lompoc, California.

PROXIMITY switch. Detects nearness of human body! Free information. Claremont Products, 860 Reed, Claremont North, Calif. 91711.

100,000 PRODUCTS Wholesale! Terrific bargains! Wholesalers, 1265-PP, Broadway, New York, N.Y. 10001.

CB EQUIPMENT—10% discount! "Flyer"—5¢ stamp. **WESTCOM**, Box 281PE, Larchmont, New York 10538.

JAPANESE or EUROPEAN DIRECTORY 200 firms \$1.00. **SURVEILLANCE EQUIPMENT**, wireless **SNOOPERMIKE** \$25.00, **SUBMINNIMIKE** 3/8 x 3/8 x 3/16 \$4.00, Brochure 25¢, **SIERRATRONICS**, Box 7497, Las Vegas, Nev. 89101.

NO telephone privacy? "Bug" on your line? Blow it off! **ENGINEERING LABORATORIES, BOX 1036, ANDERSON, INDIANA 46015.**

POLICE RADIO. Hear all police calls, fire departments, Sheriffs, taxis, ambulances, Highway Patrol. New 5 Band portable radio and direction finder. Free Booklet. Nova-Tech, Dept. 240, Redondo Beach, Calif. 90278.

PLANS AND KITS

ALLWAVE RADIO KIT. Tube, transistor included \$5.00. Headset \$2.50. Ekeradio, Box 131, Temple City, Calif. 91780.

DX CRYSTAL SET CONSTRUCTION Handbook—50¢. Catalog. Laboratories, 12041-L Sheridan, Garden Grove, Calif. 92640.

BUILD a capacitor tester for under \$5.00. Plans and instructions \$1.00. Watkins, Box 3907, Hollywood, Florida 33023.

INTEGRATED CIRCUIT KITS; COMPUTER LOGIC; Parts; Others. Catalogue free. **KAYE ENGINEERING**, Box 3932, Long Beach, California 90803.

SUPER Snooper, printed circuit \$5.95, others. Lectronix, Box 42, Madison Heights, Michigan 48071.

HIGH FIDELITY

FREE! Send for money saving stereo catalog #P10E and lowest quotations on your individual component, tape recorder, or system requirements. Electronic Values, Inc., 200 W. 20th St., New York, N.Y. 10011.

HI-FI Components, Tape Recorders, at guaranteed "We Will Not Be Undersold" prices. 15-day money-back guarantee. Two-year warranty. No Catalog. Quotations Free. Hi-Fidelity Center, 239 (P) East 149th Street, New York 10451.

"**LOW**, Low quotes: all components and recorders. HiFi, Roslyn, Penna. 19001.

TAPE RECORDERS, Hi-Fi, components, Sleep Learning Equipment, tapes. Unusual Values Free Catalog. Dressner, 1523R, Jericho Turnpike, New Hyde Park, N.Y. 11040.

CLASSIFIED ADVERTISING ORDER FORM

Please refer to heading on first page of this section for complete data concerning terms, frequency discounts, closing dates, etc.

1	2	3	4	5
6	7	8	9	10
11	12	13	14	15
16	17	18	19	20
21	22	23	24	25
26	27	28	29	30
31	32	33	34	35

_____ Words { @ 60¢ (Reader Rate) } = \$ _____
 { @ \$1.00 (Commercial Rate) }

Insert _____ time(s) Total Enclosed \$ _____

NAME _____

ADDRESS _____

CITY _____ STATE _____ ZIP _____

Signature _____

WORD COUNT: Include name and address. Name of city (Des Moines) or of state (New York) counts as one word each. Zone or Zip Code numbers not counted. (Publisher reserves right to omit Zip Code if space does not permit.) Count each abbreviation, initial, single figure or group of figures or letters as a word. Symbols such as 35mm, COD, PO, AC, etc., count as one word. Hyphenated words count as two words. PE-1067

MUSICAL INSTRUMENTS

ACCORDIONS, GUITARS, BAND INSTRUMENTS! Save to 50%. Terms. Trades. Free Trial. Free catalog. Mention instrument. Music Mart, 5535-PE Belmont, Chicago 60641.

WANTED

CASH Paid! Unused tubes, electronic equipment. Barry, 512 Broadway, NYC 10012.

QUICKSILVER, Platinum, Silver, Gold. Ores Analyzed. Free Circular. Mercury Terminal, Norwood, Mass. 02062.

\$1.00—SENDS your name to wholesalers, importers, etc. Many **FREE SAMPLES**. Shopper, 1727 State, Santa Barbara, Calif. 93101.

WANTED—Harvey Wells X'Mit T-90, R'Cvr R-9A, APS-90 power supply. Need schematic and instruction manual. Robert Carpenter, 11597 Herman Way, Los Altos, California 94022.

WANTED IRE—IEEE Publications. Pickup service on quantities. EPI, Box 67, Palo Alto, Calif. 94301.

TUBES

TUBES "Oldies", latest. Lists free. Steinmetz, 7519 Maplewood, Hammond, Indiana 46324.

TUBE Headquarters of World! Send 10¢ for Catalog (tubes, electronic equipment) Barry, 512 Broadway, N.Y.C. 10012.

RADIO & T.V. Tubes—33¢ each. Send for free list. Cornell, 4213 University, San Diego, Calif. 92105.

RECEIVING & INDUSTRIAL TUBES, TRANSISTORS. All Brands—Biggest Discounts. Technicians, Hobbyists, Experimenters—Request **FREE** Giant Catalog and **SAVE!** ZALYTRON, 469 Jericho Turnpike, Mineola, N.Y. 11501.

RAYTHEON, SYLVANIA, RCA. 70% off list, send 10¢ for catalog. T & T Sales, 4802 Ave K, Brooklyn, N.Y. 11234.

DON'T BUY TUBES—Radio, TV-Xmitting, special-purpose types until you get our price list! Lowest prices in U.S.A. 5,000 types—Guaranteed Brand New. Send postcard for TV—Special Purpose Price List. **UNITED RADIO COMPANY, P.O. BOX 1000, NEWARK, N.J. 07101.**

SHORTWAVE LISTENING

BUILD 2 Band set, tube and plan \$1.50. Ekeradio, Box 131, Temple City, Calif. 91780.

ALL Books for SWLs. Joystick variable frequency antennas. Joymatch Antenna Tuners. SWL Guide, 218 Gifford, Syracuse, N.Y. 13202.

TAPE AND RECORDERS

TAPE RECORDER SALE. Brand new, latest models, \$10.00 above cost. Arkay Sales, 1028-C Commonwealth Ave., Boston, Mass. 02215.

BEFORE Renting Stereo Tapes try us. Postpaid both ways—no deposit—immediate delivery. Quality—Dependability—Service—Satisfaction—prevail here. If you've been dissatisfied in the past, your initial order will prove this is no idle boast. Free Catalog. Gold Coast Tape Library, Box 2262, Palm Village Station, Hialeah, Fla. 33012.

STEREO TAPES. Save up to 60% (no membership fees, postpaid anywhere U.S.A.). Free 60 page catalog. We discount batteries, recorders, tape accessories. Beware of slogans "not undersold," as the discount information you supply our competitor is usually reported to the factory. **SAXITONE**, 1776 Columbia Road, Washington, D.C. 20009.

AUTOMATIC telephone connection for Concord and other transistorized recorders. **SURVEILLANCE** and Privacy Protection Devices. Free Data: Security Electronics-PER, 15 East 43rd Street, New York, N.Y. 10017.

RENT Stereo Tapes—over 2,500 different—all major labels—free brochure. Stereo—Parti, 1616-PE Terrace Way, Santa Rosa, California 95404.

HI-FI Components. Tape Recorders, at guaranteed "We Will Not Be Undersold" prices. 15-day money-back guarantee. Two-year warranty. No Catalog. Quotations Free. HiFidelity Center, 239 (PT) East 149th Street, New York 10451.

EXCHANGE, rent Stereo Car Tapes. Autotapes, Box 19086-D, Indianapolis, Ind. 46219.

SCOTCH Recording Tapes. Tape Recorders. Catalog 5¢. Tower, Lafayette Hill, Pa. 19444.

RENT STEREO TAPES—75¢ WEEK. CATALOG. ART'S, 1442 BLAZE, SIMI, CALIF. 93065.

TAPE transport. NAB recording studio quality. Build yourself for amazingly low cost. Detailed plans \$5.00. Free particulars. Pepke Laboratories, 309-B West 19 Street, New York, N.Y. 10011.

REPAIRS AND SERVICES

TV Tuners rebuilt and aligned per manufacturers specification. Only \$9.50. Any make UHF or VHF. We ship COD. Ninety day written guarantee. Ship complete with tubes or write for free mailing kit and dealer brochure. JW Electronics, Box 51C, Bloomington, Indiana 47401.

MICROPHONES rebuilt to manufacturers response curve. All brands, all types expertly repaired. All Audio Service, Box 16, Deer Park, New York 11729.

INSTRUCTION

LEARN While Asleep, hypnotize with your recorder, phonograph. Astonishing details, sensational catalog free! Sleep-Learning Association, Box 24-ZD, Olympia, Wash. 98501.

LEARN ELECTRONIC ORGAN SERVICING at home all makes including transistors. Experimental kit—trouble-shooting. Accredited NHSC, Free Booklet. **NILES BRYANT SCHOOL**, 3631 Stockton, Dept. A, Sacramento, Calif. 95820.

ASSOCIATE Degree in Electronics Engineering earned through combination correspondence-classroom educational program. Free brochure. Grantham Technical Institute, 1505 N. Western Ave., Hollywood, Calif. 90027.

HIGHLY—effective home study course for FCC commercial phone exams. Free literature! Cook's School of Electronics, P.O. Box 36185, Houston, Texas 77036.

HIGH SCHOOL DIPLOMA at home. Qualified instructors. Send age, highest grade completed, for free details. No salesman. **SOUTHERN STATES ACADEMY**, Westbury Square Professional Bldg., Dept. 5, Houston, Texas 77035.

REI First Class Radio Telephone License in (5) weeks Guaranteed. Tuition \$295.00. Job placement free. (KANSAS CITY) R.E.I., 3123 Gillham Road, Kansas City, Missouri, Telephone WE1-5444. (SARASOTA) R.E.I., 1336 Main Street, Sarasota, Florida 33577. Telephone 955-6922.

HIGHLY EFFECTIVE home study course in Electronics Engineering Mathematics with circuit application. Earn your Associate in Science Degree. Free Literature. Cook's Institute of Electronics Engineering, P.O. Box 36185 Houston Texas 77036. (Established 1945.)

FCC First Class License in six weeks—nation's highest success rate—approved for Veterans Training. Write Elkins Institute, 2603B Inwood Road, Dallas, Texas 75235.

FCC LICENSE THROUGH TAPE RECORDED LECTURES at home plus one week personal instruction in Washington, Memphis, Minneapolis, Seattle or Hollywood. Bob Johnson Radio-telephone License Training, 1060D Duncan, Manhattan Beach, Calif. 90266.

DRAFTING (Electronic, Mechanical, Architectural, Art). Home Courses \$25.00. Send \$2.00 first lesson. Prior, Inc. 23-09 169 Street, Whitestone, N.Y. 11357.

RUBBER STAMPS

RUBBER ADDRESS STAMP \$1.50. **SIGNATURE** \$2.88. **FREE CATALOG.** JACKSON PRODUCTS, 1433 WINNE-MAC, CHICAGO, ILL. 60640.

PERSONALS

INVESTIGATORS, FREE BROCHURE, LATEST SUBMINIATURE ELECTRONIC SURVEILLANCE EQUIPMENT. ACE ELECTRONICS, 11500-K NW 7th AVE., MIAMI, FLA. 33168.

BORROW \$1,205 AIRMAIL Repay \$47 for 36 months. State licensed. Postal Finance, Dept. 84-N, 200 Keeline Building, Omaha, Nebraska 68102.

"SLEEP THERAPY"—Send for free brochure, "What's It All About." Navon, Box 190-PE, Quincy, Massachusetts 02169.

BILL PROBLEMS? Poor credit no trouble. Not a loan company. Send for free application. Automatic Acceptance, 318PE Broadway Blvd., Reno, Nevada or 307PE Pocasset Ave., Providence, R. I.

INVENTIONS WANTED

PATENT Searches including Maximum speed, full airmail report and closest patent copies. \$6.00. Quality searches expertly administered. Complete secrecy guaranteed. Free Invention Protection forms and "Patent Information." Write Dept. 9, Washington Patent Office Search Bureau, 711 14th Street, N.W., Washington, D.C. 20005.

INVENTORS! Outright cash sale or royalties for your inventions. Patented. Unpatented. Active demand from our client manufacturers. Financial assistance available. Write Dept. 35, United States Invention Brokerage, 78 Wall Street, New York, N.Y. 10005.

INVENTORS. We will develop, help sell your idea or invention, patented or unpatented. Our national manufacturer clients are urgently seeking new items for outright cash sale or royalties. Financial assistance available. 10 years proven performances. For free information, write Dept. 41, Wall Street Invention Brokerage, 79 Wall Street, New York, N.Y. 10005.

INVENTIONS wanted. Patented; unpatented. Global Marketing Service, 2420-P 77th, Oakland, Calif. 94605.

INVENTIONS—IDEAS developed: **CASH/ROYALTY SALES.** Member: United States Chamber of Commerce, Raymond Lee, 230-GR PARK AVENUE, NEW YORK CITY 10017.

PATENT SEARCHES \$6.00! FREE "INVENTION RECORD"/ Information. Miss Hayward, 1029HR Vermont, District of Columbia 20005.

INVENTORS! Sell your invention for cash or royalties! Our client manufacturers eagerly seek new items. Patented. Unpatented. Financial assistance if needed. 25 years proven performances. For free information, write Dept. 20, Gilbert Adams, Invention Broker, 80 Wall St., New York, N.Y. 10005.

INVENTORS! Don't sell your invention, patented or unpatented, until you receive our offer. Eagle Development Company, Dept. P, 79 Wall Street, N.Y., N.Y. 10005.

INVENTORS Needing Help with any problem, financial, development, securing manufacturer, obtaining patent. Write the organization that delivers action and results—not promises. Pioneer Invention Service, Dept. 79, 150 Broadway, New York, N.Y. 10038.

BOOKS

FREE CATALOG. Adult Books. **POSTAL PE,** 2217 Lackland, St. Louis, Missouri 63114.

FREE Book. Prophet Elijah Coming Before Christ. Wonderful Bible Evidence. PE Megiddo Mission, Rochester, New York 14619.

FREE catalog 950 aviation/electronic/space books, Aero Publishers, 329PE Aviation Road, Fallbrook, California 92028.

UNUSUAL Books! Catalog free! International, Box 7798(PE), Atlanta, Georgia 30309.

BE A TRANSISTOR EXPERT, specially developed demonstrations help you learn easily. Instructions \$3.00. Order now to receive free supplement "How to Fix Transistor Radios". Transistor, Box 774, Devon, Pa. 19333.

PHOTOGRAPHY—FILM, EQUIPMENT, SERVICES

MEDICAL Film—Adults Only—"Childbirth"—1 reel 8mm \$7.50—16mm \$14.95. International-E, Greenvale, L.I., New York 71548.

SCIENCE Bargains—Request Free Giant Catalog "CJ"—148 pages—Astronomical Telescopes, Microscopes, Lenses, Binoculars, Kits, Parts. War surplus bargains. Edmund Scientific Co., Barrington, New Jersey 08007.

EDUCATIONAL OPPORTUNITIES

WANTED! TV—Radiomen to learn aircraft electronics servicing. Numerous job openings everywhere. Write: Academy Avionics, Reno/Stead Airport, Reno, Nevada 89506.

LEARN WHILE ASLEEP. Miraculously build Mind Power, achieve Self-Confidence, improve Health, gain Success. Method 92% effective. Details free. ASR Foundation, Box 7021EG Henry Clay Sta., Lexington, Kentucky 40502.

PRINTING

FREE Booklet "Secrets of Cutting Printing Cost." Dept. 1, 305 S. 4th, Springfield, Illinois 62701.

CB-WPE-QLS CARDS. Fast service. Low prices. Free samples. JERRY, Box 9363, Austin, Texas 78756.

THERMOGRAPHED business cards, \$2.99—1,000, free samples. Gables—405T Clifton, Glenshaw, Pa. 15116.

DO-IT-YOURSELF

BUILD your own telephone intercom—complete—less battery. Write Telephones, Box PE67, Simpson, Penna. 18407.

SAVE! Build transistorized treasure finder. Details free! Del Research, Dept. A, West Barnstable, Mass. 02668.

GOVERNMENT SURPLUS

JEEPS Typically From \$53.90 . . . Trucks From \$78.40 . . . Boats, Typewriters, Airplanes, Electronics Equipment, Photographic Equipment, used, 100,000 Bargains Direct From Government. Complete Sales Directory and Surplus Catalog \$1.00 (Deductible First \$10.00 Order). Surplus Service, Box 820-J, Holland, Mich. 49423.

AUTHORS' SERVICES

AUTHORS! Learn how to have your book published, promoted, distributed. FREE booklet "ZD," Vantage, 120 West 31 St., New York 10001.

POEMS WANTED for new song hits and recordings by America's most popular studio. Tin Pan Alley, 1650-ZD Broadway, New York 10019.

MUSIC

POEMS wanted for new songs. Nashville Music Institute, Box 532-E, Nashville, Tennessee 37202.

SONGS, POEMS WANTED! For publishing, recording at our expense! Ted Rosen, 17PE Longwood Road, Quincy, Mass.

STAMPS

VALUABLE COLLECTORS' ITEM: Official Canadian 1st Day issue of the Queen Elizabeth Royal Visit to **EXPO 67** Postage Stamp mounted on commemorative envelope bearing beautiful portrait of Her Majesty. Postmarked with highly-prized first day cancellation! **ALSO INCLUDED** to introduce you to World's Most Rewarding Hobby: (2) Complete Set of 42 English Kings and Queens, (3) Big Collectors' Catalog, and (4) "How to Collect Postage Stamps" Booklet. Also, selections of Queen Elizabeth and other fine stamps from our approval service for Free Examination. You may return selections without buying and can cancel service anytime, but the Queen Elizabeth Commemorative Envelope, 42 English Kings and Queens, Big Collectors' Catalog, and Booklet "How to Collect Postage Stamps" are yours to keep **FREE!** Send 25¢ to cover postage and handling. **KENMORE STAMP COMPANY, B-225, MILFORD, NEW HAMP., 03055. USA.**

FREE Wonderful New United States Catalog! Postage and Airmails Complete, 786 Illustrations. Special offers. Bargains Galore—Everything! Send Today. H. E. Harris, Dept. FC-1, Boston, Mass. 02117.

PRESIDENT KENNEDY Memorial Stamp First Day Cover 50¢. Artcraft, Box 66, Maplewood, New Jersey 07040.

COINS

SELLING 10 different S Lincoln cents, \$1.00; 7 small date 1960-D cents, \$1.00; 6 different S Jefferson nickels, \$1.00; 5 Barber dimes, \$2.00. Price list. Charles Lees, 2026 East Greenlee, Tucson, Arizona 85719.

LINCOLN CENT, 1943-S, 10¢, Free List. Bedrin, 250F Fulton, Hempstead, New York 11550.

HYPNOTISM

FREE Hypnotism, Self-Hypnosis, Sleep Learning Catalog! Drawer H400. Ruidoso, New Mexico 88345.

"FEMALE HYPNOTISM" Exposed, explained! "Secret Method"—they never know! \$2, rushed. Guaranteed! Isabella Hall, Silver Springs, Florida 32688.

FREE TRIAL!! Sensational! self-hypnosis record kit improves memory, concentration, personality. Results guaranteed! Forum, 333-AA10, Michigan, Chicago 60601.

HYPNOTIZE others—unnoticed. Quietly, quickly, safely. Instruction \$1.00. Litton, 32MA, Randallstown, Maryland 21133.

BUSINESS OPPORTUNITIES

INVESTIGATE ACCIDENTS! Earn up to \$1,000 and more a month in your own business. Work spare time with average earnings of \$5 to \$8 per hour. No selling. Send for Free booklet. No obligation. No salesman will call. Write: Universal Schools, CZ-10, 6801 Hillcrest, Dallas, Texas 75205.

RAISE Rabbits for us on \$500 month plan. Free details. White's Rabbitry, Mt. Vernon, Ohio 43050.

FREE CATALOGS. Repair air conditioning, refrigeration. Tools, supplies, full instructions. Doolin, 2016 Canton, Dallas, Texas 75201.

PIANO TUNING learned quickly at home. Tremendous field! Musical knowledge unnecessary. GI Approved. Information free. Empire School of Piano Tuning, Miami, Florida 33145.

ELECTROPLATING Equipment and supplies. All types for home workshops and industrial. Send \$1.00 (refundable) for equipment guide formulas, operating data, catalog. HBS Equipment Division 90, 3543 East 16th, Los Angeles, California 90023.

FREE ARCTURUS CATALOG

A trusted name in electronics since 1925
Electronic parts, tubes. Wholesale.
Thousands of items. Unbeatable prices.

ARCTURUS ELECTRONICS CO.
502-22nd St., Dept. PE, Union City, N.J. 07087

ELECTRICAL REPAIR—Washers, dryers, motors, stoves, clocks, toasters. Free details. Industrial Training Institute, Dept. 65134, 815 E. Rosecrans, Los Angeles 90059.

I MADE \$40,000.00 Year by Mailorder! Helped others make money! Start with \$10.00—Free Proof. Torrey, Box 318-N, Ypsilanti, Michigan 48197.

SELL HERTEL BIBLES—Part time. Finest reference Bible available. Demonstrator and supplies furnished. Excellent commissions. Write: International Book, Box 114PE, Wichita, Kansas 67201.

PROFITS to 50% fast! No inventory, no risk! Details 25¢. Moneysaver, Box 666Z, Aptos, Calif. 95003.

FREE Book "990 Successful little-known Businesses." Work home. Plymouth 145M, Brooklyn, N.Y. 11218.

HOW to make \$30,000 a year. I do. Complete detailed formula for success without selling. \$1.00. D. Thelin, 60 Hammond Street, Jamestown, N.Y. 14701.

REAL ESTATE

FREE!!! New Illustrated 176-page **FALL-WINTER CATALOG!** Describes hundreds of farms, ranches, homes, businesses, vacation, retirement and waterfront properties coast to coast! Specify type property and location preferred. Zip code, please. **UNITED FARM AGENCY, 612-EP** West 47th St., Kansas City, Mo. 64112. Plaza 3-4212.

EMPLOYMENT INFORMATION

FOREIGN and **USA** job opportunities available now. Construction, all trades. Earnings to \$2,000.00 monthly. Paid overtime, travel, bonuses. Write: Universal Employment, Woodbridge, Connecticut 06525.

SPORT FILMS

SUPER 8 . . . REGULAR 8 . . . VIVID COLOR. CATALOG. **SPORTLITE FILMS-PE, 20 North Wacker Drive, Chicago, Illinois 60606.**

MISCELLANEOUS

WINEMAKERS: Free illustrated catalog of yeasts, equipment. Samples, Box 7208, Minneapolis, Minn. 55412.

SPARE TIME OPPORTUNITY—MONEY—WE PAY at the rate of \$10 hr. for **NOTHING** but your opinions, written from home about our clients' products and publications, sent you free. Nothing to buy, sell, canvass, or learn. **NO SKILL. NO GIMMICKS.** Just honesty. Details from **RESEARCH, ZD2, Box 669, Mineola, N.Y. 11501.**

TEN Winemaking Recipes and Winemaking Supplies catalog 10¢. Country Winemaker, Box 243EGA, Lexington, Massachusetts 02173.

SAVE \$1000.00 every year on second cars, campers. Other hints can save you money even your life. Free information. Mann Reifschneider, D6 Box 556, Salinas, Calif. 93901.

BILLS PAID WITHOUT BORROWING—Nobody refused up to \$18,000.00. Bad credit no problem—Not a Loan Co. Write for **FREE** application—**INTERNATIONAL ACCEPTANCE, Dept. 50A, 5133 N. Central Ave., Phoenix, Arizona 85012—119 Ann St., Hartford, Conn. 06103—507 Carondelet St., New Orleans. La. 70130—**or 504 Victoria Ave., Windsor, Ontario, Canada.

STOP BURGLARS THE EASY WAY!! Atthx authentic "Protected by Electronic Sentry Alarm" Decals to auto windows, doors & windows of home, retail stores, vending machines, etc. Whether you have an alarm or not—thieves stay away! Only \$1.00 each set of two. J. Ross, 80-34 Kent St., Jamaica, N.Y. 11432 Dept. PE.

EMPLOYMENT Resumes. Get a better job & earn more! Send only \$2.00 for expert, complete Resume Writing Instructions. J. Ross, 80-34 Kent St., Jamaica, N.Y. 11432, Dept. PE.

MAIL ORDER ADVERTISERS

Obtain more reader response when Classified Ads appear in Ziff-Davis Electronics Division Annuals. Plan **NOW** for these forthcoming publications:

1968 COMMUNICATIONS HANDBOOK: The complete source for all communications information for electronics enthusiasts. Rate: 75¢ per word. Closing: October 20th; On Sale: December 20th.

1968 SPRING ELECTRONIC EXPERIMENTER'S HANDBOOK: Fills the demands of electronics hobbyists for a publication supplying useful, interesting and educational projects. Rate: 75¢ per word. Closing: December 20th; On Sale: February 1968.

Send copy and payment to be certain of space. Or write for special combination rates on these and other annuals to:

Hal Cymes, Classified Advertising Manager
ELECTRONICS ANNUALS
 One Park Avenue, New York, N. Y. 10016

**POPULAR ELECTRONICS
 SUBSCRIBER SERVICE**

Please include an address label when writing about your subscription to help us serve you promptly. Write to: Portland Place, Boulder, Colo. 80302

CHANGE OF ADDRESS:

Please let us know you are moving at least four to six weeks in advance. Affix magazine address label in space to the right and print new address below. If you have a question about your subscription, attach address label to your letter.

TO SUBSCRIBE:

Check boxes below.

- New Renewal
- 5 years \$20
- 3 years \$13
- 1 year \$5

SPECIFY:

- Payment enclosed —You get 1 extra issue per year as a BONUS!
- Bill me later.

AFFIX LABEL

If you have no label handy, print OLD address here.

please print

name _____

address _____

city _____

state _____ zip-code _____

Add'l postage: \$1 per year outside U.S., its possessions & Canada.

name _____ please print 0229

address _____

city _____

state _____ zip-code _____

**POPULAR ELECTRONICS
 OCTOBER 1967
 ADVERTISERS INDEX**

READER SERVICE NO. ADVERTISER PAGE NO.

48	Aerotron Inc	28
1	Allied Radio	100
	American Institute of Engineering & Technology	116
2	Antenna Specialists Co., The	14
	Arcturus Electronics Co	123
3	Argos Products Company	92
4	Avanti Research & Development, Inc	112
5	B & K	30
6	Burstein-Applebee Co	116
	Capitol Radio Engineering Institute, The	88, 89, 90, 91
7	Cleveland Institute of Electronics	9
8	Cleveland Institute of Electronics	36, 37, 38, 39
10	Computer Usage Education, Inc	12
	Conar	94
12	Courier Communications, Inc	92
	Coyne Electronics Institute	114
47	Delta Products, Inc	104
	DeVry Institute of Technology	5
13	EICO Electronic Instrument Co., Inc	29
14	Edmund Scientific Co	94
9	Electro-Voice, Inc	FOURTH COVER
15	Electronic Kits Supply Co	26
16	Finney Company, The	87
17	Garrard	8
18	Hallcrafters	101
19	Heath Company	95, 106, 107, 108, 109
20	Hy-Gain Electronics Corporation	7
	Industrial Training Institute	116
21	Jerrold	17
23	Johnson Company, E.F.	THIRD COVER
22	Judson Research and Mfg. Co	113
24	Lafayette Radio Electronics	93
	McGee	98
25	Milwaukee School of Engineering	105
26	Mosley Electronics, Inc	98
27	Multi-Elmac Co	115
	National Radio Institute	SECOND COVER, 1, 2, 3
	National Technical Schools	62, 63, 64, 65
28	Olson Electronics Incorporated	113
29	Pace Communications Corp	16
30	Pearce-Simpson, Inc	23
	RCA Institutes, Inc	18, 19, 20, 21
31	Ray-Tel Company	27
49	Regency Electronics, Inc	113
32	S & A Electronics Inc	114
33	S-K Wayne Tool Company	25
34	Salch & Co., Herbert	111
35	Sams & Co., Inc., Howard W	102
36	Scott, Inc., H.H.	103
37	Sentry Manufacturing Company	111
38	Shure Brothers, Inc	13
39	Sonar Radio Corp	117
40	Squires-Sanders, Inc	10
41	Squires-Sanders, Inc	11
	Sydmur Electronics Specialties	98
42	Telex/Acoustic Products	96
43	Turner Microphone Company, The	99
44	United Audio	110
	Valparaiso Technical Institute	114
45	Weller Electric Corporation	6
46	Xcelite, Inc	97

CLASSIFIED ADVERTISING 119, 120, 121, 122, 123, 124

Printed in U.S.A.

Now, famous JOHNSON high quality at a new low price!

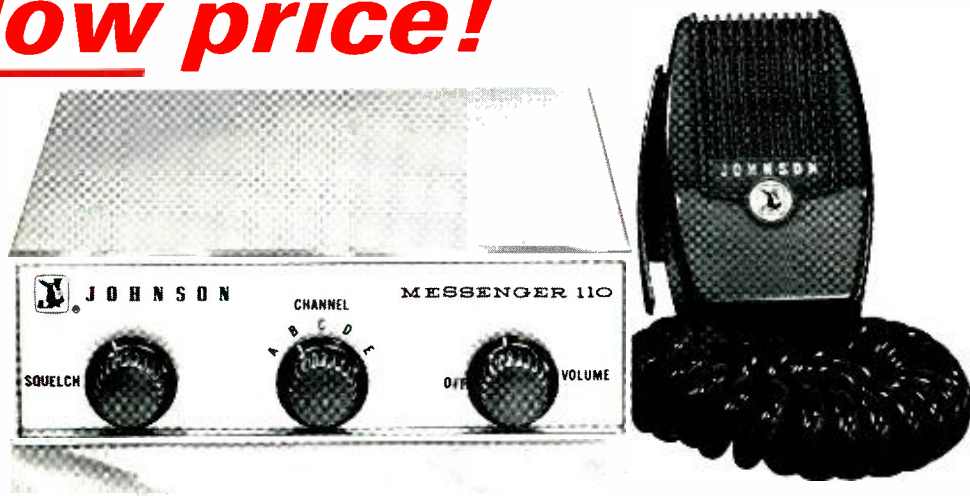

*New Messenger 110 costs **only \$99.95!***

Never before has so much quality been offered in a CB Transceiver priced so low. It's the same Johnson quality you'd normally find **only** in expensive models. Now you can have it and save, too! You get 5 channels; solid-state construction throughout . . . 14 transistors and 7 diodes for greatest reliability, lowest current drain. You also get speech compression for greater audio power and temperature compensation for year-round operation, anywhere. (Transmitter power is 5 watts, of course.)

More versatility, too, is yours with the new Messenger 110. Accessory base station power supply and rechargeable field pack enable you to use it whenever, wherever you want.

Why settle for less than the best, in both performance and price? See the New Messenger 110 at your Johnson Dealer or write for complete details.



E. F. JOHNSON COMPANY

2441 Tenth Ave. S.W., Waseca, Minn. 56093

First choice of CBers everywhere

CIRCLE NO. 23 ON READER SERVICE PAGE

Electro-Voice

Stereo

STARTER SET

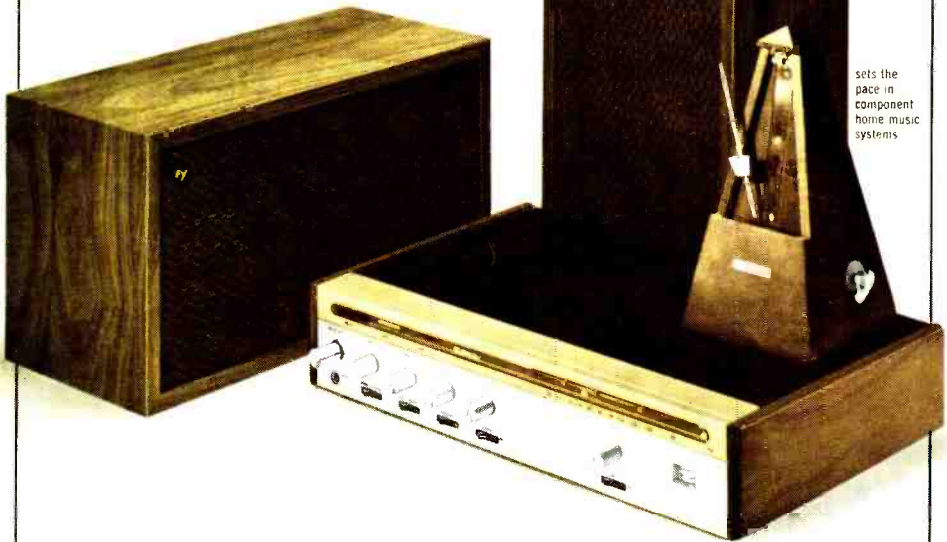

sets the
pace in
component
home music
systems

(E-V) Nowhere is the soundness of the component approach to home music better demonstrated than with the new Electro-Voice Starter Set.

The unique value of this system lies—in large part—in the modestly-priced E-V ELEVEN speaker systems. These compact basic starter units offer a most pleasant appearance and surprisingly robust performance...conclusive proof that the advantages of component reproduction need not be expensive.

But the principal unit of the Starter Set is the E-V 1177* FM Stereo receiver... and rightly so. For the future of your stereo system rests on

the ability of this receiver to meet tomorrow's needs. Right from the start you enjoy FM stereo with remarkable clarity. Yet you can expand your musical horizons as you wish, adding any component stereo record player or tape recorder at any time.

But the Starter Set goes further, providing all the power and quality needed to accommodate the very largest—and smallest—component speakers available. If you eventually desire even finer speaker systems, they're easily added. Your E-V ELEVEN's may then be moved to a second listening location where requirements are perhaps less

critical. Nothing has been lost—nothing made obsolete.

In essence, the E-V Starter Set offers you more than the initial pleasure of fine high fidelity. It is designed to grow and change with your personal needs—and without compromising your standards of musical reproduction.

You'll be surprised at the modest initial cost of the E-V Starter Set—and at how much it offers. Take the first step toward a lifetime of musical pleasure. Write today for full details, or listen to the Starter Set at fine high fidelity showrooms everywhere.

**Also available with E-V 1178 AM/FM Stereo Receiver*

high fidelity systems and speakers • tuners, amplifiers, receivers • public address loudspeakers
microphones • phonograph needles and cartridges • organs • space and defense electronics

ELECTRO-VOICE, INC., Dept. 1074P, 630 Cecil Street, Buchanan, Michigan 49107

Electro-Voice

CIRCLE NO. 9 ON READER SERVICE PAGE