

ADD POLICE TO AM/FM PORTABLES

POPULAR ELECTRONICS

JUNE
1967

50
CENTS

BUILD

Line-Operated Solid-State Audio Amplifier
Firing Range Timer
R. F. Sniffer
Clatter Stopper

SPECIAL

How To Wire Your Home for Multiple TV
Antennas, Amplifiers, Splitters,
and Transmission Lines
Home Antenna vs CATV

MORE

Converting CB To Ham Gear



E0173 490684LYN10882K086
KENNETH J LYNES
1088 22ND AV SE
MINNEAPOLIS MN 55414

Discover the ease
and excitement of NRI's

3 DIMENSIONAL METHOD

of ELECTRONICS TV-RADIO TRAINING

10 HOME-STUDY PLANS TO CHOOSE FROM

Ask men whose judgement you respect about NRI's three dimensional method of home-study training. Ask about the new, remarkable NRI Achievement Kit. Ask about NRI custom-designed training equipment, programmed for the training of your choice to make Electronics come alive in an exciting, absorbing, practical way. Ask about NRI "bite-size" texts, as direct and easy to read as 50 years of teaching experience can make them. Achievement Kit . . . training equipment . . . bite-size texts . . . the three dimensions of home-study training; the essentials you must have to make

learning easier, more interesting, more meaningful. You get them all from NRI.

Whatever your interest . . . whatever your need . . . whatever your education . . . pick the field of your choice from NRI's 10 instruction plans and mail the postage free card today for your free NRI catalog. Discover just how easy and exciting the NRI 3-DIMENSIONAL METHOD of training at home can be. Do it today. NATIONAL RADIO INSTITUTE, Electronics Division, Washington, D.C. 20016.

**BEGIN NOW AN ABSORBING
ADVENTURE—LEARN ELECTRONICS
THE EASY NRI WAY—MAIL CARD TODAY**

OVER 50 YEARS OF LEADERSHIP



IN ELECTRONICS TRAINING

1 Start Fast with NRI's New Remarkable Achievement Kit

The day you enroll with NRI this new starter kit is on its way to you. Everything you need to make a significant start in the Electronics field of your choice is delivered to your door. It's an outstanding way of introducing you to NRI training methods . . . an unparalleled "first dimension" that opens the way to new discoveries, new knowledge, new opportunity. The Achievement Kit is worth many times the small payment required to start your training. No other school has anything like it. Find out more about the NRI Achievement Kit. Mail the postage-free card today.



2 NRI "Bite-Size" Lesson Texts Program Your Training

Certainly, lesson texts are a necessary part of any training program . . . but only a part. NRI's "bite-size" texts are simple, direct, well illustrated, and carefully programmed to relate things you read about to training equipment you build. Here is the "second dimension" in NRI's training method. Here are the fundamental laws of electronics, the theory, the training of your choice, presented in a manner you'll appreciate. And in addition to lesson texts, NRI courses include valuable Reference Texts related to the subjects you study, the field of most interest to you.



3 Custom-Designed Training Kits Make Learning Come Alive

Electronics becomes a clear and understandable force under *your* control as you build, experiment, explore, discover. Here is the "third dimension" . . . the practical demonstration of things you read about in NRI texts. NRI pioneered and perfected the use of training kits to aid in learning at home. NRI invites comparison with equipment offered by any other school, at any price. Prove to yourself what 750,000 NRI students could tell you . . . that you get more for your money from NRI than from any other home-study Radio-TV, Electronics school. Mail postage free card for your NRI catalog. (No salesman will call.)

AVAILABLE UNDER NEW GI BILL — If you served since January 31, 1955, or are in service, check GI line in postage-free card.

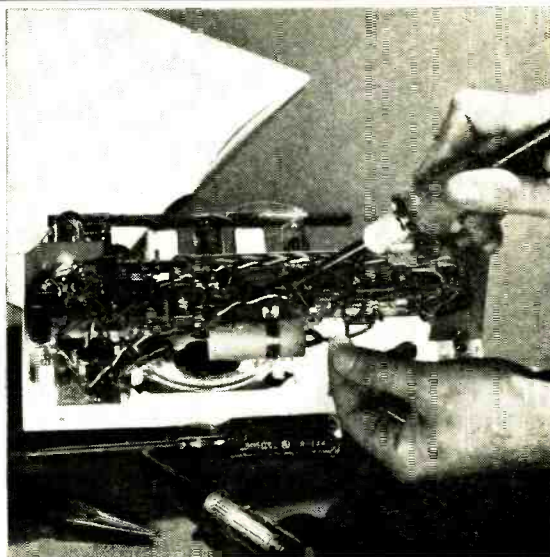

POPULAR ELECTRONICS

WORLD'S LARGEST-SELLING ELECTRONICS MAGAZINE

VOLUME 26

JUNE, 1967

NUMBER 6

SPECIAL ANTENNA SYSTEM FEATURE

- GERALD ZAPPA **44** **WIRING YOUR HOME FOR TV**
45 Selecting antennas
48 Selecting amplifiers and splitters
50 Selecting transmission lines
52 Installing the system
54 Servicing the system

FEATURE ARTICLES

- DAVID GIERKE **31** **SIMPLE-MINDED "MAGGIE"**
A natural science fair project
- MARC WEBER TOBIAS **35** **GET MORE VHF ON AM/FM TRANSISTOR RADIOS**
Pick up police, fire, taxi, airplane calls on your portable
- CALVIN F. HADLOCK **37** **FIRING-RANGE TIMER**
Beep your way to more bullseyes
- LYMAN E. GREENLEE **40** **SOLID-STATE LINE-OPERATED AUDIO AMPLIFIER**
Solid-state listening without batteries
- ART TRAUFFER **43** **NEW DIMENSION IN PORTABLE RADIO LISTENING**
- JAMES ASHE, W2DXH **55** **THE "R.F. SNIFFER"**
Not a field strength meter—but close
- I. C. CHAPEL **57** **THE "CLATTER" STOPPER**
Simple, automatic, instantaneous receiver quieting
- WALTER F. LANGE, W1YDS **59** **AMATEUR RADIO FOR CB'ERS: PART 2**
More conversions from 11 to 10 meters
- EDWARD A. LACY, K4BJL **64** **FOR WHOM DOES THE SYSTEM TOLL?**
Home antenna vs. CATV
- CHARLES J. SCHAUERS, W6QLV **68** **INFORMATION CENTRAL**
- HERB S. BRIER, W9EGQ **71** **AMATEUR RADIO**
Amateur radio has a Field Day
- MATT P. SPINELLO, KHC2060 **73** **ON THE CITIZENS BAND**
CB jamboree season
- LOU GARNER **75** **SOLID STATE**
- ROBERT LEGGE **78** **ENGLISH-LANGUAGE BROADCASTS TO NORTH AMERICA**
- HANK BENNETT, W2PNA **79** **SHORT-WAVE LISTENING**
New broadcasting stations in Cuba
- ROBERT P. BALIN **80** **TWO-LETTER QUIZ**
- 110** **DX STATES AWARDS PRESENTED**

DEPARTMENTS

- 8** LETTERS FROM OUR READERS
14 OPERATION ASSIST
15 READER SERVICE PAGE
22 NEW PRODUCTS
27 ELECTRONICS LIBRARY
29 NEW LITERATURE
82 TIPS & TECHNIQUES
112 INDEX TO VOLUME 26 (JAN.-JUNE, 1967)

POPULAR ELECTRONICS is indexed
in the Readers' Guide
to Periodical Literature

This month's cover photo by
Conrad Studios, Inc.

Copyright © 1967 by ZIFF-DAVIS PUBLISHING COMPANY. All rights reserved.

POPULAR ELECTRONICS, June 1967, Volume 26, Number 6, Published monthly at 307 North Michigan Avenue, Chicago, Illinois 60611. One year subscription rate for U.S., U.S. Possessions and Canada, \$5.00; all other countries, \$6.00. Second class postage paid at Chicago, Illinois and at additional mailing offices. Authorized as second class mail by the Post Office Department, Ottawa, Canada and for payment of postage in cash. Subscription Service: Portland Place, Boulder, Colorado 80502.

Approved for Veterans

DEVRY TECH NOT ONLY TRAINS YOU... BUT HELPS YOU GET STARTED AT NO EXTRA COST IN THE **BIG-MONEY FIELD OF**

ELECTRONICS!

✓ PREPARE AT HOME

Whether you want to prepare for a good-paying new job or for advancement in Electronics with your present employer, DeVry Tech offers specialized educational programs designed to meet your needs. You set up your own HOME LABORATORY and work over 300 construction and test procedures to develop on-the-job type skills. You build a quality Transistorized Meter, a 5-inch Oscilloscope and a special Design Console. DeVry also includes modern "programmed" texts, instructive motion pictures, Consultation Service. Effective? Yes!

✓ RESIDENT SCHOOL

If you prefer you may get all of your training in DeVry's U.S. or Canadian resident schools under the close guidance of friendly, experienced instructors. You work with a wide variety of commercial equipment similar to that actually used in industry as you prepare in our laboratories for a technician's job in Communications, Microwaves, Radio-Television, Automation, Radar, Computers, or other branch of Electronics. DeVry even provides part-time job placement service to those who wish to earn extra money while attending day or evening classes.

✓ PLACEMENT SERVICE

Meet W. E. Bartz, who has helped thousands of DeVry men toward exciting, profitable careers in Electronics. When YOU complete your program, he will help you too. As Placement Manager in touch with business and industry across the nation, Bartz knows the employer demand for DeVry-trained men. He has cooperated in placing our graduates with thousands of firms!

Men 18-45, start preparing NOW for this vast opportunity field. Soon you should be ready for DeVry's valuable employment help!



HOME LABORATORY EQUIPMENT — YOURS TO KEEP!



EXPERIENCED INSTRUCTORS



MAIL COUPON TODAY!

No Advanced Education or Previous Technical Experience Needed to Get Started

Your ambition and desire to succeed are more important! DeVry guides you every step of the way toward success.

Free

Send coupon for these two factual booklets NOW!



DEVRY INSTITUTE OF TECHNOLOGY

4141 Belmont Avenue, Chicago, Ill., 60641 Dept. PE-6-X

Please give me your two free booklets, "Pocket Guide to Real Earnings," and "Electronics in Space Travel"; also include details on how to prepare for a career in Electronics. I am interested in the following opportunity fields (check one or more):

- | | |
|--|---|
| <input type="checkbox"/> Space & Missile Electronics | <input type="checkbox"/> Communications |
| <input type="checkbox"/> Television and Radio | <input type="checkbox"/> Computers |
| <input type="checkbox"/> Microwaves | <input type="checkbox"/> Broadcasting |
| <input type="checkbox"/> Radar | <input type="checkbox"/> Industrial Electronics |
| <input type="checkbox"/> Automation Electronics | <input type="checkbox"/> Electronic Control |

Name _____ Age _____

Address _____ Apt. _____

City _____ State _____ Zip _____ Code _____

Check here if you are under 16 years of age.

HOME STUDY AND RESIDENT SCHOOL TRAINING

2103

AVAILABLE IN CANADA

DEVRY INSTITUTE OF TECHNOLOGY

4141 Belmont Avenue • Chicago, Illinois 60641

Accredited Member of National Home Study Council

The CB-20 "Reacter" is one of seven solid state CB transceiver brands on the market selling for less than \$100. Even if their specifications were comparable,*



doesn't it make sense

to buy yours from the company that has built more communications rigs by a country mile than all the others put together?



hallicrafters

A Subsidiary of Northrop Corporation
5th and Kostner Aves.
Chicago, Ill. 60624

*The CB-20's specs are a matter of conservative record: Channels: 5, crystal-controlled. Transistors: 12 plus 8 diodes, Zener voltage regulator. Sensitivity: One microvolt for 10 db S/N ratio. Audio power output: 3 watts. Power supply: 12 V. dc only. Modulation: high order. Microphone: push-to-talk ceramic. Maximum current drain: Receive, 0.75 amp.; Transmit, 1.4 amps. Dimensions: 7" x 6" x 2 1/4" LWH. Weight: 4 lbs. PS-20 AC pedestal power supply available as an accessory.

Export: Int'l. Div. Canada: Gould Sales Co.
CIRCLE NO. 15 ON READER SERVICE PAGE

POPULAR ELECTRONICS

PHILLIP T. HEFFERNAN

Publisher

OLIVER P. FERRELL

Editor

ROBERT CORNELL, WA2HDQ

Managing Editor

JOHN D. DRUMMOND

Technical Editor

WILLIAM GALBREATH

Art Director

MARGARET MAGNA

Associate Editor

ALEXANDER W. BURAWA

Assistant Editor

ANDRE DUZANT

Technical Illustrator

NINA KALAWSKY

PATTI MORGAN

Editorial Assistants

H. BENNETT, W2PNA

H. S. BRIER W9EQG

L. E. GARNER, JR.

CHARLES J. SCHAUERS, W6QLV

M. P. SPINELLO, KHCC260

Contributing Editors

LAWRENCE SPORN

Advertising Sales Manager

ARDYS C. MORAN

Advertising Service Manager

ZIFF-DAVIS PUBLISHING COMPANY

Editorial and Executive Offices

One Park Avenue, New York, New York 10016

212 679-7200

Eastern Advertising Manager, RICHARD J. HALPERN

Midwestern Office

307 North Michigan Avenue, Chicago, Illinois 60601

312 726-0892

Midwestern Advertising Manager, JAMES WEAKLEY

Western Office

9025 Wilshire Boulevard, Beverly Hills, California 90211

213 Crestview 4-0265; Bradshaw 2-1161

Western Advertising Manager, BUD DEAN

Japan: James Yagi

Ishikawa Mansion

#4, Sakuragaoka

Shibuya-ku, Tokyo

462-2911-3

Circulation Office

Portland Place

Boulder, Colorado 80302

William B. Ziff, Chairman of the Board (1946-1953)

William Ziff, President

W. Bradford Briggs, Executive Vice President

Hershel B. Sarbin, Senior Vice President

Philip Sine, Financial Vice President

Walter S. Mills, Jr., Vice President, Circulation

Stanley R. Greenfield, Vice President, Marketing

Phillip T. Heffernan, Vice President, Electronics Division

Frank Pomerantz, Vice President, Creative Services

Arthur W. Butzow, Vice President, Production

Edward D. Muhlfeld, Vice President, Aviation Division

Irwin Robinson, Vice President, Travel Division

Ziff-Davis also publishes Airline Management and Marketing, Boating, Business & Commercial Aviation, Car and Driver, Cycle, Electronics World, Flying, HiFi/Stereo Review, Modern Bride, Popular Aviation, Popular Photography, Skiing, Skiing Area News, and Skiing Trade News. (Travel Weekly is published by Robinson Publications, Inc., a subsidiary of Ziff-Davis Publishing Company.)

All subscription correspondence should be addressed to POPULAR ELECTRONICS, Circulation Department, Portland Place, Boulder, Colorado 80302. Please allow at least six weeks for change of address. Include your old address, as well as new—enclosing if possible an address label from a recent issue.

EDITORIAL CONTRIBUTIONS must be accompanied by return postage and will be handled with reasonable care; however, publisher assumes no responsibility for return or safety of art work, photographs or manuscripts.



Member Audit Bureau
of Circulations

POPULAR ELECTRONICS

NEW!
MASTER COURSE
IN COLOR TV...

WITH NTS COLOR KITS

Big 25" Color TV kits included in new Master Color TV Home Study program. Learn Color TV; keep the new 25" color TV receiver you build with exciting kits we send you. 10 million homes in this country will have color TV by the end of 1967. This industry needs technicians as never before, and NTS-trained men can move quickly into the big money.

COLOR TV SERVICING BRINGS HIGH PROFITS

New color sets need careful installation, precision tuning and skilled servicing. NTS home training can put you in this profit picture—prepare you for big pay, security, or start a business of your own.

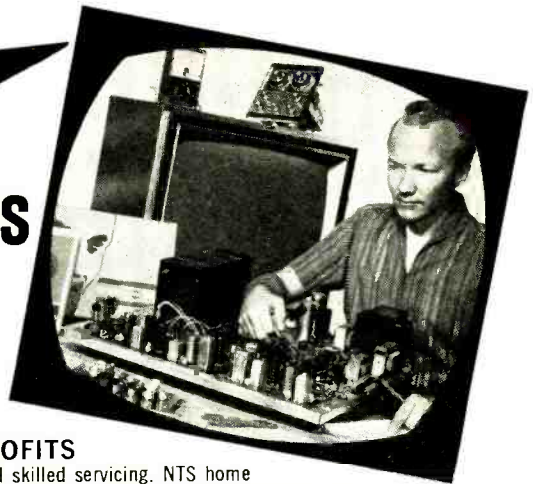

LIFT OFF...TO
A "SPACE AGE"
CAREER IN
ELECTRONICS

This is the "space age". It offers new opportunities in communications, industrial electronics, computer technology, and many others. Automation has increased the need for skilled electronics technicians in thousands of manufacturing plants. Only the well trained man makes it big. Industry wants and demands this kind of man... the NTS man. Pick your field. Let an NTS Project Method Program help you toward a well-paid career in Electronics wherever you travel.

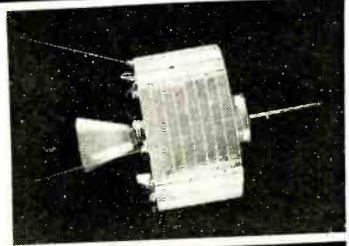

NEW CAREER KIT... FAST, EASY START TO NTS HOME TRAINING

The exclusive Project Method Career Kit helps you move quickly into your training program. Earn while you learn as you progress with your shop-tested Project Method lessons and kits.

Send for the New illustrated NTS Color Catalog. It shows the equipment and kits you work with and keep. Describes in detail the advantages of NTS Project Method Home Training. Tells you everything you need to know about starting your career in electronics.



HIGH SCHOOL AT HOME

National offers accredited high school programs. Take only subjects you need. Study at your own pace. Everything included at one low tuition. Check special High School box in coupon for full information & FREE catalog.

CLASSROOM TRAINING AT LOS ANGELES

You can take Classroom Training at Los Angeles in Sunny Southern California. NTS occupies a city block with over a million dollars in facilities devoted exclusively to technical training.

MAIL REPLY CARD OR COUPON FOR NEW, FREE COLOR CATALOG AND SAMPLE LESSON.



NATIONAL TECHNICAL SCHOOLS

World Wide Training Since 1905
 4000 S. Figueroa St., Los Angeles, Calif. 90037

You enroll by mail
 We have no salesmen: This means lower tuition for you.
 Accredited Member National Home Study Council
 Member: National Association of Trade & Technical Schools

NATIONAL TECHNICAL SCHOOLS

4000 S. Figueroa St., Los Angeles, California 90037

APPROVED FOR VETERANS



Please rush Free Color Catalog and Sample Lesson, plus detailed information on field checked below. No obligation. Dept. 205-67

- MASTER COURSE IN COLOR TELEVISION
- COLOR TV SERVICING
- MASTER COURSE IN ELECTRONICS-TV-RADIO plus ADVANCED TV and INDUSTRIAL ELECTRONICS
- ELECTRONICS-TV-RADIO SERVICING AND COMMUNICATIONS
- FCC LICENSE COURSE
- RADIO SERVICING (AM-FM-TRANSISTORS)
- TELEVISION SERVICING (including color lessons)
- STEREO, HI-FI and SOUND SYSTEMS
- BASIC ELECTRONICS
- ELECTRONICS MATH HIGH SCHOOL AT HOME

Name _____ Age _____

Address _____

City _____ State _____ Zip _____

- Check if interested in Veteran Training under new G.I. Bill.
- Check if interested ONLY in Classroom Training at Los Angeles.



GARRARD'S GREAT LAB 80

... now even greater. The new LAB 80 Mark II has an oversized, cast, dynamically balanced turntable, with an adjustable counter-balanced tone arm made of aluminum and wood for low resonance. Stylus pressure is adjusted with fine precision by quarter gram click settings. The built-in hydraulic cueing control is automatically activated. An adjustable anti-skating control equalizes out damaging side pressure on record grooves. Garrard's newly refined center drop spindle eliminates all over-arms and encumbrances. The LAB 80 handles from one to eight records safely, gently, and fully automatically when desired. The famed Garrard 4-pole shaded motor is isolated by rubber damping pads, top and bottom. With such refinements as these, at \$99.50 (less base and cartridge) the LAB 80 is the finest automatic turntable available today regardless of price. For complimentary copy of new Comparator Guide, write Garrard, Dept. AF-13, Westbury, N.Y. 11590



CIRCLE NO. 14 ON READER SERVICE PAGE

LETTERS FROM OUR READERS

Address correspondence for this department to:
Letters Editor, POPULAR ELECTRONICS
One Park Avenue, New York, N. Y. 10016

CW IS DEAD (?)

I read with great interest Herb Brier's article "CW Is Dead (?)" (February, 1967). While he has a good argument for the justification of the code requirement in the amateur radio exams, I feel that the emphasis on code contradicts the real purpose of amateur radio—which is to encourage interest in and develop a knowledge of radio. Why should the code requirement be comparatively more difficult than the theory requirement? Why not lower the code speed for the General Class exam and raise the theory to the level of Second Class Commercial theory? Why not put first things first?

TOM GALLAGHER, WA3GRF
Lawrence, N.J.

At one time, the code was the only means of communication, but it is now outmoded. It is used only on the Novice frequencies and perhaps 5% of the rest of the bands. Once the pro-code men could say that code would get through where AM wouldn't—now SSB is even better than code for DX. The FCC should want stiffer theory than code. The international regulations require that code be understood to pass any test, but they don't set any speed. A speed of 5 words per minute should be sufficient.

W. D. KASPERKOSKI, WB2SXY
Ontario, N. Y.

It is obvious that this article was authored by an avid "Brass Pounder." What is not obvious, however, is the scholarly and dogmatic statement that "... CW has a 17-dB advantage over AM phone and 8-11 dB over SSB ..." One can only assume Mr. Brier has at his disposal some very valuable reference material. Can you explain how he arrived at the conclusion in that statement?

C. F. COLE, K40MM
Eau Gallie, Fla.

We don't know how Herb Brier arrived at his figures, but it is a fact that CW can get through where AM and SSB can't. Some like the code, and some don't. There should be accommodations for all who want to contribute to the art of radio communications.

DO YOUR OWN TROUBLESHOOTING BUT ...

As manager of a TV shop, I suppose I should be a bit unhappy about your printing

Now, for men in electronics —“a whole new era of quick calculations”

thanks to this specially designed
electronics slide rule

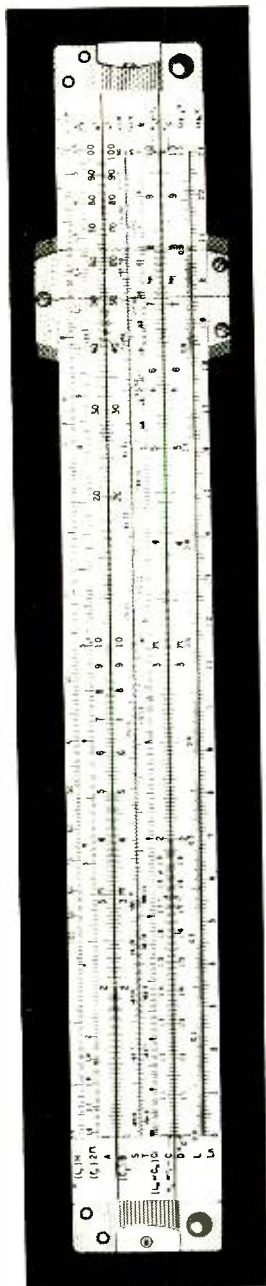

“THERE MUST BE THOUSANDS OF PEOPLE in electronics who have never had the marvelous adventure of calculating problems with a single slide rule; other thousands have had to content themselves with a slide rule not specifically designed for electronics. For both groups, the new slide rule designed and marketed by Cleveland Institute of Electronics and built for them by Pickett will open a whole new era of quick calculations.

“Even if you have never had a slide rule in your hands before, the four-lesson instruction course that is included takes you by the hand and leads you from simple calculations right through resonance and reactance problems with hardly a hitch. If you already use a slide rule, you’ll find the lessons a first-rate refresher course. And it explains in detail the shortcuts built into this new rule.”

From an article in
Radio Electronics Magazine

Want complete details about this time-saving new Electronics Slide Rule? Just mail coupon below...or write Cleveland Institute of Electronics, Dept. PE-133, 1776 East 17th St., Cleveland, Ohio 44114.

Mail this coupon for
FREE BOOKLET



CIE Cleveland Institute of Electronics
1776 E. 17th St., Cleveland, Ohio 44114

Please send me without charge or obligation your booklet describing the CIE Electronics Slide Rule and Instruction Course. Also FREE if I act at once: a handy pocket-size Electronics Data Guide.

Name _____ (please print)

Address _____

City _____ State _____ Zip _____

Accredited Member National Home Study Council
A Leader in Electronics Training ... Since 1934

PE-133

CIRCLE NO. 9 ON READER SERVICE PAGE

XL-100 Now approved by
D.O.T. for use in Canada



Tram by-the -sea

Showing up everywhere.
XL-100. The sharpest
C.3. mobile going.
Minimal adjacent channel
interference and
unsurpassed sensitivity.
23 channels. A trouble-
free transceiver
miniaturized into a dash
unit just 4x8x8 inches.
Tram XL-100. If you
don't have it, you're
relying on second best.
\$318 complete.

All use must conform with Part 95 F.C.C. regulations.
Hobby type communication or aimless small talk prohibited.

Tram Electronics, Inc.

Dept. No. E-6 Lower Bay Road, P.O. Box 187,
Winnisquam, N.H. Phone 603-524-0622.

CIRCLE NO. 35 ON READER SERVICE PAGE

LETTERS (Continued from page 8)

an article telling the average guy how to clean his TV tuner at home ("Taming Your TV Tuner," March, 1967). Some of the "dirty tuner jobs" I would have gotten will no doubt be done at home, BUT someone is sure to try and clean the one type of tuner—the RCA "New Vista"—that can't be cleaned using the method you outlined. By the time he gets through messing it up, and brings it to me to clean properly, it will cost him more than it would have if he hadn't attempted the cleaning job himself. If any of your readers own a tuner of this type, tell them to do their own troubleshooting but . . . leave the cleaning to us.

WALLY HEPWORTH
Northgate TV
Seattle, Wash.

Wally, we prefer to believe that our readers are not "the average guy."

GIANT ROBOT

I couldn't help noticing the picture of "Gorgo," the homemade robot, in your "Letters From Our Readers" column (February,

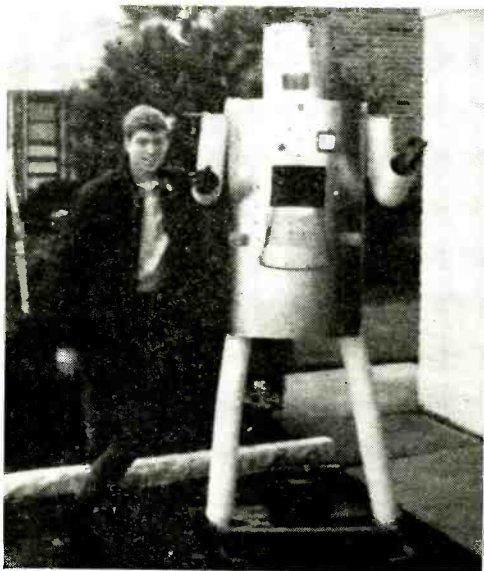

1967). "Gorgo" is probably okay for its size, but for the big jobs, I'll take MY robot, "Herbie," any day.

GLENN FIELDS
Roslyn, N. Y.

GIANT RELAY

Take one giant coil about 5" high and 1½" in diameter, some ¼" wood, some 1" wood, a handful of screws and nails, 12-gauge wire, two perforated metal strips (magnetic), and you can make a relay. The one in the picture

The

PERFECT 36

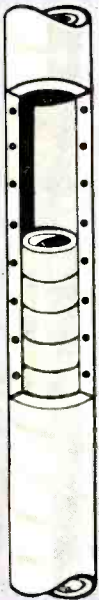

Bold . . . New . . . Revolutionary

The Perfect 36 is a citizen's band breakthrough by Shakespeare's internationally famous engineer-designers. □ The easily installed, performance-shaped, 36-inch fiberglass roof-top mobile antenna has rugged solid-state construction and handsome rocketry design. And our patented parallel fiber process completely encloses this ultra-sensitive, space-age circuitry in a power-pack unit providing the maximum performance and range-expansion which "turns country miles into city blocks." Fiberglass perma-durability eliminates problems caused in other antennas by moisture, rain, dust, salt air, extreme cold, vibrations, abrasions, and other physical hazards. □ Fiberglass' flex-strength inhibits "set" damage on impact with doors, frames, low limbs, etc., insuring that our non-corrosive, anti-static antenna never gets "out of tune." In bringing this bold, new shape to the market, we made no compromise between performance and structural make-up. □ With The Perfect 36 we have created tomorrow's finest antenna today.

... count on Shakespeare
GLASS FIBER
WONDERSHAFT ANTENNAS

C/P Corporation

A Subsidiary of Shakespeare

RFD 3 Columbia, S. C. 29205
CIRCLE NO. 8 ON READER SERVICE PAGE

June, 1967

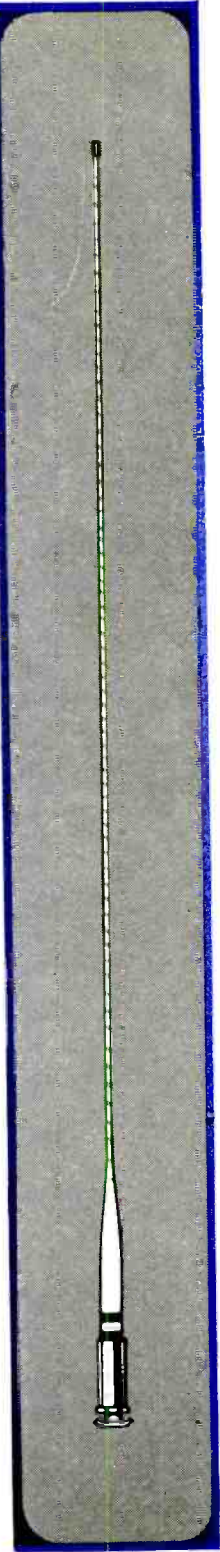

Thinking of college and a space age career?

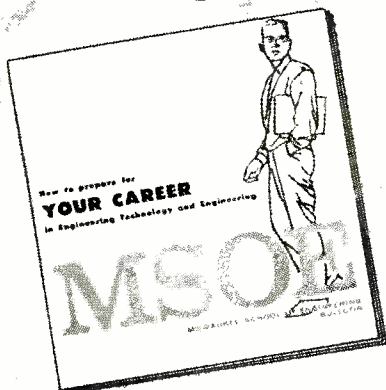

Send for this booklet on ENGINEERING TECHNOLOGY AND ENGINEERING

Learn how you can prepare for a dynamic career as an electrical or mechanical engineering technician or engineer in such exciting, growing fields as avionics, missiles, reliability control, fluid mechanics, data processing, metallurgy, microelectronics, and advanced aerospace research.

MSOE offers residence study programs leading to these degrees in engineering technology and engineering:

- 2 years — Associate in Applied Science
- 4 years — Bachelor of Science

Also get facts about scholarships and financial aids, job placement and other student services, plus photographs of MSOE technical laboratories and student activities. Courses approved for veteran training.

For your copy, just mail the coupon — no obligation.

MSOE

Milwaukee, Wisconsin 53201

Milwaukee School of Engineering
Dept. PE-667, 1025 N. Milwaukee Street
Milwaukee, Wisconsin 53201

Please send the "Your Career" booklet.
I'm interested in

- Electrical fields Mechanical fields

Name.....Age.....

Address.....

City.....State.....ZIP.....

CIRCLE NO. 23 ON READER SERVICE PAGE

MS-284

LETTERS (Continued from page 10)

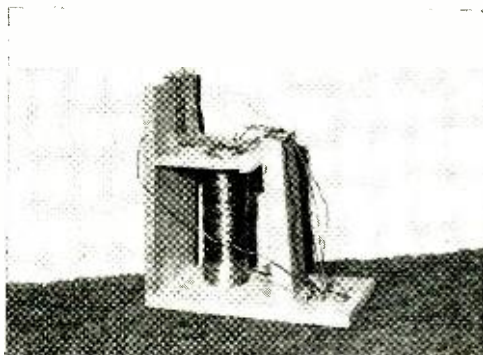

is a 12.5-volt model. It works just as any other relay does, but is about 50 times as large. One perforated metal strip serves as the armature, and the other as the stationary contact.

JOHN C. KONING
Norco, Calif.

Giant robots. Giant relays. What happened to our microminiaturization program? Fairchild, RCA, Motorola, Texas instruments, take note.

"OPERATION ASSIST" APPRECIATED?

One reader sent me a Xerox copy of a manual I requested in "Operation Assist" (February, 1967), and another reader sent me a photocopy of the schematic. So to you and to both of the readers who came to my assistance, a big thank you.

JOSEPH E. LYNCH, K9IFE
Northlake, Ill.

On three occasions in the past I responded to requests in the "Operation Assist" column, and I have yet to be thanked for any of them. I am afraid that if other persons have the same experience the column will gradually decline in popularity.

CHARLES W. LINES
Atlanta, Ga.

Just a short note to thank you for running my request for information on two units in "Operation Assist." It brought results in both cases—schematic diagrams and parts lists. This is an unusual type of column, but it is vital to hobbyists who deal in reconditioning old electronic gear and the like. Often it is extremely hard to get data on outdated equipment, and the availability of "Operation Assist" is much appreciated.

CARL MASON
Holmdel, N.J.

To all those who have benefitted from "Operation Assist": thank the responders, not the magazine. Rest assured, Charles, that your responses were appreciated—it's better to give than to receive.

-30-

Introducing the world's first 5-channel, solid state, Citizens Band Radio with a Class B push-pull audio amplifier, super-sensitive receiver, and full-powered transmitter, that comes with either palm microphone or telephone handset at no extra cost.

Total weight: 3 pounds. Total price: \$99.90.

How can anyone put so much into one radio, for so little, without cutting corners?

Anyone can't. Pearce-Simpson can.

In simple, unvarnished terms, Pearce-Simpson makes more marine radio telephones than anyone in the world.

Period.

Which means that Pearce-Simpson buys more components for marine radio telephones than anyone in the world.

In other words, because we buy in such quantity, we save money when we buy our components.

You save money when you buy our radios.

And because we have our own plastics factory and make our own telephone handsets, our own cabinets and many of our own parts, we know we start out with quality.

You know you end up with quality.

But probably the most significant part of the story is this:

The \$99.90 Sentry II, pictured here, is designed by the same tough engineers, and goes through the same tough production line and quality check points as our most sophisticated \$1,000 radio.

Result?

This little radio of ours that you buy for \$99.90 won't do the same things as our radio that you buy for \$1,000.

Obviously,

But you can't buy a better \$99.90 radio from anyone.



Nobody can make a better radio for \$99.90 Not even Pearce-Simpson.

Important: Full year warranty. 4-watt power output 0.5uv opens squelch adjacent channel 50 db down cross modulation 80 db down no close range blocking noise limiting circuit virtually eliminates ignition and alternator noise.

PEARCE-SIMPSON, INC.
P.O. Box 800/ Biscayne Annex PF-667
Miami, Florida 33152

Gentlemen: Please send your free booklet on the entire line of Pearce-Simpson Citizens Band Radios.

Name

Address

City

State

Zip

Overseas military personnel may write for special military price list.

CIRCLE NO. 27 ON READER SERVICE PAGE

"IT'S FOR YOU... LONG DISTANCE"



"Long distance", of course, is a relative term . . . but when you're talking about mobile microphones, the "long distance" a Turner M+2 can provide can be awfully important. Even at distances where you now need a telephone to contact your base station, the M+2 gives you additional output with a twist of the dial. (And the Turner +2 in your base station gives you the increased output you need to complete the communication circuit.)

If YOUR mobile rigs aren't performing the way they should, see your nearest CB dealer or distributor . . . let him show you **why** the Turner M+2/Turner +2 combination is — indeed — unique in its field.



THE TURNER MICROPHONE COMPANY
946 17th Street N.E.
Cedar Rapids, Iowa

In Canada: Tri-Tel Associates, Ltd.
Export: Ad Auriema, Inc., 85 Broad St., New York, N.Y. 10004

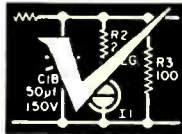

OPERATION ASSIST

Through this column we try to make it possible for readers needing information on outdated, obscure, and unusual radio-electronics gear to get help from other P.E. readers. Here's how it works: Check the list below. If you can help anyone with a schematic or other information, write him directly—he'll appreciate it. If you need help, send a postcard to Operation Assist, POPULAR ELECTRONICS, One Park Avenue, New York, N.Y. 10016. Give maker's name, model number, year of manufacture, bands covered, tubes used, etc. State specifically what you want, i.e., schematic, source for parts, etc. Be sure to print or type everything legibly, including your name and address. Because we get so many inquiries, none of them can be acknowledged. POPULAR ELECTRONICS reserves the right to publish only those items not available from normal sources.

RCA Mark VII CRM-P3A-5 CB transceiver. Schematic needed. (Luke Kulukhon, St. Lawrence Island, Cambell, Alaska 99742)

ERLA Balloon Circolid coil; tunes 200 to 550 kHz. Schematic and metal and black tuning knob needed. (J. Lee Grulkey, 2801 Greenwood Dr., San Pablo, Calif. 94806)

Sonora Model 390AN receiver; tunes on 5 bands; has 8 tubes. Schematic needed. (Edward J. Arnold, 42 W. Fordham Rd., New York, N.Y. 10468)

Shell Model 2020P amplifier. Schematic needed. (Joe Coffield, 40 Mitchell Ave., E. Northport, L.I., N.Y.)

Hallcrafters Model SX73 receiver, ser. R274D1FRR. Source for gears, drives, and parts for tuning assembly wanted. (Joseph T. Miller, Box 249, North Platte, Neb. 69101)

Midwest Model 170 receiver, circa 1938; tunes on 5 bands; has 17 tubes. Schematic needed. (D. B. MacGregor, 5251 Sleepy Hollow Rd., Rt. 1, Valley City, Ohio 44280)

Beckman Model 5630-37 counter. Schematic needed. (Robert Meijer, 1833 N. Larrabee St., Chicago, Ill. 60614)

Hobbs receiver, ser. 89569, circa 1935; tunes from 0.550 to 18 MHz; has 8 tubes. Schematic needed. (Charles Buse, 126 Los Banos Ave., Walnut Creek, Calif. 94598)

Electro Engineering Co. "Magna Tele" receiver; has 3 tubes. Schematic and technical data needed. (Albert R. Mack, 508 Dorinda St., London, Ontario, Canada)

Pilot "Pilotone" AA-410 amplifier; 100 watts output. Source for amplifier wanted. (Steven Kearns, 167 E. 67 St., New York, N.Y. 10021)

Readrite Model 432A tube tester. Tube chart and adapters #M-BJ-B1-Bo and instruction manual needed. (Joseph Bilski, 1320 N. Cleaver St., Chicago, Ill. 60622)

Paragon receiver, type RD-5, manufactured by Adams-Morgan of Upper Montclair, N.J. Schematic needed. (R. B. Harris, Box 599, 2140-3 Comm. Det., APO, New York, N.Y. 09291)

RCA Model RC 1060 receiver, circa 1949. Unit or cabinet for same wanted. (Frank E. Sayles, 45 Petteys Ave., Providence, R.I. 02909)

DuMont Model 274 A oscilloscope. Schematic and servicing instructions needed. (Robert Bazinet, 10771 Clark, Montreal 12, Canada)

Triplet Model 1213 tube tester. Tube chart needed. (Donald Kenner, 660 Wayskin Dr., Covington, Ky.)

(Continued on page 16)

POPULAR ELECTRONICS

READER SERVICE PAGE

**You can get
additional information promptly
concerning
products advertised or mentioned
editorially
in this issue**

1

Circle the number on the coupon below which corresponds to the key number at the bottom of the advertisement or is incorporated in the editorial mention that interests you.

2

Mail the coupon to the address indicated below.

3

Please use this address only for Product Service requests.

POPULAR ELECTRONICS
P. O. BOX 8391
PHILADELPHIA, PA. 19101

Please send me additional information about the products whose code numbers I have circled

1 2 3 4 5 6 7 8 9 10 11 12 13 14 15 16 17 18 19 20 21 22 23 24 25
26 27 28 29 30 31 32 33 34 35 36 37 38 39 40 41 42 43 44 45 46 47 48 49 50
51 52 53 54 55 56 57 58 59 60 61 62 63 64 65 66 67 68 69 70 71 72 73 74 75
76 77 78 79 80 81 82 83 84 85 86 87 88 89 90 91 92 93 94 95 96 97 98 99 100

NAME (Print clearly) _____

ADDRESS _____

CITY _____ STATE _____ ZIP CODE _____

VOID AFTER JULY 31, 1967

6

sonotone's dynamic cardioid mike for taping

Are unwanted sounds spoiling your home tape recordings? Has everyday household noise got you down? Sonotone has the unidirectional answer: Our CDM80 dual impedance microphone.

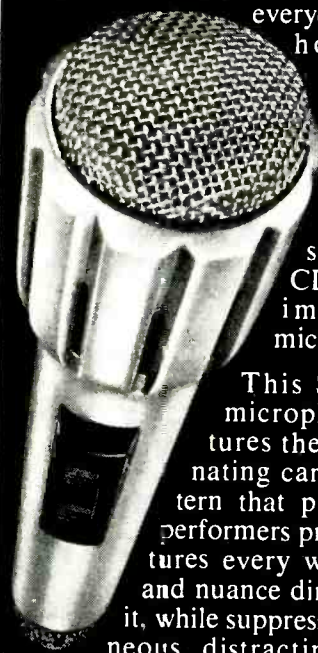

This Sonotone microphone features the discriminating cardioid pattern that professional performers prefer. Captures every word, note and nuance directed into it, while suppressing extraneous, distracting noises, boominess and feedback.

Complete with on-off switch. 15-foot cable and shield. Impedances of 200 ohms and 50K ohms. Price: \$43.50



ELECTRONIC APPLICATIONS DIVISION
SONOTONE CORPORATION • Elmsford, N.Y. 10523
Exports: Singer Prods. Co., NYC. Cable: Exregnis, N.Y.

Write TODAY for Latest
Catalog on Sonotone Microphones

CIRCLE NO. 32 ON READER SERVICE PAGE

ASSIST

(Continued from page 14)

Radio Shack Model CBK-1 CB transceiver: has 5 tubes. Schematic needed. (Neil Courtney, Tower Rd., Lincoln, Mass. 01773)

Victor Co. of Japan Model SPV-1 8" TV receiver. Tube type 21A6 (horizontal output) needed. (Wesley W. Harris, Rt. 5, Box 2325, Bremerton, Wash. 98310)

Superior Instruments Model TV-11 tube tester. Schematic and operating manual needed. (Billy J. Smith, Box 252, Meredosia, Ill. 62665)

RCA amplifier, ser. 27317, circa 1926. Schematic and source for parts needed. (Tim Hain, Box 88, Nachusa, Ill. 61057)

E. H. Scott Model SLR-F receiver, ser. 1169; tunes 80 to 550 kHz and 1.9 to 24 MHz on 5 bands. Schematic needed. (Howard Briand, 5090 George St., Halifax, N.S., Canada)

McMurdo-Silver receiver; tunes BC on 6 bands; has 11 tubes. Schematic or service manual needed. (Charles G. Baker, 122 Village Way, Ashford, Middlesex, England)

Hammarlund "Super Pro" receiver, type LXR, ser. 5271; tunes on 5 bands; has 16 tubes. Schematic and operating manual needed. (Jerry W. Ward, 1125 Gorsuch Ave., Baltimore, Md. 21218)

Superior Instruments Model 82-A tube tester. Tube chart needed. (Robert Dillard, Rt. #1, Holeyville, Ala.)

BC-654-A transceiver, surplus; tunes 3800 to 5800 kHz. Conversion data for operation on 117 volts. 60 hertz a.c. needed. (Norm Yanke, Box 325, Youbou, B.C., Canada)

Precision Model E420 dot/bar color generator, ser. 1111M; has 8 tubes. Schematic and operating manual needed. (Daniel Kalinowski, 7 Saratoga St., Commack, N.Y. 11725)

McMurdo-Silver "Silver 800" receiver, circa 1930; has 5 tubes. Schematic and technical data needed. (Maddy Sowa, Rt. 1, Box 30, Auburn, N.H. 03032)

Airline Model 62-370 receiver; tunes BC from 6 to 18 MHz; has 7 tubes. Schematic and operating manual needed. (Kenneth J. Romm, 6520 W. 82 St., Los Angeles, Calif. 90045)

Capehart-Farnsworth phonograph, circa 1953; has 5 tubes. Schematic and parts list needed. (Robert E. Rice, 1620 N. Ridge Dr., Duncan, Okla. 73533)

B & K "Dyna-Quick 500" tube tester. Schematic, operating manual, and tube chart needed. (William Neisius, 5121 Bluemound Rd., Rolling Hills Ests., Calif. 90274)

Harvey Wells Model T-90 "Bandmaster" transmitter. Schematic and operating manual needed. (Thomas Kenneally, 35 Fawndale Rd., Boston, Mass. 02131)

Webcor Model 4008 "Royalite" speaker system. Schematic needed. (William C. Wieskus, 881 West Drive, Woodruff Pl., Indianapolis, Ind. 46201)

United States Radio & TV receiver, ser. 512562, chassis 32; has 7 tubes. Schematic and technical data needed.

Atwater Kent Model 35 receiver. Schematic, speaker, and source for 01A's needed. (David Sellers, 52 Broadway, Jackson, Ohio 45610)

RT-285A/URC-11 transceiver, made by Philharmonic Radio & TV Corp. Schematic and conversion data from 144 MHz to 220 MHz needed. (Joseph Licata, 710 10 St., Union City, N.J. 07087)

Hallcrafters Model S-38D receiver; tunes 0.540 to 31 MHz; has 5 tubes. Schematic and alignment data needed. (Mike Rauscher, 17 Broadway, Hatboro, Pa. 19040)

RCA Victor Model 6K receiver, circa 1938; tunes 540 kHz to 7 MHz on 2 bands; has 6 tubes. Schematic and parts list needed. (Bruce D. Henderson, 3761 G Watkins Dr., Riverside, Calif. 92507)

R-122A/ARN-12 homing receiver, surplus, circa 1952; tunes on 31.05 MHz only; has 9 tubes. Schematic and operating manual needed. (Eric Kiaus, 4035 Cottontail Ln., Utica, Mich. 48087)

WRL "Globe Trotter" transmitter. Schematic and technical data needed. (Wesley W. Harris, Rt. #5, Box 2325, Bremerton, Wash. 98310)

Freed-Eisemann Model 35 receiver/phono, ser. 18799; tunes AM, FM, and 3 s.w. bands; has 16 tubes. Schematic and technical data needed. (Steve Miele, 102 Rhode Island Ave., Massapequa, N.Y. 11758) -30-

This **Remington** PREMIER PORTABLE TYPEWRITER

FREE



**WHEN YOU BUY THIS RCA WR-64B
COLOR BAR/DOT/CROSSHATCH
GENERATOR...THE ESSENTIAL
COLOR TV TEST INSTRUMENT**

Here's a deal you can't afford to miss! A FREE Remington portable typewriter—yours when you purchase the most essential color-TV test instrument—the RCA WR-64B!

Just imagine how handy your new typewriter will be—in the shop or at home. You'll use it almost as much as you use the RCA WR-64B—standard of the color TV servicing industry.

Here's how to get your FREE Remington Typewriter. Mail in the warranty card plus the gold label from the shipping carton of your new RCA color bar generator to RCA Test Equipment Headquarters, Bldg. 17-2, Harrison, N.J. We will ship your new Remington portable typewriter to you direct, freight prepaid. But remember—this offer covers only equipment purchased between February 1, 1967 and July 15th, 1967. To allow for postal delay, we will honor cards postmarked up to July 31st.

Plan NOW to take advantage of this BIG offer—a FREE Remington portable typewriter with your purchase of an RCA WR-64B color bar/dot/crosshatch generator.



The standard of the Color-TV Servicing Industry. Generates all necessary test patterns—color bars, crosshatch, dots plus sound-carrier. Only \$189.50*

*Optional Distributor resale price. All prices subject to change without notice. Price may be slightly higher in Alaska, Hawaii, and the West.

Ask to see it at Your Authorized
RCA Test Equipment Distributor

RCA Electronic Components and Devices, Harrison, N.J.



The Most Trusted Name in Electronics

CIRCLE NO. 28 ON READER SERVICE PAGE

Gene Frost was "stuck" in low-pay TV repair work. Then two co-workers suggested he take a CIE home study course in electronics. Today he's living in a new house, owns two good cars and a color TV set, and holds an important technical job at North American Aviation. If you'd like to get ahead the way he did, read his inspiring story here.

IF YOU LIKE ELECTRONICS—and are trapped in a dull, low-paying job—the story of Eugene Frost's success can open your eyes to a good way to get ahead.

Back in 1957, Gene Frost was stalled in a low-pay TV repair job. Before that, he'd driven a cab, repaired washers, rebuilt electric motors, and been a furnace salesman. He'd turned to TV service work in hopes of a better future—but soon found he was stymied there too.

"I'd had lots of TV training," Frost recalls today, "including numerous factory schools and a semester of ad-

vanced TV at a college in Dayton. But even so, I was stuck at \$1.50 an hour."

Gene Frost's wife recalls those days all too well. "We were living in a rented double," she says, "at \$25 a month. And there were no modern conveniences."

"We were driving a six-year-old car," adds Mr. Frost, "but we had no choice. No matter what I did, there seemed to be no way to get ahead."

Learns of CIE

Then one day at the shop, Frost got to talking with two fellow workers who were taking CIE courses... pre-

paring for better jobs by studying electronics at home in their spare time. "They were so well satisfied," Mr. Frost relates, "that I decided to try the course myself."

He was not disappointed. "The lessons," he declares, "were wonderful—well presented and easy to understand. And I liked the relationship with my instructor. He made notes on the work I sent in, giving me a clear explanation of the areas where I had problems. It was even better than taking a course in person because I had plenty of time to read over his comments."

Studies at Night

"While taking the course from CIE," Mr. Frost continues, "I kept right on with my regular job and studied at night. After graduating, I went on with my TV repair work while looking for an opening where I could put my new training to use."

His opportunity wasn't long in coming. With his CIE training, he qualified for his 2nd Class FCC License, and soon afterward passed the entrance examination at North American Aviation. "You can imagine how I felt," says Mr. Frost. "My new job paid \$228 a month more!"



"CIE training helped pay for my new house,"

says Eugene Frost
of Columbus, Ohio



Currently, Mr. Frost reports, he's an inspector of major electronic systems, checking the work of as many as 18 men. "I don't lift anything heavier than a pencil," he says. "It's pleasant work and work that I feel is important."

Changes Standard of Living

Gene Frost's wife shares his enthusiasm. "CIE training has changed our standard of living completely," she says.

"Our new house is just one example," chimes in Mr. Frost. "We also have a color TV and two good cars instead of one old one. Now we can get out and enjoy life. Last summer we took a 5,000 mile trip through the West in our new air-conditioned Pontiac."

"No doubt about it," Gene Frost concludes. "My CIE electronics course has really paid off. Every minute and every dollar I spent on it was worth it."

Why Training is Important

Gene Frost has discovered what many others never learn until it is too late: that to get ahead in electronics today, you need to know more than soldering connections, testing circuits, and

replacing components. You need to really know the fundamentals.

Without such knowledge, you're limited to "thinking with your hands" ... learning by taking things apart and putting them back together. You can never hope to be anything more than a serviceman. And in this kind of work, your pay will stay low because you're competing with every home handyman and part-time basement tinkerer.

But for men with training in the fundamentals of electronics, there are no such limitations. They think with their heads, not their hands. They're qualified for assignments that are far beyond the capacity of the "screw-driver and pliers" repairman.

The future for trained technicians is bright indeed. Thousands of men are desperately needed in virtually every field of electronics, from 2-way mobile radio to computer testing and troubleshooting. And with demands

like this, salaries have skyrocketed. Many technicians earn \$8,000, \$10,000, \$12,000 or more a year.

How can you get the training you need to cash in on this booming demand? Gene Frost found the answer in CIE. And so can you.

Send for Free Book

Thousands who are advancing their electronics careers started by reading our famous book, "How To Succeed In Electronics." It tells of the many electronics careers open to men with the proper training. And it tells which courses of study best prepare you for the work you want.

If you'd like to get ahead the way Gene Frost did, let us send you this 40-page book free. With it we'll include our other helpful book, "How To Get A Commercial FCC License." Just fill out and mail the attached card. Or, if the card is missing, write to CIE at the address below.

ENROLL UNDER G.I. BILL

All CIE courses are available under the new G.I. Bill. If you served on active duty since January 31, 1955, or are in service now, check box on reply card for G.I. Bill information.

CIE

**Cleveland Institute
of Electronics**

1776 E. 17th St., Dept. PE-55
Cleveland, Ohio 44114

Accredited Member National Home Study Council

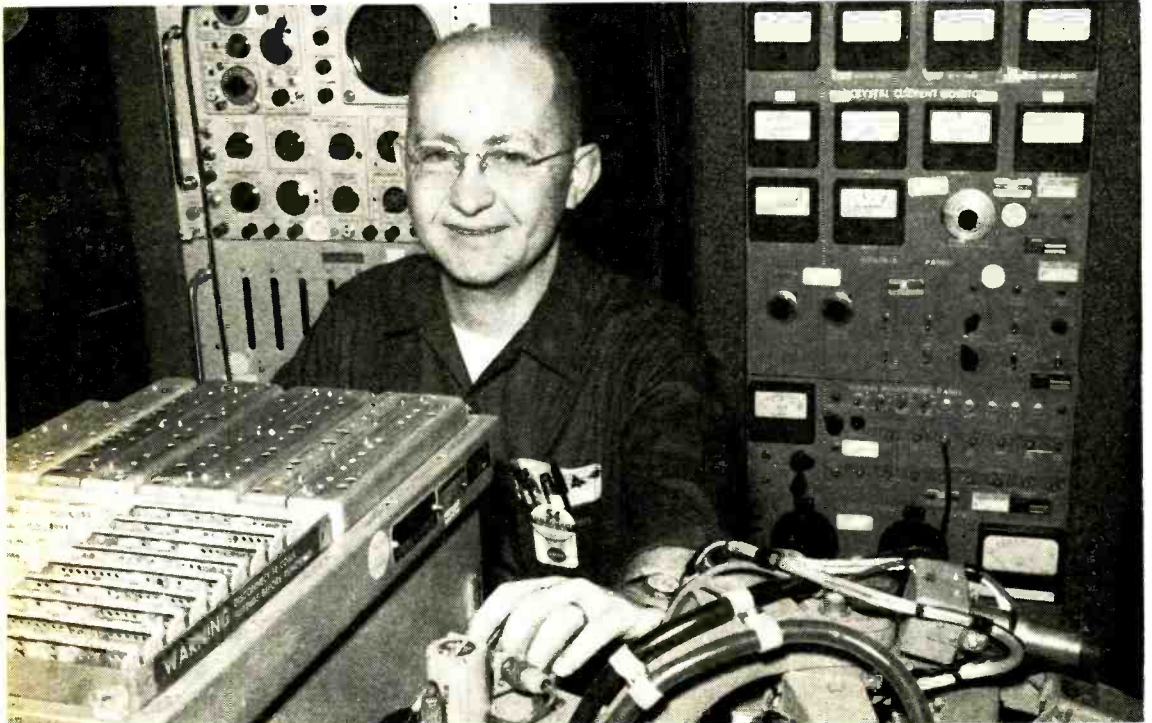

CIRCLE NO. 10 ON READER SERVICE PAGE



NEW PRODUCTS

Additional information on products covered in this section is available from the manufacturers. Each new product is identified by a code number. To obtain further details on any of them, simply fill in and mail the coupon on page 15.

CORRECTIVE-TYPE SOLDERING IRON

Breakthrough in soldering irons! The "Uni-line Mark VII" announced by *Vanguard Electronic Tools, Inc.*, is the first "corrective" type pencil soldering iron—any joint soldered improperly can be instantly desoldered simply by pressing a button. This high-quality soldering pencil is a complete unit with a built-in solder-suction assembly. It has a 40-watt heat cartridge assembly and can accommodate a variety of 10 tips and other accessories. Handle weight is 0.9 oz. and the heat cartridge weighs 0.8 oz.



Immediate production plans call for handles in four colors, cartridges in four sizes, and 33 different ruggedized tip configurations. A porcelain "Brazier Consolette" soldering stand features two waste solder depositories and a solder well which keeps the tip of the iron constantly tinned.

Circle No. 75 on Reader Service Page 15

TOP-TUNING PISTON CAPACITORS

The Components Division of *JFD Electronics* has announced a universal top-tuning assembly which adapts all JFD piston trimmer capacitors for top tuning and vertical mounting. Intended for use where space is at a premium, these assemblies are furnished in two-wire-and-pin, or four-wire configurations for printed circuit board mounting.

Circle No. 76 on Reader Service Page 15

TRANSMITTER AND RECEIVER "COMBO"

Improved versions of the well-known Heath-kit SB-400 SSB transmitter and the SB-300 communications receiver for 80- through 10-

meter amateur band coverage have been announced by the *Heath Company*. The new transmitter (shown in photo) is called the SB-401, and features a front panel control to switch from independent to transceiver operation when used in combination with its new mate, the SB-301 receiver. The SB-401 can also be operated as an independent transmitter with any communications receiver when the Heath SBA-401-1 crystal group is installed. In addition, it is less expensive than its predecessor. New features of the SB-301

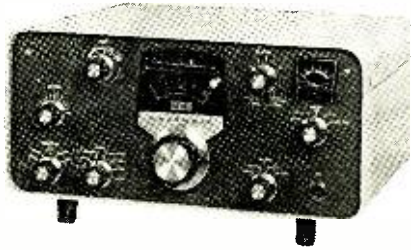

receiver include increased sensitivity, full RTTY provisions with an RTTY position on the mode switch, 15 to 15.5 MHz coverage for WWV reception, a built-in switch-selected ANL, and front panel switching for control of optional 6- and 2-meter converters. Assembly of both of these kits has been made easier by the use of "sub-pack" packaging: basic portions of each instrument are assembled as individual units, and the kit builder opens only the packages of components necessary for the particular part he is about to put together.

Circle No. 77 on Reader Service Page 15

SOLID-STATE POWER SUPPLY KIT

Providing 0-40 volts d.c. output voltage and 0-1.5 amperes output current, *Allied Radio's* Knight-Kit Model KG-663 solid-state power



supply is regulated for line and load variations, and a 0-100% variable current limiting control automatically limits short-circuit current to a safe value. Two meters monitor voltage and current simultaneously. A heavy-duty operation/standby

switch allows presetting of voltage with the load disconnected, and two pilot lights signal "standby" and "operate." Ripple, with full load, is less than 0.6 millivolt r.m.s. The KG-663 is also available factory-wired.

Circle No. 78 on Reader Service Page 15

31-CHANNEL TRANSCEIVER

Polytronics' "Poly-Comm 30" transceiver has been modified to provide 31 channels instead of 30. They include all 23 channels for long-range mobile communications plus eight ad-

NOW

A low cost Crystal for the Experimenter

International

- LOW COST
- MINIMUM DELIVERY TIME

3,000 KHz to 60,000 KHz



type "EX"

\$3.75

Postage Paid

SPECIFICATIONS: International Type "EX" Crystal is available from 3,000 KHz to 60,000 KHz. The "EX" Crystal is supplied only in the HC-6/U holder. Calibration is $\pm .02\%$ when operated in International OX circuit or equivalent.

CONDITIONS OF SALE: All "EX" Crystals are sold on a cash basis, \$3.75 each. Shipping and postage (inside U.S. and Canada only) will be prepaid by International. Crystals are guaranteed to operate only in the OX circuit or its equivalent.

MINIMUM DELIVERY TIME We guarantee fast processing of your order. Use special EX order card to speed delivery. You may order direct from ad. We will send you a supply of cards for future orders.

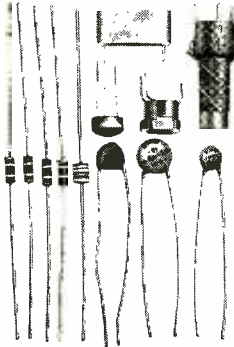
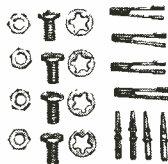
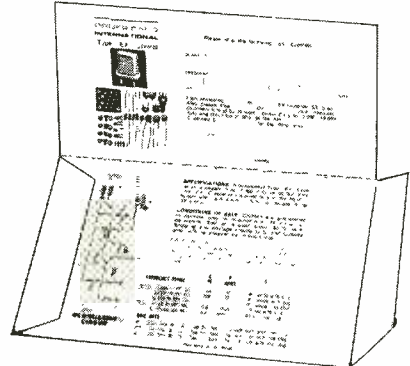

COMPLETE OX OSCILLATOR KITS

Everything you need to build your own oscillator.

\$2.35

 Postage Paid

ORDERING INSTRUCTIONS

- (1) Use one order card for each frequency. Fill out both sides of card.
- (2) Enclose money order with order.
- (3) Sold only under the conditions specified herein.



CRYSTAL MFG. CO., INC.

10 NO LEE • OKLA. CITY, OKLA. 73102

CIRCLE NO. 17 ON READER SERVICE PAGE

PRODUCTS (Continued from page 22)

ditional Part-15 channels that can be used to monitor short-range walkie-talkie operation. The unit is designed to prevent accidental or intentional switching from low to high power on the short-range channels.

Circle No. 79 on Reader Service Page 15

"BOOKSHELF" TUNER/AMPLIFIER SYSTEM

"Two on the Aisle" is the designation given the new tuner/amplifier system introduced by the *Acoustech* Division of *Koss Electronics, Inc.*; the two components are stacked



one above the other and are designed to fit into less than one cubic foot of space on an ordinary 10" home bookshelf. Because the system is entirely solid state, there is no heat problem. "Two on

the Aisle" consists of the *Acoustech* VIII FM tuner and either the *Acoustech* VA (shown) or VII integrated amplifier. The amplifier units are available factory-wired or in kit form, the tuner in a factory-built version only.

Circle No. 80 on Reader Service Page 15

THREE-IN-ONE PORTABLE TUBE TESTER

Some 800 types of radio/TV vacuum tubes (octals, loctals, 7- and 9-pin miniatures, novars, nuvistors, and compactrons) can be quick-tested with *EICO's* Model 636 tube tester. In addition, the Model 636 tests under load commonly used batteries from 1.5 to 90 volts, and it also performs as a go no-go continuity checker. Features include: transformer isolation to reduce shock hazard; a large, 3-color, easy-to-read meter; and a neon lamp short indicator. The Model 636 comes complete with Bakelite case, carrying handle, and a tube data manual.



Circle No. 81 on Reader Service Page 15

VOICE-ACTUATED MICROPHONE

If you have a battery-operated transistorized tape recorder equipped with a jack for re-

mote microphone control, you'll be interested in *Lafayette Radio Electronics'* new voice-actuated microphone. An electronically controlled relay in the microphone automatically starts the recorder when sound is picked up, automatically stops the recorder when the sound stops. The microphone is equipped with a three-position switch for voice control/off/remote functions, and with a sensitivity control.

Circle No. 82 on Reader Service Page 15

CRT ANALYZER/REJUVENATOR

All color and black-and-white TV picture tubes can be tested with the CR-35 CRT analyzer/rejuvenator announced by *The Hickok Electrical Instrument Company*. The



CR-35 checks gas, emission, shorts, opens, grid cutoff, and cathode life. It also rejuvenates, repairs shorts, and determines booster effectiveness. Continuously variable, meter-monitored test voltages assure the availability of

correct heater potentials as well as protection against obsolescence. Seven sockets cover all basing configurations, with no adapters required. When mounted in its rugged portable carrying case, the CR-35 CRT analyzer/rejuvenator measures 10³/₁₆" x 10¹/₂" x 5¹/₄", and weighs 9 pounds.

Circle No. 83 on Reader Service Page 15

DESOLDERING/RESOLDERING IRON

Only 8" long and weighing just 3¹/₂ ounces, the "Endeco Model 300" desoldering/resoldering iron available from *Enterprise Development Corporation* is particularly suitable for removing and replacing miniature components in printed circuit boards. It is rated as 40 watts at 115 volts and delivers a 720° F tip temperature. When heated, the hollow tip melts the solder, and action on the rubber bulb lifts the solder by vacuum from the connection. The tip's 360° coverage plus capillary action of the solder is said to result in a perfect resoldered connection. Tips come in five sizes.



Circle No. 84 on Reader Service Page 15

CIRCLE NO. 29 ON READER SERVICE PAGE →

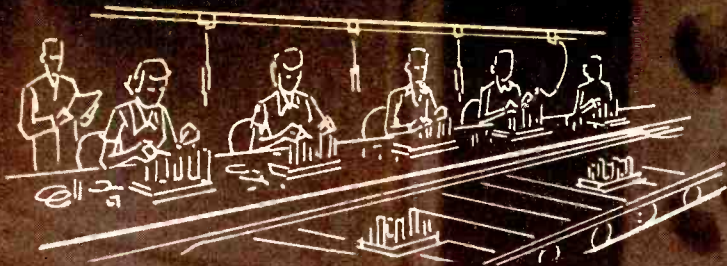

Pick the precision pliers used on electronic assembly lines

**S-K
WAYNE**
TOOLS

"Let your hands be the judge"

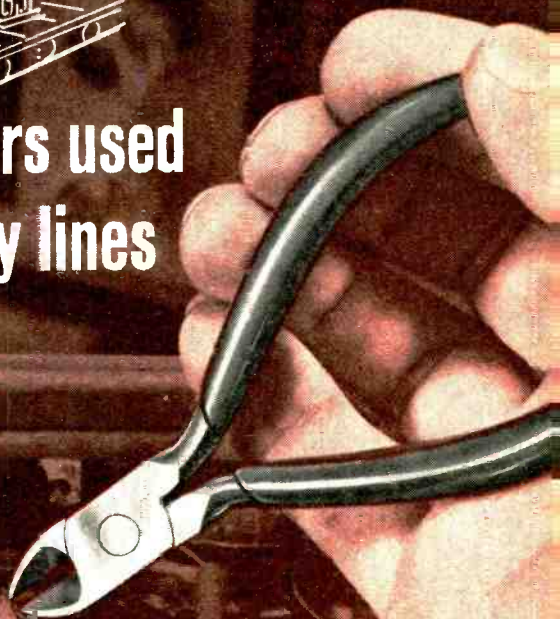

...right for you because they look better, feel better, work better

Why are S-K Wayne small precision pliers preferred for the most accurate and exacting work in such fields as hobbycrafts, watchmaking, and all phases of electronics? For the same reasons you would have for owning them:

An S-K Wayne precision plier is made to *look* better. Each tool is drop forged from fine grain tool steel. Each is individually machined. Tempered. Carefully fitted and adjusted by expert American tool craftsmen. Fully tested. And finally, the head is polished like a fine surgical instrument to a smooth, gleaming finish—the famous S-K Wayne finish recognized as the finest in professional tools.

It's made to *feel* better. Expertly balanced and

shaped to fit the hand, with cross coil springs and Cushion Grip handles to fight fatigue and provide maximum comfort.

It's made to *work* better. Small, slim, polished head design permits easy access to tight work areas—spots other pliers can't reach. With carefully filed cutting edges to assure a perfect cut every time.

Professionals and serious hobbyists like S-K Wayne's broad selection of pliers of every type and size. *You'll* like it, too.

Visit your S-K Wayne dealer and ask to make your own comparison. Then, like the professionals say: "Let your hands be the judge."

S-K WAYNE TOOL COMPANY
332 South Michigan Ave. • Chicago, Ill. 60604



Subsidiary of Symington Wayne Corporation



NO. 90

◀ 5-pc. matched set of precision pliers. Includes diagonal cutting plier, end cutting nipper, chain nose plier, flat nose plier and round nose/round jaw plier—in zipprec case.

S-K Wayne makes a complete line of professional quality tools for home, farm and industry, including: Sockets, ratchets and handles • alloy wrenches • combination and utility pliers • screwdrivers • adjustable wrenches • solid joint pliers • snips • punches and chisels • pipe wrenches • automotive tools • tool boxes



**six
five
four
three
two
one
FIRE!**

What they're counting on is you.

You're the Program Test Station Operator. An Army expert. The man in on every beat of the countdown.

Your earphones whisper crisply. Each word sends your eyes to a dial or your fingers to a switch. You check your checklist, then check the checks. Your computers calculate. You confirm. Every second counts.

But time is indifferent. It ticks along. And so does the countdown until those last, long seconds run into that one-word order: FIRE!

You push the button.

You've come a long way from high school. Back then, the only place you saw missile launchings had been on TV.

But now you have Army training behind you. An 8-hour-a-day, 5-day-a-week program that taught you a skill to build a career on. A solid career that will mean sound security all your life.

As a high school graduate, the training you selected was guaranteed in writing before you signed up. You had over 300 courses to choose from.

The one you picked was a winner. So were all the others.

Army

ELECTRONICS LIBRARY

HOW TO BUILD SPEAKER ENCLOSURES

by Alexis Badmaieff and Don Davis

It is somehow fitting that the last published book by "Alex" Badmaieff—before his untimely death, December 31, 1966—should be a "do-it-yourself" handbook. Alex had been Chief Engineer, Acoustic-Transducers, at Altec Lansing, one of the country's foremost speaker manufacturers. This handbook is a "tribute" to Alex—his energy, his imagination and his determination to improve the art. Every hi-fi enthusiast who wants to make his own speaker system should have this book at his right hand. The thoroughness of the text and drawings is simply astonishing.

Published by Howard W. Sams & Co., Inc., 4300 West 62 St., Indianapolis, Ind. 46206. Soft cover. 144 pages. \$3.25.

ELECTRICITY ONE-SEVEN ELECTRONICS ONE-SEVEN

Two fundamental courses have been prepared by a team of educational specialists under the direction of Harry Mileaf, Editor-In-Chief. *Electricity One-Seven* is an up-to-date, comprehensive course in the fundamentals of electricity. With a background of only a minimum of mathematics, a beginning student can proceed rapidly through the seven volumes in the course to an in-depth understanding of all necessary theory and pertinent practical background of electricity and electrical devices. *Electronics One-Seven* is a complete course in the fundamentals of electronics. Instead of using equipment which may become outdated as a starting point, this unique course begins with the concept of the electronic signal. Then, electronic systems are seen as a series of "building blocks" which produce desired effects on the signal. Available in single, cloth-bound editions, or sets of seven paper-bound volumes, each course is broken up into a sequence of logical learning units. Each page covers only one new concept or idea, which is defined, concisely explained, illustrated, and related to previous material. All 14 volumes are self-contained units as well as integral parts of the courses. Suitable as reference or refresher texts, they can be used individually or in combination.

Published by Hayden Book Company, Inc., 116 West 14 Street, New York, N.Y. 10011. *Electricity One-Seven*: 976 pages (6" x 9"), 941 two-color illustrations. Set of 7 paper-bound volumes, \$16.95; in single cloth binding, \$12.76. *Electricity One*, "Producing Electricity," \$2.25. *Electricity Two through Seven*, \$2.75 each. "D-C Circuits;" "A-C Circuits;,"

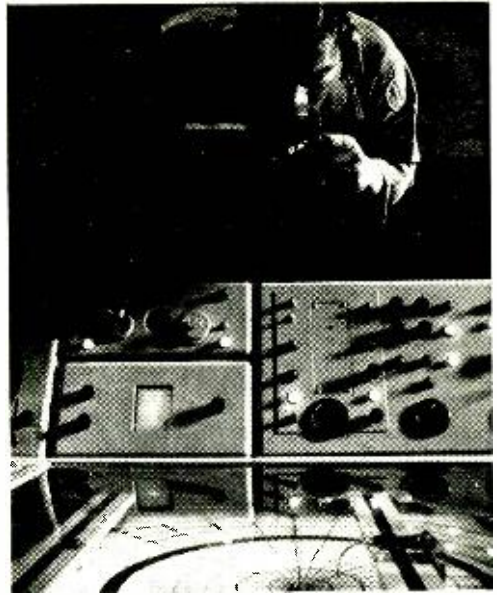

How you can become an expert in today's action Army.

Your first step should be towards your Army Recruiting Sergeant. He has all the facts on more than 300 courses open to you. You'll get the course you select guaranteed in writing before you enlist. And there's no obligation until you enlist.

Call him today. He's in the phone book listed under U.S. Government.

Meantime, get a colorful, exciting 40-page booklet about Army life and Army opportunities. Simply fill out and mail this coupon. There's no obligation.

Army

PE 6/67

OPPORTUNITIES

Box 8-G, Mount Vernon, N.Y. 10559

Please rush me your 40-page booklet,
"The Secret of Getting Ahead."

NAME _____

ADDRESS _____

CITY _____ STATE _____

ZIP CODE _____ PHONE _____

EDUCATION _____ AGE _____

CIRCLE NO. 38 ON READER SERVICE PAGE

NOW: PACE 2-WAY RADIO IN YOUR \$ 69⁹⁵ CAR



USE THE NEW PACE "AUTOMATE" ALL SOLID STATE 5-WATT TRANSMITTER to call for help when you're in trouble • Receive messages over your AM car radio . . . and get assistance in a hurry • Communicate up to 10 miles even on a weak battery • Just flip on the transmitter switch, tune your car radio to 1505, pick up the microphone, and make a call • Takes no more current than an electric clock • 12 channels available for business or personal use • Write for complete information and the name of your nearest PACE dealer.

((p)) PACE

COMMUNICATIONS CORP.

24049 Frampton Ave., Harbor City, Calif. 90710

Export Div.: 64-14 Woodside Ave., Woodside, N.Y.

Also available in Canada

CIRCLE NO. 26 ON READER SERVICE PAGE

LIBRARY *(Continued from page 27)*

"LCR Circuits," "Test Equipment," "Power Sources," "Electric Motors." Electronics One-Seven: 992 pages (6" x 9"), 943 two-color illustrations. Set of 7 paper-bound volumes, \$20.95; in single cloth binding, \$14.96. Electronics One, "Electronic Signals," \$2.95. Electronics Two through Seven, \$3.45 each: "Electronic Building Blocks," "Electronic Tubes," "Semiconductor Devices," "Power Supplies and Amplifiers," "Oscillators, Modulators, Demodulators and Discriminators," "Auxiliary Circuits and Antennas."

RADIO HANDBOOK, 17th Edition

by William I. Orr, W6SAI

It has been five years since the publication of the 16th edition of the *Radio Handbook*. During this interval, the original publishers sold their interest to the Howard Sams organization, and the 17th edition reflects a pleasant return to the original "all ham radio" concept. Miscellaneous chapters on hi-fi, electronic computers, etc., have been deleted from the new edition and that space—plus 32 additional pages—has been allocated to expanded coverage of modern-day ham radio equipment instruction and operating techniques. The *Radio Handbook* has always been referred to as the "second" handbook, indicating that as far as ham radio operators are concerned, no well-equipped shack with an experimentally-minded operator who likes to build his own equipment would be without both books. For the ham—or lab technician working with low-noise receivers and SSB transmitters—the new edition is an obvious "must." About the only negative thing that can be said with regard to the 17th edition is, "Why a white cover?"

Published by *Editors and Engineers, Ltd., New Augusta, Ind.* Hard cover. 848 pages. \$12.95.

THE RADIO AMATEUR'S HANDBOOK, 44th Edition, 1967

by The Headquarters Staff of the ARRL

The latest edition of the "first" handbook in the minds of radio amateurs is also off the presses. Essentially the same size as the 1966 edition, this one continues the process of bringing the by-now standard material up to date under the editorship of Byron Goodman, W1DX. In particular, the field effect transistor is thoroughly covered in the chapter on transistors, and construction details on an "economy" single-sideband transmitter and power supply have been added for the amateur who wants to break into sideband operation without too much expense. Incidentally, this year's cover is red.

Published by the *American Radio Relay League, Inc., Newington, Conn.* Soft cover. 704 pages. \$4.00 (U.S.A.), \$4.50 (U.S. Possessions and Canada), \$5.50 (elsewhere). Hard cover edition is \$6.50 (U.S.A., Canada, and U. S. Possessions), \$7.00 (elsewhere).

—30—

NEW LITERATURE

To obtain a copy of any of the catalogs or leaflets described below, simply fill in and mail the coupon on page 15.

Literally thousands of different types and sizes of capacitors are listed in the 32 pages of *Aerovox's Servicemen's Catalog*. Seven of the 8½" x 11" pages cover Hi-Q plate assemblies (combinations of resistor-capacitor networks in one miniature unit). For convenience, the catalog is three-hole punched, and there are two indexes—one, by classification; and two, an alphabetical-numerical index.

Circle No. 85 on Reader Service Page 15

Check full of replacement parts and service aids for radio and TV, *Workman Electronic Products'* 46-page (8½" x 11") catalog ranges not quite from a to z but from adapters and battery chargers to vibrators and wire-wound resistors. It also contains an extensive cross-reference transistor replacement chart. Profusely illustrated.

Circle No. 86 on Reader Service Page 15

A new 14-page (8½" x 11"), two-color brochure lists and describes *Sylvania Electric Products'* broad line of germanium and silicon diodes, diode arrays, and silicon rectifiers. Applications for these devices range from AM/FM and television detectors to high-speed switching circuits, computer systems, and advanced control circuitry.

Circle No. 87 on Reader Service Page 15

Anyone considering the preparation of a Science Fair Project will find many helpful hints in *Edmund Scientific's Bulletin No. 47*. Entitled "Your Science Project," this fine-print 8-pager tells you, among other things, what makes a good project, where to find suitable ideas for projects (including POPULAR ELECTRONICS, of course), and how best to display your exhibit.

Circle No. 88 on Reader Service Page 15

Centralab, the Electronics Division of Globe-Union Inc., has announced a 22-page catalog describing an extensive new line of push-button switches. Called Form No. PBS-1, the catalog contains detailed information on the modular design of these switches, and shows how the modules can be used in an almost infinite number of combinations to solve a wide variety of switching problems.

Circle No. 89 on Reader Service Page 15

June, 1967

NEW 23 Channel All Solid State CB Transceiver



PLUS 23
by **PACE**
\$199⁰⁰ with all
23 channels

Check these PLUS features

Greater talk power with full 5 watts, and 100% modulation.

Unique double conversion design and Frequency Synthesis Circuitry delivers outstanding performance.

Full size "S" meter with back-lighted scale indicates incoming signal strength, helps to set proper squelch adjustment.

Unmatched reliability from all silicon transistor design and rugged glass fiber circuit boards.

Best mobile noise limiting with exclusive heavy noise clipping switch.

Instant operation—no warmup time.

Smallest size...lower power drain...quick installation with exclusive "Latch Rak"... front panel Public Address control...all 23 channels installed and factory tuned... convert to AC power with optional power supply...from the makers of the famous PACE 5000. Write for bulletin PACE PLUS 23, and the name of your nearest PACE dealer.

((P)) PACE

COMMUNICATIONS CORP.

24049 Frampton Ave., Harbor City, Calif. 90710
Telephone (213) 325-8444

*Export: 64-14 Woodside Ave., Woodside, N.Y.
Also available in Canada.

CIRCLE NO. 41 ON READER SERVICE PAGE

punchy galore



Was it possible to put *extra* punch, *extra* power and *extra* performance into a 5 watt CB mobile radio . . . and sell it for only \$99.95? B&K, creators of the famous Cobra CAM 88, thought so—and built the new Cobra V. The 5 channel Cobra V is solid state, all-the-way. Those who have heard it and tested it say it is a most remarkable achievement in miniaturization—in CB technology—in selectivity, sensitivity and 100% modulation. It's true; this one's got punch galore. We've proven it . . . now you can. At B&K Distributors.



A DIVISION OF DYNASCAN

1801 W. Belle Plaine, Chicago, Illinois 60613

WHERE ELECTRONIC INNOVATION IS A WAY OF LIFE

BUILD... SIMPLE-MINDED "MAGGIE"

...AN ELECTRIC MOTOR WITH A WARPED,
COIL-LESS ARMATURE

M"AGGIE" IS A SIMPLETON. Her "brain" is made up of three ordinary electromagnets salvaged from a couple of door bells. For "brawn," she gets by with a twisted piece of soft, flat iron substituting for an armature.

A weird-looking contraption, *Maggie* "swears" she's a genuine, bona fide, homemade universal electric motor destined to be the "sweetheart" at your next Science Fair. For she can operate with either a.c. or d.c. power—no batteries, please—without the use of rectifiers or converters!

Students of science or electricity will find *Maggie* a rewarding project to build and operate. And teachers will find her a useful aid in putting across the basic theory of electromagnetism and its effects on movable objects.

By DAVID GIERKE

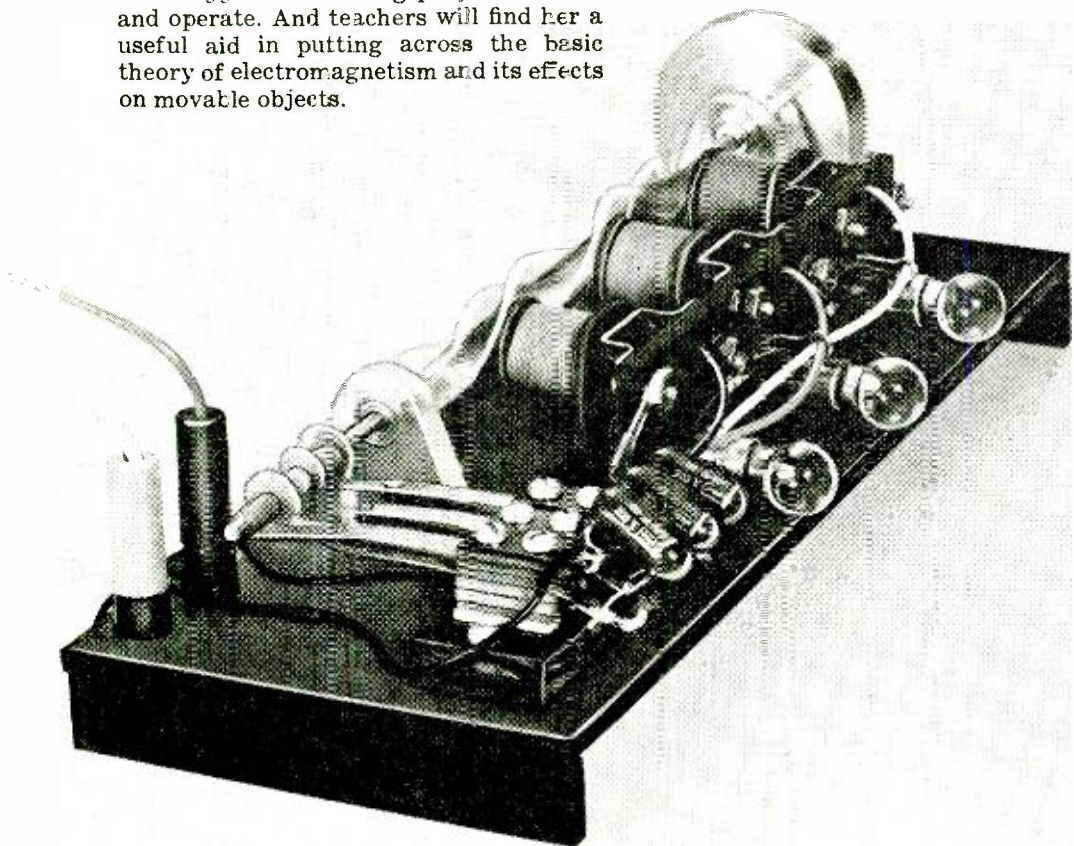

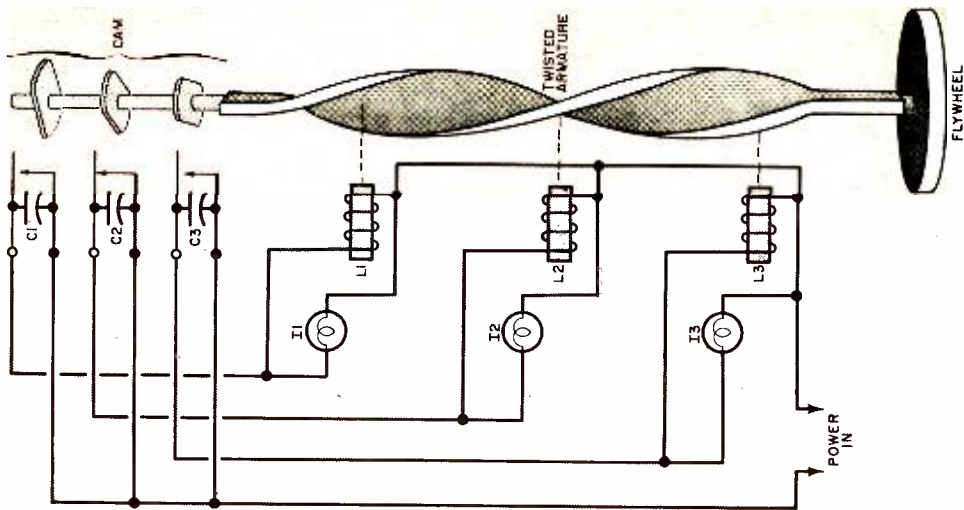

Fig. 1. Each of the cams on the twisted armature is related to a respective electromagnet to pulse the power at a precise time in order to generate maximum torque and speed while the armature is rotating.

How "Maggie" Works. The twisted armature motor operates on the basic principle of magnetic attraction. Three electromagnets (see Fig. 1) are employed in a series-aiding arrangement to provide the magnetomotive force required to drive the armature. The electromagnets are of the 6- to 12-volt variety supplied with ordinary house bell buzzers, and are aligned on a common plane.

In operation, the electromagnets are energized through a set of three commutator contacts which are alternately activated by the rotating cam fingers positioned on the armature drive shaft. To suppress arcing, capacitors *C1*, *C2*, and *C3* are bridged across respective pairs of contact terminals. Lamps *I1*, *I2*, and *I3*, each in parallel with a coil, add to the appearance of the project but are not essential to the operation of the motor. The armature, made from a flat piece of soft iron that is twisted 360 degrees, is mounted in close proximity to the poles of the electromagnets and perpendicular to them.

The electromagnets behave exactly like bar magnets with north and south poles at opposite ends. The magnetic flux traveling outside the core from the north to the south pole cuts across the armature, attracts the nearest edge of the arma-

PARTS LIST

- C1, C2, C3*—0.02- μ F, 200-volt ceramic capacitor
- I1, I2, I3*—General Electric #57 lamp, or similar
- 1— $1\frac{1}{8}$ "-diameter steel flywheel
- 1— $\frac{5}{8}$ "-wide x 6"-long strip of $\frac{1}{8}$ "-thick soft iron
- 1—12" x 12" sheet of $\frac{3}{16}$ "-thick plexiglass—see text
- 1—Motor armature—see text
- 2—Insulated banana plugs and jacks
- 3—Lamp sockets
- 3—6-12 volt electromagnets—see text
- 3—Sets of telephone relay contacts—see text
- 1— $\frac{1}{2}$ "-wide x 6"-long strip of $\frac{1}{16}$ "-thick sheet iron or heavy-gauge tin for brackets
- Misc.—Fiber discs (3), fiber spacers (3), wire, solder, #6 hardware, small ball bearings (2), power supply—6- or 12-volt filament transformer or d.c. or a.c. power supply

ture and causes it to rotate. The speed of rotation will be essentially proportional to the field strength of the electromagnets and the applied power.

To reduce friction and thereby increase efficiency and motor speed, the armature is mounted on ball bearings. A flywheel is also used to provide the necessary momentum to keep the armature rotating smoothly once it has started to turn.

Construction. The motor frame is built from $\frac{3}{16}$ "-thick plexiglass, although hardwood lumber can be used if plexiglass is not readily available. Dimensions for the

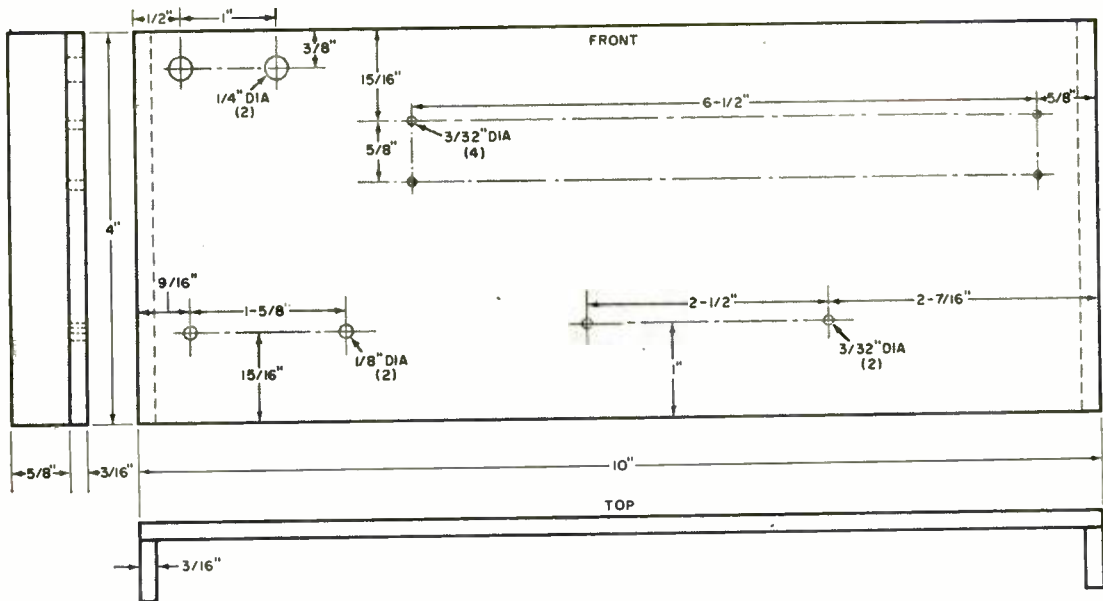

Fig. 2. The base and supports are fabricated from plexiglass and bonded together with epoxy or other type of strong plastic cement. Two pieces of plastic are used to build up the commutator support.

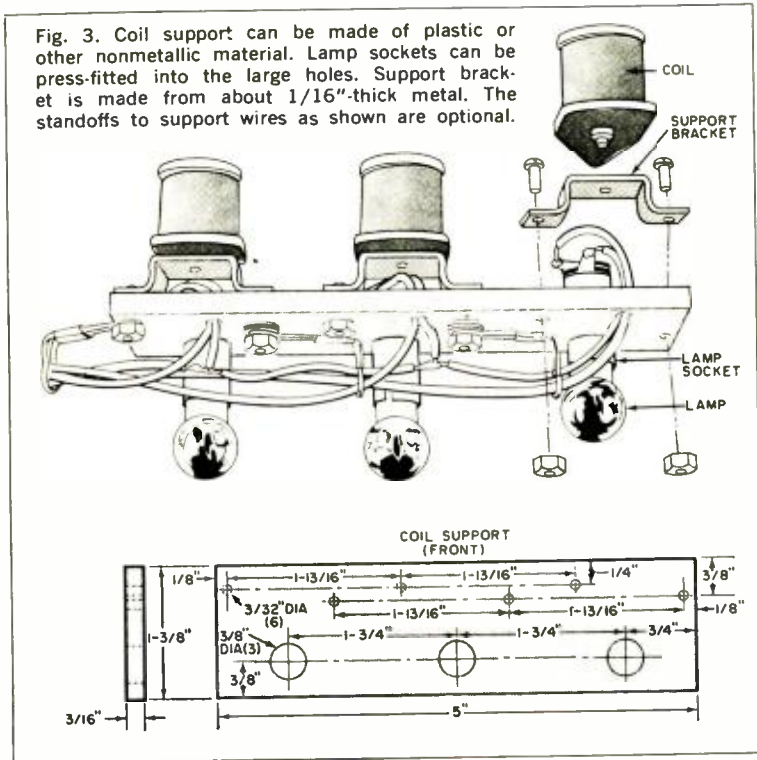
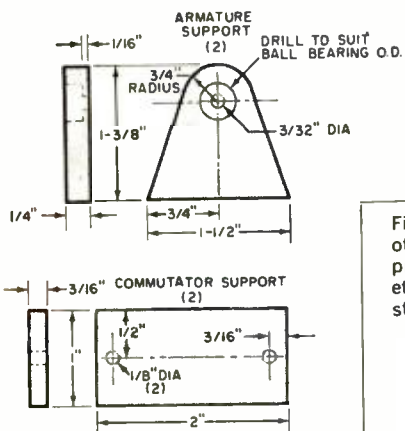

Fig. 3. Coil support can be made of plastic or other nonmetallic material. Lamp sockets can be press-fitted into the large holes. Support bracket is made from about 1/16" thick metal. The standoffs to support wires as shown are optional.

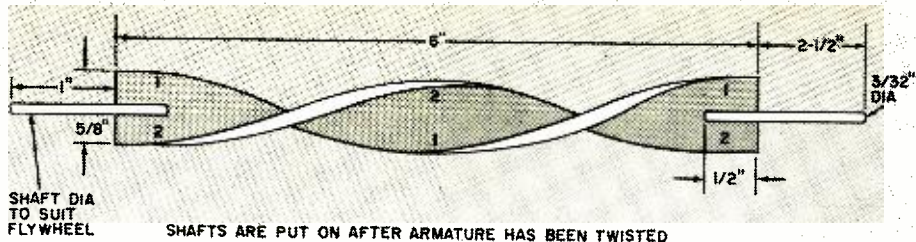

Fig. 4. The lengths of the shafts on each end of the soft iron armature should be long enough to accommodate the flywheel on one end (about 1"), and the cams and spacers on the other end (about 2 1/2").

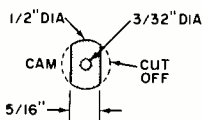

Fig. 5. Either plastic or fiber material can be used for the cams and spacers. The inner diameters of each must be small enough to require a tight press-fit to prevent slippage. Thickness of the cams is not critical.

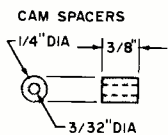

Fig. 6. Each cam should be oriented on the shaft as shown. The switches should close just as the portion of the armature's edge comes within range of the respective electromagnets. Irregularities in the twist of the armature can be compensated for by only minor adjustment of each of the cams.

base and supports are shown in Fig. 2.

Any three similar iron core coils of suitable power and flux rating can serve as the electromagnets. However, the solenoids used with home-type bell buzzers are quite satisfactory for this application, and are relatively inexpensive. In addition, they are available at practically all hardware and electrical supply stores. Since you'll need three coils, you should get two standard buzzers—each is equipped with two coils.

After each solenoid is removed from the buzzer, it is mounted on its metal support bracket (see Fig. 3) by simply pressing the core piece into the hole provided. Each coil bracket is then mounted on the plexiglass support along with the three lamp sockets.

Fig. 7. Space the cams along the shaft so that they activate their respective switches. Armature must be mounted slightly above the cores of the electromagnets in order to obtain maximum torque and eliminate the possibility of "locking" action.

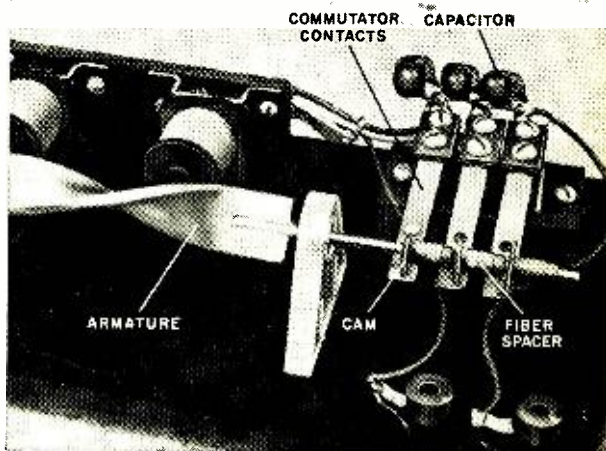

The armature is fabricated from a 5/8"-wide x 6"-long strip of 1/8"-thick soft iron twisted as shown in Fig. 4; aluminum or other non-ferrous metal *cannot* be used. You can start with a strip about 2' long. Put one end in a vise and attach a long wrench on the other end. Twist the strip until you wind up with 1 complete revolution (360°) within a 6" length. Mark this piece off and use a hacksaw to cut away the unused portions. Cut a notch on each end as shown.

After the armature has been formed, it is fitted with a shaft at either end as shown. The shaft can be welded on or simply slipped into the notch and flattened to form a tight fit. Observe that the diameter of the shaft depends on the

(Continued on page 96)

GET MORE VHF ON AM/FM TRANSISTOR RADIOS



LISTEN TO POLICE,
FIRE, TAXI,
AIRPORT, AND 2-METER
HAM CALLS
AS WELL AS TO
AM AND FM
STANDARD BROADCASTS

By **MARC WEBER TOBIAS**

YOU CAN RECEIVE police, fire, taxi, airport, business band, plus standard AM and FM broadcasts on one small portable radio selling for less than \$20.00. Sound impossible? With little more time than it takes to read this article, you should be able to modify an AM/FM portable to tune in all of the above bands and more.

The unit shown is a Channel Master Model 6475 AM/FM transistor radio, measuring about 4" x 2" x 1". Sensitivity as checked in the Colorado State University engineering laboratory was about 10 μ V for 10 dB quieting. I have been using one of these radios for the past year in the Denver, Colorado, area.

I have listened to: several FM broadcast stations; the Denver Stapleton Tower (118.3 MHz); Denver G.C.A. (119.3 MHz); Unicom frequencies (122.8 MHz); Denver Air Traffic Control Center (126-135 MHz); MARS Net (143.95 MHz);

all two-meter amateur radio (144-148 MHz); Bell Mobile Telephone Service (152-153 MHz); taxi companies (152.7 MHz); various remote pickups for radio stations in the area; Arrora Police (154.8 MHz); Denver Fire Department (154.35 MHz); Golden, Lakewood, Littleton, and Sheridan Police Departments (154-158 MHz); Denver Police—both Channels 1 and 2 (159.03, 159.21 MHz); railroad communications (160 MHz); and various business bands.

Frequency Shift. Before going into the modification details, a word about the radio's operation is called for. The tuning range is from 88 to 108 MHz on the FM band, and from 540 to 1600 kHz on the AM band. After modification, the radio will receive signals from about 100 to 160 MHz. The AM band will not be affected in any way.

There are two possible objections to this downward shift of the FM band: you won't be able to tune in FM stations below 100 MHz, and the FM dial markings will no longer apply. You can cover the original FM markings with a new dial cut from an unruled 3" x 5" index card, and inscribe on it your own markings of the new frequencies received.

Receiver tuning is very "sharp," but with surprisingly little drift.

Modification. Actual conversion is extremely simple. All you have to do is adjust two trimmer capacitors, *C1* and *C2*, and reduce the inductance of the local oscillator coil (*L3*) in the FM section, as shown in the photo. The lower the inductance of the tuning coil, the higher the operating frequency. One of the trimmers is in the oscillator circuit and the other trimmer is in the r.f. tuner stage.

Remove the back of the radio just as if you were going to change the battery. Be careful not to pull the FM telescoping antenna lead too roughly from its socket next to the tuning capacitor. Carefully spread the windings of *L3* to obtain the maximum spread possible (about 1/2") without touching *Q1* or *T2*.

Should you find a layer of wax around the coil to hold it in place, heat the screwdriver tip just enough to melt the wax and to allow you to spread the coil without damage.

Alignment and Operation. Position the radio so that the master tuning capacitor appears as shown in the photo, with the back placed along the side of the case, and the antenna fully extended with its lead plugged in. Turn the radio

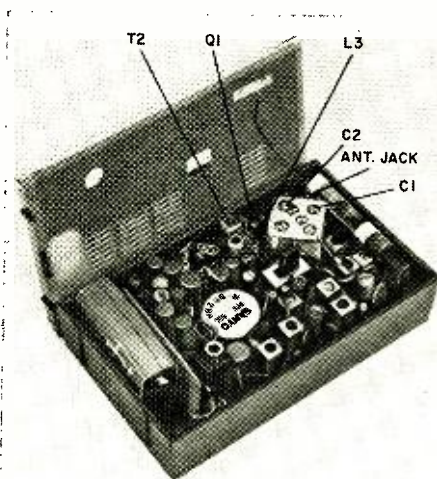

Spread FM oscillator coil *L3* as much as possible without breaking or shorting any components. Shift the FM broadcast band as far down as it will go by adjusting *C2*. Tune in a station at about 150 MHz and adjust *C1* for maximum volume. There is no need to make any other adjustments in the receiver.

on and check to see that the AM/FM switch is in the FM position.

Tune the radio for a regular FM broadcast station in the upper part of the band, somewhere in the vicinity of 99 to 108 MHz, and rotate *C2* about 90°. As you do this, you will be able to tune in the uppermost station on a lower portion of the dial. Try to get this station down to about 90 on the dial, or as low as possible. Then peak *C1* for maximum volume.

Repeat the adjustment of *C1* and *C2* two or three times. These trimmers can be rotated in either direction. Do not adjust the other two trimmers as they are in the AM section, and do not adjust anything else on the set. Replace the cover.

You should now be able to go up to about 160 MHz at the spin of the dial. Rotate it slowly if you don't want to miss any stations. The FM stations above approximately 100 MHz will come in on the lower portion of the dial. —50—

BUILD A FIRING-RANGE TIMER

YOU CAN IMPROVE YOUR
RAPID-FIRE ACCURACY
IF YOU USE THIS
AUDIBLE TIMER . . . JUST
KEEP YOUR EYE ON
THE TARGET, NOT
ON YOUR STOPWATCH!

By **CALVIN F. HADLOCK**

IS SHARPSHOOTING one of your hobbies? If so, are you really as fast as you think you are on the firing range? How would you like to "clock" your rate of fire with an automatic timer that will "beep" at precise 10- or 20-second intervals? You can build the Firing-Range Timer in an evening or two.

When you practice rapid firing, you can lay the timer on a bench or put it in your pocket with the headphone plugged in. Then, with the timing switch set to 10 seconds and the unit turned on, the gun is loaded. Listen to a few beeps to get a fix on how long the 10-second interval actually is. When ready, commence firing at the sound of a beep and cease firing at the sound of the next one. If your timing is perfect, you will be able to get the fifth shot off at the instant the last beep occurs. For time firing,

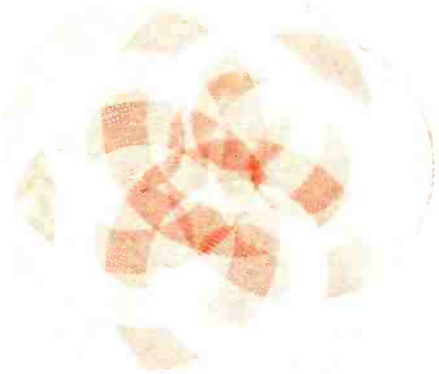

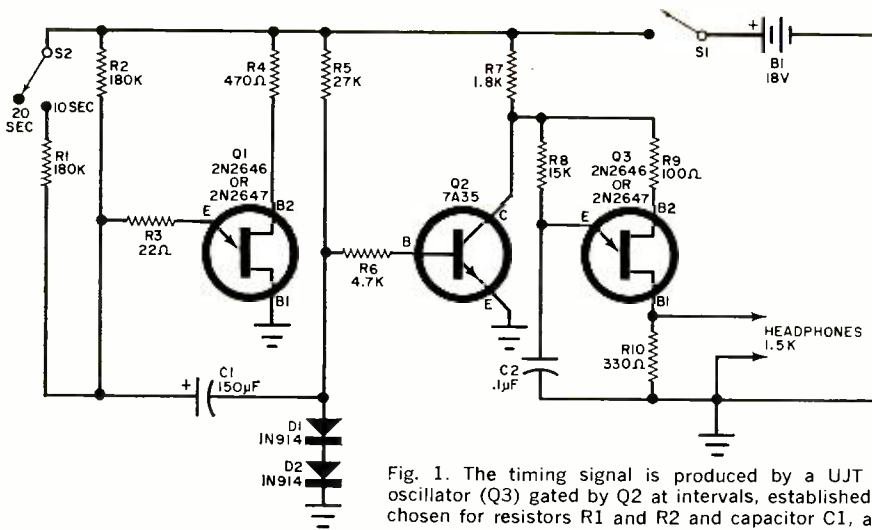

Fig. 1. The timing signal is produced by a UJT relaxation oscillator (Q3) gated by Q2 at intervals, established by values chosen for resistors R1 and R2 and capacitor C1, and by Q1.

set the switch to 20 seconds and follow the same procedure as for rapid fire.

How It Works. The timer (Fig. 1) consists essentially of a unijunction transistor timing circuit (Q1), a gating circuit (Q2), and a UJT relaxation oscillator (Q3).

With S2 open, a 20-second timing interval is set up by the values chosen for R2 and C1. With this switch closed, the timing period is halved by the parallel combination of R1 and R2 in series with

C1, and a 10-second timing is established. When power is applied through switch S1, the voltage drop across diodes D1 and D2 forward-biases Q2 and causes it to conduct. When Q2 conducts, the emitter of Q3 "sees" a very small voltage which is not enough to allow the relaxation oscillator to work.

At the same time, capacitor C1 takes on a charge through R1 and R2, or R2 alone (depending upon the position of S2), until its potential is enough to allow the emitter and base 1 junction of Q1 to

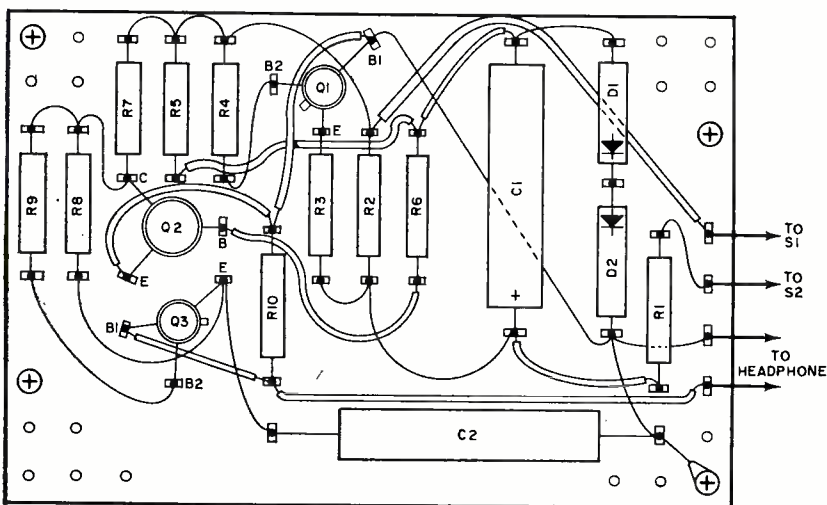

Fig. 2. Parts are first assembled on a circuit board which is then mounted on standoff spacers inside the metal case. Do not overheat the transistors or diodes when soldering the connections.

conduct readily. When $Q1$ conducts in this manner, the voltage across $C1$ appears across $D1$ and $D2$, overcomes the forward bias on $Q2$ and "shuts" it off. It takes about $\frac{1}{2}$ second to discharge $C1$ enough to allow the forward bias on $Q2$ to take command and turn $Q2$ on again, to repeat the cycle.

During the time when $Q2$ is off, the emitter of $Q3$ sees enough positive voltage to go to work and generate an audible tone.

The frequency of oscillator $Q3$ and thus the pitch of the emitted tone, is a function of the values chosen for components $C2$ and $R8$. In this application, the output is an 800-hertz note which is picked up by the headphone.

Construction. The timer is built in a 4" x 2 $\frac{1}{8}$ " x 1 $\frac{5}{8}$ " metal box. Power and timing switches $S1$ and $S2$, as well as the headphone tip jacks, can be mounted on one end of the case. The remaining parts,

accuracy, use a high-quality tantalum electrolytic capacitor for $C1$. Also, although 180,000-ohm resistors are specified for $R1$ and $R2$, it is preferable to use Trimpot or similar miniature potentiometers initially, since the value may have to be changed during calibration.

If you use the low-cost headphone suggested and would like to install it in a pair of earmuffs, drill a hole in the bottom of one earmuff, and fish the phone

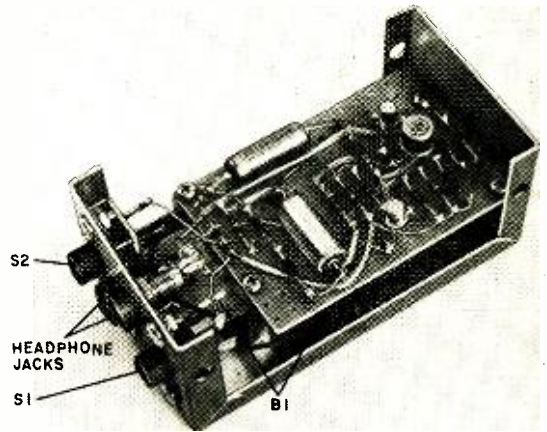

The two series-connected 9-volt batteries comprising $B1$ are tucked away under the circuit board. The headphone jacks and switches are panel-mounted.

PARTS LIST

- $B1$ —9-volt battery (2)
 - $C1$ —150- μ F tantalum electrolytic capacitor
 - $C2$ —0.1- μ F, 100-volt Mylar capacitor
 - $D1, D2$ —1N914 diode
 - $Q1, Q3$ —2N2646 unijunction transistor (General Electric)
 - $Q2$ —7A35 transistor (General Electric)
 - $R1, R2$ —180,000 ohms—see text
 - $R3$ —22 ohms
 - $R4$ —470 ohms
 - $R5$ —27,000 ohms
 - $R6$ —4700 ohms
 - $R7$ —1800 ohms
 - $R8$ —15,000 ohms
 - $R9$ —100 ohms
 - $R10$ —330 ohms
- } all resistors
} $\frac{1}{4}$ -watt
} $\pm 5\%$
- $S1, S2$ —S.p.s.t. slide switch
 - 1—4" x 2 $\frac{1}{8}$ " x 1 $\frac{5}{8}$ " gray hamcrtone aluminum box
 - 1—1 $\frac{7}{8}$ " x 3" x $\frac{1}{16}$ " circuit board, 0.180" hole spacing plain
 - 1—1500-ohm single headphone with leads (Aliced Radio 86 U 086 or similar)
 - 40—Push-in terminals for circuit board (Vector T18 or T28, 100 in package)
 - Misc.—Phone tip jacks (2), battery terminals (2), pieces of round $\frac{1}{4}$ " brass rod $\frac{3}{4}$ "-long tapped for 6-32 screws (4)

tips and cord through the hole. The single headphone snaps into the earmuff and fits snugly in place.

Calibration. For precision timing, it is usually necessary to calibrate the timer against a standard such as a stopwatch or clock with a sweep-second hand. To adjust the timing, substitute for $R1$ and $R2$ precision printed-circuit-type potentiometers having resistances of about 250,000 ohms. With switch $S2$ set to 20 seconds, adjust $R2$ for a precise 20-second interval. Then, with $S2$ set to 10 seconds, adjust $R1$ for this interval.

After you measure each potentiometer's resistance setting, you can replace the potentiometers with fixed resistors having the measured values. Should you desire any other timing intervals, just change the values of $R1$ and $R2$ accordingly.

except the batteries, must be wired on a 1 $\frac{7}{8}$ " x 3" x $\frac{1}{16}$ " perforated phenolic board as shown in Fig. 2, and the sub-assembly mounted inside the case on four $\frac{3}{4}$ "-long stand-off spacers.

The two 9-volt batteries are connected in series and tucked away under the circuit board. To insure optimum timing

SOLID-STATE LINE-OPERATED AUDIO AMPLIFIER



HIGH-IMPEDANCE FET DRIVES COMPLEMENTARY
RECTIFIER-TRANSISTOR COMBO
DIRECTLY FROM
117-VOLT A.C. POWER LINE

By **LYMAN E. GREENLEE**

IF YOU'VE always wanted a versatile solid-state audio amplifier to put a little zing in your old phonograph, or a good-quality amplifier with separate bass and treble controls for your guitar, tuner, or microphone, look no further . . . for here's a line-operated amplifier with a field-effect transistor (FET) that will give you the high impedance you need for that crystal or ceramic cartridge, and excellent frequency response for more enjoyable listening.

As a bonus, you get instant play the moment you flick the unit on. No more waiting for tubes to warm up when you update that old tube-type phono amplifier with solid-state devices. And you get to hear the beginning of every record you play.

How It Works. The audio amplifier (Fig. 1) features a field-effect transistor (*Q1*) for high input impedance, a common collector audio stage (*Q2*), and a power amplifier (*Q3*) driving a speaker transformer (*T1*).

The signal input at *J1* is applied to the gate of *Q1* through limiting resistor *R12* and coupling capacitor *C10*. The amplified output at *Q1*'s drain is coupled through *C9* to a tone control network comprised of *R2* (the bass control) *R5* (the treble control), and *R7*, a compensated volume control with tone correction provided by *C3* and *R6*. The output of the volume control is applied through *C5* to the base of *Q2*, biased by voltage divider *R8-R9*.

As a common collector amplifier, *Q2* provides a high current gain while, at

the same time, serving as an impedance-matching device for the input and output circuitry. The output of this stage is developed across *R10* and direct-coupled to the base of *Q3*, whose output is coupled to the speaker through transformer *T1*.

Diode *D2*, together with *C6*, forms a transient voltage suppression network to limit voltage surges and protect *Q3* from possible destruction. If the value of *C6* is increased beyond the recommended 0.001- μ F capacity, high-frequency roll-off can be achieved for operation with small speakers (smaller than 8 inches in diameter). However, if the capacity is increased beyond 0.005- μ F, tone quality could be adversely affected.

Diode *D1* is the line rectifier, while *R14* and *C8* are filtering elements. Since one side of the power line is grounded directly to the unit's chassis, a polarized line plug must be used. Resistor *R1* serves to isolate the input device from the amplifier's chassis.

Construction. You can build the audio amplifier circuitry on a 3½" x 5" piece of perforated circuit board, and then house the entire unit in a 3"-high by 8"-wide by 5"-deep cowl-type metal box. The operating controls, pilot lamp and input jack can be mounted on an L-

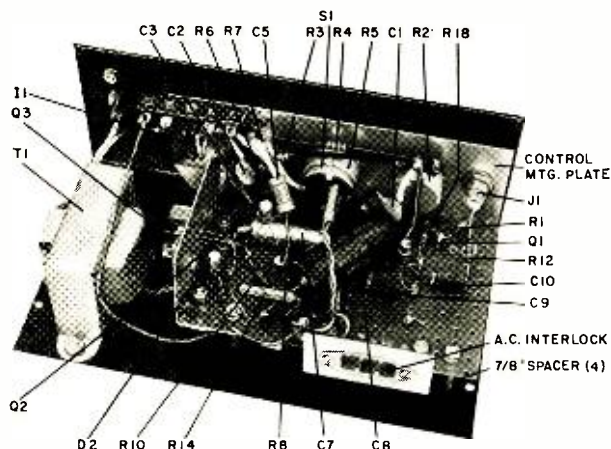

Fig. 2. Components are mounted on both sides of circuit board to conserve space. Use metal spacers (as shown) to provide adequate clearance between parts mounted on underside of board and metal cabinet.

shaped plate cut and drilled, and then screwed to the long edge of the circuit board (see Fig. 2).

The heat sink for the power transistor ($Q3$) is fabricated from a thin sheet of aluminum. An interlock for the special TV-type line cord used by the author can be mounted on a small bracket screwed to the rear of the circuit board, as shown in Fig. 2. (If you prefer to use an ordinary line cord, you can eliminate the bracket.)

The parts are mounted on both sides of the board to conserve both space and wire run, and are interconnected by means of regular push-in terminals. The top side of the board is shown in Fig. 2, and the reverse side of the board is shown in Fig. 3.

Be sure to heat-sink the transistor leads while they are being soldered. Also, observe polarities when wiring the diodes and electrolytic capacitors in the circuit.

After mounting the output transformer on the bottom plate, connect the leads to the circuit board and install the board on four $\frac{7}{8}$ "-long standoff spacers.

Operation. Before you plug the unit into the line outlet, check it over carefully to verify the correctness of your wiring. If you are satisfied that there are no errors, plug it in and turn it on. Touch the cabinet. If you feel a slight tickle or hear a loud hum, reverse the line plug. With an input connected, adjust the *BASS*, *TREBLE* and *VOLUME* controls for normal listening. -30-

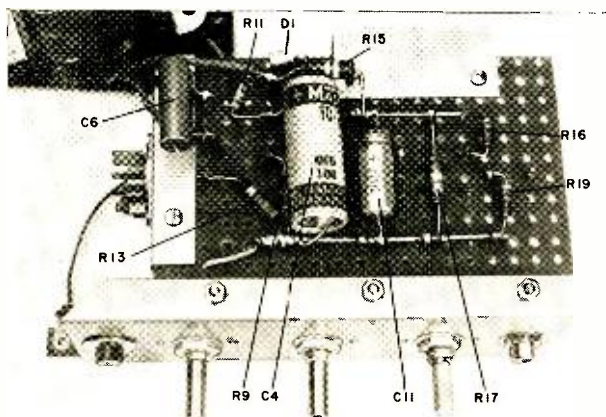
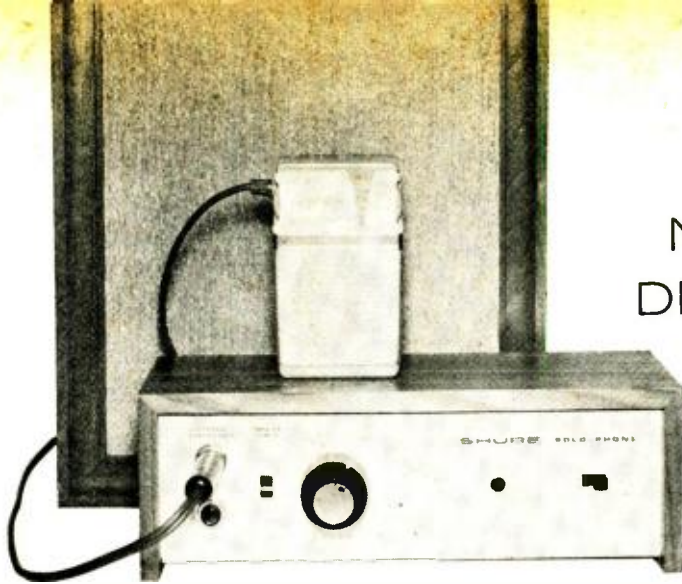

Fig. 3. Busbars eliminate the need for extra push-in solder terminals on underside of board. Solder the components directly to the busbars.



NEW DIMENSION IN **PORTABLE RADIO LISTENING**

"TWO BIT" MODIFICATION TRANSFORMS INEXPENSIVE
AM RADIO INTO HI-FI AM TUNER

By **ART TRAUFFER**

WOULD YOU CONSIDER listening to your portable transistor radio through your hi-fi amplifier? No? The notoriously poor quality sounds you hear from most inexpensive portable radios can usually be traced to the audio output transformer. If you placed a headphone across the radio's diode detector, however, you would hear much better sound—the type of sound you would normally expect from a good-quality AM tuner.

To connect the output of the diode detector up to your hi-fi amplifier, all you need do is make a simple modification in the radio. This modification can be accomplished at a cost of only "two bits"—the price you pay for a miniature phone jack and matching plug—plus a few minutes of your spare time.

Carefully remove the rear cover from your portable radio, and locate a space where the phone jack can be mounted on the case. Then drill a hole in the case and mount the jack.

Connect a short length of hookup wire from the "hot" (signal) side of the radio's volume control to the tip terminal of the jack. Solder both connections. Then connect another wire between the other side of the volume control and the common, or chassis, terminal on the jack. Replace the rear cover.

Now prepare a length of single-conductor shielded cable with the miniature phone plug at one end and a phono plug at the other. Plug the cable into the radio and the input of your amplifier, and turn both units on. All the radio needs is power—no volume—since the wiper in the volume control is not even in the circuit.

Sit back and listen to the brisk, clean quality of AM sound your radio is actually capable of delivering. And if you yearn to lounge in the sun on your patio while listening to that ball game, simply unplug the radio and take it with you. It will still work as a portable. —50—

WIRING YOUR HOME FOR TV

HOW TO PUT A TV SET IN
EVERY ROOM IN A NEW HOME
—OR AN OLD MANSION

By **GERALD ZAPPA**
Blonder-Tongue Labs., Inc.

A FIXED rooftop antenna feeding a single immovable TV set sounds antiquated, but this is exactly what many people building new homes are preparing for, and what many people in existing homes have. One TV antenna and one lead-in to one strategic location has become more or less the "standard" package for the homeowner. In a home furnished with multiple TV sets, or in a home having only one set which must be moved from room to room, the single strategic location is about as practical as a home having only a single electrical outlet for a single electrical appliance.

You do not have to accept this old "standard." You can provide as many TV outlets as you need, wherever you need them, and you can do so with a single antenna, or with several antennas. You can avail yourself of eye-pleasing flush-type wall outlets with taps for an antenna rotator control, hi-fi extension speakers, and intercom stations.

Either 300-ohm, shielded, flat, transmission line or the old standby 75-ohm coaxial cable can be used with home-type signal distribution accessories where needed. It is not difficult to make your own installation. Sufficient data is available to help you plan a logical system.

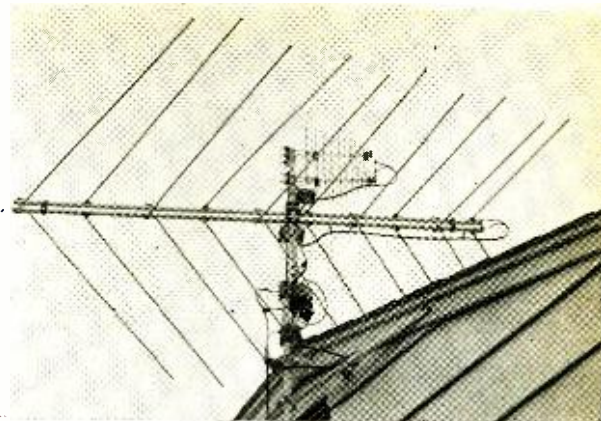

Plan Ahead. The best time to plan and install a complete system is when your house is under construction. This could be a bit of a problem if the builder won't let you work around the house, but in the final moments of consent that exist between the new home buyer and the new home builder, an air of mutual agreement usually prevails. This is the time to obtain the builder's permission to install the TV distribution system. Try to convince the builder that you will not interfere with the normal construction of the house and that you will not be on the roof until after "closing." The builder is liable for personal injury until "closing."

In an existing home, the big decision to make is whether or not to run a concealed wiring system. A surface-mount affair will work just as well but doesn't look as good. Most types of homes can be outfitted with a concealed system and flush-mounted outlets. There are ways to work around obstructions and ways to simplify installation in existing homes.

Elements of System. You should develop an overall plan to determine what you need to satisfy your present and possibly your future needs. But, before you can develop a plan, it is necessary for you to be familiar with the various components in the system.

You will want to know about antennas, transmission lines, amplifiers, splitters, couplers, matching devices, type of outlets and other related hardware. Each element is presented in the following articles to guide you to the best possible system for your particular needs.

SELECTING ANTENNAS

YOUR TV SYSTEM CANNOT
PRODUCE SIGNALS THE
ANTENNA DOESN'T PICK UP

NO CHAIN is better than its weakest link. While this is not exactly true for an antenna system (some losses can be compensated for), it is a good concept to keep in mind when planning your system. Give yourself a head start by getting the best possible antenna configuration for your needs.

As the connecting link of your TV system to the transmitted signal, the antenna must be able to pick up desired signals, separate them from multi-path reflections, if any, and perform in a uniform manner. Reception of color TV, UHF, and FM radio requires special consideration and should not be overlooked. Your system cannot function properly if the signal fed into the system is no good.

There are more antennas on the market than you can shake a mast at. There are combination types that can receive the entire VHF/FM/UHF band and there are separate antennas for each band. As a general rule, an individual antenna covering a single band or even a single channel is more efficient than the broadband types. But, unless you have a bad or peculiar reception problem, you can get good coverage with the all-band jobs.

To estimate the size and type of antenna for your system, it is only necessary to make a visual survey of the antennas in your area, or to question a TV serviceman or electronic parts distributor. Also, many antenna manufacturers are able to advise you which of their models would best serve you in your area.

Actually, the task of selecting an antenna is not difficult. Consider the distance and direction the signals have to travel to reach you, the terrain, and the general attitude of the TV viewers in your neighborhood. Bad reception reports seem to travel faster than the speed of light.

Rotator Or Fixed Position. A rotator can help solve ghosting problems, and align the antenna for maximum signal pickup. High-gain antennas usually have good front-to-back ratios and narrow beam widths; where signals come from more than one direction, you will have to either install a rotator or select an antenna for each signal path.

If there are two paths not too widely separated, you may be able to "track" both of them by accepting a slight compromise. Aim the antenna about midway between the two paths and let your TV set tell you if you can get away with it.

Mechanical Considerations. Not enough can be said about the importance of mechanical rigidity of the antenna mountings. A fallen antenna usually means disaster for the antenna itself, and possible injury to life and property, not to mention the inconvenience caused by the loss of TV viewing. A little extra care will insure many years of service from your system.

First, choose a mounting site: side wall of the house, rooftop, or chimney. The chimney, although the highest and easiest to work on, should be the last choice. Hot exhaust gases from your furnace can form harmful deposits on the antenna and mast-mounted accessories. Use the chimney if you have to, but be sure it can support your antenna and if a rain hood is not already installed, place one on the chimney to deflect at least some of the smoke from the antenna.

(Continued on page 94)

TV ANTENNA

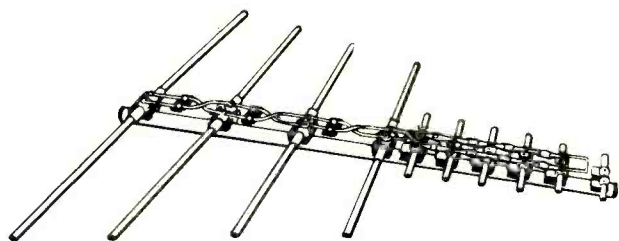

Antenna Designs
Signal Multiplier 4010

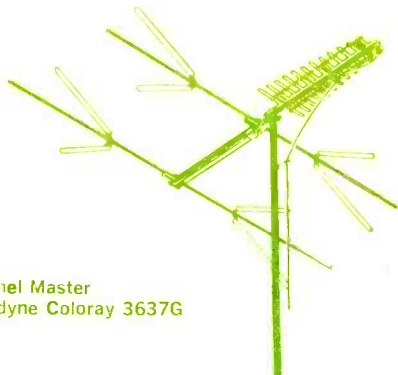

Channel Master
Ultradyne Coloray 3637G



Blonder-Tongue
Color Ranger-15

Channel Master
Stereo-Probe 9

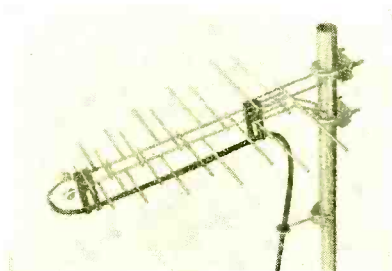
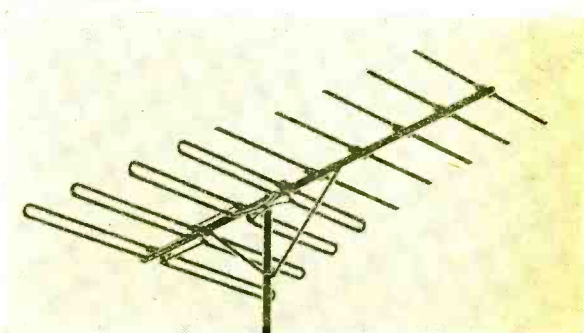

Blonder-Tongue
Golden Dart

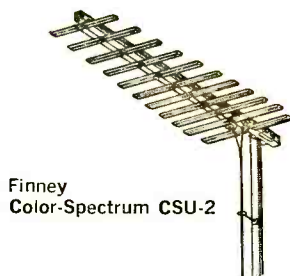

Finney
Color-Spectrum CSU-2



Finney
Color-Spectrum CS-B3

Most of the antennas shown here are representative of a line or family of related models which are available. There are smaller and larger antennas, and there are all sorts of combinations. UHF versions are often combined with VHF configurations to obtain all-channel operation. Some antennas provide for both 300-ohm and 75-ohm transmission line.

SAMPLER

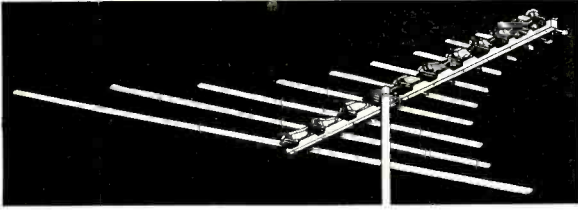

GC Electronics
Colormagic CM-12

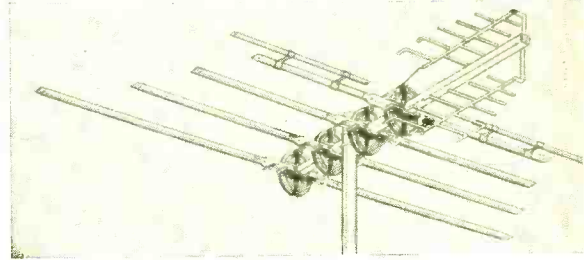

Jerrold
Vufinder VU 831

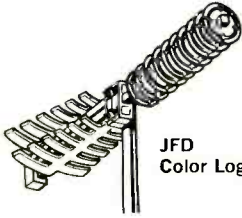

JFD
Color Log Periodic LPV-UCL22

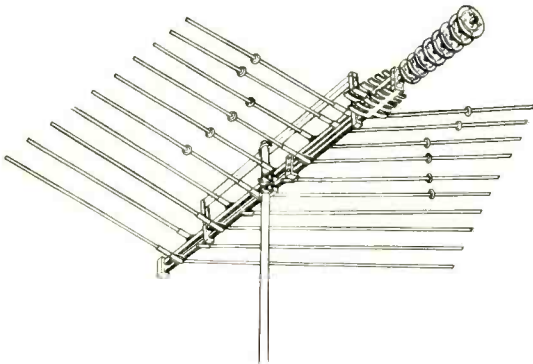

JFD
Color Laser Log Periodic LPV-CL600

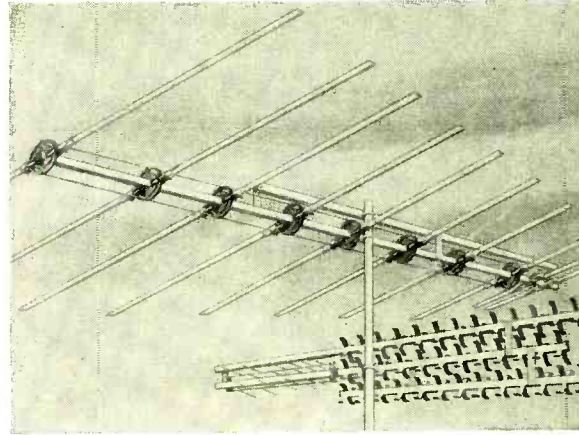

Jerrold
Pathfinder PXB-90

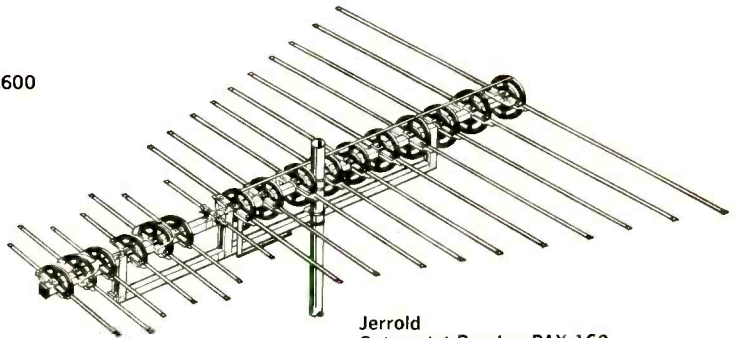

Jerrold
Coloraxial Paralog PAX-160

Color TV and stereo FM radio have spurred more antenna manufacturers to produce more types and styles of antennas. The best way to get comprehensive data for an antenna for your specific need is to write to the manufacturer. Distributors in your area are also in a position to furnish you with manufacturers' literature, and recommendations.

SELECTING AMPLIFIERS AND SPLITTERS

OF ALL the technical aspects of a quality TV or FM signal, the most decisive to a sharp picture is its signal-to-noise ratio. The term is self-explanatory—the signal is what you want, the noise is the unwelcomed guest. For the most part, the noise is generated in the TV set or the FM tuner.

The best signal-to-noise ratio in your system is found in the free space in front of your antenna. From there on, all the way to your TV set, it is a downhill fight. Both the noise generated by the set and the losses of couplers and transmission cable will lower the signal-to-noise ratio of the signal. The less noise your TV set generates, the weaker the signal your antenna system will be able to tolerate.

Amplifiers. In many suburban, rural, or fringe areas, you may have to provide some signal amplification at the antenna or the distribution point of your system to increase signal strength before it gets mixed up with the noise in the system. An amplifier boosts both signal and noise, and the trick is to get the amplifier to the signal before the noise gets in.

Where more signal is necessary because of long runs, multiple taps and outlets, a distribution-type amplifier should be used. Most of today's distribution amplifiers have a low enough noise factor to permit connection direct to the antenna, making a mast-mounted preamplifier unnecessary. (All amplifiers introduce a certain amount of noise.) Many distribution amplifiers include four-way outputs (300-ohm or 75-ohm) and eliminate the need for any additional signal splitting. However, splitting the signal at the head end (antenna end) in some installations may result in excessive cable lengths to some outlets.

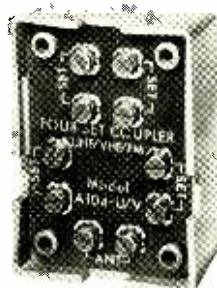
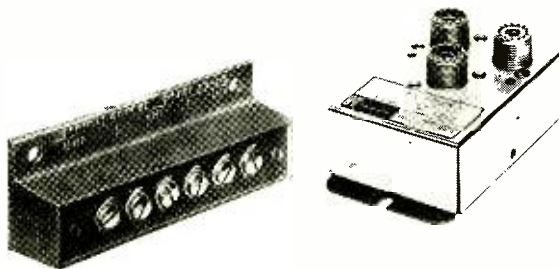

Blonder-Tongue UHF/VHF Signal Splitter UV C/S; 2-Way Hybrid MDC-2VU (top right); and 4-set Coupler A-104-U/V

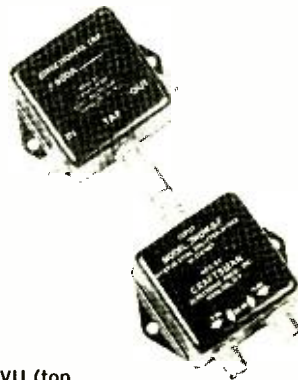

Craftsman Directional Tap and 2-Way Hybrid Splitter

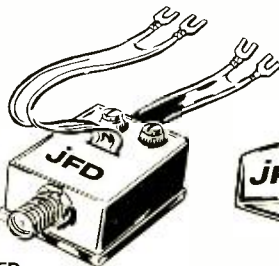
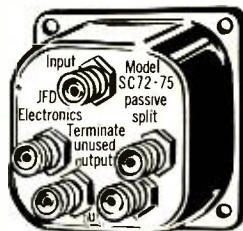
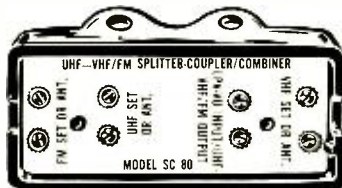

JFD UHF-VHF/FM Splitter-Coupler/Combiner SC80; 4-Way Splitter SC72-75; and Matching Transformer Kit, MT59

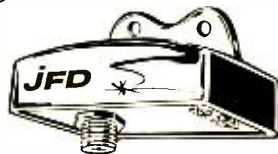

Jerrod 4-Way Splitter TAC-4

Above are a few of the hybrid and resistive inert accessories used to maintain impedance match and isolation between the various elements in the system. Signal splitters and multiple set couplers make it possible to feed several antennas to one download, feed several sets from one transmission line, and separate UHF and VHF signals. They can be mast-mounted or set-mounted.

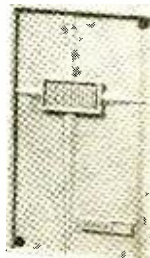



Blonder-Tongue
75-Ohm VAMP-2-75



Blonder-Tongue
Distribution Amplifier
HUB-3P

JFD
300-Ohm VUT3

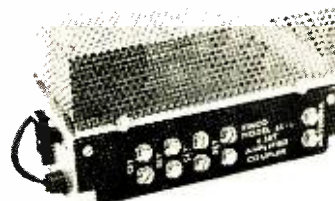
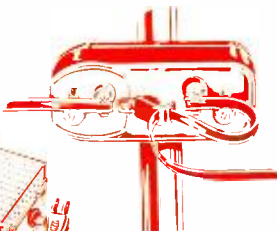
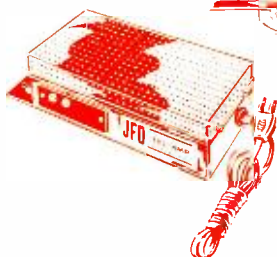

Finco 75-Ohm
to 300-Ohm 65-4-A



Finco
4-Set Amplified Couplers:
300-Ohm 65-1, and 75-Ohm 65-2

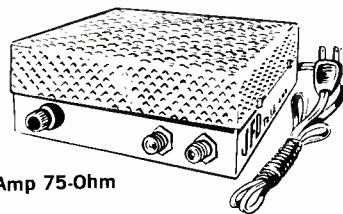

JFD
Color-Tele Amp 75-Ohm
HBV2-75

Mast-mounted 300-ohm and 75-ohm active elements (amplifiers) are used to get to the signal before the signal gets to the noise in order to obtain the best possible signal-to-noise ratio. Remote power supplies located indoors send low-voltage d.c. up the transmission line to the amplifier. TV signals and d.c. do not interfere with each other.

Distribution amplifiers and amplified couplers are used to beef up the signal enough to overcome losses in the system and to make possible long runs. Compensation for strong signals is possible.

The most often used type of amplifier is the mast-mounted preamplifier (booster). As the name implies, these amplifiers mount on the mast as close as possible to the antenna. Power (low d.c. voltage) to operate them is usually sent up the antenna transmission line from a power supply installed indoors. They are low-current, one- or two-transistor devices.

Many types of boosters are available; VHF, UHF, FM, VHF/FM, and VHF/UHF/FM. Some of the qualities of a good booster are low noise factor, high gain, and good signal-handling ability. Amplifiers using high frequency silicon transistors usually have a very low noise factor. Signal gains on the order of 15 to 20 dB can be expected.

(Continued on page 95)

SELECTING TRANSMISSION LINES

SIGNALS FLOAT THROUGH THE AIR FROM ANTENNA TO ANTENNA, BUT MUST BE GUIDED BY TRANSMISSION LINES THROUGHOUT YOUR HOME

TWIN LEAD or coax—which will it be? Unshielded twin lead can do a satisfactory job when it doesn't have to run near other wires or metal surfaces, or when it is not exposed to a lot of interference. Consider the amount of loss you can tolerate, the amount of interference, the impedance, and the ease of installation.

Twin lead, shielded or unshielded, has a nominal impedance of 300 ohms and is balanced. That is, both conductors are at equal potential with respect to ground.

Types of Twin Lead. Ordinary twin lead has the lowest signal attenuation factor, and is also very easy to work with. With certain types of fittings, stripping of insulation can be dispensed with. But or-

dinary twin lead deteriorates rapidly with weather, requires standoffs, picks up interference, and must be routed carefully so as to avoid nearby metal. Where signal strength is at a premium in deep fringe areas you may have no choice but to use a very low loss transmission line.

Shielded twin lead having an attenuation factor less than coaxial cable but more than ordinary twin lead, was introduced a few years ago to satisfy a demand for a shielded 300-ohm balanced transmission line. Like coaxial cable, this twin lead needs no special standoffs, it can be routed near metal, and the manufacturer claims that it is "suitable for direct burial—even under water."

Coaxial Cable. The coax cables used for most home TV systems have a nominal impedance of 75 ohms and are unbalanced. The outer shield of the coaxial cable is usually connected to ground both at the antenna end and at the end going to the set. The vast majority of TV sets have a balanced input impedance of 300 ohms. If coaxial cable is used, a balun or matching transformer will be needed to re-match the line to the set, both for impedance and for balance.

Coaxial cable can be run in close proximity to metal surfaces without upsetting the signal. Losses are predictable and can be compensated for. Transformers match 75-ohm cable to TV set's 300-ohm input.

Some outlet plates have a 75-to-300 ohm matching network mounted on its back side to permit direct external connection to a TV set. Additional openings accommodate extension speakers, intercom units.

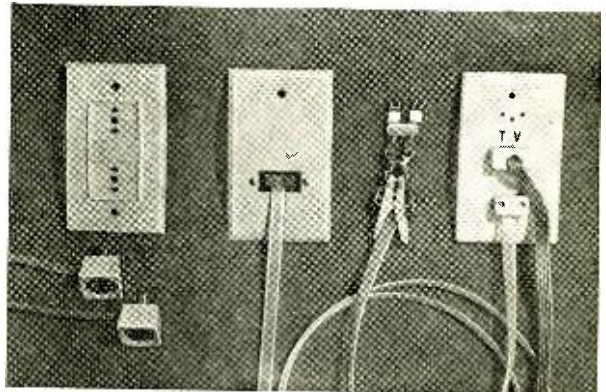
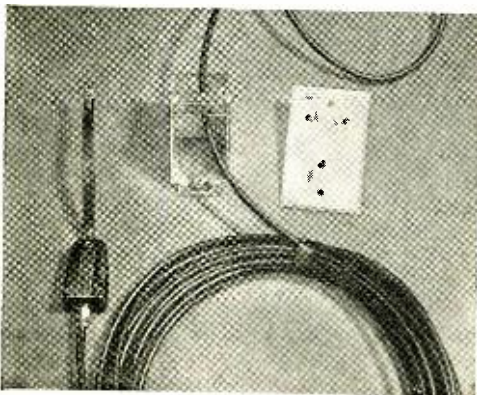

TRANSMISSION LINE

Type	Signal Loss/100'		Cost/100' (approx.)
	Ch. 13	Ch. 83	
COAX CABLE*			
RG-59/U	5.8 dB	13.5 dB	\$ 5.35
RG-59/U Foam	4.8 dB	N.A.	6.00
RG-11	2.85 dB	N.A.	11.25
RG-11 Foam	2.3 dB	N.A.	15.30
82-Channel	3.25 dB	8.2 dB	14.85
TWIN LEAD			
Shielded	4.1 dB	6.5 dB	9.90
Low-Loss Encapsulated	2.8 dB	5.6 dB	4.90
Lowest-Loss Foam-Filled	2.1 dB	3.7 dB	4.50
Ordinary Flat Type**	2.2 dB	4.5 dB	1.91
Open Wire*** (450-ohm)	0.73 dB	2 dB	4.75

*Does not include connectors and matching transformers.
 **Generally not recommended for extensive in-house runs.
 ***Extended run between antenna and house, and along the outside of the house. Matching transformers to 300 ohms are available.

Shielded 300-ohm twin lead (center) can be run through metal outlet boxes just like coaxial cable, but unshielded line (left) should go through plastic boxes or through wall openings without any metal hardware. Flat 4-conductor lead (right) can be used for rotor control or audio. Do not run antenna system lines through any boxes containing power lines.

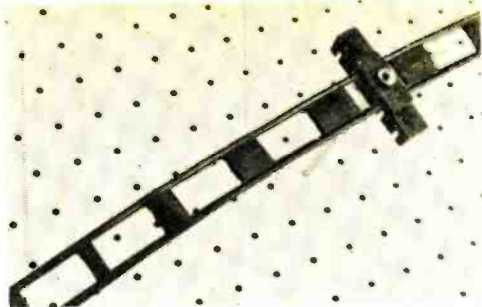
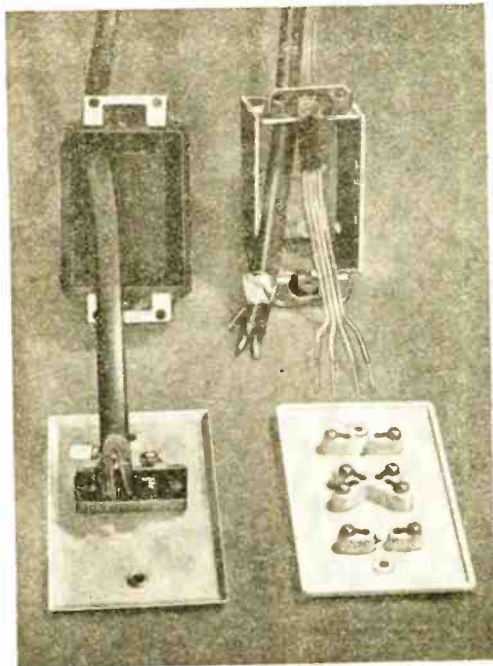

Open-wire 450-ohm transmission line has very low losses and is suitable for long runs in weak or strong signal areas. Like unshielded 300-ohm line, it is used for external wiring and should be kept away from large metal objects. Special matching transformers make this line compatible with 300-ohm TV systems. (Photo: Saxton Products, Inc.)

Coaxial cable is weatherproof and picks up very little electrical interference when properly installed and terminated. It can be passed inside metal conduit and generally routed along any convenient path. But most coaxial cables have high signal loss. The higher the signal frequency, and the longer the run, the greater the loss. This disadvantage, however, can be offset by supplying more signal from the head-end.

The need for special connectors and costlier signal distribution accessories with the coaxial cable also represents a slight disadvantage. A big advantage, however, is that the losses in a coaxial cable system are predictable and can be compensated for in a specific manner.

Also available are weather-resistant foam-filled, low-loss encapsulated twin lead and several types of coaxial cable—the most recent type being featured as 82-channel coax.

Coaxial types of outlet plates shown here also are available with openings for rotor control, audio and other applications. (Photo: Mosley Electronics, Inc.)

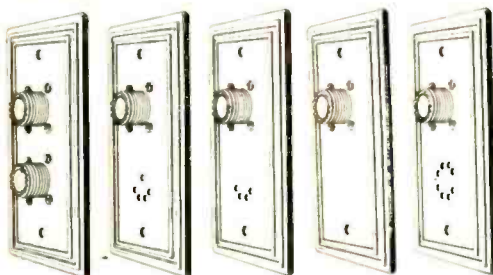

INSTALLING THE SYSTEM

INSIDE/OUTSIDE AND OVER/UNDER WIRING TECHNIQUES HELP GET AROUND OBSTRUCTIONS

NEW CONSTRUCTION or old, house for house, installation configurations are essentially the same. Take the most direct route. Take the most logical route. Make it as easy as you can by going over the ceiling, under the floor, through the closet, outside the house, inside hollow walls, etc. Use long drills, snakes, bent coat hangers, stud finders, and common sense. A floor plan showing the location for all outlets is desirable.

In a ranch-type home, all signal splitting should be performed in the attic. The wires can then be fed down between the studs, and retrieved at the outlet.

Inside, Outside Wiring. In a multi-level home, after signal splitting in the attic, if you anticipate difficulty in running the cable inside the walls, run the cable on the outside of the house. If the tap-offs are made on the outside, the cable can be fed through a wall bushing directly to the outlet site. If you prefer, the cable can be run into the house for a tap-off, and then run outside again to the next outlet. Don't forget to caulk or otherwise weatherproof all holes drilled through the outside walls.

In this type of installation, try to avoid locations close to 117-volt a.c. wall outlets. Be on the alert to prevent drilling into electrical wiring, water pipes, and other obstructions. If the house is under construction, outside wiring is not needed.

If signal splitting in the attic is not possible (you may not have an attic), or if two or more outlets must be provided in the same room, remember that most signal splitters are weatherproof and can be mounted on the outside of the house.

AUDIO AND CONTROL WIRING AND OUTLET BOXES

Auxiliary Wiring	Cost (approx.)	Comments
2-Conductor Wire Audio/Speaker	\$1.22/100'	24 gauge is suitable for short runs. Use heavier gauge for long runs.
3-Cond. Twisted Pair Intercom	1.25/100'	May require additional pairs depending on number of stations and type of intercom. Shielded pair preferred to minimize crosstalk problems.
4-Conductor Wire	2.82/100'	Used on most automatic rotators. Can be used for audio.
5-Conductor Wire Gem Box	3.54/100' .25	Required for most manually-operated rotators. Standard electrical outlet, good for coax or shielded twin lead.
Bakelite Wall Box	.75	Use for unshielded transmission lines.
Open Hole Wall Bracket	.39	Suitable for existing construction, requires cutting into wall board.

Mast-mounted preamplifier can be eliminated in a good signal area. VHF/UHF splitters help maintain impedance match at TV set in simple system at left.

Sheltered areas, under an eave or windowsill, are suitable locations for these components.

Over and Under Wiring. Sometimes the "over and under approach" can be used. With this method, second floor locations can be fed from the attic using the ranch home approach and first floor sites can be fed from the basement. A single distribution line is routed outside the house from the attic to the basement. Splitters can then be mounted on the floor joists and cables fed up through drilled holes in the floor to the outlet site.

If several outlets are required within a room, and if it isn't convenient to hide the transmission line wiring, run twin lead along the baseboard. Do not just parallel the outlets; use proper couplers.

In homes under construction, tag the wires where the outlets will be located. The "sheet-rockers" will hopefully leave an appropriate hole. Otherwise you will find the room sheet-rocked solid.

Use commercially available 75-ohm in-line connectors for joining coaxial cable in the middle of a run. A splice is never as good as an uninterrupted run. Avoid splices by buying more than enough cable at the start. When splicing audio or rotator wires, use solder, and then tape the joints. Mismatch and chemical reaction can result if coaxial cables or twin leads and other hardware are made of dissimilar materials.

Coax cables and some twin leads have critical bending radii—avoid sharp bends, excessive twisting, crushing and other forms of mechanical distortion. Also avoid stapling and nailing unshielded twin lead. If you must staple, do so sparingly. The less metal that comes in close proximity to unshielded transmission line, the better.

Coaxial cable and shielded twin lead may be lightly stapled as required. Do not pierce the insulation.

(Continued on page 88)

Four-way installation using coaxial cable requires impedance-matching transformers. Four-way splitter can be replaced by a distribution-type amplifier.

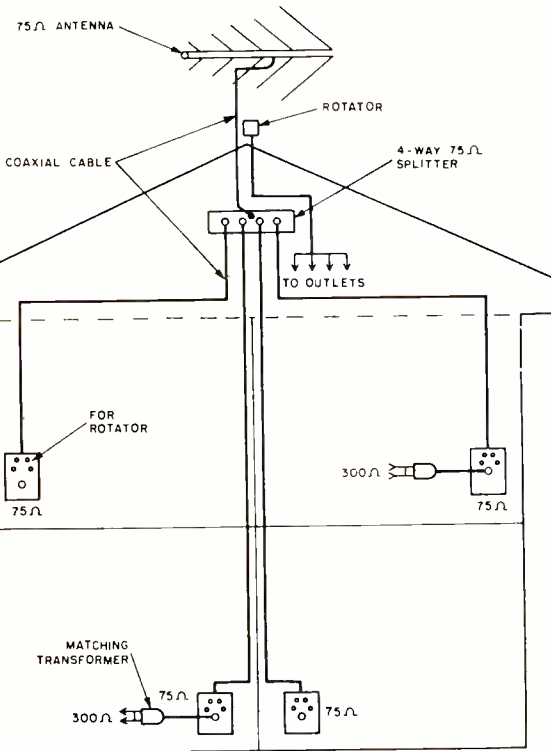
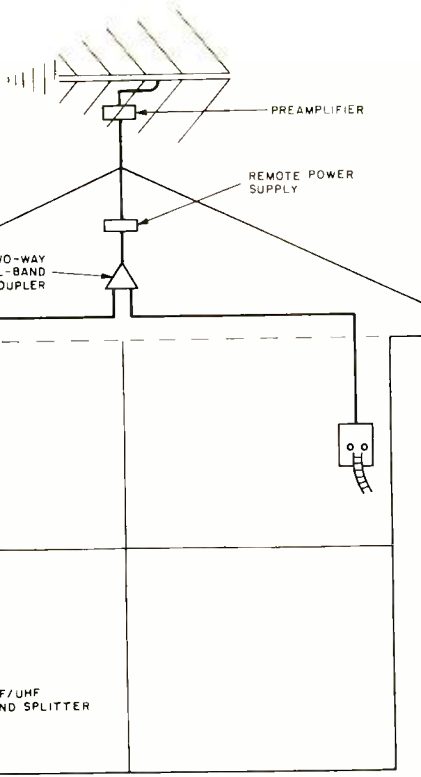

SERVICING THE SYSTEM

TOO MUCH SIGNAL
CAN BE JUST
AS BAD AS TOO
LITTLE SIGNAL

WHEN THE MOMENT of truth arrives, your system's quality will usually be as good as the time you took to plan it. Check each TV channel; look for well defined pictures, free of snow, from all TV outlets.

Should you run into any difficulties, go about troubleshooting the installation in a systematic manner. You can start at an outlet and work your way back to the antenna, or you can start at the antenna and work your way toward the outlet. The professional way is to think out the problem, start somewhere in the middle of the system, and work your way towards the troublesome end. It isn't difficult to isolate the trouble.

Weak Signal. If snow or poor quality pictures are obtained from some outlets, and not from others, it is a simple matter to check out and isolate a troublesome line or component. If snow appears

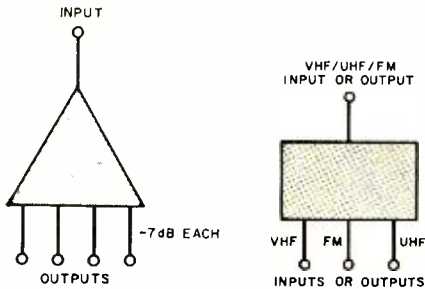

Signal splitters, multiple set couplers and amplifiers are usually schematically represented by triangles, squares, and rectangles, but not by circles.

on one channel, and not on others, you might suspect the channel or reception conditions for that channel. If snow appears on all channels and from all outlets, and if all is well with your installation, you may be in need of additional signal amplification.

One way to troubleshoot your antenna system is to substitute dummy loads for a run and work from the head-end on down. It is possible for trouble in one line to reflect back and cause trouble in other lines.

Strong Signal. In amplified systems, too much signal (overload) can also present some problems. Overload can be recognized by loss of sync, windshield wiper effect, visible "herringbone" or "beats," and a very black picture. Overload can occur at the TV set or at the amplifier. Usually, the amplifier is to blame in a majority of cases.

Try this test. Disconnect the twin lead at the set and hold it near but not touching the set's terminals. Observe the picture; if the distortion disappears and

(Continued on page 97)

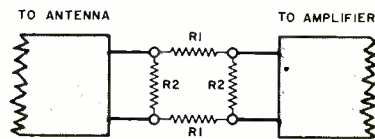

LOSS dB	R1 Ω	R2 Ω
6	110	910
12	270	510
24	1200	330

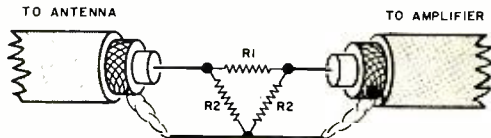

LOSS dB	R1 Ω	R2 Ω
6	56	220
12	130	120
24	560	62

Simple resistive pads for 300-ohm line (top) and for 75-ohm coax cable (bottom) can be assembled to cut signal strength and maintain correct impedance.

THE "R.F. SNIFFER"



NO HAM OR CB'ER should be without some type of r.f. signal indicator for trouble-shooting and operating transmitters, r.f. amplifiers, and oscillators. A simple r.f. field strength meter fits the bill nicely. This device is almost as versatile in r.f. circuits as a multimeter is in d.c. and low-frequency a.c. circuits. Furthermore, it is easier to use and it is more compact than most multimeters.

For versatility, few field strength meters that cost up to \$15 have an advantage over the inexpensive unit described here. The tiny "Sniffer" can "tell" you when your transmitter is on-the-air simply by "sniffing" (sampling) your transmitted carrier. *Off*-the-air tuning of low power transmitters is simplified when the "Sniffer" is used as a dummy load antenna. Also, this versatile little test instrument can "sense" when an oscillator is working correctly, and it can respond to electromagnetic radiation coming from r.f. circuits within its pick-up field.

The Circuit. The "R.F. Sniffer" circuit shown in Fig. 1 is a voltage doubler type of detector, formed by capacitors *C1* and *C2* and diodes *D1* and *D2*. This type of circuit provides almost twice as much sensitivity as would be obtained from a single-diode detector.

BUILD A FIELD STRENGTH METER FOR LESS THAN \$6

By **JAMES ASHE**, W2DXH

Resistors *R1* and *R2* and capacitor *C3* form a filter network which tends to smooth the rectified voltage to the meter to provide a steady pointer deflection. Unless the meter circuit is calibrated to yield a specific reading at a set distance from a circuit of known power, the reading obtained will be only of a relative nature. However, this circuit is typical of the type used with commercially available test equipment, such as voltmeters, oscilloscopes, and field strength meters.

Construction. Almost any type of chassis construction can be employed, but keep component leads as short as possible. If you prefer a printed circuit board layout, you can make your own by using Fig. 2 as a guide. Parts placement, however, is not critical.

Be careful to observe the proper polarity when connecting *D1*, *D2*, and the meter into the circuit. Since the "Sniffer" is to be used at r.f. frequencies, select

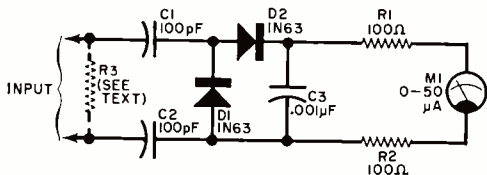

Fig. 1. Values shown for C1, C2 and C3 are for frequencies up to about 3 MHz. For higher frequencies, smaller value capacitors are required.

PARTS LIST

C1, C2—100-pF disc capacitor
 C3—0.001-μF disc capacitor
 D1, D2—1N63 point-contact diode
 M1—0-50 μA meter
 R1, R2—100-ohm, 1/2-watt resistor
 R3—52- or 75-ohm, 1-watt carbon composition resistor—see text
 Misc.—Printed circuit or perforated phenolic board, five-way binding posts or metal spacers, (2) solder, hardware, etc.

point-contact type diodes for D1 and D2. In applications where the frequency is higher than about 3 MHz, the values for C1, C2 and C3 should be considerably smaller than shown in Fig. 1.

Fasten five-way binding posts, or a pair of 1"-long threaded metal spacers as shown in Fig. 3, to the "Sniffer" to serve as input terminals.

Applications. A 6" length of hookup wire, when connected to either of the input terminals, acts as an antenna which should produce a good r.f. voltage indication on the meter. Simply set the "Sniffer" near an r.f. amplifier or a trans-

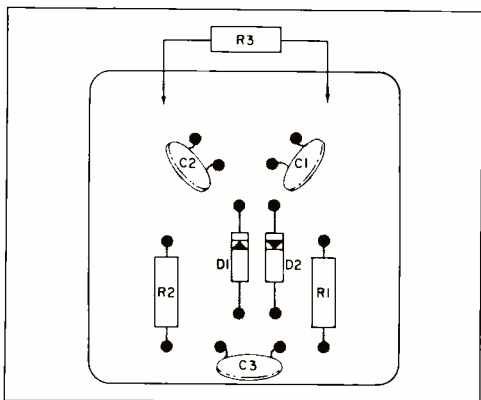

Fig. 2. Component side of actual-size printed circuit board with "see-through" view of foil side.

mitter antenna to obtain a reading. In order to prevent loading and other interactions, do not place the "Sniffer" closer to the test circuit than is necessary to obtain useful meter readings.

If you want the "Sniffer" to indicate the presence of electromagnetic radiation, bend a 6" length of wire to form a loop, and connect the ends to the inputs of the "Sniffer." This setup is used in much the same manner as you would dip a grid dip meter into a test circuit. In the case of miniaturized circuits where dipping can be difficult, make a smaller loop, but use twisted-pair wire.

For dummy load antenna operation, solder a 52- or 75-ohm carbon composi-

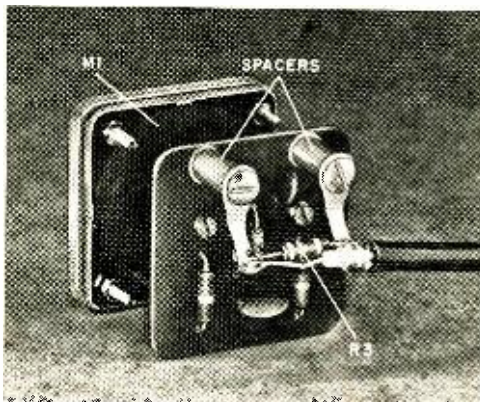

Fig. 3. Mount foil side of printed circuit board facing meter. Photo shows how coaxial cable and R3 are connected for dummy load antenna operation.

tion resistor (R3) across the "Sniffer's" input terminals as shown in Fig. 3. (The characteristic impedance of the transmission line will determine the value of the resistor needed.) Then connect the center conductor to the input terminal adjacent to C1 and the shield of the transmission line to the other input terminal. For use with transmitters capable of more than 1 watt of output power, connect two resistors in series, but wire the transmission line across only one of the resistors; the modification will safely withstand two watts of power.

If you are a ham, CB operator, hobbyist, or technician, you'll soon find the "R.F. Sniffer" indispensable for quick checks of r.f. equipment. Its light weight and small size make it convenient for mobile use.

THE "CLATTER" STOPPER

HOMEBREW GADGET
GIVES YOU AUTOMATIC
INSTANT RECEIVER
QUIETING INSTEAD OF
NERVE-RACKING
NOISE FROM NEARBY
TRANSMITTERS

By I. C. CHAPEL

ARE YOU PLAGUED by "clatter" in your radio receiver when a nearby transmitter is keyed? Many people have this frustrating experience, and quite a few of them believe that the only thing they can do about it is grimace and bear the noise. But there is a way to put a stop to the clatter without shutting down the receiver—or putting it in standby position.

All you need is a device that will quiet your receiver *only* when the clatter is present. Since this type of noise consists of a strong r.f. pulse, usually of very short duration, your radio can be momentarily quieted without seriously interrupting your listening.

The "Clatter Stopper" is an inexpensive gadget you can build to accomplish this quieting action. It is a simple detector circuit capable of energizing a magnetic reed switch which prevents the noise from reaching the speaker.

How It Works. When a sufficiently strong r.f. signal "hits" the antenna of the circuit shown in Fig. 1, the signal is detected and filtered to provide a nega-

tive d.c. voltage to the input of transistor *Q1*. (Capacitors *C1* and *C2* and diodes *D1* and *D2* form a voltage-doubler type of detector.) The negative voltage causes *Q1* and *Q2* to conduct. "Relay" *K1* becomes energized and the contacts close when the transistors conduct. The contacts are connected across the speaker voice coil and short out the speaker to silence it.

In some transistor circuits, shorting the output can damage the transistors. To avoid this problem, connect a 0.01- μ F or larger capacitor between one of the contact leads and the speaker. (Do *not* disconnect the speaker from the radio.) The signal across the speaker will be bypassed without affecting the d.c. characteristics of the output circuit.

The duration of the muting effect after the noise signal is gone depends on how long it takes for the charge across *C2* to drop off enough to bring *Q1* out of conduction. The larger the values of *C2* and potentiometer *R1*, the longer it will take for the voltage to drop down to the current cutoff point of the transistor. The values shown can produce a variable lag on the order of a few seconds, depending on the setting of *R1*.

Construction. All components, except *R1* and *J1*, can be assembled on a 2" x 3½" phenolic board, or other type of insulating material, as shown in Fig. 2.

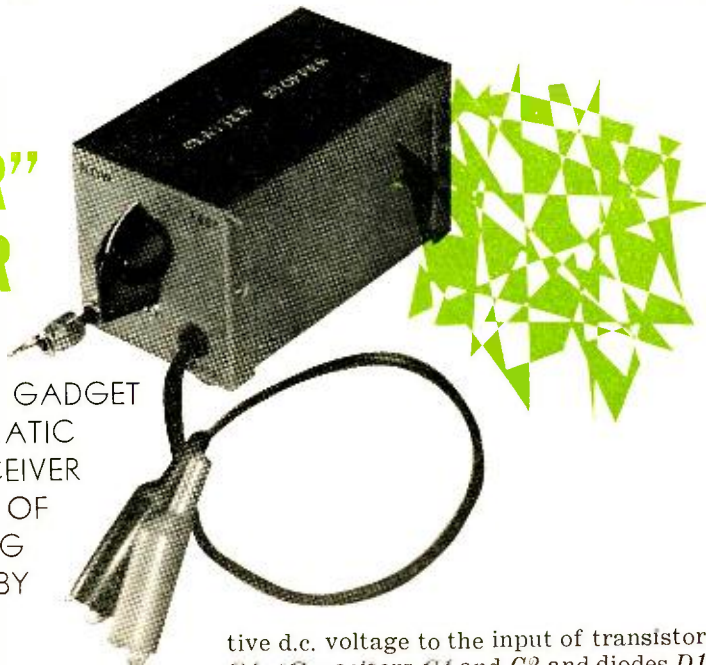
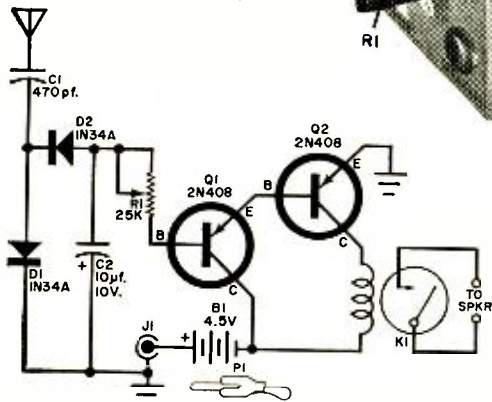

Fig. 1. A magnetic reed switch and energizing solenoid are used for K1 instead of the conventional type of relay, as shown in the schematic diagram. An s.p.s.t. switch could be substituted for J1 and P1 to control the circuit's power.



Parts layout and placement are not critical, but keep component leads as short as possible and neatly dressed.

Use 1"-long spacers to mount the circuit board inside the aluminum box to provide space for mounting B1 under the board. Mount J1 and R1 on the cabinet, and fit a small rubber grommet into the hole that will be used to pass the wires going to the speaker.

The solenoid coil for K1 should be wound on a 1/2"-diameter by 1"-long non-magnetic coil form. About 800 turns of #34 enameled wire on the coil form are needed. The finished coil should measure about 1/2" in length. A pair of solder lugs for terminating the coil windings can be attached to the coil form, or you can merely solder short lengths of hook-up wire directly to the winding ends. In either case, secure the windings in place with a coating of coil dope.

Slide the reed switch into the coil form, and K1 is ready for installation on the circuit board as shown in Fig. 2. The reed switch should be oriented in the core of the coil form to permit operation with the least amount of current flowing through the coil windings.

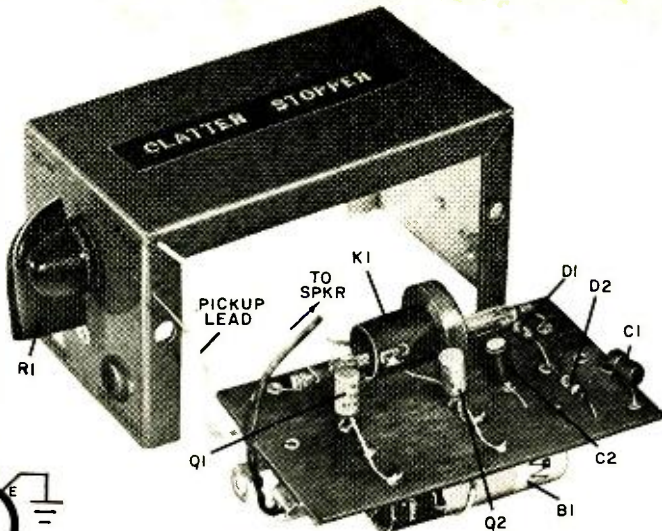

Fig. 2. Small size and few components make it possible to build "Clatter" Stopper on 2" x 3 1/2" board.

PARTS LIST

- B1—4.5-volt battery
- C1—470-pf ceramic capacitor
- C2—10- μ F, 10-volt electrolytic capacitor
- D1, D2—1N34 germanium diode
- J1—Phono jack
- K1—Magnetic reed switch and energizing solenoid—see text
- P1—Phono plug (to match J1)
- Q1, Q2—2N408 transistor
- R1—25,000-ohm linear taper potentiometer
- 1—4" x 2 1/4" x 2 1/4" aluminum utility box
- Misc.—Phenolic board, # 34 enameled wire, spacers, hardware, grommet, solder, hookup wire, etc.

If you wish, you can use a s.p.s.t. switch instead of J1 and P1 to turn the circuit on and off. Phono plug P1 is nothing more than a "gimmick" made to act like a switch. Solder a jumper wire from the center contact of a phono plug (to match J1) to the outer conductor of the plug.

The Antenna. If the opening and closing action of K1 is erratic, reduce the length of the antenna coupling between your receiver and the "Clatter Stopper." If your radio is near the troublesome transmitter, the antenna of the "Clatter Stopper" can be made very short. The further away the transmitter is, the longer the length of the antenna. —50—

Amateur Radio for CB'ers



HOW TO CONVERT YOUR CB RIG TO TEN METERS
AS AN INEXPENSIVE START IN AMATEUR RADIO

By **WALTER F. LANGE**, W1YDS

Technical staff, American Radio Relay League



IN PART 1 of this article, which appeared in the May issue, overall instructions for converting CB transceivers to 10-meter operation were presented, and eight specific units were discussed in detail. On the following pages are the conversion details for four more units representative of the problems that may be encountered in going from CB to ham operation. Remember, before you can operate on 10 meters, you must have received your General Class ham ticket.

Lafayette HB-500A. Designed for 12 volts d.c. operation, the Lafayette HB-500A CB transceiver uses 15 transistors and five semiconductor diodes. Besides realignment and a new transmitting crystal, two inexpensive capacitors have to be changed in order to convert this transceiver to 10 meters. Before adjusting the receiver, be sure the *Xtal-Tune* switch is in the *TUNE* position.

The receiver is a double-conversion superhet with a first i.f. of 3580 kHz and a second i.f. of 455 kHz. With the plates of the receiver tuning capacitor fully meshed, tune oscillator coil *L3* (see Fig. 11) to 24.920 MHz. The receiver will now cover from 28.500 to approximately 28.865 MHz. If you want to tune a different segment of the band, set the oscillator coil 3580 kHz below the bottom end of the desired tuning range. Continue the receiver alignment by tuning the receiver to mid-range while applying an appropriate signal to the input connector. Peaking base coil *L1* and collector coil *L2* of the r.f. amplifier completes the receiver conversion.

Start work on the transmitter (see Fig. 12) by replacing the CB transmitting crystal with a third-overtone FM-9 crystal in the 28.5 to 29.7 MHz range. Remove the two screws holding the bottom plate to the chassis to provide access to the soldered side of the transmitter printed circuit board. Unsolder 15-pF capacitor *C77* from across *L7*. The only 15-pF capacitor in the transmitter is *C77*, and it is located about halfway between *L7* and the heat sink for *TR-14*. Note that *C77* is not visible in Fig.

12 since the photograph shows the converted unit. Replace 150-pF capacitor *C86* across *L9* with a 100-pF unit. Capacitor *C86* is located directly to the rear of the *TR-14* heat sink.

Peak oscillator collector coil *L7* and driver collector coil *L9*. Tune final amplifier coil *L11* for maximum output. Spread the turns of *L10* apart so that the transmitter causes minimum second-harmonic interference to television Channel 2. Part of parallel-tuned second-harmonic trap *L10* is in series with the output. At this time it's a good idea to check the modulation output; if the output drops, detune *L11* on the low-frequency side (screw the slug into the coil) until upward modulation is obtained.

One final note: *L11* has a rather limited tuning range. In some transceivers, in order to tune the high end of the band, it may be necessary to remove a turn or a portion of a turn from *L11*.

Lafayette HE-20D. The Lafayette HE-20D is a hybrid CB transceiver employing ten transistors, ten semiconductor diodes and two vacuum tubes. It will operate from either 117 volts a.c. or 12 volts d.c. Before aligning the receiver, set the *Xtal-Tune* switch in the *TUNE* position.

The receiver is a single-conversion superhet with an i.f. of 455 kHz. Depending on which portion of the band you want to cover, set oscillator coil *L4* (see Fig. 13) above or below the signal range by 455 kHz. With the receiver tuning capacitor at maximum capacitance,

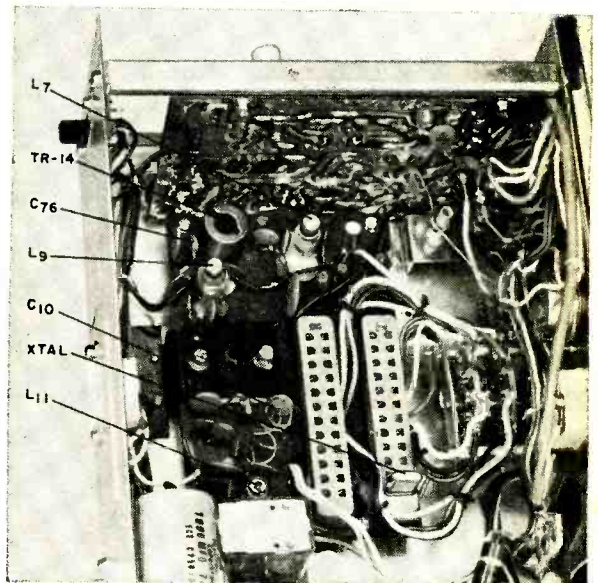
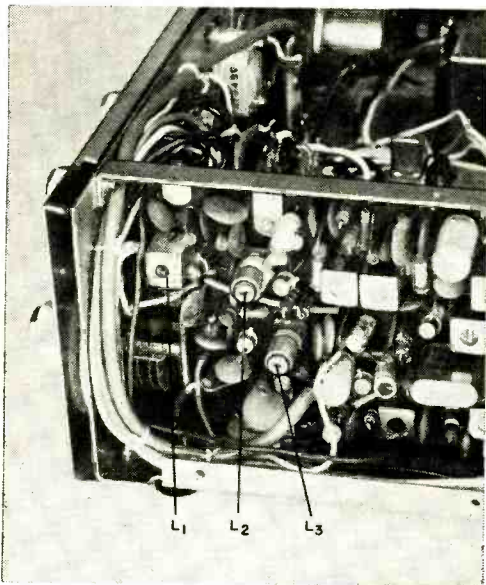

Fig. 11 and Fig. 12. The instructions in this article apply only to the Lafayette HB-500A CB transceiver—not the HB-500. Side view (at left) shows the coil positions for receiver adjustment. Top view (at right) shows the transmitter section; you may have to remove a turn from coil *L11* for full band coverage.

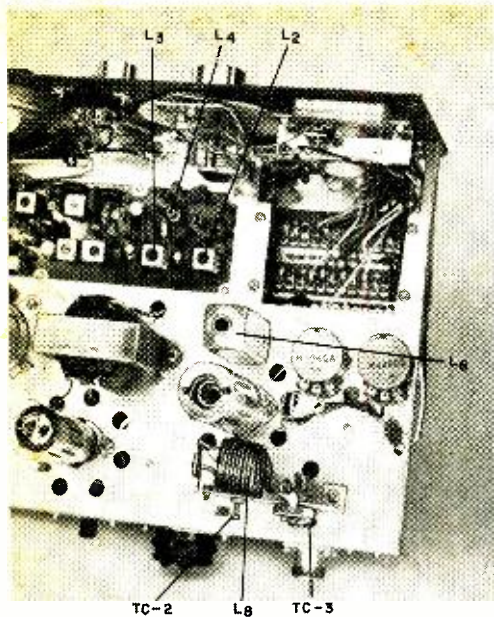

Fig. 13. No part changes are required to convert the receiver section of the Lafayette HE-20D transceiver, but three components have to be replaced or modified to put the transmitter on 10 meters.

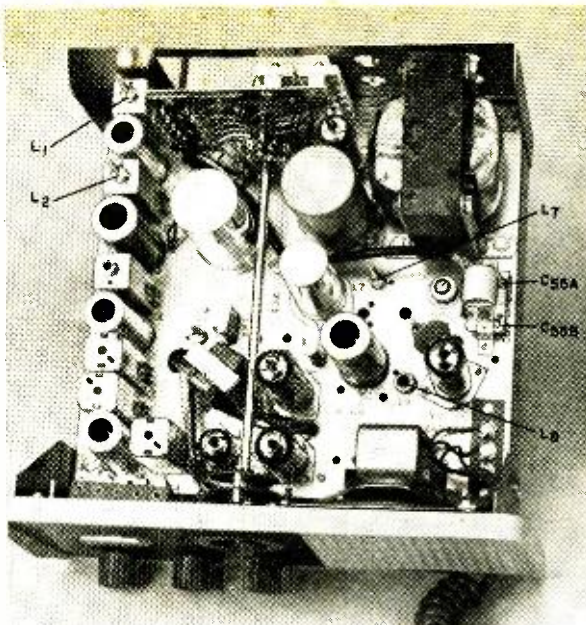

Fig. 14. In the Raytheon TWR-3 transceiver, the same crystal that determines the transmitter frequency establishes the tuning range of the receiver; before installing a new crystal, therefore, you should first choose a desirable transmitting frequency. Coils L1 and L2 must then be tuned for maximum response.

tune L_4 to 28.045 MHz. The receiver will cover from 28.500 to about 28.870 MHz. Feed a mid-range signal to the receiver and peak the r.f. stage's input and output coils, L_2 and L_3 .

A few component changes are necessary to put the transmitter on 10 meters. Replace the transmitting crystal, located on the underside of the chassis, with a third-overtone FM-9 crystal for the 28.5- to 29.7-MHz phone band. The CB transmitting crystal is located on the crystal-socket board labeled *T*. Remove one turn from pi-network coil L_8 . Replace the 200-pF capacitor connected to the receive-transmit relay with a 120-pF mica or disc ceramic capacitor. The 200-pF capacitor is the only capacitor connected to the relay.

After the changes have been made, peak oscillator coil L_6 . Then adjust plate-tuning capacitor *TC-2* and loading capacitor *TC-3* for maximum output. Start with the plates of compression trimmer *TC-3* screwed down. Alternately open up the plates of *TC-3* a small amount and peak *TC-2*. Continue these adjustments until the final amplifier is fully loaded.

Raytheon TWR-3. Designed to operate from either 117 volts a.c. or 12 volts d.c., the Raytheon TWR-3 CB transceiver employs ten vacuum tubes and four semiconductor diodes. Set the channel selector switch in the extreme counterclockwise position for tunable receiver operation. The other positions are for fixed-channel use only.

The receiver is a double-conversion super-

het with a first i.f. of 1650 kHz and a second i.f. of 250 kHz. Normally the first conversion oscillator in a CB transceiver is tunable, but in the Raytheon receiver it is crystal-controlled. An incoming signal beats with the output of the crystal oscillator, producing a difference frequency in the 1.505- to 1.775-MHz range. The resultant signal beats with the 1.755- to 2.025-MHz tunable oscillator, producing the 250-kHz second i.f.

Raytheon uses the same crystal oscillator mentioned above to determine the transmitter frequency. In this case, the output of the receiver's crystal oscillator is combined with the output of a 1650-kHz crystal oscillator, producing a difference frequency which is the transmitter frequency. The simplest way to set up the receiver's crystal oscillator is to first decide on a transmitting frequency. The receiver will tune from about 125 kHz below to about 145 kHz above this frequency. In choosing a crystal, use a third-overtone FA-5 crystal whose frequency is 1650 kHz higher than the desired transmitting frequency. For example, if you want to transmit on 28.625 MHz, use a 30.275-MHz crystal. The receiver will tune from about 28.500 to 28.770 MHz. (Note that, when you change the transmitting crystal, you also move the tuning range of the receiver.)

Once the crystal has been installed, only two coils need to be adjusted to complete the receiver conversion. With a mid-range signal applied to the antenna connector, tune the r.f. amplifier's input and output coils L_1 and

L2 for maximum response (see Fig. 14). If, after converting the receiver, you only want to listen on your transmitter frequency and don't care to tune other parts of the band, throw the channel selector switch to channel A.

Start the transmitter alignment by peaking driver grid coil L7. Then adjust the driver plate coil and the final amplifier grid coil (top and bottom slugs of L8) for maximum output. Set loading capacitor C55A at maximum capacitance. Alternately decrease the capacitance of C55A and peak plate tuning capacitor C55B until the final amplifier is fully loaded.

Squires-Sanders S5S. The Squires-Sanders S5S transceiver is a 21-transistor unit designed for 12-volt d.c. operation. It is different from the other transceivers described in this article in that the receiver section is fixed-tuned only. In order to provide tunable receiving facilities, one tuning capacitor, four silver mica capacitors, and one shaft coupling are required. No new components are needed to convert the transmitter other than a transmitting crystal.

Before disassembling the transceiver, turn the channel selector switch to channel A. Remove the four screws from the bottom of the cabinet and the three knobs from the front panel. Slide the transceiver out of its case. Now look at Fig. 15 and remove the two screws holding the channel switch wafer to the chassis. The various contacts on the switch wafer are soldered to a printed circuit board, as are the receiver oscillator components and five crystal sockets for the transmitter. Slide the switch wafer off its tuning shaft and push the circuit board towards the rear of the unit. Save the two screws and bushings that were used to space the board from the chassis.

Remove the channel indicator from the switch shaft and unbolt the detent mechanism from the chassis. Slide the mechanism out of its mounting hole and put it aside for later use. Now drill two holes in the chassis, near where the channel selector switch was mounted, so that a Millen Type 21015MK 15-pF variable capacitor can be installed in the same area. If necessary, push the pilot lamp sockets to one side or the other so that the holes can be drilled without interference.

Fasten the oscillator printed circuit board to the studs on the back side of the tuning capacitor using the screws and bushings removed earlier. Be sure the capacitor is mounted with its connecting lugs positioned as shown in Fig. 16. Bolt the front of the tuning capacitor to the chassis. Then attach a shaft coupling to the capacitor and a 3-inch length of 1/4-inch diameter shaft to the coupling. The required shaft can be obtained by sawing off a 3-inch length of rod from the previously removed switch assembly.

As shown in Fig. 17, replace 22-pF capacitor C204 on the oscillator circuit board with a 5-pF silver mica capacitor and replace 0.005- μ F capacitor C205 with a 180-pF silver mica capacitor. It's easy to locate the 22-pF and 0.005- μ F capacitors as there is only one of each value on the board.

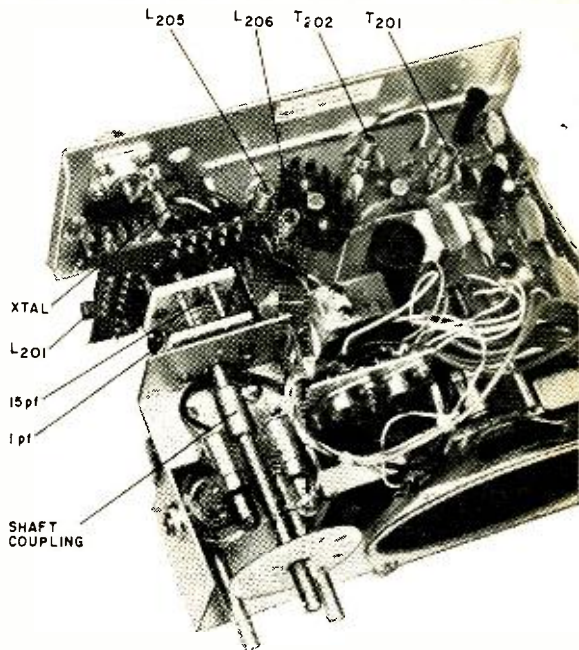
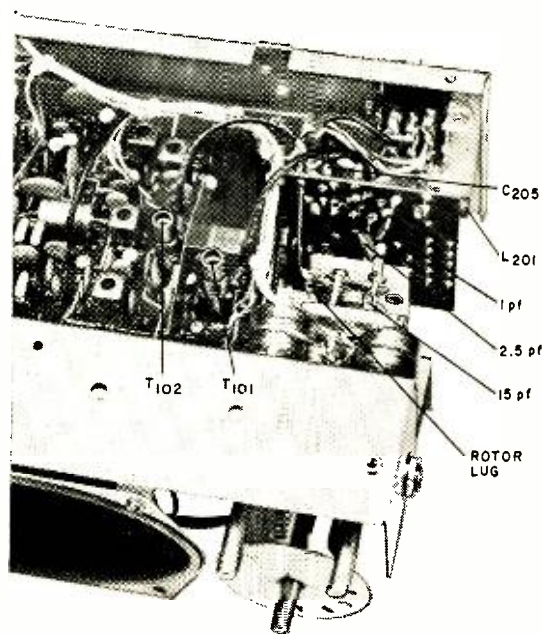

Fig. 15 and Fig. 16. Converting a Squires-Sanders S5S transceiver to 10 meters is a little complicated since the receiver section is fixed-tuned only, but you should have no trouble if you follow the directions carefully. In the top view of a converted S5S (above), the dial at the left—which originally turned a channel selector switch—now tunes a variable receiver oscillator. In the bottom view of the converted S5S (below), you can see the mounting details of the new 15-pF variable tuning capacitor which is required.



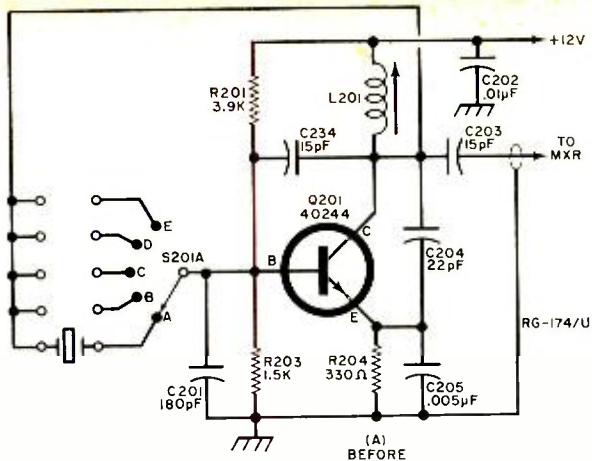
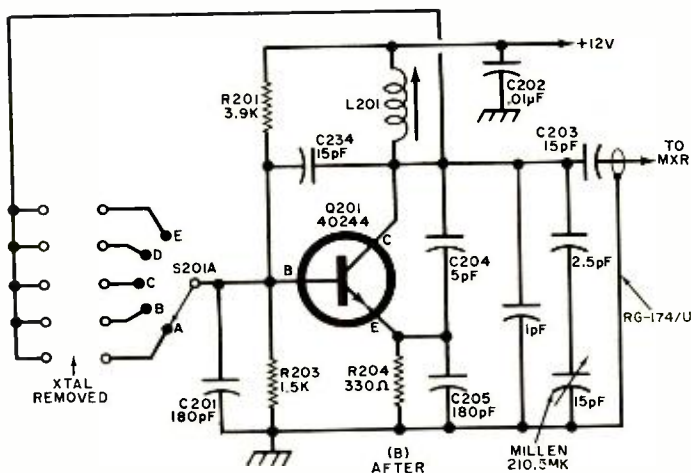

Fig. 17. These schematic diagrams show the Squires-Sanders S5S receiver oscillator before (A) and after (B) its modification from fixed to tunable service. The 22-pF capacitor (C204) and the 0.005- μ F capacitor (C205) are replaced by 5-pF and 180-pF silver mica capacitors respectively. Two other silver mica units (1 pF and 2.5 pF) are incorporated in the modified circuit.



Note in Fig. 16 that you connect the rotor lug of the tuning capacitor to the copper strip which runs across the top of the oscillator circuit board. In addition, solder a short wire between the rotor lug and the nearest mounting stud on the tuning capacitor. Solder a 1-pF silver mica capacitor between the above-mentioned strip and the strip labeled *E*. Strip *E* is the one that connects the outside contact of each receiver crystal socket together. Complete the wiring of the variable oscillator by soldering a 2.5-pF silver mica capacitor (or two 5-pF units in series) between strip *R* and the stator lug of the tuning capacitor.

Remove any receiver crystals from the board. Fully mesh the plates of the tuning capacitor. Tune oscillator coil *L201* to 39,200 MHz or to a frequency 10.7 MHz above the bottom end of the desired tuning range (the i.f. of this single conversion superhet is 10.7 MHz). If adjusted for the low end of the 10-meter band, the receiver will tune from 28,500 to 28,980 MHz. Apply a mid-range signal to

the antenna connector and peak the r.f. amplifier's input and output coils *T101* and *T102*.

Insert a third-overtone FM-9 crystal for the 10-meter phone band in transmitter crystal socket *A*. Tune the oscillator, driver and final amplifier coils, *T201*, *T202* and *L205*, respectively, for maximum output. Adjust *L206* for minimum second-harmonic interference to television Channel 2. Check the modulation of the amplifier. If the modulation is downward, detune *L205* on the low-frequency side (tune the slug into the coil) until a lamp dummy load brightens when you talk into the microphone.

Before inserting the chassis back in the case, drill a 1/4-inch hole in the side of the case opposite from where *L201* will be located when the transceiver is in the cabinet. After the unit is put back in the case, retune *L201* as described earlier. This procedure is necessary, as the cabinet detunes the oscillator coil.

For easier tuning, replace the knob on the former channel selector shaft with a larger knob.

FOR WHOM DOES THE SYSTEM TOLL?

DOES IT PAY TO
INSTALL YOUR OWN
ANTENNA, OR
SUBSCRIBE TO CATV?

By **EDWARD A. LACY**, K4BJL

Local CATV antenna system 350' high picks up signals from distances in excess of 100 miles. Signals are fed through a head-end amplifier and distribution system to provide about 1000 μ V across 75 ohms for each channel to each TV set served.

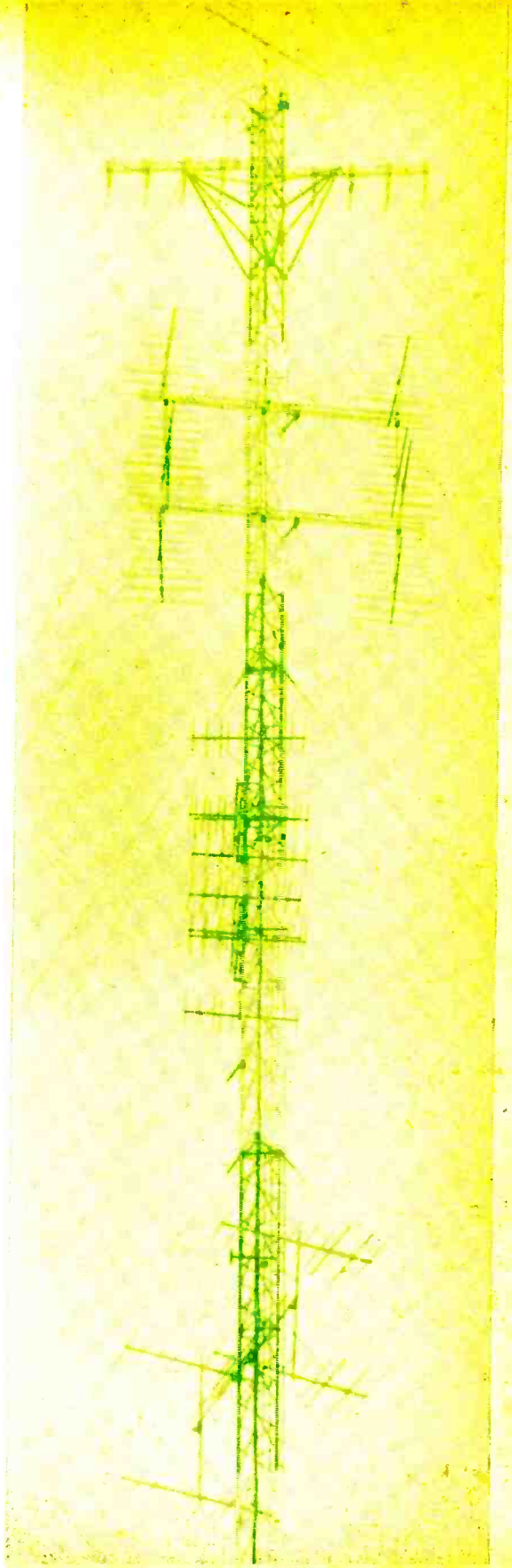

WHETHER CATV comes into your home or not depends upon whether it is available, what it offers, and how much it costs. It may also depend upon your ability to get a good signal from your antenna. Unfortunately, there is no pat answer to the question, "Shall I contract for CATV or put up my own antenna?" To install your own antenna and to subscribe to CATV is an expensive way to find the best solution, but I decided to make comparison tests while the old antenna was still working and after the CATV line was run into my home.

The tests were made in the Cape Kennedy area, where I live, to determine if it were feasible to install the newer high-gain TV antennas, transistorized preamplifiers, and low-loss coax cable or shielded twin lead, and eventually discontinue CATV. While reception in different areas is influenced by different conditions, you can make certain comparisons and can draw certain conclusions from the results of these tests if the conditions in your area are not too dissimilar to the conditions in my area.

CATV Comes to Cape Kennedy. Before CATV came into this area, it undoubtedly had some of the world's worst TV reception. A combination of salt spray, corrosion, dependence upon extended ground wave reception, and (suspected) interference from military equipment made reception vary from good to frequently bad—even though three of the so-called local stations were less than 70 miles but more than 50 miles away. A few DX hounds received four additional channels (108 to 117 miles away) by using high-gain antennas, preamplifiers, and rotors.

Not surprisingly, when CATV began signing up subscribers, the response was immediate. Within a matter of weeks, most of the people in the area were committed. It took several months to get all of the homes hooked up. The demand was so great that city officials pressured the cable company for earlier hookups.

The cable brought in Channels 6 and 9 from Orlando (about 58 miles), Channel 2 from Orange City (70 miles) and Channels 3, 8 and 13 from Tampa (about 117 miles) plus a music-time-weather channel, all of them with good to excellent quality. The occasional outages, or inter-

ference, caused by equipment failure and the process of hooking up new viewers, did not occur often enough to annoy most viewers.

Under such conditions, it didn't seem feasible to try to compete with CATV, but on the other hand, at \$5 a month, CATV comes to \$60 a year. Perhaps this sum isn't great enough to warrant an individual antenna setup, but after a few years, depending upon the initial cost of the antenna, there could be some savings by not going the CATV route.

Antenna Height. The first consideration was antenna height. Because of the low elevation, the antenna would have

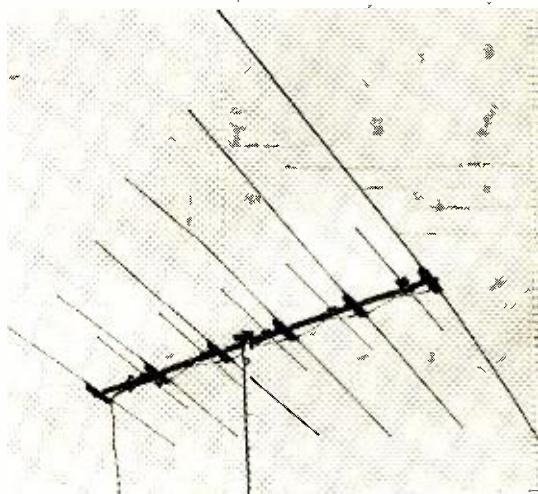

Hardly a fair comparison, but in keeping with a "worst-case" type of test, this 10'-high, 11-element antenna did bring in channels 60 and 70 miles away with results judged to be "about" satisfactory.

to be about 200 feet high in order to establish line-of-sight contact with the "nearby" stations. Obviously, this was out of the question, and there was no point in computing the height needed for the distant stations.

A leading antenna manufacturer recommended that I put the antenna up at least 100 feet. But even this height was impractical for me, and I decided to work with a 10-foot mast. (The local CATV antennas are 350 feet high.) The "worst-case" type of test was made at this low height.

In keeping with the "worst-case" phi-



Free-of-snow picture obtained with CATV. The decision to go CATV may be based upon additional channels received rather than picture quality alone.



Home antenna installation brought in satisfactory picture quality from Channels 2, 6, and 9. A mast-mounted amplifier could eliminate most of the snow.

losophy, I used the existing 11-element antenna, without an amplifier. The accompanying table shows transmitter antenna height and distance from my home, as well as the signal strength readings obtained with a field strength meter.

Evaluating Results. Signal strength meter readings are relative indicators and do not necessarily reveal picture quality. Much depends upon how free the signal is from ghosts and other interference and the sensitivity of the TV set. Readings of about 90 to 100 μV were judged to provide usable but snowy pictures.

Reception on the three "local" channels with my old antenna was just about satisfactory. A quick switch, using an

antenna "clothes pin" connector, to the CATV cable, brought in excellent pictures on all channels.

The difference in signal quality for the local channels was judged by me not to be worth the difference in cost (the approximately \$60 one-time cost of installing an antenna system that would probably last at least 5 years versus \$60 per year for the cable). On the three distant channels, the home system produced nothing but snow.

The question now was, "Is it worth \$5 per month to me to receive the three distant channels?" Two of the three channels essentially duplicated the programs that the local channels were providing. But the third channel is an educational

TV CHANNELS RECEIVED IN THE CAPE KENNEDY AREA

Call-Sign	Channel	Distance (miles)	TV-Transmitter Antenna Height (feet above sea level)	CATV Cable (μV across 75 ohms)	11-Element Antenna (μV)
WESH-TV	2	70	1030	1250	110
WEDU	3	117	not on air during tests		
WPTV	5	108	1040	950	not measured
WDBO-TV	6	58	690	900	100
WFLA-TV	8	117	1130	650	too weak
WFTV	9	58	750	700	90
WTVT	13	117	870	600	too weak

station which by itself, in my opinion, is worth the monthly payments.

Points to Consider. It's what you get for the money that counts. Convenience is important, too. If you are fortunate to have neighbors who have already gone the CATV route, you should be able to profit from their experience. However, listed here are a few of the things to consider before going CATV.

How Many New Programs Will You Receive? Just because the cable offers X number of channels does not mean that you will receive X number of different programs. Many of the programs could be duplicates. If you live near the edge of a time zone, the cable may offer you the same program at two different times, which can be important to you.

Type of Antenna Installation Needed

to Match CATV Coverage. Determine exactly which channels you want to receive. Plot their position on a road map to determine distance and direction. Aim for the transmitters, not the studios. Reception from different directions may require more than one antenna, or a rotor.

A rotor may not be desirable if you dislike adjusting the thing every time you change channels. (After all, you don't have this bother with CATV.) Then, too, a single antenna with a rotor doesn't allow you to compensate for differences between strong and weak signals. (CATV usually attempts to give you 1000 μ V across 75 ohms on *each* channel \pm a few hundred μ V.) On the other hand, the use of more than one single-channel antenna requires a mixer to feed a single lead-in.

Antenna Gain and Terrain. Even with very high gain antennas, you shouldn't try to pick up stations more than 120-130 miles away. (A thousand people will probably write in to say that they consistently receive stations 200 miles away.) Terrain and elevation obviously affect maximum usable distance.

To receive distant stations, you will need a tall antenna mount and a high-gain preamplifier. Usually, the higher the antenna the better, but antenna masts higher than 40 feet can become architectural monstrosities, cause bad neighbor relations, and in some cases require aircraft-warning lights.

Signal Strength. You may need a preamplifier. To determine how much gain your preamplifier should have, try to borrow or rent a TV field-strength meter from a TV shop. (They're scarce; you may have to call several shops.) Measure the weakest signal and work from there. A 100- μ V signal, for example, would require a voltage multiplication of 10 to bring it up to CATV standards.

Other Factors. If you are bothered by local interference, you may have to use low-loss coax or shielded twin lead. In comparing costs, allow for depreciation of your equipment. And take into consideration possible wind damage. Also consider the reliability and financial responsibility of the CATV operators.

The extra time-weather-music channel is another selling point for CATV, but the common radio is not obsolete. The decision as to whether or not to pay the toll is for you to make.

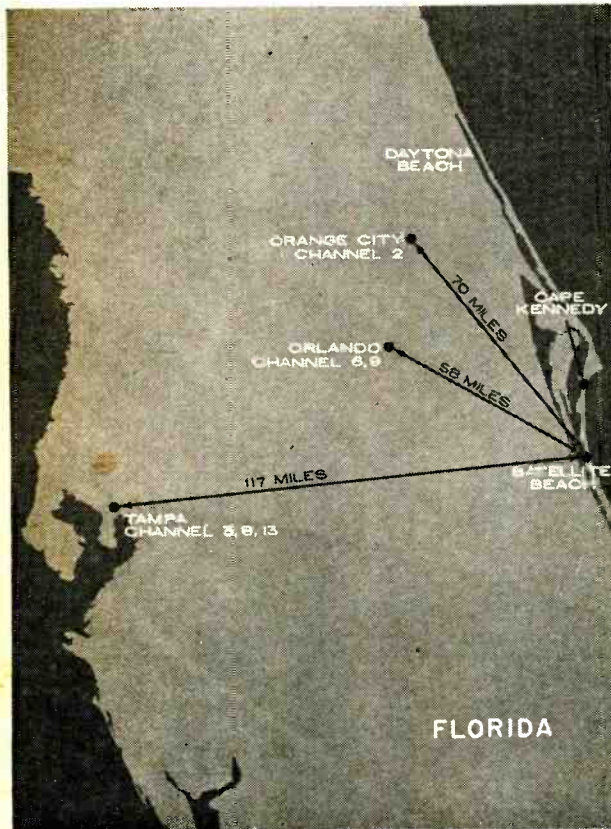

Reception in Satellite Beach, Fla., was about as bad as it could be before CATV was installed. Map shows approximate distance signals had to travel.



INFORMATION CENTRAL

By CHARLES J. SCHAUERS, W6QLV

READERS who have problems concerning things electronic are cordially invited to consult *Information Central* about them. Those questions deemed to be of greatest interest to the greatest number of people will be answered in this column; others will be answered directly. Send your questions to Information Central, 1/6 POPULAR ELECTRONICS, One Park Avenue, New York, N. Y. 10016.

CB Microphone Damage. *How come I am always replacing the microphone on my mobile CB rig? It is the crystal mike recommended by the manufacturer, but I have had to replace it three times in three years.*

Crystal microphones can be damaged by summertime temperatures in a closed automobile, and by being dropped. Never leave a crystal microphone on the car seat or in the glove compartment, or subject it to rough treatment. Dynamic-type microphones are more tolerant of heat and shock.

100-kHz Crystal Calibrator. *I want to build a simple tube-type 100-kHz crystal calibrator. If possible, it should not contain any hard-to-get components and critical tuned circuits. Can you help me?*

About the simplest type of calibrator circuit you can put together is shown in the

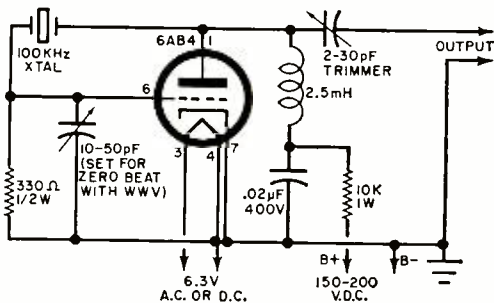

accompanying diagram. Besides satisfying the requirements you set forth, this circuit will give you a hefty signal. The 6AB4 tube does a good job, but almost any triode tube can be used instead: To operate, plug in a 100-kHz crystal and connect the output of the calibrator to the antenna input of your receiver.

Good Final Amplifier Tube. *I have heard that some of the new beam tetrode trans-*

mitting tubes have good linearity, low third-order distortion, and can easily produce 100 watts PEP in an SSB rig. Which one would you recommend for a linear final amplifier that I am building?

Personally, I would try the Amperex 8579. This particular tube has very low drive requirements and excellent linearity. It sells for about \$23. If you decide to use it in a Class C amplifier, you can expect to get about 110 watts output with 600 volts on the plate.

A.C. Hum in Old Receivers. *A neighbor gave me a 1940-style communications receiver. It is in mint condition so far as appearance goes, and it works fine except for a constant loud hum. What could be causing this hum?*

Any receiver this old probably has defunct wet electrolytic capacitors in the power supply. These capacitors dry out and should be replaced. Try replacing all of the large value electrolytic capacitors in the power supply with the newer dry types.

Smoke Signals. *When I moved to a new location, put up a new 3-band dipole antenna, and fired up my ham transceiver, something began to smoke in the final power amplifier compartment. What do you think is wrong? The unit was working well before I moved.*

Look for burned or scorched parasitic resistors in series with the plate leads to the final amplifier tubes. Also, get out your instruction book and see what it says about neutralization. It sounds to me as though your new antenna might not match your power amplifier, and this mismatch is what's cooking your components.

Crystal Checker. *I have a collection of 27-MHz third-overtone crystals. Is there some simple method of checking these crystals for accuracy and activity?*

If your CB rig has an S-meter, you should be able to use the circuit in the accompanying diagram to help you judge both crystal activity and frequency accuracy. The transistor can be any one of the following: 2N384, 2N1225, 2N1285, or 2N1396. The coil is a slug-tuned form on which 13 turns of No. 20 enamel wire are arc-wound. The

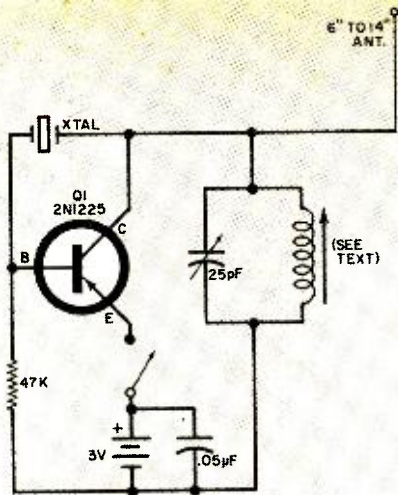

value of the resistor must be adjusted to suit the transistor—try a nominal value of 47,000 ohms; it will never be less than 10,000 ohms and rarely more than 75,000 ohms.

To use the checker, merely plug the crystal into the socket, set the receiver to the operating frequency of the crystal, and tune the trimmer capacitor for maximum S-meter reading. It is usually unnecessary to retune the trimmer for other crystals within the 27-MHz CB band. There is no danger of interference with other CB stations. How well you can judge the crystal accuracy depends upon the accuracy of the receiver's calibration. Also, S-meter readings are relative, but you will be able to predict which crystals are more active than others.

Humdinger. *The doorbell transformer mounted over the door in our kitchen hums. I didn't know these things ever went bad. What can I do about it?*

Generally speaking, these transformers have a life span of 15-20 years or more. I would suggest you replace loose screws and dried-out shock mounts if they are used. If this doesn't help, your best bet is to replace the transformer with a new one. Bell-ringing transformers are inexpensive.

Increased CB Talk Power. *Isn't there some sort of a gadget I can connect between my microphone and CB transceiver for greater talk power? I don't want to make my own, but would prefer to buy one—if the price were reasonable.*

Until the FCC changes its CB regulations, you can still add a speech amplifier/compressor between your microphone and CB transceiver. However, at least one-third of the CB transceivers sold have some sort of modulation clipping circuit already in-

stalled; adding another one on the outside won't help matters. Also, some speech amplifiers are just that and contain no provisions to limit modulation excursions; these are devices that work fine within limits, but also produce some of the worst splattering on the CB channels. One unit that you might consider buying is sold by Allied Radio as the Knight Compressor/Pre-amp (Catalog No. 17 A 6204).

CRT Shield. *I built a simple scope using surplus components. It works, but not properly. Focusing is difficult and so is pattern centering. When I pass a screwdriver near the tube, the pattern changes. What can I do?*

If you didn't put a Mu-metal shield (Millen makes them) around the tube, do so. This may eliminate your trouble. Also, check the d.c. voltage variations for proper range as you adjust the focusing and centering controls. You may have to adjust resistor values to obtain proper operation with the power supply you are using.

BFO For S.W. Receivers. *I would like to receive the International Morse Code transmissions on my all-band short-wave receiver. I am studying for my ham license and I need the practice. Can you assist me?*

The simple BFO (beat frequency oscillator) in the accompanying diagram is for a set having an i.f. of about 455 kHz. Coil L1 can be either the primary or the second-

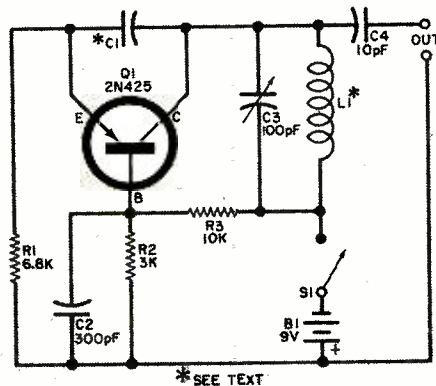

ary winding of a small 455-kHz transistor-type i.f. transformer. Capacitor C1 is a gimmick made of two 1-inch pieces of No. 20 cotton-covered wire twisted together. You can try a small 25-pF capacitor instead of the gimmick, if you wish. The leads should be twisted just enough to furnish a small amount of feedback and stable operation.

In operation, tune the small 100-pF variable capacitor (C3) to get a beat note with the code signals you pick up. Adjust it for

a desirable tone. Transistor Q1 is a 2N425 or similar type.

Place a lead from the 10-pF coupling capacitor (C4) near the receiver's antenna. If the BFO signal is not strong enough, increase the size of C4 or try a direct connection to the receiver's antenna input.

Substitute for 1LE3 Tube? *I own an old Zenith short-wave radio and my main problem is getting a replacement for one of the tubes. The tube is a 1LE3.*

If this question looks familiar to you, it should. We ran it in the April issue, and advised the writer that the 1LE3 tube was probably not available anywhere in the United States. A number of readers have written in since then telling us where this tube can be obtained. According to the mail received, the following companies carry 1LE3's: Arcturus Electronics Corp., 502 22nd St., Union City, N.J. 07087; Electro-Alarm Safety Devices, 745 N. Pleasant Ave., Fresno, Calif. 93728; Steinmetz Electronics, 7519 Maplewood Ave., Hammond, Ind. 46324; and United Radio Co., 56 Ferry St., Newark,

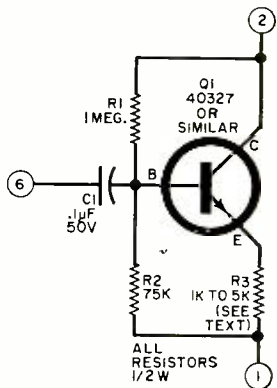

N.J. 07105. In addition, one of our readers has submitted the accompanying diagram for converting the circuit to eliminate the use of the 1LE3.

Shake Well Before Using. *Lately my black-and-white TV has been sounding off with a very high-pitched whistle. When I shake the set, the whistle disappears for awhile and then comes back. Can you help me find the trouble?*

The high-pitched whistle you hear is probably coming from the vicinity of the horizontal output transformer. If high voltage is leaking or if something on the transformer is vibrating, you may be able to pinpoint the trouble by a visual inspection or by doing some very careful listening. Tighten the transformer mount if it's loose, check lead dress, and use corona dope where needed. If broken-down insulation of high-voltage

leads or other components are causing your trouble, you may have no choice but to replace the noise-makers.

HE-45 Drift. *I own an HE-45 transceiver and am troubled by frequency drift. Is there any way I can reduce this drift?*

Try replacing the 15-pF temperature-compensated capacitor located on the rear of the receiver tuning capacitor with one of the same value. Use a zero coefficient capacitor.

Noise Generator. *When I turn on one of the hotplates on my electric stove in the kitchen, both the TV and the radio become loaded down with noise. What's wrong?*

The heating element in the plate may not be insulated properly, or you may have a defective switch.

TV and FM Antennas. *Can you refer me to an article or a booklet on the installation and maintenance of TV/FM antennas? I do not want a mathematical treatise, but do want to find out, for example (and especially), what the characteristics of UHF antennas are.*

Get a copy of the *Installation and Servicing Handbook* available from the Ziff-Davis Service Division, 595 Broadway, New York, N.Y. 10012, for \$1.40. In it you will find what you are looking for and more. Be sure to ask for the 1967 Handbook.

"Drugstore" Tube Testers. *I have been told that the tube testers in drugstores and supermarkets have been designed to sell tubes, period. Is this so? What kind of testers are they?*

Most check for emission and shorts. In this regard, they are similar in type to those used by servicemen. The problem is not so much with the tube tester as it is with the people making the tests. Knowing how to interpret and evaluate the readings is most important. However, not all tube testers are good. It's pretty hard to beat tube substitution right in your own set; but then you would have to buy more tubes anyway, and you still have to know what you are doing.

Choke Problem. *I have seen a power supply filter choke in the ground or minus leg. Why so? Shouldn't it be on the plus side?*

Actually it doesn't make any difference which leg has the filters. Much depends upon the design and layout of the equipment.

Tape Head Life. *How can I increase the life of the heads on my tape recorder?*

Keep 'em clean and use good tape. Don't let the tape come in contact with the heads when rewinding.



AMATEUR RADIO

By **HERB S. BRIER**, W9EGQ
Amateur Radio Editor

AMATEUR RADIO HAS A FIELD DAY

JUNE 24 and 25 are the dates for the annual United States and Canadian Radio Amateur "Field Day," probably the most important event of the amateur year—at least from a public relations standpoint—and many amateurs consider it the most enjoyable. Field Day demonstrates to the public the willingness and the ability of radio amateurs to furnish emergency communications when called upon. At the same time, it affords us the opportunity to test our emergency communications facilities under conditions similar to those faced in many communications emergencies.

Come June 24, amateur clubs, groups, and individuals will set up emergency-powered amateur stations in temporary locations, such as tents, bandstands, fire-ranger huts, or in specially designed communications trailers located in public parks, football fields, forest preserves, and similar localities, to work as many stations as possible in a 24-hour period. The installations will range from simple, one-man, battery-powered units to high-power, multi-station installations powered by gasoline-driven generators and capable of operating simultaneously on several different amateur bands.

Last year's Field Day attracted formal entries from 1339 groups representing 13,600 participants. Considering that a large percentage of those taking part in events of this type never submit their scores, it is safe to



Yolanda, WA9CCP, and Karl, WA9CCQ, Weissshappel are holding the 1966 "Illinois Amateur of the Year Award" received by Yolanda. (For story behind the award, see following page.) Yo and Karl's four daughters automatically head for the radio shack whenever they want their parents. Mom and Pop operate phone, CW, and RTTY with a Hallicrafters HT-37 transmitter and SX-111 receiver, a home-built linear amplifier, and a Navy-surplus RTTY unit.

The Bloomington, Indiana, Radio Club (K9IU) participates in Field Day in style in this communications trailer which the club members built and operate in cooperation with the Bloomington Civil Defense Department. Simultaneous operation of CW, RTTY, and SSB is possible from the trailer.

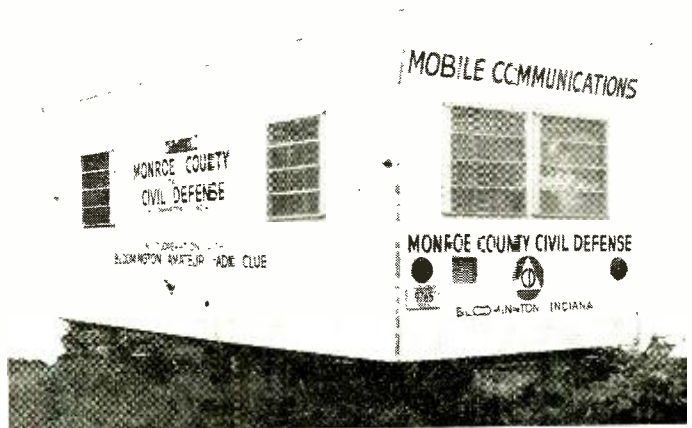

AMATEUR STATION OF THE MONTH

Audrey McRevey, WB6RMX, of Redwood City, Calif., can operate AM, CW, and SSB with her Heathkit DX-100 and SB-10 combination on 80, 40, 20 and 15 meters. But you will usually find her zipping along at about 30 wpm on a homebrew electronic keyer (completed after this picture was taken) on 80 or 40. She receives on a Hallicrafters SX-96. Audrey will get a free one-year subscription for submitting the winner for June in our Amateur Station of the Month photo contest. To enter the contest, send a clear picture of your station with you at the controls and some details on the equipment you use and your ham career to Amateur Radio Photo Contest, c/o Herb S. Brier, P.O. Box 678, Gary, Ind. 46401.

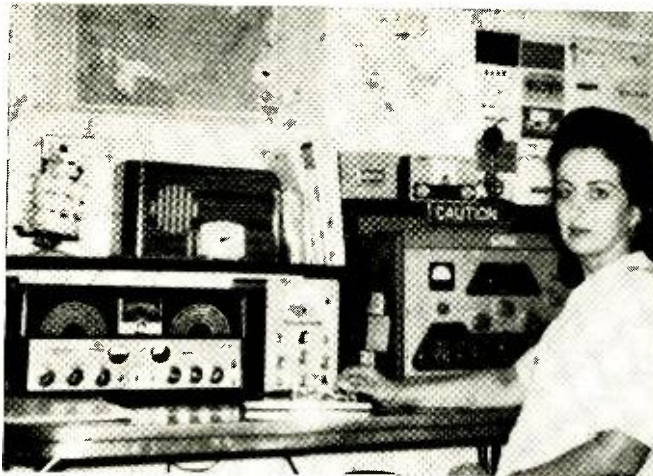

say that the actual participation was much greater than the above figures would indicate. And most of last year's Field Day amateurs will be on hand for this year's event, plus some new ones.

Whether your group is large or small, setting up a self-powered station under emergency conditions and keeping it going for 24 hours is a real challenge and a lot of fun for everyone involved. Furthermore, there is no better way known to generate favorable and well-deserved publicity for your group and amateur radio in general than to take part in Field Day. You don't need elaborate equipment; in fact, the highest scorers usually operate transmitters in

the 30 watts or under class, and only a handful of amateurs use a transmitter power in excess of 150 watts.

Why not write to the American Radio Relay League, Inc., 225 Main St., Newington, Conn. 06111, for Field Day entry blanks and official rules, and start lining up equipment today for your own Field Day participation?

Where Is the Amateur of the Year? Hamfesters Radio Club, Inc., is now soliciting nominations for its annual "Illinois Amateur of the Year Award" to be presented at the 33rd Annual Midwestern Hamfest at Santa Fe Park, near Chicago, on August 13.

Yolanda Weissappel, WA9CCP, of Berwyn, Ill., received the 1966 award in recognition of her still-continuing work in handling messages to and from U.S. personnel in Vietnam and other overseas posts. A member of the Navy Military Affiliate Radio System (MARS), "Yo" spends several hours each day handling the messages on both amateur and MARS nets—for a message total of 13,366 last year! She admits that receiving and passing on so many messages every day is a lot of work, but the joy and relief in the addressee's voice when "Yo" phones a message from a son or husband in Vietnam from whom no word has been heard for weeks makes it a labor of love.

If you have a candidate for the 1967 "Illinois Amateur of the Year Award," send his or her name, call letters, and address, plus the reasons for your nomination to Hamfesters Radio Club, Inc., 6000 South Tripp St., Chicago, Ill. 60629, by July 1, 1967. Include your own name, call letters, and address.

(Continued on page 100)

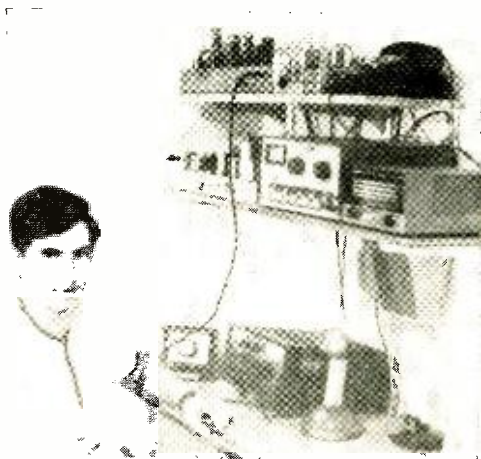

Mel Rabinowitz, WB2MGH, Bronx, N.Y., prefers 15-meter phone and 40-meter CW, but he also operates on 10, 20, and 80 meters. A Drake R-4 handles the receiving, a Heathkit DX-60 the transmitting.



ON THE CITIZENS BAND

By MATT P. SPINELLO, KHC2060, CB Editor

FROM NOW through the month of October hundreds of Citizens Band radio clubs across the United States and Canada will put last winter's plans into effect by sponsoring Citizens Band Jamborees in their areas. Many of the larger hooplas will draw from 5000 to 10,000 participants, with some events claiming guests from nearly every state in the United States and most of the provinces of Canada. Canadian get-togethers will draw a large number of U.S. CB'ers as well.

Most of the events are held primarily to raise funds for club activities, including the purchase of two-way radio equipment, emergency gear and vehicles. Many of the organizations have used their jamboree profits

CB JAMBOREE SEASON

to renovate old buses and trucks and turn them into emergency communications vehicles that can be strategically located as temporary base

stations during emergency activities. A good number of clubs already financially on their feet donate their profits to children's homes, hospitals, and homes for the mentally retarded.

Also, CB jams give people outside the world of communications a close look at what CB is all about: anyone interested in Citizens Band radio need only appear at one of the CB fests to find himself quickly engulfed in gab sessions that involve two-way radio users from hundreds of miles around. In addition, the gatherings enable local CB'ers to exchange licensing, emergency, and operational views with users from many other parts of the country.

Large equipment displays are a main part of every Citizens Band jamboree. Those in attendance can get a close-up view of the latest in CB gear; they can pick up the latest equipment literature, usually supplied for the event by various manufacturers; and they will find that the dealers and distributors who have rented display booths are



Photo courtesy of SCOPE

Aerial view of last year's South Western General Radio Association GRS/CB Campout which was held in Tillsonburg, Ontario, Canada. Over 25 states and five Canadian provinces were represented by the 6000 enthusiasts who attended. Plans for the 1967 event are being arranged to accommodate more than 10,000.



Photo by Jo Katz

Indoors or out, CB Jamboree guests are kept busy with a number of attractions designed to make their visit worthwhile. The group shown here is waiting for the "next performance" of a stage presentation, while seminars, conferences, and a kiddie show are taking place in another part of the same building.

both ready and able to answer any questions, technical or operational.

Since jamborees are designed to lure, enlighten, and entertain the whole family, most events list hefty entertainment schedules. Speeches may be made by FCC officials, CB and amateur technicians, and local authorities. Large stage shows are performed at many events. And prizes are usually given—grand prizes range from CB equipment to color TV receivers. Finally, refreshment committees see to it that absolutely no one goes away hungry!

If you've been thinking of putting CB radio to work for your business or personal

needs but aren't quite sure what it's all about, why don't you attend a CB jamboree this year? The events are usually announced well in advance through newspaper features and sometimes on radio and TV as a public service. Then, too, local electronics distributors are generally aware of what's going on and may have literature you can pick up, or a bulletin posted with the details.

If you're a member of a CB club planning a fest for this season, be sure your publicity people send us the details well in advance so that we can publicize the event in this column. If possible, include a glossy photo of last year's get-together and give us some details on its success. Forward all information to: 1967 OTCB Jamboree Calendar, POPULAR ELECTRONICS, One Park Avenue, New York, N.Y. 10016.

1967 OTCB JAMBOREE CALENDAR

Planning a jamboree, get-together, banquet or picnic? Send the details to: 1967 OTCB Jamboree Calendar, POPULAR ELECTRONICS, One Park Avenue, New York, N.Y. 10016. For more information on the jamborees listed below, contact the clubs or club representatives at the addresses given.

Huntington, W. Va. June 4
Event: 1967 Spring Carnival. Sponsor: 10-4 Radio Club, Inc. Location: Rotary Park. Contact: Midge Whiting, Secretary, 10-4 Radio Club, Inc., Apt. #5, 702½ Washington Ave., Huntington.

Goffstown, N. H. June 11
Event: Carnival '67. Sponsor: Manchester Radio Aid, Inc. Location: CWV Picnic Grounds. Contact: MRA, Box 482, Manchester, N. H.

Hannibal, Mo. June 25
Event: CB Jamboree. Sponsor: Beacon Light Citizens Band Radio Club. Location: Crystal Blue Lake. Contact: John Rethorn, KGI3288, 911 Pine St., Hannibal.

Tillsonburg, Ont., Canada July 1-2
Event: Fourth GRS-CB Campout. Sponsor: South Western General Radio Association. Contact: Gearld Inch, Campout '67 Chairman, 283 Talbot St., St. Thomas, Ont., Canada.

Painesville, Ohio July 29-30
Event: CB Campout and Jamboree. Sponsor: Five Watters of Lake County. Location: Lake County Fairgrounds. Contact: Jamboree, P.O. Box 213, Painesville.

CB Emergencies. Pittsburgh, Pennsylvania's 5-11 Radio Club sent its Emergency Radio Squad into action recently to aid in the search for two lost boys in the Penn Hills section of Pittsburgh. The squad was activated at the request of local authorities at 10 p.m. Equipped with walkie-talkies, the members joined up with the City of Pittsburgh's Canine Corps to search a densely wooded area behind a Penn Hills school. Despite 50-mi/h winds, with gusts to 90 mi/h, the volunteers continued the search until the boys were found safe and sound at approximately 3 a.m.

When an uncle of Nelson Moody, KOR1450, member of an Allied Louisiana Emergency Radio Team (Baton Rouge, La.), was rushed to a hospital under emergency conditions, it was important that Moody be notified immediately. An electronics serviceman, Moody was on a call and out of reach, so Rita Palmer, KOR6249, manned ALERT control and dispatched three mobile units in search of him. Within ten minutes, Moody was located and informed of his uncle's illness.

(Continued on page 114)



SOLID STATE

By LOU GARNER, Semiconductor Editor

WOULD YOU BELIEVE a complete TV camera no bigger than an oversized fountain pen? No? At the moment it is available only in the arsenals of fictional super-spies, but such devices may be just around the corner. A tiny all-solid-state TV camera system is now being developed by Westinghouse Electric Corporation's Aerospace Division (Baltimore, Md.) that includes a phototransistor mosaic, molecular digital logic scanning circuitry, molecular readout amplifiers, and FET readout switches.

The image-sensing mosaic, which serves as the solid-state equivalent of a vidicon (camera) tube, consists of a matrix of *npn* phototransistors on 10-mil centers. The mosaic's sensitivity spans a spectrum from infrared to visible light. As illustrated in Fig. 1, each phototransistor element has a square geometry with discrete emitter and base regions, but with a common collector element for each row of fifty transistors. No connections are made to the base regions, although the emitter electrodes are interconnected with evaporated aluminum strips in fifty isolated columns. The entire matrix is made up of 50 common-collector rows and 50 phototransistors in all.

An image is focused on the mosaic sensor by means of a conventional lens system, and each element exhibits an emitter-collector resistance proportional to the light inten-

sity. Signal readout is from common emitter and collector connections rather than by electron beam scanning.

In order that one element may be read at a time while cutoff is maintained for all other transistors, a voltage is applied to each 50-element row of collector strips and sequentially commutated through the 50 emitter columns. The phototransistor element requires a current amplifier which is capable of furnishing substantial gain over a broad bandpass.

The emitter element readout circuit includes 50 emitter-follower amplifiers that improve camera sensitivity. They also provide a high input impedance for each phototransistor and low output impedance for the following FET switching circuits.

Flip-flop binary logic is used to obtain the sequence of pulses necessary for multiplexing the readout on the mosaic sensor. The logic circuitry provides timing for pulsing the emitter readout switches, for the application of voltage pulses to the collector rows, and for synchronizing the horizontal and vertical sweep generators of the receiver monitor.

With a power consumption of less than 4 watts, the complete camera system—including lens, sensor mosaic, readout switching circuitry, preamplifiers and video mixers—is housed in a cabinet measuring only 6" x 4" x 3 1/2". However, the experimental silicon mosaic sensor is only 1.3 cm square.

Fig. 1. This mosaic sensor with x-y interconnections provides a structure which is compatible with conventional viewing systems that accept x-y data, and yet has a manageable number of leads. Internally diffused strips provide interconnections along the x axis while interconnections along the y axis are formed by vacuum-deposited metal surface bars. Access to any individual element of the mosaic is made through external leads. Only the single element at the intersection of the x-y interconnections is interrogated.

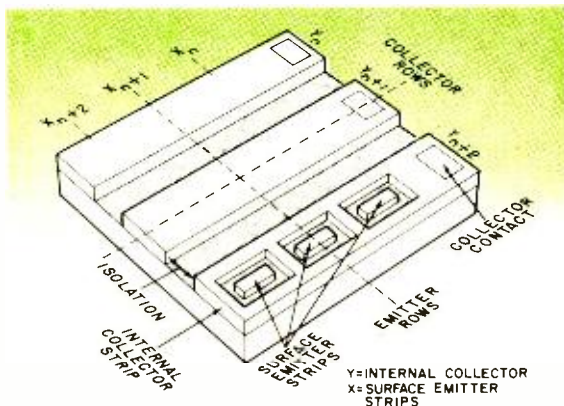
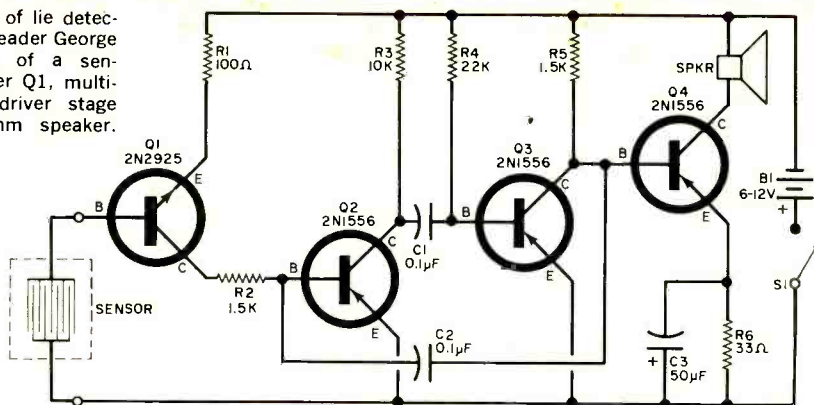

Fig. 2. Schematic of lie detector submitted by reader George J. Beck consists of a sensor, input amplifier Q1, multivibrator Q2-Q3, driver stage Q4 and an 8-ohm speaker.



So watch out! The Candid Camera of the future may be the innocent-looking oversized fountain pen projecting from the interviewer's shirt pocket!

Reader's Circuit. George J. Beck (14 Circle Dr., Bakerstown, Pa. 15007) has suggested a project which, if your subjects are cooperative, could provide a lot of fun at parties. It's the transistorized "lie detector" circuit illustrated in Fig. 2.

In coming up with his design, George has utilized a simple principle: the fact that the electrical conductivity of the human skin changes when one is under emotional stress. Such a stress can occur when you tell a deliberate lie. George's circuit converts these minute changes in skin resistance to a variable-frequency audio signal.

The lie detector consists of a sensor, an input amplifier (Q1), a multivibrator (Q2-Q3), and a speaker driver (Q4). In operation, the sensor is strapped to the palm-side of the subject's wrist, and the resistance across its sensing electrodes provides the operating bias for Q1.

The drop across R2, produced by Q1's collector current, provides the operating bias for Q2, and this bias determines the operating frequency of the multivibrator. Any change in the sensor's resistance, such as would be caused by the subject's attempt to lie, changes the frequency of the multivibrator and thus the pitch of the audio tone produced at the speaker. Operating power is supplied by B1, controlled by S1. The sensor is a two-electrode device with relatively wide contact areas; the type of sensor used for rain or dampness alarm installations should be suitable.

Transistor Q1 is a general-purpose *npn* audio unit such as a 2N2925; Q2, Q3, and Q4 are general-purpose *pnp* power transistors (2N1556's or similar). Although the transistor types are not critical, it may be necessary

for you to change the value of the base bias resistors for optimum performance of the unit if other types are used.

All resistors are half-watters except R6 which is a one-watter. Capacitors C1 and C2 can be small ceramic or tubular paper types, while C3 is a 15-volt electrolytic unit. Any standard PM loudspeaker can be used, but moderate impedance (6-8 ohms) types are preferred. Switch S1 is a s.p.s.t. toggle or slide switch. Battery B1 consists of from four to eight flashlight cells connected in series to furnish the 6-12 volt operating power.

Neither parts layout nor wiring is overly critical so that the individual builder can follow his own preferences when assembling the instrument. A perforated circuit board, printed circuit board, or metal chassis can be used. Since a "factory-built" appearance will add greatly to the psychological impact of the instrument, you may want to mount the circuitry in a sloping-panel cabinet and label it with appropriate decals.

Best results are obtained when a standardized operating technique is followed. Choose the subject (or victim) carefully. He (or she) should be cooperative and not overly nervous. The subject should be isolated from the rest of the group and seated comfortably in a chair.

When attaching the sensor electrodes to the subject's wrist, make them just tight enough to insure good electrical contact, but not tight enough to cause discomfort or to hamper circulation. Then switch on the "detector" and wait until the output tone stabilizes at a more or less constant pitch.

Start the interrogation with general questions such as: What is your name? How much is two plus two? What day is it? Then get more specific. There should be little or no change in tone when the subject answers honestly. An emotional response—a lie—should result in an easily noticed change

in the pitch of the audio tone. Allow the subject a few seconds to think about each question before answering, and allow a reasonable time between questions. Have fun!

Manufacturer's Circuit. The broadband r.f. amplifier circuit in Fig. 3 is one of several experimental circuits described in Application Bulletin 167 put out by the Vari-L Company, Inc. (207 Greenwich Ave., Stamford, Conn. 06904). According to Vari-L, this amplifier can furnish gains of from 8 to 10 dB over a frequency span of 1 to 300 MHz. Having 50-ohm input and output impedances, it can be used as an untuned r.f. booster amplifier in measuring instruments such as field strength meters, or in communications and s.w. receivers, as well as FM and TV receivers with a 50-ohm input impedance.

The circuit consists of a single amplifier stage, with $Q1$ connected in a common-base configuration. Capacitor $C1$ couples $Q1$'s emitter with the input circuit, while $R1$ is the emitter resistor. Inductor $L1$ and the primary of $T1$ comprise the collector load. The base is biased through voltage divider $R2$ - $R3$, and is bypassed by $C2$. Operating power is supplied by $B1$, controlled by $S1$, and bypassed by $C3$.

Although standard components are used in the design, all parts may not be available from your local distributor. Transistor $Q1$ is a Fairchild 2N3563, and $R1$, $R2$ and $R3$ are $\frac{1}{4}$ - or $\frac{1}{2}$ -watt resistors. Capacitor $C1$ is a chip-type (IC) ceramic capacitor, while $C2$ and $C3$ are ceramic feed-through types. Inductor $L1$ is a 0.06- μ H coil with a Q of approximately 50 at 200 MHz. Transformer $T1$ is a Vari-L 50200A "Z-Match" r.f. unit. As shown in Fig. 3, $TS1$ and $TS2$ are 2-terminal connector strips, but 50-ohm coaxial r.f. connectors could be used instead.

As is typical of high-frequency circuits, layout and lead dress are quite critical and signal leads must be kept short and direct. This project is definitely not intended for beginners.

New Developments. The Bendix Corporation (Semiconductor Division, Holmdel, N. J.) has introduced a series of 1-ampere d.c. series regulator modules. Designed for use between an unregulated d.c. source and its load, the modules conform to a standard TO-3 power transistor outline except for height, which is 0.68 inch. Each module contains circuitry equivalent to four transistors, one zener diode, one capacitor and seven resistors. Identified as the BN-4000 series, the regulators come in four models with nominal output ratings of 6, 12, 18 and 24 volts, and list for about \$30.00 each.

A unique piezjunction transistor which can be used as an electromechanical transducer is being produced in experimental quantities by Stow Laboratories, Inc. (Par-ton Rd., Stow, Mass. 01775). Dubbed a Pi-tran (pronounced "pie-tran"), the device is essentially an n pn silicon transistor which has been made sensitive to mechanical stresses. In operation, the device's top cap, which is coupled to the emitter-base junction, serves as a pressure-sensitive diaphragm. When mechanical stress is applied to the cap, the emitter-collector resistance changes. The transistor is suitable for a variety of applications ranging from exotic fluid pressure measuring instruments to simple bathroom scales. Unit price is \$100 at present.

Would you believe a s.p.d.t. electromagnetic relay in a TO-5 transistor case? How about a relay and a transistor amplifier in the same case? You'd better believe it, for such devices are now being produced by Teledyne Relays (3155 W. El Segundo Blvd., Hawthorne, Calif. 90250). Identified as the 415 Series, two models are offered. Model 10012 features an n pn silicon planar transistor amplifier, while Model 20012 incorporates an n -channel FET. These small relay/amplifiers are suitable for applications in remote control systems, display control equipment, logic circuits, computers, and data processing gear.

In what represents a real breakthrough in
(Continued on page 98)

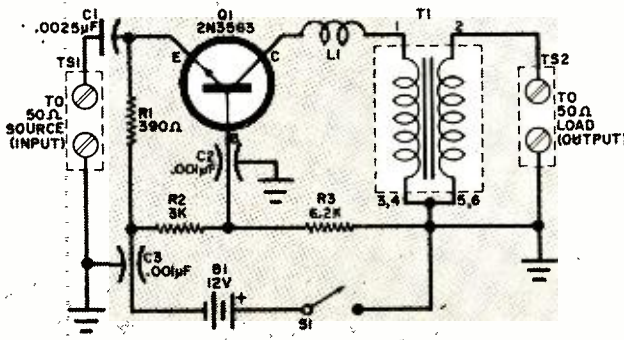

Fig. 3. One of several experimental circuits presented in Vari-L's Application Bulletin 167, this amplifier is said to furnish gains up to 10 dB over a frequency range of 1 to 300 MHz.

ENGLISH-LANGUAGE BROADCASTS TO NORTH AMERICA

FOR THE MONTH OF JUNE

Prepared by **ROBERT LEGGE**

TO EASTERN AND CENTRAL NORTH AMERICA			
TIME—EST	TIME—GMT	STATION AND LOCATION	FREQUENCIES (MHz)
7:15 a.m.	1215	Helsinki, Finland	15.185 (Tues., Sat.)
		Melbourne, Australia	11.71
7:45 a.m.	1245	Copenhagen, Denmark	15.165
6 p.m.	2300	London, England	9.58, 11.78, 15.30
		Moscow, U.S.S.R.	9.665, 11.715, 15.15
6:45 p.m.	2345	Tokyo, Japan	15.135, 17.825
7 p.m.	0000	London, England	9.58, 11.78, 15.30
		Moscow, U.S.S.R.	9.665, 11.715, 15.15
		Peking, China	15.06, 17.68
		Sofia, Bulgaria	9.70
		Tirana, Albania	7.263
7:30 p.m.	0030	Budapest, Hungary	9.833, 11.91, 15.16
		Johannesburg, South Africa	9.675, 11.90
		Kiev, U.S.S.R.	9.665, 11.955
			(Mon., Thurs., Fri.)
		Stockholm, Sweden	11.805
7:50 p.m.	0050	Vatican	7.27, 9.69, 11.76
8 p.m.	0100	Berlin, Germany	9.73, 11.89
		Havana, Cuba	6.17, 11.76
		London, England	7.13, 9.58, 11.78
		Madrid, Spain	6.13, 9.76
		Moscow, U.S.S.R.	9.665, 11.87
		Prague, Czechoslovakia	5.93, 7.345, 9.55, 11.99
		Rome, Italy	11.81, 15.41
8:15 p.m.	0115	Berne, Switzerland	6.12, 9.535, 11.79
8:30 p.m.	0130	Bucharest, Rumania	11.94, 15.25
		Cairo, U.A.R.	9.475
		Cologne, Germany	9.64, 11.945
		Hilversum, Holland	9.59
9 p.m.	0200	Lisbon, Portugal	6.025, 6.185, 9.68
		London, England	7.13, 9.58, 11.78
		Moscow, U.S.S.R.	9.685, 9.70, 11.87
		Stockholm, Sweden	11.805
9:30 p.m.	0230	Beirut, Lebanon	11.76
10 p.m.	0300	Bucharest, Rumania	9.57, 11.94, 15.25
		Budapest, Hungary	9.833, 11.91, 15.16
		Havana, Cuba	6.135, 6.17, 11.76
10:30 p.m.	0330	Prague, Czechoslovakia	6.095, 7.345, 9.55, 11.99
TO WESTERN NORTH AMERICA			
TIME—PST	TIME—GMT	STATION AND LOCATION	FREQUENCIES (MHz)
6 p.m.	0200	Melbourne, Australia	15.32, 17.84
		Tokyo, Japan	15.135, 15.235, 17.825
6:50 p.m.	0250	Taipei, China	15.125, 15.345, 17.72
7 p.m.	0300	Moscow, U.S.S.R.	15.14, 15.18, 17.76
		Peking, China	9.457, 11.82, 15.095
7:30 p.m.	0330	Stockholm, Sweden	11.805
7:45 p.m.	0345	Berlin, Germany	9.65, 11.92
8 p.m.	0400	Sofia, Bulgaria	9.70
8:30 p.m.	0430	Budapest, Hungary	9.833, 11.91, 15.16
8:45 p.m.	0445	Cologne, Germany	9.735, 11.945
9 p.m.	0500	Berne, Switzerland	9.695, 11.715
		Moscow, U.S.S.R.	9.54, 11.755, 11.85



SHORT-WAVE LISTENING

By HANK BENNETT, W2PNA/WPE2ET
Short-Wave Editor

NEW BROADCASTING STATIONS IN CUBA

A REPORT has been received which states that Cuba is constructing six new medium-wave broadcasting stations. The transmitters, purchased from Czechoslovakia, are rated at 150, 60, and 30 kilowatts (two of each). One of the 150-kW units has been installed at San German, near Holquin, and is said to be operating on 600 kHz, a channel reserved for low-power (5000 watts or less) stations. The second of the super-power units is destined to be installed in Havana. The 60-kW stations will reportedly be operating from Santa Clara and Camaguey,

with the remaining two smaller transmitters to be located at Colon and Pinar Del Rio.

Considerable concern is being expressed by some government officials at this latest move in Cuba. It is feared that the Castro regime may place some of the new stations on the so-called "clear channels" (670, 700, 720, 1120, and 1200 kHz, for example), minimizing the long-distance effectiveness of the stations now operating on those channels. Cuba is a signatory to the North American Regional Broadcasting Agreement; however, under the Castro regime, the Cubans have ignored its provisions.

As this issue goes to press, the frequencies on which the other five stations will operate are not known. Monitors are hereby requested to keep an ear open for them, and to check the effective distances covered by the transmitter which is now operating on 600 kHz.

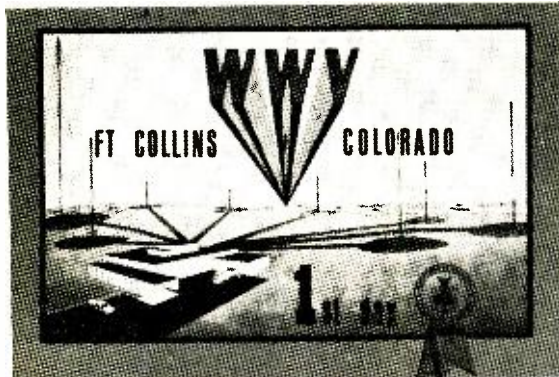

Department of Commerce
NATIONAL BUREAU OF STANDARDS

RADIO STATION WWV
FORT COLLINS, COLORADO

2.5 MHz 40 40 55' N, 105 02 31' W	15 MHz 40 40 45' N, 105 02 25' W
5 MHz 40 40 42' N, 105 02 25' W	20 MHz 40 40 53' N, 105 02 29' W
10 MHz 40 40 48' N, 105 02 25' W	25 MHz 40 40 51' N, 105 02 27' W

This is to confirm your **first day** reception report of WWV.

Leo W. Howe
Engineer in Charge

Complete Descriptions of Services of NBS Radio Stations Given in Miscellaneous Publication 236 Available from Government Printing Office—15c

Front and back of self-explanatory QSL received by Editor O. P. Ferrell. Thousands of "First Day" QSL's were sent out by WWV when the station moved from Maryland to Colorado. Bill Pearl, WPE6GLF, was awarded a special QSL and photo of the site for his unusual reception report (telephone call!).

The Higher Frequencies. The increasing numbers of sunspots are causing the higher frequencies to become far more usable over long periods of time and at much greater distances than during periods of low sunspot activity. DX'ers are currently noting numerous short-wave broadcast stations operating on 13 and 11 meters (the 21- and 25-MHz bands, respectively). And with very careful tuning, especially during daylight hours, various remote pickup units, news cruisers, and relay stations operating between 26 and 30 MHz can be heard.

DX'ers who have equipment that will tune up to around 45 MHz should keep a close watch for several European TV stations, particularly in England and France, whose audio outlets operate on 41,250 kHz (France) and 41,500 kHz (England). Your Short-Wave Editor has personally tuned in both of the latter stations with very little antenna and good reception. But it requires patience; those very high frequency signals don't come in as easily as regular broadcast station signals because of the ever-changing propagation conditions. We suggest tuning from mid-morning to early afternoon (your local time).

(Continued on page 107)

TWO-LETTER QUIZ

By **ROBERT P. BALIN**

Common technical and scientific terms are usually contracted or abbreviated sooner or later by the trade. For example, microphone has become "mike"; magnetron has become "maggie;" printed circuit board is "PC" board; signal-to-noise ratio appears as S/N; etc. Also, letter symbols are used extensively. As an electronics enthusiast, you should have little difficulty associating the abbreviations or symbols (1-10) at right with the illustrations (A-J) below.

(Answers appear on page 106)

- 1 AB _____
- 2 B-H _____
- 3 CC _____
- 4 Hg _____
- 5 IM _____
- 6 NC _____
- 7 R-Y _____
- 8 pF _____
- 9 L_M _____
- 10 V_p _____

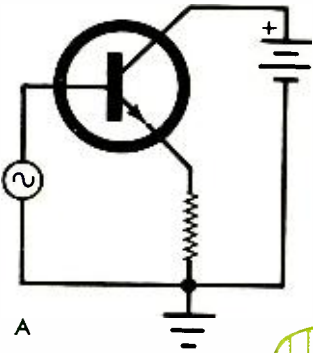

A

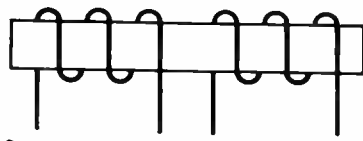

B



C

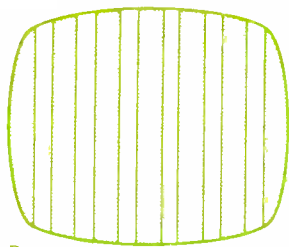

D

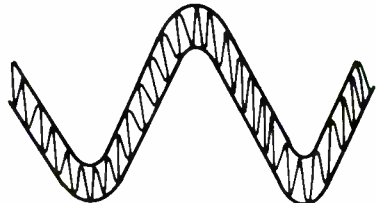

E

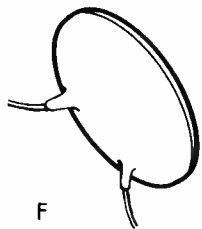

F

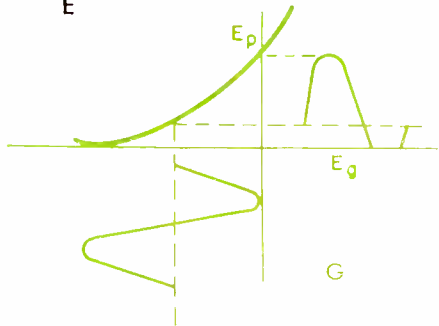

G

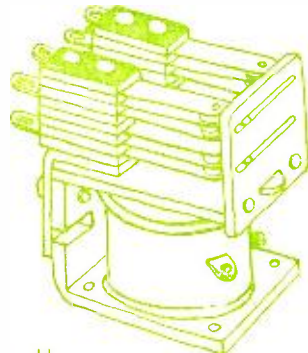

H



I



J

Squires Sanders

23'er

THE CADILLAC OF CB TRANSCEIVERS... has 23 channels of superior transistorized communication. Thirty miles (and greater) range is common. Tailored audio response and double loop AGC provide exceptionally fine intelligibility of all signals (distantly weak or unbearably strong)... reproduces them at virtually uniform and controllable audio intensity.

The exclusive Noise Silencer frees you from anyone's ignition noise. The transmitted signal is a full 5 watts... 100% modulated... it gets your message through. Join the superior communication class... with a 23'er. The price: \$235



S5S

THE WORK HORSE CB TRANSCEIVER... with many Cadillac features. The same long range capability as the 23'er... the same sensitive receiver with the Noise Silencer... a fine transmitter... but for less cost since it operates on just five channels. A most effective transceiver for heavy duty use — school busses, delivery and service vehicles, trucks. The S5S meets all of the FCC type acceptance requirements for business service. The price: \$185.00



COMING SOON — S-5 23. The Modern Miracle in low cost 23 channel transceivers... all silicon transistors... extremely sensitive ($0.1 \mu v$) FET receiver front end... high reliability integrated circuits... attractive styling... very small size... and much more. The price: LOW.



See your dealer for details or write today to SQUIRES-SANDERS, INC., Box 319a, Millington, N. J. 07946
CIRCLE NO. 33 ON READER SERVICE PAGE

PARTS
METHODS
IDEAS
GADGETS
DEVICES

TIPS & TECHNIQUES

ELECTRIC FOOD MIXER DOUBLES AS LIGHT-DUTY DRILL

If you have an old electric food mixer that still has a usable motor, don't sell it to a junk dealer. It can be converted into an electric drill for light-duty work. In most cases it is necessary only to insert an adapter chuck into one of the mixer sockets and tighten a setscrew. However, some mixers do not have setscrews; so you'll have to exercise a little ingenuity in such a case. An adapter chuck that allows larger drills to be used with $\frac{1}{4}$ " drills is the most convenient and inexpensive type. Many hardware stores sell imported chucks for about 98 cents. The mixer-cum-drill can then be used to drill holes in metal chassis or woodwork. You can also take advantage of the variable speeds available on this type of mixer.



—Art Trauffer

PLIERS MAKE SHORT-ORDER WORK OF STRIPPING INSULATION FROM WIRE IN A PINCH

Trying to wiggle a pair of diagonal cutters into a tight area to strip the insulation from a wire while at the same time trying to avoid damaging nearby components can be a frustrating experience. Here's a tried-and-true method for stripping plastic or shellacked-cotton insulations from solid wires (it seems to be a flop on stranded wires). You simply crush the insulation in the jaws of a pair of pliers. Then you can easily snip away the split insulation from the undamaged wire. Incidentally, this technique is one way of dealing with stubborn "space age" Teflon insulation.

—Winston Tharp

STEREO AMPLIFIER CAN BE MADE TO LISTEN TO ITS OWN TROUBLES

If you lose sound or hear distortion from only one channel in your stereo amplifier, you can use the other channel as a signal tracer to help you locate the trouble. All

you need is a 0.01- μ F capacitor, a short length of wire, and a couple of alligator clips. See drawing for hookup. Feed a sound program into the defective channel only from your record player or tuner, and connect the capacitive coupler to similar points in both channels. For example, the signal at the input of the second stage in the defective channel is fed to the input of the second stage



in the good channel. If you hear a clean sound, go on to the next stage towards the speaker end. If the signal is not getting through or is distorted, work towards the amplifier's input. A simple time-saving technique is to make your first check point in the central part of the amplifier and then work towards the defective end. Signal injection procedures can also be followed with this probe.

—Homer L. Davidson

ADHESIVE-BACKED RUBBER FEET ELIMINATE DRILL WORK

You have to drill holes through a cabinet to mount many types of rubber feet. "Bumper Buttons," such as are available from the 3M Company, eliminate the drilling and the nuts and bolts. These synthetic rubber "buttons" come in brown and ivory colors, in large and small sizes, and are dressed with a self-sticking adhesive coating. All you do is peel away a protective backing and stick the "buttons" onto the chassis or cabinet bottom.

—Bill Ruck

UPSIDE-DOWN SOLDERING TECHNIQUE KEEPS PLUG TIPS CLEAN

One way to prevent short circuits between the inner conductor and the shield of an audio cable and to keep solder from building up in the phono plug's tip is to pre-tin the inside of the tip, and hold the plug upside down when you apply the heat. You can do all this with the aid of a piece of scrap phenolic board or thin piece of wood.



Drill a $\frac{1}{8}$ "-diameter hole in the board to hold the plug. Feed the solder into the plug's tip and apply heat to the end of the tip only. Allow a little solder to flow into the tip,

then insert the inner conductor of the lead. The lead should be prepared and tinned beforehand. Do not use any more heat than needed to just melt the solder. Solder the cable shield to the outer conductor in the usual manner.

—D. Peterson

Help stamp out blue people

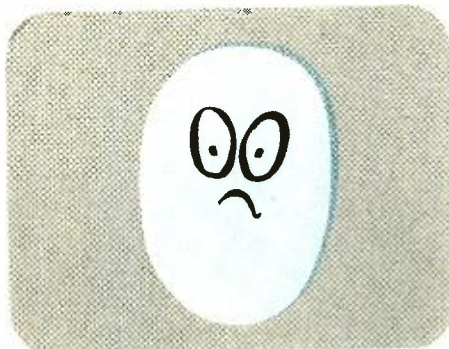

Focus on Jerrold Paralog Plus™ Coloraxial Antennas for true color

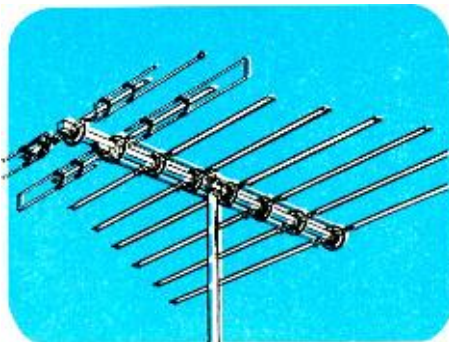

Jerrold Paralog Plus Antennas show a definite improvement in the sharpness, fidelity and color stability of the image on any TV set. Sharp directivity, uniform response and perfect matching see to that! And the rugged construction insures that the quality stays high—not for months—but for years. It's the high-gain Coloraxial antenna for people who insist on VHF and FM reception—without compromise. And there are seven models to choose from.

The Paralog Plus is one of a complete spec-

trum of problem-solving Jerrold TV reception aids—Pathfinder, VUfinder and Colorpeak antennas . . . Powermate pre-amplifiers, amplified-couplers and splitters . . . Coloraxial cable, wall outlets and wall plates. See your Jerrold distributor today. Catalog available on request.



Focusing on one thing—better reception

CIRCLE NO. 18 ON READER SERVICE PAGE

TAKE THE FIRST BIG STEP TOWARD A REWARDING CAREER IN ELECTRONICS

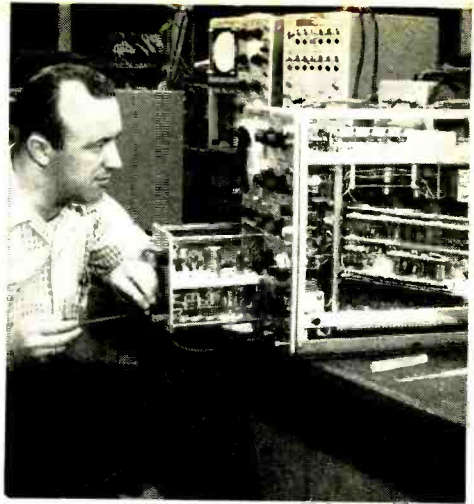

Mail card to RCA Institutes today

**Thousands of well paid jobs for
Electronics Technicians are
unfilled now**

***RCA Institutes Can Train You—
At Home—And Help You Qualify
For This Work***

It's a sad, but true, fact that today, with so many men yearning for better jobs and better incomes, thousands of well paid jobs are unfilled in the vast electronics industry.

Many of the men who could fill these jobs — that is, men with the aptitude and native interest to enjoy a career in electronics—are handicapped because for one reason or another they have not had the opportunity to train themselves for these lucrative positions.

NOW— THANKS TO RCA INSTITUTES HOME STUDY— YOU CAN TRAIN FOR A CAREER IN ELECTRONICS

Realizing that thousands of technical jobs—well paid jobs—in electronics are going unfilled each week, RCA Institutes has done something positive about the problem. To benefit the electronics industry, with its crying need for trained men . . . and to help men who really want to move into a well paid electronics job, RCA Institutes offers an ideal home training program!

HOME STUDY CAN PROVIDE CAREER OPPORTUNITIES!

To help meet the need for qualified men in the electronics field, RCA Institutes has created a wide variety of Home Training Courses, all aimed toward a profitable, exciting electronics career in the shortest possible time. Included are exclusive "Career Programs" designed to train you quickly for the job you want! Your study program is supervised by RCA Institutes experts who work with you, help guide you over any "rough spots" that may develop along the way.

OFF TO A FLYING START WITH AMAZING RCA "AUTOTEXT" METHOD

Each "Career Program" starts with the amazing "AUTOTEXT" Programmed Instruction Method — the new, faster way that's almost automatic! "AUTOTEXT" helps even those who have had trouble with conventional learning methods in the

past. It is truly the "Space Age" way to learn everything you need to know with the least amount of time and effort.

RCA INSTITUTES ENGINEERED KITS SPEED YOUR PROGRESS

To speed you on your way to a successful electronics career, your "Career Program" will include a variety of RCA Institutes engineered kits at no extra cost—each complete in itself. As a bonus, you will also receive and build a valuable Oscilloscope. You'll get the new Programmed Electronics Breadboard for limitless experiments, including building a working signal generator and a fully transistorized superheterodyne AM receiver and Multimeter.

CHOOSE YOUR CAREER PROGRAM NOW

To get a head start today on the electronics career of your choice, look over this list of RCA Institutes "Career Programs", pick the one that appeals most to you, and check it off on the attached card:

- Television Servicing
- Telecommunications
- FCC License Preparation
- Automation Electronics
- Automatic Controls
- Digital Techniques
- Industrial Electronics
- Nuclear Instrumentation
- Solid State Electronics
- Electronics Drafting

To meet other specific needs, RCA Institutes also offers a wide variety of separate courses which may be taken separately from the "Career Programs". These range from Electronics Fundamentals to Computer Programming. They are described in the material you receive.

ADVANCED TRAINING TOO

If you are already working in electronics or have some experience but want to move on up, you may start RCA Institutes training at an advanced level. No tedious repetition of work you already know!

UNIQUE TUITION PLAN

With RCA Institutes, you learn at your own pace, and you pay only as you learn. There are no long term contracts to sign . . . no staggering down-payments to lose if you decide to stop . . . no badgering bills. You pay for lessons only as you order them, and should you decide to interrupt your training at any point, you may do so and not owe one cent.

CLASSROOM TRAINING AVAILABLE

RCA Institutes Resident School is one of the largest schools of its kind in New York City with classroom and laboratory training available in day or evening sessions. Coeducational classes start four times a year. Just check "Classroom Training" on the attached card for more details.

FREE PLACEMENT SERVICE, TOO!

In recent years, 9 out of 10 Resident School students who used the Free Placement Service have been placed before or shortly after graduation. This Service is now available to Home Study students.

**ALL RCA INSTITUTES COURSES
AVAILABLE UNDER NEW GI BILL.**

**SEND ATTACHED POSTAGE PAID
CARD TODAY FOR COMPLETE
INFORMATION. NO OBLIGATION,
NO SALESMAN WILL CALL.**

RCA INSTITUTES Inc. Dept. PE-67
A Service of Radio Corporation of America
350 West 4th Street, New York, N. Y. 10014



The Most Trusted Name in Electronics

INSTALLING THE SYSTEM

(Continued from page 53)

Be On Time. There is just one right time to install the wiring in a house under construction and that is after the electrician has completed the electrical wiring and just before the "sheet-rockers" close up the walls and ceilings. Be on time! "Sheet-rockers" can close up the walls of an eight-room house in less than two days.

You'll need some basic tools: a drill, $\frac{3}{8}$ -inch and $\frac{1}{2}$ -inch wood bits. Go easy on the number of holes you make in any one piece of wood. Even a single hole in some instances is a violation and can weaken a bearing surface enough to cause trouble later on.

Outlets. Nail the outlet box to the wall stud and route each set of wires, for TV, rotor or audio, into the box. A variety of outlets are available. The single TV outlet is the most common; combination types may provide for one or more TV sets, a rotator control, radio, hi-fi, intercom, etc.

Matching plugs may or may not accompany the outlet plates on purchase.

Beware of the two-gang TV outlet plates without a suitable isolation network. Do not parallel the outlets on the single plate and expect to operate two TV's or a TV and FM tuner without

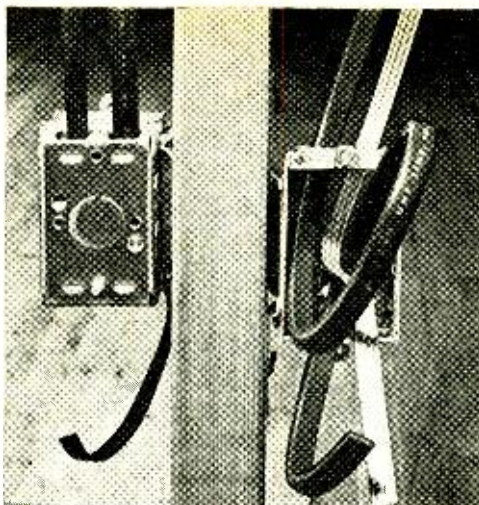

Front-to-back wiring technique is used by electricians to provide outlets to adjacent rooms. Conserve wire by running single downlead, and use a coupler.

some interference. When there is no isolation, performance of one of both sets can be marred.

These outlets can be used with electronically isolated lines feeding each of the taps. It is more economical, if signal strength permits, to use a good two-set coupler to subdivide the available signal from a single outlet.

To use your audio system, any type of matching jack and plug configuration will do. Avoid employing the same type of outlet and plug as used for the 117-

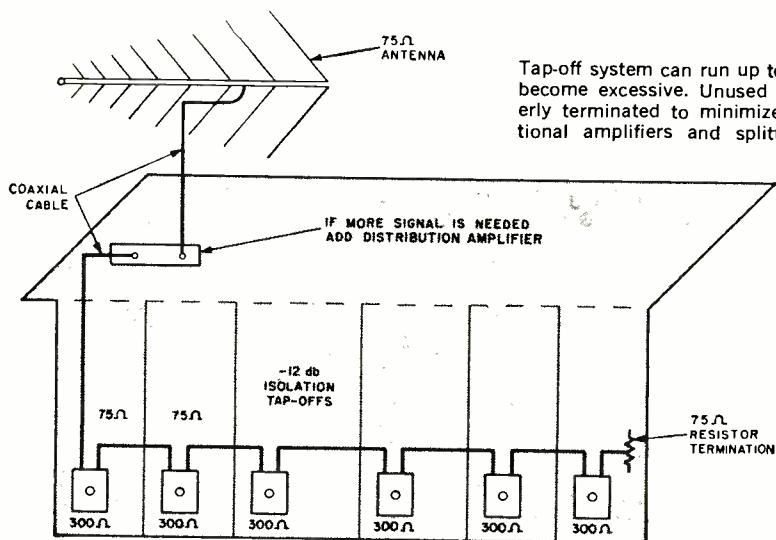

Tap-off system can run up to the point where losses become excessive. Unused outlets should be properly terminated to minimize standing waves. Additional amplifiers and splitters can be employed.

*A new dimension
in solid-state C.B.*

COURIER CLASSIC

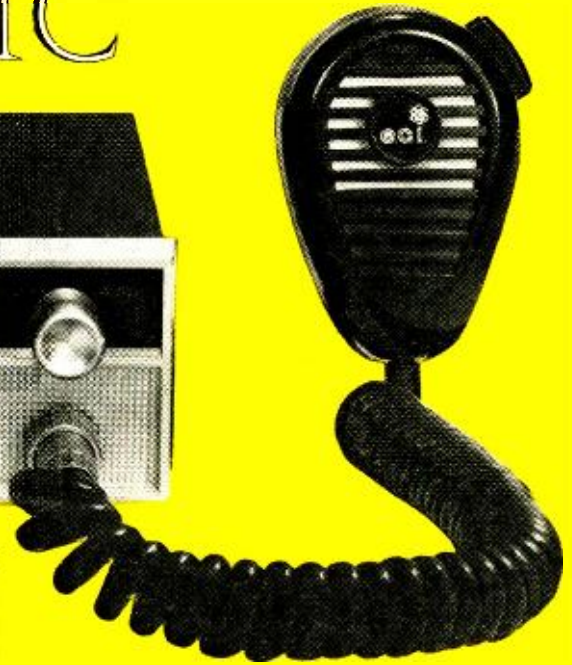
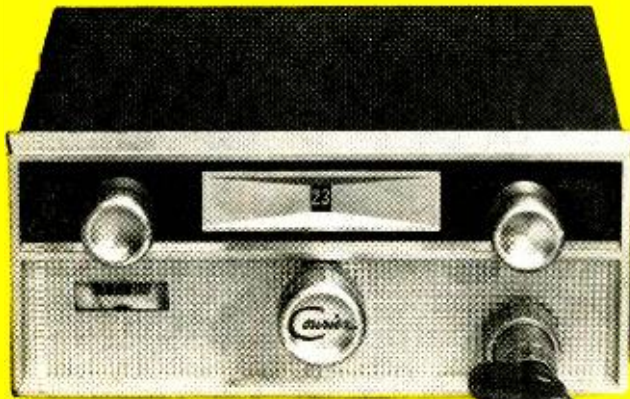

You are looking at the incomparable 23-channel Courier Classic—two years in development. Designed and engineered for total reliability, with years-ahead styling that sets a new standard of comparison. So advanced in performance, it required the creation of several new components by America's leading component manufacturers. With illuminated S meter. Illuminated channel selector. PA system. Auxiliary speaker jack. Single-knob tuning. Modulation indicator. DC cord. Exclusive Courier "Safety Circuit" to protect against mismatched antenna, incorrect polarity, and overload. The first transistor rig designed to help pierce "skip." Every known feature that could be built into a CB rig, in a compact 6½" W x 8½" D x 2½" H. Plus the industry's biggest guarantee—**10 full years!**

Just **\$189**
Complete with crystals
for all 23 channels.

 **COURIER COMMUNICATIONS, INC.**
A Subsidiary of
egi. electronics communications inc.
56 Hamilton Avenue, White Plains, New York

Yes! Tell me all about the new Courier Classic.

Name _____

Address _____

City _____ County _____

State _____ Zip _____



Popular SAMS BOOKS

USE THIS HANDY ORDER FORM

<input type="checkbox"/>	Citizens Band Radio Handbook, New Ed. 20101	\$3.50
<input type="checkbox"/>	2nd-Class Radiotelephone License Handbook, 20316	4.75
<input type="checkbox"/>	101 Ways to Use Your VOM & VTVM, New Ed. 20510	2.95
<input type="checkbox"/>	101 Ways to Use Your Oscilloscope, New Ed. 20416	2.95
<input type="checkbox"/>	How to Read Schematic Diagrams, 20337	2.25
<input type="checkbox"/>	Tape Recorders—How They Work, New Ed. 20445	3.95
<input type="checkbox"/>	TV Servicing Guide by Symptoms, 20361	2.50
<input type="checkbox"/>	Color TV Servicing Made Easy, Vol. 2, 20523	4.50
<input type="checkbox"/>	Color TV Training Manual, Rev. 20472	5.95
<input type="checkbox"/>	Color TV Trouble Clues, Vol. 2, 20121	2.25
<input type="checkbox"/>	Color TV Servicing Guide, 20358	3.95
<input type="checkbox"/>	Transistor Ignition Systems Handbook, 20238	2.95
<input type="checkbox"/>	Transistor Radio Servicing Made Easy, 20442	2.95
<input type="checkbox"/>	Transistor Specifications Manual, Rev. 20553	2.95
<input type="checkbox"/>	Tube Substitution Handbook, 10th Ed. 20534	1.75
<input type="checkbox"/>	Transistor Substitution Handbook, 7th Ed. 20529	1.75

FAMOUS ABC'S BOOKS

<input type="checkbox"/>	Lasers & Masers, 20262	\$2.25	<input type="checkbox"/>	Computers, 20012	\$2.50
<input type="checkbox"/>	Tape Recording, 20395	1.50	<input type="checkbox"/>	CB Radio, 20019	2.25
<input type="checkbox"/>	Transistors, 20440	2.25	<input type="checkbox"/>	Modern Radio, 20047	1.95

— HOWARD W. SAMS & CO., INC. —

Order from any Electronic Parts Distributor, or mail to Howard W. Sams & Co., Inc., Dept. PE-6 4300 W. 62nd St., Indianapolis, Ind. 46268

Send books checked above. \$ _____ enclosed.

Send FREE Sams Book Catalog.

Name _____
PLEASE PRINT

Address _____

City _____ State _____ Zip _____

CIRCLE NO. 30 ON READER SERVICE PAGE

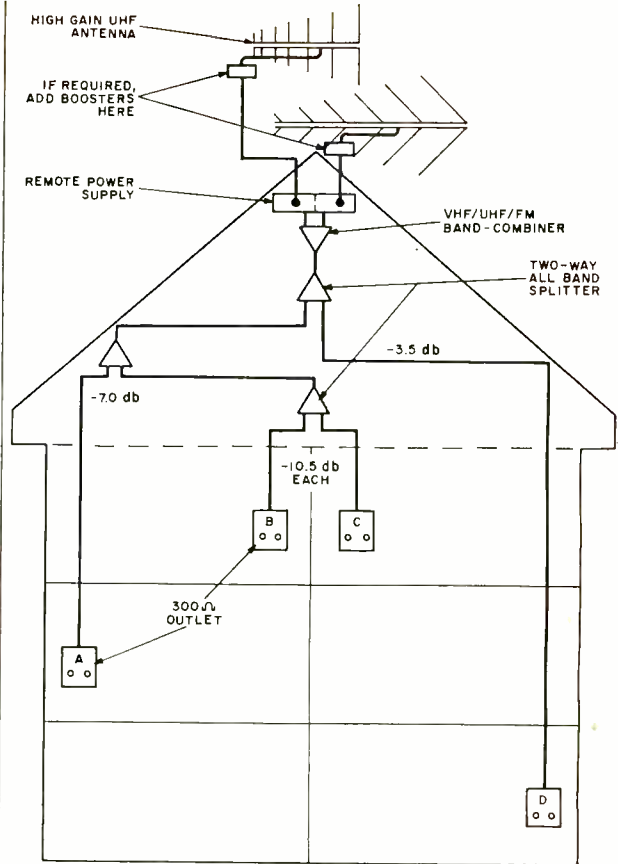

Balancing a system for proper distribution of signal strength is not difficult. Outlet D, being at the end of a long run, can be tapped off near the head end and be fired with about 50% of the total signal, whereas the line feeding outlets B and C receives only about 10% of the total signal yet delivers essentially the same amount of signal to the TV set as outlet D. How much signal you need depends upon the system's losses. Work with dB's.

volt a.c. power line to prevent someone from plugging an extension speaker into the power line.

If you choose a 75-ohm coax system, your outlets must be either the feed-through or tap-off type. Some types provide 75-ohm to 300-ohm conversion and vice versa right at the outlet. The other alternative is to run coax to the TV or tuner and use a matching transformer at the set to obtain the proper impedance match.

Terminate all unused outlets with the proper ($\frac{1}{2}$ -watt 75-ohm or 300-ohm) resistor to minimize standing waves in the system.

Discriminate Between
Desired Signal and
Unwanted Noise



with the

**FREE SPACE
STANDING WAVE
MAGNETIC ANTENNA**
UHF-VHF-FM-COLOR

Investigate now!

S & A ELECTRONICS INC.

Manufacturers of the TARGET ANTENNA

228 W. FLORENCE STREET

TOLEDO, OHIO 43605

CIRCLE NO. 40 ON READER SERVICE PAGE

Now Available For Immediate Delivery... Deluxe Heathkit Rectangular Color TV



Kit GR-295
\$479⁹⁵*

(295 sq. inch viewing area)

Exclusive Features That Can't Be Bought In Ready-Made Sets At Any Price!

All color TV sets require periodic convergence and color purity adjustments. Both Heathkit Color TV's have exclusive built-in servicing aids, so you can perform these adjustments anytime . . . *without* calling in a TV serviceman . . . *without* any special skills or knowledge. Just flip a switch on the built-in dot generator and a dot pattern appears on the screen. Simple-to-follow instructions and detailed color photos in the manual show you exactly what to look for, what to do and how to do it. Results? Beautifully clean and sharp color pictures day in and day out . . . and up to \$200 savings in servicing calls throughout the life of your set.

Exclusive Heath Magna-Shield . . . surrounds the entire tube to keep out stray magnetic fields and improve color purity. In addition, **Automatic De-gaussing** demagnetizes and "cleans" the picture everytime you turn the set on from a "cold" start.

Choice Of Installation . . . Another Exclusive! Both color TV's are designed for mounting in a wall or your own custom cabinet. Or you can install either set in a choice of factory assembled and finished Heath contemporary walnut or Early American cabinets.

From Parts To Programs In Just 25 Hours. All critical circuits are preassembled, aligned and tested at the factory. The assembly manual guides you the rest



Kit GR-180
\$379⁹⁵**

(180 sq. inch viewing area)

of the way with simple, non-technical instructions
Plus A Host Of Advanced Features . . . a hi-fi rectangular picture tube with "rare earth" phosphors for brighter, livelier colors and sharper definition . . . **Automatic Color Control** and **Gated Automatic Gain Control** to reduce color fading and insure jitter-free pictures at all times . . . deluxe **VHF Turret Tuner** with "memory" fine tuning . . . **2-Speed Transistor UHF Tuner** . . . **Two Hi-Fi Sound Outputs** for play through your hi-fi system or connection to the special limited-field speaker . . . **Two VHF Antenna Inputs** — 300 ohm balanced and 75 ohm coax . . . **1-Year Warranty** on the picture tube, 90 days on all other parts . . . plus many more deluxe features. For full details, mail coupon for FREE Heathkit catalog.

***Kit GR-295**, everything except cabinet, 131 lbs. **\$479.95**

GRA-295-1, walnut cabinet (shown above) 56 lbs. . . 19" D. x 31" H. x 34½" W. **\$62.95**

Deluxe contemporary walnut & Early American cabinets also available at \$94.50 & \$99.95

****Kit GR-180**, everything except cabinet, 102 lbs. **\$379.95**

GRA-180-1, walnut cabinet (shown above) 41 lbs. . . 18¼" D. x 28¼" W. x 29" H. **\$49.95**

Early American cabinet available at \$75.00

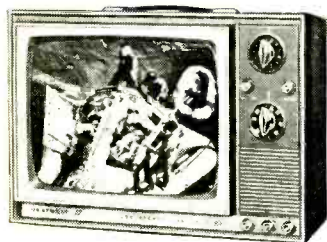

Kit GR-104
\$119⁹⁵

Deluxe 12" Solid-State B & W Portable TV

Unusually sensitive performance. Plays anywhere . . . runs on household 117 v. AC, any 12 v. battery, or optional rechargeable battery pack (\$39.95); receives all channels; new integrated sound circuit replaces 39 components; pre-assembled, prealigned tuners; high gain IF strip; Gated AGC for steady, jitter-free pictures; front-panel mounted speaker; assembles in only 10 hours. Rugged high impact plastic cabinet measures a compact 11½" H x 15¾" W x 9¾" D. 27 lbs.

Turn Page For More Heathkit® Values!

CIRCLE NO. 16 ON READER SERVICE PAGE

How To Save While Having Fun . . .



NEW
Heathkit®/Thomas
"Paramount"
Transistor
Theatre
Organ
\$995⁰⁰
 Kit TO-67

Full Professional Features At Over \$500 Savings. That's the new Heathkit version of the deluxe Thomas "Paramount" Theatre Organ. Boasts 19 voices, 200 watts peak power, chimes, 2 speaker systems, professional horseshoe console, instant-play Color-Glo keys, cool solid-state circuitry and more to make it a truly outstanding instrument you'll be proud to have in your home. Compare.

15 Manual Voices; 4 Pedal Voices . . . all at the flip of a tab. For solo work . . . diapason 16', bass clarinet 16', trumpet 16', English horn 8', oboe 8', violin 8', and tibia 16', 8', 5 1/2', 4'. For accompaniment . . . diapason 8', saxophone 8', French horn 8', oboe horn 8', and cello 8'. And now, four pedal voices . . . diapason 16', major flute 8', bass clarinet 8' and string bass 8'. And you'll soon learn combinations to produce endless voice and rhythm variations for every musical mood.

Two Separate Speaker Systems . . . a built-in 2-speed rotating Leslie plus a main system with two 12" speakers that handle the 200 watts peak power delivered by two separate transistor amplifiers.

Other Professional Features Include two 44-note keyboards, 28 notes of electronic chimes, 13-note bass pedals, keyboard & pedal sustain, reverb, selective repeat & attack percussion, manual balance, timbre mellow, variable vibrato, pedal percussion and volume, expression pedal, stereo headset outlet, and assembled hardwood cabinet and bench with walnut finish. 250 lbs. Liberal credit available . . . send for **FREE Catalog.**

Like To Hear It Perform?

Then send for organ demonstration record TOA-67-3 (7", 33 1/3 rpm). Listen to the beautiful voices, remarkable range of expression and professional capabilities of this superb instrument. Enclose 50c for postage & handling.



TOA-67-1
\$145⁰⁰

Optional Band Box Percussion

Adds 10 exciting percussion voices to the music you play . . . bass drums, two bongos, castanets, brush & crash cymbals, claves, blocks, snare drum and drum roll. One or all may be preselected to sound as you play the lower manual, pedals or both. Or voices may be added manually. 8 lbs. May be added to all other Heathkit/Thomas organs with TOA-67-2 drawer & slides @ \$35.

Build Your Own Heathkit® Electronics!

60-Watt Solid-State Guitar Amplifier . . . All The Features Guitarists Want Most!



Kit TA-16
\$129⁹⁵

Worth \$300! Two channels, 4 inputs handle accordion, guitars, organ or mike. Variable tremolo & reverb. Two foot switches. Two 12" speakers. Line bypass reversing switch for hum reduction. Leather-textured vinyl cabinet of 3/4" stock. 28" W x 9" D x 19" H. Build in 12 hours. 52 lbs.

NEW Heathkit 150-Watt Solid-State AM /FM Stereo Receiver



Kit AR-15 **\$329⁹⁵** (less cab.)

World's Most Advanced Stereo Receiver . . . with features like integrated circuits and crystal filters in the IF amplifier section; preassembled & aligned field effect transistor FM tuner for superior cross modulation index and image rejection; positive circuit protection; all silicon transistors; 2 tuning meters; and much more for the finest in stereo listening. See Julian Hirsch's review in the May issue of Hi-Fi/Stereo Review. 34 lbs.

Optional walnut wrap-around cabinet @ \$19.95

4-Band AM /Shortwave Receiver

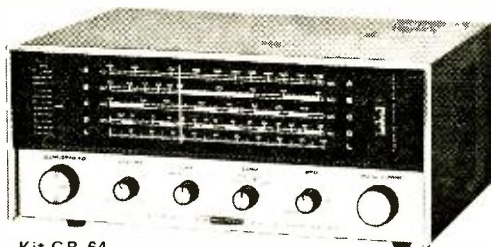

Kit GR-64
\$37⁹⁵

Hear Live Broadcast From Hundreds Of Foreign Countries. Voice of America, Radio Moscow, hams, ship-to-shore, plus popular AM. Covers 550 kHz to 30 MHz in 4 bands. Boasts 4-tube superhet circuit plus 2 silicon rectifiers; 5" speaker; BFO control; "S" meter; bandsread tuning; headphone jack; AM rod antenna; charcoal gray metal cabinet. 15 lbs.

New Low Price On Deluxe Transistor 10-Band AM /FM / Shortwave Portable . . . Save \$20!

Kit GR-43
Was \$159.95
Now
\$139⁹⁵



10 bands tune Longwave, AM, FM and 2 MHz to 22.5 MHz shortwave. Separate AM & FM tuners and IF strips. 16 transistors, 6 diodes and 44 factory assembled and pretuned circuits. 4" x 6" speaker, earphone, time zone map, listener's guide. Build in about 10 hours. 19 lbs.

FREE



World's Largest Electronic Kit Catalog!

Describes these and over 250 kits for stereo/hi-fi, color TV, amateur radio, shortwave, test, CB, marine, educational, home and hobby. Save up to 50% by doing the easy assembly yourself. Mail coupon or write Heath Company, Benton Harbor, Michigan 49022

HEATH COMPANY, Dept. 10-6
Benton Harbor, Michigan 49022
In Canada, Daystrom Ltd.

Enclosed is \$ _____, plus shipping.

Please send model (s) _____

Please send FREE 1967 Heathkit Catalog.

Name _____

Address _____

City _____

State _____

Zip _____

Prices & specifications subject to change without notice.

CL-290

CIRCLE NO. 16 ON READER SERVICE PAGE

POWERMAKER

300 Watts
for
\$59.95

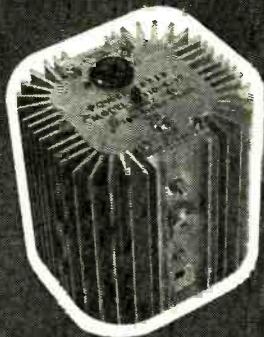

Changes 12
Volt Battery
Power to 60
Cycle AC Power

All Transistorized—Light, Compact, Rugged—Easily Installed

Runs T.V., Lights, Recorders, Public Address,
Tools, etc. In Your Auto, Trailer, Camper or Boat

Order From Your Dealer or Direct From Manufacturer
Shipping in U.S.A. \$3.00 Calif. Res. Add \$2.40 Tax



TOPAZ INCORPORATED

3800 HOUSTON STREET
SAN DIEGO, CALIF. 92110

CIRCLE NO. 35 ON READER SERVICE PAGE

SELECTING ANTENNAS

(Continued from page 45)

Two-Man Job. Familiarize yourself with antenna assembly procedure and work with another man. If possible, do not fully open the antenna elements on the ground; they will only get in the way or become damaged while making the ascent to the roof. Secure the antenna and accessories to the mast and apply a coating of weather-resistant plastic spray to the electrical and mechanical connections.

When using coax or shielded twin lead, tape the downleads to the mast in several places and provide "drip-loops" at points of entry to keep rain out of the house. Allow sufficient lengths of transmission and rotator wire, if used, to reach the input to the distribution system without a splice.

If you use unshielded twin lead, employ a sufficient number of standoffs to prevent metal contact and slack. Do not use any more standoffs than you need—the more metal you put around unshielded twin leads, the more you will upset the transmission line.

Point the antenna towards the source of the TV signal and snug up the fastening hardware. The final position of the antenna should be determined by observing the TV set.

Use guy wires on masts higher than ten feet. At least three guy wires, 120° apart, are recommended; four at 90° are best. Anchor the guy wires securely and cover the hook eyes with roofing compound to prevent water leaks. On very large, very high assemblies, use another set of guy wires at about each 10-foot level on the mast.

Feed the downleads into the house through suitable feedthrough fittings. If a rotator is used, be sure to provide enough slack on the antenna end of the transmission line to obtain freedom of antenna movement. Ground the mast with a continuous piece of #12-gauge wire to a 6' length of pipe or metal rod sunk into the earth. DO use lightning arrestors and follow the antenna manufacturer's instructions for installing them, if given. Both 300- and 75-ohm types are available.

-30-



WE DON'T
CLAIM OUR
ELECTRONIC
IGNITION
SYSTEM
IS BEST...

OUR
CUSTOMERS DO!

WRITE TODAY FOR FREE LITERATURE

JUDSON

RESEARCH AND MFG. CO.
CONSHOHOCKEN, PA. U.S.A.



CIRCLE NO. 19 ON READER SERVICE PAGE

POPULAR ELECTRONICS

AMPLIFIERS AND SPLITTERS

(Continued from page 49)

The maximum amount of signal, without overloading, an amplifier can handle is very important if you are located near a strong local TV or FM station. Two-transistor boosters will handle more signal than the single-transistor variety. Use a booster only if the situation requires it—too much signal can be as bad as not enough signal.

Splitters. Multi-set TV couplers (splitters) have been around for a long time. There are good ones and there are some very bad ones. Use good couplers.

A coupler must perform in a specified manner. It must not compromise the system's impedance. An impedance mismatch produces standing waves which can ruin color, "suck out" all or part of a TV channel from your system, or it may amplify a portion of the signal enough to overload your system or your TV set. The coupler must provide sufficient isolation between outlets to prevent interaction between TV sets, such as like-channel interference (two or more sets operating on the same channel) and interference brought on by certain combinations of channels such as channels 7 and 11. The coupler should divide the signal equally and with a minimum amount of losses.

The theoretical minimum splitting loss for a two-way coupler is 3 dB at each outlet; for a four-set coupler, it is 6 dB per outlet. There are some additional circuit losses which subtract approximately 0.5 dB for a two-way coupler, and 1 dB for a four-way coupler.

Couplers using reactive components to do the signal splitting are known as "hybrid" types. The cheaper resistive-type couplers do maintain system impedance and provide adequate isolation, but their splitting losses are usually greater than those of the hybrid types. The more losses in the system, the greater the signal strength has to be at the head end.

A UHF/VHF splitter must be used at any outlet where an all-channel TV set is to be used. A UHF/VHF/FM splitter should be installed for a TV console incorporating VHF, UHF and FM. -50-

NOW...there is another way to get through



ANTENNA

POLAR DIVERSITY LOOP ANTENNA*



The new concept in antennas that gets the signal through when others fail

The Avanti PDL-27A is a polar diversity loop antenna that provides for instant switching to transmit or receive horizontal or vertical signals. Commercially available for CB'ers for the first time—the PDL-27A offers the advantages of signal diversity found in military and trans-oceanic communication networks.

HIGH GAIN HORIZ. DIVERSITY GAIN 11 db
VERT. ISOTROPIC

MINIMUM INTERFERENCE—30 db front to back ratio.

LONG LASTING—rugged frame of aluminum and fiberglass.

EASY TO INSTALL—factory measured; cut and drilled for simple mount on pipe mast. Only 13½ lbs.

*Patent Applied For

Write today for complete information.

ANTENNA DIVISION

avanti research & development, inc.

45 W. Fullerton Avenue, Addison, Ill. 60101

Please send full details on Avanti PDL-27A antenna.

NAME _____

ADDRESS _____

CITY _____ STATE _____ ZIP _____

FREE!

BIGGER... BETTER THAN EVER!



40th ANNIVERSARY 1967 CATALOG



YOUR BUYING GUIDE FOR:

- Stereo & Hi-Fi Systems & Components.
- Tape Recorders.
- Electronics Parts, Tubes, Tools
- Phonos & Records.
- Hom Gear.
- Test Instruments & Kits.
- Cameras & Film.
- PA.
- Citizens Band.
- Radio & TV Sets.
- Musical Instruments.

**SEND FOR
YOURS TODAY!**

BURSTEIN-APPLEBEE CO.

Dept. PE 1012 McGee, Kansas City, Mo. 64106

Rush me the FREE 1967 B-A Catalog.

Name.....

Address.....

City..... State..... Zip Code.....

CIRCLE NO. 7 ON READER SERVICE PAGE

LEARN Electronics Engineering AT HOME

Fix TV, design automation systems, learn transistors, complete electronics. College level Home Study courses taught so you can understand them. Earn more in the highly paid electronics industry. Computers, Missiles, theory and practical. Kits furnished. Over 30,000 graduates now employed. Resident classes at our Chicago campus if desired. Founded 1934. Catalog: "Vets—write for information about G.I. Bill Training."

AMERICAN INSTITUTE OF ENGINEERING & TECHNOLOGY
1137 West Fullerton Parkway, Chicago, Illinois 60614

SAY YOU SAW

IT IN

POPULAR ELECTRONICS

GET INTO ELECTRONICS

V.T.I. training leads to success as technicians, field engineers, specialists in communications, guided missiles, computers, radar, automation. Basic & advanced courses. Electronic Engineering Technology and Electronic Technology curricula both available. Associate degree in 29 months. B.S. obtainable. G.I. approved. Start September. February. Dorms, campus. High School graduate or equivalent. Catalog.

VALPARAISO TECHNICAL INSTITUTE
DEPARTMENT PE, VALPARAISO, INDIANA



SIMPLE-MINDED "MAGGIE"

(Continued from page 34)

i.d. of the ball bearings you select and the flywheel used. Therefore, get bearings that are compatible with the i.d. of the flywheel opening.

The bearings are pressure-fitted into the armature supports and then the armature shafts are pushed into the bearings. Now, screw down the armature supports and secure the flywheel on one end of the shaft. Then pressure-fit fiber cams and spacers on the appropriate end of the shaft. Fabrication details for the cams and spacers are given in Fig. 5. Orient and position these parts on the shaft as shown in Figs. 6 and 7.

The switches used for the commutator are spring-contact types which can be salvaged from old telephone relays. The contact springs should have dimensions of 2 1/4" in length and about 1/4" in width. Relays that have contacts as described can be obtained from most surplus electronics parts stores at low cost. Once the switches are mounted, wire a capacitor across each, and connect the electromagnets and lamps as shown in the schematic drawing (Fig. 1).

Operation. Because *Maggie* is an inefficient old "lady," she consumes a relatively large amount of power and cannot be run from ordinary dry batteries. However, you can use any one of a number of suitable low-voltage power supplies, including a 6- or 12-volt filament transformer, a Variac, or a low-voltage d.c. supply rated at about 20 amperes.

If the armature fails to turn over with at least 6 volts across the electromagnets, adjust the cam followers so that the spring contacts will make and break contact as the armature rotates.

If you want the motor to run faster, adjust the position of the cams just as you would advance and retard a set of ignition points. Minor adjustments can make a big difference, and compensate for irregularities in the twist of the armature. You can also get more speed by increasing the operating voltage—but be sure not to exceed the power limits of the electromagnets.

-30-

SERVICING THE SYSTEM

(Continued from page 54)

if the picture appears to be more normal, your system is overloading the TV set. If the distortion is still visible, the amplifier is probably overloaded. If you have a powered splitter (distribution-type amplifier), try a resistive attenuator network at the amplifier's input terminal to tame the amplifier.

If, on the other hand, the amplifier is putting out a clean signal and it is just a matter of reducing the signal strength to one line or to one set, simply interpose an appropriate attenuator circuit. You can start with small amounts of attenuation and work up. Fixed or "switchable" in-line signal attenuators are available for purchase or you can construct your own.

Inserting an attenuator network between the antenna and a mast-mounted amplifier is ludicrous. One practical solution is to remove the booster and return it to your dealer for credit. Hook up

the antenna directly to the system and check the system's quality. If snow now appears, use your credit toward the purchase of a distribution-type amplifier.

Ghosts. Ghosting in the system usually occurs from multipath signals. The ghost, or the second image, will generally appear offset to the right of the main image, a fraction to several inches displaced. In fixed antenna systems, use voice relay from the roof to the TV set; observe the picture, and have a friend orient the antenna for none or minimum ghosting. With a rotator system, the solution is much simpler: just push the button.

Sometimes the ghost image will haunt you despite your best efforts. In this case, you are probably a victim of your locale. A bigger, more expensive antenna with a better front-to-back ratio may help.

Be on the alert for ghosts due to mismatched and improperly installed components in the system. In an antenna system there are no shorted and no open circuits—everything counts. —50—



FREE! HOW TO IMPROVE YOUR TWO-WAY RADIO!

The right communications microphone may double the talk power of even the finest transmitters! Learn how unwanted noise can be eliminated—reliability improved—intelligibility increased by proper microphone selection.

Write for our helpful free booklet today!

ELECTRO-VOICE, INC., Dept. 672P
630 Cecil Street, Buchanan, Michigan 49107
Please send the free E-V booklet on choosing communications microphones. I am interested in the following areas of two-way radio: Amateur Aviation CB Business.

NAME _____

COMPANY _____

ADDRESS _____

CITY _____ STATE _____

CIRCLE NO. 13 ON READER SERVICE PAGE

**It will actually take you longer
to read this advertisement
than to install this new
"Quick-Grip" mobile antenna
mount. No holes to drill.
Cable is completely hidden.
Makes the world's finest
antennas the world's most practical.**



Practically every A/S mobile CB antenna made may be ordered with a "Quick-Grip" mount, including all versions of the mighty Maggie Mobiles.

Model M-176, illustrated above. M-175, same coil and whip less spring. M-177 is "Quick-Grip" version of our great 18" Mighty-Mite. Mount only also available.

Complete details from your A/S dealer, or write to us.



**the
antenna
specialists
co.** division of Anzac
Industries, Inc.

12435 Euclid Ave., Cleveland, Ohio 44106

Export: 64-14 Woodside Ave., "Stripes of Quality"
Woodside, N.Y. 11377

CIRCLE NO. 3 ON READER SERVICE PAGE

SOLID STATE

(Continued from page 77)

cost, performance, and packaging. Fairchild Instrumentation has just come up with a Model 7050 DVM which is about the size of a regular multimeter (3¼" high x 6¼" wide x 7¼" deep) and sells for \$275 in unit quantities (\$249 in lots of 25 or more). The 7050 employs 12 dual in-line integrated circuits which replace more than 400 discrete components, and provides a three-and-one-half digit readout for its IC flip-flop counters for improved accuracy. The instrument has an input impedance of 1000 megohms on low ranges, makes measurements of d.c. to 1500 volts in four ranges, measures resistances to 15 megohms in five ranges, and boasts accuracies of $\pm 0.1\%$ of reading on d.c., and $\pm 0.2\%$ of reading on the ohms ranges. For further information, write to Fairchild Instrumentation, 475 Ellis Street, Mountain View, Calif. 94040.

Transistips. If you're an "old-timer" who has had experience with vacuum-tube circuits dating back several years B.T. (Before Transistors), you should be able to make the transition from bipolar transistors to field-effect transistors with a minimum of trouble. Simply consider FET's as "solid state" vacuum tubes. On the other hand, if your experience has been confined primarily to conventional transistor circuits, you may run into a number of puzzling situations when you first start working with FET's.

One area where difficulties are likely to be encountered is in the seemingly routine task of checking circuit voltages. Consider the typical transistor (bipolar) amplifier stage illustrated in Fig. 4 (a). A *pn*p transistor is used in the common-emitter configuration. Base bias is furnished through voltage divider *R1-R2*, while *R3* serves as the collector load. The component values given are typical for small signal transistors.

Suppose, now, that you have a fairly good VOM with a sensitivity of 5000 ohms/volt or better, and want to check the base-emitter and collector-emitter voltages. Using the 1-volt range of the VOM, you would connect your meter leads between the base and emitter electrodes. The voltage reading thus obtained would be very close to the actual voltage between these two points, inasmuch as the meter resistance (5000 ohms on the 1-volt range) is comparatively large in relation to the impedance of the circuit checked. The actual base-emitter impedance is appreciably less than 2000 ohms, as a result of *R2* being shunted by *Q1*'s base-emitter impedance.

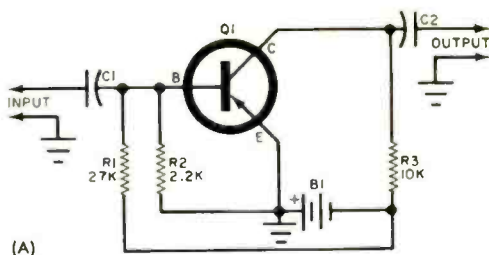

(A)

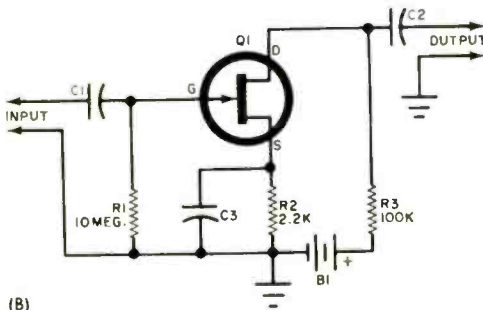

(B)

Fig. 4. A VOM of relatively low input resistance can be used to measure the base-emitter voltage of a bipolar transistor (A) without excessive circuit loading. However, the same VOM would act as a virtual short circuit if used in a similar manner to measure the source-gate voltage of a FET (B).

Similarly, if we switch to the 10-volt range and check the collector-emitter voltage, the reading obtained would be very close to the actual voltage between these two electrodes. Again, the meter's resistance (50,000 ohms on the 10-volt range) is large compared to circuit impedances. For example, R_3 , with a value of only 10,000 ohms, is but one-fifth of the meter's resistance.

Suppose we try to make corresponding voltage measurements in a typical FET circuit, using the same VOM. How would the voltage measured between similar points compare with the actual circuit voltage? A simple FET amplifier stage employing an n -channel FET, Q_1 , in a common-source configuration is shown in Fig. 4(b). Resistor R_1 is the gate resistor, and gate bias is developed across source resistor R_2 , bypassed by C_3 . Resistor R_3 is the drain load.

If the VOM leads are connected between Q_1 's gate and source, the instrument itself will act as a virtual short circuit across these two points, for its resistance (5000 ohms on the 1-volt range) is but a fraction of the circuit impedance at these points. Resistor R_1 has a value of 10 megohms, while Q_1 's gate-source impedance would be on the order of several megohms. As a result, the voltage measured would be but a small fraction of the actual bias voltage.

Live Better Electronically With

LAFAYETTE RADIO ELECTRONICS

1967 Catalog 670 FREE!

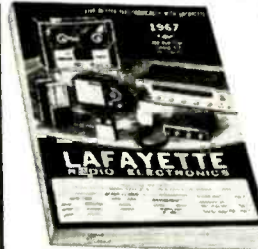

BETTER THAN EVER
512 Pages

Stereo Hi-Fi • Citizens Band • Ham Gear • Tape Recorders • Test Equipment • TV and Radio Tubes and Parts • Cameras • Auto Accessories • Musical Instruments • Tools • Books

Featuring Everything in Electronics for
• HOME • INDUSTRY • LABORATORY
from the "World's Hi-Fi & Electronics Center"

LAFAYETTE Radio ELECTRONICS
Dept. IF-7 P.O. Box 10
Syosset, L.I., N.Y. 11791

Send me the FREE 1967 LAFAYETTE Catalog 670 IF-7

Name
Address
City State
Zip
(Please Give Your Zip Code No.)

CIRCLE NO. 21 ON READER SERVICE PAGE

AM/FM VHF RECEIVERS

POLICE • FIRE • AIRCRAFT
AMATEUR • GENERAL COVERAGE

The new 364C is a self contained highly sensitive receiver offering the user continuous AM/FM coverage from 26 to 54 and 88 to 174 MC in eight bands plus one band covering 15 meters. Features: superhet circuitry, full vision calibrated dial with vernier drive, speaker, power transformer, ready to use for 110/120 V AC.



364C

\$59.95



377A

\$22.50

377A Low cost tuneable transistor converter self contained battery for car use. Three types—low or high band police and fire or aircraft. Also complete line of crystal controlled converters and squelch units for monitoring police, fire, aircraft, etc. signals.

372B Level limiting is a necessity in recording. The 372B features low distortion and adequate dynamic range for any situation. Write for full details of this and other audio equipment.



372B

\$99.95

KUHN ELECTRONICS
20 GLENWOOD CINCINNATI 17, OHIO

CIRCLE NO. 20 ON READER SERVICE PAGE

CB'ers Build-It-Yourself

AND

Save

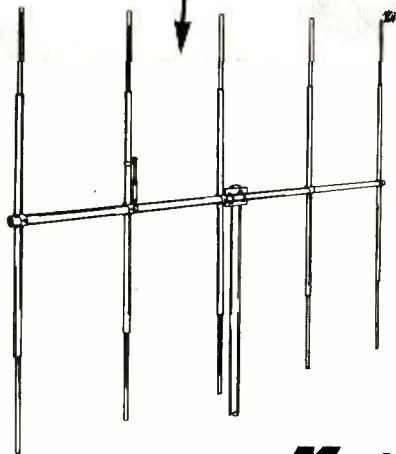

... With The NEW **Mosley**
X-27 CB Antenna Kits.

If you are one of those rugged individualists who prefer to Do-It-Yourself, let Mosley show you how to Save Time and Expense on your next antenna project. Real talk-power is assured with any one of our 3, 4 or 5 element beam kits.

Get all the facts . . . Send for your FREE detailed brochure. Name and address of your nearest authorized Mosley Dealer will be rushed to you by return mail. No salesman will call.

Mosley Electronics, Inc. Bridgeton Missouri 63042

Please send me your FREE brochure on the New Mosley X-27 CB Antenna Kits No. 133.

Name _____

Address _____

City/State _____ Zip _____

Mosley Electronics, Inc. 4610 N. Lindbergh Blvd.,
Bridgeton Missouri 63042

CIRCLE NO. 24 ON READER SERVICE PAGE

Similarly, if we switch to the 10-volt range and try to check the drain-source voltage, the measured voltage would also be a fraction of the actual voltage between these two points. The meter resistance—in this case, 50,000 ohms—is only half that of the drain load (R3, 100,000 ohms).

When checking FET circuit voltages then, remember that the meter's impedance itself may affect the results. Use as sensitive a meter as you can (a 20,000-ohm/volt meter, for example, will give more accurate measurements than a 5000-ohm/volt meter, all other factors remaining the same). If possible, use a VTVM or similar high impedance meter (but *take care* when checking IGFET or MOST types since these can be easily damaged).

Wherever possible, make your voltage measurements across low impedances. For example, in Fig. 4(b), a more accurate bias measurement could be obtained by checking the d.c. voltage across R2; this would be the approximate gate bias voltage.

Finally, if you run into a puzzling situation—*Stop, look and think!*

Until next month,

—Lou

AMATEUR RADIO

(Continued from page 72)

NEWS AND VIEWS

Although it surprises **Rex Greenwell, WA7FKT**, 2450 West 4919 South, Roy, Utah, that there are so many hams who still need QSL cards from Utah, he offers to schedule all of you and confirm the contacts. He operates AM phone and CW on 10, 15, 20, and 40 meters using a Lafayette KT-390 "Starflite" transmitter feeding 10- and 40-meter dipole antennas, and a National NC-77X receiver. Just to prove that AM phone is not yet dead, Rex made 98 contacts on that mode the week after his General ticket arrived. Forty-six states, New Zealand, and Japan worked are part of his record . . . **Bruce Shulze, WNSRHM**, 615 N. Washington St., Durant, Okla., has been keeping the bearings in his key hot since he received his license. In six weeks, he has worked 43 states, 19 Canadians, and Brazil. A Knight-Kit T-60 transmitter and R-55A receiver share time on a homebrew, 2-element, 15-meter beam (14' high) and inverted-V antennas for 40 and 80 meters. Bruce's favorite band is 40 meters . . . **Scott Thorne, WN1GYP**, 36 Atwater Rd., Collinsville, Conn., keys a Heathkit DX-40 transmitter and strains the interference from his replies with a Lafayette HA-350 receiver. Outside work is done by an 80-meter "Zepp" antenna, which also works 15 meters, and a 40-meter dipole. Thirty-one states and three Canadian provinces worked are the result.

Mike Moran, WN2ZRK, Box 117, Gardiner, N.Y., keeps his Heathkit DX-60 anchored on 3704 kHz but has worked 14 states and three Canadian provinces in a month. A National NC-270 receiver and a dipole antenna fill out Mike's equipment catalog . . . **Barry Reich, WB2SKP**, 2020 Albemarle Rd., Brooklyn, N.Y., is doing his part to dispel the idea that 50 MHz has to be a "local" band. A Clegg



Paul Demergy, W1EYP, points out that his home-brew, 80-through-10 meter transmitter is smaller than his Hammarlund HQ-150 receiver, but 160 countries worked prove that it puts out a big signal. See item below for details on W1EYP's activities.

"99'er" feeding a home-brew rotary beam has worked 41 states—38 confirmed—on 50 MHz. Aiming still higher, Barry has just purchased a Clegg "Venus" and a 3-element Hy-Gain beam, which is installed 140' high, to chase "scatter" and aurora DX on CW and SSB. A Conset 2-meter "Sidewinder" AM, CW, and SSB transceiver, and a 50-MHz homebrew high-power amplifier are also in the works . . . The discussion entitled "CW is Dead (?)" in our February column has brought forth an unusually large number of favorable comments, of which the following is representative. **William A. Montague, W8PQQ**, 2141 King Ave., Dayton, Ohio, says, "I have my Tech license and have been working for my General. The next exam will be my fifth. I may never make it, but I say by all means keep CW. The actual skill of the operator is in the code. Also, it gives him so much more distance with so much more elbow room on the bands. It is a treat to listen to a good CW operator." We agree with those sentiments.

Robert Hajdak, WN3FNT, 4 Homer St., Greenville, Pa., should be sporting his General call letters when you read this item. Ten months as a Novice have netted him 32 states, Canada, and Cuba. Forty meters is Bob's favorite, but he gets on "15" occasionally. Bob transmits on an EICO 720 running 75 watts or on a home-built 1-watter. He also has a choice of two receivers, a Hallicrafters SX-99 or a Knight-Kit R-100, but he has only one antenna—a 130' "long wire." . . . **Paul C. Demergy, W1EYP**, 24 Etna Place, West Lynn, Mass., has been an amateur since 1932 and enjoys the hobby as much today as he did 35 years ago. But the power "bug" finally got to Paul. He used to run 15 watts on phone and 25 watts on CW; his new transmitter runs 25 watts on phone and 30 watts on CW! With this super power, W1EYP has brought his station records up to WAS and WAC on both phone and CW; DXCC and 160 countries on CW, and 50 countries on AM phone. Paul receives on a Hammarlund HQ-150, and his antennas are dipoles. He informs us that CW operators are in great demand on ships and in marine radio shore stations . . . **Michael H. Wilke, WB4AQL**, 3607 Cambridge Rd., Montgomery, Ala., bounces electrons off the ionosphere on 80 and 40 meters with a "Globe Chief" running 90 watts to drive an inverted-V antenna, 40' high. A Knight-Kit R-100 handles the receiving chores, and a Heathkit HW-32 SSB transceiver

(Continued on page 106)

GET * MORE ACTION WITH

**MULTI-ELMAC
PRECISION MADE,
POPULAR PRICED
CB UNITS!**

* **CITI-FONE SS** \$169.50

**FULL
23 CHANNEL**

AC-DC Operation,
Illuminated Meter
& Channel Selector,
Triple Tuned RF,
"Noise Immune"
Squelch, Double
Tuned IF's, Ready to Operate



* **CITI-FONE 99** \$99.50

**FULL
8 CHANNEL**

AC-DC Operation,
Delayed AVC,
Electronic Switching,
2 Stage Pre-Amp
Illuminated "S"
Meter, Complete
with Crystal for 1 Channel



* **CITI-FONE II** \$49.95

**SOLID STATE
Transmitter/Converter**

Compact 3 3/4" x
4 3/8" x 1 1/2", 9
Transistor, 2
Diodes, 5 Watt
Input (FCC Max.)
100% Modulation, 12 VDC
Operation, Complete with Crystal for
1 Channel



Please send further information on Citi-Fone SS , 99 , II

MULTI-ELMAC CO.

21470 Coolidge • Oak Park, Michigan 48237

NAME _____

ADDRESS _____

CITY _____

STATE _____ ZONE _____

CIRCLE NO. 25 ON READER SERVICE PAGE

“He’s a good worker.
I’d promote him right now
if he had more
education in
electronics.”

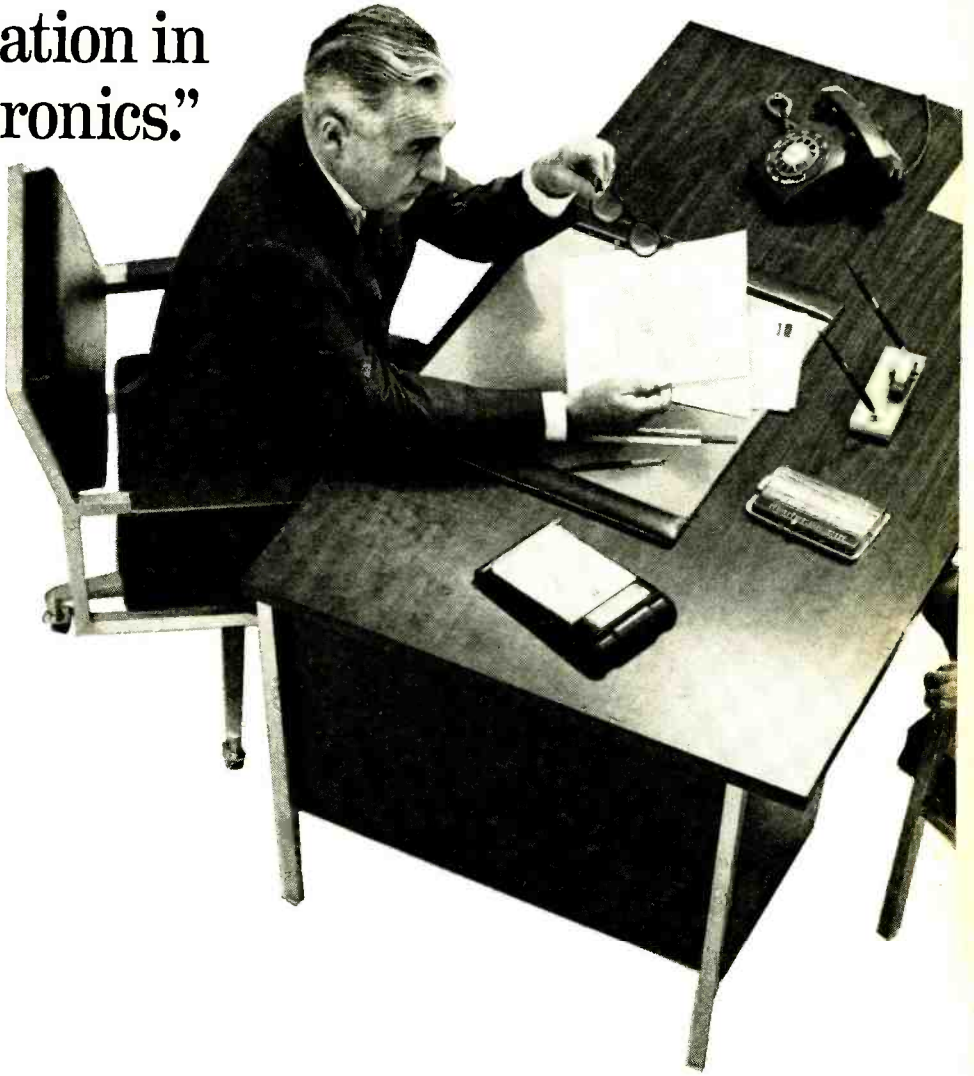

Could they be talking about you?

You'll miss a lot of opportunities if you try to get along in the electronics industry without an advanced education. Many doors will be closed to you, and no amount of hard work will open them.

But you can build a rewarding career if you supplement your experience with specialized knowledge of one of the key areas of electronics. As a specialist, you will enjoy security, excellent pay, and the kind of future you want for yourself and your family.

Going back to school isn't easy for a man with a full-time job and family obligations. But CREI Home Study Programs make it possible for you to get the additional education you need without attending classes. You study at home, at your own pace, on your own schedule. You study with the assurance that what you learn can be applied to the job immediately.

CREI Programs cover all important areas of electronics including communications, servo-mechanisms, even spacecraft tracking and control. You're sure to find a program that fits your career objectives.

You're eligible for a CREI Program if you work in electronics and have a high school education. Our FREE book gives complete information. Airmail postpaid card for your copy. If card is detached, use coupon below or write: CREI, Dept. 1228E, 3224 Sixteenth Street, N.W., Washington, D.C. 20010.



The Capitol Radio Engineering Institute

Dept. 1228 E, 3224 Sixteenth Street, N.W., Washington, D.C. 20010

Please send me FREE book describing CREI Programs. I am employed in electronics and have a high school education.

NAME _____ AGE _____

ADDRESS _____

CITY _____ STATE _____ ZIP CODE _____

EMPLOYED BY _____

TYPE OF PRESENT WORK _____ GI BILL

- I am interested in Electronic Engineering Technology
 Space Electronics Nuclear Engineering Technology
 Industrial Electronics for Automation
 Computer Systems Technology

APPROVED FOR VETERANS ADMINISTRATION TRAINING

Build your own AUTO ANALYZER —and SAVE!

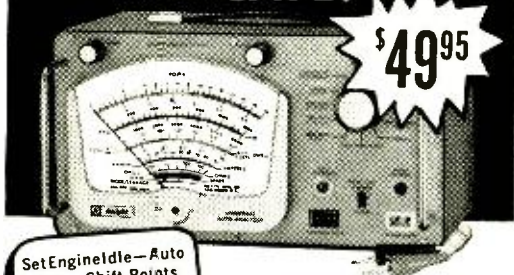

\$49⁹⁵

Set Engine Idle—Auto Trans. Shift Points

CHECK:

- Distributor wear
- Dwell angle
- Voltage regulator
- Condensers
- Point surfaces
- Coil resistance
- Ground circuits
- Alternator diodes
- Engine timing
- Spark output and much more!

WITH A **knight-kit**® FROM
ALLIED RADIO

Headquarters for Everything in Electronics

Save double on this famous Knight-Kit Auto Analyzer. Build it yourself and save factory assembly costs. Then use it for tune-ups and trouble-shooting to hold down car upkeep.

Write for special introductory offer
No Money Down - \$5 Monthly

ALLIED RADIO

Dept. 3F, P.O. Box 4398, Chicago, Ill. 60680
CIRCLE NO. 1 ON READER SERVICE PAGE

Audio-Color Lets you see your music

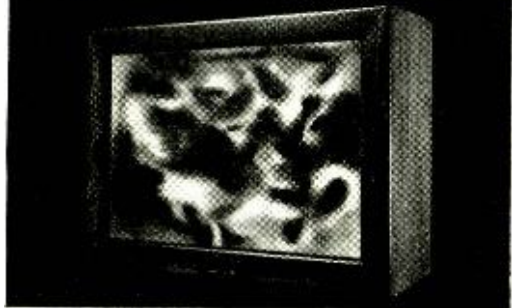

ASSEMBLED
\$54.95

KIT FORM
\$44.95

\$5 DOWN — \$5 MONTH

Walnut finished cabinet included / Shipped REA Collect

Easy to build, easy to install. All transistor AUDIO-COLOR adds a visual dimension to musical enjoyment. A brilliantly moving panorama of color casts dancing images on a soft frosted screen, reflecting rising and falling volume with each beat of the music. Here's a truly unique and exciting new musical experience. Make check or money order to CONAR.

SEND FOR FREE CONAR CATALOG

CONAR

Division of National Radio Institute,
Dept. FA7C 3939 Wisconsin Ave.,
Washington, D.C. 20016

will soon take a prominent position on the WB-4AQL operating desk.

Charles "Bud" Raridon, WB6RDC, 19927½ Lemoli Ave., Hawthorne, Calif., has worked 54 countries in eight months. A Heathkit HX-20 SSE/CW 90-watt transmitter excites a Hy-Gain 14-AVQ vertical antenna, and a Hallicrafters SX-140 receiver does the signal-sorting. A Heathkit SB-610 "Monitor-Scope" checks the quality of the outgoing signals.

Will we be seeing your "News and Views" on these pages next month? The first step is up to you. Mail that letter now, and please keep us on the list to receive your club paper. We intend to use more pictures in coming months, so don't hesitate to include a clear photo of you and your station with your letter. Send all mail to: Herb S. Brier, W9EGQ, Amateur Radio Editor, POPULAR ELECTRONICS, P.O. Box 678, Gary, Indiana 46401.

73. Herb, W9EGQ

QUIZ ANSWERS

(Quiz appears on page 80)

- 1 — G In a Class AB amplifier, plate current flows for appreciably more than half the input cycle but less than the entire cycle.
- 2 — C The B—H curve for a magnetic material represents flux density, B, varying as the magnetizing force, H, alternates in polarity and amplitude.
- 3 — A A common-collector transistor configuration (CC) is similar in appearance and operation to the familiar cathode follower amplifier in which the voltage gain is less than unity.
- 4 — J Hg is the atomic (chemical) symbol for the element mercury. In electronics, mercury is used in a tilt-action switch.
- 5 — E Intermodulation distortion (IM) results from the interaction of two frequencies (usually low and high) within an amplifier or speaker due to non-linearity of the unit involved.
- 6 — H The abbreviation NC stands for "normally closed" when used in connection with the operation of relay contacts.
- 7 — D In color television, the R—Y signal is obtained by subtracting the Y, or luminance, signal from the red (R) signal.
- 8 — F A picofarad, or pF (modern version of microfarad) is a unit of capacitance and is equal to 0.000000000001 farad, or 10⁻¹² farad.
- 9 — B Two coils wound on the same form have mutual inductance, L_M, since the current in one can induce a voltage in the other.
- 10 — I The drain-source pinch-off voltage, V_p, of a field-effect transistor is the potential at which the drain current ceases to increase.

SHORT-WAVE LISTENING

(Continued from page 79)

Monitoring Panel. *Radio RSA*, Johannesburg, South Africa, has a new monitoring panel. If you send a letter of request to the station at Box 8606, Johannesburg, you will receive a questionnaire, report forms, a booklet on reporting, and a "Monitoring Panel Bulletin" to be issued periodically. In addition, *Radio RSA* has stated that IRC's will be sent out to cover postage used in mailing the report forms back to South Africa. Here is a good opportunity for some of our monitors to perform a worthwhile service.

CURRENT STATION REPORTS

The following is a resume of current reports. At time of compilation all reports are as accurate as possible, but stations may change frequency and/or schedule with little or no advance notice. All times shown are Greenwich Mean Time (GMT) and the 24-hour system is used. Reports should be sent to **SHORT-WAVE LISTENING**, P.O. Box 333, Cherry Hill, N.J., 08034, in time to reach your Short-Wave Editor by the fifth of each month; be sure to include your WPE identification, and the make and model number of your receiver. We regret that we are unable to use all the reports received each month, due to space limitations, but we are grateful to everyone who contributes to this column.

Albania—*R. Tirana* has been found on a new frequency, 9715 kHz, from 2315 s/on, and again, in Eng., at 0230-0255.

Angola—A station thought to be *R. Clube de Angola*, 4868 kHz, was noted from 2250 to 2259 s/off with "A Portuguesa"; do not confuse this station with Ponta Delgada (Azores) on 4865 kHz which closes at 2302. Station CR6RF, *R. Clube de Benguela*, 5042 kHz, is heard at 2230 with pop music and anmts in Portuguese, s/off at 2301 with "A Portuguesa"; do not confuse this one with Bissau (Portuguese Guinea) on 5014 kHz (CR6RF can also be heard around 0545 s/on). *R. Comercial de Angola*, Sa da Bandeira, was noted at 0600 with multi-lingual anmts (including Eng.), after which it went into pop music and Portuguese anmts; good at first, it quickly faded by 0630. The frequency for the latter station is 7300 kHz, not the listed 7285 kHz.

Ascension Island—The BEC South Atlantic Relay has been noted on 15,140 kHz with the World Service at 2000-0330. A new outlet, on 9670 kHz, is heard at 0540 in French, at 0545 in Hausa, at 0600 with the Eng. World Service, and at 0630 in French; no specific mention is made of the location but the fact that the xmsns are beamed "to listeners in Africa" is the clue to the Ascension Island location.

Austria—*Austrian Radio*, Vienna, has xmsns to N.A. at 0000 on 6155 and 9770 kHz, to Central South America at 0000 on 9525 kHz, and to Central America at 0000 on 15,430 kHz; the xmsn to Australia and New Zealand has been changed to 1000-1130 on 17,820 kHz. Unidentified by many sources, the station on 6350 kHz belongs to the Austrian army and is used for training purposes Mondays to Fridays at 1030-1200 (some sources list it as being on 6255 kHz).

Brazil—Being reported for the first time is *R. Clube Bauru*, Bauru, 3275 kHz, logged at 0000 with numerous commercials and pop music.

Cape Verde Islands—A strong-level Portuguese speaking station on 21,660 kHz at 1430-1700 is listed by an overseas source as being on Cabo Verde and is seemingly a relay station. Operation is dual to 21,700 kHz but not to 21,495 kHz. Pop records were heard at 1635-1645. These broadcasts are probably beamed to the Portuguese colonies in Africa.

Ecuador—*Transmitte C. R. E.*, Guayaquil, 4750 kHz, has been noted from 0345 with ads. Latin American music and an ID at 0400, followed by a



Vernon Crumrine, Jr., WPE5EQZ, Dallas, Texas, has 13 countries verified out of 31 logged. His equipment: a Hallicrafters WR-600 and Knight-Kit "Span Master." Vernon belongs to the American SWL Club, ARRL, and International Short-Wave League.

Sonar SENTRY VHF MONITOR RECEIVERS

With Battery, Earphone, & Carrying strap less Crystals Crystals \$5.00 ea.

\$39.95

SOLID STATE

POCKET SIZE

Model	
FR-103	FR-106
150-175 MHz	25-50 MHz
	Aircraft
	108-136 MHz

LISTEN TO: POLICE, FIRE, AIRCRAFT & WEATHER REPORTS!

for Industrial, Commercial, Utility & Govt. Use
2 CHANNELS • BROADCAST BAND • CRYSTAL CONTROLLED

Designed and engineered for simplicity of operation, compact enough to fit a shirt pocket yet powerful enough to deliver a clear clean signal—it's dependable • Operates on two crystal controlled VHF channels plus broadcast band • Completely solid state for long life use • Visible battery indicator to show battery condition at all times • Built in antenna • 5 7/8" H x 2 1/2" W x 1 3/8" D. Wt. 11 oz.

SDNAR RADIO CORP., 73 Wortman Ave., Bklyn, N.Y. 11207

Please send information on VHF Monitor Receivers.

Dept. 541

Name _____
Address _____
City _____ State _____

CIRCLE NO. 31 ON READER SERVICE PAGE

UNUSUAL BARGAINS

... MANY U. S. GOV'T SURPLUS

GIANT WEATHER BALLOONS

"Balls of fun" for kids, traffic stoppers for stores, terrific for amateur meteorologists. Create a neighborhood sensation. Great backyard fun. Exciting beach attraction. Made of heavy duty neoprene. Inflate with vacuum cleaner or auto air hose, or locally available helium for high rise.

60,568AV (8' diam) \$2 Ppd.
60,632AV (16' diam) \$7 Ppd.



NEW SURPLUS NI-CD BATTERIES



Save more than 50%! Long life—accept 300 charge and discharge cycles. 1.25 Volts per cell—750 milliampere hours capacity. Excel. charge retention. Hermetically sealed. Indefinite storage life. Multiple cells welded in series—easily cut.

Combine to form btry. 7/8" dia. x 1 3/4" high. Spec. price for 100 up. Low-cost charger separate.

Order #	Cells	DC Volt.	Price Ppd.
40,986AV	1	1.25	\$ 1.50
40,987AV	2	2.50	2.75
60,633AV	3	3.75	3.60
60,634AV	4	5.00	4.80
70,812AV	Trickle Charger (1-10 cells)		10.95

Order by Stock No.—Check or M.O. Money-Back Guarantee
EDMUND SCIENTIFIC CO., Barrington, N.J. 08007

GIANT FREE CATALOG

Completely new 1967 edition. New items, categories, illustrations. 148 easy-to-read pages backed with nearly 4000 unusual items. Enormous selection of Astronomical Telescopes, Microscopes, Binoculars, Magnifiers, Magnets, Lenses, Prisms. Many war surplus items; for hobbyists, experimenters, workshop, factory. Write for Catalog "AV." Edmund Scientific Co., Barrington, New Jersey 08007



EDMUND SCIENTIFIC CO. BARRINGTON NEW JERSEY

CIRCLE NO. 12 ON READER SERVICE PAGE

The Heart of your



Radio is
Its



INSIST ON
QQC*

* Controlled Quality Crystals available only from Texas Crystals dealers. Extensive precision testing throughout manufacture enables Texas Crystals to unconditionally guarantee their frequency control crystals. Use of Texas Crystals in space program and by other governmental agencies is evidence of the quality you can count on.

If your dealer can't supply your needs, send his name with your request for catalog to our plant nearest you.



**TEXAS
CRYSTALS**

Division of Whitehall Electronics Corp.

1000 Crystal Drive
Fort Myers, Fla. 33901
Phone: 813-936-2109

4117 W. Jefferson Blvd.
Los Angeles, Calif. 90016
Phone: 213-731-2258

CIRCLE NO. 34 ON READER SERVICE PAGE

SHORT-WAVE ABBREVIATIONS

anmt—Announcement	kHz—Kilohertz
BBC—British Broadcasting Corporation	MHz—Megahertz
B/C—Broadcasting	N.A.—North America
CW—Morse code	QRM—Station interference
Eng.—English	R.—Radio
ID—Identification	RTTY—Radioteletype
IS—Interval signal	s/off—Sign-off
IRC—International reply coupon	s/on—Sign-on
	xmsn—Transmission
	xmtr—Transmitter

newscast. (Further information is requested; we can't find this one listed anywhere—Ed.)

Ethiopia—Station ETLF. *R. Voice of the Gospel*, Addis Ababa, has moved to 15,200 kHz (replacing 15,240 kHz) where it is heard at 1505 in Malgache. The closing anmts, at 1554, are given in French, Malgache, and English.

Germany (West)—*Deutsche Welle*, Cologne, is fine on 9720 kHz at 0130 with news, commentaries, and some music.

Ghana—A new frequency for "The External Service of *R. Ghana*" is 11,850 kHz; it was tuned at 2000 with Eng. news following a multilingual s/on anmt. The Eng. schedule for this station reads: to N.A. at 2000-2100 on 11,850 kHz, and to the Caribbean at the same time on 9760 kHz; at 1500-1545 to South and Central Africa on 17,910 kHz and to Australasia on 21,545 kHz; at 1330-1430 to the Near East on 17,910 kHz; at 1400-2215 to W. Africa on 6130 kHz; at 2045-2215 to Europe on 9545 kHz; and to E. Africa at 1330-1430 on 17,910 kHz, 1500-1545 on 21,720 kHz, 1645-1730 on 15,285 kHz, and 1815-1900 on 15,280 kHz.

Greenland—*Gronlands Radio*, Godthab, has been noted on 3999 kHz with news in native language to 1116 and music by Gershwin following—a most difficult logging as 3999 kHz is just within the 75-meter amateur phone band. This xmsn is not listed on the station's latest verification; only 5960 and 5980 kHz are shown as being in service, along with medium-wave outlets on 570, 650, and 820 kHz.

Honduras—Station HRXW. *R. Comayagueta*, is fair at times on listed 6110 kHz around 1230, announcing as dual to 1200 kHz, with commercials "all the time." Station HRMH. *La Voz del Junco*, is on 6075 kHz with a listeners' request period and some ads around 1100 and later.

Ireland—Listeners needing this country had best try for EIP. *Shannon Aeradio*. Weather broadcasts are given 24 hours daily on the hour and half hour (15 minutes in length) on 5559, 8828.5, and 13,264.5 kHz (day) and 3001 kHz (night). They also operate on 126.0 MHz continuously. Any CW or RTTY enthusiasts can look for EIP on 2868, 2945, 2987, 2931, 5611.5, 5626.5, 5641.5, 5671, 8862.5, 8913.5, 8947.5, 13,284.5, 13,324.5, and 13,354.5 kHz. Reports—and they will be verified—should go to Shannon Aeradio, Ballygireen, Newmart-on-Fergus, Co. Clare, Ireland.

Italy—For medium-wave DX'ers: *Milan 1*, 899 kHz, will increase power from 150 kW to 600 kW in July according to "Notizie RAI," the monthly publication of the Italian B/C Co. Reception reports will be welcome if addressed to RAI TV, Via Arsenale 21, Torino, Italy.

Korea (North)—Pyongyang has been noted on 3560 and 3320 kHz at 1420-1450. The two channels are not in parallel, but both programs feature talks.

Lebanon—Beirut was logged at 0225-0231 in Arabic, under Lisbon, on an almost impossible frequency of 9680 kHz.

Malaysia—*R. Malaysia*, Kuala Lumpur, is on a new frequency, 4895 kHz, as noted at 1402 with Eng. news, dance music, and, at 1500, a concert.

Mexico—Station XEYU. *R. Universitaria de Mexico*, Mexico City, 9600 kHz, is noted at 1700-1800 with recorded symphonic-classical music, ID's, and anmts in Portuguese; the ID indicates a dual channel on 860 kHz. Station XEUMT, R.

POPULAR ELECTRONICS

Universidad Iberoamericana, Sisoguichi, can be heard at times around 1620-1735 on 5960 kHz with lessons and some semi-classical periods (not daily, apparently).

Mozambique—Lourenco Marques is sometimes heard with the "B" program around 0430 on 6050 kHz, and dual to 11,780 and 4855 kHz. Do not confuse this broadcast with Nigeria's Commercial Service which is on a little later.

Netherlands Antilles—Station P.J.B. Bonaire, has ventured into the 16-meter band—it was logged at 2000 s/on in the European Service on 17,775 kHz.

Nicaragua—"Sunrise Serenade" with Eng. annts and music is, at press time, an 1130 feature of YNRG, *R. Zelaya*, Bluefields, on 5954 kHz. Station YNHC, *R. Hernandez Cordoba*, Ocotol, is audible under *Deutsche Welle* (West Germany) on 6100 kHz around 0200 with many Latin American pop tunes and commercials in Spanish, few ID's.

Pakistan (East)—*R. Pakistan*, Dacca, 17.630 kHz, was logged at 1242-1315 in native language. News is given at 1250-1300.

Peru—Back after a lengthy absence is OAX4R, *R. Nacional del Peru*, Lima, 9562 kHz; try for it on Saturdays at 0030 with an Eng. pop music request program or at 0330 with "Musica Peruana." Station OAX3E, *R. Huarez*, has been noted around 0400 in Spanish on 5701 kHz with lengthy musical periods; there is generally RTTY QRM on this channel.

Portuguese Guinea—Bissau is up to 5045 kHz with piano music and some dramatics at 2250; the ID's are in Portuguese and utility stations offer QRM.

SHORT-WAVE CONTRIBUTORS

Nelson Dionne (WPE1FCB), Salem, Mass.
 Ted Greisiger (WPE1FXI), Danbury, Conn.
 Eric Lebowitz (WPE2JYY), Jackson Heights, N. Y.
 William Graham (WPE2LMU), Binghamton, N. Y.
 Richard Kline (WPE2MUY), Englewood, N. J.
 Roger Greene (WPE2NFC), Bronx, N. Y.
 Charles Austin (WPE2NZY), Troy, N. Y.
 Bill Hafner (WPE2OIJ), West Islip, N. Y.
 Jay Rosenhaus (WPE2OKY), Brooklyn, N. Y.
 Robert Hejl (WPE2OMD), Farmingdale, N. Y.
 Bruno Colapietro (WPE2OHO), Endicott, N. Y.
 David Palfrey (WPE2PKC), Kearny, N. J.
 James Rivello (WPE2POK), Cherry Hill, N. J.
 Robert Kennicutt, Jr. (WPE2PRR), Port Crane, N. Y.
 Bob Huber (WPE3GUN), Wilmington, Del.
 Brian Skowron (WPE3HAL), Pittsburgh, Pa.
 Grady Ferguson (WPE4BC), Charlotte, N. C.
 Richard Johnson (WPE4HYZ), St. Petersburg, Fla.
 David Meisel (WPE4IRS), Charlottesville, Va.
 Wayne Day (WPE4JAI), Murfreesboro, Tenn.
 Edward Shaw (WPE4JHP), Roanoke, Va.
 Alan Guinn (WPE4IIR), Bristol, Tenn.
 Richard Mote (WPE5ENZ), Corpus Christi, Texas
 Charles Richman (WPE5GO), Warrenton, Va.
 Maurice Garrick (WPE6ETB), Northridge, Calif.
 Trev Clegg (WPE6FAF), Fresno, Calif.
 Bruce Sebrin (WPE6GTJ), Bethel Island, Calif.
 Bob Palmer (WPE7BB), Spokane, Wash.
 Michael Thompson (WPE7COT), Payson, Utah
 Charles Schwerin (WPE8HYH), Bay City Mich.
 George Boso (WPE8ISO), Lewisburg, W. Va.
 Dan Roberts (WPE8JIV), London, Ohio
 A. R. Niblack (WPE9KM), Vincennes, Ind.
 John Beaver, Sr. (WPE0AE), Pueblo, Colo.
 Dave Lund (WPE0AUO), Oskaloosa, Iowa
 Richard Crume (WPE0DHM), Ferguson, Mo.
 Don Brewer (WPE0EAW), Atchison, Kans.
 Jim Homan (WPE0EUS), Florissant, Mo.
 Kendall Porter (WPE0EVD), Overland Park, Kans.
 Jack Perolo (PY2PEIC), Milwaukee, Wis.
 Robert Jones (VE3PE2W), Belleville, Ont., Canada
Austrian Radio, Vienna, Austria
Sweden Culling DX'ers Bulletin, Stockholm, Sweden
 David Alpert, Morton Grove, Ill.
 George Chapple, Sunnyvale, Calif.
 Donald Cheney, Corvallis, Oregon
 Barry Deal, Ord, Nebr.
 Don Kenney, Westminster, Calif.
 John Matz, Weston, Mass.
 Christopher Schmandt, Philadelphia, Pa.
 Allen Tobin, Eau Claire, Wis.
 Tom Wilk, Chicago, Ill.

compact sets

SPEED DRIVING OF BRISTOL AND ALLEN HEX TYPE SCREWS

**No. 99PS-60
Bristol Multiple Spline Type
Screwdriver Set**

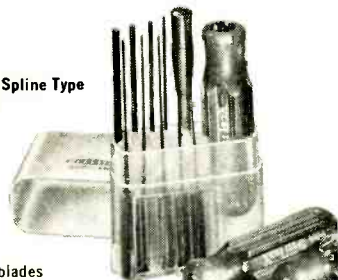

4 and 6-flute blades
with diameters from
.048" thru .183"

**No. 99PS-40 Allen Hex
Type Screwdriver Set**



Hex diameters
from .050" thru 3/16"

Compact, interchangeable blade, Xcelite sets permit quick selection of the right tool for the job. With greater reach than conventional keys, these handy blade and handle combinations make it easier to get at deep set or awkwardly placed socket screws, simplify close quarter work.

Each set contains 9 precision formed, alloy steel, 4" blades; 4" extension; shockproof, breakproof, amber plastic (UL) handle with exclusive, positive locking device.

Sturdy, see-thru plastic cases fit pocket, have flat bases for use as bench stands.

XCELITE

XCELITE INC. • 20 BANK ST., ORCHARD PARK, N. Y.

Send Bulletin N365 on 99PS-60 and 99PS-40 sets.

name _____

address _____

city _____ state & zone _____

CIRCLE NO. 39 ON READER SERVICE PAGE

DX STATES AWARDS PRESENTED

To be eligible for one of the DX States Awards designed for WPE Monitor Certificate holders, you must have verified stations (any frequency or service) in 20, 30, 40, or 50 different states in the U. S. The following DX'ers have qualified for and received awards in the categories indicated.

FIFTY STATES VERIFIED

Billy Williams, Jr. (WPE4EAX), Jacksonville, Fla.
Tony Cashon (WPE0ESL), Chadron, Nebr.
James W. Young (WPE6ENA), Wrightwood, Calif.
Robert H. Brickner (WPE3FYF), Pittsburgh, Pa.

FORTY STATES VERIFIED

Edward Miles (WPE2MHZ), Mineola, N. Y.
Elliot Straus (WPE2NOO), West Orange, N. J.
Ray K. Hartman (WPE9GON), New Berlin, Wis.
Jorge Battle (WPE2GI), Skaneateles, N. Y.
James R. Peshock (WPE5DQD), Richardson, Tex.
Ronald L. Loch (WPE9GJS), Skokie, Ill.
Mike Finigan (WPE4ISQ), Monroe, N. C.
Vincent DeMeis (WPE3FEE), Philadelphia, Pa.
Ed Rudder (WPE4EXY), Halifax, Va.
Pete Sils (WPE8JEV), Fairview Park, Ohio
Gordon Randell (WPE1GGJ), New Bedford, Mass.
Leo Stowell (WPE9HTU), E. Chicago, Ind.
John Schnell (WPE9GLS), West Bend, Wis.
Rick Jemison (WPE9HLZ), Des Plaines, Ill.
Michael A. Jungman (WPE5DQM), Randolph AFB, Tex.
Ronald Hartwig (WPE5ELA), Midland, Tex.

THIRTY STATES VERIFIED

Robert Johnston (VE3PE1SX), Oshawa, Ont., Canada
Samuel Gold (WPE6DXA), San Francisco, Calif.
Gary Phillips (WPE8HND), Dearborn Heights, Mich.
Robert Bruhns (WPE2NTQ), Huntington, N. Y.
Greg Shepard (WPE1GHL), Longmeadow, Mass.
William Thomas (WPE8IGD), Lakewood, Ohio
Donald Dobish (WPE8JF), Cleveland, Ohio
Dave Lalor (WPE5EIQ), Corpus Christi, Tex.
Ross Lambert (WPE2MFS), Riverdale, N. Y.
Arman Dolikian (WPE8IIO), Detroit, Mich.
Steve Curfman (WPE9GWK), East Alton, Ill.
Omar Eckler (WPE2PAM), Rockville Center, N. Y.
Christopher Maslen (WPE2NAO), Buffalo, N. Y.
Lewis Johnson (WPE9INF), Aurora, Ill.
Ronald Sibbitt (VE3PE2HB), Cooksville, Ont., Canada
Rodney Vlach (WPE0EPG), Benson, Minn.
Charles Harris (WPE2OGK), Rochester, N. Y.
Mark Dokulil (WPE6GCI), Reseda, Calif.
Richard Pistek (WPE9HOA), Chicago, Ill.
David Appelt (VE2PE1HU), Montreal, Que., Canada
Mark Filippi (WPE2NPY), Demarest, N. J.
A. E. Fisher (WPE1GHE), Newton, Mass.
Mike Finigan (WPE4ISQ), Monroe, N. C.
Richard Goldfinger (WPE2OOW), Pound Ridge, N. Y.
Donald Hughes (WPE6GBB), San Francisco, Calif.
Robert Fleischer (WPE2CXZ), Clifton, N. J.
Mike Mergler (WPE8JCG), Dayton, Ohio
Lance Muller (WPE6GAI), San Diego, Calif.
Reynold McGinnis (WPE0ERE), Hastings, Nebr.
Thomas Berry (WPE4HPS), Niceville, Fla.
Barry Weisman (WPE1GRQ), Newton, Mass.
Gregory Senko (WPE2OTN), West Long Branch, N. J.
John Czupowski (WPE9ETD), Cicero, Ill.
Ronald Hartwig (WPE5ELA), Midland, Tex.
Kenneth Lyon (WPE2DGV), Lockport, N. Y.
Arthur Martin (WPE0EJY), St. Paul, Minn.

Walter Miscichowski (WPE2BEH), Buffalo, N. Y.
Bruce Pigott (WPE1GMB), Medford, Mass.
John Sheatsley (WPE8JDC), Toledo, Ohio
Robert Mayer (WPE9HQG), Winnetka, Ill.
Marion Lilienthal (VE3PE2DO), Waterloo, Ont., Canada
Peter Bartlett (WPE1FSX), Marshfield Hills, Mass.
Stephen Budensiek (WPE8ISI), Salem, Ohio
William Via (WPE3FHB), Baltimore, Md.
Jack Paton (VE4PE6R), Winnipeg, Man., Canada
Wayne Harrell (WPE5EKB), El Dorado, Ark.
Philip Della Jacova (WPE2OXI), Ozone Park, N. Y.
Peter Orlando (WPE1FRZ), Concord, Mass.
Chuck Dalbec (WPE9GVK), Des Plaines, Ill.
Steve Saftler (WPE1FNV), Brockton, Mass.
Andrew Rekey (WPE9HYJ), Chicago, Ill.
Ray Drozs (WPE9EYU), Chicago, Ill.
Bernard Hughes (G2PE6D), Worcester, England
Cal Craig (WPE8IUR), Parma Heights, Ohio
Gary Zukowski (WPE9HPY), Cicero, Ill.
Dennis Eksten (WPE9DT), Loves Park, Ill.
Glen Jenkins (WPE4IVJ), Camp Lejeune, N. C.
Richard Spritz (WPE3GGE), Elkins Park, Pa.
H. C. Mickle, Jr. (WPE8JBV), Columbus, Ohio
Bertram Heiser (WPE8ITB), Ypsilanti, Mich.
William Cohn (WPE9IRR), Skokie, Ill.
Roger Thering (WPE6FUB), Barstow, Calif.
Ron Miller (WPE9HCG), Peoria, Ill.

TWENTY STATES VERIFIED

Dennis McCabe (WPE1GVB), Bedford, Mass.
James Myers (VE3PE2EJ), Val Val Caron, Ont., Canada
Bill Altigieri (WPE2KXT), Brooklyn, N. Y.
Bruce R. Pigott (WPE1GMB), Medford, Mass.
Stephen V. Maya (WPE4INF), Winston-Salem, N. C.
William B. Keller (WPE1FON), Handen, Conn.
Edward Welsh (WPE2OUU), Pennsauken, N. J.
Virginie Erwin (WPE3GNC), Quakertown, Pa.
Brian Griswold (WPE1GHW), Glastonbury, Conn.
Ferdinando O. Martino, Sr. (WPE6EPZ), Sacramento, Calif.
Barry Leslie Jones (VE3PE1ZP), Willowdale, Ont., Canada
Franklin Davy (WPE2LIO), Frenchtown, N. J.
Edward Suffern (WPE4IUZ), Jacksonville, N. C.
Keith Burton Erickson (WPE9ILB), LeRoy, Ill.
Luther Thompson, Jr. (WPE9HAZ), Lockport, Ill.
Larry Pyrz (WPE9HYF), Argo, Ill.
William Thomas (WPE8IGP), Lakewood, Ohio
Kenneth Cohen (WPE2LZJ), Woodbridge, N. J.
James Meister (WPE1GJA), Westport, Conn.
Timothy C. Armstrong (WPE6GGJ), Suisun, Calif.
Peter Kowalik (WPE3GDR), McKees Rocks, Pa.
Glen A. Jenkins (WPE4IVJ), Camp Lejeune, N. C.
Glenn Little (WPE4IYC), Savannah, Ga.
Larry Schwartz (WPE2NKZ), Linden, N. J.
Robert Wilson (VE3PE2GA), Ottawa, Ont., Canada
Darrell Neron (WPE2OXL), Williamstown, N. J.
William Farmer (WPE0EMF), Bolivar, Mo.
Charles Laddish (VE7PE1BA), Vancouver, B. C., Canada
Ronald Andrzejewski (WPE3GLK), Swoyersville, Pa.
Richard Ardini (WPE1GVT), Medford, Mass.
Jay Budzowski (WPE3GX), New Castle, Pa.
Lynn D. Brooks (WPE5EMY), Lubbock, Texas
John F. de Huarte (WPE3FLS), College Park, Md.
Gerard DeBlois (WPE1GTN), Auburn, Maine
Stanley Forsman (WPE6GIN), Santa Cruz, Calif.



With a Knight-Kit "Star Roamer," Edward C. Shaw, WPE4JHP, Roanoke, Va., has 87 countries logged, 43 verified. Ed calls himself "The Ear of Virginia." His antennas are two Windom half-wave dipoles.

South Africa—R. *RSA*, Johannesburg, continues to move around; at press time, the N.A. xmsns are on 11.880 and 9675 kHz at 2326-0325. R. *Suid Africa*, Johannesburg, is heard well on 7230 kHz, a reactivated channel with the Springbok Service at 0430.

Spanish Guinea—*Transmiste Radio Ecuatorial Bata*, *La Voz de Rio Muni*, is the ID noted during the 2110-2231 listening period (to 2200 on Sundays) which features pop music.

Sweden—Overseas sources list the Swedish coastal station, *Goteburg Radio* (south of Gothenburg), as testing almost continuously on 11.120 kHz. Evidently the tests are conducted in voice xmsns but the language is not indicated; there is said to be no music at any time. Has anyone logged these tests? Reports are welcomed and should go to *Goteburg Radio*, Onsala, Sweden.

Tanzania—When Lisbon closes at 0350 on 5985 kHz, Tanzania is audible at times with native African music and language.

Togo—R. *Togo*, Lome, has been heard with a good signal on 3222 kHz, dual to the more often heard 5047 kHz, from 2130 to 2300 s/off with "Hymn Togolaise."

U.S.S.R.—R. *Ulan Bator* (Mongolian People's Republic) has an Eng. service on Tuesdays, Wednesdays, Fridays and Saturdays at 2200-2300 and 1350-1450 on 9540 and 7340 kHz; the 11.850-kHz channel is no longer being used at this time. DX'ers needing Asiatic Russia, especially those on the East Coast, should tune to R. *Moscow's* Pacific Service from Petropavlovsk (Siberia) on 15.140 and 15.180 kHz at 0300-0400 in English.

Vatican City—*Vatican Radio* is using a number of new frequencies, some upon the recommendation of the Frequency Committee of the Association of North American Radio Clubs. Briefly, they are: 21.510 kHz at 1450 in Eng. to India; 21.485 kHz from 1435 s/on to India and S. E. Asia with an Eng. ID, then Hindi; 17.705 kHz at 1700-1740 in Eng.; 9690 kHz at 0027 in Spanish to Latin America and at 0110 in native language; 9605 kHz in Portuguese at 2040; 7270 kHz at 0025 and 6155 kHz (dual to 7270 and 9690 kHz) to N. A. from 0050 s/on.

Vietnam (North)—Hanoi is now scheduled in Eng. at 1000, 1300, 1530, and 2300, each for a 30-minute period, and in French at 2330-2345, 0415-0430, and 1330-1400 on 7210, 9760, 9840, 11.760, and 11.840 kHz. Local Vietnamese programs have also been noted around 1100 on 4820 kHz.

Vietnam (South)—Saigon, 4877 kHz, is usually good on the West Coast as late as 1530-1600 in Vietnamese with pop and traditional Oriental music and talks; this is dual to the 6165-kHz broadcast which runs at good level until 1630 when a low-powered xmtr evidently replaces the higher powered unit because the signals immediately become unreadable. There is a time signal on the hour, followed by the IS three times and the ID in Vietnamese.

-30-

New sound column

High Fidelity Speaker System

Looks beautiful, sounds excitingly different! Sound column design uses scientific focusing principle to add extra projection to high tones, re-create music with startling fidelity. Ideal for stereo. 33 1/4" h. x 10 1/2" w. x 4" d. 4 Jensen speakers — 2 specially-designed high compliance woofers, 2 direct radiator tweeters. 50 to 17,000 cps. Cabinet of genuine walnut with oiled finish . . . designed to hang on the wall like a picture.

The Astra

\$49.95 each
audiophile net

Argos
PRODUCTS COMPANY

Write for free catalog showing Argos systems for every purpose

Dept. C 600 S. Sycamore St., Genoa, Ill. 60135
CIRCLE NO. 4 ON READER SERVICE PAGE

CTI AUTOMATION ELECTRONICS HELPS YOU CRACK THE \$12,000-A-YEAR BARRIER

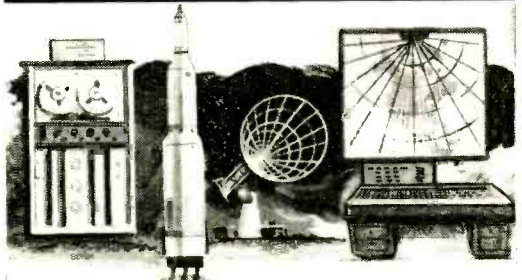

This is one of America's fastest growing industries! It offers higher pay, more job security and more job opportunities than most other fields. If you are 18 or over and want an exciting, big pay future in this dynamic field, CTI training is for you! Get the facts that can put more money in your pockets—fast! Use the coupon to send for the free CTI book—now!

APPROVED FOR GI TRAINING If you served since January 31, 1955 or are in service, check GI line in coupon

COMMERCIAL TRADES INSTITUTE—Dept. PE-667
1400 Greenleaf, Chicago, Illinois 60626

Name _____ Age _____
Address _____ Phone _____
City _____ State _____ County _____
Zip Code _____ Check for facts on GI Bill

C. T. I. is an Accredited Member National Home Study Council

INDEX

TO VOLUME 26

JAN.—JUNE 1967

AMATEUR RADIO

Amateur Radio (Brier)	
Transmitter Power vs. Communications Range	85 Jan.
CW is Dead (?)	84 Feb.
Thumbnail Review of TR-108 Two-Meter Transceiver	85 Mar.
World Peace and Amateur Radio	79 Apr.
The Fascination of Amateur Radio	93 May
Amateur Radio Has a Field Day	71 June
Amateur Radio for CB'ers (Lange)	
Part 1	51 May
Part 2	59 June
AMLIGNER (Lancaster)	60 Feb.
"Camper's Cuzzin" (Smith)	55 Mar.
Multi-Master (Boross)	75 Jan.
NBFM Routs 6-Meter TVI (Winklepleck)	73 Feb.
"R.F." Sniffer" (Ashe)	55 June
"Trans-Vox" (Caringella)	57 Jan.
VFO, Incredible (Winklepleck)	69 Apr.

AUTOMOTIVE ELECTRONICS

Auto Theft, Stamp Out (Winklepleck)	59 Mar.
Mini-Verb (Meyer)	41 May
Stethoscope, Electronic (Stella)	33 May
Tachometer, \$6 Electronic (Staerzl)	61 Apr.
Tune-Up Time, It's Spring	66 May

CITIZENS BAND RADIO

Amateur Radio for CB'ers (Lange)	
Part 1	51 May
Part 2	59 June
CB "Audio Leveler" (Meyer)	55 Feb.
CB En Route—Is It Worthwhile? (Burr)	82 Apr.
CB Radio Call Monitor (Peterson)	54 Jan.
CB Rig, Getting the Most from Your (Meyer)	72 Apr.
FCC Proposes CB "Type Acceptance" (Ferrell)	78 May
"Mule Box" (Meyer)	45 Mar.
On the Citizens Band (Spinello)	
The Walkie-Talkie Dilemma	83 Jan.
CB Club Success Story	80 Feb.
GRS Delegates Convene	80 Mar.
Questions & Answers	81 Apr.
Club Paper Swap Shop	95 May
CB Jamboree Season	73 June
"R.F. Sniffer (Ashe)	55 June
"Trans-Vox" (Caringella)	57 Jan.

CONSTRUCTION

AMLIGNER (Lancaster)	60 Feb.
Amplifier, Solid-State Line-Operated Audio (Greenlee)	41 June
Auto Theft, Stamp Out (Winklepleck)	59 Mar.
Brute-70" (Louis)	41 Feb.

"Camper's Cuzzin" (Smith)	55 Mar.
"Capsnapper" Arrests Shock Hazard (Rosenblatt)	23 Apr.
"Clatter" Stopper (Chapel)	57 June
CB "Audio Leveler" (Meyer)	55 Feb.
CB Radio Call Monitor (Peterson)	54 Jan.
CB Rig, Getting the Most from Your (Meyer)	72 Apr.
Coherer, Make Your Own (Davis)	50 May
Convert Your "All-American 5" to Marine Band (Conner)	71 Feb.
FET Set, Introducing (Allhouse)	27 May
Frequency Meter, Electronic (Henry)	73 May
"Fuzzbox" for Under \$3 (Anderton)	87 Jan.
Get More VHF on AM/FM Transistor Radios (Tabias)	35 June
Liquid Level Indicator for Blind (Cranmer)	59 May
NBFM Routs 6-Meter TVI (Winklepleck)	73 Feb.
"Maggie," Simple-Minded (Gierke)	31 June
Metal Locator, IC-67 (Lancaster)	41 Jan.
Mini-Verb (Meyer)	41 May
Motor, "Magic" (Ford)	68 Jan.
"Mule Box" (Meyer)	45 Mar.
"Multi-Master" (Boross)	75 Jan.
Необычная телевизионная антенна (Zelle)	68 Apr.
New Dimension in Portable Radio Listening (Trauffer)	43 June
"Pennant Race" Special (Burr)	31 May
Preamplifier, "Two-By-Two" Stereo (Meyer)	69 Mar.
Remote-Control System, Carrier-Current (Zarr)	50 Jan.
"R.F. Sniffer" (Ashe)	55 June
Sequence-Operated Lock (Anderson)	73 Jan.
Signal Tracer, Multipurpose FET (Randall)	43 Apr.
Sound Sync'er (Lowe)	59 Apr.
Speaker System, Mixed Twelve (Weems)	75 Mar.
Out of Tune	14 Apr.
Stacked-Antenna AM Radio (Trauffer)	40 May
Stethoscope, Electronic (Stella)	33 May
Supertrol (Lancaster)	41 Mar.
Tachometer, \$6 Electronic (Staerzl)	61 Apr.
Tic, Tac, Toe, Electric (Greenberg)	74 Apr.
Timer, Firing-Range (Hadlock)	37 June
Transistor and Diode Tester, Breakdown Reverse Voltage (Rakes)	67 May
"Trans-Vox" (Caringella)	57 Jan.
VFO, Incredible (Winklepleck)	69 Apr.
VOM Range Splitter (Rossnick)	70 Jan.

DEPARTMENTS

Electronics Library	16 Jan., 14 Feb., 26 Mar., 34 Apr., 16 May, 27 June
Ham Hobby Clearinghouse	30 Jan., 30 Mar.
Letters From Our Readers	8 Jan., 8 Feb., 8 Mar., 8 Apr., 8 May, 8 June
New Literature	26 Jan., 32 Feb., 36 Apr., 98 May, 29 June
New Products	22 Jan., 22 Feb., 22 Mar., 24 Apr., 22 May, 22 June
Operation Assist.	32 Jan., 34 Feb., 32 Mar., 28 Apr., 101 May, 14 June
Out of Tune	"Square Deal" Audio Generator (Nov. 1966, p. 59)..... 12 Jan.
Mixed Twelve System (Mar. 1967, p. 74)..... 14 Apr.	
Tips & Techniques	14 Jan., 26 Feb., 14 Mar., 16 Apr., 99 May, 82 June

FEATURE ARTICLES

Amateur Radio for CB'ers (Lange)	
Part 1	51 May
Part 2	59 June
Announcing: Unusually Adaptable Computer	88 Apr.
Biological Radio—ESP (Halacy)	53 Apr.

"Callithump," Popular Electronics (Queen & Kruzcek).....	32 May
"Coherer" (Davis).....	47 May
Tuning and Using.....	50 May
Communications Mystique (Miller).....	49 Jan.
Electronics Counterman (Miller).....	72 May
FCC Proposes CB "Type Acceptance" (Ferrell).....	78 May
For Whom Does the System Toll? (Lacy).....	65 June
Heterodyne Vegetation Meter (Morse).....	72 Jan.
Hobbyist, The (Miller).....	94 Apr.
Information Central (Schauers).....	
68 Feb., 66 Mar., 76 Apr., 81 May,	68 June
Meet Mr. FET (Garner).....	47 Feb.
Quizzes	
Power Supply Identification (Atkinson).....	86 Jan.
Semiconductor (Todd).....	59 Feb.
Graph Interpretation (Balin).....	63 Apr.
Electronics I.Q. (Balin).....	80 May
Two Letter (Balin).....	80 June
TV Color Bar Generators (Cornell).....	48 Apr.
TV Tuner, Taming Your (Smith).....	51 Mar.
Wiring Your Home for TV (Zappa).....	44 June
Selecting Antennas.....	45 June
Selecting Amplifiers and Splitters.....	48 June
Selecting Transmission Lines.....	50 June
Installing the System.....	52 June
Servicing the System.....	54 June
Zero-Beating the News.....	66 Jan., 66 Feb.

HI-FI/STEREO AND AUDIO

Amplifier, Solid-State Line-Operated Audio (Greenlee).....	40 June
"Brute-70" (Louis).....	41 Feb.
Frequency Meter, Electronic (Henry).....	73 May
"Fuzzbox" for Under \$3 (Anderton).....	87 Jan.
Mini-Verb (Meyer).....	41 May
New Dimension in Portable Radio Listening (Trauffer).....	43 June
Preamplifier, "Two-By-Two" Stereo (Meyer).....	69 Mar.
Sound Sync'er (Lowe).....	59 Apr.
Speaker System, Mixed Twelve (Weems).....	75 Mar.
Out of Tune.....	14 Apr.
"Trans-Vox" (Caringella).....	57 Jan.

PRODUCT REPORTS

It's Spring Tune-up Time (EICO 888).....	66 May
Two-Meter Transceiver (Knight-Kit TR-108).....	85 Mar.
VOM Kit, A New (Knight-Kit KG-640).....	54 Feb.

SCIENCE FAIR PROJECTS

Coherer, Make Your Own (Davis).....	50 May
Metal Locator, IC-67 (Lancaster).....	41 Jan.
Motor, "Magic" (Ford).....	68 Jan.
Simple-Minded "Maggie".....	31 June
Stethoscope, Electronic (Stella).....	33 May
Supertrol (Lancaster).....	41 Mar.
Tic Tac Toe, Electric (Greenberg).....	74 Apr.

SHORT-WAVE LISTENING

Broadcasts from Asia and Oceania (Legge).....	82 Jan.
DX Countries Awards Presented.....	116 Feb.
DX Provinces Awards Presented.....	116 Apr.
DX States Awards Presented.....	110 June
English-Language Broadcasts to North America (Legge).....	
80 Jan., 82 Feb., 84 Mar., 86 Apr., 92 May, 78 June	

Foreign-Language Broadcasts to North America (Legge).....	82 Mar., 84 May
Short-Wave Listening (Bennett).....	
International Telecommunications Union Logs	81 Jan.
Misinformation Verified.....	83 Feb.
BBC Verification Policies.....	83 Mar.
Spring Catch—North Sea Hospital Ship.....	87 Apr.
Broadcasting Station News Around the World	61 May
New Broadcasting Stations in Cuba.....	79 June
Short-Wave Certificate Application.....	115 Jan., 115 Mar.

SOLID-STATE CIRCUITS

AMLIGNER (Lancaster).....	60 Feb.
Amplifier, Solid-State Line-Operated Audio (Greenlee).....	41 June
"Brute-70" (Louis).....	41 Feb.
"Camper's Cuzzin" (Smith).....	55 Mar.
"Clatter" Stopper (Chapel).....	57 June
CB "Audio Leveler" (Meyer).....	55 Feb.
FET Set, Introducing (Allhouse).....	27 May
Frequency Meter, Electronic (Henry).....	73 May
Meet Mr. FET (Garner).....	47 Feb.
Metal Locator, IC-67 (Lancaster).....	41 Jan.
Mini-Verb (Meyer).....	41 May
"Mule Box" (Meyer).....	45 Mar.
"Multi-Master" (Boross).....	75 Jan.
NBFM Routs 6-Meter TVI (Winklepleck).....	73 Feb.
Preamplifier, "Two-By-Two" Stereo (Meyer).....	69 Mar.
Remote-Control System, Carrier-Current (Zarr).....	50 Jan.
"R.F. Sniffer" (Ashe).....	55 June
Signal Tracer, Multipurpose FET (Randall).....	43 Apr.
Solid State (Garner).....	
77 Jan., 77 Feb., 78 Mar., 83 Apr., 85 May, 75 June	
Sound Sync'er (Lowe).....	59 Apr.
Stacked-Antenna AM Radio (Trauffer).....	40 May
Stethoscope, Electronic (Stella).....	33 May
Supertrol (Lancaster).....	41 Mar.
Tachometer, \$6 Electronic (Staerzl).....	61 Apr.
Timer, Firing-Range (Hadlock).....	37 June
Transistor and Diode Tester, Breakdown Reverse Voltage (Rakes).....	67 May
"Trans-Vox" (Caringella).....	57 Jan.

TELEVISION

For Whom Does the System Toll? (Lacy).....	65 June
Необычная телевизионная антенна (Zelle).....	68 Apr.
TV Tuner, Taming Your (Smith).....	51 Mar.
TV Color Bar Generators (Cornell).....	48 Apr.
Wiring Your Home For TV (Zappa).....	44 June
Selecting Antennas.....	45 June
Selecting Amplifiers and Splitters.....	48 June
Selecting Transmission Lines.....	50 June
Installing the System.....	52 June
Servicing the System.....	54 June

TEST EQUIPMENT

AMLIGNER (Lancaster).....	60 Feb.
Frequency Meter, Electronic (Henry).....	73 May
"Multi-Master" (Boross).....	75 Jan.
"R.F. Sniffer" (Ashe).....	55 June
Signal Tracer, Multipurpose FET (Randall).....	43 Apr.
Stethoscope, Electronic (Stella).....	43 Apr.
Transistor and Diode Tester, Breakdown Reverse Voltage (Rakes).....	67 May
TV Color Bar Generators (Cornell).....	48 Apr.
VOM Kit! A New.....	54 Feb.
VOM Range Splitter (Rossnick).....	70 Jan.

POPULAR ELECTRONICS SUBSCRIBER SERVICE

Please include an address label when writing about your subscription to help us serve you promptly. Write to: Portland Place, Boulder, Colo. 80302

Change of Address:
Please let us know you are moving at least 4 weeks in advance. Affix magazine address label in space to the right and print new address below. If you have a question about your subscription, attach address label to your letter.

To Subscribe:

Check boxes below.

- New Renewal
- 5 years \$20
- 3 years \$13
- 1 year \$5

Specify

- Payment enclosed
—You get 1 extra issue per year as a Bonus!
- Bill me later.

AFFIX LABEL

If you have no label handy, print OLD address here.

name
please print

address

city

state

zip code

name please print 0214

address

city

state zip code

TELEVISION RADIO COLOR TV

MAIL COUPON FOR FREE BOOK

Coyne Electronics Institute Dept. A7-C2
1501 W. Congress Pkwy., Chicago, Ill. 60607

Send information as checked below

- HOME TRAINING in TV • Radio • Color TV • Electronics
- RESIDENT SCHOOL COURSES in Electronics, Electricity, Engineering, Radio-TV, Color TV, Refrigeration, and FCC

Name.....

Address.....

City..... State..... Zip.....

Phone..... Age.....

VA Approved—GI Bill

ON THE CITIZENS BAND

(Continued from page 74)

1967 OTCB CLUB ROSTER

Citizens Band clubs that have not reported to this column in the last 12 months should forward current membership totals, list of officers, club activities, and sample membership card and decal, if available. Photographs of activities, emergency teams, and any unusual applications of CB radio would also be appreciated. And please put us on the list to receive your monthly newspaper or bulletin. Send all material to Matt P. Spinello, CB Editor, POPULAR ELECTRONICS, One Park Avenue, New York, N.Y. 10016.

Austin, Indiana—*Progressive CB Club, Inc.* Current membership: 40. Group publishes monthly newsletter, holds annual jamboree. "coffee calls," and other projects to earn operating funds and to make donations to local organizations. Officers: Chester Sogn, president; Robert Hall, vice president; Charles Hickman, secretary; Joyce High, treasurer. Editor of club newspaper is Carl Hickman.

Waterloo, Iowa—*Northeast Iowa Citizens Band Radio Club, Inc.* Membership of 70 abides by articles of incorporation under Iowa state law, as



well as a set of club bylaws. Current officers: Bonnie Schoenfeld, K1H2656, president; Paul Katcher, KGI6441, vice president; Carol Maurer, K1H2224, secretary/treasurer; Ray Zummak, K1G8139, public relations; and a five-man board of directors.

Yonkers, New York—*Good Guy REACT of Southern Westchester.* A new branch of REACT (Radio Emergency Associated Citizens Teams) is starting with a membership of 12. The Good Guy team will serve Yonkers, Mount Vernon, New Rochelle, Scarsdale, and surrounding areas in lower Westchester County, N.Y. Coordinators for the team are Freddy Shaw, KMD1251, and Greg Greenbaum, KOD6836. The club will abide by all REACT rules and objectives, and is planning a jamboree for this summer.

Wilson, North Carolina—*Wilsonian CB Radio Club.* This club has just published its first newspaper—clean-cut—with more to come; the editor is Charles Williams, Jr., KC16790. Club was recently instrumental in collecting funds from CB'ers in a five-county area to present a blind CB'er with a transceiver. Current officers: Glenn Beaman, KCJ5580, president; Garnell Creech, KCJ9187, vice president; Alvin Ballance, KCJ5604, secretary; and Robert Whitley, KCJ5050, treasurer.

Other clubs reporting: In Covington, Kentucky, *Brent Spence Emergency Team*; in Kansas City, Missouri, *KANMO Headquarters of REACT*; in Tullahoma, Tennessee, *Windy City CB Radio Club.* I'll CB'ing you.

—Matt, KHC2060

ELECTRONICS MARKET PLACE

COMMERCIAL RATE: For firms or individuals offering commercial products or services. \$1.00 per word (including name and address). Minimum order \$10.00. Payment must accompany copy except when ads are placed by accredited advertising agencies. Frequency discount: 5% for 6 months; 10% for 12 months paid in advance.

READER RATE: For individuals with a personal item to buy or sell. 60¢ per word (including name and address). No Minimum! Payment must accompany copy.

FOR SALE

FREE! Giant bargain catalog on transistors, diodes, rectifiers, SCR's, zeners, parts. Poly Paks, P.O. Box 942, Lynnfield, Mass. 01940.

GOVERNMENT Surplus Receivers, Transmitters, Snooperscopes, Radios, Parts, Picture Catalog 25¢. **Meshna**, Nahant, Mass. 01908.

WEBBER LAB'S Police—Fire Transistorized Converter kit 30-50mc. & 100-200mc. (1 mc. spread) \$5.00 each. 26-200mc. on broadcast band using any type radio, crystal controlled \$23.00 wired pp. tunable—crystal controlled \$11.00 kit. 72 Cottage Street, Lynn, Mass. 01905.

JAPAN & Hong Kong Electronics Directory. Products, components, supplies. 50 firms—just \$1.00. Ippano Kaisha Ltd., Box 6266, Spokane, Washington 99207.

INVESTIGATORS, FREE BROCHURE, LATEST SUBMINIATURE ELECTRONIC SURVEILLANCE EQUIPMENT, ACE ELECTRONICS, 11500-L NW 7TH AVE., MIAMI, FLA. 33168.

CB-WPE-QSL CARDS. Same High Quality, Beautiful, Glossy multi-color cards. New **LOW PRICES. SAMPLES, 25¢.** Dick, WBVXK, 19QA0625, Gladwin, Mich. 48624.

R.F. CONVERTERS. World's largest selection. Also CCTV cameras, etc. Lowest factory prices. Catalog 10¢. Vanguard 196-23 Jamaica Ave., Hollis, N.Y. 11423.

RECTIFIERS, transistors, other components. Catalog free. Electronic Components Co., Box 2902C, Baton Rouge, La. 70821.

TELEPHONE VOICE SWITCH: (LS-500). ACTUATES AUTOMATICALLY AND UNATTENDED ANY TAPE OR WIRE RECORDER. PICTORIAL INSTALLATION INSTRUCTIONS INCLUDED. \$23.75. POST PAID USA, WJS ELECTRONICS, 737 NORTH SEWARD, HOLLYWOOD, CALIF. 90038.

INVESTIGATORS: KEEP IN STEP WITH ADVANCEMENTS IN THE ART OF ELECTRONICS FOR THE PROFESSIONAL. SEND \$1.00 FOR EQUIPMENT BROCHURE. WJS ELECTRONICS, 737 NORTH SEWARD, HOLLYWOOD, CALIF. 90038.

BUG DETECTOR: WILL DETECT AND LOCATE SURREPTITIOUS TRANSMITTING DEVICES IN CONFERENCE ROOMS, HOME AND OFFICES, ETC. WRITE FOR DETAILS. WJS ELECTRONICS, 737 NORTH SEWARD, HOLLYWOOD, CALIF. 90038.

DETECTIVES! Free Brochures! Electronic Surveillance Devices. SILMAR ELECTRONICS, 3476 N.W. 7th Street, Miami, Fla. 33125.

CIRCUIT Boards, Parts for "Poptronics" projects. Free catalog. DEMCO, Box 16297, San Antonio, Texas 78216.

ROCKETS: Ideal for miniature transmitter tests. New illustrated catalog, 25¢. Single and multistage kits, cones, engines, launchers, trackers, rocket aerial cameras, technical information. Fast service. Estes Industries, Penrose 18, Colorado 81240.

LOWEST Prices Electronic Parts. Confidential Catalog Free. KNAPP, 3174 8th Ave. S.W., Largo, Fla. 33540.

GENERAL INFORMATION: First word in all ads set in bold caps at no extra charge. Additional words may be set in bold caps at 10¢ extra per word. All copy subject to publisher's approval. Closing Date: 1st of the 2nd preceding month (for example, March issue closes January 1st). Send order and remittance to: Hal Cymes, POPULAR ELECTRONICS, One Park Avenue, New York, New York 10016.

SURVEILLANCE EQUIPMENT—NEW HIGH PERFORMANCE SUBMINIATURE MODELS. ELECTRONIC COUNTERMEASURE DEVICES TO PROTECT PRIVACY. FREE DATA: SECURITY ELECTRONICS-PE, 15 EAST 43RD STREET, NEW YORK, N.Y. 10017.

CB-QSL CARDS. New Designs, Record Books, Blabbermouth Awards, Gag Signs, Warning Decals, Novelties. Free Brochure. **WOODY, 8474 Watson, St. Louis, Mo. 63119.**

FREE ELECTRONICS (new and surplus) parts catalog. We repair multimeters. Bigelow Electronics, Bluffton, Ohio 45817.

NEW supersensitive transistor instrument detects buried gold, silver, coins. Kits, assembled models. \$19.95 up. Free catalog. Relco-A33, Box 10563, Houston, Texas 77018.

CONVERT any television to sensitive, big-screen oscilloscope. Only minor changes required. No electronic experience necessary. Illustrated plans, \$2.00. Relco-A33, Box 10563, Houston, Texas 77018.

COMPONENTS? Kits? Hardware? For catalogue write Trans-Vu-Pacs, Box 267, Chelsea, Mass. 02150.

DIAGRAMS—Radios \$1.00, Television \$2.50. Give make and model. Diagram Service, Box 1151PE, Manchester, Conn. 06042.

MUSIC LOVERS, CONTINUOUS, UNINTERRUPTED BACKGROUND MUSIC FROM YOUR FM RADIO, USING NEW INEXPENSIVE ADAPTOR. FREE LITERATURE. ELECTRONICS, 11500-Z NW 7th AVE., MIAMI, FLORIDA 33168.

MESHNA'S Transistorized Converter Kit \$5.00. Two models; converts car radio to receive 30-50mhz or 100-200mhz (one mhz tuning) Meshna, No. Reading, Mass. 01864.

CLOSED-CIRCUIT TV—Industrial, educational. Factory-direct prices. Write for particulars. **ATV RESEARCH, Box 396P, Industrial Division, South Sioux City, Nebr. 68776.**

TV CAMERA PLANS. Best available. Tube model, vidicon—\$3.00; transistor—\$5.00 (deductible). Flying spot scanner—\$2.50. **ATV RESEARCH, Box 396P, So. Sioux City, Nebr. 68776.**

SEE YOURSELF ON TV! Exciting hobby lets you televise live pictures right in your own home. Kits from \$18.95 to \$149.50. Catalog 10¢. **ATV RESEARCH, Box 396P, Amateur Division, South Sioux City, Nebr. 68776.**

110VAC 60cy from car generator. Powers lights, refrigerator, transmitter, receiver, etc. Simple, easy to convert. Plans, \$2.00. Tedco, Box 12098, Houston, Texas 77017.

SUDYMONT acoustic baffles. Plans \$5.95; Baffle \$26.95; with cabinet from \$39.95. Send speaker size. **SUDYMONT, 120 Liberty Str. NYC. 10006.**

COMPUTER circuit boards containing many valuable components. Ideal for hobbyists, experimenters. 3 for \$1.00 ppd. L. Short, Box 332, Kennesaw, Georgia 30144.

TELEPHONE RECORDER-ACTUATOR (TWI-007). SOLID STATE MODULE AUTOMATICALLY TURNS TAPE RECORDER, AMPLIFIER, INDICATOR LIGHT ON WHEN TELEPHONE IN USE. CONNECTED ANYWHERE ON LINE. SIMPLE INSTALLATION INSTRUCTIONS INCLUDED. PREPAID \$22.85. SURVEILLANCE RECORDER: (TWI-1000), (TWI-1010). TWILIGHT ELECTRONICS, BOX 11595-A, ST. LOUIS, MISSOURI 63105.

HOBBYISTS, EXPERIMENTERS, Amateur Scientists, Students . . . Construction Plans—All complete including drawings, schematics, parts lists, prices, parts sources . . . Laser—Build your own coherent-light optical laser. Operates in the pulsed mode, the visible light range—\$6.00 . . . Diode Laser—Invisible Light (infrared) can be continuously modulated—\$3.00 . . . Reverberator (Echo) Unit—Build your own. Use with your automobile radio, home radio or hifi, electric guitar, etc.—\$3.00 . . . Radar—Build your own ultrasonic doppler radar. Detect motion of people, automobiles, even falling rain drops. Transistorized, uses standard small 9-volt battery—\$4.00 . . . Long-Range "Sound Telescope"—This amazing device can enable you to hear conversations, birds and animals, other sounds hundreds of feet away. Very directional. Transistorized. Uses 9 V battery—\$3.00 . . . Or send 25¢ coin or stamps for complete catalogue . . . Technical Writers Group, Box 5501, State College Station, Raleigh, N.C. 27607.

FREE CATALOG—LOADS OF ELECTRONIC BARGAINS. R. W. ELECTRONICS, INC. 2244 So. Michigan Avenue, Chicago, Illinois 60616.

CRYSTALS . . . largest selection in United States at lowest prices. 48 hr. delivery. Thousands of frequencies in stock. Types include HC6/U, HC18/U, FT-241, FT-243, FT-171, etc. Send 10¢ for catalog with oscillator circuits. Refunded on first order. Jan Crystals, 2400F Crystal Dr., Fort Myers, Fla. 33901.

RADIO — T.V. Tubes—33¢ each. Send for free catalog. Cornell. 4213 University, San Diego, Calif. 92105.

SPACE AGE SILENT GUN Propels projectiles without gas—powder or air utilizing pulsed magnetic phenomena. Flashlight batteries or AC power. Engineering drawings, part sources \$3.00. Magnetic Research, Box 1711, Cedar Rapids, Iowa 52406.

NEW PRODUCT FOR ELECTRONIC TRANSDUCERS! One drop of force paint makes a transducer with **LITTLE** weight or volume. **AIR DRYING;** apply to any shape between conductive surfaces. **HUNDREDS** of transducers can be made from 1 oz. of fluid. A **DROP** of liquid will change resistance **THOUSANDS** of ohms; will operate

relays, recorders, and solid state circuits **WITHOUT** amplifier. Price \$20.00 oz. **DEAN ELECTRONICS**, Box 9265, N. Hollywood, California 91609.

WE SELL CONSTRUCTION PLANS. AMAZING NEW SUPER HOBBY CATALOG 25¢. TELEPHONE: Answering Machines, Speakerphones, Mobilephones, Automatic Dialers, Central Dial Systems, Voice Scramblers, Legal Connectors, Unit Message Alarm. **TELEVISION:** Cameras, 3D Converters, Color TV Converters, Video Recorders. **HOBBYIST:** Teletypes, Electron microscopes, Translizers, Private Eye Tail Transmitter, Fingerprint Identifier. Plans \$4.95 each. Silent Listening Device **DYNAMITER** Plans \$8.50. **COURSES:** Detective Electronics \$22.50, Telephone Engineering \$39.50, Cryptographic and Security Electronics \$27.50. Don Britton Enterprises, 7906 Santa Monica Blvd., Hollywood, Calif. 90046.

EXPERIMENTERS Having trouble understanding **TRANSISTOR** Terminology? Our pamphlet can help you. Includes **FIELD EFFECT.** Only \$1.00. Williams, Box 2131, Lehigh Valley, Penna. 18001.

CATHODIC Protection instructions \$1.00. F.F. Knapp, P.O. Box 854, Scottsdale, Arizona 85252.

NEED RESISTORS? All standard values—only 5¢ each! (½ watt) **FREE** bargain sheet. Crown TV Service, 175 Davey Street, Bloomfield, New Jersey 07003.

AUTOMATIC Degaussing easily added to Heath 21" Color TV. Information free. Box 2965-P, Amarillo, Texas 79105.

SOLID STATE SALES, would like to send you one of their free catalogs. They have for sale transistors, rectifiers, zeners, SCR's, biswitches and many other semiconductor devices in small and large quantities. **ALL DEVICES ARE CHECKED AND GUARANTEED. INTEGRATED CIRCUIT (JK,SR,SRT FLIP FLOPS AND GATES)** with checked inputs and diagrams are available. Solid State Sales, Box 74F, Somerville, Mass. 02143.

JAPANESE or EUROPEAN DIRECTORY 200 firms \$1.00. **SURVEILLANCE EQUIPMENT**, wireless **SNOOPERMIKE** \$25.00, **SUBMINNIMIKE** ¾ x ¾ x ¾/16 \$4.00. Brochure 25¢, **SIERRATRONICS**, Box 7497, Las Vegas, Nev. 89101.

CLASSIFIED ADVERTISING ORDER FORM

Please refer to heading on first page of this section for complete data concerning terms, frequency discounts, closing dates, etc.

1	2	3	4	5
6	7	8	9	10
11	12	13	14	15
16	17	18	19	20
21	22	23	24	25
26	27	28	29	30
31	32	33	34	35

Words { @ 60¢ (Reader Rate) }
 { @ \$1.00 (Commercial Rate) } = \$ _____

Insert _____ time(s) Total Enclosed \$ _____

NAME _____

ADDRESS _____

CITY _____ STATE _____ ZIP _____

Signature _____

WORD COUNT: Include name and address. Name of city (Des Moines) or of state (New York) counts as one word each. Zone or Zip Code numbers not counted. (Publisher reserves right to omit Zip Code if space does not permit.) Count each abbreviation, initial, single figure or group of figures or letters as a word. Symbols such as 35mm, COD, PO, AC, etc., count as one word. Hyphenated words count as two words.

PE-667

ELECTRONIC Listening Device. Send \$1.00 For Diagrams Of Subminiature Integrated Transmitter. B. H. Industries, Box 5174, Pasadena, Calif. 91107.

ELECTRONIC, mechanical devices catalog 10¢. Transistor boards bonanza \$5.95, **FERTIK'S**, 5249 "D," Phila. Pa. 19120.

INTEGRATED CIRCUIT Experiment Kit, \$6.95. **FET** converts your Vom to 10 Megohm input impedance. Plans, \$1.00. Others. Catalogue 25¢. Kaye, Box 3932, Long Beach, Calif. 90803.

PLANS AND KITS

"CRYSTAL SET CONSTRUCTION" Handbook—50¢. Catalog. Laboratories, 12041-L Sheridan, Garden Grove, Calif. 92640.

ALLWAVE RADIO KIT. Tube, transistor included \$5.00. Headset \$2.50. Ekeradio, Box 131, Temple City, Calif. 91780.

SUPER SNOOPER, printed Circuit Kit \$5.95. Others. Lectronix, Box 42, Madison Heights, Michigan 48071.

SHORTWAVE LISTENING

SWL PROGRAM GUIDE, listings by the hour, \$2.00. Better Shortwave Reception, \$3.40. Fun of SWLing, \$1.00. **ALL** Books for SWLs. SWL Guide, 218 Gifford, Syracuse, N.Y. 13202.

ALL SAMS BOOKS advertised in PE mailed same day. Catalog. SWL Guide, 13202.

POLICE—FIRE—AIRCRAFT—MARINE—AMATEUR CALLS on your broadcast radio with **TUNAVERTER!** Tune The Band! Economical! Guaranteed! Free Catalog! Salch Co. Dept. PE3, Woodsboro, Texas 78393.

BLUE EAGLE REPORT 60 cents, **SPANISH COUNTING STATIONS REPORT** 10 cents and **ITU BC ZONE MAP** 10 cents. Order from **SWL PUBLICATIONS, Inc.**, P. O. Box 9768, KANSAS CITY, MO. 64134.

HIGH FIDELITY

FREE! Send for money saving stereo catalog #P6E and lowest quotations on your individual component, tape recorder, or system requirements. Electronic Values, Inc., 200 W. 20th St., New York, N.Y. 10011.

HI-FI Components, Tape Recorders, at guaranteed "We Will Not Be Undersold" prices. 15-day money-back guarantee. Two-year warranty. No Catalog. Quotations Free. Hi-Fidelity Center, 239 (P) East 149th Street, New York 10451.

"LOW, Low quotes: all components and recorders. Hi-Fi, Roslyn, Penna. 19001.

TAPE RECORDERS, Hi-Fi, components, Sleep Learning Equipment, tapes. Unusual Values Free Catalog. Dressner, 1523R, Jericho Turnpike, New Hyde Park, N. Y. 11040.

EVERYONE can afford **HIGH FIDELITY** components—because of our **DISCOUNT** policy. Insured guaranteed shipments—Factory sealed cartons—**FRANCHISED**. Send for our **LOW-LOW** quote today. Sound and Sight Audio, Inc. 106 West 32 Street, New York, N. Y. 10001.

TUBES

TUBE Headquarters of World! Send 10¢ for Catalog (tubes, electronic equipment) Barry, 512 Broadway, N.Y.C. 10012.

TUBES "Oldies", latest. Lists free. Steinmetz, 7519 Maplewood, Hammond, Indiana 46324.

FREE Catalog. Electronic parts, tubes. Wholesale. Thousands of items. Unbeatable prices. Arcturus Electronics ZD, 502-22 St., Union City, N.J. 07087.

RADIO & T.V. Tubes—33¢ each. Send for free list. Cornell, 4213 University, San Diego, Calif. 92105.

RECEIVING & INDUSTRIAL TUBES, TRANSISTORS. All Brands—Biggest Discounts. Technicians, Hobbyists, Experimenters—Request **FREE** Giant Catalog and **SAVE!** **ZALYTRON**, 469 Jericho Turnpike, Mineola, N.Y. 11501.

RAYTHEON, SYLVANIA, RCA, etc., 100 lots 70% off. Less than 100 lots 60 and 10%, \$10.00 minimum order. T&T Sales Co., 4802 Avenue K, Brooklyn, N.Y. 11234. 212-241-2868.

DON'T BUY TUBES—Radio, TV Xmitting, special-purpose types until you get our price list! Lowest prices in U.S.A. 5,000 types—Guaranteed Brand New. Send postcard for TV—Special Purpose Price List. **UNITED RADIO COMPANY**, P.O. BOX 1000, NEWARK, N.J. 07101.

WANTED

CASH Paid! Unused tubes, electronic equipment. Barry, 512 Broadway, N.Y.C. 10012.

QUICKSILVER, Platinum, Silver, Gold. Ores Analyzed. Free Circular. Mercury Terminal, Norwood, Mass. 02062.

TAPE AND RECORDERS

BEFORE Renting Stereo Tapes try us. Postpaid both ways—no deposit—immediate delivery. Quality—Dependability—Service—Satisfaction—prevail here. If you've been dissatisfied in the past, your initial order will prove this is no idle boast. Free Catalog. Gold Coast Tape Library, Box 2262, Palm Village Station, Hialeah, Fla. 33012.

RENT 4-TRACK STEREO TAPES—Dependable service our keynote—**ALL MAJOR LABELS—FREE CATALOG** (48 States)—**TRIMOR** Company, P.O. Box 748, Flushing, N.Y. 11352.

STEREO TAPES. Save up to 60% (no membership fees, postpaid anywhere U.S.A.). Free 60 page catalog. We discount batteries, recorders, tape accessories. Beware of slogans "not undersold," as the discount information you supply our competitor is usually reported to the factory. **SAXITONE**, 1776 Columbia Road, Washington, D.C. 20009.

AUTOMATIC telephone connection for Concord and other transistorized recorders. **SURVEILLANCE** and Privacy Protection Devices. Free Data: Security Electronics-PER, 15 East 43rd Street, New York, N.Y. 10017.

TAPE transport. **NAB** recording studio quality. Build yourself for amazingly low cost. Detailed plans \$5.00. Free particulars. Pepke Laboratories, 309-B West 19 Street, New York, N.Y. 10011.

TAPE RECORDER SALE. Brand new, latest models. \$10.00 above cost. Arkay Sales, 1028-C Commonwealth Ave., Boston, Mass. 02215.

RENT Stereo Tapes—over 2,500 different—all major labels—free brochure. Stereo—Parti, 1616-PE Terrace Way, Santa Rosa, California 95404.

HI-FI Components. Tape Recorders, at guaranteed "We Will Not Be Undersold" prices. 15-day money-back guarantee. Two-year warranty. No Catalog. Quotations Free. Hi-Fidelity Center, 239 (PT) East 149th Street, New York 10451.

RENT Stereo-8 **CAR TAPES**. 10¢/day. Send refundable \$10.00 deposit and name of first selection. Autotapes, Box 19086-D, Indianapolis, Ind. 46219.

RENT STEREO TAPES—75¢ WEEK. CATALOG. ART'S, 1442 BLAZE, SIMI, CALIF.

DO-IT-YOURSELF

BUILD your own telephone intercom—complete—less battery. Write Telephones, Box PE67, Simpson, Penna. 18407.

BUILD Transistor Treasure Finder. Details free! Del Research Dept.-A, West Barnstable, Mass. 02668.

EQUIPMENT

FREE ELECTRONICS Catalog. Tremendous bargains. Send postcard. Electrolabs, Department C-678D, Hewlett, New York 11557.

INSTRUCTION

LEARN While Asleep, hypnotize with your recorder, phonograph. Astonishing details, sensational catalog free! Sleep-Learning Association, Box 24-ZD, Olympia, Wash. 98501.

LEARN ELECTRONIC ORGAN SERVICING at home all makes including transistors. Experimental kit—trouble-shooting. Accredited NHSC. Free Booklet. **NILES BRYANT SCHOOL**, 3631 Stockton, Dept. A, Sacramento 20, Calif. 95820.

FCC License in 6 weeks. First Class Radio telephone. Results Guaranteed. Elkins Radio School, 2603B Inwood, Dallas, Texas 75235.

ASSOCIATE Degree in Electronics Engineering earned through combination correspondence-classroom educational program. Free brochure. Grantham Technical Institute, 1505 N. Western Ave., Hollywood, Calif. 90027.

HIGHLY—effective home study review for FCC commercial phone exams. Free literature! Cook's School of Electronics, P.O. Box 517, Monticello, Ky. 42633.

HIGH SCHOOL DIPLOMA at home. Qualified instructors. Send age, highest grade completed, for free details. No salesman. **SOUTHERN STATES ACADEMY**, Professional Bldg., Dept. 5, Decatur, Ga. 30000.

REI First Class Radio Telephone License in (5) weeks Guaranteed. Tuition \$295.00. Job placement free. (KANSAS CITY) R.E.I., 3123 Gillham Road, Kansas City, Missouri, Telephone WE1-5444. (SARASOTA) R.E.I., 1336 Main Street, Sarasota, Florida 33577. Telephone 955-6922.

HIGHLY EFFECTIVE home study course in Electronics Engineering Mathematics with circuit applications. Earn your Associate in Science Degree. Free Literature. Cook's Institute of Electronics Engineering, P.O. Box 517, Monticello, Ky. 42633. (Established 1945.)

INVENTIONS WANTED

INVENTIONS wanted. Patented; unpatented. Global Marketing Service, 2420-P 77th, Oakland, Calif. 94605.

INVENTIONS—IDEAS developed: **CASH/ROYALTY SALES**. Member: United States Chamber of Commerce. Raymond Lee, 130-GR West 42nd, New York City 10036.

PATENT SEARCHES \$6.00! FREE "INVENTION RECORD"/Information. Miss Hayward, 1029HR Vermont, District of Columbia 20005.

INVENTORS! Sell your invention for cash or royalties! Our client manufacturers eagerly seek new items. Patented. Unpatented. Financial assistance if needed. 25 years proven performances. For free information, write Dept. 20, Gilbert Adams, Invention Broker, 80 Wall St., New York, N.Y. 10005.

INVENTORS! Don't sell your invention, patented or unpatented, until you receive our offer. Eagle Development Company, Dept. P, 79 Wall Street, N.Y., N.Y. 10005.

PATENT Searches including Maximum speed, full airmail report and closest patent copies, \$6.00. Quality searches expertly administered. Complete secrecy guaranteed. Free Invention Protection forms and "Patent Information." Write Dept. 9, Washington Patent Office Search Bureau, 711 14th Street, N.W., Washington, D.C. 20005.

INVENTORS! Outright cash sale or royalties for your inventions. Patented. Unpatented. Active demand from our client manufacturers. Financial assistance available. Write Dept. 35, United States Invention Brokerage, 78 Wall Street, New York, N.Y. 10005.

INVENTORS. We will develop, help sell your idea or invention, patented or unpatented. Our national manufacturer clients are urgently seeking new items for outright cash sale or royalties. Financial assistance available. 10 years proven performances. For free information, write Dept. 41, Wall Street Invention Brokerage, 79 Wall Street, New York, N.Y. 10005.

INVENTORS Needing Help with any problem, financial, development, securing manufacturer, obtaining patent. Write the organization that delivers action and results—not promises. Pioneer Invention Service. Dept. 79, 150 Broadway, New York, N.Y. 10038.

GOVERNMENT SURPLUS

JEEPS Typically From \$53.90 . . . Trucks From \$78.40 . . . Boats, Typewriters, Airplanes, Electronics Equipment, Photographic Equipment, used. 100,000 Bargains Direct From Government. Complete Sales Directory and Surplus Catalog \$1.00 (Deductible First \$10.00 Order). Surplus Service, Box 820-J, Holland, Mich. 49424.

G.I. wrist watch \$6.95. Gov't Surplus Catalog 25¢. B&F, 44, Hathorne, Mass. 01937.

REPAIRS AND SERVICES

TV Tuners rebuilt and aligned per manufacturers specification. Only \$9.50. Any make UHF or VHF. We ship COD. Ninety day written guarantee. Ship complete with tubes or write for free mailing kit and dealer brochure. **JW Electronics**, Box 51C, Bloomington, Indiana 47401.

PRECISION Servicing, complete specifications. Fair. Prebuilt, kits, test equipment. Write first. 109 Pinetree, Woodbridge, Va.

BOOKS

FREE CATALOG. Adult Books. **POSTAL PE**, 2217 Lackland, St. Louis, Missouri 63114.

FREE Book. Prophet Elijah Coming Before Christ. Wonderful Bible Evidence. **PE Megiddo Mission**, Rochester, New York 14619.

FREE catalog 950 aviation/electronic/space books. Aero Publishers, 329PE Aviation Road, Fallbrook, California 92028.

MAGAZINES

"**JAPANESE** Electronics Industry." Monthly Magazine. Sample \$1.00. Subscription \$10.00. "Oriental Electronics Directory." 200 Firms. \$2.00, Dec. Box 211, Beverly Hills, Calif. 90213.

AUTHORS' SERVICES

AUTHORS! Learn how to have your book published, promoted, distributed. **FREE** booklet "ZD," Vantage, 120 West 31 St., New York 10001.

SONGWRITERS WANTED! Send song material for recording consideration. Tin Pan Alley, 1650 Broadway, New York 10019.

MUSIC

YOUR song recorded on tape by organist. Send lead sheet and \$10.00 to J. Ferullo, 15 Spring Ave. Revere, Mass. 02151. Vocalist \$5.00 Extra.

POEMS wanted for new songs. Nashville Music Institute, Box 532-E, Nashville, Tennessee, 37202.

HYPNOTISM

FREE Hypnotism, Self-Hypnosis, Sleep Learning Catalog! Drawer H400, Ruidoso, New Mexico 88345.

"FEMALE HYPNOTISM" Exposed, explained! "Secret Method"—they never know! \$2. rushed. Guaranteed! Isabella Hall, Silver Springs, Florida 32688.

HYPNOTIZE FEMALES!—Unnoticed! Instantly! Nerves! Exciting! Send \$2.25. Research Enterprises, 29-SN21 Samoset, Woburn, Mass.

FEMALE HYPNOTISM!! Easily! Instantly! Secret Nerve Centers! \$2.20. Brugenheimer Publishers Box 158-E30, Lexington, Mass.

RUBBER STAMPS

RUBBER ADDRESS STAMP \$1.50. SIGNATURE \$2.88. FREE CATALOG. JACKSON PRODUCTS, 1433 WINNE-MAC, CHICAGO, ILL. 60640.

PHOTOGRAPHY—FILM, EQUIPMENT, SERVICES

MEDICAL Film—Adults Only—"Childbirth"—1 reel 8mm \$7.50—16mm \$14.95. International-E, Greenvale, L.I., New York 71548.

SCIENCE Bargains—Request Free Giant Catalog "CJ"—148 pages—Astronomical Telescopes, Microscopes, Lenses, Binoculars, Kits, Parts. War surplus bargains. Edmund Scientific Co., Barrington, New Jersey 08007.

EDUCATIONAL OPPORTUNITIES

WANTED! TV—Radiomen to learn aircraft electronics servicing. Numerous job openings everywhere. Write: Academy Avionics, Reno/Stead Airport, Reno, Nevada 89506.

LEARN WHILE ASLEEP. Miraculously build Mind Power, achieve Self-Confidence, improve Health, gain Success. Method 92% effective. Details free. ASR Foundation. Box 7021 Henry Clay Sta., Lexington, Kentucky 40502.

CORRESPONDENCE COURSES—B.Sc., Engineering, Electronics. Catalog \$1. Canadian Institute of Science & Technology, 263H Adelaide St., W., Toronto.

PERSONALS

INVESTIGATORS, FREE BROCHURE, LATEST SUBMINIA-TURE ELECTRONIC SURVEILLANCE EQUIPMENT. ACE ELECTRONICS, 11500-K NW 7th AVE., MIAMI, FLA. 33168.

BORROW \$1,205 AIRMAIL! Repay \$47 for 36 months. State licensed. Postal Finance, Dept. 84-E, 200 Keeline Building, Omaha, Nebraska 68102.

BILL PROBLEMS? Poor credit no trouble. Not a loan company. Send for free application. Nationwide Acceptance, Dept. PE, 930 F St. N. W., Washington, D. C. 20017, or 1326PE Plainfield St., Cranston, R. I. 02919.

PRINTING

EMBOSSED business cards, \$2.99—1,000, free samples. Gables—405T Clifton, Glenshaw, Pa 15116.

STAMPS

U.S. Stamp Catalog 25¢ gift. STAMPS, Box 64, Logan, Utah 84321.

CORNELL
33¢
TUBES
1 YR GUARANTEED
SENSATIONAL PRICES
• TUBE CARTONS
• DIODE KITS
• TOP HATS
• TUNER CLEANER
SEND FOR FREE CATALOG
4205 University Ave.
San Diego, Calif.
92105

CORNELL ELECTRONICS CO.
4205 University Ave. San Diego, Calif. 92105

REAL ESTATE

FREE!!! BIG illustrated SUMMER catalog! Describes hundreds of farms, ranches, homes, businesses, vacation, retirement and waterfront properties coast to coast! Specify type property and location preferred. Zip code, please. UNITED FARM AGENCY, 612-EP West 47th St., Kansas City, Mo. 64112. PLaza 3-4212.

MOVIE FILMS

SUPER 8 . . . REGULAR 8mm—ACTION SPORTS IN VIVID COLOR! WRITE FOR CATALOG. SPORT-LITE FILMS-PE, 20 North Wacker Drive, Chicago, Illinois 60606.

BUSINESS OPPORTUNITIES

INVESTIGATE Accidents—Earn \$750 to \$1,400 monthly. Men urgently needed. Car furnished. Business expenses paid. No selling. No college education necessary. Pick own job location. Investigate full time. Or earn \$6.44 hour spare time. Write for Free literature. No obligation. Universal. CZ-6, 6801 Hillcrest, Dallas, Texas 75205.

VENDING Machines—No Selling. Operate a route of coin machines and earn amazing profits. 32-page catalog free. Parkway Machine Corporation, 715PE Ensor Street, Baltimore, Md. 21202.

FREE CATALOGS. Repair air conditioning, refrigeration. Tools, supplies, full instructions. Doolco, 2016 Canton, Dallas, Texas 75201.

I MADE \$40,000.00 Year by Mailorder! Helped others make money! Start with \$10.00—Free Proof. Torrey, Box 318-N, Ypsilanti, Michigan 48197.

FREE Book "990 Successful, little-known Businesses." Work home. Plymouth 145L, Brooklyn, N.Y. 11218.

PIANO TUNING learned quickly at home. Tremendous field! Musical knowledge unnecessary. GI Approved. Information free. Empire School of Piano Tuning, Box 327, Shenandoah Station, Miami, Florida 33145.

LEARN TECHNICAL WRITING—at home. High paying prestige careers not requiring college. Growing demand, all industries for tech writers now. Low monthly tuition. Easy to understand. FREE career book, sample lesson. APPROVED FOR VETERANS. American Technical Writing Schools, Dept. PEC-67, 5512 Hollywood Blvd., Hollywood, Calif. 90028.

ELECTROPLATING Equipment and supplies. All types for home workshops and industrial. Send \$1.00 (refundable) for equipment guide formulas, operating data, catalog. HBS Equipment Division 90, 3543 East 16th, Los Angeles, California 90023.

RAISE RABBITS for us on \$500 month plan. Free details. White's Rabbitry, Mt. Vernon, Ohio 43050.

MAKE up to \$10,000 a year, raising chinchillas, mink, rabbits or guinea pigs for us. We supply breeding stock, equipment and feed. Send \$1.00 for catalog and complete information. Keeney Brothers Farms, Dept. ZE, New Freedom, Pa. 17349.

EMPLOYMENT INFORMATION

FOREIGN and USA job opportunities available now. Construction, all trades. Earnings to \$2,000.00 monthly. Paid overtime, travel, bonuses. Write; Universal Employment, Woodbridge, Connecticut 06525.

JOBS! Technicians, Engineers. Complete list, revised monthly. \$1.00. Box 9946, Washington, D.C. 20015.

EMPLOYMENT—US. Engineers—Electrical, Mechanical, Chemical, Civil; Techwriters, Technicians. Become your own boss, choose your own place to work and enjoy \$15,000 to \$40,000 a year, paid vacations, per diem. Why settle for less, use your abilities to their fullest on a variety of government and commercial jobs. For complete details and lists of companies, send \$10 to: R & D Consultants, Box 596, Williamstown, Massachusetts 01267.

FOREIGN EMPLOYMENT. Construction, other work projects. Good paying overseas jobs with extras, travel expenses. Write only: Foreign Service Bureau, Dept. D, Bradenton Beach, Florida 33510.

EMPLOYMENT Resumes. Get a better job & earn more! Send only \$2.00 for expert, complete Resume Writing Instructions. J. Ross, 80-34 Kent St., Jamaica, N.Y. 11432. Dept. PE.

MISCELLANEOUS

WINEMAKERS: Free illustrated catalog of yeasts, equipment. Semplex, Box 7208, Minneapolis, Minn. 55412.

MONEY—WE PAY \$10 hr. for NOTHING but your opinions, written from home about our clients' products and publications, sent you free. Nothing to buy, sell, canvass, or learn. No **SKILL. NO GIMMICKS.** Just honesty. Details from **RESEARCH**, ZD2, Box 669, Mineola, N.Y. 11501.

BACKYARD Astronomy: Giant Star Explorer Wheel Chart. \$1.25. Windhook, Box 652AA—Port Washington, N.Y. 11050.

BEERS, PEACH BRANDY, WINES—Strongest Formulas, \$2.25. (complete brew supplies hydrometers catalog included)—Research Enterprises, 29-D Samoset, Woburn, Mass. 01801.

STAMMER — Stutter — No More. (Dr. Young.) Write: Gaucho, Box 9309-E8, Chicago 60690.

STOP BURGLARS THE EASY WAY!! Affix authentic "Protected by Electronic Sentry Alarm" Decals to auto windows, doors & windows of home, retail stores, vending machines, etc. Whether you have an alarm or not—thieves stay away! Only \$1.00 for each set of two. J. Ross, 80-34 Kent St., Jamaica, N.Y. 11432 Dept. PE.

**MAIL ORDER OPPORTUNITIES
WAITING FOR YOU . . .**

in the pages of **ELECTRONICS MARKET PLACE** each month as **POPULAR ELECTRONICS** classified advertising remains your best bet for outstanding mail order responses.

Classified Advertisers find more outlets for their products and services here than in any other medium. More than 400,000 monthly buyers of **POPULAR ELECTRONICS** read these pages thoroughly as they eagerly await the offerings they know are found only in **ELECTRONICS MARKET PLACE** each issue. These readers buy because they know they can rely on the advertisers appearing in the pages of their favorite magazine.

Your mail order response can be increased substantially by running a low cost ad (\$1.00 per word—minimum \$10.00) in these columns. Forward advertising copy with your payment today in order to be certain of inclusion in the next issue—August (closing June 1st, on sale July 20th). Send to:

Hal Cymes, Classified Advertising Manager

POPULAR ELECTRONICS

One Park Avenue, New York, N. Y. 10016

POPULAR ELECTRONICS

JUNE 1967

ADVERTISERS INDEX

READER SERVICE NO.	ADVERTISER	PAGE NO.
1	Allied Radio	106
	American Institute of Engineering & Technology	96
2	Amperex Electronic Corp	FOURTH COVER
3	Antenna Specialists Co., The	98
4	Argos Products Company	111
5	Avanti Research & Development, Inc	95
6	B & K	30
7	Burstein-Applebee Co	96
8	C/P Corporation	11
	Capitol Radio Engineering Institute. The	102, 103, 104, 105
9	Cleveland Institute of Electronics	9
10	Cleveland Institute of Electronics	18, 19, 20, 21
	Commercial Trades Institute	111
	Conar	106
	Cornell Electronics Co	119
	Coyne Electronics Institute	114
	DeVry Institute of Technology	5
11	E.C.I. Electronics Communications Inc	89
12	Edmund Scientific Co	108
13	Electro-Voice, Inc	97
14	Garrard	8
15	Hallicrafters	6
16	Heath Company	91, 92, 93
17	International Crystal Mfg. Co., Inc	23
18	Jerrold	83
22	Johnson Company, E.F.	THIRD COVER
19	Judson Research and Mfg. Co	94
20	Kuhn Electronics	99
21	Lafayette Radio Electronics	99
23	Milwaukee School of Engineering	12
24	Mosley Electronics, Inc	100
25	Multi-Elmac Co	101
	National Radio Institute	SECOND COVER, 1, 2, 3
	National Technical Schools	7
26	Pace Communications Corp	28
41	Pace Communications Corp	29
27	Pearce-Simpson, Inc	13
28	RCA Electronic Components and Devices	17
	RCA Institutes Inc	84, 85, 86, 87
40	S & A Electronics Inc	90
29	S-K Wayne Tool Company	25
30	Sams & Co., Inc., Howard W	90
31	Sonar Radio Corp	107
32	Sonotone Corporation	16
33	Squires-Sanders, Inc	81
34	Texas Crystals	108
35	Topaz, Inc	94
36	Tram Electronics, Inc	10
37	Turner Microphone Company, The	14
38	U.S. Army	26, 27
	Valparaiso Technical Institute	96
39	Xcelite Inc	109

CLASSIFIED ADVERTISING 115, 116, 117, 118, 119, 120

...and still champion

Built in the best traditions of Viking craftsmanship and durability, the Messenger I continues to successfully resist all efforts to take away its position as the most popular Citizens Band transceiver ever made.

The Messenger I's unmatched performance and reliability puts you on the air with all the authority you've learned to expect from Johnson's engineering and manufacturing excellence. You'll stay on the air, too, because the Messenger I, like

all Johnson products, is built to take the tough day-in, day-out use that CB'ers demand.

Rugged cabinet and chassis design. High-impact microphone that's impervious to heat and moisture. Sensitive superheterodyne receiver for maximum communication range. Only \$99.95. FCC type accepted and DOT approved.

Be a winner! Check out a Johnson Messenger I today.

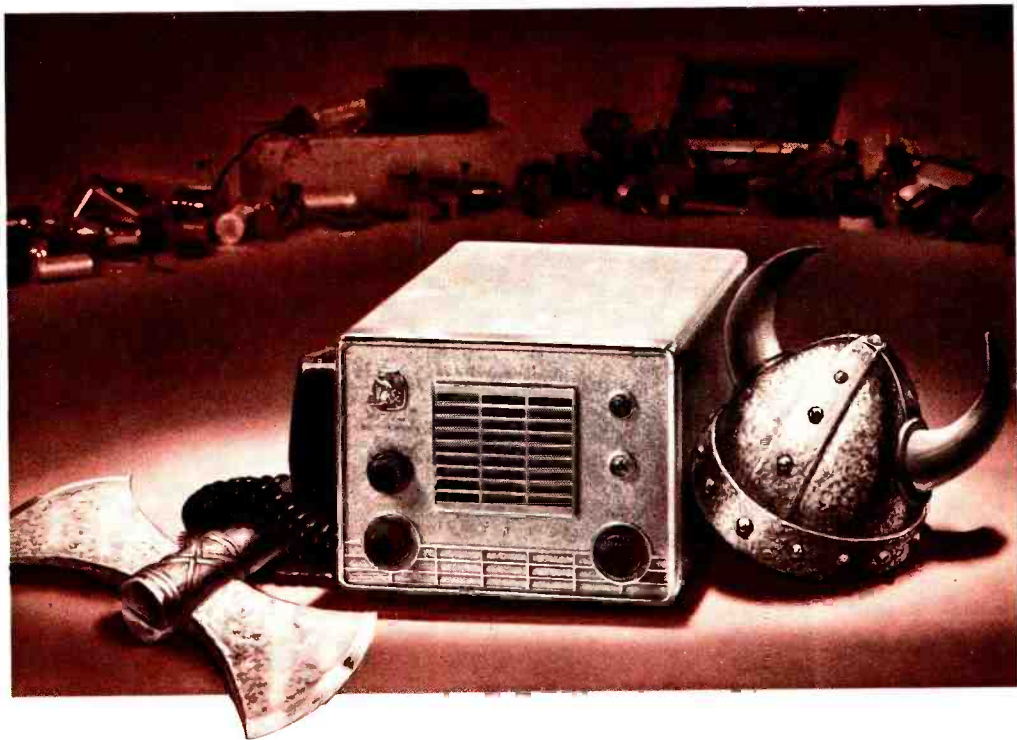

E. F. JOHNSON COMPANY

2498 Tenth Ave. S.W., Waseca, Minn. 56093

Providing nearly a half-century of communications leadership

Please send full details on the Messenger I and the rest of the winning line of Johnson CB products and accessories.

Name

Address

City State Zip

CIRCLE NO. 22 ON READER SERVICE PAGE



**One out of every five
professional servicemen
has switched to Amperex
TV replacement tubes**

It takes a lot of quality to change the buying habits of 20% of the most knowledgeable technicians in the business. These servicemen are following the pattern set by the leading TV manufacturers, who are designing more and more of their quality lines around tubes originated by Amperex. The Amperex line of popular types is expanding all the time. Look for the green and yellow cartons at your distributor's or write: Amperex Electronic Corp., Hicksville, L. I., N.Y. 11802.

Amperex

TOMORROW'S THINKING IN TODAY'S PRODUCTS

