

"Radio Moscow" Wins the DB War

POPULAR ELECTRONICS

**APRIL
1965**

**35
CENTS**

Game Uses Computer Logic

Magic Box Hi-Fi Speaker Enclosure

All About Neon Glow Lamps

144-Mc. Ham-Band Transmitter

The Saga of One QSL Too Many

**R/C
Build 1½-Ounce
Receiver**

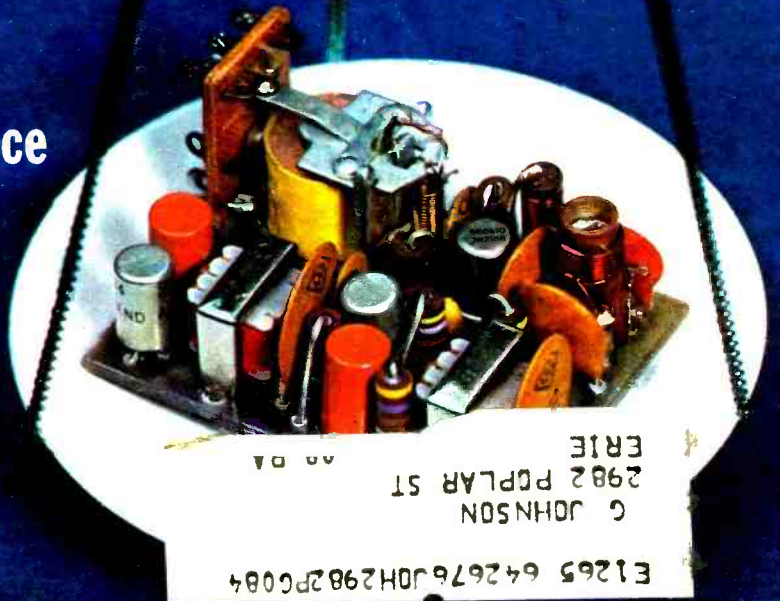



ELECTRONICS COMES ALIVE WITH CUSTOM TRAINING KITS

You get your hands on actual parts and use them to build, experiment, explore, discover. NRI pioneered and perfected the "home lab" technique of learning at home in spare time. Nothing is as effective as learning by doing. That's why NRI puts emphasis on equipment, and why it invites comparison with equipment offered by any other school. Begin now with this exciting program of practical learning created by NRI's Research and Development Laboratories. It's the best way to understand fully the skills of the finest technicians—and make their techniques your own.

GET A FAST START WITH NRI'S ABSORBING, NEW ACHIEVEMENT KIT

Delivered to your door—everything you need to make a significant start in the Electronics field of your choice! This new starter kit is an outstanding, logical way to introduce you to NRI training kits . . . an unparalleled sample of the value of NRI home-study training. What's in it? Your first group of lesson texts; a cloth vinyl desk folder to hold your study material; the industry's most complete Radio-TV Electronics dictionary; valuable reference texts; lesson answer sheets; pre-addressed envelopes; pencils; pen; engineer's ruler, and even postage. No other school has anything like it.

"BITE-SIZE" LESSON TEXTS PROGRAM YOUR TRAINING AT HOME

Certainly, lesson texts are necessary. NRI's programmed texts are as simple, direct and well illustrated as 50 years of teaching experience can make them. They are carefully programmed with NRI training kits to make the things you read about come alive. You'll experience all the excitement of original discovery.

HOBBY? CAREER? PART-TIME EARNINGS? MAIL COUPON TO NRI

Whatever your reason for wanting to increase your knowledge of Electronics . . . whatever your education . . . there's an NRI instruction plan to fit your needs. Choose from three major training programs in Radio-TV Servicing, Industrial Electronics and Communications or select one of seven NRI courses in specialized subjects. Mail coupon for NRI catalog. Find out how you can train at home this exciting, rewarding way.

DISCOVER THE EXCITEMENT OF NRI ELECTRONICS TRAINING

Founded 50 years ago—in the days of wireless—NRI pioneered the "learn-by-doing" method of home-study. Today, NRI is the oldest, largest home-study Electronics school, offering the kind of instruction that makes learning exciting, fast. You build, test, experiment, explore. Whatever your interest, your need, your education, investigate the wide variety of NRI training plans . . . find out about the NRI Achievement Kit. Check and mail the coupon now. No salesman will call. NATIONAL RADIO INSTITUTE, Washington, D.C. 20016.

50 YEARS OF LEADERSHIP IN ELECTRONICS TRAINING

any*

Yes, in any CB application...you'll outperform 'em all with a

MESSENGER®

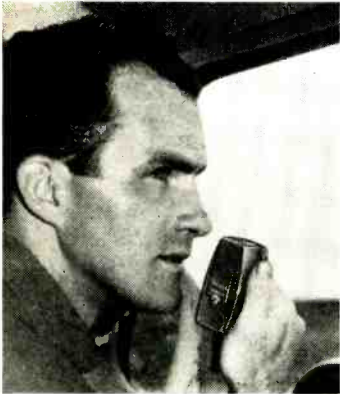

Your own 2-way radio for Business or Personal use!

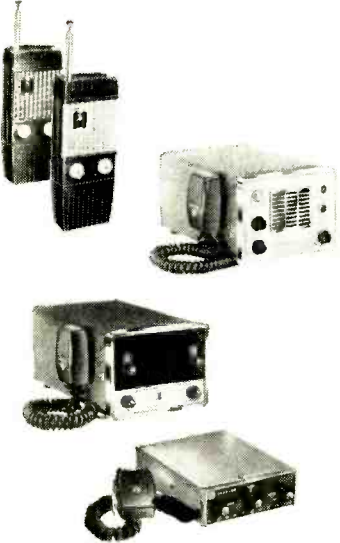

"PERSONAL MESSENGERS"—Compact, hand-held 100 milliwatt or 1½ watt units! Rugged and reliable—11 transistors, 4 diodes. Twice the sensitivity and 40% more range than similar units with conventional circuitry—more output than similar units with same rated inputs!

Cat. No. 242-101.....100 Milliwatts..... \$109.50 Net
 Cat. No. 242-102.....1½ Watts..... \$129.50 Net

"MESSENGER" AND "MESSENGER TWO"—For mobile or base stations. High efficiency design makes full use of maximum allowable legal power. Excellent receiver sensitivity and selectivity. Automatic "squelch" control. 5 crystal controlled channels on the "Messenger" and 10 crystal controlled channels plus tunable receiver on the "Messenger Two".

"MESSENGER"

Cat. No. 242-127
 115 VAC/6 VDC.....\$114.95 Net
 Cat. No. 242-128
 115 VAC/12 VDC...\$114.95 Net

"MESSENGER TWO"

Cat. No. 242-162
 115 VAC/6 VDC.....\$169.95 Net
 Cat. No. 242-163
 115 VAC/12 VDC....\$169.95 Net

"MESSENGER III"—Offers everything you ever wanted in a CB transceiver... compact size, a husky signal, extreme sensitivity, razor-sharp selectivity—and complete flexibility for base station, mobile, public address, or battery powered portable use! Double conversion receiver—set-and-forget "Volume" and "Squelch" controls—11 channel coverage—"Tone Alert" Selective Calling System available as accessory.

Cat. No. 242-150.....12 Volts DC Messenger III..... \$189.95 Net
 Cat. No. 250-823.....117 Volt AC Power Supply..... \$ 29.95 Net

The nation's most popular
 Citizens Radio equipment line!

*Rated BEST by Distributor
 Salesmen in National Survey!

WRITE TODAY for full color brochure, or see your
 Dealer/Distributor and ask for a demonstration!



E. F. JOHNSON COMPANY
 2425 TENTH AVE. S.W. • WASECA, MINNESOTA

CIRCLE NO. 16 ON READER SERVICE PAGE

POPULAR ELECTRONICS



POPULAR ELECTRONICS is indexed
in the Readers' Guide
to Periodical Literature

This month's cover photo by Al Francekevich

VOLUME 22

APRIL, 1965

NUMBER 4

Special Feature

- The Russians Are Winning the Decibel War Stanley Leinwall 42
The strength of the short-wave signal from Radio Moscow exceeds that of other European broadcasters—it shouldn't, but it does; the author theorizes why

Electronic Construction Projects

- Miniature R/Ceiver Daniel Meyer 39
Electronic Coin Tossor Woodrow Pope 50
Paragon 144 Hartland B. Smith, W8YVD 55

Audio and Hi-Fi/Stereo

- Mr. Thuras' Magic Box David B. Weems 45
Cool It for Component Longevity Kenneth Smalley 66
On High Fidelity Rodrigues 72

Amateur, CB, and SWL

- Satellites on the Air 20
Across the Ham Bands: Tips for Making Contacts Herb S. Brier, W9EGQ 73
Short-Wave Report: The Broadcaster's Side of the Verification Story
Hank Bennett, W2PNA 75
English-Language Newscasts to North America 76
DX Countries Awards 77
On the Citizens Band: New Voice for CB Matt P. Spinello, KHC2060 78
DX States Awards Presented 110

Electronic Features and New Developments

- At Last! A Home TV Tape Recorder Kit Hans F. Kutschbach 44
NEWS 54
Equipment Report: EICO 777 CB Transceiver Kit 60
The Neon Lamp Wonder Charles A. Pirollo 61
One QSL Too Many (fiction) C. M. Stanbury II 65
Equipment Report: Conar Novice Ham Station 68
Transistor Topics 69
Electronic Adjustment Quiz Robert P. Balin 71

Departments

- Letters from Our Readers 6
Out of Tune 12
Reader Service Page 15
New Products 22
Operation Assist 26
POP'tronics Bookshelf 80
Tips and Techniques 82

Copyright © 1965 by ZIFF-DAVIS PUBLISHING COMPANY. All rights reserved.

DeVry Tech Prepares You for Many Types of Jobs in Electronics

In Day or Evening Classes Or In Privacy of Your Home (Spare Time)

If you're a young man looking for a career to grow in, and to grow with — look into electronics. Or if you're 18 to 45, sick of your routine job and fed up with a small paycheck — look into electronics. For here's a field offering real money, a promising future, fine careers. When after thorough training you can say: "I'm an electronics technician," you're a man of standing in your community. And you're ready for many exciting opportunities that depend on electronics — from Radio and Television, Radar, Broadcasting or Industrial Electronics — to Automation, Computer or Missile Control work.

But don't be stopped by the word "electronics." You don't need advanced education or previous technical experience to start our program. DeVry trains you with tools in hand and equipment in front of you, with "programmed" texts and visual aids — either at home or in one of our modernly equipped resident schools. We know you will be pleased with what we have to offer. Fill out and mail the coupon for details.



Industrial
Electronics



Television



Your own
business



Communications
Plus Many Others!

50,000
GRADUATES

In only 34 years, DeVry has grown to be one of the world's largest electronics educational centers.

2,200 RESIDENT
STUDENTS

In day and evening classes DeVry Tech's modern training centers are educating men for fine careers.

5,000 FIRMS HAVE
HIRED OUR GRADUATES

DeVry men are sought after by industry, a real advantage for you when you graduate.

PART TIME INCOME
WHILE LEARNING

Make extra money servicing radios, TV sets, Hi-Fi systems in your spare time — surprisingly soon.

**SEND FOR FREE
BOOKLETS NOW**

Just send the coupon; get the story of the electronics field — and how you may prepare for it.



MAIL THIS COUPON NOW

DEVRY TECHNICAL INSTITUTE

4141 Belmont Ave., Chicago, Ill. 60641, Dept. PE-4-V

Please give me your two free booklets, "Pocket Guide to Real Earnings" and "Electronics in Space Travel"; also include details on how to prepare for a career in Electronics. I am interested in the following opportunity fields (check one or more):

- | | |
|--|---|
| <input type="checkbox"/> Space & Missile Electronics | <input type="checkbox"/> Communications |
| <input type="checkbox"/> Television & Radio | <input type="checkbox"/> Computers |
| <input type="checkbox"/> Microwaves | <input type="checkbox"/> Industrial Electronics |
| <input type="checkbox"/> Automation Electronics | <input type="checkbox"/> Broadcasting |
| <input type="checkbox"/> Radar | <input type="checkbox"/> Electronic Control |

NAME _____ AGE _____

ADDRESS _____ APT. _____

CITY _____ ZONE _____ STATE _____

- Check here if you are under 16 years of age.
Canadian residents: Write DeVry Tech of Canada, Ltd.
2098 970 Lawrence Avenue West, Toronto 19, Ontario

DeVry

Technical Institute

CHICAGO &
TORONTO

FULLY EQUIPPED FOR
IMMEDIATE OPERATION
ON ALL **23** CHANNELS



23-CHANNEL CB
mobile and base station
AM TRANSCEIVER

The satisfaction you get from CB-ing with the new *Cobra* CAM-88 is a richly rewarding everyday experience. It's rugged, handsome to have in your car or home base—and it operates like you want it to—for personal, professional or business 2-way communications in the 27 mc Citizens Band.

Outstanding Features

- Fully-Equipped for Immediate 23-channel Transmit and Receive
- Double Conversion Superheterodyne Receiver
- Transistorized 117V AC/12V DC Power Supply
- Maximum Talk Power
- Delta-Tune Fine Tuning
- Squelch Control and Standby Switch
- Illuminated Dual-Purpose Meter
Power-in (Receive)—Power-out (Transmit)
- Modulation Indicator
- Plug-in Microphone
- Convertible for Public Address

Carefully engineered design makes the *Cobra* completely reliable and easy to operate. Completely self-contained. No additional crystals needed. **\$214.95**

See your Distributor or Write for Bulletin No. 641-P

B & K/MARK

DIVISION OF DYNASCAN CORPORATION
1801 W. BELLE PLAINE AVE. • CHICAGO, ILL. 60613

Canada: Atlas Radio Corp., 50 Wingold, Toronto 19, Ont.
Export: Empire Exporters, 123 Grand St., New York 13, U.S.A.

CIRCLE NO. 41 ON READER SERVICE PAGE

SUBSCRIPTION SERVICE: All subscription correspondence should be addressed to POPULAR ELECTRONICS, Circulation Department, Portland Place, Boulder, Colorado 80301. Please allow at least six weeks for change of address. Include your old address as well as new—enclosing if possible an address label from a recent issue.
EDITORIAL CONTRIBUTIONS must be accompanied by return postage and will be handled with reasonable care; however, publisher assumes no responsibility for return or safety of art work, photographs or manuscripts.

**POPULAR
ELECTRONICS**

World's Largest-Selling Electronics Magazine

- PHILLIP T. HEFFERNAN** Publisher
OLIVER P. FERRELL Editor
W. STEVE BACON, W2CJR Managing Editor
ROBERT CORNELL, WA2HDQ Technical Editor
WILLIAM GALBREATH Art Editor
MARGARET MAGNA Associate Editor
ANDRE DUZANT Technical Illustrator
NINA CHIRKO Editorial Assistant
PATTI MORGAN Editorial Assistant
H. S. BRIER, W9EGQ Amateur Radio Editor
M. P. SPINELLO, KHC2060 CB Editor
L. E. GARNER, JR. Semiconductor Editor
H. BENNETT, W2PNA Short-Wave Editor
STANLEY LEINWOLL Radio Propagation Editor

- LAWRENCE SPORN** Advertising Sales Manager
ARDYS C. MORAN Advertising Service Manager

ZIFF-DAVIS PUBLISHING COMPANY

Editorial and Executive Offices (212 ORegan 9-7200)
One Park Avenue, New York, New York 10016

William B. Ziff, Chairman of the Board (1946-1953)
William Ziff, President

- W. Bradford Briggs, Executive Vice President
Hershel B. Sarbin, Vice President and General Manager
Philip Sine, Treasurer
Walter S. Mills, Jr., Circulation Director
Stanley R. Greenfield, Vice President
Phillip T. Heffernan, Vice President

New York Office (212 ORegan 9-7200)
One Park Avenue, New York, New York 10016
Eastern Advertising Manager, RICHARD J. HALPERN

Midwestern Office (312 Wabash 2-4911)
434 South Wabash Avenue, Chicago, Illinois 60605
Midwestern Advertising Manager, JAMES WEAKLEY

Western Office (213 Crestview 4-0265)
9025 Wilshire Boulevard, Beverly Hills, California 90211
Western Advertising Manager, BUD DEAN



POPULAR ELECTRONICS is published monthly by Ziff-Davis Publishing Company at 434 South Wabash Avenue, Chicago, Illinois 60605. April, 1965, Volume 22, Number 1. Ziff-Davis also publishes Skiing, Flying, Popular Boating, Car and Driver, Popular Photography, Hi-Fi Stereo Review, Electronics World, Modern Bride, and Skiing Trade News.) Subscription Rate: One year, \$4.00; additional postage for Canada and Pan American Union countries, \$.50; additional postage for all other foreign countries, \$1.00. Second Class postage paid at Chicago, Illinois, and at additional mailing offices. Authorized as second class mail by the Post Office Department, Ottawa, Canada, and for payment of postage in cash.

PAYMENT MAY BE REMITTED in the following foreign currencies for a one-year subscription: Australian pounds (2/6/10); Belgian francs (260); Danish kroner (36); English pounds (1/17/6); French francs (26); Dutch guilders (13); Indian rupees (26); Italian lire (3300); Japanese yen (1750); Norwegian kroner (38); Philippine pesos (21); South African rands (3.80); Swedish kronor (28); Swiss francs (23); West German marks (21).

NEW!

An Electronics Slide Rule with Self-Training Course

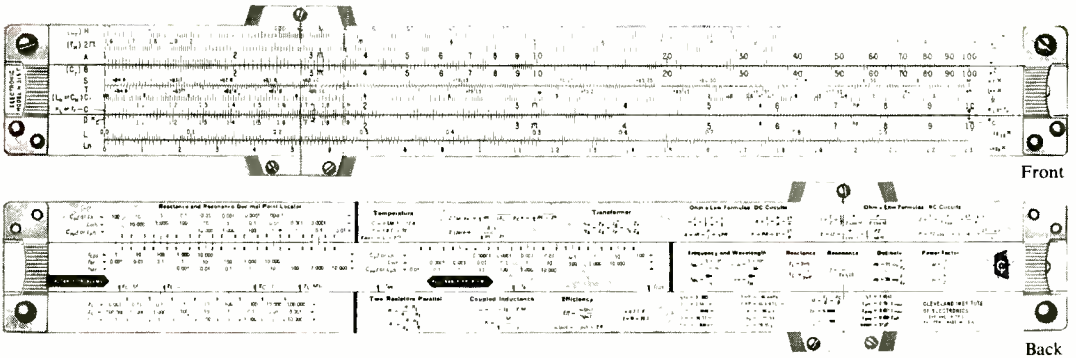

Here's the first truly professional slide rule designed especially for electronic engineers, technicians and students. No longer must you struggle along with a general purpose slide rule . . . this new CIE Electronics Slide Rule* will enable you to solve electronic problems quickly . . . accurately. It's an all-metal 10" measuring instrument that can be used for conventional computation, too.

This patented Electronics Slide Rule is made to our rigid specifications by Pickett & Eckel . . . has special scales for solving reactance and resonance problems . . . locates decimal points . . . has widely used electronics formulas and conversion factors on the back of the rule for instant reference.

An illustrated self-training course comes with each rule . . . includes clear diagrams and step-by-step explanations to make learning fast, easy. Several hundred practice problems deal with widely occurring situations in electronics . . . teaches many short cuts . . . lists the best settings for solving complex problems. Slide rule, instruction course and handsome top-grain leather carrying case . . . all yours for just \$14.95. Cleveland Institute of Electronics, Dept. PE-107, 1776 E. 17th St., Cleveland, Ohio 44114.

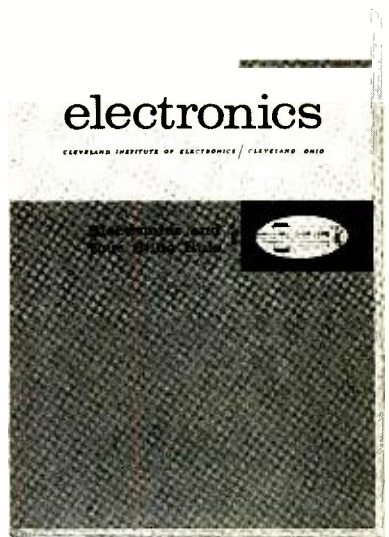

THIS SPECIAL ELECTRONICS SLIDE RULE IS AVAILABLE ONLY FROM CLEVELAND INSTITUTE AND IS GUARANTEED AGAINST DEFECTS IN MATERIAL AND WORKMANSHIP. *PATENTED BY U. S. PATENT OFFICE NUMBER 3,120,342.

SEND COUPON TODAY

to: Cleveland Institute of Electronics

1776 East 17th St., Dept. PE-107, Cleveland, Ohio 44114

- Please send me your Electronics Slide Rule with illustrated self-training course. I am enclosing \$14.95 (If not fully satisfied after 10 day trial, CIE will refund payment).
- Please send additional descriptive literature.

Name _____ (Please Print)

Address _____ County _____

City _____ State _____ Zip _____

A leader in electronics training . . . since 1934

CIRCLE NO. 4 ON READER SERVICE PAGE

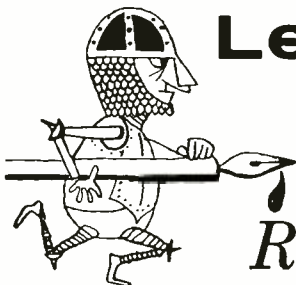

Letters from our Readers

Address correspondence for this department to:
Letters Editor, POPULAR ELECTRONICS
One Park Avenue, New York, N. Y. 10016

"The 'Transistorized' Man" Lauded

■ I have just finished rereading "The 'Transistorized' Man" (February, 1965) without losing the enthusiasm I felt on the first reading . . . As I have been a victim of muscular dystrophy since I was a child and am confined to a wheelchair. I was very interested to learn of the scientific advances in the field of myo-electricity which may be of benefit to the handicapped. Especially encouraging is the information about the amplified man projects and the construction of exo-skeletons for use in increasing the power of a man's arms and legs. . . . I purchased an electric wheelchair which can accomplish many things but not as many as anticipated. The main drawbacks are the unavailability of a compact, lightweight, efficient power source, and the bulkiness and limited maneuverability of the wheelchair itself . . . To learn that scientists are not only con-

templating such things as exo-skeletons but also doing research in this area gave me a great sense of optimism.

STANLEY J. OSOCHOWSKY
Branford, Conn.

Regulated Power Supply

■ Congratulations on a fine construction project. I'm referring to "A 1-Compactron Regulated Power Supply" (February, 1965). The unit is very compact, efficient, and it's variable. As the article says, "pick your voltage."

ROBERT WOLFF
Glencoe, Ill.

40-Meter "Mess" Draws Comments

■ "Shoot a Radio Wave Into the Air" (February, 1965) seems to indicate that all the international broadcasters on 40 meters are foreign. However, on 7265 kc. one can find a nice fat *Voice of America* signal.

D. L. GRISHAM, WPE5EEZ
Corpus Christi, Tex.

■ I agree wholeheartedly with the hams about 40 meters. However, author Leinwoll is wrong when he states that 40 is 100 percent amateur in North America. On page 110 of the same issue (in "Short-Wave Report") it is noted that our very own *Voice of America* occupies, at different times, six different frequencies on 40.

JIM LONIAK, KK8S541
Astoria, N.Y.

(While readers Grisham and Loniak are correct, it should be noted that the VOA does not use 40 meters in North America. However, the "Voice" does broadcast on 40 to audiences in Europe and Asia using trans-

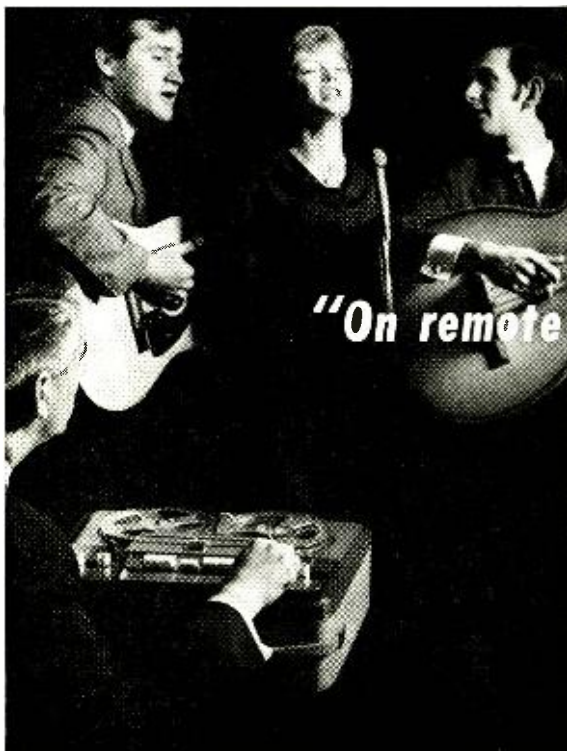

SKIP WESHNER TAPING ON LOCATION AT GREENWICH VILLAGE NIGHTCLUB, NEW YORK

CIRCLE NO. 23 ON READER SERVICE PAGE

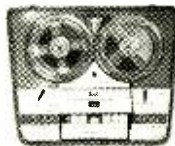

The Norelco Continental '401'
100% transistorized • 4-speed
• 4-track stereo/mono, re-
cord/playback • completely
self-contained with dual pre-
amps, dual power amplifiers,
matched speakers and stereo
dynamic microphone . . . See it at your hi-fi dealer's

—or write to Dept. HR-4, North American Philips Company, Inc., High Fidelity Products Department, 100 East 42nd Street, New York, New York 10017.

"On remote and in the studio,

my Norelco '401' has proved itself a thoroughly professional recording instrument,"
says popular FM broadcaster, Skip Weshner

"No matter where I make them, my tapes have to meet the broadcast standards of the leading FM stations around the country. My Norelco '401' gives me tapes that not only meet or exceed these standards, but on playback I defy any listener to detect the difference between my live broadcasts and my taped ones!

"My '401' has been on the firing line in all locations, five nights a week, year after year, yet has required less maintenance than any other recorder I've ever used.

"Although the '401' was designed for the convenience and for the pocketbook of the home user, in my book it's as good as having an entire recording studio in a suitcase!"

Norelco®

The price tag went on last



KLH Model Seventeen

The quality went in first. The kind of quality you can hear. Quality in the Seventeen's smooth, flawless response. Quality that gives the Seventeen the lowest harmonic distortion in the bass of any speaker in its price range. KLH quality in a handsome new oiled walnut enclosure. In the ingenious grillecloth that can be changed in a snap.

And while the quality was going in, the waste was coming out. All the waste that inflates the cost of speakers. The waste of rejects and varying quality in stock components from outside suppliers. (KLH builds, tests, and rigidly controls the quality of every component that affects the musical performance of a speaker.) The waste of obsolete design and engineering. Of inefficient and outdated manufacturing techniques. Of gingerbread 'features' that add nothing to musical performance.

When we finally had a speaker that was all quality and no waste, we put the price tag on. And you won't find a trace of puff in the price.

This is the Model Seventeen. A speaker that brings a whole new level of sound quality—a new distinction to speakers costing under \$100.

But no description can tell you how the Seventeen sounds. You've got to hear it. Only then will you be able to understand what an unusual achievement the Seventeen is in high performance at low cost. See the Seventeen at your KLH dealer now. Listen to it. Then look at the price tag. We think you'll agree that nothing touches the Seventeen for honest sound at an honest price.

**Suggested retail for eastern U.S. Slightly higher in the West.*



KLH RESEARCH AND DEVELOPMENT CORPORATION
30 CROSS STREET, CAMBRIDGE 39, MASSACHUSETTS

CIRCLE NO. 17 ON READER SERVICE PAGE

new Allen type screwdrivers

work faster, easier . . . reach where wrenches won't go



fixed handle SCREWDRIVERS

11 hex sizes:
.050" to 1/4"
Precision formed,
alloy steel blades
Shockproof,
breakproof,
amber plastic
(UL) handles

detachable BLADES

8 hex sizes:
1/16" to 3/16"
Fit all "99" Series
handles
Available singly —
as a set of six in
free plastic pouch
— or in roll kit
with handle



XCELITE INC. • 20 BANK ST., ORCHARD PARK, N. Y.
Please send free literature N763.

name _____
address _____
city _____ state & zone _____

CIRCLE NO. 40 ON READER SERVICE PAGE

Letters

(Continued from page 6)

mitters in Germany, Greece, Great Britain, Morocco, Ceylon, Rynkyu Islands, the Philippines, and Liberia. —Ed.)

■ . . . Under the Geneva Regulations, the U.S.S.R., BBC of the U.K., *Vatican Radio*, and other stations located in regions I and III, can quite legally transmit in the 7.1-7.3 mc. frequency band. Taking up the defense of the BBC, this body, unlike most national networks, does not transmit continuously throughout the clock, and cannot be accused of broadcasting to sleepers! The International Telecommunications Union does not work under entirely congenial conditions, and we should perhaps be grateful that agreement of some sort is made, and that some services are not going to be satisfied with allocations. American hams may have a grievance, but do they know that the British 40-meter ham band consists of 7-7.1 mc. on which a power input of not more than 100 watts may be used?

A. CALVERT, Radio Officer
SS Mobil Radiant
New York, N.Y.

■ I'm one of those hams who pops his gasket denouncing the use of a ham band by international broadcasting stations . . . One night not long ago I picked up no less than 19 commercial broadcast stations on

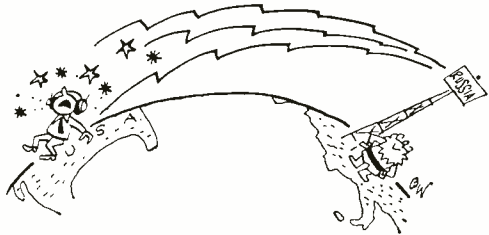

the 40-meter "amateur" band! It's downright impossible to copy c.w. on the lower part of 40 due to the squeal of commercial carriers. And phone is no better since the commercial stations have an effective bandwidth up to 25 kc. Amateur bands are for amateurs. With 2,000,000 watts of effective power, it's simply impossible for a broadcast station not to cause harmful interference.

AHMED AL-SABAH
Brooklyn, N.Y.

"Tips and Techniques" Topped

■ The basic idea of using a relay in the battery circuit of a VTVM ("Tips and Techniques," November, 1964) is basically sound, but putting a 6.3-volt a.c. relay in the filament circuit may overload and possibly burn out the transformer. The best way to make this modification is to use a 115-volt a.c. relay and connect the coil leads across the primary of the power transformer.

CLARENCE BIGELOW
Bigelow Electronics
Bluffton, Ohio

CB Dilemma: More Solutions

■ May I suggest that the Technician Class amateur license be issued for use above 144 mc. without a code test? The same thing could be done with a renewable Novice license.

JAMES M'SHANE, KGH0257
Omaha, Neb.

■ My answer to the CB Dilemma would be to relinquish interstation communication privileges and re-

NEW from RADIO SHACK

AN INTERCOMMUNICATIONS BREAKTHROUGH

REALISTIC SELECTaCOM

**WORLD'S FIRST DUAL-POWER CB
TRANSCEIVER & WIRELESS INTERCOM**



Desk-Top Size: 8 5/8 x 5 3/8 x 5"

The SELECTaCOM — attractively office-styled in a high-impact beige case, and the only NEW intercom to appear in 15 years!

SELECTaCOM Order No. 21-1160; Ship. wt. 6 lbs.



it's a wireless 100mw intercom!

House electrical wiring is NOT used to transmit! SELECTaCOM transmits the wireless CB way with crystal-controlled stability on Ch. 5. Use it with any number of similar units for an intercom "net"; also receive Ch. 5 signals from mobile or walkie-talkie CB sets! No license; no mike needed.

it's a dual 100mw/3W CB transceiver!

Low power (100 mw) operation with built-in telescoping antenna gives you NO LICENSE communications. Flip to high power, plug in external antenna for full 3-watt operation on quiet Ch. 5. It's a versatile "telephone" for the space-age.

it's sold only by Radio Shack stores!

And the Realistic SELECTaCOM is actually priced below "close-outs". The only desk-top CB on the market — and the world's first "CB intercom"! Order by mail or buy it at your nearest RADIO SHACK store. External antenna \$9.95, no. 21-901.

49.95
PAIR
99.50

YES... You can buy "ON TIME"

**AT ALL 48
RADIO SHACK STORES**
Coast-to-Coast

Mail to the Radio Shack Nearest You
Introductory Special! We Will Fill Your
SELECTaCOM Order for 50c a Unit (Post-
age & Handling) Anywhere in the U.S.A.

Send Free Radio Shack Bargain Catalog

Name _____

Street _____

City _____

State _____

Zip _____

CALIFORNIA
BAKERSFIELD — 1308 19th St.
DOWNEY — Stonewood Shop. Ctr.
LA MESA — Grossmont Shop. Ctr.
LONG BEACH — 127 W. 7th St.
LONG BEACH — 3976 Atlantic Ave.
SAN LEANDRO — Bay Fair Shop. Ctr.

CONNECTICUT
NEW HAVEN — 92 York St.
MANCHESTER — Manchester Shop. Parkade
STAMFORD — 28 High Ridge Rd.
WEST HARTFORD — 39 So. Main St.

ILLINOIS
CHICAGO — Evergreen Pk. at 95th St.

NEW HAMPSHIRE
MANCHESTER — 1247 Elm St.

NEW MEXICO
ALBUQUERQUE — 6315 Lomas, N. E.

NEW YORK
NEW YORK — 1128 Ave. of the Americas
SYRACUSE — 3057 Erie Blvd. East

MASSACHUSETTS
BOSTON — 167 Washington St.
BOSTON — 594 Washington St.
BOSTON — 110 Federal St.
BRAintree — South Shore Plaza
BROOKLINE — 730 Commonwealth Ave.
CAMBRIDGE — Fresh Pond Shop. Ctr.
FRAMINGHAM — Shoppers' World
LOWELL — Central Shop. Plaza
SAUGUS — N. E. Shop. Ctr.
SPRINGFIELD — 1182 Main St.
WORCESTER — Lincoln Plaza

MAINE
PORTLAND — Pine Tree Shop. Ctr.

MINNESOTA
ST. PAUL — 16 E. 6th St.

OKLAHOMA
OKLAHOMA CITY — Mayfair Shop. Ctr.
TULSA — 317 South Detroit St.

OHIO
CINCINNATI — 852 Swifton Ctr.

PENNSYLVANIA
PHILADELPHIA — 2327G Cottman Ave.
PHILADELPHIA — 1128 Walnut St.

RHODE ISLAND
CRANSTON — 1301 Reservoir Ave.
EAST PROVIDENCE — Shoppers' Town

TEXAS
DALLAS — 1601 Main St.
DALLAS — Medallion Center
DALLAS — 125 Wynnewood Village
FORT WORTH — 1515 So. Univ. Dr.
FORT WORTH — 900 East Berry St.
FORT WORTH — 3524 East Denton Highway
HOUSTON — 2315 Travis St.
HOUSTON — 322 Northline Mall
HOUSTON — 4759 Bissonette
SAN ANTONIO — Wonderland Ctr.
WACO — 1016 Austin Ave.

VIRGINIA
ARLINGTON — Washington-Lee Shop. Ctr.
WASHINGTON
SEATTLE — 2028 Third Ave.

CIRCLE NO. 26 ON READER SERVICE PAGE

Regency

Pick it up.
Turn it on.
Enjoy the
thrill of
DSBRC.*



Coverage? Our new Range Gain Transceiver has Regency's exclusive Double Side-Band Reduced Carrier.* It gives you four times more range than ordinary equipment under normal conditions. Puts stations you couldn't even reach before . . . just a whisper away. Gives you, as well, crystal-controlled transmission and reception on all 23 CB channels. And a Double-Conversion Superhet Receiver. Plus all these other features you've come to expect from Regency: Metered Control • Built-in Crystal Filter • Delta Tuning • Automatic Noise Limiter • Adjustable Squelch. Complete and ready to operate on all 23 channels—AC and 12V DC. . . . \$269.95

Special Offer! New Romper



For a limited time only get the best deal in CB today—our new Romper plus 23 crystals for crystal-controlled transmission and reception on all channels . . . for just \$189.95 (normally \$232.90). Write for more information. Complete, ready to operate, AC and DC cords, microphone. . . . \$189.95

A 12-month warranty with every Regency Transceiver!

Regency Electronics, Inc., 7905 Pendleton Pike, Indianapolis, Ind. 46226
CIRCLE NO. 28 ON READER SERVICE PAGE

Letters

(Continued from page 8)

strict CB to base and mobile communications. If inter-station communications are required, the licensee could be issued a special license specifying the reason.

BOB NEALIS, K1K7936
Chicago, Ill.

■ Extend the present CB band to 28.19 mc. to provide a total of 44 channels. This part of the 10-meter band is inactive . . . It is pointless to give one group more frequencies than they can use and starve another group that needs more room.

ROLAND P. CANOLES, SR., KCF1848
Sparks, Md.

■ . . . I think we should try to see what the CB'ers think about their problem. There are very few problems in our area that haven't been solved with a little common sense and consideration of others. If this "CB Dilemma," which exists in some areas, can be left to the persons involved, the users of the service, they can, with the support of the FCC, bring their dilemma to an end without any drastic curbs that would reduce the usefulness of the Citizens Band.

ROGER DENTON, KKR3956
Metairie, La.

Archimedes: Standing Room Only

■ Tut! Tut! Your transistors are showing. It was not Sir Isaac Newton but Archimedes (circa 250 B.C.) who said "Give me a place to stand and I'll move the

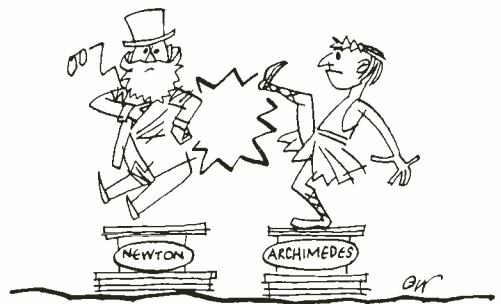

earth." as misquoted in "A Platform In the Sky" (February, 1965).

JOSEPH L. HETZEL, M.D.
Middlebury, Conn.

■ It happens to have been Archimedes. Give credit where credit is due.

The Association for Prevention of
Discrimination Against Archimedes
(RONALD J. THORNTON)
Guin, Ala.

■ The correct quotation is "Give me a fulcrum on which to rest and I will move the earth."

EDDIE HAMILTON, JR.
San Clemente, Calif.

On this matter, we have neither a fulcrum nor a place to stand. Our thanks to all of you who wrote in about it.

"Nonsense Box" Causes Chaos

■ One of your projects just made me so irritated I find it hard to control myself as I write. It turned out to be more trouble than it's worth, and the end result brought complete chaos, and I mean it literally. I recently completed the "Nonsense Box" (July, 1963),

TWO NEW KITS FROM CONAR

'ROUND THE WORLD RADIO FOR \$64.00



Designed with the novice ham radio enthusiast in mind. A complete, low cost, easy to build and easy to use amateur radio set-up that sends and receives signals around the world. Everything you'll need to begin a new, fascinating hobby is included . . . and you'll be on the air in one evening. Complete set-up includes transmitter, receiver, code key, assembly manuals, instruction manuals, ARRL Handbook and complete data about getting your Novice License. All this for just \$64.00. Use coupon below **now**. Cash or terms.

THE MODEL 400 25-WATT TRANSMITTER

Inside this attractive 10" x 7½" x 6½" dark blue cabinet is a remarkable power house. Yet, it's so simple to build, so easy to tune, even an inexperienced kit builder can be on the air in one evening. Covers the popular Novice bands—80, 40 and 15 meters. 3" square panel meter for fast "tuning up". Special variable-impedance current-limiter assures pure signal on any band, protects your valuable crystals (crystals not included). Other features: Pi-network output; transformer power supply with dual silicon rectifier to produce ripple-free DC for plate power; bleeder resistor to regulate and discharge high-voltage capacitors when gear is turned off; co-ax output.

KIT PRICE: \$32.50
(Stock #400UK)
Assembled: \$46.50
(Stock #400WT)

THE MODEL 500 3 BAND RECEIVER

Identical in size and color to the Transmitter. Offers features of receivers priced much higher. Superhet circuit has TWO stages of i-f amplification to "dig down" for weak signals. Antenna trimmer lets you adjust front end for peak reception on each of three bands. Bands cover stretches over nearly full travel of large tuning dial. Separate, stable bfo for clear reception of CW and SSB signals. Variable i-f gain. Following the detector are two stages of audio amplification to drive either the built-in speaker or headphones. Transformer operated with semiconductor rectifier to supply power for various circuits. Receives AM, CW and SSB. So easy to build, so easy to use, so easy to own. Order today.

KIT PRICE: \$37.50
(Stock #500UK)
Assembled: \$56.50
(Stock #500WT)

CONAR DA5C

Division of National Radio Institute
3939 Wisconsin Ave.,
Washington, D.C. 20016

- Please send me both new Conar Ham Radio Kits @ \$64.00 Complete
- Please send only Model 400 Transmitter Kit @ \$32.50 (Assembled \$46.50)
- Please send only Model 500 Receiver Kit @ \$37.50 (Assembled \$56.50)
- Tell me how I can buy this equipment on easy terms.

Name _____

Address _____

City _____ State _____ Zip Code _____

CIRCLE NO. 5 ON READER SERVICE PAGE

SOLDERING TIPS FOR HI-FI KIT BUILDERS



HEAT WIRES NOT THE SOLDER

Wires or leads will then become hot enough to melt the solder and it will flow into the joint. Never apply heat directly to the solder.



USE PROFESSIONAL EQUIPMENT

Virtually all radio and TV servicemen use Weller Dual Heat Soldering Guns. A Weller Expert Soldering Kit includes everything you need for strong, noise-free connections.

A Weller Dual Heat Gun is indispensable in electronic soldering. Heat and spotlight come on instantly when trigger is pulled. 2 trigger positions let you switch instantly to low 100-watt or high 140-watt heat. Low heat prevents damage to components and prolongs tip life. High heat is ready when you need it.

Kit includes gun in plastic utility case, 3 tips, tip wrench, flux brush, soldering aid and solder. Model 8200PK \$8.95. Weller Electric Corp., Easton, Pa.

Weller[®]

WORLD LEADER IN SOLDERING TECHNOLOGY
CIRCLE NO. 38 ON READER SERVICE PAGE

Letters

(Continued from page 10)

and it worked perfectly. Now all my wife and I can do is to try and keep the kids from fighting over it—and even my wife and I have been arguing about the kids arguing. Obviously, I'll have to build another one. By the way, does Author Danzis have any kids?
RICO CARNEVALE, WAØBTB
St. Joseph, Mo.

We can't speak for the author, Rico, but your Editors had the same problem. The result? A great proliferation of "Nonsense Boxes."

"Walking" Radio Receiver

■ The case of the man who hears a local radio station in his head every time he relaxes ("Odds 'N' Ends," November, 1964) is not as silly as it sounds. A machinist who somehow got bits of carborundum in



his teeth had the same problem. The material acted as a detector on local radio stations, and he also heard sounds in his head until he finally had several teeth pulled. Try to top this "walking receiver!"

TOM ADAMS, WN9LGD, WPE9GSX
Chicago, Ill.

Solving Hi-Fi Interlock Problem

■ My "Hi-Fi Interlock" ("Build Hi-Fi Interlock," August, 1964) operates properly when the tuner is used as the prime controller, but when I use the phono as the controller, the relay vibrates or buzzes like a doorbell. What can be done to remedy this problem?

R. W. SCHUMACHER
Torrance, Calif.

Chances are your record player doesn't draw enough current to activate the controlling circuit properly. One way to eliminate this problem would be to connect a small wattage lamp across the phono motor, and mount it in a convenient place. The light would put more of a load on the "Hi-Fi Interlock," and would also serve to light up your record playing area.

Out of Tune



The Sleep-O-Mat (January, 1965, page 53). In the schematic, the heater pins of V1 should be 1 and 12, not 1 and 11.

Experimenter's L Bridge (January, 1965, page 63). In the bottom photograph, R15 is incorrectly labeled C15.

-30-

LIVE BETTER ELECTRONICALLY with LAFAYETTE RADIO ELECTRONICS

HI-FI AND CB EQUIPMENT Headquarters



Model HB-500
139⁵⁰
99-3027WX

NEW! LAFAYETTE 70-WATT COMPLETE AM-FM STEREO RECEIVER

Just Add Speakers and Enjoy FM, FM Stereo and High-Quality AM Reception

- A powerful 70-Watt Amplifier plus Complete Preamplifier Control Facilities plus a Standard AM Tuner plus a sensitive FM Tuner plus an FM Stereo Tuner—all on One Compact chassis
- Amazing FM "Stereo Search" Circuit Signals Presence of Stereo Broadcasts
- Tuned Nuvistor "Front End" provides Greater Sensitivity, Lower Noise
- Bar-Type Tuning Indicator for AM and FM
- Variable AFC Control
- Imported

TAKES REELS UP TO 7"



‡ adaptable to stereo playback

DYNAMIC MICROPHONE

THE WIDELY ACCLAIMED LAFAYETTE RK-137A TAPE RECORDER

FEATURING **4** - TRACK STEREO PLAYBACK‡
4 - TRACK MONAURAL RECORD PLAYBACK

With Electronic Track Selector Switch, VU Recording Level Meter and Pause Switch For Instant Editing

Includes Lightweight carrying case, dynamic microphone, output cable, 7 inch empty tape reel.

- Two Speeds—3¾ & 7½ ips
- Pause Lever Provides Instant Stop for Editing
- Record—Erase Safety Switch
- Fast, Rugged Shift Lever Control
- Extension Speaker Jack
- High Impedance Monitoring Jack
- VU Meter Recording Level Indicator
- Electronic Track Selector Switch
- Specially Designed Heavy-Duty 6x4" PM Speaker
- Separate Erase and Record Heads
- Imported

FREE!

LAFAYETTE RADIO ELECTRONICS

1965 CATALOG NO. 650 516 PAGES!

See The Largest Selection in Our 44-Year History

- Stereo Hi-Fi — Famous Brands plus Lafayettes own Top-Rated Components
- Citizens Band Equipment
- Tape Recorders
- Ham Gear
- Radio's, TV's and Accessories
- P.A. Equipment; Intercoms
- Test Equipment
- Optical Goods
- Auto Accessories
- Musical Instruments



Model LR-800
199⁵⁰
99-0005WX

Small... Quiet... Powerful! NEW! LAFAYETTE SOLID-STATE DUAL CONVERSION 5-WATT CB TRANSCEIVER

With Authentic Mechanical Filter

- ✓ Only 3" high—fits easily in any car
- ✓ Special multi-stage noise limiting circuit ends problem of mobile noise
- ✓ The same output as the most powerful tube unit yet uses only 1/50th of the battery power

The Perfect Unit For Mobile!

- 12 Crystal Transmit and Receive Positions
- 23 Channel Tunable Receiver With Spotting Switch
- 3-Stage Transmitter Rated For Full Legal Power
- Dual Conversion Receiver with 5/10 μ V Sensitivity
- Multi-Stage Automatic Noise Limiting Circuit
- Rugged Silicon Mesa Transistors
- Compact—3"Hx11¼"Wx6¾"D
- 12V DC Mobile Operation (Negative or Positive ground)
- 117V AC operation when used with Matching Solid-State AC Power Supply (Optional at \$16.95)

Model RK-137A
89⁵⁰
99-1511WX



NEW! LAFAYETTE 23-CHANNEL 5-WATT CB TRANSCEIVER

Double Side Band Full Carrier

- ✓ 17-Tube Performance with 13 Tubes
- ✓ Low Noise Nuvistor "Front End"
- ✓ 5 Double-Tuned IF Transformers
- ✓ Meets All FCC Requirements

With Advanced "Range-Boost" Circuit

- Frequency Synthesized Circuit Provides 23 Crystal-Controlled Transmit & Receive Channels—No Extra Crystals to Buy
- Continuous One-Control Channel Tuning
- Full 5-Watt Input
- Push-To-Talk Microphone & Electronic Switching
- Dual Conversion Receiver With 3/10 μ V Sensitivity
- Delta Tuning Offers "Fine Tuning" of ± 2.5 Kc on Receive
- Illuminated "S" and RF Output Meter
- Variable Squelch, Variable Noise Limiter, AGC
- Built-in 117V AC & 12V DC Power Supply
- "Vari-Tilt" Mounting Bracket for Easy Mobile Installation
- Plug-in Facilities For Lafayette Selective Call Unit

LAFAYETTE RADIO ELECTRONICS
Dept. 10-5 P.O. Box 10
Syosset, L.I., N.Y. 11791

Send me the FREE 1965 Lafayette Catalog 650 \$ enclosed; send me (Prices do not include shipping charges).

Name.....

Address.....

City..... State..... Zip.....

CIRCLE NO. 19 ON READER SERVICE PAGE

HOBSON'S CHOICE? NEVER AGAIN!

If, in 1631, you went to rent a horse from Thomas Hobson at Cambridge, England, you took the horse that stood next to the door. And no other. Period. Hence, Hobson's Choice means No Choice.

And, as recently as 1961, if you went to buy a true high fidelity stereo phono cartridge, you bought the Shure M3D Stereo Dynetic. Just as the critics and musicians did. It was acknowledged as the ONLY choice for the critical listener.

Since then, Shure has developed several models of their Stereo Dynetic cartridges—each designed for optimum performance in specific kinds of systems, each designed for a specific kind of *porte-monnaie*.

We trust this brief recitation of the significant features covering the various members of the Shure cartridge family will help guide you to the best choice for you.

THE CARTRIDGE



V-15



M55E



M44



M7/N21D



M99



M3D

ITS FUNCTION, ITS FEATURES . . .

The ultimate! 15° tracking and Bi-Radial Elliptical stylus reduces Tracing (pinch effect), IM and Harmonic Distortion to unprecedented lows. Scratch-proof. Extraordinary quality control throughout. Literally handmade and individually tested. In a class by itself for reproducing music from mono as well as stereo discs.

Designed to give professional performance! Elliptical diamond stylus and new 15° vertical tracking angle provide freedom from distortion. Low Mass Scratch-proof. Similar to V-15, except that it is made under standard quality control conditions.

A premium quality cartridge at a modest price. 15° tracking angle conforms to the 15° RIAA and EIA proposed standard cutting angle recently adopted by most recording companies. IM and Harmonic distortion are remarkably low . . . cross-talk between channels is negligible in critical low and mid-frequency ranges.

A top-rated cartridge featuring the highly compliant N21D tubular stylus. Noted for its sweet, "singing" quality throughout the audible spectrum and especially its singular recreation of clean mid-range sounds (where most of the music really "happens".) Budget-priced, too.

A unique Stereo-Dynetic cartridge head shell assembly for Garrard and Miracord automatic turntable owners. The cartridge "floats" on counterbalancing springs . . . makes the stylus scratch-proof . . . ends tone arm "bounce."

A best-seller with extremely musical and transparent sound at rock-bottom price. Tracks at pressures as high as 6 grams, as low as 3 grams. The original famous Shure Dynetic Cartridge.

IS YOUR BEST SELECTION

If your tone arm tracks at 1½ grams or less (either with manual or automatic turntable)—and if you want the very best, regardless of price, this is without question *your* cartridge! It is designed for the purist . . . the perfectionist whose entire system *must* be composed of the finest equipment in every category. Shure's finest cartridge. \$62.50.

If you seek outstanding performance and your tonearm will track at forces of ¾ to 1½ grams, the M55E will satisfy—beautifully. Will actually improve the sound from your high fidelity system! (Unless you're using the V-15, Shure's finest cartridge.) A special value at \$35.50.

If you track between ¾ and 1½ grams, the M44-5 with .0005" stylus represents a best-buy investment. If you track between 1½ and 3 grams, the M44-7 is for you . . . particularly if you have a great number of older records. Both have "scratch-proof" retractile stylus. Either model under \$25.00.

For 2 to 2½ gram tracking. Especially fine if your present set-up sounds "muddy." At less than \$20.00, it is truly an outstanding buy. (Also, if you own regular M7D, you can upgrade it for higher compliance and lighter tracking by installing an N21D stylus.)

If floor vibration is a problem. Saves your records. Models for Garrard Laboratory Type "A", AT-6, AT-60 and Model 50 automatic turntables and Miracord Model 10 or 10H turntables. Under \$25.00 including head shell, .0007" diamond stylus.

If cost is the dominant factor. Lowest price of any Shure Stereo Dynetic cartridge (about \$16.00) . . . with almost universal application. Can be used with any changer. Very rugged.

SHURE

Stereo Dynetic®

HIGH FIDELITY PHONO CARTRIDGES . . . WORLD STANDARD WHEREVER SOUND QUALITY IS PARAMOUNT

Shure Brothers, Inc., 222 Hartrey Ave., Evanston, Illinois

CIRCLE NO. 32 ON READER SERVICE PAGE

POPULAR ELECTRONICS

PRODUCT SERVICE PAGE

You can get additional information promptly concerning products advertised or mentioned editorially in this issue

1 Circle the number on the coupon below which corresponds to the key number at the bottom of the advertisement or is incorporated in the editorial mention that interests you.

2 Add up your total number of requests and fill in the box in the upper right-hand corner of the coupon.

3 Mail the coupon to the address indicated below.

4 Please use this address only for Product Service requests.

POPULAR ELECTRONICS		NUMBER OF REQUESTS	<input type="text"/>																					
P. O. BOX 8391																								
PHILADELPHIA 1, PA.																								
<i>Please send me additional information about the products whose code numbers I have circled</i>																								
1	2	3	4	5	6	7	8	9	10	11	12	13	14	15	16	17	18	19	20	21	22	23	24	25
26	27	28	29	30	31	32	33	34	35	36	37	38	39	40	41	42	43	44	45	46	47	48	49	50
51	52	53	54	55	56	57	58	59	60	61	62	63	64	65	66	67	68	69	70	71	72	73	74	75
76	77	78	79	80	81	82	83	84	85	86	87	88	89	90	91	92	93	94	95	96	97	98	99	100
NAME <i>(Print clearly)</i> _____																								
ADDRESS _____																								
CITY _____ STATE _____ ZIP CODE _____																								
VOID AFTER MAY 31, 1965			4																					

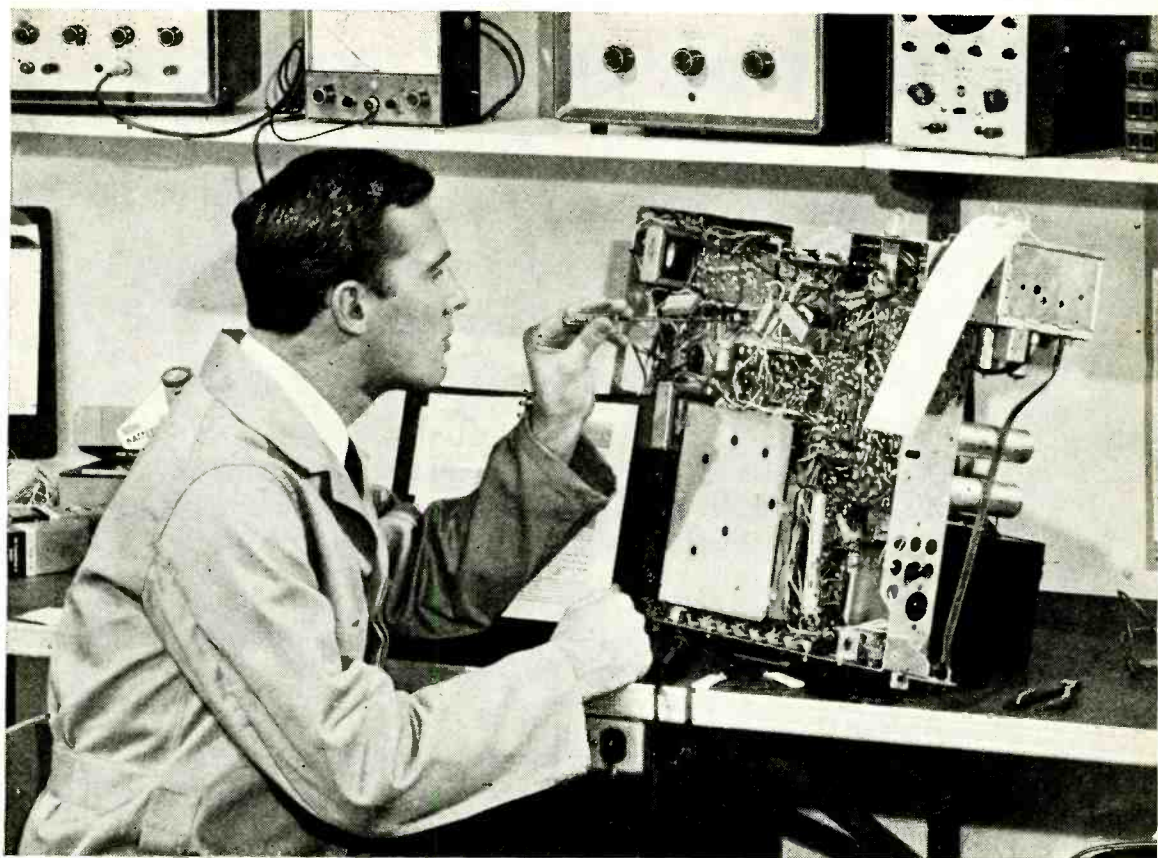

RCA TRAINING can be the smartest investment you ever made!

**Start building a profitable career in electronics now!
New RCA "AUTOTEXT" programmed instruction will help you
learn faster and easier!**

If you're considering a future in electronics, now is the time to start! A great new teaching aid—"AUTOTEXT" programmed instruction developed by RCA and introduced by RCA Institutes will help you master the fundamentals of electronics almost automatically. Even people who have had trouble with conventional home training methods are finding it easier and more fun to start their training in Electronics Fundamentals the RCA way. Prove

it to yourself as others throughout the country are now doing. An interest or inclination in electronics is what you need. RCA "Autotext" helps you to do the rest. You'll be ready to go on to advanced training sooner than you ever thought possible! The future is unlimited; the jobs are available. The important thing is to get started now.

Founded in 1909, RCA Institutes is one of the largest technical schools in the United States devoted princi-

pally to electronics. The very name "RCA" means dependability, integrity, and scientific advance. RCA Institutes offers the finest facilities of home training. A Service of the Radio Corporation of America, RCA Institutes gives you the technical instruction you need to plan, build and realize the career you want in today's fastest growing field.

Investigate your future now at RCA Institutes. It can be the smartest investment you ever made.

HOME TRAINING COURSES

RCA Institutes offer this complete selection of Home Training Courses

- Electronic Fundamentals
- Electronic Fundamentals (in Spanish)
- TV Servicing
- Color TV Servicing
- Transistors

- Communications Electronics
- FCC License Preparation
- Mobile Communications
- Automation Electronics
- Automatic Controls

- Industrial Applications
- Nuclear Instrumentation
- Digital Techniques
- Computer Programming
- Drafting

Liberal Tuition Plan. All RCA Institutes Home Study courses are available under a Liberal Tuition Plan. This plan affords you the most economical possible method of home study training. You pay for lessons only as you order them. If, for any reason, you should wish to interrupt your training, you can do so and you will not owe a cent until you resume the course. No other obligations! No installment payments required.

RCA Personal Instruction. With RCA Home Study training you set your own pace in keeping with your own ability, finances and time. RCA Institutes allows you ample time to complete the course. Your lesson assignments are individually graded by technically trained personnel, and helpful comments are added where required. You get theory, experiment, and service practice beginning with the very first lesson. All lessons are profusely illustrated. You get a complete training package throughout the entire course.



You Get Prime Quality Equipment. All kits furnished with the course are complete in every respect, and the equipment is top grade. You keep all the equipment furnished to you for actual use on the job... and you never have to take apart one piece to build another.

CLASSROOM TRAINING IN NEW YORK CITY

No previous training required. You are eligible even if you haven't completed high school.

RCA Institutes Resident School in New York City offers training that will prepare you to work in rewarding positions on research and production projects in fields such as automation, transistors, communications, technical writing, television, computers, and other industrial and advanced electronics applications. If you did not complete high school, RCA will prepare you for such training with courses specially designed to provide the basic math and physics required for a career in electronics. Check classroom training on attached card, and full information will be rushed to you.

Free Placement Service. RCA Institutes graduates are now employed in important jobs at military installations with important companies such as IBM, Bell Telephone Labs, General Electric, RCA, and in radio and TV stations all over the country. Many other graduates have opened their own businesses. A recent New York Resident School class had 93% of the graduates who used the FREE Placement Service accepted by important electronics companies... and had their jobs waiting for them on the day they graduated!



Coeducational Day and Evening Courses. Day and Evening Courses are available at RCA Resident Schools in New York City. You can prepare for a career in electronics while continuing your normal full-time or part-time employment. Regular classes four times each year.

SEND POSTCARD FOR FREE ILLUSTRATED BOOK TODAY!

SPECIFY HOME TRAINING OR CLASSROOM TRAINING.

RCA INSTITUTES, INC. Dept. PE-45

A SERVICE OF RADIO CORPORATION OF AMERICA, 350 WEST 4TH ST., NEW YORK, N. Y. 10014



The Most Trusted Name In Electronics

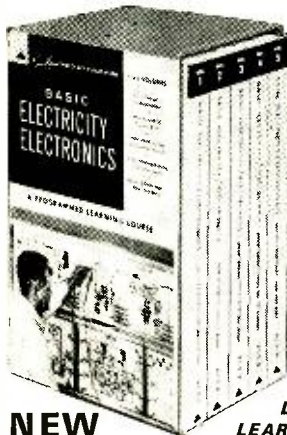

**ONLY
COURSE
OF ITS
KIND!**

**LATEST
LEARNING METHOD**

NEW

COMPLETE 5-VOLUME HOWARD W. SAMS

Basic Electricity/Electronics

A PROGRAMMED LEARNING COURSE

**now! unique, positive training
worth hundreds of dollars . . .**

First completely new Course to be published in the last 10 years... using the latest 5-step Programmed method for quick, effective, learning. This 5-volume series completely replaces any prior published basic course. Primarily intended for technician-level training; no previous knowledge of electricity or electronics required. Completion of the Course provides all the basic knowledge and preparation for advancing into the study of such specialized areas as Radio Communications, Industrial & Military Electronics, Radio & TV Repair, Electricity & Power, etc. Easy, positive self-instruction is assured by the unique, ultra-modern programmed learning method used in each volume.

- Vol. 1. Basic Principles & Applications
- Vol. 2. How AC & DC Circuits Work
- Vol. 3. Understanding Tube & Transistor Circuits
- Vol. 4. Understanding & Using Test Instruments
- Vol. 5. Motors & Generators—How They Work

(Complete Set contains over 1300 pages; 1250 illustrations; 51 chapters; in sturdy slipcase)

ECY-50. 5 Volume Softbound Edition, *only* \$19.95
ECS-50. 5 Volume Hardbound Edition, *only* \$24.95

(Individual softbound volumes available at \$4.50 each; hardbound volumes at \$5.50 each.)

10-DAY EXAMINATION PRIVILEGE

Order Today—Use Coupon Below

HOWARD W. SAMS & CO., INC.

**Howard W. Sams & Co., Inc., Dept. PE-4
4300 W. 62nd St., Indianapolis, Ind. 46206**

Send Set checked below, with 10-day examination privilege. If I am not completely satisfied, I understand I can return the Set for full refund.

ECY-50 (softbound). ECS-50 (hardbound).

\$ _____ enclosed

Send FREE Complete Sams Booklist

Name _____

Address _____

City _____ State _____ Zip _____

In Canada: A. C. Simmonds & Sons, Ltd., Toronto 7

CIRCLE NO. 29 ON READER SERVICE PAGE



The following satellites were in orbit and transmitting as this issue closed. The satellites are listed by frequency and by code name. Some satellites are mentioned several times since different frequencies are used for tracking and telemetry.

Vanguard 1*	108.012 mc.
Echo 2	136.020 mc.
Telstar 2	136.050 mc.
Alouette**	136.077 mc.
Explorer 23**	136.080 mc.
Explorer 18	136.111 mc.
Relay 1**	136.140 mc.
Relay 2	136.142 mc.
Explorer 21	136.145 mc.
Echo 2	136.170 mc.
OGO 1	136.170 mc.
Explorer 22	136.200 mc.
Tiros 8	136.233 mc.
Tiros 7	136.234 mc.
Explorer 26	136.275 mc.
Explorer 25	136.292 mc.
GGSE	136.319 mc.
Explorer 20**	136.350 mc.
Ariel 1	136.406 mc.
Syncom 2**	136.468 mc.
Syncom 3**	136.470 mc.
Ariel 2	136.558 mc.
1964 83C	136.561 mc.
Alouette**	136.593 mc.
Relay 2**	136.620 mc.
Relay 1	136.623 mc.
1963 38C (USA)	136.651 mc.
Explorer 20**	136.680 mc.
Explorer 24	136.710 mc.
San Marco	136.738 mc.
1964 40C (USA)	136.771 mc.
EGRS	136.803 mc.
Solar Radiation	136.886 mc.
Tiros 7	136.921 mc.
Tiros 8	136.924 mc.
Syncom 2**	136.980 mc.

*Transmits while satellite is in sunlight only

**Transmits only upon ground command

This listing does not include all of the satellites in orbit—many of which no longer are transmitting, or transmit erratic, very weak signals. Satellites of the Soviet Union generally use tracking and telemetry frequencies in the band between 19.990 and 20.010 mc. Exact frequencies of the Soviet satellites are broadcast by Radio Moscow immediately after launching. In orbit, but apparently not transmitting, are Cosmos 25, 31, 36, 38, 39, 40, 41, 42, 43, 44, and 48. Weak signals have been heard from Elektron 2 on 19.430 and 19.540 mc., according to some observers.

NEW! 19 Piece POWER TOOL ATTACHMENT SET

WITH
FREE
POLYSTYRENE
TOOL BOX

- CONVERTS ANY DRILL into
- POWER SCREWDRIVER
 - POWER NUT DRIVER
 - POWER SANDER
- and POWER BUFFER

with **2 SPEED**
ANGLE DRIVE

Retail Value \$12.50

Now \$ **9.95**
Only

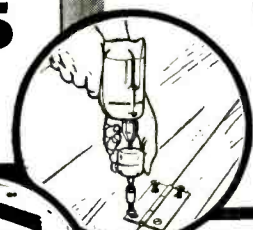
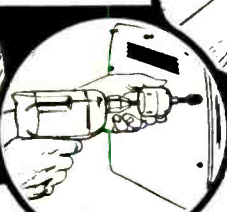
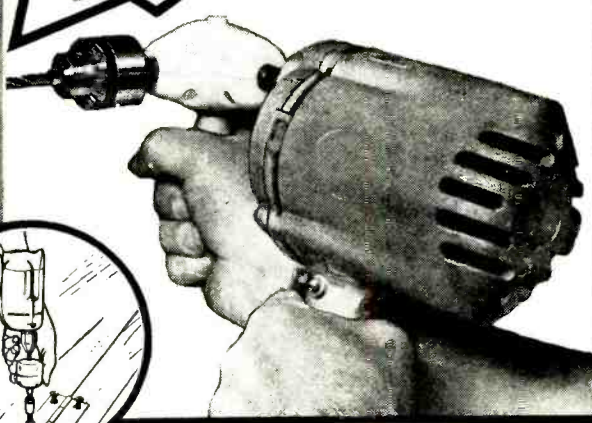

Also Available
15 PIECE
POWER TOOL
ATTACHMENT
SET

with fitted
storage and
carrying case

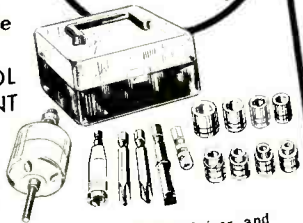

Converts any drill to a Power Screw Driver and Power Nut Driver. Contains deluxe Power Screwdriver attachment. 2 slotted and 2 Phillips type screwdriver blades, a screwfinder, power nut driver adaptor and 8 square drive machined sockets.

ONLY \$7.50

A PERFECT SET FOR EVERY POWER DRILL OWNER!

This 100% AMERICAN MADE kit is made of hardened steel with DuPont Zytel nylon housings which eliminate overheating and minimize drill load. Includes: 3 screwdriver blades, a screwfinder, 8 machined sockets and adaptors. 2 SPEED ANGLE DRIVE doubles or halves the speed of any drill. With 1 1/4" shank adaptor; 1 spindle adaptor; 1 chuck adaptor.

CONSUMER SERVICE COMPANY
160 Mercer Street, New York, N. Y. 10012

Enclosed is \$_____ Please ship me the following:

_____ 19 Piece Power Tool Set(s) at \$9.95 ea. plus 50c ea. for postage and handling.

_____ 15 Piece Power Tool Set(s) at \$7.50 ea. plus 25c ea. for postage and handling.

(N. Y. C. residents please add 4% sales tax.) Foreign orders \$1.00 additional.

Name _____ (PLEASE PRINT) PE-45

Address _____

City _____ State _____ Zip No. _____

Sorry—no charges or C.O.D. orders.

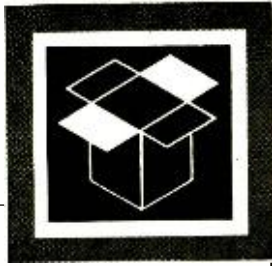

New Products

Additional information on products covered in this section is available from the manufacturers. Each new product is identified by a code number. To obtain further details on any of them, simply fill in and mail the coupon which appears on page 15.

ELECTRIC PENCIL

You can engrave your name or other markings on your equipment and tools with the Model V-69 "Electric Pencil" produced by *Burgess Vibrocrafters, Inc.* Suitable for use on metals, wood, or plastic, it handles like an ordinary lead pencil. When you place it in a writing position, the motor starts; when you put it down, the motor turns off—automatically. Housed in red



high-impact plastic, the V-69 weighs less than 10 ounces and is less than 5½" in length.

Circle No. 75 on Reader Service Page 15

VERSATILE TURNTABLE

An automatic foolproof glide to and from the record groove is one of the features of the PE-34 turntable announced by *Elpa Marketing Industries Inc.*, manufactured by Perpetuum-Ebner, and marketed under a PE-Elpa trademark. Another feature is a semipneumatic cueing and indexing tone arm control for 7- 10- and 12-inch records which permits start or stop at any point during record play. At the completion of play, the tone arm lifts up automatically. The four-speed, nonmagnetic heavy aluminum weighted turntable is mounted on precision bearings, insuring accurate speed, minimum wow



and flutter. Price, \$72, including full year guarantee, strobe disc, and 45-rpm adapter. Satin walnut base is optional at \$6.00.

Circle No. 76 on Reader Service Page 15

"BURNOUT-PROOF" VOM'S

Each of the three new volt-ohmmeters announced by *Electronic Measurements Corp.* is available either in factory-wired or kit form. The pocket-size Model 102 (3¼" x 6¼" x

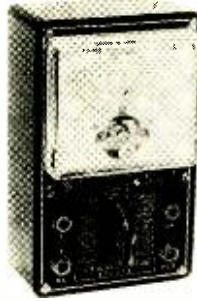

2") is housed in a high-impact Bakelite case (see photo). Its 800- μ a. meter movement has 5 a.c. and 5 d.c. voltage ranges; 4 d.c. and 3 a.c. current ranges; and 3 resistance ranges. Model 109 (5¼" x 6¼" x 2½") has a 40- μ a. meter, with 5 db ranges. Model 103 is the same size as the 109 but incorporates a 800- μ a. meter. The meter movements in all units are shunt-protected by

a diode—to absorb damaging high-energy, high-voltage surges; to prevent meter burn-out, and bent indicator needles; and to eliminate fuse replacement. Prices range from \$13.50 to \$27.95.

Circle No. 77 on Reader Service Page 15

VIBRATOR ELIMINATOR

The "Vi-Tran II" solid-state vibrator eliminator being offered by *I.E.H. Manufacturing Co.* will replace the standard 4-pin vibrator in communications equipment operating from 5 watts up to 25 watts of power, 6 or 12 volts. Suitable for commercial and emergency applications, such as police radio, ambulances, fire engines, cabs, heavy-duty CB equipment, and business radio, its use results in drastically reduced noise (since vibrator hash is eliminated), and power conservation through increased efficiency, increased output, and cooler operation. Two models of the "Vi-Tran II" are available: the VE 196 (pin #1 positive), and the VE 197 (pin #1 negative). Price, \$9.95.



Circle No. 78 on Reader Service Page 15

SELECTIVE MECHANICAL FILTER

Lafayette Radio Electronics has introduced a highly selective mechanical filter for use with standard broadcast, short-wave, c.w. and SSB communications receivers, and CB transceivers. With the influx of new stations and narrow bandwidths prevalent today, it is desirable to increase the selectivity of existing receivers having an intermediate frequency of 455 kc. This mechanical filter closely ap-

Anyone (including your wife) can make just as fine a tuner as Fisher

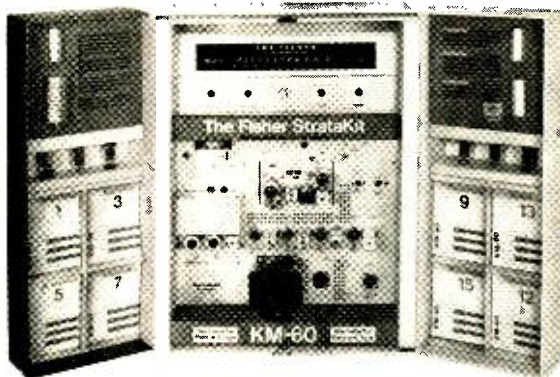

...with the Fisher KM-60 StrataKit.

The Fisher KM-60 StrataKit makes it so easy to build an elaborate, high-performance FM-multiplex tuner that the technical experience or inexperience of the kit builder becomes totally irrelevant. Audio engineers and housewives can build the KM-60 with equal facility and completely equal results. And the results are spectacular.

The StrataKit method of kit construction is an exclusive Fisher development. Assembly takes place by simple, error-proof stages (Strata). Each stage corresponds to a separate fold-out page in the uniquely detailed instruction manual. Each stage is built from a separate packet of parts (StrataPack). The major components come already mounted on the extra-heavy-gauge steel chassis. Wires are pre-

cut for every stage—which means every page. All work can be checked stage-by-stage and page-by-page, before proceeding to the next stage.

In the KM-60 StrataKit, the front-end and multiplex stages come fully assembled and pre-aligned. The other stages are also aligned and require only a simple "touch-up" adjustment by means of the tuner's laboratory-type d'Arsonval signal-strength meter.

When it comes to performance, the advanced wide-band Fisher circuitry of the KM-60 puts it in a spectacular class by itself. Its IHF sensitivity of 1.8 microvolts makes it the world's most sensitive FM tuner kit. Capture ratio is 2.5 db; signal-to-noise ratio 70 db. Enough said.

Price, \$169.50. Walnut or mahogany cabinet, \$24.95. Metal cabinet, \$15.95.

Price, \$24.95. Metal cabinet, \$15.95.

FREE! \$1.00 VALUE! The Kit Builder's Manual, an illustrated guide to high fidelity kit construction, complete with detailed specifications of all Fisher StrataKits.

Fisher Radio Corporation 104
21-40 44th Drive
Long Island City, N. Y. 11101

Please send me The Kit Builder's Manual without charge.

Name _____

Address _____

City _____ State _____

New Products

(Continued from page 22)

proximates the steep-skirted, flat-top, ideal bandpass response required. At 2.5 kc. on either side of the center frequency, the filter provides 60 db attenuation of unwanted signals, insuring complete adjacent channel rejection. Price, \$19.95.

Circle No. 79 on Reader Service Page 15

DYNAMIC TRANSISTOR TESTER

Simplicity and speed of operation are featured in the new ESCO transistor tester. The Model XT-1 tests all types of transistors in or out of circuit, instantly, without charts. It pinpoints open, shorted, or leaky transistors, and requires no meters or switches. An audible tone gives test results immediately and accurately.

Circle No. 80 on Reader Service Page 15

ANTENNA-CONVERTER INTEGRATED UNIT

Introduced by Channel Master Corp., the Model 4003 "Convertenna" combines an all-channel indoor antenna system with a built-in transistorized UHF converter, and is said to provide excellent reception of strong VHF, UHF, black and white, color, FM mono and FM stereo signals. The VU-82 antenna section of the unit is two separate antennas built into one, each operating independently; a dipole with extra-long 96" elements provides for VHF and FM stereo reception, while a stacked UHF antenna using a Super Turnstile "butterfly" design provides for UHF reception. The transistorized converter section features a nite-lite dial, vernier tuning channel selector, and 300-ohm output and input impedance match. Price, \$39.95.

Circle No. 81 on Reader Service Page 15

TRANSISTORIZED STEREO AMPLIFIER

The Model LA-340 stereo amplifier recently introduced by Lafayette Radio Electronics is a low-cost, completely integrated, solid-state amplifier with 20 watts IHFM music power for each channel. Compactness (it's

11 $\frac{3}{4}$ " x 3 $\frac{3}{4}$ " x 10 $\frac{1}{2}$ ") and the absence of heat permits bookshelf or table-top use. Five pairs of stereo inputs accommodate a tuner, phono with magnetic or ceramic cartridges, tape recorder, and auxiliary program sources. There is also a front panel stereo headphone jack and switch to silence speakers, a concentric volume control, and a separate on/off power switch with pilot lamp. Frequency response is ± 1 db from 30 to 20,000 cycles; harmonic distortion, 1%. Price, \$79.95.

Circle No. 82 on Reader Service Page 15

SINE/SQUARE-WAVE AUDIO GENERATOR

Sine- and triggered square-wave outputs from 10 to 100,000 cycles in four overlapping bands are provided by the all-transistor audio signal generator announced by Path Products Corporation. Manufactured in England by Nom-brex, the Model #63 is powered by a self-contained standard 9-volt transistor-radio type battery. Among the features claimed for the factory-wired and calibrated generator are: unusually small size (6 $\frac{1}{2}$ " x 4 $\frac{1}{2}$ " x 2 $\frac{1}{2}$ "); light weight (less than 2 pounds); stability (accuracy within 5%); low distortion (less than 1% on sine waves, 0.3 μ sec. rise time on square waves); and durability. Price, \$59.25, complete with test leads, battery, and instructions.

Circle No. 83 on Reader Service Page 15

BATTERY-OPERATED STEREO RECORDER

Said to be the first portable, battery-operated stereo tape recorder available, the Saxon 755 incorporates 14 transistors—7 per channel—and operates approximately 15 hours on standard 1 $\frac{1}{2}$ -volt D cell batteries. Manufactured by Kouyoh International, it has three capstan-governed tape speeds—7 $\frac{1}{2}$, 3 $\frac{3}{4}$, and 1 $\frac{7}{8}$ ips—with fast forward and fast rewind functions. Frequency response extends from 50 to 15,000 cycles, signal-to-noise ratio is 45 db at peak record signal, and wow and flutter are less than 0.24% at 7 $\frac{1}{2}$ ips. The unit will also operate from external 117-volt a.c. or 12-volt d.c. power sources.

Circle No. 84 on Reader Service Page 15

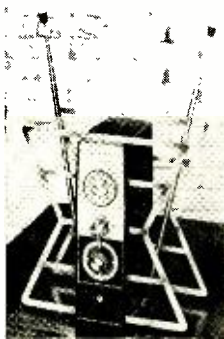
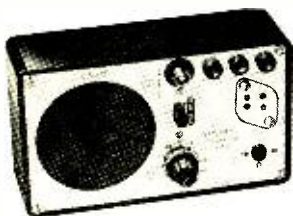

REVOLUTION IN CB BASE ANTENNAS

ROTATE THE SIGNAL NOT THE ANTENNA

The Unique New Model M-119
Electronic Sector Phased
Omni-beam antenna

THE  **Scanner**
PAT. PENDING

- Electronic focus and beam rotation for maximum distance—No mechanical rotator needed
- Change signal direction instantly
- Full-circle scan coverage—No blind spots
- Compact—17½ ft. vertical elements arranged on 3 ft. radius circle
- Resists over 100 mph winds
- Easy one-man installation
- 7.75 db directional gain
- 23 db front to back ratio
- Priced 30% below old fashioned beam arrays



Scan Control Unit, with Indicator lights, instantly changes signal direction—just flip the switch.

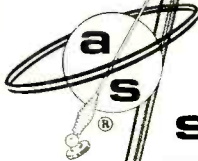

**the
antenna
specialists co.**

12435 Euclid Ave., Cleveland, Ohio 44106
64-14 Woodside Ave. Woodside 77, N.Y.

Export Div.:

Stripes of Quality



CIRCLE NO. 1 ON READER SERVICE PAGE

BECOME A RADIO TECHNICIAN
For ONLY \$26.95

BUILD 20 RADIO CIRCUITS AT HOME

with the New
Progressive Radio "Edu-Kit"[®]
ALL Guaranteed to Work!

only
\$26.95
Reg. U.S.
Pat. Off.



A COMPLETE HOME RADIO COURSE

- BUILD**
- 12 RECEIVERS
 - 3 TRANSMITTERS
 - SIGNAL TRACER
 - SIGNAL INJECTOR
 - CODE OSCILLATOR
 - SQ. WAVE GENERATOR
 - AMPLIFIER

- No Knowledge of Radio Necessary
 - No Additional Parts or Tools Needed
 - Excellent Background for TV
- Training Electronics Technicians Since 1946

FREE SET OF TOOLS, PLIERS-CUTTERS, TESTER, SOLDERING IRON.

WHAT THE "EDU-KIT" OFFERS YOU

The "Edu-Kit" offers you an outstanding PRACTICAL HOME RADIO COURSE at a rock-bottom price. You will learn radio theory, construction and servicing, and will learn how to build radios, using regular schematics; how to solder and wire in a professional manner; how to service and troubleshoot radios. You will learn how to work with punched metal chassis as well as the new Printed Circuit chassis. You will learn the principles of RF and AF amplifiers and oscillators, detectors, rectifiers, test equipment. You will learn and practice code, using the Progressive Code Oscillator. You will build 20 Receiver, Transmitter, Code Oscillator, Signal Tracer, Square Wave Generator, Amplifier and Signal Injector circuits, and learn how to operate them. You will receive an excellent background for TV. In brief, you will receive a basic education in Electronics and Radio, worth many times the small price you pay, only \$26.95 complete.

PROGRESSIVE TEACHING METHOD

The Progressive Radio "Edu-Kit" is the foremost educational radio kit in the world, and is universally accepted as the standard in the field of electronics training. The "Edu-Kit" uses the modern educational principle of "Learn by Doing." You begin by building a simple radio. Gradually, in a progressive manner, and at your own rate, you construct more advanced multi-tube radio circuits, learn more advanced theory and techniques, and work like a professional radio technician. These circuits operate on your regular AC or DC house current.

THE KIT FOR EVERYONE

You do not need the slightest background in radio or science. The "Edu-Kit" is used by young and old, schools and clubs, by Armed Forces Personnel and Veterans Administration for training and rehabilitation. One of the most important aspects of the "Edu-Kit" is the Consultation Service which we provide. We welcome students to send us their problems, whether related to any of the material covered in the "Edu-Kit" course, or encountered in other experiences in the field of electronics.

THE "EDU-KIT" IS COMPLETE

You will receive all parts and instructions necessary to build 20 different radio and electronic circuits, each guaranteed to operate. Our kits contain tubes, tube sockets, variable, electrolytic, mica, ceramic and paper dielectric condensers, resistors, tie strips, coils, hardware, tubing, punched metal chassis, Instruction Manuals, hookup wire, solder, selenium rectifiers, volume controls, switches, etc. You receive Printed Circuit materials, including Printed Circuit Chassis, special tube sockets, hardware and instructions. You also receive a useful set of tools, pliers-cutters, professional electric soldering iron, and a self-powered dynamic Radio and Electronics Tester. The "Edu-Kit" also includes Code instructions and the Progressive Code Oscillator. You will also receive lessons for servicing with the Progressive Signal Tracer and the Progressive Signal Injector, a High Fidelity Guide, FCC Amateur License Training, and a Quiz Book.

All parts, components, etc., of the "Edu-Kit" are 100% unconditionally guaranteed, brand new, carefully selected, tested and matched. Everything is yours to keep. The complete price of this practical home Radio and Electronics course is only \$26.95.

TROUBLE-SHOOTING LESSONS

You will learn to troubleshoot and service radios, using the professional Signal Tracer, the unique Signal Injector, and the dynamic Radio and Electronics Tester. Our Consultation Service will help you with any technical problems.

J. Stasaltis, of 25 Poplar Pl., Waterbury, Conn., writes: "I have repaired several sets for my friends, and made money. The "Edu-Kit" paid for itself. I was ready to send \$240 for a course, but I found your ad and sent for your kit."

FREE EXTRAS

- Set of Tools • Radio Book • Radio and Electronics Tester • Electric Soldering Iron • Pliers-Cutters • Tester Instruction Book • Hi-Fi Book • TV Book • Quiz Book • Membership in Radio-TV Club • Consultation Service • FCC Amateur License Training • Printed Circuitry • Certificate of Merit • Valuable Discount Card
- UNCONDITIONAL MONEY-BACK GUARANTEE

ORDER FROM AD—RECEIVE FREE BONUS RADIO & TV PARTS JACKPOT WORTH \$15

- "Edu-Kit" Postpaid, Enclosed full payment of \$26.95.
- "Edu-Kit" C.O.D. I will pay \$26.95 plus postage.
- Send me FREE additional information describing "Edu-Kit."

Name
Address

PROGRESSIVE "EDU-KITS" INC.

(ATT: S. GOODMAN, M.S. in Ed., PRES.)

1186 Broadway Dept. 638D Hewlett, N. Y.
CIRCLE NO. 24 ON READER SERVICE PAGE

Operation Assist

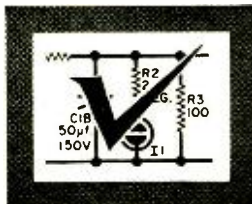

THROUGH THIS COLUMN we try to make it possible for readers needing information on outdated, obscure, and unusual radio-electronics gear to get help from other P.E. readers. Here's how it works: Check the list below. If you can help anyone with a schematic or other information, write him directly—he'll appreciate it. If you need help, send a postcard direct to OPERATION ASSIST, POPULAR ELECTRONICS, One Park Avenue, New York, N.Y. 10016. Give maker's name, model number, year of manufacture, bands covered, tubes used, etc. State specifically what you want, i.e., schematic, source for parts, etc. Be sure to print or type everything legibly, including your name and address. Because we get so many inquiries, none can be acknowledged, and POPULAR ELECTRONICS reserves the right to publish only those items that are not available from normal sources.

Schematic Diagrams

Amrad receiver, ser. 81-64903, circa 1929. Has 8 tubes. (R. D. Sayre, 6604 W. Franklin St., Richmond 26, Va.)

Majestic battery eliminator, ser. 9P6-574308. 115 volts, 50/60 cycles. Has #80 tube. Made for use with Majestic Model 90 chassis only. RCA Model V-205 receiver, ser. 028005. Tunes BC and s.w. on 3 bands. Has 78-rpm phono, 9 tubes, and electric tuning. (R. Wilson, 8 Del Rey Ct., Vallejo, Calif. 94590)

Stromberg-Carlson Model 61-H receiver. Tunes 3 bands. Has 7 tubes. (J. Padgett, 929 Homer Ave., Kansas City, Kan. 66101)

Panoramic Model SA 3 "Panadaptor," Type T-200. (L. V. Masters, 6920 Adams Ave., La Mesa, Calif.)

Heath Model 05 oscilloscope. **Jackson** Model 109 electronic voltohmmeter. (L. M. Jenne, P. O. Box 8707 S.S., Tampa, Fla. 33604)

Philco Model 40-145 receiver, code 121. Tunes 550 kc.-18 mc. on 3 bands. (Ed Rorzsek, 643 Tenth St., Clairton, Pa. 15025)

Bendix Model MN-26 receiver. Has 12 tubes. Tunes 3 bands. (Doug Renwick, P.O. Box 814, Stettler, Alberta, Canada)

Freed-Eisemann Model 70 radio-phonograph combination, ser. FM501477, chassis #65, circa 1948. Tunes AM, and FM, s.w. bands. Has 20 tubes and magic eye. (Richard Franz, 563 Dubois Ave., Valley Stream, N. Y. 11581)

RCA Model V-215 receiver, circa 1942. Tunes BC and 2.3 to 15.4 mc. on 3 bands. Has 9 tubes. **G.E.** Model LC-619 receiver, circa 1939. Tunes BC and 5.3 to 18 mc. on 2 bands. Has 6 tubes. (Arnold Walter, 155 Bathurst, Tonawanda, N. Y. 14151)

RCA Model 10K1 receiver. Tunes 150 to 410 and 530 to 60,000 kc. on 5 bands. Has 9 tubes, including a 6E5. (Barry Browning, 77 Saugatucket Rd., Peace Dale, R. I. 02879)

Radio Apparatus Corp. Model PR31 police FM receiver. Tunes 30 to 50 mc. Has 6 tubes. (Walter L. Newman, 531 Forest Lane, Belton, S. C. 29627)

Transis-Tronics Model TEC S-15 stereo amplifier. (R. J. Dunnigan, 1141 Huffman Ave., Dayton, Ohio 45403)

E. H. Scott Model HH-60 receiver, circa 1940. Tunes 550 kc. to 22 mc. on 4 bands. Has 16 tubes and 2

(Continued on page 28)

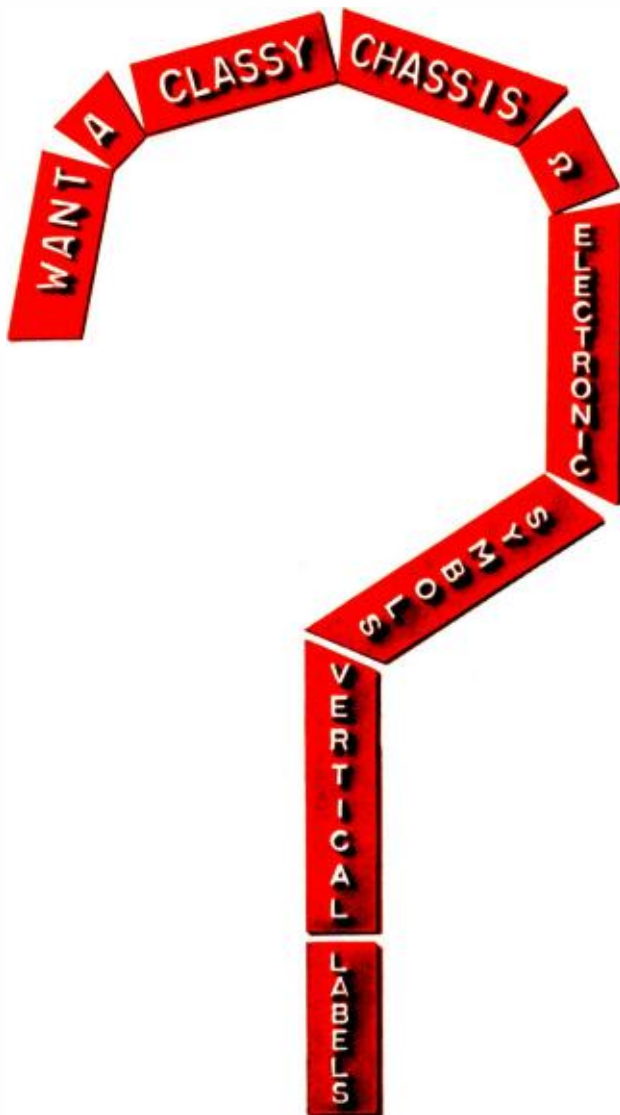

DYMO CAN DO

Electronic hobbyists (and pro's) prefer fast, neat professional Dymo Identification Systems. For labeling switches, dials, knobs. For personalizing equipment (especially test or CB units that leave your shack or shop). Dymo offers a complete range of tools: $\frac{1}{4}$ ", $\frac{3}{8}$ ", $\frac{1}{2}$ " sizes. Tools that write vertically or horizontally. Spe-



cial character wheels with electronic and mathematical symbols. More than 16 colors of self-sticking vinyl tape. Write for complete information. No obligation.

DYMO®

DYMO INDUSTRIES, INC., BERKELEY, CALIFORNIA

CIRCLE NO. 7 ON READER SERVICE PAGE

Operation Assist

(Continued from page 26)

chassis. (Herbert J. Lange, Route 4, Box 94 B, Salem, Oreg. 97302)

Emerson receiver, ser. AM 1523150, circa 1940. Tunes BC and s.w. bands. Has 6 tubes. (John Zammikfel, 32 Fowler Ave., Yonkers, N. Y. 10701)

Crosley Model XJ receiver, circa 1920. Has 4 tubes. Battery-operated. (James Coverdale, Skyvue Dr., Waterloo, Iowa 50707)

Robin Radio Model 103 transistorized converter, ser. 205. Tunes 262.5 kc., i.f. (G. J. Kane, 7603 Kipling Pky., S.E., Washington, D.C. 20028)

Special Data or Parts

David Grimes Model 5B baby grand duplex, circa 1925. Five 201A's, 1 112A, and schematic needed. (Albert Malone, 3 Circle Ave., Mill Valley, Calif.)

Buick Model 980782 "Sonomatic" auto radio, ser. 251590, circa 1952; has 6 tubes. Parts list and schematic needed. (James Goodman, 612 Glenview Ave., Glen Burnie, Md. 21061)

Rocketest tube tester, ser. 329. Tube chart, schematic, and other data wanted. (C. H. Maquet, 1708 N. 22, Springfield, Ill. 62702)

Solar Model CF capacitor analyzer. Schematic and operating info needed. (Leo E. Smith, R.D. 1, Box 375B, Sandy, Utah 84070)

Truetone Model D1104 receiver, circa 1942; tunes BC and s.w. on 3 bands; has 6 tubes. **Zenith** Model 6-S-229 receiver, circa 1940's; tunes 550 kc. to 18 mc. on 3 bands; has 6 tubes. Schematics and alignment data needed. (Gene Peterson, Route 2, Altamont, Kan.)

Stewart Warner Model CW-S-52245 transmitter, part of TCS-8 equipment. Schematic, operating manual and other info needed. (Larry Sala, Box 801, Redmond, Oreg. 97756)

National Model HRO 60-T receiver. One or all plug-in coil assemblies wanted. (F. J. Wasem, Science Dept., Sampson Hall, U. S. Naval Academy, Annapolis, Md.)

Triplett Model 1-177-B tube tester made for U.S. Army. Tube testing charts needed. (Arnold Harvey, 700 Silvercrest Ave., Akron, Ohio 44314)

Clough Brengle Model CRA oscilloscope, ser. 1214; has #80, #81, #885, #57, #2A5, and 906 tubes. Schematic and operating instructions needed. (Arnold Walter, 155 Bathurst, Tonawanda, N. Y. 14151)

Atwater Kent Model 55 receiver, circa 1929. Source for receiving tubes needed. (H. G. Walesch, 221 Harvester Rd., Orange, Conn. 06477)

Zenith Model VII receiver, ser. 7647281. Dial threading, tube and fuse identification and "C" battery info needed. **King** Model 80 receiver, ser. 4343. Original on-off switch needed. (J. N. Clapp, 1516 Elm St., Davenport, Iowa 52803)

Dumont Model 340 oscilloscope, year unknown. Manual, schematic, and parts list needed. (John F. Browning, 35 Oxford St., Worcester, Mass. 01609)

Philco Model 43-X receiver; tunes 550 kc. to 20 mc.; has 4 bands and 8 tubes. Operating info and 39/44 Raytheon tube needed. (Joey Powell, Rt. 2, Box 300, Whiteville, N.C.)

American Bosch Model 650 receiver, circa 1948; tunes 550 to 16,000 kc.; has 3 bands and 6 tubes. **Majestic** Model 130-A receiver, circa 1930; has 7 tubes. Schematics and other available data wanted. (David Shanks, 3rd, RFD #1, Box 169, Granville, Summit, Pa. 16926)

Imperial Model 200 tube tester, ser. 8800. Tube tester chart needed. (Carl Geselichen, 617 E. Front Ave., Bismarck, N.D. 58501)

Panoramic Model LP-1 sonic analyzer. Instruction manual and power supply needed. (W. L. Kennamer, 1008 Wilbanks Ave., East Gadsden, Ala.)

Motorola Model WR4 broadcasting record player, circa 1941. Schematic and other available data needed. (John D. Rawcliffe, 68 Harrison St., Verona, N.J. 07044)

(Continued on page 32)



GUARDIAN 23

23 CHANNEL CB RADIO • \$299.50

- Transistorized universal power supply
- Dual conversion superhet receiver with low-noise Nuvistor front end
- RF gain control, tone control, and noise limiter switch
- Automatic speech clipping
- Illuminated "S" meter, channel selector and modulation indicator
- Superior squelch circuit
- Two stage TVI filter
- Special close tolerance crystals
- Full 5 watt legal input operating at 50% of capacity, insuring long component life and tremendous power reserve for overload protection.

OTHER PEARCE-SIMPSON AWARD-WINNING CB MODELS

The "ESCORT"
8 channels
(23 channels
trans/receive
W/ext. xtl socket)
\$229.95



The "COMPANION II"
5 channels
(23 channels
trans/receive
W/ext. stl socket)
\$189.50



PEARCE-SIMPSON, INC.
MIAMI, FLORIDA

NEW

FROM PEARCE-SIMPSON

GUARDIAN 23

23 CHANNELS — featuring Pearce-Simpson's exclusive HETROSYNC® circuitry. Two signals are combined instead of the usual three providing outstanding stability and maximum protection against spurious signals. Precision hand-wiring, utilization of electronic components that far exceed industry standards, rigid quality control, comprehensive testing and tuning and a final, exhaustive *individual* performance test assure you of the finest that electronic technology can produce. For that BIG CB signal see the Guardian 23 at your dealer today!

PEARCE-SIMPSON, INC. PE-465
2295 N.W. 14th Street • Miami, Fla. 33125
Please send full information and model specifications for the Guardian 23, Escort and Companion II.

Name.....

Address.....

City.....State.....

ALL NEW!

The most up-to-date
guide available today
to the world
of specialized
Radio Communications!

Here is an information-packed "encyclopedia" covering each of the major branches of specialized radio communications—

4 BIG SECTIONS

CITIZENS RADIO SERVICE
AMATEUR RADIO
SHORT WAVE LISTENING
BUSINESS RADIO SERVICE

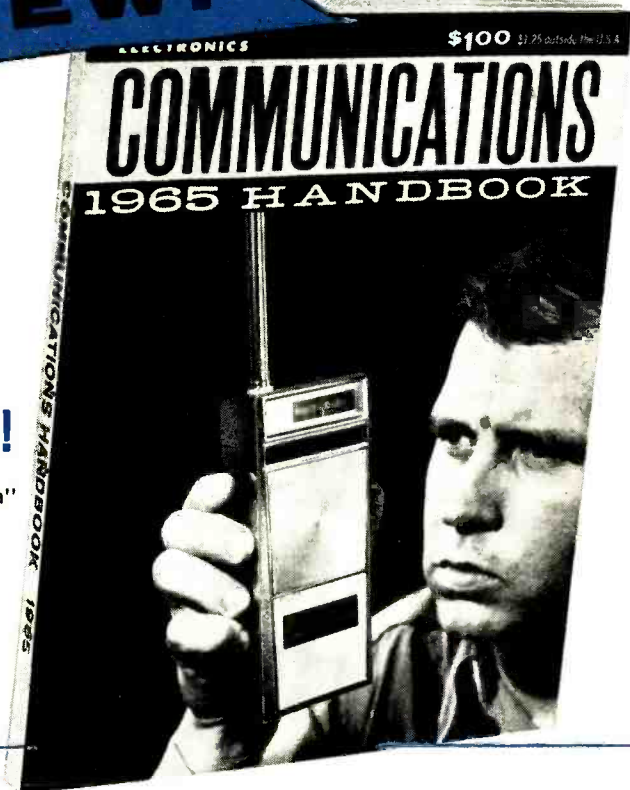

148 PAGES...

Complete with charts, tables and illustrations this all-new work brings you exclusive information on such vital subjects as obtaining your license, establishing your CB station, CB ethics—practice and procedure, SWL and station reporting, CB clubs, Ham license application procedures, learning the code, typi-

cal business radio installations, and much more—every major area of the field is covered by a leading authority and presents a wide range of material—from basic fundamentals for the beginner through exclusive up-to-the-minute data and techniques essential for those in advanced communications.

EXTRA!
FOR THE FIRST TIME
TWO EXCLUSIVE DIRECTORIES

- ★ Complete directory of all new Citizens Band equipment
- ★ Complete specifications on every new 1965 SWL Receiver and every new 1965 CB Transceiver

only \$100

ZIFF-DAVIS SERVICE DIVISION, Dept. CH
589 Broadway, New York, N.Y. 10012

Please send my copy of the 1965 COMMUNICATIONS HANDBOOK. My dollar (plus 15¢ for shipping and handling; 25¢ outside U.S.A.) is enclosed.

name _____ please print _____ PE-45

address _____

city _____ state _____ zip code _____

13 HEATHKIT® VALUES... SEE THE

GR-53A
\$399⁰⁰
 (less cabinet)

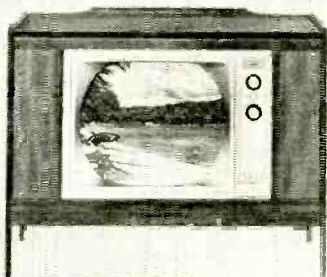

Deluxe 21" All-Channel Hi-Fi Color TV

Only color TV you can build . . . only color TV you can adjust & maintain yourself with exclusive "built-in service center" . . . only color TV you can install 3 ways—wall, custom cabinet, or either Heath factory-built cabinet. Tunes all channels, 2 thru 83 to bring you 21" of true-to-life color and black & white pictures, plus hi-fi sound. All critical circuits prebuilt & aligned . . . assembles in just 25 hours!

Kit GR-53A, chassis tubes, tuners, speaker,
 127 lbs. \$399.00
 GRA-53-7, deluxe walnut cabinet, 85 lbs. . . . \$115.00
 GRA-53-6, walnut-finished cabinet, 52 lbs. . . . \$49.00

GD-983
\$849⁰⁰
 (Includes bench)



Deluxe Heathkit/Thomas "Coronado" All-Transistor Organ

Saves up to \$400 . . . Easy to build & play . . . No extras to buy! Features 17 true organ voices; 28 notes of chimes; built-in 2-speed rotating Leslie, plus 2-unit main speaker systems; two full-size 44-note keyboards; reverb; attack, sustain & repeat percussion (the only organ to give you all 3); stereo chorus control for exciting "stereo" effects; 75-watt peak music power amplifier; and hand-crafted, hand-rubbed walnut cabinet & bench. Hear it yourself—Send 50c for demonstration record GDA-983-2, 7", 33 1/3 rpm. Organ wt. . . . 242 lbs. Also available, low-cost Heathkit/Thomas "Largo," organ only, 158 lbs. \$349.00



Low-Cost 40-Watt Transistor Stereo Amplifier
 Produces full 66 watts IHF music power at ± 1 db from 15 to 30,000 cps. Quick, clean "transistor sound." 5 stereo inputs. Walnut cabinet. 23 lbs. Matching AJ-33A AM/FM/FM Stereo Tuner \$99.95.

AA-22
\$99⁹⁵



Deluxe 70-Watt Transistor Stereo Amplifier
 Enjoy cool, instant operation, long life, and natural "transistor sound." Enjoy 100 watts IHF music power at ± 1 db from 13 to 25,000 cps. Walnut cabinet. 29 lbs. Matching AJ-43C AM/FM/FM Stereo tuner \$129.95.

AA-21C
\$149⁹⁵

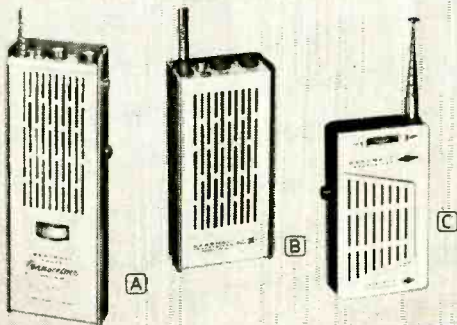

Heathkit Walkie-Talkies!

- A** 1-Watt GW-52 . . . up to 3-mile operation; 10-transistor, 2-diode circuit; \$20 rechargeable battery; metal case; specify channel; pair \$139.95, each \$74.95.
- B** 9-Transistor GW-21 . . . up to 1-mile operation; crystal-controlled transmit & superhet receive; metal case; specify channel; pair \$74.95, each \$39.95.
- C** 4-Transistor GW-31 . . . 1/4 mile operation or more; no license, tests, age limit; fits in pocket; metal case; specify channel; pair \$35, each \$19.95.

OTHER 237 IN FREE CATALOG!

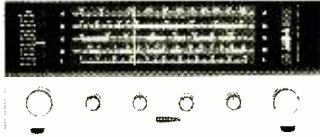

GR-64 New! Heathkit Shortwave Radio!
\$39⁹⁵ Covers 550 kc to 30 mc—includes AM plus 3 shortwave bands; 5" speaker; lighted bandspread tuning dial, relative strength indicator & 7" slide-rule dial; BFO; 4-tube circuit plus 2 rectifiers; "low-boy" metal cabinet; 13 lbs.

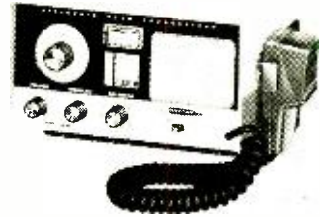

MW-34
\$89⁹⁵
Deluxe 5-Channel CB Transceiver!
 Features 5 crystal-controlled transmit & receive channels; new front-panel crystal socket to change transmit crystal of one channel; new spotting switch; new TVI filter; new calibrated "S" meter; 3-way power supply for fixed or mobile operation; metal cabinet; 19 lbs.

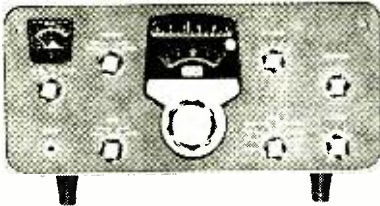

Deluxe Single Sideband Amateur Receiver!
SB-300
\$265⁰⁰
 Covers 80 thru 10 meter bands with all crystals furnished, plus provisions for VHF. 1 kc dial calibrations—100 kc per dial revolution. Tuning dial to knob ratio approx. 4 to 1. Less speaker. 22 lbs. Matching transmitter & KW linear amplifier also available.

NEW! NELI Torque Fire® . . . Only All Silicon Electronic Ignition System!
GDP-95
\$62⁵⁰
 Not a kit . . . installs in just 5 minutes! Cannot be damaged by improper installation. Provides fewer tune-ups, longer plug life, greater gas economy, instant starts in all weather. Transfer from car to car . . . present system is left intact. Operates on 6, 12, or 24 v. DC, pos. or neg. grd. . . any car or truck. 3 lbs.



Heathkit Vacuum Tube Voltmeter
IM-11
\$24⁹⁵
 Single AC/Ohms/DC probe; 7 AC/DC/Ohm ranges; 1% precision resistors for high accuracy; frequency response ± 1 db from 25 cps to 1 mc; voltage doubler rectifier; simple circuit board construction; 5 lbs. Available wired, IMW-11, at \$39.95.



NEW! Deluxe All-Transistor AM Portable!
GR-24
\$29⁹⁵
 6 transistor, 2-diode circuit gives 8 transistor performance. Uses standard flashlight batteries . . . requires only 1/10 operating cost of pocket-size portables. RF stage & double-tuned I.F. stage for greater sensitivity & selectivity. Built-in 1/2" dia. rod antenna, 4" x 6" speaker, vernier tuning, slide-rule dial, & black simulated leather case. 6 lbs.



FREE CATALOG

See these & over 250 other Heathkits. Save up to 50% by doing the easy assembly yourself. Send for your free copy today

HEATH COMPANY, Dept. 10-4
 Benton Harbor, Michigan 49023
 In Canada: Daystrom, Ltd., Cooksville, Ontario

Enclosed is \$ _____, plus postage. Please send model(s) _____

Please send my Free 1965 Heathkit Catalog.

Name _____ (Please Print)

Address _____

City _____ State _____ Zip _____

Prices & specifications subject to change without notice. CL-204R



Hallicrafters performance standards for just \$99.95



new CB-7 six-channel CB transceiver

- New all-electronic push-to-talk circuitry.
- Compact new size—just 12" x 5" x 7".
- Nothing else to buy—110V. AC or 12V. DC operation.
- Accessories available: S-meter; Noise Eliminator; Receiver Tuning; Encoder/Decoder.
- 100% modulation, sensitivity 1 μ v.

Write for complete specifications today!

hallicrafters
Dept. 4, 5th & Kostner Aves.,
Chicago, Ill., 60624



Export: Hallicrafters Int'l. Div. Canada: Gould Sales Co. Montreal, P.Q.
CIRCLE NO. 11 ON READER SERVICE PAGE



AUDIO VENDOR

● The original endless loop tape magazine in a new plastic re-usable pack for easy storage. 3 5/8" reel available in 3, 5, 8, 12 and 15 minute standard timings at 3 3/4 ips. Fits most standard reel recorders. At your dealers.

Cousino
ELECTRONICS CORPORATION
DEPT. PE
1941 FRANKLIN AVE. • TOLEDO, OHIO 43624

CIRCLE NO. 6 ON READER SERVICE PAGE

Operation Assist

(Continued from page 28)

Crosley "Super 11" Model 1117 receiver, ser. 1347947, circa 1939; has 11 tubes and covers 510 kc. to 21.750 mc. Schematic and any other available data wanted, plus source for 6K5-G tube. **Silvertone** Model 1965 receiver, ser. 475N90, circa 1930; has 8 tubes and covers 550 kc.-16.0 mc. Schematic and source for #80, #75 and #41 tubes needed. (Carleton May, Elliott St., Westminster, Mass.)

Rogers-Majestic (Canadian) Type SRS22 receiver, ser. B9591, circa 1938; has 8 tubes and covers two bands. Source for parts and schematic needed. (J. Stanley Koper, 7500 Foster St., District Heights, Md. 20028)

Hickok Model 600 tube tester, ser. 71-10093. Manual and schematic needed. (Albert J. Carr, 948 Abilene St., San Gabriel, Calif. 91776)

RCA console radio, ser. 020801, circa 1935, model unknown; tunes AM and s.w.; has 9 tubes and push buttons. Installation manual, tuning scale, and schematic needed. (Ray Peterson, 219 Barnes Hall, Central Michigan University, Mount Pleasant, Mich.)

Precision Model E-100 sweep generator. Operating manual needed. (Steve Topley, 145 Quarry St., Mt. Pleasant, Pa.)

Dumont Model 331 cathode-ray oscillograph; has 25 tubes. Manual and schematic needed. (John R. Raiger, 6725 S. Komensky Ave., Chicago, Ill. 60629)

Philco Model 51-PT 1234 TV receiver, circa 1947. Servicing data and schematic needed. (Gregory J. Perreault, 4524 Lawn Ave., Western Springs, Ill. 60558)

Magnavox Model RAL-S receiver, ser. 885, type CMX-46156-A; tunes 0.30 to 23 mc.; has 115-volt, 60-cycle a.c. power supply, ser. 1153; manufactured for Navy Dept. Any available information wanted. (Jim Kerr, 2702 N. Range Rd., Port Huron, Mich.)

Silvertone Model 8074 hi-fi tape recorder, ser. 528-58022; has radio chassis, ser. 528.59051. Operating manual needed. (Reginald Rosevear, Jr., 4536 Maria Ave., N.E., Salem, Oreg. 97303)

Fada Model 175-A neotrodyne receiver, ser. 41831, type 170-A; has 5 201-A's. Year of manufacture, schematic, and horn wanted. (John A. Blackman, Rt. 2, Box 19, Dothan, Ala.)

Rauland BC-221-a.c. frequency meter, TM11-300 needed. (J. Vieira, 406 Raspberry St., Erie, Pa. 16507)

Link Model 2975 FM transceiver (15VR-D1), ser. 96234; tunes 450-470 mc. Manual and schematic needed. (Michael Liptak, 90 Jefferson St., Yonkers 2, N.Y.)

RCA "Radiola 60" receiver. **Wurlitzer** "Mohawk" ear-phone radio, circa 1924; has 9 UV201's. Operating instructions and schematics wanted. (Ted Whitus, 178 Floradale Ave., Tonawanda, N.Y. 14151)

35A3 tube or possible substitute (25C3). Tube source needed. (Gilbert Althage, Box 6652, Patrick AFB, Fla. 32925)

-30-

SOURCES OF INFORMATION

Information on military equipment can be obtained from the Superintendent of Documents, Government Printing Office, Washington, D.C. 20402. If a manual is out of print, contact: Chief, Photo Duplication Service, U. S. Library of Congress, Washington, D. C. 20540, to determine availability and cost. Photocopies of certain commercial radio and TV manuals may also be had through this duplication service. Cowan Publishing Co., 14 Vanderverter Ave., Port Washington, N.Y. 11050, and Editors and Engineers, Summerland, Calif., have schematics and data available on surplus equipment. Howard W. Sams Co., 4300 West 62 St., Indianapolis 6, Ind., and Supreme Publications, 1760 Balsam Rd., Highland Park, Ill., can supply diagrams and operating instructions on much commercial radio and TV as well as other home entertainment equipment. Supreme can also furnish material on antique radios.

There are **72** reasons why you will want this exciting book of electronics projects:

- Car Battery Saver
- Build a Telephone Beeper
- 40-Meter Antenna for Small Roof and 67 other great projects...
- Electronic Stop Watch
- Plug-In Transmitter Crystal Switch

One Tube Screen Modulator • X-Line Tachometer • Build a Stereo Indicator • Nonsense Box • Better Model Control • X-Line Charger • Cheater Cord Deluxe • 60-Cycle Repulsion Coil Resonance Engine • Automatic Safety Flasher • Handy EP Pack • 2-Meter Simple Superhet • The Signal Stethoscope • VHF Listener • 2-Tube Superhet for 80 Meters • Transistorized 6-Meter Converter • SCR Tester • Multiple Meter Test Set • The Squealer • Build The Reflectoflex • The Cloud Sentinel • Sports Car Mike Stand • Boost Box • Loud Hailer For The Telephone • Extra "Lamp Handee" • Footpads for Headphones • The Identominder • AND MANY MORE...

HERE IS THE MOST EXCITING COLLECTION OF ELECTRONICS PROJECTS AVAILABLE ANYWHERE.

Each project is complete with detailed charts, circuit diagrams, cutaways, photographs, step-by-step instructions—and each one means hours of fun and excitement.

If you enjoy the challenge of building useful electronic devices... this is the book for you!

ZIFF-DAVIS SERVICE DIVISION, Dept. EEH
589 Broadway, New York, N.Y. 10012

Please rush my copy of the all-new 1965 ELECTRONIC EXPERIMENTER'S HANDBOOK. My \$1.25 (plus 15¢ for shipping and handling; 25¢ outside U.S.A.) is enclosed.

name please print PE-45

address

city state zip code

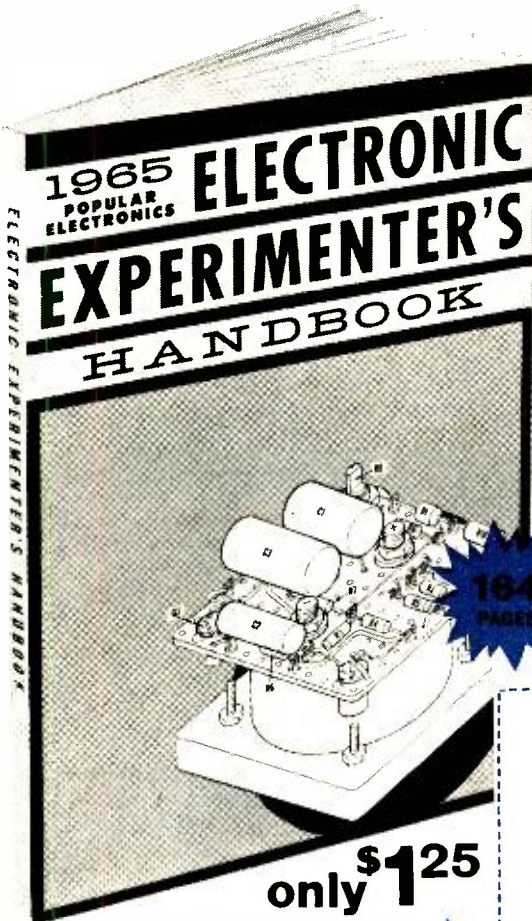

only \$1.25

FILL IN, DETACH AND MAIL THIS COUPON TODAY!

Choose Your Tailor-Made Course in N.T.S. "PROJECT METHOD" ELECTRONICS

Now! N.T.S. — one of America's oldest leading home-study and resident technical schools—offers you **GREATER CAREER OPPORTUNITIES IN ELECTRONICS.**

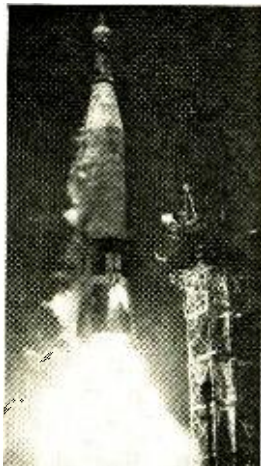

You can install and maintain electronic circuitry in missiles and rockets . . . specialize in microwaves, radar, and sonar.



You can succeed in TV-Radio Communications . . . prepare for F.C.C. License, service advanced satellites for industry and defense.



You can service and repair the electronic "brains" of industry — computers, data processing and other automation equipment.

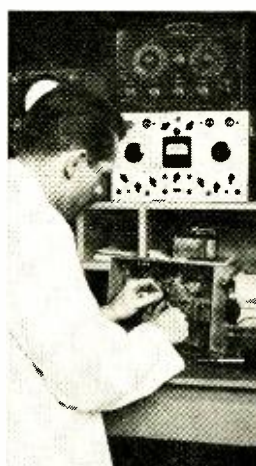

You can become a highly-paid TV-Radio Technician, an electronics field engineer, or succeed in your own sales and service business.

CHOOSE YOUR FIELD—INSURE YOUR FUTURE!

1 ELECTRONICS-TV-RADIO SERVICING AND COMMUNICATIONS

A basic course thoroughly covering fundamentals of electronics, radio, TV servicing and communications.

2 MASTER COURSE IN ELECTRONICS-TV-RADIO, ADVANCED TV AND INDUSTRIAL ELECTRONICS

Qualifies you as a Master Electronics Technician — the Man in Demand.

3 FCC LICENSE COURSE

Preparation for this government license essential for many interesting jobs in radar, radio, television, communications, guided missiles, many others. Upon completion of this course, if you do not pass the FCC exam, your tuition will be refunded in full.

4 RADIO SERVICING (AM-FM-TRANSISTORS)

Train for radio sales and service with dealer or distributor.

5 TELEVISION SERVICING (INCLUDING COLOR)

Covers installation, adjustment, repair and servicing of black and white and color television . . . prepares you for your own sales and service business.

6 STEREO, HI-FI AND SOUND SYSTEMS

A growing field. Prepares you to build, install and service modern sound equipment for home or industry.

7 BASIC ELECTRONICS

Gives you the fundamentals you must know to build on for a future Electronics career. Also offers an excellent background for Salesmen, Purchasing Agents, and others in Electronics.

8 ELECTRONICS MATH

Simple, easy-to-follow instructions in the specialized math you need in many electronics jobs.

INDUSTRY WELCOMES N.T.S. STUDENTS AND GRADUATES

N.T.S. HOME TRAINING: QUICK, PRACTICAL WAY TO HIGHER PAY, LIFELONG BENEFITS

N.T.S. "Project Method" Courses can help you get a new and better job — or move up to higher pay in your present one.



N.T.S. "Project Method" home training lessons are shop-tested in the Resident School in Los Angeles. You work on practical job projects, learn to use shop manuals and schematics. Your N.T.S. training is individual. You proceed at your own pace. The Schools' practical methods plus more than 60 years of experience have helped thousands of students all over the world to successful careers.

Most courses include Equipment Kits. There are no Kit Deposits. Everything included in your low tuition.



HIGH SCHOOL AT HOME

Learn easily. New modern method. National also offers accredited high school programs for men and women. Take only subjects you need. Study at your own pace. Latest approved textbooks — yours to keep — everything included at one low tuition. Check High School box in coupon for information.



BENEFIT NOW AND ALL YOUR LIFE WITH N.T.S. HOME TRAINING

The personal guidance you receive during your training can be very helpful to your progress. Many N.T.S. students are able to earn more money within a few months. You can pick and choose your career. Work in industry or go into business for yourself.

Your services will always be in demand wherever you go — and you can pick your spot!

N.T.S. Graduate Advisory Service can help you answer technical questions in establishing your own business and in countless other ways after you've completed your training.

MAIL REPLY CARD
OR COUPON FOR
FREE BOOK AND
SAMPLE LESSON

In Field of Your Choice

You Enroll by Mail — and Save Money.
No Salesmen: This means lower tuition for you.
Accredited Member N.H.S.C.

Sample Lesson



CLASSROOM TRAINING AT LOS ANGELES

If you wish to take your Electronics-TV-Radio training in our famous Resident School in Los Angeles — the oldest and largest School of its kind in the world — write for special Resident School catalog and information, or check coupon.

NATIONAL TECHNICAL SCHOOLS
WORLD WIDE TRAINING SINCE 1905
4000 S. Figueroa St., Los Angeles, Calif 90037

NATIONAL TECHNICAL SCHOOLS

4000 S. Figueroa St., Los Angeles, California 90037

Please Rush FREE Electronics "Opportunity Book" and actual sample lesson on course checked below:

- Electronics-TV-Radio Servicing and Communications
- Master Course in Electronics-TV-Radio
Advanced TV and Industrial Electronics
- FCC License Course
- Radio Servicing (AM-FM-Transistors)
- Television Servicing (Including Color)
- Stereo, Hi-Fi and Sound Systems
- Basic Electronics Electronics Math

Dept.
205-45

Name _____ Age _____

Address _____

City _____ State _____ Zip _____

- Check here if interested ONLY in Classroom Training at L.A.
- Check here for High School Department Catalog only.



Is our silicon showing

?

Compare these S-9500 Specs! Power output, both channels IHF music power: 50 watts at 1% I.M. distortion. Continuous sine-wave power output (two channels): 36 watts at 1% distortion. Power bandwidth: 12-35,000 cps. at 1% distortion. Hum and noise: Phono—70db, Tuner—80db. Sensitivity: Phono—1.8 mv, Tuner 0.25v. Also available: 150-watt music power Silicon Solid-State amplifier, S-9000, \$299.50

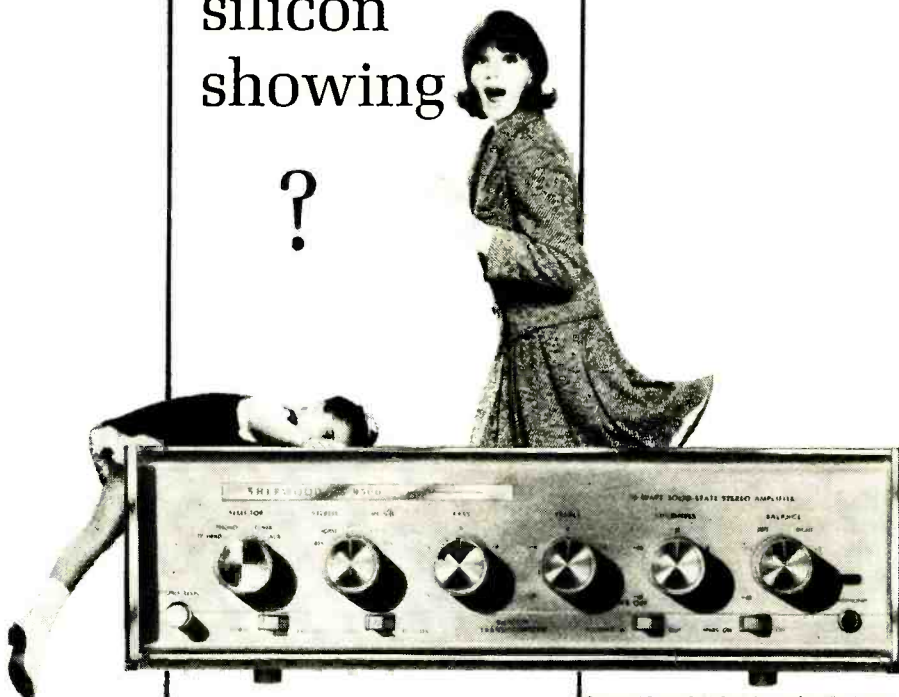

Sherwood S-9500 Solid-State 50-watt Amplifier \$179.50

Well, it should be... if only to show you how very lucky you'd be to own the Silicon transistorized circuitry of the S-9500. We wish you could SEE the difference which costs us 50% more than the usual Germanium way of transistorizing your circuit; you will HEAR the difference. Furthermore, this 50-watt Sherwood integrated amplifier-preamplifier can be squeezed into the tightest custom installation, with no heat problems either. Perhaps, you are wondering if these transistors will really stand up. Just perfectly, because the new Sherwood all-Silicon circuitry virtually eliminates transistor failure caused by shorted speaker terminals or other improper operation. And all this for only \$179.50.

Write now for our latest catalog detailing this remarkable amplifier as well as Sherwood's world-famous FM tuners and speaker systems. Dept. 4P.

Sherwood

Sherwood Electronic Laboratories, Inc.,
4300 North California Ave., Chicago 18, Illinois

CIRCLE NO. 31 ON READER SERVICE PAGE



BUILD A MINIATURE R/CEIVER

By DANIEL MEYER

*You can control models and other gadgets
on land, at sea, or in the air,
with this 1 1/2-ounce, three-transistor receiver*

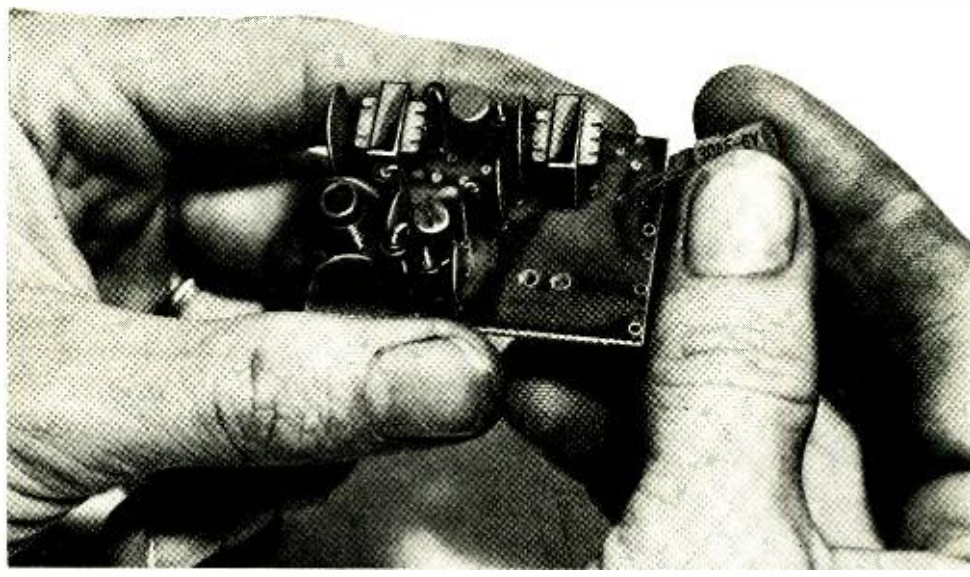

LESS THAN half the size of a package of cigarettes, this lightweight, three-transistor radio-control receiver can be used in cars, boats, and in the home. It's suitable for remote operation of toys, models, garage doors, or any other control application you might have. The receiver circuitry contains a sensitive superregenerative detector, a tone-modulated selector, and a relay in the output. Its small size is made possible by the use of transistors and a printed circuit board—which allows quick assembly of components.

The R/Ceiver is operated by a 600- to

800-cycle tone-modulated carrier on the 27-mc. remote-control channels. This type of operation makes it possible to use the rather broad tuning superregenerative detector without interference problems. Voice modulation even on the same channel will almost never energize the receiver relay. A continuous tone in the proper frequency range must be received before the relay will operate.

The sensitive relay is isolated from the receiver circuits and can be connected to anything you want to control as long as the 0.5-amp., 50-volt rating of the relay contacts is not exceeded.

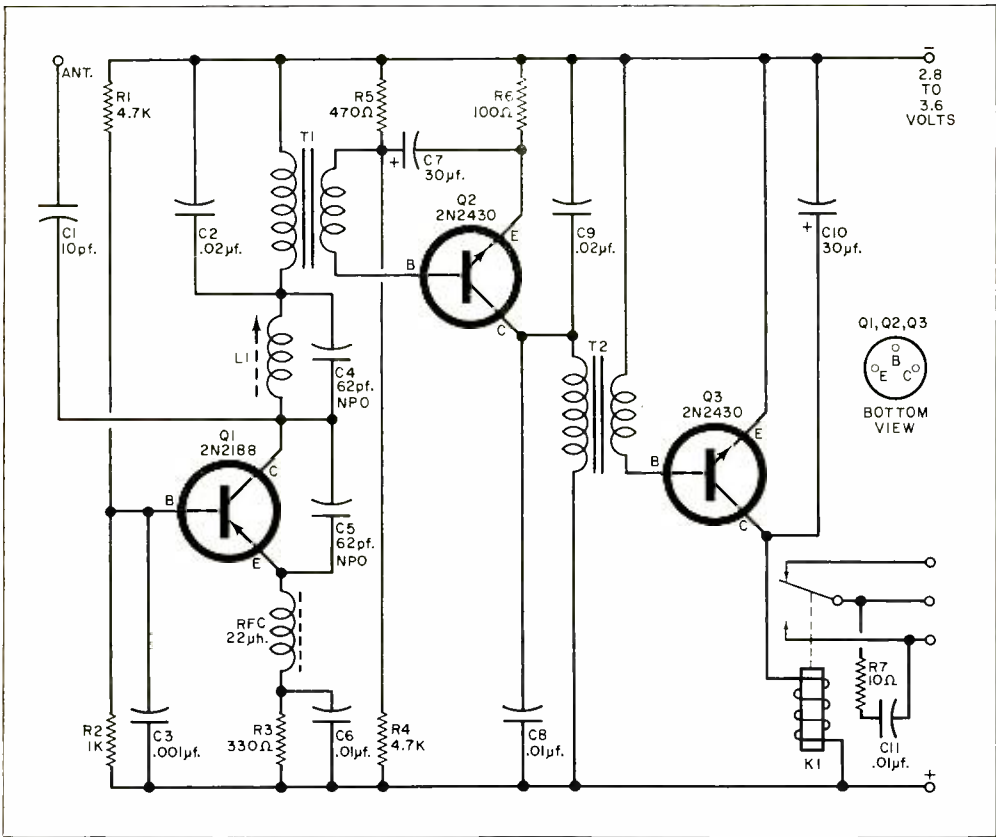

Transistor Q1 is part of a sensitive superregenerative detector which demodulates a tone-modulated control signal. The tone burst only is then amplified by Q2 and passed on to Q3 to activate the relay.

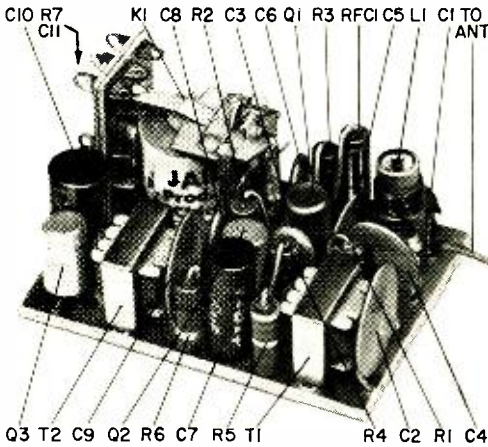

Printed circuit board permits upended parts layout to provide a compact layout with adequate space for all components. Photo is actual size. Parts R7 and C11 are shown in detail drawing on the next page.

PARTS LIST

- C1—10-pf. ceramic capacitor
- C2, C9—0.02-μf., 50-volt ceramic capacitor
- C3—0.001-μf. ceramic capacitor
- C4, C5—62-pf., NPO ceramic capacitor
- C6, C8, C11—0.01-μf., 50-volt ceramic capacitor
- C7, C10—30-μf., 15-volt electrolytic capacitor
- K1—100-ohm sensitive relay (Jaico Products Co., Chicago, or equivalent)*
- L1—7½ turns of #26 enameled wire on 0.20"-diameter coil form, with powdered iron tuning core*
- Q1—2N2188 transistor
- Q2, Q3—2N2430 transistor
- R1, R4—4700-ohm, ½-watt resistor
- R2—1000-ohm, ½-watt resistor
- R3—330-ohm, ½-watt resistor
- R5—470-ohm, ½-watt resistor
- R6—100-ohm, ½-watt resistor
- R7—10-ohm, ¼-watt resistor
- RFC1—22-μh. r.f. choke*
- T1, T2—Miniature interstage transformer: primary, 10,000 ohms; secondary, 2000 ohms*
- 1—Printed circuit board*

*A set of parts consisting of a predrilled printed circuit board, T1, T2, L1, RFC1, and K1 is available for \$9 pp. from Daniel Meyer, Box 16041, San Antonio, Texas 78216

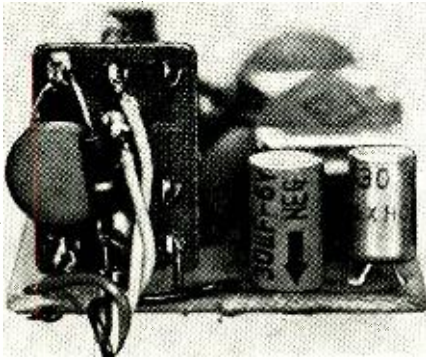

Flexible wire connected between the external components and relay board will prevent breakage due to vibration. Shock-mount unit with foam rubber.

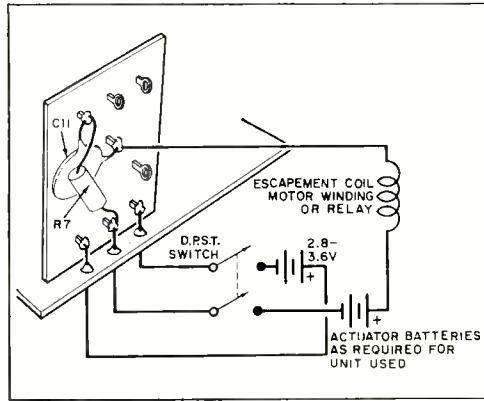

Detail drawing shows location and connection of R7 and C11, as well as how to hook up external circuit. Do not exceed current rating of relay contacts.

How It Works. Transistor *Q1* acts as a superregenerative detector, which oscillates at a frequency determined by tuned circuit *L1* and *C4*. Oscillation is quenched (cut off) at an ultrasonic rate, which is determined by the values of the base bias and emitter resistors and their associated bypass capacitors (*R2*, *R3*, *C3* and *C6*). Capacitor *C5*, connected to the emitter and collector of *Q1*, provides the feedback needed to sustain oscillation.

The antenna is loosely coupled to the tuned circuit by *C1*. The loose cou-

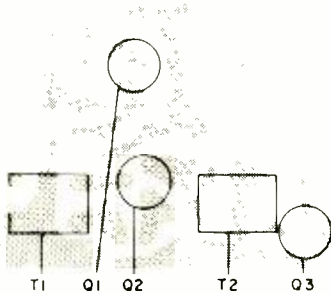

Actual-size photo of printed board. Circles and squares show which openings to use for transistors and transformers, and are not part of circuitry.

pling reduces antenna loading effects on the tuned circuit. Capacitor *C2* filters out the r.f. carrier and quench signals, and leaves just the detected tone modulation across the primary of *T1*.

The tone signal is transformer-coupled

to the base of audio amplifier *Q2*. Transformer *T2* delivers the signal from the collector of *Q2* to the base of *Q3*. Transistor *Q3* conducts in the presence of the tone signal, specifically the positive half cycles, and energizes the relay (*K1*).

Construction. Use of a printed circuit fiberglass board makes the receiver very rugged and compact, and easy to build. Start construction by mounting the transformers. Be careful not to pull the leads out of the transformers or to cut the wires when stripping the insulation. The blue and red leads are the primary side and should be installed in the transformer lead holes next to *C2* and *C9*. Bend the tabs on the transformer brackets to grip the board.

Next, install the tuning coil (*L1*) and the r.f. choke (*RFC1*). Do not use too much force on the coil, to avoid pulling the lugs out of the coil form. Install the three transistors, making sure that the leads are in the correct holes. Basing for all three transistors is shown on the schematic. Some transistors have a red dot next to the collector lead.

Now install the capacitors and observe polarity, particularly for *C7* and *C10*. Install the resistors and mount the relay. The relay coil is connected to the holes in the board with short pieces of bare wire.

Bend all component leads to grip the board, and trim. Solder all connections and avoid bridging adjacent conductors.

(Continued on page 94)

DURING the past several years, many of you who listen to foreign short-wave broadcast stations may have wondered about the tremendously strong signals received from *Radio Moscow*. This winter of 1964-1965 the *Radio Moscow* English-language broadcasts during the evening hours on 7150, 7205, and 7310 kc. were stronger than those of any other station in the 40-meter band. Based on the location of *Radio Moscow* transmitters and their distance from the U.S.A., this should *not* be the case.

Although the exact location of all of the Russian transmitter sites is not known, there is reason to believe that one of the sites used for international broadcasting toward North America is in the southern Ukraine between Kiev and Odessa. Roughly speaking, the distance from Odessa to the east coast of the U.S.A. is about 4900 miles. The distance from the transmitters of the BBC in England to the U.S.A. is about 3500 miles. Signals from these two stations must travel the great circle route to reach North America. The world map below shows the normal paths these signals travel. Note that not only is the Russian signal traveling 1300-1400 miles further than the BBC signals (also on the 40-meter band), but that the Soviet signals are further north and closer to the auroral zone. Both factors are quite significant.

In general, the further radio signals must travel from a transmitting station,

THE RUSSIANS ARE WINNING THE DECIBEL WAR

By **STANLEY LEINWOLL**
Radio Propagation Editor

**Radio Moscow has a stronger
40-meter signal
than all other stations.
They may be ahead
of the free world in
broadcasting techniques**

the weaker they are. Based on the locations of the BBC and *Radio Moscow* transmitters, we would expect the signals from the Soviet station to be from 3 to 6 db weaker than signals from the BBC—all other things being equal. Yet, *Radio Moscow* is generally about *10 decibels stronger* than the BBC.

The more northerly course of the Russian signal is important because the ionosphere in the auroral zone is frequently unstable. Northern lights, or

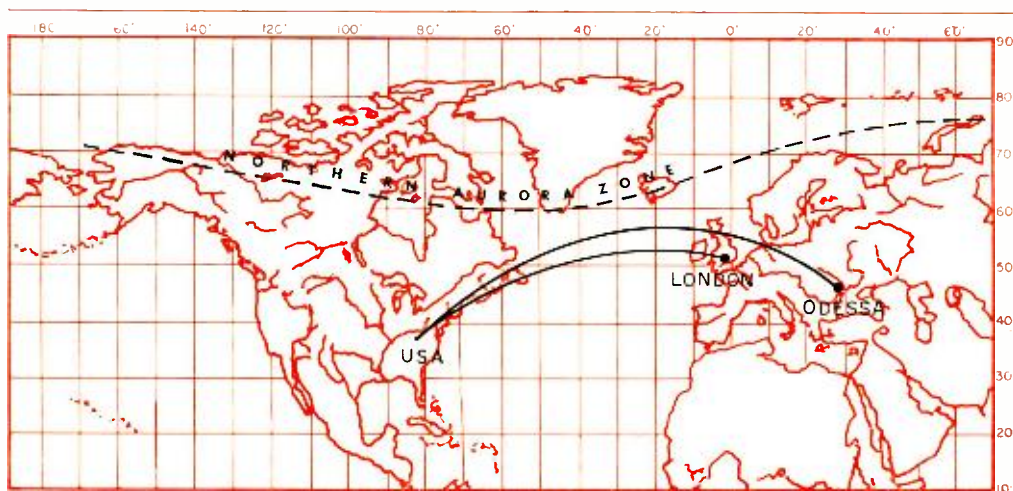

Signals from Radio Moscow travel about 1400 miles further than those of the BBC, and are closer to the northern auroral zone—two very good reasons why the Soviet signals should be weaker and more erratic.

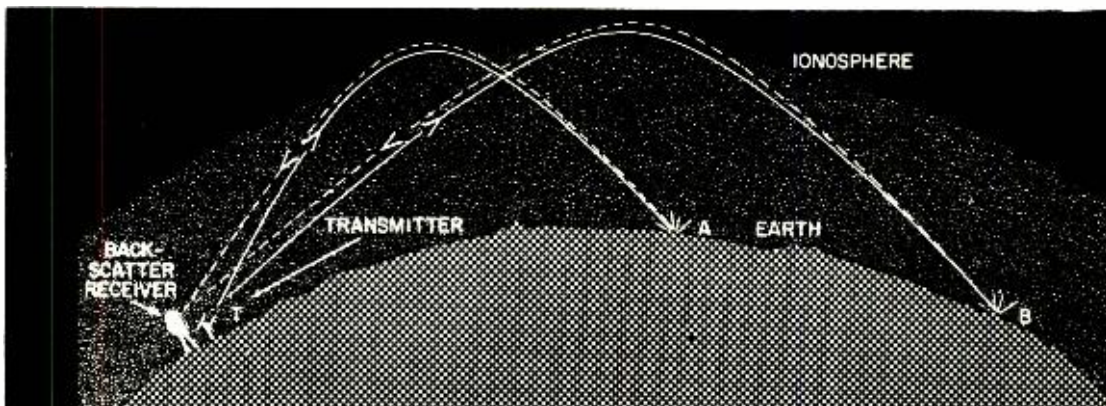

The mechanics of determining the best angle of radiation by means of backscatter are fairly simple. The transmitter radiates a very short pulse of high-intensity signal that is reflected by the ionosphere and returns to earth a great distance away. Some of the signal is reflected by the earth's surface in such a fashion as to be returned to the location of the transmitter by the same route through the ionosphere—this is called "backscatter." The intensity of the returned signal is

directly related to the angle of radiation; the most favorable angle produces the strongest backscatter. American scientists believe that the Soviets find the best angle of radiation for each of their broadcasts, taking advantage of propagation conditions. Short-wave transmitters of the free world, apparently unlike those of Radio Moscow, are fixed and radiate at only one main angle in a take-it-or-leave-it fashion—resulting in a 6 to 10 db weaker signal than that of the Russians.

auroras, are very common in this zone and adversely affect radio transmissions passing through the zone or close to it. During periods when the ionosphere is disturbed, the auroral zone moves south and signals that are normally stable are weakened. This is why transmissions from the BBC to North America, for example, "break up" before signals from Rome and Madrid. The latter signals travel further to the south and are therefore less prone to auroral effects even during very disturbed receiving conditions.

In spite of the northerly location of the Moscow path, however, *Radio Moscow remains stronger* than most other stations in the 40-meter band even during ionospheric storms.

Is It Power? If SWL's receive *Radio Moscow* signals about 10 db stronger than signals from the BBC, and if we consider that the BBC uses 75-kilowatt transmitters and high-gain curtain antennas which are closer to America by more than 1000 miles, then a few simple calculations would seem to lead us to the conclusion that the power of *Radio Moscow* transmitters is on the order of *1000 kilowatts, or more!* But this is not so, for as far as is known the most powerful transmitters the Russians use for international broadcasting are on the

order of 120 kilowatts. What, then, are the Russians doing that is—in effect—giving them a power gain of ten over what they actually have?

The mystery deepens if you listen carefully to *Radio Moscow* when it comes on the air. As described by Walter Bain of Page Communications Engineers, Inc., the Russian signal will rise and fall in strength over a period of several minutes—not related to normal fading of DX signals. After this abnormal fade, the signal level increases to a peak value and then remains very high for the remainder of the broadcast.

Scientists are becoming convinced that they have unraveled this mystery. Since the Soviets are apparently not using super-powerful transmitters, they must be doing something to their signals. The signal variation may be related to a technique called "backscattering" and the Russians may be "slewing" their antennas.

Backscatter. The principle of backscatter has been known for a long time. Essentially, a radio signal, on returning to earth after being reflected by the ionosphere, is scattered in all directions because of the irregularities on the earth's surface. A small fraction of the signal goes back to the transmitter site

(Continued on page 96)

AT LAST!

A HOME TV TAPE RECORDER KIT!

By HANS F. KUTSCHBACH

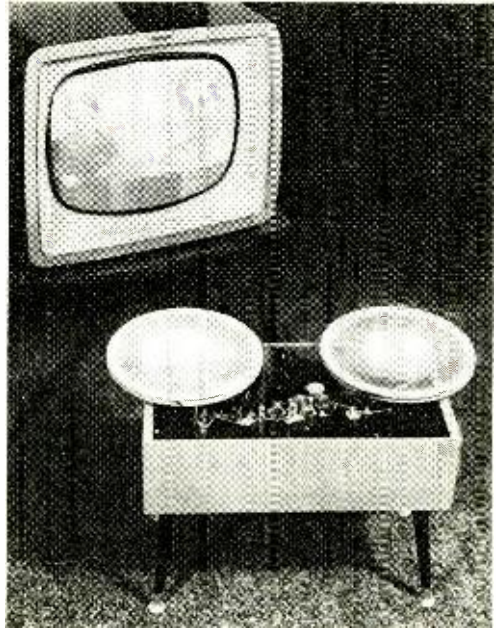

Relatively low in price, the new VKR 500 puts TV taping and electronic home movies within reach of the hobbyist

A HOME TV tape recorder for the average hobbyist, long promised by manufacturers on both sides of the Atlantic, appears to have become a reality. Such a machine, capable of recording up to an hour of sound and video on an 11½" reel of ¼" magnetic tape, is now being marketed in kit form by Wesgrove Electronics, Ltd., of Worcester, England. Price of the machine, known as the VKR 500, is \$392.00.

Although work on developing a low-priced TV tape recorder has been going forward for at least ten years, the race quickened in late 1963 when Telcan, Ltd., another English firm, announced it would market the first such machine. Several other manufacturers jumped on the bandwagon in 1964. However, all have encountered difficulties.

Performance of the VKR 500. Although Telcan, Ltd., which started all the furor, is now bankrupt, the VKR 500 seems to have inherited some of the general characteristics of the Telcan machine. However, the specifications of the VKR 500 hint at added versatility and, presumably, better performance. Two tracks, each with sound and video, can be recorded on ¼" tape at speeds of 90, 120,

or 150 ips as selected by the user. This gives a maximum running time of 30 minutes per track at 90 ips on an 11½" reel.

Video signals taken from the video detector of a TV set or from a TV camera are recorded on a 70-mil segment on the outside edge of the tape by a fixed-position video record/playback head. The system of vision recording is said to "utilize direct recording of a predistorted video waveform with a unique system

(Continued on page 99)

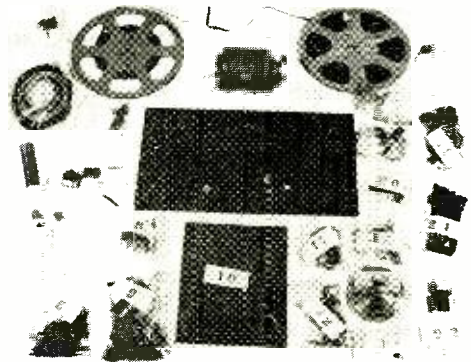

In order to keep price low and to make the unit immediately available, the VKR 500 is supplied only in kit form. Some of the components are shown here.

MR. THURAS' MAGIC BOX



By **DAVID B. WEEMS**

The distributed port bass reflex was invented 35 years ago; with a modern-day hi-fi speaker, it sounds better than ever

MY INTRODUCTION TO HI-FI occurred about 15 years ago when I heard a speaker in a bass reflex enclosure. I was so impressed I bought some plywood and started building bass reflex cabinets, finally owning more boxes than I had speakers to fit. A few years later, I learned about the use of ducts or "tunnels," which permitted a reduction of enclosure volume for a given resonant frequency. Since just about all commer-

cial cabinets of the era had only single ports, the ducted port was apparently a new development of vague and mysterious origin.

Another variation in the bass reflex cabinets of the '50's was the "distributed port," consisting of several small holes drilled in the face of the baffle to replace the single large hole. The proponents of the distributed port claimed that a smoother hi-fi response

resulted from the resistive force that the multiple small holes exerted on the flow of air through them.

Then the stereo age arrived, and the need for double speaker systems created a demand for compact enclosures. We began to hear less about distributed ports and more about the ducted port, which now finally had its day. Those pioneers of the 1950's who had advocated them were simply ahead of their time.

Recently I became curious about the origin of the bass reflex. I knew that its invention by A. L. Thuras of Bell Telephone Laboratories had probably had greater influence on high-fidelity speaker systems than any other development, but details on just what he invented seemed non-existent. Finally after a fruitless search in hi-fi books and several libraries, I sent 25 cents to the

U. S. Patent Office and received a copy of Patent No. 1,869,178, "A Sound Translating Device."

I eagerly examined the drawings, expecting to find the typical boxed-in speaker with a rectangular port below it in the front panel. To my surprise there was instead a series of short pipes surrounding the speaker. Not only did Thuras invent the bass reflex, but a "distributed duct" bass reflex. But the real shocker came when I looked at the patent filing date: August 15, 1930!

The more I studied the patent specifications, the more intriguing they became. The enclosure had esthetic drawbacks, such as a square face and a volume of more than 9 cubic feet, but I was convinced that the original design had unusual merit if only it could be matched to present-day speakers. Finally I decided to try, and here is the result—a smooth-operating "sound translating device" of the highest order. It is designed to operate with the University "Mustang" series of speakers.

Construction. The box itself is conventional. You may make minor changes in construction, but you should not change the inside dimensions. If you make any significant volume changes, good luck, but don't expect to predict a match for any particular speaker or resonant frequency from the published bass reflex charts you might have on hand. Those charts apply to single ports or ducts and are not valid for the multiple pipe baffle. I found this out when the indicated pipe length proved to be too short.

Except for the cardboard tubes, the materials are conventional and readily available. You can probably find tubes of the diameter listed at a neighborhood furniture store or rug dealer, but if the store is a small one, you may have to ask the owner to reserve one or two for you. My nearest furniture store had two empty tubes twelve feet long standing in a corner waiting for the trash collector. If you can't find tubes with the same inside diameter, you may have to use larger ones, changing the number of tubes to maintain approximately the same cross-sectional area. Or you can cut square openings and fabricate plywood ducts with inside dimensions of $1\frac{1}{16}$ " x $1\frac{1}{16}$ ".

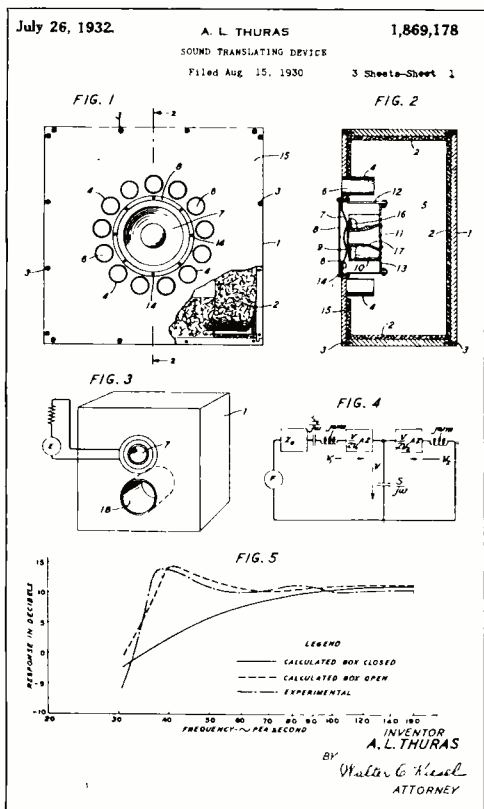

A. L. Thuras filed a patent application for this distributed port enclosure on August 15, 1930, and assigned the patent rights to the Bell Telephone Company. He called it a "Sound Translating Device."

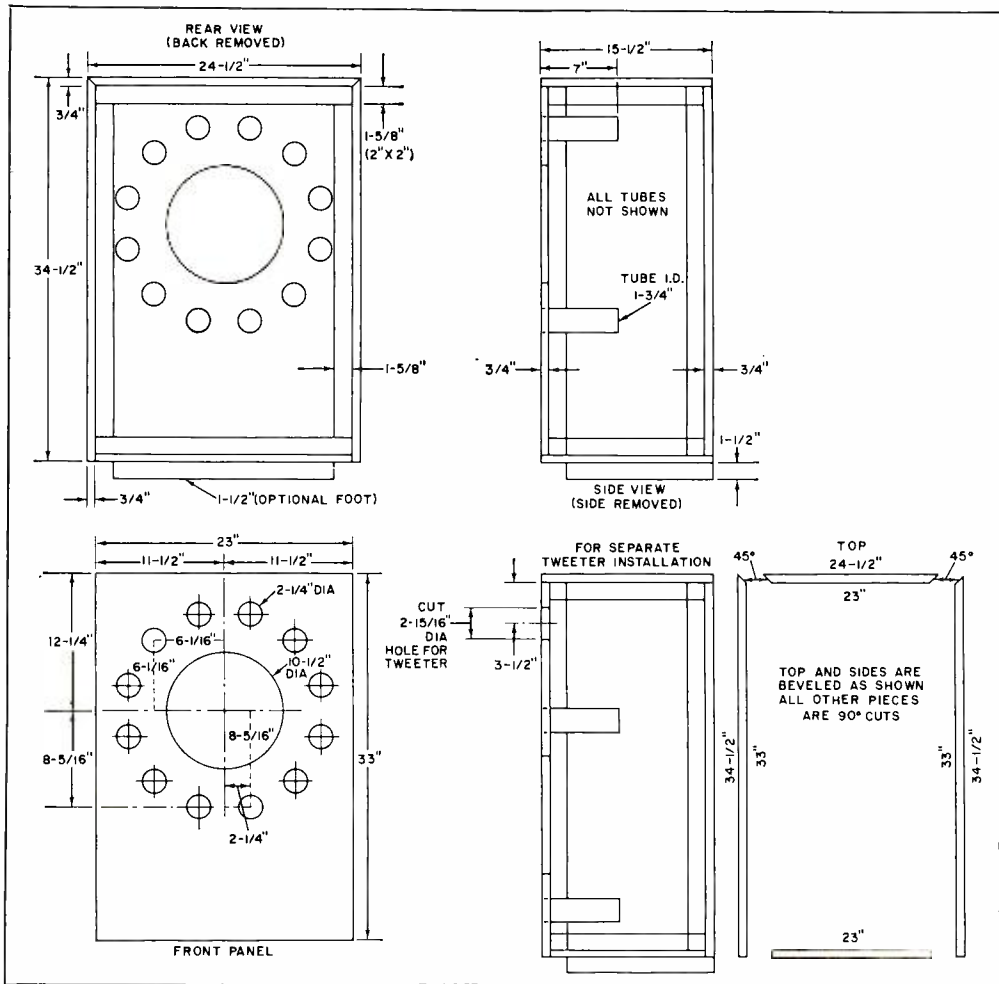

Outline drawings above show the general arrangement to use in building a duplicate of A. L. Thuras' distributed port reflex. A University "Mustang" speaker was tested in this enclosure and sounded fine. If more highs are desired because of room acoustics, mount a separate tweeter as shown at the lower right.

BILL OF MATERIALS

- Cut from 3/4" plywood:
- 2—23" x 33" pieces for front and back panels
 - 2—15 1/2" x 3 1/2" pieces for sides
 - 1—15 1/2" x 2 1/2" piece for top
 - 1—15 1/2" x 23" piece for bottom
- Cut from fir or pine 2 x 2's (actually 1 5/8" x 1 5/8"):
- 4—10 3/4" pieces for corner cleats
 - 4—23" pieces for top and bottom cleats
 - 4—30" pieces (approx.—cut to fit) for side cleats
- 12—2 1/4"-o.d., 1 3/4"-i.d., 7"-long pieces of cardboard mailing tubes for pipes
- 1—6-1/16" x 6-1/16" piece of cardboard or wood for pattern board
- 1—2 3/4" x 8-5/16" piece of cardboard or wood for pattern board
- Misc.—7 doz. #9 x 2" flat-head wood screws (see text), glue, grille cloth, trim, legs—if desired

The first step after cutting out the parts is to screw and glue the braces or cleats to the top and bottom. The sides are then fastened to the top and bottom, using glue and screws through the corner braces into the sides. It is then possible to cut the side cleats, which serve as anchors for the front and back, to fit exactly. Incidentally, if your lumber dealer does not have pre-cut 2 x 2's, he may supply you with pieces that have been ripped from 2 x 4's. In that case the dimensions may be slightly different and require longer or shorter screws. Be sure to check the screw length.

The only part of the design which re-

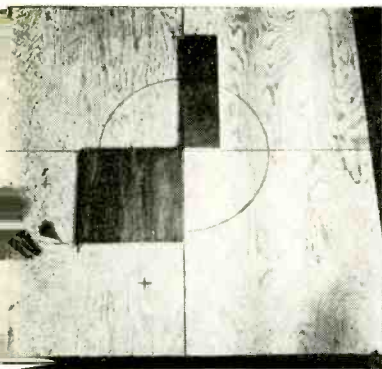

Centers for port holes are marked out using two pattern boards. Dimensions of the boards are given in the Bill of Materials. How they are used is described below.

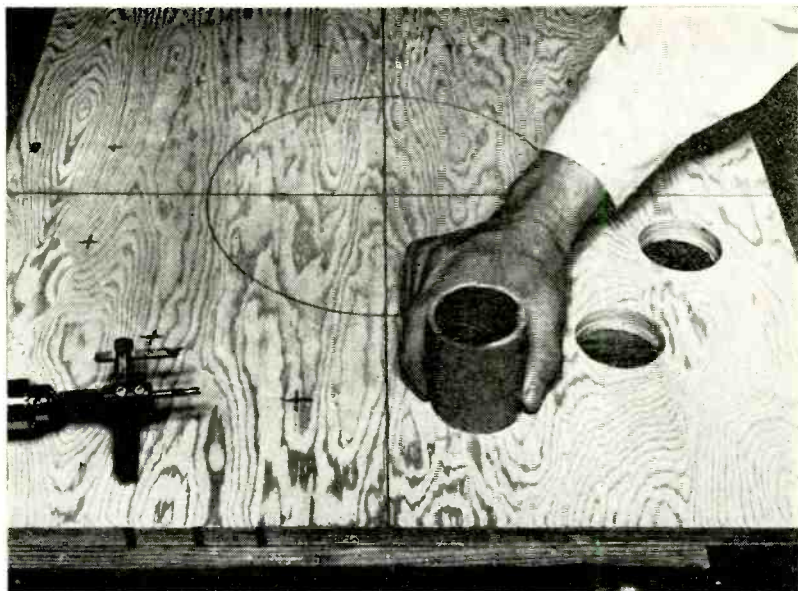

Bore the port holes using a heavy-duty "fly" or circle cutter with a low-speed electric drill. An Arco hole saw can be employed if the diameter of the saw matches the outside diameter of the cardboard tubes.

quires careful planning and measuring is the front baffle. I found that "pattern boards" made from scraps of plywood greatly simplified the location of the 12 holes for the pipes. First locate and draw the circle for the speaker cutout; then divide the circle into quadrants, extending the lines to the edges of the board. The middle hole in each quadrant can then be located by positioning the $6\frac{1}{16}$ "-square pattern board with one corner at the center of the circle and the sides bounded by the quadrant lines as shown in the photo. The other two holes in each quadrant are located by positioning the other pattern board with the longer side first on one quadrant line, then the other, keeping a corner at the circle's center (see photo).

The holes can be easily cut with a circle cutter and a large portable drill. It's possible to cut them with a small high speed drill, but such an operation is hazardous. Keep a firm control on the drill at all times and a safe distance between it and your knees or feet. Cut some sample holes in waste plywood first and check for a tight fit with a piece of tubing. When the cutting of the port holes and speaker opening is completed, glue the 7-inch tubes in place so that

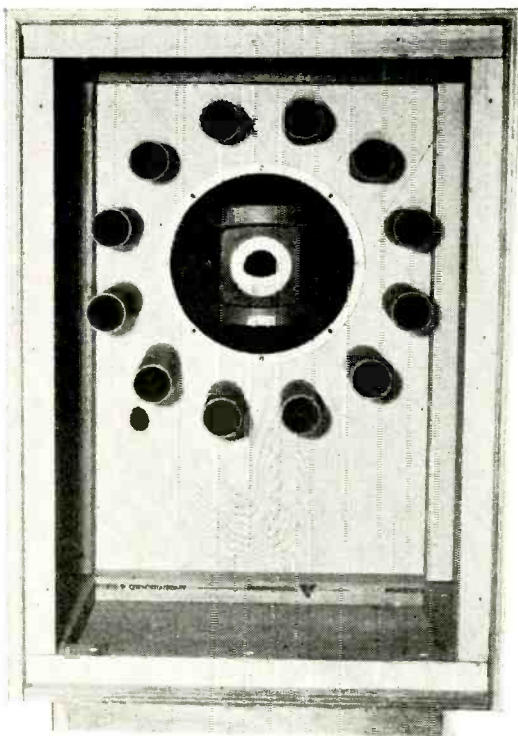

This rear view of the speaker enclosure does not show the cotton or cheesecloth batting used to dampen boomy resonances. See text on next page.



The cardboard tubes should fit snugly into the port holes. The length of the tubes recommended for use with a University "Mustang" speaker is 7 inches. Glue each of the tubes in place so that the end of the tube is exactly flush with the front panel.



Ordinary plastic grille cloth is carefully tacked to the front of the enclosure. Mitered strip of molding covers the tacks and frayed ends of the cloth.

the end of each tube is flush with the front of the board. Mount the board, and you are ready to finish the cabinet.

Don't forget to use padding on at least the top, one side, and back—more if you wish. The pipes offer a convenient anchor for a particularly effective placement of padding. I made a "doughnut" of heavy cotton batting sandwiched between layers of cheesecloth and cut openings in the cheesecloth for the pipes; this suspends the sheet of batting just in back of the speaker without totally enclosing the speaker and putting a pressure compartment around it.

Variations. For a full-range speaker such as the University M-12T or M-12D, construct the enclosure as shown here. If you want to use a separate woofer-tweeter arrangement such as the M-12 "Mustang" woofer plus the T-202 super tweeter, the front panel can be inverted with the woofer and pipes in the lower part and a tweeter opening cut near the top. If you substitute other speakers, the bass resonance of the speaker should be similar to that of the "Mustang" series, or about 40-50 cycles.

If you build this enclosure, you can honestly tell your friends that it's 35 years ahead of its time.

TRUE YES HEADS BLACK WIN GREEN

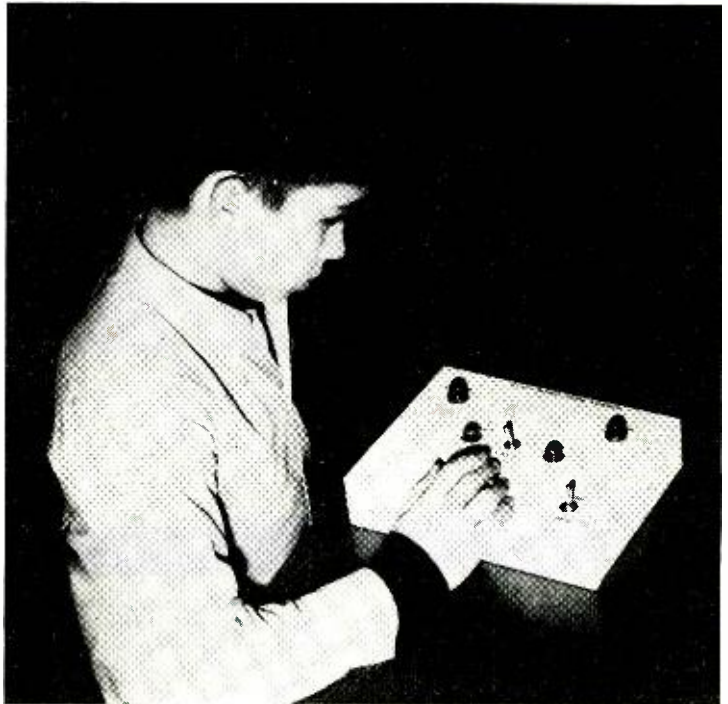

HERE'S a clever computer-type gadget that will provide hours of fun for "youngsters" of all ages, and at the same time teach basic computer logic. A good science fair project, the "Electronic Coin Tosser" simulates electronically the toss of a coin. The probability of the *HEADS* lamp lighting is 50:50. That is, if the game is played one hundred times, the heads will come up approximately fifty times.

To play the game, turn the power switch on and allow time for the lights to quit blinking. Now make your call by throwing the *CALL* toggle toward *HEADS* or *TAILS*. Toss the coin by pressing the *TOSS* button momentarily. The lamps begin to blink, and increase in speed; suddenly the blinking stops; and just as suddenly you win or lose, for the *HEADS* or *TAILS* lamp goes on, and so does the appropriate *WIN* or *LOSE* lamp.



CALL switch leaning towards *HEADS* allows *WIN* lamp to light if electronic flip-flop stops on heads. Press *TOSS* button to match wits with the "brain."

Theory of Operation. A computer-type logic diagram for the game is shown in Fig. 1. Like a double-throw switch, the flip-flop circuit places a signal first on one side, then on the other. Looking at the switch or the flip-flop circuit at any given instant, you will find that when there is an *on* condition on one side there is an *off* condition on the other, and vice versa. Actually, any binary type of indication can be programmed, such as 1 and 0; on and off, plus and minus, hot and cold, black and white, heads and tails, etc.

In this project, the readout is *HEADS* and *TAILS*, and *WIN* and *LOSE*. If the flip-flop in our game stops on heads, the *HEADS* output will be a 1 and the

ELECTRONIC COIN TOSSER

By WOODROW POPE

Design Engineer
Collins Radio Co.

FALSE
NO
TAILS
WHITE
LOSE
RED

TAILS output will be a 0. These signals as well as the signals from the *CALL* heads and tails switch are fed to a series of logic gates. There are four *AND* gates (*G1, G2, G3, G4*) and 2 *OR* gates (*G5, G6*). Each gate has provisions for two input signals and one output signal. The output signal depends upon the input signal.

To simplify matters, consider heads to be 1 and tails to be 0 when heads are called. When tails are called, tails become a 1 and heads a 0. The *AND* gate requires a 1 on both inputs to give a 1 on the output; a 1 and a 0, or a 0 and a 0, on the inputs gives a 0 on the output. An *OR* gate requires a 1 on either input to give a 1 on the output; a 0 and a 0 on the inputs give a 0 on the output.

In order to light the *WIN* lamp, a logic 1 on its input is needed. This means the *OR* gate (*G5*) must have a logic 1 on at least one of its inputs. To reach this condition, one of the *AND* gates must have logic 1's on both its inputs.

Assume heads is called. This puts a logic 1 on input #1 of gate *G1* and gate *G4*. It also puts a logic 0 on input #1 of gate *G2* and on input #2 of gate *G3*

(logic 0 means tails was not called). Also assume that the flip-flop circuit stops on heads, putting out a 1 on the heads output and a 0 on the tails output.

So now we have: a 1 on inputs #1 and #2 of gate *G1*, and it puts out a 1; and both inputs of gate *G2* have 0's, and it puts out a 0. Gate *G5* now has a 1 on input #1 and a 0 on input #2 and so it puts out a 1, and causes the *WIN* lamp to light. What about gates

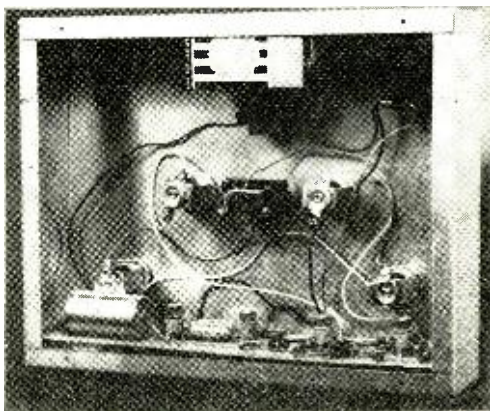

Rear view of Electronic Coin Tosser shows simplicity of wiring and assembly. Battery can be held in place with a dash of glue, or a suitable bracket.

G_3 and G_4 ? Gate G_3 has a 1 on input #1 and a 0 on input #2, so its output is a 0. Gate G_4 has a 1 on input #1 and a 0 on input #2, so it too puts out a 0. Gate G_6 has 0's on both inputs, so its output is 0 and the *LOSE* lamp does not light. Try your hand at the three other possible combinations.

How It Works. The circuit consists of an astable and a bistable multivibrator, as shown in Fig. 2. The astable multivibrator looks like an ordinary collector-coupled circuit except that the two bias resistors (R_3 and R_4) are connected to a 150- μ f. capacitor (C_1). When the *TOSS* button (S_1) is closed, C_1 takes on a

charge from B_1 through R_1 and applies this voltage to R_3 and R_4 and allows the astable multivibrator to oscillate. Oscillations continue until the voltage across C_1 falls below the level required to forward-bias Q_1 and Q_2 .

The output from the collector of Q_2 is fed to the inputs of the bistable multivibrator through C_4 and C_5 . The signal at this point is in the form of a square wave and triggers the bistable multivibrator (Q_3 and Q_4). In the absence of an input signal, either Q_3 or Q_4 is conducting all the time. When Q_3 conducts, Q_4 is off, I_3 is on, and I_4 is off. When Q_4 conducts, Q_3 is off, I_3 is off, and I_4

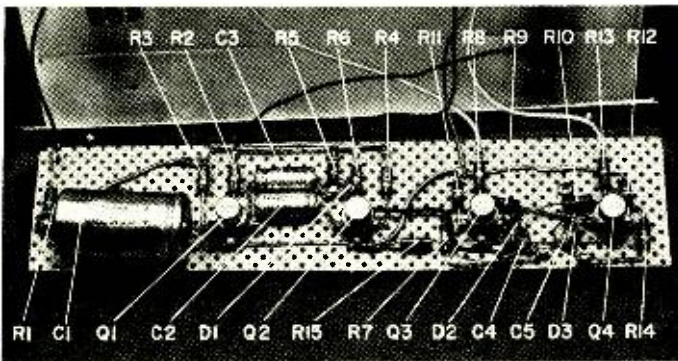

All components are mounted on Vectorbord with push-in terminals. Use of transistor sockets eliminates possible soldering heat damage to the transistors. Entire assembly can be secured to the cabinet by a machine screw and nut at each end. Use suitable standoffs to keep the bottoms of the push-in terminals from touching the cabinet.

Fig. 1. Computer logic diagram shows action required to light WIN or LOSE lamps. Selection of heads with the CALL switch places a 1 on input #1 of G_1 and G_4 . If the flip-flop oscillator stops on heads, it places a 1 on the inputs of G_2 and G_3 . All other inputs on G_1 through G_4 have a 0. Since G_1 is the only gate with a 1 on both inputs, its output is a 1. AND gates have an output of 1 when both inputs are 1. OR gates (G_5 and G_6) require at least a 1 on either of the inputs to signal a 1 on the output. A 1 output from an OR gate is needed to light the WIN or LOSE lamps. Since G_5 has a 1 on one of its inputs, its output is 1 and the WIN lamp lights. See text and try your hand at logic.

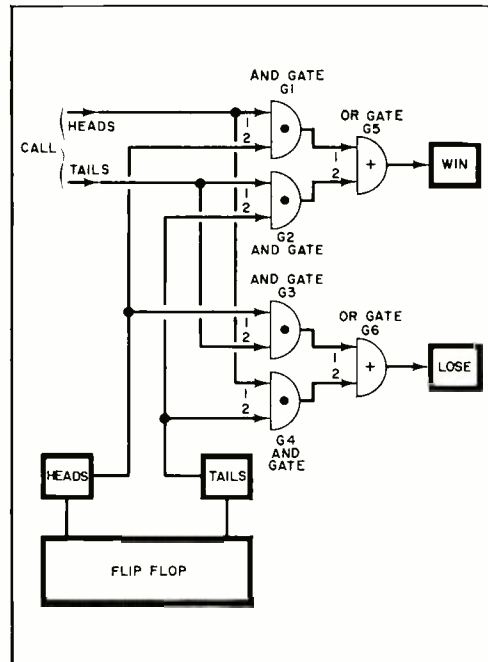

is on. In the presence of an input signal, Q3 and Q4 cycle on and off continuously. When the input signal is removed, the circuit reverts back to one of its two possible stable states.

Switch S3 connects I1 and I2 in series with the appropriate circuit. When the call is heads, I1 is in series with I3 and

I2 is in series with I4. If tails is called, the series connections are interchanged; I1 and I4 are in series, and I2 and I3 are in series. If the manual selection of heads or tails coincides with the random electronic selection of heads or tails, the WIN light (I1) goes on; otherwise the LOSE light (I2) lights up.

Construction. A 2" x 7" x 9" aluminum chassis is used to hold the game. The circuit is built on a piece of 1 3/4" x 8" Vectorbord using push-in terminals.

Layout is not critical but care should be taken when soldering diodes and transistor leads so that they do not become overheated. Polarity of diodes and electrolytic capacitors must be observed. Transistor sockets are convenient to use and eliminate the possibility of ruining a transistor with a soldering iron.

A d.p.s.t. switch (S2) is used as an on/off switch, but a s.p.s.t. unit will do just as well. Connect the positive side of the battery directly to the lead serving as ground.

The chassis is finished with flat white paint and lettered with rub-on decals. Lenses for the WIN and LOSE lamps are colored green and red respectively. HEADS and TAILS lens color could be either amber or white.

PARTS LIST

B1—9-volt battery (Burgess 2N6 or equivalent)
C1—150-μf., 100-volt d.c. electrolytic capacitor (d.c.w.v. could be as low as 10 volts)
C2, C3—7-μf., 50-volt d.c. electrolytic capacitor
C4, C5—0.002-μf. ceramic capacitor
D1, D2, D3—1N34A diode
I1, I2, I3, I4—#49 lamp
Q1, Q2, Q3, Q4—2N404 transistor
R1—680 ohms
R2, R6—1000 ohms
R3, R4—6800 ohms
R5—3300 ohms
R7, R14—10,000 ohms
R8, R13—68 ohms
R9, R10—820 ohms
R11, R12—100,000 ohms
R15—15 ohms
S1—Normally open push-button switch
S2—D.p.s.t. toggle switch (s.p.s.t. may be used)
S3—D.p.d.t. toggle switch
1—2"x7"x9" aluminum chassis
4—Lamp holders with lenses; 1 red, 1 green, and 2 amber
Misc.—1 3/4"x8" Vectorbord and push-in terminals, or equivalent, to hold components; four transistor sockets (optional); battery connector terminals; and wire

*all resistors
 1/2-watt carbon,
 ±10%*

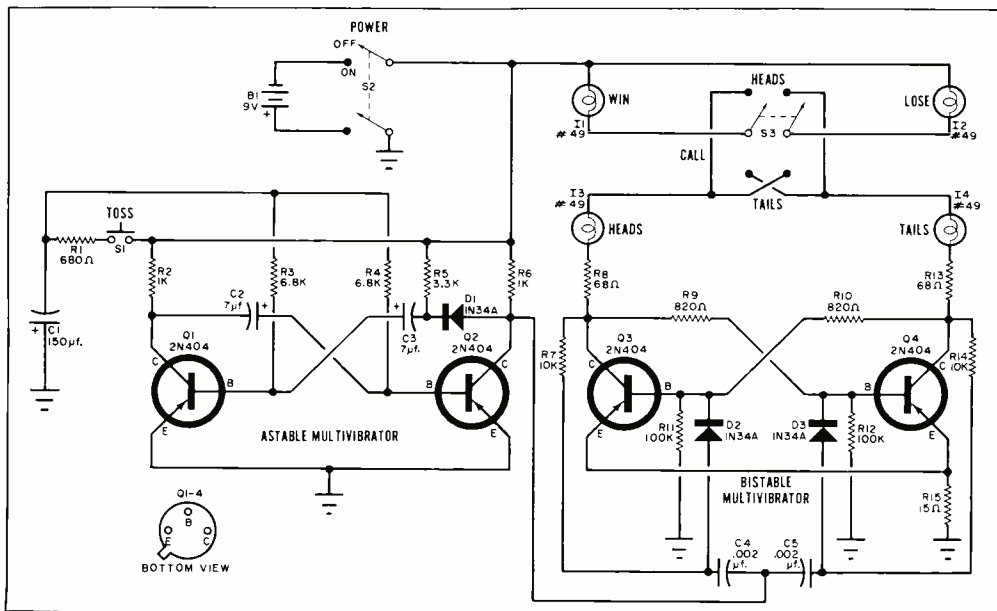
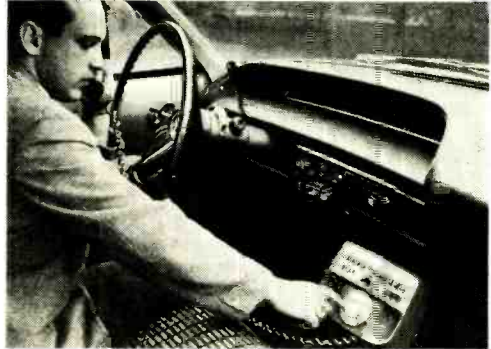

Fig. 2. Bistable multivibrator flip-flops from heads to tails only when the astable multivibrator is in action. Position of S3 and electronic selection of heads or tails determines the win or lose indication.

DIAL PHONE GOES MOBILE—The "MJ" mobile radio telephone system developed by Bell Labs makes possible dialing of calls—just as with an ordinary telephone—both to and from a mobile unit. Other innovations are duplex operation (simultaneous reception and transmission), and automatic "search" circuitry that locates a clear channel for the calls.



LASER PISTOL—A pistol-shaped laser sound projector that can send voice and other signals great distances over powerful light beams has been demonstrated by IBM. The 12-oz. gallium arsenide laser-modulator draws just 1½ watts of power from external dry batteries to produce ½-watt output peaks. Just 6" long, pistol operates at room temperature.



DEAF-TALKIE—Wireless and completely portable, this auditory training unit developed by Electronic Futures, Inc. receives classroom broadcasts from a loop antenna strung around the room. Unit permits deaf students to move about freely, participating in games and other activities. Accessory mike allows student to hear his own voice—an aid in teaching him proper speech.

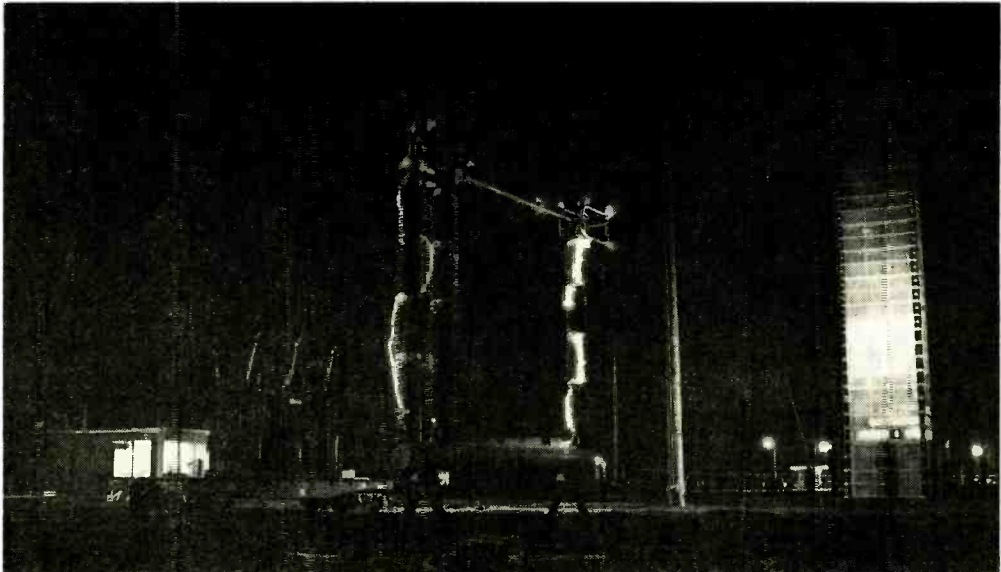

MAN-MADE LIGHTNING—Spectacular display is from Westinghouse's outdoor circuit breaker test lab, Trafford, Pa. Installation tests breakdown voltages to 1,000,000 volts, simulates 6,400,000 volts of lightning.

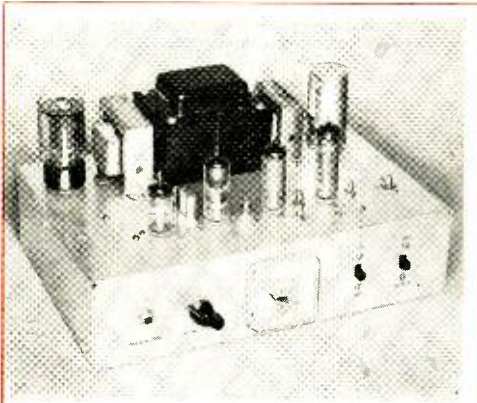

BUILD THE PARAGON 144

Would you like to
put a truly effective phone
signal on 2 meters?
Here's a little rig that's
ideally suited for
Novice, Technician, or General

By HARTLAND B. SMITH, W8VVD

WHETHER you're a Novice weary of pounding brass, a Technician fed up with 6-meter TVI complaints, or a General tired of ear-shattering QRM, there's an answer to your problem: 2-meter phone. Even if you don't live in an area where there's much 2-meter activity, it will pay you to keep a 2-meter rig on the shelf just to take advantage of VHF band openings, and possibly the satellite repeater capabilities of OSCAR III and other ham satellites to follow.

As long as you're going to give 2 meters a whirl, you'll want a transmitter that radiates a truly effective signal. The "Paragon 144," rated at 20 watts input on AM phone, has been designed to do just that. Thanks to its relatively simple circuitry, straightforward parts layout and ease of adjustment, any

reader who can drill, file, saw and solder will have little difficulty in putting it on the air.

The Circuit. Referring to the schematic on page 58, *V1a*, a triode oscillator, utilizes third-overtone crystals cut for about 36 mc. Pentode *V1b* doubles the oscillator frequency to around 72 mc.; *V2* serves as a second doubler, boosting the frequency to 144 mc. An Amperex 6360 twin-tetrode, *V3*, is used as a self-neutralized push-pull final power amplifier.

Audio from the microphone is amplified by *V4a* and *V4b* and is then applied to the grid of the Class A Heising modulator, *V5*. An ordinary filter choke, rather than an expensive modulation transformer, superimposes audio from the modulator onto the d.c. power fed to the final amplifier.

An 0-5 ma. meter (*M1*) may be clipped across a number of different shunt resistors to indicate final plate current, final grid current, and the plate currents of either the first or second doubler. (These test points are indicated on the schematic as "TP1," "TP2" etc.) Silicon diodes *D1* through *D6* serve as power supply rectifiers.

Chassis Preparation. Long leads and haphazard parts placement cannot be tolerated in a 2-meter transmitter: carefully follow the layout diagrammed in Fig. 1 and Fig. 2. The 3" x 8" x 12" chassis should be of aluminum rather than steel—aluminum is easier to work and exhibits better conductivity than steel.

Before mounting the tube sockets, study Fig. 3 to make certain the pins are correctly oriented. The rotor of *C13* is hot with r.f., so it cannot be fastened directly to the chassis. Cut a 3/4" x 1/4" piece of insulation from a sheet of 1/16" polystyrene or Bakelite. Mount *C13* in a hole drilled at the center of the insulator and then fasten the insulator to the chassis as shown in Fig. 7. Make certain the 3/8" nut on the threaded shaft bushing of *C13* clears the edges of the 1/2" chassis hole (see Fig. 5) through which it protrudes.

Wiring. Wire the heaters first. Cut the green-yellow transformer wire to a length of about an inch and tape the end to prevent it from shorting against another wire or component. Ground one green wire to the mounting foot of the 4-

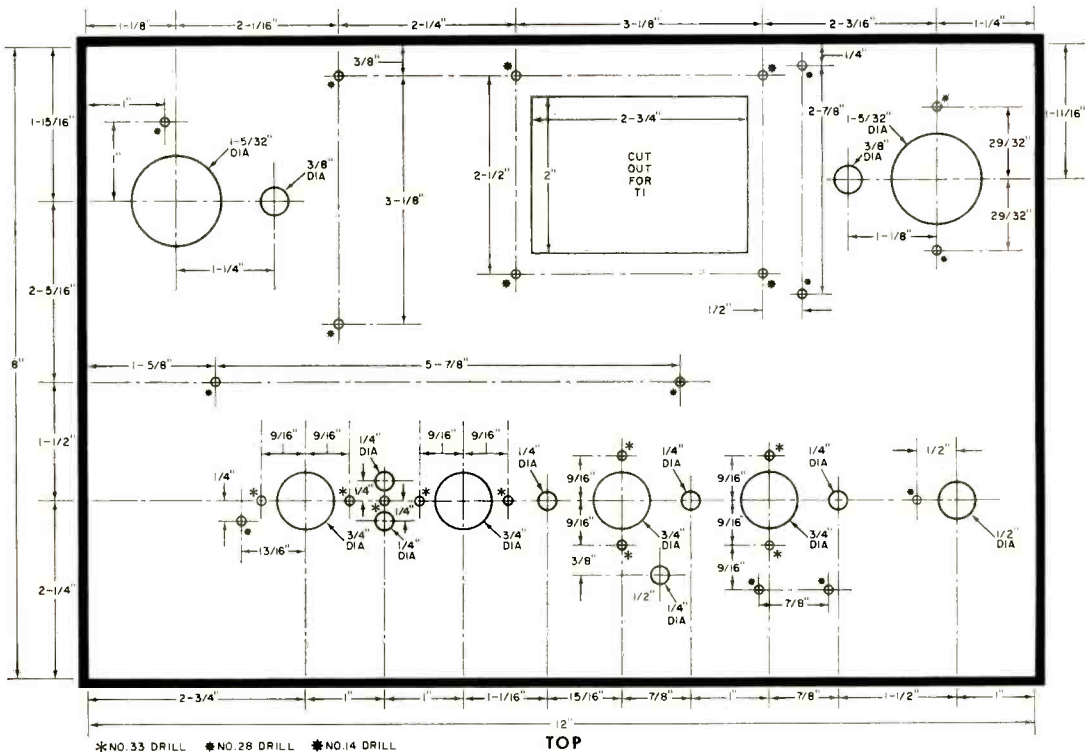

Fig. 1. Diagram shows cutouts, mounting holes in top of chassis. At front, from left to right, are V4, V1, V2, V3. Large hole at top left is for mounting V5; opposite are cutouts for T1 and for capacitor C25.

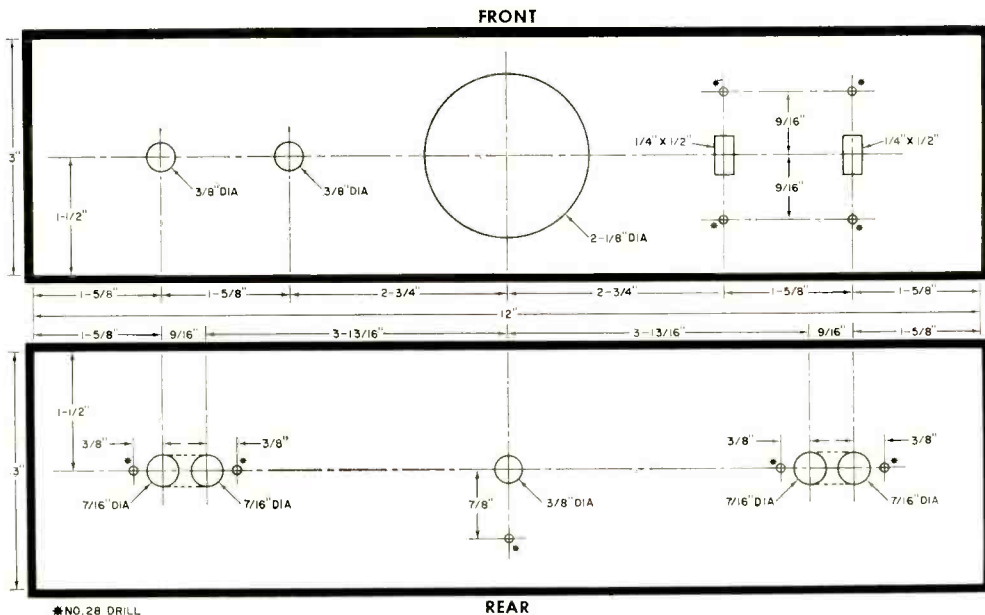

Fig. 2. Cutouts in front panel are (left to right) for mike jack, audio gain control, meter, on-off switch, and send-receive switch. Those on the rear are for mounting TS1, the a.c. line cord, and TS2.

Fig. 3. The photo at right shows an overall view of the chassis bottom looking from front to back. In building unit, it is essential that tube sockets be oriented as shown and coils positioned correctly.

PARTS LIST

- C1—10-pf., 1000-volt NPO ceramic disc capacitor (Sprague Series 10TCC, Type Q10, or equivalent)
 C2, C4, C6, C8, C10, C21, C22, C23, C24—0.001- μ f., 1000-volt ceramic disc capacitor
 C3, C7—25-pf., 1000-volt NPO ceramic disc capacitor (Sprague Series 10TCC, Type Q25, or equiv.)
 C5— \sim 7-1.5 pf. miniature variable capacitor (E. F. Johnson Type 160-104 or equivalent)
 C9—14.2-2.3 pf. miniature variable capacitor (E. F. Johnson Type 160-107 or equivalent)
 C11, C12—8-2.2 pf. miniature variable butterfly capacitor (E. F. Johnson Type 160-208 or equiv.)
 C13—32-3 pf. miniature variable capacitor (E. F. Johnson Type 160-130 or equivalent)
 C14—16- μ f., 150-volt electrolytic capacitor
 C15, C16, C17, C18, C19, C20, C28, C30—0.01- μ f., 1000-volt disc ceramic capacitor
 C25—40/40/20- μ f., 450/450/25-volt electrolytic capacitor
 C26, C29—150-pf., 1000-volt disc ceramic capacitor
 C27—10/10- μ f., 450/450-volt electrolytic capacitor
 D1, D2, D3, D4, D5, D6—750-ma., 400-PIV silicon diode (Lafayette Radio 19G5001 or equivalent)
 J1—Standard open-circuit phone jack
 L1—11 turns of \approx 20 bare wire, spaced diameter of wire, on a $\frac{3}{8}$ " x $\frac{1}{8}$ " phenolic slug-tuned coil form (J. W. Miller 21.1000RBI coil form, available from Allied Electronics, Stock No. 63G909, for 64 cents)
 L2—4 turns of \approx 20 tinned wire, $\frac{1}{2}$ " diameter, turns spaced $\frac{1}{8}$ "; $\frac{1}{2}$ " leads
 L3—4 turns of \approx 20 tinned wire, $\frac{1}{2}$ " diameter, turns spaced $\frac{1}{8}$ "; 1" leads; coil tapped one turn from C9 end
 L4—2 turns of \approx 20 tinned wire, $\frac{1}{2}$ " diameter, turns spaced $\frac{1}{8}$ "; 1" leads; coil tapped at midpoint
 L5—6 turns of \approx 12 bare wire, $\frac{1}{2}$ " diameter, turns spaced $\frac{1}{8}$ "; $\frac{3}{4}$ " leads; $\frac{1}{2}$ " space at center of coil for insertion of L6; coil tapped at midpoint
 L6—2 turns of \approx 12 bare wire, $\frac{1}{2}$ " diameter, turns spaced $\frac{1}{8}$ "; 1" leads
 L7—2.3-h., 150-ma. filter choke (Allied Radio 61G482 or equivalent)
 L8—3-h., 150-ma. filter choke (Allied Radio 61G483 or equivalent)
 M1—0-5 ma. d.c. panel meter
 R1—39,000-ohm resistor
 R2—100,000-ohm, 1-watt resistor
 R3—100,000-ohm resistor
 R4, R7—68,000-ohm, 1-watt resistor
 R5, R8—82-ohm resistor
 R6—47,000-ohm resistor
 R9—15,000-ohm resistor
 R10—1500-ohm resistor
 R11—56,000-ohm, 1-watt resistor
 R12—20,000-ohm, 1-watt resistor
 R13—39-ohm resistor
 R14—1000-ohm, 20-watt resistor
 R15, R16, R17, R18, R19, R20—220,000-ohm resistor
 R21—100-ohm, 20-watt resistor
 R22—270,000-ohm, 2-watt resistor
 R23, R27—120,000-ohm resistor
 R24—2.2-megohm resistor
 R25, R31—330,000-ohm resistor
 R26—500,000-ohm potentiometer
 R28, R30—8200-ohm resistor
 R29—1000-ohm resistor
 R32—150,000-ohm resistor
 R33—200-ohm, 10-watt resistor
 RFC1, RFC2—1.8- μ h. r.f. choke (Ohmite Z-144)
 S1—S.p.s.t. slide switch
 S2—D.p.d.t. slide switch
 T1—Power transformer: secondaries, 650 volts @ 150 ma., center-tapped; 6.3 volts @ 5 amp; 5 volts @ 5 amp
 TS1, TS2—2-screw terminal strip
 V1—6AU6A vacuum tube
 V2—5763 vacuum tube
 V3—Imperex 6360 or 6360A vacuum tube
 V4—12AX7A vacuum tube
 V5—6L6GC vacuum tube
 Xtal—Third overtone crystal for a frequency between 36 and 37 mc. (36.250 mc. to 36.750 mc. for Technicians and Novices)
 1—Crystal socket
 4—9-prong miniature tube socket
 1—Octal tube socket
 11 Tie strips: 4 one-terminal, 1 two-terminal, 1 three-terminal, 5 four-terminal strips
 1— $\frac{3}{4}$ " x $1\frac{1}{4}$ " piece of 1/16" polystyrene
 1— $1\frac{3}{4}$ " x $2\frac{1}{4}$ " metal shield for 6360—see text
 1—3" x 8" x 12" aluminum chassis (Bud AC-424)
 Misc.— \approx 20 solid hookup wire, \approx 12 bare wire, piece of 300-ohm twin lead, a.c. line cord and plug, pointer knob, $\frac{3}{8}$ " grommets, ground lugs, 4-36 and 6-32 machine screws and nuts, solder, decals, fine stranded wire and clips for meter leads

All resistors
 $\frac{1}{2}$ -watt, 10%,
 unless otherwise
 specified

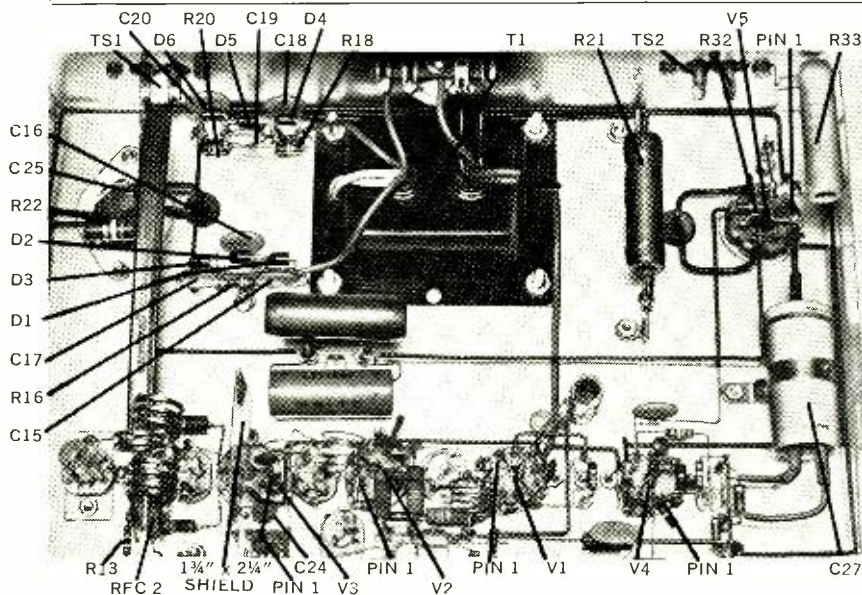

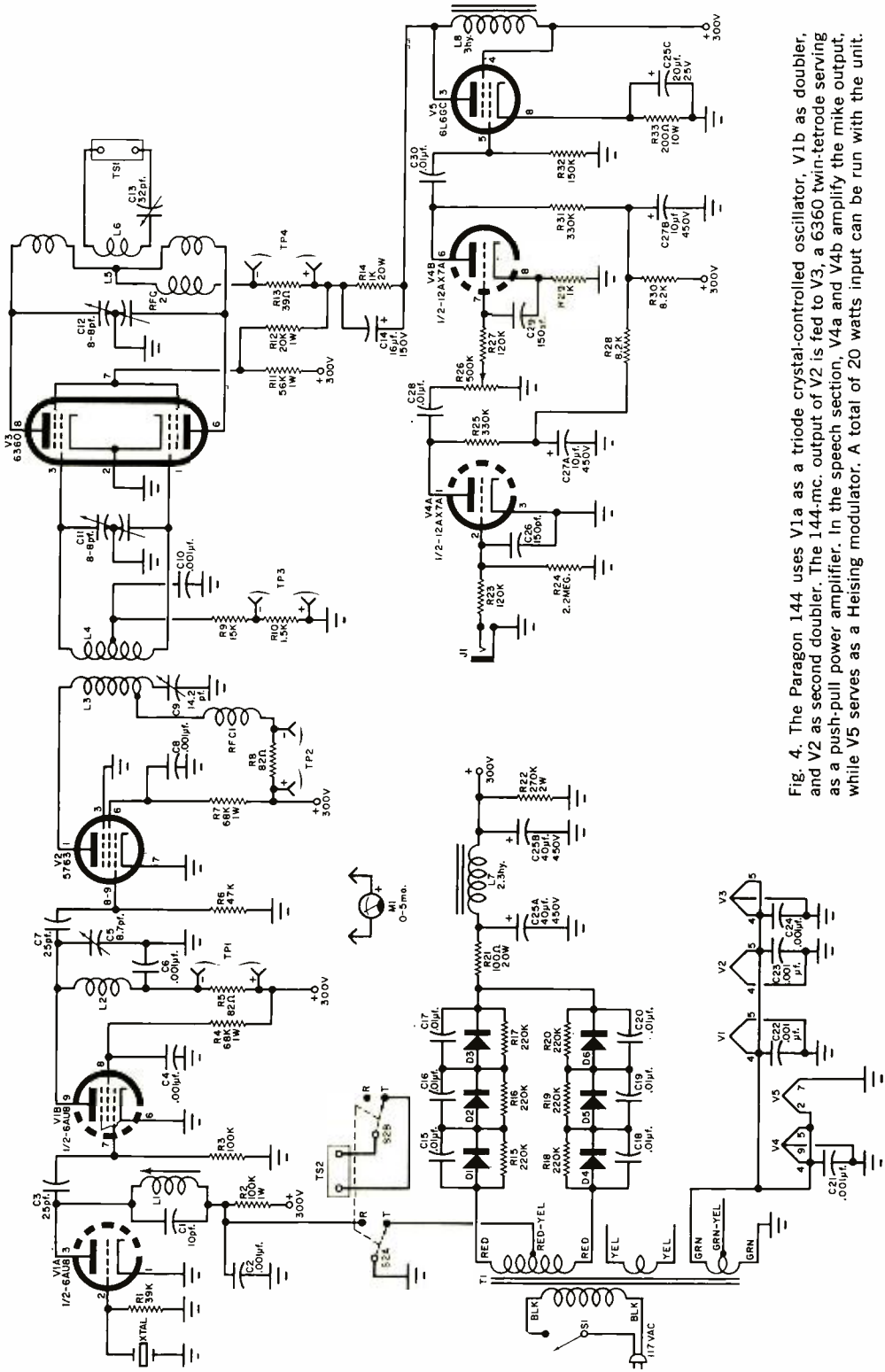

Fig. 4. The Paragon 144 uses V1a as a triode crystal-controlled oscillator, V1b as doubler, and V2 as second doubler. The 144-mc. output of V2 is fed to V3, a 6360 twin-tetrode serving as a push-pull power amplifier. In the speech section, V4a and V4b amplify the mike output, while V5 serves as a Heising modulator. A total of 20 watts input can be run with the unit.

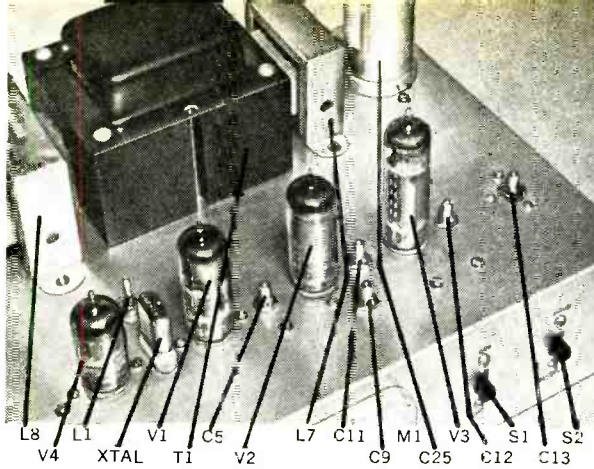

Fig. 5 (top). View of chassis top shows location of r.f. coils and capacitors, as well as other major components. Text describes how to tune up stages.

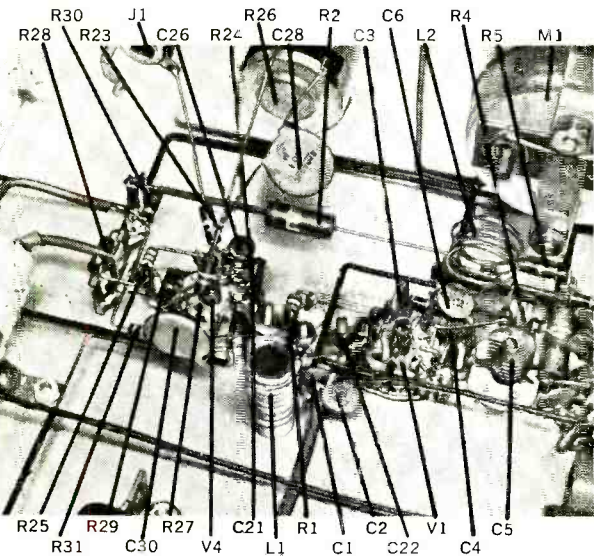

Fig. 6 (center). Photo of left side of chassis, as viewed from bottom, shows sockets of $V1$ and $V4$ and associated components; also note $J1$, $R26$, and $M1$.

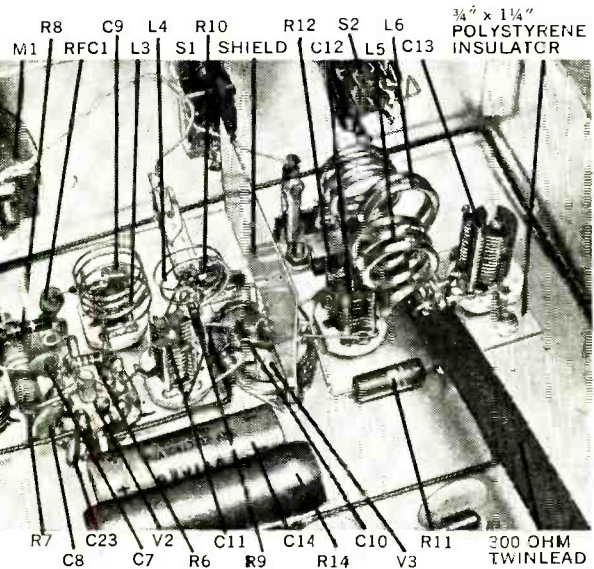

Fig. 7 (bottom). Right side of chassis (from below) shows shield across 6360 socket, polystyrene insulator used to mount $C13$. Note coils $L3$, $L4$, $L5$, $L6$.

lug terminal strip on the rear edge of the chassis (see Fig. 3). Run the other green wire to pin 4 of $V1$. Connect one branch of the heater line to pin 5 of $V2$, and then to pins 4 and 5 of $V3$. Run the other branch first to pins 4 and 5 of $V4$, and then to pin 2 of $V5$. Cut off and tape the yellow transformer wires.

The long wires going to $S1$ and $S2$, as well as those carrying d.c. to various parts of the circuit, should be kept out of the way by running them along the chassis edge. Be sure to observe correct polarity when wiring in diodes $D1$ through $D6$, and the electrolytic capacitors (including $C14$).

Solder all chassis connections associated with $V1$, $V2$, $V3$, and $V4$ directly to the socket mounting flanges. Run each ground lead from the specified tube pin to the nearest point on the flange. Ground the metal center post of each miniature socket. Shorten the leads of the 0.001- μ f. bypass capacitors until they barely reach the appropriate terminals and the socket flanges.

Wind all coils, except $L5$ and $L6$, with No. 20 solid tinned wire obtained by stripping insulation from the hookup wire you are using. Space the winding of $L1$ (wound on a slug-tuned coil form) sufficiently to prevent the turns from shorting against one another. Coat the finished coil with polystyrene cement.

Use a penlight cell as a temporary winding form for the balance of the coils. After each has been completed, stretch it lengthwise until the turns are spaced $\frac{1}{8}$ " apart.

Solder one end of $L2$ to $C5$'s stator support rod nearest $V1$ (see Fig. 6). The opposite end of this coil goes to the nearest terminal of a 4-lug tie strip located directly behind $M1$. Capacitor $C6$ and $R5$ also go to this same terminal,

(Continued on page 89)

Equipment Report

EICO 777 CB TRANSCEIVER KIT

BOTH the price and sophistication of CB gear are constantly on the rise, the first more or less as a result of the second. With these facts in mind, it is refreshing to find an under \$100 transceiver (in kit form) that offers a dual-conversion receiver, automatic noise limiter, squelch, tunable or crystal-controlled receive functions, S-meter, and a sensitivity of $1 \mu\text{v}$. for a 10 db signal-to-noise ratio. This unusual unit is the EICO Model 777 de luxe Citizens Band transceiver, which carries a price tag of \$99.95 as a kit, and \$149.95 factory-wired.

The transmitter of the 777, which comes preassembled, preset and sealed, has provisions for six crystal-controlled channels; power input is the usual 5 watts, with a pi-network matching circuit on the output side. Modulation is automatically limited to just under 100 percent. The power supply is the vibrator-transformer type operating on 117 volts a.c., and 6 or 12 volts d.c.

As might be expected with a unit that uses 8 tubes (14 tube functions), assembling the 777 is a sizable task. However, construction is reasonably well detailed in the manual, and the experienced builder should have little difficulty. The unit built and tested by POPULAR ELECTRONICS performed as well as, or better than, specified (see "Box Score" below).

Physically, the Model 777 transceiver is compact, measuring just $6'' \times 8\frac{1}{2}'' \times 10''$, light in weight (14 lb.), and lends itself to either fixed or mobile use. And, as we mentioned elsewhere, it's a lot of transceiver for the price. —30—



Above: an external view of the 777, which measures $6'' \times 8\frac{1}{2}'' \times 10''$. Below: top-of-chassis arrangement; factory-assembled transmitter is on left subchassis.

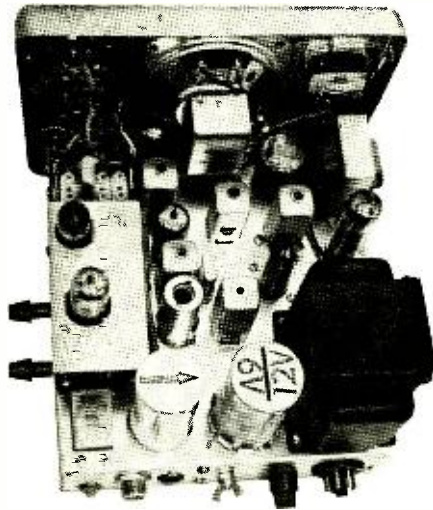

Due to compactness of unit, wiring is crowded (below), but construction data is adequate. The shielded box at the lower left contains the power supply.



Circle No. 85 on Reader Service Page 15

BOX SCORE				
	Excel- lent	Good	Fair	Poor
Talk Power	✓			
Selectivity	✓			
Sensitivity	✓			
Squelch	✓			
Noise Limiting	✓			
Stability	✓			
Operating Ease		✓		

THE NEON LAMP WONDER



By CHARLES A. PIROLO

***Comprehensive guide to neon lamps: how to use—
how to choose—how to get the most out of them
—how they work—and selected circuit applications***

NEON GLOW LAMPS are used in a myriad of devices from doorbell buttons to computers. They are dependable and economical and will stay lit continuously for 3 to 5 years at a cost of about 2 cents a year. They do not burn out. They reach the end of their useful life as the firing voltage gradually rises and the bulbs become blackened. They can take fairly rough treatment because there is no filament to break from shock or vibration. The NE-2, for example, is rated at only 1/17 of a watt and produces no appreciable heat. An NE-2 operating on 125 volts with a 150,000-ohm series resistor will still be useful after 25,000 hours of service.

How They Work. The neon glow lamp is a simple cold cathode device. Two or more electrodes are sealed in a small glass tube. The air in the tube is first

evacuated and then neon gas under moderately low pressure is added just prior to sealing. While the theory of operation is quite complicated and involves neutral atoms, excited atoms, positive ions and electrons, it isn't necessary to chase each electron, ion, and atom to understand how it works.

Simply supply enough energy to "tear off" some electrons from a neutral atom and you end up with a positive ion. If enough of these atoms are modified in this manner, the gas is said to be ionized. Ionized gas permits current to flow from one electrode to the other and heat the gas, causing it to glow with its familiar orange light. Neon gas glows at a wavelength somewhere between 5200 and 7500 angstroms.

Pulling an electron from an atom requires energy. The energy may come from collisions between electrons and

excited atoms when in the presence of an electric field. Ultraviolet rays, X rays and cosmic rays can also ionize neon gas. Even ambient light conditions, both natural sunlight and man-made light, can provide some of this energy.

Radioactive additives are placed inside some lamps to furnish energy to speed up the action and reduce the "dark effect." When glow lamps are placed in a darkened area, their starting voltage sometimes rises. In most indicator applications, you will find that the dark effect is more pronounced with high brightness lamps.

Ballast Resistor. A ballast resistor is needed to protect the neon lamp against excessive current. Omit the ballast on a 117-volt hookup and you are likely to see a bright, short flash, the glass envelope might break, and one of the wire electrodes will probably disappear. Stick to photographic flash bulbs if you must use neon lamps without a resistor. However, some lamps may already have a ballast resistor internally connected in their bases.

It is not necessary to use the exact resistance value listed in the table at right. The popular NE-2 for instance, calls for a 150,000-ohm resistor, but you could use values of 120,000 to 220,000 ohms, or even higher. Resistor tolerance of 10% is more than satisfactory. An increase in resistance decreases the light, but increases the life; a decrease in resistance increases the light but decreases the life of the neon lamp.

If the 150,000-ohm series resistor used with the NE-2 is reduced to 100,000 ohms, life expectancy is likely to drop from the 25,000 hours to about 7500 hours. A 50,000-ohm resistor will cut the useful life to about 500 hours.

Indicator Types. Neon glow lamps for indicator applications are divided into two broad general categories: standard brightness and high brightness. The two look alike but the high brightness lamp is about ten times brighter than the standard brightness lamp. At the expense of longevity, brightness levels can be increased up to 20 times. Both types are available with or without a base. The standard brightness NE-51 and high brightness NE-51H, for example, have a

bayonet base, while the NE-2 and NE-2H have wire leads.

The wire lead neon lamps can be soldered directly into a circuit, require no sockets, and because of their tiny size can be tucked into a small space. The base types require sockets and are easier to replace; when panel-mounted, they are usually accessible from the front and eliminate the need to pull the chassis or do any soldering just to change or check the lamp.

How To Select Lamps. Some of the least expensive and most practical types of neon lamps for indicator use are presented here. Unless you are building highly specialized circuits, you will find that the lamps listed in the table will satisfy most of your needs. A rule-of-thumb guide for selecting a neon lamp in terms of brightness type is to choose a standard brightness lamp for normal indoor lighting conditions and a high brightness lamp where a higher light output is needed. Outdoor devices should be equipped with high brightness lamps, if possible.

Standard brightness lamps can be installed in any piece of electronic gear where the minimum operating voltage is more than 65 volts a.c., or more than 90 volts d.c. Some neon lamps may fire on less than these voltages. If a lamp is located in an area where ambient light conditions are high, it will fire at a lower voltage. The 65-volt figure is not an exact rating, but a good one to work with.

As a neon lamp ages, the firing voltage changes. A new NE-2, for example, may fire at 65 volts a.c. After about 100 hours of operation, this voltage may decrease to 60 volts, but with further burning, the voltage will slowly rise throughout the life of the lamp.

Ignition voltage of the high brightness types is about 95 volts a.c. or about 135 volts d.c.

How To Install Them. There will be no problem with the base-equipped lamps, if you have the proper lamp socket. You can install the socket directly on the front panel or chassis in any convenient location. The wire lead type does not present any problems either. With the aid of a few shop tips, you can handle

NEON GLOW LAMPS FOR INDICATOR USE

Lamp Number	Average Useful Life, Hours (d)	External (e)‡ Resistance Required (ohms)	M.O.L. Inches	Base	Bulb† (Clear)	Nominal Current, Ma.	Circuit Volts A.C. or D.C.	(e) Watts, Nominal
HIGH BRIGHTNESS LAMPS								
NE-2H	25,000	30,000	¾ (a)	2" Wire Term.	T-2 (g)	1.7	110-125 (f)	1/5
NE-2J	25,000	30,000	15/16	S. C. Mid. Flange	T-2 (g)	1.7	110-125 (f)	1/5
NE-2P	25,000	30,000	¾ (a)	1" Wire Term.	T-2 (c)	1.7	110-125 (f)	1/5
NE-51H	25,000	45,000	1 3/16	Min. Bay.	T-3¼	1.2	110-125 (f)	1/7
STANDARD BRIGHTNESS LAMPS								
NE-2	25,000	150,000	1 1/16 (a)	1" Wire Term.	T-2	0.5	110-125	1/17
NE-2D	25,000	100,000	15/16	S. C. Mid. Flange	T-2 (g)	0.6	110-125	1/15
NE-2E	25,000	100,000	¾ (a)	2" Wire Term.	T-2 (g)	0.6	110-125	1/15
NE-2M	25,000	150,000	¾ (a)	1" Wire Term.	T-2 (c)	0.5	110-125	1/17
NE-17	7,500	30,000	1½	D. C. Bay.	T-4½	2.0	110-125	1/4
NE-30	10,000	None‡	2¼	Med. Screw (b)	S-11	12.0	110-125	1
NE-34	10,000	None‡	3½	Med. Screw	S-14	18.0	110-125	2
NE-45	7,500	None‡	1 17/32	Cand. Screw	T-4½	2.0	110-125	1/4
NE-48	7,500	30,000	1½	D. C. Bay.	T-4½	2.0	110-125	1/4
NE-51	15,000	200,000	1 3/16	Min. Bay.	T-3¼	0.3	110-125	1/25
NE-56	10,000	None‡	2¼	Med. Screw (b)	S-11	5.0	220-250	1
NE-57	7,500	None‡	1 17/32	Cand. Screw (b)	T-4½	2.0	110-125	1/4
NE-58	7,500	None‡	1 17/32	Cand. Screw	T-4½	2.0	220-250	1/2
NE-79	10,000	7,500	2	D. C. Bay.	S-7	12.0	110-125	1

† Bulbs are designated by a letter to indicate shape and a figure to indicate the approximate diameter in eighths of an inch. (a) This dimension is for glass parts only. (b) Center electrode connected to base shell. (c) Round end bulb. (d) Values shown are for indicator use on a.c., unless otherwise noted. Life on d.c. is approximately 60% of a.c. values. (e) On 110-125 volt circuits. (f) Use 135 volts minimum for satisfactory direct current operation. (g) Formed tip bulb. ‡ In order to properly control the lamp current, a ballast resistor must be used. Lamps having screw bases have the necessary resistor built in. Those having bayonet bases and those listed with wire terminals do not have a built-in resistor. The table shows the value of the external resistor to be used for normal operation at indicated circuit volts. Additional types are listed in manufacturers and distributors catalogs.

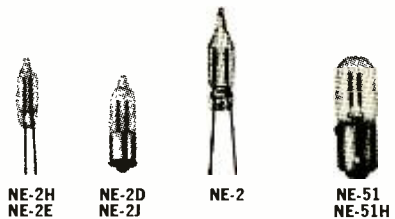

For most applications standard brightness lamps will do. High brightness lamps are easier to see, but require a higher firing voltage. Higher ballast resistors increase life and decrease brightness.

the lamps quite easily and with a good deal of versatility. Most of them can be held in place simply by the stiffness of the wire leads. A half-section of a fuse clip can also be used to hold a lamp. You can use various types of cements.

Another method is to push the lamp partially through a grommet mounted on the panel or chassis.

Current leakage across a switch is sometimes great enough to keep a neon lamp glowing dimly. Sometimes clean-

ing the switch will help and sometimes higher value resistors in series with the lamp will kill the low glow. It should be noted that a switch is not necessarily defective because it causes the low glow, but a clean switch with a better quality insulation will usually eliminate this problem.

Circuit Applications. Figure 1 shows some of the various places a neon lamp can be installed in a radio, hi-fi, or TV set to indicate the presence or absence of voltage. Location of the lamp depends upon the type of information you are looking for. At point *A* the lamp serves as a line voltage monitor and will stay on as long as the line voltage is present. Switching the equipment on or off will not affect the light.

The lamp at points *B* and *C* will tell you if the switch is on or off. When the switch is open, the lamp at *B* will be on (providing line voltage is present), and at point *C* the light will go off. Close the switch and the light at *B* will go off, and the light at *C* will go on.

If B-plus voltage is present, lamps *D* and *E* will glow. The "deeper" you can go into the circuit, the more telltale the lamp indication. Normally B-plus would have to be in working order at point *E* for the lamp to glow. Here the lamp shows that B-plus voltage is present and that the circuit beyond is not shorted or causing an excessive load.

If in doubt about how far you can go into the circuit, install the neon lamp at point *D*. Other B-plus locations may not provide the additional 0.3 to 1.9 milliamperes drawn by the neon lamp without changing the B-plus voltage distribution

in the circuit. If the d.c. voltage exceeds 150 volts, increase the value of the ballast resistor accordingly. A typical B-plus deficiency could be predicted by the presence of light from the tube filaments, but no glow from the neon lamp.

The neon lamp can be used as a polarity indicator. The electrode acting as the cathode glows when voltage is applied. In a d.c. circuit, the electrodes "see" the same polarity, unless the leads are reversed, and only one electrode will glow. In an a.c. circuit, both electrodes will glow because each of them acts as a cathode on each alternation of the line voltage.

It is often desirable to know which conductor of a house power line is hot, or if the fuse that was pulled really killed the line. Either hold one lead of a neon lamp tester in your hand, or ground it and touch the other lead of the tester to the power line conductors, one at a time. The lamp will glow if a con-
(Continued on page 88)

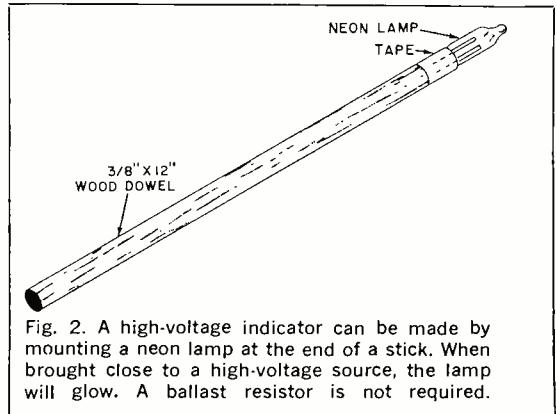

Fig. 2. A high-voltage indicator can be made by mounting a neon lamp at the end of a stick. When brought close to a high-voltage source, the lamp will glow. A ballast resistor is not required.

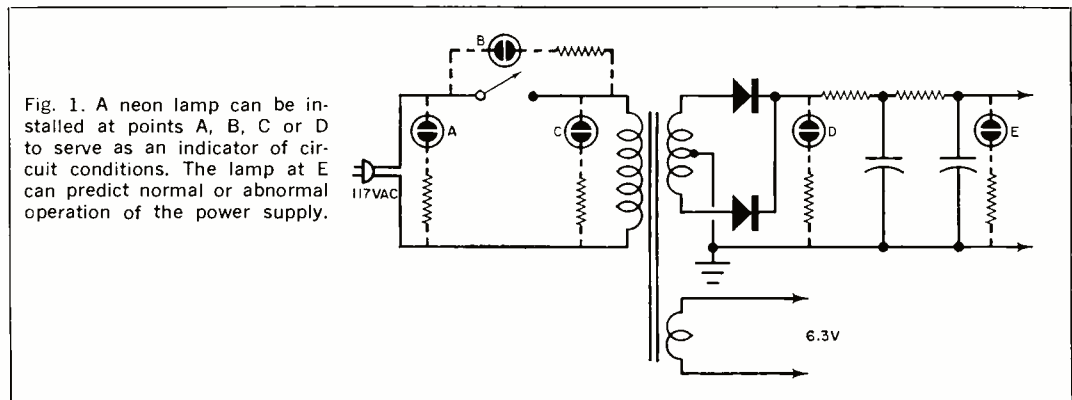

Fig. 1. A neon lamp can be installed at points A, B, C or D to serve as an indicator of circuit conditions. The lamp at E can predict normal or abnormal operation of the power supply.



ONE QSL TOO MANY

By C. M. STANBURY II

*When you go fishing for DX,
you never know
what you're likely to catch*

THE Rose County DX Club isn't much. It has only ten members, two with a little talent, and the rest with hopes but not much else. I'm one of the "no talents."

During the winter, when all of the Lake Michigan resorts are closed, the only sport left is DX'ing. Every year the club gives out a trophy which one of the talents, Scott Hunter (a big fellow) and Taylor Bird (a little guy), always wins. We peasants give it a try, just to prove we have the proper club spirit. Of course, Hunter and Bird plan the contest themselves—rules and all.

This year, though, it looked as if the talents had outsmarted themselves. For '64-'65, the trophy was to go to the member who first verified thirty states below three megacycles.

With our contest not five minutes old, I logged KOU on 2566 kc., the San Pedro Marine Operator from California. Then I followed up the next day with a real toughie state, Oregon, via KQX, the Portland Marine Operator, on 2598 kc. And to make my west coast marine band sweep complete, I got KOW on 2522 kc.

After that I banged away at those easy clear-channel BCB operations like KMOX, St. Louis; KSL, Salt Lake City; and so on. Come November 10, I had twenty-nine states verified.

Then I logged number thirty: NAA, the super-powered U.S. Navy job at Cutler, *Maine*, probably the toughest state of them all. On December 1, in came their royal blue QSL, which meant that I should be the champion—except for one thing: *the way I logged NAA.*

The club had to call a special meeting, with Hunter and Bird—each one state short of that winning mark—as co-chairmen. They reached for the gavel simultaneously, but Hunter came up with it and wrapped for order.

"George," he said in his commanding voice, "may we see your QSL from NAA."

I'm George. I gave him the card.

Hunter turned it over several times with Bird peering over his shoulder. Finally he held it up so that the whole group could see it, which gave Bird a chance to read the back of it.

The deep voice boomed again: "This card is for both NAA and amateur sta-
(Continued on page 93)

HEAT is the number one enemy of electronic equipment. The life of capacitors is shortened, transformers break down, and the tubes themselves—responsible for generating 99% of the heat—finally collapse of exhaustion. In the old days when receivers and phonographs were boxy, there was generally enough air circulation to dissipate the heat. However, with stereo hi-fi designed for eye appeal and more and more components being mounted in custom-built cabinets, the heat problem is getting bigger and bigger. The simplest solution is often the most direct: ventilation—or more air circulation. If you have, or are considering, a custom component hi-fi installation, invest in a “Whisper” fan (Rotron Mfg. Co., Woodstock, N.Y.) sold at scores of radio stores. An exceptionally quiet fan using only 7 watts, it is likely to return its original cost many times over.

—Kenneth Smalley



Spot selected to mount the Whisper fan should permit free air flow. Mark off the four mounting holes and cut the opening with a sabre or keyhole saw.

COOL IT FOR

Why keep your hi-fi running at



After large opening has been made, drill holes that will easily pass the long bolts to hold the fan.

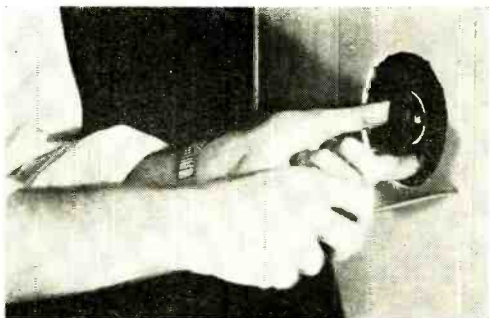

Don't forget that screens and filters are available from the manufacturer. In some spots, the fan should suck air in; in others, it should blow air out.

COMPONENT LONGEVITY

oven temperatures when all it needs is a breath of fresh air?

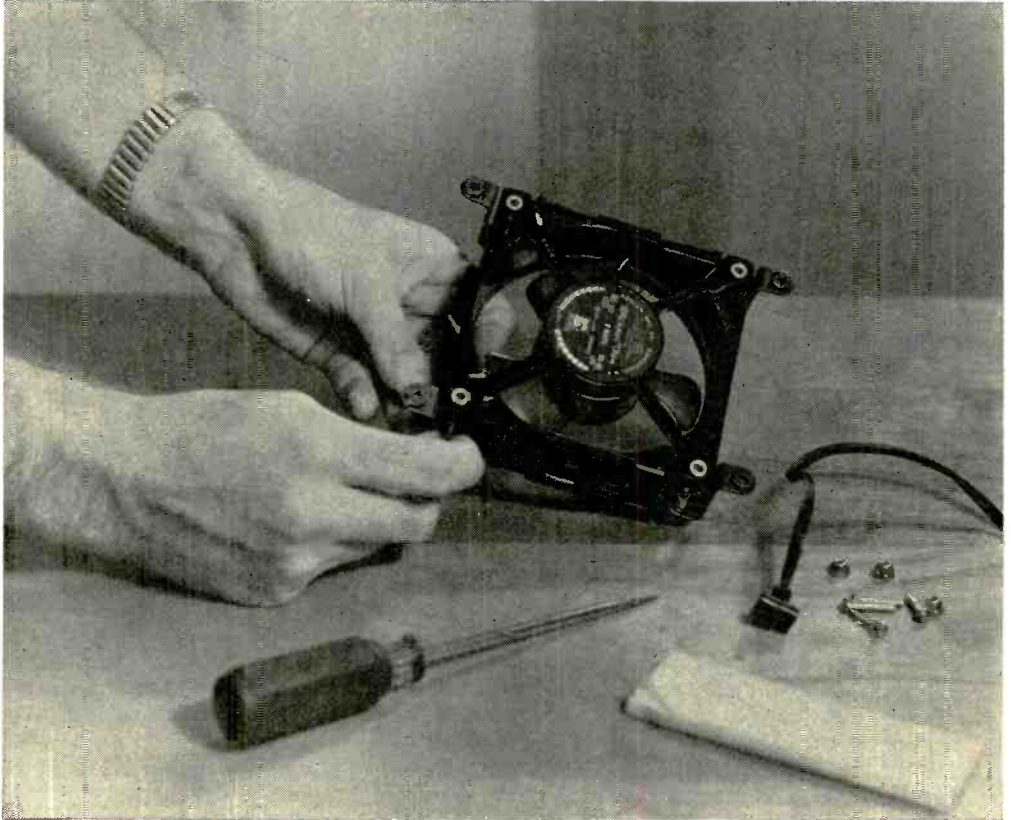

The a.c. is plugged into the fan proper with the cord supplied by the manufacturer. This cord is then plugged into a spare accessory socket on the amplifier. The fan then goes on when the hi-fi is on.

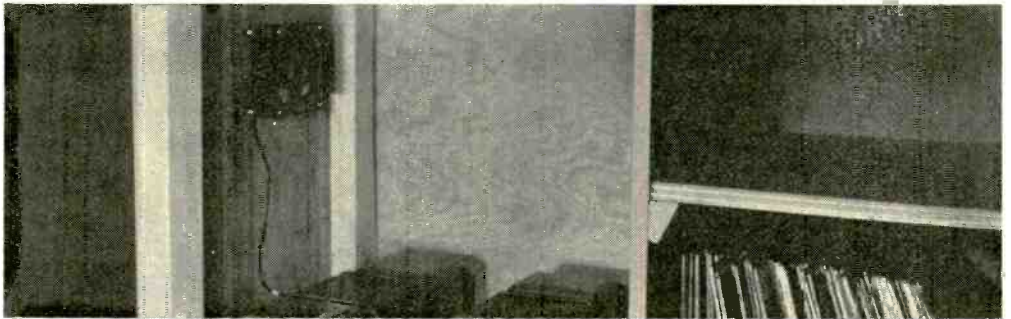

In this installation, the cabinet was red-hot after the stereo hi-fi had been on for about 30 minutes. The two big power amplifiers generated several hundred watts of heat. When the fan was installed the air circulation dropped the inside cabinet temperature 30 to 40 degrees down from the old high mark.

Equipment Report

CONAR NOVICE HAM STATION

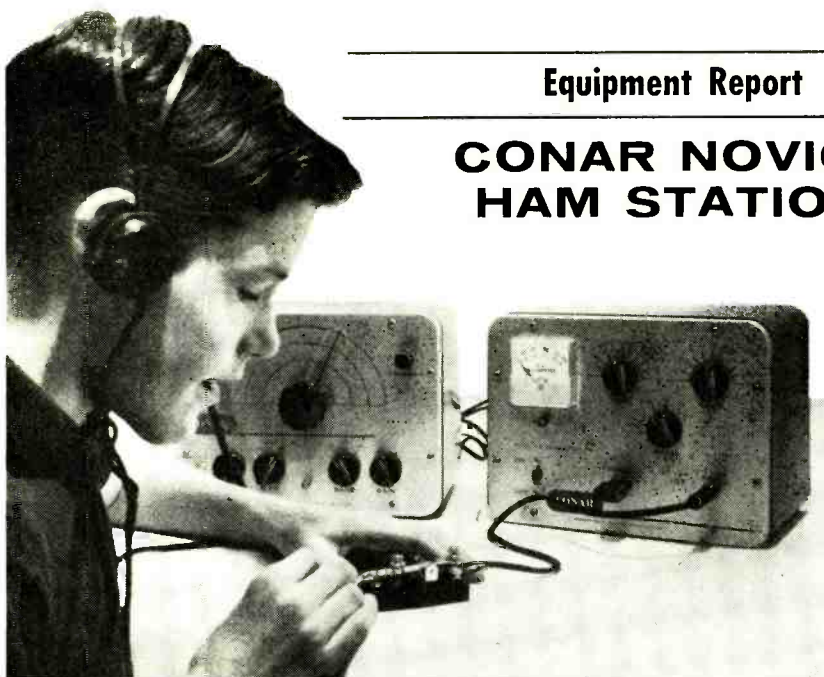

COMMERCIAL equipment designed specifically for the Novice ham bands is a rarity; as often as not, the beginner ends up buying expensive advanced gear (which he will not be able to fully utilize until he gets his General Class ticket), or builds from scratch. Into this gap has stepped Conar Instruments Division of the National Radio Institute, which recently announced the availability of the Model 400 three-band Novice transmitter, and the Model 500 three-band Novice communications receiver.

Model 400 Transmitter. Rated at 25 watts input, the Model 400 transmitter

is a crystal-controlled unit that offers front panel bandswitching to cover the high-frequency Novice bands: 80, 40, and 15 meters. A single 6DQ6B functions in a grid-plate power oscillator circuit. The power supply is transformer-operated with two silicon diodes in a full-wave rectifier circuit.

Other features of the transmitter include a panel meter, pi-network output circuit, and coaxial output socket. The Model 400 is housed in a compact 6½" x 7½" x 10" cabinet with anodized aluminum front panel.

(Continued on page 112)

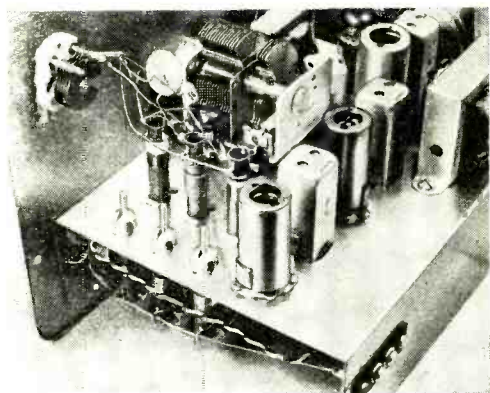

Dual-purpose tubes and diode rectifier give Model 500 receiver performance of 8-tube unit. Conventional superhet circuitry, separate BFO are used.



Model 400 transmitter uses 6DQ6B in crystal-controlled power oscillator circuit. Rig offers 25 watts input on three high-frequency Novice ham bands.



Transistor Topics

By LOU GARNER, Semiconductor Editor

THE PULSED OPERATION of gallium arsenide semiconductor devices at microwave frequencies was reported two months ago in our February column. Now, for the first time, continuous and coherent microwave oscillations of substantial power have been generated in a similar device. Drs. Basil W. Hakki and John C. Irvin, of the Bell Telephone Laboratories, achieved c.w. oscillations in gallium arsenide at a frequency of 4.35 gigacycles and a power output of 15.5 milliwatts.

Although still experimental, the device may eventually be used as an oscillator in microwave communications systems. Its power output is now comparable to that achieved in the same frequency range with the best tunnel diodes, but even higher outputs are anticipated, for a peak power of 1.8 watts has already been attained in pulse operation at 4.96 gigacycles. Present efficiency of the device is about two percent.

An *n*-type gallium arsenide was used in the experiments. Measuring approximately 50 x 250 x 250 microns, the material was placed in a tunable microwave cavity. The c.w. oscillations were generated when a d.c. field intensity in excess of 3000 volts/centi-

meter was applied to it. The generated signal was relatively free of random modulation.

Continuous-wave operation was made possible by: (1) selecting the proper high-resistivity semiconductor; (2) improving the quality of electrical contacts on the material; and (3) improving the conduction and convection of heat away from the device and into a moderately cooled heat sink during operation.

Recount! Back in our January, 1964, column, we predicted that a semiconductor phono cartridge would be introduced during 1964. Later, in our January, 1965, column, we "scored" ourself a *strike-out* on this prediction, for we hadn't received word of such a development. Just recently, however, we've learned that a recount is in order. Larry Eugene, public relations counsel for the Euphonics Corporation (Guaynabo, Puerto Rico), has written that his client did, in fact, introduce such a unit in late 1964.

Designed for stereo applications, the Euphonics pickup uses semiconductor elements smaller than its diamond stylus tip. With

Continuous microwave oscillations of substantial power have been generated for the first time in a gallium arsenide semiconductor device by Drs. Basil W. Hakki (left) and John C. Irvin (right) of Bell Telephone Laboratories. Here, the two scientists are examining the specially designed microwave cavity that houses the semiconductor during its operation.

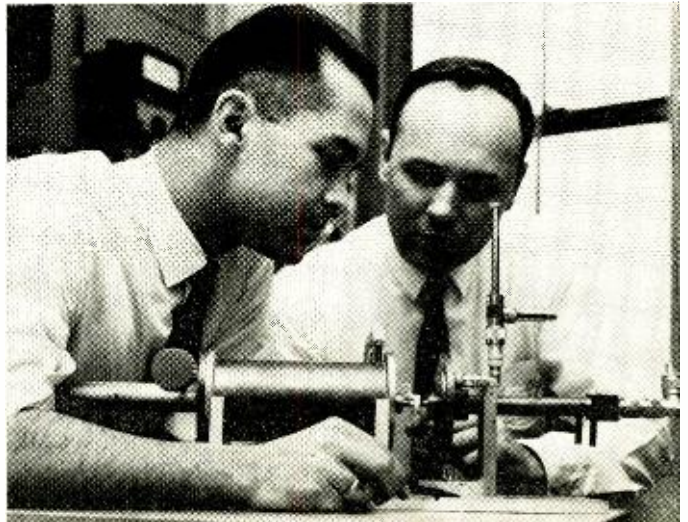

an output impedance of 600 ohms, the cartridge has an inherent frequency response from d.c. to 30 kc. Essentially a variable resistance device rather than a voltage generator, the unit requires an external d.c. power supply for operation.

Our final score on our 1964 predictions, then, is two triples and seven home runs in nine times at bat!

Manufacturer's Circuit. A number of readers have requested circuits featuring field-effect transistors (FET's). Although these units are relatively expensive, their high input impedance characteristics are desirable for many applications and this, in itself, may outweigh the disadvantage of their high cost.

An easily duplicated FET amplifier circuit is illustrated in Fig. 1. Developed by Texas Instruments (P. O. Box 5012, Dallas 22, Texas), this circuit features a *p*-channel 2N2386 FET (*Q1*) direct-coupled to a 2N929 *npn* transistor (*Q2*). With an extremely high input impedance, the circuit is suitable for use in audio amplifiers, test instruments, and experimental controls.

All fixed resistors are half-watt, 5% tolerance types; *R5* and *R6* are small potentiometers; *C1* is a 1- μ f., 200-volt, metallized paper capacitor, and *C2* is a 100- μ f., 15-volt electrolytic; *D1* is a 1N757 diode; *J1* and *J2* are standard coaxial jacks; power switch *S1* is a s.p.s.t. toggle, slide or rotary type;

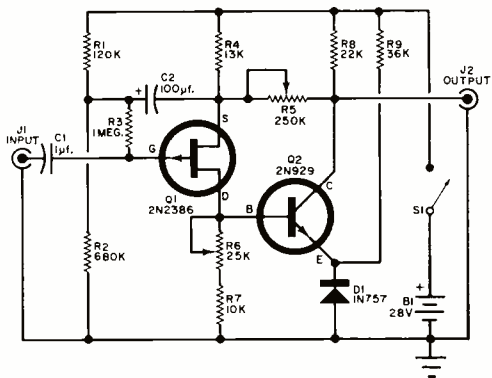

Fig. 1. High input impedance amplifier circuit, built around a Texas Instruments' field-effect transistor, has a bandwidth of from 1 cycle to 200 kc. when connected to a source whose output impedance is 100,000 ohms.

Fig. 2. Timer circuit submitted by reader Charles D. Rakes is used for time-compression photographic studies. Timing intervals from 1 second to several minutes can be obtained.

and *B1* is a 28-volt d.c. power source which may be either a line-operated supply or appropriate series-connected batteries.

The amplifier can be assembled on a conventional metal chassis or on a suitable etched circuit board. Although layout is not especially critical, good wiring practice should be observed. Once the circuit is wired and checked for errors, bias control *R6* must be adjusted for optimum performance; adjust it to obtain an 18-volt reading on a high-impedance voltmeter connected between *Q2*'s collector and circuit ground.

In operation, *R5* serves as a semi-fixed gain control. It can be adjusted for an overall voltage gain from unity to 20. When the control is adjusted for a gain of 10, the circuit has an effective input impedance of 50 megohms at 1 kc., and 10 megohms at 10 kc. Its overall frequency response depends on the impedance of the driving source. If the source has an impedance of 100,000 ohms, the circuit's 3 db bandwidth is from 1 cycle to 200 kc., but the upper limit drops to 8 kc. if the source has an impedance as high as 10 megohms.

Reader's Circuit. Charles D. Rakes (Oak Grove, Mo.), who submitted the interesting timer circuit shown in Fig. 2, uses it in a unique application. It serves to trip the shutter of an 8-mm. motion picture camera at preset intervals, automatically taking single-frame time-study pictures.

Transistors *Q1* and *Q2* are used in a direct-coupled amplifier arrangement to actuate a small relay (*K1*) which, in turn, applies a control bias to a power transistor (*Q3*), operating an electromechanical solenoid (*K2*) which trips the camera's shutter. Operating power is supplied by a 12-volt lantern battery (*B1*).

Closing switch *S1* permits *C1* to charge up slowly through *R1* and *R2*. As the voltage across *C1* builds up, zener diode *D1* conducts, charging *C2* and applying forward base bias to *Q1*. Current then flows through *Q1*'s emitter load (*R5*), applying forward base bias to *Q2* through current limiting

(Continued on page 100)

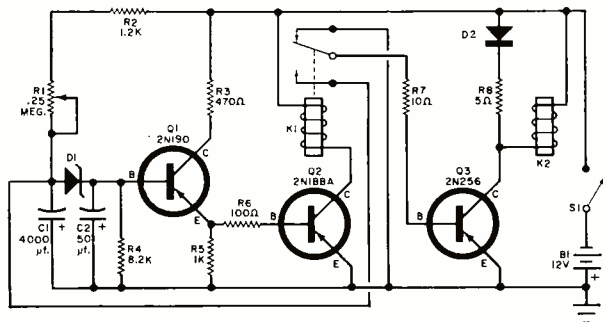

ELECTRONIC ADJUSTMENT QUIZ

By ROBERT P. BALIN

Variable controls are placed in electronic circuits to tune, to compensate, or to adjust for desired operation. Resistive, capacitive and inductive elements can all be made into variable

type components. In the practical situations shown here (1-8), see if you can tell what kind of adjustment must be made, or what effect the adjustment will have.

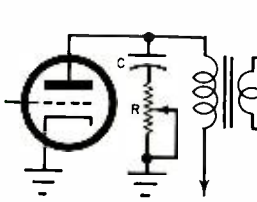

Moving tone control slider toward ground will cause an apparent (A) increase or (B) decrease in the low-frequency response of this audio amplifier?

1 _____

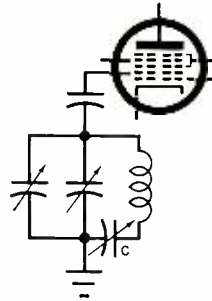

Padder capacitor C in a radio oscillator section helps track the low end of the band. To move a received signal higher up on the dial, the padder must be (A) increased or (B) decreased?

2 _____

The frequency of this blocking oscillator is controlled by a variable resistor. Moving the slider toward ground will (A) increase or (B) decrease the frequency?

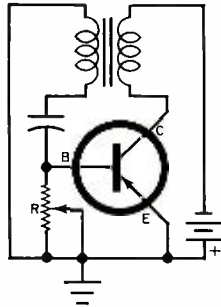

When the iron core is moved deeper into the coil, in this light-dimming circuit, the lamp will (A) increase or (B) decrease in brightness?

4 _____

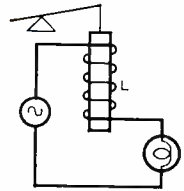

3 _____

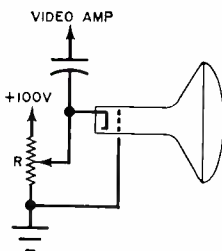

Moving the slider of the brightness control away from ground will (A) increase or (B) decrease the brightness of the TV picture tube?

5 _____

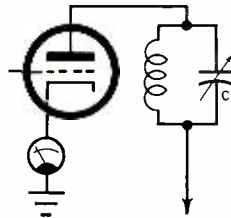

As the circuit is brought closer to resonance by adjusting the variable capacitor, the cathode current (A) increases or (B) decreases?

6 _____

Moving the slider of the volume control away from ground (A) increases or (B) decreases the volume?

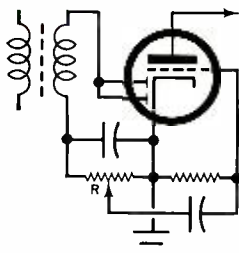

Coil adjustments can be checked with a brass- or iron-tipped tuning wand. Inserting a brass core into the coil improves alignment. This tells you that (A) more or (B) less inductance is needed.

8 _____

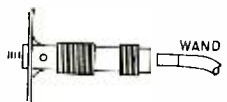

(Answers on page 95)

On High Fidelity

By RODRIGUES



"It happened again, Doctor; he's hypnotized by the strobe disc."

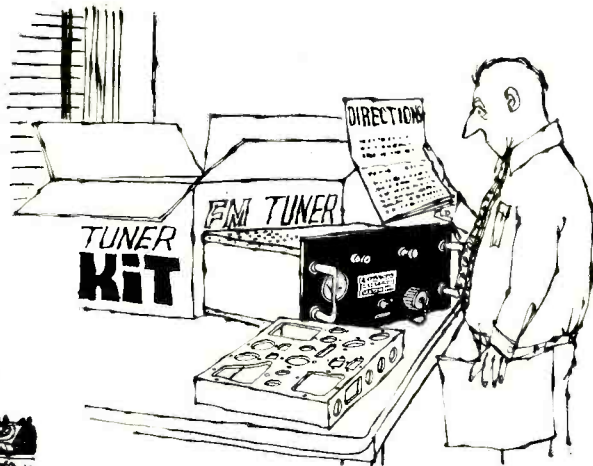

"To secure the PARTS to build your hi-fi FM tuner, simply disassemble this war surplus radar receiver."

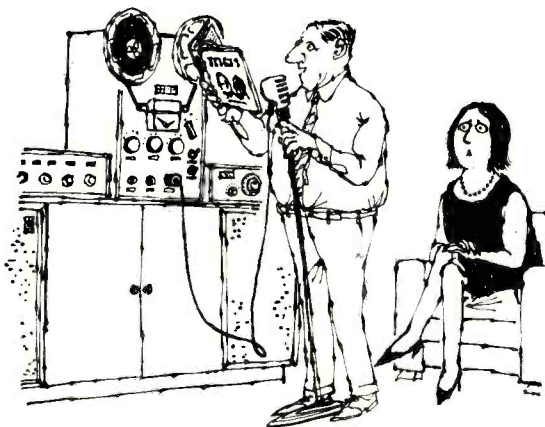

"Is there a chance of hearing a prerecorded tape tonight?"

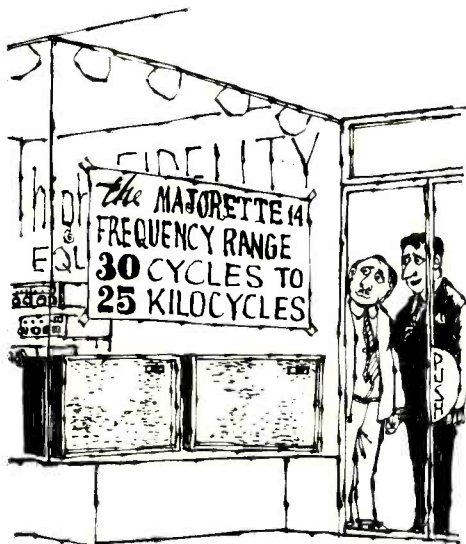

"Somehow, kilocycles sounds more impressive."



"Wrong house; they have nothing but mono hi-fi."

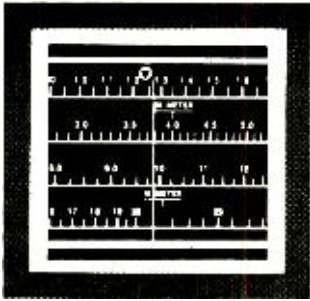

Across the Ham Bands

By **HERB S. BRIER**, W9EGQ
Amateur Radio Editor

TIPS FOR MAKING MORE CONTACTS

THE DIFFERENCE between success and failure in amateur radio is usually a combination of small things rather than a single large factor. For example, although high transmitter power makes it easier to establish contacts and work DX, it doesn't help as much as the average low-power operator believes. A good antenna in a good location is more important than high power, and a good receiver is even more important. Yet, many hams get amazing results with none of these three advantages, and others with all of them have poor records. The difference is obviously in the way the equipment is operated; a few hints, therefore, may help you improve your results.

Do you spend much of your time tuning and retuning your transmitter? Since a good transmitter will stay tuned indefinitely, unless it is purposely detuned, this time could better be spent in making contacts. Dig out the instruction manual and carefully tune up your transmitter on each band and frequency on which you plan to operate, and make a chart of all control settings. Then, in the future, you can shift frequency and,

by referring to the chart, pretune the transmitter before you turn it on. In preparing the chart, you will probably be surprised to discover how much you can shift frequency within a band merely by switching crystals or turning the VFO dial.

If your transmitter is crystal-controlled, a handful of crystals a few kilocycles apart can be an excellent investment. To have much chance of success in answering CQ's, you normally need to get within a few kilocycles of the caller's frequency. And when you call CQ yourself, it is good operating to choose the most interference-free frequency available. Often shifting frequency just a kilocycle or two is more effective in avoiding interference than fitting halfway across the band.

It takes no genius to discover that activity and interference in the amateur bands are greatest in the evening hours and on week-ends. Consequently, an effective way to improve your results with low power is to operate outside of these times as much as possible. Another effective measure is to shift to a different mode or a less crowded

Amateur Station of the Month

Old-timer Hadley Henderson, now WA2ARJ of Millville, N.J., earned his first ham license back in 1928. Currently, his Heathkit DX-100B transmitter, Hammarlund HQ-140X receiver, a separate 6-meter transmitter, and a Gonset 2-meter "Gooney Box" permit Hadley to cover all amateur frequencies up to 148 mc. In addition, he operates a Heathkit HW-12 75-meter mobile transceiver in his car and a completely separate fixed station under the call letters of WB2JGS in Vineland, N.J. Hadley is Civil Defense RACES Officer for Cumberland County, N.J., and is also a member of MARS. For submitting this winning photo for April in our Amateur Station of the Month contest, he will receive a one-year subscription to POPULAR ELECTRONICS. If you would like to enter the contest, send us a clear picture of your station—preferably showing you at the controls—together with some data about your amateur career. All entries should go to Herb S. Brier, Amateur Radio Editor, P. O. Box 678, Gary, Ind. 46401.



band at these times. Many operators shift from phone to c.w. and others move up to the 50- and 144-mc. bands where—in the more populated areas at least—even the simplest transceiver permits making interference-free contacts within a radius of 25 to 50 miles.

Swiss Quad Antenna. As spring arrives, many hams' thoughts turn to new antennas. A directional antenna that has become quite popular in Europe in the past year and is exciting considerable interest in the United States is the "Swiss Quad" developed by HB9CV. This array has been described in different European amateur journals, including the *RSGB Bulletin* (England), June, 1964.

Possibly the most interesting feature of the "Swiss Quad" is its all-metal construction, which is achieved by bending the center section of each element inward to the center support pipe to support the element. Such construction is possible because the center of each element is at zero r.f. potential.

Swiss Quad proponents claim a 6 to 14 db gain for this antenna as compared to a reference dipole (depending on many factors). Although these figures appear high for such a simple configuration, the results obtained prove that the antenna is an excellent performer. The front-to-back ratio of the "Swiss Quad" runs about the same as from a conventional "Quad" antenna.

Although not intended as a complete, how-to-build design, the drawing at right should provide sufficient information to allow anyone who wishes to experiment with the "Swiss Quad" to do so. The dimensions given are for the center of the 15-meter band. Multiply them by 1.5 for 20 meters and by 0.75 for 10 meters.

If the center support is located in the mechanical and electrical center of the array, the crossed elements may be grounded directly to it. If, however, the array is displaced slightly from the center by clamping the crosspieces to the side of the pipe, it is recommended that they be insulated from the pipe to preserve electrical symmetry.

Both the "reflector" and "director" are fed via the double-ended *gamma* match. Either 50- or 75-ohm (nominal) coaxial cable may be used to feed the array, with the higher-impedance cable supposedly increasing the frequency bandwidth of the array slightly.

Tuning of the "Swiss Quad" is accomplished by sliding the horizontal end-pieces in and out of the "X" frames, while keeping the "reflector" 5 percent longer than the "director." The distance on either side of the center of the *gamma* wire (where the center conductor of the coaxial cable is connected) determines the SWR on the

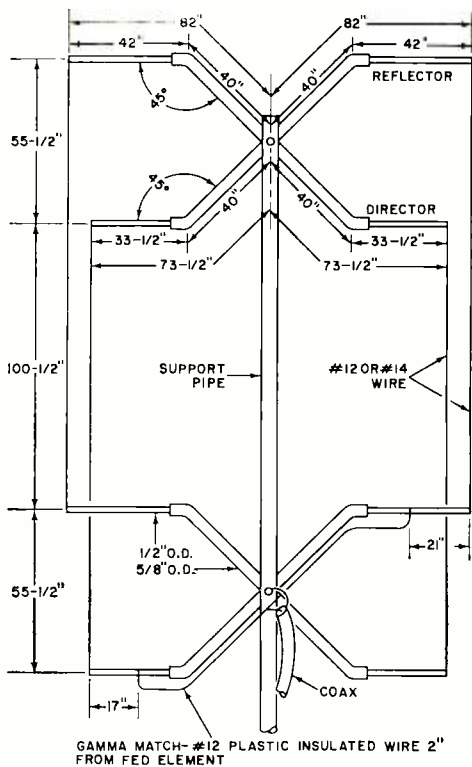

Essential dimensions of all-metal, 15-meter "Swiss Quad" directional antenna. Shield of coaxial feedline is connected to the center of the fed elements.

transmission line. The *gamma* length shown will serve as a starting point. Connect the shield of the coaxial feedline to the center of the fed elements.

(To prevent unnecessary correspondence, your Amateur Radio Editor cannot furnish any additional information on the "Swiss Quad," except to report that the several he has heard and worked seemed to put out an excellent signal.)

Notes from Club Bulletins. *Auto Call* (Washington, D.C.), December, 1964, reports that the Fort Belvoir Red Cross Director called the Fort Belvoir Amateur Radio Club station, asking that an emergency message be relayed to a Navy man stationed at McMurdo Sound, Antarctica. WA4VMZ, a Technician operator who happened to be at the station, phoned Tom, W4TDT, with the intention of requesting that he handle the message on 20 meters. Tom wasn't home then, but when he called home a few minutes later to report that he had run out of gas, he learned about the emergency. WA4MVZ picked Tom up in his car and drove him home. Once there, the W4TDT
(Continued on page 101)



Monthly Short-Wave Report

By **HANK BENNETT**, W2PNA/WPE2FT
Short-Wave Editor

THE BROADCASTER'S SIDE OF THE VERIFICATION STORY

REGULAR readers of this column are aware that we have been emphasizing the increasing tendency of many short-wave stations to send out QSL cards that are little more than souvenirs. We recently received a letter from one of Europe's top short-wave broadcasters, *Radio Nederland*, in which Mr. E. Van Eldik, Deputy Director of the Engineering Department, presents the views of his station with respect to reception reports and requests for verification. His letter follows:

"The sending of reception reports and their verification by means of special QSL cards is a custom which originated in the early days of radio. In those days, a reception report was of real value to any radio station. Today, things have changed, especially with regard to those stations that have communications with permanent correspondents. Since broadcasting stations do not work with one permanent counter station, but seek, instead, to reach listeners in the largest possible areas, listener reports have retained their original value for these stations.

"Although there have been no binding conditions imposed [as to what should be in-

cluded in a reception report], things have reached the stage where every report and every verification has to meet certain requirements. *Radio Nederland* has always welcomed reports by short-wave listeners and in the future we will continue to reply to their communications in keeping with standards applicable in the DX world. That is, date, time, and frequency will be mentioned.

"Naturally, we at *Radio Nederland* also have to make certain conditions for those who want to receive a QSL card. These conditions are not different from those generally made by other stations. We ask that a report contain, at least, the date, time, and frequency on which the reception took place, as well as a number of program items and an evaluation of the reception.

"Although it is not a general requirement (as yet), we should like to suggest that dates and times be stated in Greenwich Mean Time (GMT) and, if possible, supplemented with the local time of the broadcasting station. North American listeners often state times in EST, PST, etc. It stands to reason that converting these times requires special attention and effort on the



The main receiver used by Richard Sears, WPE1FNM, of Cambridge, Mass., is a National NC-60; he has two other broadcast-band sets for listening to local stations. The antenna is a 40' vertical. To date, Dick has 27 countries verified out of 59 logged.



Also located in Cambridge, Mass., Michael O'Neil, WPE1FNB, is basically a ham-band DX'er. Mike has 28 countries verified (39 logged) and 15 states (17 logged). His equipment? A Hallicrafters S-120 receiver and a Lafayette HE-100 walkie-talkie.

ENGLISH-LANGUAGE NEWSCASTS TO NORTH AMERICA

All of the stations below specifically beam English-language newscasts to the U.S.A. The times may vary a few minutes from day to day.

COUNTRY	STATION	FREQUENCY (kc.)	TIMES (EST)
Argentina	Buenos Aires	11,780, 9690, 6090	2200, 0100 (Mon.-Fri.)
Australia	Melbourne	17,840, 15,220 9580	2030, 2130, 2230 0745
Bulgaria	Sofia	9700 7290	1900, 2000, 2300 1630
Canada	Montreal	11,760, 9625, 5990 9625, 5970 5970	1800 (Caribbean) 0215, 0300 (W. Coast) 0800
Congo (East)	Leopoldville	11,755	1630
Congo (West)	Brazzaville	15,190	1430
Czechoslovakia	Prague	11,990, 9795, 7345, 7115, 5930	2000, 2230
Denmark	Copenhagen	15,165 9520	0730 2100
West Germany	Cologne	11,795, 9640, 9545 9640, 6160	1010 2040
		9735, 9575, 6160, 6145	0000
Hungary	Budapest	9833, 9540, 6234 9833, 7305, 7215, 6234	1930, 2030 2200, 2330
Italy	Rome	9575, 5960	1930, 2205
Japan	Tokyo	15,135, 11,780	1900
Jordan	Amman	9555	2015
Lebanon	Beirut	9750	2130
Netherlands	Hilversum	11,730, 9590 15,425, 15,220 15,425, 11,730	1600 1130 (Tues., Fri.) 1535 (Tues., Fri.)
Netherlands Antilles	Bonaire	9685	2300
Portugal	Lisbon	6185, 6025	2100, 2245
Romania	Bucharest	9590, 9570, 5910, 7225, 6190, 5990 (9570 not used at 2030)	2330, 2200, 2030
Spain	Madrid	11,715, 9615, 6140	2200, 2100, 2000
Sweden	Stockholm	15,300 5990	0900 2215, 2045
Switzerland	Berne	9535, 6105, 6080 15,305	2015 2315
Turkey	Ankara	15,165	1700
United Kingdom	London	15,300, 11,860 9510, 6195	1100 1700, 1800, 1900, 2100
U.S.S.R.	Moscow	9700, 9680, 9660, 9650, 9640, 9620, 9570, 7440, 7360, 7310, 7290, 7240, 7170, 7150 (may not all be in use at any one time)	1730, 1900, 2000, 2100, 2300, 0040
Vatican City	Vatican City	9645, 7250, 5985	1950

part of those in charge of verifications. Should our suggestion be generally accepted, needless to say it will be highly appreciated by us (and, we believe, by other stations).

"It seems to us that many short-wave fans have difficulty in stating the right frequency. We feel that we cannot dispense with this condition because, without this minor problem, the element of sportsmanship would be lacking. As a rule, we permit a deviation of 5 kc. Some short-wave fans try to soften our hearts by telling us that they do not have a calibrated receiver,

but since practically all stations announce their frequencies at the opening and closing of their programs (and often in between as well), we cannot take this as an excuse.

"Finally, we draw attention to the stating of some program details. Short-wave listeners should be aware that they are asking for a 'reward' from the broadcasting station. Before sending in a report, they should ask themselves whether it is a worth a reward. Too often we send a verification with a certain reluctance, not because the report was incorrect but because everything

(Continued on page 107)



DX AWARDS

Have you won a 25 or 50 Countries Verified DX Award? If not, why not? Read the rules carefully, and when you think you're ready, send in your entry. If you *have* won an award, why not dig a little deeper into that QRM and try for a higher category? (You'll find the complete Countries List for DX Awards on pages 84-85 of the 1965 COMMUNICATIONS HANDBOOK helpful.)

1 Each applicant must be a registered WPE Short-Wave Monitor, and must enter his call letters on the application form.

2 Each applicant must submit a list of stations for which he has received verifications, one for each country heard. The list should contain 25, 50, 75, 100, or 150 countries, depending on which DX award is being applied for. And the following information must be furnished in tabular form for each verification:

- (a) Country heard
- (b) Call-sign or name of station heard
- (c) Frequency
- (d) Date station was heard
- (e) Date of verification

All the above information should be copied from the station's verification. Do not list any verification you cannot supply for authentication on demand.

3 All pertinent verifications, whether QSL cards or letters, should be carefully packaged and stored by the applicant until such time as instructions are received to send in some or all of them for checking purposes. Instructions on how and to whom to send the verifications will be given at that time. Failure to comply with these instructions will disqualify the application.

4 A fee of 50 cents (in U.S. coin) must accompany the applicant's list of verifications to cover the costs of printing, handling, and mailing. This fee will be returned in the event that an applicant is found to be ineligible for any of the awards. Applicants outside of the United States may send 60 cents (U.S.) in coins of their own country if they so desire. However, please do not send any International Reply Coupons (IRC's) or personal checks when applying for a DX Award.

5 Apply for the highest DX award for which you are eligible. If, at a later date, you become eligible for a higher award, then apply for that award, following these rules and regulations exactly as before.

6 Mail your verification list, fee, and the application form to: Hank Bennett, Short-Wave Editor, POPULAR ELECTRONICS DX AWARDS, P. O. Box 333, Cherry Hill, N. J. 08034. Include in the envelope only those items which are directly related to your entry for the award. Do not include an application for a Short-Wave Monitor Certificate (you are not eligible for any of the awards until you have a Short-Wave Monitor Certificate in your possession). If you want to ask other questions or supply news items, reports, etc., use another envelope.

POPULAR ELECTRONICS' DX AWARD APPLICATION FORM

(please print)

WPE Call Letters _____

Name _____

Address _____

City _____

State _____

Zip Code _____

Please enter my application for the following POPULAR ELECTRONICS' DX AWARD:

(check one) **25** **50** **75** **100** **150**

I have enclosed a list of the required number of countries, and I hereby certify that I hold a verification from at least one short-wave broadcasting station in each of the countries listed

I have enclosed 50 cents to help cover the costs of processing and mailing my DX Award

Signature _____ Date _____ 1965

Mail to Hank Bennett, POPULAR ELECTRONICS DX AWARDS, P. O. Box 333, Cherry Hill, N. J.



On the Citizens Band

with **MATT P. SPINELLO**, KHC2060, CB Editor

IT ALL STARTED too many transmissions ago. **STORY:** . . . 49 Citizens Band mobile units assisted local authorities in tracking down two escaped convicts in less than an hour . . . The next morning the *Daily Bugle* gave the capture front page copy, *with no mention of the CB'ers whatever!* **STORY:** . . . 25 mobile units of

NEW VOICE FOR CB

the CBCBC Rescue Squad participated in "Operation Salk," distributing vaccine to more than 50 local centers, and transporting those to be inoculated to and from the distribution centers. . . The local *Ready Register* picked up this one and gave the club the following plug: "The group of short-wave radio operators, more often referred to as *amateur ham hobbyists*, aided authorities in the distribution, etc, etc.!" These two stories happen to be fictional, but they are typical of the distorted coverage given CB time and again by big city presses and local news sheets from New York City to Red Wood City. It's no wonder the general public isn't sure just *what* CB radio is all about!

In the last two years, we have heard of several actual incidents where CB'ers were

either not mentioned in the newspapers or were classified as "hams" following their voluntary efforts to assist as needed. While it's no disgrace to be called an amateur radio operator, we wonder how many hams would appreciate a paper reporting that their assist was one where "the *CB'ers* helped relay the message across three states in an effort to locate the missing man."

Your CB Editor, therefore, has started an unofficial campaign to bring the facts about CB to the attention of the general public via AM broadcast stations, in an all-out effort to explain the Citizens Radio Service, its primary purpose, and the manner in which it is being put to use in public service and emergency activities.

CB and AM Radio. First to accept the idea was radio/TV personality Bob Gregory. Bob invited us to discuss CB radio in an interview on his show, "Viewpoint," aired over WBEL radio, Beloit, Wisconsin. Our 30-minute chit-chat (without call-signs) generated an excellent response from listeners who had been unaware the service even existed, and from many CB'ers who were happy to hear that at last the public might learn the difference between a.c./d.c., BC/CB, sandwich spread and hams!

Then we approached Dean Claggett, general manager of WOBT radio in Rhine-

Radio/TV announcer Bob Gregory was the first to interview your CB Editor, over WBEL radio, on the uses and purpose of the Citizens Radio Service.

Station WOBT's general manager, Dean Claggett, helped field-test "Project Interview." Program drew raves from Wisconsin CB'ers and other listeners.



lander, Wis., 250 miles north of Beloit. Dean was most cooperative and felt the subject would create widespread interest among his listeners. Our prerecorded interview drew much favorable comment, with requests for more information and a repeat airing of the interview.

Following the tape session, Dean drove us to the home of WOBT staff announcer Ray Walters, active among CB and amateur ranks as KLF1745/W9RHT; his XYL, Norma, is W9IWM. As Ray is a 12-year veteran and has been a CB operator for the past two years, we felt that he would be able to put us in touch with CB'ers in the area to get their reaction to the broadcast. We wanted a cross-section of views to compare with those of the WBEL listeners.

There are some 200 CB'ers in Rhinelander and the surrounding area, over 100 of whom are members of one of two CB clubs: Rhinelander CB Club and Vacationland CB Radio Club (REACT members), covering the counties of Forest, Vilas, Marathon, Oneida and Langlade. After landline calls to several of them, we were convinced that AM radio could well be the "new voice for CB." The opinions of WOBT listeners paralleled those on the WBEL broadcast. In fact, two listeners requested a 15-minute weekly show on CB, or on communications in general; others were as delighted as the Beloit listeners to find that someone was at last defining CB radio for the public.

We have since contacted other radio stations for similar interviews, and the future also promises some public service television exposure.

Project "Interview." If every CB club in the country would prepare local statistics concerning their membership, projects and activities, and approach local radio stations with a request for a public service interview within a 15- or 30-minute segment, we could blanket the AM listening public's air

The WOBT staff announcer, Ray Walters, KLF1745/W9RHT, put us in touch with CB'ers in his area to get their opinions on the "New Voice for CB."



waves across the U.S. in fairly short order.

We suggest that the president of each club, and possibly one other officer or board member, present the idea to the local station. Radio stations are always on the lookout for interesting subjects, but you'll have to "sell" the program director or station manager first. So be sure you have your program format down pat!

To make certain that neither you nor your interviewer get off the track, prepare a

(Continued on page 98)

1965 OTCB JAMBOREE CALENDAR

Planning a jamboree, get-together, banquet or picnic? Send the details to: 1965 OTCB Jamboree Calendar, POPULAR ELECTRONICS, One Park Avenue, New York, N. Y. 10016. For more information on the jamborees listed below, contact the clubs or club representatives at the addresses given.

Floral Park, N. Y. April 24
Event: Annual New York State REACT Jamboree. Location: Salisbury Park, Nassau County. Contact: Nassau County REACT, Box 162, Floral Park, N. Y. 11001, or call 516 437 8033.

Polkville, N. C. April 25
Event: Cedar Park CB Jamboree. Location: 13 miles north of Shelby. Sponsor: Little Rotunda CB Club. Contact: Geo. Hoover, KDD0550, Box 74, Polkville, N. C.

Rockford, Ill. May 23
Event: First CB Jamboree. Location: Illinois National Guard Armory, 605 N. Main St. Sponsor: Rock River Valley CB Club. Contact: RRVCB Jamboree, Box 793, Rockford, Ill.

Utica, Mich. June 5-6
Event: Southeastern Michigan Jamboree. Location: Swiss Valley Park. Sponsor: CB'ers of Detroit, Mich.

Marion, N. C. June 11-13
Event: Second Annual National CB Grandfather Mountain Jamboree. Location: Grandfather Mountain, MacRea Meadows. Sponsors: Lake City CB Club and McDowell County Rescue Squad. Contact: Grandfather Mountain Jamboree, Box 656, Marion, N. C.

Canton, Ohio June 13
Event: CB picnic. Sponsor: Hall of Fame CB Radio Club.

Rock Island, Ill. June 19-20
Event: Iowa-Illinois CB Club Jamboree. Location: Rock Island County Fair Grounds.

York, Pa. June 26-27
Event: York CB Assistance Club Jamboree.

Rutland, Vt. June 27
Event: Third Annual Vermont CB Jamboree. Sponsor: Otter Valley Citizens Band Radio Club, Inc. Contact: Vermont CB Jamboree, Box 669, Rutland, Vt.

Kentland, Ind. June 27
Location: Newton County Fairgrounds. Sponsor: Central Illiana CB Club. Contact: Donna LaCosse, Publicity Chairman, Morocco, Ind.

Alliance, Ohio July 11
Event: CB Picnic. Sponsor: Carnation City CB Club.



POP'tronics Bookshelf

RADIO AND TELEVISION RECEIVER CIRCUITRY AND OPERATION, Revised Edition

by Alfred A. Ghirardi and Jess E. Dines

Put two of the best writers about electronics together and what have you got? Well, for one thing, a pretty darn good book that is likely to be a classic. Not that writing a classic is something new to Alfred Ghirardi—ask any ham, engineer, or technician in this game prior to World War II if he didn't lean heavily on Ghirardi's *Radio Physics Course*. In this revised edition of R&TRC&O, Ghirardi and Dines have wrapped up the whole subject of receivers in one astonishingly complete package. The only thing they didn't cover is antennas—the subject of the jacket illustration. (Oh, well, there's no telling what an art director is likely to do.) This is a very strong basic text—highly recommended.

Published by Holt, Rinehart and Winston, Inc., 383 Madison Ave., New York, N.Y. 10017. Hard cover. 556 pages. \$10.00.



ADVANCED SERVICING TECHNIQUES Volume 2: Stereo Amplifiers, FM and FM Multiplex, Record Changers, Home Intercoms and Combination Receivers

by Orville Neely, Lawrence Massaro,
Robert S. Harris, Murray Rosenthal,
and William P. Kist

One of the primary purposes of this book, prepared under the sponsorship of the Electronics Industry Association, is to expand the technical skills of the practicing technician and those about to enter the servicing field. It presents systematic, organized, industry-approved trouble-shooting procedures, utilizing the latest techniques and instruments. First, an introduction to each major subject literally takes the reader by the hand and brings him up to date; next, the circuits are shown and described; and

finally an excellent "how to" section tells how to quickly restore equipment to proper operation. The material is clearly understandable, profusely illustrated, and practical. The coverage of contemporary equipment should prove to be a valuable time-saving aid on the workbench. Recommended for classroom use as well as for individual home study.

Published by John F. Rider Publisher, Inc., 116 West 14 St., New York, N.Y. 10011. Hard cover. 178 (8½" x 11") pages. \$5.95.



BASIC MATHEMATICS FOR ELECTRICITY AND ELECTRONICS

by Bertrand B. Singer

It's rather difficult to rhapsodize about a textbook on mathematics—unless it really has something different to sell. Believe it or not, this book does have a few things that catch the eye. First, it adheres strictly to basics and provides hundreds of examples to test your understanding. Secondly, the so-called "rules" are emphasized by outlining them in a gray tone—making them practically jump off the page. Lastly, someone had the foresight to have imprinted inside both covers all of the symbols and abbreviations encountered in this book. While the volume is undoubtedly a schoolroom text, it's a book any technician or experimenter will find valuable.

Published by McGraw-Hill Book Co., 330 West 42 St., New York, N.Y. 10036. Hard cover. 600 pages. \$7.50.



LIGHTNING IN HIS HAND: THE LIFE STORY OF NIKOLA TESLA

by Inez Hunt and Wanetta W. Draper

Fans of Nikola Tesla and his famous coils should greet this latest biography with enthusiasm. The authors of the volume—popular writers on the history of the West—discovered during their research work that Tesla had performed some of his most important experiments in Colorado, and that a little isolated mining community was the scene of the world's first experiment with high voltage a.c. for long-distance power transmission. Tesla's early childhood, and his triumphs in lighting the Columbian Exposition and in harnessing Niagara Falls for generating power are graphically related. A number of photographs add an interesting dimension to the book.

Published by Alan Swallow, 2679 South York St., Denver, Colo. 80210. Hard cover. 269 pages. \$5.00.

—30—

Some plain talk from Kodak about tape:

Sensitivity and frequency response

Controlling every electrical factor involved in the making and using of sound tape is a bit like trying to watch a three-ring circus . . . it can be done, but you need fast eyeballs. Let's discuss two critically important parameters: sensitivity and frequency response.

Sensitivity means the degree of output for a given input.

We put in a 400-cycle signal and measure the output. The result: low-frequency sensitivity. A 400-cycle note recorded at 15 inches-per-second gives us a wave length that the tape "sees" of roughly .0375 inches, and by a happy coincidence this wave length penetrates the entire depth of the oxide coating, but not the support material. Everything else being equal, low-frequency response is a function of the thickness of the coating. The thicker the coating, the better the bass response. We choose 400 cycles instead of, let's say, 20 cycles because the 400-cycle note tells us just as much—and has an added advantage. An engineer can *hear* 400 cycles, so we have audio monitoring as well as instrumented observation on a scope face.

The high-frequency test gives us a fairly accurate picture as to just how smooth the surface of the tape is. Good high-frequency response is impossible on a tape having a rough surface. High frequencies affect fewer oxide particles. If the tape surface is rough, the low points will represent gaps in the oxide and cause a loss of H.F. response. We test our high-frequency sensitivity at

15,000 cycles. At 15 ips, the arithmetic looks like this:

frequency sensitivities, as well as a nice flat response.

$$\frac{\text{inches}}{\text{second}} = \frac{\text{inches}}{\text{second}} \times \frac{\text{second}}{\text{cycles}} = \frac{\text{inches}}{\text{cycles}} \text{ which is wave length } (\lambda)$$

THUS:

$$\frac{15 \text{ inches}}{\text{second}} = \frac{15 \text{ inches}}{\text{second}} \times \frac{\text{second}}{15,000 \text{ cycles}} = \frac{1 \text{ inch}}{1000 \text{ cycles}} = 1 \text{ mil wave length}$$

At this high frequency we are recording only on the surface of the tape. If any roughness is present, big troubles result. For example: if you have a surface condition where the amplitude of the roughness is just .0001 inches and your recorded signal has a 1-mil wave length, you will lose 5.5 db in high-frequency response!

We are working toward a point: KODAK Sound Recording Tape is unsurpassed in smoothness, the surface varies no more than 25-50 millionths of an inch from a theoretically perfect plane.

Frequency response is the arithmetic subtraction of high-frequency sensitivity from low-frequency sensitivity. It's quite an easy matter to juggle the characteristics of an oxide around so that frequency response is nice and flat. If your oxide has poor high-frequency sensitivity, you can degrade L.F. sensitivity, and thus effect a flat response. But is the resulting L.F. loss worth it? We don't think so. That's why we designed our coating to give us superior low- and high-fre-



Next time we'll chat about a few other basic considerations.

KODAK Sound Recording Tapes are available at all normal tape outlets: electronic supply stores, specialty shops, department stores, camera stores . . . everywhere.

FREE! New comprehensive booklet covers the entire field of tape technology. Entitled "Some Plain Talk from Kodak about Sound Recording Tape," it's yours free on request when you write Department 8, Eastman Kodak Company, Rochester, N. Y. 34650.

©Eastman Kodak Co. MCMLXI

EASTMAN KODAK COMPANY, Rochester, N. Y.

CIRCLE NO. 8 ON READER SERVICE PAGE



Tips and Techniques

GROMMET-TIRED TRANSISTORS PREVENT SHORT CIRCUITS

Grommets can be used to protect lead-mounted transistors against vibration and short circuits. You simply fit a grommet over a transistor in much the same way as you would fit a tire over a wheel. This technique will also permit you to leave longer leads on the component and provide a little more protection against heat damage from the soldering iron. Use of a

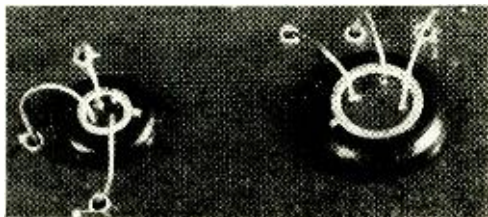

grommet may slightly increase operating temperatures, but ordinarily will not create a problem in small current circuits. A 3/16"-i.d. grommet is suitable for the smaller TO-18 transistor case and a 1/4"-i.d. unit can be stretched to fit over the larger TO-5 container.

—Don Lancaster

NO SHOCKS FROM CUT FUEL LINES

Plastic fuel line cut to size can be fitted over the handles of small tools such as pliers, cutters, screwdrivers, etc., to provide a better grip and insulation from electric shock. Many of the fuel lines available from auto parts stores have dielectric strengths of more than 1000 volts per mil.

—Mike Herrins

TUNE THE TRAP WITH YOUR TRANSMITTER

In the absence of a signal generator, tunable traps designed to operate within the frequency range of an available transmitter can be tuned accurately with the aid of a field strength meter and the transmitter. Simply connect one side of the trap to a short length of wire and the other side to

a field strength meter, set the transmitter on the desired frequency, and tune the trap for a null reading. Watch your signal strength, keeping it down to a minimum, and rock the trap adjustment to be sure you are at the bottom of the response curve.

—Richard Mollentine

RESISTOR AND CAPACITOR FILE IN THREE-RING NOTEBOOK

Resistors, capacitors, diodes, and other small components having axial leads can be placed in a three-ring notebook for safe and orderly storage. To find a component is as easy as flipping the pages of a book. Each page, or card, is made from lightweight



cardboard, as used by some shirt launderers, or from paper file folders. About a dozen cards can be prepared at once. Draw a series of vertical lines about 1" apart on one

card, stack the cards, and drill a batch of holes about 1/2" apart along each vertical line from top to bottom; the distance between the lines and between the holes can be varied to suit the size of the components to be filed. Also drill three holes on one side of the cards to accommodate the three rings. When you file the parts, "catalog" them according to their ratings.

—Gregorio O. Loveria

SMALL MAGNETS FROM SMALL SPEAKERS

If you need a small magnet to pick up or hold small parts made of iron, you can salvage one from an old loudspeaker. A speaker magnet is usually force-fitted and



cemented into position just behind the voice coil. Clamp the rear part of the speaker and a large nut in a vise so that the nut will press against the magnet as the vise jaws are closed. Use

just enough pressure to break the cement bond and move the magnet as far as it will

go. Then remove the speaker from the vise and pry out the magnet with a screwdriver.

—John A. Comstock

NEW LIFE FOR OLD LABELS AND DECALS

Labels and decals tend to deteriorate with age—some become cracked and discolored, or break up when applied, and others are just too fragile to handle. Several coats of clear plastic can be sprayed onto the front surface of a label or decal to provide a smooth, thin, protective film. Avoid excessive build-ups and prevent “running” by using long, smooth sweeping motions. Two



or three passes per coat are usually enough; allow each coat to dry before applying successive coats. After the sprayed decal has been placed on a panel, additional protection and improved appearance can be had by applying another coat or two to the entire panel.

Luis Vicens

CROCHET HOOPS FRAME SPEAKER OPENING

A neat-looking speaker grille can be made with a pair of crochet hoops available in various sizes at the 5 and 10 cent store or yarn shop. The inner hoop should be just large enough to allow the speaker frame to

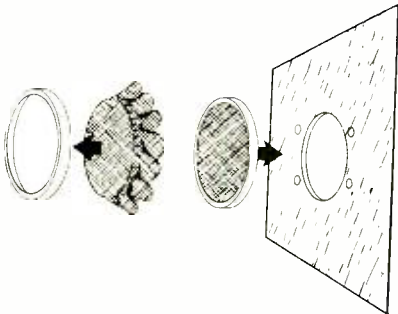

fit inside. Stretch a piece of grille cloth over the inner hoop, secure the outer hoop, smooth out the wrinkles, and cut off the surplus material. You can then glue the cloth, frame and all, to the cabinet, or let the speaker hold the grille in place when it is bolted down.

—Henry R. Rosenblatt

April, 1965

Thinking of college and a space age career in electronics?

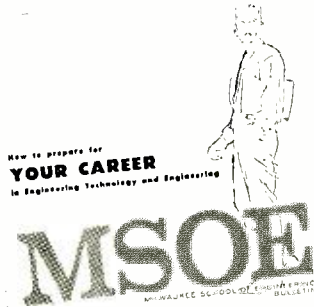

Send for this booklet on ENGINEERING TECHNOLOGY AND ENGINEERING

Learn how you can prepare for a dynamic career as an electrical or mechanical engineering technician or engineer in such exciting, growing fields as avionics, missiles, reliability control, fluid mechanics, data processing, metallurgy, microelectronics, and advanced aerospace research.

MSOE offers residence study programs leading to these degrees in engineering technology and engineering:

- 2 years — Associate in Applied Science
- 4 years — Bachelor of Science

Also get facts about scholarships and financial aids, job placement and other student services, plus photographs of MSOE technical laboratories and student activities. For your copy, just mail the coupon — no obligation.

MSOE

Milwaukee School of Engineering

Milwaukee School of Engineering
Dept. PE-465 1025 N. Milwaukee Street
Milwaukee, Wisconsin 53201

Please send the "Your Career" booklet. I'm interested in

- Electrical fields
- Mechanical fields

Name..... Age.....

Address.....

City.....State.....ZIP.....

MS-227

CIRCLE NO. 20 ON READER SERVICE PAGE 83



This important job (and its big salary) is reserved for a qualified electronics technician. It can be you!

It's a fact. There are *thousands* of jobs like this available *right now* for skilled electronics technicians. What's more, these men are going to be in even *greater* demand in the years ahead. But how about you? Where do you fit into the picture? Your opportunity will never be greater . . . so act *now* to take advantage of it. The first step? Learn electronic fundamentals . . . develop a practical understanding of transistors, troubleshooting techniques, pulse circuitry, micro-electronics, computers and many other exciting new developments. Prepare yourself now for a job with a bright future . . . unlimited

opportunity . . . lasting security . . . and a steadily-increasing salary.

Over 15,500 ambitious men are using Cleveland Institute Electronics Training Programs as a stepping stone to the good jobs in electronics. Why not join them? You will learn at home, in your spare time, and tuition is remarkably low. Read the important information on the facing page. Then fill out the postage-free reply card and drop it in the mail today. Without obligation we'll send you all the details. But act now . . . and get *your* high-paying job just that much sooner.

How You Can Succeed In Electronics

... Select Your Future From Five Career Programs

The "right" course for your career

Cleveland Institute offers not one, but five different and up-to-date Electronics Home Study Programs. Look them over. Pick the one that is "right" for you. Then mark your selection on the reply card and send it to us. In a few days you will have complete details . . . without obligation.

1. Electronics Technology

A comprehensive program covering Automation, Communications, Computers, Industrial Controls, Television, Transistors, and preparation for a 1st Class FCC License.



2. First Class FCC License

If you want a 1st Class FCC ticket *quickly*, this streamlined program will do the trick and enable you to maintain and service all types of transmitting equipment.



3. Broadcast Engineering

Here's an excellent studio engineering program which will get you a 1st Class FCC License and teach you all about Program Transmission and Broadcast Transmitters.



4. Electronic Communications

Mobile Radio, Microwave, and 2nd Class FCC preparation are just a few of the topics covered in this "compact" program . . . Carrier Telephony too, if you so desire.



5. Industrial Electronics & Automation

This exciting program includes many important subjects such as Computers, Electronic Heating and Welding, Industrial Controls, Servomechanisms, and Solid State Devices.



An FCC License . . . or your money back!

In addition to providing you with comprehensive training in the area indicated, programs 1, 2, 3, and 4 will prepare you for a Commercial FCC License. In fact, we're so certain of their effectiveness, we make this *exclusive offer*:

The training programs described will prepare you for the FCC License specified. Should you fail to pass the FCC examination after completing the course, we will refund *all* tuition payments. You get an FCC License . . . or your money back!

CIE's "AUTO-PROGRAMMED" method helps you learn faster and better

Cleveland Institute uses the new programmed learning approach. This "Auto-Programmed" method presents facts and concepts in small, easy-to-understand bits . . . reinforces them with clear explanations and examples. Students learn more thoroughly and faster through this modern, simplified method. You too will absorb . . . retain . . . advance *at your own pace*.

Free nationwide job placement service . . . for life, for every CIE graduate

Once enrolled with CIE, you will get a bi-monthly listing of the many high-paying interesting jobs available with top companies throughout the country. Many Cleveland Institute students and graduates hold such jobs with leading companies like these: American Airlines, American Telephone and Telegraph, General Electric, General Telephone and Electronics, IBM, Motorola, North American Aviation, New York Central Railroad, Raytheon, RCA and Westinghouse.

Electronics is a fast moving, dynamic industry . . . Cleveland Institute keeps you current

The Electron Bulletin is CIE's bi-monthly digest of new developments in the world's fastest growing industry. As a CIE student, you will get a free copy throughout your training to keep you up-to-date on Masers, Lasers, Solid State Devices, and other new inventions.



Full accreditation . . . your assurance of competence and integrity

Cleveland Institute of Electronics is accredited by the Accrediting Commission of the National Home Study Council. You can be assured of competent electronics training by a staff of skilled electronics instructors.

**Your Future In Electronics Is
Up To You. Make It A Brighter One.
Mail Reply Card Today.**

Cleveland Institute of Electronics

Dept. PE-28-B, 1776 E. 17th St., Cleveland 14, Ohio

The Neon Lamp Wonder

(Continued from page 64)

ductor is hot. Holding the lead in your hand is not as good as grounding, but it works in most cases and a very soft glow can be detected, provided that you are not completely insulated from the ground. The tester is nothing more than a neon lamp with a suitable ballast mounted in a small pencil-like holder equipped with two test prods. They are inexpensive and commercially available.

Indicating Devices. A high-voltage indicator can be made from a neon lamp taped to the end of a $\frac{1}{4}$ " or $\frac{3}{8}$ " wood dowel, about 12" long, as shown in Fig. 2. Since the leads are not connected to anything, no ballast resistor is needed. The lamp becomes excited right through the glass. Screwdrivers with neon lamp indicators can be used to perform these tests, just by bringing the screwdriver blade close to the high voltage points. After a little practice it is possible to predict the presence or absence of high voltage: in the horizontal output and high-voltage circuits of a TV set; at the spark plugs, distributor cap, or ignition coil in an automobile ignition system; in a neon sign installation; etc.

An r.f. sniffer is shown in Fig. 3. The sniffer can help you find both wanted

Fig. 3. The r.f. sniffer can be made so sensitive that body radiation will cause the lamp to glow.

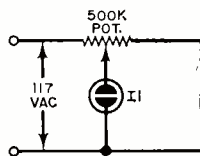

and unwanted r.f. oscillations. The 500,000-ohm potentiometer is adjusted until the neon lamp ignites, then backed off until the lamp just goes out. The lamp is now biased just below ignition. In fact, it is possible to adjust the lamp so critically that radiation from your body will cause it to glow. It is possible to predict if an r.f. oscillator is working and, with a little experience, be able to determine the relative strength of the r.f. field. Here it is only necessary to place the

lamp close to the circuit; no direct connection is needed.

The megger is still another type of indicator. As its name implies, it can be used as a rough check for high resistances on the order of 25 to 400 megohms. The circuit shown in Fig. 4 is a simple relaxation oscillator. The a.c. input voltage is rectified by *SR1* and filtered by *C1*. Resistor *R1* isolates the probe from the power line to prevent electrical shock and *R2* is an additional current limiter. The value of the d.c. voltage, the resistor under test and *C2* determine

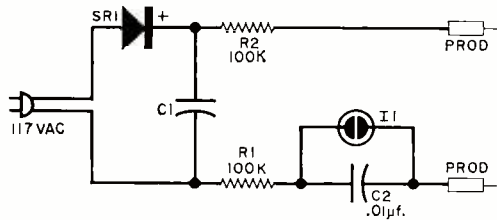

Fig. 4. This relaxation oscillator serves as a megger. The higher the resistance, the longer it takes to fire the lamp. A 400-megohm resistor will allow the lamp to flash at a rate of once per second.

the number of flashes-per-second from the neon lamp. Since d.c. voltage and *C2* are fixed, only the resistor under test will cause the flashing rate to vary. The rate can be expected to change as follows: 400 megohms, 1 per second; 200 megohms, 2 per second; 100 megohms, 4 per second; 50 megohms, 8 per second; and 25 megohms, 16 per second. If you increase the value of *C2* or decrease the d.c. voltage, the flashing rate will decrease because it will take more time for *C2* to charge up to the firing voltage.

More types of indicator applications are possible. When coupled with thermistors, humistors and photoconductive cells, neon lamps can be made to respond to heat, humidity, and light, respectively, at remote locations. The table and certain other technical details in this article were obtained from catalogs and the *Glow Lamp Manual* published by the General Electric Co., Nela Park, Cleveland 12, Ohio. If you would like to dig deeper into this subject, the *Glow Lamp Manual*, edited by J. W. Tuttle and C. R. Dougherty of GE's Miniature Lamp Department, is highly recommended. —50—

Build the Paragon 144

(Continued from page 59)

as shown in Fig. 6. Connect the ground end of *C6* to the rotor lug of *C5*. Solder one end of *L3* to a stator support rod on *C9* (see Fig. 7). The opposite end of this coil goes to pin 1 of *V2*. Attach *RFC1* to the coil, one turn from *C9*. Connect *L4* to the stator lugs of *C11*, rather than to the stator rods. The ends of *L5*, on the other hand, go to the rods, rather than to the lugs, of *C12*. Both the grid and plate leads of *V3* run to the stator lugs of *C11* and *C12*.

A few words of explanation will clear up any confusion which may exist as a result of the foregoing discussion of lugs and rods. Each miniature variable capacitor used in the Paragon 144 has small solder lugs for making electrical connections to both the rotor and stator plates. In those cases where it is impractical to utilize the stator lugs, connections can be made to the stator support rods which extend about $\frac{3}{16}$ " beyond the rear of the capacitors.

To prevent self-oscillation, the input and output circuits of *V3* must be shielded from each other. Suitable material may be obtained from a well-tinned vacuum-type coffee can. Make the shield $1\frac{3}{4}$ " x $2\frac{1}{4}$ ". Scrape the paint off the printed label side of the tin and solder the shield to the center post and terminal 9 of *V3*'s socket. Cut a small notch in it to clear terminals 4 and 5. The shield's position is illustrated in Figs. 3 and 7.

Solder *L6* to the two center lugs of a 4-lug terminal strip. Install 300-ohm twin-lead between the terminal strip and *TS1*. Solder a 5" length of stranded hookup wire to each terminal of *M1*; attach miniature alligator clips to the free ends of these wires.

Note that *R23*, *C26*, *R27*, and *C29* filter out r.f. energy which might otherwise be rectified by the first two audio amplifier stages and cause annoying r.f. feedback to develop in the modulator section of the transmitter. These capacitors and resistors will function effectively only if they are installed in the proper manner. Cut one lead of each resistor to a length of $\frac{1}{4}$ ". Connect the



Hy-Gain Hy-Q Toppers

for preferred
high-on-vehicle
mounting

Only Hy-Gain Toppers offer top loaded design...acknowledged by every authoritative reference to deliver superior performance.

- New Hy-Q Solid State Loading Coil
- 23 Channel Broadband Performance
- Lifetime Adjustable Tuning
- Rugged Mechanical Reliability
- Roof Mount - Deck Mount
Cowl Mount - Fender Mount

For optimum performance...maximum reliability...specify Hy-Gain antennas and accessories...built to serve you best!

For full particulars, write for Catalog No. 11

HY-GAIN ELECTRONICS CORPORATION
8493 N.E. Highway 6, Lincoln, Nebraska

CIRCLE NO. 14 ON READER SERVICE PAGE

Get Your First Class Commercial

F. C. C. LICENSE QUICKLY!

Career opportunities in *communications electronics* are almost unlimited. Prepare now. Let Grantham train you—by correspondence, or by classroom and laboratory instruction. Get your *first class commercial* F.C.C. license in as little as 3 months, or at a slower pace if you prefer. Then, continue in more-advanced electronics training if you wish. Diploma awarded. Our catalog gives full details.

Learn how our training can prepare you for your F.C.C. license; write or telephone the School at any one of the teaching divisions listed below. and ask for "Catalog 53."

Grantham School of Electronics

1505 N. Western Av., Hollywood, Cal. 90027
(Phone: HO 9-7878)

408 Marion Street, Seattle, Wash. 98104
(Phone: MA 2-7227)

3123 Gillham Road, Kansas City, Mo. 64109
(Phone: JE 1-6320)

818-18th St., NW, Washington, D.C. 20006
(Phone: 298-7460)

1965 CAR and DRIVER
YEARBOOK



Big Wheel small tag...



The 1965 CAR AND DRIVER YEARBOOK is here . . . and there . . . and everywhere you find men who really love cars! This new edition is a true gem, sparkling with 144 photo-packed pages—a veritable International Auto Show in print! Check all these exclusive highlights . . .

- Road Tests on 58 imported and domestic cars!
- A comprehensive tech section on racing cars, complete with cutaways and specifications!
- Big Accessories Section!
- New portfolio of exciting racing photographs!

plus . . . complete specifications on all the 1965 automobiles . . . a consumer's comparison of Ford, Dodge, Pontiac . . . your own personal showroom to the dazzling auto world of 1965!

Big wheel? You bet. Small tag? \$1.25 is all. So don't miss it—fill in and mail the handy coupon below today, and we'll have your copy on the way before you can shout "Where's my copy?"!

Ziff-Davis Service Division / Dept. CDY
589 Broadway / New York, N. Y. 10012

What are you waiting for? My \$1.25 (plus 15¢ for shipping and handling; 25¢ outside U. S. A.) is enclosed for the 1965 CAR AND DRIVER YEARBOOK. Send my copy at once, today. Now!

name _____ PLEASE PRINT

address _____

city _____ state _____ zip code _____

(Payment must be enclosed with order)

short lead of *R23* to pin 2, *V4a*, and the long lead to *J1*. The short lead of *R27* goes to pin 7 of *V4b*, while the long one goes to the center terminal of *R26*. Trim the leads of *C26* and *C29* to $\frac{1}{4}$ ". Capacitor *C26* goes between pins 2 and 3 of *V4a*. Connect *C29* to pins 7 and 8 of *V4b*.

Adjustment. First carefully check the completed transmitter for wiring errors, then plug in a 36-mc. crystal, *V1*, *V4*, and *V5*. Connect *M1* across *R5* (*TP1*), and plug in the a.c. cord. Set *R26* for minimum gain and turn the slug of *L1* fully counterclockwise when viewed from the top of the chassis. Throw *S1* to "On," and, after a one-minute warm-up, throw *S2* to "Send." If the crystal is oscillating, the meter needle will rise to about 1. As you screw the coil slug clockwise, the reading will slowly drop to about 0.8, and then suddenly jump to approximately 1.5 when the crystal goes out of oscillation.

If the meter reads 1.5 at all settings of *L1*, the crystal is not oscillating. Check for either a wiring error associated with *V1*, or too many turns on *L1*. When you finally have *V1* working properly, set *L1* for a meter reading between 0.9 and 1. Flick *S2* up and down several times to make sure the crystal starts up readily.

During the following tune-up procedure, refer to the chart on page 91 when you want to know the actual value of current indicated by *M1* as it is clipped across the different shunt resistors.

Disconnect the a.c. plug and connect the meter leads across *R8* (*TP2*). (Caution! Never touch the meter leads without first removing the a.c. plug from the wall socket!) When changing the leads to a different test point, make certain the clips do not short against other components. Always keep them as far as possible from the coils and tuning capacitors.

Replace the a.c. plug and insert *V2* in its socket. After warm-up, throw *S2* to "Send." As you tune *C5*, the meter indication should vary between about 1.6 and 2.4. Set *C5* for the lowest meter reading, cut the power, and turn the chassis over and examine it. If *C5*'s plates are somewhere between minimum and maximum capacity, *L2* has the proper inductance.

CURRENT MEASUREMENTS

Test Point and Measurement	Typical Reading	Multiply By	Actual Current
TP1—V1b plate current	.9	20	18 ma.
TP2—V2 plate current	1.6	20	32 ma.
TP3—V3 grid current	1.6	2	3.2 ma.
TP4—V3 plate current	2.3	40	92 ma.

Note: Variations of $\pm 15\%$ are normal

Measurements shown in chart are made by clipping leads from M1 across appropriate test points. After initial tune-up, meter can be connected permanently across TP4 for monitoring final plate current.

If minimum current occurs at minimum capacity, less inductance is needed. If full capacity is required for a current dip, the inductance is too small. Squeeze the turns together to increase the inductance, or pull them apart to lower it. If there is no current change as C5 is tuned, recheck the wiring associated with V1b and V2.

The next step is to move the meter clips to R10 and connect a 15-watt light bulb across TS1. Plug in V3. Turn the power on and tune C9 and C11 for the highest meter indication. It should be in the neighborhood of 2 if L3 and L4 have been correctly wound and installed. If the highest reading is obtained with either C9 or C11 at the extremes of their ranges, stretch or squeeze the coils as suggested in the previous paragraph.

Slowly tune C12 and C13 until the light bulb glows most brightly. Use a nonmetallic screwdriver on C13. Now, adjust L1 counterclockwise until the meter drops to approximately 1.6.

After pulling out the power plug, connect the meter clips across R13 (TP4). Re-install the plug and experiment with various settings of C12 and C13, and the position of L6 with respect to L5. In this way, you'll become thoroughly familiar with how these adjustments affect transmitter output as indicated by the meter needle and bulb brightness.

Plug a crystal or ceramic microphone into J1. Advance R26 until the meter needle flickers very slightly and the bulb intensity increases noticeably as you speak into the mike. Do not raise the

Identical twins

Best way to bring out the best in your tape recording equipment, stereo or mono, is to use the famous Sonotone Ceramike® matched twins. Each set is a selected matched pair exhibiting similar coloration, frequency response and output characteristics within ± 2 db. Ceramike models include a new low-impedance version, "CMT-1050WR," for transistorized tape recorders, and "CMT10A" for tube tape recorders. A low priced series is also available starting at under \$10.00.



Sonotone Corp., Electronic Applications Div., Elmsford, N. Y.

CIRCLE NO. 34 ON READER SERVICE PAGE

Eliminate Vibrator Hash Forever with QUIETRON



NEW TRANSISTORIZED VIBRATOR

For easy plug-in replacement. Two types to cover all CB makes and models.

P— The Original Transistor Vibrator Replacement.

N— Now, the most copied unit.

- Boosts Efficiency
- No Mechanical Noise
- No Moving Parts
- 90 Day Guarantee

NEW LOW
PRICE
4⁹⁵

Announcing the new Quietron Senior . . . a superior unit with highest gain matched transistors. Only **9⁹⁵**

Your set requires only one Quietron (P or N). Now available at many electronic dealers. Ask your dealer which type fits your set or write RaeCo direct for complete information.

RaeCo, Inc.

Dept. PE-4, 1351 Deloss,
Indianapolis, Ind. 46203

CIRCLE NO. 27 ON READER SERVICE PAGE

Back Issues Available

Use this coupon to order back issues of **POPULAR ELECTRONICS**

We have a limited supply of back issues that can be ordered on a first-come, first-served basis. Just fill in the coupon below, enclose your remittance in the amount of 50¢ each and mail.

ZIFF-DAVIS SERVICE DIVISION
Dept. BCPE 589 Broadway
New York 12, New York

Please send the following back issues of **POPULAR ELECTRONICS**.

I am enclosing to cover cost of the magazine, shipping and handling.

Month Year

Month Year

Month Year

Name

Address

City..... Zone..... State.....

No charge or C.O.D. orders please. PE

send for New **FREE** **CRYSTAL CATALOG** ... with New **TRANSISTOR OSCILLATOR CIRCUITS**

Citizen Band Class "D" Crystals

3rd overtone — .005% tolerance — to meet all FCC requirements. Hermetically sealed HC6/U holders. 1/2" pin spacing. .050 pins. (Add 15¢ per crystal for .093 pins). **\$2.95 EACH**

All 23 channels frequencies in stock: 26.965, 26.975, 26.985, 27.005, 27.015, 27.025, 27.035, 27.055, 27.065, 27.075, 27.085, 27.105, 27.115, 27.125, 27.135, 27.155, 27.165, 27.175, 27.185, 27.205, 27.215, 27.225, 27.255.

Matched crystal sets for ALL CB units (Specify equipment make and model numbers) **\$5.90 per set**

RADIO CONTROL CRYSTALS

in HC6/U HOLDERS—SIX FREQUENCIES

In stock for immediate delivery (frequencies listed in megacycles): tolerance .005%. 1/2" pin spacing. .050 pin diameter. (.093 pins available, add 15¢ per crystal). **\$2.95 EACH**

26.995, 27.045, 27.095, 27.145, 27.195, 27.255 **\$2.95 EACH**
(add 5¢ per crystal for postage and handling)

ORDER FROM CLOSER PLANT TEXAS CRYSTALS

DEPT. PE
1000 Crystal Drive
FORT MYERS, FLORIDA
Phone 813 WE 6-2109

Division of



AND
4117 W. Jefferson Blvd.
LOS ANGELES, CALIF.
Phone 213-731-2258

CIRCLE NO. 36 ON READER SERVICE PAGE

gain beyond this level. More audio will merely result in excessive distortion and a broad signal.

The transmitter is now ready to go on the air. Connect a 300-ohm feedline between *TS1* and a good 2-meter beam antenna. Adjust *C12* and *C13* so that the meter reads between 2 and 2.5 at resonance dip. This indicates an input power of between 16 and 20 watts.

Tips On Operation. Most 2-meter operators use crystal-controlled rigs and tend to stick to a single frequency. However, if you decide to purchase a number of crystals in order to hop around the band, it will pay you to put knobs on *C12* and *C13* so you won't have to hunt up a screwdriver to QSY.

You can ignore the other adjustments when changing crystals if you stagger-tune them. To do this, set *L1* and *C9* for a meter indication of 1.5 with your lowest frequency crystal in the socket. For this tuning operation, the meter is connected across *R10* (*TP3*). Peak *C5* and *C11* for a 1.5 reading with your highest frequency crystal, and from then on, just retune *C12* and *C13* slightly when you change frequency.

Once you have the transmitter working properly, the meter clips can be connected permanently across *R13* to permit you to monitor plate current during each transmission. The antenna change-over and receiver muting relays in your shack may be controlled by *S2b*, thereby providing you with one switch operation. Access to *S2b* is provided by *TS2*.

Results. When the prototype was first put on the air, it produced 18 QSO's from 20 calls, a 90 percent batting average. Comments received over the air were uniformly complimentary with regard to signal strength and audio quality.

If you live in relatively flat country and use a 6- to 8-element beam mounted 40 or so feet in the air, the Paragon 144 will provide consistently strong signals at a distance of about 30 miles. Usable signals can be expected up to 40 or more miles under normal day-to-day conditions. A higher tower and larger antenna, or a hill-top location, will stretch these figures significantly. However, when skip conditions are good, you'll be able to work 300 miles and beyond, even with a low-gain, chimney-mounted antenna array.

-30-

One QSL Too Many

(Continued from page 65)

tion K1NIA. How do we know which station you heard?"

"It specifies 17.8 kc. on the back," I explained, keeping calm. "That's not an amateur frequency."

Bird's head bobbed up and down as he agreed, "He's right, it does say that. George is right."

Hunter gave him a look, and the little man shut up.

"What is your receiver?" Hunter wanted to know next.

"A 1939 Philco." I began to sweat.

"And it tunes?" Hunter, the inquisitor, queried.

"530 to 3200 kc.," I replied, after taking a long, deep breath.

Bird chirped, "Then how could you hear a station on 17.8 kc.? It's impossible, absolutely impossible."

"I heard NAA because of CFNB." I could almost see my DX trophy slipping away.

"I suppose they were relaying the U.S. Navy."

"No," and I assumed my most scientific tone of voice, "CFNB is at Fredrickton, New Brunswick, and operates on 550 kc."

The little man tapped his fingers on the table.

"It has to be states, not Canadian provinces," he sneered.

Bird I could stare down, and I did.

"On its way to Rose County," I stated confidently, "CFNB's signal passes over

the powerful ground wave of NAA. The ground wave is so strong that it literally modulates CFNB, producing signals at 532.2 and 567.8 kc. The 567.8 kc. frequency is always covered by QRM, but on November 10 the 532.2 kc. frequency was quite readable."

There was a deadly silence.

"And that's your case," Hunter stated grimly.

"Yes." I secretly wished I had kept my big mouth shut about the whole thing.

"Very well. If the club members do not object, Bird and I will consider the matter for a few minutes and then render a verdict."

This group never objected to anything.

The self-appointed judge and jury moved off into a corner, while I went up and retrieved my QSL.

They were back in three minutes flat. I figured it would be the ax, quick, but they proved to be real sports.

Hunter stood there towering over me. "If this ground-wave modulation thing really happened, we want to hear it," he boomed.

I blinked, and replied, "NAA isn't there every night."

"Unless we can hear it for ourselves, your QSL won't count." Hunter was relentless. "It'll have to be destroyed as fraudulent."

Bird hurried out to his car and came back with a General Electric RAX-1 which tuned all the way down to 200 kc. He plugged the set in, then hitched a wire from its antenna terminal to the radiator pipe. They sure were giving me all the breaks!

"All right, show us," Hunter demanded. There was a wicked smile on his face.

EARN Electronics Engineering DEGREE

You can earn an A.S.E.E. degree at home. College level HOME STUDY courses taught so you can understand them. Continue your education, earn more in the highly paid electronics industry. Missiles, computers, transistors, automation, complete electronics. Over 27,000 graduates now employed. Resident school available at our Chicago campus—Founded 1934. Send for free catalog.
AMERICAN INSTITUTE OF ENGINEERING & TECHNOLOGY
1137 West Fullerton Parkway, Chicago 14, Ill.

GET INTO ELECTRONICS

V.T.Y. training leads to success as technicians, field engineers, specialists in communications, guided missiles, computers, radar, automation. Basic & advanced courses. Electronic Engineering Technology and Electronic Technology curricula both available. Associate degree in 29 months. B.S. obtainable. G.I. approved. Start September, February. Dorms, campus. High school graduate or equivalent. Catalog.

VALPARAISO TECHNICAL INSTITUTE
DEPARTMENT PE, VALPARAISO, INDIANA



New Amateur Catalog!



Build your own amateur transmitter, or buy it completely wired and tested from the popular Johnson "Viking" line. Catalog 965 features transmitters, station accessories, keys, practice sets.

Send for your free copy today!



E. F. JOHNSON COMPANY
2409 Tenth Ave. S.W. • Waseca, Minn. 56093

With Bird hovering just behind me, my hand shook so badly I could hardly tune to 532.2 kc. But I did. It took a moment for our ears to adjust to that jumble of tones. Then the DX spirit must have felt kindly towards yours truly, because there it was, NAA, interspersed with a V marker.

"I hear a marker, anyway," I said meekly.

Hunter's face was deadpan.

Then there was another sound—a broadcast station cutting in and out with NAA's key. My luck didn't quit. NAA went into a message, an error, and a long dash. During that dash CFNB identified loud and clear.

Bird grabbed the set and shook it. "There must be something wrong with the radio," he declared.

"Must be," echoed Hunter faintly.

I made my voice big and deep like Hunter's normally was, and I said, "It's *your* receiver."

Then I walked out with the trophy. ~~30~~

Miniature R/Ceiver

(Continued from page 41)

The antenna lead can be any piece of wire 18 inches or longer. Use of light-weight wire on the order of No. 26 AWG to interconnect the receiver to external components will keep the wiring bundle small and flexible and better able to withstand vibration. Mount the receiver in a small plastic box to prevent dust from getting into the relay.

Almost any type of actuator used with this receiver will require an arc suppression network to protect the relay contacts. This network consists simply of a 10-ohm resistor (*R7*) and a 0.01- μ f. capacitor (*C11*) across the relay points.

Using the R/Ceiver. If the R/Ceiver is to be used in a model airplane, it should be shock-mounted with foam or rubber material. There are many types of actuators available for use in model airplanes, cars and boats. Airborne actuators are usually of the rubber-band powered escapement type and are light in weight. Motor-driven types are generally used in cars or boats where more

power is needed and weight is not a problem.

Self-neutralizing types of actuators provide alternate right and left control. Compound types provide right-side control on the first burst of tone signal, left with the second, and motor control with the third. This makes it unnecessary to remember what the last control position is. You just press the transmitter key once for right, twice for left, or three times for motor. The mechanism cycles back to neutral when the tone signal stops.

If the R/Ceiver is to be used for garage door operation or some other application requiring maximum security, cut down the size of the antenna. The receiver should not be allowed to pick up any signals that are weaker than your own weakest signal. You can make this adjustment by transmitting a signal at maximum range, then trimming the antenna and increasing the relay spring tension until the receiver will just operate.

Final Adjustments. The receiver needs 2.8 to 3.6 volts to operate. Two standard 1.5-volt cells in series can be used. (A separate power supply should be employed for the device being controlled.)

To check out the receiver, connect the batteries and put a weak signal on the air from your transmitter, or from a signal generator tuned to the proper frequency. The signal is amplitude (600- to 800-cycle) tone-modulated at a frequency within the range of 26.995 to 27.255 mc., in conformance with proper Class C operation. Modulation should be at least 85%.

Tune *L1* until the relay pulls in. Use a fiber or plastic-tip tuning tool to avoid loading and detuning effects. As you rotate the core into the coil, count the number of turns from the point where the relay first pulled in to the point where the relay drops out. Back up the core to a mid position, half the number of turns you counted.

It is very important to use a weak signal when tuning. If the signal is too strong, the tuning range will seem to be very broad, and it will be hard to find the best core setting. An alternate method of tuning is to connect a high-impedance phone across the secondary of *T2* and tune for the loudest tone. ~~30~~

Adjustment Quiz Answers

(Quiz appears on page 71)

- 1 — B Increasing the amount of resistance increases the reactance of the frequency-sensitive RC circuit which bypasses fewer high frequencies. The more high frequencies reaching the loudspeaker, the less bass there seems to be. Actually, the low-frequency response is not significantly affected.
- 2 — A Increasing the capacitance of the series padder decreases the resonant frequency of the oscillator. It then becomes necessary to decrease the capacitance of the main oscillator capacitor to come back to the i.f. frequency, in order to receive the same station. The dial indicator which is ganged to the tuning capacitors will move upscale accordingly.
- 3 — B The frequency of the oscillator varies inversely as the time required for the capacitor to discharge through the potentiometer to ground. Moving the slider toward ground increases the amount of resistance in the circuit, increases the discharge time, and lowers the frequency.
- 4 — B Moving the core into the coil increases the permeability of the magnetic circuit so that the amount of magnetic flux around the coil increases. The back e.m.f. becomes greater and further reduces the amount of voltage available to light the lamp.
- 5 — B Moving the slider toward the positive voltage makes the cathode of the CRT more positive with respect to the grid, and reduces the beam current.
- 6 — B A parallel-tuned circuit has its greatest impedance at its resonant frequency, and thus reduces the plate and cathode currents to their minimum value.
- 7 — A The detected audio signal is developed across the potentiometer, which is connected as a variable voltage divider. The amount of signal fed to the triode amplifier is greater when the amount of resistance between the slider and ground is greater.
- 8 — B When nonmagnetic materials, such as brass, are placed in the vicinity of a coil, they effectively reduce its inductance. To reduce inductance after the wand is removed: if the core is made of brass, move it in more toward the center of the coil length; if the core is made of iron, move it away from the center.

INTERNATIONAL EXECUTIVE 750-HM2

Checks operating performance of 24 circuits including filament, plate and input voltages, transmitter forward and reflected power, modulation, etc. This "years ahead" built-in test feature makes tune-up and servicing easy. Switch, located on transmitter receiver unit, is used for selecting circuits. The 750-HM2 has 23 crystal controlled channels. Operates on 115 vac or 6-12 vdc.

NEW

CB TRANSCEIVER WITH 24 BUILT-IN TEST CIRCUITS



● WRITE FOR THE NAME OF YOUR NEAREST DEALER

18 NORTH LEE • OKLAHOMA CITY, OKLA

CIRCLE NO. 15 ON READER SERVICE PAGE

NEW - - by KUHN AM/FM VHF RECEIVER

New model now covers 26-54 and 88-174 MC in eight overlapping calibrated bands with large full vision dial. New circuitry. High sensitivity. Ideal for listening to Aircraft, CB, Police, Fire, Amateur, or other signals as well as regular FM broadcast stations. Completely self-contained with headphone jack for private listening.

353B \$59.95
inc. FET

AIRCRAFT • POLICE • FIRE



348A
Complete
\$34.95

315-B
5-54 MC
\$17.95

115-160 MC
\$18.95



Transistorized, directly tuneable converter. Powered with self-contained mercury cell. Excellent sensitivity and stability. Designed for car, home or portable receivers.

Converts home or car radios to receive Fire, Police, Aircraft, CB, SW, etc. Exceptional sensitivity on High and Low Bands. High Band type adjusts to bracket 115-160 MC. Low Band type should be ordered for 33-41 MC, 40-52 MC, 26-30 MC, 9-12 MC, etc. May be adapted for transistorized car radios.

Order today or send for free catalog on full line of converters and receivers for every application.



20 GLENWOOD
CINCINNATI 17,
OHIO

CIRCLE NO. 18 ON READER SERVICE PAGE

20 PIECE SUPER SOCKET TOOL KIT

**Ideal for
HOME
CAR
SHOP
HOBBY
OFFICE
etc.**



**WITH
REVERSIBLE RATCHET,
UNIVERSAL HANDLE**

Wide range of sockets
and screwdriver bits
for screws, bolts, nuts
with square, hex, slotted
or recessed heads.
Complete with offset and
double offset adapters,
awl point, etc.

\$4.95
Only Complete

Handsomely
packaged in
a specially
designed
storage box.

Mail Today!

CONSUMER SERVICE COMPANY
160 Mercer St., New York, N. Y. 10012

Enclosed is \$_____ for _____ Socket
Tool Kits at \$4.95 ea. plus 35¢ ea. for postage
and handling (N. Y. C. residents please add 4%
sales tax.) Foreign orders 50¢ additional.

Name _____
(PLEASE PRINT) PE-45

Address _____

City _____ State _____ Zip Code _____
Sorry—No charges or C.O.D. orders.

The Decibel War

(Continued from page 43)

—being “scattered” in the direction from which it came. The strength of the “backscatter” echo depends on the strength of the signal which struck the ground after reflection by the ionosphere.

It follows that if a wide range of high frequencies are transmitted, some frequencies will penetrate the ionosphere and go into space, some will be absorbed, and some will be reflected. Backscatter will be received only for the frequencies that are reflected. Furthermore, the round-trip time delay of a very short pulse of radio energy is related to the distance at which the signal was scattered. The longer the time delay, the further away the signal was returned to earth.

If the characteristics of the transmitting antenna are known, then from its vertical radiation pattern and the time delay of the backscattered pulse, the approximate height of the part of the ionosphere that reflected the signal can be determined.

It can be seen that a number of very useful facts can be obtained from an operational backscatter system: (1) We can first determine the range of frequencies the ionosphere is reflecting at any given time; (2) From the strength of the backscatter signal we can learn which frequencies are strongest on reaching the earth from the ionosphere, and this tells us which frequencies the ionosphere is propagating best; (3) From the time delay of the returned pulse and the characteristics of the transmitting antenna pattern, we can also learn the height of the ionosphere from which these signals are being reflected.

Using this information, it is thus possible to schedule frequencies that will deliver the best signals to a given target area. But, better still, with this system the optimum radiation angles for an international broadcasting station can be determined.

Suppose, for example, that the Russians have determined, by conventional radio forecasting techniques, that at a

particular hour the 7-mc. band should be optimum for transmission to the United States. The optimum radiation angle for this transmission will depend upon the height and state of the ionosphere. A backscatter system that would transmit very short pulses at various vertical angles could tell the broadcaster which radiation angle was returning the strongest signal, and consequently which angle would deliver the strongest signal. Appropriate adjustments in the vertical radiation angle of the antenna could then be made.

Slewing. Experiments have shown that a gain of from 6 to 10 db is possible by making optimum use of the height of the ionosphere. When the height is known, "slewing" (adjusting the radiation angle of the antenna) is one way in which this gain can be achieved. It would appear, therefore, that the technique of slewing in conjunction with a backscatter system is what the Russians are employing in order to deliver such strong signals to the United States.

Use of optimum vertical radiation angles would also account for Russian signals continuing strong during ionospheric disturbances. We are learning, from propagation experiments conducted on rockets and satellites, that during certain types of disturbances the ionosphere "tilts" and is no longer parallel to the earth's surface. Such tilts could affect optimum radiation angles, and therefore backscattering for optimum angles would be an invaluable tool during ionospheric storms.

The Russians tell us very little about their technical facilities, and we can only surmise from what we observe.

Based on the level of signals delivered by the BBC with known transmitter power and antenna gain, we must conclude that the Russians, whose transmitting sites are much further away, are either using extremely high power transmitters (a very dubious possibility) or, what seems much more likely, are employing propagation techniques which the United States would not be in a position to implement for at least two—and possibly five—more years. —30—



The grand prize in Empire Scientific Corp.'s 1965 round-the-world music festival contest is a 21-day tour of Europe's great music and drama festivals for the winner and his guest. In addition, there will be 50 prizes for the runners-up: Deutsche Grammophon albums containing Beethoven's nine symphonies conducted by Herbert Von Karajan. The contest consists of rearranging an alphabetical list of the ten features of the Empire "Royal Grenadier" speaker system in their proper order of importance. You can obtain an entry form from your hi-fi dealer.



Motorists driving through the Chesapeake Bay Bridge-Tunnel in Virginia can listen to their car radios thanks to a new antenna-amplifier system. Ceiling antenna cables were originally built into the two-mile-long tunnel sections to provide two-way short-wave communications. All that was necessary to add auto AM reception was to install AM antennas at the tunnel ends, boosting their output with broadband amplifiers. The output is fed to the ceiling cables which radiate it to passing cars.

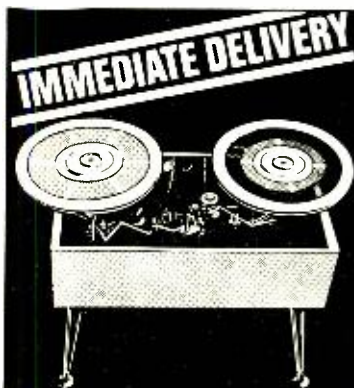

TAPE T.V. PICTURES AT HOME NOW ! VIDEO RECORDER KIT only \$392 complete

The amazing V.K.R. 500 is the world's first low-price television tape recorder for immediate delivery! Its ingenious design in kit form allows easy assembly for the engineer and enthusiast alike. Suitable for 525 line system, the V.K.R. 500 has entirely transistorised circuits using silicon transistors on single printed circuit board, and may be used for recording from your own ITV camera or 'off the air' television programmes. A special feature is the employment of N.I.S.R. (Non Integrating Sync. Regeneration) for really stable operation. The V.K.R. 500 is the machine you've been waiting for. **ORDER NOW!**

Running time up to 30 minutes approx. on standard 1/4" magnetic tape

WESGROVE ELECTRICS LIMITED

Nash House, New Street, Worcester, England.

Telephone: Worcester 25948

CIRCLE NO. 39 ON READER SERVICE PAGE

On the Citizens Band

(Continued from page 79)

question "lead sheet" for him. If the interview is to be lengthy, you might also want to have some notes scrawled on an "answer sheet."

A copy of the 1965 COMMUNICATIONS HANDBOOK will provide the vital statistics you'll need for information on a national level. As for local or area color, just cover the public service activities that CB'ers in your area have been engaged in; explain the setup of your monitoring system, rescue squad, and emergency assistance to individuals or authorities.

It may help get your foot in the door if you take a copy of this issue with you to show the program director documentation of your purpose in requesting the interview. It will give him an idea as to how the service has been misrepresented and how two radio stations have started the ball to "re-enlightenment" rolling.

Forward us copies of scripts used, if possible, or a tape dub. At any rate, send us the details of your interview, along with the results, and have your club photographer get a good, clear shot for possible use in this column. Be sure to include names, addresses, and other pertinent information.

Our sincere thanks go to Dean Claggett of WOBT and to Bob Gregory of WBEL for the opportunity to field-test "Project Interview." We also thank Ray and Norma Walters and all the CB'ers of Beloit and Rhineland, Wis., who helped us prove our point.

1965 OTCB Club Roster. The following clubs are being placed on the OTCB club roster this month for the first time. If your



At the 11th Annual Speed Weeks Motor Classic in Miami, Fla., December 1-7, Pearce-Simpson CB equipment was credited with saving life and property. Units were installed at the starting line, in 5 ambulances, and at 14 danger points along the course.

club is not listed, or if your secretary has not forwarded us information within the last year on membership totals, new officers, activities and development of special rescue or assistance squads—report in now!

● Ouilmette CB Club, Wilmette, Ill. Officers: Robert Drucker, KHD7861, president; Steve Terry, KBH0810, secretary/treasurer. The club holds meetings in the Northern Illinois/Wisconsin area, and publishes a monthly newsletter and call directory.

● Tidewater Emergency Radio Rescue and Assistance Club, Norfolk, Va. Organized in July, 1964, the club now has 35 members. Officers: Blake Fritz, president; Ron McCoo, vice president; Chloris Fritz, secretary; Ray Poythress, treasurer; and Ernie Hamel, communications officer. TERRAC members participated in assists during the hurricane season, aiding motorists and home owners during high water flooding. Meetings are held on the second and fourth Friday of each month.

● Southeast Iowa Citizens Band Radio Patrol, Fairfield, Iowa. This club has been organized for "some time," but "Harold" didn't send details. How about it, Harold?

● S9 Citizens Band Radio Club and Emergency Team, Wakefield, Mass. Officers: Dave Yetman, KKB1221, president; Buddy Smith, KKB2859, vice president; Harvey Dillinger, KBE0345, secretary/treasurer. Their emergency team monitors channel 9 to aid motorists on Routes 128, 28 and 93. The membership of 22 is made up of CB'ers from 14 to 23 years of age.

● Sandusky County CB Radio Club, Clyde, Ohio. Organized in September, 1964, the club now has a membership of 86. Their activities are tied in with civil defense, the Red Cross, local police and sheriff departments. Officers: Gene Womeldorff, KHG8760, president; Barney Celek, KHJ6954, vice president; Richard Roy, KLM9512, secretary; Woody Haynes, 19A7656, treasurer; and Harold Zilles, KHI7381, in charge of membership.

● Northeast Florida CB Radio Association, Jacksonville, Fla. Organized last summer. Temporary officers: O. S. Craig, president; and Jack Pierce, secretary/treasurer. Their aims are to give tourists passing through the area road information, emergency assistance, etc.; to aid locally in emergencies and disasters; and to educate local citizens on the value of CB radio communications for personal, business and emergency use!

We expect to see many of your gleaming antennas at several of the upcoming jamborees. Watch for our oversized red I. D. badge—trip us if we pass you by. We'll be glad to chat on any subject you wish—so long as it concerns "the increasing importance of the Citizens Radio Service!"

I'll CB'ing you.

—Matt, KHC2060

Home TV Tape Recorder Kit

(Continued from page 44)

of sync recovery in the replay mode." The sound is converted to an FM signal which is impressed on a 20-mil segment of the tape between the video segment and the tape center. A separate sound record/playback head is used.

Other Details. The VKR 500 uses 22 silicon transistors, 2 germanium transistors, and 6 diodes; a printed circuit board contains most of the circuitry. The video signal is fed to the recording head from a special factory wired and tested unit containing the driver transistor and critical inductive components which "predistort" the video signal. The replay preamplifier is also factory wired and tested. The sync pulses are fed to the recording head in "differentiated" form. An unusual four-stage regenerator is used for recovery of the sync pulses on replay.

Mechanically, the new TV tape recorder has been made as simple and rugged as possible. The flywheel and capstan are belt-driven by a $\frac{1}{10}$ hp. motor. The layout of the tape transport is conventional, with the tape passing through a tension device after leaving the take-off reel, going past the erase magnet, the sound and video heads, the capstan, and then onto the take-up reel. Physically, the VKR 500 measures 20" x 77" x 107", and weighs 28 pounds. Power consumption is 200 watts.

Building the Recorder. Assembly of the VKR 500 is said to be within the capabilities of the average technician or hobbyist. Since almost all of the circuitry, with the exception of the power supply and record/playback heads, is mounted on the printed circuit board, wiring is simplified. According to the manufacturer, the tape transport can be built with simple tools, and total construction time is 12 hours.

If the VKR 500 lives up to its promise, it should meet a great many requirements in laboratory, industrial and educational closed-circuit TV systems, and, most impressive, as a home entertainment device for taping TV programs and "electronic movies."

-30-

action CITI-FONE SS



WRITE, WIRE or PHONE TODAY FOR COMPLETE INFORMATION

COMPLETE \$169.50

MULTI-ELMAC COMPANY
21470 COOLIDGE HIGHWAY OAK PARK 37, MICH.

Name

Address

City Zone State

CIRCLE NO. 21 ON READER SERVICE PAGE



**3
BIG
3's
FOR CB**

THE TURNER MODEL 333

This professional noise-cancelling communications microphone is ideal for CB, amateur, marine and other mobile use. Clear, crisp voice reproduction. Rugged cycloc case. Response: 300-3000 cps. \$21.50, list.

THE TURNER MICROPHONE COMPANY
546 17th Street N.E.
Cedar Rapids, Iowa

In Canada: Tri-Tel Associates, Ltd.,
81 Sheppard Ave. West, Willowdale, Ontario

CIRCLE NO. 42 ON READER SERVICE PAGE

DO YOU SAVE YOUR COPIES OF

POPULAR ELECTRONICS ?



Make sure they're kept neat and always handy for instant reference—with a handsome file that's designed to hold a full year's copies!

- washable Kivar cover creates a leather-like appearance
- available in maroon backing with black sides or black with maroon
- 24-carat solid gold leaf embossed lettering for magazine's name
- attractively priced at only \$2.95 each, 3 for \$8.00, 6 for \$15.00
- files are shipped to you prepaid and are fully guaranteed

NOTE: these special-quantity prices apply for any combination of titles, so you can have them for all your favorite magazines.

Order several today—for all the Ziff-Davis magazines: Popular Photography, Modern Bride, HiFi/Stereo Review, Electronics World, Popular Electronics, Flying, Car and Driver, Popular Boating, Amazing, and Fantastic, and for your other favorite publications, as well. (Ziff-Davis magazines available in colors of your choice as noted in coupon. Other publications will be shipped in standard colors available.)

Jesse Jones Box Corp., Dept. P.E. Box 5120
Philadelphia 41, Pa.

Please send me: (Fill in title, quantity and check appropriate column for color desired)

MAGAZINE TITLE	QUANTITY	BLACK BACKING/ MAROON SIDES	MAROON BACKING/ BLACK SIDES
Popular Electronics _____	_____	_____	_____
_____	_____	_____	_____
_____	_____	_____	_____

\$2.95 each, 3 for \$8.00 or 6 for \$15.00—shipped prepaid—fully guaranteed

Total amount enclosed _____

Name _____

Address _____

City _____ Zone _____ State _____

Transistor Topics

(Continued from page 70)

resistor $R6$. Transistor $Q2$ conducts and closes the relay ($K1$). The closed relay applies $C1$'s charge to $Q3$'s base through current limiting resistor $R7$, permitting this transistor to conduct and to actuate the solenoid ($K2$).

The relay is held closed for a short interval, while $C2$ discharges through $R4$ and $Q1$'s base-emitter circuit. During this period, $C1$ is discharging through $R7$ and $Q3$'s base-emitter circuit. When $C2$'s charge drops sufficiently, $Q1$'s emitter current becomes less, $Q2$'s base bias is lowered, and the relay opens. The cycle then repeats itself.

Diode $D2$ and resistor $R8$ are included to damp out transient spikes which might otherwise develop across the solenoid, and thus to protect $Q3$.

Standard components are used throughout. Except for potentiometer $R1$, all resistors are half-watt units. Resistor $R8$ is made up of two 10-ohm resistors connected in parallel; $C1$ and $C2$ are both 6-volt electrolytic capacitors, with ratings of 4000 μ f. and 50 μ f., respectively. Smaller units may be paralleled to obtain the capacitance needed, if desired. $D1$ is a 4-volt, 1/2-watt zener diode and $D2$ is a 1-ampere silicon diode. All transistors are *pnp* units; $Q1$ is a 2N190, $Q2$ a 2N188A and $Q3$ a 2N256. The relay is a Potter & Brumfield RSSD with a 6-volt, 335-ohm coil; the solenoid is a 6-volt Guardian unit with a 4.7-ohm, 1.27-ampere coil; and $S1$ is any standard s.p.s.t. switch.

The timer can be assembled breadboard fashion, on a small metal chassis, on an etched circuit board, or in a standard Mini-box, as preferred. Neither layout nor lead dress is critical.

The instrument's timing interval is determined by $R1$'s setting and, according to Charles, ranges from approximately 1 second to several minutes. He indicates, further, that he has used the timer for taking pictures for continuous periods of over 100 hours (with a 3-minute timing cycle) without noticeable deterioration of the battery.

Piggyback Parking. Motorists may find that their parking costs will increase if experiments now being carried out in Whittier, Calif., are successful. In an effort to prevent motorists from using unexpired time on parking meters, engineers have developed unique transistorized circuits which will automatically reset the meters to zero as cars pull out of the parking spaces.

The basic principle of operation is relatively simple. An infrared sensor mounted in the meter detects heat from the car's engine. As the car pulls away, the heat rays are "chopped" by a grid-like filter, developing a pulse-like signal. This signal, amplified, is used to trigger a silicon switch or unijunction transistor which, in turn, operates a relay, triggering the meter's timer and returning it to zero. The meter then remains at zero until reset by the next motorist's coin.

Theoretically, the new meters will simultaneously increase parking revenue and reduce traffic congestion—the former by canceling unused time and requiring each motorist using a parking space to insert his own coins, the latter by keeping motorists from circling around looking for unexpired time on meters.

It's "30" for now, fellows. I'll be back next month . . .

—Lou

Across the Ham Bands

(Continued from page 74)

transmitter amplifier wouldn't work. While trying to repair the trouble, he heard KC4USB, Byrd Station, on the frequency on which the receiver was accidentally tuned to. KC4USB was raised with the transmitter exciter but was unable to contact McMurdo. A Navy plane that happened to be in the air finally delivered the message to its destination. Some time later, W4LKJ telephoned the Red Cross Director and gave him McMurdo's return message which detailed how the Navy man was being flown home from the Antarctic.

In the December, 1964, "Across the Ham Bands," we reported that Kayla, WØHJL,

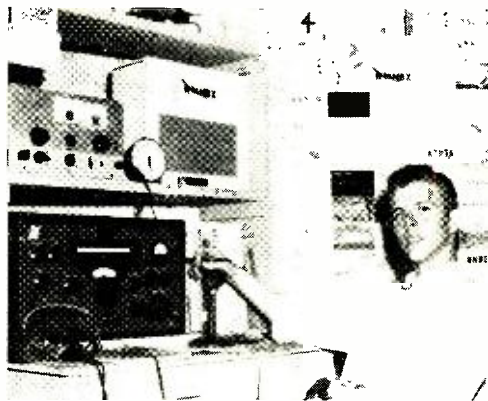

Dave Slaughter, WN4MBX, Jacksonville, Fla., has worked 38 states, 9 countries, on 15 and 40 meters.

had prophesied in the Denver Radio Club's *Round Table* that the minimum point of the current sunspot cycle would occur in August, 1964. At that time (and later), most experts were predicting the minimum for April, 1965. The payoff: According to ARRL Official Bulletin #984, the Central Radio Propagation Laboratory of the National Bureau of Standards believes that the minimum probably did occur in late summer, 1964. Chalk that one up to Kayla, a very smart YL!

News and Views

Jim Wolff, WN9NC5, 432 Short St., Collinsville, Ill., started out in "overdrive" and worked 25 states and Canada in 40 days. The scene was 40 meters; the antenna a 40-meter dipole, 20' high; the receiver a Knight-Kit R-109A; and the transmitter a Knight-Kit T-60. When not working 40 meters, Jim is now on 2 meters with a Heathkit "Twoer" feeding a home-brew, 5-element beam. . . **Dennis Silage, WB2LGJ**, and his sister, **Vicki, WB2PWI**, (14), operate on 6 meters from 62 Hancock St., Trenton, N.J. They run 50 watts to a home-brew transmitter feeding a 5-element Cush-Craft beam. They receive via a home-built converter into a Lafayette HE-30 receiver. At time of (Continued on page 106)

ONE FOR THE ROAD

BROWNING DRAKE CB MOBILE UNIT!

Compact (8" x 3" x 9") 23-channel mobile transceiver has reliable tube circuitry plus same base station performance as famous Browning Eagle. For full details, write for new, colored CB catalog.

Contact Franchise Division for information on available service center areas.



browning
LABORATORIES, INC.

Dept. PE-10 Union Avenue, Laconia, N.H., 03246

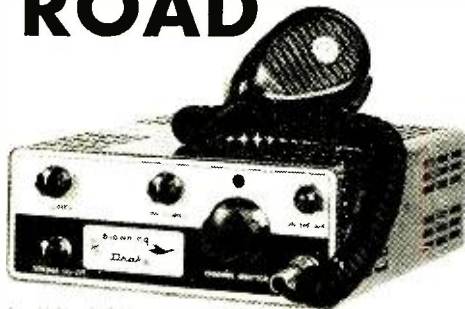

CIRCLE NO. 2 ON READER SERVICE PAGE

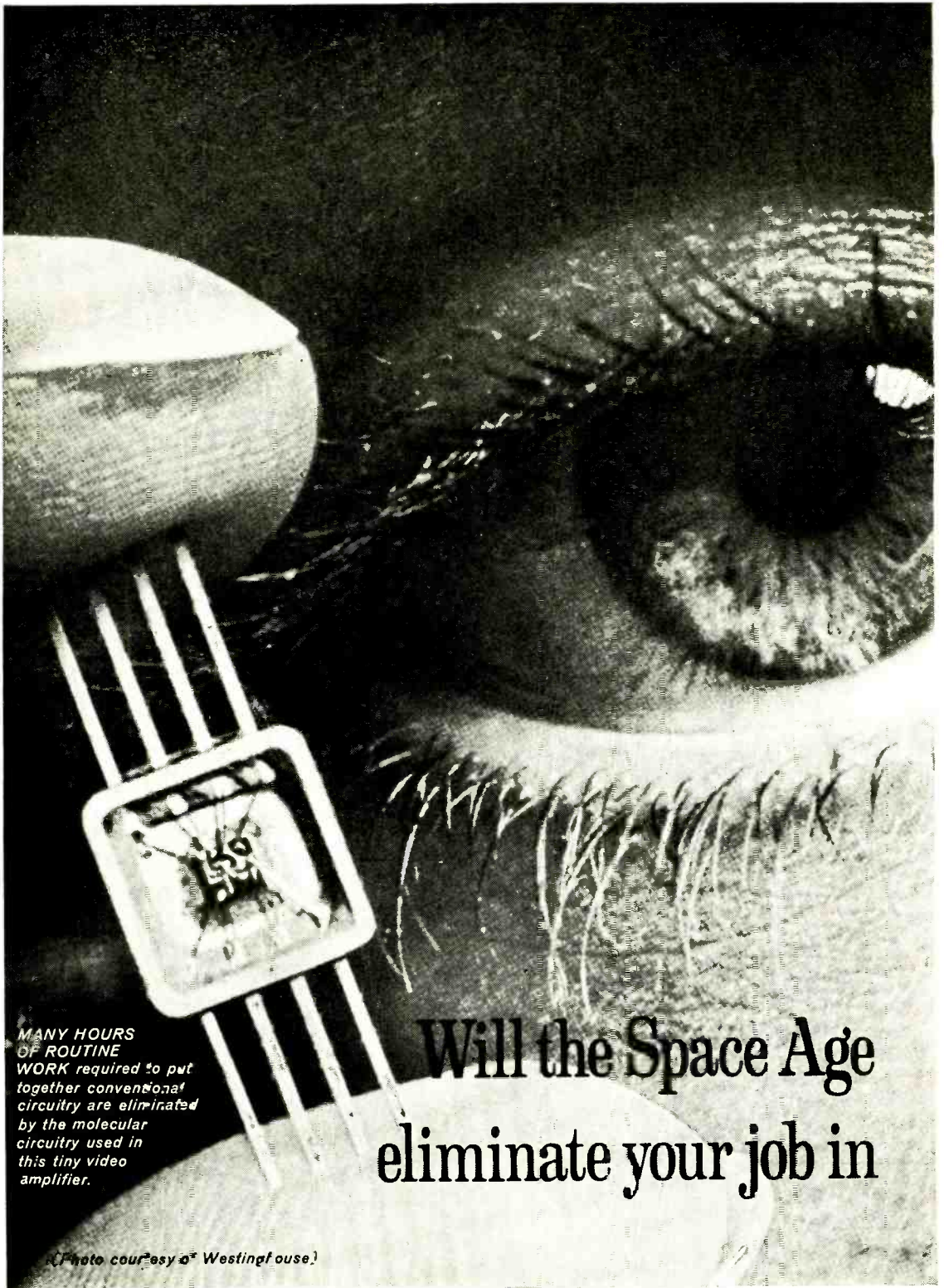

*MANY HOURS
OF ROUTINE
WORK required to put
together conventional
circuitry are eliminated
by the molecular
circuitry used in
this tiny video
amplifier.*

**Will the Space Age
eliminate your job in**

(Photo courtesy of Westinghouse.)

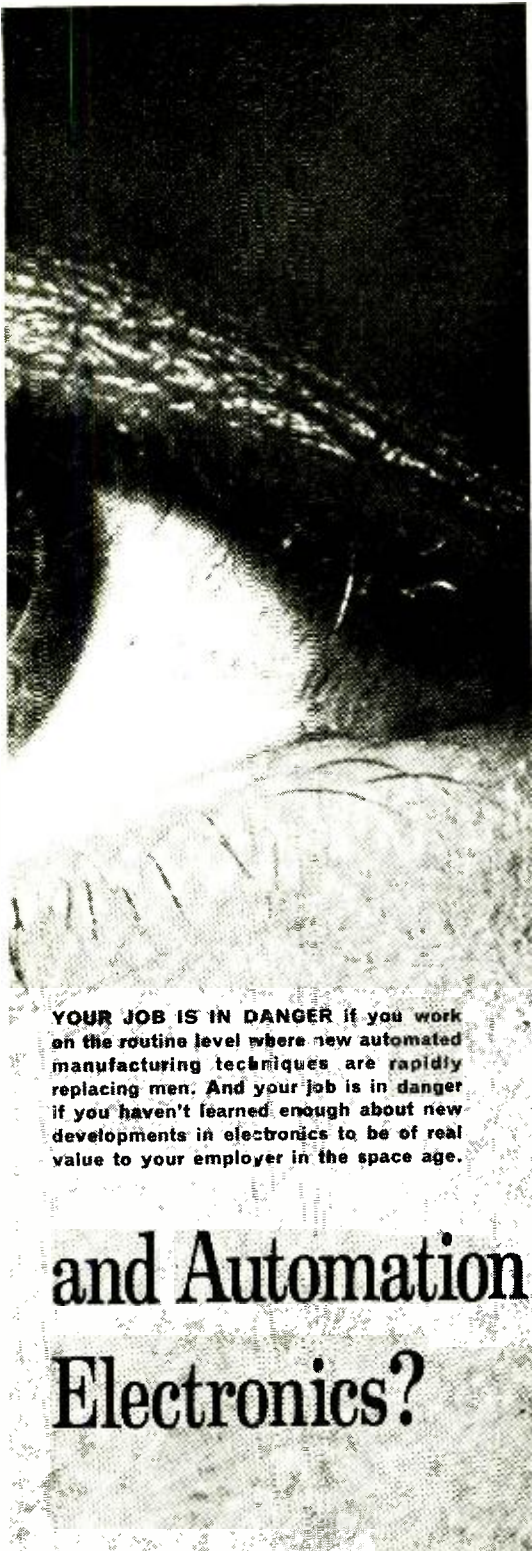

YOUR JOB IS IN DANGER if you work on the routine level where new automated manufacturing techniques are rapidly replacing men. And your job is in danger if you haven't learned enough about new developments in electronics to be of real value to your employer in the space age.

and Automation
Electronics?

Protect your future through the New CREI Programs in Space Electronics

Will the space age end your career in electronics? Or will it open up new opportunities for you? What happens depends on whether or not you supplement your education in electronics with the new knowledge needed to make you a valuable employee today. The new CREI Programs in Space Electronics offer you the up-to-date knowledge employers want and need.

SPACE DATA SYSTEMS—Includes multi-channel recording, analog to digital conversion systems, data acquisition and processing.

SPACECRAFT TRACKING AND CONTROL—Includes such areas of space technology as orbit calculation and prediction, inertial guidance, electromagnetic wave generation, space surveillance and environment.

AEROSPACE RADAR ENGINEERING—Includes specialized knowledge of surveillance radar, antennas, receivers, components and microwave equipment used in space applications.

■ The first extension programs developed specifically to help men in electronics apply their experience to the space effort.

■ Content developed to meet employment requirements as determined by consulting government and private organizations in the space field. Text material prepared in leading space-oriented organizations.

CREI also offers specialized education in these important areas of electronics: **Automation, Industrial, Nuclear, Servomechanisms, Computers, Radar, Communications, Aeronautical, Navigational and Television.**

You are eligible for these programs if you work in electronics and have a high school education.

FREE BOOK gives full information on CREI programs.



For your copy, mail postpaid card or write: CREI, Dept. 1204-C, 3224 Sixteenth St., N. W., Washington, D. C. 20010

THE CAPITOL RADIO ENGINEERING INSTITUTE
Accredited Member of the National Home Study Council



→ first
time
ever ←
→ published!



1965 FLYING ANNUAL & pilots' guide

182 pages brimming with facts, prices, performance comparisons, and featuring 23 pilot reports — with how-to articles that illustrate new techniques for increasing your flying skills — with a full-color state chart included as a handsome bonus! Don't miss the FLYING ANNUAL — it's the most valuable aviation yearbook ever compiled!

DELUXE EDITION
Leatherflex-bound
... just \$2.50!



A handsome and permanent edition that belongs in every airman's library! Great way to preserve this valuable "collector's item" for constant use all during 1965. (Check appropriate box on coupon.)

FILL IN AND MAIL THIS COUPON TODAY!

Ziff-Davis Service Division / Dept. FA
589 Broadway / New York, N.Y. 10012

Roger! Send my copy of the 1965 FLYING ANNUAL right away!

- \$1.25 (plus 15¢ for shipping and handling, 25¢ outside U.S.A.) is enclosed. Send me the regular edition.
- \$2.50 enclosed. Send me the Deluxe Leatherflex-Bound edition, **postpaid**. (Allow two extra weeks for delivery.)

NAME
ADDRESS PC 45
CITY STATE
ZIP CODE

(Payment must be enclosed with order)

writing. Dennis had 20 states and an RCC to his credit, and Vicki five states. But Dennis is now studying electrical engineering at Northeastern University; so Vicki's total should be soaring.

Samuel Vitale, K8VJU, 4372 N. off. Detroit, Mich., claims that once a ham tries RTTY (radioteletype) he finds it so interesting that he will seldom go back to any other mode of transmission. Sam uses a model 19 RTTY unit with an automatic tape unit. One thing about RTTY enthusiasts: they are usually great builders. Sam is no exception. When he got his unit, he immediately stripped it down and rewired it, built a couple of power supplies, a terminal unit, and a frequency-shift keyer. Other equipment at K8VJU includes a Heathkit "Apache" transmitter, a Mosley TA-33-40 rotary beam atop a 60' crank-up tower, and a Hammarlund HQ-145 receiver. If you can stop Sam from talking about his RTTY gear, he will admit that he has worked all states and lots of DX... **John Feltz, WN9LWJ**, 594 Walker St., Stevens Point, Wis., works all the Novice bands. A Globe Chief 90 and a Johnson "Adventure" transmitter shoot the electrons up separate doublet antennas for 80, 40, and 15 meters; the receiver is a National NC-270. Thirty-five states and three Canadian provinces have been worked, with 30 states and a couple of the Canadians confirmed, on these bands. On two meters, John's "Twoer" is tied to a 5-element beam up 35 feet.

The S.S. *Hope* will be stationed in the harbor at Conakry, Guinea, until August 15. The ham station aboard the ship has been signing W8BZB/7G1; being Maritime Mobile, it doesn't count as a DXCC country. But 7G1H, operated by Virg. WA2WUV, and other licensed *Hope* personnel, counts as a valid Guinea contact. Send QSL cards to Harold Charvat, K9BPO, 207 Mandel Lane, Prospect Heights, Ill. . . . **Stewart C. Reid, CE3UF**, El Bosque, Santiago, Chile, prefers 15 meters, where he has worked 68 countries and over 100 U.S. stations on AM phone and c.w. His "powerhouse" runs 75 watts to a pair of 807's modulated by a pair of 1625's. The receiver is an Italian 16-tube Gelloso G209. Three-element beams for 20 and 15 meters and a 40-meter dipole handle the outside work. Stewart is waiting for the arrival of a Heathkit HW-32 SSB transceiver; when it arrives and is assembled, he will be active on 20-meter SSB.

Stephen Hawley, WN4UAZ, 814 N. Fourth St., Central City, Ky., made 12 contacts in nine states his first day on the air. And by the end of the week, he had 102 contacts in 33 states logged. Now at the six-month point, Steve's record is 1098 contacts in 45 states and 13 countries. He feels that a year as an SWL helped him when he got on the air. A Heathkit DX-40 transmitter, a Lafayette HE-30 receiver, and separate dipoles for 80, 40, and 15 meters comprise the station. But when Steve's WA4 call arrives—he has already passed the exam—a Swan SW-350 SSB/A.M./c.w. transceiver will be added to the operating desk . . .

George Marzloff, W5KQN, 7237 Anno, Arabi, La., couldn't find anyone to give him the examination when he was ready for his Novice ticket; so he visited the FCC and passed the General Class exam instead. He recommends the AMECO Amateur Radio Theory Course (so does your Amateur Editor), saying that anybody who studies the book seriously *has* to be able to pass the General exam. George's Heathkit DX-20 transmitter runs 30 to 40 watts to a 40-meter dipole on 40 meters, the only band he works. A Lafayette KT-320 helps George listen; he has heard 42 states, Canada, Canal Zone, and Nicaragua answer his calls, and has the QSL cards to prove it!

We'll be looking for *your* picture and "News and Views" next month; so don't forget to send them. If possible, we would also like to see your club paper. Write to: Herb S. Brier, W9EGQ, Amateur Radio Editor, POPULAR ELECTRONICS, P.O. Box 678, Gary, Ind. 46401. 73.

Herb, W9EGQ

Short-Wave Report

(Continued from page 76)

indicated that it was prepared without the slightest interest. The stations do everything possible to create good will among the listeners, but this cannot always be a one-sided affair. If the short-wave listener wants to preserve his hobby, he should definitely observe the above-mentioned points.

"Before concluding this letter, we should like to confirm emphatically that we have had the best of experiences with the WPE stations and that many among them are on our list of permanent monitors. We wish them and their hobby the very best and we hope to receive many more pleasant reports and/or letters from them."

So there you are, Monitors. Mr. Van Eldik has presented a good case from the standpoint of the station. Make certain that your reception report is worth a verification before you send it, regardless of the station for which it is intended. You'll be doing your part in helping our hobby maintain high standards.

Current Station Reports

The following is a resume of current reports. At time of compilation all reports are as accurate as possible, but stations may change frequency and/or schedule with little or no advance notice. All times shown are Eastern Standard and the 24-hour system is used. Reports should be sent to SHORT-WAVE REPORT, P.O. Box 333, Cherry Hill, N.J., 08034, in time to reach your Short-Wave Editor by the fifth of each month; be sure to include your WPE identification, and the make and model number of your receiver. We regret that we are unable to use all of the reports received each month, due to space limitations, but we are grateful to everyone who contributes to this column.

Albania—A very rarely heard station is *R. Shkodra* on 8215 kc. It reportedly is on the air now at 0800-1000.

Angola—Due to poor reception on 9765 kc.,

Emissora Oficial de Angola has been testing on 9555 kc.—English is aired weekdays at 0510-0550 and Portuguese at 0600-0700; Eng. is also broadcast at 1215-1255 on 7235 and 9555 kc., and French at 0515-0555 on 6195 and 9700 kc. and at 0615-0655 on 6195 kc. A previously unidentified station on 11,685 kc. is *R. Diamang*, removed from 9612 kc.; it operates at 1300-1430 weekdays and at 0600-0730 on Sundays. *R. Clube do Huambo*, Nova Lisboa, has been logged on 5060 kc. from 1530 to 1559 s/off.

Australia—Melbourne's complete Eng. schedule reads as follows: to N.A. at 0714-0815 on 9580 kc. and at 2000-2245 on 15,220 and 17,840 kc.; to the British Isles and Europe at 0314-0415 on 9570 and 11,710 kc.; to the Mid-Pacific Islands at 1929-0145 on 15,240 kc., at 0159-0712 on 7190 kc., and at 1300-1615 on 11,840 kc.; to the South Pacific Islands at 0100-0415 on 9570 and 11,710 kc. and at 1300-1715 on 9600 kc.; to Indonesia, Malaysia, S., S.E., and S.W. Asia at 1714-2000 on 15,220 kc., at 1845-0430 on 17,870 kc., at 2000-0300 on 21,540 kc., at 0330-0430 on 11,880 and 15,220 kc., at 0429-1230 on 9570 kc., and at 0930-1230 on 7220 kc.; to E. Asia and N.W. Pacific Islands at 0359-0500 and 0600-0712 on 11,810 kc., at 0600-0712 on 9580 kc., and at 1559-1800 on 15,240 and 17,820 kc.

A new time station. VMG. is reportedly operating on 5500, 7500 and 12,000 kc. The 7500-kc. outlet operates continuously; the schedules of the others are not yet known. Location and other details are also unknown at press time.

Austria—*R. Osterreich* broadcasts "Deutschler-nen in Osterreich" in the European Service in Eng. on Tuesdays and Saturdays at 1330 on 6155 and 7245 kc.; in French on Saturdays and Sundays at 1230 on the same channels; in Russian on Sundays and Thursdays at 1130 on 6155, 7245, 9770 and 11,785 kc.; in Arabic on Saturdays and Sundays at 0730 on 6155, 7245, and 9770 kc. (repeated on Thursdays and Saturdays at 1030 on 6155, 7245, 9770 and 11,785 kc.); and in Spanish on Tuesdays and Thursdays at 1230 on 6155 and 7245 kc.

Brazil—Being reported for the first time, *XYA, Radiodifusora Koraima*, Boa Vista, is on 4835 kc. with 1000 watts; it has been noted in New England from 1930 to 1945 with Brazilian music and a very pleasant-sounding feminine announcer.

Burundi—*R. Burundi* is on the air at 2300-0045, 0500-0645 and 1000-1515 weekdays and at 2300-0700 and 0930-1515 Sundays on 6195 kc. They plan to add a 25-kw. xmtr during the current year.

China—Peking was noted on 9955 kc. with French ID and programming from 1500 to 1510, but it soon faded; heavy RTTY interference made reception impossible. Another station, reported as being in Kwangsi but thought to be in Nanning, on 5010 kc., has been heard at 0645-0700 with Chinese language and music.

Congo (West)—Brazzaville has replaced 11,725 kc. with 11,930 kc. for the French xmsn at 1400-1600, dual to 15,370 kc.



A COMPLETE CB SYSTEM EVERYBODY CAN AFFORD!

NEW Model H SONAR CITIZENS BAND RADIO

Nobody but nobody but SONAR can give so many quality features at this unbelievable price—yet maintain dependable performance

- Universal Solid State power supply • "Locked-Channel" receiver fine tuning • 7 internal crystal positions • External crystal 23 channel coverage • built-in squelch & automatic noise limiter for crisp, clear communications • high styled, compact and easy to install • Class B modulation • Full 5 watt input • For 12 VDC & 117 VAC only.

SONAR RADIO CORP. 73 Wortman Ave., Brooklyn 7, N. Y.

Please send me complete information on Model "H" CB Radio

Dept: 379

Name _____

Address _____

City _____

State _____

CIRCLE NO. 33 ON READER SERVICE PAGE

MOVING?

ATTACH LABEL HERE

If you've recently changed your address or plan to in the near future, be sure to notify us at once. Place magazine address label here and print your new address below.

NEW ADDRESS:

Name _____

PLEASE PRINT

Address _____

City _____ State _____ Zip _____

PLEASE FILL IN MOVING DATE BELOW:

If you have any other questions about your subscription be sure to include your magazine address label when writing us.

Mail to: POPULAR ELECTRONICS,
Portland Place, Boulder, Colorado 80301

“Use it



with any 12 volt CB transceiver”

New Cadre Selective Call encoder-decoder

Put an end to meaningless chatter at the home base and in the mobile units. Contact only the stations you want to talk to. 3-tone, fool-proof selective call system provides up to 24 different tone codes. Code can be changed in field easily with no special relay needed. Easy connection to any of the famous Cadre 5-watt CB transceivers—works with all 12 volt transceivers, regardless of make. Cadre 524, only \$69.95.



CADRE INDUSTRIES CORP.
Commercial Products Div., Endicott, N.Y.
CIRCLE NO. 3 ON READER SERVICE PAGE

SHORT-WAVE ABBREVIATIONS

c.w.	Morse code	QSL	Verification
Eng.	English	R.	Radio
ID	Identification	RTTY	Radioteletype
kc.	Kilocycles	-/off	Sign-off
kw.	Kilowatts	- on	Sign-on
N.A.	North America	xm-s-n	Transmission
QRM	Station interference	xmtr	Transmitter

Easter Island—While we do not normally list ham radio loggings in this column, a good catch for anyone is CEOAG, operated by a Canadian Medical Expedition. The station contacts VE2CBC, Montreal, daily at 1130-1200 and 1530-1600 and the frequencies of 14,110 and 21,245 kc. are most likely to be used, both for phone and c.w. xm-sns. No definite direct address is available at this time but presumably reports can be sent in care of Mr. Albert Tunis, McGill University, Montreal 2, Quebec.

Ecuador—Station HCVS6, *La Voz de Saquisilí*, 4899 kc., verified promptly, stating the frequency as 4904 kc., power as 300 watts. Their schedule is 0715-1315 and 1500-2200. Reports go to Senor Segundo Arcecio Corrales, Director.

Station HCHA2, *R. Ondas Quevedenas*, Quevedo, 2610 kc., evidently needed six reports before a reply was made. They list their 1370-kc. outlet as using no less than *eight* type 833 tubes for amplifiers with 5000 watts output; the short-wave outlet is rated at 600 watts.

England—An item in a local newspaper stated that a bill had been introduced in Parliament which would make it an offense to supply food, fuel, or advertising to the numerous pirate broadcasters operating off the British coast.

Ethiopia—Station ETLF, Addis Ababa, has an Arabic xm-s to Eastern Mediterranean areas at 1200-1325 on 7255 kc.

Germany (East)—A program schedule recently received lists xm-sns to N.A. at 2000 and 2130 on 9560 and 5970 kc. (East Coast) and at 2245 and 2345 on 9560 and 6050 kc. (West Coast). The station was noted on 11,815 kc., up from its listed 11,795 kc. channel, at 1130 ending Eng. and starting German.

Gibraltar—DX'ers wishing to log this rare country should look for MLU2, a c.w. station operating on 11,655 kc. Try for it around 0200 when it generally has a "V" running marker.

Haiti—Station 4VEB, *R. Caribees*, Port-au-Prince, was noted on 6020 kc. from 0521 to 0550 with symphonic music; and 4VEH, Cap Haitien, was noted on 9770 kc. from 0730 to 0900 with the Eng. "Back to the Bible." It has been announced that a new 1000-watt outlet will be placed on 830 kc.

India—The latest schedule from *All India Radio* shows these Eng. xm-sns: to S. E. Asia at 1330-1500 on 11,810 and 15,225 kc.; to Burma and Malaya at 0030-0910 on 6150, 7225 and 9765 kc.; to Australia and New Zealand at 1000-1100 on 11,710 and 15,165 kc. and at the same time to China and N.E. Asia on 9655, 11,700, 15,105 and 17,855 kc.; to E. Africa at 0430-0440 on 15,130 and 17,855 kc. and at 1840-1930 on 7180, 9680, 11,815 and 11,940 kc.; to W. Africa at 1945-2045 on 7125, 9690 and 11,740 kc. and at the same time to the United Kingdom and Western Europe on 6130, 7235, and 9915 kc.

An article in the *New York Times* states that India has decided to set up a 1000-kw. medium-wave xmtr in Calcutta to help counter Chinese propaganda. The decision reverses a previous one that two short-wave xmtrs would serve the purpose.

Ivory Coast—*R. Abidjan* has Eng. scheduled Mondays through Saturdays at 1330-1400 on 11,820 and 7215 kc. Another outlet has been logged on 3235 kc. at 1730 with a newscast in French.

Mauritius—Another excellent catch for the c.w. boys is GZC on 8726 kc. They run 10 kw. to a dipole. A QSL was signed by W. Aldwyn Owens,

VQ8BO. We received no time listing for this station but your Short-Wave Editor has logged it during late evening tuning.

Mexico—A new station is XEMP. *La Charita del Cuadrante*, Mexico City, on 11,737 kc.; it has been noted at 1700-1730 and later with Latin American pop tunes, and relays medium-wave XEMP, 710 kc. Station XEHH has abandoned 11,885 kc. and returned to 11,880 kc.

Nepal—Foreign reports indicate that *R. Nepal* is being logged on 4600 kc. at 0900 and earlier, and on 7105 kc. with news in Eng. and Hindi at 0400.

Netherlands Antilles—Another previously unreported frequency used at times by *Trans World Radio*, Bonaire, is 11,930 kc., noted from 1450 to 1502 s/off. Many other reports indicate that this station is being heard in virtually all parts of N.A. on many short-wave channels and, evenings, on 800 kc., with QRM generally limited to the mid-

SHORT-WAVE CONTRIBUTORS

Walter Foy (*WPE1AED*), Springfield, Mass.
 Ernest Zecchini (*WPE1CIH*), Lawrence, Mass.
 Gerry Cohen (*WPE1FNT*), West Hartford, Conn.
 David Smith (*WPE1GBC*), Everett, Mass.
 Riley Sundstrom (*WPE2AJ*), Stockton, N. J.
 R. Joslin (*WPE2BTO*), Camden, N. J.
 Frank Brandon (*WPE2ESP*), Schuylerville, N. Y.
 Paul Harig (*WPE2GCX*), Auburn, N. Y.
 Robert Wechsler (*WPE2IGE*), Brooklyn, N. Y.
 Ben Stanilka (*WPE2IYW*), Ticonderoga, N. Y.
 Leslie Glanz (*WPE2JDO*), Brooklyn, N. Y.
 Eric Lebowitz (*WPE2JH*), Jackson Heights, N. Y.
 William Graham (*WPE2LMU*), Binghamton, N. Y.
 Stephen Dionne (*WPE2LOU*), Binghamton, N. Y.
 Mike Esposito (*WPE2MFO*), Brooklyn, N. Y.
 Bernard Greene (*WPE2MNI*), Brooklyn, N. Y.
 Douglas Lamerson (*WPE2MNV*), Richmond Hill, N. Y.
 Charles Coombe (*WPE2MOB*), Trenton, N. J.
 William Kasperkoski (*WPE2MRL*), Ontario, N. Y.
 Charles Schwartzbard (*WPE2TA*), Passaic, N. J.
 Robert Naale (*WPE3DIX*), Allentown, Pa.
 George Gorsline, Jr. (*WPE3EFF*), State College, Pa.
 Walter Pyne (*WPE3ETH*), Hagerstown, Md.
 Jack Pleska (*WPE3EUN*), Simpson, Pa.
 Wayne Blair (*WPE3FAZ*), Altoona, Pa.
 Paul Baker (*WPE3FWO*), Waynesboro, Pa.
 Grady Ferguson (*WPE3BC*), Charlotte, N. C.
 Chuck Edwards (*WPE3BNK*), Fort Lauderdale, Fla.
 Edward Odum (*WPE4EDQ*), Mobile, Ala.
 Bruce Churchill (*WPE4EVD*), Virginia Beach, Va.
 Kenneth Alyta, Jr. (*WPE4FYB*), Charlotte, N. C.
 Marc Arenstein (*WPE4GSP*), Richmond, Va.
 David Jones (*WPE4HID*), Albany, Ga.
 Bobby Conder (*WPE4HOT*), Winston-Salem, N. C.
 Robert Davis (*WPE5AUR*), San Antonio, Texas
 Jack Keene (*WPE5BMP*), Houston, Texas
 Del Hirst (*WPE5CFU*), Snyder, Texas
 Jack Page, Jr. (*WPE5DXH*), Pontotoc, Miss.
 Shafer Hanish (*WPE6BPN*), Hartford, Conn.
 Wally Hackett (*WPE6EFA*), Los Angeles, Calif.
 Mark Donnell (*WPE6FRJ*), San Jose, Calif.
 John Gleason (*WPE6FW*), San Bruno, Calif.
 Richard England (*WPE8FY*), Utica, Mich.
 Alexander Chyrtta (*WPE8FZY*), Campbell, Ohio
 Kenneth Rosen (*WPE8HSZ*), Detroit, Mich.
 R. D. Palmer (*WPE8AST*), Decatur, Ill.
 Ray Fansler (*WPE9CQC*), Fairfield, Ill.
 Irwin Tatelman (*WPE9HIF*), Chicago, Ill.
 John Beaver, Sr. (*WPE9EAE*), Pueblo, Colo.
 Jack Perolo (*WPE10PEIC*), San Paulo, Brazil
 Dave Mitchell (*WPE11AR*), Burnaby, B. C., Canada
 David Ballentine, Pine Grove, W. Va.
 Joe Esser, New Kensington, Pa.
 Ron Geise, Elkhorn, Wis.
 George Gray, Brookfield, Ill.
 Jim Keller, Grandview, Mo.
 Joe Piechuta, Meriden, Conn.
 Jim Preston, Reedsville, W. Va.
 Dave Schmidt, Green Ridge, Pa.
 Gale Shafer, Deming, Wash.
All-India Radio, New Delhi, India
Radio New York Worldwide, New York, N. Y.
Sweden Calling DX'ers Bulletin

**"On the same plane as
 Scott factory-wired units...
 Excellent"** (AMERICAN RECORD GUIDE)



Audio experts agree . . . Scott kits consistently deliver the finest performance on the market. Scott kits are designed to the same rigid standards as factory-wired units.

The LT-110B FM stereo tuner features Sonic Stereo Monitor and factory-wired "front end" and Time-Switching multiplex sections. 2.0 μ v IHFM sensitivity. \$139.95.

LK-72B 80-watt Stereo Amplifier Kit . . . a perfect match, in both looks and performance. \$149.95

FREE 20-PAGE BOOKLET

Rush me Scott's free 20-page Custom Stereo Guide: 520-04

Name _____ Address _____

City _____ State _____ Zip _____



H. H. SCOTT, INC., 111 Powdermill Rd., Maynard, Mass. Export:
 Scott International, Maynard, Mass. Cable HIFI

CIRCLE NO. 30 ON READER SERVICE PAGE

\$130 → PROFIT
RACE DAY **DON'T SHOOT IN THE DARK**
GET RIGHT ON THE TARGET

Sensational book reveals secrets of 10 world's greatest professional race investors. 25 yrs. actual results included. Shows 7 in 10 plays won and \$130 average race day profit with \$50.

BOOK CONTAINS—

THE WASHINGTON "WONDER" SYSTEM—A PROVED FORTUNE SPINNER. Over 20 years spent finding out exactly why horses lose, and exactly why horses win, and in even further perfecting and improving this wonderful professional backers method.

THE NEW YORK "GOLDEN-DOLLAR" SYSTEM—A sparkling truly "golden" and ingenious method with a really fantastic winning potential. Considered to be the "zenith" of all systems. Invented after many years of the most scrupulous study and painstaking research.

THE IRISH "GOLDEN-SHAMROCK" SYSTEM—A very fine money spinning system which has a terrific appeal because of its ingenious method of selection. The favorite system of the inventor—a professional backer in that country.

THE ENGLISH "BRITISH-BULLDOG" SYSTEM—This is a verifiable master plan, formerly used exclusively by the English highly successful backer who invented same. A truly wonderful piece of work.

THE GERMAN "BERLIN-BEAUTY" SYSTEM—A very cleverly conceived and well tried method which the professional backer who invented same claims to be the best in the world.

THE ITALIAN "TREASURE" SYSTEM—A highly ingenious method with an amazing potential of almost limitless winnings. Invented and perfected by the most clever professional backer in Italy.

THE CANADIAN "EL DORADO" SYSTEM—Invented by a professional backer who has been acclaimed a racing genius, this system brings almost unbelievably wonderful results.

THE AFRICAN "WONDER-DIAMOND" SYSTEM—Clever reasoning, countless years of investigation and research has made this system one of the very best in the world.

THE DUTCH "HEAVENLY" SYSTEM—A method with a fantastic winning potential invented by Holland's top professional backer.

THE FRENCH "MAGNIFICENT" SYSTEM—This one too is a real "gold mine" and truly "magnificent." The professional backer who invented same claims it to be unbeatable.

Genuine copyright book supplied only by publishers. Wins at all tracks, horses, harness, dogs. Send coupon for fascinating free brochure: Hitchings Box 5715 PE-A, Carmel, Calif.

Hitchings Box 5715 PE-A, Carmel, Calif.
 (Please send Free Brochure)

Name _____

Address _____

City _____ State _____

CIRCLE NO. 13 ON READER SERVICE PAGE

western states (CKLW, Windsor, Ont.) and far southwestern areas (XELO, Mexico).

Peru—*R. Onda Azul*, Puno, 4801 kc., finally verified after three years of trying on the part of the reporter. It is noted around 2100 with cultural programs. The address is: P. O. Box 112, Puno.

Tentatively logged was OAX5V. *R. Villarica, Radiodifusora Huancavelica*, 4885 kc., with pop waltzes to 1745, then Latin American music. Station OAX4S, *R. Onda Popular*, Lima, 6260 kc., was heard at 1930-2030 with pop Spanish music and ID's every five minutes; reports go to Av. Franklin D. Roosevelt 105, Lima, Peru.

One of the surest ways to verify Peru is via

OCB26, a station of All America Cables & Radio, Inc., Lima, on 7640 kc. It usually transmits around 2300 with receiver adjustment tests. Reports go to Casilla 2336, Lima.

Poland—Warsaw's latest schedule shows Eng. to the British Isles at 1330-1357, 1430-1500 and 1630-1655 on 6135 and 7125 kc., at 1530-1600 on 5950 and 7145 kc., and at 1730-1800 on 5950 and 9540 kc. Other overseas Eng. xmsns are at 0230-0300 and 0330-0400 on 9675, 11,840 and 15,120 kc.

Portugal—Lisbon has been noted with its "Voice of the West" program at 1310 on 17,740 kc.

Reunion—*Radiodiffusion Television Francaise*, St. Denis, now operates as follows: Sundays to

DX States Awards Presented

To be eligible for one of the DX States Awards designed for WPE Monitor Certificate holders, you must have verified stations (any frequency or service) in 20, 30, 40, or 50 different states in the U.S. The following DX'ers have qualified for and received awards in the categories indicated.

Thirty States Verified

William Woodfield (WPE4HGT), Norfolk, Va.
Ronald L. Koch (WPE9GJS), Skokie, Ill.
John Schnell (WPE9GLS), West Bend, Wis.
Reg. Firth (WPE2GJO), Amsterdam, N. Y.
Walter McCabe (WPE3EPW), Williamsport, Md.
David Rogers (WPE5DRJ), Buffalo, Okla.
R. Stephen Dildine Jr. (WPE5CUO), Los Alamos, N. M.
Douglas E. Byron (WPE2LAR), Poughkeepsie, N. Y.
Viktor K. Decyk (WPE1FCD), Colrain, Mass.
V. W. Matlack (WPE0EAQ), Ames, Iowa
Mike Glover (WPE4GCZ), Denver, Colo.
Harvey Stern (WPE2HSQ), New York, N. Y.
David Bennett (VE7PE1R), Richmond, B. C., Canada
Paul Herman Jr. (WPE9GZP), Chicago, Ill.
Mike Wilson (VE6PE4N), Calgary, Alta., Canada
Alan L. Michalek (WPE1CRM), Springfield, Mass.
Mike Shannon (WPE9HDX), Appleton, Wis.
Eugene Bond Jr. (WPE2JHW), Moorestown, N. J.
Victor Lipinski (WPE4HTV), Alexandria, Va.
Kenneth L. Gartland (VE1PE7M), Windsor, Nova Scotia
Robert Osowicki (WPE2LVD), Amsterdam, N. Y.
Robert A. Howell (WPE8GXG), East Lansing, Mich.
David Lee Evans (WPE8GCX), Pataskala, Ohio
Jeff Tallent (WPE4HUZ), Louisville, Ky.
Chas. J. Matterer (WPE6DGA), San Leandro, Calif.
James E. McDonald (WPE0CYR), Mason City, Iowa
Dennis R. Rodgers (WPE8HXY), Saginaw, Mich.
William Campbell (WPE2JHA), Canandaigua, N. Y.
Bruce Drewett (WPE4GXG), Miami, Fla.
Conrad R. Durocher (WPE1ASP), Framingham, Mass.
William Kilroy (WPE3FOB), Washington, D. C.
Edward H. Rollfs (WPE1FNU), Topsfield, Mass.
Richard Clinard (WPE4GNV), Madison, Tenn.
Howard Weber (WPE6EIS), Maywood, Calif.
Jerry Florance (WPE2DB), Butler, N. J.
James Meinken (WPE9HDM), Evanston, Ill.
Larry Lehmer (WPE0CRW), Council Bluffs, Iowa
Vincent DeMeis (WPE3FEE), Philadelphia, Pa.
Hugh Ducklow (WPE9GZN), Appleton, Wis.
Arthur W. Peterson (WPE6FMV), San Pablo, Calif.
Edward A. Smith (WPE7AVQ), Corvallis, Oreg.
David Chaffin (WPE4HJZ), Chattanooga, Tenn.
Michael Cripps (WPE0DTV), St. Louis, Mo.
Joel Resnick (WPE2LMZ), New York, N. Y.
Douglas Stark (WPE4FSX), Bethesda, Md.
Ira Stoler (WPE2LZG), Brooklyn, N. Y.

Twenty States Verified

Tim Bartholow (WPE8HYA), Cambridge, Ohio
James L. Kowalski (WPE9GZB), Two Rivers, Wis.

Pete Sils (WPE0EAX), Cedar Falls, Iowa
William A. Gode (WPE9GUP), Northbrook, Ill.
Benjamin Abell III (WPE3BCA), Houghesville, Md.
Brent H. Holcomb (WPE4HLH), Clinton, S. C.
Francis Domineski (WPE3EPB), Wellsboro, Pa.
Earl B. Frederick (WPE3EFZ), Lancaster, Pa.
John Bouck Jr. (WPE0EDS), Kansas City, Mo.
Larry E. George (WPE8IAV), Streetsboro, Ohio
Allan S. Jones (VE3PE2AM), Islington, Ont., Canada

Mark Clark (WPE9EQQ), Rockford, Ill.
George N. Kovatch (WPE3FYL), Hazleton, Pa.
Alan Burnley (WPE2MRJ), Westfield, N. J.
Chris Lieberz (WPE6FLD), Los Angeles, Calif.
Ron Slinger (WPE7BNA), North Bend, Oreg.
Jim Kline (WPE9DZP), Genoa, Ill.
Robert Jernoske (WPE2KBA), Paulsboro, N. J.
Steve Kerrel (WPE4FZZ), Chester, Va.
Gordon E. Fish (WPE4HEJ), Salem, Va.
Doug McAbee (WPE8HLZ), Goodrich, Mich.
John Kennerdell (WPE2GZO), Orchard Park, N. Y.
T. Fleming (WPE2LMY), Albany, N. Y.
Richard Luecke (WPE9GKZ), Des Plaines, Ill.
Edward Zebrowski (WPE1FTG), Holyoke, Mass.
Irwin Tatelman (WPE9HIF), Chicago, Ill.
Jack W. Kallmeyer (WPE8GYZ), Kettering, Ohio
Dennis Skupien (WPE9DJL), Chicago, Ill.
Jay Booth (WPE3FUN), Wilmington, Del.
David C. Miller (WPE2MNS), Medina, N. Y.
Louis Votto (WPE1GAI), Hamden, Conn.
Joseph V. Muckin (WPE2MKF), Spotswood, N. J.
Brian Begg (WPE2IPR), Milltown, N. J.
Ben Ludeman (WPE5CQI), Cotulla, Tex.
Charles Maier (WPE3FXJ), Baltimore, Md.
Dan S. Parker (WPE7CAV), Pocatello, Idaho
John Brush (WPE3FZD), Coraopolis, Pa.
James P. Foley (WPE9GOI), Milwaukee, Wis.
Stephen W. Saffler (WPE1FNV), Brockton, Mass.
Carl J. Swanson (WPE6DTJ), Fremont, Calif.
James Moore (WPE4GOI), Nashville, Tenn.
Walt Mixon (WPE5EAK), Jackson, Miss.
Tom Lane (WPE9HFI), Rockford, Ill.
A. R. Brownsberger (VE3PE2DM), Toronto, Ont., Canada

Marshall Salt (WPE3ERC), Reading, Pa.
Howard Sherer (WPE2LTP), Albany, N. Y.
Bradley Connors (WPE3FWZ), Chevy Chase, Md.
William White (WPE4IBE), Augusta, Ga.
Roger Thering (WPE6FUB), Barstow, Calif.
Douglas Messimer (WPE3FMZ), Enola, Pa.
Henry B. Henderson (WPE4IAV), Halifax, Va.
Richard Lauhead (WPE0DTX), Edwood, Nebr.
Donald G. Bulgin (VE3PE1IC), Toronto, Ont., Canada
Timmy Towerly (WPE5DRA), Port Arthur, Tex.
Edward Jacobson (WPE2JEL), Westburn, N.Y.
Stuart R. Fichtner (WPE8HWH), Vandalia, Ohio

Thursdays at 2130-2245 on 2246, 3380 and 4807 kc.; Mondays to Fridays at 0230-0445 on 3380, 4807 and 7245 kc. and at 0900-1300 on 2246, 3380 and 4807 kc.; also Fridays at 2130-2245, Saturdays at 0800-1330 and 2200-0000, and Sundays at 0800-1300, all on 2246, 3380, and 4807 kc.; and Saturdays at 0230-0800 and Sundays at 0000-0800 on 3380, 4807, and 7245 kc. The power on 3380 kc. is 1500 watts; other channels are rated at 4 kw.

Saudi Arabia—Djeddah is heard on 9670 kc. at 2357-0030 with talks in Arabic and Latin American music. New xmt's were recently placed in service on 11,855 kc. at 1400, dual to 9670 kc., in Arabic.

Senegal—DX'ers who want to verify Dakar air radio should tune to 5596.5, 8896.5, or 11,385 kc. at 15 and 45 minutes past the hour for weather reports. The vocal ID is *Attention, Attention, Ici Dakar*. Reports go to A. C. Gerard, B. P. 8072, Dakar, Senegal. (You might enclose a selection of U.S. postage stamps—the gentleman is a collector.) Dakar also operates on 8820, 6612, and 8879 kc. 24 hours daily with aeronautical information.

South Africa—The *R. Highveld* program is now noted on 9500 kc. from 1530 with pop music and ads in Afrikaans and Eng.; there is an Eng. newscast earlier at 1400. *Springbok Radio*, 9720 kc., is heard from 0000 s/on with Eng. pop music and ads and an Eng. newscast at 0030. The Africa Service is broadcast weekdays at 2200-2300 on 6150 and 7270 kc., at 0500-0800 on 15,220 and 17,805 kc., at 0800-1120 on 11,900 and 15,220 kc., at 1120-1300 on 9525 and 11,900 kc., and at 1300 to close on 7270 and 9525 kc.

Spanish Guinea—Strong in the east and excellent on the West Coast is EAJ206. *R. Ecuatorial*, Bata, on 4926 kc. from around 1625 to 1704/close (east) and the extended Saturday schedule at 1800-1830 (west) with all-Spanish music and newscasts. This station provides West Coasters with a good chance to log this rare country.

Sweden—A new omnidirectional xmsn from Stockholm on 9620 kc. includes German at 0430-0500, French to 0530, Swedish to 0600, and Eng. to 0630.

Uganda—*R. Uganda*, Kampala, is now scheduled as follows: Red Network at 2245-0045 and 0900-1602 on 3340 and 4976 kc. and at 0100-0630 on 3340 and 7195 kc.; Blue Network at 2245-0045 and 0900-1602 on 5026 kc. and at 0100-0630 on 7110 kc. Both networks use Eng. and various local dialects. Reports are welcomed.

U.S.S.R.—*R. Moscow*, Komsomolsk, Siberia, is heard on 7280 kc. from 0450 to 0516/fade in Japanese with Russian music. ID: *Kochira Moskau Hoso Desu*.

Venezuela—Station YVOC, San Cristobal, is heard on 4980 kc. at 1900-2000 with Latin American and old U.S. pop records of the 1930's and 1940's, news in Spanish, and frequent commercials and announcements.

Windward Islands—St. Georges is now operating on 2415 kc. at 1740-2115. The 5010-kc. channel is in use until 1735, the 3280-kc. outlet at 1700-2115.



SWITCHCRAFT®

**FIND THE
PRECISE
AUDIO
ACCESSORY
YOU NEED
FAST!**

- Jacks
- Plugs
- Adaptors
- Couplers
- Extension
Jacks
- Speaker
Controls
- "Mini-Mix"—
mixers, etc.

look for the

AUDIO ACCESSORY SELF-SERVICE CENTER

At last! All the confusion and "wait" gone. Fail-Safe quality. Packages factory sealed, precisely labeled by name, type, mating part, price. Guaranteed.

Send for Complete Catalog:

SWITCHCRAFT, INCORPORATED
5563 No. Elston Ave., Chicago, Illinois 60630

CIRCLE NO. 35 ON READER SERVICE PAGE

SAY YOU SAW

IT IN

POPULAR ELECTRONICS

**FREE! NEW CAREER GUIDE TO
Success in ELECTRONICS**



Automation, Math—Basic or Advanced
Wide choice of new Home Study Programs to prepare you for well paying career or advancement in present job. Choose Service, Broadcasting, Industrial, Automation. We assist you in choosing best program . . . save time and money. Tuition refund surety. Since 1931. Write today—

CENTRAL TECHNICAL INSTITUTE
Dept. 01045, 1644 Wyandotte St. • Kansas City, Mo. 64108

NEW PORTABLE VACU VISE® WITH FREE GIFT



TO HOLD:
Lightly hold Vacu-Vise
in place. Turn down
Vacu-Lever with
finger-tip.

TO RELEASE:
Release Vacu-Lever
with finger-tip.
Vacu-Vise lifts off.

**ONLY
\$6.95**

**NO CLAMPS! NO SCREWS!
ATTACHES INSTANTLY, HOLDS SECURELY**

**Will not mar furniture
or table tops!**

**For The "DO IT YOURSELFER"
For The REPAIRMAN
For The MAN WHO NEEDS
A THIRD HAND**



Holds firmly in
any position.

You'll wonder how you ever got along before you had the new VACU-VISE with "Super Vacuum" Power that HOLDS . . . it's like having a third hand . . . anywhere . . . on the job . . . right where you need it. No Clamps—No Screws—the Super Vacuum base does it all for you! Just one turn of a Vacu-Lever (use your finger-tip . . . no strength needed) and VACU-VISE holds firm and fast to any smooth non-porous surface such as Formica, Linoleum, metal, glass, etc. Large 2½" jaws with "V" grooves hold your work firmly to table top—bench. Completely portable—weighs only 3 lbs.



FREE GIFT

Order immediately and receive FREE a set of Vacu Vise SLIDE ON Rubber Jaws for use when working on fragile or delicate materials.

WARRANTED FOR ONE YEAR!
Will be replaced without charge in the event of any defect arising from normal use.

CONSUMER SERVICE COMPANY
160 Mercer St., New York, N. Y. 10012

Enclosed is \$_____ for _____ Vacu Vise at \$6.95 ea. plus 55¢ ea. for postage and handling. (N. Y. C. residents please add 4% sales tax.) Foreign orders \$1.15 additional.

Name _____ (please print)

Address _____

City _____ State _____ Zip Code _____

Sorry—No Charges or C.O.D. orders. PE-45

Conar Novice Ham Station

(Continued from page 68)

Model 500 Receiver. Multipurpose tubes and a semiconductor rectifier give the Conar receiver the performance of an 8-tube unit, although only 4 tubes are used. The circuit consists of a converter, two i.f. stages, and two stages of audio. A separate BFO stage permits reception of c.w. and SSB signals.

Essentially, the receiver covers the same bands as the transmitter, 80, 40, and 15 meters, with some overlap. The large knob and slow tuning ratio of the unit makes tuning a snap—even SSB signals can easily be rendered intelligible. Other advantages of the receiver design are an antenna trimmer for peaking up signals, a variable i.f. gain control, and a built-in speaker. The receiver is also transformer-operated, and the cabinet and panel design matches that of the transmitter.

Assembly. Although both the Model 400 transmitter and the Model 500 receiver are available in wired form, most Novices will undoubtedly want to put together their own units. An excellent feature of the kits are the large, two-color pictorial diagrams with assembly instructions printed on them. With the information provided, either unit can be put together in an evening or two.

The Model 400 transmitter is priced at \$32.50 in kit form and \$46.50 wired; the Model 500 receiver sells for \$37.50 as a kit, and \$56.50 fully wired. Both units are available as a "package" at \$64 (kits), or \$97 (wired). As an additional bonus, a copy of the ARRL *Radio Amateur's License Manual* is included with the purchase of both kits.

Taking their low prices into consideration, the units wired and tested by POPULAR ELECTRONICS left little to be desired in terms of performance, appearance, ease of construction, or operating convenience. Together, the Model 400 transmitter and Model 500 receiver should prove to be a popular combination for the newcomer to the amateur radio fraternity.

-30-

Circle No. 86 on Reader Service Page 15

POPULAR ELECTRONICS

ELECTRONICS MARKET PLACE

COMMERCIAL RATE: For firms or individuals offering commercial products or services. 75¢ per word (including name and address). Minimum order \$7.50. Payment must accompany copy except when ads are placed by accredited advertising agencies. Frequency discount: 5% for 6 months; 10% for 12 months paid in advance.

READER RATE: For individuals with a personal item to buy or sell. 45¢ per word (including name and address). No Minimum! Payment must accompany copy.

FOR SALE

FREE! Giant bargain catalog on transistors, diodes, rectifiers, components, valuable parts, equipment. Poly Paks, P.O. Box 942, Lynnfield, Mass.

GOVERNMENT Surplus Receivers, Transmitters, Snooper-scopes, Radios, Parts, Picture Catalog 20¢. Meshna, Nahant, Mass.

TRANS-NITION electronic ignition parts kit. Negative ground \$20.00. Coil, Manual special \$8.50. Manual \$2.00. Anderson Engineering, Epsom, New Hampshire.

DIAGRAMS for repairing Radios \$1.00. Television \$2.50. Give make model. Diagram Service, Box 1151 PE, Manchester, Connecticut 06042.

ROCKETS: Ideal for miniature transmitter tests. New illustrated catalog, 25¢. Single and multistage kits, cones, engines, launchers, trackers, technical information, etc. Fast service. Estes Industries, Penrose 18, Colorado.

CB WPE QSL Cards, Samples Free. Radio Press, Box 24, Pittstown, New Jersey.

"SPECIAL! WPE-SWL-CB-QSL cards, 3 colors, \$2.50 per 100—Free Samples, Garth, Jutland, New Jersey."

TRANSISTORIZED Products Importers catalog, \$1.00, Intercontinental, CPO 1717, Tokyo, Japan.

CANADIANS—GIANT Surplus Bargain Packed Catalogs. Electronics, Hi-Fi, Shortwave, Amateur, Citizens Radio. Rush \$1.00 (Refunded). ETCO, Dept. Z., Box 741, Montreal, CANADA.

TV CAMERAS, transmitters, converters, etc. Lowest factory prices. Catalog 10¢. Vanguard, 190-48 99th Ave., Hollis, N.Y. 11423.

WEBBER Labs. Transistorized converter kit \$5.00. Two models using car radio 30-50Mc or 100-200Mc, one Mc spread. Easily constructed. Webber, 40 Morris, Lynn, Mass.

JAPAN & Hong Kong Electronics Directory. Products, components, supplies. 50 firms—just \$1.00. Ippano Kaisha Ltd., Box 6266, Spokane, Washington 99207.

DIAGRAMS Radios \$1.00 Televisions \$1.00. Schematics, 618 Fourth Street, Newark, New Jersey 07107.

CANADIANS, TRANSISTORS AND PARTS. Free catalogue contains reference data on 300 transistors. J. & J. Electronics, Box 1437, Winnipeg, Manitoba.

CB QSL-WPE-SWL cards—Attractive 2 & 3 colors, glossy white. Call records books, Plastic card holders, Warning, Police, Gag, Call letter signs, Plastic badges, Maps, etc. Send 25¢ (refundable) for catalog No. 107. WOODY, 2611 Shenandoah, St. Louis, Mo. 63104.

CB-WPE-QSL CARDS. New "FROSTALEEN" Paper. **16 SAMPLES,** 25¢. Dick, W8VXK, 1996P N, M-18 Gladwin, Michigan 48624.

COMPONENTS? Kits? Hardware? For catalogue write Trans-Vu-Pacs, Box 267, Chelsea, Mass. 02150.

CB QSLs \$2.00 per 100 postpaid. Free sample. Hobby Print Shop, Umatilla, Fla. 32784.

PRINTED CIRCUIT BOARDS. Hams, Experimenters. Catalog 10¢. P/M Electronics, Box 6288, Seattle, Wash. 98188.

GENERAL INFORMATION: First word in all ads set in bold caps at no extra charge. Additional words may be set in bold caps at 10¢ extra per word. All copy subject to publisher's approval. Closing Date: 1st of the 2nd preceding month (for example, March issue closes January 1st). Send order and remittance to: Hal Cymes, POPULAR ELECTRONICS, One Park Avenue, New York, New York 10016.

INVESTIGATORS, FREE BROCHURE, LATEST SUBMINIATURE ELECTRONIC SURVEILLANCE EQUIPMENT. ACE ELECTRONICS, 11500-L NW 7TH AVE., MIAMI 50, FLA.

CITIZEN BANDERS! Get base station Performance with your mobile units. No modifications or soldering necessary. Proven performance. Send for free details or send (\$15.00) to: T. Francis, 15 Park Row, N.Y. 38, N.Y.

HEAR AIRCRAFT, TOWER EMERGENCIES, WEATHER. 9 transistor AM-FM, VHF aircraft portable pocket receiver. Complete \$26.50. Free details. **BUILD TINY ULTRA-SENSITIVE FM WIRELESS MIKE** transmits 200'. Instructions only. \$4.95. Parts available from us. TRANSCO, Box 13482 North Country Branch, St. Louis, Mo. 63138.

ACHTUNG! Das machine is nicht fur Gerfingerpoken und mittengraben. Is easy schnappen der Springenwerk, blowenfusen und poppencornen mit spitzensparken. Ist nicht fur gewerken by das Dummkopfen. Das rubbernecken sightseeren keepen hands in das pockets. Relaxen und watch das Blinkenlights. This attractive, engraved metal plaque only \$2.00 each. ppd. Southwest Agents, Dept. P, Box 12283, Fort Worth, Texas 76116.

WALKIE-TALKIE. Construct 2"x1"x1/2" transistorized, long range, 100 milliwatt marvel for \$10. Plans, **FREE GIFT,** \$2.00. Baker Electronics, R.R. 1, Greencastle, Ind.

LASER: Hobbyists, experimenters, amateur scientists. Build your own coherent-light optical laser. Complete instructions, schematic diagrams and parts list. \$6.00. Same as above, diode laser. \$3.00. Technical Writers Group, Box 5501, State College Station, Raleigh, N.C.

REVERBERATOR (Echo) UNIT—Build your own. Complete plans, schematic parts list—\$3.00. Use with automobile radio, home radio, or record player. Technical Writers Group, Box 5501, State College Station, Raleigh, N.C.

QSL-CB-SWL (Letters)—Cards Printed; Samples 10¢. **MARTIN,** 828-B Schuylkill Avenue, Reading, Pa.

QSL'S \$1.75/100 up. Catalogue-samples 10¢. Longbrook, Box 393-Y, Quakertown, N.J. 08868.

TRANSISTOR IGNITION described June 1963 Popular Electronics, "Operation Pickup." Complete kit guaranteed components. Now only \$13.95. **NEW MODEL T-1A** including special DELCO transistor and 400:1 coil. Complete kit, \$16.95. Factory wired, \$18.95. **MONEY BACK GUARANTEE.** Specify make, year of Car. **ELECTROMART,** 1616 South 81st Street, Milwaukee, Wisconsin 53214.

NEW MAGNETIC DEVICE—Engineers, Inventors, Experimenters, Hobbies. Latest Theory in Basic Magnetism. Create new Products by Experimenting with the Magnetic Ladder Acceleration Solenoid using D.C. Plans \$1.00. Jesse Costa, Box 26, Waquoit, Mass. 02570.

\$1.00 DELIVERS Plastic Packets for 60 QSL's. TEPABCO, Brown Blvd., Gallatin, Tennessee.

MERCURY Wetted Relays SPDT, 5 amp Contacts 2/\$5. List 10¢. Fertik's, 9th Tioga, Phila., Pa. 19140.

CB CARDS—Economy line. Some low as \$1.50 hundred. Send 10¢ for samples. Signal, Adams County, Manchester, Ohio.

WAIT! Is that condenser you are about to use from your junk box good or bad? Be sure! Check it with a Model C-85 condenser checker. \$5.50. Central Manufacturing Co., Opelika, Alabama.

HUGE excess inventory of new electronic components. \$1.00 buys \$10.00 worth of top quality resistors, transistors, capacitors, relays, etc. Don't miss this fabulous bargain, send \$1.00 per box to Baker Electronics, R.R. 1, Greencastle, Indiana, for prompt, postpaid delivery. Satisfaction guaranteed.

NGK Spark Plugs. Cooper electrode gives 3 times wider heat range. 40% Longer Life. \$1.10 each. Box 3, 1861 Hyde, San Francisco 94109.

NEW Supersensitive transistor locators detect buried gold, silver, coins. Kits, assembled models. \$19.95 up. Underwater models available. Free catalog. Relco-A33, Box 10563, Houston 18, Texas.

CONVERT any television to sensitive, big-screen oscilloscope. Only minor changes required. No electronic experience necessary. Illustrated plans, \$2.00. Relco Industries, Box 10563, Houston 18, Texas.

RAY GUN—Want to build a Laser? Shoots a pencil-thin beam of light, burns anything in its path, even diamonds! You can build our model for about \$40.00! Blue-prints, directions, price and parts lists, only \$9.95 ppd. M J Research Company, 7110 Cedar, Shawnee Mission, Kansas.

INVESTIGATORS—Electronic surveillance devices. Price breakthrough on ultra miniature professional devices. Free details. Trol Electronics-PE, 342 Madison Avenue, New York, N.Y.

PRINTED Circuit Boards—Parts Kits for "Poptronics" projects. Free catalog. DEMCO, Box 16041, San Antonio, Texas 78216.

TELEPHONE Voice Switch: (LS-500). Actuates automatically and unattended any tape or wire recorder. Pictorial installation instructions included. \$23.75. Postpaid USA, WJS Electronics, 1525 No. Hudson, Hollywood, Calif.

RESISTORS, NEWEST TYPE METAL-FILM, COPPER CIRCUIT BOARD, CAPACITORS, TERMINAL BLOCKS, FREE CATALOG, FARNSWORTH ELECTRONIC COMPONENTS, 88 Berkeley, Rochester, New York 14607.

INVESTIGATORS, keep in step with advancements in the art of electronics for the professional. Send \$1.00 for equipment brochure. WJS Electronics, 1525 North Hudson, Hollywood, California 90028.

FREE catalog: Wholesale Electronic parts and equipment. Royal, Box 2591, El Cajon, Calif.

COLOR for your blinkers, indicators. Ne2 TYPE glow discharge bulbs. \$0.75 each. Specify color. Slow decay green, \$1.50. Exotic Inventions, 3927 Nineteenth Street, San Francisco, Calif. 94114.

'64 FORD CUSTOM \$899. Yes, you're seeing right. Buy cars plus hundreds of other items at below wholesale. Complete details and catalog of sources \$1.00. FINLAY, 11944 Culver Drive, Culver City, Calif. 90230.

TV CAMERA Under \$40.00—Completely transistorized Space Age Flying Spot Scanner—Schematics, Photographs, Plans—\$3.00. Robot Light Seeker—Plans, Photographs—\$3.00. Beck, 777 Ruth Drive, Newbury Park, Calif. 91320.

WE SELL CONSTRUCTION PLANS: \$50 TV Camera, \$40 Automatic Telephone Answering Machine, \$50 Ultrasonic Dishwasher, \$15 Bell System Type Speakerphone, Phonevision, Private Eye Tail Transmitter, \$75 Electron Microscope, \$10 Legal Telephone Connector, Electronic Tranquilizer, Transistorized Teletype, Police Radar Detector plus Legal Jammer, Telephone Extension in your car, Television Recorder, 3D TV Converter. Plans \$4.75 each. FREE Super Hobby Catalog. COLOR TV Converter. Completely Electronic. No Mechanical Gadgets. Costs about \$35. Construction Details \$4.75. Don Britton Enterprises, 7906 Santa Monica Blvd., Hollywood, Calif. 90046.

TRANSISTORIZED CONVERTER 26-200 MC. Receive signal from 26 to 200 MC (1 MC spread), on broadcast band using car radio, crystal control or tuneable (1 MC spread). Kit \$11.00 pp. Wired \$20.00 pp. Webber Labs, 40 E Morris St., Lynn, Mass.

NICKEL Cadmium Batteries Everlasting—3 Stage Compressors—3000 P.S.I. Rockey Assos., Box 25017, Los Angeles, Calif. 90025.

DYNA-PAK—completely transistorized unit; used as signal generator, voltage monitor, continuity tester, code oscillator, code monitor and other uses. \$2.98. Deltronic Labs, Box 128, Horsham, Pa.

110VAC 60cy from car generator. Powers lights, refrigerator, transmitter, receiver, etc. Simple, easy to convert. Plans, \$2.00. Tedco, P.O. Box 12098, Houston, Texas 77017.

CLASSIFIED ADVERTISING ORDER FORM

Please refer to heading on first page of this section for complete data concerning terms, frequency discounts, closing dates, etc.

1	2	3	4	5
6	7	8	9	10
11	12	13	14	15
16	17	18	19	20
21	22	23	24	25
26	27	28	29	30
31	32	33	34	35

Words { @ 45¢ (Reader Rate) } = \$ _____
 { @ 75¢ (Commercial Rate) }

Insert _____ time(s) Total Enclosed \$ _____

NAME _____

ADDRESS _____

CITY _____ ZONE _____ STATE _____

Signature _____

WORD COUNT: Include name and address. Name of city (Des Moines) or of state (New York) counts as one word each. Zone or Zip Code numbers not counted. (Publisher reserves right to omit Zip Code if space does not permit.) Count each abbreviation, initial, single figure or group of figures or letters as a word. Symbols such as 35mm, COD, PO, AC, etc., count as one word. Hyphenated words count as two words.

PE-465

DIGITAL CIRCUITS: Set-reset FLIP-FLOPS for operation up to 1,000,000 pulses per second, PULSE GENERATORS, FULL ADDERS, and LOGIC GATES. All circuits fully transistorized and mounted on plug-in printed circuit boards. A connector is provided with each unit. Rugged wide temperature range industrial units available. Type FF-1A flip-flop and connector for 10,000 pps operation: \$3.87. Postage paid. Send for free literature giving detailed specifications of all circuits. KOMTRON, Box 275, Little Falls, N. J. 07424.

PHOTOELECTRIC CELL, 1 1/4"x1" Selenium, make light meter, control lights, doors, etc. 2/\$1.00. Baier, 4922 Oakley, Chicago, 60625.

SAVE ON ALTON IGNITION Components, Hall Engineering, 2241 N.W. 33rd, Oklahoma City, Oklahoma 73112.

GOVERNMENT Surplus grab box, 20 pounds, resistors, capacitors, transformers, tubes, hardware. Useful material. \$3.49. Add postage for 22 lbs. Catalog 10¢, free with order. Jeff-Tronics, 4791 Memphis Ave., Cleveland, Ohio 44109.

15 DISTANCE One-tube plans—25¢. "One-tube Handbook"—50¢. Includes Data sheets, catalog. Laboratories, 1131-L Valota, Redwood City, Calif.

COLOR TV for your car. Complete construction plans \$5.25. Seaway Electronics, 6311 Yucca, Hollywood, Calif. 90028.

SOLID State modules, transistors, kits. 5-tube radio kit, \$10.95. 10-watt stereo amp, \$19.95. 30-watt stereo amp, \$36.50. Modules power amp, \$4.95. Phono Preamp, \$4.95. Metronome, \$1.95. Transistors for all projects. Send 10¢ for catalog. Brandwein Co., 306 W. 100th St., N.Y.C. 10025.

SHORTWAVE LISTENING

SW LISTENERS GUIDE, easy to use. English programming. **DOUBLES LISTENING PLEASURE.** \$2.00. SWL Guide, 218 Gifford, Syracuse 2, N.Y.

HIGH FIDELITY

"**LOW,** Low quotes: all components and recorders. HiFi, Roslyn 9, Penna."

HI-FI Components, Tape Recorders, at guaranteed "We Will Not Be Undersold" prices. 15-day money-back guarantee. Two-year warranty. No Catalog. Quotations Free. Hi-Fidelity Center, 1797 (P) 1st Avenue, New York, N. Y. 10028.

FREE! Send for money saving stereo catalog #P4E and lowest quotations on your individual component, tape recorder, or system requirements. Electronic Values, Inc., 200 W. 20th St., New York, N.Y. 10011.

MC Gee Radio Company. Big 1965 176 Page Catalog Sent Free. America's Best Values. HiFi—Amplifiers—Speakers—Electronic Parts. 1901 McGee Street. Dept. PE, Kansas City 8, Missouri.

"**THE BEST BASIC BOOK NOW AVAILABLE ON HIGH FIDELITY**" says Electronics Illustrated about Allison's High Fidelity Systems—A User's Guide. \$1.00 postpaid. Vilchur's more technical Reproduction of Sound was reviewed in Esquire as "far and away the best introduction to the subject ever written." \$2.00 postpaid. Order directly from publisher, Acoustic Research, Dept. PE, 24 Thorndike Street, Cambridge, Mass. 02141. Literature on AR speakers and turntables also sent on request.

TUBES

BEFORE You Buy Receiving Tubes, Test Equipment, HiFi Components, Kits, Parts, etc. . . . send for Giant Free Zalytron Current Catalog, featuring Standard Brand Tubes: RCA, GE, etc.—all Brand new Premium Quality Individually Boxed, One Year Guarantee—all at Biggest Discounts in America! We serve professional servicemen, hobbyists, experimenters, engineers, technicians. Why Pay More? Zalytron Tube Corp., 469-E Jericho Turnpike, Mineola, N. Y. 11502.

POPULAR SEPTEMBER 1964
ELECTRONICS



Send
**POPULAR
ELECTRONICS**
Every
Month

NAME

ADDRESS

CITY STATE ZIP

3 years for \$10

Check one: 2 years for \$7

1 year for \$4

In the U. S., and possessions.

Payment Enclosed Bill Me

Foreign rates: Canada and Pan American Union countries, add .50 per year; all other foreign countries, add \$1 per year.

New Renewal

Mail to: **POPULAR ELECTRONICS**

Dept. 0026, 1255 Portland Place, Boulder, Colo.

TUBE Headquarters of the World! Free Catalog (tubes, electronic equipment) write! Barry, 512 Broadway, N.Y.C. 12.

RADIO & T.V. Tubes—33¢ each. Send for free list. Cornell, 4213 University, San Diego, California 92105.

TUBES. Oldest, latest. Lists free. Steinmetz, 7519 Maplewood, Hammond, Ind.

HAM EQUIPMENT

CBERS'S, HAMS, SWL'S! Clipper-filter kit, \$10.99, wired \$14.99. GW-10, GW-11, GW-12 Preselector kits \$8.99, wired \$11.99. Free catalog. HOLSTROM ASSOCIATES, P. O. Box 8640-E, Sacramento, Calif. 95822.

WANTED

CASH Paid! Unused tubes, electronic equipment. Barry, 512 Broadway, N.Y.C. 12.

QUICKSILVER, Platinum, Silver, Gold. Ores Analyzed. Free Circular. Mercury Terminal, Norwood, Mass.

REPAIRS AND SERVICES

TV Tuners rebuilt and aligned per manufacturers specification. Only \$9.50. Any make UHF or VHF. We ship COD. Ninety day written guarantee. Ship complete with tubes or write for free mailing kit and dealer brochure. JW Electronics, Box 51C, Bloomington, Indiana.

TRANSISTOR radio repair. \$4.50 each. Guaranteed 90 days. Returned COD. TRANSERVICO, Box 1022P, Bloomington, Indiana 47402.

METERS—Multimeters Repaired and Calibrated. Free estimates—Catalog. Bigelow Electronics, Box 71-E, Bluffton, Ohio.

TAPE AND RECORDERS

TAPE Recorders, Hi-Fi, components, Sleep Learning Equipment, tapes. Unusual Values Free Catalog. Dressner, 1523PE, Jericho Turnpike, New Hyde Park 11, N. Y.

BEFORE Renting Stereo Tapes try us. Postpaid both ways—no deposit—immediate delivery. Quality—Dependability—Service—Satisfaction—prevail here. If you've been dissatisfied in the past, your initial order will prove this is no idle boast. Free Catalog. Gold Coast Tape Library, Box 2262, Palm Village Station, Hialeah, Fla 33012.

RENT Stereo Tapes—over 2,500 different—all major labels—free brochure. Stereo—Parti, 1616-PE Terrace Way, Santa Rosa, California.

TAPE-MATES MAKES AVAILABLE TO YOU—ALL 4-TRACK STEREO TAPES—ALL LABELS—POSTPAID TO YOUR DOOR—AT TREMENDOUS SAVINGS. FOR FREE BROCHURE WRITE TAPE-MATES CLUB, 5280—P. W. PICO BLVD., LOS ANGELES, CALIF. 90019.

STEREO TAPE. Save up to 60% (no membership fees). We discount recorders, batteries, accessories. We mail prerecorded tape, prepaid, anywhere that United States rates prevail. Free 60 page catalog. Saxitone, 1776 Columbia Road, Washington, D.C. 20009.

RENT 4-TRACK STEREO TAPES—Narrow it down, it has to be TRIMOR—Goodbye to partial satisfaction—Service and Dependability our keynote—**ALL LABELS and TITLES**—No Deposit—Postpaid both ways. (48 states)—**FREE BROCHURE and TAPE CATALOG.** TRIMOR Company P. O. Box 748, Flushing, N.Y. 11352.

TAPE RECORDER BARGAINS. Brand new, latest models, \$10.00 above cost. Arkay Sales, 22-03 Riverside Ave., Medford, Mass. 02155.

SCOTCH Recording Tape, Big Discounts: 1200 Feet Mylar 99¢. Brookline Electronics, 2831 West 23rd Street, Brooklyn, N.Y. 11224.

TOP quality Sarkes Tarzian's Galaxie tensilized Mylar tapes: 1800'—\$1.56, 2400'—\$2.59, 3600'—\$3.69, plus postage. Money back guarantee. Free Price list, handbook: "Fun with your tape recorder". Pofe Electronics, 1716-PE Northfield, Muncie, Indiana.

HELP WANTED

EARN CASH Commissions plus free gifts. Sell matchbook advertising. Sales kit furnished. Matchcorp., Dept. MD-45, Chicago 60632.

PATENTS

INVENTIONS; Ideas developed for Cash/Royalty sales. Raymond Lee, 1606G Bush Building, New York City 36.

PATENT search and evaluation of market potential of inventions. \$15. Patent Searches, Box 8925-E, Chicago 60666.

PHOTOGRAPHS

PHOTOGRAPHS and transparencies wanted, to \$500.00 each. Valuable information free—Write Intraphoto-PE, Box 74607, Hollywood 90004.

SUMMER CAMPS

ELECTRONICS and **SCIENCES**, FCC licenses. All Land and Water Sports. Co-ed 7-17. **CAMP MINNOWBROOK**, Lake Placid, N.Y. Established 1949. Brochure: 440 West End Ave., New York, N.Y. 10024.

MOVIE FILMS

TEACH Yourself—**GOLF—BOWLING—TRAIN YOUR DOG**, too! by ordering **SPORTLIGHT** 8mm Instructional Films. 4 GOLF lessons (woods, short irons, greater distance, cure slice) with **JOHNNY REVOLTA**, **MICKEY WRIGHT**. 3 **BOWLING** lessons (4-step, **FAZIO**, **LADEWIG**; 5-step, **NAGY**). **DOG TRAINING**, **WILLIE NECKER**. Each 50' film \$2.99 ppd—any 4, \$10.45; all 8—\$18.95. **SPORTLIGHT FILMS**, 20-PE North Wacker Drive, Chicago, Ill. 60606.

PLANS AND KITS

BUILD Yourself! Fantastic 200 MPG Carburetor! V-8, Six, Etc! Patent Drawings, Description, \$5.00. FraDor, Lakeville 5, Indiana 46536.

WIRELESS Broadcaster, miniature, transistorized. Plans \$1.00. Baker Electronics, R.R. 1, Greencastle, Indiana.

14 WEATHER Instrument Plans \$1.00. Saco, Box 2513B, South Bend, Indiana.

PRINTED Circuit Kit—complete two copper clad boards 2 $\frac{3}{8}$ x 5, etch tray, etchant, etching resist, layout grids, cleaning pad, instructions. \$2.98. Deltronic Labs, Box 128, Horsham, Pa.

SOLAR Powered Radio \$3.95, Diode Radio \$1.50, Voice Transmitter \$4.95, **LECTRONIX-PE**, Box 42, Madison Heights, Michigan 48071.

ACCESSORIES

24" MAGNET \$1.00 Permanent Flexible—Catalog: 617-A Seventh Street, San Francisco, Calif, 94103

INSTRUCTION

LEARN While Asleep, hypnotize with your recorder, phonograph. Astonishing details, sensational catalog free! Sleep-Learning Association, Box 24-ZD, Olympia, Wash.

FCC License in 6 weeks, First Class Radio telephone. Results Guaranteed. Elkins Radio School, 2603B Inwood, Dallas, Texas.

LEARN ELECTRONIC ORGAN SERVICING at home all makes including transistors. Experimental kit—trouble-shooting. Accredited NHSC. Free Booklet. **NILES BRYANT SCHOOL**, 3631 Stockton, Dept. A, Sacramento 20, Calif.

REI First Class Radio Telephone License in (5) weeks Guaranteed. Tuition \$295.00. Job placement free. Radio Engineering Institute, 1336 Main Street, Sarasota, Fla.

ELECTRONICS—F.C.C. License Training—Correspondence, or resident classes. Free details. Write: Dept. 3, Grantham Schools, 1505 N. Western, Hollywood, Calif. 90027.

BE YOUR Own Television Repairman! Instruction Book, \$1.25—Build your own Radio-Telescope! Instruction Book, \$3.00 (Satisfaction Guaranteed) Abrilz, K2BDB, Westhampton Beach, New York 11978.

HIGHLY—effective home study review for FCC commercial phone exams. Free literature! Cook's School of Electronics, Craigmont, Idaho 83523.

PLASTICS

NEW Liquid Casting Plastic, clear, colors, Embed real flowers, butterflies, photos, coins. Send 25¢ for two handbooks, "How to Cast Liquid Plastics" and "How to Earn Extra Money at Home." Castolite, Dept. 108-D, Woodstock, Illinois.

The largest stock of obsolete tubes in the USA at the lowest prices—COMPARE

BRAND NEW

UNITED'S FIRST QUALITY

TUBES

DISCOUNTS up to 20% OFF

GUARANTEED ONE FULL YEAR! NOT USED! NO PULLS!

WHY PAY MORE?

TYPE	PRICE	TYPE	PRICE	TYPE	PRICE	TYPE	PRICE	TYPE	PRICE	TYPE	PRICE	TYPE	PRICE	TYPE	PRICE
0A2	.90	3B7	1.35	5U4	.60	6B8L	1.52	6E6Y	1.23	6N7G	1.75	6E8A	1.49	12FA6	.97
0A3	.90	3BA6	.95	5U8	.84	6B8A	.98	6E6X	2.79	6Q7G	1.95	6E9B	1.99	12FA6	.97
0A4G	1.75	3C5S	.53	5V3	1.59	6B8B	.77	6E2S	1.39	6Q7M	2.00	10A11	1.69	12FM6	.81
0B3	.80	3BE6	.80	5V4	1.45	6B8C	.83	6E4	1.41	6Q11	1.29	10B8	1.99	12F08	1.19
0B3	1.20	3B8A	1.18	5V6	.65	6B8D	.83	6F4	1.10	6R7	1.75	10B8S	1.45	12FR8	1.48
0D3	.75	3BU8	.76	5W4	1.75	6B8E	1.08	6FD7	1.73	6S4	.56	10C8	1.49	12FX5	.96
0C3	2.75	3BY6	.56	5X8	.84	6B8F	.99	6F5GT	1.50	6S4	1.95	10D7	1.29	12FX6	1.27
0V4	.95	3BZ6	.54	5Y3	.47	6B8G	1.42	6F6M	1.69	6S4	1.95	10E7	1.43	12GW6	1.15
1A3	1.49	3C5S	.90	5Z3	2.00	6B8H	1.79	6F7	3.95	6S4	1.95	10G7	1.75	12H6	1.19
1A5	1.49	3CF6	1.05	5Z4	1.90	6B8I	1.34	6F8	3.25	6S4	1.95	10H7	1.21	12J6	1.19
1A6	1.49	3C6	.58	6A3	2.75	6B8J	1.46	6F8	3.25	6S4	1.95	10J8	1.35	12K5	1.19
1A7	1.95	3CY5	1.18	6A4	2.20	6B8K	1.46	6F8	3.25	6S4	1.95	10K8	1.15	12K8	1.50
1AB5	.75	3DG4	1.48	6A6	1.75	6B8L	1.65	6F8	3.25	6S4	1.95	10M8	1.15	12L8	.50
1A2	.85	3DN6	.52	6A7	2.65	6B8M	1.98	6F8	3.25	6S4	1.95	10N8	1.15	12M8	2.95
1A4	1.30	3DM6	.58	6A8GT	.95	6B8N	1.71	6F8	3.25	6S4	1.95	10P8	1.15	12N8	1.19
1AF4	1.45	3DT6	.52	6A9M	1.75	6B8P	1.35	6F8	3.25	6S4	1.95	10Q8	1.15	12O8	1.19
1AG4	2.20	3DZ7	.52	6A9	.52	6B8Q	1.75	6F8	3.25	6S4	1.95	10R8	1.15	12P8	1.19
1AJ5	1.05	3EH7	1.00	6A8S	3.00	6B8R	1.75	6F8	3.25	6S4	1.95	10S8	1.15	12Q8	1.19
1AU3	1.25	3EJ7	1.00	6A8T	1.00	6B8S	1.39	6F7	1.39	6S4	1.95	10T8	1.15	12R8	1.19
1AX2	.95	3ER8	1.31	6A8CS	1.95	6C5M	2.45	6F7	1.39	6S4	1.95	10U8	1.15	12S8	1.19
1AY2	.98	3FH5	.95	6A8D	.95	6C8C	1.45	6F7	1.39	6S4	1.95	10V8	1.15	12T8	1.19
1B3	.88	3F5S	1.18	6A8T	3.25	6C8C	1.45	6F7	1.39	6S4	1.95	10W8	1.15	12U8	1.19
1B4P	2.00	3GK5	1.49	6A8E	2.50	6C10	1.53	6F7	1.39	6S4	1.95	10X8	1.15	12V8	1.19
1C5	.98	3G6	1.42	6A8F	1.77	6C10	1.53	6F7	1.39	6S4	1.95	10Y8	1.15	12W8	1.19
1CG	.98	3GW5	.98	6A8G	.99	6C10	1.53	6F7	1.39	6S4	1.95	10Z8	1.15	12X8	1.19
1D5GP	.98	3HA5	1.49	6A8F4	.98	6C10	1.53	6F7	1.39	6S4	1.95	10Z8	1.15	12Y8	1.19
1D7	1.25	3I8	1.25	6A8G	2.45	6C10	1.53	6F7	1.39	6S4	1.95	10Z8	1.15	12Z8	1.19
1DN5	.53	3H58	1.29	6A8F11	.99	6C10	1.53	6F7	1.39	6S4	1.95	10Z8	1.15	12Z8	1.19
1E5CP	.98	3Q4	1.35	6A8CS	1.68	6C10	1.53	6F7	1.39	6S4	1.95	10Z8	1.15	12Z8	1.19
1E7	.95	3R5	1.25	6A8D	1.68	6C10	1.53	6F7	1.39	6S4	1.95	10Z8	1.15	12Z8	1.19
1F4	.95	3S4	.75	6A8M	1.11	6C10	1.53	6F7	1.39	6S4	1.95	10Z8	1.15	12Z8	1.19
1F5	.95	3V4	.61	6A8H	1.25	6C10	1.53	6F7	1.39	6S4	1.95	10Z8	1.15	12Z8	1.19
1F6	1.20	3G16	.60	6A8J	1.20	6C10	1.53	6F7	1.39	6S4	1.95	10Z8	1.15	12Z8	1.19
1G3	.88	4AV6	.70	6A8B	1.73	6C10	1.53	6F7	1.39	6S4	1.95	10Z8	1.15	12Z8	1.19
1G4	1.75	4BA6	.85	6A8K	.90	6C10	1.53	6F7	1.39	6S4	1.95	10Z8	1.15	12Z8	1.19
1G6	1.50	4B6	.85	6A8L	.90	6C10	1.53	6F7	1.39	6S4	1.95	10Z8	1.15	12Z8	1.19
1H4	1.25	4BC8	1.02	6A8M	1.40	6C10	1.53	6F7	1.39	6S4	1.95	10Z8	1.15	12Z8	1.19
1H5	2.59	4B8L	1.00	6A8N	1.45	6C10	1.53	6F7	1.39	6S4	1.95	10Z8	1.15	12Z8	1.19
1H6	.98	4B8	1.43	6A8O	1.95	6C10	1.53	6F7	1.39	6S4	1.95	10Z8	1.15	12Z8	1.19
1J3	.88	4B7	1.00	6A8P	1.95	6C10	1.53	6F7	1.39	6S4	1.95	10Z8	1.15	12Z8	1.19
1K5	.98	4B58	.96	6A8Q	.76	6C10	1.53	6F7	1.39	6S4	1.95	10Z8	1.15	12Z8	1.19
1K6	.98	4B8	1.20	6A8R	2.59	6C10	1.53	6F7	1.39	6S4	1.95	10Z8	1.15	12Z8	1.19
1K3	.98	4B8	1.20	6A8S	1.95	6C10	1.53	6F7	1.39	6S4	1.95	10Z8	1.15	12Z8	1.19
1L4	1.30	4B7	1.00	6A8T	2.45	6C10	1.53	6F7	1.39	6S4	1.95	10Z8	1.15	12Z8	1.19
1L6	2.35	4CB6	.87	6A8B	1.50	6C10	1.53	6F7	1.39	6S4	1.95	10Z8	1.15	12Z8	1.19
1L7	1.30	4C6	.87	6A8C	1.50	6C10	1.53	6F7	1.39	6S4	1.95	10Z8	1.15	12Z8	1.19
1LA5	2.60	4CY5	1.10	6A8Q6	1.05	6C10	1.53	6F7	1.39	6S4	1.95	10Z8	1.15	12Z8	1.19
1LA6	1.49	4D6	1.01	6A8Q7	1.55	6C10	1.53	6F7	1.39	6S4	1.95	10Z8	1.15	12Z8	1.19
1LB6	1.49	4E17	1.29	6A8B	1.20	6C10	1.53	6F7	1.39	6S4	1.95	10Z8	1.15	12Z8	1.19
1LC5	1.05	4DT6	.87	6A8S	1.03	6C10	1.53	6F7	1.39	6S4	1.95	10Z8	1.15	12Z8	1.19
1LC6	1.60	4EH7	1.47	6A8R6	1.50	6C10	1.53	6F7	1.39	6S4	1.95	10Z8	1.15	12Z8	1.19
1LD5	1.95	4E17	1.29	6A8B	1.20	6C10	1.53	6F7	1.39	6S4	1.95	10Z8	1.15	12Z8	1.19
1LE3	1.25	4EM6	1.19	6A8R11	1.65	6C10	1.53	6F7	1.39	6S4	1.95	10Z8	1.15	12Z8	1.19
1LG5	1.98	4E58	1.79	6A8S5	.79	6C10	1.53	6F7	1.39	6S4	1.95	10Z8	1.15	12Z8	1.19
1LM4	1.80	4E6	1.01	6A8R	1.95	6C10	1.53	6F7	1.39	6S4	1.95	10Z8	1.15	12Z8	1.19
1LN5	1.25	4GK5	1.59	6A8S7	1.00	6C10	1.53	6F7	1.39	6S4	1.95	10Z8	1.15	12Z8	1.19
1NS	1.75	4CM6	1.25	6A8S8	1.30	6C10	1.53	6F7	1.39	6S4	1.95	10Z8	1.15	12Z8	1.19
1PS	2.00	4CS8	1.91	6A8S11	1.95	6C10	1.53	6F7	1.39	6S4	1.95	10Z8	1.15	12Z8	1.19
1Q5	1.95	4H5	.91	6A8T	.84	6C10	1.53	6F7	1.39	6S4	1.95	10Z8	1.15	12Z8	1.19
1R4	1.00	4CZ6	1.19	6A8U	.95	6C10	1.53	6F7	1.39	6S4	1.95	10Z8	1.15	12Z8	1.19
1R5	.90	4HA5	1.85	6A8V	1.05	6C10	1.53	6F7	1.39	6S4	1.95	10Z8	1.15	12Z8	1.19
1R6	.90	4HA5	1.85	6A8W	1.05	6C10	1.53	6F7	1.39	6S4	1.95	10Z8	1.15	12Z8	1.19
1S2A	1.90	4H6	.91	6A8V	.52	6C10	1.53	6F7	1.39	6S4	1.95	10Z8	1.15	12Z8	1.19
1S4	1.45	4HM6	.91	6A8V	.52	6C10	1.53	6F7	1.39	6S4	1.95	10Z8	1.15	12Z8	1.19
1S5	.90	4HS8	1.18	6A8U7	.54	6C10	1.53	6F7	1.39	6S4	1.95	10Z8	1.15	12Z8	1.19
1T4	.79	4I4	1.25	6A8B	1.20	6C10	1.53	6F7	1.39	6S4	1.95	10Z8	1.15	12Z8	1.19
1T5	.80	4JC6	1.35	6A8V5	1.45	6C10	1.53	6F7	1.39	6S4	1.95	10Z8	1.15	12Z8	1.19
1U4	.70	4JD6	1.35	6A8V6	1.44	6C10	1.53	6F7	1.39	6S4	1.95	10Z8	1.15	12Z8	1.19
1U5	.87	4J8	1.19	6A8V7	1.44	6C10	1.53	6F7	1.39	6S4	1.95	10Z8	1.15	12Z8	1.19
1V	1.05	5AN8	.88	6A8W8	.88	6C10	1.53	6F7	1.39	6S4	1.95	10Z8	1.15	12Z8	1.19
1V2	.79	5A05	.52	6A8X3	1.05	6C10	1.53	6F7	1.39	6S4	1.95	10Z8	1.15	12Z8	1.19
1X2B	.84	5AR7	.74	6A8X4	1.05	6C10	1.53	6F7	1.39	6S4	1.95	10Z8	1.15	12Z8	1.19
1Z2	3.25	5AS8	1.75	6A8X5	1.44	6C10	1.53	6F7	1.39	6S4	1.95	10Z8	1.15	12Z8	1.19
2A3	2.50	5AT8	.81	6A8X7	1.25	6C10	1.53	6F7	1.39	6S4	1.95	10Z8	1.15	12Z8	1.19
2A5	1.95	5AU4	1.25	6A8X8	1.34	6C10	1.53	6F7	1.39	6S4	1.95	10Z8	1.15	12Z8	1.19
2AG	3.75	5AV8	.98	6A8Y3	1.05	6C10	1.53	6F7	1.39	6S4	1.95	10Z8	1.15	12Z8	1.19
2A7	1.50	5AW4	1.00	6A8Z8	2.15	6C10	1.53	6F7	1.39	6S4	1.95	10Z8	1.15	12Z8	1.19
2AF4	1.80	5AZ4	1.98	6B4	3.95	6C10	1.53	6F7	1.39	6S4	1.95	10Z8	1.15	12Z8	1.19
2AH2	1.34	5BR	2.09	6B5	4.00	6C10	1.53	6F7	1.39	6S4	1.95	10Z8	1.15	12Z8	1.19
2A52	1.30	5BC3	.89	6B7	2.75	6C10	1.53	6F7	1.39	6S4	1.95	10Z8	1.15	12Z8	1.19
2B3	1.70	5BE8	1.27	6B8	2.50	6C10	1.53	6F7	1.39	6S4	1.95	10Z8	1.15	12Z8	1.19
2B7	.95	5BK7	.89	6B10	1.35	6C10	1.53	6F7	1.39	6S4	1.95	10Z8	1.15	12Z8	1.19
2BN4	.98	5B07	.99	6B3	1.05	6C10	1.53	6F7	1.39	6S4	1.95	10Z8	1.15	12Z8	1.19
2CY5	.95	5BR8	.81	6B4E	4.49	6C10	1.53	6F7	1.39	6S4	1.95	10Z8	1.15	12Z8	1.19
2D21	.75	5E8	1.79	6B7	1.59										

PRINTING

BOOK Printing. Lowest cost. Paperbacks or hard covers. Catalog free. Addams Press, 30 West Washington, Chicago, Ill. 60602.

INVENTIONS WANTED

INVENTORS! Don't sell or license your invention for cash or royalties until you receive our offer. Financial assistance available. For free information write, Dept. 71, International Invention Institute, 17 Park Row, New York 38, N.Y.

INVENTORS. We will develop, help sell your idea or invention, patented or unpatented. Our national manufacturer clients are urgently seeking new items for outright cash sale or royalties. Financial assistance available. 10 years proven performance. For free information, write Dept. 41, Wall Street Invention Brokerage, 79 Wall Street, New York 5, N.Y.

INVENTIONS wanted. Patented; unpatented. Global Marketing Service, 2420-P 77th, Oakland 5, Calif.

INVENTORS! Don't sell your invention, patented or unpatented, until you receive our offer. Eagle Development Company, Dept. P, 79 Wall Street, N.Y. 5, N.Y.

PATENT Searches including Maximum speed, full airmail report and closest patent copies, \$6.00. Quality searches expertly administered. Complete secrecy guaranteed. Free Invention Protection forms and "Patent Information." Financial assistance available. Write Dept. 9, Washington Patent Office Search Bureau, 1426 G Street, N.W., Washington 4, D.C.

INVENTORS! Sell your invention for cash or royalties! Our client manufacturers eagerly seek new items. Patented. Unpatented. For free information, write Dept. 20, Gilbert Adams, Invention Broker, 80 Wall St., New York 5, N.Y.

INVENTORS Needing Help with any problem, financial, development, securing manufacturer, obtaining patent. Write the organization that delivers action and results—not promises. Pioneer Invention Service, Dept. 79, 150 Broadway, New York 38, N.Y.

INVENTORS! Outright cash sale or royalties for your inventions. Patented. Unpatented. Active demand from our client manufacturers. Financial assistance available. Write Dept. 35, United States Invention Brokerage, 78 Wall Street, New York 5, N.Y.

INVENTORS! We can help you present and sell your invention, patented or unpatented. For free details write Hanover Invention Brokerage, Dept. 616, 120 Liberty Street, New York 6, N.Y.

GOVERNMENT SURPLUS

JEEPS \$64.50 . . . Boats \$6.18 . . . Typewriters \$4.15 . . . Airplanes, Electronics Equipment, 100,000 Bargains Typically Like These Direct From Government in Your Area. For Complete Directory and Surplus Catalog Send Only \$1.00. Surplus Service, Box 820-J, Holland, Michigan.

"GOVERNMENT SELLS".—Surplus Electronics; Oscilloscopes; Transceivers; Test Equipment; Radar; Walkie-Talkies; Boats; Jeeps; Aircrafts; Misc.—Send For—"U.S. Depot Directory-Procedure"—\$1.00—Service, Box 425 (ZE), Nanuet, N.Y.

GOVERNMENT Surplus. Complete Sales Directory \$1.00. Surplus Publications, Box 45781E, Los Angeles 45, Calif.

JEEPS—\$62.50, Transmitters—\$6.18, Typewriters—\$4.15. Walkie-Talkies, Oscilloscopes, Multimeters. Typical Surplus Prices. Exciting Details Free. Enterprises, Box 402-B9, Jamaica 30, N.Y.

MUSIC

POEMS wanted for songs and records. Send poems, Crown Music, 49-RB West 32, New York 1.

AUTHORS' SERVICES

AUTHORS! Learn how to have your book published, promoted, distributed. FREE booklet "ZD," Vantage, 120 West 31 St., New York 1.

REAL ESTATE

FLORIDA Water Wonderland—Homesites, Cottagesites, Mobilesites, Established area. \$390 full price, \$5.00 month. Swimming, fishing, boating. Write, Lake Weir, 38bf, Silver Springs, Fla. Ad 6-1070 (F-1)

FREE!—ALL NEW! SPRING CATALOG Thousands of properties described, photos galore—Land, farms, homes, businesses—recreation, retirement. 472 offices coast-to-coast, "World's Largest." Mailed Free! STROUT REALTY, 50-ZD East 42nd St., N.Y. 17, N.Y.

FREE! Big illustrated real estate catalog. Top values coast to coast! Farms, Ranches, Homes, Businesses, Waterfront, Recreation, Retirement properties. United Farm Agency, 612-B West 47th St., Kansas City, Mo. 64112. PLaza 3-4212.

HYPNOTISM

FREE Hypnotism, Self-Hypnosis, Sleep Learning Catalog! Drawer H400, Ruidoso, New Mexico 88345.

HYPNOTIZE UNNOTICED! PATENTED new hand device makes you a Hypnotist first day or refund! Hypnotist's Handbook included! \$2.00. Hypnosis Foundation, Box 487, La Mesa 9, California.

RECORDS

DISCOUNT Records, All Labels—Free List. Write Cliff House, Box 42-P, Utica, N.Y.

DISCOUNTS on all LP's. Free details. Citadel Record Club, 545 Fifth Ave., Dept. 22, New York 17, N.Y.

PHOTOGRAPHY—FILM, EQUIPMENT, SERVICES

MEDICAL Film—Adults Only—"Childbirth"—1 reel 8mm. \$7.50—16mm \$14.95. International-E, Greenvale, L.I., New York.

SCIENCE Bargains—Request Free Giant Catalog "CJ"—148 pages—Astronomical Telescopes, Microscopes, Lenses, Binoculars, Kits, Parts. War surplus bargains. Edmund Scientific Co., Barrington, New Jersey.

FREE illustrated photographic bargain book. Central Camera Co., Dept. 45-D 230 So. Wabash, Chicago, Ill.

EDUCATIONAL OPPORTUNITIES

LEARN While Asleep. Remarkable, Scientific, 92% Effective. Details Free. ASR Foundation, Box 7021, Dept. e.g., Lexington, Kentucky.

MONEY Back Guarantee—C.I.S.T.—The World Wide Institute of Home Study—34 Global centres—260 courses—Engineering, Electronic, Academic and Commercial—send for your Free 100 page copy of 'Career Opportunities' today—No salesman will call. C.I.S.T., 627 Garden City Building, 263 Adelaide St. W., Toronto, Canada.

MISCELLANEOUS

HYPNOTIZE secretly, cleverly, one glance . . . or money-back. \$2. Elton's, Box 18223-PE2, Indianapolis, Indiana, 46218.

DEEPLY in debt? Clear credit—quick relief. Write Advisor, Box 48337-ZD1, Los Angeles 90048.

SELF-HYPNOSIS in one evening or pay nothing. Full instructions only \$2.00. Elton's, Box 18223-PE3, Indianapolis, Indiana 46218.

RAISE money fast—easy proven sources—free particulars. Advisor, Box 48337-ZD2, Los Angeles 90048.

SELF-HELP IDEAS, Guaranteed. Free Details. Reddy, 713 East First, Auburn, Indiana 46706.

ADVERTISING SPECIALTIES Over 500 Manufacturer's names and addresses. Send \$5.00 check or money order to 1-0-1 Services, P.O. Box 101, W. Mifflin, Pa.

BEERS, PEACH BRANDY, WINES—Strongest Formulas, \$2.00. (Complete brew supplies—hydrometers catalog 10¢)—Research Enterprises, 29-D Samoset Rd., Woburn, Mass.

"GIANT ARMS" Dr. Young's D.C. Revolutionary discovery. \$2.00. Satisfaction or refund. Gaucho, Box 9309-S8, Chicago 90, Ill.

STAMMER—Stutter—No More. (Dr. Young.) Write: Gaucho, Box 9309-E8, Chicago 90.

HANDSOME 6-shot revolver shoots .22 blanks. Complete with 100 rounds ammunition \$7.25 ppd. Less Ammunition \$5.95. Extra Shells \$1.50 per 100. J & J Distributors, Box 2664, Wilmington, Del.

FOUR LIVE Color Changing Chameleons, Postpaid \$1.00. Reptile Price List, 25¢. Biological Center, Box 96-ZD, Norco, Louisiana 70079.

LET our more than 415,000 monthly readers learn of the advantages of doing their substantial mail order business with YOU! Your classified advertisement in the **ELECTRONICS MARKET PLACE** will cost little—only 75¢ per word—but you will be more than satisfied with the results achieved. New type style makes YOUR advertisement easier to read (thereby allowing you more exposure)—and you may run extra words in all capital letters for just 10¢ a word additional. The next available issue is June and your payment and copy should be received by April 1st to insure insertion. Write your copy, prepare remittance, and send today to: Hal Cymes, Classified Advertising Manager, **POPULAR ELECTRONICS**, 1 Park Ave., New York, N.Y. 10016.

COINS

NOW! Get 3 Real Old Lincoln Cents! Send 10¢ and receive 1919, 1920 and 1925. (Only one set to a customer.) Other offers on approval. Littleton Coin Co., Littleton H12, N.H.

5 INDIAN Cents \$1.00. 5 Liberty Nickels \$1.00. Doktor, 5028 W. Pico, Los Angeles, Calif. 90019.

STAMPS

KENNEDY MEMORIAL 1st Day Cover. Valuable Collectors' Item! Official First Day Issue of the John Fitzgerald Kennedy Memorial Postage Stamp mounted on commemorative envelope bearing portrait of famous President. Postmarked with highly-prized first day cancellation! **ALSO INCLUDED**, to introduce you to the World's Most Enjoyable Hobby: (2) Complete set of 36 U.S. Presidents. (3) Big Collector's Catalog, (4) Exciting selection of stamps on approval, and (5) "How to Collect Stamps" book. Send only 25¢. Kenmore, Milford KP-779, New Hampshire.

FREE U.S. Illustrated Catalog, Simmy's, 40 Court Street, Boston, Mass. 02108.

POPULAR ELECTRONICS

April 1965

ADVERTISERS INDEX

READER SERVICE NO.	ADVERTISER	PAGE NO.
	American Institute of Engineering & Technology	93
1	Antenna Specialists Co., The	25
41	B & K/Mark	4
2	Browning Laboratories, Inc	101
3	Cadre Industries Corp	108
	Capitol Radio Engineering Institute, The	102, 103, 104, 105
	Central Technical Institute	111
	Cleveland Institute of Electronics	84, 85, 86, 87
4	Cleveland Institute of Electronics	5
5	Conar	11
6	Cousino Electronics Corporation	32
	DeVry Technical Institute	3
7	Dymo Industries	27
8	Eastman Kodak Company	81
9	Electro-Voice, Inc	FOURTH COVER
10	Fisher Radio Corporation	23
	Grantham School of Electronics	89
11	Hallcrafters	32
12	Heath Company	30, 31
13	Hitchings	109
14	Hy-Gain Electronics Corporation	89
15	International Crystal Manufacturing Co., Inc	95
16	Johnson Company, E.F.	1
	Johnson Company, E.F.	93
17	KLH Research and Development Corporation	7
18	Kuhn Electronics Inc	95
19	Lafayette Radio Electronics	13
20	Milwaukee School of Engineering	83
21	Multi-Elmac Company	99
22	Nation-Wide Tube Co	119
	National Radio Institute	SECOND COVER
	National Technical Schools	34, 35, 36, 37
23	North American Philips Company, Inc	6
43	Pearce-Simpson, Inc	28
24	Progressive "Edu-Kits" Inc	26
25	RCA Electronic Components and Devices	THIRD COVER
	RCA Institutes, Inc	16, 17, 18, 19
26	Radio Shack	9
27	RaeCo, Inc	91
28	Regency Electronics, Inc	10
29	Sams & Co., Inc., Howard W	20
30	Scott Inc., H.H.	109
31	Sherwood Electronic Laboratories, Inc	38
32	Shure Brothers, Inc	14
33	Sonar Radio Corp	107
34	Sonotone Corp	91
35	Switchcraft Inc	111
36	Texas Crystals	92
42	Turner Microphone Company, The	99
37	United Radio Co	117
	Valparaiso Technical Institute	93
38	Weller Electric Corp	12
39	Wesgrove Electrics Limited	97
40	Xcelite Inc	8
CLASSIFIED ADVERTISING 113, 114, 115, 116, 118, 119, 120.		

Printed in U.S.A.

CIRCLE NO. 25 ON READER SERVICE PAGE →

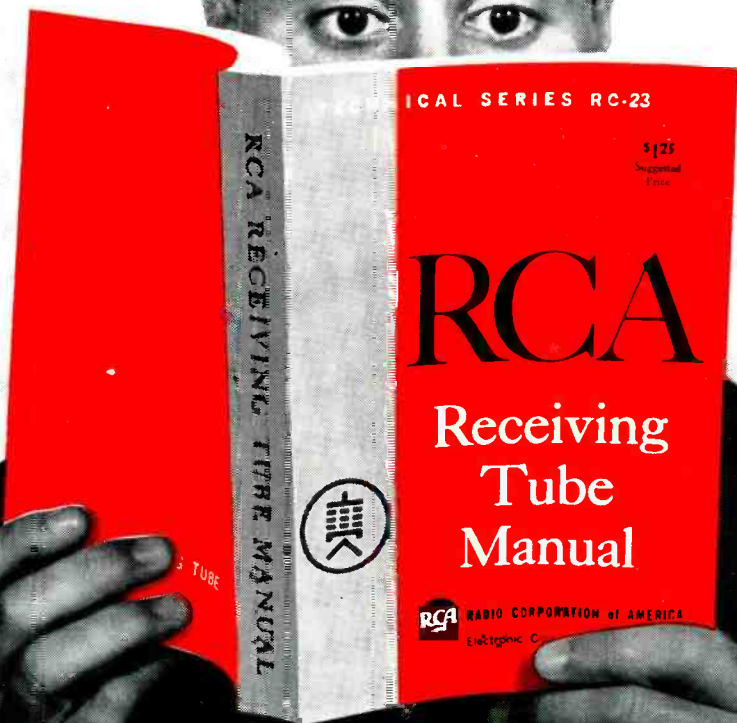

You can't put it down!

THE NEW RC-23!

Latest and best edition of the famous RCA Receiving Tube Manual

Look at the great new features of the best selling tube manual in the industry:

- ★ A record 608 data-packed pages
 - ★ In addition to data on over 1,000 receiving tubes, the RC-23 includes data on color and B&W picture tubes, voltage-reference tubes, voltage-regulator tubes
 - ★ New format, new type-face for easier reading
 - ★ Popular circuit section with its many timely, practical tube applications
 - ★ Revised and expanded Applications Guide covering 42 specific function classifications
- Now available from your local authorized RCA Tube Distributor

RCA ELECTRONIC COMPONENTS AND DEVICES, HARRISON, N.J.



The Most Trusted Name in Electronics

HIFI/Stereo Review

June, 1964

"...the designers of the E-V TWO were aiming for a smooth, uncolored sound, and they have succeeded very well. Overall the E-V TWO is a very smooth and musical reproducer."

Radio-Electronics

February, 1964

"In brief, the E-V TWO's produce a quite spectacular sound with a big, low-down bass...that is the best, to my ears, that Electro-Voice has yet produced."

POPULAR SCIENCE

June, 1964

"They effortlessly fill my large listening room with clean, well-balanced sound."

© 1964, Popular Science Publishing Co., Inc.

AUDIO

April, 1964

"...the Electro-Voice Model SIX is as close in sound to a Patrician as one can come without being a Patrician. You listen."

high fidelity

April, 1964

"Reproducing test tones, the Model SIX was found to have a remarkably smooth, clean and uniform response across the audio range!... But whatever one's personal listening tastes are, it would seem there is an E-V model to suit them."

The American Record Guide

December, 1963

"(I) have found them to be smooth and easy-to-listen-to...I found the top end very smooth and silky, not overbright, and also it extended well beyond the 15-cc. claim of the manufacturer."

If Speakers Could Blush, **Ours Would!**

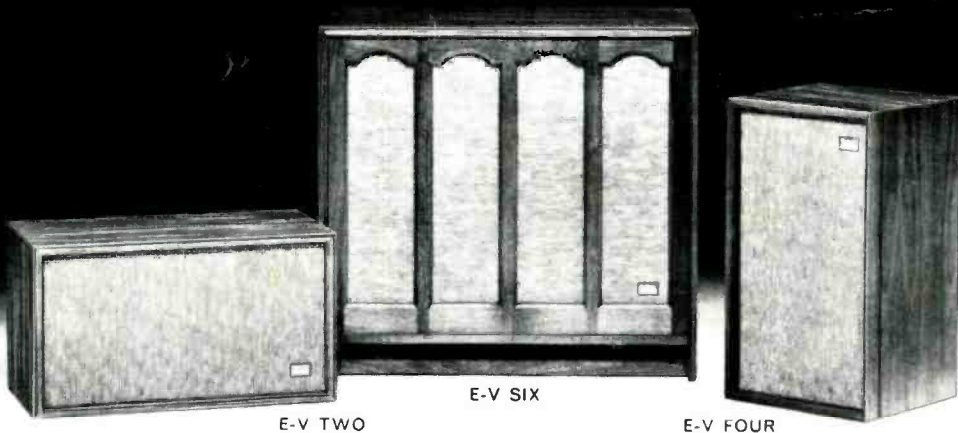

Read what the critics say about the new E-V TWO, E-V FOUR and E-V SIX acoustic suspension speaker systems. Then conduct your own impartial listening test. For a complete set of review reprints, plus the name of your nearest franchised E-V hi-fi showroom, write us today.

E-V Two, \$120.00; E-V Six, \$371.25; E-V Four, \$151.87

ELECTRO-VOICE, INC., Dept. 454P, Buchanan, Michigan 49107

Electro-Voice
SETTING NEW STANDARDS IN SOUND

CIRCLE NO. 9 ON READER SERVICE PAGE
www.americanradiohistory.com