

Build a **FALLOUT** Monitor

POPULAR ELECTRONICS

JULY
1962

35
CENTS

- ▶ One-Tube Aero Receiver
- ▶ Transistorized Tremolo
- ▶ Printed Circuit Repairs
- ▶ Whistle Switch
- ▶ Fish Finder



Build TV Set (p. 61)

Home Study School of its Kind Training in Industrial ELECTRONICS

Prepare NOW
FOR THE HIGHER REWARDS
ELECTRONICS
OFFERS THE QUALIFIED
TECHNICIAN

PRINCIPLES, PRACTICES, MAINTENANCE



Expanding uses of Electronics in industry, business, defense, increase the demand for Electronic Technicians. Electronics needs *more Technicians* than engineers—from four to seven times more! To meet this demand NRI offers a new, comprehensive course in ELECTRONICS—Principles, Practices, Maintenance. This training stresses *fundamentals*. It is the *only* course which includes specially developed training equipment to give experience with basic Electronic devices. It is for beginners, or experienced men who wish to expand their knowledge.

and current in circuits you build. You use a Vacuum Tube Voltmeter which you construct with equipment NRI supplies. Later on, if you select the Electronics Course, you study effects of feedback; work with multivibrators used in binary counters and as frequency dividers. You work with telemetry circuits used in satellites; with basic computer circuits. If you like working with your hands, you'll enjoy learning Electronics with NRI.

JOB COUNSELORS RECOMMEND

Today, a career in Electronics offers unlimited opportunity. Job Counselors advise, "For an interesting career, get into Electronics." The National Association of Manufacturers says: "There is no more interesting and challenging occupation in American industry."



NRI can provide the training—right in your own home and in your spare time. No need to go away to school. There are no special requirements of previous Electronic experience, or education in particular subjects. Mail postage-free card now. Read about Electronics opportunities, about NRI courses, about the NRI trial plan. NATIONAL RADIO INSTITUTE, WASHINGTON 16, D. C.

OTHER NRI COURSES

1. Radio-TV Servicing

AM-FM Radios, TV sets, Stereo Hi-Fi, other "home Electronic devices." Many good jobs for Service Technicians, or start your own spare-time or full-time business. Training equipment included.

2. Communications

Prepares for a career in broadcasting: AM, FM, TV station operation; police, marine, aviation radio, two-way radio, microwave, etc. Training equipment included.

www.americanradiohistory.com



A Message from

J. Morrison Smith
President

National Radio Institute
"Nothing is farther from the truth—than the idea that *only* engineers, with college degrees, are needed in Electronics. Authorities point out: For every *one* engineer required, Electronics needs *four to seven* Technicians. NRI trains you for technical careers in many different Electronics fields."

MULTIPLEXING INCLUDED

NRI training keeps up with the times. For instance, NRI course material covers FM Stereo Broadcasting, Multiplexing equipment, other new Electronic developments.



SPECIAL TRAINING EQUIPMENT

NRI Electronics, Servicing and Communications courses include—at no extra cost—special training equipment to give shop and laboratory experience in your own home. All equipment is yours to keep. Projects you build, experiments you perform, make NRI lessons come to life. Complex subjects become interesting, easy-to-grasp. No matter which course you select, your first projects are measuring voltage



Oldest and Largest School

Helping men to succeed by Home Study training is our *only* business. FREE 64-page Catalog gives facts about careers, shows what you learn, tells about NRI's courses for FCC License, Industrial Electronics, Servicing, Communications.



Conar Custom 70 Table Model Kit

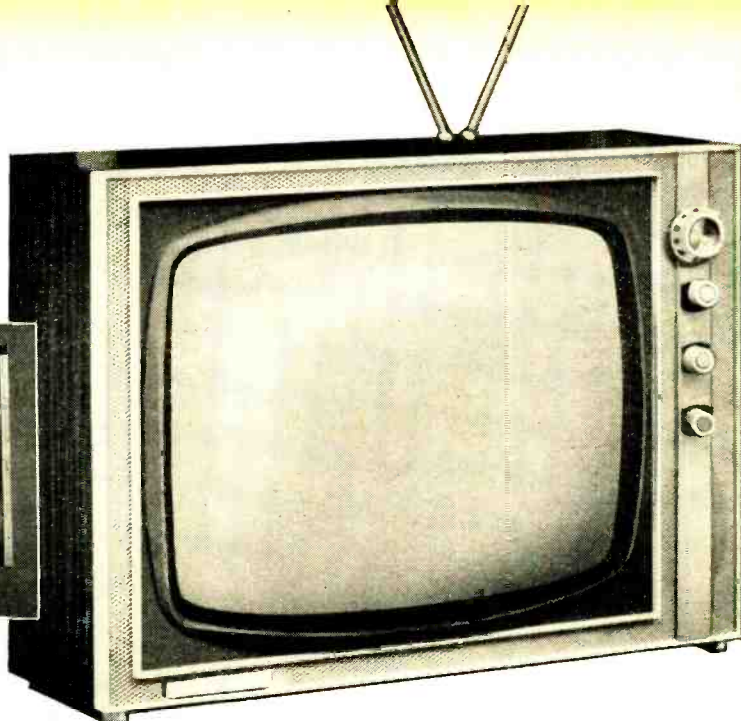
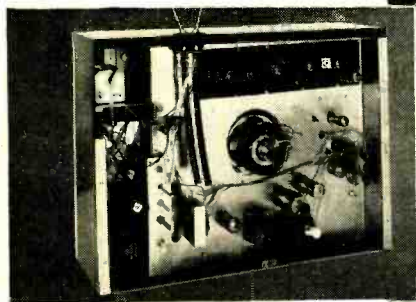

The kit builder's newest showcase

Experienced do-it-yourselfer or unskilled novice, anyone would be pleased as punch to show off this set as his greatest triumph in the lively art of electronic kit building. The Conar Custom 70 is a top-quality television receiver . . . complete in every detail. It's fun to build and fun to watch, from the first construction step to the first proud turn of the on-off switch. The one low price includes everything . . . 206 sq. in. picture tube, attractively slim cabinet, the best American-made parts we could find, even a crayon for marking chassis connections. And if you have ever fumbled with loose kit parts in little brown envelopes, you'll appreciate Conar's cleverly-designed packaging arrangement.

This is no portable, rinky-dink set. It's a top-quality table model with the equivalent of 21 tubes in a custom-designed circuit. Conar developed the Custom 70 out of experience with more than 10,000 TV set kits. You'll be putting together the kind of set that would retail at

well over \$200. With our simple diagrams, assembly manual and your screwdriver, pliers and soldering pencil you're ready and able to go to work on one of the most rewarding projects ever offered the do-it-yourself enthusiast. Order as a complete kit, or in four "pay-as-you-build" stages. Either way you build it, you'll have fun and satisfaction. We guarantee it!

FEATURES FOUND ONLY IN THE FINEST SETS

- Extremely stable trouble-free circuit with transformer power supply which isolates chassis and cabinet from the power line (Interior view above shows Custom 70 without rear cover, inter-lock power cord and shield can.)
- Brilliant glare-free, sharp picture; plenty of contrast and brightness—even under strong light.
- 19° aluminized 114° self-focusing picture tube with non-glare bonded safety face plate and big 206 sq in. of viewing area.
- New high gain, high signal-to-noise ratio VHF front-end tuner. Already factory assembled and pre-aligned. Has "Lock-Set" feature—no need to readjust fine tuning when you change channels.
- Uses 3 stages of pre-aligned video IF; separate pre-aligned 4.5 mc. sound IF amplifier and 2-stage video amplifier. Bandwidth is 3.5 mc. It has keyed AGC sync noise limiter. Audio power is enough to drive extra speakers.
- Uses latest type multi-purpose tubes; has built-in rabbit-ear antenna, optional connections for outdoor antenna; cabinet is styled to match any decor, is only 22" high, 17" wide, 13½" deep over all, including tube curvature and rear cover projection.

GUARANTEE

If you don't think the Custom 70 is all we say it is, just send it back and we'll promptly refund every penny. That goes for performance as well as parts.

CHECK THE PLAN YOU WANT

- SEND THE COMPLETE KIT. Enclosed is full price of \$135.
- I'LL PAY AS I BUILD. Enclosed is \$36 for my first of four packages. I'll order the others as ready at the same price.
- SEND ASSEMBLY MANUAL. Enclosed is \$2. Credit the \$2 to my future order.

CONAR[®] instruments

GA2C

3939 Wisconsin Ave., Washington 16, D. C.

I understand prices include 10% Federal Tax. I will pay shipping costs upon arrival.

NAME _____

ADDRESS _____

CITY _____ ZONE _____ STATE _____

A Division of National Radio Institute

POPULAR ELECTRONICS



POPULAR ELECTRONICS is indexed
in the Readers' Guide
to Periodical Literature

This month's cover photo by Bruce Pendleton
"Custom 70" TV Kit courtesy of Conar
Instruments; Bar Generator courtesy of
EICO Electronic Instrument Co., Inc.

VOLUME 17

JULY 1962

NUMBER 1

Special Construction Feature

Radiation Fallout Monitor.....R. L. Winklepleck 37

Electronic Construction Projects

Smoother Shaves with Smoother Current.....Joseph R. Noonan 43
The Fish Finder.....R. L. Winklepleck 57
Whistle Switch.....Martin J. Leff 63
Transformer for D.C.....Ben Richards 67
Compactron Frequency Calibrator.....Herb S. Brier, W9EGQ 75
Traveling? Take Your Shaver with You.....Walter Robson 83

Audio and High Fidelity

Hi-Fi Showcase.....28
Test Bench Squawk Box.....Art Trauffer 42
Transistorized Tremolo.....A. E. Donkin, W2EMF 49
Slim-Line Speaker Kit.....70

Amateur, CB, and SWL

FCC Report.....Robert E. Tall 10
One for the Road.....Howard F. Burgess, W5WGF 44
Across the Ham Bands: SWL "Souvenir Hunters" and
QSL Cards.....Herb S. Brier, W9EGQ 74
On the Citizens Band.....Dick Strippel, 2W1452 77
CB Sam Was Careful.....David Moore 78
Short-Wave Report: POP'tronics "Mailbag".....Hank Bennett, W2PNA 81
Short-Wave Monitor Certificate Application.....82

Electronic Features and New Developments

News Scope.....6
Tech-Lyte Kit.....48
First Aid for Printed Circuits.....J. W. I. Cody 53
All About Conar TV Kit (Cover Story).....61
Transistor Topics.....Lou Garner 71
Hobnobbing with Harbaugh: I Was Just Looking.....Dave Harbaugh 79
Electronic Coupling Quiz.....Robert P. Balin 80
Third Eye for Space Explorers.....84
The River Sniffer (a Carl and Jerry Adventure).....John T. Frye, W9EGV 85

Departments

Coming Next Month.....16
POP'tronics Bookshelf.....18
Letter Tray.....24
New Products.....91
Tips and Techniques.....94
Electronics Datebook.....95

Copyright © 1962 by ZIFF-DAVIS PUBLISHING COMPANY. All rights reserved.



crunch

Apples taste better when you're six years old. What's more they *sound* better. Those crunching noises reverberating through your head are exciting. You keep wondering if they can be heard on the "outside." Remember?

Naturally, you'll never hear an apple like that again. But if you've retained even a little sonic sensitivity, we can offer you an experience almost as pleasant.

Make your next recording on Audiotape.

You'll find that the wonderful quality of this tape provides more clarity, more range, eliminates noise

and distortion problems. And you'll find this quality is consistent from reel to reel and within every reel of Audiotape.

Whether you're taping a small apple-cruncher or a great symphony orchestra, there's an Audiotape exactly suited to your needs. From Audio Devices, for 25 years a leader in the manufacture of sound recording media—Audiodiscs*, Audiofilm* and . . .

audiotape
TRADE MARK

AUDIO DEVICES INC., 444 Madison Ave., N. Y.
Offices In Los Angeles, Chicago, Washington, D. C.

*TRADE MARK

POPULAR ELECTRONICS

World's Largest-Selling Electronics Magazine

Publisher **PHILLIP T. HEFFERNAN**
 Editor **OLIVER P. FERRELL**
 Managing Editor **JULIAN M. SIENKIEWICZ, WA2CQL**
 Art Editor **JAMES A. ROTH**
 Associate Editors **MARC E. FINKEL**
RICHARD A. FLANAGAN
MARGARET MAGNA
 Draftsman **ANDRE DUZANT**
 Amateur Radio Editor **H. S. BRIER, W9EQG**
 CB Editor **D. STRIPPEL, 2W1452**
 Semiconductor Editor **L. E. GARNER, JR.**
 Short-Wave Editor **H. BENNETT, W2PNA**
 Contributing Editor **J. T. FRYE, W9EGV**
 Editorial Consultant **OLIVER READ, W4TWW**
 Advertising Manager **WILLIAM G. McROY, 2W4144**
 Advertising Service Manager **ARDYS C. MORAN**

ZIFF-DAVIS PUBLISHING COMPANY

Editorial and Executive Offices (Oregon 9-7200)
 One Park Avenue, New York 16, New York

William B. Ziff, Chairman of the Board (1946-1953)
 William Ziff, President

W. Bradford Briggs, Executive Vice President
 Hershel B. Sarbin, Vice President and General Manager
 M. T. Birmingham, Jr., Vice President and Treasurer
 Robert P. Breeding, Circulation Director
 Charles Housman, Financial Vice President
 Stanley R. Greenfield, Vice President

Midwestern and Circulation Office (Wabash 2-4911)
 434 South Wabash Avenue, Chicago 5, Illinois
 Midwestern Advertising Manager JAMES WEAKLEY

Western Office (CRestview 4-0265)
 9025 Wilshire Boulevard, Beverly Hills, California
 Western Advertising Manager, WILLIAM J. RYAN, 11Q3002

Foreign Advertising Representative
 D. A. Goodall Ltd., London, England



Member
 Audit Bureau of
 Circulations

SUBSCRIPTION SERVICE: All subscription correspondence should be addressed to POPULAR ELECTRONICS, Circulation Department, 434 South Wabash Avenue, Chicago 5, Illinois. Please allow at least six weeks for change of address. Include your old address as well as new—enclosing if possible an address label from a recent issue.

EDITORIAL CONTRIBUTIONS must be accompanied by return postage and will be handled with reasonable care; however, publisher assumes no responsibility for return or safety of art work, photographs or manuscripts.

Always say you saw it in—POPULAR ELECTRONICS

NOW YOU CAN
 BUILD A FINE
Schober Organ



FOR ONLY
\$550

You can assemble this new Schober Spinnet Organ for \$550 — or half the cost of comparable instruments you have seen in stores. The job is simplicity itself because clear, detailed step-by-step instructions tell you exactly what to do. And you can assemble it in as little as 50 hours.

You will experience the thrill and satisfaction of watching a beautiful musical instrument take shape under your hands. The new Schober Electronic Spinnet sounds just like a big concert-size organ — with two keyboards, thirteen pedals and magnificent pipe organ tone. Yet it's small enough (only 38 inches wide) to fit into the most limited living space.

You can learn to play your spinet with astounding ease. From the very first day you will transform simple tunes into deeply satisfying musical experiences. Then, for the rest of your life, you will realize one of life's rarest pleasures — the joy of creating your own music.

For free details on all Schober Organs, mail the coupon now. No salesman will call.

THE *Schober Organ* CORPORATION

43 West 61st Street, New York 23, N. Y.
 Also available in Canada and Australia.

MAIL THIS COUPON TODAY

The Schober Organ Corporation, Dept. PE-9
 43 West 61st Street, New York 23, N. Y.

- Please send me FREE booklet and other literature on the Schober Organs.
- Please send me the Hi-Fi demonstration record. I enclose \$2 which is refundable when I order my first kit.

Name.....

Address.....

City.....Zone...State.....

**NOW...GET
EVERYTHING
YOU NEED TO
PREPARE TO EARN
REAL MONEY IN**

ELECTRONICS

**From RADIO • TELEVISION • RADAR
To GUIDED MISSILE CONTROL, etc.**



One of
Today's
BRIGHTEST
Opportunity Fields!



Today's great Electronics field offers you a chance of a lifetime to prepare for highly interesting work and a wonderfully promising future! With so many new developments coming up in Electronics, opportunities for trained men were never brighter. Send coupon for details.

Right in your own home you may now get one of today's most interesting . . . **PRACTICAL WAYS** to prepare for a good job or your own business in Electronics. No previous technical experience or advanced education are needed! DeVry Tech brings you a unique **3-WAY COMBINATION** of texts, home movies and real equipment—the same type of basic equipment as found in our well-equipped Chicago and Toronto Laboratories.

EMPLOYMENT SERVICE EARN WHILE YOU LEARN

. . . helps you get started toward a good job, or toward advancement in the company you now work for. **FREE** to all graduates.

DeVry Tech's practical program helps you to earn **EXTRA MONEY** in your spare time, servicing Radio and TV sets.

**Your Guide
to PROFITABLE JOB OPPORTUNITIES**

See how **YOU** may get ready for Jobs as:

- TV-Radio Broadcast Technician**
- Color Television Specialist**
- Radar Operator • Laboratory Technician**
- Airline Radio Man • Computer Specialist**
- Quality Control Manager**

Your Own Sales & Service Shop...**PLUS MANY OTHERS**

SEND FOR FREE BOOKLET!

"One of North America's Foremost Electronics Training Centers"



Accredited Member
of National Home
Study Council

DeVRY TECHNICAL INSTITUTE
CHICAGO 41, ILLINOIS

**E-X-C-L-U-S-I-V-E
EQUIPMENT!**

As part of your home laboratory projects, you **BUILD** and **KEEP** this fine quality combination 5-inch **COLOR OSCILLOSCOPE** and a Jewel Bearing **VACUUM TUBE VOLTMETER**. You will find this latest DeVry equipment ideal for helping you earn in your spare time while a student—and later when working full time in the field.

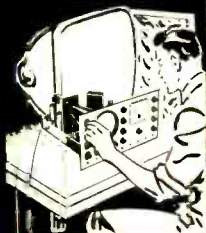

HOME MOVIES

Thanks to this exclusive home training aid, many important fundamentals quickly become "movie clear." Now you can actually see electrons on the march and other "hidden actions"—a wonderful advantage that is almost like having a teacher at your side.

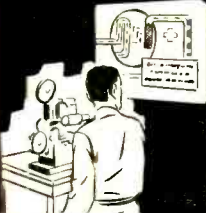

300 EXPERIMENTS

Build over 300 practical projects from many shipments of Radio-Electronic parts. You build and operate **TV-Radio Circuits** . . . wireless microphone . . . and many other major projects—all designed to provide outstanding practical experience at home.



**BUILD AND KEEP A
BIG 21-INCH TV SET**

For added practical experience, you can also build and keep this quality 21-inch TV SET that provides TV reception at its finest (DeVry Tech also offers another home training without the TV set).

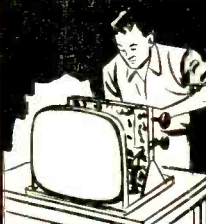

MAIL COUPON TODAY!

DeVRY TECHNICAL INSTITUTE
4141 Belmont Avenue, Chicago 41, Ill., Dept. PE-7-S

Please give me your **FREE** booklet, "Electronics in Space Travel," and tell me how I may prepare to enter one or more branches of Electronics.

Name _____ Age _____
(PLEASE PRINT)
 Street _____ Apt. _____
 City _____ Zone _____ State _____

Canadian residents address: DeVry Tech of Canada, Ltd.
970 Lawrence Avenue West, Toronto, Ontario

2046

POPULAR ELECTRONICS is published monthly by Ziff-Davis Publishing Company at 434 South Wabash Avenue, Chicago 5, Illinois. **Subscription Rates:** One year United States and possessions, \$4.00; Canada and Pan American Union Countries, \$4.50; all other foreign countries, \$5.00. Second Class postage paid at Chicago, Illinois, and at additional mailing offices. Authorized as second class mail by the Post Office Department, Ottawa, Canada, and for payment of postage in cash. July, 1962. Volume 17, Number 1.



HOT NEWS—London's firefighters will be equipped with new-type portable radiotelephones that "speak only when spoken to." The specially designed VHF transceivers are being supplied to the London Fire Brigade by a Raytheon Company subsidiary. Unlike ordinary mobile radiotelephones, the new units incorporate analog computers. When a set is on "receive," it continuously sorts the various noises heard on ordinary two-way radios and silences the speaker until it hears a valid broadcast from another fire station or firefighter—eliminating the usual interference noises. The portable unit shown at left weighs only five pounds and command instructions can be easily heard above the noise at the scene of action.



POSTAGE STAMP STEREO—Electronic developments that are ushering in the space age will be adding exciting new wonders to the consumer market. One such item, a stereo amplifier the size of a postage stamp, was demonstrated by the Martin Company at the recent IRE Show in New York City. It is a member of a whole family of tiny electronic devices, tabbed "MARTEC" (for Martin Thin Film Electronic Circuit), intended for use in missile systems where space, weight, and reliability are prime considerations. So small indeed is a MARTEC computer circuit that it must be examined under a microscope (see photo).



TANKS A LITTLE—In a move to pare training costs, the U. S. Army has shrunk a battlefield, reduced maneuverable tanks to a fraction of their size, and brought miniature warfare to life in simulated combat. A mockup of 30 acres of terrain and radio-controlled miniature tanks—one of the micro monsters sports a turret TV camera—was built for the Army by General Dynamics/Electric Boat to 1/20th actual size. Costs of operating a real platoon of five tanks in actual training situations are conservatively estimated at over \$75 a mile, while the simulator costs only pennies to run. A student tank platoon leader directs the five tanks while viewing the TV picture transmitted by the lead tank. Instructors rate performance by listening to commands and observing platoon maneuvers and "battle" developments.



BEEP, BEEP, BOOP, BEEP! The world's first completely transistorized radio navigational beacon is now undergoing field trials at Mount McQuoid, the holding area for jet aircraft using Mascot Airport at Sydney, Australia. Developed by an ITT Australian affiliate, transistorized beacons are expected to serve an important function at many small and infrequently used airports that presently lack navigational aids due to high costs. Designed for isolated locations, these beacons can withstand all Australian climatic conditions—temperatures from 14° to 140° F and up to 100% relative humidity. Due to low power drain, a wind-driven generator can supply the power necessary to transmit omnidirectional Morse-code beacon signals.

(Continued on page 8)

The Same School That Originated The RTS BUSINESS PLAN

... NOW
Proudly
Presents...

A SPECIAL COMPACT COURSE COVERING ALL THREE PHASES OF **ELECTRONICS**

The Entire Course Is Made
Up Of The Following:

- 35 LESSONS COVERING BASIC AND INTERMEDIATE ELECTRONICS
- 9 EQUIPMENT KITS COMPLETE WITH TUBES AND BATTERIES
- SOLDERING IRON
- 25 LESSONS COVERING THESE ADVANCED ELECTRONIC SUBJECTS:
Thyratron Tubes • Semiconductors • Electronic Symbols and Drawings • Voltage-Regulators • Electronic-Timers • Control Systems • X-Rays • Photoelectric Devices • Dielectric Heating • Geiger Counters • Pulse Circuitry • Clippers and Limiters • Multivibrators • Electronic Counters • Radar • Magnetic Amplifiers • Analog Computers • DC Amplifiers • Digital Computers • Storage Systems • Input and Output Devices • Servomechanisms • Telemetering
- 60 EXAMINATIONS
- UNLIMITED CONSULTATION SERVICE
- KIT MANUALS
- DIPLOMA UPON GRADUATION

**BASIC • INTERMEDIATE • ADVANCED
DESIGNED FOR THE BUSY MAN OF TODAY**

This is MODERN training for the MODERN man. You'll find no "horse and buggy" methods here. Every page of this streamlined course is devoted to important Electronics principles and practical projects. You'll be amazed how fast you grasp Basic Electronics the RTS way. RTS has combined modern THEORY and PRACTICE to make this the finest training program of its kind available!

SATISFIES NOVICE, TECHNICIAN OR HOBBYIST

Whether you're new to Electronics or an old "pro," chances are you'll find this to be the ideal course for you. The novice will appreciate the completeness of the training. It starts with the most basic considerations, covering each important point thoroughly, yet concisely. The technician will enjoy the practical review of fundamentals and profit from the 25 advanced subjects covered.

RTS GIVES YOU "TOP MILEAGE" FOR YOUR TRAINING DOLLAR

The price quoted below buys EVERYTHING—there are no extras to pay for. RTS has gone "all out" to give you the best training value in America. Why pay hundreds of dollars for training such as we offer when it's available for this LOW PRICE? If you can find a better training bargain... BUY IT!

CAN BE COMPLETED IN MONTHS INSTEAD OF YEARS

Some students will complete this course with "Jet-Like" speed but we allow up to two years if your circumstances require it. You study at your own rate. You are ENCOURAGED but not pushed. You'll find the lessons professionally written. LET US SEND YOU ONE OF THESE LESSONS ALONG WITH YOUR CAREER BOOKLET SO YOU CAN SEE FOR YOURSELF. NO OBLIGATION!

AND MUCH MORE...

RTS' Membership in
The Association of
Home Study Schools
is your assurance of
Reliability, Integrity and
Quality of Training.



RTS ELECTRONICS DIVISION
815 E. ROSECRANS AVENUE
LOS ANGELES 59, CALIFORNIA

Est. 1922



L 01C

COMPLETE
COST...
INCLUDES ALL KITS,
TUBES, BATTERIES, ETC.
\$125.00*

**Rush
Coupon**

**NO
SALESMAN
WILL
CALL!**

* TERMS ALSO AVAILABLE
AS LITTLE AS

\$500 DOWN \$500 PER MONTH

**SAVE TIME—SEND
\$5.00 WITH COUPON**
YOUR FIRST LESSONS AND
KIT WILL BE RUSHED TO YOU
THE SAME DAY THEY ARE RECEIVED!

DON'T LOSE OUT—FIND OUT!

RTS ELECTRONICS DIVISION, Dept. PE72

815 E. ROSECRANS AVENUE LOS ANGELES 59, CALIFORNIA

Rush me full information by return mail. (Please Print)

Name _____ Age _____

Address _____

City _____ Zone _____ State _____

ENROLL ME NOW **SEND MORE FACTS**

Continued

UPI

A LIGHT MEAL—Frying pans become instruments of modern science as the young homemaker tries to cook eggs with the heat from two 300-watt spotlamps. She is successful with the conventional lamp aimed at the frying pan at the left, but not so with the other pan. Here, a new "Cool Beam" G.E. lamp has no effect on the egg. This revolutionary spotlamp is expected to be widely used in food, candy, and other stores where heat due to high-intensity lighting can cause damage to fresh meat, candy, and certain fabrics.

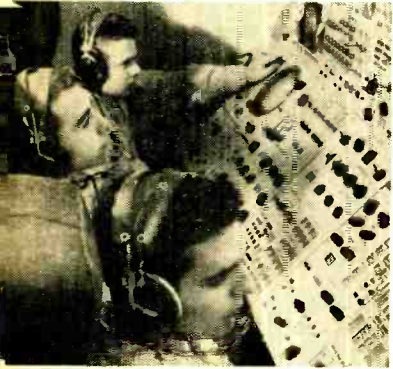

LAND-LOCKED ASTRONAUTS practice a moon flight in a simulated three-man lunar-probe spacecraft to help discover the effects that confinement and reduced physical activity will have on the spacecraft crew's ability to perform specified tasks. Three employees in the Martin Company's Space Systems Division recently "flew" the spacecraft simulator on a mission from earth, into lunar orbit, and back again. They were confined to the simulator for seven days, their only contact with "earth" being through a simulated radio communications system. As a result of the knowledge gained during this test, the spacecraft and associated equipment were modified to prepare for more extensive and more sophisticated research into simulated manned space flight.



UPI

RED TINSEL—At left is a sample of the metal foil which is being dropped in the Allied air corridors leading to Berlin in an attempt to jam radar communications of Western planes flying over East Germany. Commonly called "chaff," or sometimes "window," the pieces of metal foil are used as confusion reflectors. A few pounds of foil dropped at 50,000 feet will almost make a radar operator believe he is seeing the ghost of the "Hindenburg" returning to Berlin. Being very light, the chaff floats to the ground slowly, jamming radar signals for long intervals.



UPI

SCIENCE ON SKIS—Getting ready to carry scientific research to the ski trails, engineer William Johansen of the Stockholm Central Institute straps his new invention on the back of a skier. The lightweight portable apparatus is a cross between an electrocardiograph and an ultra-short-wave transmitter. It will detect and transmit the pulse beat of the skier in action to a special receiver which is tied into a computer and recorder. Small electrodes attached to the athlete's chest pick up heart beats much as the astronauts' electrodes do. This invention will be used in research connected with body activity measurements in various sports.

Clip this coupon for
FREE INFORMATION

**ON YOUR
FUTURE IN
ELECTRONICS!
NO OBLIGATION!**



PROFITS FROM ELECTRONICS contains valuable information on the many different profit opportunities for you in the exploding field of electronics... information that helps you pin-point exactly which area of electronics can be most profitable for you! TO GET YOUR COPY, MAIL THE CAREER COUPON TODAY!

ELECTRONICS CAREER COUPON

01072E

Please send me your FREE booklet "PROFITS FROM ELECTRONICS" and tell me how Central training can qualify ME for a high-pay career in Electronics.

Name..... Age.....

Address.....

City..... Zone.....

State..... County.....

I am interested in Home Study Training

I am interested in Resident Training

CENTRAL TECHNICAL INSTITUTE

1644 WYANDOTTE, KANSAS CITY 8, MO.

Accredited Member National Home Study Council



DISCOVER YOUR CAREER IN ELECTRONICS

**THERE'S A PLACE FOR YOU IN THE DYNAMIC,
\$11,000,000,000 FIELD OF ELECTRONICS!**

Today—there are many exciting opportunities for you in Industrial Electronics, Automation, Radio, Color TV, Radio-TV Broadcasting, Communications Electronics, Radar, Missiles, Computers, Nuclear Energy, and many other areas. The electronics industry is growing so rapidly that **LAST YEAR, THERE WERE NOT ENOUGH TECHNICALLY-TRAINED PERSONNEL TO FILL ALL OF THE JOBS OPEN WITH ELECTRONICS COMPANIES!** With the electronics field expanding so FAST, every day you gain in starting your career training is **MONEY IN YOUR POCKET.** If you're interested in a rewarding, secure future in electronics—let Central Tech help you learn about the field. Mail the above CAREER COUPON TODAY! NO OBLIGATION!

CENTRAL HAS THE FACILITIES AND THE EXPERIENCE TO TRAIN YOU FOR SUCCESS IN ELECTRONICS



AUTOMATION LAB Central Tech's \$250,000 Data Processing Center contains a Remington-Rand UNIVAC computer system, a Bendix G-15 computer, and accessory data processing equipment. Students actually use this equipment in learning Electronic Computer Programming as well as Computer Technology.



RADIO-TV BROADCAST LAB This Studio Lab has three separate control rooms and is equipped with five modern TV cameras, a switching and control console, TV film projectors, recording console, FM transmitter, microphones, special lighting facilities and other accessory equipment.



PRACTICAL ELECTRONICS LABS The practical application of theory is an important part of Central's home study and resident curriculums. In Central's Practical Electronics Labs, students gain actual experience working with circuitry, components and test equipment.



HOME STUDY Students enrolled in Central Tech's excellent home study course have a double advantage. Central's highly qualified teaching staff employ the most modern lesson materials and personalized home instruction methods, together with a wide variety of Central's exclusive **INSTANT KITS.** The experience gained by building these kits gives students a thorough knowledge of electronics assembly.

CENTRAL TECH'S TRAINING EXPERIENCE INCLUDES THESE FIRSTS:

- Central constructed and operated Station W9XAL, the FIRST Television Station west of Chicago to broadcast on a daily schedule.
- Central was granted one of the FIRST THREE High Fidelity commercial broadcast station permits issued by the Federal Communications Commission.
- Central Technical Institute was the FIRST civilian school in the United States selected by the U.S. Signal Corps to train radio operators and repairmen during W.W. II.
- Central Technical Institute was the FIRST Technical Institute in the United States to have a complete electronic computer system installed as a teaching aid.

IF YOU'RE INTERESTED IN AN ELECTRONICS CAREER, LET CENTRAL TECH HELP YOU LEARN ABOUT THE MANY PROFITABLE OPPORTUNITIES IN THE FIELD. MAIL THE ABOVE CAREER COUPON TODAY!

Central Technical Institute

1644 Wyandotte, Kansas City 8, Missouri



FCC Report

By **ROBERT E. TALL**
Washington Correspondent

SUBSTANTIAL revisions in the organization of the Federal Communications Commission—with some pointed toward the agency's administration of the citizens radio service—have been under active study by the Commission for some time.

Under contract from the Bureau of the Budget, a management consulting firm reviewed the agency's operations over a period of several months, and has submitted a number of recommendations for changes in the organization of the FCC staff. While it is up to the Commission itself to carry through on the recommendations—and some of the suggestions are not regarded

in a very favorable light at the agency—agreement on a number of the points raised is likely.

What does it mean for the CB service? The personnel assigned to administer the citizens service will be cut loose from some of their other responsibilities and allowed to devote more time and attention to the problems of the CB service, providing a more individual approach to CB problems.

Under the Hood. FCC engineers, and others associated with the mobile radio communications field, are paying increasing attention to efforts of mobile radio equipment manufacturers to reduce interference stemming from the electrical systems of the users' automobiles. The first breakthroughs have already occurred, and it is now possible for a CB'er or other mobile radio licensee to equip his car with such devices as low-radio-interference mechanical alternators, or fully electronic alternators or ignition systems.

License Fees. With virtually all interested parties having been heard from, there appears little doubt that the non-commercial two-way radio field has again escaped the formidable "filing fee" proposal of the FCC, which would have put the Commission in the position of charging money for the submission of an application, whether or



OUTDOOR Model SWO is a high efficiency, doublet type antenna with superior trap design for substantially improving DX reception and Signal/Noise ratio. Peaked for the most popular Short Wave bands — 11, 13, 16, 19, 25, 31 and 49 meters. Complete with instructions for assembly in minutes. Only **\$14.75.**

BRING IN STATIONS NEVER HEARD BEFORE
with optimum performing antennas designed for

SHORT WAVE LISTENING

from
HY-GAIN ANTENNA PRODUCTS
DEPT. 137 LINCOLN, NEBR.



INDOOR

Model SWI is specifically designed for indoor use, when an outdoor antenna is impractical. It is housed in attractive grey plastic case and covers 5-30 mc, including all seven popular short wave bands. Guaranteed for finest performance of any indoor antennas. "Match" and "tune" controls. May also be used as an antenna tuner with existing short wave antennas. Only **\$14.75.**

The antenna is the key to better performance in any Short Wave Listening system. The Hy-Gain Models SWO and SWI are the finest available in their price range for improving DX and reducing fading.

BREAK THROUGH TO HIGHER PAY

in ELECTRONICS

TV-RADIO

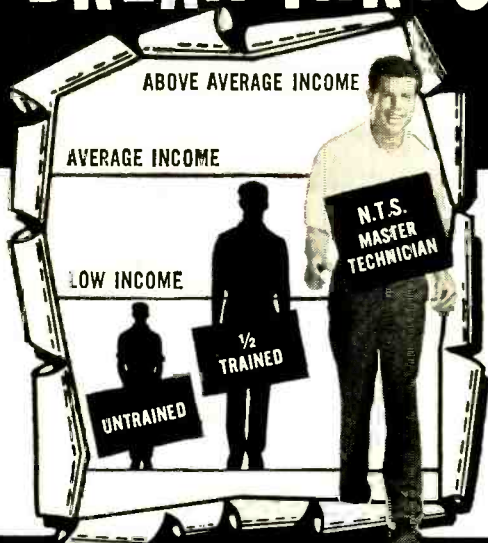

START NOW! Break through the Earning Barrier that stops half-trained men. N.T.S. "All-Phase" training prepares you — at home in spare time — for a high-paying CAREER in Electronics — TV — Radio as a MASTER TECHNICIAN. One Master Course at One Low Tuition trains you for unlimited opportunities in All Phases: *Servicing, Communications, Preparation F.C.C. License, Broadcasting, Manufacturing, Automation, Radar and Micro-Waves, Missile and Rocket Projects.*

A more rewarding job... a secure future... a richer, fuller life can be yours! As an **N.T.S. MASTER TECHNICIAN** you can go straight to the top in industry... or in your own profitable business.

You work on actual job projects

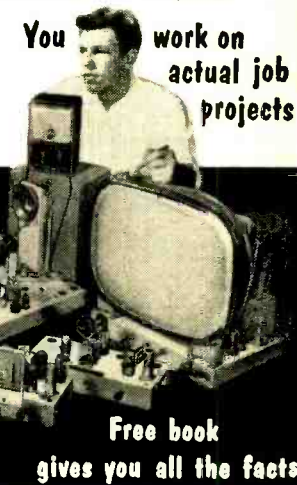

SUCCEED IN MANY HIGH-PAYING JOBS LIKE THESE...

- TV-Radio Sales, Service and Repair
- Profitable Business of Your Own
- Communications Technician — F.C.C. License
- Hi-Fi, Stereo & Sound Recording Specialist
- TV-Radio Broadcasting Operator
- Technician in Computers & Missiles
- Electronics Field Engineer
- Specialist in Microwaves & Servomechanisms
- Expert Trouble Shooter
- All-Phase Master Technician

19 BIG KITS YOURS TO KEEP

Free book gives you all the facts

NATIONAL TECHNICAL SCHOOLS

WORLD-WIDE TRAINING SINCE 1905
4000 SO. FIGUEROA ST., LOS ANGELES 37, CALIF., U. S. A.

Write Dept. R2G-72



ACCREDITED MEMBER
... the only nationally recognized accrediting agency for private home study schools.

RESIDENT TRAINING AT LOS ANGELES

If you wish to take your training in our Resident School at Los Angeles, the world's TV capital, start NOW in our big, modern Shops, Labs, and Radio-TV Studios. Here you work with latest Electronic equipment — professionally installed — finest, most complete facilities offered by any school. Expert friendly instructors. Personal attention. Graduate Employment Service. Help in finding home near school — and part time while you learn.

WRITE FOR SPECIAL RESIDENT SCHOOL CATALOG AND INFORMATION

N.T.S. Shop-Tested HOME TRAINING is **Better, More Complete, Lower Cost**... and it is your key to the most fascinating, opportunity-filled industry today!

YOU LEARN QUICKLY AND EASILY THE N.T.S. SHOP-TESTED WAY

You get lessons, manuals, job projects, unlimited consultation, graduate advisory service.

You build a Short Wave-Long Wave Superhet Receiver, plus a large-screen TV set from the ground up, with parts we send you at no addi-

tional cost. You also get a Professional Multimeter for your practical job projects.

EARN AS YOU LEARN... WE SHOW YOU HOW!

Many students pay for entire tuition — and earn much more — with spare time work they perform while training. You can do the same... we show you how.

SEND FOR INFORMATION NOW... TODAY! IT COSTS YOU NOTHING TO INVESTIGATE.

N.T.S. HOME TRAINING is

- Classroom Developed
- Lab-Studio Planned
 - Shop-Tested
- Industry-Approved
- Specifically Designed for Home Study



MAIL COUPON NOW for FREE BOOK and ACTUAL LESSON

NO OBLIGATION!
NO SALESMAN WILL CALL

NATIONAL TECHNICAL SCHOOLS

WORLD-WIDE TRAINING SINCE 1905

Mail Now To
National Technical Schools, Dept. R2G-72
4000 S. Figueroa St., Los Angeles 37, Calif.
Please rush FREE Electronics-TV-Radio "Opportunity" Book and Actual Lesson. No Salesmen will call.

Name _____ Age _____
Address _____
City _____ Zone _____ State _____

Check here if interested ONLY in Resident Training at Los Angeles.
 VETERANS: Give date of discharge _____

FCC Report

(Continued from page 10)

not the application resulted in a license.

This is one proposal you can expect to die quietly, at least in its present form, despite a great variance of feeling on the subject between the FCC Commissioners themselves, and between Congressional leaders.

Most numerous among the flood of comments opposing the "fee" suggestion were those from radio amateurs and public safety radio communications licensees and organizations, but all licensee types were heard from.

FCC "Forfeitures." At the time this column was written, it was an odds-on bet that Congress would pass, and President Kennedy would sign, new amendments to the Communications Act which would permit the FCC to slap \$100 fines on radio licensees violating 12 specific provisions of the agency's rules. The Commission was going ahead with its planning to put the program into effect as soon as possible after it became law.

Officers of the Commission made it clear that they were not particularly "against" CB or other types of mobile radio licensees, and were not planning a full-blown crusade to crack down on insignificant or non-harmful infringements of the Commission's rules. But they expect to get a little more respect from CB marine, and other mobile radio operators due to the agency's new authority.

Also in the Congressional mill at the time this column was written was a Communications Act amendment permitting the Commission to stop requiring that applications, and other documents submitted to it, be subjected to "oath or affirmation" before filing. The measure was more than halfway to its goal as law. In asking Congress to make the change, the Commission said the present requirement that applications be notarized is an "unnecessary burden" on both the public and itself.

New CB Form. Citizens Band equipment salesmen and other interested "bulk" users of FCC citizens radio application forms (Form 505) have been advised by the Commission that a new, simplified version of the form will be available within a month or so—by early fall at the latest—and will become effective as soon as it is practicable.

Mandatory cutoff date for the use of the present Form 505 has not yet been established. Starting this fall, however, CB applicants will be cautioned to question their salesmen as to whether the older

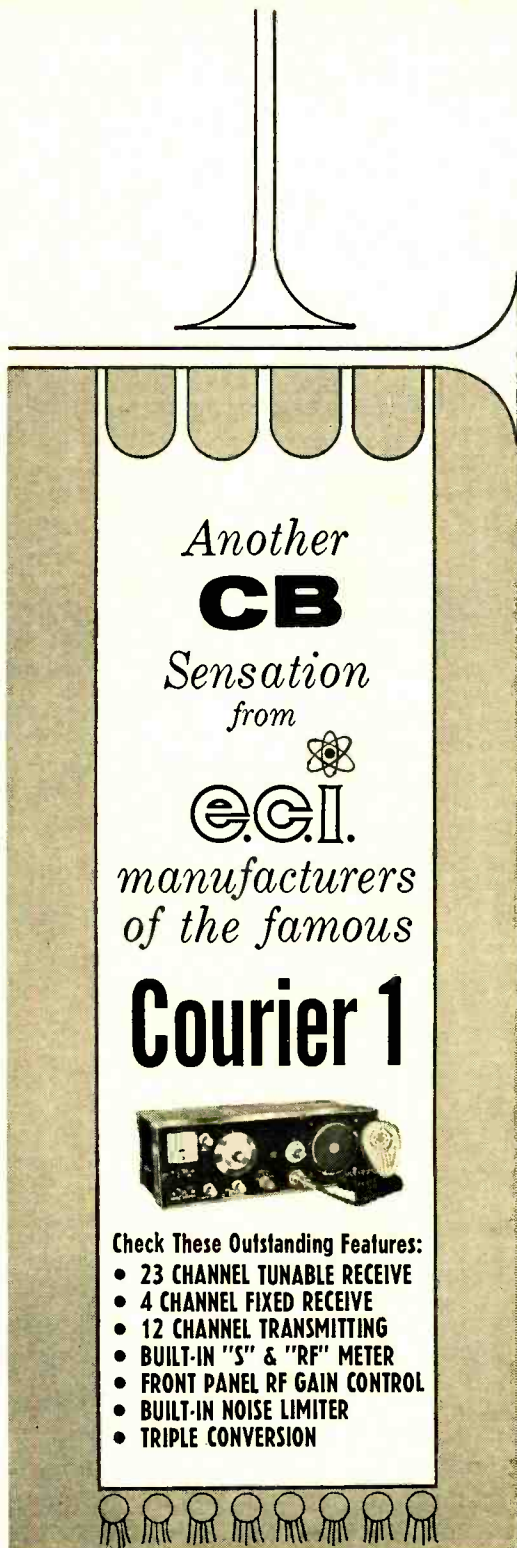

Another
CB
Sensation
from

manufacturers
of the famous
Courier 1

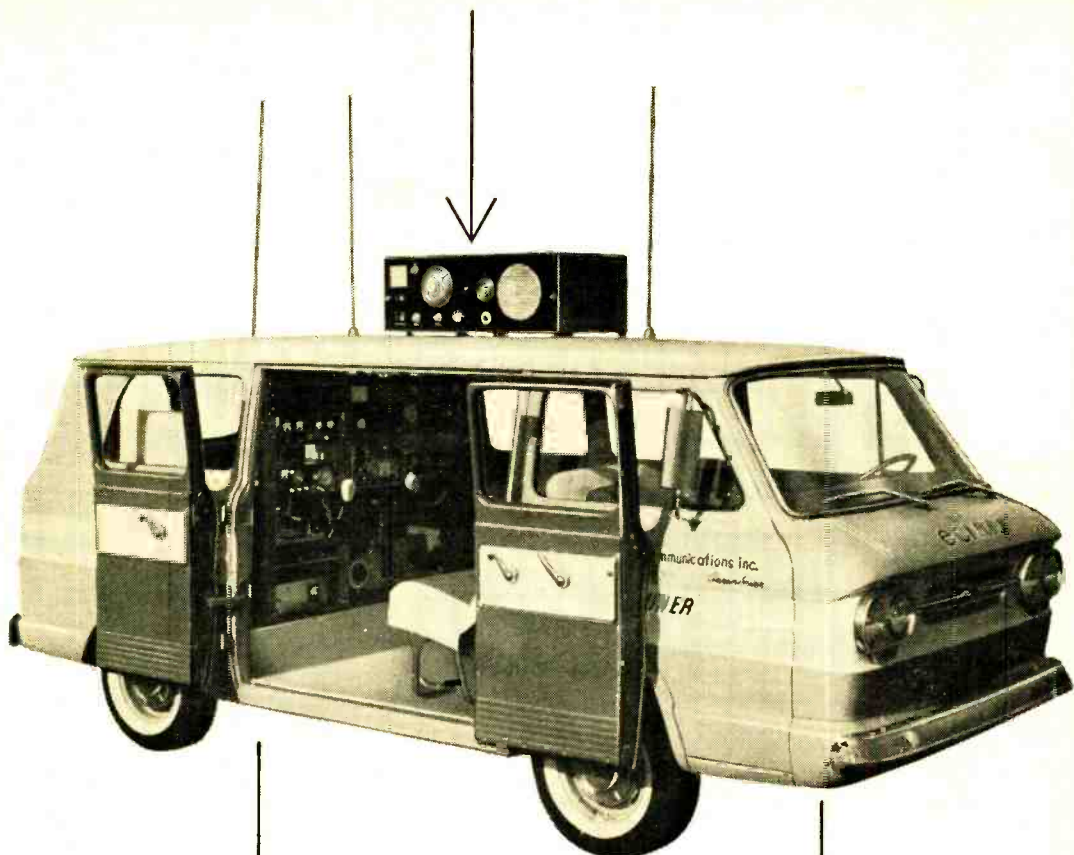

Check These Outstanding Features:

- 23 CHANNEL TUNABLE RECEIVE
- 4 CHANNEL FIXED RECEIVE
- 12 CHANNEL TRANSMITTING
- BUILT-IN "S" & "RF" METER
- FRONT PANEL RF GAIN CONTROL
- BUILT-IN NOISE LIMITER
- TRIPLE CONVERSION



COURIER MOBILAB?



write for free brochure

\$189.50

Slightly higher
west of Rockies

This is the new Courier 1 mobile electronics center . . . a traveling CB communications laboratory available for your inspection, use and education at rallies, shows, clinics, meetings and special events. We cordially invite you to drop us a line, telling us when your club or association is having a big event and we'll try to be on hand with the mobile lab. You'll find it to be a carefully designed, precision engineered rolling CB center that will help solve any CB problems. It's also our way of helping you prove to yourself that the Courier 1 is, by far, the one outstanding transceiver available anywhere! Here are some of the "Mobilab's" features:

- Equipped with 3 Courier 1 CB units, 3 antennae, audio amplifiers, Variac, scopes, meters, microphones, P.A. System, etc.
- Checks and measures any unit from any source for modulation, power output, DC current, standing wave ratio.



e.c.i. electronics communications, inc. 325 no. macquesten pkwy, mt. vernon, n. y.

July, 1962

13

START YOUR CAREER IN ELECTRONICS NOW AT RCA INSTITUTES...

Choose from this list

	Course	Qualifications	Length of Course
A	Electronics Technology (T-3)	High School Grad, with Algebra, Geometry, Physics or Science	Day 2¼ yrs. (N.Y., L.A.) Eve. 6¾ yrs. (N.Y.)
B	Industrial and Communications Electronics (V-7)	2 yrs. High School with Algebra, Physics or Science	Day 1½ yrs. (N.Y., L.A.) Eve. 4½ yrs. (N.Y.) Eve. 3 yrs. (L.A.)
C	Electronics and Television Receivers (V-3)	2 yrs. High School with Algebra, Physics or Science	Day 9 mos. (N.Y., L.A.) Eve. 2¼ yrs. (N.Y.) Eve. 1½ yrs. (L.A.)
D	Radio Telegraph Operating (V-5)	2 yrs. High School with Algebra, Physics or Science	Day 9 mos. (N.Y.) Eve. 2¼ yrs. (N.Y.)
E	Electronic Drafting (V-11, V-12)	2 yrs. High School with Algebra, Physics or Science	Eve. Basic: 1 yr. (N.Y.) Advanced: 2 yrs. (N.Y.)
F	Automation Electronics (V-14)	Radio Receiver and Transistor Background	Sat. 44 wks. (N.Y.) Eve. 9 mos. (N.Y.)
G	Digital Computer Electronics (V-15)	Radio Receiver and Transistor Background	Sat. 32 wks. (N.Y.) Eve. 6 mos. (N.Y.)
H	Computer Programming (C-1)	College Grad. or Industry Sponsored	Sat. 32 wks. (N.Y.) Eve. 6 mos. (N.Y.)
I	Computer Programming (C-2)	Programming Experience	Sat. 16 wks. (N.Y.) Eve. 3 mos. (N.Y.)
J	Color Television	Television Background	Eve. 3 mos. (N.Y., L.A.)
K	Transistors	Radio Background	Eve. 3 mos. (N.Y., L.A.)
L	Technical Writing	Electronics Background	Eve. 3 mos. (N.Y.)
M	Technical Writing (V-10)	High School Graduate	Eve. 1½ yrs. (L.A.)
N	Preparatory (P-1)	1 yr. High School	Day 3 or 6 mos. (N.Y.) Day 3 mos. (L.A.)
O	Preparatory Mathematics (P-0A)	1 yr. High School	Eve. 3 mos. (N.Y.)

RCA Institutes is one of the largest technical institutes in the United States devoted exclusively to electronics. Free Placement Service. Applications now being accepted for next term classes in Los Angeles and New York.



The Most Trusted Name
in Electronics
RADIO CORPORATION OF AMERICA



Send to the school nearest you -

RCA Institutes, Inc. Dept. PER-72

Pacific Electric Building 350 West Fourth Street
610 S. Main St., L.A. 14, Calif. New York 14, New York

Please send me your FREE catalog. I am interested in the courses circled below.

A B C D E F G H I J K L M N O

Name _____ (please print)

Address _____

City _____ Zone _____ State _____

For Home Study Courses See Ad On Opposite Page

FCC Report

(Continued from page 12)

forms are still effective, to prevent an unnecessary delay in the Commission's processing of their applications.

Under the new setup, equipment manufacturing firms will be permitted to print their own stock of the application forms, but the Commission warns that "care should be taken that the finished product is an exact duplicate, not only in text but also in dimensions and in paper stock and color." The agency recommends "photocopy reproduction."

Rules Flap at FCC. Critics of the FCC's CB rules got an unexpected assist several months ago when one of the Commission's hearing examiners—a king of a "judge" in formal agency hearings—put the blast on the citizens service regulations, and, in effect, called several of the rule sections too vague to be enforceable.

There was little expectation that the examiner's views would go unchallenged by the FCC Safety & Special Radio Services Bureau, however, and it was doubtful that the examiner's decision—in a CB enforcement case—would have any appreciable immediate effect on the agency's administration of the service. Several of the CB rule sections scored by the examiner were already undergoing revisions at the staff level of the Commission.

CB'ers who do not think the citizens rules are clear in all cases would have been warmed by the examiner's conclusion that the CB rules leave "a good deal to be desired as an instrument of regulation." The examiner noted that he, as an experienced government attorney, doesn't have a "clear idea" of what several sections of the rules are expected to convey, and doesn't know how the average layman can be expected to understand them.

Particularly cited in his decision as being "deficiencies" was the use of such terms as "personal," "private," or "substantive" communications, which, he said, do not hold water from a legal point of view as they were construed by the FCC staff in the enforcement case.

CB Petition. In one of the latest formal moves seeking revisions in the citizens rules, the 14W Association of Seattle, Wash., has petitioned the FCC to exempt five consecutive frequencies at either the upper or lower extreme of the present Class D frequencies from several current CB restrictions. The purpose would be to put the "uncontrollable elements" in the CB service in a "specific segment of the band" and permit users conforming to the

RCA training at home can be the smartest investment you ever made

Look what you get in the Course in Radio and Electronic Fundamentals

40 Fascinating THEORY LESSONS



Containing all the basic principles of radio and electronics in easy-to-understand form.

40 EXPERIMENT LESSONS



Each containing absorbing, practical experiments bound together in 20 books.

40 SERVICE PRACTICES



Full of practical, time-saving and money-saving servicing tips, bound into 20 books.

15 KITS

to build a Multimeter, AM Receiver and Signal Generator. Kits contain new parts for experiments, integrated so as to demonstrate what you learn in the lessons and to help you develop technical skills. Each kit is fun to put together!

PLUS ALL THIS AT NO EXTRA COST...

MULTIMETER



A sensitive precision measuring instrument you *build* and *use* on the job. Big 4½" meter with 50 micro-amp meter movement. 20,000 ohms-per-volt sensitivity d-c, 6,667 a-c.

SIGNAL GENERATOR



A "must" for aligning and trouble-shooting receivers. Build it for your own use. 170 KC to 50 MC fundamental frequencies for all radio and TV work.

AM RECEIVER



Have the satisfaction of building your own radio receiver with this high-quality 6-tube superheterodyne set. Big 5" speaker, fine tone!

Also, comprehensive, fully-integrated home study courses in • *Television Servicing* • *Color Television* • *Automation Electronics* • *Transistors* • *Communications Electronics* • *Computer Programming*. Stake out your future in electronics with any one of this wide variety of courses.

Practical work with the very first lesson! Pay-only-as-you-learn! No long-term contracts to sign! No monthly installments required. Pay only for one study group at a time, if and when you order it!

SEND FOR FREE HOME STUDY CATALOG TODAY!

RESIDENT SCHOOL COURSES in Los Angeles and New York City offer comprehensive training in Television and Electronics. Day and Evening classes. Free Placement Service. Catalog free on request.



RCA INSTITUTES, INC.
A Service of Radio Corporation of America • 350 W. 4th St., New York 14, N. Y. • 610 S. Main St., Los Angeles 14, Calif.

RCA INSTITUTES, INC. Home Study School, Dept. PE-72

A Service of Radio Corporation of America
350 West Fourth Street, New York 14, N. Y.

Without obligation, rush me the FREE 64-page illustrated booklet "Your Career in Electronics" describing your electronic home study training program. No salesman will call.

Name.....

Address.....

City..... Zone..... State.....

Veterans: Enter discharge date.....

CANADIANS —Take advantage of these same RCA courses at no additional cost. No postage, no customs, no delay. Send coupon to: RCA Victor Company, Ltd., 5581 Royalmount Ave., Montreal 9, Quebec.



The Most Trusted Name in Electronics

For Resident School Courses See Ad On Opposite Page

SEE and HEAR the



MOSLEY CM-1 receiver

- First low priced receiver with double conversion and crystal controlled first oscillator.
- First receiver with 5 dual-purpose tubes of one type and 4 semi-conductor diodes which perform all functions usually requiring 12 or more tube sections.

● First low priced receiver with selectivity, sensitivity and stability that equals receivers selling for \$100.00 or more higher.

Amateur Net, \$182.70 (All crystals included)

Matching Speaker, Amateur Net, \$16.95*

Write for complete descriptive brochure.

* Slightly higher west of Rockies and outside U.S.A.



**Strictly for SWL's
who want Better Listening!**

2 Multi-band Antennas
by **MOSLEY**

Experienced Short Wave Monitors know that a resonant antenna at any one band of frequencies is much more efficient than a random length of wire.

Here are two MOSLEY Dipole Antennas designed to provide the utmost in antenna performance because each is resonant at a number of short wave frequency bands!

Each antenna comes in easy-to-assemble kit form and is complete with wire, weather-proof trap assemblies, center connector, end insulators and 100 feet of 75 ohm lead-in. A pair of wire-cutting pliers will be all you need to quickly assemble either antenna. Attach end insulators to convenient supports, connect lead-in to receiver . . . and tune in new horizons of exciting short wave listening!

Model SWL-7 - Covers 11, 13, 16, 19, 25, 31 & 49 Meter Short Wave Broadcast Bands. SWL Net Price, \$14.75

Model RD-5 - Covers 10, 15, 20, 40 & 80 Meter Amateur Bands. SWL Net Price, \$15.75

See your favorite SWL and Ham Equipment Dealer Today!
Beams and Verticals are fine for SWL DX-ing, too! MOSLEY makes 'em all!



FCC Report

(Continued from page 14)

intent of the citizens rules to operate with "minimum conflict."

The Seattle 14W Association declared that improper usage of the Class D service has reached such proportions that it "threatens to eclipse the worthwhile purposes for which the service was originated." The group said it feels that most people, "given the opportunity to both engage in their hobby without recourse to examination and also conform to regulations," would take advantage of the requested rule changes and shift their activity "to frequencies where both of these ends were afforded."

CB Speech. More than 2000 Class D citizens radio service licensees, gathering at the Morrison Hotel in Chicago several months ago, were advised by FCC Land Transportation Division Chief Ivan H. Loucks not to look for relaxations by the Commission on present power output or antenna height limitations in the Class D service, but to expect the issuance of some proposed rule changes soon.

Mr. Loucks, whose division administers the citizens service at the staff level of the Commission, said that the agency has "many of the present problems involving the citizens service under consideration," and that the present rules "are far from static" and have "definitely not been frozen in their present form."

-30-

COMING NEXT MONTH

2nd Annual CB Equipment Buyers Guide & Directory

(see page 29)

● ONE-ARMED THEREMIN

A good ear, a steady hand, and a little practice are all it takes to play this intriguing electronic music-maker. And an old a.c./d.c. receiver is about all you'll need to build it.

ON
SALE
JULY
26

● 1-2-3 TOTALIZER

Here's an electronic counter that's guaranteed to find plenty of applications. It responds to either light or dark pulses and is capable of registering up to 400 counts per minute.

● 6-METER TRANSCEIVER

A triple triode does double duty as a plate-modulated transmitter and a regenerative receiver for 6 meters.

Always say you saw it in—POPULAR ELECTRONICS

Build your own superb
SCOTT KITS!



**HAVE
FUN...
SAVE
MONEY**

Have fun... save money... build the best! Now you can get world-famous Scott stereo components in kit form. Think of it... you can build the fabulous new LT-110 FM Multiplex Stereo Tuner... your choice of two complete stereo amplifiers, or a preamp and separate power amp... all from H. H. Scott!

Write today. Find out about these exciting Scott kits.

**Choice of 3 Booklets
FREE**



H. H. Scott, Inc. 111 Powdermill Road, Dept. 520-07-3 Maynard, Mass.

Send me the booklets checked below:

- 20-page "Guide to Custom Stereo" Complete technical information on kits 16-page booklet explaining FM Stereo

Name _____

Address _____

City _____

Zone _____

State _____

Export: Morhan Exporting Corp., 458 Broadway, N.Y.C.

TRAM'S Citizen's Band
MOBILE
ENGINEERED
for the Perfectionist!

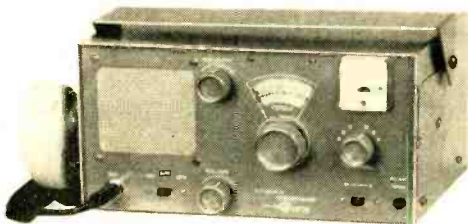

Model TR-70 . . . \$225

- HIGHEST TRANSMITTER OUTPUT
- BEST RECEIVER PERFORMANCE

Tram's 10 day money back trial allows you to be the judge.

Now improved over Base station performance.

Write for free technical information on the TR-27 Base and TR-70 Mobile

TRAM ELECTRONICS
P. O. BOX 187, WINNISQUAM, N. H.

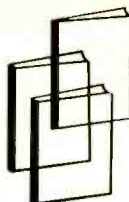

**POP'tronics
Bookshelf**

**FUNDAMENTALS OF SEMICONDUCTOR
AND TUBE ELECTRONICS**

by H. Alex Romanowitz

Beginning with a review of "non-electronic" circuit theory and an introduction to the use of the multi-meter, the vacuum-tube voltmeter and the oscilloscope, this volume discusses tube and semiconductor theory from an engineering viewpoint. Basic concepts of physics, however, are drawn upon for supporting evidence. Some of the special topics covered are: switching and pulse-shaping circuits, zener and tunnel diodes, magnetic amplifiers and photoelectric control circuits. There is also introductory material on microminiaturization.



Published by John Wiley & Sons, Inc., 440 Park Ave. S., New York 16, N.Y. 620 pages. Hard cover. \$8.25.



**SILICON CONTROLLED RECTIFIER MANUAL,
Second Edition**

The continued growth of knowledge in controlled rectifier theory, application, and rating is reflected in this new edition of General Electric's SCR Manual, which exceeds its predecessor in size by 100 pages and five chapters. Included among the new chapters are "Static Switching Circuits," "A.C. Phase Controlled Circuits," and "Selecting the Right SCR." Most of the original chapters have been revised and expanded, and appearing for the first time are

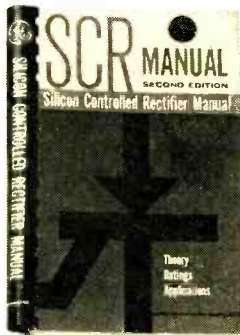

original chapters have been revised and expanded, and appearing for the first time are

Always say you saw it in—POPULAR ELECTRONICS

What Does F. C. C. Mean To You?

What is the F. C. C.?

F. C. C. stands for Federal Communications Commission. This is an agency of the Federal Government, created by Congress to regulate all wire and radio communication and radio and television broadcasting in the United States.

What is an F. C. C. Operator License?

The F. C. C. requires that only qualified persons be allowed to install, maintain, and operate electronic communications equipment, including radio and television broadcast transmitters. To determine who is qualified to take on such responsibility, the F. C. C. gives technical examinations. Operator licenses are awarded to those who pass these examinations. There are different types and classes of operator licenses, based on the type and difficulty of the examination passed.

What are the Different Types of Operator Licenses?

The F. C. C. grants three different types (or groups) of operator licenses—commercial radiotelePHONE, commercial radioteLEGRAPH, and amateur.

COMMERCIAL RADIOTELEPHONE operator licenses are those required of technicians and engineers responsible for the proper operation of electronic equipment involved in the transmission of voice, music, or pictures. For example, a person who installs or maintains two-way mobile radio systems or radio and television broadcast equipment must hold a radiotelePHONE license. (A knowledge of Morse code is NOT required to obtain such a license.)

COMMERCIAL RADIOTELEGRAPH operator licenses are those required of operators and maintenance men working with communications equipment which involves the use of Morse code. For example, a radio operator on board a merchant ship must hold a radioteLEGRAPH license. (The ability to send and receive Morse is required to obtain such a license.)

AMATEUR operator licenses are those required of radio "hams"—people who are radio hobbyists and experimenters. (A knowledge of Morse code is necessary to be a "ham".)

What are the Different Classes of RadiotelePHONE Licenses?

Each type (or group) of license is divided into different classes. There are three classes of radiotelePHONE licenses, as follows:

(1) Third Class RadiotelePHONE License. No previous license or on-the-job experience is required to qualify for the examination for this license. The examination consists of F. C. C. Elements I and II covering radio laws, F. C. C. regulations, and basic operating practices.

(2) Second Class RadiotelePHONE License. No on-the-job experience is required for this examination. However, the applicant must have already passed examination Elements I and II. The second class radiotelePHONE examination consists of F. C. C. Element III. It is mostly technical and covers basic radiotelePHONE theory (including electrical calculations), vacuum tubes, transistors, amplifiers, oscillators, power supplies, amplitude modulation, frequency modulation, measuring instruments, transmitters, receivers, antennas and transmission lines, etc.

(3) First Class RadiotelePHONE License. No on-the-job experience is required to qualify for this examination. However, the applicant must have already passed examination Elements I, II, and III. (If the applicant wishes, he may take all four elements at the same sitting, but this is

not the general practice.) The first class radiotelePHONE examination consists of F. C. C. Element IV. It is mostly technical covering advanced radiotelePHONE theory and basic television theory. This examination covers generally the same subject matter as the second class examination, but the questions are more difficult and involve more mathematics.

Which License Qualifies for Which Jobs?

The THIRD CLASS radiotelePHONE license is of value primarily in that it qualifies you to take the second class examination. The scope of authority covered by a third class license is extremely limited.

The SECOND CLASS radiotelePHONE license qualifies you to install, maintain, and operate most all radiotelePHONE equipment except commercial broadcast station equipment.

The FIRST CLASS radiotelePHONE license qualifies you to install, maintain, and operate every type of radiotelePHONE equipment (except amateur, of course) including all radio and television stations in the United States, and in its Territories and Possessions. This is the highest class of radiotelePHONE license available.

How Long Does it Take to Prepare for F. C. C. Exams?

The time required to prepare for FCC examinations naturally varies with the individual, depending on his background and aptitude. Grantham training prepares the student to pass FCC exams in a minimum of time.

In the Grantham correspondence course, the average beginner should prepare for his second class radiotelePHONE license after from 300 to 350 hours of study. This same student should then prepare for his first class license in approximately 75 additional hours of study.

In the Grantham resident course, the time normally required to complete the course and get your license is as follows:

In the M thru F DAY course, you should get your first class radiotelePHONE license at the end of the 12th week of classes.

In the M-W-F EVENING course, you should get your first class radiotelePHONE license at the end of the 20th week of classes.

In the Tu-Th EVENING course, you should get your first class radiotelePHONE license at the end of the 30th week of classes.

The Grantham course is designed specifically to prepare you to pass FCC examinations. All the instruction is presented with the FCC examinations in mind. In every lesson text and pre-

examination you are given constant practice in answering FCC-type questions.

Why Choose Grantham Training?

The Grantham Communications Electronics Course is planned primarily to lead to an F.C.C. license, but it does this by TEACHING electronics. This course can prepare you quickly to pass F. C. C. examinations because it presents the necessary principles of electronics in a simple "easy to grasp" manner. Each new idea is tied in with familiar ideas. Each new principle is presented first in simple, everyday language. Then after you understand the "what and why" of a certain principle, you are taught the technical language associated with that principle. You learn more electronics in less time, because we make the subject easy and interesting.

Is the Grantham Course a "Memory Course"?

No doubt you've heard rumors about "memory courses" or " cram courses" offering "all the exact FCC questions". Ask anyone who has an FCC license if the necessary material can be memorized. Even if you had the exact exam subject on a question and answers, it would be much more difficult to memorize this "meaningless" material than to learn to understand the subject. Choose the school that teaches you to thoroughly understand—choose Grantham School of Electronics.

Is the Grantham Course Merely a "Coaching Service"?

Some schools and individuals offer a "coaching service" in FCC license preparation. The weakness of the "coaching service" method is that it presumes the student already has a knowledge of technical radio and approaches the subject on a "question and answer" basis. On the other hand, the Grantham course "begins at the beginning" and progresses in logical order from one point to another. Every subject is covered simply and in detail. The emphasis is on making the subject easy to understand. With each lesson, you receive an FCC-type test so you can discover daily just which points you do not understand and clear them up as you go along.

Advanced Resident Training

The Grantham F. C. C. License Course is Section I of our Electronics Series. Successful completion of this course is a prerequisite for enrollment in Section II which deals with more advanced material. However, it is not necessary for the student to take Section II unless he wishes to advance beyond the level of a first class F. C. C. License.

Accredited by the National Home Study Council



What NHSC Membership Means:

Over the years, people have come to respect membership in the National Home Study Council as a hallmark of quality. No school can be a member of the Council unless it has met the rigid standards set up by the Council's Accrediting Commission. This means that all schools, such as Grantham Schools, Inc., which display the seal of the National Home Study Council have demonstrated their integrity and adherence to high ethical standards. It means that they offer quality instruction at reasonable tuition rates. It means that these schools believe in, and are specialists in, the home study method of instruction.

For further details concerning F. C. C. licenses and our training, send for our FREE booklet, "Grantham Training". Clip the coupon below and mail it to the School nearest you.

Get your First Class Commercial F. C. C. License Quickly by training at



GRANTHAM SCHOOL OF ELECTRONICS

1505 N. Western Ave.
Los Angeles 27, Calif.
(Phone: HO 7-7227)

408 Marion Street
Seattle 4, Wash.
(Phone: MA 2-7227)

3123 Gillham Road
Kansas City 9, Mo.
(Phone: JE 1-6320)

821-19th Street, N.W.
Washington 6, D. C.
(Phone: ST 3-3614)

MAIL TO SCHOOL NEAREST YOU

(Mail in envelope or paste on postal card)

TO: GRANTHAM SCHOOL OF ELECTRONICS

1505 N. Western • 408 Marion • 3123 Gillham Rd. • 821-19th, NW
Los Angeles • Seattle • Kansas City • Washington

Please send me your free booklet telling how I can get my commercial F.C.C. license quickly. I understand there is no obligation and no salesman will call. 23 k

Name _____ Age _____

Address _____

City _____ State _____

I am interested in: Home Study, Resident Classes

MAIL COUPON NOW—NO SALESMAN WILL CALL →

want to boost your pay?

Move Ahead in ELECTRONICS

Get All 3 Free!



Get This Handy Pocket
Electronics Data Guide Folder
Free . . .

Puts all the commonly used conversion factors, formulas, tables, and color codes at your fingertips. Yours absolutely free if you mail the coupon today. No further obligation!



find out how . . .

1. You can get job security. Specialized education is the road to higher salary and important jobs in the growing field of electronics.
2. You can solve the problems that stump other technicians. Problems in electronics are becoming more complex. Your ability to solve problems will help you get ahead in your field.
3. You can handle new electronic devices. Every day, advances are being made in electronics. Only through education can you find out how to keep up with these developments and how to use the new devices.

Sorry—Not For Beginners!

Please inquire only if you really want to get ahead and to add to what you have already learned in school, in the service, or on the job. Some previous schooling or experience in electronics, electricity, or related fields is necessary for success in Cleveland Institute programs.

Cleveland Institute of Electronics

1776 E. 17th St. Desk PE-92 Cleveland 14, Ohio

Your FCC License Or Your Money Back!

Completion of the Master Course (both Sections) will prepare you for a First Class Commercial Radio Telephone License with a Radar Endorsement. Should you fail to pass the FCC examination for this license after successfully completing the Master Course, you will receive a full refund of all tuition payments. This guarantee is valid for the entire period of your enrollment agreement.

Investigate Our NEW Training Program
in Computers, Servo Mechanisms
Magnetic Amplifiers, and others

Accredited by the National Home Study Council

MAIL COUPON TODAY



Cleveland Institute of Electronics

1776 E. 17th St., Desk PE92, Cleveland 14, Ohio

Please send Free Career Information prepared to help me get ahead in Electronics. I have had training or experience in Electronics as indicated below:

- | | |
|---|---|
| <input type="checkbox"/> Military | <input type="checkbox"/> Broadcasting |
| <input type="checkbox"/> Radio TV Servicing | <input type="checkbox"/> Home Experimenting |
| <input type="checkbox"/> Manufacturing | <input type="checkbox"/> Telephone Company |
| <input type="checkbox"/> Amateur Radio | <input type="checkbox"/> Other |

In what kind of work are you
now engaged?

In what branch of Electronics
are you interested?

Name Age

Address

City Zone State PE92

BUILD YOUR AMATEUR TRANSMITTER from these easy-to-build kits!



ADVENTURER — 50 watts CW input rugged 807 transmitting tube, instant bandswitching 80 thru 10 meters. Crystal or VFO control, wide range pi-network output.

VALIANT — 275 watts input CW and SSB (P.E.P.) with auxiliary SSB exciter, 200 watts phone; instant bandswitching 160 thru 10 meters. Crystal or VFO control, wide range pi-network output, timed sequence keying.

RANGER II — 75 watts CW, 65 AM. Also serves as RF audio exciter. Self-contained bandswitching 160 thru 6! VFO or crystal control. Timed sequence keying, wide range pi-network output.



Adventurer



Valiant



Ranger II

Write today — FREE 30-page amateur catalog!



E. F. JOHNSON COMPANY

2403 Tenth Ave. S.W. • Waseca, Minn.

Name _____

Address _____

City _____ State _____



GREENLEE CHASSIS PUNCHES

Make accurate, finished holes in 1½ minutes or less in metal, hard rubber and plastics. No tedious sawing or filing — a few turns of the wrench does the job. All standard sizes . . . round, square, key, or "D" shapes for sockets, switches, meters, etc. At your electronic parts dealer. Literature on request.

GREENLEE TOOL CO. 
2028 Columbia Ave., Rockford, Illinois

Bookshelf

(Continued from page 18)

an application index (which cross-references hundreds of basic circuit possibilities against major types of applications), silicon-controlled rectifier selection charts, and a regular subject index.

Published by the General Electric Co., Rectifier Components Dept., Auburn, N.Y. 352 pages. Soft cover. \$1.50.



HANDBOOK OF ELECTRONIC TABLES AND FORMULAS

by the Howard W. Sams Engineering Staff

This revised edition of the *Handbook of Electronic Tables and Formulas* includes 50% more information than the former one—much of it suggested by readers of the first volume. The book is broken down into seven sections: "Electronics Formulas and Laws," "Constants and Standards," "Symbols and Codes," "Service and Installation Data," "Design Data," "Mathematical Tables and Formulas," and "Miscellaneous Data." Thirty-five diversified tables are included. In addition, there is a six-page, full-color fold-out chart covering the latest FCC allocations for the entire frequency spectrum; the chart shows at a glance which services operate within given frequency bands and what frequencies are assigned for specific services.

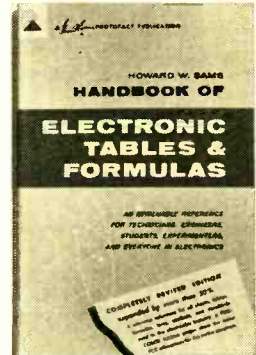

Published by Howard W. Sams & Co., Inc., 1720 East 38th St., Indianapolis 6, Ind. 192 pages. Hard cover. \$3.95.



1926-38 RADIO DIAGRAMS

compiled by M. N. Beitman

This reprinted edition of Volume One in Supreme's series of radio manuals contains approximately 200 schematics from about 60 manufacturers. The book also includes servicing information and an alphabetical index of the sets covered. It should be of particular value to those enthusiasts who

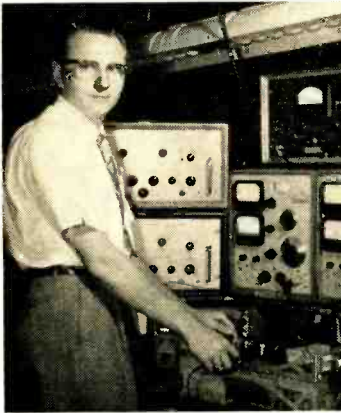

RICHARD S. CONWAY (CREI grad 1960) is Supervisor, Electronic Test Department Wilcox Electric Co., Kansas City, Mo.



ROBERT T. BLANKS (CREI grad 1960) is Engineer, Research & Study Div., Vitro Labs., Division of Vitro Corp. of America, Silver Spring, Md.

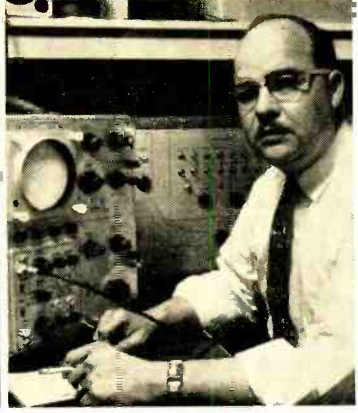

MEARL MARTIN, Jr. (CREI grad 1956) is a Senior Engineer and Field Support Manager, Tektronix, Inc., Portland, Oregon.

Why do these men now enjoy profitable careers in electronics that others still dream about?

SUCCESS IS NO ACCIDENT. There is a reason why some men move ahead in electronics while others stand still, year after year, in routine, low-paid jobs. Responsible, rewarding positions in electronics require advanced technical knowledge. Without such knowledge, you cannot hope for success no matter how bright and ambitious you are.

THE THREE MEN SHOWN ABOVE realized that career opportunities would open up for them only if they gained the practical knowledge of electronic engineering technology demanded by industry. They gained this knowledge through CREI Home Study Programs and achieved the success they desired.

YOU HAVE THE SAME OPPORTUNITY. Through CREI Home Study Programs, you can acquire the practical working knowledge of advanced and up to date electronic engineering technology that will put you on the level of specialization where men are most in demand.

YOU WILL FOLLOW THE FOOTSTEPS of the thousands of CREI men who hold positions as associate engineers, engineering aides, field engineers, project engineers and technical representatives. They work in every area of electronics, from manufacturing to the space program.

WHEN YOU ENROLL IN A CREI HOME STUDY PROGRAM, you study courses to which a number of leading engineers and scientists have made substantial contributions. You are guided and assisted by CREI's staff of experienced instructors.

YOU HAVE A CHOICE OF PROGRAMS covering every field of electronics:

RADAR • COMPUTERS • SERVOMECHANISMS • INSTRUMENTATION • AERONAUTICAL AND NAVIGATIONAL • COMMUNICATION • TELEVISION • AUTOMATION AND INDUSTRIAL ENGINEERING TECHNOLOGY • NUCLEAR ENGINEERING TECHNOLOGY

CREI EDUCATION IS RECOGNIZED by many large corporations such as National Broadcasting Company, Pan American Airways, Federal Electric Corporation, The Martin Company, Canadian Broadcasting Co., Mackay Radio, and many others. These companies often pay all or part of CREI tuition for their employees.

CREI HAS 35 YEARS OF EXPERIENCE in advanced technical education through home study. CREI has de-

veloped electronics courses for the Army Signal Corps, special radio technician courses for the Navy, and group training programs for leading aviation and electronics companies. CREI also maintains a Residence School in Washington, D. C.

YOU CAN QUALIFY for a CREI Program, if you have basic knowledge of radio or electronics and are a high school graduate or the equivalent. If you meet these qualifications, write for FREE 58-page book describing CREI Programs and career opportunities in advanced electronic engineering technology. Mail coupon or write to: The Capitol Radio Engineering Institute, Dept. 1207-K 3224 Sixteenth St., N.W., Washington 10, D. C.

Mail coupon today for FREE 58-page book



THE CAPITOL RADIO ENGINEERING INSTITUTE

Founded 1927

Dept. 1207-K 3224 Sixteenth St., N.W., Washington 10, D.C.

Please send me details of CREI Home Study Programs and Free Book, "Your Future in Electronics and Nuclear Engineering Technology." My qualifications are noted to obtain immediate service.

CHECK FIELD OF GREATEST INTEREST:

- Electronic Engineering Technology Nuclear Engineering Technology
 Servo and Computer Engineering Technology Automation and Industrial Electronic Engineering Technology
 Aero and Navigational Engineering Technology

Name Age

Address

City Zone State

Employed by

Type of present work

Education: Years High School Other

Electronics Experience

Check: Home Study Residence School G.I. Bill 29

GIANT CB SALE!!!

- 50 ft.—RG58u COAX CABLE..SALE \$1.95
- 100 ft.—RG58u COAX CABLE..SALE \$2.99
- 50 ft.—RG 8u COAX CABLE..SALE \$4.49
- 100 ft.—RG 8u COAX CABLE..SALE \$7.99
- 15-PC. CB SILENCER KIT (tune gen. supp.+feed-thrus+spark plug & distr. suppressors, etc.) SALE \$3.99
- JK GOLD. LINE CB CRYSTALS (trans. or rec.) (specify make, model, channel)..... SALE \$1.99
- COMMAND 12-POSITION CHANNEL SELECTOR (reg. \$10)..... SALE \$4.99
- COMMAND SUPER-III—3-ELEMENT CB BEAM ANTENNA (heavy-duty, alloy construction) (vertical or horizontal)..... SALE \$11.99
- COMMAND SUPER V—5-ELEMENT CB ANTENNA (super-high-gain and rugged) (vertical or horizontal)..... SALE \$18.99
- COMMAND CONTACT II—STAINLESS STEEL SPRING, STAINLESS STEEL 102" WHIP+CHROME BODY MOUNT..... SALE \$6.89
- SPECIAL VALUE: HIGH GAIN GROUND PLANE ANTENNA (Solid alum. radials) Terrific value SALE \$8.99
- PL-259 COAX CONNECTORS—39¢ ea. 10 for \$3.50
- SO-239 COAX CONNECTORS—39¢ ea. 10 for \$3.50
- UG176 ADAPTORS for 58u—14¢ ea. 10 for \$1.19
- TOKYO ROSE CRYSTAL STUDIO MIKES FOR CB.....SALE \$4.89

Check items wanted. Return ad or order with check or money order. Include postage, excess refunded. 50¢ service charge on orders under \$5.00. Beams and Contact II shipped Railway Express.

CB DEALERS: Write for Quantity Prices!

GROVE ELECTRONIC SUPPLY COMPANY
4103 W. Belmont Ave., Chicago 41, Ill.

- Rush items checked
- Send FREE catalog of giant CB Values

Name (please print)
Address
City Zone State

Bookshelf

(Continued from page 20)

have a continuing interest in repairing and restoring old receivers.

Published by Supreme Publications, 1760 Balsam Rd., Highland Park, Ill. 240 pages. Soft cover. \$2.50.

New Literature

A 12-page illustrated brochure, describing the principles and function of language laboratories, has recently been published by Edwards Company, Inc., Norwalk, Conn. The free booklet (No. D-102) details the Edwards language teaching equipment and includes an outline of the three basic systems for language laboratory operations.

The revised and enlarged edition of the "Allied Electronics Data Handbook" contains an up-to-date listing of the most commonly used tables, formulas, and reference material. New material in this 80-page handbook includes basic transistor formulas and symbols, transistor circuit configurations, a battery interchangeability guide, charts showing direct interchangeability between American and British tubes, and attenuator network formulas. All the reference material of the earlier editions has been retained. If you would like to have a copy, send 35 cents to Allied Radio Corp., 100 N. Western Ave., Chicago 80, Ill.

A new 8-page catalog for the "hobbyist" can be obtained free by writing to Wilson's of Cleveland, 6502 N.W. 16th St., P.O. Box 8995, Fort Lauderdale, Fla. It illustrates and describes various devices ranging from miniature electric motors to accessories and kits.

"How To Make Quality Tape Recordings At Home" is a 16-page booklet directed at improving home recording techniques. A chart of playing times for all available tape thicknesses, reel sizes, and recording speeds is included. Send 10 cents to Triton Electronics, Inc., 62-05 30th Ave., Woodside 77, N. Y., for your copy.

A stereo/high fidelity brochure covering a variety of products is now available free of charge from Altec Lansing Corp., 1515 S. Manchester Ave., Anaheim, Calif. Featured in the brochure (#AL-1302-3) is the new 708A "Astro" stereo, AM-FM multiplex, tuner-amplifier—a complete stereo system packaged in a single chassis. —30—



V.I.P.*

Shakespeare fiberglass construction in a top-loaded whip. VIP is a handsome, rugged 4' shaft — its coil embedded in thousands of tiny glass fibers parallel to the axis. —Withstands impact and flexing; reduces precipitation static; won't corrode!

*Very Impressive Package

575



COLUMBIA PRODUCTS COMPANY
Shakespeare Co. Subsidiary, Columbia, S. C.

LAFAYETTE

AMERICA'S VALUE LEADER

HI-FI · AMATEUR · CB · RADIO

"WORLD FAMOUS" HE-29B 10-TRANSISTOR CITIZENS BAND

"WALKIE TALKIE"
T.M.



3995
NO MONEY
DOWN

SET OF 2 78.88

- Transmits & Receives up to 2 miles
- Crystal Controlled on Both Transmit & Receive
- Push-to-Talk Operation
- 46" Telescoping Antenna
- Earphone For Personal Listening
- Leather Case with Shoulder Strap

Ideal for Sportsmen — boating-fishing — camping

Now Lafayette has done it again. The world Famous HE-29 has been further improved. Packed with power, 10 hand-picked transistors plus 1 diode extend the range of the HE-29B up to two miles under average conditions i.e., no intervening obstructions.

No license or permit required. Compact, pocket size unit provides complete portable two way communications. Transmitter section is crystal controlled. Crisp, clear reception is furnished by the efficient superheterodyne receiver. Power is supplied by 8 miniature standard penlight batteries with a life expectancy of up to 50 hours.

Housed in a handsome black and chrome case. Supplied with leather carrying case w/Shoulder strap earphone, antenna, batteries and crystals for channel 10. Size: 6 3/4 x 3 1/4 x 1 1/4". Shpg. wt., 3 lbs.

HE-29BL Net 39.95
Set of 2 Net 78.88

NEW! LAFAYETTE HE-20C CLASS D Deluxe CITIZENS BAND TRANSCEIVER



10950

No Money Down
NOW WITH These
ADDED FEATURES

- 8 Crystal — Control Receive Position's
- 8 Crystal — Control Transmit Positions
- Improved Series Gate — Noise Limiter
- Built-in 12 Volt Power Supply • Efficient Pi-Network

Quality engineering, design, and features give this Deluxe transceiver a place all-its-own in the Citizens Band Field. The HE-20B supplies you with a highly efficient 2-way radio-telephone communications system from your office, truck, auto, boat, store, home, etc.

HE-20C WX 109.50

LAFAYETTE'S

NEW MAIL ORDER and SALES CENTER

111 JERICHO TURNPIKE
(2 Blocks West of South Oyster Bay Rd.)

SYOSSET, LONG ISLAND
NEW YORK



NEW LAFAYETTE 2-SPEED STEREO PLAYBACK TAPE DECK



5950

No Money
Down

- Dual NARTB Equalized Transistor Preamps
- Frequency Response: 50-15,000 CPS @ 7 1/2 ips
- Playback: 1/4 & 1/2 Track Stereo; 1/2 Track & Full Track Monaural

Enjoy the superlative reproduction and fidelity of pre-recorded tape at the price you'd expect to pay for a record changer. Precision engineered, with its own 6-transistor stereo preamplifiers designed to play back tapes with true NARTB hi-fi tape equalization, quality tape handling mechanism and heads. Accepts reels to 7". 10 1/2" Dx 14 3/8" W x 5" H.

RK-141WX Shpg. wt., 17 lbs. Net 59.50
RK-148W Furniture Grade Walnut Base wt., 4 lbs. Net 6.95
RK-147W Portable Carrying Case wt., 5 lbs. Net 9.95

NEW! LAFAYETTE STEREO FM MULTIPLEX ADAPTER KIT

1950



- Less Than 1% Distortion
- Self-Powered
- Noise Filter (switchable)
- Prealigned Coils
- Stereo Separation — 30 db @ 400 cps
- 3 Tubes — 2 Dual, 1 Triple-Purpose Tube + Silicon Rectifier
- Ideal For Any Tuner With Multiplex Output Jack

Enjoy thrilling FM stereophonic sound from any recent Lafayette Tuner or any other quality wide-band FM or FM-AM tuner with multiplex jacks. Hear the full range of audio frequencies in all the realism and magnificence of stereo sound by simply adding this low-cost Lafayette Multiplex adapter Kit. Engineered for anyone to build and operate, the KT-220 is easily connected to your tuners.

Size 8 1/2" W x 4 3/8" D x 4 3/4" H for 110-125 volts, 60 cycles AC.
KT-220 Shpg. wt., 4 lbs. Net 19.50

FAMOUS "MIGHTY 9" T.M.

9 TRANSISTOR
PERSONAL PORTABLE

REG. 25.88

NOW
ONLY

1995



- 3 Audio Stages
- Lightweight, Shirt Pocket Size
- 9 Transistors, 2 Diodes, 1 Thermistor
- Complete with Carrying Case Batteries and Earphone

Lafayette's "Mighty-9" portable, the most powerful transistor radio, is the answer for those who want the best, without spending the most. Compare this portable with others selling for much more — compare feature for feature and you'll see why the Lafayette "Mighty-9" is your best buy. Size: 4 1/2" H x 3 W x 1 3/4" D. Shpg. wt., 2 1/2 lbs. FS-91L 19.95

LAFAYETTE RADIO DEPT. IG-2
P.O. BOX 10, SYOSSET, N.Y.

FREE!

- Rush my FREE Lafayette Summer Supplement Catalog.
- Please send me #....., Shipping Charges Collect. I am enclosing \$.....

Name _____
Address _____
City _____ Zone _____ State _____



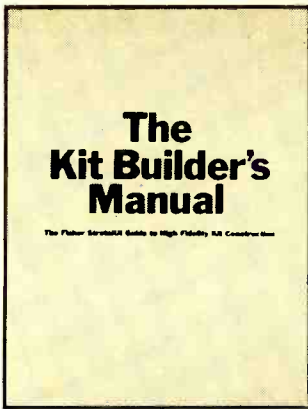

FREE! \$1.00 VALUE!

Fisher Radio Corporation, maker of Fisher StrataKits, has prepared this valuable reference guide as a public service to all high fidelity enthusiasts interested in kit building. A free copy is yours for the asking. Please use this coupon.

Fisher Radio Corporation
 21-52 44th Drive Long Island City 1, N. Y.
 Please send Kit Builder's Manual without charge.

Name _____
 Address _____
 City _____ Zone _____ State _____ 10718

YOU SAVE MONEY!

**RUSH US YOUR LIST
 OF HI-FI COMPONENTS
 FOR A VERY SPECIAL
 GROUP QUOTATION**

**WRITE FOR FREE AUDIO
 DISCOUNT CATALOG A-15**

*New low prices on tape re-
 corders, amplifiers, tuners,
 loudspeakers, cartridges, etc.*

KEY ELECTRONICS COMPANY
 120 LIBERTY STREET
 NEW YORK 6, N. Y.

I would like to report that we're pleased
 ults. To improve the operation of the Citizen
LETTER
 on, we changed L2 to 7 or 8 turns of #22
TRAY
 e on a 1/4" aluminum rod. Constructive
 its were cut somewhat by using the chassis

Address correspondence for this department to:
 Letters Editor, POPULAR ELECTRONICS
 One Park Avenue, New York 16, N. Y.

Pen Pal Wanted

■ I'm 21 years old, employed by the Austrian television system, and have been a subscriber to your magazine for several years. One of my

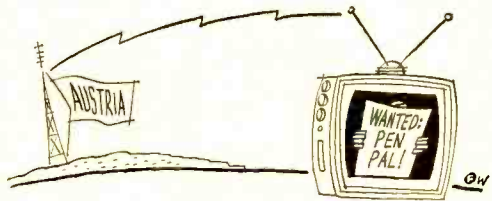

hobbies is short-wave communications, and I would like to get in touch with a "pen pal" having similar interests.

PETER PETROVICH
 Landstrasse 90/17
 Vienna III, Austria

Correction Corrected

■ In the article "Short Wave for Beginners" (January 1962 issue), Hank Bennett tells us that Leopoldville is in the Congo and Brazzaville is in Katanga. Leonard Phelps, in his correction (April 1962 "Letters") says that Leopoldville is in Katanga and Brazzaville is in the Congo. Both statements are wrong (or only partly right). Actually, Brazzaville is the capital of the Congo Republic (formerly French Middle Congo); Leopoldville is the capital of the neighboring Republic of Congo (formerly Belgian Congo); Katanga (capital, Elisabethville) is one of the six provinces comprising the Republic of Congo.

STEWART WEST
 Union, N.J.

With at least four Congos to worry about here, it's no wonder that Messrs. Bennett and Phelps (and the "Letters" Editor) were confused. Thanks for finally clearing it all up, Stewart.

Mobile Multiplexer

■ Your article called "In-Car FM for MPL" (January 1962 issue) was quite interesting, and I determined to go ahead and install an FM radio in my car. Since the convertible already has two rear speakers (one on each side of the rear seat), I decided to add multiplex as well. I purchased a Knight Model KS-11 multiplex adapter kit and rewired the filaments for 12 volts. I also bought a

Always say you saw it in—POPULAR ELECTRONICS

mobile plate supply, which handles both the receiver and the converter. The amplifier in the AM radio is used for the extra channel. I had previously installed provisions for disconnecting the AM



set's r.f. stages, because I use the radio as an auxiliary amplifier—feeding a speaker under the hood.

ALLAN L. STARR
Coral Gables, Fla.

Sounds like an intriguing installation, Allan, but it's too bad that you get only "mono" reception in the engine compartment.

Which Band for Police?

■ I'm planning to build equipment for tuning in police calls and other "public service" communications, and have been looking over the "Police Special Receiver" (July 1959 issue) and "The '10-8' De Luxe Converter" (January 1962 issue). What puzzles me is that the former tunes 30-50 mc., the latter 150.8-162 mc.; yet both are supposed to pick up police transmissions. Would I need both sets to get complete coverage?

JULIUS SISKE
Baltimore, Md.

Groups of frequencies in both the 30-50 mc. and 150.8-162 mc. bands are allocated for "public safety" use. This classification includes police, fire, and related services. If you're interested primarily in picking up a specific service in your neighborhood, check first to find out what frequencies are involved.

"Rat Runner"

■ I read Ken Gilmore's "Ultrasonics—Successes of Silent Sound" (December 1961 issue) with interest. One of the ultrasonic devices mentioned in the article was a unit designed to rid ware-



houses of rats. Could you tell me the name and address of the manufacturer so that I can write for more information?

JOHN CANNON
Milwaukee, Wisc.

One manufacturer of such a "rat runner" is Dynamic Sound, Inc., 15235 Lorain Ave., Cleveland 11, Ohio.

Compactron VHF Receiver

■ I converted the "Compactron VHF Receiver" (September 1961 issue) to cover the 35-54 mc.

range with very good results. I used Ohmite Z-50 chokes for L1, L3, L5, and L6 and a Hammarlund HF-15 variable capacitor for C3. In addition, I made up a new coil (having 12 turns instead of 2) for L2 and dropped the supply voltage to about 150 volts by installing a 1200-ohm resistor in series with R9.

JIMMY SLAGLE
Henrietta, Texas

■ I built the "Compactron VHF Receiver" but, not being able to obtain the Merit power transformer specified, I used a Stancor PS-8415 instead. The Stancor differs from the Merit in that the former's high-voltage winding has slightly lower voltage and current ratings and the filament winding has no center tap. I grounded one side of the Stancor's filament winding in place of a center tap, but made no other wiring changes. The set is an excellent performer and is in constant use.

KERRY S. HAUPTLI, WPE2FLA
Westfield, N. J.

P. E. Collection For Sale

■ I've subscribed to—and read—POPULAR ELECTRONICS ever since the first issue. However, since my P.E. collection is beginning to take up more room than I can afford to give it, I've decided to let the whole shebang go to the first reader who



sends me \$20.00. Every issue published to date is included, and there are duplications of the first few. No issues will be sold separately.

LAWRENCE CHURCHILL
314 N. 7th St.
Watska, Ill.

Okay, Larry—stand by for the avalanche, and we hope you're not mad at us.

-30-

HOW TO ORDER BACK ISSUES

Every month POPULAR ELECTRONICS receives many requests from readers who would like to know how to order back issues. Some readers want to obtain particular articles they have missed, while others want to complete their own back-issue files.

If you would like to order a specific issue of P.E., address your inquiry to:

Circulation Department
POPULAR ELECTRONICS
Ziff-Davis Publishing Co.
434 S. Wabash Ave.
Chicago 5, Ill.

Enclose 35 cents for each copy of issues less than six months old, 40 cents for each copy of older issues. Be sure to state the month and year of the issue(s) you want. In the event a requested issue is no longer in stock, your money will be returned.

Developed in the field

to pay off in performance down the road

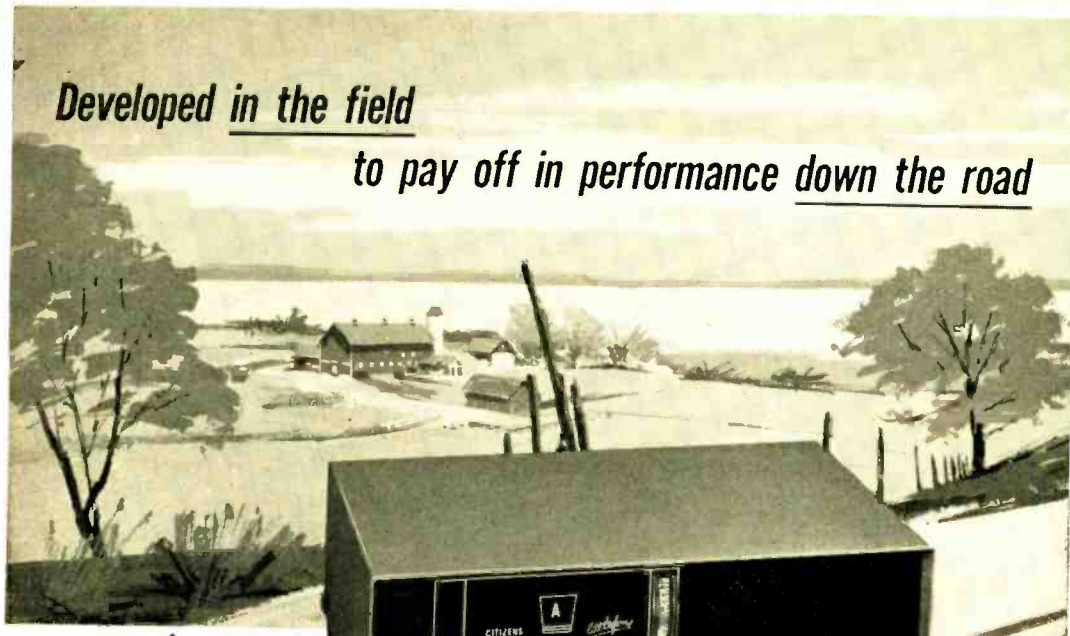

NEW
CB-3A *littlefone*

dual conversion,
8-channel citizens band

TRANSMITTER/RECEIVER



\$159⁹⁵ (S-meter optional extra)

During a recent seven-month period, the Hallicrafters Company conducted a most unusual field test of its CB-3 citizens band transmitter. Through every conceivable condition of terrain, and weather, with almost completely continuous operation, the CB-3 was punished unmercifully and methodically . . . evaluated from every angle with the engineer's fine needle. Our purpose was not to prove something but to learn something. And in learning, to improve. Result: the new CB-3A "Littlefone"—solid and versatile expression of Hallicrafters' dedication to "THE NEW IDEAS IN COMMUNICATIONS."

EXTREME CONDITIONS WERE THE RULE

Early in July, 1961, test vehicles equipped with CB-3's were dispatched from Chicago northward into Wisconsin and Minnesota. A limited geographic area was picked, with no pre-planned route. Each short range destination was a "target of opportunity"—chosen to take advantage of the *worst possible conditions* as they occurred.

On D-day the temperature was 95°, and it ranged down to -20° before the test was completed. Identical and controlled transmission tests were conducted in both hilly and flat terrain, in cities and woodlands.

The CB-3 was operated on a continuous basis for periods ranging from four to twelve hours. More than 30,000 miles of mobile operation in the test vehicle were logged, plus unrecorded periods in trucks, boats—even an airplane.

TESTS WERE VARIED AND THOROUGH



All tests were conducted on both an objective and competitive basis. At various times, standard equipment of the five most popular transceivers were employed in the same or directly comparable situations. Relative range, modulation, channel interference and heterodyne were measured.

Base units also were interchanged, and four different basic antenna systems rotated both in base and mobile installations. In all, more than 150 antenna installation modifications were made.

WHAT WE FOUND OUT

Range and speech quality were exceptional. The CB-3 under "normal" conditions (average of hilly and flat terrain, moderate weather conditions) produced 10-2 copy at 20 miles . . . up to 40 miles in the lake region of Wisconsin . . . as low as 8 miles in the lead and zinc mining regions southwest.

Average performance over the entire seven-month period was a *minimum* of 7% and a *maximum* of 12% greater range of intelligible speech than the five other units tested.

Always say you saw it in—POPULAR ELECTRONICS



In the major metropolitan areas visited, some adjacent-channel interference was experienced on all units during peak traffic periods.

Reliability: in over 1,600 hours of operation, not a single major failure was experienced. Total parts replacement—two panel bulbs, one vibrator, two tubes. No visible deterioration of automotive electrical system. A microphone cord was broken due to carelessness.

Antennas: Major deterrent to good communications was observed to be faulty antenna installation throughout the test areas. Of more than 90 existing base stations co-operating in the tests, most were using improper or unmatched antennas. Range was increased (all brands) from a minimum of 50% to 70% with corrective measures.

General observations: Mechanical design and exclusive drop-down chassis construction of the CB-3 permitted far easier access for crystal changing and removal of unit for base use.

External S-meter was required during tests; observers with technical background felt a need for S-meter provision in the CB-3.

Eight-channel flexibility and crystal controlled operation on both transmit and receive functions were distinctly superior to competitive systems, particularly in mobile and heavily populated areas.

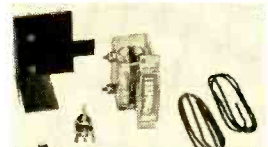

Hallicrafters S-meter kit, optional at \$8.95

Easy to install in place of removable panel.



Result—the new CB-3A with field-tested improvements!

- 8-channel, crystal-controlled convenience
- Maximum adjacent-channel rejection without loss of sensitivity through new type dual conversion.
- Removable panels for S-meter, future accessories.
- Built-in accessory jack (external speaker, etc.)
- FCC Type-Accepted.

Transmitter: 100% modulation on positive peaks; output amp. adjustable for maximum legal input; matches 50 ohm antenna systems; series-tuned 2nd harmonic trap for excellent TV suppression.

Receiver: Dual conversion—adjacent channel rejection 40 db. minimum; sensitivity less than 1 microvolt for 10 db. signal to noise ratio; 6 kc. selectivity; electronic squelch operates on less than 6 db. change; audio output over 2 watts.

the new ideas
in communications
are born at . . .



hallicrafters

5th and Kostner Aves., Chicago 24, Illinois

A DOWN-TO-EARTH GUIDE TO Modern Test Procedures

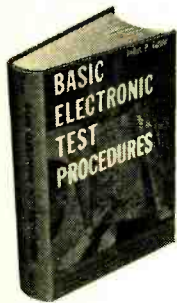

Alternate Test Methods •
Cautions • Correct Instrument
Usage • Readings •
Connections and Control
Settings • Test Techniques •
Time-Saving Methods . . . and
all the rest!

Rufus P. Turner's 316-page manual, **BASIC ELECTRONIC TEST PROCEDURES** with more than 190 illustrations, pattern photos and procedure diagrams teaches you to test any circuit, equipment or component in a fraction of the usual time. It is a complete course in professional testing techniques written so you can easily understand it! For instance, you learn to check for distortion by the 'scope, rejection filter, harmonic distortion meter, wave analyzer or oscillator methods. You learn to measure resistance and leakage with a current meter, a voltmeter, voltmeter, ohmmeter, or via the bridge method—and so on.

Includes Current checks; measuring Power, Capacitance, Inductance, Resistance, Phase, Distortion, Modulation; testing Tubes and Semiconductors, Transmitters, AF and RF circuits; checking Sensitivity, Gain, Fidelity, Noise, etc. Shows which instruments to use and how to use them for troubleshooting and alignment of AM and FM radios, TV. Even includes industrial electronic measurements of Photocells; Strain, Pressure, Vibration, Temperature and Time measuring devices. Price only \$8.50. Use coupon today for 10-day free trial.

HERE'S WHAT YOU NEED TO KNOW ABOUT Oscilloscopes!

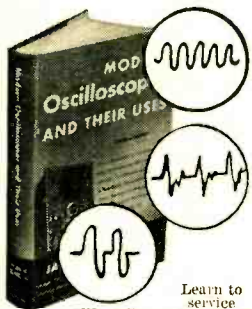

'Scope experts
get the big pay jobs!

Men who really know how to use oscilloscopes locate troubles faster, repair them more accurately—and this famous manual teaches you the methods they use. In short, **MODERN OSCILLOSCOPES AND THEIR USES** get right down to earth in bringing you the complete "know how" of using the handiest, most versatile instrument of them all!

Learn to service
ANY radio or TV faster
with the handiest
instrument of all!

Particular attention is paid to realignment procedures.

Every detail of testing is explained from connecting the 'scope and setting its controls to adjusting components in the chassis being tested. Illustrated instructions teach you to analyze patterns. Even includes data on quantitative measurements (as used in color TV servicing) and use of 'scopes in industrial electronics and atomic work. 370 illustrations. Price \$8.75.

PRACTICE 10 DAYS FREE!

Dept. PE-72
HOLT, RINEHART & WINSTON, INC. No. 623900
P.O. Box 2334, Grand Central Station,
New York 17, New York

Send book(s) checked below for free examination. In 10 days, I will either send price shown (plus postage) or return books postpaid and owe nothing.

BASIC ELECTRONIC TEST PROCEDURES (#708933) . . . \$8.50
 MODERN OSCILLOSCOPES AND THEIR USES (#708818) . . . \$8.75

SAVE! Send cash with order and we pay postage. Same 10-day return privilege with your money promptly refunded.

Name _____

Address _____

City, Zone, State _____

OUTSIDE U.S.A.—Add 50¢ to each book, cash with order only.

This offer expires March 30, 1963.

Hi-Fi Showcase

A quick look at new products
in the stereo/hi-fi field*

A couple of speakers and a record changer are all it takes for a complete stereo system, once you've assembled **Allied Radio's** new **KU-45 "Audio Center"** kit. An AM/FM/FM-stereo tuner and a 32-watt stereo amplifier in a single "package," the **KU-45** employs 20 tubes and offers a frequency response within 1 db from 30 to 16,000 cycles at its rated power. Even if you're not an experienced kit builder, there's no reason to shy away from the **KU-45**—it

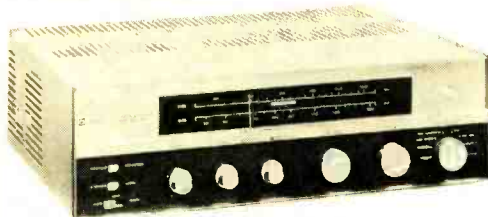

Allied KU-45 AM/FM tuner/amplifier

comes complete with a special pre-wired and pre-aligned FM "front assembly" along with all parts, tubes, wire, and solder (not to mention detailed, easy-to-follow instructions). Among its other features: a center-channel output for a third stereo speaker; input facilities for a stereo record player as well as tape recorder inputs and outputs, dual-concentric, clutch-type bass and treble controls. The kit is priced at \$129.95; a special anodized case sells for \$7.95, and a simplified version without the FM-stereo circuitry is available for \$109.95. . . . First of a line of portable tape recorders from **Citroen Electronics**, the Model 660 is powered with a "cartridge" of six penlight batteries. A two-speed device, the 660 operates at both 1 7/8 and 3 3/4 ips and is perfect for hi-fi applications requiring a general, all-round portable recorder. Available accessories include an a.c. adapter, a foot control, and an automobile cigarette lighter adapter; price of the 660 itself is \$149.95.

Dynaco has a multiplex (FM-stereo) adapter kit specifically designed to complement the company's FM-1 tuner. Complete-

*Write to the manufacturers listed at the end of this column for more data on products mentioned

Always say you saw it in—POPULAR ELECTRONICS

LOOKING FOR SOMETHING NEW IN CB GEAR?



A Transceiver Kit?



A Speech Compressor?



A One-Hole Antenna Mount?

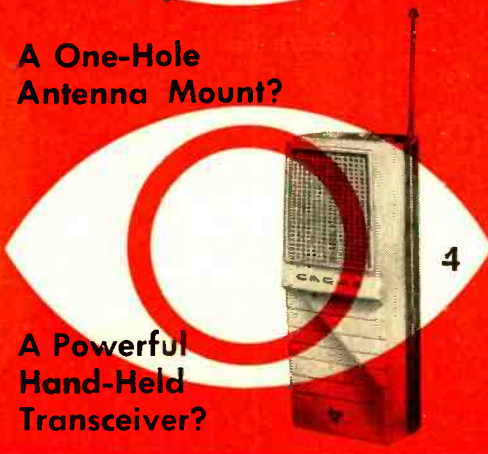

A Powerful Hand-Held Transceiver?

Get Comparative Statistics on
ALL CB EQUIPMENT
in the 2nd Annual CB Equipment
Buyers Guide & Directory

a part of the

**AUGUST 1962 ISSUE of
POPULAR ELECTRONICS**

(on sale July 26)

PLUS: All of our usual features, construction projects, and departments

- 1 Daystrom Model DM-348
- 2 SpeakEasy
- 3 Webster
- 4 Cadre Model C-75

Showcase

(Continued from page 28)

ly automatic in operation, the FMX-3 adapter fits any of Dynaco's FM tuners and is wholly contained on the tuner chassis. In operation, a stereo broadcast automatically lights up the word "stereo" on the front panel, and a special filter network eliminates beats and whistles for perfect off-the-air tape recording. The adapter kit is priced at \$29.95, while a complete FM-stereo tuner, factory-assembled and tested, sells for \$169.95. . . . An inexpensive "miniature" tape recorder may be a handy little "adjunct" to your stereo setup, but the 3" reel capacity of most of these units doesn't allow much playing time. In answer to this problem, *Ferrodynamics* is producing a 3¼" reel containing 600 feet of ½-mil Mylar tape. The result: up to one hour of playing time on a two-track, 3¼"-ips recording. As a bonus feature, the tape has a dry synthetic lubricant that eliminates squeal and reduces head wear. Suggested list price, \$1.79.

From *Gotham Audio* comes a unique audio equalizer that combines almost every conceivable function of frequency discrimination. Built around a single inductively tuned

circuit, the EQ-1000 universal equalizer provides high-frequency boost and droop, low-frequency boost and droop, high- and low-frequency sharp cutoff, and band-pass and band-reject functions with slopes as high as 24 db per octave. Intended primarily for professional applications in the recording and broadcasting fields, it lists at \$1650.00. . . . The Model M1 multiplex (FM-stereo) adapter by *Grommes* comes fully wired and ready-to-go. Suitable for use with any high-quality FM tuner, it is inserted between the tuner's multiplex output and your amplifier's "auxiliary" inputs. The M1 is priced at \$59.95, and a cover is available for \$5.00 more. . . . The newest line of magnetic tape on the market is put out by an old-timer in other fields—*Eastman Kodak*. A high-quality, exceptionally uniform recording tape, it's available on 3", 5", and 7" "Thread-Easy" reels in both 1- and 1½-mil thicknesses. Each reel is packaged in a convenient one-piece box and protected by a dustproof polyethylene bag.

A compact, 2-speed tape recorder with provisions for 4-track monaural record and playback as well as 4-track stereo playback, *Lafayette's* RK-137 incorporates separate record/erase heads and a push-button safety switch to prevent accidental erasures. The RK-137 accommodates up to 7" reels, oper-

BUILD THE FINEST *Professional Quality* CUSTOMIZED

TV KIT

On Easy "Pay As You Wire" Terms. Only \$15 for the Starting Package!

The "PROFESSIONAL" Series—designed for the perfectionist seeking the finest in TV performance. Easy to assemble. No technical knowledge required. An ideal "Learning" Kit with a Complete Course of Study is available.

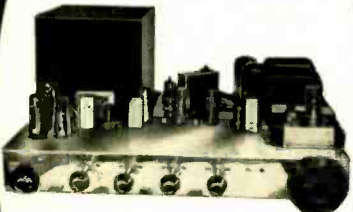

Also available: WIRED CHASSIS for custom installations with a choice of vertical or horizontal controls and the newest 19", 23" or 27" Picture Tube.



A few of the Professional Quality Features:
Choice of push-pull 10-watt audio or output to your Hi-Fi system . . . D.C. restoration . . . Ultra-linear sweep circuits . . . Newest Standard Coil Model PKO Automatic Fine Tuner . . . Supersensitivity for fringe areas . . . Complete line of Accessories for Custom Installations.
Choice of 19", 23" or 27" CRT. Prices range from \$119 to \$199.

U.S. Armed Services and over 4000 schools and colleges have selected Transvision Receivers for educational television.

Interested in Electronics?

Learn the basic principles of electronics from the Course available with the Kit.



TRANSVISION Grey Oaks Ave. Yonkers, N.Y. Y05-6900



Beautiful Cabinets designed to enhance sound quality and blend with modern decor. For TV or combination TV and Hi-Fi.

ASSEMBLY MANUAL—\$2

See how easy it is to assemble the Transvision Kit. Cost of Manual refunded on purchase of Kit.

----- START NOW — MAIL THIS COUPON -----

TRANSVISION Electronics, Inc., Grey Oaks Ave., Yonkers, N.Y. PE-T7

Send Free 8-page Catalog Enclosed is \$2. for Assembly Instructions so that I might see how easy it is to assemble the Transvision Kit. I understand that this will be refunded if I purchase a kit.

Enclosed is \$15 for the Starting Package. I understand that I can buy packages one at a time as I wire. (Models range from \$119 to \$199.)

Name.....Address.....

City.....Zone.....State.....

THE ONE AND ONLY **knight-kit**® "SPAN MASTER!"®



WORLD-WIDE 4-BAND SHORT WAVE RECEIVER KIT

ONLY
\$25.95

SEND NO MONEY

only \$5 per month

GREAT TO BUILD!
GREAT TO OWN!
packed with endless
listening thrills

You can hear *everything* on the fun-to-build "Span Master"—far and away the leader in its class for radio coverage, sensitive performance and value. Continuous tuning from 540 kc to 30 mc lets you hear ships, planes, direct broadcasts from Moscow, Berlin, Rome, London, Paris; tunes the 160, 80, 40, 20, 15 and 10-meter Ham bands—plus powerful local AM reception and dozens of other exciting broadcast services.

Bandspread dial and fine regeneration make tuning an easy pleasure. Has headphone terminals and speaker cut-out switch for private listening. Super-sensitive circuit. Easy to assemble from step-by-step instruction manual—includes list of foreign stations and international Morse code. Pyroxylin-covered cabinet with perforated white baffle and satin-chrome control panel. Complete with all parts, tubes, wire and solder. Size, 6¼ x 14 x 6¾". For 110-125 v., 60 cycle AC. Shpg. wt., 8 lbs.

83 YX 258BC. "Span Master" Kit, only **\$25.95**
83 Y 100. Outdoor Antenna Kit **\$ 1.03**
59 Y 110. Dual Headset **\$ 2.08**

Satisfaction guaranteed or your money back!

ALLIED RADIO
KNIGHT ELECTRONICS DIVISION



Tune world capitals direct



Hear ships at sea



Hear planes in flight



Tune all your favorite local AM programs

- Tunes Shortwave and Broadcast Bands continuously from 540 kc to 30 mc
- Bandspread Control for easy, enjoyable shortwave tuning
- Sensitive Regenerative Circuit for world-wide radio reception
- Built-in Speaker plus headphone terminals for privacy listening
- Transformer Powered for maximum circuit performance
- Handsome modern styling—includes wood cabinet

SEND NO MONEY
order today!

ALLIED RADIO
100 N. Western Ave., Chicago 80, Ill.

Ship me the following:

- "Span Master" 4-Band Receiver Kit 83 YX 258BC
 Antenna Kit 83 Y 100 Dual Headset 59 Y 110
 Ship No Money Down on Allied's Credit Fund Plan

Name _____
PLEASE PRINT

Address _____

City _____ Zone _____ State _____

Superior's New Model 820

TUBE TESTER



TESTS ALL MODERN TUBES
INCLUDING THE NEW

- ✓ NOVARS
- ✓ NUVISTORS
- ✓ 10 PINS
- ✓ 12 PIN COMPACTRONS

SPECIFICATIONS:

- Employs new improved emission circuit.
- Tests over 850 tube types.
- Tests OZ4 and other gas filled tubes.
- Employs new 4" meter with sealed air-damping chamber resulting in accurate vibrationless readings.
- Use of 26 sockets permits testing all popular tube types.
- Dual Scale meter permits testing of low current tubes.
- 7 and 9 pin straighteners mounted on panel.
- All sections of multi-element tubes tested simultaneously.
- Ultra-sensitive leakage test circuit will indicate leakage up to 5 megohms.

Model 820 comes complete with tube charts and instructions; housed in handsome, portable, Saddle-Stitched Texon case. Only **\$3850**

SHIPPED ON APPROVAL
NO MONEY WITH ORDER - NO C. O. D.

Try it for 15 days before you buy. If completely satisfied then send \$5.00 and pay balance at rate of \$5.00 per month until total price of \$38.50 (plus postage) is paid - No Interest or Finance Charges Added! If not completely satisfied, return to us, no explanation necessary.

MOSS ELECTRONIC, INC.
DEPT. D-906, 3489 Tenth Ave., New York 34, N.Y.
Please rush Model 820. If satisfactory, I will pay on terms specified. Otherwise I will return tester.

Name _____
Address _____
City _____ Zone _____ State _____
All prices net, F.O.B. N.Y.C.

Showcase

(Continued from page 30)

ates at 3 $\frac{3}{4}$ and 7 $\frac{1}{2}$ ips, and is equipped with jacks for both microphone and radio/phono inputs. Among its other features: a pause button, a vu meter, a fast-forward and a fast-rewind function. Operating from any 117-volt, 60-cycle a.c. line, the recorder measures a compact 6 $\frac{1}{2}$ " x 13 $\frac{1}{2}$ " x 10 $\frac{5}{8}$ " and sells for \$89.50. . . . Another new Lafayette product, the LT-78 stereo tuner, offers complete facilities for AM, FM, and FM-stereo reception. The superheterodyne AM circuit has three i.f. stages for high gain, and an 8000-cycle bandwidth for wide response; the FM circuitry features a 200-kc. bandwidth, a Foster-Seeley discrimi-



Lafayette LT-78 stereo tuner

nator, and variable a.f.c. There is also a rear-panel-mounted stereo dimension control, a front-panel noise filter switch, fly-wheel tuning, and a pilot light to indicate when the multiplex is switched on. Price? Again, a low \$89.50. . . . Designed for use with automatic turntables, *Pickering's* new U38/AT cartridge has some extremely impressive characteristics. For one thing, it combines the mu-metal shielding of the stereo "Fluxvalve" with a high output (10 mv.) for good signal-to-noise ratio. What's more, it tracks at pressures from 2 to 5 grams, provides a response within 2 db from 20 to 20,000 cycles, and offers a channel separation of 35 db. Supplied with universal mounting hardware, the cartridge carries a price tag of \$46.50.

An adapter for 10 $\frac{1}{2}$ " reels that can give you up to 12 hours playing time per reel takes just three minutes to install. Made by *Roberts Electronics*, it fits the company's 990 four-track stereo recorder, 199D tape deck, and 191 and 192 professional recorders (although both the 191 and the 192 require a special motor for the adapter). Price, \$49.50. . . . Two *Robins Industries* products are just the thing to help you take care of your tape heads. Packaged together in one "kit" are a two-ounce bottle of head cleaner with an applicator, and a two-ounce bottle (again with applicator) of lubricant for recording heads and tape guides. Price of the TK-6 kit, \$2.00.

If you've been looking for an easy way Always say you saw it in—POPULAR ELECTRONICS

KUHN

"LEADERS IN SPECIALIZED RECEIVING EQUIPMENT"

MOBILE FIXED CONVERTERS

- POLICE
- FIRE
- COMMERCIAL
- CITIZEN'S BAND

345A Complete \$29.95



A new high gain Crystal Controlled Converter. Excellent sensitivity. Rugged construction. Easy to install. Designed for standard transistor car radios. Requires no high voltage supply. 2-54 MC or 150-162 MC.

KUHN CONVERTERS . . . the most advanced line . . . designed for optimum performance.



348A Complete \$34.95

Transistorized, directly tunable Converter. Powered with self-contained mercury cell. Excellent sensitivity and stability. Designed for car, home or portable receivers. Two types available: Aircraft VHF 115-130 MC or 150-162 MC.



344A Complete \$23.95

A new low cost Crystal Controlled Converter designed for use with standard transistor car radios. Operates directly from 12V DC. Rugged construction. Good sensitivity. Range 2-54 MC.

ORDER TODAY or SEND FOR FREE CATALOG . . . containing complete information on a full line of CONVERTERS AND RECEIVERS FOR EVERY APPLICATION

315A



Complete \$14.95

A low cost Tunable Converter for any 10 MC area of: 26-54 MC, Aircraft VHF, or 150-160 MC. Easily installed. For use with home or auto sets. 315A Directly Tunable Converter. Available in four ranges: 26-30 MC, 30-50 MC, 115-130 MC, or 150-160 MC. Complete \$21.95



20 GLENWOOD CINCINNATI 17, OHIO

here's CB
with

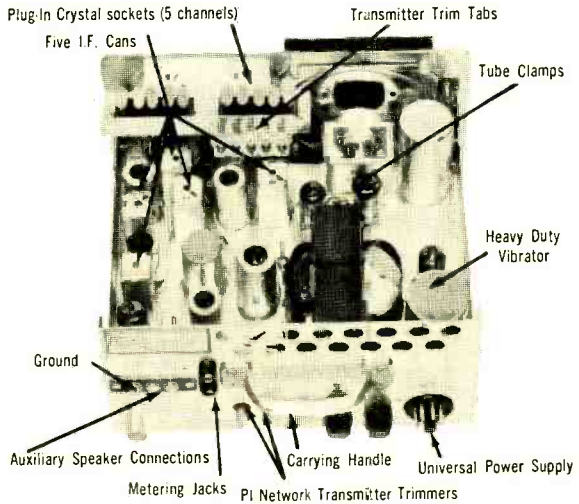

REACH RAY-TEL TWR 2

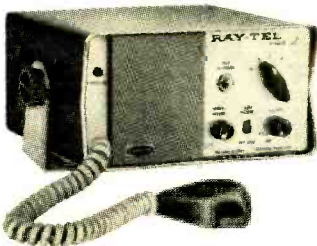

only \$189⁹⁵*

This rugged, compact, dependable 2-way radio is performance-engineered to give you consistently clearer CB transmission and more stable reception.

Raytheon Ray-Tel TWR-2 features super-sensitive dual conversion super-heterodyne receiver for maximum coverage, selectivity and sensitivity.

Raytheon crystals are ground to military specs. Each tube is clamped in to withstand the rugged field conditions

**Suggested list price*

associated with military type usage.

TWR-2 comes complete . . . ready to use right out of the box. No printed circuits, no relays. Full-range automatic volume control, automatic accurate tuning, noise-free stand-by reception, trim tabs for "on the nose" frequency performance.

For particulars on Ray-Tel TWR-2, including spec sheet and schematics, write Raytheon Company, P. O. Box 720, Westwood, Massachusetts.

DISTRIBUTOR PRODUCTS DIVISION

WESTWOOD, MASSACHUSETTS





**SELL YOUR USED
EQUIPMENT Through
POPULAR ELECTRONICS'
Classified Columns!**

The 400,000 readers of **Popular Electronics** are interested in your used electronic gear or components. If you have something to sell, let the readers of **Popular Electronics** know about it through the classified advertising columns. It costs very little—**60 cents a word**, including your name and address. Minimum message—10 words.

For
further
information
write:

Martin Lincoln
POPULAR ELECTRONICS
One Park Avenue
New York 16, N. Y.

Showcase

(Continued from page 32)

to convert binding posts or other screw- or solder-type terminals on stereo/hi-fi equipment to "quick-connect" phono jacks, *Switchcraft's* No. 373 molded audio adapter will do just that. A two-conductor long-handle phono jack connected to a 3" length of stripped and tinned shielded cable, the 373 mates with standard *Switchcraft* and *RCA*-type phono plugs. . . . Searching the band for FM stereo broadcasts? You'll find them quick as a wink with *Scott's* new Sonic-Monitor and Model 340 FM tuner/

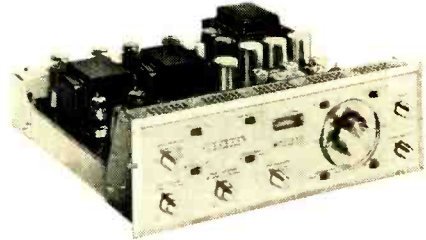

Scott 340 FM tuner/amplifier

amplifier. The first *Scott* product to feature this new device, the Model 340 has an output of 60 watts, and provides inputs for tape recorder, phono cartridge, or auxiliary sources. A special filter makes for noise-free off-the-air stereo tape recordings, and an ultra-sensitive silver-plated "front end" provides an IHFM sensitivity of better than 2.5 μ v. To locate an FM-stereo broadcast, all you do is switch the "Sonic Monitor" to "Monitor" and tune across the dial until you hear a "monitor" tone from your speaker. Switch the Sonic Monitor to "Listen," and there's your FM-stereo program! The unit incorporates a professional-type tuning meter, and a handsome accessory case is available. Price of the 340, \$379.95.

- Allied Radio Corp.*, 100 N. Western Ave., Chicago 80, Ill.
- Citroen Electronics Corp.*, 832 N. La Brea, Los Angeles 38, Calif.
- Dynaco Inc.*, 5912 Powelton Ave., Philadelphia 4, Pa.
- Ferrodynamics Corp.*, Gregg St. & Route 17, Lodi, N.J.
- Gotham Audio Corp.*, 2 W. 46th St., New York 36, N.Y.
- Grommes Div., Precision Electronics Inc.*, 9101 King Ave., Franklin Park, Ill.
- Eastman Kodak Co.*, Rochester 4, N.Y.
- Lafayette Radio Electronics Corp.*, 111 Jericho Turnpike, Syosset, L.I., N.Y.
- Pickering & Co. Inc.*, Sunnyside Blvd., Plainview, N.Y.
- Roberts Electronics, Inc.*, 5920 Bowcroft St., Los Angeles 16, Calif.
- Robins Industries Corp.*, Flushing 56, N.Y.
- Switchcraft, Inc.*, 5555 N. Elston Ave., Chicago 30, Ill.
- H. H. Scott, Inc.*, Dept. P, 111 Powdermill Rd., Maynard, Mass.

BUILD 20 RADIO

only
CIRCUITS AT HOME
 with the New
PROGRESSIVE RADIO "EDU-KIT"®
A Practical Home Radio Course **\$26.95**



Training Electronics Technicians Since 1946

- Now Includes**
- ★ RECEIVERS
 - ★ TRANSMITTERS
 - ★ SQ. WAVE GENERATOR
 - ★ SIGNAL TRACER
 - ★ AMPLIFIER
 - ★ SIGNAL INJECTOR
 - ★ CODE OSCILLATOR
- ★ No Knowledge of Radio Necessary
 - ★ No Additional Parts or Tools Needed
 - ★ EXCELLENT BACKGROUND FOR TV
 - ★ **SCHOOL INQUIRIES INVITED**
 - ★ Sold In 79 Countries

YOU DON'T HAVE TO SPEND HUNDREDS OF DOLLARS FOR A RADIO COURSE

The "Edu-Kit" offers you an outstanding PRACTICAL HOME RADIO COURSE at a rock-bottom price. Our Kit is designed to train Radio & Electronics Technicians, making use of the most modern methods of home training. You will learn radio theory, construction practice and servicing. THIS IS A COMPLETE RADIO COURSE IN EVERY DETAIL. You will learn how to build radios, using regular schematics; how to wire and solder in a professional manner; how to service radios. You will work with the standard type of punched metal chassis as well as the latest development of Printed Circuit chassis. You will learn the basic principles of radio. You will construct, study and work with RF and AF amplifiers and oscillators, detectors, rectifiers, test equipment. You will learn and practice code, using the Progressive Code Oscillator. You will learn and practice trouble-shooting, using the Progressive Signal Tracer, Progressive Signal Injector, Progressive Dynamic Radio & Electronics Tester, Square Wave Generator and the accompanying instructional material. You will receive training for the Novice, Technician and General Classes of F. C. C. Radio Amateur License. You will build 20 Receiver, Transmitter, Square Wave Generator, Code Oscillator, Signal Tracer and Signal Injector circuits, and learn how to operate them. You will receive an excellent background for television, Hi-Fi and Electronics. Absolutely no previous knowledge of radio or science is required. The "Edu-Kit" is the product of many years of teaching and engineering experience. The "Edu-Kit" will provide you with a basic education in Electronics and Radio, worth many times the complete price of \$26.95. The Signal Tracer alone is worth more than the price of the entire Kit.

THE KIT FOR EVERYONE

You do not need the slightest background in radio or science. Whether you are interested in Radio & Electronics because you want an interesting hobby, a well paying business or a job with a future, you will find the "Edu-Kit" a worth-while investment. Many thousands of individuals of all

ages and backgrounds have successfully used the "Edu-Kit" in more than 79 countries of the world. The "Edu-Kit" has been carefully designed, step by step, so that you cannot make a mistake. The "Edu-Kit" allows you to teach yourself at your own rate. No instructor is necessary.

PROGRESSIVE TEACHING METHOD

The Progressive Radio "Edu-Kit" is the foremost educational radio kit in the world, and is universally accepted as the standard in the field of electronic training. The "Edu-Kit" uses the modern educational principle of "Learn by Doing." Therefore you construct, learn schematics, study theory, practice trouble shooting—all in a closely integrated program designed to provide an easily-learned, thorough and interesting background in radio. You begin by examining the various radio parts of the "Edu-Kit." You then learn the function, theory and wiring of these parts. Then you build a simple radio. With this first set you will enjoy listening to regular broadcast stations. Learn theory, practice testing and trouble-shooting. Then you build a more advanced radio. Learn more advanced theory and techniques. Gradually, in a progressive manner, and at your own rate, you will find yourself constructing more advanced multi-tube radio circuits, and doing work like a professional Radio Technician.

Included in the "Edu-Kit" course are 20 Receiver, Transmitter, Code Oscillator, Signal Tracer, Square Wave Generator and Signal Injector Circuits. These are not unprofessional "breadboard" type circuits, but professional circuits, constructed by means of professional wiring and soldering on metal chassis, plus the new method of radio construction known as "Printed Circuitry." These circuits operate on your regular AC or DC house current.

THE "EDU-KIT" IS COMPLETE

You will receive all parts and instructions necessary to build 20 different radio and electronics circuits, each guaranteed to operate. Our Kits contain tubes, tube sockets, variable, electrolic, mica, ceramic and paper dielectric condensers, resistors, tie strips, hardware, tubing, punched metal chassis, Instruction Manuals, hook-up wire, solder, selenium rectifiers, volume controls and switches, etc. In addition, you receive Printed Circuit materials, including Printed Circuit chassis, special tube sockets, hardware and instructions. You also receive a useful set of tools, a professional electric soldering iron, and a self-powered Dynamic Radio and Electronics Tester. The "Edu-Kit" also includes Code Instructions and the Progressive Code Oscillator, in addition to the Questions and Answers for Radio Amateur License training. You will also receive lessons for servicing with the Progressive Signal Tracer and the Progressive Signal Injector, a High Fidelity Guide and a Quiz Book. You receive Membership in Radio-TV Club. Free Certificate of Merit and Discount Privileges. You receive all parts, tools, instructions, etc. Everything is yours to keep.

PRINTED CIRCUITRY

At no increase in price, the "Edu-Kit" now includes Printed Circuitry. You build a Printed Circuit Signal Injector, a unique servicing instrument that can detect many Radio and TV troubles. This revolutionary new technique of radio construction is now becoming popular in commercial radio and TV sets.

A Printed Circuit is a special insulated chassis on which has been deposited a conducting material which takes the place of wiring. The various parts are merely plugged in and soldered to terminals.

Printed Circuitry is the basis of modern Automation Electronics. A knowledge of this subject is necessary today for anyone interested in Electronics.

UNCONDITIONAL MONEY-BACK GUARANTEE

ORDER DIRECT FROM AD—RECEIVE FREE BONUS RESISTOR AND CONDENSER KITS WORTH \$7

- Send "Edu-Kit" postpaid. I enclose full payment of \$26.95.
- Send "Edu-Kit" C.O.D. I will pay \$26.95 plus postage.
- Rush me FREE descriptive literature concerning "Edu-Kit."

Name

Address

PROGRESSIVE "EDU-KITS" INC.

1186 Broadway, Dept. 594-D, Hewlett, N. Y.

FREE EXTRAS

• SET OF TOOLS

- SOLDERING IRON
- ELECTRONICS TESTER
- PLIERS-CUTTERS
- ALIGNMENT TOOL
- WRENCH SET
- VALUABLE DISCOUNT CARD
- CERTIFICATE OF MERIT
- TESTER INSTRUCTION MANUAL
- HIGH FIDELITY GUIDE & QUIZZES
- TELEVISION BOOK & QUIZZES
- TROUBLE-SHOOTING BOOK
- MEMBERSHIP IN RADIO-TV CLUB: CONSULTATION SERVICE & FCC AMATEUR LICENSE TRAINING
- PRINTED CIRCUITRY

SERVICING LESSONS

You will learn trouble-shooting and servicing in a progressive manner. You will practice repairs on the sets that you construct. You will learn symptoms and causes of trouble in home, portable and car radios. You will learn how to use the professional Signal Tracer, the unique Signal Injector and the dynamic Radio & Electronics Tester. While you are learning in this practical way, you will be able to do many a repair job for your friends and neighbors, and charge fees which will far exceed the price of the "Edu-Kit." Our Consultation Service will help you with any technical problems you may have.

FROM OUR MAIL BAG

J. Statawis, of 25 Poplar Pl., Waterbury, Conn., writes: "I have repaired several sets for my friends, and made money. The "Edu-Kit" paid for itself. I was ready to spend \$240 for a course, but I found your ad and sent for your Kit."

Ben Valerio, P. O. Box 21, Magna, Utah: "The Edu-Kits are wonderful. Here I am sending you the questions and also the answers for them. I have been in Radio for the last seven years, but like to work with Radio Kits, and like to build Radio Testing Equipment. I enjoyed every minute I worked with the different kits; the Signal Tracer works fine. Also like to let you know that I feel proud of becoming a member of your Radio-TV Club."

Robert L. Shuff, 1534 Monroe Ave., Huntington, W. Va.: "Thought I would drop you a few lines to say that I received my Edu-Kit, and was really amazed that such a bargain can be had at such a low price. I have already started repairing radios and phonographs. My friends were really surprised to see me get into the swing of it so quickly. The Trouble-shooting Tester that comes with the kit is real swell and finds the trouble, if there is any to be found."

BEST BUYS IN STEREO AND MONO HI-FI

New Transistorized Stereo/Mono 4-Track Tape Deck RP100 Semikit (electronics in kit form) \$299.95 Wired \$399.95



28W Integrated Stereo Amplifier HF81 Kit \$69.95 Wired \$109.95



New FM-AM Stereo Tuner ST96 Kit \$89.95 Wired \$129.95 Incl. FET

FM Tuner HFT90 Kit \$39.95 Wired \$65.95 Incl. FET Metal Cover \$3.95



AM Tuner HFT94 Incl. FET Kit \$39.95 Wired \$65.95

New 70-Watt Integrated Stereo Amplifier ST70 Kit \$99.95 Wired \$149.95



New 40-Watt Integrated Stereo Amplifier ST40 Kit \$79.95 Wired \$129.95

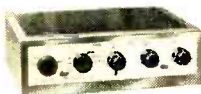

Stereo Preamplifier HF85 Kit \$39.95 Wired \$64.95

Stereo Power Amplifiers

	Kit	Wired
100W HF89:	\$99.50	\$139.50
70W HF87:	\$74.95	\$114.95
28W HF86:	\$43.95	\$74.95



NEW FM-Multiplex Autodaptor MX99 Kit \$39.95 Wired \$64.95 Cover Optional, \$2.95 (Patents Pending)



Bookshelf Speaker System HFS1 Kit \$39.95 Wired \$47.95



EICO

EXCELLENCE IN CREATIVE ELECTRONICS

BEST BUYS IN CITIZENS TRANSCEIVERS, HAM GEAR, RADIOS

Citizens Band Transceivers from Kit \$59.95 Wired \$89.95

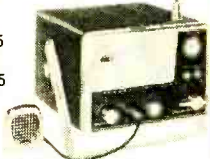

New 60W CW Transmitter #723 Kit \$49.95 Wired \$79.95

NEW Walkie-Talkie Citizens Band Transceiver #740 Kit \$54.95 Wired \$79.95 Complete with rechargeable battery & charger.



Over 2 MILLION EICO Instruments in use throughout the world. Compare, take them home — right "off the shelf" — from 1500 neighborhood dealers, most of whom offer budget terms.

BEST BUYS IN TEST EQUIPMENT

New Metered Variable Auto-Transformer AC Bench Supplies Model 1073 (3 amps) Kit \$35.95 Wired \$47.95 Model 1078 (7½ amps) Kit \$42.95 Wired \$54.95



Peak-To-Peak VTVM = 232 & Uni-Probe® Pat. = 2,790,051 Kit \$29.95 Wired \$49.95



VTVM = 221 Kit \$25.95 Wired \$39.95

DC-5 MC 5" Scope = 460 Kit \$79.95 Wired \$129.50



5" Push-Pull Scope = 425 Kit \$44.95 Wired \$79.95

Tube Tester #625 Kit \$34.95 Wired \$49.95



RF Signal Generator #324 Kit \$26.95 Wired \$39.95



1000 Ohms/Volt V-O-M = 536 Kit \$12.90 Wired \$16.90



6- & 12V Battery Eliminator & Charger #1050 Kit \$29.95 Wired \$38.95



Extra-filtered for transistor equip. #1060 Kit \$38.95 Wired \$47.95

NEW AC Volt-Watt Meter #260 Kit \$49.95 Wired \$79.95



Multi-Signal Tracer #145A Kit \$19.95 Wired \$28.95



EICO, 3300 N. Blvd., L.I.C. 1, N.Y. PE-7
 Send free Catalog describing over 106 top-quality products, free Stereo Hi-Fi Guide, free Short Course for Novice License, name of nearest EICO dealer. Send new 36-page GUIDEBOOK TO HI-FI for which I enclose 25¢ for postage & handling.

Name
 Address
 City Zone State
 Add 5% in the West

Listen to the EICO Hour, WABC-FM, N. Y. 95.5 MC, Mon.-Fri., 7:15-8 P.M.

© 1962 by EICO, 3300 N. Blvd., L. I. C. 1, N.Y.

RADIATION FALLOUT MONITOR



By R. L. WINKLEPLECK

MOST OF US in this country," warns a recent Federal Civil Defense Administration booklet, "live within fallout range of some target which it might be important for the enemy to destroy." "Fallout," of course, causes the residual radiation from a nuclear explosion. Consisting of particles of radioactive debris which have been carried into the upper air by the force of the blast, it drops to earth over a wide and only generally predictable area.

The "Radiation Fallout Monitor" described here provides a means for keeping track of the radiation level in your neighborhood. Using one of

RADIATION FALLOUT MONITOR

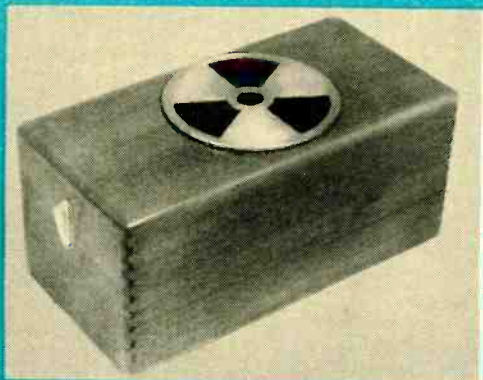

the least expensive Geiger-Mueller tubes available, the unit will give you a good idea of the natural radiation density—and any deviations will be immediately apparent. Using little current, it can be left operating continually to serve as a round-the-clock monitor.

This monitor, however, is to be considered only as an extra household precaution. The most reliable source of emergency information continues to be your local Civil Defense office. They'll know if the radiation from fallout has reached a dangerous level, and will advise you of the necessary protective measures to take.

About the Circuit. The approximately 800 volts required for the operation of the Geiger-Mueller tube (*V1*) is developed by a voltage-multiplier circuit consisting of diodes *D1-D6* and capacitors *C1-C6*. Resistor *R1* and capacitor *C7* act as a filter network, and load resistor *R2* tends to prevent excessive voltage fluctuation.

Don't attempt to check the supply voltage with a VOM, incidentally. You won't get a correct reading because even the high resistance of this instrument is enough to cause an overload. A VTVM with a high-voltage probe must be used.

The output of the supply is fed to *V1* through current-limiting resistor *R4*. Ordinarily, this voltage is not enough to cause *V1* to conduct. But when the glass



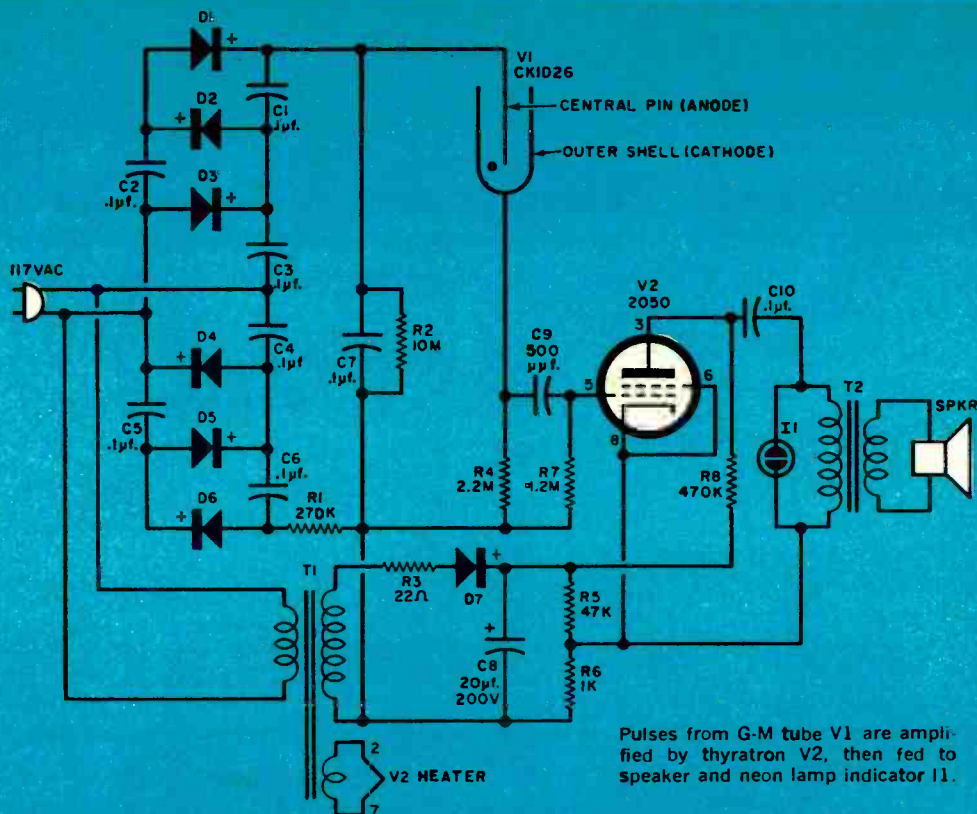

Pulses from G-M tube V1 are amplified by thyatron V2, then fed to speaker and neon lamp indicator I1.

PARTS LIST

- C1, C2, C3, C4, C5, C6, C10—0.1- μ f., 400-volt paper capacitor
 C7—0.1- μ f., 1000-volt paper capacitor
 C8—20- μ f., 200-volt electrolytic capacitor
 C9—500- μ f. mica capacitor
 D1, D2, D3, D4, D5, D6, D7—1N2070 diode (Texas Instruments)
 I1—NE2 neon lamp
 R1—270,000 ohms
 R2—10 megohms
 R3—22 ohms
 R4—2.2 megohms
 R5—47,000 ohms, 1 watt
 R6—1000 ohms, 2 watts
 R7—1.2 megohms

all $\frac{1}{2}$ -watt, 5% resistors unless otherwise specified

- R8—470,000 ohms, $\frac{1}{2}$ watt, 5%
 SPKR— $1\frac{1}{4}$ " miniature speaker, 10-ohm voice coil (Lafayette SK-61 or equivalent)
 T1—Power transformer; primary, 117 volts a.c.; secondaries, 125 volts @ 15 ma., 6.3 volts @ 0.6 amp. (Stancor PS-8415 or equivalent)
 T2—Miniature output transformer; primary, 2000 ohms; secondary, 8-10 ohms (Lafayette TR-93 or equivalent)
 V1—CK1026 Geiger-Mueller tube (Raytheon)
 V2—2050 thyatron tube
 1— $3\frac{1}{4}$ " x $7\frac{1}{2}$ " section of perforated board
 Misc.—Wooden, plastic, or metal box, screen wire and scrap aluminum for speaker opening, scrap Lucite for I1's window, hardware, etc.

wall of the tube is penetrated by a particle of gamma radiation, the halogen gas inside ionizes for an instant, allowing conduction. This causes a positive pulse of a few volts to appear across R4.

Thyatron tube V2 serves to amplify the pulse. Its plate is supplied with approximately 170 volts by a separate power supply consisting of transformer T1, diode D7, current-limiting resistor R3, and filter capacitor C8. The voltage

is delivered to V2 through load resistor R8, and V2's cathode is biased about 4 volts positive with respect to its control grid by means of voltage-dividing resistors R5 and R6.

With no voltage across R4, the cathode bias prevents the thyatron from conducting. But when a radiation particle causes a positive pulse to appear across that resistor, V2's grid swings positive and conduction occurs. The instantaneous

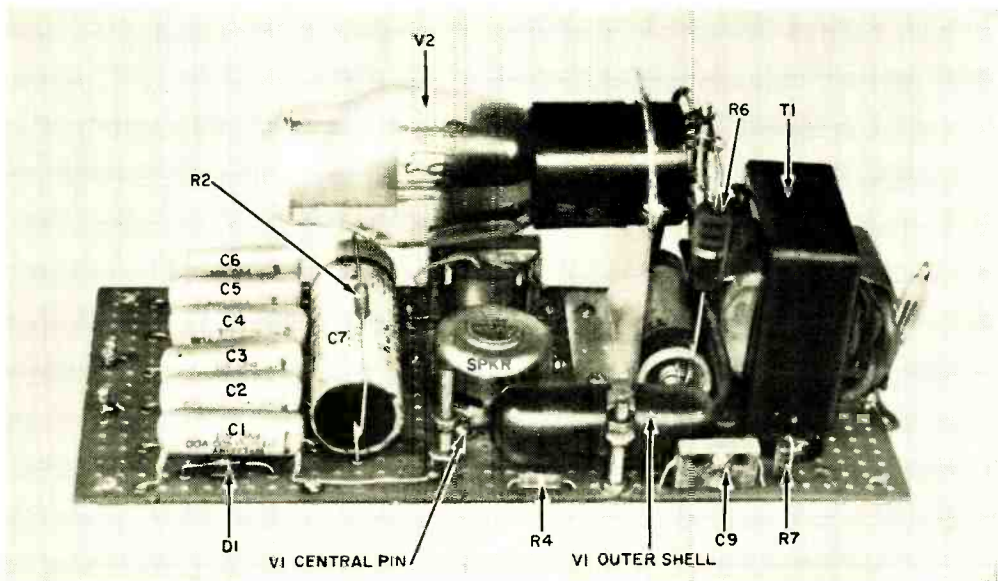
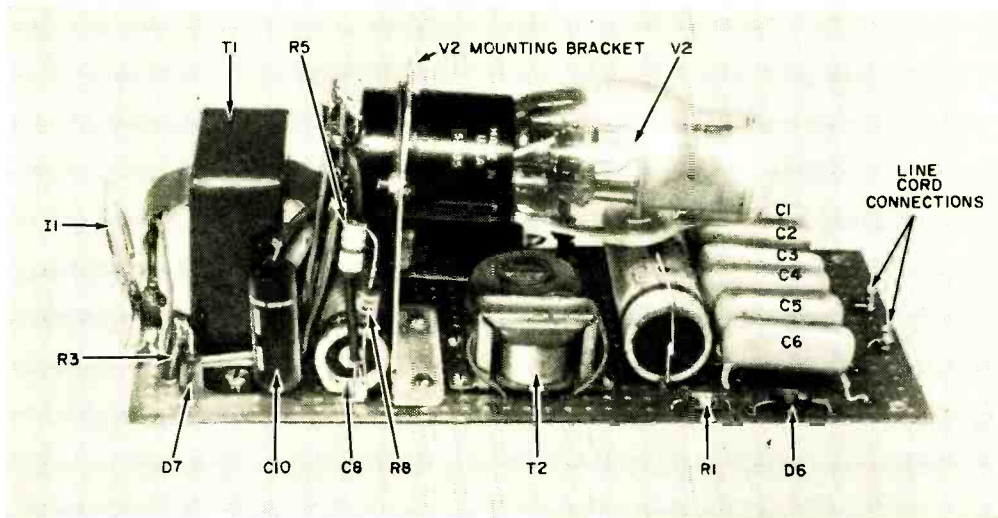

Views of both sides of the perforated board clearly show locations of the major components. Diodes D2, D3, D4, and D5, however, are mounted in the spaces between capacitors C1 and C6 and are not visible. The line connections are made via a pair of metal terminals inserted near C1 — C6.

ous voltage drop across R8, caused by the current drawn by the conducting thyatron, is fed through capacitor C10—ionizing neon lamp I1. This gives a visual indication of the presence of the particle and also induces a voltage in the secondary of output transformer T2, causing the speaker to click.

Thyatron V2 would normally continue to conduct, even when the pulse disappears from the control grid. However, the instantaneous voltage drop across R8

is large enough to reduce the plate voltage of the thyatron to the point where conduction cannot be maintained. Therefore, the tube cuts off, the load disappears from R8, and the plate voltage rises in readiness for the next pulse. This conduction/non-conduction cycle can be repeated a maximum of about 60 times per second.

Construction. The circuit is assembled on a 3¼" x 7¼" section of perforated board. All of the components are mounted

RADIATION FALLOUT MONITOR



on one side of the board and (in most cases) their leads are passed, through convenient perforations, to the other side. Here, the actual wiring is carried out; make all connections point to point and cover bare leads with spaghetti wherever necessary.

In some cases, the author ran component leads through brass eyelets installed on the board, rather than directly through the perforations. The eyelets make convenient junction points and, if all leads passing through are soldered in place, provide an extra-rigid mounting.

Thyratron *V2* is mounted horizontally, its socket being installed on a home-made aluminum "L" bracket. The exact dimensions of the bracket are not important, but see that the socket is raised high enough above the circuit board so that *V2* will clear all of the components.

The Geiger-Mueller tube (*V1*) is held in place by a spring clip mounted on a machine screw and nut which, in turn, are anchored to the board. This clip also serves as a contact to the outer shell, or cathode, of the tube. It's connected into the circuit via a solder lug installed under the screw head.

Tube *V1*'s central pin, or anode, passes through a small hole drilled in another machine screw mounted near the tube. A second solder lug is similarly installed to connect the assembly into the circuit. Run a nut down the screw to make a secure electrical connection with the pin, but make it only finger-tight (this also applies to the nut holding the cathode clip). Excess pressure can easily ruin the tube.

The speaker specified in the Parts List is a bit larger than the one actually used by the author. It makes for a slightly tighter fit on the board, but has the advantage of being provided with its own mounting lugs, and it gives more volume as well. No great change in the relative

component positions shown in the photographs is required.

The author installed his completed circuit board in a wooden box which originally contained "Christmas" after-shave lotion. The speaker opening on top of the box was covered with black screen wire and decorated with the familiar radiation warning symbol (cut from a scrap of sheet aluminum). Flashes from the neon lamp are visible through a piece of Lucite glued into the end of the box near *11*.

A set of rubber feet was installed on the box bottom—giving enough clearance for ventilating air to pass through several holes drilled there. An exit for the heated air is provided by the speaker opening.

The housing for the board isn't critical, of course, and you can adapt any metal, plastic, or wooden box which appeals to you. Just be sure to make adequate provisions for ventilation.

(Continued on page 100)

Author used shaving-lotion box (shown here with cover off) as a cabinet. Any similar container will serve if adequate ventilation is provided.



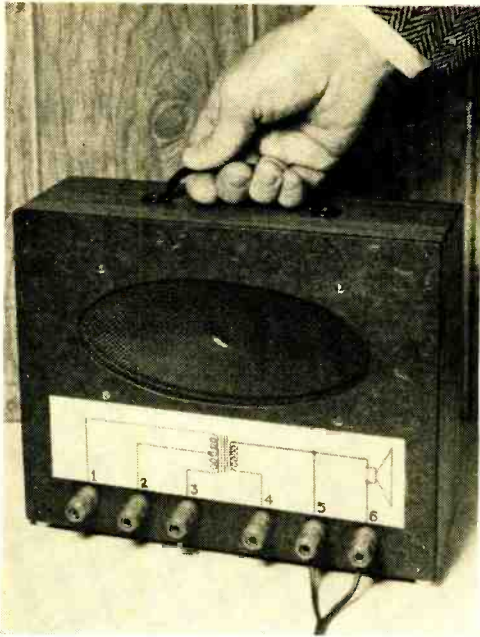

Designed for the serviceman, this Test Bench Squawk Box supplies for chassis under repair the missing audio circuit elements left behind in the customer's house.

The unit is as easy to assemble as it is to use. Rear view of author's model shows a Magnavox 4" x 8" PM speaker, output transformer, binding posts, connecting wiring.

TEST BENCH SQUAWK BOX

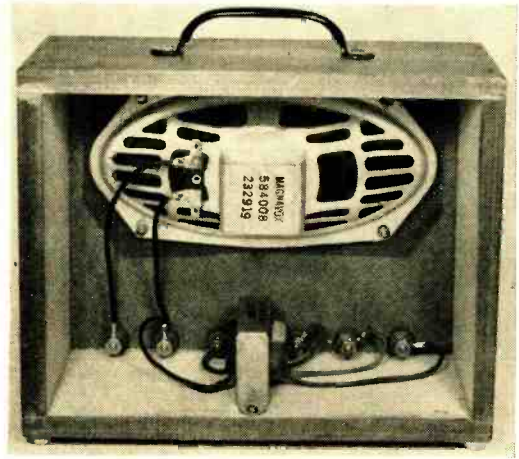

SERVICEMEN, professionals and amateurs alike, often work on television, hi-fi and radio chassis whose mating speakers are not on the test bench but miles away in the owners' cabinets. In most cases, the speakers are left behind because they are bulky, difficult to remove, and, once removed, prone to damage. Then how does one listen to the equipment being tested and repaired? It's easy, if you own a Test Bench Squawk Box. If you don't have one, an evening's time plus a few ducats for parts are all that is needed to assemble this audio aid.

The size and shape of the enclosure for the speaker are determined by the speaker size you plan to use. Standard auto replacement PM speakers are ideal; they range in size from 3" x 5" to 6" x 9", with a few odd-ball sizes thrown in. Assemble the enclosure using 1/2" hard-

wood for the sides, top and bottom, and 1/4" fiberboard for the front. Cut out a port for the speaker, and then mount the speaker, six 5-way binding posts, and an audio output transformer so that the unit resembles the author's Squawk Box shown above. The transformer's output winding impedance should match the speaker's impedance, and the primary winding should be on the order of 5000 ohms center-tapped.

Interconnect the components following the schematic diagram shown on the unit in the photo at top, left; if you attach a similar schematic to the front panel of your Squawk Box, you will know at a glance how to connect the unit to a chassis. Then top off the construction by adding four rubber feet, a carrying handle, and—if you wish—a fiberboard back panel to close up the unit.

—Art Trauffer

SMOOTHER SHAVES

with Smoother Current

IF YOUR TRUSTY electric shaver "groans" in the morning and can't quite seem to "get going," maybe it needs a little d.c. "stimulation." Many of the older a.c./d.c. shavers which creep on a.c. often purr delightfully when operated on d.c. What's the answer? Build this little plug-in a.c.-to-d.c. converter—it'll take only an hour or so of your time and less than \$3.00 of your cash.

Start construction by cutting a $1\frac{3}{16}$ "



hole in the center of each end of the utility box (it's easiest to use a chassis punch, but a circle cutter will also do the trick). Next, mount plug *P1* in one hole, and jack *J1* in the other, using the retainer rings supplied. This done, wire up the converter, following the schematic diagram and the photos at right. When wiring, be especially careful not to make any connections to the metal box itself—to prevent any possibility of an electric shock.

Your power converter is now ready to go. Simply plug your shaver into the converter, and the converter into a 117-volt a.c. outlet, and you'll shave with pleasure. It's best to unplug the converter when it's not in use, incidentally—someone might be tempted to insert a high-wattage or an a.c.-only appliance into it.

—Joseph R. Noonan

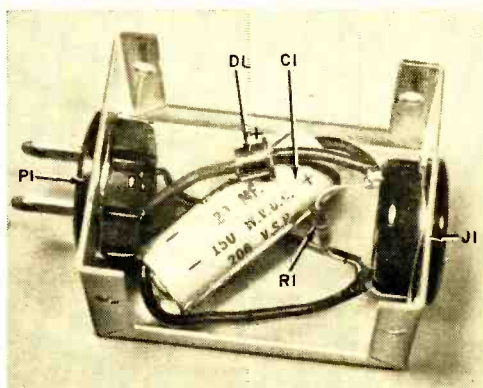

PARTS LIST

- C1*—20- μ f., 150-w.v.d.c. electrolytic capacitor
- D1*—750-ma., 200-PIV silicon diode (Lafayette Radio Type SP-197 or equivalent)
- J1*—2-pole female a.c. socket, retainer-ring mounting (Amphenol Type 61-F or equivalent)
- P1*—2-pole male a.c. plug, retainer-ring mounting (Amphenol Type 61-M or equivalent)
- R1*—100,000-ohm, $\frac{1}{2}$ -watt resistor
- 1— $2\frac{3}{4}$ " x $2\frac{3}{8}$ " x $1\frac{5}{8}$ " aluminum utility box (Bud CU-3000-A or equivalent)
- Misc.—Insulated hookup wire, spaghetti, solder

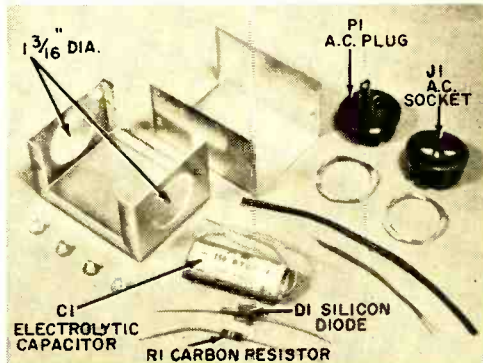

All the parts you'll need are shown here; the photo at the top of the page tells you how to mount them.

Wire the converter exactly as shown in diagram below. "Plus" of *D1* must connect to "plus" of *C1*.

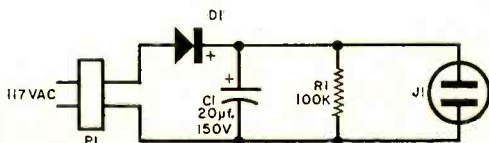

ONE FOR THE



**Auxiliary receiver tunes 122—144 mc.,
operates from any 12-volt car battery**

SOME EXCITING LISTENING is to be had in the VHF regions—signals from airplanes en route, emergency operations at airports, Civil Air Patrol missions, even local hamfests lurk in these frequencies, literally waiting to be pulled in. Unfortunately, though, most of the VHF “events” seem to take place just when you don’t have a VHF receiver handy!

Of course, the obvious way to be prepared for a “find” on the VHF airwaves is to carry a VHF receiver in your car at all times. There’s nothing very original about this idea, and it may even sound somewhat impractical. But it is just what we would like to suggest: “One For The Road” . . . and only the road; a VHF receiver so small that it can get lost in the glove compartment and so inexpensive that you can toss it into the car and forget it until you need it!

Although the unit shown here is the extreme in simplicity, it covers the 122-144 mc. range and is more than capable of satisfying the curiosity of the occa-

sional VHF “eavesdropper.” In addition, it can do a creditable job as an auxiliary receiver in times of emergency.

Since it uses one of the tubes designed for “hybrid” car radios, the need for vibrators or high-voltage power supplies is eliminated—the only power required to operate this receiver is 12 volts d.c. Thus, not only are costs and circuit complications reduced, but installation is as quick as 1-2-3. In fact, all you have to do to install this receiver is plug it into your cigarette lighter!

About the Circuit. As you may have already noted, the 12EC8 tube in the set consists of a triode and a pentode in the same envelope. Fortunately, the tube’s triode section will oscillate at frequencies up to 200 mc. or more with plate voltages as low as 6 volts! And the same characteristics that make it a good VHF oscillator also make it a good superregenerative detector.

A single tube in a superregenerative circuit can often equal a full-sized com-

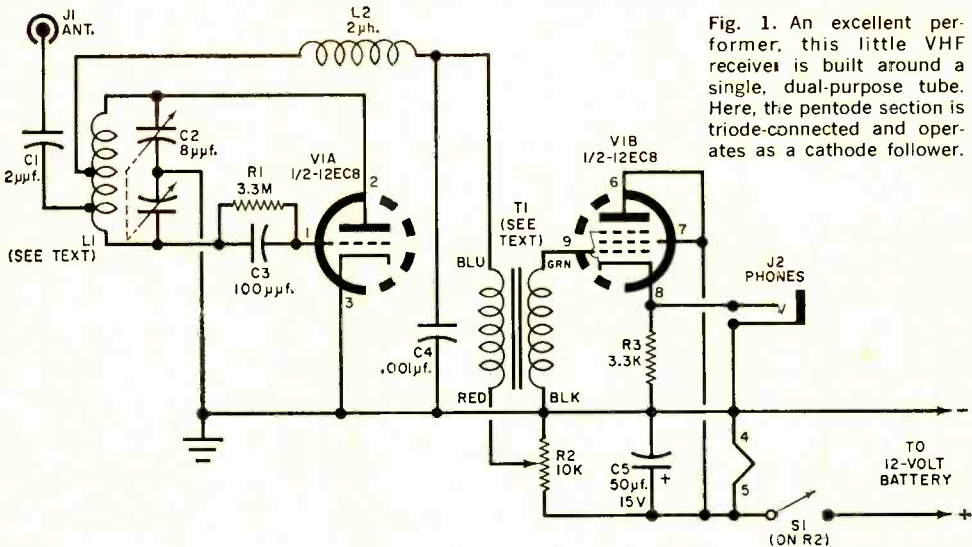

Fig. 1. An excellent performer, this little VHF receiver is built around a single, dual-purpose tube. Here, the pentode section is triode-connected and operates as a cathode follower.

PARTS LIST

- C1—2- μ f. mica or ceramic capacitor
- C2—8- μ f. midjet variable capacitor, "butterfly" type (E. F. Johnson 160-208 or equivalent)
- C3—100- μ f. mica capacitor
- C4—0.001- μ f. ceramic capacitor
- C5—50- μ f., 15-w.v.d.c. electrolytic capacitor
- J1—Banana jack
- J2—Miniature phone jack, non-shorting type (insulated type required for circuit in Fig. 2)
- L1—Antenna coil (5 turns of #16 wire, $\frac{3}{8}$ " in diameter, spaced $\frac{1}{2}$ " long, tapped at center and 1 turn from end)
- L2—2- μ h. r.f. choke or 24 turns of #30 enameled wire close-wound on and connected in parallel

- with a 2-megohm, $\frac{1}{2}$ -watt resistor
- R1—3.3-megohm, $\frac{1}{2}$ -watt resistor
- R2—10,000-ohm miniature potentiometer, linear taper, with s.p.s.t. switch S1
- R3—3300-ohm, $\frac{1}{2}$ -watt resistor
- S1—S.p.s.t. switch (on R2)
- T1—Miniature interstage transformer, at least 1:3 turns ratio—see text
- V1a/V1b—12-12EC8 tube
- V1—4" x 2" x 2 $\frac{3}{4}$ " aluminum utility box (Bud CU-2115-A or equivalent)
- Misc.—Mica-filled 9-pin socket for V1. Telescoping antenna, scrap aluminum for shelf, wire, solder, earphones, etc.

munications receiver in sensitivity. However, one of the unfortunate features of the "superregen" is its tendency to radiate interference on the channel being received. In this receiver, the power input to the detector is in the vicinity of 300 microwatts or less, so radiation should be of little concern.

With the triode section of the tube used as a detector, the pentode section is still available as a stage of audio amplification. However, in the circuit shown in Fig. 1, the pentode is triode-

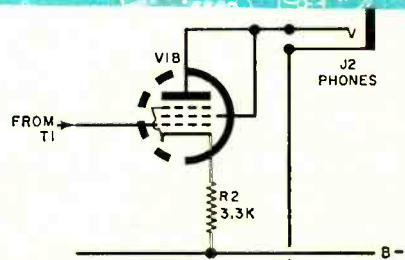
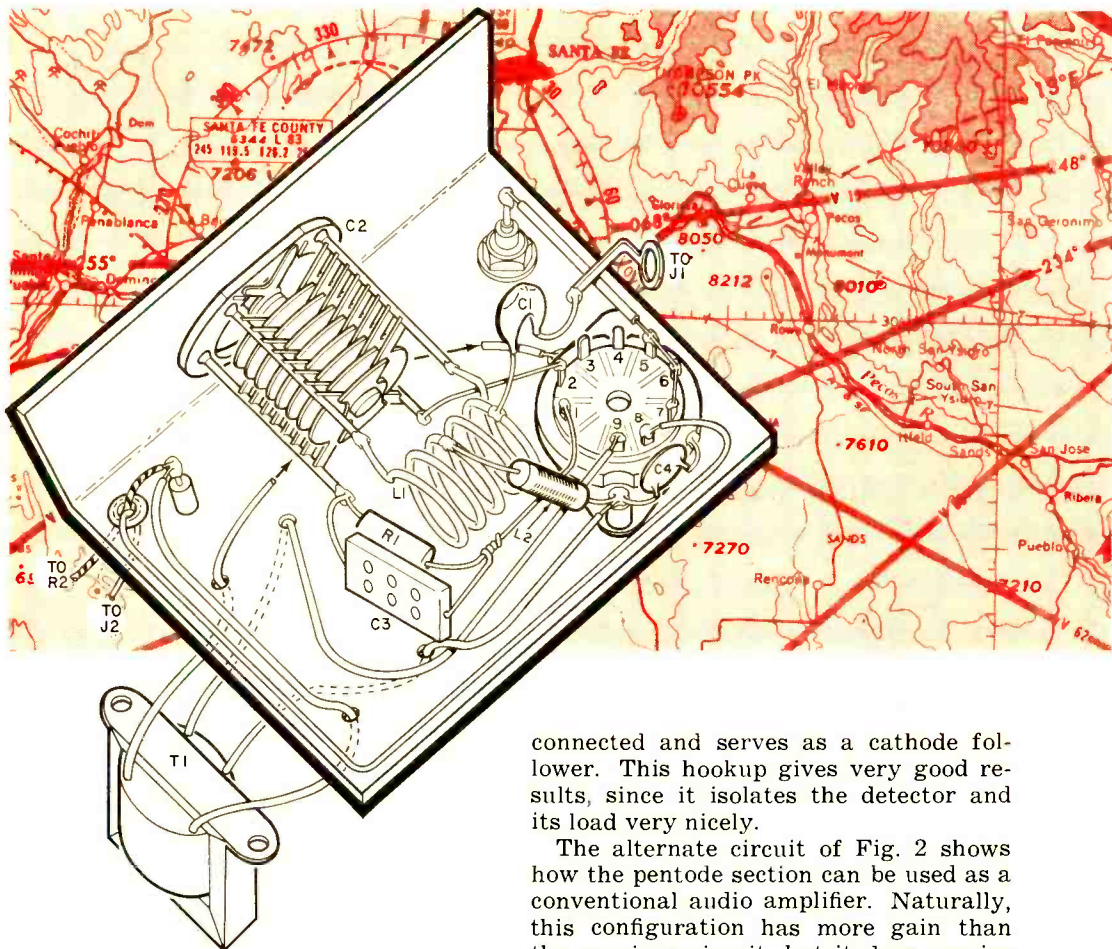
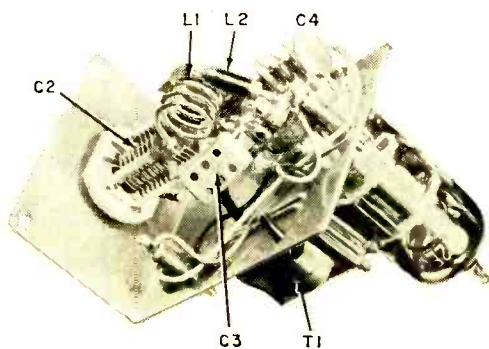

Fig. 2. Placing the phones in the plate lead increases overall gain.



An aluminum shelf (above), about 2¼" deep x 1⅞" wide, holds most of the components, with tuning capacitor C2 mounted on the shelf's 1" lip. Holes in lip of shelf (below) must match those in front panel of case.



connected and serves as a cathode follower. This hookup gives very good results, since it isolates the detector and its load very nicely.

The alternate circuit of Fig. 2 shows how the pentode section can be used as a conventional audio amplifier. Naturally, this configuration has more gain than the previous circuit, but it does require that the output jack be insulated. However, the added voltage gain will be appreciated in many cases, especially if you intend to do most of your listening with headphones.

Construction. If full speaker volume is your goal, then your best bet is to build the circuit of Fig. 1 and feed its output into the audio section of your car radio. Alternatively, with the 4" x 2" x 2¾" case suggested, there's still room enough for the serious experimenter to include a power transistor to drive a speaker.

Several versions of the receiver have been built, and they have all worked—even with substitute parts and some pretty "haywire" hookups! With the construction and circuit as simple as they are, the photos and drawings should just about tell the complete story.

In the author's case, the small interstage transformer (T1) came from his

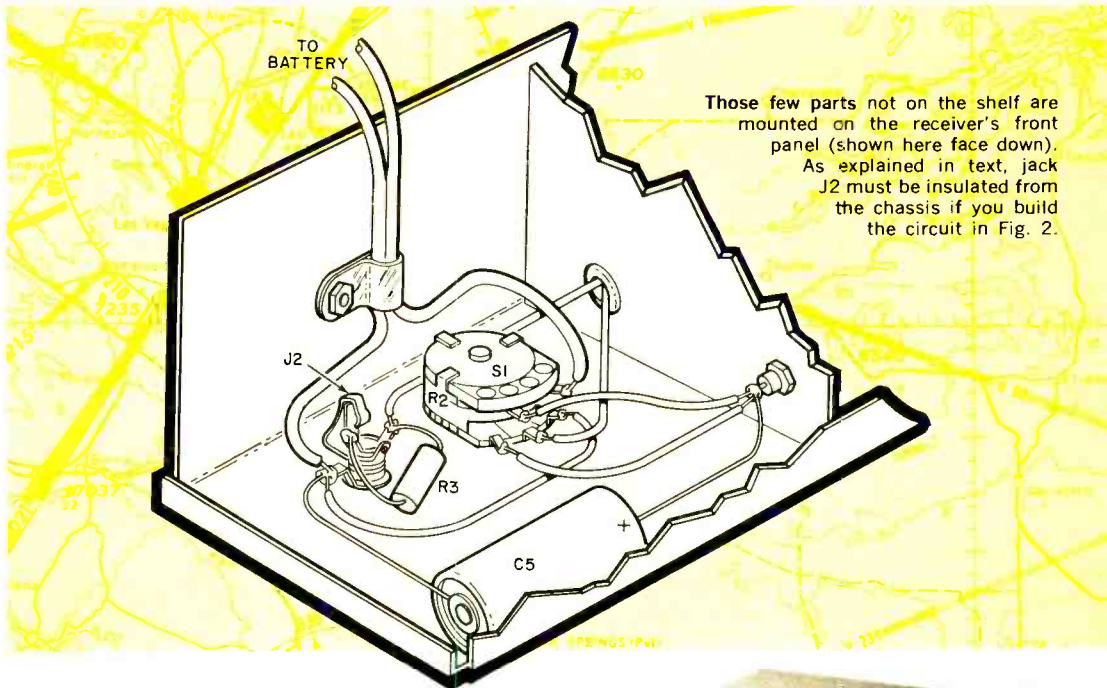

Those few parts not on the shelf are mounted on the receiver's front panel (shown here face down). As explained in text, jack J2 must be insulated from the chassis if you build the circuit in Fig. 2.

spare-parts box, but any miniature plate-to-grid coupling transformer with a turns ratio of 1:3 or more will work (the Argonne Type AR-155 is a good choice). A standard size interstage transformer can be used with quite a saving in cost if the receiver is spread out on a larger chassis.

All of the parts except regeneration control R2 and capacitor C5 should be mounted on a small aluminum shelf. As long as you keep the leads from capacitor C2 to socket pins 1 and 2 as short as possible, placement of the other components isn't especially critical. For best results, however, coil L1 should be kept at least 1/4" away from such large parts as transformer T1 or the chassis itself.

Adjustment and Operation. After the receiver is wired, it can be tested by "clipping" it across a 12-volt car battery for a trial run—just make sure that the ground lead on the receiver is connected to the negative lead on the battery. Plug a pair of phones into the phone jack and advance the regeneration control until you hear the familiar smooth rushing sound of the superregenerative detector.

If the signals are strong enough, a 12" section of a telescoping antenna inside
(Continued on page 96)



Completed receiver (above) needs only an earphone, an antenna, and a battery to operate. Note that the entire receiver is housed in front portion of the case (below).

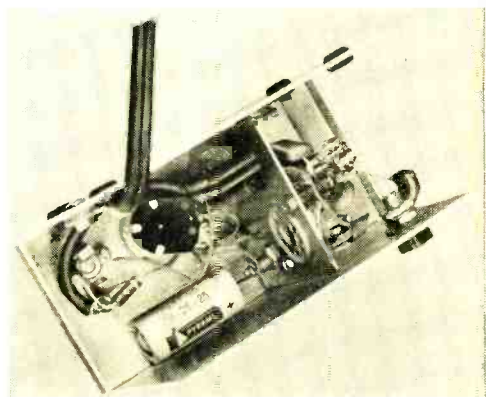

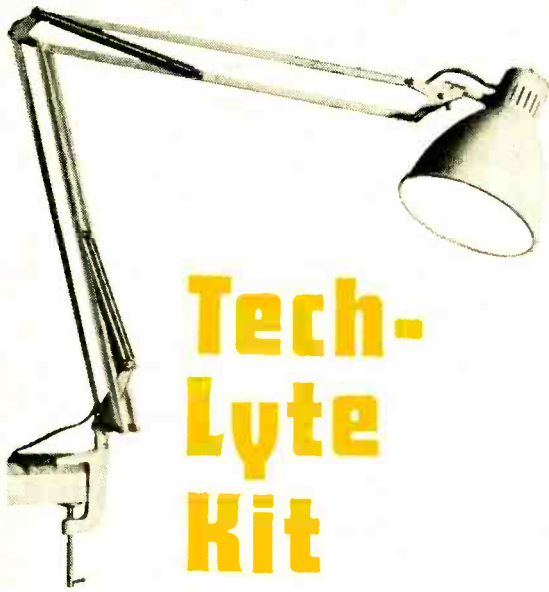

Tech-Lyte Kit

Proper lighting is frequently overlooked in the home electronics lab or workshop. Why strain your eyes peeking into dark corners when you can buy a kit for only \$9.95 and assemble a free-movement utility lamp? Sold by Zack Electronics, 1422 Market St., San Francisco 2, Calif., the "Tech-Lyte" kit was put together in the POP'tronics lab in just about 30 minutes.

In Photo 1 are the unassembled parts as they arrive from the manufacturer. Photos 2 and 3 show how the base clamp and arms are mounted, as well as the counterbalancing springs which permit free lamp movement. A rod for the lamp shade (Photo 4) is attached to the neck assembly elbows which hold the other ends of the tubular arms together. The line cord to the lamp is carefully strung down the arms and around the elbows to prevent it being pinched or shorted out.

The lamp shade and socket (Photo 5) complete the assembly. Immediately available, the Tech-Lyte comes in grey, black, brown, or mist green.

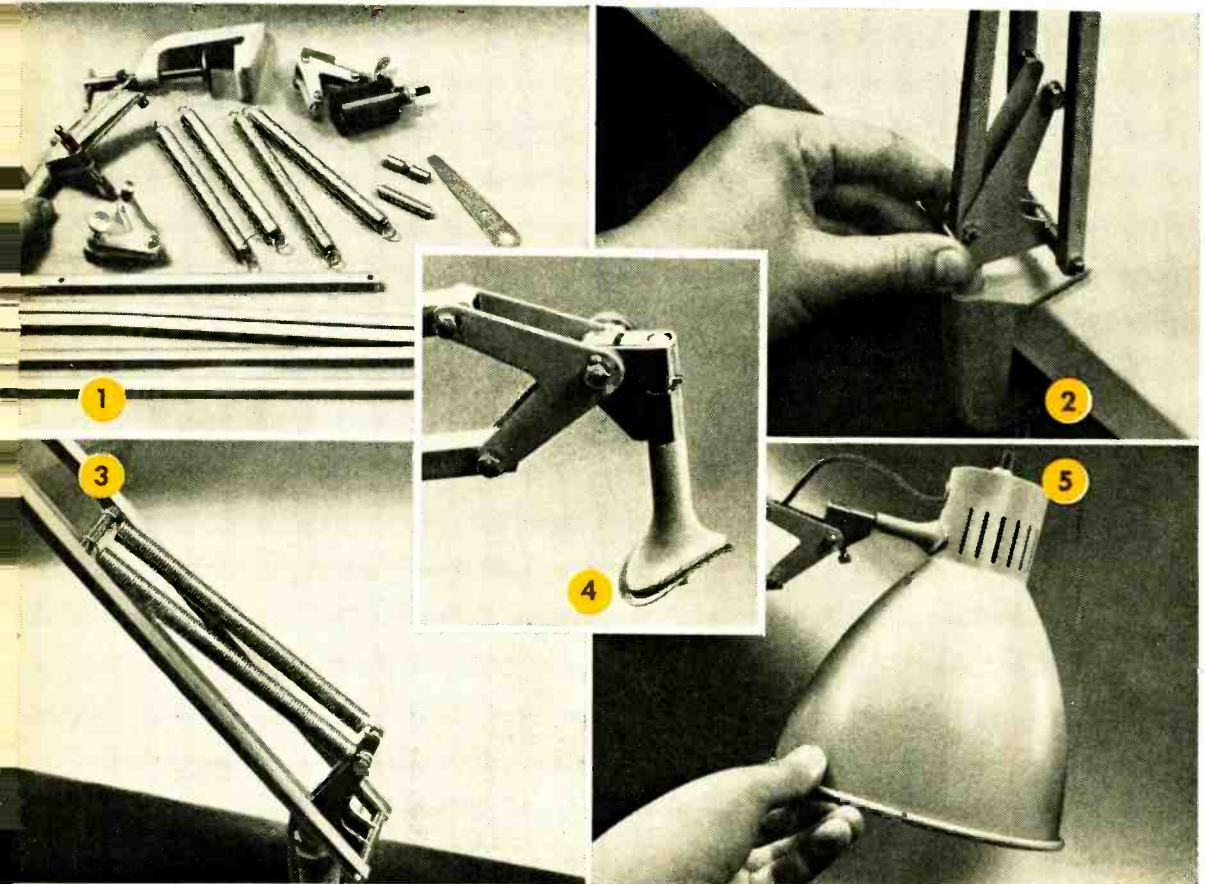



TRANSISTORIZED TREMOLO

... adds "color" to musical instruments

By A. E. DONKIN, W2EMF

GOT A MUSICIAN in the family? You can delight him (or her) and your friends by constructing this little electronic tremolo. Reasonably easy to build, it makes a perfect addition to an electric guitar. Add a suitable mike, and you can use it with almost any musical instrument.

Like other tremolos, this device produces a "throbbing" effect on the sound of an electric musical instrument which is played "through" it. Unlike some versions, however, this circuit is transistorized and battery-operated, with several resultant advantages.

For one thing, the number of components is reduced; and so, too, is the cost. In addition, the unit is small enough and light enough to be attached

directly to the musical instrument; this means that it can be readily controlled by the musician himself. Finally, the battery power supply substantially reduces the possibility of hum in the amplifying system.

About the Circuit. The transistorized tremolo is connected between the output of an electric musical instrument and an audio amplifier. It functions by varying the amplitude of the electrical signal from the musical instrument at a rate of about 5 to 15 times per second.

In the circuit shown here, transistor *Q1* is connected as an amplifier and is biased to draw very little collector current. To match the impedance of a magnetic instrument pickup, its input impedance has been increased by leaving

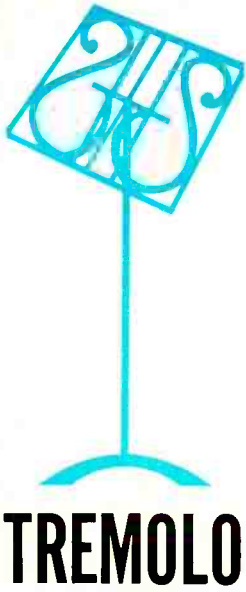

TREMLO

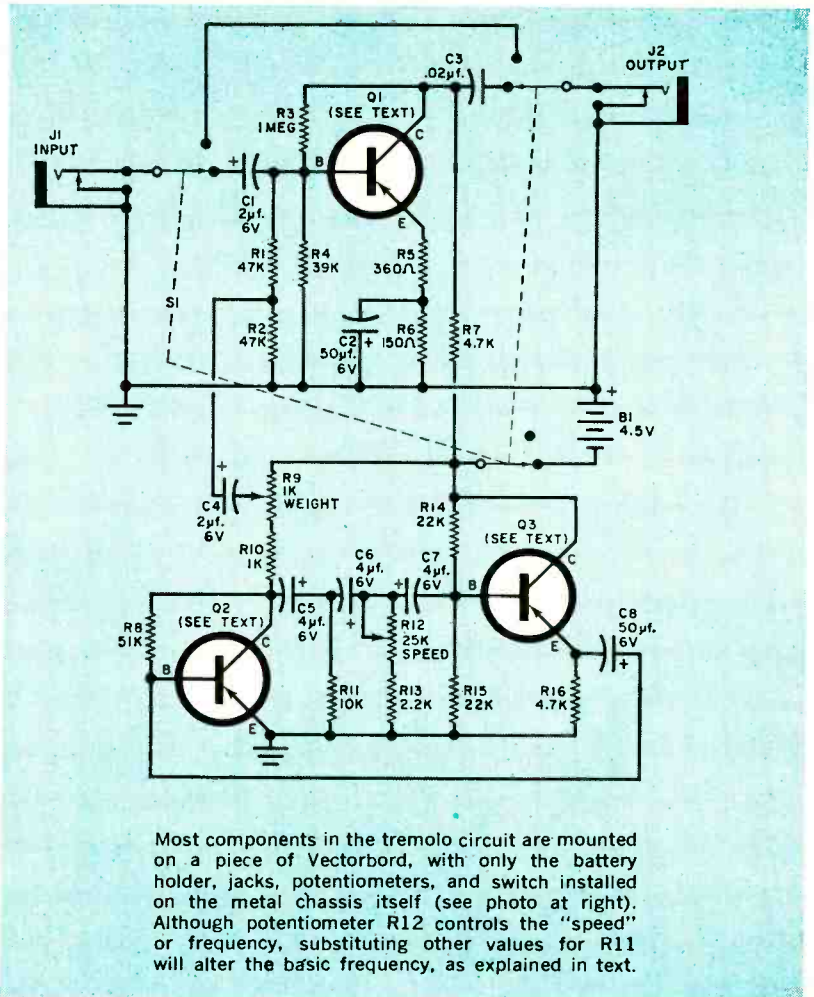

a portion of the emitter resistor unby-passed ($R5$).

Since transistor $Q1$ is operated in the low-current region, its gain varies rapidly with changes in collector current. A low-frequency (5- to 15-cycle) signal is superimposed on the d.c. bias for this stage via resistors $R1$ and $R2$, causing the collector current (and hence the gain) to vary.

Transistors $Q2$ and $Q3$ operate as a phase shift oscillator to generate the 5- to 15-cycle signal. Transistor $Q2$ is a common-emitter amplifier supplying the phase shift network, and $Q3$ is an emitter follower to adjust impedances and provide positive feedback. The frequency of the phase shift oscillator is adjusted

by varying one "leg" of the phase shift network (potentiometer $R12$); the depth or "weight" is controlled by adjusting potentiometer $R9$.

Construction. Layout of the transistorized tremolo isn't critical, but it's still a good idea to follow the author's parts placement as nearly as possible. A $2\frac{1}{16}$ " x $3\frac{1}{2}$ " piece of Vectorbord facilitates mounting the smaller components, and Vector terminals can be used as tie-points where needed.

Potentiometers $R9$ and $R12$, jacks $J1$ and $J2$, switch $S1$, and the battery holder should be mounted in the utility box first, leaving as much room as possible for the Vectorbord assembly (be sure to allow enough clearance to insert and re-

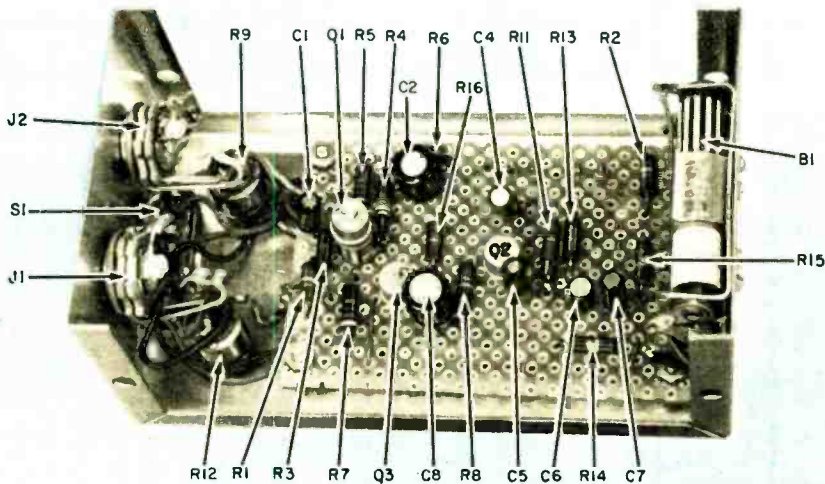

PARTS LIST

B1—4.5-volt battery (three Burgess Type 7 "slim" penlight cells in series or equivalent)
 C1, C4—2- μ f., 6-w.v.d.c. miniature electrolytic capacitor
 C2, C3—50- μ f., 6-w.v.d.c. miniature electrolytic capacitor
 C3—0.02- μ f. miniature paper capacitor
 C5, C6, C7—4- μ f., 6-w.v.d.c. miniature electrolytic capacitor
 J1, J2—Phone jack, shorting type
 Q1, Q2, Q3—Audio transistors, pup type (Lafayette SP-239 or equivalent)
 R1, R2—47,000 ohms
 R3—1 megohm
 R4—39,000 ohms
 R5—360 ohms, 5%
 R6—150 ohms
 R7, R16—4700 ohms
 R8—51,000 ohms, 5%

All resistors
 $\frac{1}{2}$ watt, 10%,
 unless otherwise noted

R9—1000-ohm miniature potentiometer, linear taper
 R10—1000 ohms
 R11—10,000 ohms
 R12—25,000-ohm miniature potentiometer, linear taper
 R13—2200 ohms
 R14, R15—22,000 ohms
 S1—3-pole, double-throw slide switch (Lafayette SW-94, with one section unused, or equivalent)
 1—5 $\frac{1}{4}$ " x 3" x 2 $\frac{1}{8}$ " aluminum utility box (Bud CU-2106-A or equivalent)
 3—Battery holders (Keystone Type 137 or equivalent)
 1—2 $\frac{1}{16}$ " x 3 $\frac{1}{2}$ " piece of Type 85G24EP Vectorbord
 Misc.—Type T28 Vector push-in terminals, miniature knobs for R9 and R12, wire, solder, hardware, etc.

move the batteries). The Vectorbord should then be cut and drilled, after which the other components can be mounted.

Although the transistors in the author's model are of the "2 for 98 cents" variety, they function quite satisfactorily. For optimum results, the transistors should be interchanged in the circuit, and Q1 selected for lowest noise (Q2 and Q3 aren't particularly critical). If the transistors are installed in either socket or Vector terminals, they can be "selected" after the Vectorbord assembly has been wired into the Minibox.

When wiring, be sure to "heat sink" the transistor leads with a pair of long-nose pliers. You may want to use the

same treatment for the electrolytic capacitors, just to be on the safe side; in addition, the polarities of the electrolytics must be observed.

After the wiring is completed, the Vectorbord should be fastened to the top of the box with $\frac{1}{4}$ " spacers, and the leads from it to the balance of the circuit soldered in place.

Check-Out and Operation. The unit is ready for testing. Install the batteries, again observing polarity, and turn the unit on. To check for oscillation of Q2 and Q3, simply measure the collector voltage of Q2 or the emitter voltage of Q3. A rapid fluctuation indicates that the oscillator is operating properly.

Now insert the tremolo between the

TREMOLO

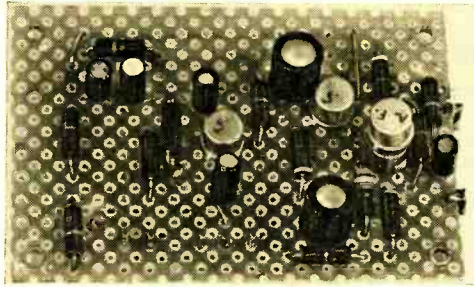
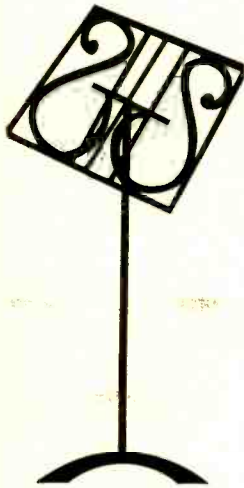

Here's how the Vectorbord subassembly should look when it's ready to be installed in the chassis box.



Hooking up the transistorized tremolo is simplicity itself—just plug the electric guitar or other musical instrument into jack J1 on the tremolo and connect an audio amplifier and speaker to jack J2.

output from the musical instrument and the input to your amplifier, as shown. The “weight” control, $R9$, should be adjusted until a “throbbing” is noticeable in the amplifier output; don’t advance the “weight” control too far or you may cause a “thumping” sound in the

speaker. The “speed” control, $R12$, governs the rate of tremolo and should be adjusted to suit your taste.

If desired, the range of adjustment of the “speed” control can be modified by adding a resistor in parallel with $R11$, since reducing the effective value of $R11$ will increase the speed. In the author’s model, $R11$ was paralleled with a 1000-ohm resistor for an effective value of about 900 ohms.

Possible Troubles and Cures. The simplicity of the circuit is some insurance against trouble. If the components and wiring seem to be okay, lack of oscillation may be due to low β in $Q2$ or $Q3$, although the requirements for this portion of the circuit aren’t very exacting.

“Thumping” can be reduced by experimenting with smaller values for capacitor $C3$. The final value for this component depends to some extent on the amplifier you happen to use, but don’t reduce the capacitance too much or you’ll cut out most of the low frequencies.

Since the amplifier stage ($Q1$) is operated at low collector current, the amplitude of the input signal is limited, and large signals will cause distortion. Even so, most guitar pickups won’t overload $Q1$. But if distortion does occur, you should be able to correct it by reducing the output level of the instrument and increasing the gain of the amplifier accordingly.

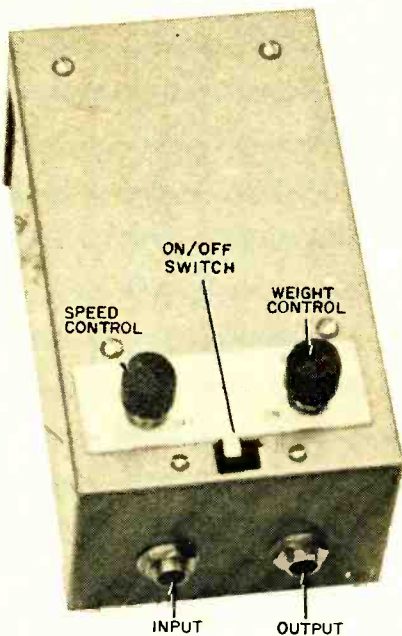

The transistorized tremolo, all wired up and rarin' to go. See text for instructions on adjusting speed and weight controls.

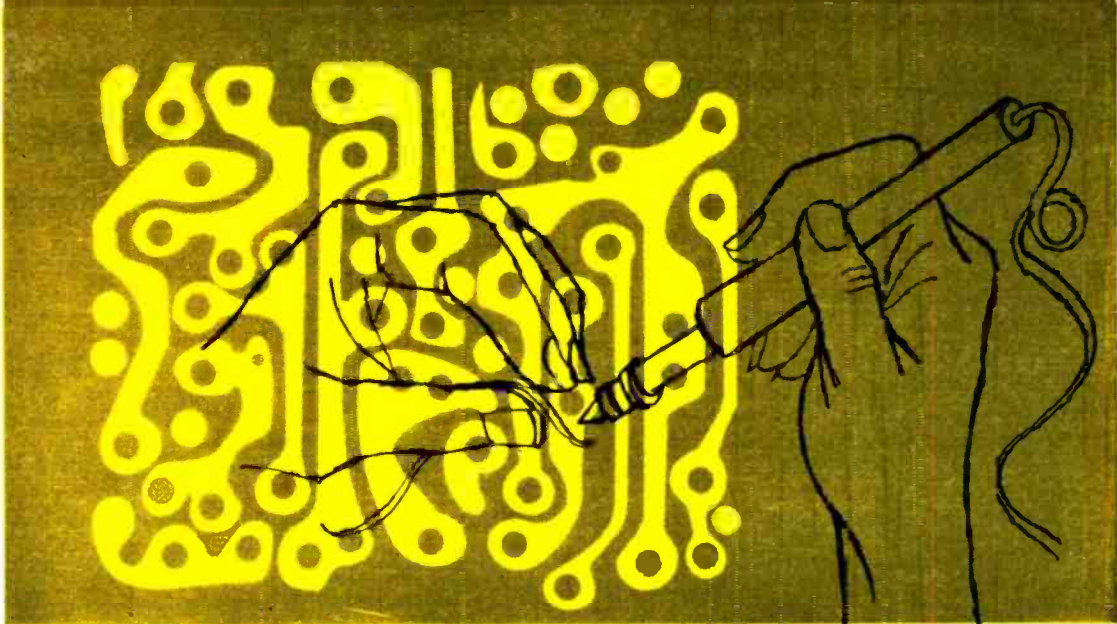

First Aid for PRINTED CIRCUITS

*Because they differ radically
from conventional circuitry,
printed boards require some
specialized servicing techniques*

By J. W. L. CODY

Systems Operation,
Heavy Military Electronics Dept.,
General Electric Co.,
Syracuse, N.Y.

DURING THE PAST DECADE OR SO, printed circuits have been perfected to an amazing degree. Today, practically all electronic equipment manufacturers use them in their products. In fact, the list of equipment containing printed boards is almost endless—television sets and radio receivers, timing units, hi-fi/stereo equipment, photo-cell devices, meters, computers, transmitters, strain gauges, motors, switches, automobile gauges, moisture detectors, and even musical instruments.

Like anything else, of course, the components used on printed-circuit boards can't last forever. But careful replacement of defective components by a skilled and experienced technician can restore a printed-circuit board to a "like-new" condition. Use of the procedures we're going to outline should serve to decrease the time con-

PRINTED CIRCUITS

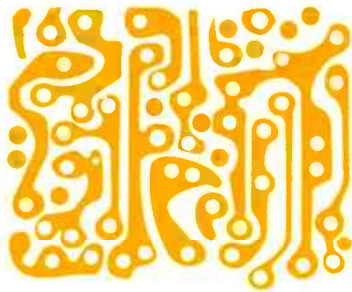

sumed in servicing printed circuits and reduce the number of boards that have to be scrapped.

A Word About Tools. To repair printed-circuit boards successfully, it is absolutely essential to use the proper tools. To disregard this rule could mean considerable damage to, or even destruction of, the board under repair.

In checking and tracing circuits on printed boards, needle-tipped test prods should be used to penetrate the lacquer coating of the board.

A low-wattage soldering iron is a "must," since such an iron will furnish sufficient heat to melt solder reasonably fast and yet not produce excessive heat which might damage the board. An iron with a 25-watt element should be used for replacing components, and a desoldering kit for removing them.

The multiple component bar tip is used where components with clusters of connections in a line are to be removed; the circular tips are used for removing tube sockets, transformers, and other components which have a circular cluster of connections; the slotted tip is especially useful for removing solder and at the

An important tool: fluorescent lamp with built-in magnifier. This is Dazor's Model M-209.

Tools You'll Need to Repair Printed Circuits

- Fluorescent light fixture with built-in magnifier
- Six-volt, 25-watt soldering iron, with transformer
- Low-heat desoldering iron kit, including several special tips (multiple component bar, slotted soldering aid, and various-sized circular tips)
- Rosin core solder (60/40)
- Diagonal cutters
- Long-nose pliers
- Curved long-nose pliers
- Tweezers
- Thin blade knife (to separate flat component contacts)
- Needle-tipped test prods
- Rosin lacquer
- Lacquer solvent
- Six-inch calipers (to identify points from one side of board to the other)
- Soft brass wire brush



same time straightening bent lugs. The slotted tip also serves the purpose of "soldering" in portions of a board where space is especially limited; in this case, the slot should be carefully filled with solder and the solder transferred to the joint.

You'll find other useful tools listed in the box at left below.

Replacement Techniques. Where a resistor or other component with end leads is mounted parallel to the board (or even vertically, with one lead looped over and bent down to the board), replacement is a simple task.

For example, to replace a resistor, you just cut the old component in two with a pair of diagonal cutters, crush the ends so that portions of the old leads contained within the resistor body can be used for installing the new component, make loops in the leads still affixed to the board, join the loops with the leads of the new component, and solder the connection carefully. (Be sure to use as little heat as possible, since excessive heat can cause the printed wire to raise from the board).

If a component is mounted vertically,

clip the leads as close to the body as possible. Or, if the component is seated on the board, as in some circuits, clip the top lead and unsolder the bottom lead. Remove the bottom lead from the hole, then place one lead from the new component in the hole and solder it in place. Finally, join and solder the top lead to the clipped lead which was removed from the defective component.

A simple jig can be assembled by using two wooden blocks (their size will depend on the dimensions of the board to be repaired). With two ordinary, spring-type clothespins mounted on each block, the defective board can then be clamped in the clothespins between the blocks and repaired. Pieces of felt cloth should be cemented to the upper and lower jaws of each of the clothespins to protect the board from damage.

In the event that any of the printed conductors have been broken, either by rough handling or a short circuit, they should be repaired. If the break is $1/16''$ or less in length, the copper should be cleaned carefully with solvent and solder flowed into the break to effectively "bridge" the gap. A small brass

Safe desoldering of printed-circuit boards is one of the first steps in repairing them. The specialized components shown below are part of Ungar's Model 270 desoldering kit, and include a tip for components with "in-line" contacts (left), circular contacts (center), and wire leads (right).

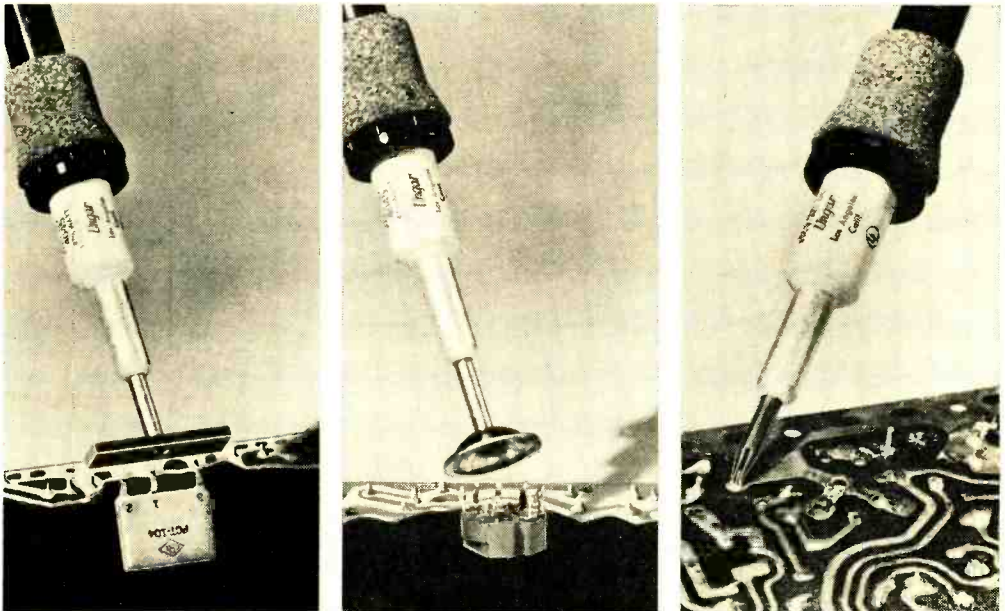

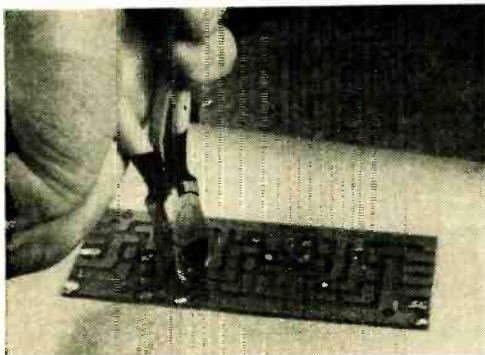
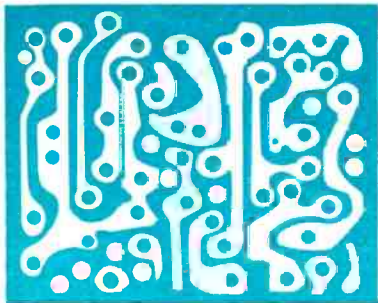

CUTTING. Replacing a resistor is easy if you do it right. First, cut it in half with side-cutting pliers.

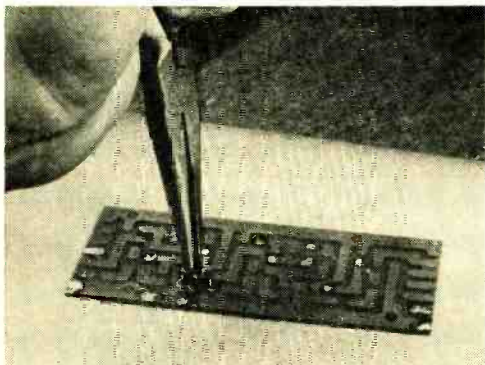

CRUSHING. Smash the rest of the resistor with a pair of pliers, and you're left with two bare leads.

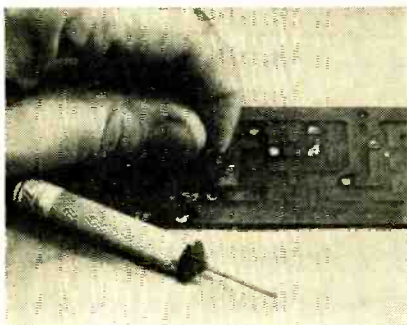

brush can often be used to advantage in cleaning the copper, incidentally.

Where the break is of greater magnitude, a wire "bridge" will be required. The ends of the copper conductor should be carefully cleaned with solvent and a brass brush. Then a piece of tinned #22 wire, long enough to bridge the break and provide a $\frac{1}{4}$ " lap at either end, should be laid in place. Solder the ends of the wire to the copper conductor, and the job is done.

From time to time, you'll no doubt run across cracked or even broken boards. Whether or not to repair these boards will depend on several conditions: (1) the severity of the break, (2) the availability of a replacement board, and (3) whether or not the equipment can be left
(Continued on page 99)

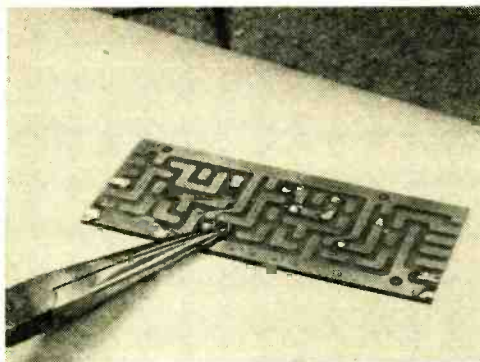

LOOPING. With a little practice, you can use long-nose pliers to form a tiny loop at end of each lead.

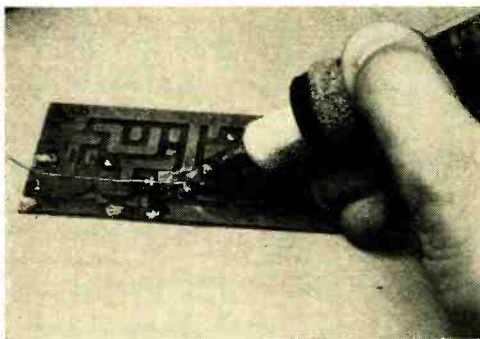

SOLDERING. Pass the leads from the new component through the loops, then solder them in place.

For more professional-looking loops, you'll want to use one of the "pig-tail" tools now on the market. The one shown here is made by Twirl-Con.

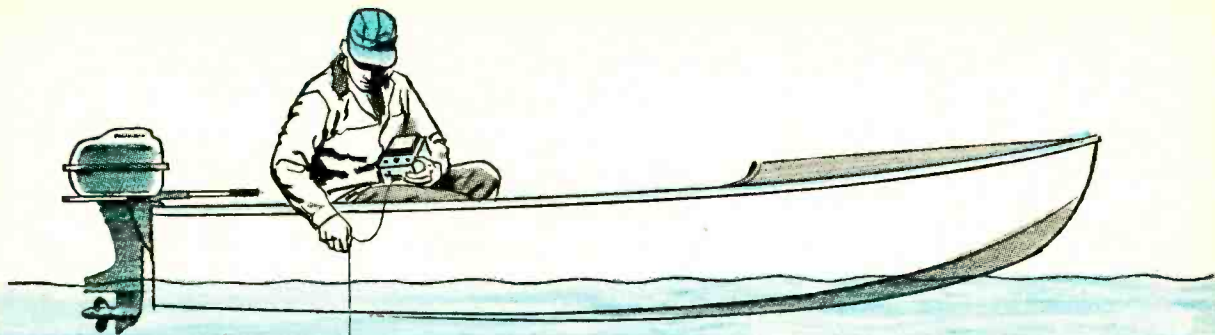

THE FISH FINDER

Pity the poor fish when anglers probe the depths with underwater thermometers

By R. L. WINKLEPLECK

NOT LONG ago, a "fishing nut" friend of mine dropped in with a problem. He needed an instrument, small enough to take on fishing trips, that would quickly and accurately read water temperature at various depths. When asked what he wanted with such a unit, he offered the following explanation.

Different kinds of fish, it seems, have different preferences for the temperature of the water in which they swim. And water temperature (especially the temperature of still or slowly flowing water) is apt to vary with depth. By measuring the temperature at the depth of each "catch," he hoped to work up charts showing the temperature preferences of various species of fish. With the charts, he could select his future catches by placing his hook at a depth having the proper temperature for the type of fish desired.

The author doesn't guarantee the soundness of this theory, but the unit he designed to do the measuring is described here. If you'd like to try your hand at "scientific" fishing, or if you have any other use for a portable, remote-reading, 40-90°F thermometer, you'll

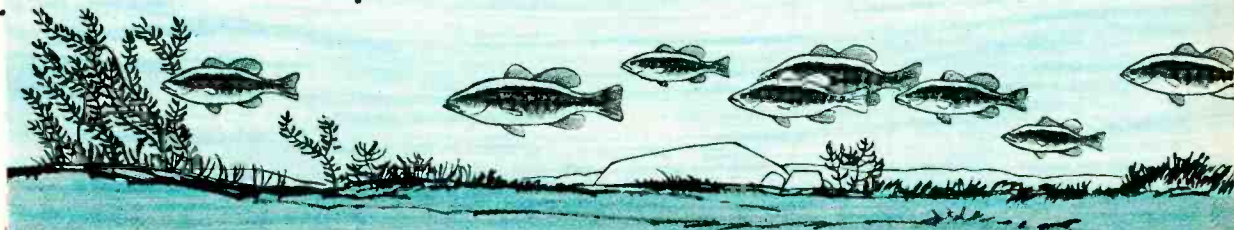

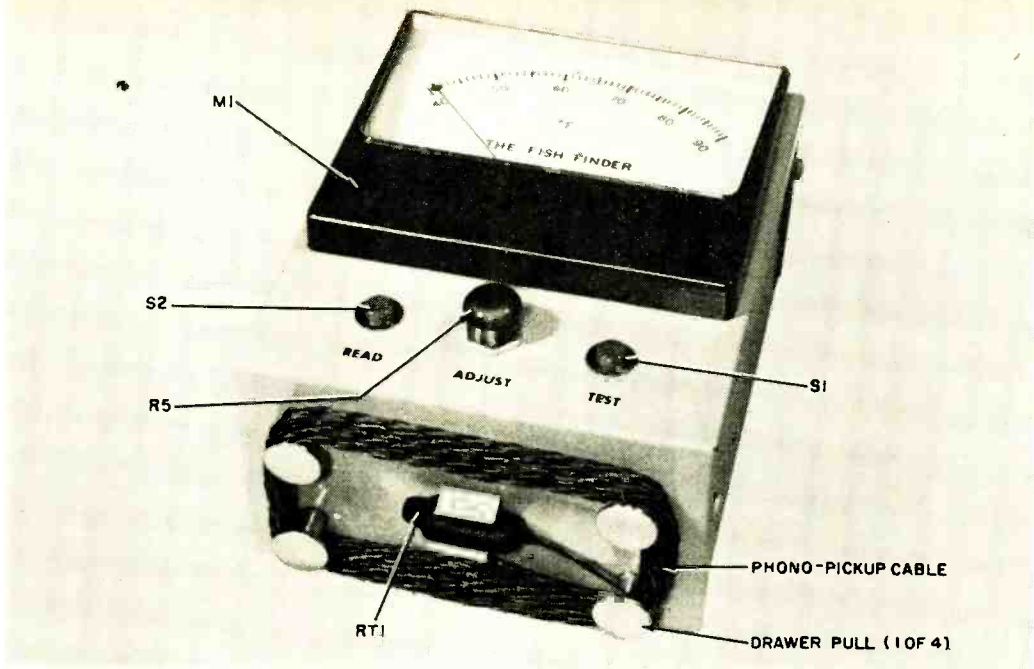

Completed "Fish Finder" is neat, attractive, and professional-looking. For protection against corrosion, apply a couple of coats of paint to box before mounting components.

find it worth your while to take a few hours of your time and put together the "Fish Finder."

About the Circuit. Operation of the Fish Finder depends on a device called the "Thermistor," a resistor which varies inversely in value with the temperature. When the temperature goes up, the resistance of the Thermistor goes down—and vice-versa.

But for our purpose, the important thing about the change of the Thermistor's resistance with temperature is that it's large . . . large enough so that the resistances of switch contacts, long leads connecting the Thermistor to the indicating device, etc., can be ignored in com-

parison. And we can read the greatly changing resistance with relatively insensitive meters and without elaborate amplifying circuits.

The Thermistor used in the Fish Finder forms part of a Wheatstone bridge circuit (see schematic diagram). Two "arms" of the bridge are resistors R_3 and R_4 ; the other two are the Thermistor ($RT1$) and potentiometer R_2 . Assuming that the "Test" push-button ($S1$) is in the position shown (not depressed), the voltage from the battery appears (via "Read" push-button $S2$ and potentiometer R_5) across the bridge between the junction of $RT1$ and R_3 and that of R_2 and R_4 .



Notice, in this case, that R_3 and R_4 make up one voltage divider and RT_1 and R_2 make up another. Since R_3 and R_4 have the same value, the voltage appearing at their junction is one-half the voltage impressed across the bridge. And, when R_2 is adjusted to the same value as RT_1 , the voltage at their junction is also one-half the voltage across the bridge. Therefore meter M_1 , which is connected across the two junctions, sees no voltage difference between its terminals and reads "Zero."

But if the temperature of RT_1 should change, its resistance would change proportionally. This, of course, would alter the voltage at the junction of RT_1 and R_2 . And, since the voltage at the R_3 - R_4 junction remains the same, meter M_1 now sees a potential difference and shows a reading. The magnitude of the reading is proportional to the temperature change at RT_1 , so M_1 may be calibrated as a thermometer.

Potentiometer R_2 determines which resistance value of RT_1 will "balance" the bridge, giving a zero reading on M_1 . Hence, R_2 controls the lower temperature limit of M_1 's calibration.

Potentiometer R_5 adjusts the voltage input to the bridge. It has no effect on the meter reading while the bridge is in a balanced condition because there will be no voltage difference between the junction of RT_1 and R_2 and that of R_3 and R_4 whatever the voltage input. However, potentiometer R_5 does determine how high the meter will read for a given degree of temperature change (or bridge imbalance). Therefore, it controls the upper temperature limit of M_1 's calibration.

"Test" switch S_1 and resistor R_1 are used to maintain a check on the battery voltage. When S_1 is depressed, the arm of R_5 is switched from the junction of

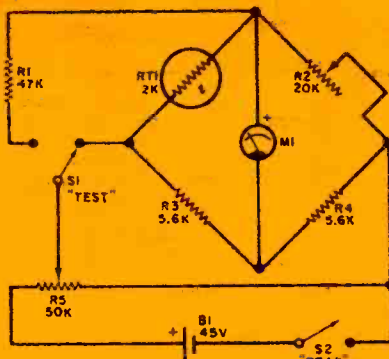

Thermistor (RT_1 on schematic) is used as one leg of a Wheatstone bridge indicator.

PARTS LIST

- B_1 —45-volt battery (Burgess XX30 or equivalent)
- M_1 —0.1 ma. meter (Simpson Model 1329 or equivalent—see text)
- R_1 —47,000-ohm, $\frac{1}{2}$ -watt resistor
- R_2 —20,000-ohm potentiometer, linear taper
- R_3, R_4 —5600-ohm, $\frac{1}{2}$ -watt, 5% resistor
- R_5 —50,000-ohm potentiometer, linear taper
- RT_1 —2000-ohm Thermistor (Veco 32D14*)
- S_1 —S.p.d.t. push-button switch
- S_2 —S.p.s.t. push-button switch
- 1—7" x 5" x 3" aluminum utility box (Bud CU-3008-A or equivalent)
- 1—4 $\frac{1}{2}$ " x 3 $\frac{3}{4}$ " section of perforated board
- 25'—Phono pickup arm cable, vinyl insulated (Belden Type 8430 or equivalent)
- Misc.—Foam plastic or rubber, plastic tube, solder, tool dip, connector for B_1 , drawer pulls, grommet, plywood, etc.

*Three dealers handling Veco products are: Electronics Center, 160 5th Ave., New York, N. Y.; Electronics Supply, 11201 W. Pico Blvd., W. Los Angeles, Calif.; and Radio Shack Corp., 730 Commonwealth Ave., Boston, Mass.

R_3 and RT_1 to the free end of R_1 . This provides a reference reading on M_1 which does not vary with temperature but is dependent only on the voltage of B_1 . (Though RT_1 remains in the circuit when S_1 is depressed, its effect on the

meter reading becomes negligible.) As the battery voltage decreases, the meter is brought back to the reference point by adjusting *R5*.

Construction. All of the components except Thermistor *RT1* are housed in an aluminum utility box. A 6" x 5" x 3" box was used by the author, but the more common 7" x 5" x 3" size specified in the Parts List will do as well.

Locate switches *S1* and *S2*, potentiometer *R5*, and meter *M1* on the box's front panel. Resistors *R1*, *R3*, and *R4*, and potentiometer *R2*, are mounted on a 4½" x 3¾" piece of perforated board.

Meter *M1*'s terminal posts are passed through two holes made in the board, and a solder lug, washer, and nut are installed on each post. The nuts and washers rigidly hold the board assembly in place, while the solder lugs provide a means of connecting the meter to the rest of the circuit.

Battery *B1* is wedged in between the board and the top of the box. A scrap of foam plastic or rubber glued underneath the battery provides further support, and sideways movement is restricted by a pair of hollow dowels slipped over the upper meter mounting screws.

Four small drawer pulls mounted on the bottom of the box serve as a rack on which the 25' Thermistor cable can be coiled when it is not in use. Since the drawer pulls which the author had on hand were fitted with wood screws, a 4½" x 2¼" piece of plywood was placed in the box bottom for them to "bite into."

Waterproofing. Both the Thermistor and the Thermistor-cable junction must be suitably waterproofed. In the model described here, *RT1* was connected to the cable and slid into a plastic tube. The tube was then wrapped with wire solder (which acts both as a sinker and a heat-transfer surface).

Next, the whole assembly was dipped several times in encapsulating compound—allowing each layer to dry before re-dipping—until a solid, waterproof surface was built up. The net result was a short cylinder about the diameter of a penlight cell. It is held in place on the bottom of the box by means of a battery clip.

An alternative waterproofing method

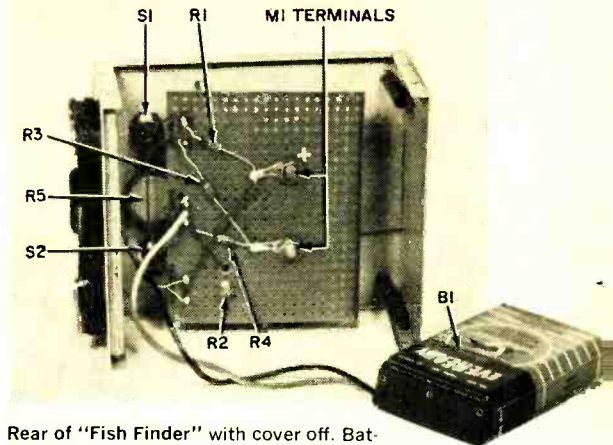

Rear of "Fish Finder" with cover off. Battery *B1* mounts in space behind perforated board.

might be simply to put several coats of encapsulating compound on the bare Thermistor, and its leads, after attachment to the cable. This might provide better heat-transfer characteristics, but the finished assembly would be awkwardly shaped and more susceptible to accidental damage. Another disadvantage is that a separate weight would then have to be attached to sink the Thermistor.

Regardless of how you carry out the waterproofing, a good preparation to use for encapsulating is "Insl-X Tool Dip." It's manufactured by the Insl-X Co., Inc., Ossining, N. Y., and is available by mail from Allied Radio, 100 N. Western Ave., Chicago 80, Ill. (Cat. No. 42 N 400 for the 6-oz. size).

The free end of the Thermistor cable is fed into the box through a grommet-lined hole in the bottom. To prevent moisture from leaking in, seal the grommet with household cement.

Calibration. The instrument was designed to cover a 40-90°F range (the most useful for the majority of fishing situations), but the upper and/or lower limit of this range may be shifted several degrees to suit individual tastes.

Begin the calibration by preparing a jar of water whose temperature has been set at exactly 40°F (or at the lower limit of the temperature range you desire) with an accurate thermometer. Remember that the larger the volume of water you use, the more stable the temperature

(Continued on page 97)

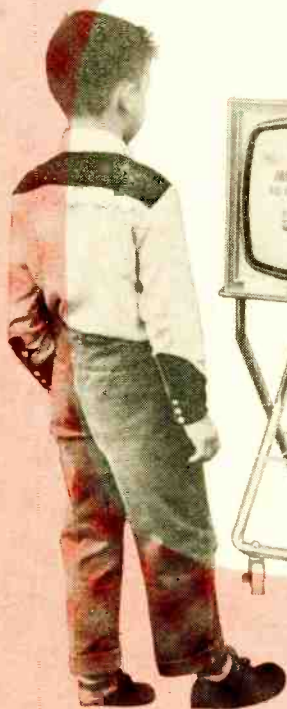

ALL ABOUT **CONAR TV KIT**

**New kit manufacturer
gets off to glowing
start with TV receiver**

Kit has built-in "rabbit ears" antenna. Boy and cart are extras not supplied with the kit.

COVER STORY

THERE'S something very exciting about assembling your own TV set. Maybe it's because everyone talks about building amplifiers, tuners, receivers, etc. Building a TV set is still held in awe, and many experimenters who wouldn't hesitate to dig into an amplifier just don't seem interested. Or are they? We believe that they are, but are reluctant to *chance* assembling something where the smallest error would be "obvious." Also, they may fail to consider that kit designs have come a long way in the past three or four years.

A prime example of how easy it is to assemble your own TV set is illustrated by the Conar "Custom 70" produced by Conar Instruments (division of National Radio Institute, Washington 16, D. C.). A 15-tube receiver (plus a 19AUP4 "pic" tube, as it is called), the Custom 70 is modern in circuit design and packaging. It is sold as a single kit

for \$135.00 (including Federal tax), or under a "pay as you build" plan with four packages at \$36.00 each. We recommend the single package—once you've started, you're not likely to want to quit and wait for the delivery man.

The Custom 70 makes use of a printed circuit for the i.f. channels, a transformer power supply (no shock hazard), and a carefully prealigned TV tuner. All other wiring is point-to-point, and there's plenty of working room. You can expect to spend between 10½ and 12 hours soldering in the various components.

Mechanical assembly will probably consume between 3½ and 4½ hours. This includes unpacking, mounting sockets and tie points, mounting subchassis, and installing the pic tube and chassis in the cabinet.

Conar's instruction manual is most comprehensive and spells out each wir-

Yoke assembly and centering rings in TV set are precision-manufactured. Connections to the picture tube go to plugs on the front of the chassis. "Pic" tube is aluminized and self-focusing.

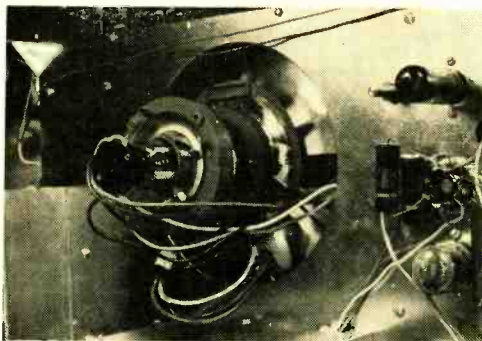

We recommend that the builder take a felt marking pencil and identify the front and rear of the chassis, as well as the various controls. This will simplify the wiring and eliminate errors.

After 14 hours of assembly time, the first picture on our screen came as a pleasant surprise. Slight distortion on left side of the screen was removed by resetting the ringing coil slug.

ing step in detail. In fact, the only objection we had to the Custom 70 was that the instructions could have been more succinct. But then, when you have assembled this kit, you really feel you know your TV receiver backwards and forwards—something you can't say for a set you buy off the shelf.

One thing we feel should be emphasized is that the Custom 70 is "safe." The high-voltage supply is fully caged in a separate metal box and, once assembled, need never be touched. All other set voltages are of the order found in amplifiers and tuners. The transformer power supply is completely isolated from the a.c. line, reducing shock hazards; and once the pic tube is in the cabinet, it is grounded to the chassis with "Aquadag" strips.

At present-day prices, this kit will save you \$35 - \$50 over off-the-shelf prices. If that doesn't sound like much, once again may we say, "There's something very exciting about assembling your own TV set." -50-

As many readers are no doubt aware, Transvision Electronics, Inc. (New Rochelle, N. Y.) also sells TV kits, and has been doing so for several years. The TV receivers come in a wide variety of screen sizes and price ranges, and a catalog is available from Transvision for the asking.



THE WHISTLE SWITCH

**A cinch to build,
this whistle-operated relay
will turn electrical equipment
on or off from distances
up to 100 feet**

By MARTIN J. LEFF

IN A LARGE mid-town Manhattan photo studio, the photographer had just finished posing his pretty model. "We're ready to shoot now," he said; "hold it while I switch on the lights." Expecting him to turn and walk to the distant wall switch, the model was understandably startled when he merely put his fingers to his lips and emitted a piercing whistle. But, in instant response to his signal, the great banks of lights overhead flicked on.

The photographer was using a variation of the "Whistle Switch." Responding to a whistle of the "puckered lips" variety, this unit will turn electrical equipment on or off from up to about 15 feet away. The range can be increased to about 50 feet by using a "lips and fingers" whistle, and mechanical whistles—such as the "police" type—will actuate the switch at distances up to about 100 feet.

Definitely more economical than the conven-



SWITCH

tional radio remote-control system, the Whistle Switch costs about \$30.00 to build. And the price will be reduced materially if you already have some of the parts on hand.

About the Circuit. The whistle command is picked up by the carbon microphone (*MIC*) and converted to an electrical pulse. Amplified by transistors *Q1* and *Q2*, the pulse charges capacitor *C4* (which is connected in *Q2*'s collector circuit). Relay *K1*'s coil, connected in parallel with capacitor *C4*, is then energized—and *K1*'s contacts close, connecting the 117-volt line to the coil of latching relay *K2*.

With *K2*'s coil energized, that relay's contacts switch from "off" to "on," or from "on" to "off," depending on which position they were originally in. Then, as soon as the whistle stops, capacitor *C4* discharges, opening *K1*'s contacts and de-energizing *K2*. The contacts of *K2*, however, remain locked in whichever position they were switched to.

Since *K2*'s contacts control the line voltage to outlet *J1*, any device plugged into that outlet will be "whistle-controlled." One whistle will turn it on, the next will turn it off, etc.

The sensitivity of the Whistle Switch is governed by potentiometer *R1*, which acts as a mike gain control. Resistors *R3/R4* and *R6/R7* are voltage dividers, supplying bias for transistors *Q1* and *Q2*, respectively. Coupling capacitors *C1*, *C2*, and *C3* also act (in conjunction with *R1*, *R4*, and *R7*, respectively) as high-pass filters. The filtering action reduces the circuit's response to low-frequency noises (voices, etc.), while having no effect on the response to whistles.

Power for the Whistle Switch comes from the a.c. line via low-voltage transformer *T1* and a rectifying and filtering circuit consisting of diodes *D1* and *D2*, capacitors *C5* and *C6*, and resistor *R9*. Resistor *R8* is a bleeder for the power supply.

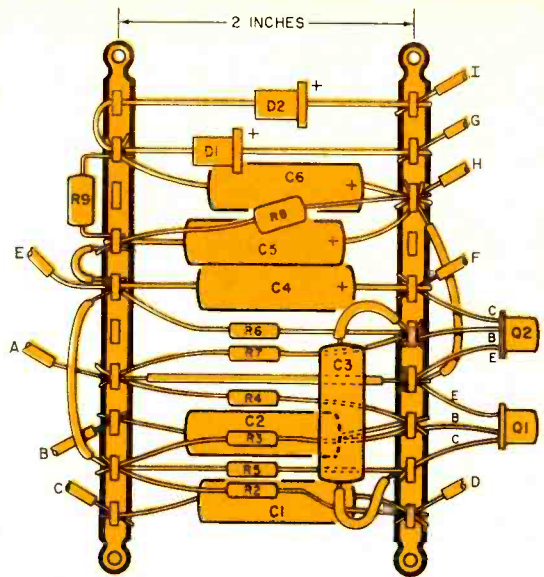

PARTS LIST

- C1*, *C2*, *C3*—0.1- μ f., 200-volt paper capacitor
- C4*—2- μ f., 25-volt electrolytic capacitor
- C5*, *C6*—50- μ f., 25-volt electrolytic capacitor
- D1*, *D2*—SR-200 diode (Sylvania)
- J1*—Surface-mounted duplex outlet (household type)
- K1*—Sensitive relay; 2300-ohm, 4.6-ma. coil (Sigma 11F-2300-G/SIL or equivalent—see text)
- K2*—Ratchet-impulse relay, 115-volt a.c. coil (Potter & Brumfield AP11A or equivalent—see text)
- MIC*—Telephone-type carbon microphone cartridge—see text
- Q1*, *Q2*—2N631 transistor (Raytheon)
- R1*—10,000-ohm, 2-watt potentiometer, linear taper

Construction. All of the components within the dotted box on the schematic diagram are mounted between two 10-lug (none grounded) terminal strips. Begin construction by temporarily screwing these two strips (parallel to each other and 2" apart) to a wooden board. Then wire the components to the strips as shown in the pictorial diagram of the assembly and in the schematic. Install a 6" lead at all points where a wire must run from the assembly to another part of the circuit. These points are lettered "A" through "I" in both the pictorial and schematic diagrams.

The completed terminal strip assembly is removed from the board and mounted under the top of a 6" x 5" x 4" aluminum

Begin construction by temporarily fastening the two terminal strips to a board. After wiring as shown at left, remove assembly from board and mount in utility box.

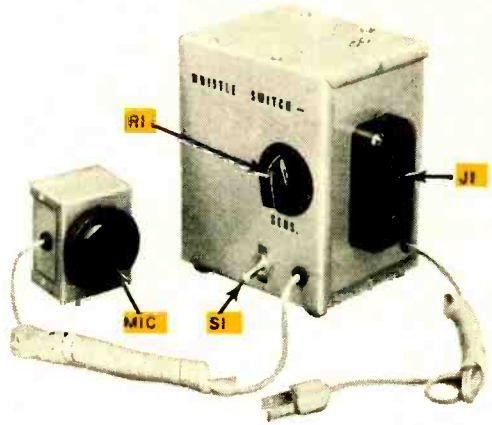

utility box (see photos). Transistors *Q1* and *Q2*, as used in this circuit, are quite temperature-sensitive. Therefore, they are snapped into a couple of fuse clips (which act as heat sinks) fastened next to the terminal strip assembly.

Potentiometer *R1*, switch *S1*, and relay *K1* are mounted on the front panel of the utility box. Since one side of the a.c. line will appear on the frame of relay *K1*, the latter must be insulated from ground. The author solved this problem by in-

Completed Whistle Switch is shown above. Mike is in separate box to prevent pickup of relay noises.

- R2*—3300 ohms
- R3*—1 megohm, 5%
- R4*—10,000 ohms, 5%
- R5*—10,000 ohms
- R6*—750,000 ohms, 5%
- R7*—4300 ohms, 5%
- R8*—2200 ohms, 1 watt
- R9*—100 ohms, 2 watts

all 10%, 1/2-watt resistors unless otherwise specified

S1—D.p.s.t. switch

T1—Filament transformer; primary, 117 volts; secondary, 26.5 volts CT @ 0.6 ampere (Thor-darson 21F27 or equivalent)

1—6" x 5" x 4" aluminum utility box (Bud CU-2107-A or equivalent)

1—2 3/4" x 2 1/8" x 1 3/8" aluminum utility box (Bud CU-2100-A or equivalent)

2—10-lug (none grounded) terminal strips (Cinch-Jones 2010 or equivalent)

Misc.—Fuse clips, #16 and #22 hookup wire, zip cord, line cord and plug, grommets, etc.

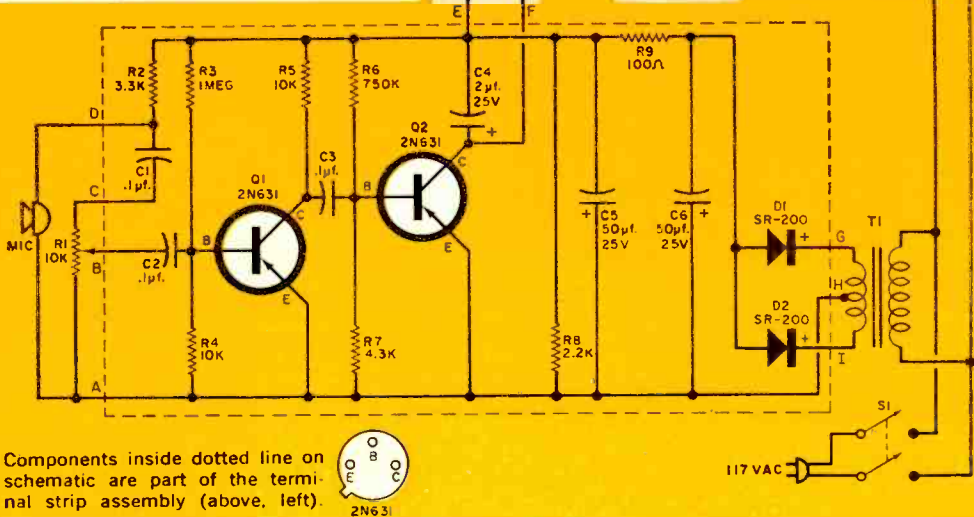
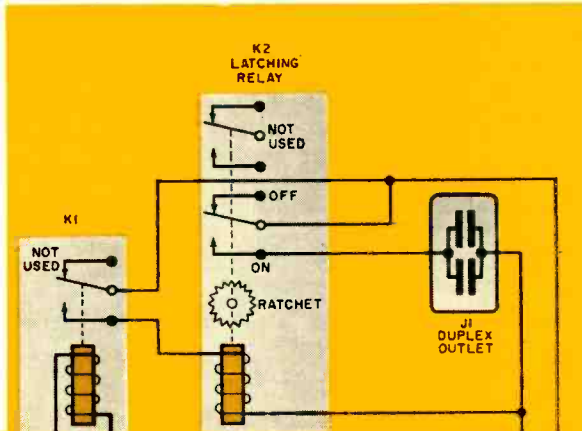

Components inside dotted line on schematic are part of the terminal strip assembly (above, left).

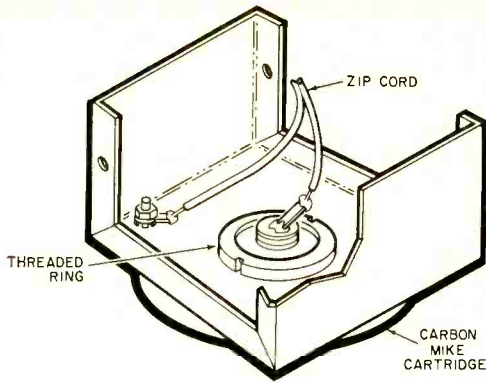

Method of mounting mike on box will vary with type of cartridge employed. Author's installation (see text) is illustrated here.

stalling *K1* on a small square of insulating material which, in turn, was fastened to the panel. If you prefer, you can use a Sigma 11F2-2300-G/SIL for *K1* instead of the unit specified in the Parts List; the two relays are identical, except that the former is already mounted on an insulated base.

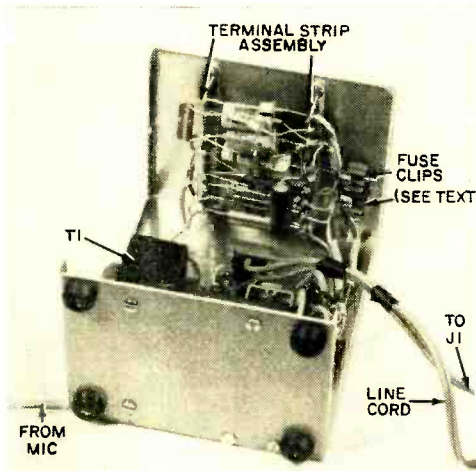

Positioning of terminal strip assembly can be seen in the photo above (note fuse clips used as heat sinks for Q1 and Q2). View at right shows wiring associated with cover.

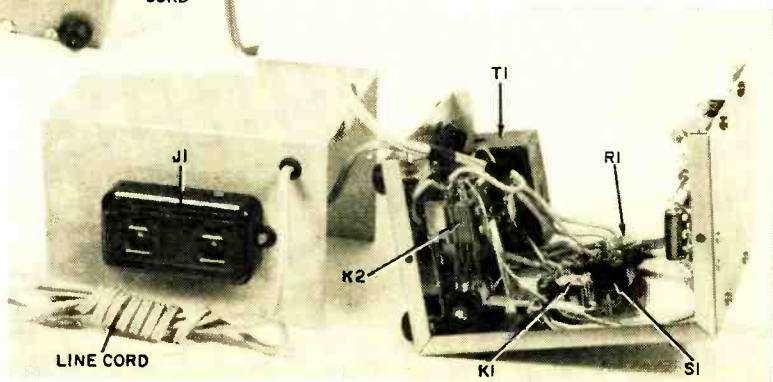

Mount transformer *T1* and relay *K2* on the bottom of the box. The transformer is located as far as possible from sensitive relay *K1* so that *K1* won't be affected by the transformer's magnetic field.

The relay specified for *K2* in the Parts List was used primarily because the author happened to have it on hand. It has two sets of s.p.d.t. contacts. One of these was not employed in this application; the other was used as a s.p.s.t. switch. Any similar relay will work in this circuit as long as it has a 117-volt coil and at least one set of s.p.s.t. contacts.

Outlet *J1* is located on one of the sides of the box cover, and both its cord and the line cord enter the box through grommets near the outlet. A similar hole at the bottom of the front panel accepts the cord from the microphone.

To prevent the microphone from picking up noise from relays *K1* and *K2*, it is mounted in a separate utility box (2¾" x 2⅛" x 1⅝"). A carbon mike, salvaged from a government-surplus handset, was used by the author. The threaded ring sealing the carbon chamber was removed and re-installed as a retaining ring to hold the microphone in place on the box's front panel (see drawing). If you use this method of installation, be careful not to spill any of the carbon granules while you have the ring unscrewed.

A 5' zip-cord cable is attached to the microphone and run out of the utility box through a grommeted hole. In the model shown, one lead of the mike cable was grounded to the box because the threaded retaining ring (automatically grounded) also serves as one of the mike contacts.

(Continued on page 98)

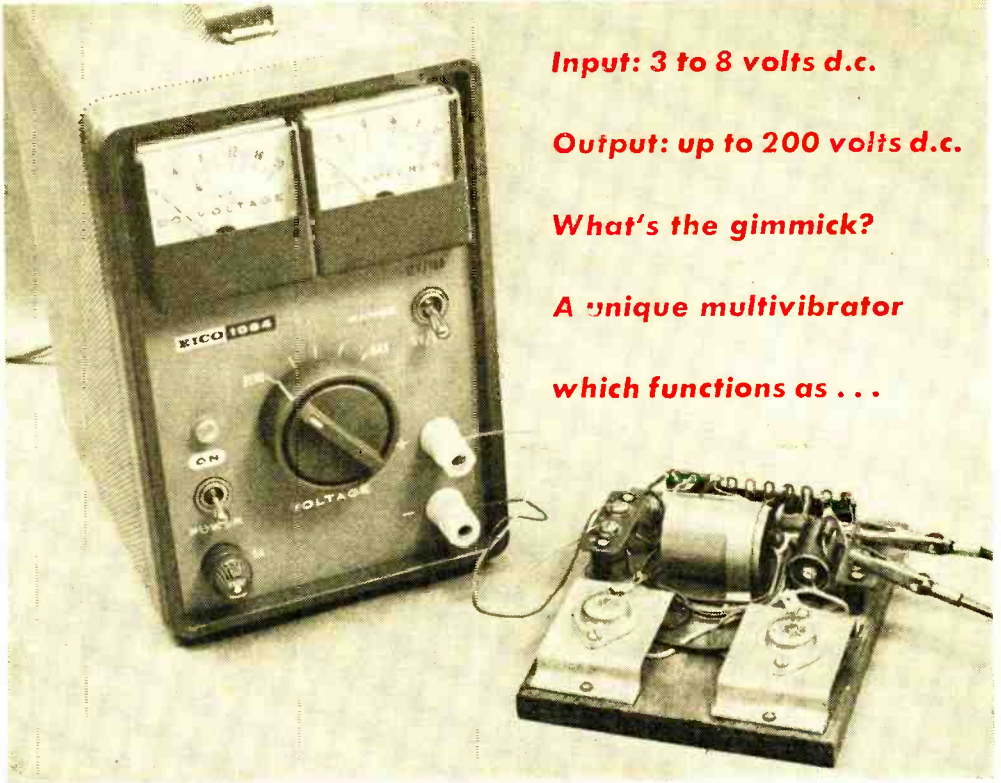

Input: 3 to 8 volts d.c.

Output: up to 200 volts d.c.

What's the gimmick?

A unique multivibrator

which functions as . . .

A TRANSFORMER FOR D.C.

By BEN RICHARDS

ONE of the drawbacks of vibrator-type power supplies stems from the fact that they usually have fixed input and output voltages, which may or may not be satisfactory in emergency applications. Not so with such gadgets as the d.c.-to-d.c. inverter discussed here, however—it's no trouble at all for this little unit to deliver 135 volts of B+ from a 6-volt auto battery charger (for powering your CB rig, say), or 67½ volts of B+ from a couple of flashlight batteries (for a portable radio).

Impossible as it may sound, this device actually "transforms" d.c. voltages. How? By changing the incoming d.c. to a.c., stepping it up in a transformer, and rectifying the output.

The circuit uses two transistors in con-

junction with a sharply saturating transformer. When power is applied, one transistor will always conduct a little more heavily than the other. Due to feedback within transformer *T1*, the first transistor tends to turn full "on" and the other transistor to turn full "off." This condition prevails until the transformer core saturates.

When the core saturates, the feedback voltage drops, and the field in the transformer core starts to collapse, causing the feedback voltage to change polarity and thus reverse the "on-off" condition of the transistors. This basic action keeps repeating. The a.c. generated in the collector winding is stepped up by transformer *T1*, then rectified in the full-wave bridge circuit (*D1*, *D2*, *D3*, *D4*);

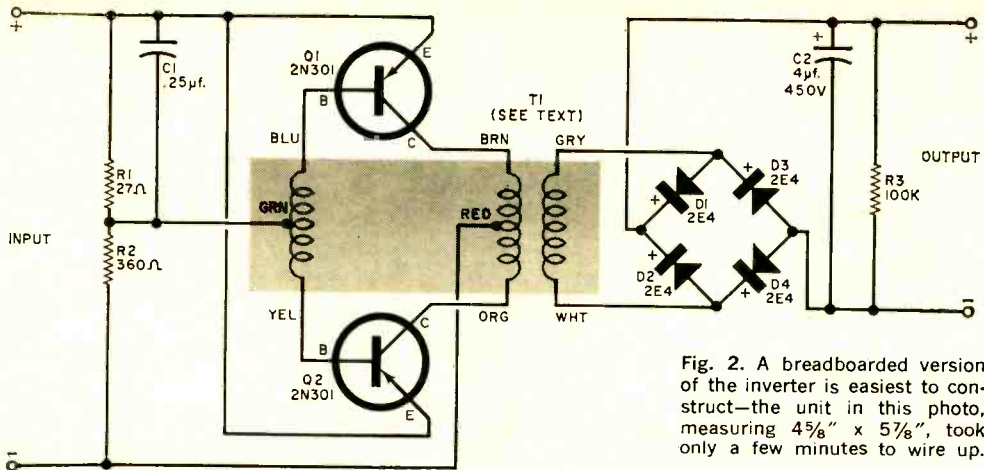

Fig. 1. Schematic diagram of inverter. See next page for circuit of optional hash filter.

Fig. 2. A breadboarded version of the inverter is easiest to construct—the unit in this photo, measuring 4 5/8" x 5 7/8", took only a few minutes to wire up.

PARTS LIST

- C1—0.25-µf., 200-volt paper capacitor
- C2—4-µf., 450-w.v.d.c. electrolytic capacitor
- D1, D2, D3, D4—200-ma., 400-PIV silicon diode (International Rectifier Type 2E4 or equivalent)
- Q1, Q2—2N301 transistor (RCA)
- R1—27-ohm, 5%, 1/2-watt resistor
- R2—360-ohm, 5%, 1/2-watt resistor
- R3—100,000-ohm, 1-watt resistor
- T1—Toroidal transformer (Milwaukee Electromagnetics Type PC005, available from Milwaukee Electromagnetics, P.O. Box 4476, Milwaukee, Wis., for \$4.95, postpaid)
- Misc.—Terminal strips, wire, hardware, chassis, etc.

Parts for Hash Filter

- C3, C4—100-µf., 15-w.v.d.c. electrolytic capacitor
- C5—0.1-µf., 400-volt paper capacitor
- L1—50 turns of #16 enameled wire, close-wound in two layers on 3/4"-O.D. insulated form
- L2—2.5-µh., 125-ma. r.f. choke
- Misc.—Shielded box, hardware, etc.

capacitor C2 provides filtering, and resistor R3 acts as a bleeder.

Construction. The wiring is extremely simple and not at all critical in the "sure-fire" circuit shown in Fig. 1. Although Fig. 2 shows most of the connections for a "breadboard" construction, the type of mounting is pretty much up to you. For example, Fig. 3 pictures the circuit "packaged" into a unit approximately 3" x 3" x 1", with all components except the transistors "potted" in an epoxy resin.

Regardless of how you assemble the inverter, be sure to mount the two transistors on separate aluminum or copper heat sinks at least 3 or 4 square inches in area. Since the cases of the transistors are connected to the collectors, mica insulators must be placed under the transistors if a metal chassis is used.

When wiring, pay particular attention to the polarity of the diodes and electrolytics as well as the color coding on transformer T1. Leads can be soldered directly to the pins of the transistors, but be sure to use a heat sink during soldering; gripping the pins with a pair of long-nose pliers close to the transistor body should do the trick.

Hash Filter. If the inverter is to be used in communications circuits, the hash filter shown in Fig. 4 should be added.

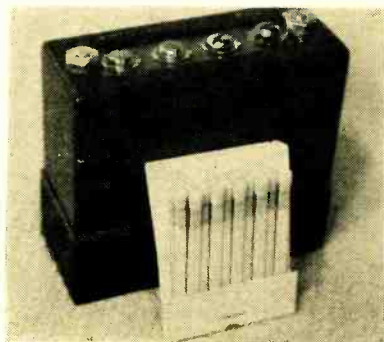

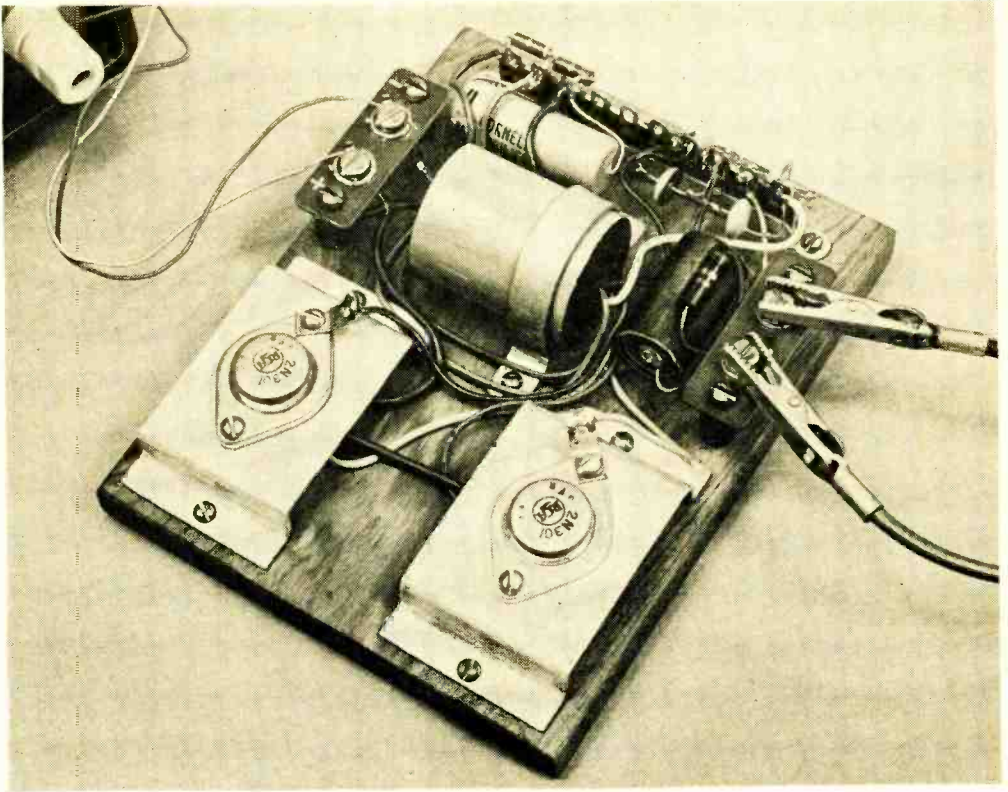

In this case, both the inverter and the filter can be built in a metal box. The leads to the battery should be kept as short as is practical and should be placed well away from antennas and other "inputs."

If desired, the negative input lead can be grounded to the chassis; components $C3$, $C4$, and $L1$ can then be placed in the positive lead. Naturally, the polarity of both of the capacitors will have to be reversed.

Components $L2$ and $C5$ should be placed in the negative output lead and the positive output lead grounded to the chassis if a negative output voltage is desired. For a less stringent application, but one still requiring some hash filtering, $C4$, $L2$, and $C5$ can be omitted.

Testing and Use. Apply 3 volts to the input terminals, being careful to observe polarity (improper polarity can damage the transistors). If the output voltage
(Continued on page 96)

Fig. 3. For a more professional appearance, the inverter can be housed in a wooden or metal box and suitably "potted."

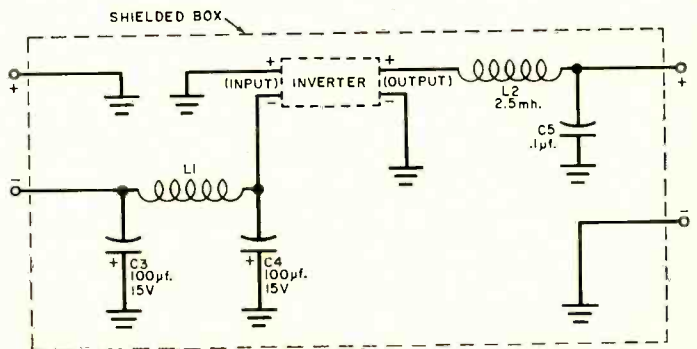

Fig. 4. This circuit shows an optional hash filter which may be required with r.f. circuits. See text for details.



SLIM LINE SPEAKER KIT

THE YOUNG LADY above has found a way to have stereo and make use of a fireplace mantle only 6" wide at the same time—her "hubby" just finished assembling a pair of KS-1 "Slim-Line" speaker kits. Selling for \$59.50, the KS-1 kit is a member of the new StrataKit line introduced by Fisher Radio Corporation (21-52 44th Drive, Long Island City, N. Y.)

Capable of producing a smooth, well-balanced sound extending from about 45 through 18,000 cycles, two KS-1 speaker kits can be put together in under two hours. Although they are sealed enclosures, the KS-1's make up a relatively high efficiency speaker system, requiring very little amplifier power output.

If the wife decides she doesn't like the speakers on the mantle, she can obtain special legs for the system from Fisher at \$2.50 a set.

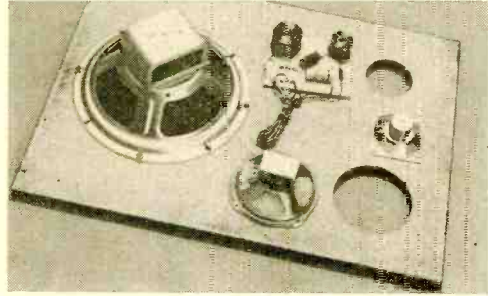

- 1 Each KS-1 "Slim-Line" kit contains 3 speakers and a prewired crossover network. The woofer arrives premounted.

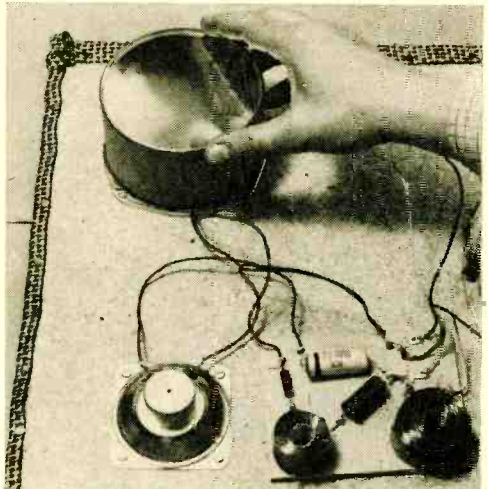

- 2 Templates position holes for mounting tweeter and mid-range speaker. Housing prevents woofer/mid-range interference



- 4 Cardboard tube in center is not a bass reflex port, but a means of rigidly separating the front and back boards.



- 3 Preassembled wood frame is stained or painted before mounting front baffle with speakers and grille cloth attached.

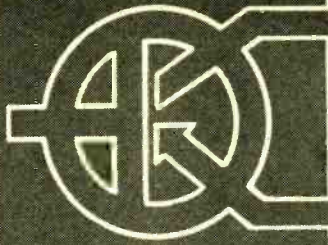

Transistor Topics

By **LOU GARNER**, Semiconductor Editor

BACK in October, 1961, we discussed the Transis-Tronics Model S-15 transistorized stereo amplifier. Since the weather was quite mild at that time, we didn't emphasize one advantage of transistorized over tube-operated hi-fi/stereo equipment—*cooler operation*—which is a natural result of the higher efficiency of solid-state circuitry coupled with the elimination of red-hot tube filaments and heaters.

At this season, however, with temperatures soaring into the 90's in many areas, cooler operation becomes an *important* advantage. "Music of a Summer Night" can be much more pleasant if natural summer heat isn't augmented by excessive heat from the equipment that's reproducing the music. In addition, lower operating temperatures mean longer-lived capacitors and other components.

Today, a fully transistorized hi-fi/stereo installation is practical, for the firm which introduced the Model S-15 stereo amplifier (Transis-Tronics, Inc., 1601 W. Olympic Blvd., Santa Monica, Calif.) is now producing a companion

FM stereo multiplex tuner (see Fig. 1). With an audiophile net price of \$179.50, the instrument, Model FM-15MX, is the same size as the S-15, measuring approximately 3" x 10" x 8½". A clue to its cool operation is given by its rated power consumption of only ¼ *watts*—less than one-tenth that of comparable tube-operated tuners!

Covering the FM broadcast band from 88 to 108 mc., the FM-15MX has a specified sensitivity of 1.8 μ v. for 20 db quieting, or 2.5 μ v. for 30 db quieting. Its i.f. bandwidth is 270 kc. at the -6 db points, while its frequency response is 20 to 20,000 cycles \pm 1 db. At 100% modulation, the tuner delivers an output of 1 volt, with the noise level down 66 db. A moderate output impedance is provided, permitting the use of shielded connecting cables up to 20 feet in length with little or no high-frequency roll-off.

A total of 20 transistors and 9 diodes is used in the complete tuner, with 8 transistors employed in the multiplex section. A built-in regulated power supply is provided, using a bridge rectifier,



Fig 1. Transis-Tronics' Model FM-15MX FM stereo tuner draws astoundingly little power from the a.c. line, thanks to its completely transistorized circuitry. A perfect match for the company's Model S-15 all-transistor stereo amplifier, the FM-15MX uses 20 transistors and 9 diodes, and features its own built-in regulated power supply.

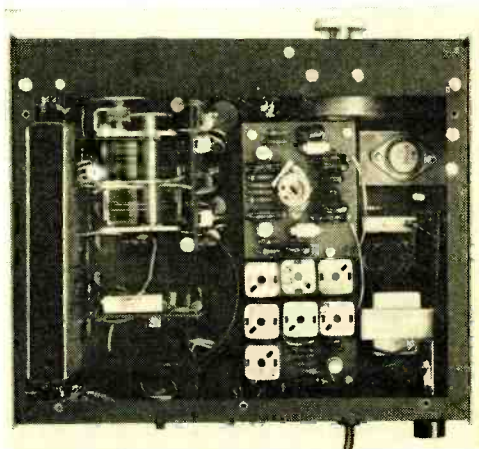

a pair of transistors, and a zener diode. Other features include a tuned r.f. stage, automatic frequency control, interstation muting, a "local-distant" sensitivity control, and a tuning meter.

New Breadboard. Newcomers to electronics often are puzzled by the expression "breadboard." This is actually a throwback to the early days of radio, when both receivers and transmitters were assembled on wooden breadboard "chassis." Major components were held in place with wood screws, and wiring was by means of stiff, bare busbar. Today, the word "breadboard" refers to an experimental circuit assembled for test purposes, even if wired semi-permanently on a conventional metal chassis.

When "breadboarding" circuits using semiconductor devices, it's generally a good idea to try to minimize the number of times that a component must be soldered in place (excessive heat can ruin transistors and diodes). One useful technique is illustrated in Fig. 2—the use of coil spring connectors as terminal points. They are mounted as needed on a perforated board, with component connections made by simply slipping the leads between individual spring coils. No soldering is required, and parts and connections may be changed easily as often as necessary.

A basic kit for this type of circuit breadboarding has been introduced by the Sheatz Electrode Co. (6506 Ridge Dr., Washington 16, D. C.). The kit includes a 5" x 8" perforated board, 15 spring electrodes, 4 rubber feet, and a metal inserter. Individual kits sell for \$2.65, plus postage; additional kits, if ordered at the same time, are only \$1.65 each (plus postage).

Readers' Circuits. The selectivity of a tuned circuit depends primarily on the Q of the coil. An almost infinite number of L/C combinations will tune to a specific frequency, but only a limited number will have optimum Q 's. Reader Don Stovicek (1190 E. 177th St., Cleveland 19, Ohio) decided to make use of optimum Q 's in the design of a simple AM broadcast-band receiver.

As shown in Fig. 3, Don used a tapped coil ($L1$) as well as a conventional tuning capacitor ($C2$) in the receiver's tuned circuit. Thus, both inductance and capacitance can be adjusted when tun-

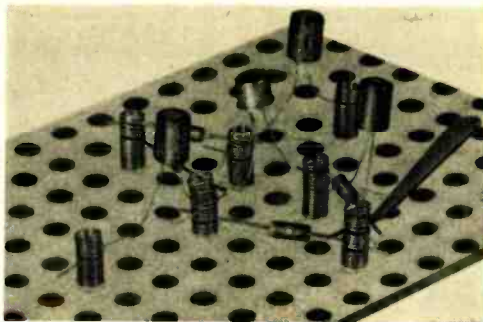

Fig. 2. Looking for an easy way to "breadboard" your semiconductor circuits? This is a typical circuit assembled from a Sheatz Electrode Co. kit.

ing to different stations, permitting the optimum Q to be obtained. Emphasizing this feature, Don dubbed his set the "Super Selecto."

In operation, r.f. signals picked up by the antenna are coupled through $C1$ to tuned circuit $L1/C2$, where the desired station is selected. The selected signal is detected by diode $D1$ and coupled through $C3$ to a common-emitter audio amplifier, $Q1$; transistor base bias is furnished through $R1$. After amplification by $Q1$, the audio signal drives the headphones used as $Q1$'s collector load. Operating power is furnished by a 3-volt battery, $B1$, controlled by $S2$.

Except for the coil, all components are standard and readily available through regular parts suppliers. Capacitors $C1$ and $C3$ can be disc, ceramic, or tubular types; $R1$ is a $1/2$ -watt resistor; and $C2$ a familiar 365- μf . tuning capacitor. Diode $D1$ is a 1N34 or 1N34A, and $Q1$ a 2N233 *npn* transistor. Switch $S1$ is a 5-pole rotary switch, and $S2$ a s.p.s.t toggle or slide switch. Battery $B1$ is a 3-volt unit made up by connecting two penlight or flashlight cells in series. The coil, $L1$, consists of 175 turns of #28 enameled wire, close-wound on a $3/8$ " form, with taps at 50, 100, 125, and 150 turns. Standard, 2000-ohm headphones should be used.

The "Super Selecto" receiver can be assembled on a small plastic or metal chassis, depending on individual preferences. Neither layout nor lead dress should be critical, but care should be taken not to overheat the diode or transistor leads when these components are soldered in place.

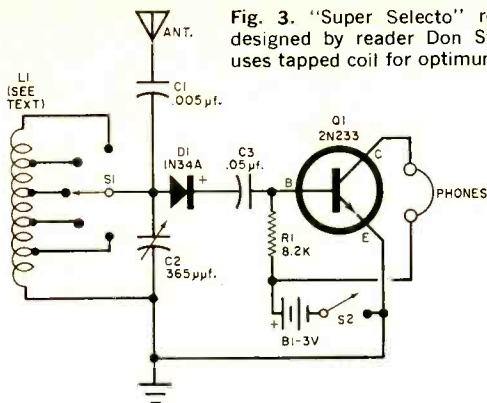

Fig. 3. "Super Selecto" receiver designed by reader Don Stovicek uses tapped coil for optimum "Q."

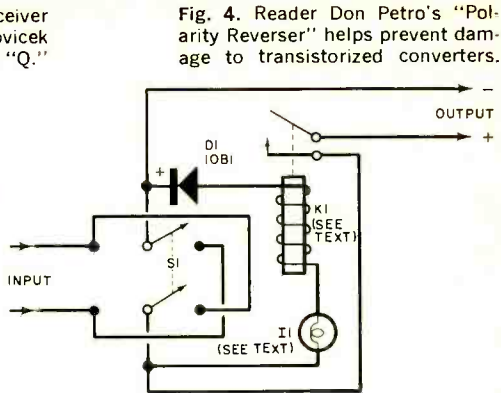

Fig. 4. Reader Don Petro's "Polarity Reverser" helps prevent damage to transistorized converters.

In use, a short to moderately long antenna will be required, depending on the number of stations in your area and how much of a DX'er you are. Both *S1* and *C2* should be adjusted when tuning individual stations to obtain optimum sensitivity and selectivity.

Recognizing the increased popularity of transistorized power converters and the problems encountered when they are installed in different boats, automobiles, and other vehicles, reader Don Petro (Alder Flats, Alberta, Canada) developed the "Polarity Reverser" circuit illustrated in Fig. 4. Placed between a transistorized converter and the d.c. power source, the unit permits the d.c. polarity to be reversed easily. In addition, it protects the converter against possible damage which may be caused by the accidental application of improper d.c. polarity.

Standard parts are used throughout. Switch *S1* is a 15-amp. d.p.d.t. toggle switch with a center "off" position, *D1* is an International Rectifier Type 10B1 silicon diode, *K1* a Potter and Brumfield Type SP11 relay, and *I1* a standard pilot lamp; the particular type of pilot lamp as well as the specific relay you use should be chosen on the basis of the d.c. source voltage.

The unit itself is assembled in a small Minibox and fitted with suitable input and output connectors, such as binding posts or heavy-duty screw terminals. Both sets of relay contacts are connected in parallel.

In use, the "output" terminals are connected to the power converter with indicated polarity and the "input" termi-

nals to the power source. Switch *S1* is switched first one way, then the other, until the pilot lamp lights, indicating that proper d.c. polarity has been obtained. The connecting leads should be of adequate size to handle the currents encountered with minimum voltage drop, of course.

Product News. MED Electronics, Inc. (1200 First St., Alexandria, Va.) has just introduced a transistorized personal small arms detector. Worn by a detective or industrial security officer, it permits a suspect to be "frisked" without actual body contact and without his knowledge.

A new line of low-cost photoconductor devices has been introduced by Sylvania Electric Products, Inc. (730 Third Ave., New York 17, N. Y.). They consist of a cadmium sulphide cell on which "comb-shaped" electrodes have been deposited, and their spectral response closely approximates that of the human eye. These devices can be used in burglar alarms, industrial controls, garage-door openers, doorway annunciators, photographic equipment, etc.

Motorola, Inc. (5005 E. McDowell Rd., Phoenix, Ariz.) is now producing a series of eight germanium power transistors with junction temperature ratings of 110°C and maximum power dissipation ratings of 170 watts. Type numbers are 2N2075 through 2N2082, and specifications are available from the factory on request.

That about covers the semiconductor front for now. We'll be back next month with more info . . .

—Lou

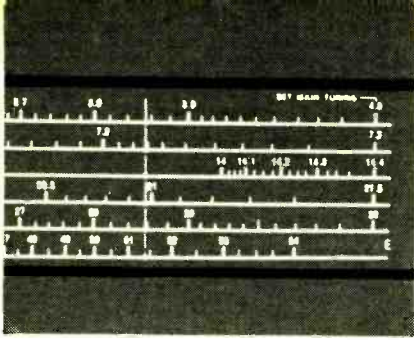

Across the Ham Bands

By **HERB S. BRIER**, W9EGQ
Amateur Radio Editor

SWL "SOUVENIR HUNTERS" AND QSL CARDS

WE hams all know the thrill of receiving a QSL card from a new state or country. It adds to our "Worked All States" or "DX Century Club" collections and serves as a memento of a pleasant radio chat. Short-wave listeners are equally happy to receive QSL cards in reply to their reception reports. Most of them, however, are not too satisfied with the low percentage of replies they get from hams.

To remedy the deficiency, a few so-called SWL's have revived an old trick. Their gimmick is to write to the hams whose names and call letters appear in our "News and Views" section—especially the "rare" ones—with the story: "I'm new at the SWL game. Please send me one of your QSL cards."

There is nothing particularly wrong with such requests from real beginners, if they are accompanied by return post-

age (most of them are not), and if the hams involved are willing to give away their QSL cards as souvenirs. But some of these "SWL" characters are real "sharpies." They aren't satisfied with a mere souvenir; they want a full-fledged confirmation, based upon their claim of having heard the ham's station "often" or at some indefinite time.

One Novice recently featured in "News and Views" received two fraudulent reports—one for 80 meters, and the other for 15 meters—from the same fellow. When the Novice demanded specific data on the alleged reception of his signals, he received a word-for-word copy of the item that had appeared in the "News and Views" section!

Probably the best thing a ham can do with such a report is to write across it: "Sorry, this report does not agree with my station log," and return it to the

Novice Station of the Month

Ronnie Blackwell, WN5AQQ, Amarillo, Texas, sent in this prize-winning photo of himself and his rig. WN5AQQ transmits CW on 80 meters with a Heathkit DX-40 and receives on a Hammarlund HQ-100; he also has a Heathkit Two-er transceiver. His 80-meter antenna is a half-wave dipole, and he feeds either a 10-element beam or a ground-plane vertical on "2."

Ronnie will be awarded a one-year free subscription to P.E. for his photo. If you would

like to try for a similar award, send us a picture of your station—preferably showing you at the controls, and be sure to include with your entry some information about yourself, your equipment and your activities. You may be one of the lucky winners. Non-prize-winning photos will also be published as space permits. Entries should be sent to Herb S. Brier, Amateur Radio Editor, POPULAR ELECTRONICS, P.O. Box 678, Gary, Indiana.



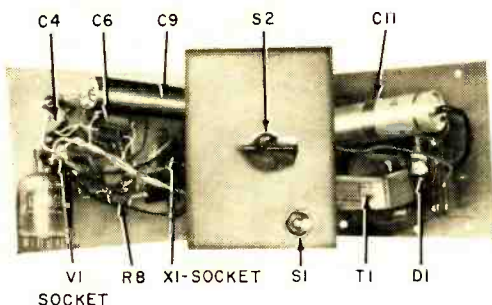

Most of the circuitry in the compactron frequency calibrator is mounted on the two covers of an aluminum utility box. The 6D10 compactron (VI) has been removed from its socket and placed in lower corner of cover shown at far left.

sender (if he furnished return postage). Don't yell "Fraud!" unless it positively is one. An incorrect report could be the result of an error in copying a call letter.

SWL/QSL Bureau. Here's a more pleasant item for SWL's who like to *earn* the cards in their collections. Many SWL's (especially those with WPE numbers assigned to them by POPULAR ELECTRONICS—see page 82), who have sent reports to hams outside the United States, may have a foreign confirmation or two waiting for them at the SWL/QSL Bureau. This bureau is manned by LeRoy Waite, WPE2AK, 39 Hannum St., Ballston Spa, N. Y.

A retired mail carrier, Roy started the SWL/QSL Bureau when he heard that the American Radio Relay League was receiving many foreign QSL cards for U.S. and Canadian SWL's. The ARRL QSL Bureaus could not handle these cards, and they were being returned to their senders. As Roy's service becomes better known, he is gradually distributing more and more QSL cards from overseas hams to North American SWL's.

If you are an SWL and would like to receive any cards which may have come in for you, send Roy a business size (Post Office #8), stamped envelope, addressed to yourself, along with your request. Include your WPE identification, if you have one. If there are no cards for you at the bureau at the present time, Roy will keep your envelope on file and send you any that might arrive there in the future. But remember: no stamped envelope, no cards.

We would like to stress the fact that Roy does *not* handle *outgoing* SWL cards to overseas hams. Also, incoming cards from overseas SWL's to United States

and Canadian hams are still being handled by the ARRL QSL Bureaus.

Missing DX Cards. While we're on the subject of bureaus, if you're a ham who has worked a DX station and not received a QSL, the chances are better than even that the missing card is waiting for you at the ARRL QSL Bureau for your call area. In the K9/WA9/W9 bureau alone, there are over 7000 unclaimed DX cards on file addressed to hams—hundreds of them for Novices.

To pick up your DX cards from the bureau, print your call letters in the upper left-hand corner of a large envelope, address it to yourself, insert the envelope in another one, and send it to your call area QSL manager. His address is printed in most issues of QST and at the head of each U. S. and Canadian call area listing in the "Radio Amateur's Call Book Magazine."

COMPACTRON FREQUENCY CALIBRATOR

This crystal-controlled frequency calibrator is designed around one of the General Electric "compactron" tubes. The type used here, a 6D10, is equivalent to three 12AT7 triode units in a single envelope.

About the Circuit. In position 2 of switch S2, the calibrator produces marker signals, accurate within cycles, every 100 kc. across your receiver dial. The signals extend up to approximately 30 mc., thereby marking most amateur band edges and every 100 kc. within the bands.

In position 3 of S2, a multivibrator circuit modulates the basic 100-kc. signal to produce additional signals every 10 kc. across the receiver dial. This provides markers for the remaining band edges

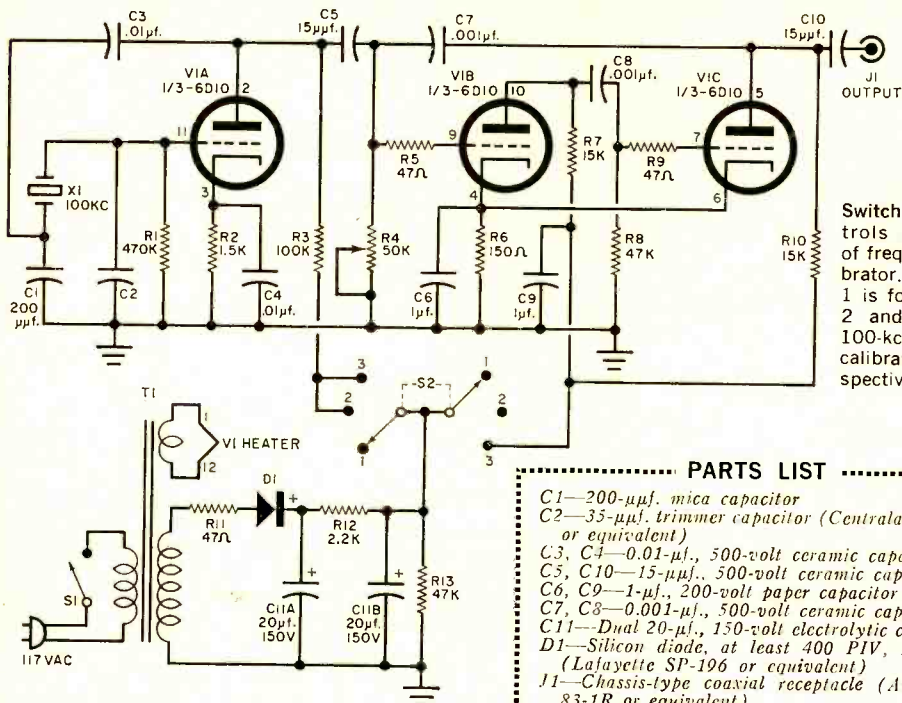

Switch S2 controls operation of frequency calibrator. Position 1 is for standby, 2 and 3 select 100-kc. or 10-kc. calibrations, respectively.

PARTS LIST

- C1—200- μ f. mica capacitor
- C2—35- μ f. trimmer capacitor (Centralab 827-D or equivalent)
- C3, C4—0.01- μ f., 500-volt ceramic capacitor
- C5, C10—15- μ f., 500-volt ceramic capacitor
- C6, C9—1- μ f., 200-volt paper capacitor
- C7, C8—0.001- μ f., 500-volt ceramic capacitor
- C11—Dual 20- μ f., 150-volt electrolytic capacitor
- D1—Silicon diode, at least 400 PIV, 150 ma. (Lafayette SP-196 or equivalent)
- J1—Chassis-type coaxial receptacle (Amphenol 83-1R or equivalent)
- R1—470,000 ohms
- R2—1500 ohms
- R3—100,000 ohms
- R4—50,000-ohm potentiometer, screwdriver-adjusted
- R5, R9, R11—47 ohms
- R6—150 ohms
- R7, R10—15,000 ohms
- R8—47,000 ohms
- R12—2200 ohms, 1 watt
- R13—47,000 ohms, 1 watt
- S1—S.p.s.t. switch
- S2—2-pole, 3-position rotary switch
- T1—Power transformer; primary, 117 volts; secondaries, 125 volts @ 15 ma., 6.3 volts @ 0.6 ampere (Stancor PS-8415 or equivalent)
- V1—6D10 compactron (General Electric)
- X1—100-kc. crystal (Bliley Type KV3 or equivalent)
- 1—4" x 5" x 3" aluminum utility box (Bud AU-1028 or equivalent)
- Misc.—Sockets for V1 and X1, terminal strips, solder lugs, wire, etc.

below 30 kc. and for any other 10-kc. point within the bands.

Position 1 of S2 is for "standby" operation. With the switch in this position, the plate voltage to the 6D10 is disconnected, but the heater remains on.

Construction and Adjustment. For ease of construction, the calibrator circuitry is built on the top cover of a 3" x 4" x 5" aluminum utility box (Bud AU-1028 or equivalent), and the power supply on the bottom cover. Switches S1 and S2 are mounted on the front of the box itself; the output connector (J1) is installed on the rear. Be sure to make the leads interconnecting the components on the covers with those on the box long enough to permit wiring all connections before closing up the box.

With the construction completed, connect output jack J1 to the antenna terminal of your receiver using a length of coaxial cable. Then tune the receiver to Station WWV on 2.5, 5, 10, or 15 mc., shut off the receiver BFO, and turn switch S2 to position 2. Capacitor C2 is now carefully adjusted for a "zero beat" (no whistle or growl from the speaker) between the calibrator signal and that of WWV. This must be done

during a period when WWV itself is not broadcasting a tone.

Next, locate two adjacent signals from the calibrator on the receiver dial, and turn switch S2 to position 3. Finally, adjust resistor R4 until you hear *exactly* nine steady signals between the 100-kc. points you have just located on the dial. Care must be used in making this adjustment, or you may set the multivibrator to 12.5 kc.—or some other submultiple of 100 kc.—instead of to the desired 10 kc.

(Continued on page 103)



On the Citizens Band

with **DICK STRIPPEL**, 2W1452, CB Editor

COMMUNITY service, without a doubt, is one of the most valuable functions an organized group of CB'ers can perform. The Citizens Band lends itself to this function because of the simplicity of CB equipment and its ease of operation, plus the fact that anyone authorized by a licensee can operate a CB transmitter. We're quite happy to note that many of the CB clubs we've heard from during the past year are dedicated to providing emergency communications for local authorities.

A fine example of a community service group is the Winnebago County (Iowa) Emergency CB Net. Organized by Frank W. Arnold, 17W2153 (346 West G St., Forest City, Iowa), the net boasts 24 base station units (two operated on a 24-hour basis), 31 mobile units, and 8 hand-held portable units.

Since Frank has been active in the local fire department and American Red Cross for a number of years, it's only logical that the net works closely with these two organizations. In addition to the CB units in Winnebago County, the net maintains contact with five nearby counties in Iowa and two across the Minnesota state line.

Channel 2 is strictly an emergency channel in the area; police, fire, and ambulance units continually monitor this channel. At the other end of the spectrum, channel 22 is used for general net communications. When the net is activated, Frank, as net controller, monitors both channels 2 and 22, plus the local 75- and 10-meter ham emergency nets.

Our hats are off to the Winnebago County Emergency CB Net, and its net controller, for a top-notch job of organization.

Want a Rule Changed? Recently, we stated in this column that writing one's congressman to try to have some CB rules changed was like asking a local

politician to fix a traffic ticket. As a result, our mail was quite heavy with letters of protest. It might be a good idea to clarify this point.

While the U. S. Congress indeed makes laws, it had nothing at all to do with setting up the Citizens Band. Many years ago, Congress enacted the necessary statutes which empowered the Federal Communications Commission to administer all radio transmitting activity in the United States. As we have said before, it was the FCC that gave us our band, and it will be the FCC that will take it away if abuses warrant it.

If you feel that certain CB rules need changing, there is a very slim chance that your congressman will even *try* to do anything for you. The FCC is under the executive branch of the government, while Congress is the legislative branch. Chances are that your congressman will just acknowledge your letter and possibly inform you of the proper way to submit your ideas to the FCC.

Contrary to some opinions, the FCC is



Frank W. Arnold, 17W2153, net controller and organizer of the Winnebago County (Iowa) Emergency CB Net, is shown holding one of the net's eight portable CB units. Frank's equipment includes three CB rigs, an FM monitor, and a ham-band receiver for the 75- and 10-meter emergency nets.

not a monstrous, impersonal, governmental bureau. It has, in the past, changed rules pertaining to various radio services. These changes have made some rules more lenient and some rules tougher. One of the main criteria the FCC employs is that the changes must be in the best interests of the majority of all users of the various radio services.

Each licensee should have a general knowledge of the procedures involved, and easy access to the regulations pertaining to an FCC petition. Obviously, since the majority must profit by any change, the FCC will only consider petitions which are drawn up in a logical and legal manner.

In this nation of ours, the government is for, by, and of the people, and we certainly want to keep it that way. But if we feel that we should change some of the rules, let's go about it in the proper way. If our suggestions carry enough weight, we can definitely expect them to be heard.

Jamborees. With the warm summer weather encouraging out-of-door activities, many CB organizations are planning appropriate get-togethers.

One of the biggest on the docket for this month is the Mobile Civil Emergency Unit National Jamboree at the New York State Fairgrounds in Syracuse, N. Y., on July 6, 7, and 8. There will be lots of equipment on hand to examine, as well as plenty of fun, amusement, prizes, good

food, and—best of all—good companionship.

The MCEU is the only truly national CB club. If you're interested in joining it, or attending its jamboree, get in touch right away with Chuck Satterlee, National Secretary, MCEU, 1203 Butternut St., Syracuse 8, N. Y.

Base Station Transceiver. As this is being written, we're giving the new Tram Electronics TR-27 transceiver a real workout. This unit is quite large—almost 16" long and about 8" high. It's specifically designed for base station use.

Employing a 5763 transmitting-type tube as its final amplifier, the TR-27 puts out a healthy 3.5 watts into our lab-quality output meter, something we've seen only a few other units do. On "Receive," dial calibration is excellent, selectivity more than adequate, and the unit's ability to stay set to a tunable channel is superb. Its extreme sensitivity is due in large part to the use of three dual triodes as r.f. amplifier, first and second mixers, and local oscillators. The oscillators, incidentally, are voltage-regulated.

Operating is a snap with the "touch-to-talk" Turner microphone supplied with the TR-27 and a completely adjustable noise limiter which really knocks out the stubborn ignition interference our location is plagued with. Six crystal-controlled receive and transmit channels

(Continued on page 101)

CB Sam was careful

CB Sam was careful
not to imitate the gang.
They didn't know procedure
nor did they give a hang.
He'd always mark the frequency
and check if it was clear
Before he'd switch to transmit,
so he wouldn't interfere.

Sam kept his station orderly,
and spoke with poise and ease.
He frowned on working "DX,"
and refused to shoot the breeze.
But do not be deceived
by his "Net Control" type drawl:
This blemish-free CB'er
sends with a bootlegged call.

by David Moore



Hobnobbing with Harbaugh

I Was Just Looking!



ELECTRONIC COUPLING QUIZ

By ROBERT P. BALIN

If you know your coupling circuits and terminology, you should be able to match the types of coupling listed numerically on the right with diagrams A through H below. Place your answers in the spaces provided, then turn to page 102 and find out how right (or how wrong!) you are.

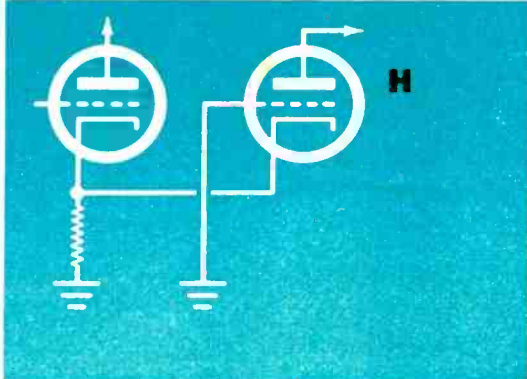
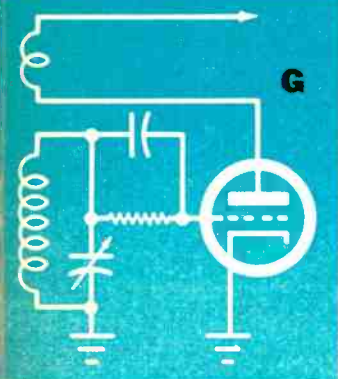
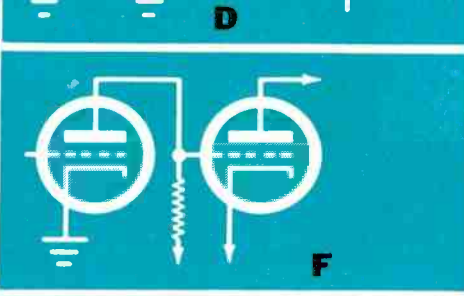
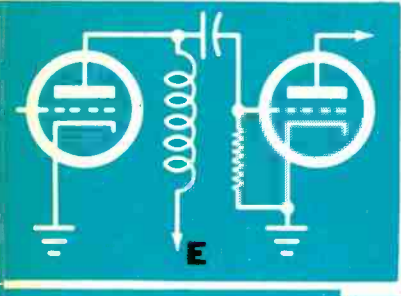
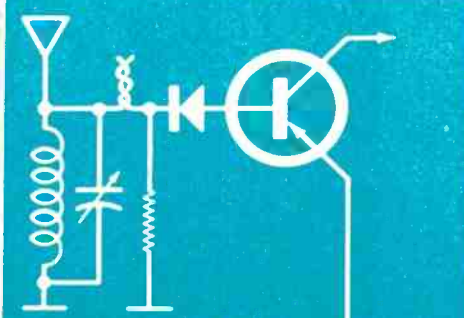
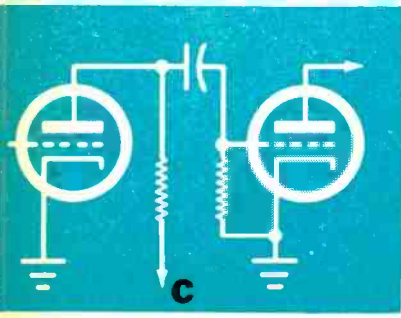
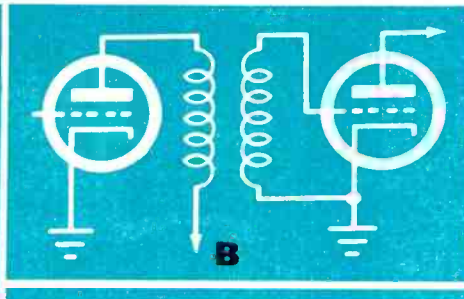
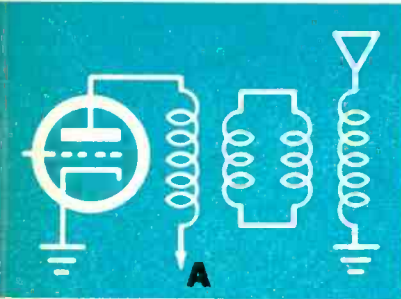

1 Direct coupling

2 R-C coupling

3 Tickler (inductive coupling)

4 Impedance coupling

5 Cathode coupling

6 Link coupling

7 Gimmick (capacitive coupling)

8 Transformer coupling

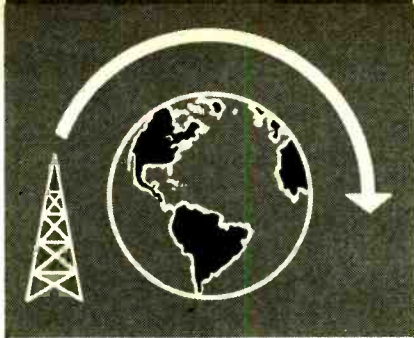

Monthly Short-Wave Report

By **HANK BENNETT**, W2PNA/WPE2FT
Short-Wave Editor

POP'TRONICS "MAILBAG"

OUR recent columns featuring typical questions from readers on the various phases of short-wave listening (July and November 1961 issues) have been so well received that we plan to continue to use a question-and-answer format occasionally. While it's true that most of our readers are already well versed in the SWL hobby, there are also many newcomers every month. And our purpose is to serve the beginner as well as the veteran DX'er. Accordingly, here are a few more of the questions most frequently pulled out of the POP'tronics "Mailbag."

Q: Why don't you list schedules of stations within the continental United States in *Short-Wave Report*?

A: We feel that listings of the more distant stations make better use of the

space available to us each month. A very large percentage of our readers are in the United States, and virtually everyone can hear our own stateside stations with little or no trouble.

Q: During periods of the year when Daylight Saving Time is observed in many areas, how should we show the times in our reports?

A: This column is based on Eastern Standard Time. Your reports, for the sake of convenience in the preparation of this column, should always be made in EST.

Q: Is it permissible to send reports to Iron Curtain countries?

A: There's no law against sending reports to stations behind the Iron Curtain,

ENGLISH-LANGUAGE NEWSCASTS TO NORTH AMERICA

All of the stations listed here specifically beam transmissions to the USA that contain newscasts. The times of the newscasts may vary within the periods indicated; those which are broadcast fairly regularly at specific times are shown in parentheses.

COUNTRY	STATION	FREQUENCY (kc.)	TIMES (EST)
Belgium	Brussels	9705	0000
East Congo	Leopoldville	11,755	1700-1715 (1700)
England	London	15,420, 17,810	1130-1245 (1200)
Finland	Helsinki	15,190	0630
Italy	Rome	11,905, 9575	1930-1950, 2205-2225 (1930, 2205)
Netherlands	Hilversum	11,730, 9590	1625-1720 (1630)
Portugal	Lisbon	6025, 6185	2100-2130, 2300-2330
Spain	Madrid	9360	2215-2300, 2315-0000, 0015-0100
Sweden	Stockholm	11,805	2215-2245
Switzerland	Berne	11,865, 9535, 6165	2030-2215, 2315-0000 (2030, 2215)
Turkey	Ankara	9515	1815
USSR	Moscow	Numerous	2000-0100
West Germany	Cologne	9640, 9575, 6100	1900-2200, 2200-0100
		6100, 9705	1715-1845
		6145, 9735	0000-0130
Yugoslavia	Belgrade	6100	1700-1715 (1700)



The listening post of Jon Louis Lenard, WPE9CSB, of Des Plaines, Ill., contains a Heath AR-3 receiver, and a Knight Span Master for standby use. Jon's antenna system consists of five dipoles. He has 37 countries logged, 29 verified.

nor is there any penalty for receiving verifications from them. However, you should watch out for possible propaganda which may follow in the mail; if it reaches you, it can be refused and returned to your local postmaster.

Q: Why do you give publicity to stations that place propaganda above entertainment?

A: Normally we give little or no room to stations in that category. But frequency and/or schedule changes are newsworthy items, and we try to treat them accordingly.

Q: Do all Russian stations verify?

A: According to a recent letter from *Radio Moscow*, it is the only Russian station that verifies. However, we know definitely that *R. Tashkent* has verified many reports. And *R. Kiev* just recently sent a verie to a reader in New York City, stating that reports are welcome but that the *R. Kiev* programs are intended mainly for Ukrainians living outside of the Soviet Ukraine.

Q: Why don't you list the receivers used by your many reporters? This might enable some of us to realize quickly whether or not we stand a chance of hearing any of those rare stations.

A: We are considering doing so, but this could result in fewer listings. You fellows with the lower priced receivers

(Continued on page 104)

SHORT-WAVE MONITOR CERTIFICATE APPLICATION

To become a Short-Wave Monitor registered with POPULAR ELECTRONICS, just follow these simple directions:

1 Fill out the form below. (You must be a short-wave listener presently active in the hobby to be eligible for a Short-Wave Certificate.)

2 Send us 10 cents in coin to cover the cost of the certificate as well as the handling and registration

costs. If you live outside the United States and cannot obtain U. S. coins, send either 15 cents in Canadian currency or two International Reply Coupons (IRC's).

3 Insert the application form, coins (or IRC's) and a stamped, self-addressed envelope in another envelope and mail it to:

Monitor Registration, POPULAR ELECTRONICS
One Park Avenue, New York 16, N. Y.

(Please Print)		Ham	
Name		Call-Area Prefix
Address	City	Zone	State
Receivers	Make	Model
	Make	Model
Principal SW Bands Monitored	Number of QSL Cards Received	
Type of Antenna Used		
Signature	Date		



TRAVELING?

Take your shaver with you

By WALTER ROBSON

If you're like most men who do a lot of traveling, you'd probably find it very convenient to be able to shave in your car from time to time. Nowadays, of course, this is fairly easy to arrange—if you want to spend the money. Electric shavers that plug into the cigarette lighter are available, as are converters to change the six or twelve volts from a car battery to the 117 volts necessary to operate a standard shaver.

But if your car is equipped with a tube-type radio, you probably already own a converter that will supply more than enough voltage to run your home shaver! You guessed it—it's the receiver's B-plus supply. All you have to do is tap it and drop the voltage to the correct value. Interested? Then read on.

Preparing the Receiver. First make sure that your set has a high-voltage "B" supply. Models which are transistorized, and some models using tubes, employ low-voltage supplies and are not suitable. The easiest way to check is to turn on the set and listen for the tell-tale hum of a vibrator. If you hear it, you've got a high-voltage supply.

Now remove the radio from the car and locate the rectifier tube. This is usually an OZ4 "cold-cathode" type as shown in the schematic diagram, but you might also encounter heater-type tubes such as the 6X4. Having located the tube, unsolder and remove the lead (or leads) from its cathode terminal (pin 8 if it's an OZ4, pin 7 if it's a 6X4).

Install a 3-lug terminal strip (TS1) at

Wiring of shaver outlet box and connections between box and receiver are shown in diagram. Shaded areas indicate existing wiring in receiver power supply.

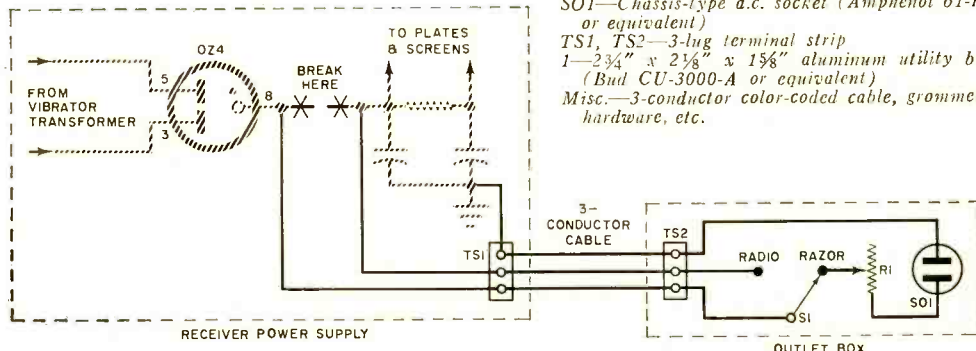

PARTS LIST

- R1—1000-ohm, 10-watt, adjustable power resistor
- S1—S.p.d.t. toggle switch
- SO1—Chassis-type a.c. socket (Amphenol 61-F1 or equivalent)
- TS1, TS2—3-lug terminal strip
- 1—2 $\frac{3}{4}$ " x 2 $\frac{1}{8}$ " x 1 $\frac{3}{8}$ " aluminum utility box (Bud CU-3000-A or equivalent)
- Misc.—3-conductor color-coded cable, grommets, hardware, etc.

some convenient spot near the rectifier tube. The lead (or leads) just disconnected are wired to one lug, the second lug is connected to the rectifier's cathode pin, and the third is grounded. Do not solder any of the connections at this time.

Constructing an Outlet Box. The shaver outlet (*SO1*), together with a s.p.d.t. switch for transferring high voltage from the receiver to the outlet and vice-versa, is housed in a small aluminum utility box. Also located in the box are voltage-dropping resistor *R1* and 3-lug terminal strip *TS2*.

Mount these components and wire them according to the schematic. Then run one end of a short length of color-coded three-wire cable into the box through a grommet and connect it to *TS2* as shown. Don't replace the box cover when wiring is complete; resistor *R1* will have to be adjusted later.

Installation and Adjustment. Run the other end of the three-wire cable into the receiver through a convenient opening and wire it to *TS1*. If no opening exists, drill an appropriate hole and line it with a grommet.

The receiver, with the attached outlet box, is now placed in the car. Don't install the set in the dashboard until final

checks are made, but temporarily connect the battery, antenna, and speaker wires. With switch *S1* in the "Radio" position, turn on the receiver; it should operate normally.

With the receiver in operation, set the slider on *R1* for maximum resistance, connect a d.c. voltmeter across *SO1*, and plug in your shaver. Caution: although no voltage appears across *R1* or *SO1* with switch *S1* in the "Radio" position, be careful! You can still get a shock from the wiring associated with *S1* or *TS2*.

Snap *S1* to the "Razor" position, transferring the B-plus voltage to *SO1*. If the voltage across *SO1* is less than 117, set *S1* at "Radio" again and move *R1*'s slider to a lower resistance position. Return *S1* to "Razor" and once again read the voltage across *SO1*. If it's still less than 117 volts, repeat the above procedure. Once you've adjusted the slider for a full 117 volts, the razor should operate—at its normal speed—whenever *S1* is set at "Razor."

If all is well, replace the receiver in the dashboard and install the cover on the outlet box. Then mount the box in some convenient spot under the dash, and you'll have shaving power whenever you want it.

-50-

Third Eye for Space Explorers

The first astronaut to land on the moon may need an eye in the back of his head, and a new "Electrocular" headset (right) perfected by Hughes Aircraft may well provide it. The headset contains a miniature cathode-ray tube (A) to receive, say, a closed-circuit TV picture, as well as an internal mirror (B) to "bend" the image toward the viewing eyepiece (C). A microphone (D) for voice communications is optional. Since the monocle-type eyepiece is a transparent mirror, the wearer can look through the image, when necessary, to concentrate on what is actually in front of him.

The apparent size of the image (up to eight feet in diameter) varies according to where he focuses his eyes. Many other applications are anticipated for the new device—it's being used by the pilot at left, for example, to receive pictured information from the control tower on air traffic and ground conditions.



The RIVER SNIFFER

By
JOHN T. FRYE
W9EGV

a Carl and Jerry Adventure

"THIS IS the life," Carl sighed contentedly; "no lessons, no exams, no ROTC drills, no nothin'!" He and his friend, Jerry, were sprawled on their backs on the river bank staring upward through the sycamore leaves at a buzzard sail-planing in the cloudless summer sky above. Down at the edge of the water, two fishing rods rested in a couple of forked sticks.

Before Jerry could answer, a slight splashing from the river attracted his attention. Raising himself on one elbow so that he could get a better look, he exclaimed, "Hey, Carl, look at those fish on top of the water!"

Two large bass were thrashing about on the surface, obviously in their dying throes. Even as the boys watched, the splendid fish turned belly-up and floated quietly downstream; and, looking more closely, Carl and Jerry saw that the two were accompanied by other dead and dying fish of various sizes.

The throbbing of an outboard motor was heard downriver, and an aluminum boat carrying a young man dressed in a game warden's uniform came in sight around a bend in the stream. When he saw the boys, he ran the bow of the boat up on the bank, cut the motor, and stepped out.

"That's a mighty sorry sight," he remarked, motioning toward the floating fish. "I'd certainly like to catch whoever keeps dumping that fish-killing stuff into the river."

"You mean it has happened before?" Carl queried.

"About once a week all spring, but not always on the same day or night. When someone calls in and reports dead fish, I get right on it; but I never know how far the fish float after dying. How-



ever, this is the farthest upstream I've found them, and some of those fish are still wiggling. This time, at least, the stuff must have entered the river from this bank and not too far upstream; but I've covered every foot of the river for five miles in either direction without finding a single likely source of pollution. If only I had some way of knowing just as soon as the stuff hit the river—even before the fish began to die—I'd stand a chance of tracing it. At least I could collect a strong enough sample for accurate analysis before the polluting substance was too greatly diluted."

Jerry was looking very interested. "You mean you need some kind of a robot to sample the river water continuously and give some sort of alarm when an unusual amount of destructive chemical floats past it?"

"Exactly, but I guess there's no such gadget."

"Don't make book on it. I have an idea: if you'll take that glass jug lying in the weeds across to the other side of the river and fill it, my friend here and I will try to build such a robot for you. Electronics is our field. I can't promise anything, but you can give us your telephone number and we'll call you if we come up with something."

"Okay, what have I got to lose? But what do you want with the water?"

"We'll need a sample of normal, unpolluted river water to work with."

WHILE Bill Herber, the game warden, was collecting the water, Carl and Jerry reeled in their lines. A half hour later they were entering the coolness of their basement laboratory at Jerry's home, and Jerry went straight to a stack of papers resting on a shelf. He sorted through them until he found what he sought.

"Ah, here it is," he said. "I was sure I had saved the description of the River Robot Monitor that Mr. Edward J. Cleary, Executive Director of ORSANCO, sent me."

"Bully for you; so what is it?"

"It's a unit of a system of continuous automatic electronic river pollution monitors used by the Ohio River Valley Water Sanitation Commission to keep a continuous check on the Ohio River water. Eleven of these unattended robot de-

vices are strung along the river. They constantly test the water for seven different variables: dissolved oxygen, chloride, hydrogen ion, specific conductance, oxidation-reduction potential, temperature, and solar radiation. The various sensors feed their information into a telemeter transmitter at each location, and all the transmitters are connected by telephone wires to a telemeter receiver in Cincinnati. At regular intervals this receiver calls each monitor for a report. Signals received actuate a transcriber which automatically types the information on tabulation sheets for diagnosis of river conditions."

"So that's why you told Mr. Herber not to bet there wasn't a river robot monitor! We're not going to try to build one of these robots, are we?"

"Hardly. They're quite complicated and cost a lot of money. But I'm hoping we can build a simple gadget based on a single sensing unit that will serve our purpose."

"How about the hydrogen ion measuring part? If I remember my chemistry, that's an indication of the acidity of a solution."

"Either the acidity or alkalinity of the solution," Jerry corrected. "If you recall, the potential hydrogen ion concentration, or pH factor, is measured on a 0-14 scale, with 7 being the number associated with 'pure water.' Numbers going downward from 7 indicate increasingly acid solutions. Readings going upward from 7 indicate increasingly strong base solutions. Since the number is actually the negative logarithm of the hydrogen ion concentration, each pH unit represents a tenfold change in solution strength. Compared to a pH 5 solution, a pH 4 solution is ten times more acid, and a pH 3 solution is a hundred times more acid."

"One way to measure the pH of a solution," he continued, "is to add special organic indicators and observe the color change that results. A better method, in many respects, is to employ an electro-metric device that translates the pH of the solution into a reading on a meter whose scale is marked off in pH units. That's the kind of pH indicator our chemistry prof at Parvoo University used in his lectures last year."

"Fine. All we have to do is build a pH meter and let the meter-deflecting

current also operate a sensitive relay that will sound an alarm."

"It's not that easy," Jerry demurred. "Until I read this pamphlet called 'The Development of pH Instrumentation' by A. O. Beckman of Beckman Instruments, Fullerton, California, I had a hazy notion a pH meter was a relatively simple gadget that employed either a current conducted through the solution or a voltage produced by galvanic action on electrodes immersed in the solution to deflect a meter. Actually the latter principle is the one employed, but both the electrode used and the indicating meter are very special types.

"Oxidizing of ordinary metallic electrodes immersed directly in the solution prohibits their use; so a special 'glass electrode' is employed. Picture an electrode surrounded by a low-resistance, non-oxidizing solution in a test tube that's immersed in a solution being tested. The test tube wall keeps the solution being tested from oxidizing the electrode, but a voltage appears across this glass membrane which is proportional to the difference in hydrogen ion concentration of the solution on either side. As you can guess, this glass electrode is an extremely high resistance device, and special

means are necessary to measure the voltage developed. In practice, a not-too-simple feedback amplifier translates this voltage into meter-deflecting current."

"Say no more; we'll not try to build a pH meter. Got any other ideas?"

"Yes. We know that the presence of acid greatly influences the conductivity of a solution. What say we build a simple bridge circuit in which two legs are fixed resistors, a third leg is the resistance appearing between two electrodes immersed in the river, and the fourth leg is a variable bridge-balancing resistor in series with a special temperature-sensitive resistor also in the water? We can drive the bridge with a few volts of a.c. produced by a simple transistorized chopper."

"Why the temperature-sensitive resistor and why the a.c.?" Carl wanted to know.

"D.c. would quickly polarize our electrodes and render them useless," Jerry replied. "Also, conductivity changes considerably with temperature, and we want our device to respond only to chemical change; so we must compensate the bridge for the effect of temperature change in the river water. A little battery-powered transistorized amplifier will



magnify any a.c. voltage resulting from bridge unbalance.

"This amplified output can be rectified with a diode," Jerry went on, "and used to drive a meter and a sensitive relay connected in series. An increase or decrease in the conductivity of the water flowing past the electrodes will unbalance the bridge and cause the relay contacts to close and the meter to read upscale. Closing of the contacts can sound an alarm."

"Sounds good; let's try it," Carl said, rubbing his hands impatiently.

LIKE most electronic devices, the "river sniffer," as the boys dubbed their brain child, was not nearly so easy to put into practice as it sounded in theory. They spent three full days building a really stable transistorized amplifier, finding the proper thermistor to keep the bridge balanced during a 20° temperature change in their jug of river water, and adjusting the sensitivity of the relay so that it remained open with the electrodes in a weak salt solution but closed when the solution was weakened with more water or strengthened with a little more salt. Finally, though, they were partially satisfied with the operation of their invention—a good technician is rarely completely satisfied—and they called Mr. Herber.

He drove them to a farmhouse where he kept his boat, about a quarter of a mile upstream from where they had met him. The river sniffer, housed in a weatherproof box, was installed on the river bank; and the sensing electrodes were placed well out in the current. Jerry carefully balanced the bridge with the aid of the indicating meter.

A bell was installed in the farmer's house and connected with a bell transformer and the contacts of the sniffer's relay so that the closing of the contacts would ring the bell. Then, after extracting a promise from the farmer to call Mr. Herber immediately if the bell rang, they left the robot to its sentry duty.

It was shortly after midnight that same night when Jerry's telephone rang.

"Hi," said the voice of Mr. Herber, "the farmer says that gadget of yours is ringing the bell off his wall. Want to go along and see what's up?"

"Sure," Jerry answered. "I'll get Carl,

and we'll be out front waiting for you."

It did not take long to reach the farm. The farmer, clad in his nightshirt, was sitting in his kitchen malevolently eying the clanging bell on the wall. Jerry disconnected it; the farmer went back to



bed; and the boys and the game warden walked down to the river sniffer.

"Wow!" Jerry exclaimed as he lifted the lid and glanced at the meter reading with the aid of his flashlight. "Something is really boosting the conductance. What say we take the sniffer with us in your boat and see if we can't run down the source of the pollution?"

IN A FEW MINUTES they were heading upstream. Jerry was in the bow with his sniffer; Carl was in the middle; and Bill Herber operated the outboard motor at the stern. As the boat moved to the middle of the river, the meter reading declined; but swinging back toward the bank pushed it higher than ever. It continued climbing slowly until they were about a quarter of a mile upstream; then suddenly it dropped to the bridge-null value.

"Back up," Jerry said; "we've run out of it."

Mr. Herber reversed the boat's direction, and the meter reading shot upward. The game warden then maneuvered the boat under Jerry's direction until it became apparent the polluting substance was coming from beneath some low-hanging bushes growing on the bank. Suddenly he revved up the motor and headed straight for these bushes. As the boys ducked, branches scraped along the metal hull and the boat emerged in a shallow creek whose mouth had been concealed by a thin screen of willows.

"Better watch your propeller," Jerry warned as he peered over the side with

First new concept in citizen's band equipment in two years! . . . Heathkit 4-Position Selective-Call kit



*an exclusive with
Heath, this inexpensive
unit converts your
CB station from
"party line" confusion
to "private line" calling
convenient*

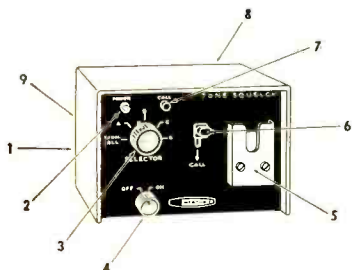

FEATURES

(1) squelch time-delay control, (2) power indicator, (3) tone selector switch (4 tones plus "monitor all" position), (4) tone squelch "defeat" switch to normal operation (5) "lift-to-operate" microphone bracket, (6) "call" lever (7) "call" indicator, (8) external alarm contacts to signal received call, (9) input and output level controls.

Here's welcome news for the serious user of Citizen's Band two-way radio. Heath's new Selective-Call Kit with tone squelch makes it possible for you to enjoy the calm of a CB station that is completely silent, yet ever alert for a personal call . . . makes it possible for you to call your choice of four specific units in your system at the touch of a button.

Using a unique new method, Heath's Selective-Call Kit features an *exclusive* 4-position rotary selected resonant-reed relay which responds only to calls transmitted by similarly equipped units using the same tone frequency. Upon receipt of the proper tone, your unit will automatically "come to life" permitting you to hear the call letters transmitted . . . you reply by merely lifting the microphone and acknowledging. At all other times, your station is peacefully quiet, allowing you to perform your job without one ear "cocked", for this unit does your listening for you.

To call another unit, just select the correct one of four tone frequencies, press the lever, and the called station will be waiting for you. Nothing could be simpler or more convenient. A "defeat" switch allows normal transceiver operation at any time. Equip all your CB units now with this economical new advance in communication ease . . . instructions included for installation with most popular CB transceivers using PTT.

Kit GD-162A (AC), no money down, \$5 mo. \$33.95; Kit GD-162D (DC) \$37.95



GW-11 3-channel transceiver from \$69.95



GW-12 Single channel all crystal controlled transceiver from \$39.95



GW-31 Low Cost "Wakie-Talkie" from \$24.95



GW-21 Superhet "Wakie-Talkie" from \$44.95



HEATH COMPANY
Benton Harbor 10, Michigan

Ordering instructions: Fill out the order blank. Include charges for parcel post according to weights shown. Express orders shipped delivery charges collect. All prices F. O. B. Benton Harbor, Mich. A 20% deposit is required on all C.O.D. orders. Prices subject to change without notice. Dealer and export prices slightly higher.

Enclosed is \$ _____; send _____

Name _____

Address _____

City _____ Zone _____ State _____

priced from \$109.50...

HAND-HELD, MOBILE, BASE STATION

2-WAY RADIO

VIKING MESSENGERS

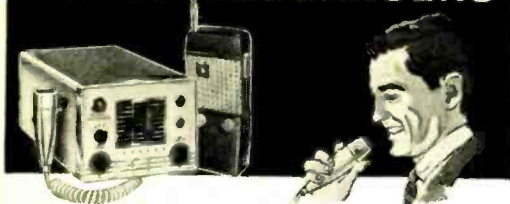

Now, 3 feature packed Johnson Messengers...
outperforming everything else in the field!

Compact, hand-held 100 milliwatt or 1 watt "Personal Messengers". Rugged and reliable—11 transistors, 4 diodes! Superheterodyne receiver and exclusive tuned RF amplifier gives twice the sensitivity and 40% more range than similar units with conventional circuitry—more output than similar units with same rated inputs!

For mobile or base stations—performance proved Viking "Messenger" punches your signal across the miles! High efficiency design makes full use of maximum allowable legal power. Excellent receiver sensitivity and selectivity. Automatic "squelch" control—5 channel coverage. Only 5 1/2" x 7" x 1 1/2", easy to install anywhere!

WRITE TODAY

for
Information packed
4 Color Catalog



Manufacturers of the world's most widely used personal communications transmitters.



E. F. JOHNSON COMPANY

2407 10th Ave. S.W., Waseca, Minnesota.

Please rush "Messenger" details to:

NAME _____
ADDRESS _____
CITY _____ STATE _____

GET INTO ELECTRONICS

V.T.I. training leads to success as technicians, field engineers, specialists in communications, guided missiles, computers, radar, automation. Basic & advanced courses. Electronic Engineering Technology an ECPA accredited Technical Institute curriculum. Assoc. degree in 29 mos. H.S. obtainable. G.I. approved. Start Sept., Feb. Dorms. campus. H.S. graduate or equivalent. Catalog.

VALPARAISO TECHNICAL INSTITUTE

Dept. PE VALPARAISO, INDIANA



SONGS

into DOLLARS!

NEW Songwriters, Poets, Composers may gain SUCCESS, FAME, WEALTH. Songs Composed, PUBLISHED. Appraisals, details FREE from...

NORDYKE SONGS & MUSIC

6000 Sunset, HOLLYWOOD 283, California, U.S.A.

NEW MAGIC RADIO WALKIE TALKIE!

TALK TO ANYONE ANYWHERE BY RADIO!

Sends your voice to any car or house radio. Works up to 1-2 miles from car to car or 1-5 or more blocks house to house depending on local conditions. JUST PUSH BUTTON TO TALK—NO COMPLICATED HOOKUPS OR WIRES—ANYONE CAN USE IT. Transistor powered by flashlight batteries. NO LICENSE OR PERMITS NEEDED. GUARANTEED TO WORK. 1 YR. SERVICE GUARANTEE. SHOULD LAST FOR YEARS!

SEND ONLY \$3.00 (cash, ck., mo) and pay postman \$9.95 COD postage or send \$12.95 for postpaid delivery. Ready to operate, with clear instructions. Order your Radio-Talkie today—now!

WESTERN RADIO • Dept. TEL-7 • Kearney, Nebr.



his flashlight; "the water's not more than a foot deep."

"No sweat," Mr. Herber replied. "This motor doesn't have a propeller. It operates on a jet principle and will run in four inches of water."

At this moment Jerry spied a trickle of water dribbling from a large tile set in the bank of the creek, and a little checking with the river sniffer confirmed that the water pollution was coming from this tile.

Bill Herber stepped out of the boat and motioned for the boys to follow him toward a large concrete building a short distance away. A light was shining from the windows and through the open door, and inside they found a young man busily pouring some liquids from carboys into a large vat.

When Mr. Herber explained the reason for their visit, the young man shook his head ruefully. "I'm afraid I'm the one you're looking for," he admitted. "The first of the year I started a little plating business here. I use sulphuric acid to clean the parts before putting them in the plating bath. About once a week I flush the dirty and weakened acid down that sewer that leads into the crick and mix up a new batch, as I'm doing now. I never thought about killing fish or causing any other trouble, and I can assure you it won't happen again."

"I'm sure it won't," Mr. Herber said kindly, "but I'll have to report it, and there's a fine for river pollution. I hope they go easy on you. Come on, boys; let's get back to town."

AS the game warden drove Carl and Jerry home, he declared, "I sure do appreciate what you fellows did for me. I don't know how to thank you. I wish I had brains enough to build something like that river sniffer of yours."

"We lucked out," Jerry said modestly. "Had it been something other than a strong acid that was killing the fish, the sniffer might not have worked so well. And as for paying us, how about showing us a spot where we really can catch some fish?"

"That I can do. Be ready with your rods and a can of stinkworms about four o'clock tomorrow afternoon, and I'll show you the best channel-cat fishing east of the Mississippi!"

—50—

Always say you saw it in—POPULAR ELECTRONICS

New Products

TRANSISTORIZED SIGNAL GENERATOR

The Model 36-564 lightweight signal generator produced by GC Electronics facilitates the repair of radio receivers and audio equipment. Designed for trouble-shooting by the signal-injection method, the 16-ounce transistorized unit feeds an approximately 400-cycle tone into r.f., i.f., or audio stages. An output volume control is provided, as well as two 18" test leads. The "ground" test lead is terminated in an insulated alligator clip, the "hot" lead in a thin test probe for maneuvering freely in crowded circuitry. Power for the two transistors (a 2N363 and a 2N483) is supplied by an internal, 6-volt battery. Price, \$9.95. (GC Electronics, Inc., 400 S. Wyman St., Rockford, Ill.)



CONTACT CLEANING KIT

"Contacare II," developed by Standard Kollsman, is a kit for cleaning and protecting the contacts of TV tuners. Included in it is a bottle of non-flammable contact cleaning solution, a lint-free cloth to apply the solution, and a tube of non-evaporating lubricant. The lubricant is used to protect the contacts as well as to lubricate the mechanical parts of the tuner. Also supplied in the compactly boxed kit is an instruction sheet outlining the recommended step-by-step procedure for tuner contact servicing. Price, \$1.25. (Standard Kollsman Industries, Inc., 2085 N. Hawthorne Ave., Melrose Park, Ill.)



"CORDLESS" AM RADIO KIT

The new Heathkit six-transistor "cordless" AM table radio is intended for either indoor or outdoor use. Known as Model GR-131, its leakproof "cathodic envelope" battery pack provides 500 to 1000 hours of operation, and the push-pull output stage and 4" x 6" PM speaker make for "big set" tone quality. Other features are a built-in ferrite rod antenna and a special "overload diode" for preventing distortion of signals from strong local stations. The set covers the standard broadcast band (535-1620 kc.) and is housed in an ivory and pastel-green plastic cabinet. Price, \$19.95 without battery; the battery pack (Model GRA-131-1) sells for \$1.10 extra. (Heath Co., Benton Harbor, Mich.)



SOUND FOR HOME MOVIES

Any silent home-movie projector becomes a sound projector with the help of an "Audio Sync" unit made by Concord Electronics. Narration, music, and sound effects can be added to existing film, or sound can be recorded while shooting new film with any movie camera. Designed for use with the Concord Model 220 tape recorder, the device is simpler and less expensive than other methods of sound synchronization. The price of the "Audio Sync" is under \$30.00, while the companion tape recorder costs less than \$160.00. Write to the manufacturer for a free booklet explaining the system. (Concord Electronics Corp., 809 Cahuenga Boulevard, Los Angeles 38, Calif.)



CB NOISE SUPPRESSION KITS

Ignition and generator noise interfering with reception on mobile Citizens Band equipment can be suppressed with one of two new kits developed by Raytheon. And, by lowering the threshold of background noise, each will increase the effective range of the equipment. For ordinary interference problems, a "standard" kit provides generator and ignition-coil capacitors, distributor and spark-plug suppressors, and the neces-

Products

(Continued from page 91)

sary mounting hardware. The "de luxe" kit, providing a greater degree of noise reduction, includes everything in the standard kit plus two additional capacitors, an RC



network, and shielded generator wires. (See photo.) The standard kit retails for \$10.95, the de luxe kit for \$24.95. (Distributor Products Division, Raytheon Company, 411 Providence Turnpike, Westwood, Mass.)

SHORT-WAVE RADIO KIT

Youngsters learn the principles of transistor electronics while they assemble the G.E. Model EF-150 short-wave radio kit. Five transistors and three pretuned i.f.

transformers are used in the 6-18 mc., AM or CW set, and the chassis is of the printed-board

type. Sensitivity is 50 microvolts

on voice, 5 microvolts on CW; a 12-to-1 ratio vernier tuning dial provides extra station selectivity. The kit comes complete with 35' of antenna, soldering iron, solder (a special low-melting point type for extra safety), short-wave log, broadcast-band spectrum chart, and timetable of international broadcasts. Price, \$29.95. (General Electric, 4505 E. Genesee St., De Witt, N.Y.)

CIRCUIT BREADBOARDING SYSTEM

An electronic-circuit breadboarding system, known as "Pin Up," is available from Photographic Instruments. The system utilizes removable pins which are inserted in elastic grommets to make common contact with up to eight leads. A 6¾" x 13½" x 2" 16-gauge steel chassis, incorporating over 1000 perforations, provides flexibility in the locations of terminals and components.

Heavy components can be readily accommodated, and both top and underside wiring can be employed. The system's parts are available separately, but a kit (No. CX-500) for breadboarding the average 6-tube circuit sells for \$16.50. (Photographic Instruments Co., Inc., 1163 West Walnut St., Des Plaines, Ill.)

DEPTH SOUNDER KIT

One of a new line of electronic kits for marine enthusiasts, the Daystrom Model DM-234 depth sounder has a range of from 0 to 200 or more feet. Ideal for detecting submerged obstacles, schools of fish, etc., the transistorized instrument operates from its own built-in battery supply or from the boat's 12-volt system.

The transducer connects to the indicating unit via a watertight coaxial connector and may be mounted through the hull, transom mounted (with a special accessory bracket), or temporarily outboard. Like the other kits in the line, the Model DM-234 is designed for the "first time" builder. Priced at \$79.95 in kit form, it is also available factory-assembled (Model DMW-234) for \$119.95. Accessory mounting bracket, \$9.95. (Daystrom Products Corp., P.O. Box 167, St. Joseph, Mich.)



S.W. RECEIVER FOR HI-FI FANS

Said to be the first short-wave receiver designed for use with a hi-fi system, the National NC-105 is equipped with a tuner output jack. The set covers 550 kc. to 30 mc. in four bands and comes with a Q-multiplier, noise limiter, and BFO. Also featured are a bandspread scale, illuminated S-meter, earphone jack, and separate r.f. and audio gain controls. When not being



played through a hi-fi system, the NC-105 can be used with its own built-in speaker. Price: \$119.95 in metal case (illustrated); \$139.95 in walnut case. (National Radio Co., Inc., Dept. P, Melrose, Mass.) -30-

The most informative books for the experimenter and electronic hobbyist



VACUUM-TUBE CIRCUITS FOR THE ELECTRONIC EXPERIMENTER by Julian M. Sienkiewicz. At last in one book—all the basic diagrams, schematics, and other vital information on vacuum-tubes and their circuits. 192 pgs. 100 illus. **\$4.95**

CLASS D CITIZENS RADIO by *Leo G. Sands*
The first complete book on the two-way radiotelephone. Its history, rules, how it works, applications, equipment, receiver circuits, transmitters, antennas, installations, illus. **\$4.95**

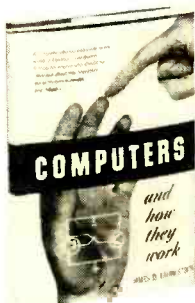
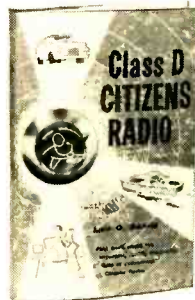

COMPUTERS AND HOW THEY WORK by *James D. Fahnstock*
A fact-filled guidebook to electronic computers. More than 110 illus. easy-to-follow tables in nine sections will help you understand all major types of computing mechanisms. **\$4.95**

THE ELECTRONIC EXPERIMENTER'S MANUAL by *David A. Findlay*
With this guide you can put theory into practice. Learn about every component used in experimentation, every tool, its function and why it is used. A perfect guide to professional know-how. **\$4.95**

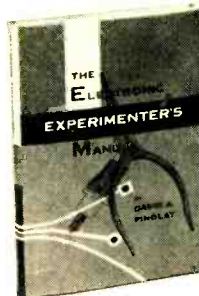

USE THIS HANDY ORDER FORM

ELECTRONICS BOOK SERVICE—A. S. Barnes & Co. Inc.
151-51 Seventh Avenue, Whitestone 57, N.Y. PE 41A

Please send me the books I have checked below:

I enclose \$ _____ (You pay all postal charges.) Send C.O.D. (I pay charges)

___ copy (ies) VACUUM-TUBE CIRCUITS FOR THE ELECTRONIC EXPERIMENTER \$4.95

___ copy (ies) CLASS D CITIZENS RADIO \$4.95

___ copy (ies) COMPUTERS AND HOW THEY WORK \$4.95

___ copy (ies) THE ELECTRONIC EXPERIMENTER'S MANUAL \$4.95

NAME _____

ADDRESS _____

CITY _____

ZONE _____

STATE _____

If I am not fully satisfied I can return these books in seven days for a full and prompt refund.

Tips and Techniques

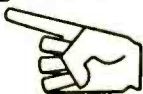

CARRYING CASE FOR TEST INSTRUMENTS

An excellent test instrument carrier can be improvised from an inexpensive cardboard suitcase. These



suitcases are available at most "5-and-10's" in a variety of sizes and need only be lined with appropriate padding. Foam rubber or plastic makes an ideal material for this purpose; just cut it to size with a scissors and

glue it to the top, bottom, and sides of the cardboard suitcase.

—H. Leeper

EASY ADJUSTMENT FOR REPLACEMENT LOOPS

Replacement loop antennas are usually supplied with extra turns so that they can be "trimmed down" to the proper inductance after installation. In cases where the inductance is just a bit too high, it's usually easier to spread the turns than to trim the

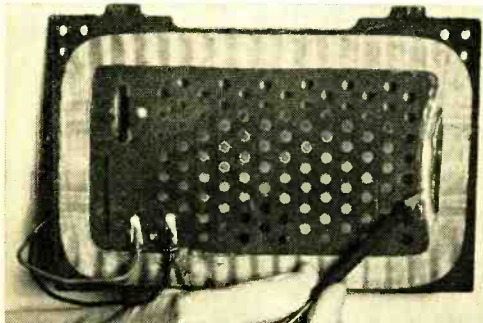

wire. Just melt the wax at one point on the loop and move the turns apart until the stations appear at the proper dial settings.

—Art Trauffer

SMALL ALLIGATOR CLIP CLEANS CORRODED TUBE PINS

Next time you're faced with the problem of cleaning corroded tube pins, try rubbing them between the jaws of a small alligator clip. The narrow "nose" of the clip fits easily into tight corners, and the sharp, spring-loaded jaws have an excellent abrasive action. You'll find this a much faster and easier method than using sandpaper or a pocket knife.

—John A. Comstock

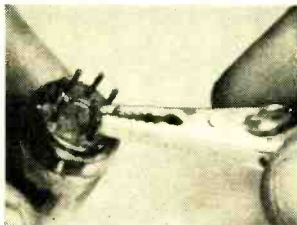

MINIATURE CHASSIS FROM DEFECTIVE PRINTED BOARD

A printed-circuit board that has been discarded because of an open circuit or some other defect has by no means reached the end of its usefulness. With the printed wiring and solder removed (see "before and after" photo), it makes a fine chassis for a piece of miniaturized equipment. You can remove the wiring with etching solution and the solder can be melted off. The "stripped" board should then be cleaned up with a light sanding.

—H. L. Davidson

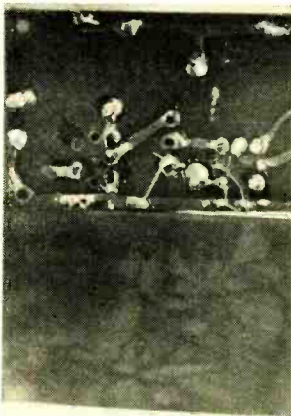

SPRAYING CONE MAKES SPEAKER MORE "BASSY"

Apply a few light coats of spray varnish or lacquer to the cone of a small speaker and a more "bassy" sound will be produced. The spray treatment lowers the cone's resonant frequency and at the same time cuts down on its high-frequency response.

A greater ratio of bass to treble output is thus produced. Spraying also protects the cone from dampness, lengthening its life.

—Robert Hertzberg





ELECTRONICS DATEBOOK

- AUG. 13-16**
Pacific Energy Conversion
Conference
Fairmont Hotel,
San Francisco, Calif.
- AUG. 14-16**
International Conference on
Precision Electromagnetic
Measurements
NBS Boulder Labs, Boulder, Colo.
- AUG. 21-24**
Western Electronics Show &
Convention (WESCON)
Statler Hilton Hotel & Memorial
Sports Arena, Los Angeles, Calif.
- AUG. 31-SEPT. 9**
World's Fair of Music and Sound
McCormick Place, Chicago, Ill.
- SEPT. 1-3**
National ARRL Convention
Memorial Coliseum,
Portland, Oregon
- SEPT. 19-20**
Industrial Electronics Symposium
Hotel Sheraton, Chicago, Ill.
- OCT. 2-4**
National Symposium on Space
Electronics & Telemetry
Fontainbleu Hotel,
Miami Beach, Fla.
- OCT. 7-12**
American Institute of Electrical
Engineers Fall General Meeting
Pick-Congress Hotel, Chicago, Ill.
- OCT. 8-10**
National Electronics Conference
(NEC)
McCormick Place, Chicago, Ill.
- OCT. 15-19**
Audio Engineering Society Fall
Convention & Exhibit
Barbizon-Plaza Hotel,
New York, N. Y.
- NOV. 28-DEC. 2**
International Communications Fair
New York Coliseum, New York, N. Y.

FREE CAREER BOOKLET

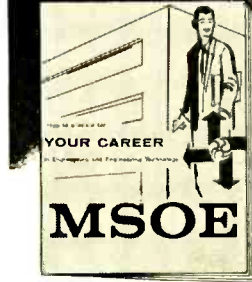

To guide you to a
successful future in

ELECTRONICS RADIO-TV COMPUTERS ELECTRICAL ENGINEERING

This interesting pictorial booklet tells you how you can prepare for a dynamic career as an Electrical Engineer or Engineering Technician in many exciting, growing fields:

**MISSILES • AVIONICS • AUTOMATION
SALES • DEVELOPMENT
ELECTRICAL POWER • ROCKETRY
RADAR • RESEARCH**

Get all the facts about job opportunities, length of study, courses offered, degrees you can earn, scholarships, part-time work — as well as pictures of the Milwaukee School of Engineering's educational and recreational facilities. No obligation — it's yours free.

MILWAUKEE SCHOOL OF ENGINEERING

MAIL COUPON TODAY!

Milwaukee School of Engineering
Dept. PE-762, 1025 N. Milwaukee St., Milwaukee, Wis.
Please send FREE "Your Career" booklet

I'm interested in
 Electronics Radio-TV Computers
 Electrical Engineering Mechanical Engineering

Name..... Age.....
PLEASE PRINT

Address.....

City..... Zone..... State.....
 I'm eligible for veterans education benefits.
 Discharge date..... MS-117

One for the Road

(Continued from page 47)

your car should be sufficient. The same antenna will do for weaker signals if you hold the receiver out of a window, but for best results you should mount a good VHF antenna on the outside of your car.

Very little "trimming" or adjusting will be required, although in some cases it may be necessary to vary the location of the point where antenna coupling capacitor $C1$ is tapped onto the tuning coil in order to get the detector to oscillate. It's a good idea to make this connection at the grid end of the coil as a start. Then, if the detector refuses to oscillate even with the regeneration control at maximum, move the tap one turn closer to the center of the coil.

The ideal method of checking the frequency range covered by the receiver is to feed in signals of known frequencies from a signal generator. Lacking a signal generator, the range can be checked with an absorption-type wavemeter or a grid dip meter, since the detector is of the oscillating type. And, even if you don't have either of these instruments, it's always possible just to tune in "known" stations and use the dial settings as marker points. Some "squeezing" or "pulling" of the coil may be required in order to get the set to tune the intended range.

If speaker operation is desired, it should be an easy trick to feed the output of the circuit in Fig. 1 into the audio portion of your car radio, as mentioned earlier. Just be certain that you have a coupling capacitor at the input to the amplifier in order to keep the small amount of d.c. at the output jack from being fed into the audio amplifier.

Since a superregenerative detector also produces frequencies just above the audible range, an amplifier capable of passing these frequencies—a hi-fi unit, for example—may be inclined to "howl" when connected to the receiver. This noise can usually be stopped by placing a 0.01- μ f. capacitor across the output of the circuit in Fig. 1.

Ready to Go. However you use this little receiver, you'll find that it boasts

a sensitivity equal to that of units costing many times as much. On the other hand, the output of a single tube with less than a milliampere of plate current can't give more than medium headset volume when used by itself, so don't expect the impossible. As we said before, this is an auxiliary receiver—just "One For The Road." -30-

Transformer for D.C.

(Continued from page 69)

is approximately 80 volts with no load, the inverter is working properly.

Ohm's law can be used to relate power output, load resistance, and output voltage: $P = (E_{out})^2/R$. Thus, if we have 130 volts out and a resistive load of 3000 ohms, the power output would be 5.63 watts. The maximum allowable load in watts is numerically equal to $1.4 E_{in} - 2.1$, and the load resistance drawing maximum allowable power will be approximately equal to $800 \times (E_{in})^2/P - 1600$. For example, with 6 volts input, the maximum load is 6.3 watts, as provided by a resistor of approximately 3000 ohms. The input voltage may range from 3 to 8 volts.

The approximate output voltage for any input between 3 and 8 volts and any load resistance equal to or larger than that drawing maximum allowable power can be calculated using the simple formula and equivalent circuit shown in Fig. 5. With a 6-volt input and a 5000-ohm

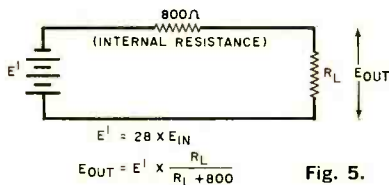

Fig. 5.

load, for example, the output will be $28 \times 6 \times 5000/5800$, or about 145 volts, and the power output will be $(E_{out})^2/R$, or approximately 4.2 watts.

A word of warning: this inverter can provide a nasty shock if you're not careful, so treat the output terminals with respect! -30-

The Fish Finder

(Continued from page 60)

will remain. And, when adding hot or cold water to make adjustments, always mix well so that the temperature will be uniform throughout the liquid.

Now set potentiometer *R5* at mid-range and place *RT1* in the water. Wait several seconds for the temperatures of the Thermistor and surrounding water to equalize, and depress *S2*. Then adjust potentiometer *R2* so *M1* reads "Zero."

Prepare another jar of water as above, but this time set the temperature at 90°F (or at the upper limit of the temperature range you desire). Place *RT1* in the water and wait several seconds. Then depress *S2* and adjust *R5* for a reading of exactly full scale on *M1*.

If you have used both the specified meter and the temperature range employed by the author, this just about completes the calibration procedure.

It is not really necessary to make up a new face for *M1* as the author did; the meter, as supplied, has exactly 50 divisions, so each division represents one degree. Since the resistance change of *RT1* is not exactly linear with respect to temperature, however, there will be a slight error around the mid scale of the meter (the 40° and 90° points, of course, remain accurate). For most purposes, this error is small enough to be ignored.

Should you use a different model meter (any 0-1 ma. unit will work) or temperature range, though, you might find it impossible to use the meter face supplied. In this case, after setting *R2* and *R5* as above, you must gradually vary the temperature of the water in your calibrating bath, marking each degree on the meter as indicated on your thermometer.

With the temperature adjustments taken care of, only one more step remains before the Fish Finder is ready for service. Just press *S1* and *S2* simultaneously (the temperature of *RT1* makes no difference here) and note the meter

FIRST ON CB



THE TURNER 350C

Microphones always come first with us—we're a one line company of microphone specialists. This has helped make the Turner Model 350C the microphone most used as standard equipment on CB.

THE TURNER MICROPHONE COMPANY
946 17th Street NE
Cedar Rapids, Iowa



with 1 pair of crystals,
microphone and power cables

\$179.50

NOW... Tomorrow and for years to come!

Sonar CITIZENS BAND RADIO

- 8 Channels, crystal controlled transmitter and receiver
- Tunable receiver for 22 channels
- Transmitter 100% Class B modulated
- Adjustable squelch
- Automatic noise limiter
- R. F. Power indicator
- 1 Year guarantee
- Easy to install. Ideal for home, boat, car or business.
- Weighs only 9 lbs. ... 4¾ x 9½ x 11¼
- FCC Type accepted (° in preference to only certification).

SONAR RADIO CORPORATION, 73 Wortman Ave. • B'klyn 7, N.Y.
Please send me complete information on Model "E" CB Radio. Dept. 142

NAME _____
ADDRESS _____
CITY _____ STATE _____

Your Copies of POPULAR ELECTRONICS



ARE
VALUABLE

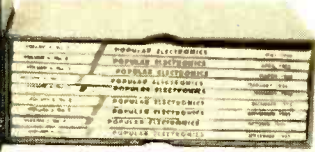

**KEEP THEM NEAT . . . CLEAN . . .
READY FOR INSTANT REFERENCE!**

Now you can keep a year's copies of POPULAR ELECTRONICS in a rich-looking leatherette file that makes it easy to locate any issue for ready reference. Specially designed for POPULAR ELECTRONICS, this handy file—with its distinctive, washable Kivar cover and 16-carat gold leaf lettering—not only looks good but keeps every issue neat, clean and orderly. So don't risk tearing and soiling your copies of POPULAR ELECTRONICS—always a ready source of valuable information. Order several of these POPULAR ELECTRONICS volume files today. They are \$2.50 each, postpaid—3 for \$7.00, or 6 for \$13.00. Satisfaction guaranteed or your money back. Order direct from:

JESSE JONES BOX CORP. Dept. PE

(Established 1843)

Box 5120 Philadelphia 41, Pa.

ASSEMBLE THIS ALL BAND BATTERY SHORT WAVE RADIO FOR \$9.95!



LISTEN AROUND THE WORLD—UP TO 12000 MILES AWAY!

Ships, Aircraft, Voice of America, Russia, London, Australia, Amateur, Citizens, Police—Also USA Broadcast. 5 WAVE BANDS, 5 to 40 MC. Calibrated tuning dial, wt. only 3 lbs. WONDERFUL FOR EVERYONE—NOW HEAR THE WHOLE WORLD TALKING DAY OR NIGHT! Send only \$1.00 (cash, ck., mo) for EZ plans, parts lists, prices, photos and details on kit or factory wired. CREDIT ALLOWED ON PARTS.

WESTERN RADIO • DEPT. BRE-7 • KEARNEY, NEBR.

reading. This is the battery voltage reference point (see below) and should be marked by a small dot on the meter face.

Using the Fish Finder. All you have to do is lower the Thermistor to the desired depth, wait a bit, and press *S2* to take a reading. Continuous readings may be taken by holding *S2* in the depressed position and slowly lowering *RT1* from the surface. Be sure you allow enough time for the temperature change to register at each level before you move on.

From time to time, depress *S1* and *S2* simultaneously and check to see that *M1*'s reading corresponds to the battery voltage reference point. If it does not, adjust *R5* until it does. When *R5* will no longer perform this adjustment, it's time to change the battery. -30-

The Whistle Switch

(Continued from page 66)

Now run the mike cord and a heavy-duty line cord into the main box and complete the wiring. Trim each lead from the terminal strip assembly, as you come to it, to an appropriate length. Use #16 hookup wire for the leads running from *S1* to *J1* and the contacts of *K2*. Elsewhere, #22 wire may be used.

Operation. Plug the apparatus to be controlled into *J1*, plug the Whistle Switch into the line, and close *S1*. Set the microphone well away from the main unit. The sensitivity control (*R1*) should be adjusted so that the relays just respond to your whistle under actual operating conditions.

Because of manufacturing variations in the transistors, the sensitivity of your unit may vary from that of the author's model. If the sensitivity is too high (relays respond to extraneous noise regardless of the setting of *R1*), increase resistor *R3* to 1.5 megohms. Should the sensitivity be too low (relays don't respond at all), try reducing *R3* to 750,000 ohms.

The power-handling capacity of the Whistle Switch depends primarily on the rating of relay *K2*'s contacts. With the relay specified here, loads up to about 600 watts can be safely controlled. -30-

First Aid for Printed Circuits

(Continued from page 56)

in a "down" condition until a replacement board can be obtained.

If you do decide to repair a cracked board, simply drill two small holes (1/16" or less in diameter) about 1/4" on either side of the crack. These holes will allow the insertion of a loop of wire to hold the cracked board together; naturally, the loop should be located where it will not interfere with the wiring of any of the components.

The cracked board should then be drawn tightly together and the loop secured. In some cases, you may want to make more than one loop, depending on the length of the crack as well as the precise amount of open board area you happen to have at your disposal.

After the loops have been secured, use the point of a sharp knife to form a slight channel along the course of the crack, then fill this channel with house-

hold or epoxy cement. When the cement has set, the board is again ready for use.

Summing Up. Although this discussion of printed-circuit repair is by no means exhaustive, it should help you understand some of the principles involved. For just as printed boards represent a distinctive type of wiring, so, too, they

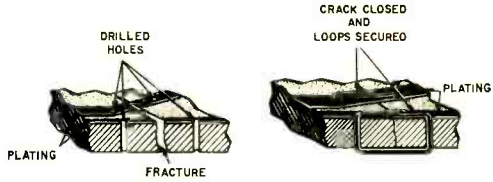

With one or two loops of fine wire and some cement, it's easy to repair cracked printed-circuit boards.

require a distinctive type of repair with a specialized approach.

Actually, an extensive survey has indicated that printed-circuit boards require far less servicing than circuits with conventional wiring. But when servicing is needed, the techniques outlined above should prove helpful.

-30-

NOW . . . AT LAST YOU CAN SAVE ON FAMOUS MAKE TUBES!

BRAND NEW FAMOUS MAKE

Radio & TV

TUBES

65% To
90% OFF LIST

SPECIAL OFFER . . .

For Limited Time Only! FREE Spanking New SILVER DOLLAR With Order Or \$25 Or More

Part Listing - Almost Every Famous Make Tube in Stock!

TYPE	PRICE	TYPE	PRICE	TYPE	PRICE	TYPE	PRICE	TYPE	PRICE	TYPE	PRICE
02A	.79	5CL8A	1.10	6BC8	1.39	6CL6	1.49	7AU7	.90	12CU6	1.49
1A7GT	1.39	5CZ5	1.49	6BE6	.77	6DA1A	.77	7B5	.99	12L6GT	.87
1G3/1B3GT	.99	5FV8	1.10	6BG6GA	2.08	6DE4	.98	7H7	2.83	12SA7GT	1.49
1H5GT	1.39	5J6	.95	6BH8	1.19	6DE8	.85	7C5	1.19	12SK7GT	1.31
1L5	1.49	T8	1.15	6BR6	.91	6DK6	.80	7F7	.99	12SN7GT	.84
1NSGT	1.82	5U1GB	.69	6BK1	2.69	6DN6	1.19	7N7	2.49	12SQ7GT	1.29
1J5	.55	5V8	1.15	6BK5	1.29	6D9B	1.39	8AW8A	1.27	12X1	.65
1T4	.82	5V8	1.25	6BR7B	1.15	6DT6A	.75	8BH8	1.19	12XDE7	1.19
1U4	.87	5V4GA	1.22	6BL1	2.25	6EAT	1.19	8CG7	.87	12BD7	1.03
1U5	.75	5V8	1.11	6BL7GTA	1.45	6EAS	1.07	8CM7	.95	14A7	1.99
1X2B	1.06	5V3GT	.44	6BR8	1.10	6EM7	1.69	8CN8	1.29	14B6	1.46
2CY6	.95	6AM4	.75	6BR5	.79	6H6	.55	8E8B	1.19	14Q7	1.99
3A3	1.15	6AC7	1.09	6BR6GTA	1.39	6J5GT	.49	8ET7	1.36	17AX4GT	.94
3AL5	.85	6AF4A	1.40	6BT3A	1.19	6GA	.95	9AU7	.87	17D1	.95
3AU6	.75	6AG5	.95	6BR8A	1.27	6H6GT	.89	9UBA	1.21	17DQ6B	1.47
3BN6	.99	6AH4GT	1.15	6BR8	1.29	6H7B	2.89	10D17	1.19	19A UJ	1.19
3BY6	.75	6A16	1.01	6BR8	.95	6SA	.71	11C77	1.13	19BG6GA	2.15
3CB6	.79	6AK5	1.49	6BY5GA	1.59	6SA7GT	1.43	12AE6A	.69	19T8	1.17
3DK6	.98	6AL5	.64	6BZ6	.78	6SN7GT	1.34	12AF6	.79	25CD6GB	1.99
3V4	.85	6AM8A	1.19	6BT7	1.40	6SL7GT	1.19	12AT6	.63	25L6GT	.79
4HC6	.82	6AN8	1.39	6C1	.64	6SN7	1.01	12A7T	.99	25V4GT	.84
4BQ7A	1.47	6AQ5A	.89	6CH6	2.79	6SQ7GT	1.36	12AV6	.75	32E7	.77
4V2A	.75	6AS5	.83	6C6B	.75	6C6	1.15	12AL7A	.86	32E7S	.77
4EH7	1.33	6AS8	1.33	6CD6GA	1.99	6UBA	.74	12AX4GT	.89	35L6GT	.84
5AM8	1.24	6AU6A	.69	6CT7	.86	6V6GT	1.04	12AX7A	.85	35V4	.89
5AN6	1.40	6AU8A	1.19	6CC8B	1.15	6V7GT	.79	12BAG	.67	35Z5	1.99
6AQ5	.75	6AV5GA	1.39	6CL8	1.25	6V6GT	.98	12BE6	.69	50A5	1.99
6ASA8A	.90	6AV6	.57	6CL8A	1.10	6X4	.55	12BH7A	1.05	69C5	.75
6AT8	1.15	6AW8A	1.30	6CN7	1.19	6X8	1.09	12BW7A	1.49	69PC1	.52
6BR8	1.27	6AX4GTB	.90	6CN7	.59	7A7	.59	12BY7A	1.09	117L7GT	2.99
5CG8	1.10	6BAG	.69	6CQ8	1.10	7AG7	.89	12C5/12C5S	.80	117Z3	1.49

Money cheerfully refunded within five (5) days, if not completely satisfied! **FREE POSTAGE ON ORDERS OF \$5 OR MORE IN USA AND TERRITORIES.** 25c Handling Charge required on any order less than \$5. Send 25c deposit on C.O.D.'s. Send approximate postage with Canadian and foreign orders. No minimum purchase required . . . You get these low prices on any quantity you buy!

STANDARD BRANDS TUBE COMPANY

ROMANO BUILDING

HARRISON, NEW JERSEY

HU. 4-9848

Dept. PE 7

1962 CAR AND DRIVER YEARBOOK

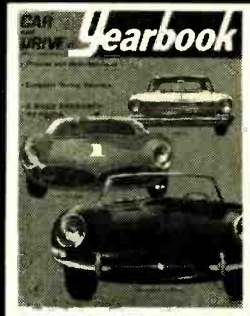

**your buying guide
to 224 new cars**

Here's the one place you can compare the 224 foreign and domestic cars on the market — complete with pictures, prices performance data and specifications.

Plus these exclusive features:

- Road Research Reports on 8 top cars by the editors of CAR AND DRIVER
 - Survey of technical developments
 - Listing of all importers of cars in the U.S.—complete with addresses
 - Gallery of famous drivers
 - Interviews with top executives in the automotive industry and in government
- The 1962 CAR AND DRIVER YEARBOOK is now on sale. Get your copy today at your favorite newsstand. Or send in this coupon and we will mail your copy.

Only \$1.00

Retail Sales Division
Ziff-Davis Publishing Co.—Dept. BT
One Park Avenue
New York 16, New York

Please send me a copy of the new 1962 CAR AND DRIVER YEARBOOK. I enclose \$1.00, the cost of the YEARBOOK, plus 10c to cover mailing and handling charges. (Canada and Foreign, \$1.25 plus 10c postage.)

Name _____

Address _____

City _____ Zone _____ State _____

(add 3% sales tax if New York City resident)

PE782

Radiation Fallout Monitor

(Continued from page 41)

Operation. First of all, remember that this is not a precision instrument. Nor will it respond to extremely high levels of radiation (about 60 counts per second, as mentioned earlier, is the maximum). For this reason, it's not suitable for use in locating areas of heavy contamination during emergencies. What it will do is provide an approximate indication of the normal level of background radiation in your area, giving positive evidence when the count varies excessively.

To operate the device, just plug it into the line. (No on-off switch is provided because the current drain is so low that the unit can be left running continually.) After the thyatron heater has warmed up, the instrument will begin to respond to background radiation. This activity will be sporadic—there may be no pulses for several seconds, then several at once.

To get an idea of the counts per minute at any given time, always make your observations over a period of several minutes and take an average. The author has measured rates ranging from a low of 30 counts per minute to a high (during a period of fallout from the Russian bomb tests) of over 100. In the P.E. editorial offices, as this article is being prepared for publication, the instrument registers about 15 counts per minute.

Small variations in the rate are not significant (they may be due, in part, to variations in line voltage). But if the radiation level begins to drive V_2 at a frequency close to its maximum ability to respond, chances are that something unusual has occurred.

If you find your instrument counting at a very high frequency, don't be immediately concerned about radiation injury (even luminous watch dials, when placed close to V_1 , will produce quite high rates). You'd better check your radio, though, to see if there's anything going on. We hope that a radiation emergency situation will never arise, but if it does, remember that official information and instructions will be broadcast (via Conelrad) over 640 or 1240 kc. on your AM dial.

—50—

On the Citizens Band

(Continued from page 78)

are available, in addition to full tunable coverage of all 23 channels.

Julian M. Sienkiewicz, 2W5115 (Managing Editor of POP'tronics), tied in his TR-27 with the "Gabble Killer" described in the April 1962 issue. The



base station (see photo) is the pride of his XYL, who reports no QRM to interfere with the hi-fi set.

Call-Sign Auto Licenses. Back in the April issue, we reported that there was an outside chance of CB'ers being able to obtain call-sign auto license plates, and that the state of Wisconsin had already approved several applications for these plates. This was a false rumor. The Wisconsin Motor Vehicle Department has since informed us that Wisconsin does *not* issue license plates with Citizens Band call-signs. The confusion was probably due to the fact that the state *does* issue plates incorporating amateur call letters, provided that the hams have the necessary receiving and transmitting equipment permanently installed in their cars.

Club Notes. The 5-11 Radio Club of Pittsburgh (868 Glass Run Rd., Pittsburgh 36, Pa.) has celebrated its third anniversary. This organization gained national recognition and local promotion through a series of radio programs on station WYRE and a feature article in the Sunday *Pittsburgh Press*. . . . Jack Leach, Publicity Chairman of the 27 Meggers C.B. Club (1814 Beaconwood,

THE CLUB PAPER

Does your CB club want to start a newspaper? If you're not sure how to go about it, you'll be interested in a 56-page booklet entitled "The Club Paper" which tells the would-be editor exactly what to do. Written by Ralph Anderson, W3NL, who has been editor of a club newspaper himself for many years, it discusses duplicating methods, offset, preparation of copy, assembly, addressing and mailing methods and procedures, inexpensive do-it-yourself printing and photographic equipment. If you'd like a copy, send 50 cents (in coin or stamps—*no checks*) to cover handling costs to Ralph V. Anderson, W3NL, 2509 32nd St., S.E., Washington 20, D.C. The supply of copies available is limited, so don't delay.

South Euclid 21, Ohio) was the winner of the Browning Golden Base Station which was on display at the NCRL convention at Chicago recently. . . . Four members of the Qui-Co Citizens Radio League (1748 Centre Ave., Reading, Pa.) participated in a mock alert with the 9209th Air Force Reserve Recovery Squadron, providing back-up communications. . . . The CB Socialites, in Massachusetts, is a unique organization in that its primary purpose is strictly social. Perhaps this is the secret of its success. It does provide emergency mobile communications, and has been called upon in the past to do just that, but the club is best known for its outings, trips, and picnics. Contact Frank W. Marshall, 7 Newton Ave., Haverhill, Mass., if you're interested in joining.

-30-



"How do you read us? . . . Over . . ."



If you've recently changed your address, or plan to in the near future, be sure to notify us at once. We'll make the necessary changes on your mailing plate, and see to it that your subscription continues without interruption. Right now—print the information requested in the spaces below and mail it to:

**POPULAR ELECTRONICS,
434 So. Wabash Ave., Chi-
cago 5, Illinois.**

Name _____ Please PRINT!

°Account No. _____

Old Address _____

City _____ State _____

New Address _____

City _____ Zone _____ State _____

Mail copies to new address starting with
.....issue.

*(Your Account Number appears directly
above your name on the mailing label.)

Coupling Quiz Answers

(Quiz on page 80)

- 1 — **F** Direct coupling feeds the output from the plate of one stage directly to the grid of another. It is the only type of coupling that has a frequency response without lower limit.
- 2 — **C** R-C coupling (for resistor-capacitor coupling) requires a coupling capacitor and a grid resistor in addition to the plate load resistor. It is the most popular type for voltage amplifiers, since the cost, size, and weight of the necessary components are very low, and frequency response is broad.
- 3 — **G** A tickler winding on a coil makes use of inductive coupling to permit signals from the plate circuit to be fed back to the grid circuit.
- 4 — **E** Impedance coupling provides a method of obtaining a high value of plate load impedance with a corresponding low d.c. voltage drop. The inductor has little d.c. resistance but a high reactance at the frequencies to be handled.
- 5 — **H** Cathode-coupling results in a circuit which is essentially a cathode follower driving a grounded-grid amplifier. It provides a high degree of isolation between the input and output circuits.
- 6 — **A** Link coupling is a variation of inductive coupling, since it effectively produces inductive coupling between two coils having no mutual inductance. Its chief use is in r.f. circuits.
- 7 — **D** A gimmick consists of two insulated conductors twisted together to provide a capacitive coupling sufficient to pass a small amount of signal.
- 8 — **B** Transformer coupling provides a low d.c. voltage drop as well as proper impedance matching. A high-quality unit is required for good frequency response.

Across the Ham Bands

(Continued from page 76)

News and Views

Bob Read, WNØAGF, 103 Arcadian Ct., McPherson, Kansas, excites a 40-meter dipole antenna with a home-brew transmitter sporting a pair of 807's in the output stage. With a war-surplus BC-312 to do the receiving, Bob's 40-meter total is 41 states worked. He also works 2 meters with a Gonset IV Communicator, plus a surplus T-23 transmitter and a 2-meter converter in front of the BC-312. States are far apart in the west, so he has only two states worked on that band. . . .

Bob Plechaty, K9CGD, 2427 Westover Ave., North Riverside, Ill., works both phone and CW on 2 meters. A home-built transmitter running 12 watts input to the 6360 final tube (featuring "controlled-carrier" modulation of his own design) drives a Hy-Gain 210, 10-element beam in the attic. A Hallicrafters SX-101A, plus a home-built converter ahead of it, takes care of bringing the signals in. "Not many states worked, but a lot of swell contacts" covers Bob's record. . . . **James**

John W. Laing, KN7PRS, 2540 E. Heatherbrae, Phoenix, Ariz., uses a good portion of the wide-open spaces in the west for his antenna farm; it contains a 3-element, wide-space, 15-meter beam antenna, dipoles for 80 and 40 meters, and a 20-element beam for 2 meters, all 25' high. A Harvey-Wells T-90 transmitter handles the 15-, 40-, and 80-meter bands, while a Johnson 6N2 and a home-built transceiver take care of 2 meters. A Hammarlund HQ-170 receiver, plus a "W7RVX" home-brew, 2-meter converter, does the receiving. Forty states and 11 countries make up John's brag list, but he's still waiting for QSL cards from some of them. His favorite bands are 15 and 2 meters. . . . **Sid Bondurant, WN5AIX**, Box 215, Forest, Miss., envies those Novices with walls full of QSL cards. His first seven months as a Novice were spent getting his equipment and then replacing burned-out components in it. But he worked Minnesota on his first CQ—not bad for 80 meters and an antenna 12'

high. Watch him go now. Sid's transmitter is a Heathkit DX-35, and his receiver is a Hallicrafters S-20R.

Bob Stewart, WV2WJU, 1459 Lombardy Blvd., Bayshore, L. I., N. Y., says he works nights and hams all day—sometimes to the disgust of his wife. In five months on the air, this system has put 36 states and 11 countries into Bob's logbook. A Globe Chief 90A transmitter feeds his 40-meter dipole antenna on both 40 and 15 meters. Bob must like receivers; he has three of them—a Hammarlund HQ-140X, a Hallicrafters S-20R, and an RME 69. . . . **Rog, KN1SPM**, 62 Mark St., Springfield, Vermont, offers to sked any Novice who needs a Vermont contact. Better make the sked on 40 or 80 meters; his receiver doesn't work on 15 at



Walt Pinner, WN8BHK, Novi, Mich., uses homemade equipment except for the receiver, a Knight R-100, which he put together from a kit. Walt operates on 80 and 40 meters, has worked 36 states and Canada.

present. Rog's "monster" is a Globe Chief 90A feeding separate dipoles 50' high on each Novice band. The receiver is a National NC-109. Twenty-seven states and GI6YM, Northern Ireland, are what Rog talks about when asked "What have you worked?"

Bill Harding, WA6SMD, Box 424, Westwood, Calif., disagreed with my comments in the February column that fellows with an inexpensive receiver and an inefficient antenna often get better results on the lower frequency amateur bands than on 15 meters. Running 40 watts to his transmitter with one crystal and receiving on a "\$10.00 regenerative receiver," Bill reports working 11 states east of the Mississippi on 15 in three days. He didn't mention the type of antenna he was using. . . . **Allen Jones, K9DZE**, 211 S. Roeske, Michigan City, Ind., used a home-brew 25-watter during his Novice career. Now he has both a Heathkit DX-35 and a Globe Chief 90A transmitter to go with his General license. He uses the VFO described in our December 1961 column to drive them.

Let's hear from YOU for the next *Across the Ham Bands*. Send all mail for the column to: Herb S. Brier, W9EGQ, Amateur Radio Editor, POPULAR ELECTRONICS, P. O. Box 678, Gary, Indiana, 73.

Herb, W9EGQ

ATTENTION WESTERN NOVICES!

The Northwest Slow Speed Net (NSN) meets every night except Sundays on 3700 kc. at 0500 GMT (9:00 p.m. PST). At least one member tunes the entire 80-meter Novice band for calls from "rock-bound" Novices who want to report into the net. All new members receive an attractive net QSL card, and a request accompanied by a stamped return envelope will bring a sheet explaining NSN operations. Address the request to: Jim Cassidy, K7IWD, 4224 S. E. View Acres Rd., Milwaukie 22, Oregon.

POPULAR
ELECTRONICS

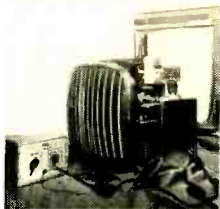

Send
**POPULAR
ELECTRONICS**
Every Month

NAME.....

ADDRESS.....

CITY..... ZONE..... STATE.....

3 years for \$10

Check one: 2 years for \$7

1 year for \$4

in the U. S., and possessions.

Payment Enclosed Bill Me

Foreign rates: Canada and Pan American Union countries, add .50 per year; all other foreign countries, add \$1 per year.

New Renewal

Mail to:

POPULAR ELECTRONICS

Dept. PE-762H, 434 S. Wabash Ave.

CHICAGO 5, ILL.

Short-Wave Report

(Continued from page 82)

can still log many of the rare stations by careful tuning and infinite patience.

Q: Why not publish a list of "materials" that are available from the short-wave stations, such as leaflets on antenna tips, reception ideas, and the like?

A: Unfortunately, we do not have such a list at hand. If you'll work one up, we'll be glad to include it in a future column.

Q: In a recent column, you suggested that Swan Island might not be the actual location of *Radio America*, formerly known as *Radio Swan*. Exactly where is this station?

A: We have no positive proof as to whether this station is or isn't on Swan Island, since we continue to receive conflicting reports. During the past week alone, one report stated in no uncertain terms that the station was on Swan Island, while another report—from an airline pilot equipped with a direction-finder—claimed that the station was aboard ship, apparently in an eastsoutheastward direction from Miami. In his letter, the pilot said that he had flown over the ship.

If you have any questions which you think might be of general interest, send them in. We'll try to answer them in a future POP'tronics "Mailbag."

Current Station Reports

The following is a résumé of current reports. At time of compilation all reports are as accurate as possible, but stations may change frequency and/or schedule with little or no advance notice. All times shown are Eastern Standard and the 24-hour system is used. Please send all reports to your Short-Wave Editor, P. O. Box 254, Haddonfield, N. J., in time to be in our hands by the eighth of each month. Be sure to include your WPE call letters.

Andorra—*R. des Vallees d'Andorre*, 6305 kc., is noted at times at 0104-0130 with variety music and a good signal.

Austria—The latest schedule for Vienna as

Always say you saw it in—POPULAR ELECTRONICS

read over the air is as follows: 21,475 kc. at 0500-0700; 17,865 kc. at 0800-1100; 17,765 kc. at 1100-1300; 15,305 kc. at 0300-0500; 11,785 kc. at 0300-1200; 9770 kc. at 0600-1200 and 1800-2300; 9610 kc. at 0100-0400; 9540 kc. at 1900-2300; 7245 kc. at 0900-1500; 7200 kc. at 0100-0900; and 6155 kc. at 2330-1700 and 1800-2000. Most of the programs are made up of music and the ID is usually given in Eng., Ger., and French. Reports go to Austrian Shortwave Service, Vienna 50, Austria.

Brazil—"Don't destroy your radio set yet," said a Ger. language advertisement in a Brazilian newspaper. It suggested that the readers tune to *R. 9 de Julho*, 9620 kc., for "Melodian de Ultramar" daily at 1900-2000 and "Klassische Meistermusik" on Sundays and holidays at 1300.

Ceylon—The Commercial Service continues to be noted at times on 15,265 kc. around 2030-2230 with Eng. news, records, and ads. Another outlet is 9560 kc., noted at 1030 with a soap commercial and "Musical Medicine" program in English. The *Voice of America* has opened up on 11,725 kc. at 0700-0800 in English.

Chile—*R. Corporacion*, Santiago, is heard on 15,150 kc. at 1830-1930 with sports, news at 1900, a play at 1910. This station was also heard at 0700 with news. All programs are in Spanish.

CE1190, *R. Cooperativa Vitahicia*, Valparaiso, 11,900 kc., was noted with Coca-Cola ads at 1855, news at 1900.

Colombia—HJGF, *R. Bucaramanga*, 4845 kc., has an Eng. program daily at 2200-2300. They verify with a pennant, letter, and some Colombian stamps.

Congo—A station reported on 10,690 kc. is *R. Bukavu*, according to *Sweden Calling DXers*. Reception time was given as 1300, with local time given as GMT plus 2½ hours.

Cuba—This appears to be the latest schedule from Havana: to North, Central, and South America in Sp. at 0600-1245 on 5990, 6017, 9765, and 15,340 kc., at 1600-0115 on 6017 and 9765 kc., at 1600-2200 on 5990 kc.,



Bill Rogers, WPE4DJQ, of Asheville, N. C., listens with a Knight Ocean Hopper and an Echophone receiver, aided by a 50' long-wire antenna. To date he has 18 countries logged, 10 of which are verified. Bill also holds the amateur call WN4EMB.



BLUE RIBBON QUALITY

UTICA Leads The
Way With



THE NEW
T&CII

FEATURES:

- 5 Channel crystal controlled transceiver
- Tunable receiver
- "S" meter
- Output strength indicator
- External crystal socket
- Auxiliary speaker terminal
- Dual conversion
- Built in noise limiter and squelch circuit
- Universal power supply—6 VDC, 12 VDC, 110 VAC
- Chrome cabinet

UTICA ALSO PRODUCES

- MC27 Town & Country Transceiver
- Gizmotchy Horizontal-Vertical Beam Antenna
- Buddy Whip Mobile Antenna
- Buddy Drooping Ground Plane Antenna

UTICA COMMUNICATIONS CORP.

5055 N. Kedzie Avenue • Chicago 25, Ill.

NEVER FAIL—

ZONE YOUR MAIL

The Post Office has divided 106 cities into postal delivery zones to speed mail delivery. Be sure to include zone number when writing to these cities; be sure to include **your** zone number in **your** return address—after the city, before the state.

B. S. DEGREE IN 36 MOS.

INDUSTRY AND GOVERNMENT NEED 50,000 NEW ENGINEERS EACH YEAR!

Accelerated year-round program puts you in the job-market a whole year early! Also B.E. degree in 27 mos. Aeronautical, Chemical, Civil, Electrical, Mechanical, Electronics; Math, Chemistry, Physics. Quality instruction; widely recognized. Graduates employed from coast to coast. Self-help program. Modest rate. Start July, September, January, March, June. Catalog: 2472 E. Washington Blvd., Fort Wayne 2, Indiana.

INDIANA TECHNICAL COLLEGE

SHORT-WAVE CONTRIBUTORS

Albert Coie (WPE1COC), Saugus, Mass.
 Paul Pietras (WPE1DBH), East Greenwich, R. I.
 Steve Foisey (WPE11C), Keene, N. H.
 Gene Motter (WPE11W), Needham, Mass.
 Joseph Russo (WPE2CRX), Toms River, N. J.
 Dave Listort (WPE2FGX), Elmont, N. Y.
 Henry Marbach (WPE2FHU), White Plains, N. Y.
 Robert Auerhahn (WPE2FVU), Jericho, N. Y.
 Paul Harig (WPE2GCX), Auburn, N. Y.
 Paul Shuter (WPE2GIA), Long Beach, N. Y.
 Vincent Argenzio (WPE2GME), Rutherford, N. J.
 Adolph Almsay (WPE2GMF), Mastic Beach, N. Y.
 Bruce Coleman (WPE2GVA), Westfield, N. J.
 Gary Davis (WPE2GOY), Collingswood, N. J.
 Richard Witkowski (WPE2GOV), Jersey City, N. J.
 Jack Sand (WPE2IBW), Haddon Heights, N. J.
 Douglas Benson (WPE2MI), Schenectady, N. Y.
 Bill Beaver (WPE3BZI), Mt. Pleasant, Pa.
 Robert Boyer (WPE3CKM), Pottstown, Pa.
 William Streib (WPE3CLA), Baltimore, Md.
 Alfred Ioppolo (WPE3CUG), Philadelphia, Pa.
 Danny Brodt (WPE3CHJ), Gaithersburg, Md.
 Robert Leamy, Jr. (WPE3OM), Erie, Pa.
 Grady Ferguson (WPE4BC), Charlotte, N. C.
 Sim Broadfield (WPE4CCO), Rocky Mount, N. C.
 David Humphrey (WPE4CLO), Savannah, Ga.
 Walter McDonald (WPE4CWU), Hapeville, Ga.
 Isabel Santor (WPE4DXL), Miami, Fla.
 Edward Odum (WPE4EDJ), Mobile, Ala.
 David Doernberg (WPE4EGB), Atlanta, Ga.
 Charles Howard, Jr. (WPE4EHT), Tampa, Fla.
 Buford Reynolds (WPE4EMF), Nashville, Tenn.
 Bruce Orcutt (WPE4ENZ), Brandon, Fla.
 Jimmy Boockholdt (WPE4OAI), Eutaw, Ala.
 Samuel Robertson (WPE5AON), Little Rock, Ark.
 Robert Davis (WPE5AUR), San Antonio, Texas
 Carl Niendorff (WPE5BBX), Dallas, Texas

Jack Keene (WPE5BAIP), Houston, Texas
 Mike Moore (WPE5BOR), Bossier City, La.
 Allen Fryou (WPE5CBW), New Orleans, La.
 Jack Pritchard (WPE5CDV), Dallas, Texas
 Chris Maher (WPE5CEV), Jackson, Miss.
 Bessie Coston (WPE5CFO), Winfield, Texas
 Ted Drew (WPE5CMS), Arcadia, Calif.
 Gerald Sato (WPE5DBC), Los Angeles, Calif.
 Richard Rush (WPE5DEJ), Maywood, Calif.
 Wayne Erskine (WPE5DHR), San Jose, Calif.
 Steve Coombes (WPE5DIE), Arcadia, Calif.
 Ray Schroff (WPE5AST), Tucson, Ariz.
 Bob Helmeccamp (WPE5DEL), Norwood, Ohio
 Mike Kander (WPE5MS), Dayton, Ohio
 Robin Fisher (WPE5OG), Beach City, Ohio
 Barry Norrgran (WPE5PHZ), Lansing, Ill.
 Robert Miller (WPE5CLI), Milwaukee, Wis.
 Jon Lenard (WPE5CSB), Des Plaines, Ill.
 Dan Lyon (WPE5DMJ), Lincolnwood, Ill.
 Joe Brown (WPE5DTO), Chicago Heights, Ill.
 Tom Reitze (WPE5EDO), Evanston, Ill.
 John Beaver, Sr. (WPE5OAE), Pueblo, Colo.
 Bill Holscher (WPE5GTE), St. Louis, Mo.
 Tim Hartmann (WPE5BBS), St. Louis, Mo.
 Gerry Dexter (WPE5OJJ), Waverly, Iowa
 Pfc. Victor Norwood (DL3PE1AE), APO, New York, N. Y.
 Edward Tilbury (KL7PE1K), Eagle River, Alaska
 B. D. Minielly (VE3PE1K), Kitchener, Ont.
 Brian Casey (VE3PE1IF), Ottawa, Ont.
 George Kennedy (VE3PE1MT), Kingston, Ont.
 Bernard Brown (BB), Derby, England
 James Britton (JB), Brockway, Pa.
 Marlin Field (MF), Benton Harbor, Mich.
 Harley Rutstein (HR), Englewood, N. J.
 G. Schmeisser (GS), Lindenhurst, N. Y.
Sweden Calling DXers Bulletin

at 1600-1800 on 15,340 kc., at 1815-2245 on 11,760 kc., and at 2300-0115 on 6060 kc., Eng. at 2200-2330 and 0000-0100 on 5990 kc., Fr. at 2330-0000 on 5990 kc.; to Europe on 15,290 kc. at 1400-1445 in Fr. and to 1545 in English; to Mediterranean areas at 1300-1430 in Fr. and to 1545 in Sp. on 15,140 kc. (varies to 15,190 kc.) and in the 16-meter band, exact frequency not definite.

A new station with the call-sign CMKX is noted well at 1700-2300 on 5563 kc. in the midst of the aero channels.

Czechoslovakia—Prague has opened on 7438 kc. with uninterrupted Czech and classical music at 2000, then into Sp. at 2100. This is apparently a crude attempt to block *R. Libertad* on the same channel. Programs in Eng. are noted to N.A. at 2200-2300 and 0000-0100 on 5930, 7345, 9550, 9795, and 11,990 kc., and to New Zealand, Australia, Japan, and Far East areas at 1300-1355 on 11,725, 15,285, and 21,450 kc.

Egypt—Cairo is heard on 12,050 kc. at 1330-1400 in Persian beamed to the Middle East; on 11,745 kc. in Arabic at 2215-2230 (this is the Home Service); and on 17,750 kc. at 0830-0930 with Eng. news, talks, and native music.

Fiji Islands—Suva will soon be testing the second 10-kw. xmtr on 4785 kc. This is to be used for Eng. programs. The first 10-kw. unit operates in Fijian on 4755 kc. and has been heard at 0230-0300 with native language and music.

Germany (West)—Here is the schedule for *Die Deutsche Welle*, Cologne: to Eastern N.A. at 1900-2200 on 6100, 9575, and 9640 kc., and at 1715-1845 on 6100 and 9605 kc.; to Western N.A. at 2200-0100 on 6100, 9575, and 9640 kc., and at 0000-0130 on 6145 and 9735

kc.; to Central America at 2045-2345 on 6145 and 9735 kc., and at 1900-2030 on 6145 and 9605 kc. A Persian service has been started at 0500-0525 on 17,845 kc. in parallel with 15,405 and 11,795 kc.

Italy—Rome has opened on 11,905 kc., dual to 9575 kc., and has dropped 6010 kc. for the 1930-1950 and 2205-2225 broadcasts to North America.

Japan—The latest schedule from Tokyo reads: to N.A. at 1930-2030 on 17,895, 15,390, and 15,135 kc.; to N.A. and L.A. at 2200-0000 on 15,235, 11,780, 11,705, and 9505 kc.; to Hawaii at 0030-0200 on 17,725 and 15,235 kc.; to Europe at 0115-0345 on 15,135 and 17,895 kc.; to Australia and New Zealand at 0430-0530 on 15,235 and 11,875 kc.; to Philippines and Indonesia at 0730-0930 on 11,780 and 15,135 kc.; to S.E. Asia at 0800-1100 on 9675 and 11,705 kc.; to South Asia at 1000-1130 on 9525 and 11,780 kc.; to Middle East and North Africa at 1145-1345 on 7195, 9525, and 11,780 kc.; to Africa at 1500-1600 on 9525 and 11,875 kc. The General Overseas Service is broadcast at 2000-2030, 2100-2130, 2200-2230, 2300-2330, and 0000-0030 on 15,105, 15,195, and 17,755 kc.; at 0100-0130, 0200-0230, 0300-0330, 0400-0430, and 0500-0530 on 11,725, 15,195, and 11,855 kc.; and at 0600-0630, 0700-0730, 0800-0830, 0900-0930, 1000-1030, and 1100-1130 on 11,725, 11,815, and 11,855 kc.

Kuwait—The present schedule for Kuwait Broadcasting and Television Service is 2130-0200 and 0400-1600 on 4967.5 kc. (10 kw.) and 0400-1600 on 15,150 kc. (50 kw.) in Arabic only. A letter from the station mentions the near-future beginning of test xmsns on 6055, 9520, and 15,150 kc. with announcements in "other than Arabic languages" — which should make ID easier.

Leeward Islands—A French-speaking station being reported on 830 kc. in the broadcast band during evening hours has been positively identified as *Radio Caribe Nacional*. St. Lucia. Their schedule reads 0600-0800 and 1000-2115, with Eng. given (and being reported) at 1500-1700. Verification is by letter and colorful travel folder. Do not confuse this station with *R. Caribe*, Santo Domingo, D. R., on 860 kc.

Liberia—ELWA, Monrovia, now operates on 9655 kc., dual to 11,825 kc., on Tuesdays at 2145 to North America. The former is a new frequency.

Luxembourg—*The Station of the Stars* is operated by Compagnie Luxembourgeoise de Telediffusion on 6090 kc. with 5 kw. at 1300-2100. Programs are almost entirely in Eng. and feature American records and many commercials. Reports go to *R. Luxembourg*, 38 Hertford St., London, W. 1, England.

Pakistan—Karachi has Eng. dictation news at 0835-0850 to the Middle East on 11,672 kc. A dual channel, though not heard, may be 21,590 kc.

Pitcairn Island—VR6AC has verified, giving the schedule as "around 2130" (EST) on 14,000 kc. Broadcasts are mostly religious in nature and intended for nearby islands.

Romania—Bucharest is scheduled to N.A. at 2200-2230 and 2330-0000 on 15,380, 11,885, 11,810, 9570, 9510, 7195, and 6190 kc., and at 2030-2130 on all of these channels except 9570 kc. Other broadcasts areas include

SHORT-WAVE ABBREVIATIONS

Eng.—English
Fr.—French
Ger.—German
GMT—Greenwich Mean Time
kc.—Kilocycles
kw.—Kilowatts

L.A.—Latin America
N.A.—North America
R.—Radio
s/off—Sign-off
Sp.—Spanish
xmsn—Transmission
xmtr—Transmitter

Europe at 1430-1500, 1600-1630, and 1730-1800 on 9510 and 7195 kc. (1430-1500 only on 9570, 7195, and 6190 kc.); the Near and Middle East at 1400-1430 on 9570, 7195, and 6190 kc.; Asia at 1000-1030 on 15,250 kc.; Africa at 1000-1030 on 15,380 and 11,810 kc.

Sarawak—Kuching has been noted at 0719-0815, with Eng. news at 0800, on 4950 kc. This is a poor signal and may be extremely difficult to copy.

South Africa—*Springbok Radio*, Paradys, has been heard on 3356 kc. from 2310 to 2330 s/off with recordings and commercials. The 15,275-kc. channel is tuned at 1221-1245 with news, music, science programs.

Spanish Guinea—*R. Ecuatorial*, Bata, 7847 kc. has music and announcements from 1650 with s/off at 1707. Signal is generally poor but it gains towards s/off time.

Tonga Islands—Another very elusive broadcast-band station is ZCO, 1020 kc. Their schedule is 0100-0430 and 1300-1515 Monday through Saturday. There is a mailbag on the first Thursday of every month at 0345, and reports are eagerly welcomed. The address:

1-YR. GUARANTEED RADIO & TV TUBES

NEW LOW PRICE

\$30 PER 100 TUBES

Free Bonus! Plastic Universal alignment tool (regular 99¢ value) with every order of \$8.00 or more.



Factory Used or Factory Second Tubes! TRU-VAC will replace FREE any tube that becomes defective in use within 1 year from date of purchase!

ALL TUBES INDIVIDUALLY BOXED! CODE DATED & BRANDED "TRU-VAC"

Partial Listing Only	Thousands	More Tubes in Stock!	SPECIAL
024 3V4 GAC7	6AV6 6BB8	6C5T	6SN7GT . . . 30c
1A7GT 4BQ7A 6AF4	6AW8 6B88	6C6S	7H7 12AX7 12Q7
1B3GT 4B58 6AG5	6AX4GT 6B75G	6C6U	7N7 12B4 12SA7
1H5GT 4B77 6AH3GT	6AX4GT 6B75G	6C6U	7N7 12B4 12SA7
1R5 4CB6 6AH6	6B8 6B27	6DEE	7A7 7X6 12BA6 12SK7
1S5 5AM8 6AK5	6BA6 6C4	6DC6GT	6SK7 7B4 7X7 12BE6 12SN7GT
1T4 5AN8 6AL5	6BC5 6CA8	6DQ6	6SL7 7B5 7T4 12BE6 12SQ7
1U4 5AT8 6AM8	6BC8 6CB6	6F6	6SN7GT 7B6 7T4 12BF6 12V6GT
1U5 5AV8 6AN8	6BD6 6CD6G	6H6	6SQ7 7B7 12A8 12BH7 12W6GT
1V2 5A24 6AQ5	6BE6 6CF6	6J5	6SR7 7B8 12AB5 12BL6 12K4
1X2 5C68 6AQ6	6BF5 6J6	6T4	7C4 12A06 12B06 17AX4
2AF4 5R4 6AQ7	6BC6G 6CBL6	6J7	6T8 7C5 12AF6 12BR7 17D4
2B4 5T8 6AR5	6BH6 6CB8	6K6GT	6U5 7C6 12A05 12B7V 19AU4GT
2C5 5U4 6AS5	6BJ6 6C8	6K7	6U8 7C7 12A16 12C2A 19BG6G
3AL5 5U8 6AT6	6BK5 6CL6	6N7	6V6GT 7E5 12A17 12CN5 19T8
3BC5 5V4G 6AU4GT	6BK7 6CM6	6G7	6W4GT 7E6 12A06 12D4 25Z6GT
3BN6 5V6GT 6AUSGT	6BL7G 6C16	6G8	6XGT 7F1 12A17 12F8 35A5
3BZ6 5X8 6AU6 6BN6	6CN7 658GT	6X4	7F7 12AV6 12K5 35B5
3CB6 5Y3 6AU8 6BQ6GT	6CQ8 6SA7	6X5GT	7F8 12AV7 12K7 35C5
3S4 6AB4 6AV5GT	6D7 6S8	6S7	7G7 12L6 35W4

BRAND NEW 1-YEAR GUARANTEED TV PICTURE TUBES. Below Listed prices do not include dhd. Add Additional \$5.00 Deposit on tube sizes to 20". On 21" and 24" tubes—\$7.50. Deposit refunded immediately when dhd is returned prepaid. Aluminized tubes—\$4.00 extra. Picture tubes shipped only to continental USA and Canada—All tubes F.O.B. Harrison, N. J.

10BP4 8.95	16RP4 9.95	20DP4 16.95	21EP4 16.95
12LP4 9.95	17AVP4 15.95	20HP4 17.95	21FP4 17.95
14BP4 10.95	17BP4 10.95	21AP4 27.95	21FP4 24.95
16AP4 13.95	17GP4 18.95	21ALP4 23.95	21WP4 20.95
16DP4 10.95	17HP4 12.95	21AMP4 22.95	21XP4 21.95
16CP4 16.95	17QP4 23.95	21AP4 23.95	21ZP4 23.95
16KP4 9.95	20CP4 16.95	21AVP4 23.95	24AP4 28.95
16LP4 10.95	19AP4 15.95	21AWP4 23.95	24CP4 27.95

Sensational Offer!
"Self Service"
TUBE CHECKERS

For Our Warehouse
\$37.95

Let your customers test their own tubes! These reliable, re-conditional 22-socket tube checkers will return your investment in one week or less with little or no effort. Handsome, field-tested console models complete with key for bottom door and neon-lighted head!

USED TV CONSOLES

Require only minor adjustments. 16", 17" and 19" screens . . . none smaller! Special TV Consoles 10", 12" and 14" while they last \$8.95 as is. Sets stamped FOB, Harrison, N. J.

\$16.95
(As Is)

ATTENTION QUANTITY USERS! Big Discounts Are Yours . . . Call or Write for Our New Tube "Private Label" Special! Money cheerfully refunded within five (5) days, if not satisfied!

SHIPPING INSTRUCTIONS: TRU-VAC® PAYS YOUR POSTAGE on orders of \$5 or more in USA and Territories. Send approximate postage on Canadian and foreign orders. Any order less than \$5 requires 25¢ handling charge. Send 25¢ on C.O.D.'s.

TRU-VAC

Dept. PE-7

Harrison Avenue • Box 107 • Harrison, N. J. HUmboldt 4-9770

POPULAR ELECTRONICS

Advertisers' Index

July 1962

ADVERTISER	PAGE
Allied Radio	31
Audio Devices Inc.	3
Capitol Radio Engineering Institute. The	21
Central Technical Institute	9
Cleveland Institute of Electronics	19
Columbia Products Company	22
DeVry Technical Institute	5
E.C.I. Electronics Communications, Inc.	12, 13
EICO (Electronic Instr. Co. Inc.)	36
Electronics Book Service—A. S. Barnes & Co. Inc.	93
Fisher Radio Corporation	24
Grantham School of Electronics	17
Greenlee Tool Co.	20
Grove Electronic Supply Company	22
Hallcrafters	26, 27
Heath Company	89
Holt, Rinehart & Winston, Inc.	28
Hy-gain Antenna Products	10
Indiana Technical College	105
Johnson Company, E. F.	20, 90
Key Electronics Company	24
Kuhn Electronics, Inc.	32
Lafayette Radio	23
Milwaukee School of Engineering	95
Mosley Electronics Inc.	16
Moss Electronics, Inc.	32
National Radio Institute	SECOND COVER, 1
National Technical Schools	11
Nordyke Music Publishers	90
PACO Electronics Co., Inc.	FOURTH COVER
Progressive "Edu-Kits" Inc.	35
RCA Institutes, Inc.	14, 15
RTS Electronics Division	7
Rad-Tel Tube Co.	112
Raytheon Company	33
Sarkes Tarzian, Inc.	THIRD COVER
Schober Organ Corporation, The	4
Scott Inc., H. H.	18
Sonar Radio Corporation	97
Standard Brands Tube Company	99
Tram Electronics	18
Transvision Electronics, Inc.	30
Tru-Vac	107
Turner Microphone Company, The	97
Utica Communications Corp.	105
Valparaiso Technical Institute	90
Western Radio	90, 98, 105

ALL SHORT-WAVE REPORTERS!

Your reports will be read and processed faster if you send them directly to:

Hank Bennett, Short-Wave Editor
POPULAR ELECTRONICS
 P. O. Box 254
 Haddonfield, N. J.

Make sure you include your WPE call letters with your report.

Mr. R. Geoff Hagget, Manager, The Tonga Broadcasting Commission, P. O. Box 36, Nuku'alofa, Tonga Islands.

Upper Volta—*R. Ouagadougou*, Haute-Volta, operates weekdays at 0100-0300, 0700-0830, and 1200-1700 (Sundays at 0300-1800) on 4815 kc. (25 kw.) and 7230 kc. (4 kw.) in Fr., Eng., and vernaculars. No mention was made of 11,630 kc., reportedly being tested.

USSR—*R. Khabarovsk* was noted on 6115 kc. at 0400 with a time signal and talk in Russian. This is dual to 7210 and 9377 kc., and both of these broadcasts were also heard.

Windward Islands—Grenada is noted at 1500-2115 on 3280 and 9815 kc.; also to 1300/ close to England on 15,400 kc. The 3365-kc. outlet is not in use at present.

Clandestine—*R. Espana Independiente* (Spain-?) has been heard again on 6980 kc. (varies) from 1530 to 1830 s/off in Sp. with long talks.

R. Portugal Libero is on 11,672 kc. at 0915, interfering with *R. Pakistan*. This one reportedly moves to the 31-meter band, exact frequency not known, during late afternoons and/or evenings.

-30-

THE BREADBOARD by Sinclair



I'M A MINIATURIZATION ENGINEER. YOU'VE PROBABLY HEARD ABOUT SOME OF MY ACCOMPLISHMENTS:



MICROMODULAR RADIOS THAT CAN BE HELD IN A TEASPOON, TRANSISTORS SO SMALL THAT 20,000 FIT ON A POSTAGE STAMP,



TINY COMPUTER ELEMENTS THAT.... **OH, OH**, HERE COMES THE **BOSS!**

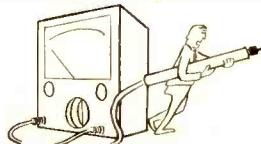

WELL, BACK TO WORK.

Always say you saw it in—POPULAR ELECTRONICS

ELECTRONICS MARKET PLACE

RATE 60¢ per word. Minimum 10 words prepaid. September issue closes July 6th. Send order and remittance to Martin Lincoln, POPULAR ELECTRONICS, 1 Park Ave., New York 16, N. Y.

FOR SALE

GOVERNMENT Sells Surplus: Electronics; Oscilloscopes; Transceivers; Test Equipment; Radar; Sonar; Walkie-Talkies; Boats; Jeeps; Aircrafts; Misc.—Send for "U.S. Depot Directory & Procedures"—\$1.00—Brody, Box 425(PE), Nanuet, New York.

TV Tuners—Rebuilt or Exchanged \$9.95 complete—all types—fast, guaranteed service. Send tuner with all parts to: L.A. Tuner Exchange, 4611 West Jefferson Blvd., Los Angeles 16, California.

GOVERNMENT Surplus Receivers, Transmitters, Snooper-scopes, Parabolic Reflectors, Picture Catalog 10¢. Meshna, Malden 48, Mass.

DIAGRAMS for repairing Radios \$1.00, Television \$2.00. Give make, model. Diagram Service, Box 672-PE, Hartford 1, Conn.

BEFORE You Buy Receiving Tubes or Hi-Fi Components send now for your giant Free Zalytron current catalog—featuring nationally known Zalytron First Quality TV-Radio Tubes, Hi-Fi Stereo Systems, Kits, Parts, etc. All priced to Save You Plenty—Why Pay More? Zalytron Tube Corp., 220 W. 42nd St., NYC.

"SPECIAL! WPE-SWL-CB-QSL cards, 3 colors, \$2.50 per 100—Free Samples, Garth, Union, New Jersey."

CITIZENS Band—Maximum quieting with OZCO "Snoozer." Largest selling add-on squelch still only \$2.00 each, \$3.95 pair postpaid! Guaranteed. OZCO, Canaan, Connecticut.

SAVE dollars on radio, TV-tubes, parts at less than manufacturer's cost, 100% guaranteed! No rebrands, pulls. Request Bargain Bulletin. United Radio, 1000-E, Newark, N. J.

RUBBER Stamps personal or Business write. N. Albergio 121-18 Rockaway Blvd. South Ozone Park 20, N.Y.

INVESTIGATORS, write for free brochure on latest sub-miniature electronic listening devices. Dept. 7A, Ace Electronics 11500 NW 7th Ave., Miami 50, Fla.

CB WPE QSL Cards, Finest Quality, Multicolor, 10¢ For Samples. Radio Press, Box 24, Pittstown, New Jersey.

EMERGENCY Power Convert Auto Type Generator For 120V 60cy Output To 750W Instructions \$2.50 Winding Kit Less Generator \$7.95. W. Houck, Box 8331, Orlando, Fla.

CONVERT Any television to sensitive, big-screen oscilloscope. Only minor changes required. Simple plans \$1.95. Relco, Box 10563, Houston 18, Texas.

DIAGRAMS—For T.V. \$2. Radio \$1. Hiatt Diagrams, Box 816, Laredo, Tex.

TRANSFIRE Transistor electronic ignition. Saves gas, tune-ups. Points, plugs last to 100,000 miles. Top performance, improved starting. Parts, Complete systems, Kits, from \$34.95. Literature. Palmer Electronics, 40E, Carlisle, Massachusetts.

SMALL set builder's big information catalog—25¢, refundable. Laboratories, 1131-L Valota, Redwood City, California.

HiFi AMPLIFIERS, tuners, speakers, radios, telescopes, microscopes, cameras. Free Catalog. GM PhotoElectronics, 623 Gay, Knoxville 2, Tennessee.

FREE—R.C.A., G.E., etc. tubes catalog. Discount to 75% from list. Picture tubes at 75¢ inch up. Parts, parts kits at 1/10 original cost. Needles, tube testers, silicones, seleniums, 7" TV bench test tube. \$6.99—and more. Arcunus Electronics Corp., P.E. 402—22nd Street, Union City, New Jersey.

PROFESSIONAL Electronic Projects—Organs, Timers, Computers, Industrial, etc. \$1 up. Catalog Free. Parks, Box 1665, Seattle 55, Washington.

TV tuners rebuilt \$9.95—Ninety day guarantee. Western Tuner Rebuilders, 4130 El Cajon Blvd., San Diego 5, California: 3040 West Sunset Blvd., Los Angeles, California.

2 X 3 FCC warning decal against illegal use 35¢ each, 3/\$1.00. Code caller, (Q Bird), kit \$2.50, wired \$3.50. CB Products, Box 457, Encino, California.

TV Tuners—rebuilt or exchanged \$9.95. Most tuners shipped same day received. Valley Tuner Service, 18530 Parthenia, Northridge, Calif.

POCKET sized, low impedance, square-wave generator. Variable Frequency, 200 to 4000 cycles. Build it yourself for \$9. Send \$1.00 and stamped envelope for schematic to, Ace, 11500-F NW 7th Ave., Miami 50, Florida.

CB'ERS dual conversion adapter kit, all parts, schematic, pictorial; hear only the channel you tune. For HE-15, 15A; TR-800, 910, etc. \$14.95, with tubes \$16.95. For HE-20, 20A; Mark VII \$15.50, with tubes \$17.50 or \$5.00 deposit plus C.O.D. Bainbridge Radio, 2649 Bainbridge Ave., New York 58, N. Y.

MORSE code by sleep teaching. Guaranteed. 4 taped lessons to 18 WPM; \$12.95 each. Electro-Sleep, 8959 Wonderland Ave., Hollywood 46, Calif.

ELECTRONIC kits wired and tested, write for estimate. Roy's Kit Service, 29 Grove St., Homer, N. Y.

CIRCUITS designed to your specifications. Specialties—power supplies, amplifiers switching networks, computer circuits. Precision Design, Box 7802, Essex, Maryland.

ROCKETS: New illustrated catalog, 25¢. Single and multi-stage kits, cones, engines, launchers, trackers, technical information, etc. Fast service. Estes Industries, Penrose 18, Colorado.

CONVERTERS: Monitor police, fire amateur, citizens band signals. Adapt to any car radio with no internal connections. Write for brochure. Box 438, Jacksonville, Texas.

FREE list. Do-it-yourself circuits for building many economical miniaturized shop equipment items. Voice relays, signal generators, etc. Send stamped addressed envelope. Dept.-2K, 11500 NW 7th Ave., Miami 50, Florida.

FREE literature. OZCO "1-10'er" antenna coupler allows the use of any CB Mobile antenna for both CB and Broadcast radio—even at the same time! Guaranteed unsurpassed. Only \$5.95 postpaid. OZCO, Canaan, Connecticut.

TELEPHONE extension in your car. Answer your home telephone by radio from your car. Complete diagrams and instructions \$2.00. C. Carrier Co., 5880 Hollywood Blvd., Hollywood 28, Calif.

EAVESDROP with a pack of cigarettes. Miniature transistorized FM radio transmitter. Complete diagrams and instructions \$2.00. C. Carrier Co., 5880 Hollywood Blvd., Hollywood 28, Calif.

BE a spy. Correspondence course on wire tapping, bugging, telescopic sound pickup, recording techniques, microphotography, and invisible photography. Lessons in surveillance, tailing, and use of equipment. Complete course \$22.50. C. Carrier Co., 5880 Hollywood Blvd., Hollywood 28, Calif.

TV tape recorder. Build your own video recorder. Complete correspondence course and construction details. \$22.50. C. Carrier Co., 5880 Hollywood Blvd., Hollywood 28, Calif.

TELEPHONE voice switch (LS-500). Actuates automatically and unattended any tape or wire recorder. Pictorial installation instructions included. \$23.75. Post Paid US. WJS Electronics, 1130 N. Highlands Ave., Los Angeles 38, Calif.

INVESTIGATORS. Do your own sound work. Send \$1.00 for brochure of latest electronic equipment. WJS Electronics, 1130 N. Highland Ave., Los Angeles 38, Calif.

"EMBOSSD" business cards, 1,000 \$4.00; Miniature \$3.00. Card Service, Box 2131, Tulsa, Oklahoma."

POLICE radar detector. Stop before those radar speed traps. Fool proof, legal system. Complete diagrams and instructions \$2.75. C. Carrier Co., 5880 Hollywood Blvd., Hollywood 28, Calif.

JUNK your distributor and voltage regulator. Improve automobile mileage and performance. Construction details for transistorized distributor and voltage regulator \$4.75. No moving parts. DB Enterprises, 8959 Wonderland Ave., Hollywood 46, Calif.

TV camera. Build for less than \$50. Construction details \$4.75. DB Enterprises, 8959 Wonderland Ave., Hollywood 46, Calif.

EYELET setting tool for punched or printed circuit boards. \$1.00 including eyelets. RFE Lab, Box 535, Berkeley I, Calif.

WPE-CB-QSL cards—Brownie-W3CJF—3110A Lehigh, Allentown, Pa. Catalogue with samples 25¢.

NAVY Mine Timers 0-145 Days, 12 V.D.C. Motor New \$5.00, J. C. Hoover S.A. Box 195 ETA, Treasure Is., San Francisco, Calif.

BARGAINS! Used CB, Amateur equipment! List 10¢. Brands, Sycamore, Ill.

POLICE, radar detector parts cost only \$3.00. Send \$1 for plans which includes Jammer information to Radet, P.O. Box 7432, Cleveland 30, Ohio.

"LISTEN-in-Coil" picks up any telephone conversation in vicinity. No connection to telephone necessary. Easily concealed. \$2.98 complete. Acoustical Research, 512 E. 80 St. NYC

C'BILEERS, use CB mobile antenna for transceiver and auto radio simultaneously! DP-2 kit, \$4.49. GW-10, GW-11 owners, get 20—DB better reception with SK-3 preselector kit, \$8.99. HAMS, SWL'S, tunable 3.5-30 megacycle SK-20 preselector kit, \$18.98. All complete, postpaid! Holstrom Associates, Box 8640, Sacramento 22, California. (Dealers, inquire)

ORGAN Owners: Add 32 pedals to your spinet, Brochure, WEMCO, Box 142, Dearborn, Michigan.

LIKE To Build? Try 73 Magazine. \$3.50 Year, Sample 40¢. 1379 East 15th, Brooklyn 30, N.Y.

SEMICONDUCTOR light activated switches. 80 to 500 ft. candles of light switches these ¼ ampere subminiature semiconductors into conduction. Used with miniature lamps, complete electrical isolation from trigger source is possible. Units were fully described in May Popular Electronics: Carl and Jerry feature article. Prices start as low as \$3.00 for 25 volt units. Available through G-E Semiconductor Distributors. Ask for the G.E. ZJ235 or write us at Section A, Rectifier Components Dept., General Electric Co., Auburn, N.Y.

TV Tuners Rebuild \$9.95—Ninety Day Guarantee. Western Tuner Rebuilders, 4130 El Cajon Blvd., San Diego 9, California.

FREE Confidential Electronic Catalog—Unbeatable—Knappe, 3174 8th Ave. SW., Largo, Florida.

WANTED

TRIGGER—W9IVJ. We Buy Shortwave Equipment For Cash. 7361 North, River Forest, Ill., Phone PR 1-8616.

QUICKSILVER, Platinum, Silver, Gold. Ores Analyzed. Free Circular. Mercury Terminal, Norwood, Mass.

OLD Canadian Coins, Electronic Parts, Stamps, Radios, Etc. Send What you Have to: Howard A. Little, Bonavista, N.F.L.D.

TAPE AND RECORDERS

SELF-Hypnosis may help you many ways. New tape or LP-record teaches you quickly, easily! Free literature. McKinley Company, Box 3038, San Bernardino, California.

TAPE Recorders, Hi-Fi, components, Sleep Learning Equipment, tapes. Unusual Values. Free Catalog. Dressner, 1523PE. Jericho Turnpike. New Hyde Park. N. Y.

SAVE 30% Stereo music on tape. Free bargain catalog/blank tape/recorders/norelco speakers. Saxitone, 1776 Columbia Road, Washington, D.C.

RENT Stereo Tapes—over 2,500 different—all major labels—free catalog. Stereo—Parti, 811-G Centinela Ave. Inglewood 3, California.

4/TR Stereo Tapes—bought, sold, rented, traded! Free Catalog/Bargain closeouts. Columbia, 9651 Foxbury, Rivera, California.

GLOBAL Tape Recording Exchange Hobby Club most rewarding hobby known for all ages, music, educational knowledge, or small talk. Write Mailway Co., 216 W. Jackson Blvd., Chicago 6, Ill. or 51 W. 35th St., New York 1, New York.

HIGH-FIDELITY

DISGUSTED with "Hi" Hi-Fi Prices? Unusual discounts on your High Fidelity Requirements. Write Key Electronics, 120 Liberty St., New York 6, N. Y. Cloverdale 8-4288.

PRICES? The Best! Factory-Sealed Hi-Fi Components? Yes! Send for free catalog. Audion, 25P Oxford Road, Massapequa, N. Y.

RECORDERS, Components. Free wholesale catalogue. Carston, 125-P East 88. N. Y. C. 28.

AT last—transistor high fidelity FM tuner with AFC, multiplex provision. Fully assembled quality import. Satisfaction guaranteed. \$39.95, Pennwood Communications, Box 164, Camden, N. J.

DON'T Buy Hi-Fi components until you get our low, low quotation. We guarantee "We will Not Be Undersold." Easy-Pay-Plan. Send 10¢ for wholesale catalog and Best Buy Hi-Fi list. Hi-Fidelity Center, 220-PC E. 23rd St., N.Y. 10, N.Y.

MIRACLE Hi-Fi Enclosure, construction drawings and assembly instructions. \$2.00. Kits and assembled cabinets also available. Gough & Company, Box 254, San Carlos, California.

REPAIRS AND SERVICING

ELECTRONIC Kits Constructed By Experienced Laboratory Technicians. Work Guaranteed!—Martin Electronic Laboratories, Box 41, Brookfield, Illinois.

GOVERNMENT SURPLUS

JEEPS \$278, Airplanes \$159, Boats \$7.88, generators \$2.68, typewriters \$8.79, are typical government surplus sale prices. Buy 10,001 items wholesale, direct. Full details, 627 locations, procedure only \$1.00. Surplus, Box 789-C1, York, Penna.

U.S. Government Surplus—Jeeps, \$264.00, Radios, \$2.53, Guns, Typewriters, Cameras, Tools, Thousands of items. Fabulously Low Surplus Prices. Complete Information Sent Immediately. Send \$1.00 to:—Surplus, P.O. Box 50512, Dept. R, New Orleans 50, Louisiana.

PATENTS

PATENT Searches, \$6.00. For free Information Record, and "Information Inventor's Need, write: Miss Heyward, 1029 Vermont Avenue NW, Washington 5, D. C.

INVENTIONS WANTED

INVENTIONS wanted. Patented; unpatented. Global Marketing Service. 2420-P 77th. Oakland 5, Calif.

WE develop, promote, and protect your product or ideas. Write for information. Product Promotion Development, Little Building, Boston 16, Mass.

INSTRUCTION

NEW Trade? Electronic. Mechanical Drafting pay \$150 week. Send \$2 first lesson, complete home study course \$25. Prior Inc., 23-09 169th St., Whitestone 57, New York.

FCC LICENSE in 6 Weeks, First Class Radio telephone. Results Guaranteed. Elkins Radio School, 2603B Inwood, Dallas, Texas.

LEARN While Asleep, hypnotize with your recorder, phonograph. Astonishing details, sensational catalog free! Sleep-Learning Association, Box 24-ZD, Olympia, Washington.

PHOTOGRAPHY for pleasure or profit. Learn at home. Practical basic training. Long established school. Free Booklet. American School of Photography, 835 Diversey Parkway, Dept. 253B, Chicago 14, Illinois.

PHOTOGRAPHY-FILM, EQUIPMENT, SERVICES

SCIENCE Bargains—Request Free Giant Catalog "CJ"—144 pages—Astronomical Telescopes, Microscopes, Lenses, Binoculars, Kits, Parts, War surplus bargains. Edmund Scientific Co., Barrington, New Jersey.

STAMPS AND COINS

FOR Sale—Newfoundland Stamps! 100 Fine Newfoundland Stamps—\$1.00. 100 all different—\$3.50. Harry Phillips Sales, Bonavista-2S, Nfld, Canada.

TERRIFIC Stamp Bargain! Israel—Iceland—San Marino—plus triangle set—Plus Antigua—Borneo—Virgin—Scouts—Congo—Russia—Plus large stamp book—all four offers free—Send 10¢ for mailing cost. Empire Stamp Corporation, Dept. Z2, Toronto, Canada.

START approval business—details 10¢. Steele, Box 553-H, Pacific Grove, Calif.

1960 UNITED NATIONS commemorative stamps, ALL mint 4¢ and 8¢ commemorative sets only one dollar with request for approvals. Adults only. Martin Stamp Co., Box 12-A, Gravesend Sta., Brooklyn 23, New York.

LEATHERCRAFT

FREE "Do-It-Yourself" Leathercraft Catalog. Tandy Leather Company, Box 791—D46, Fort Worth, Texas.

EDUCATIONAL OPPORTUNITIES

ENGINEERING Education for the Space Age. Northrop Institute of Technology is a privately endowed, nonprofit college of engineering offering a complete Bachelor of Science Degree Program and Two-Year accredited technical institute curricula. Students from 50 states, many foreign countries. Outstandingly successful graduates employed in aeronautics, electronics, and space technology. Write today for catalog—no obligation. Northrop Institute of Technology, 1179 West Arbor Vitae Street, Inglewood 1, California.

DETECTIVE Profession. Home Study. Lapel pin, Certificate, Future. Box 41197-AG, Los Angeles 41, Calif.

BUSINESS OPPORTUNITIES

BUY Direct from factories. Appliances, cameras, watches! Free details! Cam Co., 436 PE Bloomfield Ave., Verona, N. J.

VENDING Machines—No Selling. Operate a route of coin machines and earn amazing profits. 32-page catalog free. Parkway Machine Corporation. Dept. 12. 715 Ensor St., Baltimore 2, Md.

ELECTROPLATING equipment and supplies. All types for home work shops. Free Catalog. HBS Equipment Division. 3445 Union Pacific. Los Angeles 23, Calif.

SECOND Income From Oil Can End Your Toil! Free Book And Oilfield Maps! National Petroleum, Panamerican Bldg.—ZD. Miami 32, Florida.

EARN \$3.00 hour—home sparetime. Easy Pump Lamps assembling. No canvassing. Write: Ougor, Caldwell 15, Arkansas.

I MADE \$40,000.00 Year by Mailorder! Helped others make money! Start with \$10.00—Free Proof. Torrey, Box 3566-N. Oklahoma City 6, Oklahoma.

ASSEMBLE artificial lures at home for stores. Materials supplied free. Profitable! Write: Lures, Ft. Walton Beach 1, Florida.

ACCORDION amplification supplies: Earn extra money at home by custom amplifying accordions and pianos. We supply complete instructions, full kits or parts. Send 25¢ for brochure. Box 206, North Wales, Pa.

FREE Book "990 Successful, Little-Known Businesses." Work home! Plymouth—455R, Brooklyn 4, New York.

MAKE \$3.00 hourly, doing survey work, also make money with a camera. Details free. Mancuso, Box 183-p, Bloomfield, N. J.

SOMEONE "borrowing" your personal copy of Popular Electronics each month? You ought to be taking advantage of Popular Electronics' convenient re-sale plan. Sell copies in your store . . . perform a good service for your customers . . . with no risk involved. For details, write: Direct Sales Department, Popular Electronics, One Park Avenue, New York 16, New York.

WHATEVER your needs, Popular Electronics classified can solve them. Simply place an ad in these columns and watch your results pour in.

EMPLOYMENT INFORMATION

HIGH Paying Jobs in Foreign Lands! Send \$2.00 for complete scoop! Foreign Opportunities, Box 172, Columbus 16, Ohio.

FOREIGN Employment information. Europe, Africa, Asia, South America. Free Transportation. Up to \$1600.00 monthly. Sensational opportunities. Construction workers, clerks, truck drivers—every occupation. Complete information, application form, sent immediately by return mail. Satisfaction guaranteed. Only \$2.00 (\$2.25 airmail) (C.O.D.'s accepted) to: Jobs, P.O. Box 50512, Dept. CC, New Orleans 50, Louisiana.

MISCELLANEOUS

INDEPENDENT Thinkers—investigate Humanism! Write American Humanist Association, Dept. PE, Yellow Springs, Ohio.

PEACH Brandy—Cherry Cordial—Wine—Beer—old rare formulas for personal use. Send \$1.00. Research Enterprises, Dept. D, 29 Samoset Road, Woburn, Mass.

"HYPNOTIZE . . . One word . . . One Fingersnap." on stage. Satisfaction—or refund. \$2. Hypnomaster, Box 9309-E8, Chicago 90.

"HOMEBREW GUIDE" Complete Illustrated Instruction Manual, \$2.00. Supply Catalog Included. CalBrew Supplies, Box 1005, Seaside, California.

SEXTANTS aircraft fairchild jaguar watch powered shoots stars, astronauts \$37.50. VHF-FM transceiver 144-174MC including mike, speaker, control, antenna \$1.50. Other surplus aircraft parts applicable to marine. Write O'Keefe Surplus Aircraft, Box 284, Stanhope, N. J.

INVESTIGATORS, free brochure, latest subminiature electronic listening devices. Dept-7K, 11500 NW 7th Ave., Miami 50, Fla.

AUTHORS! Learn how to have your book published, promoted, distributed. FREE booklet "ZD," Vantage, 120 West 31 St., New York 1.

"HOME Brewing! Beers, Wines." Complete instructions \$1. (Guaranteed.) Crystal's, 28-BPE7, Millburn, New Jersey.

HYPNOTIZE Unnoticed, quickly, effortlessly or refund! Thousands satisfied! \$2. Timmer, Box 244, Cedarburg, Wis.

RECEIVE Big Mail! Samples, magazines, catalogues. Get listed 25¢. Logan, (300-A), 8-288 Charles, Winnipeg 4, Manitoba.

NEW Vortex theory for elementary particles and forces. 30 pages. 25 cents ppd. C. F. Krafft, 4809 Columbia Road, Annandale, Virginia.

MIMEOGRAPHING—cut costs—offset quality—fine reproductions from originals onto electronic stencils, \$2.25 per., Electro Stencil, 79 White Beeches, Dumont, New Jersey.

"HOMEBREW!" . . . Peach brandy, beer, wines, others! Proven recipes! Thousands sold nationwide! \$1.00. (Guaranteed!) Research Enterprises, 29-D, Samoset Road, Woburn, Mass.

IDENTIFY your tools, equipment! Your name—address printed on 50 decals, size 2" x 3/4", only \$1.00 postpaid. Hallwos, 14 Dixel, Dept. PE, Cahokia, Illinois.

WHATEVER your needs, Popular Electronics classified can solve them. Simply place an ad in these columns and watch your results pour in.

RAD-TEL



WHY PAY MORE!

**RAD-TEL'S QUALITY
BRAND NEW TUBES
1 YEAR GUARANTEE**
TUBES FOR TV, RADIO, AND HI-FI

UP TO **75% OFF***

**1-DAY
SERVICE**

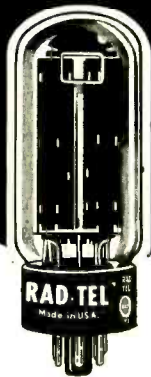

**OVER 500
TYPES IN
STOCK**

* Manufacturers Suggested List Price

FREE!

Send For New Tube & Parts Catalog
& Trouble Shooting Guide

CAM-DWELL DISTRIBUTOR POINT INDICATOR

FOR CARS, TRUCKS, ENGINES, ETC.



No. A2 \$3.95

Now, anyone can set distributor points. It's done electronically and automatically. No other equipment needed, no outlet. You don't have to remove the distributor. Pocket-sized, precision-engineered, high quality testing instrument for use on cars, trucks, marine engines, industrial equipment, tractors, farm machinery and road equipment. It's accurate . . . It's portable . . . It's LOW priced!



RAD-TEL TUBE CO.

Dist. PEZ

55 CHAMBERS STREET, NEWARK 5, NEW JERSEY

TV, RADIO
AND HI-FI

TERMS: 25% deposit must accompany all orders, balance COD. Orders under \$5: add \$1 handling charge plus postage. Orders over \$5: plus postage. Approx. 8 tubes per 1 lb. Subject to prior sale. No COD's outside continental USA.

**EACH TUBE INDIVIDUALLY & ATTRACTIVELY
BOXED & BRANDED RAD-TEL**

Qty.	Type	Price	Qty.	Type	Price	Qty.	Type	Price	Qty.	Type	Price
—	024	.79	—	6AU4	.82	—	6J6	.67	—	12CX6	.54
—	1AX2	.62	—	6AU6	.52	—	6K6	.63	—	12DA*	.69
—	1B3	.79	—	6AU7	.61	—	6CS	1.06	—	12DB5	.69
—	1DN5	.55	—	6AU8	.87	—	6N7	.96	—	12DE8	.75
—	1G3	.79	—	6AV6	.41	—	6S4	.51	—	12DL8	.85
—	1J3	.79	—	6AW8	.90	—	6SA7GT	.76	—	12DQ6	1.04
—	1K3	.79	—	6AX4	.66	—	6SG7GT	.41	—	12DS7	.79
—	1R5	.62	—	6AX5	.74	—	6SH7GT	.49	—	12DT5	.76
—	1S4	.59	—	6AX7	.64	—	6SJ7	.88	—	12DT7	.79
—	1S5	.51	—	6AX8	.92	—	6SK7GT	.74	—	12DT8	.79
—	1T4	.58	—	6BA6	.50	—	6SL7GT	.80	—	12DU7	1.01
—	1U4	.57	—	6BA8	.88	—	6SN7GT	.65	—	12DW8	.89
—	1U5	.50	—	6BC5	.61	—	6SQ7	.73	—	12DZ6	.56
—	1X2B	.82	—	6BC7	.94	—	6T4	.99	—	12ED5	.69
—	2AF4	.96	—	6BC8	.97	—	6T8	.85	—	12E66	.54
—	2BN4	.64	—	6BD5	1.25	—	6U8	.83	—	12EK6	.56
—	2EN5	.45	—	6BE6	.55	—	6VG6T	.54	—	12EL6	.50

—	3AL5	.42	—	6BF5	.90	—	6W4	.60	—	12EM6	.79
—	3AU6	.51	—	6BF6	.44	—	6W6	.71	—	12EN6	.78
—	3AV6	.41	—	6BG6	1.66	—	6X4	.39	—	12EZ6	.53
—	3BA6	.51	—	6BH6	.65	—	6X5GT	.53	—	12F8	.66
—	3BC5	.54	—	6BH8	.87	—	6X8	.80	—	12FA6	.79
—	3BE6	.52	—	6BJ6	.62	—	7A8	.68	—	12FM6	.43
—	3BN6	.76	—	6BJ7	.79	—	7AU7	.61	—	12FR8	.91
—	3BU8	.78	—	6BK7	.85	—	7B6	.69	—	12FX8	.85
—	3BY6	.55	—	6BL7	1.00	—	7EY8	.73	—	12GC6	1.06
—	3BZ6	.55	—	6BN4	.57	—	7F8	.90	—	12J8	.84
—	3CB6	.54	—	6BN6	.74	—	7N7	.90	—	12K5	.65
—	3CS6	.52	—	6BQ6	1.05	—	757	1.01	—	12L6	.58
—	3DG4	.85	—	6BQ7	1.00	—	7Y4	.69	—	12SA7	.92
—	3DK6	.60	—	6BS8	.90	—	8AU8	.83	—	12SF7	.69
—	3DT6	.50	—	6BU8	.70	—	8AW8	.93	—	12SH7	.49
—	3Q4	.63	—	6BX7	1.02	—	8B05	.60	—	12S17	.67
—	3Q5	.80	—	6BY5	1.15	—	8CG7	.62	—	12SK7	.74

**RAD-TEL TUBE CO. NOT AFFILIATED WITH ANY
OTHER MAIL ORDER TUBE COMPANY**

—	3S4	.61	—	6BY6	.54	—	8CM7	.68	—	12SL7	.80
—	3V4	.58	—	6BY8	.66	—	8CN7	.97	—	12SN7	.67
—	4BQ7	1.01	—	6BZ6	.55	—	8CS7	.74	—	12S07	.78
—	4BZ7	.96	—	6BZ7	1.01	—	8CX8	.93	—	12U7	.62
—	4BZ9	1.10	—	6BZ8	1.09	—	8Y8	.94	—	12V6	.53
—	4CS6	.61	—	6C4	.43	—	85N7	.65	—	12W6	.69
—	4DT6	.55	—	6CB6	.55	—	9CL8	.78	—	12XA	.38
—	5AM8	.79	—	6CD6	1.42	—	11CY7	.75	—	17AX4	.67
—	5AN8	.86	—	6CE5	.57	—	12A4	.60	—	17BQ6	1.09
—	5AQ5	.52	—	6CF6	.64	—	12AB5	.55	—	17DQ6	1.06
—	5AS8	.86	—	6CG7	.61	—	12AC6	.49	—	17W6	.70
—	5AT8	.80	—	6CG8	.77	—	12AD6	.57	—	18FW6	.49
—	5AV8	1.01	—	6CK4	.70	—	12AE6	.43	—	18FY6	.50
—	5BC8	.79	—	6CL8	.79	—	12AF7	.94	—	18FX6	.53
—	5BE8	.83	—	6CM6	.64	—	12AF3	.73	—	19AU4	.83
—	5BK7	.82	—	6CM7	.66	—	12AF6	.49	—	19BG6	1.39
—	5BQ7	.97	—	6CM8	.90	—	12AJ6	.46	—	19C8	1.14

—	5BR8	.79	—	6CN7	.65	—	12AL5	.45	—	19T8	.80
—	5BT8	.83	—	6CQ8	.84	—	12AL8	.95	—	21EX6	1.49
—	5CG8	.76	—	6CR6	.51	—	12AQ5	.60	—	25AV5	.83
—	5CL8	.76	—	6CS6	.57	—	12AT6	.43	—	25AX4	.70
—	5CM8	.90	—	6CS7	.69	—	12AT7	.76	—	25BK5	.91
—	5CQ8	.84	—	6CU5	.58	—	12AUG	.51	—	25BQ6	1.11
—	5CZ5	.72	—	6CU6	1.08	—	12AU7	.60	—	25C5	.53
—	5EA8	.80	—	6CY5	.70	—	12AV6	.41	—	25CA5	.59
—	5EU8	.80	—	6CY7	.71	—	12AV7	.75	—	25CD6	1.44
—	5J6	.68	—	6DA4	.68	—	12AX4	.67	—	25CU6	1.11
—	5J8	.81	—	6DB5	.69	—	12AX7	.63	—	25DN6	1.42
—	5U4	.60	—	6DB6	.51	—	12AY7	1.44	—	25EH5	.55
—	5U8	.81	—	6DE6	.58	—	12AZ7	.86	—	25L6	.57
—	5V3	.90	—	6DG6	.59	—	12B4	.63	—	25W4	.68
—	5V6	.56	—	6DK6	.59	—	12BA7	.84	—	32E15	.55
—	5X8	.78	—	6DN6	1.55	—	12BD6	.50	—	32L7	.90
—	5Y3	.46	—	6DQ6	1.10	—	12BE6	.53	—	35B5	.60

—	6AR6	1.20	—	6DT6	.53	—	12BF6	.44	—	35C5	.51
—	6AB4	.46	—	6DT8	.79	—	12BH7	.77	—	35L6	.57
—	6AC7	.96	—	6EA8	.79	—	12BK5	1.00	—	35W4	.42
—	6AF3	.73	—	6EB5	.72	—	12BL6	.56	—	35Z5	.60
—	6AF4	.97	—	6EB8	.94	—	12BQ6	1.06	—	36AM3	.36
—	6AG5	.68	—	6EM5	.76	—	12BR7	.74	—	50B5	.60
—	6AH4	.81	—	6EM7	.82	—	12BT7	.78	—	50C5	.53
—	6AH6	.99	—	6EU8	.79	—	12BY7	.77	—	50EH5	.55
—	6AK5	.95	—	6EW6	.57	—	12BZ7	.75	—	50L6	.61
—	6AL5	.47	—	6EY6	.75	—	12C5	.56	—	70L7	.97
—	6AM8	.78	—	6F5GT	.39	—	12CN5	.56	—	70Z5	.69
—	6AQ5	.53	—	6FE8	.75	—	12CR6	.54	—	807	.70
—	6AR5	.55	—	6GH8	.80	—	12CU5	.58	—	11Z73	.61
—	6AS5	.60	—	6GK6	.79	—	12CUG	1.06	—		
—	6AS6	.80	—	6GN8	.94	—			—		
—	6AT6	.43	—	6H6	.58	—			—		
—	6AT8	.79	—	6J5GT	.51	—			—		

**BIG SAVINGS ON PARTS
IN CATALOG**

PRINTED IN U.S.A.



LOWER THE COST OF FUN WITH VERSATILE TARZIAN TAPE



Talk Long Distance for Only 10¢ per Hour

You can record a 24 minute conversation (at 3¾ i.p.s.) on a 225-foot reel of Tarzian Tape and mail it anywhere in the U.S. for 4¢ postage. No one worries about the telephone bill...and the same reel can be used again and again with no decrease in sound reproduction quality. That's a lot of friendly communication—the easy Tarzian Tape way. And you get a handy mailing carton as well!

Turn Free Sound Waves into a Complete Music Library

Have you an AM or FM radio, or a TV set? If so, you can tape music and variety programs being broadcast every day—or, for that matter, borrow your friend's records and put them on tape. You'll pay for your tape recorder with the money you save on records—one inexpensive 1200 foot reel of high fidelity Tarzian Tape holds a full hour of music recorded at 7½ i.p.s.



Make a Priceless Family Heirloom—The Easy Tarzian Way

Next time the family gets together for a special occasion... and everytime a high point comes along in the lives of the children and grandchildren... be sure to record the events on long-lasting Mylar®-base Tarzian Tape. The tape will last indefinitely—and so will your pleasure—with a priceless heritage of voices and events unique to your family. Such moments can seldom be repeated, but thanks to Tarzian Tape they can always be remembered.

Buy, Borrow or Beg

Buy, borrow, or beg a reel of Tarzian Tape—either Mylar or acetate base, on a 3, 5, or 7-inch reel, and compare its sound reproduction to that of *any other tape* on the market. Your own ears will tell you why Tarzian is the best buy for modern tape recording. While you're at it, send for our free 32-page booklet, "The Care and Feeding of Tape Recorders".



*DuPont trademark for polyester film



SARKES TARZIAN, INC.

World's Leading Manufacturers of TV and FM Tuners • Closed Circuit TV Systems • Broadcast Equipment • Air Trimmers • FM Radios • Magnetic Recording Tape • Semiconductor Devices
MAGNETIC TAPE DIVISION • BLOOMINGTON, INDIANA
Export: Ad Aurlema, Inc., N. Y. • In Canada, Cross Canada Electronics, Waterloo, Ont.



C-25. IN-CIRCUIT CAPACITOR TESTER KIT. Reveals shorted or open capacitors in the circuit, including electrolytics. Also reveals dried-out electrolytics through the Electrolytic Capacitance Dial. **Kit: \$19.95; Factory Wired, ready to operate: \$29.95.**



G-70. VACUUM TUBE VOLTMETER KIT. Uses stabilized bridge circuit to provide measurements on 7 DC and 12 AC voltage ranges, plus 7 decibel and 7 wide-spread electronic ohmmeter ranges. **Kit: \$31.95; Factory Wired, ready to operate: \$49.95.**



G-30. RF SIGNAL GENERATOR KIT. Highly accurate, stable. Also designed for use as a Marker Generator in sweep alignment procedures. Eight frequency ranges: 160 kc to 240 mc. **Kit: \$32.95, Kit with Prealigned Tuner: \$39.95; Factory Wired, ready to operate: \$44.95.**



MX-100. STEREO MULTIPLEX ADAPTER KIT. All critical circuitry factory adjusted and prealigned. Maximum stereo separation between 20-15,000 cps, with low distortion. Stereo switch permits either front-panel separation control or maximum separation adjusted at factory. **Kit: \$49.95; Factory Wired, ready to operate: \$69.95.**



ST-26. FM TUNER/AMPLIFIER KIT. Low-cost combination hi-fi FM music system. Requires only the addition of external speaker (see L-3) to complete system. Pre-Built Front End fully adjusted and prealigned at factory. **Kit: \$54.95; Factory Wired, ready to operate: \$69.95.**



L-3. SPEAKER SEMI KIT. Ultra compact, graciously styled system. Lifelike response from high efficiency speakers Walnut finished cabinet. Size: 13 3/4" L x 6 1/2" H x 7 1/4" D. **Semi-Kit: \$19.95.**

PACO KITS

THE KITS YOU BUILD IN 1/3 LESS TIME



FROM BOX...



TO BEETHOVEN IN 1/3 LESS TIME!

In timed, competitive tests, twin brothers — with twin backgrounds and skills — proved that Paco kits are faster, easier and more fun to build than almost-identical kits sold by other kit makers. They discovered that there's no guessing with Paco: parts are neatly packaged and precisely labeled; instruction books are complete and easy to follow. Accurate drawings to actual scale and fold-out diagrams are printed right next to step-by-step directions. ■ The twins also proved that Paco pleasure doesn't end with the wiring. The ST-25 MX FM Stereo Multiplex Tuner[®], for example, looks and performs like twice the price: frequency response is 30 to 20,000 cps within 2 db; sensitivity is 1.5 μ v for 20 db quieting. It features self-contained, prealigned and fully shielded front end, FM Stereo multiplex circuitry, dual limiters, AFC with panel switch for AFC defeat and "eye"-type tuning indicator. Why not put Paco to your test. **Kit: \$69.95 net, (factory wired, ready to operate: \$99.95).** See your dealer or write today for details to Paco Electronics Co., Inc., 70-31 84th Street, Glendale 27, New York, a division of Precision Apparatus Company, Inc. Export: Morhan Corporation, 458 Broadway, New York 13, New York. In Canada: Atlas Radio Corporation, 50 Wingold Avenue, Toronto, Canada.

*AS PICTURED ABOVE

PACO KITS



THE KITS YOU BUILD IN 1/3 LESS TIME