

HOW U.S. RADARS MAP THE MOON

POPULAR

MAY

1961

ELECTRONICS

35
CENTS

How to Get Peak CB Performance

Play 4-Track Tapes the Easy Way

- 
- Build an R.F. Probe
 - 3-Station Intercom
 - Grid Dip Oscillator
 - Nuvistor R.F. Stage

THE SEMICONDUCTOR DIODE

- What It Is
- How It Works
- What It Does

(page 88)

IONOVAC (page 58)



This is CADRE 2-Way Radio

developed by **CADRE INDUSTRIES CORP.**
for the 27 Mc **CITIZENS BAND OPERATION**

These CADRE units are built to the highest standards of the electronics industry, by a company that has been long established as a prime manufacturer of precision electronic research equipment and computer assemblies. CADRE transceivers are 100% transistorized — compact, lightweight . . . engineered for unparalleled performance and reliability.

The CADRE 5-Watt Transceiver, at \$199.95, for example, for offices, homes, cars, trucks, boats, aircraft, etc., measures a mere 11 x 5 x 3", weighs less than 6 pounds. Nevertheless, it offers 5 crystal-controlled transmit/receive channels (may be used on all 22), and a range of 10 miles on land, 20 over water!

The CADRE 100-MW Transceiver, \$124.95, fits into a shirt pocket! Weighs 20 ounces, yet receives and transmits on any of the 22 channels . . . efficiently, clearly . . . without annoying noise. A perfect "pocket telephone"!

For the time being, it is unlikely that there will be enough CADRE transceivers to meet all the demand. Obviously, our dealers cannot restrict their sale to the fields of medicine, agriculture, transportation, municipal services, etc. However, since these CADRE units were engineered for professional and serious commercial applications—and cost more than ordinary CB transceivers — we believe that as "water finds its own level," CADRE transceivers will, for the most part, find their way into the hands of those who really need them.

Write for complete information and detailed specifications.

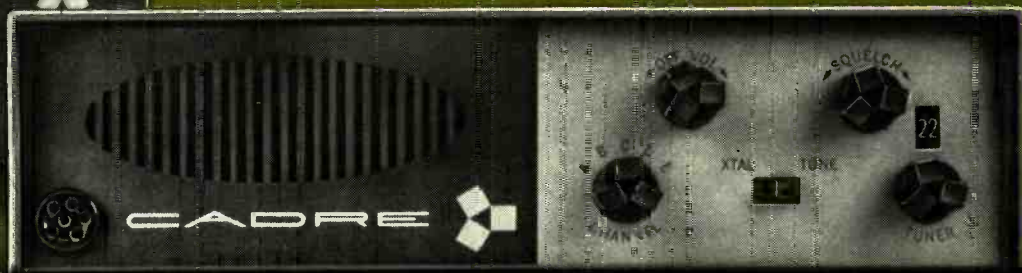

CADRE INDUSTRIES CORP., Endicott, N. Y.

Prices appearing in this advertisement are suggested retail prices

new!

outstanding value

Electro-Voice®

ULTRA-COMPACT SPEAKER SYSTEMS

in kit form

Now Electro-Voice takes the mystery out of ultra-compact speaker systems. No longer are the components a "sealed" secret. You see what you get, know what you get, and enjoy the fun and economy of building your own speaker system. All the materials and instructions you need are included in the package. These new kits are exactly the same as the carefully-designed, assembled systems currently sold by Electro-Voice. Systems that produce a clarity of sound that enable you to feel the deepest bass, marvel at the effortless clarity in the midrange, and delight in the brilliant definition of the upper harmonics.

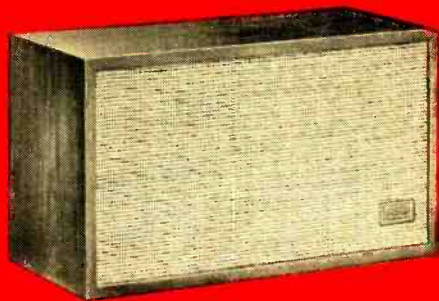
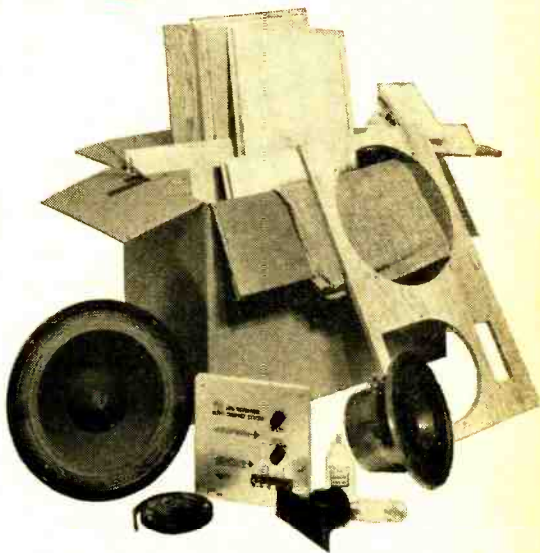

Performance Depends on Component Quality

Within each Electro-Voice system, every component is engineered to complement perfectly the others with which it is used. Some of the outstanding features you'll be receiving are illustrated in the cutaway view of the Esquire 200 featured above: (1) Substantial magnetic circuits for maximum sensitivity, power handling capacity, and uniformity of response. (2) High compliance viscous damped cloth suspension for smooth response and low resonant frequency. (3) Edgewise-wound voice coil for most effective use of available magnetic energy. (4) Die-cast frames for greatest reliability of performance. (5) True electrical crossover, at exceptionally low frequency of 200 cycles, to minimize all forms of distortion associated with the use of woofers covering the midrange. (6) Midrange speaker in a totally isolated cavity for outstandingly uniform response throughout the range over which it is employed. (7) Sonophase® throat structure and integral diffraction horn to give virtually unequaled high frequency response range, with excellent coverage of the whole listening area. (8) Two level controls which permit exact adjustment of response characteristics to personal taste and individual acoustic environments.

A Variety of Prices and Performance

The Esquire 200—Now the value-packed Esquire is available in three different forms... the handsome Esquire 200, the economical unfinished Esquire 200 Utility and the new Esquire 200 Kit. Each is a full three-way system with a 12" woofer, 8" cone-type mid-range speaker and E-V Super Sonax very-high-frequency driver. Esquire 200—14" high x 25" wide x 13½" deep. Hand-rubbed Walnut, Mahogany or Limed Oak.... \$133.00. Esquire 200 Unfinished Fir Utility—14" high x 23½" wide x 12" deep.... \$107.50. Esquire 200 in easy-to-assemble Kit form—14" high x 23½" wide x 12" deep.... \$93.00.

The Regal 300—A premium-quality, three-way system utilizing the finest quality components to assure the best sound possible in a small-sized system. Deluxe 12" woofer, a Deluxe 8" cone-type midrange speaker, and a compression-type, diffraction horn-loaded very-high-frequency driver. 14" high x 25" wide x 13½" deep. Walnut, mahogany, or limed oak.... \$179.00. Unfinished fir.... \$149.00. In Easy-to-assemble Kit Form.... \$125.00.

Consumer Products Division

Electro-Voice

Dept. 514P Electro-Voice, Inc., Buchanan, Michigan

POPULAR ELECTRONICS is published monthly by Ziff-Davis Publishing Company, William B. Ziff, Chairman of the Board (1916-1933), at 134 S. Wabash Ave., Chicago 5, Ill. Second-class postage paid at Chicago, Illinois. Authorized by Post Office Department, Ottawa, Canada, as second-class matter. SUBSCRIPTION RATES: One year U.S. and possessions, and Canada \$4.00; Pan-American Union Countries \$4.50, all other foreign countries, \$5.00.

POPULAR ELECTRONICS

VOLUME 14

NUMBER 5

MAY

1961



POPULAR ELECTRONICS is indexed
in the Readers' Guide
to Periodical Literature

Special Feature

The Semiconductor Diode.....	Jim Kyle, K5JKX/6	88
What It Is—How It Works—What It Does		

Electronic Construction Projects

3-Way Intercom.....	Julian M. Sienkiewicz	52
High-Compliance Speaker.....	Alfred B. Anderson	68
TRANSIDIP.....	L. W. Aurick, W2QEX	70
R.F. Probe Peps Up VTVM.....	Forrest H. Frantz, Sr.	77
Transistor Mounting Tips.....		80
Nuvistor R.F. Amplifier.....	Herb S. Brier, W9EGQ	87

Audio and High Fidelity

Hi-Fi Showcase.....		14
Tape Decks for Stereo.....	Richard A. Flanagan	48
Introducing the Ionovac.....		56
Toscanini in Stereo.....	Richard A. Flanagan	62

Amateur, CB, and SWL

Armed Forces Day Program.....		32
Getting Peak CB Performance.....	Dick Strippel, 2W1452	58
On the Citizens Band.....	Tom Kneitel, 2W1965	83
Across the Ham Bands: Sending QSL and SWL Cards.....	Herb S. Brier, W9EGQ	85
Short-Wave Report: Calibrating a Receiver.....	Hank Bennett, W2PNA	105
DX'ers Win Edison Award.....		114
Short-Wave Monitor Certificate.....		123

Electronic Features and New Developments

Radar Explores the Moon.....	Ken Gilmore	41
Electronics Checks Bone Mending.....	James G. Busse	46
Explaining Tuned Circuits (After Class Feature).....	Saunders Harris, W1NXL	64
Roll-Away Nose Cone.....		73
Vary That Line Voltage.....		81
Audible Ball for the Blind.....		82
Transistor Topics.....	Lou Garner	102
Carl and Jerry: Operation Worm Warming.....	John T. Frye, W9EGV	107

Departments

POP'tronics News Scope.....		6
FCC Report.....	Robert E. Tall	10
New Products.....		22
POP'tronics Bookshelf.....		28
Letters from Our Readers.....		35
Tips and Techniques.....		38
Space Electronics.....	Oliver P. Ferrell	74

Copyright © 1961 by ZIFF-DAVIS PUBLISHING COMPANY. All rights reserved.

LAFAYETTE is America's Citizens Band Headquarters

Complete Portable Communications for Everyone



Ship to Shore



On the Farm



Construction Work

NO LICENSES, TESTS OR AGE LIMITS

HE-29

LAFAYETTE 9 TRANSISTOR CITIZENS BAND "WALKIE TALKIE"

49.95
2.00 Down
2 for 96⁵⁰

PORTABLE—
POCKET SIZE
Only
6³/₈x3¹/₄x1⁵/₈"



- Completely Wired—Ready to Operate • Fully Transistorized—9 Transistors plus 1 Diode • Uses Inexpensive Penlight Batteries
- No License, Tests or Age Limits • Comes with Leather Carrying Case, Earphone, Antenna, Batteries and Crystals

As simple and easy to use as the telephone—and twice as handy. Receives and transmits up to 7 miles under favorable conditions, or 1.5 miles under average conditions. Weighs only 18-oz. and slips into your pocket. Push-to-talk button operates built-in speaker as sensitive microphone.

LAFAYETTE HE-20A DELUXE Citizens Band TRANSCEIVER

109⁵⁰ 5.00 Down

Now With Added Deluxe Features—

- Pi-Network for Greater Power Output • Calibrated "S" Meter
- 14 Tube Performance, 3 Diodes • Built-in 12 Volt Power Supply for Mobile Use • Complete with Matched Crystals for Channel 9

A highly efficient 2-way communications system operating over a distance of up to 20 miles or more depending on terrain. Features



Made in U.S.A.

4 crystal-controlled transmit positions and 4 crystal-controlled receive positions. Tuneable superhet receiver covers all 23 assigned channels. Other highlights include dependable push-to-talk ceramic mike & relay, adjustable squelch control, automatic series gate noise limiter and illuminated dial.

LAFAYETTE HE-15A

Made in U.S.A.



ONLY
57⁵⁰
5.00 Down

SUPERHET

CITIZENS BAND TRANSCEIVER

NOT A KIT

- Completely Wired—Not A Kit • 5 Crystal-Controlled Transmitting Positions • Tuneable Receiver Over Full 23 Channels • High Output Crystal Microphone • Complete with Transmitting Crystal for Channel 9

A compact, precision transmitter and receiver covering up to a 20 mile or more radius, depending upon conditions. The HE-15A features an effective full-wave variable noise limiter, RF jack on front panel, planetary vernier tuning, 5-prong microphone jack for easy relay addition, and 12 tube performance from 4 dual-function tubes, 2 single-function tubes, 2 rectifiers.

HE-19 Telescoping Whip Antenna	Net 3.95
HE-16 Power Supply for 12 Volts	Net 10.95
HE-18 Power Supply for 6 Volts	Net 10.95

LAFAYETTE All-in-One CITIZENS BAND MOBILE ANTENNA

HE-800WX
6.95

- Chrome Swivel Base • Stainless Steel Spring
- 102¹/₂" Stainless Steel Whip for Optimum 11-Meter Performance

Chrome swivel ball mount base designed for mounting on any surface. Stainless steel spring holds rod in properly adjusted position and prevents rod damage from shocks and blows. Stainless steel whip for maximum resiliency and strength.



NEW! LAFAYETTE RADIO FIELD INDICATOR

- Continuously Indicates Transmitter Output • Rugged 200 ua Meter Movement • Requires No Electricity, Batteries or Transmitter Connection

Check the performance of marine, mobile or fixed transmitter. Features a 200 ua meter movement with variable sensitivity control. Earphones can be plugged in for an aural check of output. Antenna extends from 3¹/₄" to 10³/₄". Magnet on bottom plate allows easy mounting on car dash or metal surfaces. Size, less antenna, 3³/₈W, 2¹/₄H, 2"D.

TM-14
6.95

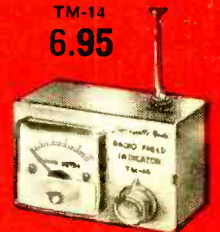

**LAFAYETTE
RADIO**

PLEASE INCLUDE SHIPPING CHARGES WITH ORDER

165-08 LIBERTY AVENUE, JAMAICA 33, N. Y. • OTHER LOCATIONS

NEW YORK, N. Y.
100 6th Avenue

NEWARK, N. J.
24 Central Avenue

BRONX, N. Y.
542 E. Fordham Rd.

PARAMUS, N. J.
182 Route 17

BOSTON, MASS.
110 Federal Street

PLAINFIELD, N. J.
139 W. 2nd Street

POPULAR ELECTRONICS

World's Largest-Selling Electronics Magazine

Average Net Paid Circulation Over 357,000

This month's cover photo by Bruce Pendleton
"Iionovac" courtesy of DuKane Corporation

Publisher

PHILLIP T. HEFFERNAN

Editor

OLIVER P. FERRELL, 2W1665

Managing Editor

**JULIAN M. SIENKIEWICZ
WA2CQL**

Art Director

JAMES A. ROTH

Associate Editors

**RICHARD A. FLANAGAN
MARGARET MAGNA**

Assistant Editor

MARC E. FINKEL

Editorial Assistants

**MARY ANNE O'DEA
MARIA SCHIFF**

Draftsman

ANDRE DUZANT

Editorial Consultant

OLIVER READ, W4TWV

Contributing Editors

**H. BENNETT, W2PNA
H. S. BRIER, W9EGQ
J. T. FRYE, W9EGV
L. E. GARNER, JR.
T. KNEITEL, 2W1965**

Advertising Manager

WILLIAM G. McROY, 2W4144

COMING NEXT MONTH

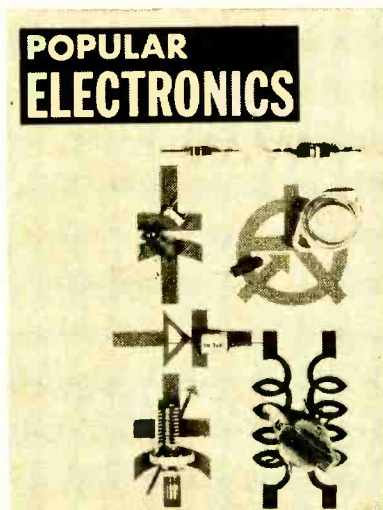

(ON SALE MAY 25)

● **SOIL MOISTURE METER**

This summer, let electronics tell you when to water your lawn. A low-cost unit, the moisture meter is simple enough to be built and operated by anyone.

● **FISH CALLER**

If the fish don't seem to be visiting your fishing area, try inviting them in with this "caller." Crisp audio signals from a home-brew transistorized oscillator will literally lure fish to your lures.

● **CONVERTED CB TRANSCEIVER**

CB'ers who have gone "ham" can use their old transceivers on the 10-meter band. The conversion of a typical unit will serve as a useful guide.

● **HEART-BEAT DETECTOR**

Complete plans for building a transistorized amplifier for detecting and measuring heart beats.

ZIFF-DAVIS PUBLISHING COMPANY,
One Park Ave., New York 16, N. Y.
William B. Ziff, Chairman of the Board
(1946-1953); William Ziff, President;
W. Bradford Briggs, Executive Vice
President; Hershel B. Sarbin, Vice
President and General Manager;
Michael Michaelson, Vice President
and Circulation Director; M. T. Bir-
mingham, Jr., Vice President and
Business Manager; Richard Kislik,
Treasurer; Charles Housman, Finan-
cial Vice President.



BRANCH OFFICES: Midwestern Office,
434 S. Wabash Ave., Chicago 5, Ill.,
Jim Weakley, Advertising Manager;
Western Office, 9025 Wilshire Blvd.,
Beverly Hills, Calif., William J. Ryan,
Western Manager.

Foreign Advertising Representatives:
D. A. Goodall Ltd., London; Albert Mil-
hoda & Co., Antwerp and Dusseldorf.

SUBSCRIPTION SERVICE: Forms 3579 and all subscription correspondence should be addressed to Popular Electronics, Circulation Department, 434 South Wabash Avenue, Chicago 5, Illinois. Please allow at least four weeks for change of address. Include your old address as well as new—enclosing if possible an address label from a recent issue.

CONTRIBUTORS: Contributors are advised to retain a copy of their manuscripts and illustrations. Contributions should be mailed to the New York Editorial Office and must be accompanied by return postage. Contributions will be handled with reasonable care, but this magazine assumes no responsibility for their safety. Any copy accepted is subject to whatever adaptations and revisions are necessary to meet the requirements of this publication. Payment covers all authors', contributors' and contestant's rights, titles, and interest in and to the material accepted and will be made at our current rates upon acceptance. All photos and drawings will be considered as part of material purchased.

In Spare Time at Home . . . **PREPARE FOR A BETTER JOB**
 . . . **OR YOUR OWN BUSINESS** in One of Many Branches

of **ELECTRONICS**

RADIO - TELEVISION - RADAR



NEW!
NEW!
NEW!

Shown above is the valuable new combination oscilloscope and voltmeter which DeVry Tech men build during the new training program. But that's not all! New movies, new experimental projects—all prepare you thoroughly in this latest and greatest DeVry Tech training program.



21 INCH

Build and keep this BIG DeVry Engineered TV set—easily converted to U.H.F. (optional training feature at moderate added cost.)

If you are seeking a better job or a business of your own, the appealing field of Television-Radio-Electronics offers **REAL PROMISE!**

In this fast-growing field, trained Electronic technicians find many good-paying, interesting jobs in manufacturing, installing, operating, servicing. Equally important is the fact that these are **GOOD JOBS**—offering the kind of a future that an untrained man often dreams about.

No previous technical experience or advanced education needed. Prepare for this profitable field in your spare time at home, or in our modern Chicago or Toronto Laboratories. Nothing else like it! Send for **FREE** details.

EARN WHILE YOU LEARN!

After you get part of DeVry Tech's training with equipment at home, you may then in your spare time, begin to earn real money servicing Radio and Television sets.

Your Guide to Profitable Job Opportunities!

- TV-Radio Broadcast Technician
- Color Television Specialist
- Radar Operator • Laboratory Technician
- Airline Radio Man • Computer Specialist
- Missile Electronics Technician
- Your Own Sales & Service Shop
- . . . **PLUS MANY OTHERS**

HOME MOVIES

. . . make important points crystal clear. Speeds your learning. It's almost like having an instructor at your side!



COLOR TV

DeVry Tech's program also includes training in Color Television

MILITARY SERVICE

If you are subject to military service, the information we have should prove very helpful. Mail coupon today.

YOU ALSO GET . . .

the same **EMPLOYMENT SERVICE** that has helped thousands of our graduates toward fine careers in Electronics.

You work over **300** Learn-By-Doing projects

Build over 300 practical projects from many shipments of Radio-Electronic parts. You build and operate V-Radio circuits...wireless microphone...and many other major projects—all designed to provide outstanding practical experience at home.

Send for **2 FREE** Booklets Now!

Accredited Member of National Home Study Council
 "One of North America's Foremost Electronics Training Centers"



Electronics in SPACE TRAVEL

POCKET GUIDE to Real Earnings

ACT NOW! Get information-packed publication **FREE!** Mail coupon today.

DeVRY TECHNICAL INSTITUTE

1414 Belmont Ave., Chicago 41, Ill., Dept. PE-5-R

Please give me your two **FREE** booklets: "Pocket Guide to Real Earnings" and "Electronics In Space Travel"; also include details on how to prepare for a career in Electronics.

Name _____ Age _____

PLEASE PRINT

Street _____ Age _____

City _____ Zone _____ State _____

For details of Canadian Training Programs, address DeVry Tech of Canada, Ltd., 970 Lawrence Avenue West, Toronto 19, Ontario

2044-A

DeVRY TECHNICAL INSTITUTE

CHICAGO 41, ILLINOIS

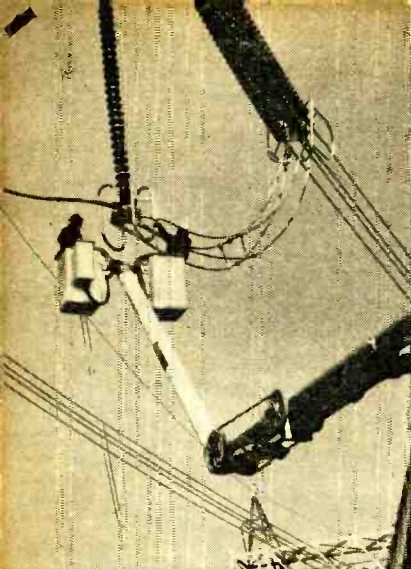

◀ **750,000 POUNDS OF ALUMINUM** will be used in General Electric's experimental 4.3-mile transmission line for voltages up to three-quarters of a million—more than three times the power of the 220,000-volt lines now in use. In addition to the Alcoa 2.32-inch aluminum conductors (the largest ever made commercially), the system boasts many other all-aluminum products supplied by the Aluminum Company of America. Among them: one of the largest aluminum transmission towers ever erected and a mammoth aluminum substation with virtually all components—including structural members, bolts, nuts, and plates—made of aluminum. The 105-foot transmission tower weighs only 15,000 pounds compared to the 40,000 pounds of a similar steel tower. America's future in high-voltage transmission lines may very well hinge on the metal—aluminum—that electricity refines.

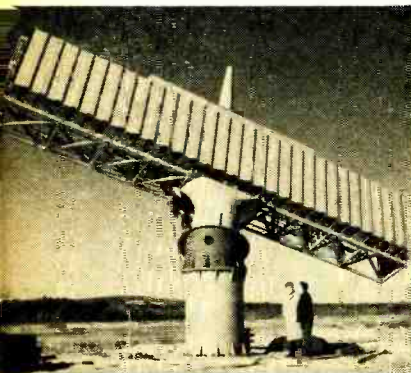

◀ **SOON TO JOIN THE NAVY** is Raytheon's seagoing radar system—touted as one of the largest ever developed. Designed to give early warning against air attacks, the system—with its monster-sized, 40'-long aluminum antenna—will be installed on Navy picket ships and cruisers. An intricate antenna design permits tailoring of the radar beam pattern to the most advanced search techniques. Inside the antenna there is an ensemble of 150 horns and interconnecting wave guides that would look like a plumber's nightmare to the uninitiated. The radar system, tabbed the AN/SPS-38, will baffle enemy attempts to jam it, and provide more time to set tactical operations in motion in the event of an attack.



◀ **SYNTHETIC QUARTZ CRYSTALS**, mass-produced for communications purposes, are now pouring out of the Western Electric Company's Merrimack Valley Works in Massachusetts. Previously, the only source of quartz crystals had been mines in the dark interior of Brazil manned by free-lance native miners—resulting in unstable supplies and high prices. The new factory grows quartz crystals of superior size and quality in a sort of scientific rock garden, under tremendous pressure and fierce heat. It takes only three men and as many weeks for Western Electric to "reproduce" what nature took many eons to produce.



◀ **THE FIRST MISSILE-FIRING RAILROAD CAR** for the U. S. Air Force Minuteman ICBM has been constructed at ACF Industries' Berwick, Pa., plant. The Boeing Airplane Company will outfit the car with launching gear and "electronics" for the three-stage, solid-fuel "bird." Eventually, the Air Force will have several missile trains roaming the rails throughout the nation—with any railroad siding a potential launching site, it would be impossible for an enemy to knock them out. Modern-day Casey Joneses will be missile men!

More on page 8

BREAK THROUGH TO HIGHER PAY

in ELECTRONICS

TV-RADIO

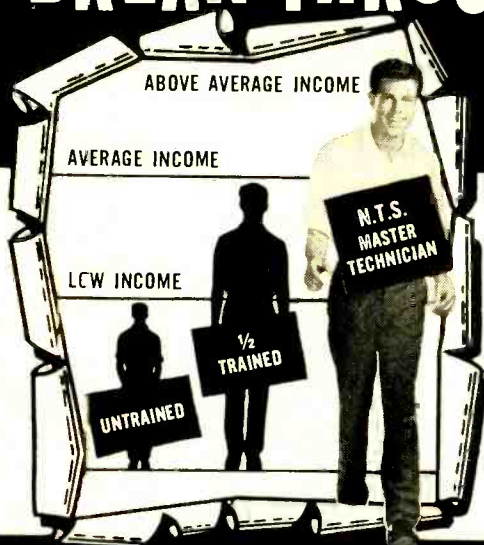

START NOW! Break through the Earning Barrier that stops half-trained men. N.T.S. "All-Phase" training prepares you — at home in spare time — for a high-paying CAREER in Electronics — TV — Radio as a MASTER TECHNICIAN. One Master Course at One Low Tuition trains you for unlimited opportunities in All Phases: Servicing, Communications, Preparation F.C.C. License, Broadcasting, Manufacturing, Automation, Radar and Micro-Waves, Missile and Rocket Projects.

A more rewarding job... a secure future... a richer, fuller life can be yours! As an **N. T. S. MASTER TECHNICIAN** you can go straight to the top in industry... or in your own profitable business.

You work on actual job projects

SUCCEED IN MANY HIGH-PAYING JOBS LIKE THESE...

- TV-Radio Sales, Service and Repair
- Profitable Business of Your Own
- Communications Technician — F.C.C. License
- Hi-Fi, Stereo & Sound Recording Specialist
- TV-Radio Broadcasting Operator
- Technician in Computers & Missiles
- Electronics Field Engineer
- Specialist in Microwaves & Servomechanisms
- Exper: Trouble Shooter
- A 1-Phase Master Technician

19 BIG KITS YOURS TO KEEP



Free book gives you all the facts

NATIONAL TECHNICAL SCHOOLS

WORLD-WIDE TRAINING SINCE 1905

4000 SO. FIGUEROA ST., LOS ANGELES 37, CALIF., U. S. A.

Write Dept. R2G-51



RESIDENT TRAINING AT LOS ANGELES

If you wish to take your training in our Resident School at Los Angeles, the world's TV capital, start NOW in our big, modern Shops, Labs, and Radio TV Studios. Here you work with latest Electronic equipment — professionally installed — finest, most complete facilities offered by any school. Expert friendly instructors. Personal attention. Graduate Employment Service. Help in finding home near school — and part time job while you learn.

WRITE FOR SPECIAL RESIDENT SCHOOL CATALOG AND INFORMATION



ACCREDITED MEMBER
... the only nationally recognized accrediting agency for private home study schools.

N.T.S. Shop-Tested HOME TRAINING is **Better, More Complete, Lower Cost**... and it is your key to the most fascinating, opportunity-filled industry today!

YOU LEARN QUICKLY AND EASILY THE N.T.S. SHOP-TESTED WAY

You get lessons, manuals, job projects, unlimited consultation, graduate advisory service.

You build a Short Wave-Long Wave Superhet Receiver, plus a large-screen TV set from the ground up, with parts we send you at no addi-

tional cost. You also get a Professional Multitester for your practical job projects.

EARN AS YOU LEARN... WE SHOW YOU HOW!

Many students pay for entire tuition — and earn much more — with spare time work they perform while training. You can do the same... we show you how.

SEND FOR INFORMATION NOW... TODAY! IT COSTS YOU NOTHING TO INVESTIGATE.

N.T.S. HOME TRAINING is

- Classroom Developed
- Lab-Studio Planned
- Shop-Tested
- Industry-Approved
- Specifically Designed for Home Study

ACTUAL LESSON

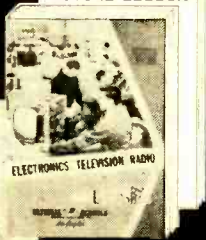

MAIL COUPON NOW for **FREE BOOK** and **ACTUAL LESSON**

NO OBLIGATION!

NO SALESMAN WILL CALL

NATIONAL TECHNICAL SCHOOLS

WORLD-WIDE TRAINING SINCE 1905

Mail Now To
National Technical Schools, Dept. R2G-51
4000 S. Figueroa St., Los Angeles 37 Calif.

Please rush **FREE** Electronics-TV-Radio "Opportunity" Book and Actual Lesson. No Salesman will call.

Name _____ Age _____
Address _____
City _____ Zcne _____ State _____

Check here if interested **ONLY** in Resident Training at Los Angeles.
VETERANS: Give date of discharge _____

NEWS SCOPE

Continued



◀ **LITTLE "EMANCIPATORS"**—tiny pocket radio receivers designed by General Electric—are helping key personnel at Ormond Beach Hospital, Fla., make better use of "on-call" time, and have eliminated the need for them to stay close to telephones. Surgical nurses, anesthetists, and physicians, who formerly had to make 20-minute telephone "report-ins," can now be reached instantly even if they are on a lonely strip of beach, at a movie, or just shopping for a pair of shoes. Time signals every half hour inform the listener that the set is working and within range of the transmitter.



◀ **DOLLAR BILL CHANGERS** that work for nothing are arriving on the American scene. They are machines, made by A.B.T. Division of Automatic Canteen Company of America, which accept dollar bills and give in return a dollar's worth of dimes, nickles, and quarters. Deep in the heart of each "changer" are magnetic amplifiers which can "sense" and validate genuine U. S. one dollar bills, rejecting all phonies, foreign currency, and bills of higher denominations. About 600 machines are already in use throughout the country, primarily at vending machine locations.



◀ **"COOK-IT-YOURSELF" ELECTRONIC CAFETERIAS** will soon be taking the place of conventional steam-table setups. Three or four different hot meals will be served by the cafeterias, even though they have no kitchens, cooking utensils, or steam tables. Prepared by an outside commissary, the meals are frozen, served refrigerated, and reheated by the cafeteria's patrons in just 60 seconds using Radarange microwave ovens made by Raytheon. Small plants and business offices will be able to offer employees complete hot meals where cold sandwiches now hog the menu.



◀ **WEAK HEARTS NOW HAVE STRONG HOPES** of survival due to two new devices developed by Westinghouse. One unit, called the "Cardiac Pacer," can stimulate a faltering heart; a second one, the "Cardiac Monitor," broadcasts an emergency alarm to a doctor up to 2½ miles away. The Pacer is a transistorized unit that emits electrical impulses to trigger the heartbeat; both the rate and amplitude of these impulses can be regulated to suit the individual patient's needs. The Monitor, a fully transistorized unit, indicates the heart rate on a dial and sets off a high-pitched alarm signal if the pulse deviates or stops. During a normal heartbeat, an audible "beep" can be heard. When the alarm signal sounds, a transmitter built into the Monitor activates a pocket-sized receiver carried by the doctor. Soon Doctor Kildare will be able to spend more time putting than pulse-taking.



PUZZLED

...no need to be

look to this sign of assurance!

The Distributor displaying this sign will solve your tuner problems at a profit to you.

He has available the New Standard Tuner Replacement Guide, including replacement parts listings. This is the only Guide of its kind in the world. Covers all Standard tuners produced through 1959. Includes replacements for many tuners not produced by Standard.

He handles our 48-hour Factory Guaranteed Repair Service and Trade-In Allowance on unrepairable Standard tuners.

See This Authorized Distributor Today



standard kollsman

INDUSTRIES INC. Formerly Standard Coil Products Co., Inc.
2085 N. HAWTHORNE AVENUE, MELROSE PARK, ILLINOIS

COMPLETE SERVICE TRAINING

.. written so you can understand it!



Only \$17
for the complete
2-volume course

ALMOST 1500 PAGES!

Fix any TV or Radio Ever Made

EASIER-BETTER-FASTER!

No complicated theory or mathematics! These famous Ghirardi books get right down to brass tacks in showing you how to handle all types of AM, FM, and TV service work by approved, professional methods. Almost 1500 pages and over 800 clear illustrations show how to handle every phase of troubleshooting and servicing. Each book is co-authored by A. A. Ghirardi whose manuals have helped train more servicemen than any other books or courses of their kind!

1—Radio and Television Receiver TROUBLESHOOTING AND REPAIR

A complete guide to profitable professional methods. For the beginner, it is a comprehensive training course. For the experienced serviceman, it is a quick way to "brush up" on specific jobs, to develop improved techniques or to find fast answers to puzzling service problems. Includes invaluable "step-by-step" troubleshooting charts that show what to look for and where. 820 pages, 417 illustrations, price \$10 separately.

2—Radio and Television Receiver CIRCUITRY AND OPERATION

This 669-page volume is the ideal guide for servicemen who realize it pays to know what really makes modern radio-TV receivers "tick" and why. Gives a complete understanding of basic circuits and circuit variations; how to recognize them at a glance; how to eliminate guesswork and useless testing in servicing them. 417 illus. Price separately \$9.00.

Special low price . . . you save \$2.00

If broken into lessons and sent to you as a "course," you'd regard these two great books as a bargain at \$100 or more!

Under this new offer, you buy both books for only \$17.00 . . . you save \$2.00! No lessons to wait for. You learn fast—and right!

STUDY 10 DAYS FREE!

623900

Dept. PE-51, HOLT, RINEHART & WINSTON, INC.,
Technical Div., 383 Madison Ave.,
New York 17, N. Y.

Send books below for 10-day FREE EXAMINATION. In 10 days I will either remit price indicated (plus postage) or return books postpaid and owe you nothing.

Radio & TV Receiver **TROUBLESHOOTING & REPAIR** (Price \$10.00 separately) No. 708214

Radio & TV **CIRCUITRY & OPERATION** (Price \$9.00) No. 708214

Check here for **MONEY-SAVING COMBINATION OFFER** . . . Save \$2.00. Send both of above big books at special price of only \$17.00 for the two. (Regular Price \$19.00 . . . you save \$2.00.) No. 709006

SAVE! Send cash with order and we pay postage. Same return privilege with money promptly refunded.

Name

Address

City, Zone, State

Outside U.S.A.—\$10.50 for **TROUBLESHOOTING & REPAIR**; \$9.50 for **CIRCUITRY & OPERATION**; \$18.00 for both. Cash only, but money refunded if you return books in 10 days.

Above offers expire Jan. 31, 1962



FCC Report

☆☆☆☆☆ ☆☆☆☆☆☆☆ ☆☆☆☆☆☆☆

By **ROBERT E. TALL**
Washington Correspondent

THIS YEAR'S session of Congress could do a man-sized favor for CB'ers and others. The FCC has again requested an amendment to the Communications Act which would remove the requirement that applications for licenses be notarized before they are submitted to the agency.

Under the existing law, the FCC has to require that applications for radio licenses of all types be subjected to "oath or affirmation"—even though the agency itself has complained about the unnecessary time and trouble involved for both the FCC and radio users. Time and again, the agency has pointed out that other laws provide penalties for making false statements to government agencies, and that the present notarization requirement is a headache to everybody involved.

Until the law is changed, however, FCC staff members concerned with the Citizens Band are pleading with prospective CB'ers to make sure that their applications comply with this requirement. In most states, notary publics are the people to see; but justices of the peace serve in some localities, while postmasters will do the job in others.

Citizens Band licensees have created another "sore spot" at the FCC which the Commission had not encountered to any great degree with the older radio services—stemming from the fact that CB licensees sometimes change their addresses without notifying the agency. In most of the radio services that the FCC regulates, licenses are held by businesses or public safety organizations which do not shift addresses very often. Individual licensees, however, who hold practically all of the CB licenses, frequently move to a new location. A num-

Always say you saw it in—POPULAR ELECTRONICS

For serious-minded men desiring higher income and status-

CREI has developed a program of home study that is comparable in technological content to advanced residence courses in electronics. The program was developed hand-in-hand with leading companies and Government agencies contributing to the Nation's efforts in electronics, communications, missiles, and space exploration.

This CREI program in Electronics Engineering Technology may be completed in 2 to 4 years, depending on how much of your spare time you can devote to study. The courses are presented in easy-to-understand form. Our instructors will give you personal attention and assist you when you need help.

To qualify CREI graduates for advancement to key technical positions, CREI offers a complete program in electronics, including—

Automation • Instrumentation • Industrial Electronics
Aeronautical Electronics • Guided Missiles • Radar
Servo-mechanisms • Computers • Astronautics • Telemetering • Communications • Electronics Manufacturing • Field Engineering • Nuclear Engineering

A COLLEGE-LEVEL EXTENSION PROGRAM IN ELECTRONICS

There is a drastic need in the electronics industry for well-educated engineers and technical personnel. Although the great majority of students find ample opportunity for advancement with their present companies, CREI maintains a Placement Bureau to assist graduates and advanced students in finding more desirable positions. For many years, the demand for CREI graduates and advanced students has far exceeded the supply.

A few of the private companies and government agencies whose officials approve CREI for their own personnel:

U. S. Navy (5,240 enrolled in extension program)
Army, Air Force, Marine Corps, Coast Guard
Columbia Broadcasting System
National Broadcasting Company
Federal Electric Corporation

Florida Power & Light
Pan American Airways
United Airlines
The Martin Company
All America Cable & Radio
Voice of America
... and many others

QUALIFICATIONS FOR CREI. You qualify if you have a high school diploma or equivalent, and if you have had basic electronic training and practical experience in electronics. Available to Veterans.

CREI's Extension Division offers you a college-level home study program in electronics comparable in technological content to advanced residence courses.

Mail this coupon . . . today!

CAPITOL RADIO ENGINEERING INSTITUTE

ECPD Accredited Technical Institute Curricula • Founded 1927
Dept. 1205-H, 3224 16th St., N.W., Washington 10, D.C.
England: CREI London, Granville House,
132-135 Sloane Street, London S.W. 1, England

Please send me your course outline and FREE 56-Page Book "Your Future in Electronics and Nuclear Engineering Technology" . . . describing opportunities and CREI home study courses in Advanced Engineering Technology.



Check field of greatest interest

- Radar, Servo and Computer Engineering Technology
- Electronic Engineering Technology
- Communications Engineering Technology
- Television Engineering Technology
- Aeronautical Electronic Engineering Technology
- Automation and Industrial Electronics Engineering Technology
- Nuclear Engineering Technology

Name _____ Age _____
Street _____
City _____ Zone _____ State _____

Check: Home Study Residence School Korean Veteran

To obtain fast, immediate service and to avoid delay, it is necessary that the following information be filled in:

Employed by _____

Type of Present Work _____

Education: _____

Years of High School _____

Other _____

Electronics Experience _____

*lowest cost
master antenna system
ever developed*



**NEW
BLONDER-TONGUE
TRANSISTOR 4-SET
BOOSTER—MODEL IT-3**

*All the gain you need from
one antenna for 4 TV or FM sets!*

This new transistor-operated 4-set booster provides higher gain and lower noise than any comparable vacuum tube unit. There are no tubes to replace, lower power drain and negligible heat—all contributing to lower cost, longer maintenance-free operation than any unit on the market. List price of model IT-3, \$32.50.

SUPERB 1, 2, 3 or 4 SET PERFORMANCE

• **1 SET**—B-T 'straight thru' circuit provides full gain without isolation losses (Gain: 9 to 14 db, TV; 8 to 12 db, FM).

• **2, 3 OR 4 SETS**—splitting circuit provides gain and inter-set isolation necessary to provide top performance on 2, 3 or 4 sets. Gain two sets—each set 4 to 8 db; Gain three sets—each set 3 to 4 db; Gain four sets—each set 2 to 3 db.

Sold through distributors. For details write:

engineered and manufactured by

BLONDER-TONGUE
9 Alling St., Newark, N. J.

Canadian Div.: Benco Television Assoc. Ltd., Toronto, Ont.
Export: Morhan Export Corp., New York 13, N. Y.
home TV accessories • UHF converters • master TV systems • Industrial TV systems • FM/AM radios

ber of CB'ers have been ordered off the air until they go through the whole licensing process again, starting from scratch.

The FCC does not demand that CB'ers get its permission to change their residences, but it does want to know about address changes within a reasonable period of time. As long as an application for "modification of address" is on file at the agency, operating with an old license is permissible until the new one arrives. If the application is not on file, however, and the CB'er is monitored at an address different from that shown on the license, or otherwise gets caught in the change-of-address snare, he is in jeopardy of losing his license.

On the amateur radio side, Washington communications officialdom turned out in force again this year to honor the recipients of the 1961 Edison Amateur Radio Award—John T. Chambers, of Palos Verdes Estates, Calif., and Ralph E. Thomas, of Kahuku, Hawaii. The Edison award, inaugurated nine years ago for outstanding public service by amateur operators, was issued for the first time this year for a scientific achievement.

California-Hawaii transmissions by these two radio engineers confirmed the theory that u.h.f. frequencies are not limited to line of sight. See page 114 for details on their accomplishment.

The new chairman of the FCC, Newton N. Minow, who just took over his duties a couple of months ago, admitted during confirmation hearings before a Senate committee that he knew little about the work of the Commission when first tapped by President Kennedy for the job. But his activities since then indicate that he is learning fast.

The 35-year-old former Chicago attorney is expected to be one of the "strongest" chairmen the FCC has had for some years. Moreover, his close liaison with the White House and some influential politicians could result in FCC procedure changes which would be hard to put across without such connections. Mr. Minow, among other things, was a law partner of the new United Nations Ambassador, Adlai E. Stevenson; he also served as administrative assistant to Mr. Stevenson when the latter was Governor of Illinois.

—30—

NEW knight-kits®

A PRODUCT OF ALLIED RADIO

- simply great!

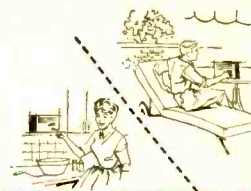

measures
engine speed,
0-8000 rpm



it's WIRELESS—
just plug in
and TALK!

New Money-Saving Electronic Tachometer Kit

Most Accurate at this Low-Cost—Unaffected by Temperature

ONLY \$19.95 Another KNIGHT-KIT first—a precision tachometer in money-saving, easy-to-build form. Helps you drive at your best engine speed efficiency, like the professionals. Temperature-compensated Zener diode regulator contributes to exceptional 5% of full-scale accuracy, regardless of voltage or temperature changes. Operates with 4, 6 or 8 cylinder automotive engines; simple 3-wire installation. Universal mount fits dash or steering column. Ideal also for high-powered outboard marine engines using primary ignition system from 2 cycle 2 cylinder and up. Big illuminated D'Arsonval meter; linear 0-8000 rpm scale; reference pointer may be preset to any desired speed. With cables, mounting hardware, wire and solder. Shpg. wt., 2 lbs.

83 Y 944. Only \$2 Down. NET. \$19.95

Deluxe Wireless Intercom Kit at Lowest Cost

Works Anywhere Without Wires—No Installation!

This easy-to-assemble intercom operates without installation or wiring—just plug into any AC or DC wall outlet for step-saving communication! Change locations easily—anywhere. Ideal for home, office or store. In the home, you can communicate with nursery, garage, basement or patio. In office or shop, provides time-saving communication. Will operate between adjacent buildings that are on same electric-company line transformer. Perfect for baby sitting. Features power-line noise silencing circuit for absolutely quiet "standby"; premium quality throughout. Has Talk-Listen switch, with lock-on feature for constant listening. Handsome cream-toned plastic cabinet, 9 x 5½ x 5½". Can be used in systems consisting of 2 or more units, as desired. Shpg. wt., 3½ lbs.

ONLY \$18.95

83 Y 941. NET. Each Station \$18.95
20 YX 272-2. Complete 2-Station System. NET \$36.95

BIG SAVINGS ON KITS in Allied's Summer Sale Book!



KN-3000 AK Electrostatic Speaker system Kit

Save \$25.00 Regularly \$99.50—Summer Sale price slashed to \$74.50! Finest high-compliance speaker system delivering absolutely fabulous sound. Includes 12" extra-low resonance woofer; two patented Arthur Janszen electrostatic tweeters; premium quality power supply (pre-wired); hardwood panels for building sealed enclosure, Korina veneer panels (unfinished) for external surfaces; acoustic damping material. Assembled size, 14 x 26½ x 13". Response, 30-25000 cps. Capacity, 50 watts music waveform. Shpg. wt., 50 lbs.

35 DU 767. Only \$5 Down. NET. \$74.50

C-27 Citizens Band Transceiver Kit with Press-to-Talk Microphone

Combination regularly \$89.45—now reduced to \$84.45! Genuine dual-conversion superhet receiver for highest sensitivity and selectivity; 2-channel crystal-controlled full 5-watt transmitter. Features: Automatic noise limiter; continuously variable squelch control. With one transmitting crystal (channel 1-22—specify). Includes quality Press-to-Talk Microphone. Shpg. wt., 21 lbs.

Save \$5.00
20 YU 271-3. Only \$5 Down. NET. \$84.45



FREE!

Send for the big bargain-packed Allied Summer Sale Book—save as never before on everything in Electronics!

Send for it!



ALLIED RADIO, Dept. 23-E1
100 N. Western Ave., Chicago 80, Ill.

Please ship me the following:

- 83 Y 944 Tachometer Kit. 83 Y 941 Intercom Station.
 35 DU 767 Speaker Kit. 20 YX 272-2 Intercom System.
 20 YU 271-3 Transceiver with Mike. \$_____ enclosed
 Send Free Allied Summer Sale Book No. 205

Name _____
PRINT
Address _____
City _____ Zone _____ State _____

order from **ALLIED RADIO**

Hi-Fi |

Showcase

NEW hi-fi/stereo products continue to roll off production lines and into dealers' showrooms. While space prevents us from listing each and every one, you'll find the month's more outstanding releases discussed below. If you would like to have additional information on a particular product, simply write to the individual manufacturer or distributor—names and addresses appear at the end of this column on page 20.

Big bass from a small enclosure is one of the wonders of modern hi-fi. In the "Eldorado" bookshelf enclosure by *Argos*, it results from a tuning tube and ducted port precisely matched to a 12" woofer. Measuring only 14¼" x 27" x 10", the TSE-3AS incorporates two 3½" tweeters in addition to the woofer

(all Jensen's, by the way) for an overall response of 40 to 17,000 cycles. With input impedance to a built-in crossover network rated at 8 ohms, the TSE-3AS can be used with virtually any amplifier. Price, \$39.95. . . . From *Allied Radio* comes a new "add-on" electrostatic tweeter designed to supplement existing speaker systems with high-frequency response from 1000 cycles to the limits of audibility. Supplied complete with built-in crossover network, balance control, and power supply, the Knight KN-825 incorporates a curved radiating element said to provide a full 90° dispersion of sound. A mere 8" x 10" x 3", the KN-825 has an ivory-colored, perforated plastic grille; top and bottom are of oiled walnut. Price, \$26.95.

Billed as the most powerful and versatile stereo receiver on the market, *Crosby's* R80 boasts push-button source selection and ganged, push-pull knobs. Other features include a two-channel indicator for tuning and program level; variable mono/stereo blend lights; speaker/head-set selector; volume control for third-speaker installation; con-

◆ EVOLUTION OF A FAMOUS TAPE RECORDER



(MODEL EI. 3536)

- ◆ Four-track stereophonic or monophonic recording and playback
- ◆ Three speeds—7½, 3¾ and 1½ ips
- ◆ Completely self-contained, including dual recording and playback preamplifiers, dual power amplifiers, two Norelco wide-range loudspeakers (second in lid) and stereo dynamic microphone (dual elements)
- ◆ Can also be used as a quality stereo hi-fi system with tuner or record player.

PLUS—"Sound-on-Sound"...for adding sound over previously recorded sound, without any danger of erasure!
PLUS—Mixing facilities...for recording any two sources of sound simultaneously!

Complete with dual-element microphone and two matched Norelco loudspeakers: **\$399.50**

the *Norelco*[®]

CONTINENTAL '400'

a new 4-track stereo-record/
 stereo-playback tape recorder
 guild-crafted for you by
 Philips of the Netherlands

For complete descriptive literature write to:
 North American Philips Co., Inc.
 High Fidelity Products Division
 230 Duffy Avenue
 Hicksville, L. I., N. Y.

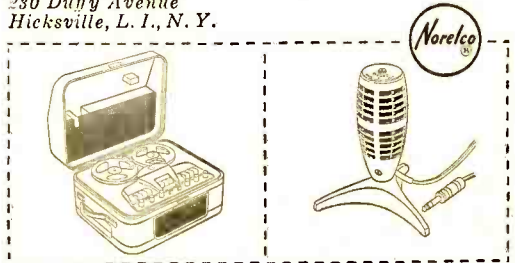

Do you WISH you were EMPLOYED in ELECTRONICS?

Get Your First Class Commercial F.C.C. LICENSE QUICKLY!

F.C.C. LICENSE—THE KEY TO BETTER JOBS

An F.C.C. commercial (not amateur) license is your ticket to higher pay and more interesting employment. This license is Federal Government evidence of your qualifications in electronics. Employers are eager to hire licensed technicians.

WHICH LICENSE FOR WHICH JOB?

The THIRD CLASS radiotelephone license is of value primarily in that it qualifies you to take the second class examination. The scope of authority covered by a third class license is extremely limited.

The SECOND CLASS radiotelephone license qualifies you to install, maintain and operate most all radiotelephone equipment except commercial broadcast station equipment.

The FIRST CLASS radio telephone license qualifies you to install, maintain and operate every type of radiotelephone equipment (except amateur) including all radio and television stations in the United States, its territories and possessions. This is the highest class of radiotelephone license available.

GRANTHAM TRAINING PREPARES YOU

The Grantham course covers the required subject matter completely. Even though it is planned primarily to lead directly to a first class FCC license, it does this by TEACHING you electronics. Some of the subjects covered in detail are: Basic Electricity for Beginners, Basic Mathematics, Ohm's and Kirchoff's Laws, Alternating Current, Frequency and Wavelength, Inductance, Capacitance, Impedance, Resonance, Vacuum Tubes, Transistors, Basic Principles of Amplification, Classes of Amplifiers, Oscillators, Power Supplies, AM Transmitters and Receivers, FM Transmitters and Receivers, Antennas and Transmission Lines, Measuring Instruments, FCC Rules and Regulations, and extensive theory and mathematical calculations associated with all the above subjects explained simply and in detail.

OUR GUARANTEE

If you should fail the F.C.C. exam after finishing our course, we guarantee to give additional training at NO ADDITIONAL COST. Read details in our free booklet.

Learn by Correspondence or in Resident Classes

Grantham training is offered by correspondence or in resident classes. Either way, we train you quickly and thoroughly--teach you a great deal of electronics and prepare you to pass the F.C.C. examination for a first class license. Get details now. Mail coupon below.

This booklet
FREE!

This free booklet gives details of our training and explains what an F.C.C. license can do for your future. Send for your copy today.

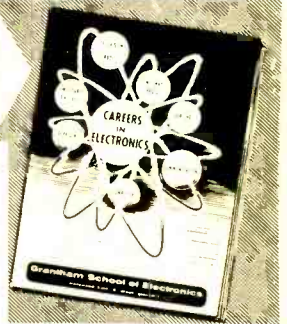

To get ahead in electronics—first, you need the proper training; then, you need “proof” of your knowledge. Your first class commercial F.C.C. license is a “diploma” in communications electronics, awarded by the U.S. Government when you pass certain examinations. This diploma is recognized by employers. Grantham School of Electronics specializes in preparing you to earn this diploma.

Grantham training is offered in resident classes or by correspondence. Our free booklet gives complete details. If you are interested in preparing for your F.C.C. license, mail the coupon below to the School's home office at 1505 N. Western Ave., Hollywood 27, California—the address given in the coupon—and our free booklet will be mailed to you promptly. No charge—no obligation.

Grantham School of Electronics

HOLLYWOOD
CALIF.

SEATTLE
WASH.

KANSAS CITY
MO.

WASHINGTON
D. C.

RESIDENT CLASSES
HELD IN FOUR CITIES

If you are interested in attending day or evening classes mail the coupon for free information to our home office in Hollywood, Calif.



(Mail in envelope or paste on postal card)

To: **GRANTHAM SCHOOL OF ELECTRONICS**
1505 N. Western Ave., Hollywood, Calif.

Gentlemen:

Please send me your free booklet telling how I can get my commercial F.C.C. license quickly. I understand there is no obligation and no salesman will call.

Name _____ Age _____

Address _____

City _____ State _____

I am interested in: Home Study, Seattle classes

Hollywood classes, Kansas City classes, Washington classes

13-E

MAIL COUPON NOW—NO SALESMAN WILL CALL →

**At last!
a speaker cabinet kit
with a choice of styling!**



**UNIVERSITY'S
MEDALLION
KIT features 5
'Select-a-Style'
snap-on grilles**



NOW, the exciting new styling concept of the Medallion XII speaker system is available in cabinet kit form too! For the first time, you can take pride in assembling a high fidelity speaker cabinet that's styled to your taste . . . and hers too! The secret's in the interchangeable snap-on grilles, available in Swedish Modern, Colonial, Italian Provincial, French Provincial and Contemporary. Practical? If you ever change your decor, just change the grille.

Each grille frame is authentically interpreted, expertly crafted and pre-assembled for you, with only the grille cloth and hardware to be mounted. The cabinet itself is easy to assemble, with every piece precision machined to the closest tolerances . . . selected 3/4" hardwoods assuring resonant-free performance. And smooth-grained veneers make it easy to achieve a professional finish.

The Medallion's exceptional versatility extends to its speaker mounting board as well . . . letting you plan virtually any type of multi-speaker system using either a high compliance or high efficiency 12" woofer, 8" cone speaker or driver/horn for mid-range, and wide-angle horn or University's fabulous Sphericon for treble. If you desire a single integrated wide-range speaker, University's new Series 200 high compliance speakers will easily outperform most multi-speaker systems.

And it fits anywhere! On floor or bench . . . even built-in. With or without its matching base, as highboy or lowboy. Only 17"x24"x12 1/2" deep, it's ideal as a stereo pair.

See the Medallion at your University dealer now. You'll surely agree that as a kit, assembled cabinet, or complete Medallion XII speaker system, it's the most intriguing and sensible idea yet in high fidelity!

NET PRICES: Cabinet kit — \$49.95. Grille kits—Contemporary, \$7.95, others, \$12.95 each. Base kit—\$12.95.

Write for University's new 'Informal Guide to Component High Fidelity.' Desk A-5, University Loudspeakers, Inc., White Plains, N.Y.



A Division of Ling-Temco Electronics, Inc.

Showcase

(Continued from page 14)

curved tuning dial; and facilities for an accessory multiplex adapter. The R80 is priced at \$375, exclusive of enclosure; matching metal or wooden cabinets are available at \$17.95 and \$30, respectively. . . . Designed to provide background music in home or office, the **Grommes Model 510** is a complete FM tuner, pre-amplifier, and 20-watt amplifier in a single package. With inputs for phono, tape, and microphone, the amplifier section is also equipped with loudness, bass, and treble controls; not to be outdone, the tuner section boasts an electronic tuning eye and flywheel tuning. Supplied less enclosure, the Model 510 is priced at \$149.95; a matching enclosure sells for \$10.00.

From **Lafayette Radio** comes an all-in-one stereophonic music center complete with individual FM and AM tuner sections, dual 20-watt amplifiers, and two self-contained preamps. Both AM and FM sections feature individual precision tuning meters and flywheel action for precise station selection; front-panel amplifier controls include bass, treble, balance/volume, and 4-position selector and mode switches. Finished in brown and brass with a contrasting dial face, the LA-225 measures 5 1/4" x 17 1/2" x 15" and is priced at \$174.95.

If you happen to own either a Wollensak or Revere monophonic or 2-track stereo tape recorder and want to take advantage of the new 4-track stereo tapes, you'll be interested in the WR-60 4-track conversion kit from **Nortronics**. A 4-track stereo record/play head and a 4-track stereo erase head mounted in a head-shifting mechanism, the WR-60 permits playback of both 2- and 4-track prerecorded tapes as well as recording 4 monophonic tracks on a single machine. For stereo recording, of course, you'll need an additional recording pre-amplifier (such as the Nortronics RA-100). Price of the WR-60, \$49.50. . . . One of the oldest problems of the tape fan—splicing—is almost child's play with the little "Jiffy" splicer produced by **Rason**. A compact 4 1/4" x 1 1/2", the "Jiffy" allows precise, accurate editing,

(Continued on page 20)

Always say you saw it in—POPULAR ELECTRONICS

AT LAST!

RADIO-TV and ELECTRONICS TRAINING ... AT A PRICE YOU CAN AFFORD!



***21 INCH**
Receiver Kit included

Yes, this great course costs far less than any training of its kind given by other major schools! Radio-Television Training School will train you for a good job in Television or Industrial Electronics — **AT HOME IN YOUR SPARE TIME.**

Think of it—a complete training program including over 120 lessons, Fourteen Big Radio-Television Kits, Complete Color-TV Instruction, Unlimited Consultation Service... **ALL at a really big saving to you.** How can we do this? Write to us today... and find out!

And what's more — you can (if you wish) **OPEN YOUR OWN RTS-APPROVED AND FINANCED RADIO-TV SERVICE SHOP**

We Want Many More Shops This Year

This 38 year old training organization — called RTS, that's Radio-Television Training School — wants to establish a string of Radio-TV Repair Shops in principal cities throughout the U. S. So far, a great many such shops are **NOW IN BUSINESS AND PROSPERING.** We are helping and training ambitious men to become future owners and operators of these shops in all areas.

FOR UNSKILLED INEXPERIENCED MEN ONLY — WE TRAIN YOU OUR WAY!

We must insist that the men we sign up be trained in Radio-TV Repair, Merchandising and Sales by our training methods—because **WE KNOW** the requirements of the industry. Therefore, we will **TRAIN YOU**... we will show you how to earn **EXTRA CASH**, during the first month or two of your training period. **YOU KEEP YOUR PRESENT JOB. TRAINING TAKES PLACE IN YOUR OWN HOME, IN YOUR SPARE TIME!**

COMPLETE COLOR TV INSTRUCTION INCLUDED

you build these and other units



RADIO-TELEVISION TRAINING SCHOOL
815 EAST ROSECRANS AVENUE
LOS ANGELES 59 CALIFORNIA

Est. 1922



ACT NOW!

RTS APPROVED SERVICE SHOP

Get your free book on the **FAMOUS RTS BUSINESS PLAN** find out how you can open **A REPAIR SHOP OF YOUR OWN**

We supply and finance your equipment

When you are ready and qualified to operate one of our RTS-Approved TV Repair Shops **WE WILL SUPPLY AND FINANCE EVERY BIT OF EQUIPMENT YOU NEED TO GET STARTED** plus an inventory of parts and supplies. In other words we will stake you... **AN OFFER NEVER MADE BEFORE BY ANY TRAINING ORGANIZATION.** Under the RTS Business Plan you receive:

1. An electric sign for the shop front.
2. Complete laboratory of test equipment.
3. Letterheads, calling cards, repair tickets, etc.
4. Basic inventory of tubes, parts, supplies.
5. Complete advertising and promotional material.
6. Plans for shop arrangement.
7. Instructions on how to go into business.
8. Continuous consultation and help.
9. The right to use RTS Seal of Approval, and the RTS Credo.
10. The right to use the Famous Trade Mark.

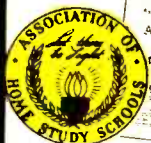

RTS' Membership in The Association of Home Study Schools is your assurance of Reliability, Integrity, and Quality of Training.

ALL THESE FREE!



CUT OUT AND MAIL — TODAY!

RADIO-TELEVISION TRAINING SCHOOL
815 EAST ROSECRANS AVE Dept. PE-51
LOS ANGELES 59 CALIFORNIA

SEND ME FREE — all of these big opportunity books — "Good Jobs in TV-Electronics," "A Repair Shop of Your Own" and "Sample Lesson." I am interested in:

- Radio-Television Industrial Electronics (Automation)

Name _____ Age _____

Address _____

City & State _____

Mail This Coupon Now — No Salesman Will Call

IT COULD HAPPEN TO YOU...



Somewhere it said: "Build this kit in an amazing 10 hours!" Looks like you're running into overtime because you spent the first 7½ hours sorting out the jumbled mess of small parts and hardware. Well, it's good training for looking for needles in haystacks.



If drug manufacturers made the mistakes in labeling you find in some kits, the world would be a quieter, lonelier place. You know a selenium rectifier when you see one, and if this is a selenium rectifier, you're Thomas Alva Edison.



Let's see. On Page 5 it says: "See diagram Page 12." On Page 12 it says: "See instructions Page 5." Well, if you hold Page 5 open with your tongue, and Page 12 open with your left ear, that still leaves you three fingers on your left hand free for soldering and also...

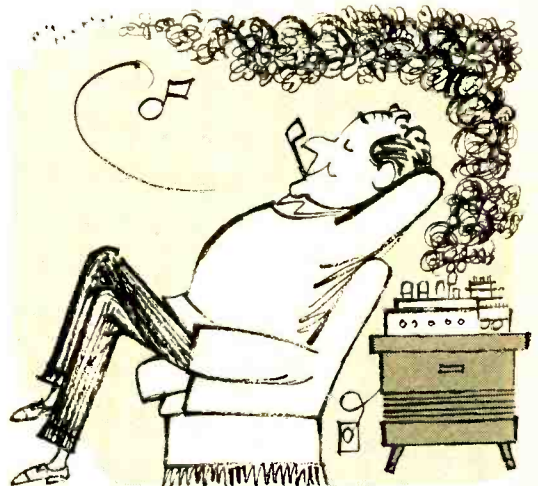

Don't look now, but while Heifetz fiddles, your amplifier burns. When the smoke clears, you'll probably find that the 100 microfarad electrolytic was shorted because it had not been pre-tested. All work and no play, makes Jack a very mad boy!

UNLESS THE KIT YOU BUILD IS A PACO

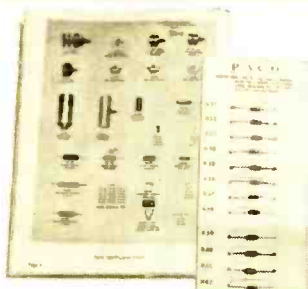

No mistaken identity or endless searching. Parts are clearly pictured and labeled; resistors are neatly mounted and identified.

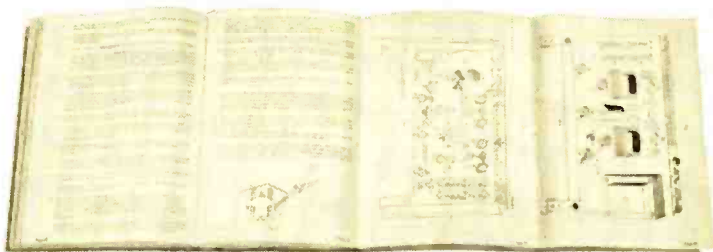

Step-by-step instruction book makes assembling a Paco Kit foolproof! Paco gives you giant, fold-out diagrams on corresponding instruction pages so you can see both at the same time.



PACO Model C-25 IN-CIRCUIT CAPACITOR TESTER KIT

Reveals dried out, shorted, or open electrolytics—in the circuit—with Paco's exclusive Capacity Dial. Instantly finds open or direct shorted capacitors without removing from circuit. Great time saver!

Specifications:

SIMPLE SEQUENTIAL TEST: reveals open or shorted capacitors, including electrolytic types.

ELECTROLYTIC DIAL: indicates actual electrolytic values while capacitor is in-circuit; any electrolytic which yields a capacity reading on Electrolytic Dial is automatically revealed as not open or shorted.

ELECTROLYTIC TEST: indicates in-circuit electrolytic capacity from 2 mfd to 400 mfd in two ranges; condenser is automatically proved non-short and not open if Capacity Reading can be obtained.

Model C-25: Kit, complete with PACO detailed assembly-operating manual. **Kit Net Price: \$19.95**
Model C-25W: Factory-wired, ready to operate. **Net Price: 29.95**



PACO Model DF-90 TRANSISTORIZED DEPTH FINDER KIT

Protect your boat against shoals and underwater hazards with this compact, easy-to-read depth finder. Transistors prolong battery life, provide utmost accuracy and portability. A boon to fishermen—locates hard-to-find schools of fish. A low cost safety device for every boat owner.

Specifications:

FULLY TRANSISTORIZED: 5 transistors, with a low battery drain for extremely long battery life.

HIGH INTENSITY INDICATOR: for sensitive, accurate response under all conditions.

FAST, EASY READINGS: made possible by means of over-sized scale calibrated at one-foot intervals from 0 to 120 feet.

Model DF-90: Kit, complete with PACO detailed assembly-operating manual. **Kit Net Price: \$84.50**
Model DF-90W: Factory-wired, ready to operate. **Net Price: \$135.50**



PACO Model SA-40 STEREO PREAMP-AMPLIFIER KIT

Assemble a superb home music system with this true 40 watt stereo preamp-amplifier. Unmatched flexibility, less than 0.5% distortion, and handsome design make this the ideal component for music lover and audiophile alike!

Specifications:

MUSIC WAVEFORM POWER OUTPUT: 25 watts per channel (50 watts total).

RESPONSE: 30 cps to 90Kc, $\pm 1.0\%$ db

HARMONIC DISTORTION: less than 0.5% at 20 watts per channel output.

Model SA-40: Kit, complete with black and gold case and PACO-detailed assembly-operating manual. **Kit Net Price: \$79.95**

Model SA-40W: Factory-wired, with black and gold case, ready to operate. **Net Price: \$129.95**

FREE! COMPLETE ILLUSTRATED CATALOG

Mail this coupon for the complete Paco catalog of electronic equipment kits, including test instruments, measuring instruments, and high fidelity components.

PACO KITS BY PACOTRONICS, INC.

Paco Electronics Company, Inc., Dept. PE-5
70-31 84th Street, Glendale 27, L. I., N. Y.
Please send me your complete illustrated catalog.

Name

Address

City Zone State

©PACOTRONICS, INC. 1961

find new
adventure in
amateur
radio...

with

Viking

1st choice of
amateurs the
world over!

loaded with features... kit or wired!



ADVENTURER—50 watts CW input 80 through 10 meters. 240-181-1... Kit Am. Net. \$54.95	RANGER—75 watts CW input; 65 watts phone—160 through 10 meters. 240-161-2... Kit Am. Net. \$229.50 240-161-1... Wired Am. Net. \$329.50	VALIANT—275 watts CW and SSB; 200 watts A.M.—160 through 10 meters. 240-104-2... Kit Am. Net. \$349.50 240-104-2... Wired Am. Net. \$439.50
--	--	--



E. F. JOHNSON CO.

2433 10th Ave. S.W. • Waseca, Minn.

Complete specifications and schematics on all Johnson transmitters, amplifiers, station accessories, keys and practice sets!

NAME _____
ADDRESS _____
CITY _____ STATE _____

QUICKLY CUT HOLES
in metal, plastics,
hard rubber...



GREENLEE CHASSIS PUNCHES

Make smooth, accurate openings in
1½ minutes or less... for sockets,
plugs, controls, meters, panel
lights, etc. Easy to use...
simply turn with wrench.
Many sizes and models.

Write for literature.

GREENLEE TOOL CO., 1915 Columbia Ave., Rockford Illinois

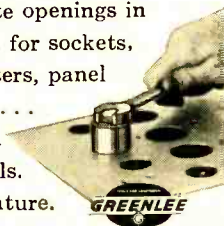

Showcase

(Continued from page 16)

and is so designed that it can be attached directly to any tape deck. Price, \$2.50. . . . Latest from *Sherwood* is a 50-watt stereo amplifier/preamplifier featuring 15 front-panel controls and 12 inputs for maximum flexibility in home music systems. The S-5500 delivers 24 watts per channel at a low ½% harmonic distortion and incorporates two cathode-follower outputs and a front-panel tape-monitoring switch for home or professional stereo tape recording. Ultra-compact, the S-5500 measures 4" x 14¼" x 14" and is priced at \$159.50, less case.

If you're using a magnetic phono cartridge and thinking about giving a ceramic unit a try, *Sonotone's* "Velocitone" assembly may be the answer. Consisting of a "9T" ceramic stereo cartridge and two factory-matched equalizers, the assembly makes a perfect replacement for magnetic cartridges. Simply install the cartridge in your tone arm and plug the equalizer into your amplifier's magnetic phono input. The hum-free cartridge offers response within 1 db from 20 to 17,000 cycles; required tracking force is 2-3 grams, depending on whether you have a professional arm or changer. Assembly prices are \$20.50 with sapphire tips, \$23.50 with diamond-sapphire styli. . . . A new stereo amplifier from *Trutone Electronics* is made up of two 15-watt units and self-contained preamplifiers. With a variety of inputs—phono cartridge, tape head, tuner, or other equipment, the Model 1230 also has rumble and scratch filters and a blended third-channel output. Price, \$119.75.

- Allied Radio Corp. (Knight), 100 N. Western Ave., Chicago 80, Ill.*
- Argos Products Co., So. Sycamore St., Genoa, Ill.*
- CBS Electronics, 100 Endicott St., Danvers, Mass.*
- Crosby Electronics, Inc., 135 Eileen Way, Syosset, N. Y.*
- Grommes Div., Precision Electronics, Inc., 9101 King Ave., Franklin Park, Ill.*
- Lafayette Radio Electronics Corp., 165-08 Liberty Ave., Jamaica 33, N. Y.*
- Nortronics Co., Inc., 1015 S. 6th St., Minneapolis 4, Minn.*
- Rason Mfg. Co., 3050 West 21st St., Brooklyn 24, N. Y.*
- Sherwood Electronic Laboratories, Inc., 4300 N. California Ave., Chicago 18, Ill.*
- Sonotone Corp., Elmsford, N. Y.*
- Trutone Electronics, Inc., 6912 Santa Monica Blvd., Hollywood 38, Calif.*

Always say you saw it in—POPULAR ELECTRONICS



Accredited by the National Home Study Council

good training doesn't cost . . . it pays!

An FCC License Or Your Money Back!

Completion of the Master Course (both Sections) will prepare you for a First Class Commercial Radio Telephone License with a Radar Endorsement. Should you fail to pass the FCC examination for this license after successfully completing the Master Course, you will receive a full refund of all tuition payments. This guarantee is valid for the entire period of your enrollment agreement.



find out how . . .

1. You can handle the new electronic devices.
2. You can solve the problems that stump your fellow technicians.
3. Training is Job Insurance when employment is tough to find . . . and more money for you when times are good.

Get This Handy Pocket Electronics Data Guide

FREE . . .

Puts all the commonly used conversion factors, formulas, tables, and color codes at your fingertips. Yours absolutely free if you mail the coupon today. No further obligation.

Cleveland Institute of Electronics
1776 E. 17th St. Desk PE77 Cleveland 14, Ohio

May, 1961

How To Get an

FCC License

(Commercial)



Increase Your Technical Knowledge
Get a government license plus an understanding of such electronic applications as computers . . . industrial electronics . . . radar . . . communications . . . and many more.

NOT FOR BEGINNERS
Please inquire only if you really want to get ahead and to add to what you have already learned in school, in the service, or on the job. Some previous schooling or experience in electronics, electricity, or related fields is necessary for success in Cleveland Institute programs.

Get All Three Booklets . . .

Free



Cleveland Institute of Electronics

1776 E. 17th St. Desk PE 77 Cleveland 14, Ohio

Please send Free Career Information Material prepared to help me get ahead in Electronics and a free copy of your "Pocket Electronics Data Guide." I have had training or experience in Electronics as indicated below:

- | | |
|---|---|
| <input type="checkbox"/> Military | <input type="checkbox"/> Broadcasting |
| <input type="checkbox"/> Radio-TV Servicing | <input type="checkbox"/> Home Experimenting |
| <input type="checkbox"/> Manufacturing | <input type="checkbox"/> Telephone Company |
| <input type="checkbox"/> Amateur Radio | <input type="checkbox"/> Other |

In what kind of work are you now engaged?

In what branch of Electronics are you interested?

Name..... Age.....

Address.....

City..... Zone..... State..... PE77

FREE **GIANT 1961 204 PAGE CATALOG**

B-A 1961
ANNUAL CATALOG #11

SAVE UP TO 50% ON B-A SELECTED KITS

HI-FI AND STEREO SYSTEMS & COMPONENTS

TOP VALUES IN POWER AND HAND TOOLS

30 PAGES OF BARGAINS NOT IN ANY OTHER CATALOG

RADIO TV ELECTRONICS

BURSTEIN-APPLEBEE CO.

Dept. PE, 1012 McGee St., Kansas City 6, Mo.

Send Free 1961 B-A Catalog No. 611

Name

Address

City State

SEND FOR IT TODAY

PURCHASING A HI-FI SYSTEM?

TIME PAYMENTS AVAILABLE
Up to 2 Years to Pay!

Send Us Your List of Components For A Package Quotation

YOU CAN BUY WITH CONFIDENCE AT AIREX
All merchandise is brand new, factory fresh and guaranteed.
Free Hi-Fi Catalog

AIREX RADIO CORPORATION

85-PE Cortlandt St., N. Y. 7

Jim Lansing*
 Altec Lansing
 Electrovoice
 Jensen • Hartley*
 University • Viking
 Acoustic Research
 Janszen • Superscope
 Wharfedale
 USL Citizen Band
 Gonset • HalliCrafter
 Texas Crystals
 Concertone
 Bell • G.E.
 Weathers
 Harman-Kardon
 Eico • Pilot • Fisher
 ESL • Roberts
 Bogen • Leak • TEC
 Dynakit • H. H. Scott
 Thorens* • Sherwood*
 Dual Changer
 DeWald
 Sony • Challenger
 Wollensak • Pentron
 Garrard • Quad*
 Miracord • Pickering
 Glaser-Steers
 Components
 Rek-O-Kur • Tandberg*
 Audio Tape • Cotrac
 Norelco • Magnecord*
 Fairchild • Gray
 Artizan Cabinets
 Rockford Cabinets
**Fair Traded*

WO 4-1820

NEW products

TRANSISTOR TESTER

The Model 700 transistor tester produced by Mercury Electronics Corp. (77 Searling Ave., Mineola, N. Y.) is said to be so designed that it cannot become obsolete when new transistors are introduced. All transistors can be checked without time-consuming reference to data charts. In addition, the Model 700 checks all diodes for forward/reverse ratio. Power is supplied by an easily replaceable battery; the metal carrying handle folds back to serve as a convenient rest. Price, \$24.25.



without time-consuming reference to data charts. In addition, the Model 700 checks all diodes for forward/reverse ratio. Power is supplied by an easily replaceable battery; the metal carrying handle folds back to serve as a convenient rest. Price, \$24.25.

BASIC RADIO COURSE

The second half of a new two-part radio course, latest in the Heathkit series of "learn-by-doing" electronics projects, is

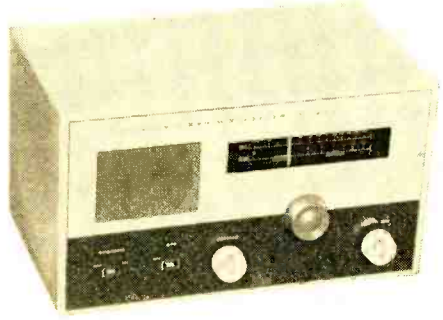

now available. The EK-2A, "Basic Radio—Part 1," led to the construction of a regenerative receiver. The EK-2B, "Basic Radio—Part 2," enables the builder to

Always say you saw it in—POPULAR ELECTRONICS

Coming...

**THREE NEW INTERNATIONAL
EXECUTIVE TRANSCEIVERS**

A NEW line of Executives engineered to meet NEW standards of performance for Citizens 2 Way radio communication.

**INTERNATIONAL
TRANSCEIVERS**

Executive

THREE NEW MODELS to select from . . . each incorporating engineering changes and design that Citizen Licensees have asked for.

Complete details NEXT MONTH from International Crystal Manufacturing Co. . . . Pioneer in Citizens radio communication . . . Specialists in precision radio crystals for frequency control.



INTERNATIONAL CRYSTAL MANUFACTURING CO., INC.

18 NORTH LEE • OKLAHOMA CITY, OKLAHOMA

CB Owners: IT'S WHAT GOES OUT ON THE AIR THAT COUNTS!

Get maximum amplifier output and outstanding performance from your 5-watter by using famous PR CRYSTALS. These high-active crystals get greater distance than ordinary sluggish crystals. Clearer reception too. Put PR Crystals in your set today, and get the STRONGEST SIGNALS POSSIBLE WITHIN POWER LIMITS.

SWITCH TO A BETTER CHANNEL

Be smart... have several sets of PR Crystals... two or three sets at least. Then you can switch channels at will, to avoid jamming. PR CRYSTALS ARE AVAILABLE IN ALL 23 CITIZENS BAND CHANNELS.

Type Z-9R, Calibrated .005%, \$2.95 each. EVERY PR CRYSTAL IS UNCONDITIONALLY GUARANTEED.

Get PR's Now From Your Jobber.



PETERSEN RADIO CO., INC.

2800 West Broadway
Council Bluffs, Iowa



products

(Continued from page 22)

improve his EK-2A radio until he has completed a two-band superheterodyne unit capable of receiving both broadcast and short-wave stations. Price is the same for both the EK-2A and the EK-2B—\$19.95 each. (Heath Company, Benton Harbor, Mich.)

RECHARGEABLE BATTERY

Tired of replacing flashlight batteries at frequent intervals? The Gould "NICAD" battery promises 250 charging cycles, and to recharge it, you just remove the cap at one end and plug the battery into any 117-volt a.c. outlet. The cells are of nickel-cadmium construction and are hermetically sealed. Price, \$18.75. (Gould National Batteries, Inc., 931 Vandalia St., St. Paul 14, Minn.)

"PIGGY-BACK" SCREWDRIVER

Four tools are combined in one with the new Vaco "piggy-back" screwdriver. The Amberyl handle has a reversible blade (3/16" standard screwdriver or No. 1 Phillips bit) at one end, and a 1/4" hex socket on the other end which also serves as a holder for a midget instrument-type screwdriver. Result: the "piggy-back" set fits most screws and nuts found around the house. Price: \$1.60, postpaid. (Vaco Products Co., 317 E. Ontario St., Chicago 11, Ill.)

LOW-COST P.A. AMPLIFIER

With a frequency response of ± 2 db, 70-10,000 cycles, the Knight KN-3010 10-



watt amplifier provides smooth, clear reproduction of speech and music for

Always buy you saw it in—POPULAR ELECTRONICS

EARN \$10,000 A YEAR

- DIESEL ELECTRONICS
 AUTO AUTOMATION

The average starting salary of students, completing our FCC License, Electronics Technician Course, and those completing our Diesel Automotive Training, is \$4,300 per year.

After becoming familiar with the industry, their salary usually increases to \$6,000 or \$7,000 per year.

After they become senior technicians, or master mechanics, they can earn \$8,000 to \$10,000 per year.

When they become specialists, or a part of management... or start their own business... they can earn considerably more.

RESIDENT SHOP TRAINING is easier and costs less than you may think! We provide you with housing and part-time jobs while in school, plus free nation-wide placement service for graduates.

Check subject above in which you are interested and mail for

FREE BOOKLET
BAILEY
Technical Schools
 Veteran Approved
 1626 S. Grand, Rm. 28, St. Louis 4, Mo.

Your Future in ELECTRONICS AND AUTOMATION
 Your Future in DIESEL and AUTO MECHANICS

Name _____ Age _____
 Street _____
 Town _____ Zone _____ State _____

general public-address use. Several output impedance connections and a 70.7-volt tap accommodate a wide variety of speaker arrangements; a jack for making tape recordings is also provided. Two inputs accept a high-impedance mike and a crystal or ceramic phono cartridge; the phono input may also be used with a radio tuner or a tape recorder. Stock #35 DX 788, \$29.95. (*Allied Radio Corp.*, 100 N. Western Ave., Chicago 80, Ill.)

AUTOMATIC VOM

Only one scale is visible at a time on the "V O Matic 360," an automatic volt-ohm-milliammeter produced by *B&K Mfg. Co.* (1801 W. Belle Plaine Ave., Chicago 13, Ill.). All scales are direct-reading and are automatically selected by the range switch. A mirrored scale and knife-edge pointer further facilitate pre-



cise readings, and the meter is protected against extreme overload. Sensitivity is 20,000 ohms per volt d.c., 5000 ohms per volt a.c. The unit covers a.c. and d.c. volts, d.c. current, a.f. (output), and resistance in 25 ranges; 18 separate overlay meter scales are provided for supplementary ranges. Price, \$59.95; an optional leather carrying case sells for \$11.95.

REGULATED POWER SUPPLY KIT

A versatile variable power supply kit is being offered by *PACO Electronics* (70-31 84th St., Glendale 27, L. I., N. Y.). The Model B-12 features fully variable and regulated d.c. plate voltages from 0 to 400 volts at 150 ma.; also provided are bias voltages from 0 to 150 volts at 2 ma. and three 3-ampere

a.c. filament outputs (two at 6.3 volts and one at 12.6 volts). The unit has high output stability with changes in load or line voltage—internal impedance



is less than 10 ohms from d.c. to 1 mc., and ripple is less than 0.003 volt r.m.s. Price of kit, \$69.95; a factory-wired version is also available at \$99.95.

PHONE/C.W. TRANSMITTER

Practical for fixed or mobile amateur use, the compact Ameco TX-86 transmitter covers 80 through 6 meters at 90-watts c.w. input. Peak input power on phone is also 90 watts. The pi output circuit will match all antenna impedances from 35 to 600 ohms. Power requirements are 6.3 volts at 3.2 amperes (or 12.6 volts at 1.6 amperes), 300 volts d.c. at 75 ma., and 600 volts d.c. at 150 ma. (A matching 117-volt a.c. power supply, the PS-3, is also available.) In kit form, the trans-



mitter is priced at \$84.95; wired, \$109.95. When ordering, specify auto voltage. (*American Electronics Co.*, 178 Herricks Rd., Mineola, L. I., N. Y.)

from

ELECTRONICS

BOOK SERVICE

books on radio & tv servicing ...yours for a 7-DAY FREE EXAMINATION!

Here is a comprehensive selection of books covering the field of radio and television servicing—for your use and profit! You'll find practical guides, reference books, background and advanced texts to give you step-by-step procedures for finding troubles and repairing radio receivers, television and FM sets, setting up your own servicing business, designing and building, and much more—each book filled with descriptive illustrations and diagrams.

And you can have one or more of these top notch best sellers—for 7 days FREE!

Simply write your choices on the coupon below and mail it today. Read and enjoy your books for seven full days. If, after that time, you do not agree that they are everything you want, return them and owe nothing. Otherwise, send along your payment of our bill plus a small charge for postage and handling.

Here is the perfect way for every serviceman to build the library he must have. Order now!



2404. FM RADIO SERVICING HANDBOOK, King

This is a practical guide to frequency-modulated V.H.F. radio receivers, their design, construction, alignment and repair. Includes chapters on adaptors, aerials, and high-fidelity audio equipment. A good introduction to FM theory, kept as non-mathematical as possible. \$5.00

2410. TELEVISION AND RADIO REPAIRING, Markus

This book shows how to test, repair and replace each component of TV and radio receivers, power supplies, resistors and condensers, coils, tuning devices, and speakers. Shows what servicing involves, how to get information and tools necessary. The book includes the T.V. Detect-O-Scope. \$7.95



2422. HANDBOOK OF TV REPAIR, Hertzberg

The simple mechanical and electrical maladies which are the great majority of television set troubles—what you can do about them and what not to try. Covers tubes and testing, antennas, UGH converters, fringe-area reception, the set and the chassis. \$2.50

2506. FUNDAMENTALS OF RADIO AND ELECTRONICS, Everitt, et al

All you need to know on electronics and radios is found in this book—including transistors and vacuum tube principles and circuits. A product of close collaboration among five radio authorities, it is perfect for self-study. 832 pp. \$11.35

2402. PRACTICAL RADIO SERVICING, Marcus and Levy

Dealing with the common types of radios in use, a-c/d-c receivers, photograph players, and batter and three way portables. This book not only describes circuit fundamentals and servicing instruments and methods, but also gives graded job sheets giving valuable practical experience. Includes the indispensable Radio Detect-O-Scope. Illustrated. \$8.95

2403. ELEMENTS OF RADIO SERVICING, Marcus and Levy

Gives practical, step-by-step procedures for finding troubles in radio receivers and making repairs. Readers with a background of simple radio theory can easily understand the book. Emphasizes over-all servicing procedures. \$7.25

2406. ESSENTIALS OF TELEVISION, Sturzberg, Osterheld and Voegtlin

Comprehensive study of basic TV circuits. The operation of a color set and three monochrome receivers is described in detail from the antenna to the picture tube and loudspeaker. Features the sound section, waveforms, the picture tube, etc. Complete with illustrations, examples, questions, problems. \$8.95

2409. TELEVISION FOR RADIOMEN, No!!

Here are the principles and essential mathematics of television. Detailed studies of cascade tuners, new video amplifier techniques, large screen picture tubes, modern deflection systems, latest antenna detail. Covers U.H.F., color TV, transistors, some topics not dealt with before. Construction, operation and servicing of television. \$10.00



2411. TELEVISION SERVICING, Levy and Frankel

Explains how to find the section in which the trouble occurs and then to find the defective component. From the circuits discussed, which are employed in over 95% of TV receivers now in use, the reader gains an understanding of the principles involved. A knowledge of basic electronics is essential. \$7.75

2423. BE YOUR OWN TELEVISION REPAIRMAN, Guth

Seventy-five percent of the time the only trouble with your TV set is a faulty tube. With this complete book, covering all manufacturers' models, you can easily replace the tube yourself. One dollar saves big repair charges. \$1.00



2804. RADIO AND TELEVISION MATHEMATICS, Fischer

Whenever you need to look up the use of a formula or the correct substitution of numbers, you can find it here—rapidly. More than 700 step-by-step solutions of the usual problems encountered in radio, television and industrial electronics, including all those needed for FCC exams. \$6.95

2419. BASIC TELEVISION, Grob

The basic book for training television servicemen and technicians. No mathematics other than simple arithmetic and algebra is needed. 660 pages with illustrations. \$9.25

2420. TELEVISION FUNDAMENTALS, Fowler and Lippert

A simple nonmathematical presentation of the basic principles the radiotechnician must know in order to install and service television receivers. Sound treatment of each element of the system—from the antenna to the picture tube. \$8.50

2424. TELEVISION SERVICING, 3rd Edition, Buchsbaum

Complete, most recent information on the design, construction, and servicing of both black-and-white and color sets. Shows how to locate and repair every conceivable trouble. \$7.15

2427. COLOR TELEVISION FUNDAMENTALS, Kiver

This book can teach anyone familiar with monochrome television how to install and service color TV sets. All circuit discussions employ highly successful step-by-step approach. \$7.25

CITIZENS BAND TRANCEIVERS ARE

times more powerful . . .

WITH THE
Hy-gain 3-element beam

Tremendous forward gain of 9db; F/B ratio of 25db; F/S ratio of 40db. Provided with bracket for vertical mounting to contact mobile or ground plane base stations. 2" O.D. 8 ft. boom. Elements approx. 16½ ft. long, all aluminum, heat-treated alloy. Hardware iridite treated to military specs. Rotate with TV rotor. Exclusive Beta-matching system. Factory pre-tuned, easy to assemble. May be stacked vertically or horizontally for re-doubling power.

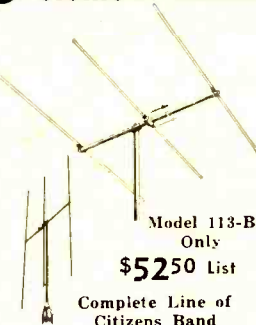

Model 113-B
Only

\$5250 List

Complete Line of
Citizens Band
Antennas

POP'tronics Bookshelf

ELECTRONIC ORGAN HANDBOOK by H. Emerson Anderson

With the growing interest in home electronic organs (about a million of them

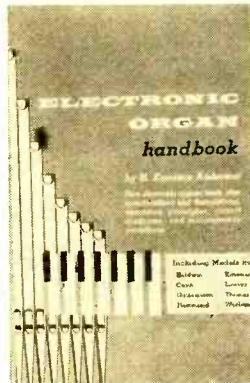

are now in use in the U.S.), this handbook is a sound investment for service technicians, as well as for organ owners and potential buyers. The first chapter covers basic theory, and the following chapters dig deep into organs manufactured by Baldwin, Conn,

Gulbrandsen, Hammond, Kinsman, Lowrey, Thomas, and Wurlitzer. Also covered are Leslie organ speaker systems and electronic organ tuning devices.

Published by Howard W. Sams & Co., Inc., 1720 East 38th St., Indianapolis 6, Ind. Soft cover. 272 pages. \$4.95.



VACUUM-TUBE CIRCUITS FOR THE ELECTRONIC EXPERIMENTER by Julian M. Sienkiewicz

How many times have you looked for a diagram of a basic vacuum-tube circuit that you could use as a guide in building some practical electronic device? At last, in one book, experimenters can find almost all the basic diagrams, schematics, and other vital information they will ever need on vacuum tubes and their circuits. Beginning with the Edison effect (the birth of the diode), the author leads the experimenter right up to the multi-element vacuum tubes used today. Vacuum-tube circuit design is described in understandable, down-to-earth language. With this book, plate resistance, transconductance, gain, load lines, characteristic curves, and the like will

Always say you saw it in—POPULAR ELECTRONICS

Hy-gain antenna products

1135 NO. 22ND ST. LINCOLN, NEBRASKA

Please Send: Technical Bulletin on Model 113-B. FREE Citizens Band Catalog. FREE Ham Antenna Catalog.

NAME: _____

ADDRESS: _____

CITY & STATE: _____

SAVE \$75

Assemble your own high quality Citizens Band and 10 meter amateur band radiophone with the all-new SPRINGFIELD TR-28 chassis

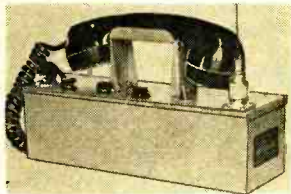

Complete
electronic
chassis—only

\$24.98
post-paid

100 milliwatt 23 channel transmitter with 4 channel selector switch.

23 channel supersensitive receiver with noise limiting and AVC action plus extended frequency range for 10 meter amateur band.

Electronic chassis is complete with all transistors plus crystal for 1 channel.

Meets FCC requirements for both unlicensed and licensed operation. No age restrictions for unlicensed operation.

Complete instructions for quick assembly. No knowledge of electronics necessary as chassis is factory wired, tested and guaranteed.

Accessories for completing the walkie-talkie as illustrated are available at low cost.

Requires only 8 standard flashlight batteries. Battery life 1,000 hours.

Range from ½ to 10 miles depending on conditions.

New sectional construction for easy maintenance and repair if ever required. Transmitter and receiver may be detached and used separately as each contains its own audio and RF circuits.

FREE R. F. power indicator kit with each order

SPRINGFIELD ENTERPRISES

Dept. E-5 196-23 Jamaica Ave., Hollis 23, N.Y.

no longer be mysterious terms but useful ones. Some 100 illustrations are included.

Published by Ziff-Davis Publishing Company, 1 Park Avenue, New York 16, N. Y. Hard cover. 192 pages. \$4.95.



FUN WITH ELECTRICITY by Tom Kennedy, Jr.

An excellent volume for developing a boy's interest in electricity and science, this is a basic how-to-do-it, how-to-understand-it guide. The author begins with a brief but clear explanation of the theory of electricity, then goes into the function and care of the simple tools needed to construct the projects described. Among these projects, which are presented in an easy-to-follow, step-by-step manner, are a simple d.c. motor, an a.c. generator, a spark coil, a Tesla coil, and many others.

Published by Gernsback Library, Inc., 154 West 14th St., New York 11, N. Y. 128 pages. Soft cover. \$2.65.



SOLAR CELL AND PHOTOCELL HANDBOOK by John Sasuga

Written by the manager of International Rectifier Corporation's Photocell Department, this handbook is a revision and updating of IRC's "The Use of Selenium Cells and Sun Batteries" (1955). The twelve chapters cover both the science and technology of these versatile photoelectric devices, and over 75 practical circuits and demonstrations are included. The new handbook also contains considerable data on recently developed silicon solar cells and their use in satellites and space vehicles.

Published by International Rectifier Corp., 1521 E. Grand Ave., El Segundo, Calif. Soft cover. 111 pages. \$2.00.



ELECTRICITY AND ELECTRONICS—BASIC, Second Edition by William B. Steinberg and Walter B. Ford

This popular textbook has been revised to keep pace with the latest electronic

developments and refined to make its instructional method even more effective. Written in simple language, the book discusses both the practical and the theoretical aspects of electricity, magnetism, and electronics. Theoretical principles are illustrated with simple experiments which the reader himself can make. This edition contains new material on transistor fundamentals and silicon rectifiers, and many new projects have been added.

Published by American Technical Society, 848 E. 58th St., Chicago 37, Ill. Hard cover. 262 pages. \$4.50.



PIN-POINT TROUBLE-SHOOTING SERIES

This novel series of four handbooks is designed especially for on-the-job trouble-shooting.

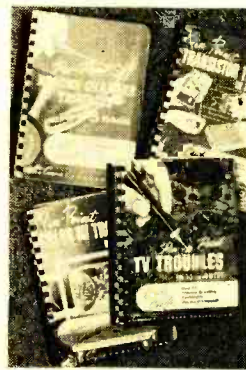

A simple cross-index in each book tells you in what section you'll find the cause of a particular trouble. Handy check-charts then help locate the exact trouble spot. The four volumes are "Pin-Point TV Troubles in 10 Minutes" (332 pages, \$4.95); "Pin-Point

Record Changer Troubles in 5 Minutes" (320 pages, \$3.95); "Pin-Point Color TV Troubles in 15 Minutes" (548 pages, \$5.95); and "Pin-Point Transistor Troubles in 12 Minutes" (525 pages, \$5.95).

Published by Coyne Electrical School, Educational Book Publishing Div., 1455 W. Congress Pkway, Chicago 7, Ill. Soft covers. Spiral bound. Series price, \$18.95 (monthly payment plan optional).



TELEVISION TUBE LOCATION GUIDE Vol. 10

This tenth in a series of TV tube location guides will help you to make a preliminary diagnosis of the set's trouble

FREE CAREER BOOKLET

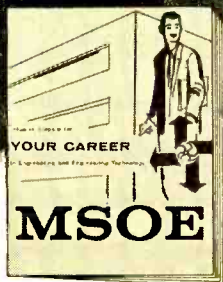

To guide you to a
successful future in

ELECTRONICS RADIO-TV COMPUTERS ELECTRICAL ENGINEERING

This interesting pictorial booklet tells you how you can prepare for a dynamic career as an Electrical Engineer or Engineering Technician in many exciting, growing fields:

**MISSILES • AVIONICS • AUTOMATION
SALES • DEVELOPMENT
ELECTRICAL POWER • ROCKETRY
RADAR • RESEARCH**

Get all the facts about job opportunities, length of study, courses offered, degrees you can earn, scholarships, part-time work — as well as pictures of the Milwaukee School of Engineering's educational and recreational facilities. No obligation — it's yours free.

MILWAUKEE SCHOOL OF ENGINEERING

MAIL COUPON TODAY!

Milwaukee School of Engineering

Dept. PE-561, 1025 N. Milwaukee St., Milwaukee, Wis.

Please send FREE "Your Career" booklet

I'm interested in

Electronics Radio-TV Computers
 Electrical Engineering Mechanical Engineering

Name _____ Age _____

Address _____

City _____ Zone _____ State _____

I'm eligible for veterans education benefits.
Discharge date _____ MS-117

Bookshelf

(Continued from page 29)

without removing the chassis from the cabinet. There are over 100 diagrams showing tube, fuse, and control locations in 1959-1960 sets. Guide-key and blank-space positions on the tube sockets are also given, making it easier to replace a tube in an out-of-the-way socket. Each diagram is accompanied by a tube failure chart which lists the tubes most likely to cause sync loss, picture loss, etc.

Published by Howard W. Sams & Co., Inc., 1720 East 38th St., Indianapolis 6, Ind. Soft cover, plastic binding. 96 pages. \$1.25.

New Literature

Stereo hi-fi fans will be interested in three booklets available on request from Harman-Kardon, Plainview, L. I., N. Y. One describes new Harman-Kardon instruments—stereo receivers, FM-AM tuners, and amplifiers—in all price ranges; another covers the Citation preamplifier, amplifier, FM tuner, and loudspeaker kits; the third contains room-decorating ideas to help you get the very best results from your stereo equipment.

Generally considered the "Bible" of the model railroad industry, the new 1961 "HO Model Railroader's Catalog" contains everything conceivable for "HO" fans. All manufacturers are represented in its 96 pages, which include over 25,000 pictures and descriptions. Many new sections, such as one devoted to replacement parts, have been added. If you're interested, send 25 cents to America's Hobby Center, Inc., 146-148 West 22nd St., New York 11, N. Y.

If you enjoy listening to the U.S. Armed Forces Radio and Television Service (AFRTS) short-wave programs, you probably will want to get their complete short-wave schedule. It's available from the AFRTS at either 1016 N. McCadden Pl., Los Angeles 38, Calif., or 250 W. 57th St., New York 19, N. Y. This schedule is a good bet for those who like to receive QSL's.

—30—

BUILD 20 RADIO

CIRCUITS AT HOME

with the New

PROGRESSIVE RADIO "EDU-KIT"®

A Practical Home Radio Course

ONLY
\$26.95

Reg. U. S.
Pat. Off.



Now Includes

- ★ 12 RECEIVERS
- ★ 3 TRANSMITTERS
- ★ SQ. WAVE GENERATOR
- ★ SIGNAL TRACER
- ★ AMPLIFIER
- ★ SIGNAL INJECTOR
- ★ CODE OSCILLATOR

- ★ No Knowledge of Radio Necessary
- ★ No Additional Parts or Tools Needed
- ★ EXCELLENT BACKGROUND FOR TV
- ★ School Inquiries Invited
- ★ Sold In 79 Countries

**YOU DON'T HAVE TO SPEND
HUNDREDS OF DOLLARS FOR A RADIO COURSE**

The "Edu-Kit" offers you an outstanding PRACTICAL HOME RADIO COURSE at a rock-bottom price. Our Kit is designed to train Radio & Electronics Technicians, making use of the most modern methods of home training. You will learn radio theory, construction practice and servicing. THIS IS A COMPLETE RADIO COURSE IN EVERY DETAIL.

You will learn how to build radios, using regular schematics; how to wire and solder in a professional manner; how to service radios. You will work with the standard type of punched metal chassis as well as the latest development of Printed Circuit chassis.

You will learn the basic principles of radio. You will construct, study and work with RF and AF amplifiers and oscillators, detectors, rectifiers, test equipment. You will learn and practice code, using the Progressive Code Oscillator. You will learn and practice trouble-shooting, using the Progressive Signal Tracer, Progressive Signal Injector, Progressive Dynamic Radio & Electronics Tester, Square Wave Generator and the accompanying instructional manual.

You will receive training for the Novice, Technician and General Classes of F.C.C. Radio Amateur Licenses. You will build 20 Receiver, Transmitter, Square Wave Generator, Code Oscillator, Signal Tracer and Signal Injector circuits, and learn how to operate them. You will receive an excellent background for television, Hi-Fi and Electronics.

Absolutely no previous knowledge of radio or science is required. The "Edu-Kit" is the product of many years of teaching and engineering experience. The "Edu-Kit" will provide you education in Electronics and Radio, worth many times the complete price of \$26.95. The Signal Tracer alone is worth more than the price of the entire Kit.

THE KIT FOR EVERYONE

You do not need the slightest background in radio or science. Whether you are interested in Radio & Electronics because you want an interesting hobby, a well paying business or a job with a future, you will find the "Edu-Kit" a worth while investment.

Many thousands of individuals of all

ages and backgrounds have successfully used the "Edu-Kit" in more than 79 countries of the world. The "Edu-Kit" has been carefully designed, step by step, so that you cannot make a mistake. The "Edu-Kit" allows you to teach yourself at your own rate. No instructor necessary.

PROGRESSIVE TEACHING METHOD

The Progressive Radio "Edu-Kit" is the foremost educational radio kit in the world, and is universally accepted as the standard in the field of electronics training. The "Edu-Kit" uses the modern educational principle of "Learn by Doing." Therefore you construct, learn schematics, study theory, practice trouble shooting—all in a closely integrated program designed to provide an easily-learned, thorough and interesting background in radio.

You begin by examining the various radio parts of the "Edu-Kit." You then learn the function, form and wiring of these parts. Then you build a simple radio. With this first set you will enjoy listening to regular broadcast stations. Then you practice testing and trouble-shooting. Then you build a more advanced radio, learn more advanced theory and techniques. Gradually, in a progressive manner, and at your own rate, you will find yourself constructing more advanced multi-tube radio circuits, and doing work like a Professional Radio Technician.

Included in the "Edu-Kit" course are twenty Receiver, Transmitter, Code Oscillator, Signal Tracer, Square Wave Generator and Signal Injector circuits. These are not unprofessional "breadboard" experiments, but genuine radio circuits, constructed by means of professional wiring and soldering on metal chassis, plus the new method of radio construction known as "Printed Circuitry." These circuits operate on your regular AC or DC house current.

THE "EDU-KIT" IS COMPLETE

You will receive all parts and instruction necessary to build 20 different radio and electronics circuits, each guaranteed to operate. Our Kits contain tubes, tube sockets, variable, electrolytic, mica, ceramic and paper dielectric condensers, resistors, tie strips, coils, hardware, tubing, punched metal chassis, Instruction Manuals, hook-up wire, solder, selenium rectifiers, volume controls and switches, etc.

In addition, you receive Printed Circuit materials, including Printed Circuit chassis, special tube sockets, hardware and instructions. You also receive a useful set of tools, a professional electric soldering iron, and a self-powered Dynamic Radio and Electronics Tester. The "Edu-Kit" also includes Code Instructions and the Progressive Code Oscillator. In addition to F.C.C.-type Questions and Answers for Radio Amateur License training, you will also receive servicing with the Progressive Signal Tracer and the Progressive Signal Injector, a High Fidelity Guide and a Quiz Book. You receive Membership in Radio-TV Club, Free Consultation Service, Certificate of Merit and Discount Privileges. You receive all parts, tools, instructions, etc. Everything is yours to keep.

PRINTED CIRCUITRY

At no increase in price, the "Edu-Kit" now includes Printed Circuitry. You build a Printed Circuit Signal Injector, a unique servicing instrument that can detect many Radio and TV troubles. This revolutionary new technique of radio construction is now becoming popular in commercial radio and TV sets.

A Printed Circuit is a special insulated chassis on which has been deposited a conducting material which takes the place of wiring. The various parts are merely plugged in and soldered to terminals.

Printed Circuitry is the basis of modern Automation Electronics. A knowledge of this subject is a necessity today for anyone interested in Electronics.

FREE EXTRAS

• SET OF TOOLS

- SOLDERING IRON
- ELECTRONICS TESTER
- PLIERS-CUTTERS
- ALIGNMENT TOOL
- WRENCH
- VALUABLE DISCOUNT CARD
- CERTIFICATE OF MERIT
- TESTER INSTRUCTION MANUAL
- HIGH FIDELITY GUIDE • QUIZZES
- TELEVISION BOOK • RADIO TROUBLE-SHOOTING BOOK
- MEMBERSHIP IN RADIO-TV CLUB; CONSULTATION SERVICE • FCC AMATEUR LICENSE TRAINING
- PRINTED CIRCUITRY

SERVICING LESSONS

You will learn trouble-shooting and servicing in a progressive manner. You will practice repairs on the sets that you construct. You will learn symptoms and causes of trouble in home, portable and car radios. You will learn how to use the professional Signal Tracer, the unique Signal Injector and the dynamic Radio & Electronics Tester. While you are learning in this practical way, you will be able to do many a repair job for your friends and neighbors, and charge fees which will far exceed the price of the "Edu-Kit." Our Consultation Service will help you with any technical problems you may have.

FROM OUR MAIL BAG

J. Statatits, of 25 Poplar Pl., Waterbury, Conn., writes: "I have repaired several sets for my friends, and made money. The "Edu-Kit" paid for itself. I was ready to spend \$240 for a course, but I found your ad and sent for your Kit."

Ben Valerio, P. O. Box 21, Magna, Utah: "The Edu-Kits are wonderful. Here I am sending you the questions and also the answers for them. I have been in Radio for the last seven years, but like to work with the Edu-Kits, and like to build Radio Testing Equipment. I enjoyed every minute I worked with the different kits; the Signal Tracer works fine. Also like to let you know that I feel proud of becoming a member of your Radio-TV Club."

Robert L. Shuff, 1534 Monroe Ave., Huntington, W. Va.: "Thought I would drop you a few lines to say that I received my Edu-Kit, and was really amazed that such a bargain can be had at such a low price. I have already started repairing radios and phonographs. My friends were really surprised to see me get into the swing of it so quickly. The Trouble-shooting Tester that comes with the Kit is really swell, and finds the trouble, if there is any to be found."

UNCONDITIONAL MONEY-BACK GUARANTEE

**ORDER DIRECT FROM AD—RECEIVE FREE BONUS
RESISTOR AND CONDENSER KITS WORTH \$7**

- Send "Edu-Kit" postpaid. I enclose full payment of \$26.95.
- Send "Edu-Kit" C.O.D. I will pay \$26.95 plus postage.
- Rush me FREE descriptive literature concerning "Edu-Kit."

Name

Address

PROGRESSIVE "EDU-KITS" INC.

1186 Broadway, Dept. 580D, Hewlett, N. Y.

Armed Forces Day Program for Amateurs and SWL's

ALL U. S. and overseas radio amateurs are invited by the Army, Navy, and Air Force to participate in the Twelfth Armed Forces Day amateur radio program on Saturday, May 20, 1961.

There will be a c.w. code receiving contest, open to any short-wave listener who can copy International Morse Code at 25 words per minute. A message from the Secretary of Defense will be sent. Each participant who submits a perfect copy of the c.w. message will be awarded a Department of Defense certificate of merit signed by the Secretary.

A radioteletypewriter (RATT) transmission will be sent by Headquarters MARS and Navy radio stations. A message from the Secretary of Defense will be transmitted at 60 words per minute. This contest is open to everyone. Again, a certificate will be awarded for perfect copy.

A military-to-amateur transmitting and receiving test will be conducted for all holders of valid U. S. amateur radio station licenses. Headquarters radio stations of the Army, Navy, and Air Force will operate on spot frequencies outside the amateur bands and establish radio contact with amateur stations. A colorful one-time Armed Forces QSL card will acknowledge contact—each service headquarters will acknowledge separately so amateurs will have an opportunity to qualify for three different QSL cards.

C.W. and RATT Schedules. Each transmission for the c.w. and RATT receiving contests will commence at the times indicated below, with a ten-minute CQ call to permit the participants to adjust their equipment. The CQ will be immediately followed by the message. It is not necessary to copy more than one station and no extra credit will be given for so doing.

Transcriptions should be submitted "as received." No attempt should be made to correct possible transmission errors. Time, frequency, and call-sign of the station copied should be indicated as well as the name, call-sign (if any), and address of the individual submitting the copy.

Competition entries should be sub-

mitted to the Armed Forces Day Contest, Room BE1000, The Pentagon, Washington, D. C., and postmarked not later than May 31, 1961.

C.W. RECEIVING CONTEST

Time	Station	Frequency (kc.)
2200 EST	WAR/AIR	3347, 14405, 20994
2200 EST	NSS	3319, 4010, 6970, 14480
1900 PST	AGUSA	6997.5
	NPG	3319, 7595, 14927.5
	NPD	7455
	AG6AIR	7832.5

RATT RECEIVING CONTEST

Time	Station	Frequency (kc.)
2235 EST	WAR	3347, 14405, 20994
	NSS	3319, 7375, 14480
	AIR	7915
2135 CST	A5USA	5395
	NDS	7455
	AG5FFR	7305
1935 PST	AG6AIR	7832.5
	A6USA	6997.5
2145 CST	NDF	7380
	NDW	3319, 7375
	NPD	7455

Military-to-Amateur Test. Military stations WAR, AIR, and NSS will be on the air from 1000 EST to 2400 EST. These stations will listen for calls from amateurs within the appropriate amateur bands. Contacts will consist of a brief exchange of location and signal report. No traffic-handling or message exchange will be permitted.

Station	Frequency (kc.)	Amateur Band (mc.)
WAR	4020 (AM)	3.8 to 4
	4025 (c.w.)	3.5 to 3.8
	6997.5 (c.w.)	7 to 7.2
	20994 (c.w.)	21.1 to 21.25
NSS	4010 (c.w.)	3.5 to 3.8
	6970 (c.w.)	7 to 7.2
	13680 (c.w.)	14 to 14.2
	14480 (c.w.)	14 to 14.2
	*4012.5 (AM)	3.8 to 4
		7.2 to 7.3
	14385 (SSB)	14.2 to 14.35
	3319 RATT	3.5 to 3.8
	7375 RATT	7 to 7.2
	**20050 RATT	
AIR	3347 (c.w.)	3.5 to 3.8
	7635 (AM)	7.2 to 7.3
	14405 (SSB)	14.2 to 14.35
	15715 (c.w.)	14 to 14.2

*Operator transmitting on 4012.5 (AM) will listen in the AM, SSB, sections of the 40- and 75-meter bands for AM or SSB stations.

**NSS will key 20050 kc. simultaneously with one of the RATT frequencies listed above. This frequency will be used as frequency propagation conditions dictate.



NRI—Oldest and Largest Radio Television School Now Offers NEW HOME STUDY TRAINING IN INDUSTRIAL & MILITARY ELECTRONICS

Special Training Equipment Included

No extra cost. In NRI Electronics training especially developed training equipment brings to life theory you learn in illustrated lessons. You get practical experience with thyratron tube circuits, multivibrators, capacitors, diodes, transistors, telemetry, computer circuits and other basic circuits and components.

TRAINING AID 1 Get practical experience measuring voltage, current, building circuits.

TRAINING AID 2 Build Vacuum Tube Voltmeter. Make tests on series and parallel circuits.

TRAINING AID 3 Practice with resistors, capacitors, coils. Work with half-, full-wave, bridge, voltage doubler and pi-type filter circuits.

TRAINING AID 4 Build circuits with pentode tubes, selenium rectifiers, transistors. Build oscillator, check signal phase shift with oscilloscope.

TRAINING AID 5 Experiment with thyratron tube circuits, Lissajous patterns. Study basic amplitude detector circuits, modulation, demodulation.

TRAINING AID 6 Get practical experience with magnetic amplifiers, learn to use modified Prony brake; determine motor torque. Use strobe disc to measure motor speed.

TRAINING AID 7 Learn effects of feedback. You build and experiment with dc coupled (instrument) amplifier. Study broadband amplifiers; photocells.

TRAINING AID 8 Experiment with multivibrators used as timing generators in binary counters, and as frequency dividers. Learn to use blocking oscillators, thermistors.

TRAINING AID 9 Practical experience in telemetry circuits used in earth satellites, remote control devices. Work with basic circuits used in digital and analog computers.

TRAINING AID 10 Assemble circuits in electrical and electro-mechanical systems, make valuable practical electronic circuits.

Growth creates need. Rapidly expanding use of Electronic equipment in industry, business, military is increasing the demand for Electronic Technicians. To help meet this demand, NRI now offers a complete course in **ELECTRONICS—Principles, Practices, Maintenance** in addition to NRI training in Radio-TV Servicing and Radio-TV Communications.



Job Counselors Recommend

Job counselors will tell you that men with technical Electronic training are in demand—that future opportunities are great. And because the work is important—the pay is high. NRI catalog shows how you can join graduates now enjoying interesting careers in this age of Electronics.

Learn More to Earn More

Waiting and wishing for a better job won't get you ahead. *You must act!* The ambitious man—with or without previous experience—can train at home the NRI "learn-by-practice" way. Keep your present job while training. NRI supplies training at low cost because it is the oldest, largest home-study school of its kind. Plan now to earn more. Send for FREE 64-page catalog.

FOR MORE INFORMATION—TURN PAGE

Cut Out and Mail—No Stamp Needed

NRI NATIONAL RADIO INSTITUTE
WASHINGTON 16, D. C. Dept. IDD-4

Send me your Electronic, Radio-TV catalog without cost or obligation. (No representative will call. Please PRINT.)

Name _____ Age _____

Address _____

City _____ Zone _____ State _____

ACCREDITED MEMBER NATIONAL HOME STUDY COUNCIL

Send for
64-Page
CATALOG
FREE

The Amazing
Field of
Electronics



**ELECTRONICS NEEDS
4 TO 7
QUALIFIED TECHNICIANS**

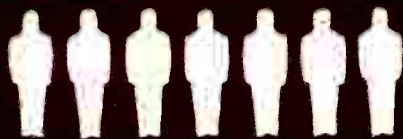

**FOR EVERY
GRADUATE ENGINEER**



**Choose from 3 Fields
of Opportunity**

There's an NRI course for each of the three major branches of Electronics. The **FREE CATALOG** we send helps you select training of your choice.

1 INDUSTRIAL ELECTRONICS

Principles, Practices, Maintenance of computers, servomechanisms, telemetry, other Electronic equipment.

2 RADIO-TV SERVICING

Service and maintain Radios, TV sets, Hi-Fi, PA systems. A profitable field, full or spare-time.

3 COMMUNICATIONS

Training for men who wish to operate and maintain radio and TV stations, police, marine and mobile radio, etc.

SEE OTHER SIDE

**Join The Thousands
Who Trained For
Advancement With NRI**

Thousands of NRI graduates throughout the U. S. and Canada are proof that it is practical to train at home. NRI graduates are in every kind of Electronics work: inspectors, maintenance men, assistant engineers, testers, lab technicians, or holding essential Government posts. Read what these men have to say about NRI home-study "learn-by-practice" training:



A GOOD CHANCE FOR ADVANCEMENT exists for Roger E. Vallerand of Hartford, Conn., at Hamilton Standard, United Aircraft Corp. electronic division. "I can truthfully say that anyone contemplating taking the course will have no regrets. Many thanks to NRI."



NOW FOREMAN FOR AN ELECTRONICS FIRM, Thomas R. Favaloro started working even before finishing the NRI course. He is with Technical Appliance Corp., Shelburne, N. Y. In charge of all government and communications divisions. He says, "it is responsible for my whole future."



"THE FINEST JOB I EVER HAD" is what Thomas Bilak, Jr., Cayuga, N. Y., says of his position with the G. E. Advanced Electronic Center at Cornell University. He writes, "Thanks to NRI, I have a job which I enjoy and which also pays well."

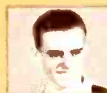

"I ACTUALLY ENJOY GOING TO WORK." That's how Duane E. Bitner, Manchester, N. H., describes his position with Raytheon working on the Hawk Missile System. "I can truthfully say your course gave me my biggest boost."



BUILDING ELECTRONIC CIRCUITS on specially-designed plug-in type chassis, is the work of Robert H. Laurens, Hammonton, N. J. He is an Electronic Technician working on the "Univac" computer. "My NRI training helped me to pass the test to obtain this position."

FIRST CLASS
PERMIT
NO. 20-R
(Sec. 34.9, P.L.&R.)
Washington, D.C.

BUSINESS REPLY MAIL

NO POSTAGE STAMP NECESSARY IF MAILED IN THE UNITED STATES

POSTAGE WILL BE PAID BY

NRI National Radio Institute
3939 Wisconsin Avenue
Washington 16, D.C.



**Oldest and Largest
School of Its Kind**

Training men to succeed by home study has been the National Radio Institute's *only* business for over 45 years. NRI is America's oldest and largest Electronics home-study school. Don't delay. Cut out and mail **POSTAGE-FREE CARD**.

MAIL POSTAGE-FREE CARD

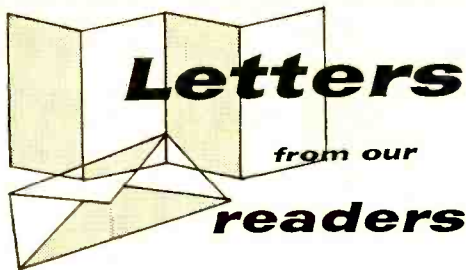

Bonus Band DX'ing

■ After reading with interest the article in the February 1961 issue entitled "DX'ing on the Bonus Band," I would like to call your attention to the fact that coastal-harbor station KOU (see chart on page 56) is actually owned by the Pacific Telephone and Telegraph Company and located in San Pedro, Calif. Of the three frequencies listed for this station, 2522 and 2598 kc. are used in the day-time only (7:00 a.m. to 7:00 p.m.); the 2566-kc. frequency is a 24-hour channel.

L. E. MYERS
Sales Manager, Radio
Pacific Telephone & Telegraph Co.
Los Angeles, Calif.

■ I would like to thank you and author Tom Kneitel for the "DX'ing on the Bonus Band" article in the February issue. With the help of the information it contained, I have verified many marine stations.

JIM ALBRINCK, WPESAZJ
Reading, Ohio

"Sweet Sixteen" Satisfying

■ Here is a picture of three of the four "Sweet Sixteen" speakers we built from the instructions in the January 1961 issue of your magazine. We'd like to suggest to your readers who have not yet built one that the plywood panels on the front and back be at least $\frac{3}{4}$ " thick instead of the $\frac{5}{16}$ " specified. We used $\frac{3}{4}$ " panels, as we found the vibration to be much less with the thicker panel, and the sound range wider—particularly at the



bass end. The fidelity of our speakers is equal to that of many selling for several times the cost of ours, and we are well satisfied with them.

LINWOOD N. ROBUST
Baltimore, Md.

Reader Robust is not alone in his enthusiasm for the "Sweet Sixteen" setup—literally hundreds of others are more than satisfied with the "Sweet Sixteen" systems they have built. For some reader

queries (and answers) as well as instructions on how to add a tweeter to the "Sweet Sixteen," see the article beginning on page 55 of the April 1961 issue.

R.F. Power Meter Calibration

■ I constructed the r.f. power meter ("Build an R.F. Power Meter," by Joseph Tartas, W2YKT) in the June 1960 issue, but had difficulty calibrating it. Using the 60-cycle power source required for calibration, I had to insert an additional 0.9- μ f. capacitance to supplement C_1 and C_2 . This was necessary to make the d.c. voltage from the D_2 diode to ground equal to the a.c. voltage



across R_1 (as measured with an RCA Volt-Ohmyst). The extra capacitance was removed after calibration.

JAMES M. STEUBER, WSUOZ
Albuquerque, N.M.

Author Tartas tells us that he agrees with reader Steuber's procedure. Other readers, please take note.

Infrared Burglar Alarm

■ I enjoyed reading "Build an Infrared Burglar Alarm" in your February 1961 issue, but found one point confusing. In the first sentence of the second paragraph on page 49 ("When the test alarm is turned off by R_2 , open S_2 "), shouldn't " S_2 " be " S_1 "?

BRUNO FRIIA
Philadelphia, Pa.

You're absolutely right, reader Friia, and we regret to say that there is another misprint in the article. The first sentence in the third paragraph on page 49 should read: "To operate the system as a store announcer, go through the adjustment procedure described for the burglar alarm but leave S_1 closed after sensitivity control R_2 has been adjusted to turn off the alarm."

"Flexiformer" May Be Lethal

■ A section of the article on "The Flexiformer" in your February 1961 issue discusses the use of this device as a current transformer to measure high values of current. It is my belief that you should point out the lethal potential that might be encountered in the open secondary if the meter is disconnected while heavy current is flowing in a

COYNE'S New Complete

Pin-Point TROUBLE SHOOTING Series

See All 4 Books On 7-Day FREE TRIAL!

Takes Headaches Out Of All Servicing Problems!



Pin-Point

Transistor Troubles in 12 Minutes!

Trouble-shoot every type of circuit in ALL transistorized equipment! 525 pages; hundreds of illustrations; 120 check charts! \$5.95

Pin-Point

Record Changer Troubles in 5 Minutes!

Locate mechanical and electronics troubles fast. Covers all makes. 320 pages; 450 photos; 58 check charts! \$3.95

Pin-Point

TV Troubles in 10 Minutes!

Find the exact sound or picture trouble in any TV set from 700 possibilities! 300 pages; 300 diagrams, check charts! \$4.95

Pin-Point

Color TV Troubles in 15 Minutes!

Covers every type color TV and picture tube! 550 pages; 362 check charts, diagrams, picture patterns! \$5.95

Simple Check Chart System Saves Time

These amazing practical handbooks with an ENTIRELY NEW METHOD, show you how to find the trouble in ANY tv, record changer or transistor circuit FAST! Index tells you where to look; famous Check-Charts help you pin-point the exact trouble in minutes! These on-the-job books quickly pay for themselves in profitable new business and valuable time saved!

SEND NO MONEY

Just mail coupon for 7 DAY FREE TRIAL. If you keep all 4 books, pay only \$3.00 per month until \$21.35 plus postage is paid. Cash price for Set only \$18.95. Or return books and pay nothing. Either way, FREE BOOK IS YOURS.

VALUABLE FREE GIFT!
Send for FREE TRIAL OFFER of all 4 Pin-Point books and get FREE book, "Bigger Profits in TV" whether you keep series or not!

FREE TRIAL OFFER...Mail Coupon Now!

Educational Book Publishing Div.
COYNE ELECTRICAL SCHOOL, Dept. 51-PE
1455 W. Congress Pkwy., Chicago 7, Ill.

- Rush 4-book PIN-POINT Series for 7-day FREE TRIAL per offer. For individual books, check below.
- RECORD CHANGER (\$3.95 plus postage)
- TRANSISTORS (\$5.95 plus postage)
- TV (\$4.95 plus postage)
- COLOR TV (\$5.95 plus postage)

Name.....Age.....

Address.....

City.....Zone.....State.....

\$18.95 Cash Price enclosed for 4 books.
 Send 4 books C.O.D. for \$18.95 plus M.O. fee. COYNE PAYS POSTAGE ON ALL CASH & C.O.D. ORDERS. 7-Day money-back guarantee on Cash or C.O.D. orders.

Letters

(Continued from page 35)

one- or two-turn primary. Most laboratory current transformers are provided with a built-in shorting switch across the secondary to help prevent this dangerous condition.

C. E. CHERRY, Chairman
Engr., Science, Math. Div.
College of Marin
Kentfield, Calif.

We hope that all readers experimenting with the "Flexiformer" will read the above letter closely and take appropriate precautions.

Complete POP'tronics Set

■ I have been reading your magazine since it first came out, and I have every issue. All of the copies



are in very good condition, and I would like to sell them. Do you know of anyone who would be interested?

GEORGE ENGLE
2965 N.W. 83 St.
Miami 47, Fla.

Here's a chance for some lucky reader to pick up those choice back issues.

Czech Pen Pal

■ I'm 17 years old, an amateur radio operator (OK3-8087), and I'd like to correspond with American radio operators (preferably male) about my own age. Could you please publish my name and address in your magazine?

IVAN SOMORA
Csl. armády 65
Piesbany
Czechoslovakia

Valves, Anyone?

■ I am interested in restoring antique radios of the 1920's such as the Atwater Kent, Zeta, etc., but I am having trouble obtaining tubes (CX 301A, CX 345, UX 201) and information concerning these radios. Can you help me out?

PAUL H. FUGE
455 Bayberry Rd.
Somerville, N. J.

Try Leotone Radio Corp., 65 Dey St., New York 7, N. Y., for the tubes you mention; and try Supreme Publications, 1760 Balsam Rd., Highland Park, Ill., for schematics on these and other sets. Incidentally, Supreme will send you a master index to all their publications for 25 cents. —30—

Now you can build almost any kind of electronic device!



Send for FREE
7-Day Trial Examination
of this Valuable
Book!

Here are the ABC's of 50 vacuum-tube circuits for electronics experimentation and project construction — all fully diagrammed, complete with parts list.

HOW many times have you wanted a diagram of a basic vacuum-tube circuit which you could use as a guide in building hi-fi components, receivers, transmitters, intercom systems, test equipment and other electronic gear? At last, in one book, you can find all the basic diagrams, schematics and other vital information on vacuum tubes and their circuits essential for such projects!

You'll Become An Expert On All Types of Vacuum Tubes

Beginning with the Edison effect (the birth of the diode), Julian M. Sienkiewicz, Managing Editor of Popular Electronics, leads you right up to the multi-element vacuum tubes used in everyday circuits. The first four chapters are devoted to the operation of diodes, triodes, tetrodes, and pentode and beam-power tubes. Chapter five covers construction practices, tools, and test equipment, along with workshop hints that will be a real boon to all who want to get the most out of their equipment. Chapter six contains a collection of fifty vacuum-tube circuits that gives you a basic library of useful circuits for quick and trouble-free reference.

One hundred vacuum-tube schematics, plate-characteristic curves, simplified diagrams, test circuits and other selected illustrations supplement the informative text to make this book one of the most useful and invaluable manuals for your electronic experiments and hobby projects.

192 pages, 100 illustrations \$4.95

PARTIAL CONTENTS:

DIODE VACUUM TUBES.

Emission — Diode Operation — Rectification Power — Supply Filters — Detection (AM and FM).

TRIODE VACUUM TUBES.

Triode Operation — The Triode Test Circuit — Control — Triode Characteristics — Plate Characteristic Curves — Plate Resistance — Amplification Factor.

TRIODE AMPLIFIERS.

Load Lines — Operating Point — Cathode Bias — Cathode Load Lines — Signal Amplification — Signal Inversion — Voltage Gain — Computing Voltage Gain — Distortion.

MULTI-ELEMENT TUBES.

Miller Effect — Tet-

rodes — Pentodes — A.C. Plate Resistance — Transconductance — Amplification Factor — The Pentode Voltage Amplifier — Operating Point — Cathode Bias — Distortion — Beam-Power Vacuum Tubes — Audio Output Stage.

CIRCUIT CONSTRUCTION HINTS.

Checking Components — Fixed Resistors — Capacitors — Transformers and Coils — Vacuum Tubes — Where To Buy — Test Equipment — Vacuum Tube Voltmeter — Oscilloscope — Signal Generators — Tools — Soldering — Chassis Construction — BASIC VACUUM TUBE CIRCUITS.

ZIFF-DAVIS PUBLISHING COMPANY

ELECTRONICS BOOK SERVICE

One Park Avenue
New York 16, N. Y.



Please send me VACUUM-TUBE CIRCUITS FOR THE ELECTRONIC EXPERIMENTER for a free 7-day trial examination. I understand that if I am not completely satisfied, I may return the book and owe you nothing. Otherwise, I will remit \$4.95 plus small charge for postage, packing and handling. Same return privilege and prompt refund guaranteed!

NAME _____
(please print)

ADDRESS _____

CITY _____ ZONE _____ STATE _____

EF547

SAVE MORE with

• Tested for mutual conductance in our labs! •
 1-Yr. free replacement guarantee! • Prompt refunds on defective mids.

SONAR TUBES

Spec. Pur. & Trmtg. and Ind. Tubes			
Type	Price	Type	Price
OA2	50	1A10A	8.50
OA3	75	1A4GY	1.00
OA4	75	6L1WA	1.15
OB2	65	218	8.00
OB3	50	1J29	8.00
OC3	50	1J29	32.00
OD8	55	807	1.00
2E21	1.00	813	8.00
2E26	75	815	1.70
3A4	75	815	1.70

RECEIVING TUBES			
Type	Price	Type	Price
02A	45	3BC7	.88
1A7GT	45	3BN6	.80
1B3GT	52	3C106	.80
1H4GT	52	3C106	.80
1H6GT	52	3C106	.80
1L4	45	3C86	.42
1L6	52	3L4	.49
1N3GT	52	3Q4	.49
1H5GT	52	3B4	.44
1R5	41	3V1	.44
1R5	41	3V1	.44
1T1	39	1B27A	.65
1U4	41	3AN8	.65
1V2	42	3AT8	.65
1X2	49	3AW1	.44
3A5	95	3BK7	.78
		3B1	.51
		3B2	.51

SONAR
 ELECTRONIC TUBE CO.
 112 Martin St.
 Paterson 3, N. J.

All adv. tubes not nec. new, but may be elec. pref. fac. 24s or used. Ea. clearly marked. All usg. ind. 2% hltg. chr. Orders under \$5 inc. 2% dep. on C.O.D.'s. Send approx. 194g. on Canada & foreign orders. Write for comp. list of tubes & spec. purp. tubes.

BUILD THE PROJECTS DESCRIBED IN THIS ISSUE OF POPULAR ELECTRONICS

WITH THESE PRODUCTS



TRANSIDIP
 Uses Bud Chassis Box
 CU-2106A.....\$1.02

3-WAY INTERCOM
 Uses Bud Universal Sloping Panel Cabinet
 AC-1613.....\$2.10

All Bud products are available for immediate delivery from your Authorized Bud Distributor. They are the best for applications described in these projects.

WATCH FOR THESE LISTINGS EVERY MONTH IN POPULAR ELECTRONICS

BUD RADIO, INC.
 2118 East 55th Street Cleveland 3, Ohio
 Dept. P.E.

Tips and Techniques



PHONO CARTRIDGE IDENTIFICATION

Phono cartridges are made in so many different shapes and sizes that it's sometimes difficult to tell by looking at one whether it's a magnetic or crystal/ceramic type. A quick way to find out is to

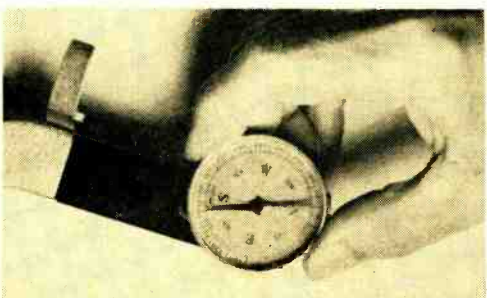

hold a pocket compass close to the front of the cartridge or tone arm. If the cartridge is a magnetic type, the needle will swing around and point toward the cartridge. If it's a crystal or ceramic type, the needle will move very little—or not at all.

—Art Trauffer

BAYONET SOCKET CONVERSION

A bayonet socket can easily be converted to accept a screw-base bulb. Simply take a pair of long-nose pliers and bend the

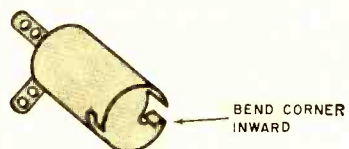

edge of one of the L-slots slightly inward, as shown. The bulb will screw in without difficulty.

—Jacob Jacobs, W6GCU

HANDY TUBE REMOVER/REPLACER

To remove miniature tubes from hard-to-reach places, use a short piece of 1/2" plastic water pipe with a 1" lengthwise slit on one end. Push the slitted end

Always say you saw it in—POPULAR ELECTRONICS

over the tube to lift it out. To replace the tube, push it back into the pipe and reinsert it in its socket; then push the eraser end of a long pencil down to the tube to hold it in place while you remove the pipe. Larger diameter plastic pipe may be used in the same way to remove full-sized tubes.

—Harold B. Burnham, KN4W1Q

ADDING INVERSE FEEDBACK

If your radio or record player uses a single output tube with a bypass capacitor across its cathode resistor, you can significantly improve its response and linearity by this simple trick. Just remove the capacitor—thereby adding a worthwhile amount of constant-current inverse feedback to the audio circuit. A little gain is lost in the process, but if

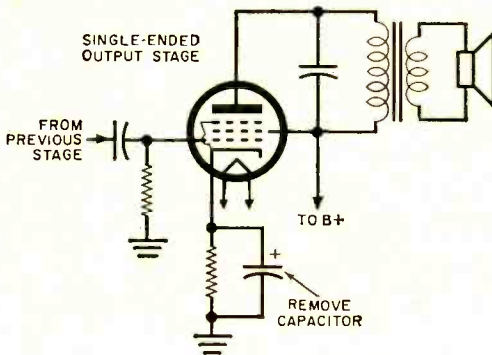

you have a musical ear you'll be glad to sacrifice some gain for improved clarity.

—Carl Dunant

METER FACE CLEANING

Scratched transparent plastic meter faces can be easily restored to brand-new condition. Just rub the damaged area vigorously with a cotton cloth moistened slightly with electric shaver sharpening compound. Don't attempt to clean such meter faces with carbon tetrachloride, however; carbon tet and similar organic cleaning solutions will ruin the surface of most plastics.

—Brother Leo Raymond, W0TPN

SOLDERING MULTI-PIN PLUGS

Making strong, clean connections to the terminals of multi-pin plugs is simplified with this technique. Insert a length of thin (.062-diameter) 50/50 rosin core

solder into each terminal and cut it off flush with a pair of side-cutters. Apply the soldering iron to the terminal and

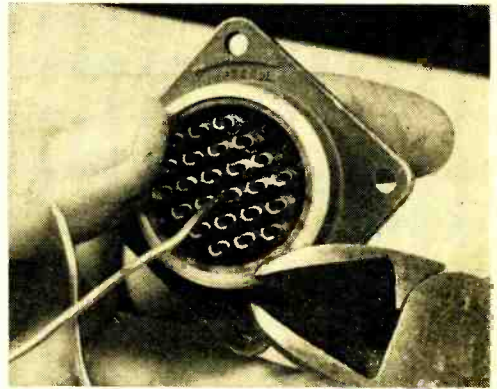

gently insert the wire (tinned) as the solder melts. A piece of spaghetti which has been slipped over the wire prior to soldering can be used to cover the joint.

—Clyde C. Cook

SOLDERING SHIELD

An ordinary asbestos kitchen "hot pad" makes a handy surface on which to rest work to be soldered. It will facilitate the soldering operation and protect the finish of your workbench.

—Mike Swink, K0VVR

EMERGENCY POWER SAW BLADE

If you break the blade on your power saber saw and have no replacement on hand, you can make a temporary substi-

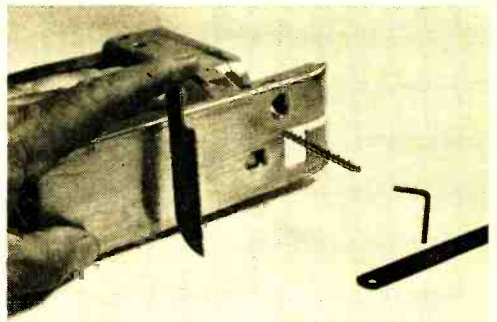

tute from a standard hacksaw blade. Break off a piece of the hacksaw blade and grind it down to fit into the power saw chuck. The blade's tip should also be rounded off to make cutting starts easier.

—H. L. Davidson

BEST BUYS IN STEREO AND MONO HI-FI

New Stereo/Mono 4-Track Tape Deck RP100 Semikit (electronics in kit form) \$289.95 Wired \$395.00

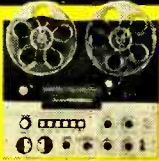

New FM-AM Stereo Tuner ST96 Kit \$89.95 Wired \$129.95 Incl. FET



New 70-Watt Integrated Stereo Amplifier ST70 Kit \$94.95 Wired \$144.95



New 40-Watt Integrated Stereo Amplifier ST40 Kit \$79.95 Wired \$124.95

FM Tuner HFT90 Kit \$39.95 Wired \$65.95 Incl. FET Metal Cover \$3.95



28W Integrated Stereo Amplifier HF81 Kit \$69.95 Wired \$109.95



AM Tuner HFT94 Incl. FET Kit \$39.95 Wired \$65.95



Stereo Preamplifier HF85 Kit \$39.95 Wired \$64.95



Stereo Power Amplifiers
100W HF89: \$99.50 Kit \$139.50
70W HF87: \$74.95 Kit \$114.95
28W HF86: \$43.95 Kit \$74.95



Stereo/Mono Changer/Player 1007 with stereo cartridge and dual sapphire styli \$49.75



Bookshelf Speaker System HFS1 Kit \$39.95 Wired \$47.95



BEST BUYS IN CITIZENS TRANSCEIVERS, HAM GEAR, RADIOS

Citizens Band Transceivers from Kit \$59.95 Wired \$89.95

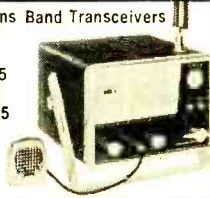

New 60W CW Transmitter = 723 Kit \$49.95 Wired \$79.95



Transistor Portable Radio RA6 Kit \$29.95 Wired \$49.95 Incl. FET



EXCELLENCE IN CREATIVE ELECTRONICS

Over 2 MILLION EICO instruments in use throughout the world. Compare, take them home — right "off the shelf" — from 1500 neighborhood dealers, most of whom offer budget terms.

BEST BUYS IN TEST EQUIPMENT

New Metered Variable AC Bench Supplies Model 1073 (3 amps) Kit \$35.95 Wired \$47.95 Model 1078 (7½ amps) Kit \$42.95 Wired \$54.95



Peak-To-Peak VTVM = 232 & Uni-Probe® Pat. = 2,790,051 Kit \$29.95 Wired \$49.95 VTVM = 221 Kit \$25.95 Wired \$39.95



DC-5 MC 5" Scope = 460 Kit \$79.95 Wired \$129.50 5" Push-Pull Scope = 425 Kit \$44.95 Wired \$79.95



Tube Tester = 625 Kit \$34.95 Wired \$49.95



RF Signal Generator = 324 Kit \$26.95 Wired \$39.95



1000 Ohms/Volt V-O-M = 536 Kit \$12.90 Wired \$14.90



6- & 12V Battery Eliminator & Charger = 1050 Kit \$29.95 Wired \$38.95 Extra-filtered for transistor equip. = 1060 Kit \$38.95 Wired \$47.95



R-C Bridge & R-C-L Comparator = 950B Kit \$19.95 Wired \$29.95



Multi-Signal Tracer = 145A Kit \$19.95 Wired \$28.95



EICO, 3300 N. Blvd., L.I.C. 1, N.Y. Pf. 5
 Send free Catalog describing over 80 top-quality products, free Stereo Hi-Fi Guide, free Short Course for Novice License, name of nearest EICO dealer. Send new 36-page GUIDEBOOK TO HI-FI for which I enclose 25¢ for postage & handling.

Name.....
 Address.....
 City..... Zone... State.....
 Add 5% in the West

Listen to the EICO Hour, WABC-FM, N. Y. 95.5 MC, Mon.-Fri., 7:15-8 P.M.

© 1961 by EICO, 33-00 N. Blvd., L. I. C. 1, N. Y.

RADAR EXPLORES THE MOON

Electronic engineers have developed unique methods to determine the roughness of the lunar surface

By **KEN GILMORE**

This antenna has been used in both the Venus planetary radar contact and moon-mapping activity of MIT's Lincoln Laboratory.

ALTHOUGH man has not yet set foot on the surface of the moon, Mars, or Venus, his radar "fingers" have already reached out and touched these solar-system neighbors of ours.

We are getting important new information from our first electronic interplanetary trips. Scientists recently learned, for example, that Venus and other planets are much hotter and farther away from us than we had thought. Further striking new advances in radar equipment and spectacular progress in the techniques of analyzing and interpreting radar echoes may soon bring answers to questions such as:

- How rough is the surface of the moon?
- Does Venus, eternally covered by its thick mantle of clouds, rotate as does the earth—and if so, how fast? Does it have mountains, seas, icecaps, and forests?
- Is it true that the sun has a highly variable atmosphere of charged particles which, as some scientists theorize, reaches out beyond the earth?
- What does the dark side of Mercury look like?
- How dense are the ionized particles known to exist in space? How thick is the cosmic dust endlessly drifting through the universe?
- After years of speculation, what *are* the mysterious "canals" of Mars?

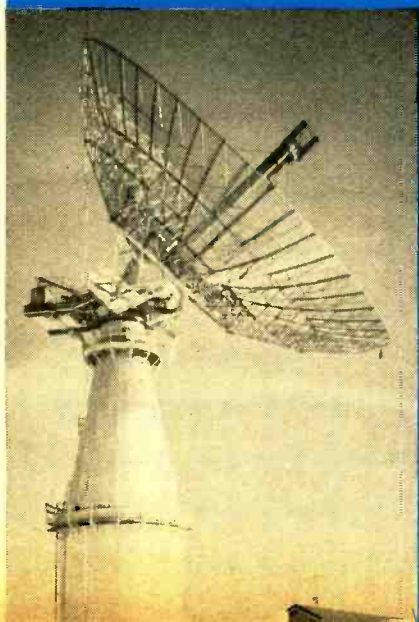

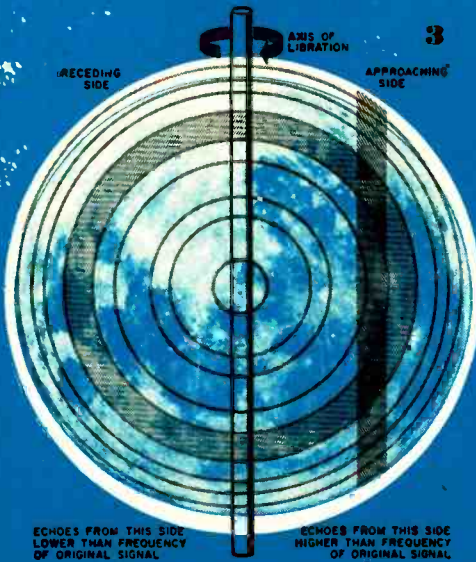

Fig. 1. Each concentric ring shown represents the lunar area capable of reflecting radar signals of specific millisecond time delay.

Fig. 2. As the moon rotates, it also librates, so that radar echoes vary above or below their radiated microwave frequency. Shaded section at right represents a certain frequency band which is located above radiated frequency.

Fig. 3. Combining both time delay and frequency selection tells us that the radar echo came from a fixed area of the lunar surface.

Radar Astronomy. The new branch of electronics seeking answers to these and related questions, radar astronomy, is even younger than the more widely known radio astronomy—itsself no old-timer. *Radio* astronomy, touched off in 1931 when Karl Jansky discovered the strange radio noises of the heavens, consists mainly of listening to the static generated by ionized gas clouds and stars throughout the universe. In *radar* astronomy, on the other hand, we send out the signals ourselves, then receive and record the echoes when they come back.

It began in 1946 when the Army Signal Corps managed to bounce the first

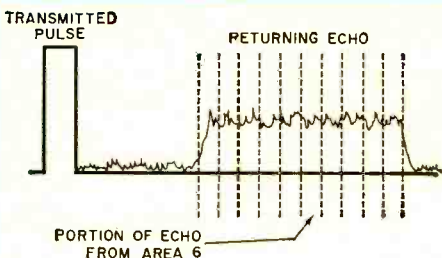

Lunar radar echoes are long in duration since the same narrow pulse must be reflected from a spherical surface. The echo can be easily divided up into segments to match those in Fig. 1.

SCALE
FACTOR

MOON POWER SPECTRUM

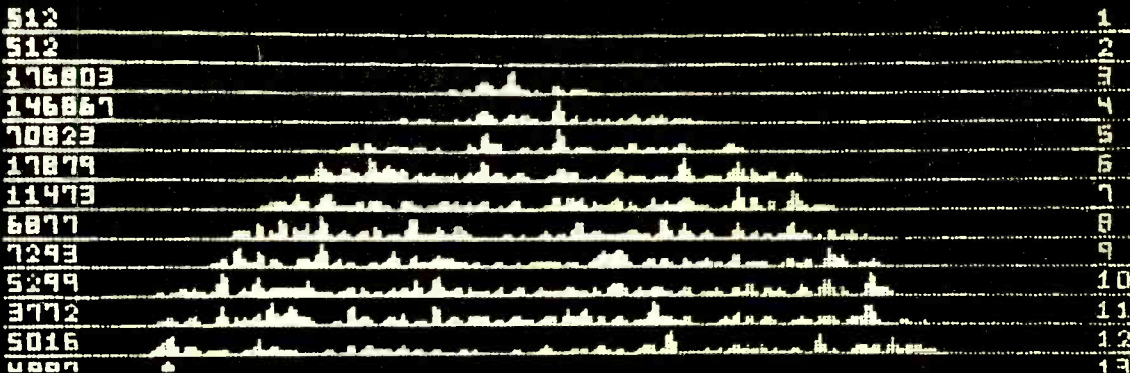
RANGE
BOX

Using techniques described in this article, scientists at the Lincoln Laboratory have made this radar map of the moon. When this system has been further improved, detailed maps of the surface of Mars and Venus may be possible.

signal off our closest heavenly neighbor, the moon. For the next decade, electronic techniques and equipment improved—radar transmitters became more powerful, the receivers used to detect the extremely weak echoes more sensitive. Finally, in early 1959, a group of scientists at MIT's famous Lincoln Laboratory made radar contact with Venus. Less than a year later, workers at Stanford University got echoes from the sun—over 90 million miles away.

Until recently, all we could do with these radar contacts was measure distance. We couldn't "see" much detail because radar beams, like light beams, spread out as distance increases. The "tightest" beams are about one minute (1/60th of a degree) wide. Also, the fineness of detail which the beam can distinguish depends on its diameter at the target. When the target is at interplanetary distances, the beam spreads thousands of miles. Thus it has about the same *resolving power*—detail-seeing ability—as the human eye. You can see only the barest detail on the moon with the unaided eye, and planets are simply pinpoints of light. They look about the same to radar. Optical telescopes, on the other hand, can see far finer detail.

For some time, researchers have been looking for a way to improve radar's resolving power. The obvious method—

narrowing the beam—wasn't practical. Even small improvements would require tremendously large antennas. Finally, scientists at Lincoln Laboratory came up with an ingenious plan for improving radar's resolution—without narrowing the beam at all. With the new method, radar resolution now almost equals telescopic resolution on the moon, *and far surpasses it at interplanetary distances.*

Listening for Echoes. When we look at the moon, it seems to be a flat disc in the sky, although it is really a sphere. The center of the sphere is closest to us, the outer edges farther away.

When we bounce a radar signal off the moon, a strange thing happens. We send out a pulse of one length, and get back a much longer echo. This is because part of the signal bounces off the center (which is closest), part bounces off some distance away from the center, and so on, all the way out to the edge. It is as though we were getting a series of echoes from a number of different targets, each slightly farther away than the preceding one, so that all blend and overlap into one long echo.

If we select a small part of the signal, say the first 1/10th that returns, we know this is the echo from the moon's center. The next 1/10th will be from an area surrounding the center slightly farther from us, and so on. By selecting various parts of the echo, we can isolate



This computer at Lincoln Laboratory analyzed 10,000,000 computations to confirm existence of weak radar echoes from Venus.

Intensity and time duration of the radar returns from Venus matched these two curves prepared by the computer.

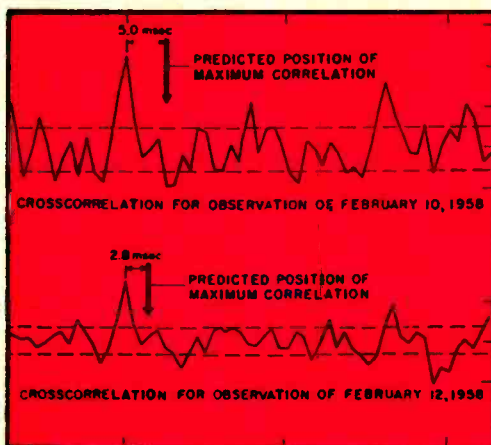

echoes from various ring-shaped portions of the moon's surface—see Fig. 1. The drawing at the bottom of page 42 is an idealized representation of how such an elongated return echo might look. The various parts of the echo are from the numbered circular portions on the moon's surface.

We have now narrowed down the portion of the moon's surface from which the echoes are coming, but for the system to be really useful in mapping the satellite by radar, we must narrow it down still further. And in the moon's slight natural movement, Lincoln Laboratory scientists found the key to doing just this. Although the face of the moon does not rotate with respect to the earth—this is why we always see the same side—it does wobble. Scientists call this wobbling "libration."

As the moon librates, it turns slightly in one direction, then back in the opposite direction, and so on. As it librates in one direction, one outer edge is moving toward earth; the other, away from us. Now, as a radar beam strikes the entire surface of the moon, the echo which bounces off the side coming in our direction is slightly raised in frequency, due to the Doppler effect. (This is the effect discovered many years ago which seems to make a train whistle change in pitch as the train approaches, then

passes you.) The signal coming from the receding side is lowered in frequency. The center, which remains at a constant distance, returns an echo at the same frequency as the original signal.

With various portions of the moon's surface returning echoes of different frequencies, by tuning in only echoes of one frequency and rejecting the rest, we can listen to echoes from any part individually. See Fig. 2. (The order reverses, but the principle remains the same as the moon librates back in the opposite direction.)

By tuning only for one frequency, and at the same time selecting only one part of the returning pulse, both of our selection systems are in operation. The only echo we receive is from the two small spots on the moon where the two patterns overlap—see Fig. 3.

Mapping the Moon. Using this technique, scientists have made a rough radar map of the moon, as shown on page 43. Radar pictures made in this way will never be as sharp as telescopic pictures of the moon that we have had for years. But the system still has tremendous value. It can give a pretty good idea of how rough certain parts of the moon's surface are—essential information for a space ship landing.

The primary value of the new radar mapping technique lies in the fact that

while the resolving power of a light telescope diminishes with distance, the resolving power of the new radar telescope does not diminish with distance. Since the Doppler and time delay effects used are functions of the size and speed of rotation of a planet, and *not its distance from earth*, this radar system will resolve features easily and accurately on Mars, Venus, Mercury, or any other planet our radar is strong enough to reach. The moon is now serving to calibrate and test the system so scientists can compare results with known terrain. Soon, radar eyes will be turned on the planets.

The planets are millions of miles away and radio energy loses strength rapidly as it travels through space. It follows the *inverse square* law, which means that if you double the distance a signal has to travel, you end up with not one half, but the square root of the power you had before. Since a radar signal has to travel two ways—out to the target and then back—the strength of its signal diminishes more rapidly. It varies inversely as the *fourth power* of the distance. In other words, when you double the radar distance, you get back only 1/16th the power.

Mapping the Planets? To reach the planets and get a return echo, we need tremendous amounts of transmitted power—all that we can generate. Even

at maximum power, the echo that comes back is not a sharp pip, easily received and spotted. All we get from outer space is a lot of noise. Somewhere buried in that hash, we hope, is the signal we want. But the signal may be as much as 10,000 times weaker than the hash which is drowning it out.

Scientists are managing to solve the problem of detecting weak signals by sending out a string of pulses, rather than one pulse, lasting—in the case of the Venus contact, for example—just under five minutes. The return signal—a lot of hash with some echoes mixed in—is fed to a computer which electronically adds up all the areas where the pulses ought to be. Since the returning pulses are regular, and the noise is irregular, theoretically the pulses will add up faster than the noise. This theory actually works in practice. The computer, after making as many as 10,000,000 separate computations, has spotted unmistakable echoes.

Radar astronomy, with its new techniques and improved equipment, will soon set out on what may be the most spectacular job of its career: mapping the planets. And when man himself actually leaves on his first trip, his travels will be far safer, surer, and more valuable, because the fingers of radar astronomy will have already paved the way for him. -30-

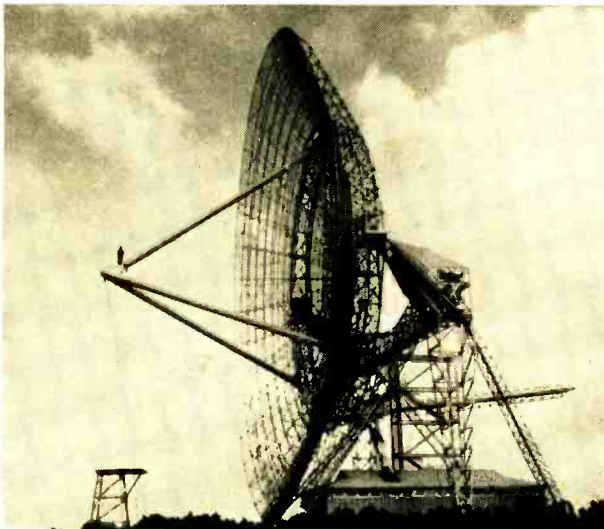

Working actively in the field of radar astronomy is the Stanford Research Institute, Menlo Park, Calif. This 142-foot antenna, erected by Stanford in northern Scotland, will be used for moon-echo studies similar to those being made by Lincoln Laboratory.

ELECTRONICS CHECKS BONE MENDING

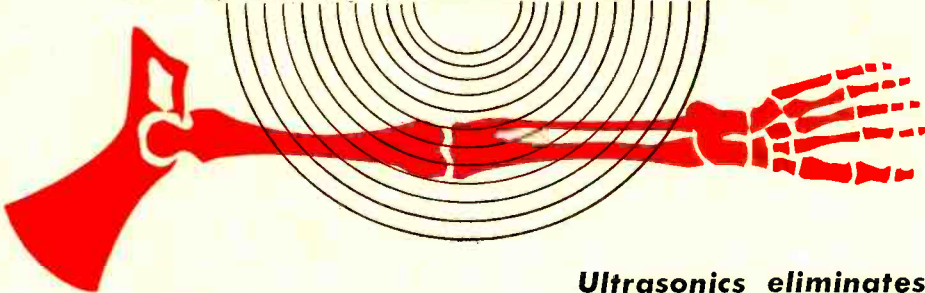

By JAMES G. BUSSE

**Ultrasonics eliminates
danger of X-ray poisoning**

MIX two doctors, an electronics enthusiast, and a few broken bones together—and just about anything can happen! An unusual electronic instrument for detecting broken bones was the result when Dr. George T. Anast of the Shriners' Crippled Children's Hospital in Chicago teamed up recently with Dr. Irwin M. Siegel and Ted Fields of the Veterans Administration Hospital. The new device, called a "soniscope," uses high-frequency sound waves to discover fractures and keep track of the way they mend without exposing patients to repeated doses of X rays.

The idea for the soniscope originally came from an electronic instrument used by the concrete industry to find breaks in concrete forms by measuring the speed of sound waves passing through them—if a form is broken, the break slows down the sound waves. Wouldn't a fracture slow down sound waves passing through a bone, too? The three men decided to find out.

Borrowing some equipment from the Portland Cement Research Association

in Skokie, Ill., they began experimenting on volunteer patients with broken arms or legs. The method worked! After some slight modifications in the basic circuit of the cement industry's instrument, they were able to detect simple fractures in a matter of seconds.

Then they made an amazing discovery. The soniscope could not only determine whether a bone was broken, but it could also accurately measure the degree

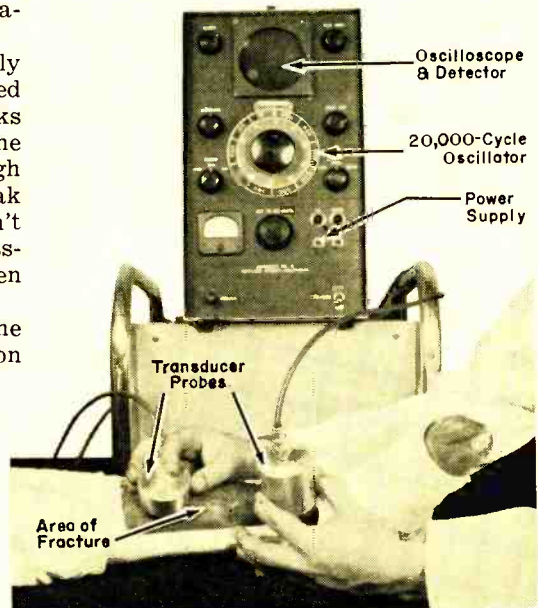

The soniscope in action—checking the healing of a broken leg. Ultrasonic sound waves pass between two transducer probes; the speed of the waves is displayed on an oscilloscope.

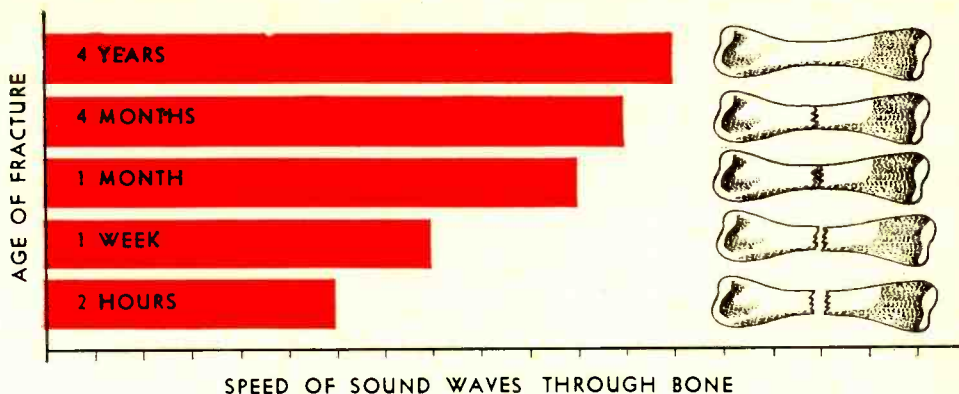

Sound waves are slowed down by a bone fracture. Doctors compare the speed of the waves in a broken leg or arm with their speed in an unbroken leg or arm of the same patient. As healing progresses, the speed increases. By eliminating the need for many X-ray checks on bone knitting, sonic "snooping" also eliminates the danger of radiation exposure.

to which the bone had knitted—more accurately than ordinary X rays and without exposing the patient to the dangers of radiation.

In practice, the sonoscope is used in the following manner. Suppose you fall off a stepladder and injure your arm. You're rushed to the doctor's office. Unless he is absolutely certain the arm is broken, the doctor takes two metal probe-like transducers and lightly touches them to your arm, one on either side of the suspected fracture. Ultrasonic sound waves pass harmlessly through your arm—you can't hear them or feel anything but the pain in your injured arm.

Eying an oscilloscope, the doctor takes a reading. Then he touches the probes to your other arm and takes another reading. Instantly, he knows whether the injured arm is broken, cracked, or simply bruised.

If neither arm is broken, the sound waves will take an equal time to travel an equal distance through the bone in each arm. But when a bone in one arm is broken, the sound waves will be

slowed down considerably at the point of fracture. Cracked bones also slow down the sound waves but not as much as fractures do.

Say that your arm is broken. The doctor may have one X ray taken just to make sure there aren't any complications. If it's a clean break, he will then proceed to set the bone in the ordinary manner.

Later, while putting on the cast, he will leave two small holes in the cast on either side of the fracture. During your subsequent visits, he will insert the probes in these holes, switch on the sonoscope and take a reading. By comparing the newer readings against previous ones, he can tell exactly how well your bone is healing and when the cast should come off.

Thus, it will no longer be necessary to go through the time-consuming and possibly harmful series of X rays usually taken to make sure the bone is knitting properly. And the expense involved will probably be a great deal less since the cost of all those X rays will be eliminated. -30-

Editor's Note: Doctors are also making use of ultrasonography—another field of medical sonar and "radar." Unlike the sonoscope, which measures travel time of sound waves, an instrument called the

"ultrasonoscope" listens for returning echoes. This method is being investigated by the GPL Division of General Precision, Inc., for the accurate diagnosis of eye ailments.

TAPE DECKS FOR STEREO

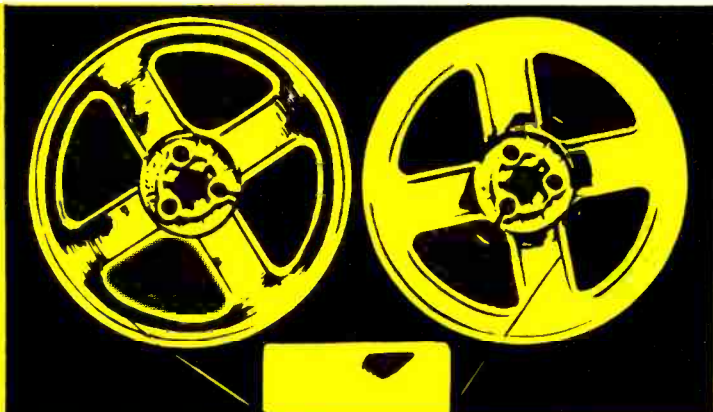

Hints on adding a 4-track stereo tape deck to your hi-fi system

By **RICHARD A. FLANAGAN**

Associate Editor

ALTHOUGH most music enthusiasts have marveled at the outstanding realism and fidelity of modern 4-track stereo tapes, many never seem to get around to playing anything but discs. Yet the majority of preamplifiers have equalized inputs for tape heads, and the number of prerecorded 4-track tapes is growing by leaps and bounds.*

One of the simplest ways to add tape to your stereo system lies in the 4-track stereo tape decks now produced by a number of manufacturers. Priced as low as \$74.95, some of these decks are intended for playback only and therefore have but one set of tape heads—one for each stereo channel.

Others, by including erase and record/playback heads, have all the mechanics of a recorder. Not only can they be used for playback, but it's a simple matter to add a suitable erase and record preamp at some later date.

Hooking up a tape deck is a ridiculously simple procedure whether your present preamp is equipped for tape or

whether you purchase one of the inexpensive accessory preamps made especially for the purpose (see photo of Sony deck on page 50). Even so, connecting leads should be as short as possible.

The thing to keep in mind is that the output level from a tape head is measured in millivolts. For this reason, any hum or noise introduced in the connecting leads will be amplified hundreds of times and may give rise to unpleasant listening. Ground loops, too—the result of grounding a lead at more than one point—may cause trouble. But a little experimenting with short, direct leads should clear up any difficulties.

Since a tape deck consists essentially of a motor, heads, and mounting board, it should be clear that the quality of these components as well as the number of operating features will be a major factor in the price you pay.

For example, the sound of your tapes will be governed to a large extent by the constancy with which the deck's motor moves your tapes past its heads. The better the motor and capstan assembly, the more uniform the speed.

Noteworthy features of some popular tape decks are illustrated on the following three pages.

*A good way to start your tape library is through United Stereo Tapes' "Sampler Series." Four different tapes, priced at \$3.95 each, cover the four major fields of music—popular, classical, jazz, and "sound sensations." Ten different selections appear on each "Sampler" tape.

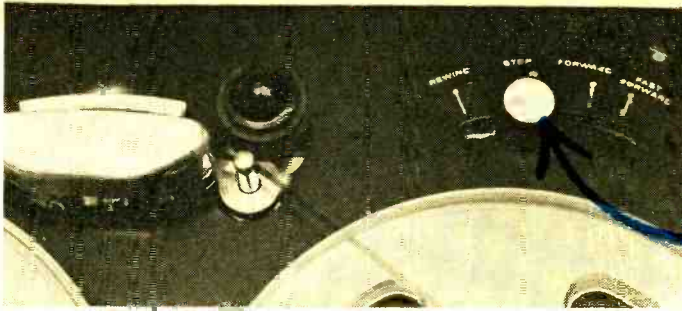

Single knob selects play, rewind, and fast-forward functions on Heathkit AD-70

Speed can be changed at the flick of a knob on Sony 262-D

Play, stop, and rewind control are at your fingertips

Fast-forward lever operates only in play position

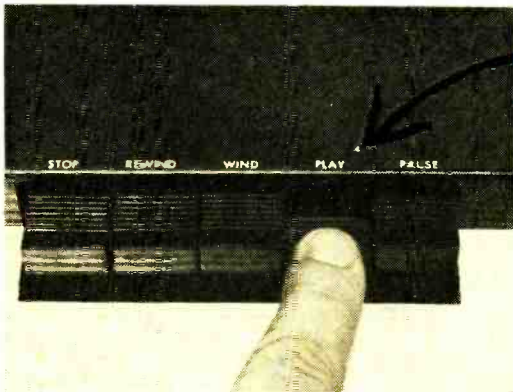
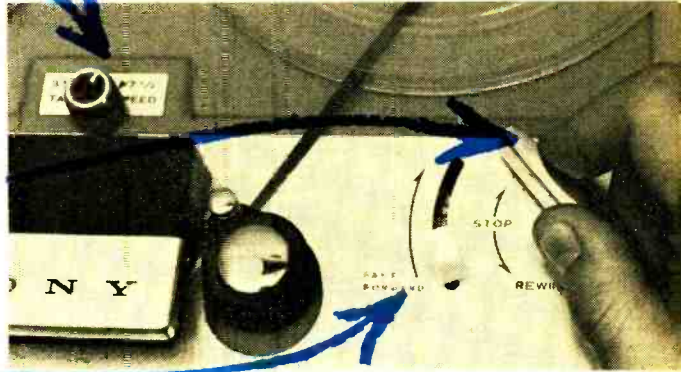

Push buttons on Telectro 900-4 provide for simple operation

Counter is handy for gauging tape playing time

Speed and standby levers are included on Knight KN-4000 control panel

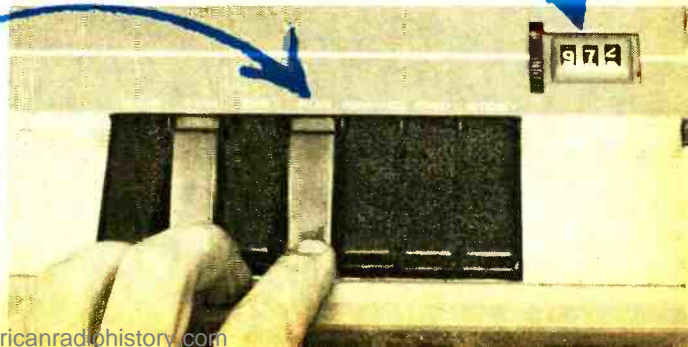

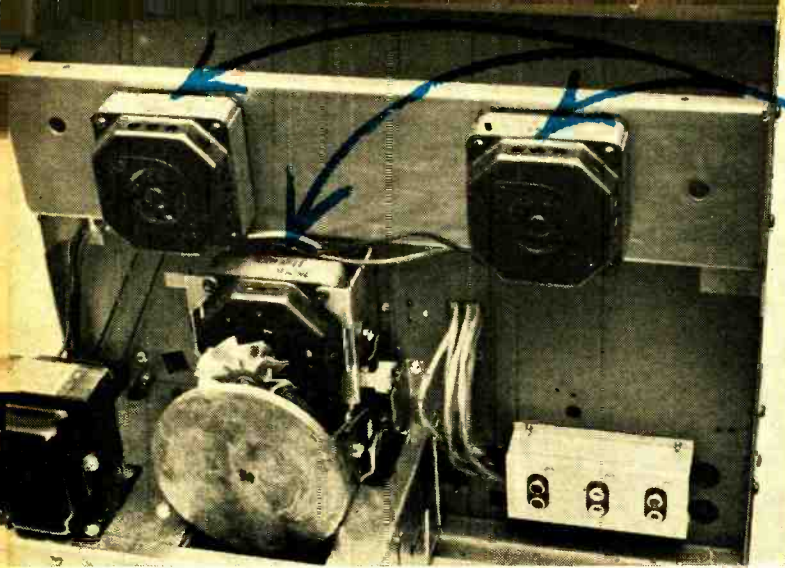

Individual take-up, feeds, and capstan motors on Knight KN-4000 offer smooth performance of professional machines

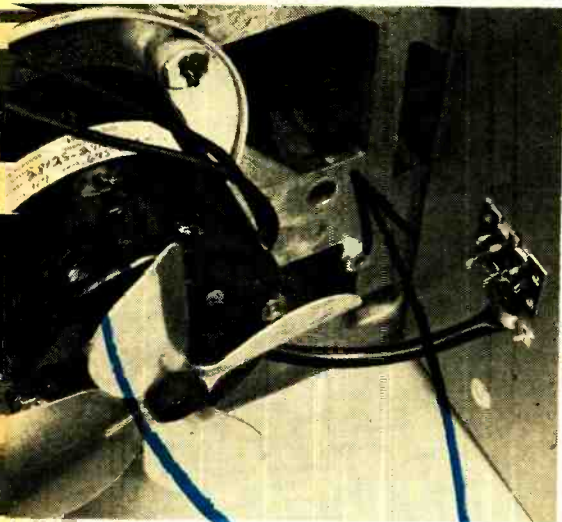

Single high-quality motor powers Ampex 934

Die-cast chassis provides secure base

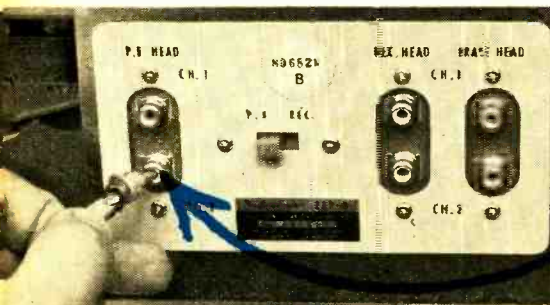

Hooking up is a simple matter with most decks - on the Sony 262-D, jacks are located on a convenient plate with a switch to select record or playback functions

WHERE TO GET THEM

Ampex—Ampex Audio Company, Sunnyvale, Calif. (Model 934, \$199.50)

Bell—Bell Sound Div., Thompson-Ramo-Wooldridge, Inc., 555 Marion Rd., Columbus, Ohio (Model T-321, \$159.95)

Heath—Heath Company, Benton Harbor, Mich. (Model AD-70, \$74.95)

Knight—Allied Radio Corp., 100 N. Western Blvd., Chicago 80, Ill. (Model KN-4000, \$134.50)

Sony—Superscope, Inc., Dept. F, Sun Valley, Calif. (Model 262-D, \$89.50)

Telectro—Telectrosonic Corp., 35-18 37th St., Long Island City 1, N. Y. (Model 900-4, \$89.95)

Bonus features on
Ampex 934 include
speed-change
knob, quarter-track/
half-track head
elevator, and
automatic shut-off
switch

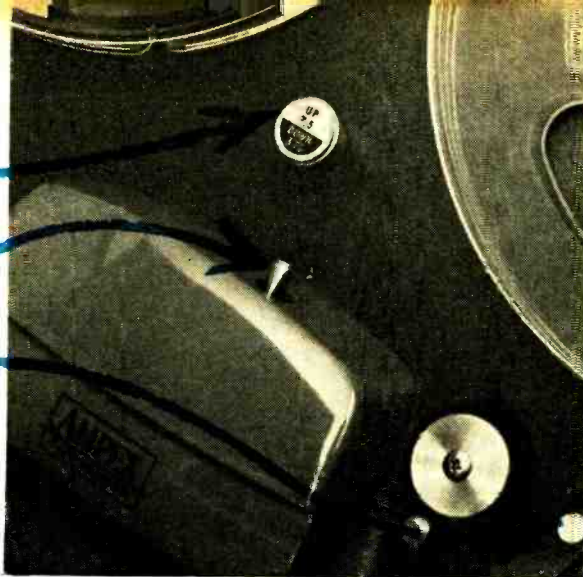

Screwdriver adjusts
take-up tension on
Heathkit AD-70

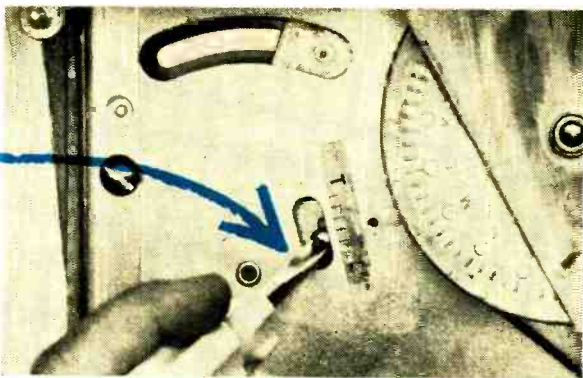

Knob selects 3-3/4
or 7 1/2 ips speeds on
Telectro 900-4

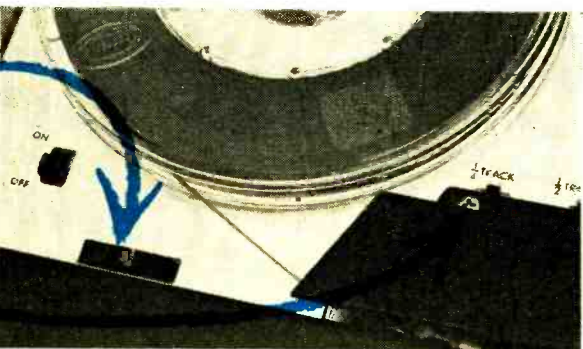

Lever shifts heads
for quarter-track
or half-track
operation

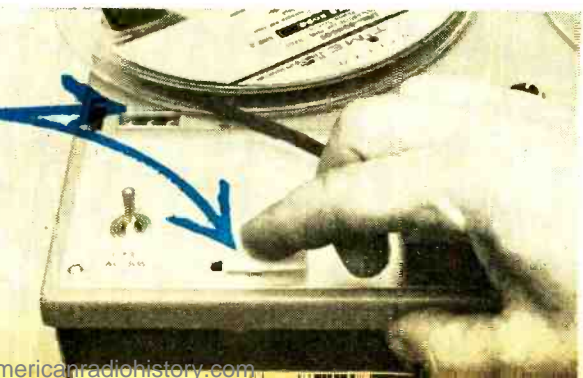

Tape counter and
instant-pause
switch make for
simple editing
with Sony 262-D

3

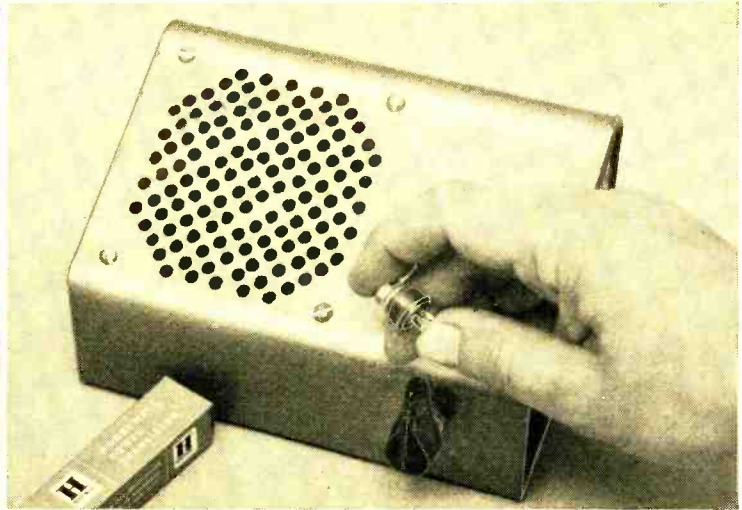

WAY INTERCOM

By JULIAN M. SIENKIEWICZ

Managing Editor

Unique circuit uses two 2N1502 power transistors for instant communication at the flip of a switch

Detail 1. Location and sizes of chassis holes. Check hole centers against parts for accuracy before drilling; be sure all holes are drilled before starting assembly of intercom unit.

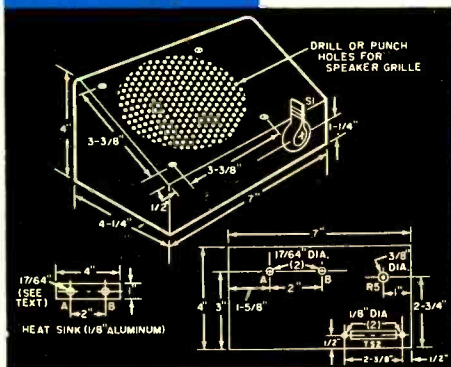

COMPACT and easy to build, the three-way intercom described here* has a number of outstanding design features. For one thing, it's battery-operated—which means that it can be used anywhere without the need for an a.c. line. For another, it's completely transistorized, and consumes no power until the "talk" switch is pressed.

Even more important, any one of the three stations in the system can "talk" to either of the other two. In addition, each station is identical, and each has its own amplifier to amplify your voice and pass it on to the desired station. This way, even though the other two stations are "off," you will still be able to get your call through.

Construction. Assembling and wiring the intercom should present no problems either to the advanced experimenter or to the beginner. However, to avoid any possible trouble, even the experienced

*Designed by engineers of the Minneapolis-Honeywell Regulator Company, Semiconductor Products, 2747 Fourth Ave. South, Minneapolis 8, Minn.

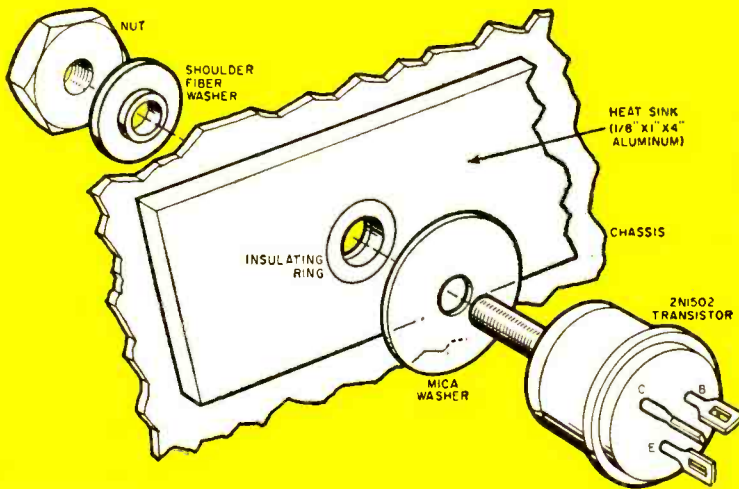

Detail 2. Transistor mounting technique uses heat sink to radiate transistor heat yet electrically isolates transistor from chassis.

Detail 3. Prewiring "talk" switch *S1* greatly simplifies wiring and reduces construction time. Check wiring carefully when completed.

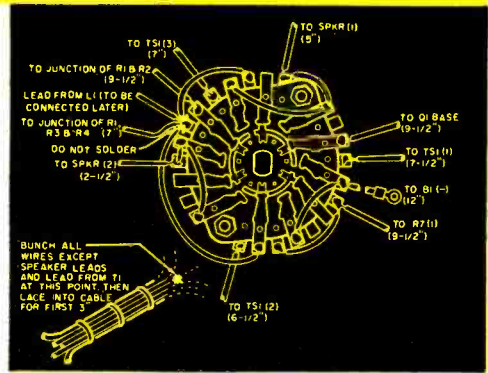

builder should follow the detail drawings carefully, as well as the construction procedure outlined below. Since the three units are identical, all of the drawings show details for one station only.

The first step is to drill the chassis—Detail 1 gives the location and the sizes of the holes. Before drilling, be sure that the parts you have purchased will mate correctly with the planned holes. The only critically located holes are those marked *A* and *B* on the back surface of the chassis and the mating holes in the heat sink as shown in Detail 1; when the heat sink is mounted, its holes must line up with holes *A* and *B* on the rear panel.

The first components to be mounted are power transistors *Q1* and *Q2*. It is important that neither the studs on the transistors nor the transistor cases touch the metal heat sink or chassis. To prevent this, the holes in the heat sink should be enlarged so that small insulating rings can be cemented in place to line them—the rings can be fabricated from phenolic tubing or stiff spaghetti.

(See Detail 2.) A mica washer, shoulder fiber-washer, and nut come with each 2N1502 transistor.

Mount both transistors as shown in Detail 2 and turn the nut one-quarter-turn after it is finger-tight. If you did the job right, an ohmmeter across the mounting nut and the heat sink or chassis will indicate an open circuit. If the ohmmeter indicates a short circuit or some finite resistance, don't go any further until you locate the trouble.

The "talk" switch, *S1*, should be wired as shown in Detail 3. Before you start, be sure the notch on the shaft of the switch faces to the right when the back of the switch is towards you. Use different colored wires so they can be identified easily after they are cabled together. Make all the connections necessary, then bring the leads around the edge of the switch and bunch them together at one point as indicated in Detail 3. Lace the

bunched wires for a distance of three inches and tie off the lacing cord tight.

Switch *S1* can now be mounted to the front panel of the chassis—refer to Detail 1. Use a lock washer and nut to secure the switch in place loosely, and observe where the notch on the shaft is located. Rotate the switch until the notch points to the right side of the front panel, then tighten the mounting nut.

Next, mount *L1* (the filament transformer used as a choke) on the speaker bracket; then mount the speaker in the chassis. Also mount potentiometer *R5* and terminal strip *TS1*.

Detail 4 is the complete pictorial diagram for one station. As you wire it, constantly recheck your work; it will pay in the long run, since the wiring is quite dense. When the unit is completed, a final wiring check should be made. If you use different colored wires throughout, checking will be comparatively easy. And you'll have a neater-looking unit if you take time to lace wires which group together.

Finally, secure battery *B1* to the bottom plate. Using masking tape, fix the battery to the bottom plate and fit the chassis together. If the battery does not butt against anything, mark its position on the bottom plate and install an

aluminum strap bracket to hold it in place. If the battery butts against one or more parts, loosen the masking tape and try a new position.

Installation. A three-wire twisted cable is all that is needed to connect the three stations to each other. See interconnection diagram on page 116. Although shielding isn't necessary, you can use three-wire shielded mike cable if you happen to have some on hand—it will reduce hum picked up from the a.c. line. After the three wires are connected to *TS1* on each unit, wire the shields of the two cables together and ground to a water pipe. Then, at each station, connect the shield to terminal 4 of *TS1*.

To operate the intercom, throw switch *S1* to the left or right, depending on which station you want to contact. Release the switch at the end of your message and wait for a reply. The spring-loaded talk switch always returns to the "listen" or "off" position when not held down. In the event you wish to monitor the children's bedroom, for example, the spring can be removed from *S1* and the switch set to "talk"—the switch has a "detent" which will hold it in position when the spring is removed. To obtain the desired volume, simply adjust potentiometer *R5*.

(Continued on page 116)

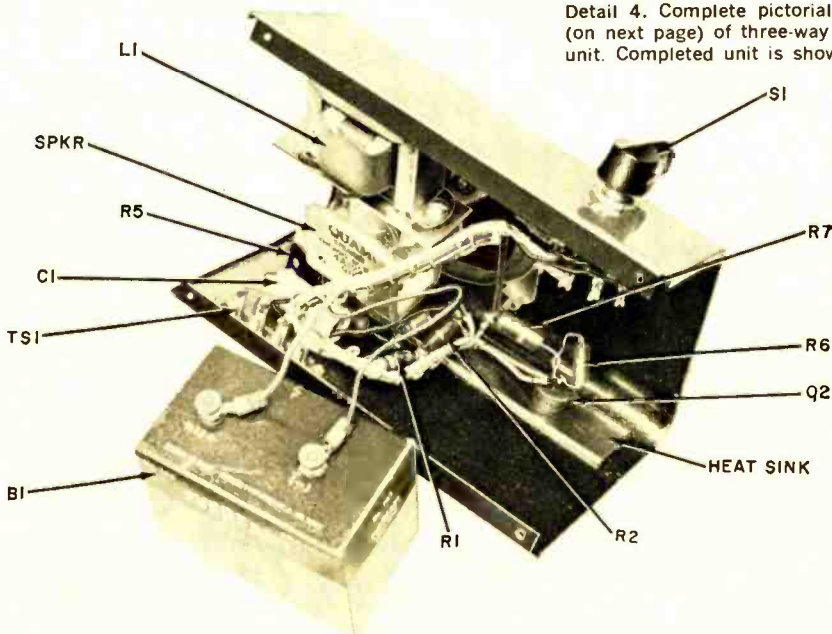

Detail 4. Complete pictorial diagram (on next page) of three-way intercom unit. Completed unit is shown below.

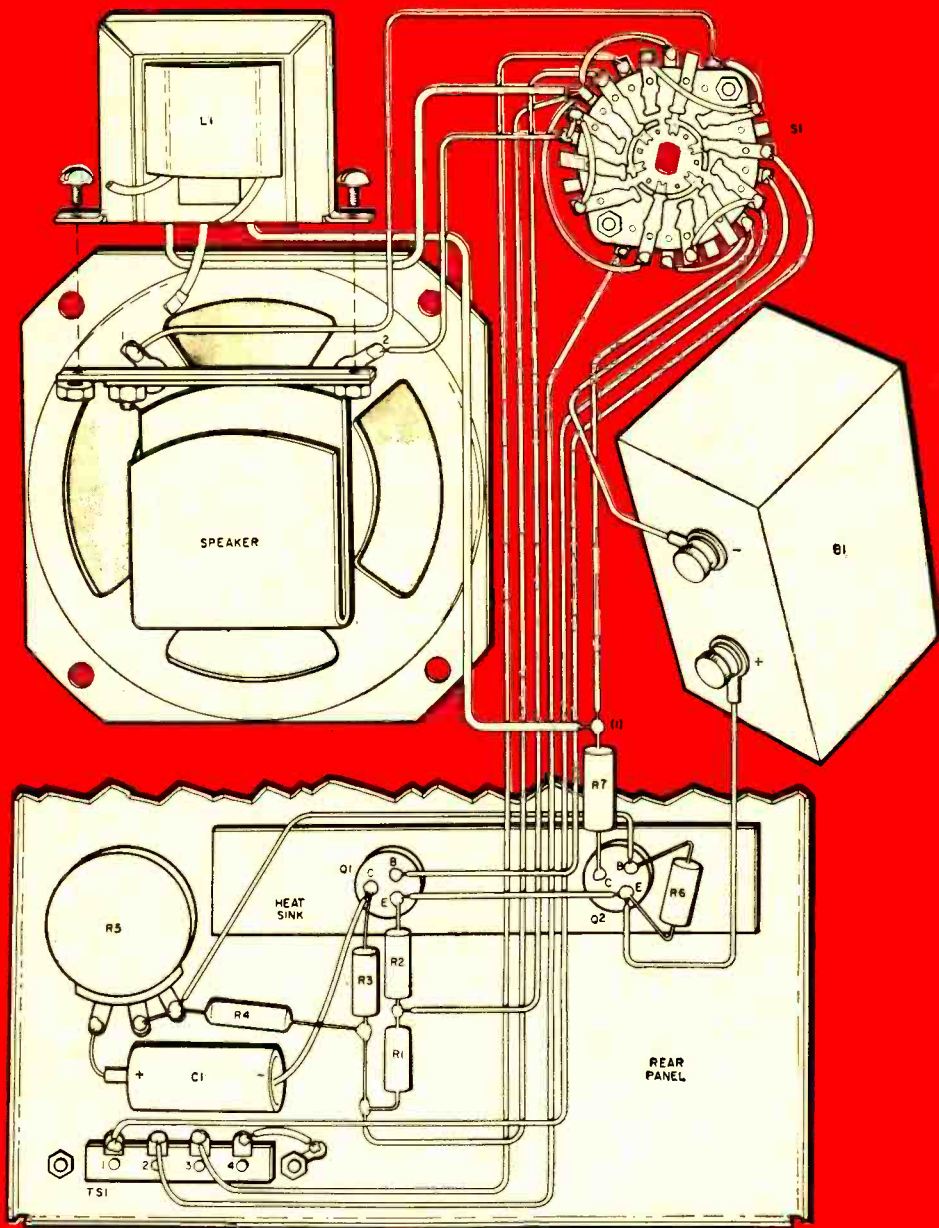

PARTS LIST FOR ONE STATION

- B1*—22.5-volt battery (Eveready #763 or equivalent)
- C1*—10 μ l., 25-volt d.c. electrolytic capacitor
- L1*—Filament transformer used as choke; primary, 117 volts (not used), secondary 6.3 volts @ 1.3 amperes (Stanco P-6134 or equivalent)
- Q1, Q2*—2N1502 power transistor (supplied with mounting hardware by Minneapolis-Honeywell)
- R1*—15,000-ohm, $\frac{1}{2}$ -watt resistor
- R2, R6*—100-ohm, $\frac{1}{2}$ -watt resistor

- R3*—470-ohm, $\frac{1}{2}$ -watt resistor
- R4*—6800-ohm, $\frac{1}{2}$ -watt resistor
- R5*—10,000-ohm potentiometer, linear-taper
- R7*—10-ohm, 1-watt resistor
- S1*—3-position, 6-pole spring-return switch (Centralab #1448)
- TS1*—4-lug, screw-type terminal strip
- SPKR*—4" PM speaker, 45-ohm voice coil (Quam #4A1Z45 or equivalent)
- 1—7" x 4" x $\frac{1}{2}$ " aluminum universal sloping-panel cabinet (Bud AC-1613 or equivalent)

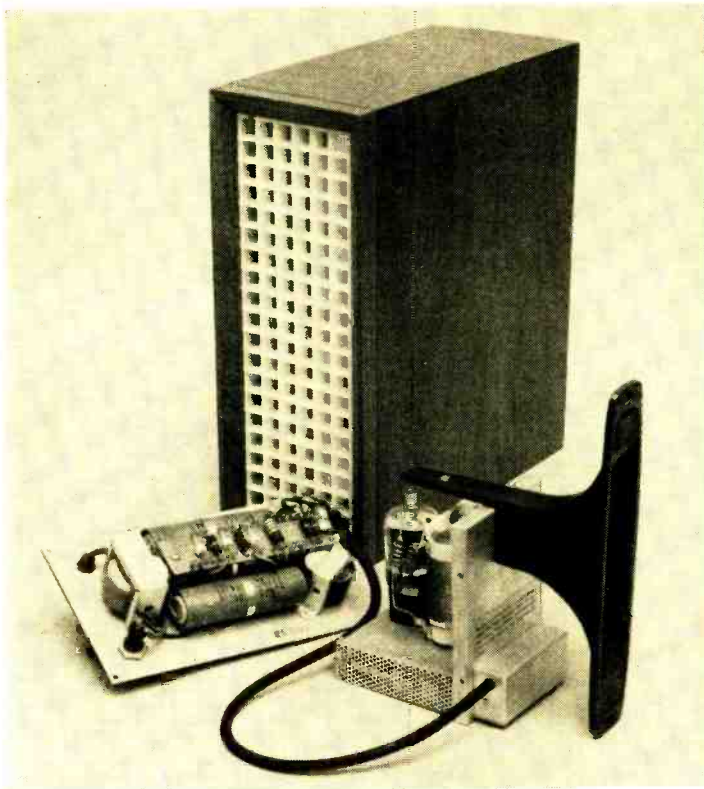

Introducing the **I**ONOVAC

**Revolutionary speaker
employing no moving parts
generates sound on
a tiny cloud of ionized air**

ASIDE FROM the sound it produces—or, more correctly, *reproduces*—a speaker is a pretty uninteresting performer. More like a bowl of mush than a “snap, crackle, and pop” breakfast cereal, a speaker has none of the hand-warming capabilities of the transformer, none of the comforting glow of the vacuum tube. Like the transistor, the speaker is a comparatively cold and colorless component—all speakers, that is, save one.

The exception is the “Ionovac.” Although this speaker is unique in a number of important ways, one of its characteristics strikes home above all others—the purple cloud of ionized air which glows within the very heart of its sound-producing element. Far from being flat in its eye-appeal, the Ionovac

Cell replacement in Ionovac takes only a few minutes. To simplify procedure, manufacturer has placed quartz cell in a ceramic support bar that is spring-loaded.

Ionized air within quartz cell is only sound generator in Ionovac. Exponential horn amplifies audio component of modulated r.f. signal supplied to quartz cell.

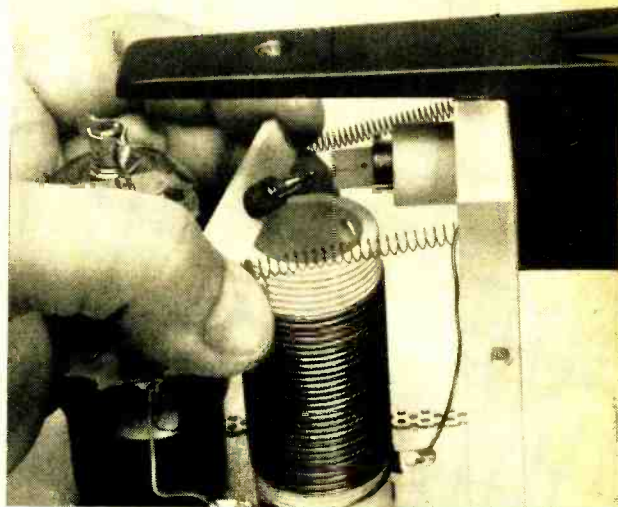
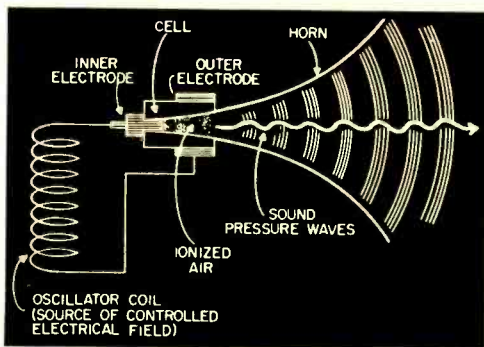

glows and signals anyone nearby that it is ready to reproduce sound. As you've probably guessed, however, this glow isn't present for decorative purposes. Instead, it is the key to the operation of a new type of speaker, as we'll see shortly.

The development of the Ionovac actually stems from a decades-long quest for undistorted reproduced sound. Operating on quite different principles from the familiar cone-type unit, the Ionovac is a speaker—more properly described as a transducer—with negligible mass and inertia. In other words, it is one of the few speakers that doesn't vibrate a diaphragm or plate back and forth to produce sound.

Cone-Type Structure. Before taking a closer look at what goes on inside the Ionovac, let's review some of the basics underlying the operation of the popular cone-type speaker. Produced in sizes all the way from tiny 2-incher's to hefty 30-incher's, all cone-type speakers employ a magnet as an integral part of their structure. The magnet is attached securely to the speaker frame and is therefore held rigidly in place. The speaker cone is also attached to the frame, but only at its outer edge.

Wound in circular fashion around the center of the cone are a few turns of wire—the "voice coil" or "speech coil,"

as it is also sometimes called. Feeding an alternating voltage into the voice coil causes the coil to swing alternately plus and minus at the frequency of the incoming signal.

Since the voice coil is located very near the magnet—it actually surrounds the magnet in most speakers—such variations in polarity will cause the voice coil to be alternately attracted and repelled by the magnet. And with the voice coil actually part of the cone structure, its movement causes the cone to move, too.

Wasted Energy. But a little reflection will tell us that there are problems with cone-type speakers which can never be fully overcome. For one thing, no matter how feather-light and paper-thin the diaphragm, it still has a certain degree of inertia, which means that energy must be wasted to move the cone at all.

At the higher frequencies, the effect of inertia can be particularly disastrous. The situation may eventually reach a point where more of the comparatively delicate high frequencies are being used to put the speaker in motion than to produce sound!

It was such problems as these that led to the Ionovac. Patented by a Frenchman, Siegfried Klein, in the early 1950's, the Ionovac actually succeeds in doing

(Continued on page 117)



GETTING PEAK CB PERFORMANCE

By DICK STRIPPEL, 2W1452

How and why of power and field strength meters

NOW THAT the FCC permits non-technically-licensed persons to adjust the *output* circuits of *multi-stage* Citizens Band transmitters, you hear a lot of talk about field strength meters, r.f. power meters, dummy loads, and so forth. To get the most range out of your CB rig, you must get the most out of your antenna, and these things all play a vital role in obtaining this goal.

It's all a question of efficiency. While CB transmitters are rated in terms of power *input* (five watts maximum), their output is quite a bit less than that. At best, the design maximum efficiency of the final amplifier of any transmitter is 75%. Thus, the absolute maximum possible *output* of a CB transmitter is a little more than 3½ watts.

Coil heating, from current passing through it, poor mechanical connections and losses in the coaxial cable feeding the transmitter can eat up a watt or so more. Improper match between the

transmitter, coax, and antenna can also be responsible for a loss of more than 50% of the remaining output. It is in this area where field strength meters, dummy loads, and r.f. power meters play their parts.

The *Field Strength Meter* is a relatively simple device which picks up a small amount of the actual signal radiated by the antenna, rectifies it with a crystal diode, and applies the resultant d.c. to a sensitive meter. By making transmitter and other adjustments for a maximum field strength meter reading, the user can determine when the maximum possible power is being transferred to the antenna.

A *Dummy Load* is simply a well-shielded resistance which simulates the characteristics of the antenna and coaxial transmission line.

The *Power Output Meter* is a device connected to the output of your CB transmitter. A small part of the signal



CESCO Transicheck measures output power in watts, and may be used to check on feed line efficiency.

across the built-in dummy load is rectified and fed to a calibrated meter. Accuracy of reading depends upon the dummy load, but for all general purposes both the CESCO and Philmore meters mentioned in the accompanying table are within ± 0.1 watt output.

Initial Matching. You may wonder why a field strength meter and a dummy load are necessary if you follow many manufacturers' instructions to tune your transmitter first for maximum glow in a pilot light bulb attached to the antenna fitting, and then merely substitute the antenna.

While the bulb is a simple means of showing when the transmitter is putting out maximum signal, the bulb's actual ohmic resistance varies with current flowing through it and may be anywhere from a few ohms to more than 100 ohms. This variable resistance will

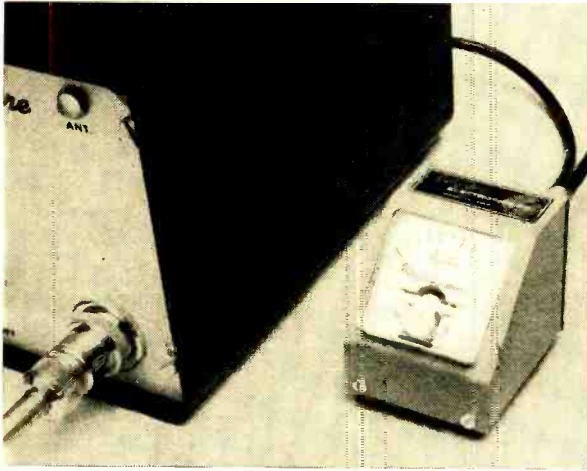

Rutherford M-100 reads output power in watts. It may be left in the feed line as a speech monitor.

not offer a good "match" to the transmitter which is designed to operate into a stated, unvarying, resistive load—in almost every case, it will be either 52 or 75 ohms.

To load a CB transmitter properly, we must have an "initial match," with the transmitter output, coaxial cable, and antenna each representing the same nominal value of impedance.

Most transmitters using a fixed output "link" of several turns of hookup wire around one end of the final amplifier tank coil will not accurately match either a 52- or 75-ohm load—dummy or antenna. A simple modification which will give excellent results is to disconnect the ground lead from this link and substitute a mica compression trimmer for the direct connection. A trimmer with a maximum value of about 250 $\mu\text{f.}$ will be about right. To tune up the transmitter with this trimmer added, alternately adjust it and make the usual

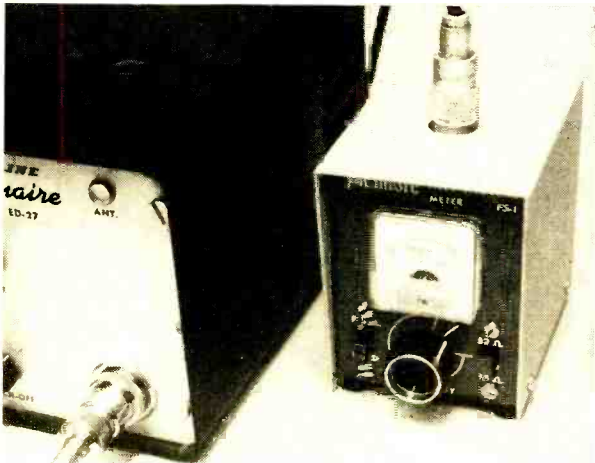

Philmore FS-1 is a combination power output meter (reading in watts) and a sensitive field strength meter.

output tank adjustment for maximum signal.

Tuning the Transmitter. With the dummy load attached to the transmitter's output fitting, place the field strength meter near it. Make the necessary output adjustments (follow the manufacturer's instructions) for maximum field strength reading. If you have a dummy load which incorporates a meter, make adjustments for maximum reading of this meter.

Insert a milliammeter in the final amplifier circuit and note the value of current. (This procedure is discussed in the manufacturer's instructions to make certain power input is within legal limits.) Now remove the dummy load and substitute the antenna.

If the meter reading changes (gen-



Globe output meter serves as monitor and modulation check. It is left in transmission line at all times.

SPECIALIZED TEST EQUIPMENT FOR THE CITIZENS BAND

Company	Model No.	Price	Comments
Continental Electronics & Sound Co. (CESCO) 6151 Dayton Liberty Rd. Dayton 18, Ohio	Transicheck CB-52-C	\$19.95	Accurate reading of power output across 100-ohm load. May be used to adjust antenna loading and as a field strength meter (if close-coupled).
Crown Elec. Prods. Co. P. O. Box 171 Orange, N. J.	TS	\$16.95	Reads approximate power output across 50-ohm dummy load. Model LS is similar but may be left in feed line as an output and modulation monitor.
Globe Electronics 22-30 South 34th St. Council Bluffs, Iowa	Tenna-Meter TM-1	\$15.95	Relative power output indicator at 52 ohms. May be left permanently in feed line. Consumes no power. May be used with ham transmitters to 300 watts output.
Heath Company Benton Harbor, Mich.	PM-2	\$12.95 (kit)	Miniature field strength meter. Untuned. Good sensitivity. Has magnetic base for dashboard mounting.
Lafayette Radio 165-08 Liberty Ave. Jamaica 33, N. Y.	TM-16	\$14.95	Remote-reading field strength meter. Most sensitive of group tested due to built-in transistor amplifier. Tunable to ham bands.
Philmore Mfg. Co. 130-01 Jamaica Ave. Richmond Hill 18, N. Y.	FS-1	\$17.50 (kit) \$26.25 (wired)	Combination field strength and power output meter. May be switched to either 52- or 75-ohm load. Reads fairly accurate power output. Field strength sensitivity is fair to good.
Radio Shack 730 Commonwealth Ave. Boston 17, Mass.	H94LX556	\$ 6.95	Miniature field strength meter. Fair sensitivity. Untuned. Has magnetic base for dashboard mounting. Has phone jack.
Rutherford Electronics Co. 8944 Lindblade St. Culver City, Calif.	M-100	\$24.50	Reads relative power output across 50-ohm load. Consumes no power and may be left in feed line. Manufacturer suggests use of 50-ohm termination (T-101) for tune-up purposes.
Seco Mfg. Co. 5015 S. Penn Ave. Minneapolis 19, Minn.	CRYSTAL-alignMETER 500	\$29.95	Multiple-purpose tune-up and test instrument. Has built-in pickup loop for close coupling to antenna base. Also has 15-foot accessory cable for remote connection to antenna. Reads approximate relative power output.



Lafayette field strength meter has built-in single-transistor amplifier. Right-hand control broadly tunes the input circuit.



Heathkit and Radio Shack field strength meters have magnets in underside of case to hold meter to automobile steel dashboards.

SECO CRYSTAL alignMETER can be used for a variety of duties. In this photo, remote connecting cables to antenna are shown.

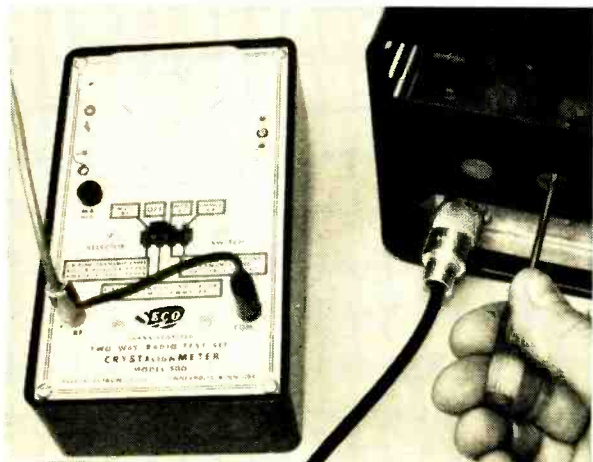

erally downward), it indicates that the antenna does not have the proper value of impedance. This stands to reason because the dummy load represents the theoretical antenna impedance. If we tune the transmitter to it, and if the cable is of the proper value, the only thing which could be wrong is the antenna. The coaxial cable transmission line *length* is of no consequence for matching—it could be hundreds of feet long and if the dummy load were connected at its far end, the meter reading would be the same as with the dummy load at the transmitter.*

“But I purchased the proper antenna,” you might say. “How could it be wrong?” In a great many cases, the difference won’t be too great, but nearby trees, buildings and large masses of metals, even under the antenna, could change its characteristics materially. Fortunately, there are several simple ways we can change the impedance of the antenna. The field strength meter will tell us when the optimum point is reached.

If there is a change in the input current to the final amplifier when the antenna is substituted for the dummy load, we know a mismatch exists. However, we do not know whether the antenna should be “lengthened,” “shortened,” or other characteristics changed to obtain a match. We must try each method for best results.

After you have adjusted your transmitter for maximum output to the dummy load, *make no further adjustments to your transmitter*. Set up your field strength meter at a convenient place about 10 to 20 feet from your antenna, preferably at or near the same height as the antenna’s base. Note its reading when tuned for maximum indication and do not move it during the following adjustments.

(Continued on page 118)

*So that there will be no misunderstanding of this point, the length of the transmission line does have an effect on power output—since there must be “transmission power losses” in the coaxial cable. Obviously, coaxial transmission lines should be as short as possible.—Editor.

When stereo threatened obsolescence for some of the greatest recordings of the century, a musician who is also an engineer went to work to save them. The result is that you can now hear . . .

NBC



TOSCANINI **in**

FEW MUSIC LOVERS would deny that Arturo Toscanini was one of the two or three great conductors of all time. During the decades before his death—in 1957—Toscanini was famed both in the concert hall and on records. As he grew older, his concert performances were more and more infrequent, but his discs became the highly prized possessions of a host of admirers. No one, it seemed, could quite equal the “Maestro.”

With the advent of stereo, however, Toscanini's recordings appeared doomed for the dustbin. The Maestro was dead, all his recordings were monaural, and record buyers were far more interested in “What's the latest?” than “What's the best?”

It was at this point that George R. Marek, vice-president and general manager of the RCA Victor Records Division, determined that something had to be done—and quickly—if the art of the famed Arturo Toscanini were to survive in the age of stereo. Without prompt action, it seemed, Toscanini might soon become little more than simply another

legendary “great name” of the past.

Looking over the Toscanini legacy of tapes, Marek decided that some of the more recent recordings might be salvable—if they could be “reprocessed” in stereo. Marek assigned Jack Somer—a musician *and* an engineer—to delve into the matter and determine experimentally just what could be done and—more important—how.

In all, Somer spent 2½ years developing a system of “electronic stereo” for the Toscanini tapes and producing commercially releasable “masters.” The setup he used, ultimately, was a series of high- and low-pass filters interconnected with three reverberation units. Placing himself at his “re-recording console” with a full musical score in front of him, Somer played the original Toscanini tapes (recorded at 30 inches per second) and proceeded to re-record the sound.

What he has come up with is admittedly not stereo in its purest form—no one could ever make one microphone do the work of two—but Somer's electronic

Reprocessing of original Toscanini monophonic recordings by Jack Somer (below, right) of RCA was achieved by filters and reverb devices. Actual arrangement of instruments in orchestra (below, left) is key to understanding basis of Somer's technique: generally speaking, higher pitched instruments are grouped at the left, lower pitched instruments at the right.



STEREO

By **RICHARD A. FLANAGAN**
Associate Editor

stereo has given new life to the Toscanini interpretations. And with the help of Dick Gardner, one of Toscanini's engineers, Somer was even able to make some improvements over the old recordings. "Many of the instruments in the orchestra stand out with much greater clarity than before," he remarks.

The secret behind his technique lies in the placement of the various instruments in the orchestra itself. (Somer states that a "mental arrangement of the instruments of the orchestra" was all-important in his knob-twirling—one of the reasons that he, as an engineer and a musician, was so admirably suited to the job.) Since the higher pitched instruments—violins, for example—are generally located on the left, and the lower pitched instruments—tympani, basses, etc.—on the right, Somer was able to "divide" the orchestra electronically into two separate "channels."

After literally months of "cut and try," Somer eventually determined that he needed three separate signals on both "channels"—high-pass, low-pass, and

"straight." But the high-pass was predominant on the left channel, with frequencies above 200 to 1000 cycles emphasized. And on the right channel, the low-pass filter came into play, with heaviest emphasis below about 2000 cycles and with highs added above about 3000 to 5000 cycles.

To date, three Toscanini tapes have been "reprocessed"—Respighi's *Pines and Fountains of Rome*, Dvorak's *Symphony No. 5* ("From the New World"), and the Moussorgsky-Ravel *Pictures at an Exhibition*. While Somer admits that the resultant sound is best described as "early stereo," he also has this to say:

"No technical progress, great and satisfying as it may be to the ear, will prevent us from appreciating the fruits of years and lifetimes of loving work of music men who did not enjoy the advances of science while they lived." If he's right, Somer's "electronic stereoizing" of the original monophonic Toscanini recordings should do much to perpetuate the genius of one of the greatest conductors of all time. —30—

EXPLAINING TUNED CIRCUITS

ELECTRONICS
POPULAR
AFTER CLASS
feature

By SAUNDER HARRIS
WINXL

Coil and capacitor combinations lie behind every tuned circuit, and some do a better job than others. Here's the complete story of how they work and why

LARRY was busy listening to the chatter of the 40-meter band on Ken's receiver. An old hand on the air, Ken watched as his young friend delicately turned the bandspread dial.

"Smooth-operating gadget, isn't it, Larry?"

"You said it, Ken. Boy, the way this thing separates signals is amazing. Listening to 40 meters on *my* receiver is like trying to count the noodles while the soup is being stirred. With this one, not only can you count the noodles, but you can pick the particular noodle you want out of the soup at any time."

"You're always thinking about eating." Ken shook his head. "Well, Larry, you can thank the tuned circuits in this baby for separating signals. As a matter of fact, if it weren't for tuned circuits, you and I would be collecting stamps for a hobby instead of guiding electrons through wires. There wouldn't be any radio . . . or TV for that matter. Some horrible thought, eh?"

"Now that you've mentioned it, Ken, I've always wondered how receivers separate one frequency from another—especially two frequencies almost on top of each other." Larry flipped off the receiver and sat back. "Can you make with some explaining on the topic, friend?"

"Since you put it so nicely, I'll be glad to. As usual, we'll start off with some basic facts."

Ken took up paper and pencil as he said, "Tuned circuits in receivers are

combinations of inductance, capacitance, and resistance. These three elements are usually arranged in a two-leg parallel circuit, like this." He passed the drawing he had made over to Larry.

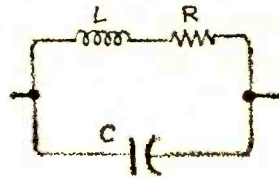

Larry studied the drawing for a moment. "So receiver tuned circuits are made up of coils, capacitors, and resistors?"

"Not exactly, Larry. Actually," Ken explained, "the resistance is not deliberately added. It pops up in the circuit because the wire making up the coil, *L*, and the connecting leads and solder joints all insert some resistance into the tuned circuit. We try to avoid unintentional resistance by keeping leads short and making good solder connections."

"I'm with you so far, but I still don't see how receiver tuned circuits work. What happens when I turn the tuning knob of a receiver?"

"Let's not get ahead of ourselves, Larry." Ken paused a moment. "Now, one of the things that makes a tuned circuit possible is the fact that both a coil and a capacitor oppose the flow of alternating current through them. This

opposition to current flow can be considered as resistance, but in a.c. circuits it's called reactance.

"As you increase the frequency of an alternating current passing through a capacitor, it becomes easier for that current to get through—in other words, the capacitive reactance decreases. For the coil, however, the higher the frequency, the rougher it is for the current to get through—the inductive reactance increases as the frequency rises."

Ken paused again to see if everything he had said so far was understood. At a nod from Larry, he went on.

"The second thing that makes tuned circuits possible is that, unlike pure resistance, both capacitive and inductive reactances have directional properties. Take a look at that parallel-tuned circuit I showed you and imagine an alternating current flowing through it.

"Each element in the circuit will have a current flowing through it, the amount of current depending on the reactance of the circuit component. The thing to keep in mind, though, is that the current through the coil will always be opposite in 'polarity' to the current through the capacitor . . ."

AT this point, Larry yelled, "Whoa up! I'm beginning to get lost!"

"Relax, the hard part's over now." Ken took a ruler from the workbench and handed it to Larry. "Here, let's see you balance this on your finger."

Larry took it, looking puzzled. "What has balancing a ruler got to do with tuned circuits?" He shrugged, "Okay, so I've got it balanced. What happens now?"

"A tuned circuit is very similar to the situation you have with the ruler balanced on your finger. Can you imagine how you might get a similar electrical balance in this parallel-tuned circuit?"

Larry frowned; then a big grin suddenly appeared on his face. "Wait a minute! Suppose I put a voltage of a certain frequency across the circuit. Let's say that at that frequency the capacitive reactance is greater than the inductive reactance . . ."

Ken nodded encouragingly.

"As I raise the frequency, the capacitive reactance gets smaller and the inductive reactance gets larger . . ."

"Right, Larry! Go on."

"If I keep raising the frequency, I'll eventually reach a point where the capacitive reactance and the inductive reactance are equal. This part is easy, but what happens inside the parallel-tuned circuit when we have this electrical balance?"

"The frequency at which the capacitive and inductive reactances are equal is called the resonant frequency. To see what happens inside the parallel-tuned circuit at resonance, look at this diagram, Larry."

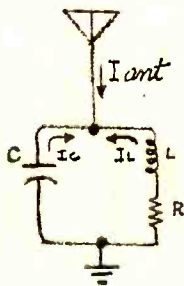

"Do you recall Kirchoff's law about currents that enter and leave any point in a circuit adding up to zero? Well, at resonance, since the inductive and capacitive reactances are equal, the currents in L and C are also equal but *opposite* in phase; so they add up to zero. Now, if I_L and I_C add up to zero at resonance, what is the value for I_{ant} ?"

Larry began to think aloud. "Let's see . . . the three currents have to add up to zero. That means I_C plus I_L plus I_{ant} equals zero. But at resonance, I_C and I_L add up to zero, so that leaves only I_{ant} to equal zero . . . hey, the current from the antenna is zero!"

"Right you are, Larry." Ken sounded pleased. "But let's put that mental solution of yours down on paper to be sure we have it cold."

$$\begin{aligned}
 I_C + I_L + I_{ant} &= 0 \\
 \text{but } I_C + I_L &= 0 \\
 \text{so } 0 + I_{ant} &= 0 \\
 \text{therefore } I_{ant} &= 0
 \end{aligned}$$

"Say, Ken," Larry asked, "if the antenna can't pass any current through the parallel-tuned circuit at the resonant

frequency, then the tuned circuit behaves exactly like an open circuit. Is that correct?"

"Sure thing—so far you're batting a thousand. Now let's draw the schematic diagram of a receiver front end, and come to some conclusions." In a moment the sketch was done.

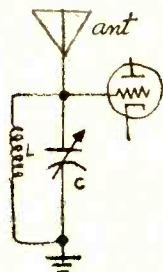

Ken continued with his explanation. "First off, let's see what happens at the resonant frequency. The tuned circuit behaves like a very high impedance or high-value grid resistor at this frequency, and very little of the signal picked up by the antenna passes to ground through the tuned circuit. Instead, the control grid of the vacuum-tube stage connected to the top of the tuned circuit sees nearly all of this signal and amplifies it.

"Other signals picked up by the antenna which are lower than the resonant frequency do not meet with this high impedance. They are bypassed to ground through the coil, L , which offers very little impedance. Hence, the control grid sees no signal developed across the tuned circuit. True, there is some signal, but it is probably smaller than the noise generated in the tube and will not be amplified. Signals higher than the resonant frequency are bypassed to ground because the capacitor, C , offers very little impedance, and again the control grid receives no useful signal."

"Fine, Ken, I think I'm beginning to understand. But I noticed that you made the capacitor in the diagram a variable job . . ."

"And with good reason," Ken shot back. "Think a moment. If we use fixed values for L and C , only one frequency will resonate across this circuit. And . . ."

Larry didn't let him finish, but broke in, saying, "Oh, I see! If we couldn't vary the C , we could only listen to one

frequency; and if no station were transmitting on this frequency, we wouldn't hear anything."

"Right again. So we use a variable capacitor and vary the value of C so we can pick out the frequency at which we want to resonate the tuned circuit. This way, we pick the station we want—not let the station find us."

"I get you," said Larry. "Now where do we go from here?"

"WELL, now that we've tackled tuned circuits in words, I'd like to show you how they work out in terms of equations for reactances and resonance. That's the best way to see what's going on."

Larry winced, and Ken laughed at the uncomfortable look on his young friend's face. "You might as well get the equations down for figuring resonant frequencies," he said. "They're handy to know, and you'll need them if you take the General Class ham exam. I guarantee they're easy to understand."

Ken did some writing, then pushed the paper over so Larry could read it.

$$\begin{aligned} \text{Inductive Reactance} &= 2\pi fL \\ \text{Capacitive Reactance} &= \frac{1}{2\pi fC} \end{aligned}$$

"I'll bet I can figure out how we find the resonant frequency for a tuned circuit from those two equations. This isn't bad after all," Larry admitted.

"Go to it, and good luck," said Ken.

"Well, I guess the f in the formulas stands for the frequency, the C for capacitance in farads, and the L for inductance in henrys."

"Okay. And . . .?"

"A few minutes ago you mentioned that at the resonant frequency the capacitive and the inductive reactances are equal. So, if we set each of the reactance formulas equal to each other, and do a little fancy algebra work, we should get one formula for the frequency, f , in terms of L and C ."

"Nice going, Larry—that's 100% correct." Ken was really pleased. "I'll save you some brainwork and show you how it works out." He took the scratch paper from Larry and wrote:

$$2\pi fL = \frac{1}{2\pi fC}$$

"Now I solve for f by simple algebra and come up with an equation worth remembering." Ken wrote down:

$$\text{Resonant Frequency } f = \frac{1}{2\pi\sqrt{LC}}$$

"In this equation, Larry, you must remember that the frequency comes out in cycles per second. The capacity must be expressed in farads and the inductance in henrys. You'll get all fouled up if you use the wrong units. π (π) is just your old friend from geometry, 3.14."

"Isn't there any formula in microfarads and microhenrys we can use, Ken? Changing all the units around could make an awful mess."

"I'm glad you asked that, Larry. There sure is. Here, let me write it out for you."

$$f = \frac{159}{\sqrt{LC}}$$

"This formula is real easy to use," said Ken, passing the paper to Larry. "The capacitance units you substitute for C are micromicrofarads ($\mu\mu\text{f.}$); the inductance units you substitute for L are expressed in microhenrys ($\mu\text{h.}$). These are the values you'll most likely use in practical work. Your answer then comes out in megacycles."

"It's all clear now," observed Larry, as he finished studying the equations.

"SAY, before we call it a night, Ken, would you do me a favor and explain what they mean by the Q of a tuned circuit?"

"I sure will; Q is an important part of any discussion of tuned circuits and we shouldn't forget to clear up any doubt as to what it means. Do you remember what you said about the sharp tuning of my receiver a while back?"

"Do I!" replied Larry. "It was terrific."

"It was the Q of the circuit that made it that way. But I cheated before, Larry," Ken admitted. "I drew the front

end of a receiver showing the tuned circuit without the resistance. Let's draw it again, and patch up our thinking. At the same time, you'll get a clear understanding of exactly what Q is." He began to sketch quickly.

"Before," Ken continued, "we said that at the resonant frequency the currents I_c and I_L added up to zero. This just

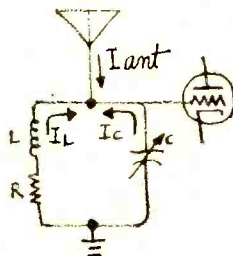

ain't so. The resistor, R , causes a phase shift in the coil leg of the tuned circuit. Since this resistance is small, the phase difference between the currents I_c and I_L is slightly less than 180 degrees, and summing up these two currents will not give us zero. A very small current will be left. Back to friend Kirchoff . . ."

Again Larry interrupted, "I get it! The sum of the currents entering and leaving any one point in a circuit must be zero—so since the sum of I_c and I_L is a very small current, a current of equal size but opposite phase must be supplied to the tuned circuit by the antenna."

"Atta boy, Larry," said Ken beaming. "Antenna current flows in spite of the fact that the circuit is at resonance. The tuned circuit, instead of being an open circuit, now exhibits some high resistance. This will always be the case since we can never get rid of the resistance in the coil or at soldered connections. But we can keep the resistance down to some low value where it won't bother us."

"Why?" Larry asked.

"The more resistance in the circuit, the less selective the circuit. That's why your receiver has trouble separating close stations and mine doesn't. Mine is more selective.

"We can say the same thing in a different way," Ken pointed out. "The more resistance in a tuned circuit, the lower its Q . The Q of a circuit is a numerical way of expressing the merit of
(Continued on page 125)

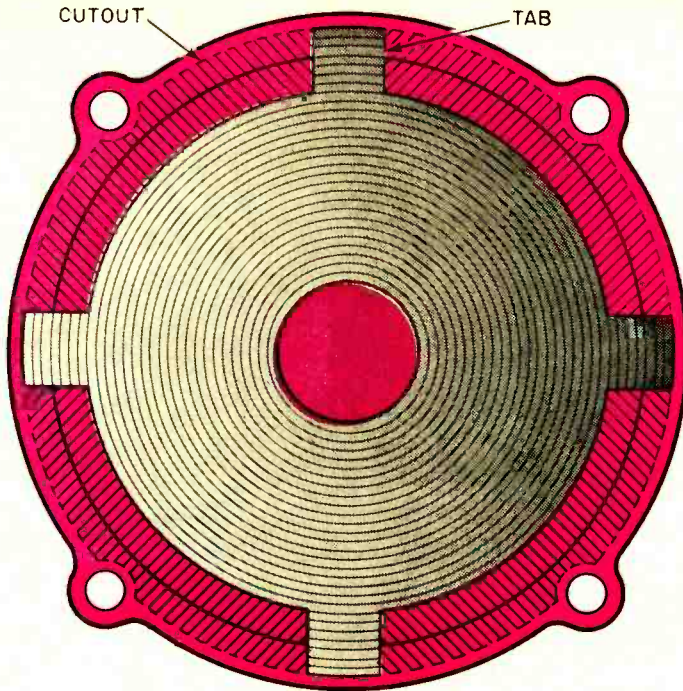

HIGH-COMPLIANCE SPEAKER

Simple alterations reduce the resonance and improve the performance of any 8" speaker

By ALFRED B. ANDERSON

SMALL, low-resonance, high-compliance speaker systems are generally characterized by clean, deep bass response. Unfortunately, though, they are also characterized by high cost. For this reason, you may decide to do exactly what the author did—build your own! The cost is remarkably low, and you'll end up with a high-compliance speaker that will reward you with fine sound as well as the genuine sense of craftsmanship that comes from a job well done.

Begin by selecting an inexpensive 8" PM speaker having a relatively heavy magnet and an 8- or 16-ohm voice coil. Since the idea is to cut out the speaker's corrugated cone edge and replace it with a ring of soft chamois skin to increase

the cone's compliance, it's best to avoid either larger or smaller speakers—unless you're an expert, they may prove too difficult to handle.

Before deciding on a specific speaker, test the spider suspension (the corrugated material on the voice-coil end of the cone) with your fingers to make sure it is soft; if it's stiff, it's a safe bet that you can't lower the cone resonance much. A second thing to watch is the holes in the speaker's frame—make sure they're big enough to let you get your fingers in to work with the back of the cone.

Procedure. First, carefully pry off the cardboard retainer ring on the front of the speaker with a knife; put it neatly

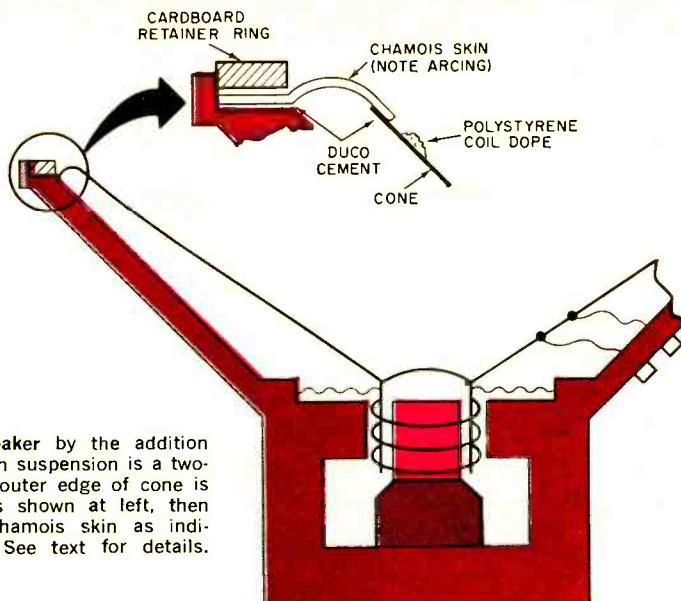

Modifying a speaker by the addition of a chamois-skin suspension is a two-step procedure; outer edge of cone is first removed as shown at left, then replaced with chamois skin as indicated at right. See text for details.

aside, since you will want to glue it back in place later. Now, using a razor blade or small scissors, cut the cone rim, except for the four tabs, as shown on page 68.

Next, cut out a ring of soft, thin, whole chamois skin (available at most hardware stores) slightly smaller than the diameter of the speaker and $\frac{1}{4}$ " wider than the gap where the cone rim was cut. Glue the chamois ring to the speaker frame, using Duco cement; then arc the ring and glue it around the edge of the cone an inch or two at a time, as shown above. (You'll probably find it best to apply the cement to the frame and cone edge rather than the cloth itself). Now, cut out the four tabs from the rear, replace the cardboard retainer ring, and your speaker is finished.

Result. The resonance of your speaker should now be very low. (The speaker shown here has a free-air resonance of 35 cycles, and another 8" unit the author constructed resonates at 26 cycles!) To complete the system, mount the speaker in a small, airtight, fiberglass-filled enclosure (see photograph) at least 1 cu. ft. in volume. Although this will raise the speaker's resonance to 70 or 80 cycles, the bass will be solid down to about 50 or 60 cycles.

An even larger enclosure will mean

lower resonance and deeper bass, but keep the baffle down to bookshelf size. (A bigger enclosure may provide insufficient damping, with the result that the cone will move too far and distort the sound even at low power.) If you have trouble with cone breakup, you can stiffen the cone's outer edge by painting it with polystyrene coil dope.

Two of these speakers produce excellent sound on stereo, and a tweeter can easily be added for increased treble response. -30-

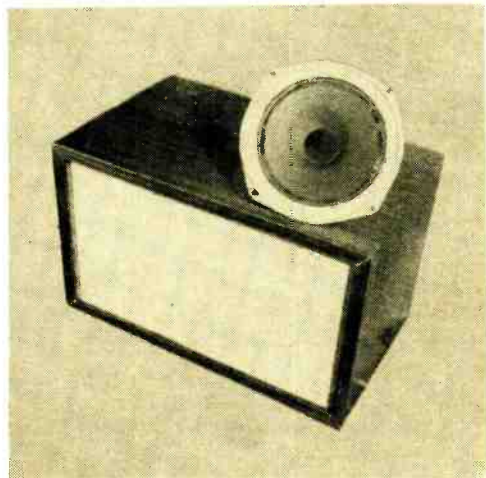

TRANSIDIP

Battery-powered and portable, this transistorized grid-dip meter will make a valuable addition to your test gear **By L. W. AURICK, W2QEX**

FOR MANY YEARS one of the most useful instruments around shop or shack has been the grid-dip meter. A simple oscillator tunable over a wide frequency range, it can also serve as a BFO or an absorption frequency meter, for example. The "Transidip" grid-dip meter described here uses a single transistor and carries its own built-in battery. Unfettered by the a.c. line, it is free to roam from rooftop beam to mobile whip, and to become your constant companion on field trips.

The tuning range of the "Transidip" is from 5.8 to 59 megacycles, including the Citizens Band as well as all ham bands between 40 and 6 meters. And it is relatively easy to construct, since wir-

ing is not critical and all parts are readily available from local and mail order parts suppliers.

Construction. The Transidip is housed in a 5¼" x 3" x 2⅛" aluminum box (Bud CU-2106A or equivalent). Follow the layout shown in the pictorial diagram and you will have no trouble either building or calibrating the unit. Most components are wired point-to-point by their leads as shown.

Make coupling loop *L1* from a piece of bare No. 18 wire; this loop, which is shown in detail on page 72, plugs into jacks *J1* and *J2*. Tuning coil *L2* consists of 37 turns of wire cut from a piece of B&W No. 3008 coil stock. Make taps at 15, 23, 29, and 33 turns from one end of *L2* as shown; to do so, press down the turns at each side of the spot where the turn is to be tapped. If adjacent turns should short during this operation, simply pass a razor blade between them to provide the proper spacing.

Both the rotor and stator of tuning

Follow the pictorial diagram carefully when building the Transidip. Wiring isn't critical, but be sure to observe polarities on battery B1, meter M1, and diode D1.

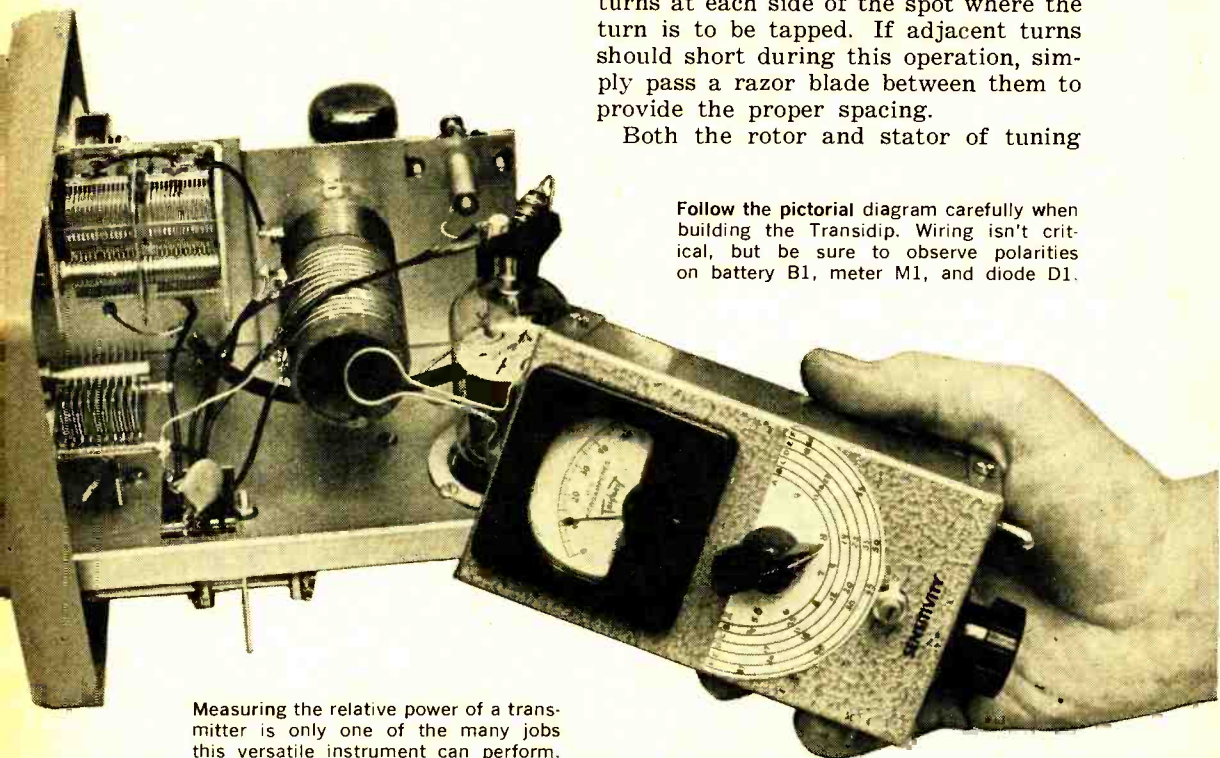

Measuring the relative power of a transmitter is only one of the many jobs this versatile instrument can perform.

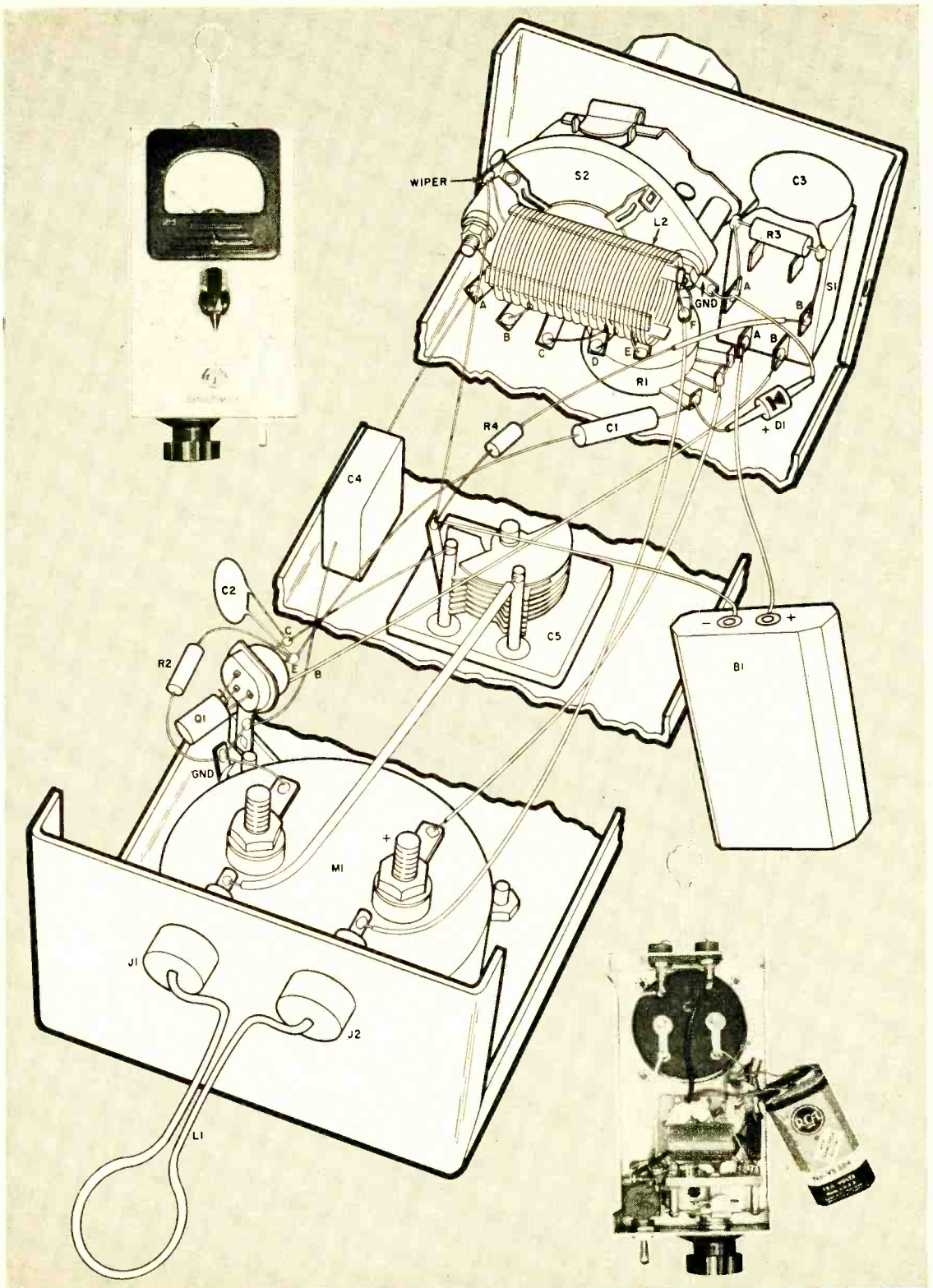

HOW IT WORKS

Transistor *Q1* is operated as a variable frequency oscillator tuned by capacitor *C5* and coil *L2*. Meter *M1*, connected in the emitter circuit of *Q1*, measures the r.f. output of *Q1* as rectified by diode *D1*. Since coupling loop *L1* is connected in series with coil *L2*, it serves to couple the oscillator's output to circuits under test.

When *C5-L2* are tuned to the frequency of an external tuned circuit near *L1*, power is transferred from the oscillator to the external circuit, resulting in a dip in the meter reading. This indication signifies that the oscillator and external circuit are resonant at the same frequency. The dial shows the frequency common to both.

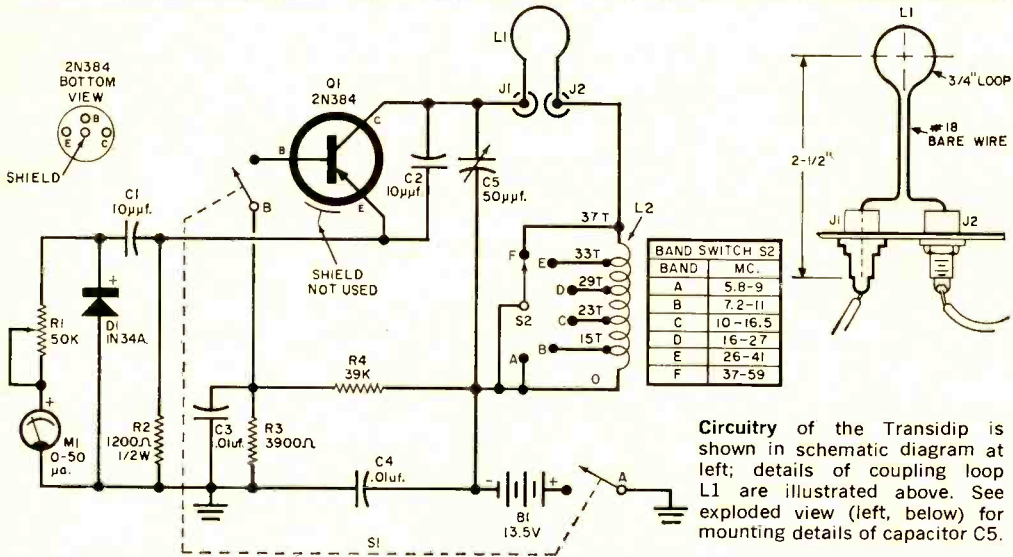

Circuitry of the Transidip is shown in schematic diagram at left; details of coupling loop *L1* are illustrated above. See exploded view (left, below) for mounting details of capacitor *C5*.

capacitor *C5* should be insulated from the box. Use a thin fiber shoulder washer on *C5*'s shaft and a larger flat fiber washer on the front panel of the box. The capacitor's mounting nut will hold the combination tightly in place.

The usual precautions should be taken when soldering the diode and the transistor into the circuit—be sure to use a heat sink with diode *D1*. Transistor *Q1* is mounted in a socket, the mounting flange of which is soldered to a ground lug connected to the box. As the shield lead on *Q1* is not used, just clip it off near *Q1*'s body—but make certain that you're clipping the right lead.

No mounting is used for battery *B1*; the unit specified is exactly the right length to be wedged across the width of the box's cover. However, the battery must be wired with the proper polarity; wrong polarity can ruin the transistor. Also watch the polarity of meter *M1*.

Calibration. To calibrate capacitor *C5* for each band, make a temporary paper dial and paste it under *C5*'s knob. Then, using a calibrated receiver, you can

(Continued on page 115)

PARTS LIST

- B1*—13.5-volt transistor battery (RCA VS-304 or equivalent)
C1, *C2*—10- μ f. mica capacitor
C3, *C4*—0.01- μ f., 150-volt ceramic or mica capacitor
C5—50- μ f. variable capacitor (Hammarlund HF-50 or equivalent—see text)
D1—1N34A diode
J1, *J2*—Phone tip jack
L1—Coupling loop—see text
L2—Tuning coil, 37 turns of No. 3008 B&W Miniductor coil stock tapped at 15, 23, 29, and 33 turns—see text
M1—0 to 50 d.c. microammeter (Lafayette TM-200 or equivalent)
Q1—2N384 transistor (or equivalent)
R1—50,000-ohm, 1/2-watt composition potentiometer (Mallory SU-35 or equivalent)
R2—1200-ohm, 1/2-watt resistor
R3—3900-ohm, 1/2-watt resistor
R4—39,000-ohm, 1/2-watt resistor
S1—D.p.d.t. toggle switch
S2—Single-pole, six-position non-shorting rotary switch (Centralab 2501 or equivalent)
 1—5 1/4" x 3" x 2 1/8" aluminum box (Bud CU-2106A or equivalent)
 Misc.—Hardware, knobs, transistor socket, etc.

ROLL-AWAY NOSE CONE

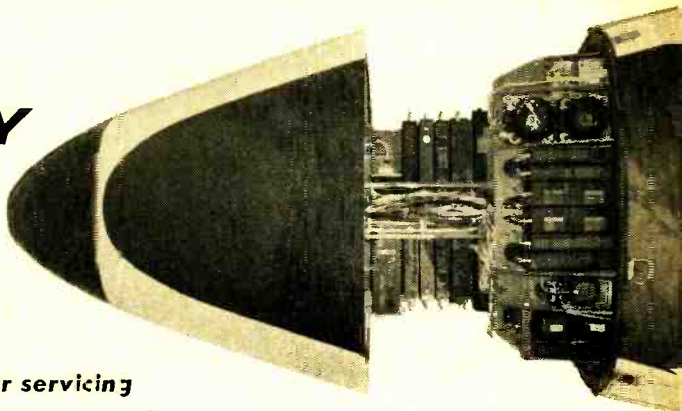

**Tweaking the JetStar's nose
exposes electronic apparatus for servicing**

THE NEW four-engine "JetStar," Lockheed Aircraft's entry into the pint-sized jet transport field, has a nose for electronics.

When the same electronics system carried by huge jetliners had to be packed into the small transport, Lockheed engineers came up with a unique solution. They housed all of the JetStar's complex electronic apparatus—comprising over 25 separate pieces of equipment—in the plane's nose compartment.

Since the cone which covers this compartment slides open with ease on a smooth roller-and-track assembly, service technicians have no problem reaching the equipment. To top it off, the

center of this "roll-away" nose cone stands only about six feet above ground level, which makes accessibility just that much greater.

The communications, navigation, and air traffic control systems tucked away in the nose of the 550-mile-an-hour jet include equipment for v.h.f. communications, navigation by visual omni-range or automatic direction finder, instrument landing, and weather radar. Much of the equipment is duplicated to provide alternate facilities in case of failure, yet the JetStar's novel nose actually has room to spare to accommodate future developments in electronic aircraft control. —30—

Ease of access to electronic equipment is obvious in this shot of opened nose cone. Shelf shown is only 5½ feet above ground.

Ready to roll off production line in Marietta, Ga., the JetStar will make its debut this year in corporate fleets of six nations.

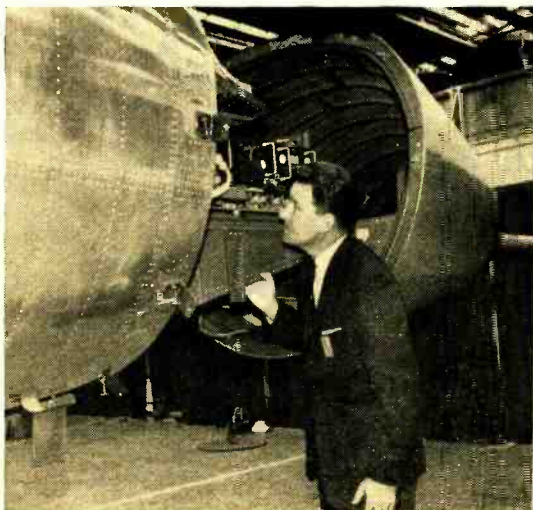

SPACE ELECTRONICS



Spinning satellite, built by Hughes Aircraft, is an "active" repeater. It weighs 32 pounds and is powered by silicon cells.

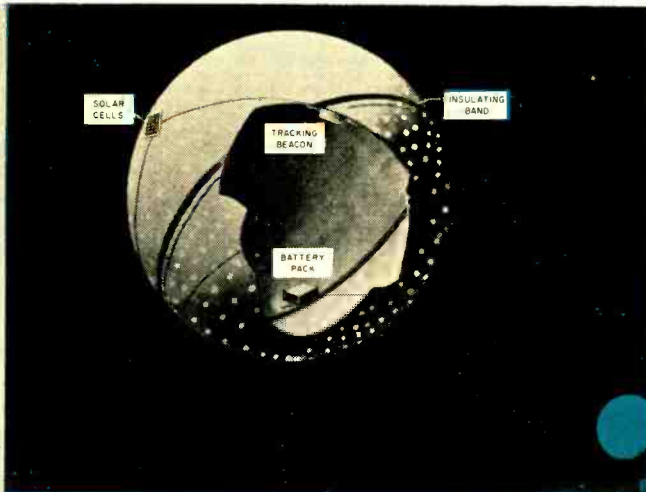

Apparently damaged during the unfolding of Explorer IX, the beacon transmitter did not operate. It was powered by solar cells.

THE ATMOSPHERE we breathe has a dual purpose—it supplies life-sustaining oxygen and serves as an "invisible shield" to protect earthlings from the harmful radiation abounding in outer space. This shield does have one tremendous disadvantage: radiation that cannot pierce the shield from without is therefore probably unknown to us—and part of this radiation is in the radio-frequency band *below* 500 kc. Scientists have long wondered if by any chance there are radio signals outside the earth's atmosphere in the very-long-wave band. The only way to find out is to go outside the atmosphere and listen.

What's Out There Dept. Just such a project is being discussed as a joint British/NASA venture for 1961-62. Signals picked up by special British receiving equipment tuned to the low frequencies would be rebroadcast on the v.h.f. channels. A trailing long wire ejected by the satellite would make a resonant antenna system.

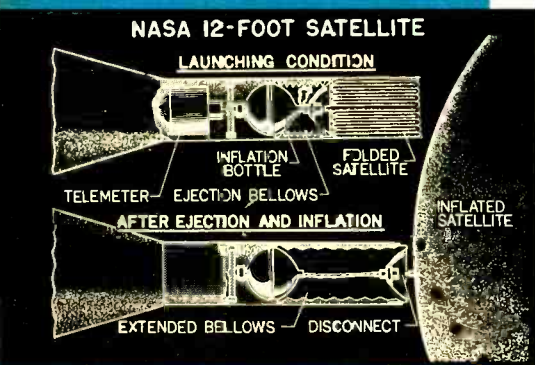

Explorer IX was carefully packed into nose of Scout II rocket and launched by NASA. Test was only partially successful.

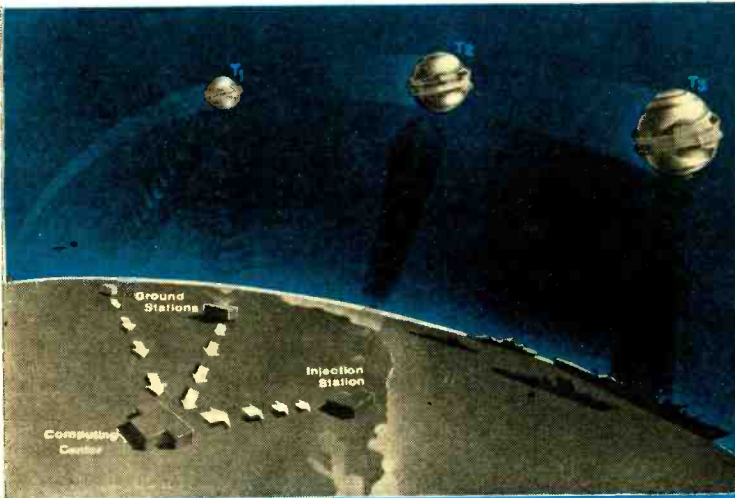

The Transit satellites are navigational beacons operating on paired frequencies. Transit III-B is on 54, 162, 216 and 324 mc.

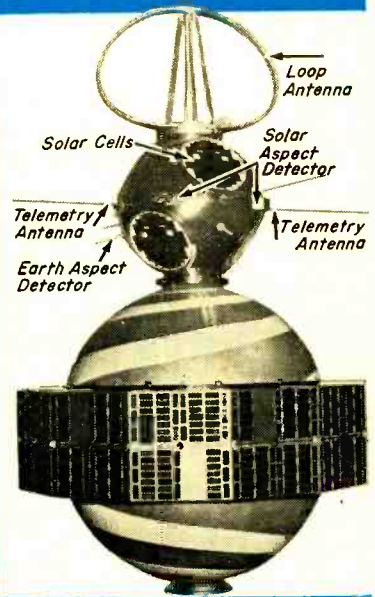

The "neck" joining Transit III-B and the NRL LOFTI satellite failed to separate after February 21 launch.

Scientists reason that long-wave reception should be pretty good 1000 miles above the surface. Lightning static which prohibits low-frequency reception of weak signals will probably be largely screened off by the ionospheric "shield."

A "reverse" of this experiment was conducted during the lifetime of satellite Explorer VI (launched August 7, 1959). Aboard the payload was a U. S. Navy receiver tuned to NSS on 15.5 kc. Apparently the idea was to determine the strength of this low-frequency signal—the results have never been made known. Some Navy technicians say that satellites may provide the answer to communicating with underwater submarines, but just how remains a mystery in our eyes—packing "Big Jim," the Navy's present megawatt long-wave transmitter, into a satellite doesn't seem quite possible.

A second attempt to monitor powerful signals on the low frequencies was made with the LOFTI satellite—launched Feb-

ruary 21, 1961. LOFTI contained a U. S. Navy receiver tuned to the 300,000-watt signal of NBA. This station is on 18 kc. from the Canal Zone. This satellite rode "piggy-back" on Transit III-B (see photo above). One of the two low-frequency receivers aboard LOFTI is working and the characteristics of 18-kc. reception are being recorded.

Satellite Briefings. Although the Russians have widely publicized the "fact" that their Venus probe satellite operates on 922.8 mc., it has not been heard by monitors in North America. The British receiving station at Jodrell Bank was given sufficient information to track this satellite in late February. However, the Russian Venus probe did not respond to "ground command" signals after February 22nd (it was launched February 12th). Keyed to respond every five days, the Venus probe could not be heard on Monday, February 27th, nor Saturday, March 4th.

The Venus probe is supposed to have

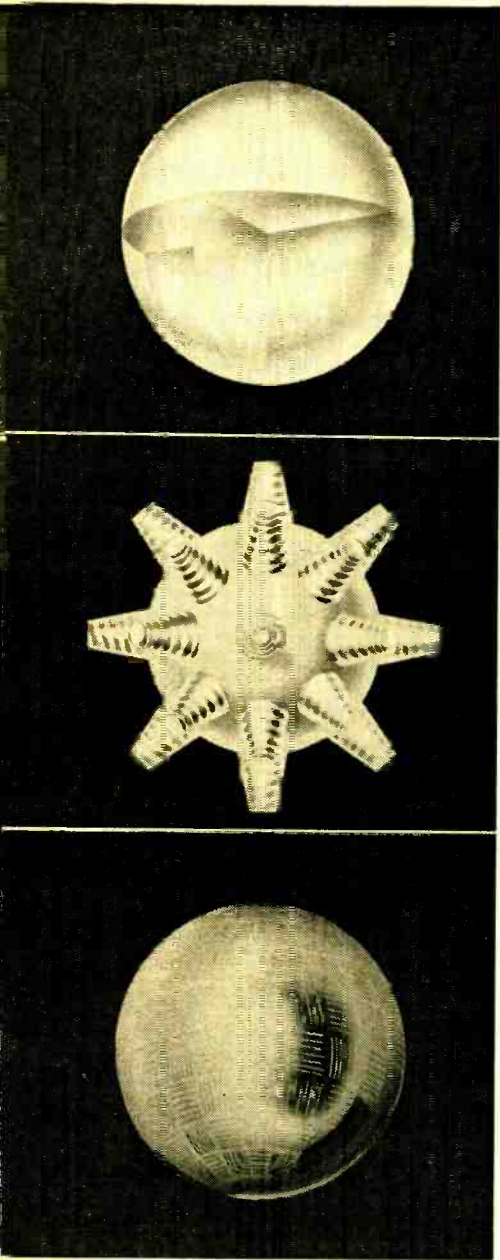

Suggested designs for passive or Echo-type satellites worked up by Ryan Aeronautical Company. At the top is a corner reflector fitted into a sphere. In the center, 26 cones have been formed into helical antennas. At bottom, dipole strips have been attached to the balloon—they are at right angles to one another to counteract polarization changes as the satellite spins and wobbles in orbit.

carried four antennas—one non-directional, two moderately wide beams, and one very sharp beam antenna. The latter beam had been designed to unfold to a six-foot diameter when the probe reached the vicinity of Venus.

A 12-foot polka-dot balloon was launched by NASA from Wallops Island on February 16. Called Explorer IX, the beacon transmitter—operating on 136 mc.—was damaged as the balloon unfolded from the rocket's fourth stage. Several days later the satellite was "found" through optical means and is now in orbit. Explorer IX is too small for Echo-type communications and was launched to measure air drag on balloon satellites in the upper atmosphere.

Three new satellites can be added to the list of "Radio Signals from the Satellites" appearing on page 65 of our April column. They are Discoverer XXI, gathering infrared data, Transit III-B, and LOFTI. Frequencies used by Discoverer XXI have not been revealed. Transit III-B is putting out weak signals on exactly 54, 162, 216 and 324 mc. (the same as Transit II-A), plus a special transmitting setup on 224, 421 and 448 mc. LOFTI is on 136.0 mc.

As we mentioned last month, Echo-type satellites are also called "passive" satellites—meaning that they simply reflect radio signals. Active satellites contain radio receivers and transmitters to rebroadcast signals upon command from ground stations. The Courier I-B is a good example of a working "active" satellite.

Vastly improved passive satellites have been suggested by the Ryan Aeronautical people. Some of their proposed designs are shown at left. Included are the corner reflector, wide-band multi-helix, and resonant dipoles with dual polarization. Each design has been calculated to be more efficient than the spherical balloon. Engineers and space experimenters hope that the resonant dipole idea will be exploited in a satellite launching later in 1961.

Because of interference problems near the 108 mc. frequency used by the American satellites, all launchings after June 1961 will be tracked with beacons operating between 136 and 137 mc. Minitrack stations (to be discussed in

(Continued on page 113)

R.F. PROBE PEPS UP VTVM

Easy-to-build attachment helps you to trouble-shoot r.f. circuits

By FORREST H. FRANTZ, Sr.

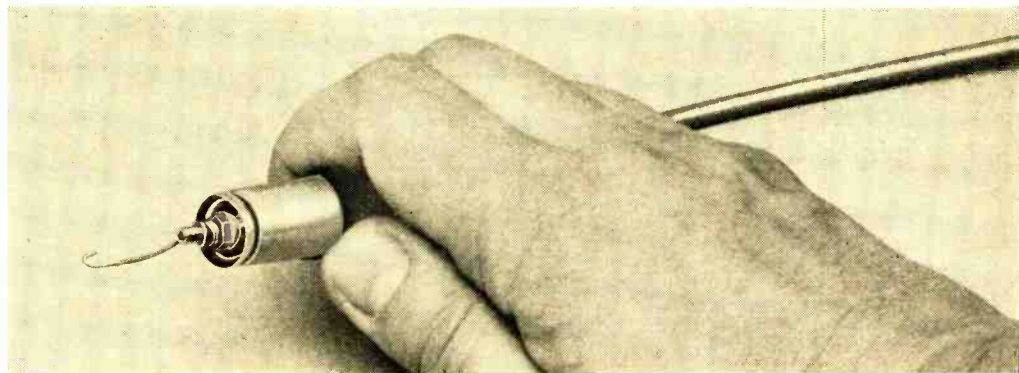

YOU CAN INCREASE the utility of your vacuum-tube voltmeter considerably by building an r.f. probe for it. Although a standard VTVM has an input capacitance which limits its a.c. measurements to frequencies below about 50 kc., an r.f. probe will push this frequency range well into the short-wave region. In fact, the probe described here can boost your VTVM's upper frequency limit into the 6-meter band—a frequency jump of over 1000 times!

What It Is. An r.f. probe is nothing more than an r.f. detector which rectifies r.f. signals and delivers a d.c. output proportional to the voltage applied to the probe's tip.

As shown in Fig. 1, capacitor *C1* passes r.f. signals but blocks d.c. volt-

ages which would contribute to the voltmeter reading and possibly damage diode *D1*. The diode rectifies the r.f. signal by shorting out the negative a.c. pulses, leaving a positive pulsating voltage which must be filtered to obtain accurate meter readings.

Fig. 1. Circuit of r.f. probe. Aluminum foil surrounds its three components and serves as shield.

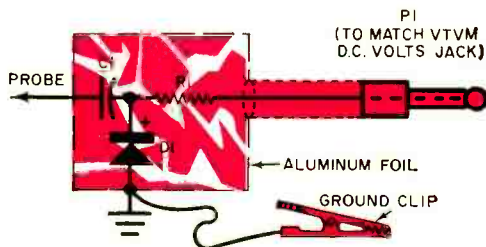

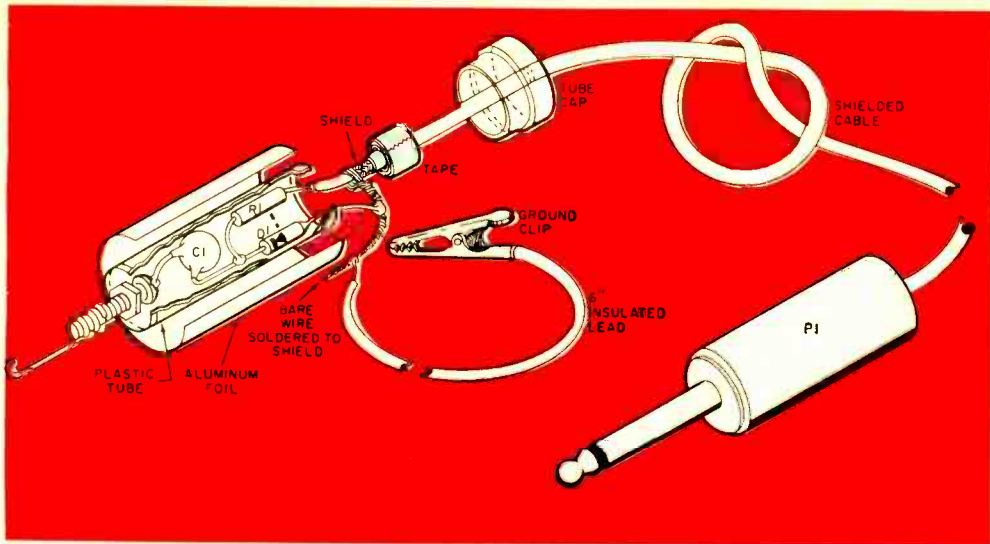

Fig. 2. Pictorial diagram shows how author's probe was assembled. Hook added to probe screw simplifies trouble-shooting.

PARTS LIST

- C1*—0.0002- μ f., 1000-volt ceramic capacitor (Sprague 5CA-12 or equivalent)
- D1*—1N34A diode
- P1*—Phone plug / Lafayette MS-455 or equivalent—see text)
- R1*—4.7-megohm, $\frac{1}{2}$ -watt resistor
- 1—30" length of shielded single-conductor cable (Belden 8401 or equivalent)
- 1—Minigator clip (Mueller #30 or equivalent)
- 1— $\frac{1}{8}$ " x 2 $\frac{1}{2}$ " plastic tube—see text
- Misc.—Aluminum foil, tape, hardware, etc.

Resistor *R1* is part of the necessary filter. The other part of the filter is the stray capacitance contributed by the shielded cable on the probe and the stray capacitance of the VTVM's internal wiring.

Construction. The probe is built in a plastic tube or bottle about 9/16" in diameter and 2-1/16" long. You can use a larger tube if you wish, but it should be made of plastic and have a screw-type or force-fit cap. See Fig. 2.

Only the three electronic components already mentioned are used in the probe: *C1* is a 0.0002- μ f., 1000-volt ceramic disc capacitor; *D1* is a 1N34A diode; and

Only a few parts are needed to construct the probe, as shown in the photograph. When soldering, be sure to use a heat sink for diode *D1*, and to observe the polarity indicated on the schematic diagram.

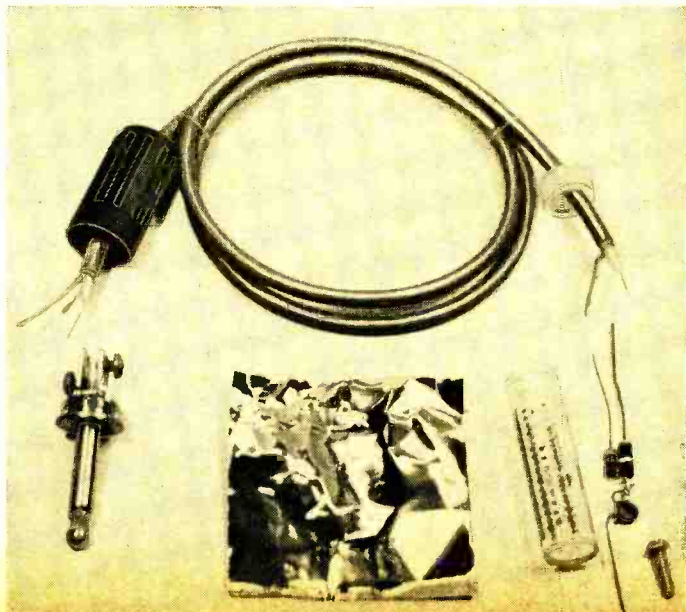

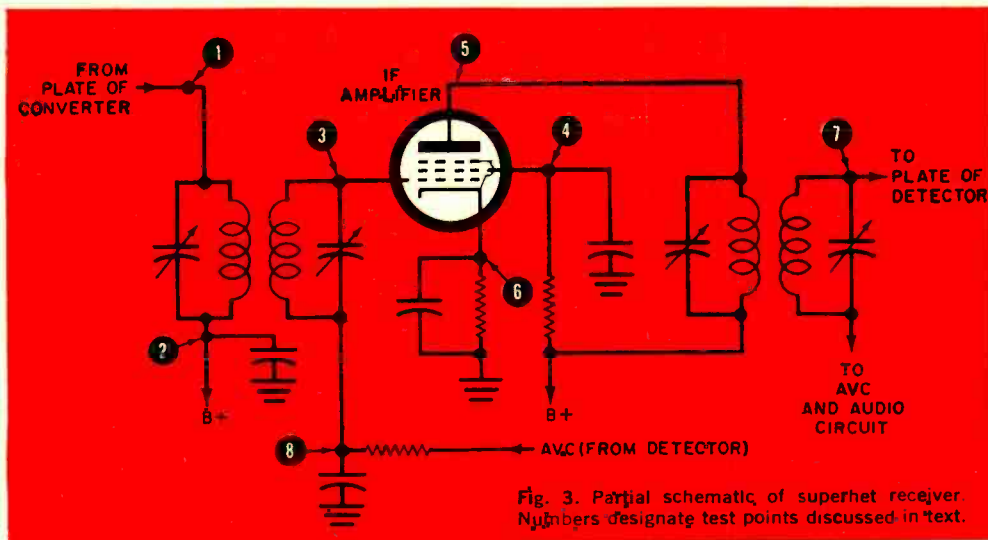

Fig. 3. Partial schematic of superhet receiver. Numbers designate test points discussed in text.

$R1$ is a 4.7-megohm, $\frac{1}{2}$ -watt resistor. Before assembling the probe, solder the cathode of $D1$ to one end of $R1$ and to one end of $C1$; this leaves one end of each component free. Be sure to use a heat sink when soldering $D1$.

Next, solder the free end of capacitor $C1$ to the head of a $\frac{3}{4}$ " 6-32 screw. Solder the free end of resistor $R1$ to the center lead of a shielded cable which should first be passed through a $\frac{1}{4}$ " hole in the cap of the tube. (Use a drill or hot ice pick to make the hole.) Finally, solder the free end of diode $D1$ to the cable shield; a short bare wire, about 3" long, should also be soldered to the shield.

Prepare the probe's body for assembly by drilling a $\frac{5}{32}$ " hole in the bottom of the tube. After drilling, glue a piece of aluminum foil to the outside barrel of the probe as shown in the pictorial diagram.

Now push the machine screw connected to $C1$ through the hole from inside the tube, and attach a nut to hold the screw in place. The screw serves as the probe's "hot" contact; if desired, a short length of bare wire can be twisted around the screw for more critical "probing."

Push the cap over the open end of the tube with the short bare wire passing between the cap and tube. Then solder a 6" insulated lead to the bare wire and tape this junction to the aluminum foil

so that a good electrical connection is made between the foil and the junction. The tape also serves to hold the cap in place.

Finally, fit the free end of the 6" insulated lead with a small alligator clip which serves as the probe's ground terminal. The free end of the shielded cable should be connected to a plug ($P1$) that matches your VTVM; be sure to connect the cable's center lead to the plug's "hot" terminal.

Operation. Plug the probe into your VTVM and set the VTVM's range switch to "plus d.c. volts." The d.c. scale will now give the peak voltage of the r.f. signal. To obtain the r.m.s. value, multiply by approximately 1.1. When you use the probe to check the operation of a superhet receiver, for example, ground the probe's alligator clip to the receiver's chassis and touch the probe to selected points in the set.

Shown in Fig. 3 is a partial circuit of a typical superhet receiver; generally, signal voltage should be present at odd-numbered test points and should increase as the probe is moved to a higher odd number. However, when proceeding from the plate of one stage to the grid of the next stage, signal voltage should remain about the same. No signal voltage should be present at any even-numbered test point; if it is, the bypass capacitor at that point should be checked to see if it is open.

TRANSISTOR MOUNTING TIPS

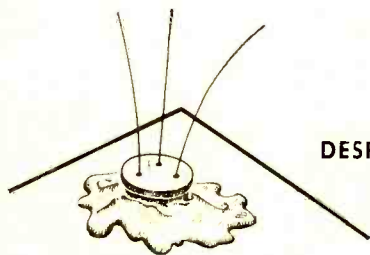

DESPERATION MOUNT

Need some way to shock-mount a lead-type transistor? Simply build a little pool of Duro plastic rubber and stick the transistor—wire leads up—in it. When the latex dries, the transistor will be shock-mounted and the leads readily accessible.

—John A. Comstock

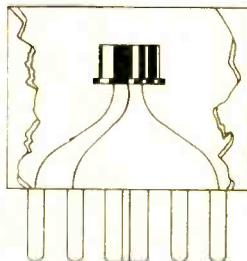

EASY INTERCHANGE

The one way to find out how transistors really work is to build a lot of small projects. But you will probably not want to keep many of these projects for any length of time, and you *will* want to use the transistors over and over again—making for wear and tear on these delicate parts. A good way to keep your transistors healthy and happy is to mount them in an old octal socket. Every workshop has plenty of old octal glass tubes around. Just break out the glass and clean the solder from the pins. Then carefully solder the wire leads of your most frequently used transistors in a “standard” pin arrangement: base to pin #1, collector to pin #5 and emitter to pin #8.

—Jeff S. Hurlburt

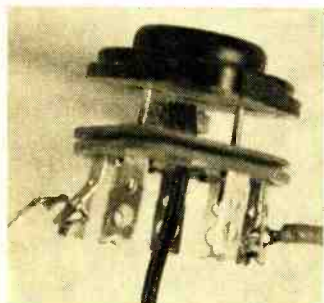

CONVERTED SOCKET

Are you aware that common power transistors, such as the 2N307, 2N255, etc., come in a TO-3 type-approved case and can be inserted in a 9-pin miniature tube socket? But before rushing out and sticking a power transistor in a 9-pin socket, you must make provision for the collector lead. Just pass a machine screw through one of the transistor mounting holes. Take a short wire lead with a solder lug on one end and fasten it to the screw. Bring the lead through the eyelet in the center of the tube socket and solder the free end to one of the unused socket lugs. The photo shows the three leads in place, but not the collector lead attached to a tube socket lug.

—Hartwell M. Hughes

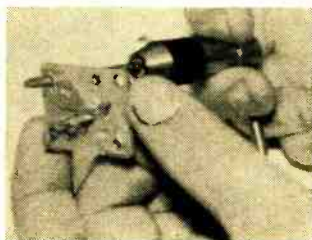

RETAPPED TRANSISTOR SOCKET

The convenience gained by using a 10-cent Cinch-Jones power transistor socket is often lost due to its 6-20 threading. But you can take a hand tap and retap the hole in the metal contact to accept a 6-32 screw, which you're more likely to have on hand.

—Paul Galluzzi

**EICO Model 1073 kit
provides a
continuously variable
0-140 volt
a.c. line supply**

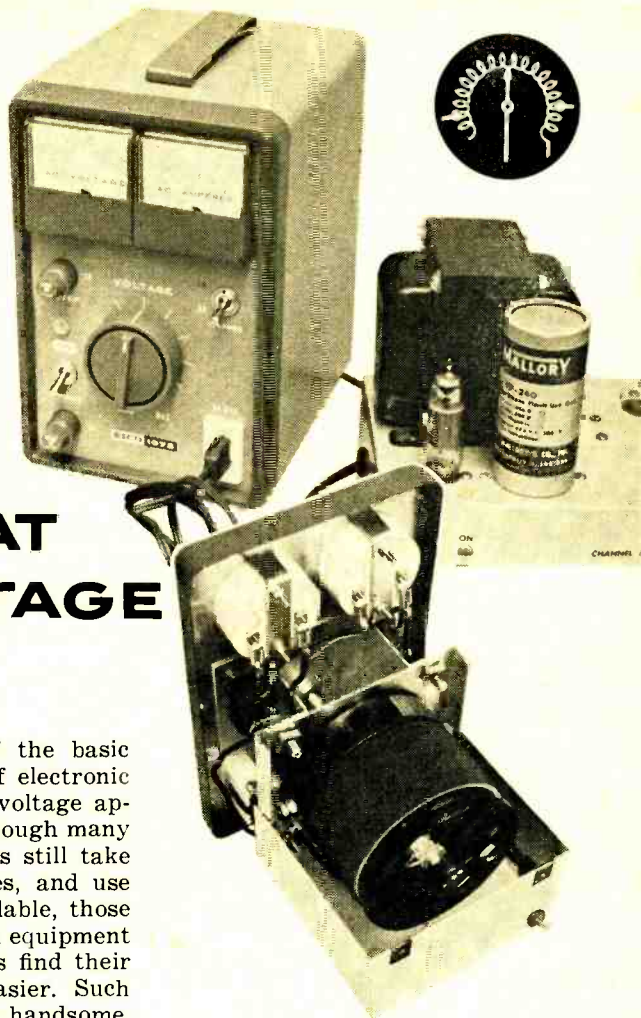

VARY THAT LINE VOLTAGE

IT'S easy to forget one of the basic rules for testing a piece of electronic equipment—that the proper voltage appear across its a.c. plug. Although many servicemen and experimenters still take “pot luck” with line voltages, and use whatever happens to be available, those who have the facilities to feed equipment with known variable voltages find their trouble-shooting jobs much easier. Such facilities can be found in one handsome, compact package—the Model 1073 variable a.c. supply kit—available from EICO (33-00 Northern Blvd., Long Island City, N. Y.).

The heart of the unit is an efficient variable autotransformer which will deliver 0-140 volts, at a maximum of 3 amperes, from a 120-volt line. Output from the autotransformer is fed to a socket on the front panel, to which the equipment to be tested is connected. The supply itself plugs into any convenient wall outlet.

Hooked up in this manner, the voltage across the equipment is controllable by a convenient knob and is continuously monitored by a clearly marked meter. A similar meter reads the current drawn by the apparatus under test; a dual-range instrument, it reads 0-1 ampere

or 0-3 amperes at a flick of the range switch. An on-off switch and separate fuses for the ammeter and the autotransformer itself complete the front panel.

Once you get the unit together, you'll be surprised at the number of uses you'll find for it. Most electronic equipment is designed for operation on 117 volts; servicing data (voltage readings, for example) are usually based on this figure. Actual line voltages, however, may vary from 105 to 125 volts depending on the area and time of day. The answer? Use the variable supply to boost or reduce the voltage to the proper value.

Do you suspect that a tube or other component is cutting out intermittently? You can decrease trouble-shooting time

Schematic for the EICO Model 1073. Meter range switch automatically cuts out fuse F2 when 3-ampere scale is being used. Fuse F1 then protects meter as well as autotransformer.

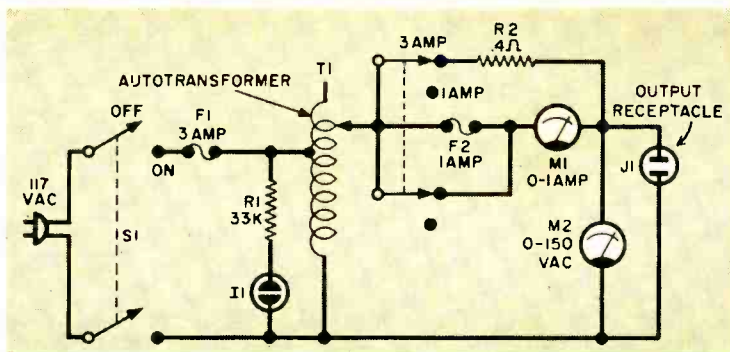

by making it fail immediately with a shot of extra-high line voltage. Want to know how much power a piece of apparatus draws? Plug it into the supply and multiply the voltage and current meter readings. You can even use the supply to reduce the power of a heavy-duty soldering iron (if it doesn't draw more than 3 amperes) to the 6 or 8 watts suitable for transistor work.

We found the Model 1073 very easy to put together. We would suggest, though, that the solder lugs be screwed to the autotransformer before it is mounted,

instead of afterward as recommended. You'll also find that you need at least a 100-watt soldering iron for making good joints with the #14 hookup wire.

Although assembling the Model 1073 kit takes only about four hours, the supply is also available ready wired for those who don't care to do their own construction; prices are \$35.95 and \$47.95 respectively. The Model 1078, a unit mechanically identical with the 1073 but having a current capacity of 7½ amperes, sells for \$42.95 in kit form, \$54.95 wired.

-30-

AUDIBLE BALL FOR THE BLIND

After prolonged research, England's Royal National Institute for the Blind has come up with a practical "audible" playing ball. Previous audible balls for the blind have contained small objects—dried peas, for instance—which rattled as the ball bounced. But all ceased to emit any sound when at rest.

Presently undergoing intensive tests, the new ball contains a small electronic sounding unit housed in sponge rubber within a protective outer casing. Powered by a miniature accumulator which is rechargeable from a dry battery, the sounding unit emits a "bleeping" sound continuously for up to ten hours on a single charge. A built-in on/off switch is so designed that it isn't subject to vibration or "bounce."

The ball has been circulated widely to schools for the blind in Britain, and reports indicate that it will fulfill a long-felt want, especially in the lives of blind children. In time, it may even enable them to add both cricket and football to the list of sports in which they are able to participate.

-30-

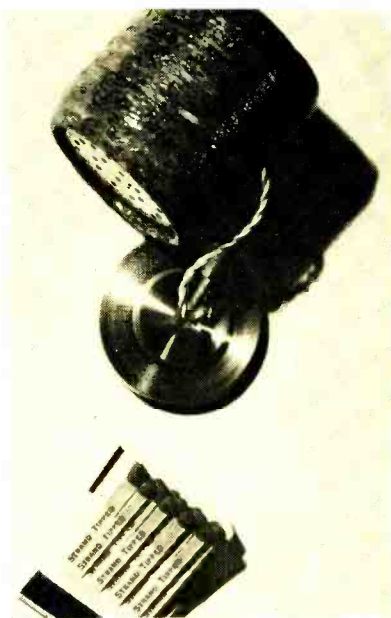

On the Citizens Band



By TOM KNEITEL, 2W1965

WE RECENTLY RECEIVED some interesting statistics on how the wheels are grinding in the licensing division of the Federal Communications Commission. The FCC is receiving about 11,000 CB applications a month now, an increase of 1500 a month over last summer. With this load, it takes six to seven weeks for the applications to be approved.

It's surprising how large a number of applications are rejected. For instance, 6449 Class D stations were approved last August—out of 10,911 CB applications. Even when you take into account that these figures include a small number of Class A, B, and C applications, it still means that well over one quarter of all applications were "bounced."

In September 1960, 6103 licenses were issued for 10,322 applications; in October, 8733 for 10,451; in November, 7157 for 11,025. But even though the trend seems to be improving, there is really no good reason why *every* application shouldn't be approved.

Since the rules permit just about anybody to qualify for a station, the difficulty must be in the way the applications are filled out. FCC Form 505 (the CB application) is worded very plainly, contains no difficult questions, and doesn't solicit an overabundance of information. It's possible that many applicants just don't read the questions well enough to answer them properly.

This brings us to another point—that of a CB club's responsibility to the community. Certainly, offering advice on filling out a "505" is within the scope and purpose of every CB club, and clubs should help prospective CB'ers (who, after all, are prospective club members) complete their applications in a manner that will be acceptable to the FCC. The various clubs might consider establishing an "Application Advisory Commit-

tee" to perform this service, and also to demonstrate the proper operation of CB equipment to prospective CB'ers.

Clubs which participate in this type of community service should send a press release about it to local newspapers, which will probably print the information.

All news releases should be typed or mimeographed on club letterheads, dated, and include the name and telephone number of the Public Information Officer. They should be kept short, be worded in proper English, and contain all the facts. Such releases should be issued immediately after an emergency mission, and as far in advance as possible when they concern a club activity.

About this time of year many of us begin thinking thoughts nautical. Now, at the mention of the word "nautical," *you* may envision a 55-foot Chris-Craft, sleek and white, the salt spray whipping across its bow. But that's not what *I* think of. I visualize the radio equipment on board—possibly Bendix



Marine's CB transceiver (which looks pretty much like the Gonset G-12).

A rig suitable for either shipboard or land-lubber use, the Bendix set has a snazzy tri-colored front panel, relatively uncluttered in appearance. It comes in

two models, one for 117 volts a.c. / 12 volts d.c. and another for 117 volts a.c. / 6 volts d.c. With a superhet receiver (plus r.f. stage), the set has four transmit/receive channels and push-to-talk operation. A pi-network in the output allows you to load it into just about anything from a wet piece of string to a beam.

If you plan on using CB aboard your boat, don't expect to employ it for emergency purposes. The Coast Guard does *not* monitor CB on a nation-wide basis, and doesn't seem to have any plans to do so. Marine-CB is strictly for personal or business use.

In response to a large number of letters from readers, here's a listing of the CB channels used for specific purposes:

- Channel 7** General "inter-station" use
- Channel 9** National Calling Channel for all stations; also, working channel for fishing and other commercial vessels
- Channel 13** Non-commercial (pleasure) vessels
- Channel 15** National transportation services; hotels, motels, service stations, restaurants, etc.
- Channel 20** Boy Scouts of America

Part 19 doesn't say you can't, so somebody did. Yep, somebody found a brand-new use for CB. Apparently thinking that CB meant "Cupid's Band," Ralph Nelson, 18W3943, "merged stations" with Gwen Miller, 18A9864. Gwen's the Editor of the "CB News & Views" of the Illinois Citizen's Radio League, and Ralph's the Managing Editor. News item: 18W seeking 18A, object 18Q.

On the serious side, CB'ers continue to prove their usefulness in emergencies. Major Albert Zuckerman, 2A5805, of the Bronx County Unit, New York City Auxiliary Police, reports that his CB'ers took part in the aftermath of the disastrous air tragedy over Brooklyn, N. Y., last December when a United DC-8 jet airliner collided in mid-air with a T.W.A. Constellation.

Answering an emergency call at 10 p.m., the Bronx group rounded up 8 mobile CB units and 40 Auxiliary Police and sped to the scene of the accident. Working through the night and into the following day, they helped control the crowds and patrol the area.

Like many other organized CB/CD units, this group conducts a brief radio

drill once a week to make sure that all units are in proper operating condition.

A number of clubs have notified us of their existence and asked that we pass the news along to you.

The "Metropolitan Citizens Radio Association" of Hingham, Mass., has been in operation since December, 1960. CB'ers "down east" should contact William M. Antoine, 496 Main St., Hingham, Mass., if they are interested in joining.

The "14W Association of Seattle" is an "old-time club," having organized back in February, 1960. They have over 100 members and meet each month. Contact Allen W. Tropicke, 14W1078, 2116 Ferry Ave., Seattle 16, Wash., if you live in that area.

A club in Henderson, Ky., was started last October. Kentuckians should write to Wayne D. Copeland, 1221 Boeb St., Henderson, Ky., for further information.

The "C.B. Pioneers 5 Watt Radio Club" is active around Elkhart, Indiana. Hoosier CB'ers should get in touch with Mrs. Frank M. Hoover, 18B3096, RR #1, Box 63, Elkhart, Ind., for details.

You might like to look into the Winegard "Multibeam" vertical 2-element 11-meter beam. With minor adjustments, this high-gain beam antenna can vary

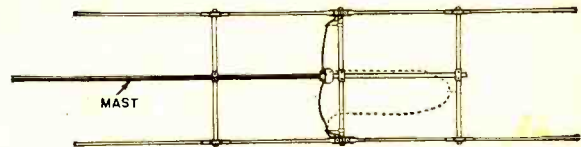

its signal pattern all over the place. It's available through many radio supply houses.

Here's a reminder. After a few months on the air, some CB'ers tend to get lazy in their operating habits. Little things like forgetting to give your entire call-sign over the air, or not limiting transmissions to 3 minutes with a 2-minute break, begin cropping up.

Naturally, nobody's saying that these things, in themselves, will lead to the "ruination" of the Citizens Band. But when you reach that stage, it's only a short slip to larger violations. It takes such little effort to operate properly and it means so much. Why not do your share in making CB a "better place to live"?

-30-



Across the Ham Bands

By
HERB S. BRIER
W9EGQ

SENDING QSL AND SWL CARDS

MOST hams and short-wave listeners like to receive QSL cards, but they quickly learn that there is more to obtaining one than merely asking for it. In fact, it seems that the more you want a particular card, the harder it is to get. This is true whether you are just starting out and trying to get cards from the 10 mainland call areas or the 50 cards for your worked-all-states certificate. It's even the case if you are a seasoned DX chaser going after the cards that will put you in the DX Century Club—100 countries confirmed.

Make Your QSL Complete. If you are a ham, your card should contain the following information: your call letters, name, and address; the call letters of the station worked; date and time of contact

(time preferably in GMT for DX contacts); an accurate signal report; and the band and mode of transmission used for the contact. Also, as most hams are interested in the equipment other hams are using, a brief description of your rig and antenna is usually appreciated. And remember, neatness counts—no one likes to receive a sloppy QSL card.

Mail your QSL *as soon as possible!* To speed it on its way, put it in an envelope and send it airmail. If your card arrives while the contact is still fresh in the recipient's mind, he is likely to mail his own card immediately—if he has not already done so.

When mailing your card, be sure the other fellow's complete address is given. Don't address the card to "Jerry Doaks,

Ham of the Month

Bob Gunderson, W2J10, has taught a fully accredited evening course in electronics at New York Institute For The Education Of The Blind since 1937—the year after he himself graduated from the school.

Possibly the greatest obstacle facing the sightless person in studying electronics or in becoming a ham is the lack of available technical information. Since 1950, Bob has helped overcome this obstacle by editing and publishing the "Braille Technical Press," which now has a readership of over 5000. Subscriptions are \$7.00 a year (\$10.00 for the "talking-book" edition) but are free to those who cannot afford to subscribe. (The "BTP" is supported by ham clubs, manufacturers, distributors, and individual hams; contributions may be sent to The Braille Technical Press, Inc., 984 Waring Ave., New York 69, N.Y.)

Bob has also designed and built over 50 auditory electronic test instruments, such as ohmmeters, voltmeters, and grid-dip oscillators for the blind electronic technician. They "read out" the desired information as a change of an audible tone, instead of using a meter as in conventional instruments.

The technical-information man for Terminal-Hudson, New York area electronic parts distributors, Bob also designs commercially manufactured ham equipment. He holds a G.E. Edison Award for being an outstanding radio amateur, and operates on all the popular ham bands—from 3.5 through 148 mc.



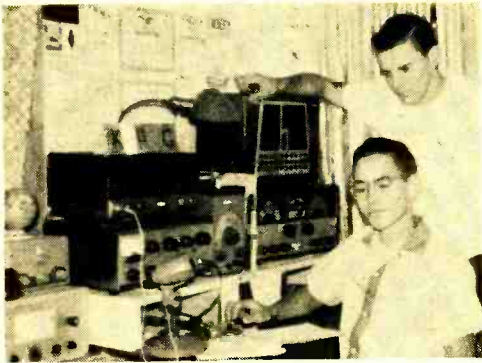

Paul, VE2BBF, is impressed with the friendliness of hams, beginners and old-timers alike.

Horace, K1LJG, who thanks POP'tronics for his start in radio, is showing Charlie, K1HRK, how he works his key.



ATTENTION NOVICES!

If you haven't already sent us a picture of yourself and your Novice station, this is a good time to do it. Each month POPULAR ELECTRONICS will publish what we feel is the best picture of a Novice station received that month, and the winner will get a free one-year subscription to P.E. (If you're already a subscriber, we'll extend your subscription for an additional 12 issues.) Pictures not chosen as prize winners and other suitable ham pictures will also be published as space permits. Send your pictures to Herb S. Brier, W9EGQ, c/o POPULAR ELECTRONICS, One Park Ave., New York 16, N. Y.

VE3EZ, Canada." Postmasters are not in the habit of checking ham call books to find out just where in Canada Jerry Doaks lives—this is your job. The Radio Amateur Call Book Magazine, available from parts stores and mail order houses which sell ham equipment, lists U. S. hams in one volume and the rest of hamdom in another.

Of course, it takes some time after a license is issued before its call letters appear in the "Call Book." Therefore, for the first few months of his ham career, a new ham must transmit his address to every contact from whom he wishes to receive a card.

Sending Foreign QSL's. Oddly enough, you can send QSL cards to most foreign amateurs even if you do not have their addresses—via their country's QSL Bureau. The addresses of the QSL Bureaus are published twice a year, usually

in the June and December issues of QST, and head each country's listing in the foreign edition of the "Call Book."

Few foreign hams consider the U. S. A. as "DX," because they work so many of us. Consequently, they usually QSL U. S. contacts only on the receipt of our cards. Also, they normally send their cards via the QSL Bureaus, unless postage is furnished for a direct reply. So keep a supply of stamped large envelopes, addressed to yourself and with your call letters printed in the upper left-hand corner, on file with your local call-area QSL Bureau. The address of your QSL Bureau heads your call-area listing in the "Call Book" and also appears bi-monthly in QST.

To receive DX cards directly, some hams include International Reply Coupons with their QSL's. Unfortunately, IRC's are often difficult to redeem in remote areas. A more effective method of prepaying the postage on these cards is to send the actual foreign postage stamps with your card. An excellent source of the stamps is Addison N. Ringler, W2SAW, 466 Weaver Rd., Webster, N. Y.; send him a large, stamped, self-addressed envelope, and ask for details and a list of countries for which he can supply stamps.

SWL Cards. Most hams who receive SWL cards do not value them highly because the average card says nothing more than "I heard you call CQ. Please QSL." This is why so many of them go unanswered. But any ham will welcome

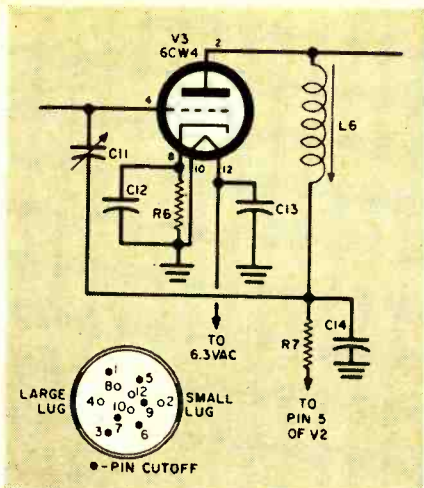

ADDITIONAL PARTS

- C11—2.5 to 7 μf . ceramic trimmer capacitor (Centralab 827-A or equivalent)
 C12, C13—0.001 to 0.005 μf . ceramic or mica capacitor
 C14—47- or 50- μf . mica or ceramic capacitor
 L6—Nine turns of ≈ 22 enameled wire close-wound on $3/8$ "-diameter iron slug-tuned form (Miller #4400 or equivalent)
 R6—120-ohm, $1/2$ -watt resistor
 R7—1800-ohm, $1/2$ -watt resistor
 V3—6CW4 tube (RCA)
 1—Socket for 6CW4 tube (Cinch #133-65-10-001 or equivalent)

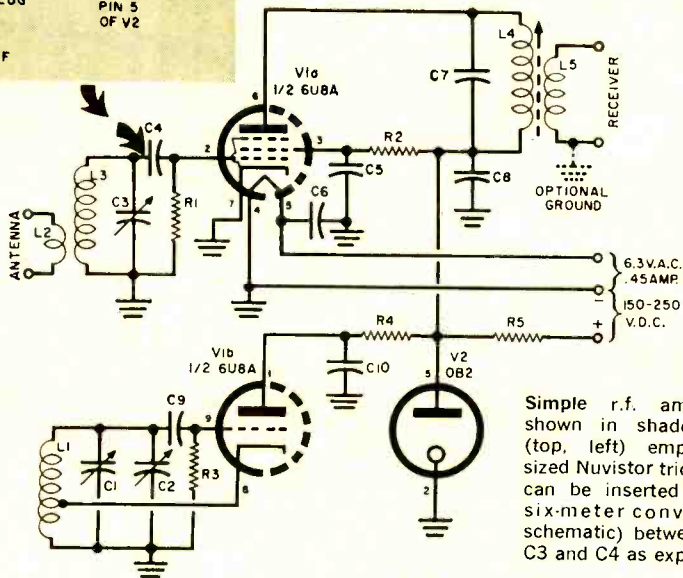

Simple r.f. amplifier stage shown in shaded schematic (top, left) employs peanut-sized Nuvistor triode. The stage can be inserted in circuit of six-meter converter (large schematic) between capacitors C3 and C4 as explained in text.

and usually answer an informative SWL card.

If you are a SWL'er, and you hear a ham CQ'ing with no success, send him a card containing a complete signal report. This will let the ham know he is getting out and, at the same time, will give him a good idea of his possible contact area. (See *Short-Wave Report*, June, 1960, for information on SWL club QSL Bureaus.)

The most interesting report I ever received was from an SWL'er: Nick Bambridge, 68 Penilee Terrace, Glasgow SW2, Scotland. It was in the form of a graph of my signal strength and readability during an entire contact. In addition, Nick reported on the quality of my transmission, described his receiving equipment, mentioned what other signals

he was hearing, and told me about local weather conditions. To top it off, he included a self-addressed envelope and an IRC for my reply. Nick says that he gets virtually 100% response from his SWL reports to hams.

NUVISTOR R.F. AMPLIFIER

Adding an RCA 6CW4 Nuvistor to the simple six-meter converter described in the February 1961 *Across the Ham Bands* will take only a few hours and greatly improve the converter's usable sensitivity. Smaller than a thimble, the 6CW4 seems to perform as well or better on six or two meters than other v.h.f. r.f. amplifier tubes costing far more. You should have no trouble adding the stage if you follow the diagram and the pro-

(Continued on page 126)

THE SEMICONDUCTOR DIODE

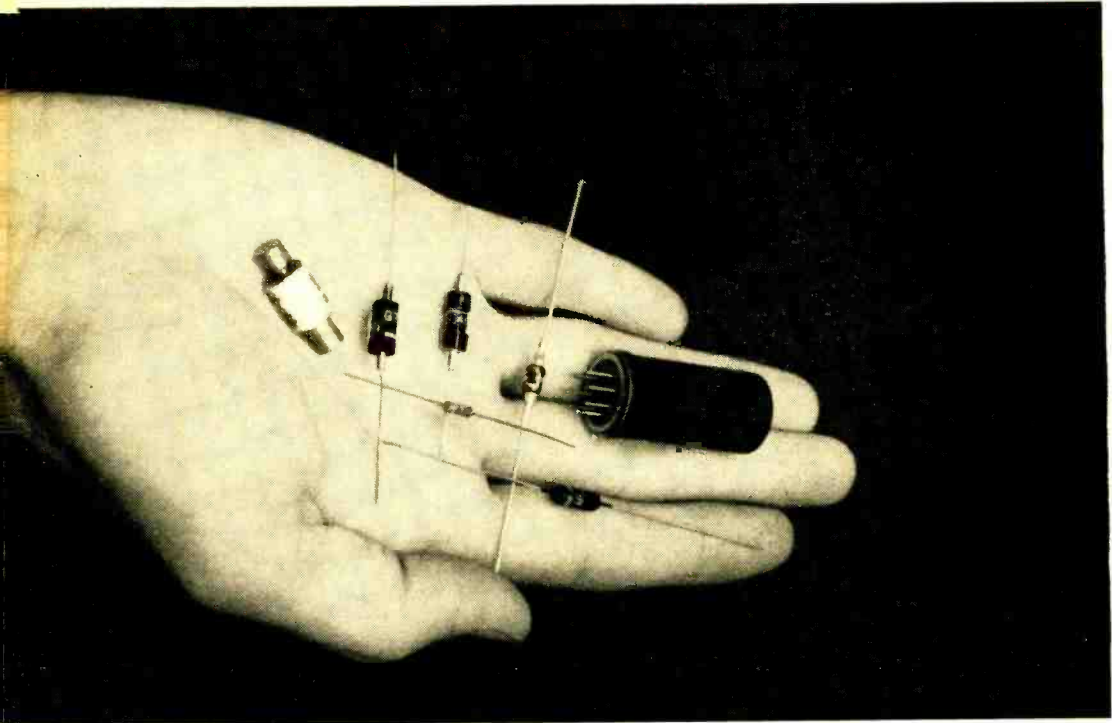

What it is
How it works
What it does

By **JIM KYLE**, K5JKX/6



A SEVEN story high intercontinental missile roars skyward on a column of fire. Within the silvery giant, hundreds of tiny semiconductor diodes control its every movement.

A television camera is focused on a man. Millions of viewers are watching. Between the man and the millions of viewers are dozens of semiconductor diodes—without them television could not function.

Older than radio itself, and once thought obsolete, semiconductor diodes today are the workhorses of the electronics industry. They form the heart of nearly all digital computers—the giant electronic brains that can predict an election outcome or control a manufacturing plant. They make radar pos-

sible. They detect radio signals, and, on occasion, generate those same signals.

What are these devices? How do they work? What are their characteristics? How are they used?

In essence, the answers are simple. First of all, a semiconductor diode is a one-way street for electric currents. It will allow the current to flow freely in one direction, but will block it almost completely in the other. Because of this characteristic, the semiconductor diode can perform a wide variety of jobs and is one of our most basic electronic servants.

HOW THE DIODE WORKS

To understand how a semiconductor diode works, let's go back a bit and examine electricity itself. An electric current is simply another name for a flow of electrons—the basic electrical charge found in all elements. Electricity flows when electrons move from one atom of a substance to the next.

In some materials—copper, silver, aluminum, and many other metals—the electrons can move easily. These substances are called *conductors*.

In other materials—glass, porcelain, hard rubber, and many plastics—the electrons can move only with great difficulty. In fact, only a very few electrons can move at all in these substances, even under great electrical pressure; and so flow of electric current through them is blocked. We call these substances *insulators*.

Between conductors and insulators are many materials which are neither good conductors nor acceptable insulators. The electrons of their atoms are free to move, but are not so free as in a conductor. These substances are known as *semiconductors*.

Types of Semiconductors. Although many semiconductors exist (most materials fall into this classification), only a few are used in electronics. Those most widely used are germanium, silicon, selenium, and copper oxide. In past years, galena (a form of lead oxide) was also used.

These particular semiconductors have a strange property. Under certain special conditions, electrons can flow *out* of them easier than *in*. Under other conditions, the situation is reversed:

electrons come *in* freely, but have difficulty getting *out*.

Since this strange property makes itself evident only when electrons enter or leave the semiconductor material, it is useful only when the semiconductor is in contact with a conductor. This contact may be made in two ways: by point contact, in which the semiconductor and the conductor make contact at only a single point; and by surface contact, in which they meet over a broad area. Each way has its advantages.

An early example of point-contact use is the old-fashioned crystal set. Invented about 1906 by two experimenters named H. H. Dunwoody and G. W. Pickard, this was the mainstay of radio for nearly 20 years. It consisted of a small piece of galena crystal and a spring-wire "cat-whisker." The user moved the cat-whisker over the surface of the crystal until a sensitive spot was located.

An example of surface-contact application is the copper-oxide stack, widely used in both test equipment and in telephone engineering. Developed about 1925, this device consists of alternate discs of lead and copper oxide, stacked face-to-face and held together by an insulated bolt through the center. It re-

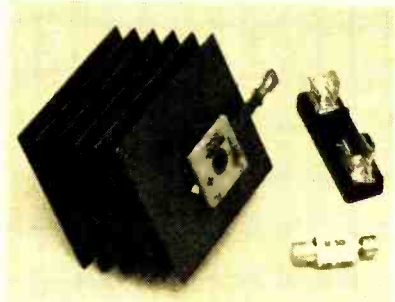

Selenium rectifiers, in use for over 25 years, are giving way to smaller silicon diodes such as Sarks-Tarzian's 1N1083.

quires no adjustment. However, technical limitations restrict its use.

Another example of surface-contact diodes is the modern grown-junction unit, such as the 1N34 so widely used by experimenters.

Electron Flow. At this point, let's narrow the field down to a typical point-contact unit such as the crystal set and

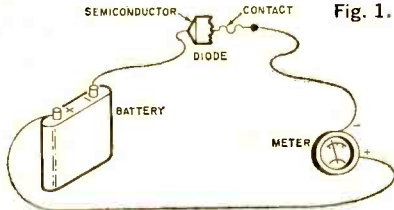
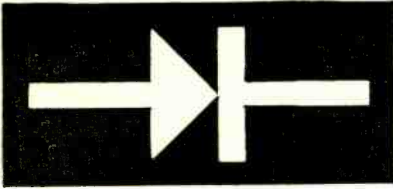

take a look at what happens when this semiconductor diode is connected to a battery and a meter. See Fig. 1.

When the battery is connected, its voltage forces electrons of the interconnecting wire into the semiconductor, across the contact point, into the conductor, through the meter, and back through the other interconnecting wire into the battery.

You can see that with the battery connected in one direction, electrons are forced *out* of the semiconductor at the contact point. If the battery's polarity is reversed, electrons will be forced *into* the semiconductor.

Let's assume that this particular diode is made from a semiconductor that is stingy with electrons; that is, it accepts electrons readily, but doesn't let go of them so easily.

When the battery is connected in the first direction, forcing electrons *out* of the semiconductor at the contact point, the semiconductor material exhibits great resistance. Only a few electrons are released to travel on through the meter and back to the battery, and so only a small current flows.

However, when the battery is reversed, we're pushing electrons *into* our greedy semiconductor, and it readily accepts all we can offer. Many electrons move through the meter, or, in other words, a large current flows.

Only the action at the contact point is important; the other electrical connection to the semiconductor material covers a much larger area and, since re-

sistance is proportional to area, has much lower resistance. However, it does contribute to the diode's *forward resistance*, which we'll talk about more a bit later.

If a different semiconductor—one that is generous instead of miserly—is used, the situation will be exactly opposite to that described above. However, the diode would still be a one-way street. The only difference is that it would be one-way in the other direction.

This one-way-street action is similar in effect to the action of a diode vacuum tube, such as the familiar type 5U4-G. In the vacuum tube, heat generated in the filament causes electrons to literally boil off its surface. When the plate of the tube is made positive, the electrons flow to it. However, since like charges repel each other, the electrons will not go to the plate when it is negative.

Pros and Cons. In both the semiconductor diode and its vacuum-tube cousins, current flows readily in only one direction. This property makes them useful in changing a.c. to d.c., and they

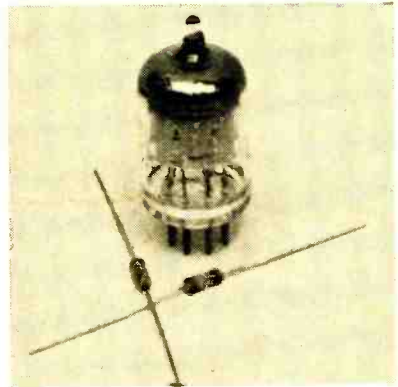

Two low-cost diodes replace 6AL5 vacuum tube, saving filament power and space.

are widely used in electronic power supplies for this reason.

A great advantage of the semiconductor diode over its vacuum-tube cousins is that the semiconductor version does not require heat to move its electrons. This eliminates the hot and power-wasting filament.

Another advantage is the smaller size possible with semiconductors. Typical semiconductor diodes are no bigger around than a pencil, and less than an

inch long—compared to the $\frac{3}{4}$ " diameter and $1\frac{1}{4}$ " length of the smallest standard vacuum diodes.

Another point of difference between the semiconductor diode and its vacuum-tube cousins—but it's not usually considered an advantage—is the matter of reverse current.

In the semiconductor diode, current flows more easily in one direction than in the other. However, in the vacuum-tube version, current can flow *only* in one direction. While the semiconductor diode is like a one-way street for electrons, the vacuum diode is more like a subway turnstile. You *can* go the wrong way on a one-way street; you *can't* go the wrong way through a turnstile.

While this might look like a big disadvantage for the semiconductor diode, it usually isn't harmful in practice. Present-day diodes may pass a million times as much current in one direction as in the other; the small number of electrons which get through the wrong way have little or no effect on diode operation.

Since the point-contact diode is the



Fig. 2.

oldest type, the standard schematic symbol for a semiconductor diode is based on it. See Fig. 2.

Regardless of whether the semiconductor is stingy or generous with electrons, the arrow of the symbol points *against* the flow of traffic in our one-way street. This confusing situation came about in earlier years, before scientists had learned as much about the diode as they know today. The original direction for the arrow was chosen arbitrarily, and the symbol had been in use for some time before they discovered the arrow was pointing the wrong way!

CHARACTERISTICS

The main property of a semiconductor diode is that it will pass current easily in one direction, and will allow only a small amount of current to flow the other way. The easy-current direction is usually called *forward*, while the other

direction, quite naturally, is called *reverse*.

Current. One of the basic characteristics on which these diodes are rated is the amount of current which the unit will let through in each direction. The ratings are listed in terms of *forward current* and *reverse current*. Forward current, i.e., current going in the easy direction, is always the larger of the two. Frequently forward current is measured in hundreds of milliamperes while reverse current is given in microamperes.

Another way of looking at these diodes is to examine their resistance. Since resistance (in ohms) is equal to the applied voltage divided by the current (in amperes) which flows through the circuit, you can see that resistance in the forward direction is much lower than resistance in the reverse direction. The more common way of putting this is to say that *forward resistance* of a semiconductor diode is low while *reverse* or *back resistance* is high.

Resistance. However, semiconductor diodes have an unusual resistance characteristic. Their resistance varies in accordance with the voltage you apply to them. At low voltages, forward resistance is high; at higher voltages, it drops. Reverse resistance, on the other hand, is extremely high at low voltages, but drops to zero or even exhibits negative characteristics at some critical point as voltage increases.

The critical point at which reverse resistance tends to disappear is called the diode's *peak inverse voltage* (usually abbreviated PIV) and is a key characteristic of power rectifiers.

Engineers call a resistance characteristic of a semiconductor diode *nonlinear*, because the plotted line on a graph comparing voltage against current appears as a curve instead of a straight line. The nonlinear resistance of the semiconductor diode makes it useful as a detector, as a mixer, and as a modulator;

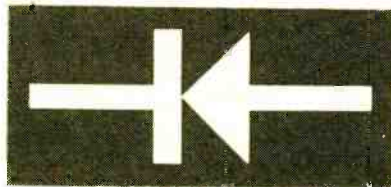



however, the nonlinear resistance also makes it difficult to specify any other diode characteristic. For instance, a vacuum diode can be rated for 300 milliamperes of current, and this will be true at any voltage. Before a semiconductor diode can be rated, however, you must specify the voltage.

The same is true of the all-important reverse resistance rating. The same diode may have a reverse resistance of one megohm, less than an ohm, or even negative 100 ohms, depending entirely upon the voltage at which the reading is taken.

Voltage. All diode characteristics, therefore, are given in terms of current at some specified voltage. Different manufacturers use different voltages, and to complicate things still more, some firms rate different diodes at different voltages. This makes comparison of two diodes, on the basis of rated characteristics, almost impossible unless both are rated under the same conditions.

Manufacturers of diodes, however, furnish another item which can help you avoid this problem—the *characteristic curve* of the diode. See Fig. 3.

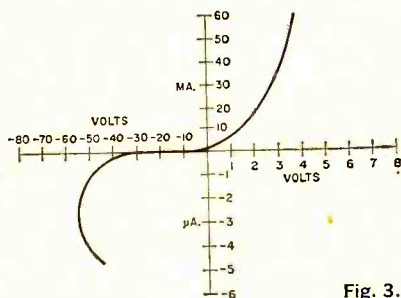

Fig. 3.

The vertical scale in Fig. 3 shows current; the horizontal scale, voltage. Note that forward voltages and currents are

expressed in larger units than are reverse values; this is customary in the preparation of diode characteristic curves.

With a set of characteristic curves, you can determine the characteristics of a diode at any operating point. Simply look up the current value for the voltage you intend to use, and determine the resistance by using Ohm's law. To compare two different diodes, compare the shape of the curves.

Bias. A term worth mentioning at this point, since you'll hear it frequently in dealing with semiconductor diodes, is *bias*. Bias consists of a voltage applied to a diode to make it operate at the point desired by the designer. If the voltage applied causes forward current to flow, it's called *forward bias*. If it's applied in the reverse direction, the term is *reverse bias*. A diode to which such a voltage is applied is said to be *biased*.

In addition to the major characteristics which we've examined so far—forward current, reverse current, forward resistance, reverse resistance, and peak inverse voltage—semiconductor diodes have two more important characteristics. They are the *thermal characteristic* and *diode capacitance*.

Temperature. "Thermal characteristic" simply is a fancy way of saying "how heat affects the diode." We stated earlier that in the vacuum-tube diode electrons were boiled off the filament by heat. Actually, heat increases the movement of all electrons, something like popcorn on a hot stove. At high temperatures, the electrons move more freely.

Up to a certain point, heat has little effect on a semiconductor diode. Al-

Power rectifier diodes come equipped with screw studs for mounting to heat sinks. Unit shown here is rated at 70 amperes.



though reverse current increases slightly, forward current increases in the same ratio. At the critical temperature, however, the crystal structure breaks down and current flows just as freely in either direction. Some diodes recover when they are cooled, while others are ruined for good.

The manufacturer usually rates his product to be used within a certain temperature range, and this range is generally far greater than the temperatures at which you are likely to use it (a typical operating range is from 40 degrees below zero to 300 degrees above). However, if excessive current is sent through the diode in either direction, it may heat—internally—to a point far above the critical breakdown temperature. This is the most frequent cause of diode failure.

Capacitance. The last major characteristic is diode capacitance. A capacitor, by definition, is made up of two conductors separated by a dielectric. Thus, the semiconductor material itself can be the dielectric of a capacitor whose plates are the conductors on either side.

Actually, the physicists tell us, most semiconductor diodes show a greater capacitance than we would expect, due to something called the *barrier effect*. This is a function of the applied voltage. As a result, the capacitance of a semiconductor diode changes with the voltage in a manner similar to the diode's resistance.

This capacitance has little effect on forward resistance or forward current, since the diode is conducting and the capacitance is shorted out. However, the diode's capacitance can be important when the diode is not conducting, since the capacitance will allow very-high-frequency alternating currents to pass.

Most semiconductor diodes have a capacitance in the neighborhood of 3 to 5 $\mu\mu\text{f}$. Those diodes built especially for use at radar frequencies have even less capacitance.

HOW DIODES ARE USED

Of what practical use is the semiconductor diode's one-way-street property? One of the more obvious applications is in changing alternating current into direct current, such as in a receiver's power supply. The diode is simply connected

in series with the a.c. coming from the transformer. Those half-cycles which constitute forward voltage go through the diode into the filter circuit, while half-cycles of inverse voltage are blocked.

Half-Wave Rectifier. The circuit in Fig. 4, called a half-wave rectifier, is the simplest possible, but it is hardly the

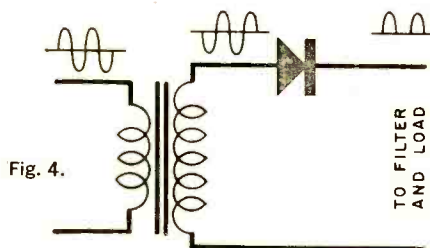

Fig. 4.

most efficient. Half of the a.c. power is not used. However, by connecting three additional diodes into a "bridge" circuit, the half-cycles of opposite-polarity a.c. can be steered in the proper directions so that both halves of each cycle are used and yet the power supplied to the filter is direct current. Refer to Fig. 5.

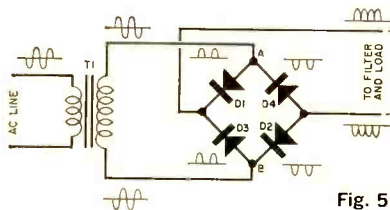
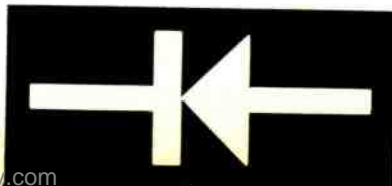

Fig. 5.

When the voltage at point A in Fig. 5 is positive, the voltage at point B will be negative, since the supply voltage is alternating. The electrons flow from point B through diode D2 to the filter and load circuit, and are blocked at D3 and D4 since their reverse resistance is high. From the load and filter, the electrons return through diode D1 to point A.

On the other half-cycle, electrons flow from point A through diode D4 to the filter—being blocked at diodes D1 and D2 by the reverse resistance—then return to point B through D3.

Other rectifier circuits using more than



one diode are popular. They include voltage multipliers which make it possible to obtain as much as 1000 volts of direct current from a 117-volt power line without using transformers, dual-voltage circuits which provide two different direct voltages from one transformer, and "bias-supply" circuits which can be made to fit into less space than a conventional vacuum-tube rectifier alone.

The semiconductor diode most widely used for power supply rectifiers is the selenium stack. However, silicon junction diodes capable of handling four to five times the current of the selenium stack in one-tenth the space are rapidly becoming popular.

Diode Detector. The semiconductor diode also finds wide use in radio receivers, television sets, radar, and test equipment, as a detector of r.f. power.

The circuit of the diode detector is identical to that of the half-wave recti-

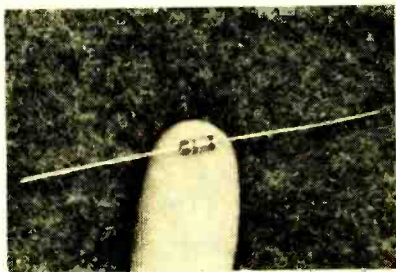

Small semiconductor diodes have axial leads, eliminating the need for sockets.

fier—it contains a source of power, the diode, and a load, all connected in series. However, the operation is slightly different.

During each cycle of r.f. energy, the diode allows current to pass in the forward direction but blocks the flow of reverse current. The current flowing in the forward direction produces a voltage drop in the load resistor which is paralleled with a low-value capacitor. If the

strength of the r.f. power is changing, the d.c. voltage across the load resistor will change at the same rate. And if this change occurs at an audio frequency, the voltage across the load resistor will vary at the same a.f. rate.

The average strength of the d.c. voltage across the detector load resistor is proportional to the average strength of the r.f. voltage applied to the circuit. In radio receivers, this effect is used to provide *automatic volume control*, while in test equipment it is used to measure r.f. with a conventional d.c. voltmeter.

Vacuum-tube diodes, which operate in similar fashion, can be used for these purposes at moderately high frequencies. However, at the extremely high frequencies used in radar, they fail to function properly. Here, the semiconductor diode's very low capacitance makes it the only usable detector.

Computer Circuits. A few paragraphs earlier, we met the bridge rectifier circuit, and saw how the semiconductor diode was capable of steering an incoming signal into one of several directions. This property is widely used in computer circuitry, where the proper combination of diodes can actually make logical decisions.

A basic circuit of this type is shown in Fig. 6. This circuit is exceptionally

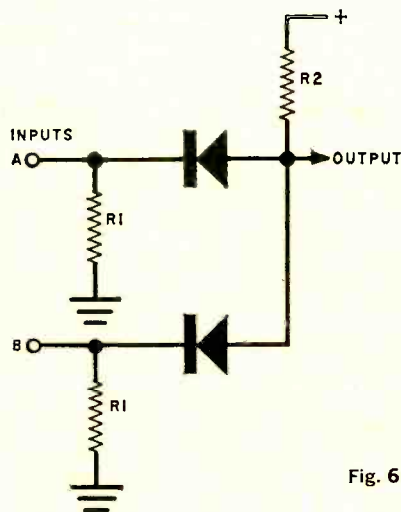
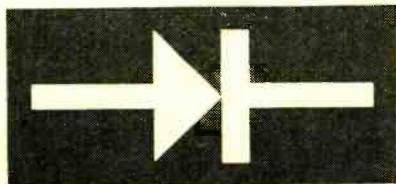

Fig. 6.

choosy—it will produce an output signal only if you give it signals at both of its inputs. If you give it a signal at only one of the input terminals, it produces

nothing. This is called a logical "and" circuit, since it must have both signal *A* and signal *B* to provide an output. Another way of putting it is to say that the circuit must decide whether both inputs are present before deciding to produce an output.

With no input signals applied, both diodes are biased in the forward direction by the positive voltage through $R2$; $R1$'s value is very much less than that of $R2$, so the output is nearly zero. With a positive input signal applied to either *A* or *B* but not to both, the diode without an input signal still shorts the voltage from $R2$ through $R1$ to ground and no output is developed. However, with positive input signals applied to both *A* and *B* at the same time, both diodes are biased in the reverse direction. Current through $R2$ meets the high reverse resistance of the diodes, and in consequence is shunted through the output circuit.

Typical values for $R1$ and $R2$ are 10 ohms and 10,000 ohms, respectively. The voltage source is usually about 12 volts.

Similar circuits are used to develop outputs if a signal is applied to either input; to develop output if a signal is applied to either input but not to both; and to develop output at all times except when a signal is applied to both inputs.

Circuits such as these form the basis of many of the giant computers. Each circuit is simple enough, but a typical computer may contain literally thousands of them. The semiconductor diode makes this possible; if you were to try to use vacuum diodes in its place, you would find that filament power requirements alone would mount to hundreds of kilowatts!

Automatic Noise Limiter. Another use of the semiconductor diode's "gating" ability is in the automatic noise limiter found in many ham-type radio receivers. The purpose of the noise limiter is to steer the desired audio signals to the loudspeaker, and to gate any noise bursts caused by passing cars or by static crashes to ground.

While dozens of noise-limiter circuits exist, the circuit shown in Fig. 7 is one of the simplest and is unusually effective on many types of noise.

With no noise, the limiter diode is forward-biased by the d.c. voltage devel-

Fig. 7.

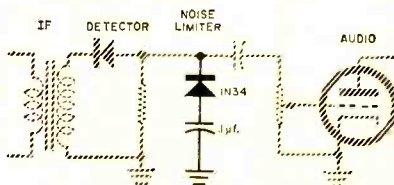

oped across the detector load resistor, and it conducts until the capacitor charges to the value of this voltage. At this point, the bias on the limiter diode drops to zero.

Remember that when we were discussing the nonlinear resistance of the diode, we found it had high forward resistance at low voltages, and low resistance at higher voltages? With no noise, and consequently no bias, the diode's resistance is high and the capacitor is effectively out of the audio circuit.

However, when a noise pulse—whose voltage is much higher than the average signal—comes along, the picture changes. The diode is once more biased to a low-resistance point, and gates the noise pulse through the capacitor to ground. As soon as the pulse is gone, diode resistance returns to its normal high value.

Mixers. Semiconductor diodes are also widely used as mixers in extremely high frequency superhet receivers, such as radar and microwave-relay sets. In this application, they outperform any available tube. In fact, much of the progress that separates today's semiconductor diodes from the ancient crystal set can be traced to World War II development of the diode for use in radar sets as the mixer element.

A complete explanation of this form of diode operation requires pages of mathematical equations; in simplified form, this is how it works:

The diode is connected to the antenna of the set, and is also connected to a local oscillator whose frequency is separated from that of the incoming signal by some small, desired amount. Signals coming from the antenna mix, in the

diode, with those from the local oscillator.

The diode's output, you can see, will consist of pulses of direct current occurring on each half-cycle of the antenna signal, and other pulses every half-cycle of the local-oscillator signal. In addition, however, two new signals are created. Their frequencies are equal to the sum and the difference of the antenna and local-oscillator signals, and their strength is proportional to the product of the two input signals.

Since only the incoming antenna signal is changing in strength, the difference signal will be a replica of the antenna signal but at a lower frequency. Thus, the tricky microwave signal is converted to a lower frequency signal which can be handled by more conventional means.

Semiconductor diodes excel as microwave mixers because of their extremely low capacitance. Other types of mixer circuits fail to operate at frequencies higher than about 900 megacycles, but semiconductor diode mixers continue to operate up to 30,000 mc., and some new types promise to work at even higher frequencies.

Special Uses. Many special-use circuits have been developed around semiconductor diodes. Telephone engineers use diodes as modulators, making use of the nonlinear resistance. Under certain conditions, the resistance of a diode can become negative—and it can then be used as an oscillator. Under other conditions, diode capacitance can be varied at an extremely rapid rate—and this leads to the “parametric amplifier” which makes possible communication by moon-bounce and radar contact with distant planets.

“Special” Diodes. The many uses we've listed so far for the semiconductor diode barely begin to show the variety of jobs to which this electronic workhorse is hitched daily. In addition to conven-



Packaging of diodes in tube shells permits replacement of 5U4, 5W4, 5Y3, 6X4 and other rectifiers. Cartridge-cased diodes are used in the newer TV sets.

tional diodes such as we have discussed, there are dozens of “special” diodes in which one characteristic or another is stressed, and more new types are being developed every month.

Among these “special” diodes are the tunnel diode, which operates at speeds near that of light; the Zener diode, which can regulate voltages in the same manner as a VR tube; and the voltage-variable capacitor—which is really a diode at heart.

Yes, the semiconductor diode has traveled a long way since its original discovery in 1874, 13 years before Dr. Heinrich Hertz discovered radio itself. From the primitive crystal set and crude copper-oxide stacks, through the sealed-unit microwave mixers of World War II and into the era of the junction diode (announced in 1948), it has been one of the most basic, most useful, and least understood of our electronic servants. Overshadowed in the early 1920's by its bigger and hotter rival, the vacuum tube, the semiconductor diode is only now regaining its place—as electrons' one-way street.

-30-

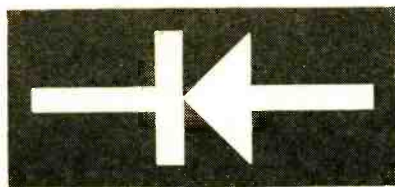

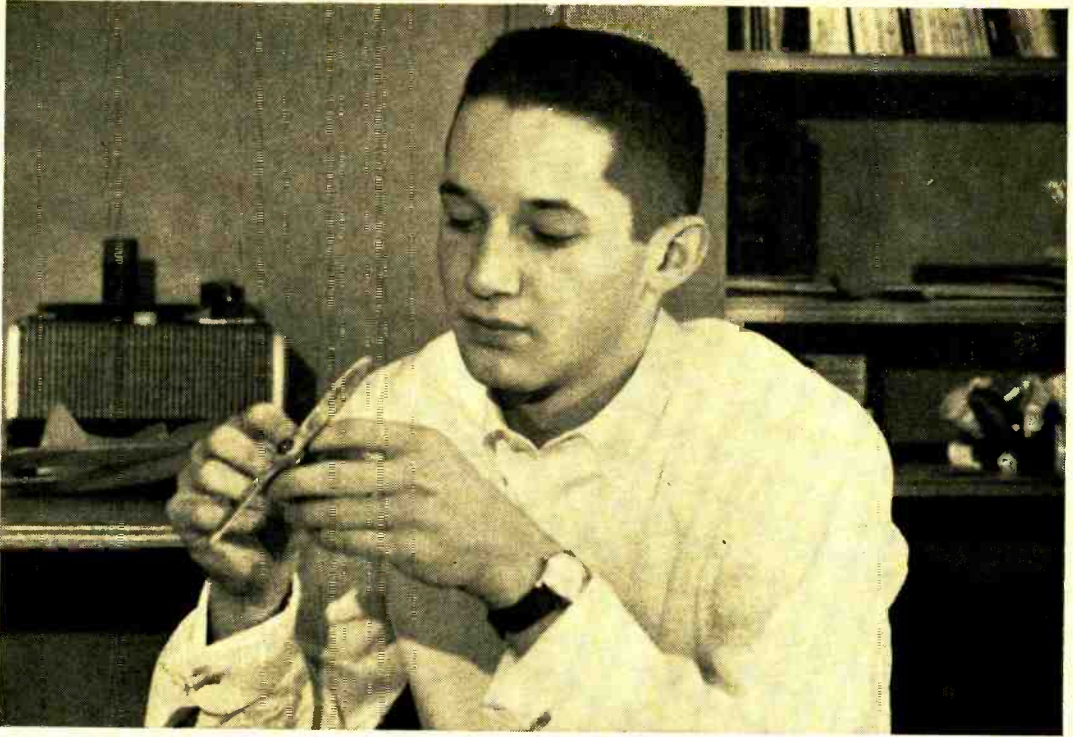

Career-minded Jay C. Douglass of Elizabethtown, Pa., asked...

“How should I get started?”

This year some 100,000 ambitious young people will answer this question the same way Jay Douglass did—they will become members of the Air Force. The road they will start upon leads straight into the Aerospace Age. And the organization of which they will become a part is the most important one in our world. For it is our country's first line of defense.

In time to come many of these young men will advance to the role of skilled technicians in such fields as airplane and missile maintenance, communications

equipment, computers, radar. A number of these young men will enter the vital support specialties—administration, supply, air police...to name a few. Any one of these career fields holds the promise of a bright and rewarding future—a future *you* should know about in detail right now.

Getting started in the right job, is important to any young man...or any young woman. To find out if your start might best be made in Air Force blue, clip and mail this coupon.

U. S. Air Force



Airman 2C Douglass is presently working as an electronics specialist at Duluth Air Base, Minnesota. As Air Force aptitude tests indicated, he finds he can handle his job well. He feels he has made a good start.



Career Information

Dept. MP15, Box 7608
Washington 4, D. C.

I am a citizen (or resident) of the U.S.A. Please send me your illustrated booklet.

Name _____ Age _____

Address _____

City _____ County _____ State _____

A PROPHECY

For men and women with a sincere desire to succeed



"In the years that have passed since my days on the faculty of RCA Institutes, I have become even more firmly convinced that the individual who continues his education . . . particularly his technical education . . . is the individual who profits both as a thinking man and as a working man. Science and industry will reward you for your talents and energy. Out of your efforts may come inventions, new products, processes and services. There is everything good yet to be accomplished in our lives and in our work. What man has done, man can do better."

A handwritten signature in dark ink, reading "David Sarnoff". The signature is written in a cursive style with a horizontal line underneath.

Chairman of the Board,
Radio Corporation of America

RCA Institutes Offers the Finest of Home Study and Resident Training for Your Career in the Rapidly Expanding World of Electronics

RCA Institutes, founded in 1909, is one of the largest technical institutes in the United States devoted exclusively to electronics. A service of Radio Corporation of America, RCA Institutes offers unparalleled facilities for technical instruction . . . tailored to your needs. The very name "RCA"

means dependability, integrity, and scientific advance.

RCA Institutes Home Study School, licensed by the New York State Department of Education, offers a complete program of integrated courses for beginners and advanced students rang-

ing from electronic fundamentals to automation. All courses are designed to prepare you for a rewarding career in the rapidly expanding world of electronics. *The caliber of the training you receive is the finest!* And you get top recognition as an RCA Institutes graduate!

HOME STUDY COURSES *in* *Electronic Fundamentals • TV Servicing* *Color TV • Electronics for* *Automation • Transistors*

Voluntary Tuition Plan. The important thing to remember about RCA Institutes Training is the convenient, *no-obligation payment plan*. This plan affords you the most economical possible method of home study training because you pay for each study group only when you order it. If you interrupt your course *at any time, for any reason*, you owe nothing more. You *never* have to pay for the whole course if you don't complete it. No other obligations. No monthly installment payments!

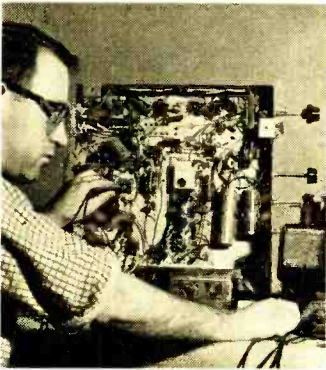

RCA Instruction is Personal. With RCA Home Study training you set *your own pace* in keeping with *your own ability*, finances, and time. The Institutes allows you ample time to complete the course. Your lesson assignments are individually graded by

technically trained personnel, and helpful comments are added where required. You get theory, experiment, and service practice beginning with the very first lesson. All lessons are profusely illustrated. You get a *complete training package* throughout the entire course.

You Get Prime Quality Equipment. All kits furnished with the course are complete in every respect, and the equipment is top grade. You keep all the equipment furnished to you for actual use on the job... *and you never have to take apart one piece to build another!*

* * *

RESIDENT SCHOOLS *in* Los Angeles and New York City train you for any field of Electronics you may choose!

No Previous Technical Training Required For Admission. RCA Institutes Resident Schools in Los Angeles and New York City offer training that will prepare you to work in re-

warding positions on research and production projects in fields such as automation, communications, technical writing, television, computers, and other industrial and advanced electronics applications. Even if you did not complete high school, RCA will prepare you for such training with courses specially designed to provide the basic math and physics required for a career in electronics.

Free Placement Service. RCA Institutes graduates are now employed in important jobs at military installations such as Cape Canaveral, with important companies such as IBM, Bell Telephone Labs, General Electric, RCA, and in radio and TV stations all over the country. Many other graduates have opened their own businesses. A recent New York Resident School class had 92.06% of the graduates who used the Free Placement Service accepted by important electronics companies... *and had their jobs waiting for them on the day they graduated!*



Coeducational Day and Evening Courses. Day and Evening Courses are available at Resident Schools in New York City and Los Angeles. You can prepare for your career in electronics while continuing your normal full-time or part-time employment. Regular classes start four times each year.



**SEND POSTCARD FOR FREE
 ILLUSTRATED BOOK TODAY!
 SPECIFY HOME STUDY OR
 RESIDENT SCHOOL**

RCA INSTITUTES, INC. A Service of Radio Corporation of America 350 W. 4th St., N.Y. 14, N.Y. • 610 S. Main St., Los Angeles 14, Calif.



The Most Trusted Name in Electronics

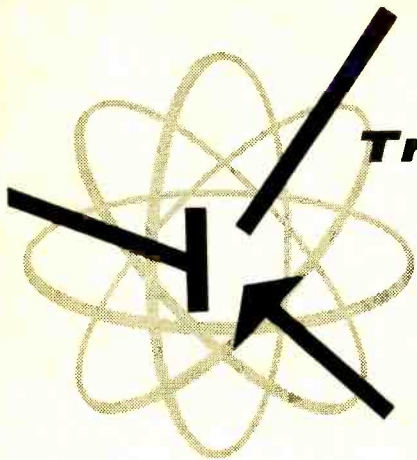

Transistor Topics

By LOU GARNER

Although the transistor is still "top dog" in its field, other types of semiconductor devices are rapidly assuming new importance on the industrial scene. However, except for such familiar units as signal diodes, power rectifiers, controlled rectifiers, Zener diodes, and photocells (including "sun batteries"), most of the newer devices have not yet found their way into mass-produced products.

As a general rule, really new components are not used in large quantities until after they have undergone a "breaking in" period. During this time manufacturers conduct extensive performance and reliability tests, and make careful comparisons between the new devices and more familiar units. Only after design engineers are convinced that the new components offer real advantages over older units, either in terms of improved performance, better reliability, or lower production costs, will they start incorporating the devices into new product designs.

Where larger manufacturers are concerned, the delay between the announcement of a new device and its actual use in mass production may range from as little as two to as many as six years. As a result, small manufacturers with more flexible schedules, custom builders, and home experimenters are usually the first to use new devices.

As an example, the tunnel diode—al-

though introduced many, many months ago and now being produced in a variety of types by most major semiconductor manufacturers—has only recently found its way into production equipment. Several firms are producing low-power u.h.f. signal generators featuring tunnel diode oscillators. Similarly, the high-gain ARA Composite transistor is still used in rather limited quantities, principally in precision servo systems and control devices.

Among the other new semiconductor devices which are not yet being used in quantity—but from which we may expect to hear great things in the future—are the *Varactor* diode, the *Frigistor*, and Raytheon's interesting *Raysistor*.

The *Varactor* diode probably will find its major application in microwave communications, possibly in conjunction with tunnel diode circuits. Useful in the 2000- to 20,000-mc. range, a Varactor diode acts as a variable capacitor (hence the name . . . *Variable reactor*). In operation, these units can take a microwave signal and kick it to a higher energy

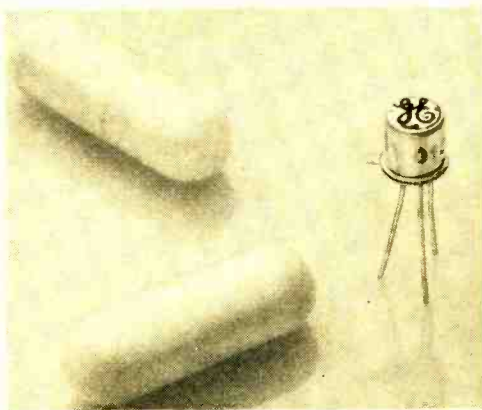

Tunnel diodes, such as the General Electric unit shown here, are now coming into widespread use.

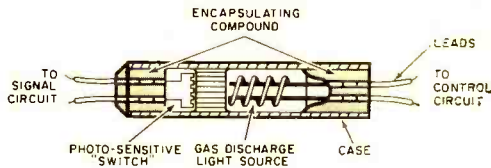

Fig. 1. Cross-sectional view of Raytheon's new Raysistor, a unique device which combines electro-optical techniques with a semiconductor element.

level by phasing in a "pump" signal generated by another source within the circuit. They are still quite expensive—a series of seven gallium arsenide types introduced recently by RCA sell for from \$200 to \$700 each.

The *Frigistor* is a semiconductor element which can be used for heating or cooling, depending on the polarity and amplitude of current passed through it, and can also be used as a source of electric power when heated by an external source. A single small Frigistor heated to 100°C can supply over 1000 ma. at 100 millivolts. Prices range from \$23.00 for a single element to \$440.00 for a multi-element unit. For the serious experimenter, the General Thermoelectric Corporation (Box 253, Princeton, N. J.) offers a "Thermoelectrical Experimental Kit" at \$500.00; the kit includes a pair of Frigistors, heat sinks, various adapter plates, heater assemblies, thermometers, thermistors, insulation material, a d.c. power supply, and an assortment of component parts, as well as a comprehensive manual of experiments.

Raytheon's *Raysistor* is a four-terminal electro-optical device incorporating a light source and a photosensitive semiconductor element. A cross-sectional view of a typical unit is shown in Fig. 1, the device's schematic symbol in Fig. 2. In operation, the application of a control signal to the light circuit excites the semiconductor, dropping its effective resistance by a factor of about 1,000,000. Thus, the semiconductor is, in effect, a light-sensitive switch which can open or close an external signal circuit. Either a.c. or d.c. control currents can be used and the switched signal can be either a.c. or d.c. Unlike most non-mechanical control devices, there is no electrical connection between the control and sig-

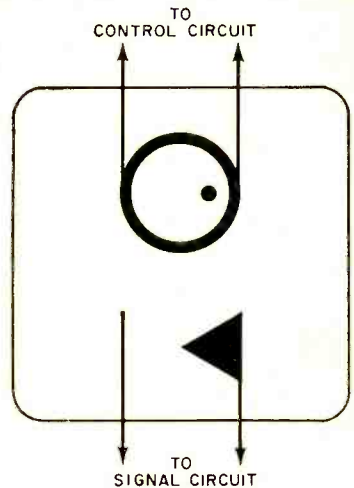

Fig. 2. Schematic symbol for the Raysistor. Note that there isn't any electrical connection between the control and signal circuits.

nal circuits. The Raysistor's potential applications are as control links in a.g.c. loops, relays in control devices, modulators or choppers, and elements in logic and computer circuits. It is priced at about \$11.00.

Reader's Circuit. A self-contained audio source can be a valuable addition to the home electronics workshop. If you're interested in stereo recording, for example, you can use the device as an aid to microphone placement . . . and it can serve in a similar capacity when you're setting up a multi-microphone p.a. installation. Such a unit is useful, too, for a "one-man" check-out of transceivers, wireless broadcasters, detectaphones, and intercom installations. In addition, if the on-off switch is paralleled with a standard handkey, the device can be used as a code practice oscillator. These applications, together with the circuit in Fig. 3, were suggested by reader Eugene Richardson of Alexandria, Va.

Referring to the schematic diagram, a *pnp* power transistor (*Q1*) is used as a modified Hartley oscillator, with the tapped secondary winding of a "universal" output transformer (*T1*) serving both to provide the feedback necessary to start and sustain oscillation and as an auto-transformer matching the transistor to a PM speaker's voice coil. Base bias is furnished through the trans-

former winding and series limiting resistor $R1$, shunted by resistor-capacitor network $R2-C2$.

The circuit's operating frequency is determined in part by the transformer's characteristics, by a shunt capacitor ($C1$) across part of the transformer's normal "primary" winding, by the speaker loading, and by the RC network

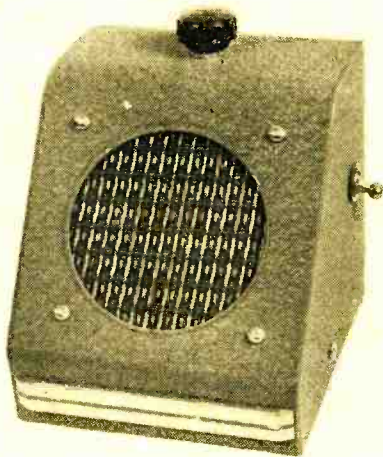

Audio tone source submitted by reader Eugene Richardson is housed in meter case. Control on top adjusts frequency.

($B1$) is made up by connecting two (or more) standard flashlight cells in series; three volts delivers quite ample room volume, but up to six volts can be used if a 470-ohm resistor is substituted for $R1$.

Neither parts layout nor lead dress is critical. The circuit can be assembled on a fiber or plastic board or on a small metal chassis, with the unit itself installed in a small Minibox, cigar box, second-hand intercom cabinet, or whatever else is available. Gene assembled his unit in a sloping front meter case (see photo) and used conventional chas-

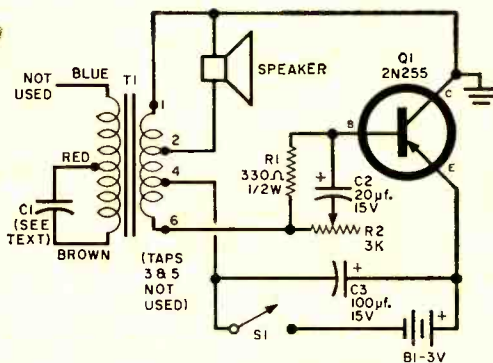

Fig. 3. Schematic diagram of audio tone source. Using a power transistor, it provides good loudspeaker volume.

across the base resistor. Adjusting $R2$, then, permits some control over output tone. Operating power is supplied by a 3- to 6-volt battery ($B1$) controlled by s.p.s.t. switch $S1$.

All parts are standard and readily available through local as well as mail order suppliers. Transformer $T1$ is a tube-type "universal" output transformer such as a Merit Type A-2900 or Stancor Type A-3856; the PM speaker is a 4" to 6" unit with a 3.2-ohm voice coil. Capacitor $C1$ is optional, depending on output tone desired, but may be a 400-volt tubular paper type with a value of from .0005 to .002 $\mu\text{f.}$; $C2$ and $C3$ are 15-volt electrolytics. Resistor $R1$ is a standard half-watt carbon unit and $R2$ is a standard potentiometer; $S1$ may be a toggle, slide, rotary, or push-button switch (or a handkey if you wish to use the device as a CPO). The power supply

construction; he points out that the circuit design permits the transistor's collector to be connected directly to "ground," facilitating the mounting of the power transistor.

Once the unit is assembled, double-check all connections *before* installing the battery or turning the unit "on," paying particular attention to electrolytic and battery polarities. It's usually best to leave $C1$ disconnected and to determine its value by experiment after the basic oscillator circuit has been tested, with the final value chosen to give the tone range desired. Too large a value for $C1$ will "kill" oscillation.

New Transistors. Texas Instruments (P.O. Box 312, Dallas 21, Texas) has introduced two ultra-fast switching transistors made by the epitaxial manufacturing process. These are the first

(Continued on page 124)



Short-Wave Report

By **HANK BENNETT**
W2PNA/WPE2FT

CALIBRATING A RECEIVER

YOUR Short-Wave Editor is frequently asked how a listener can determine the exact frequency of a station—especially when the station does not announce its frequency and when the listener does not have a listing of stations and their frequencies. Judging from many reports, some listeners—especially newcomers to the hobby—often have to resort to pure guesswork.

Many receivers simply are not calibrated nearly as well as we would like. Even the higher priced models are liable to be off frequency—one of the receivers

used by your Short-Wave Editor leaves a lot to be desired at the high end of the 19-meter band. Then, adding to the already present confusion is the failure of some stations to announce their frequency *correctly*; a glaring example is *Radio Congo's* statement, made over a period of time this past winter, that they were operating on 11,795 kc. when in reality they were on 11,755 kc. And another ever-present pest is the station that could best be described as a "channel-hopper"; it moves around from place to place, probably for very good reasons, but it keeps the listener in a constant quandary.

Ever hear of a crystal calibrator? It's a pocket-sized instrument that amateurs



Giacomo Perolo, PY1PE1D, of Bauru, Brazil, has 100 veries from 69 countries in his collection. Receiving on a Hammarlund HQ-100, he also uses a preselector/booster and 100-kc. calibrator (both home-built) plus a tape recorder. Giacomo is Short-Wave Manager for PRG8-ZYR31, Bauru Radio Clube.



as well as SWL's call on for checking receiver dial calibration and band limits, and even for receiver r.f. alignment. In fact, it's a useful tool in any phase of radio where accurate marker signals at multiples of 100 kc. come in handy.

Say that you have a crystal calibrator and want to know what frequency a certain station is on. Let's assume that you know you are tuned to London but that you don't know which channel it is. You do know, though, that it's around the middle of the 9-mc. band. The crystal calibrator is turned on. You set your receiver to a *known* frequency (WWV on 10,000 kc., for example). Then you count the number of 100-kc. beats down to your station with the unknown frequency.

Let's assume that you find your station between the fourth and fifth beats. This would mean that your London outlet is between 9500 and 9600 kc. Now perhaps you can get your bandspread set so that both the fourth and fifth beats appear within the bandspread range. Using a piece of graph paper to

plot the frequency, or even just approximating it, you'll find that London is actually on 9510 kc.

If you're a do-it-yourself'er, we think you'll find the Heathkit HD20 crystal calibrator to your liking. A handy little (2½" x 4½" x 2⅝") piece of equipment available in kit form from the Heath Company, Benton Harbor, Mich., it provides an accurate signal source with output signals at 100-kc. intervals all the way up to 54,000 kc.—well beyond the range of frequencies covered by the majority of SWL receivers. The HD20 uses a 100-kc. crystal, a 2N409 transistor, and a 9-volt battery, all of which are included in the kit.

Did we hear you say that you were afraid to tackle a kit because you don't know anything about construction? Forget it! A booklet that comes with the HD20 very clearly describes the complete construction in both words and pictures. If you can handle a soldering iron, you should be able to do the job in one evening.

(Continued on page 120)

Simple graph showing how a crystal calibrator is used to find frequencies of short-wave stations.

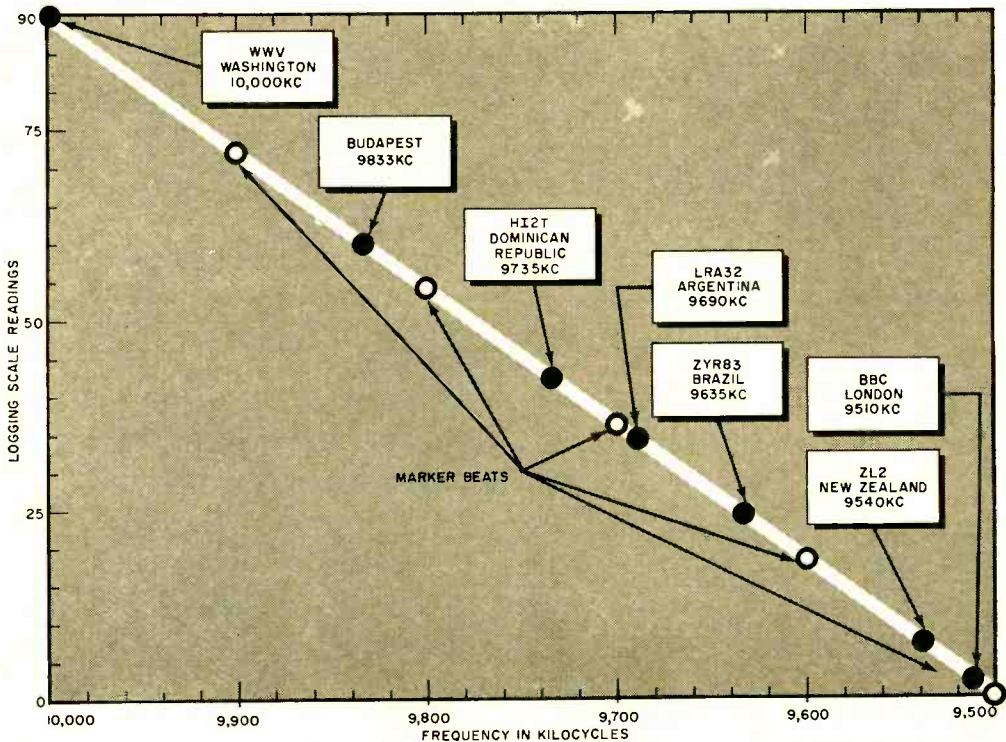



By
JOHN T. FRYE
W9EGV

Carl and Jerry

Operation Worm Warming

CARL AND JERRY were riding along the river road on a beautiful afternoon in early May. Carl was driving, and Jerry was sitting beside him holding a compact battery-operated 75-meter transceiver on his knees. The bright day seemed all the brighter because it had arrived after almost a solid week of heavy rain.

"Jer, do you think we'll be able to hear that transmitter back in our laboratory?" Carl asked.

"I'd hate to say," Jerry answered. "We'll only be four or five miles from it, and it'll be running a hundred and fifty watts input; but a transmitting antenna consisting of the outside shield of fifty or sixty feet of RG-8/U coax cable running inside a sewer isn't the best radiator in the world. You said the signal was only S3 at your place right next door.

"But from what I've been reading," he continued hopefully, "it's barely possible we may be able to hear the signal down in that limestone cave along the river. Anyway, if we can't hear the signal, we can do some plinking with your .22; so the afternoon won't be wasted."

"That coax pushed into the basement drain a lot easier than I expected," Carl observed; "and it certainly loaded the transmitter. What time did you set the timer to turn on the transmitter and start the automatic keyer?"

"Three o'clock. That will give us plenty of time to rig up an antenna inside the cave. The transmitter will send 'A' over and over for a full half hour before shutting itself off."

"Has anyone had much luck sending radio signals through the earth?"

"Well, in May, 1959, the Space Elec-

tronics Co. people sent a message from an abandoned borax mine at Boron, California, to a point more than 100 miles away. During the past thirty years many individuals and commercial concerns in different parts of the world have carried on experiments designed to send

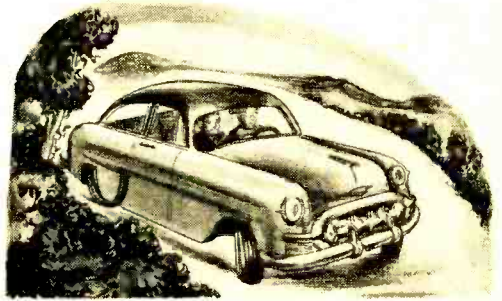

signals through the earth; until recently, though, most of them have been failures or very limited successes.

"But the attention paid to this kind of communication has increased sharply the last few years. The military is very much interested in a transmission system buried deep in the earth and not dependent on vulnerable transmission lines, relay towers, and so on. Even an atomic attack could not destroy such a system. Millions of dollars are being spent on underground radio communications experiments right now."

"How did Space Electronics send the message?" Carl wanted to know as he pulled the car off the road and parked it beneath an overhanging limestone cliff.

"The signal from the transmitter went up to the earth's surface and excited the ground-atmosphere interface. Because of the discontinuity between the

conducting earth and the non-conducting atmosphere, the waves traveled along this interface in a manner similar to the way a high frequency travels along the outside surface of a conductor. When the signal came to a point above the receiving station, it went down through the earth to the receiver."

"Is that the way you think the signal will travel from our sewer antenna to the cave?"

"No, I'm hoping we may hear the signal through wave-guide action. You see, beneath the earth's topsoil are layers of sedimentary rock—some wet, some dry. The wet layers act as the boundaries and the dry layers as the interiors of natural wave guides, and a radio wave of the proper frequency can go along between two wet layers just as a u.h.f. signal goes along a metal wave guide. Right now the soil itself is sopping wet with the rain. I'm hoping that the soil will form the top and that a wet layer of sedimentary rock down below will form the bottom of a wave guide which will lead the signal right into our cave. It'll be more luck than sense if it does, but we'll never know until we try."

"Okay," Carl said as he got out of the car. "I'll take the rifle, the gasoline lantern, and the bundle of dowel sticks; you bring the transceiver and that old field coil from a dynamic speaker. We want to string up as much antenna as we can, and there must be half a mile of fine wire on that coil."

THE BOYS began walking down the steep path that led to the river and the cave entrance, but they started to slide and ended up on the rocky ledge bordering the stream amid a small landslide of loose stones and muddy earth.

"Whew!" Carl exclaimed as he picked himself up and brushed off his clothing; "that ground is sure soft. It's a good thing the rain stopped when it did or

the road would be sliding down into the river."

A few minutes later they were back a couple of hundred feet in the narrow, twisting cave that ran into the limestone bluff.

"Guess we may as well set up shop here," Carl said as he held the lantern high above his head and looked around. "I've never gone beyond this point myself, but I think the cave peters out pretty quickly. You check out the receiver, and I'll string up some wire for an antenna."

The boys had brought along the transceiver because it contained the only battery-operated receiver they had. Jerry placed it on the dry floor of the cave and prepared it for operation. Carl stuck short pieces of the small dowel stick into crevices in the cave walls and strung the fine enameled wire stripped from the speaker field coil on these crude but adequate insulators. He snapped the end of the wire loose from the spool, and Jerry scraped off the insulation and fastened it to the antenna post of the receiver.

They tuned the receiver back and forth across the 75-meter phone band and the adjacent 80-meter c.w. band with the beat frequency oscillator turned on, but were unable to hear that first weak heterodyne even though they knew the band must be busy on a Saturday afternoon.

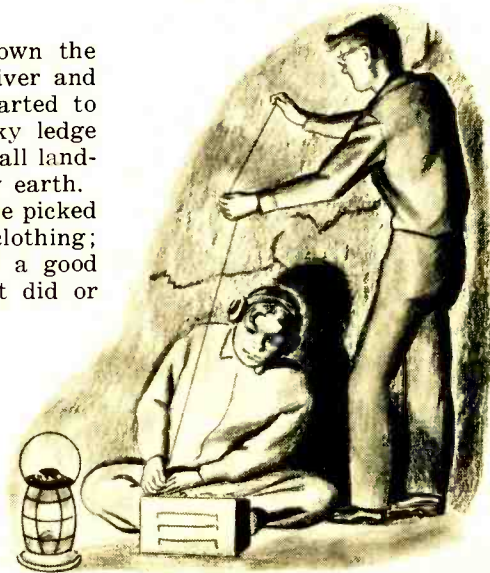

"Well," Jerry observed, "if we hear *anything*, it's going to have to be our own transmitter, which should be turning itself on about now. Listen hard."

He turned the gain full on so that the cave was filled with the loud hissing of the sensitive receiver, but not a trace of a signal could be heard on the 3780-kc. frequency of the automatic transmitter. They tried putting a ground on the receiver. They tried shortening the antenna. Finally, they even carried the receiver to the other end of the antenna and connected it there. Nothing made any difference. Not a sound, outside of the heterodyne hiss, could be heard.

"Well, that's that," Jerry said as he glanced at his wrist watch and shut off the receiver. "The transmitter will cut itself off now."

"It may as well," Carl growled. "All it did was warm the fish worms with the r.f. Let's take the rifle and—"

He was interrupted by a low rumbling sound that seemed to come from the distant mouth of the cave. It continued for several seconds and then stopped.

"Earthquake!" Carl shouted, leaping to his feet and heading for the cave entrance at a lope. Ordinarily Jerry was not as quick as Carl, but this time he was right at his chum's heels when the former sprawled headlong and smashed the lantern he was carrying. The cave was plunged into darkness.

"Quit walking on me!" Carl said indignantly, pushing Jerry off him and scrambling to his feet. He took a flashlight from his pocket and turned it on. The beam revealed a tapering wedge of mud and loose stones that went from the floor of the cave all the way up to the roof. In his haste, Carl had slammed into it. "Wow!" he exclaimed in awe. "An earthslide has covered the cave entrance. We're in a bind now."

"Yeah," Jerry agreed. He took the flashlight and carefully inspected the wall of mud still oozing toward them and the sides of the cave. "I remember that this turn was ten or fifteen feet inside the cave," he announced; "so we know the wall of earth is at least that thick. We could never dig through it without tools."

"Someone will find our parked car and start looking for us, won't they?" Carl asked in a hoarse voice that abruptly

squeaked on the last word he spoke.

"Maybe, but where will they look? They'll never think of this cave now that the entrance is covered up. Actually, not too many people know about it anyway. But let's not hit the panic button. Let's go on back to the transceiver."

"Lot of good that will do us," Carl muttered as he examined the shattered mantles of the gasoline lantern. "Strong signals can't even get into this hole; so our four or five watts have a fat chance getting out. I'm going to do a little exploring farther back in the cave. Maybe there's another way out."

CARL WENT AHEAD with the flashlight, and Jerry was right behind him. The walls of the cave narrowed quickly, and soon the roof dipped down until the boys had to stoop to proceed.

"It ends in a solid wall about ten feet ahead," Carl said over his shoulder. "Hey, wait a minute!" He scrambled ahead on his hands and knees and then bent his head back and looked upward. "Jer!" he exclaimed, "I'm looking right into a sort of chimney that goes straight up through the rock. It's about three or four feet across, and I'd guess it was seventy-five to a hundred feet to the top; but I can see blue sky up there, and is it ever pretty!"

He backed out and let Jerry crawl into the narrow space to examine the opening.

"Well, at least we won't suffocate," Jerry concluded as the boys returned to where they could stand erect.

"Maybe we could build a fire and someone would see the smoke," Carl suggested hopefully.

"We could if we had something to burn and if the smoke didn't smother us before anyone saw it," Jerry discouraged him.

"How about yelling up the chimney?"

"Think hard. We've been up on that bluff above the car. Try to picture where the top of this opening must be."

Carl nodded glumly. "Yeah, I know; it's right in the middle of that big briar patch. No one but rabbits would be traipsing around in there."

He turned off the flashlight to conserve the batteries, and the two boys sat silent in the pitch darkness.

"If we just had some way of getting

(Continued on page 112)

Only Heath offers
Top Quality at the
Lowest Price, and....



NOW—we guarantee you

At your service . . .

THE NEW HEATHKIT AUTOMATIC GARAGE DOOR OPENER!

Compare price, compare features, and you'll buy this latest Heathkit labor-saving wonder! Opens and closes all overhead track-type doors up to 8' high automatically! Garage light turns on when door is open, stays on for short period after door closes! Safety release device. Adjustable operating force! Tone-coded "hi-power" 6 or 12 v transmitter and special receiver prevents interference. Easy one-man assembly. All parts included. 65 lbs.

Kit GD-20 (mechanism, transmitter, receiver) . . . \$11 dn., \$10 mo. **\$109.95**
Kit GDA-20-1 (extra transmitter) . . . \$2.50 dn., \$5 mo. **\$24.95**



BIG-BUY PORTABLE 4-TRACK STEREO TAPE RECORDER

All-in-one monophonic or 4-track stereo tape record and playback! Two tape control levers; individual tone balance and level controls; monitoring switch for listening while recording; "pause" button for editing; two "eyes" to check recording levels. Also functions as "hi-fi stereo center" for record players, etc., or to feed tape music to separate hi-fi system. Parts for all amplifiers and speakers included; turquoise and white cabinet and 3 3/4" x 7 1/2" speed tape deck are assembled. Less mic.

Kit AD-40 . . . 49 lbs. . . \$18 dn., \$16 mo. **\$179.95**
Assembled ADW-40 . . . 49 lbs. . . \$30 dn., \$26 mo. **\$299.95**



NEW HIGH FIDELITY PA AMP.

Heath exclusive; 20 watt *hi-fi* rated PA amp. Two inputs; equalization switches; electrical mixing; sealed "pads"; tape recorder, line, and voice coil output. Plug-in, low-Z mic. Xformers separate. 24 lbs.
Kit AA-31 . . . \$6 dn., \$6 mo. **\$59.95**
Mic. Xformers, AN-11 **\$11.95**

"LEGATO-COMPACT"

All Altec Lansing speakers! 2-12" hi-compliance woofers; exponential horn and driver; range 30-22,000 cps; assembled. 800 cps network. 30 watts program; 16 ohm Z. Assembled, finished cabinets: 32" x 19" d x 32 3/4" h 132 lbs.
Kit AS-21U, unfin. **\$224.95**
Kit AS-21W, wal. . . **\$229.95**
Kit AS-21M, mahog **\$229.95**



HEATH COMPANY Benton Harbor, Michigan

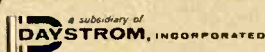

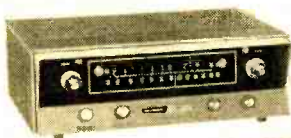

Introducing a new styling concept in two popular Heathkit Stereo Units



Here's a handsome matching pair for your new Heathkit stereo system! Both have new louvered wrap-arounds of luggage-tan vinyl-clad steel with contrasting charcoal-grey front panels framed with polished aluminum bezels... a regal new look to Heath's medium-price stereo line.

HEATHKIT AJ-11 AM/FM TUNER

Successor to the popular AJ-10, this new version features fly-wheel tuning, two "magic-eye" tuning indicators, adjustable FM automatic frequency control, AM "fidelity" switch for max. selectivity or fidelity, dependable 12 tube circuit, built-in power supply. 21 lbs.

Kit AJ-11...\$7 dn., \$7 mo. **\$69.95**
Assembled AJW-11...\$13 dn., \$11 mo. **\$129.95**

HEATHKIT AA-151 28-WATT STEREO AMPLIFIER

Here's the popular SA-2 model all dressed up in brand-new styling. Delivers 28 hi-fi rated watts (14 per channel) for plenty of power. Has clutched volume controls, ganged tone controls, 4 dual inputs. 28 lbs.

Kit AA-151...\$6 dn., \$6 mo. **\$59.95**
Assembled AAW-151...\$12dn., \$11mo. **\$119.95**

can build any Heathkit!



IGNITION ANALYZER

Switch to primary, secondary, parade or superimposed patterns. See condition of plugs, points, wiring, coil & condenser. Plug-in ID-11 Timing Light available. 15lbs.

Kit IO-20...\$9 dn. **\$89.95**
Assembled IOW-20 **\$169.95**



NEW TELEPHONE AMPLIFIER!

Hands-free phone chats! Ideal for conferences, dictation, etc. Place handset on cradle, unit turns on, instantly ready! All-transistor; long-lasting battery power. Easy to build. Ivory color.

Kit GD-71...4 lbs. **\$19.95**



LOW COST DEPTH SOUNDER

Best value in marine electronics. Detects fish, submerged objects, and bottom depth. Big 4 3/4" dial calibrated from 0-100'. 6-transistor circuit, battery powered. Corrosion & splash-resistant aluminum cab. Transducer included. 9 lbs.

Kit MI-10 \$7 dn., \$7 mo. **\$69.95**



LOW COST 3-BAND MARINE RDF

Deluxe features at minimum cost. Covers 200-400kc beacons, 550-1600 kc broadcast, 1700-3400 kc marine band. Loop and "sense" antennas eliminate double null. 9-transistor circuit, battery powered. Pre-assembled tuning unit.

Kit DF-3 12 lbs. \$10 dn. **\$99.95**

You get guaranteed success with Heathkit!

Never before has a manufacturer of do-it-yourself kits guaranteed your success in completing a project. Heath does so and backs it up with an iron-clad, money-back guarantee! By making this guarantee, we hope to banish any doubt you may have about your ability to build a kit. How is such a guarantee possible? The careful planning that goes into the design of Heathkit equipment revolves around this paramount thought—anyone, regardless of background or experience, must be able to build any Heathkit. This same thought guides the writing of the detailed Heathkit assembly instructions with the world famous "check-by-step" system. These attributes plus the experience of a million customers attests to the fact that anyone can build a Heathkit. Order your favorite Heathkit today. Enjoy top quality equipment with savings of up to 50% and the satisfaction of doing it yourself. Get guaranteed success with Heathkit!

MONEY BACK GUARANTEE

The Heath Company *unconditionally guarantees* that you can build any Heathkit product and that it will perform in accordance with our published specifications, by simply following and completing our check-by-step instructions, or your purchase price will be cheerfully refunded.

FREE Catalog!

Contains complete descriptions and specifications on all of the above new models plus more than 200 other famous Heathkit items. Send for your free copy, use the coupon below: see how you can enjoy top quality equipment with savings of up to 50% with Heathkit!



Ordering Instructions: Fill out the order blank. Include charges for parcel post according to weights shown. Express orders shipped delivery charges collect. All prices F.O.B. Benton Harbor, Mich. A 20% deposit is required on all C.O.D. orders. Prices subject to change without notice. Dealer and export prices slightly higher.

Please send the following items:

Item	Model No.	Price

Order direct by mail or see your Heathkit dealer.

Ship Parcel Post Express C.O.D. Best Way



HEATH COMPANY
Benton Harbor 10, Michigan

PLEASE SEND MY FREE COPY OF THE 1961 HEATHKIT CATALOG

Name _____

Address _____

City _____ Zone _____ State _____

Carl and Jerry

(Continued from page 109)

a wire outside for an antenna, we could use the transceiver to get help," Jerry mused. "How about your throwing a rock with a wire tied to it up through that hole?"

"Oh, sure! Should I do it lying on my back or toss it up over my shoulder while I'm on my hands and knees?" Carl asked sarcastically. "Whitey Ford himself couldn't throw a rock up to the top of that hole in the position he'd have to take. We need a trench mortar—Hey! That's it! Turn on the light and start shaving down one of those dowel sticks with your knife until it will fit loosely in the barrel of the rifle. Get a move on. The state traffic net meets in forty-five minutes, and Chuck, back in town, is net control tonight. If anyone can hear us, he will."

While Jerry was working down the dowel stick, Carl pried the lead bullet from a .22 cartridge and sealed the powder in the case by shoving the sharp edge of the brass case through a cake of chewing gum. This was inserted in the chamber of Carl's bolt-action rifle, and the long, slender wooden stick was pushed down the barrel until the end was resting against the chewing-gum wadding.

Next, Carl stripped fine wire from the field coil and carefully arranged it in



a huge spiral directly beneath the vertical opening. The end of the wire from the center of this flat coil was securely fastened to the wooden stick at the point where it emerged from the muzzle. Finally, Carl used loose rock to wedge the rifle securely against the side of the chimney with its sights aimed

squarely at the center of the blue patch of sky above.

"I guess we're ready," Carl said to Jerry.

"Fire one!" Jerry shouted.

Carl pulled the trigger, and there was a muffled explosion. The coil of wire



disappeared in a blur of motion except for a dozen or so outside turns.

"That did it!" Carl said joyfully as he peered up the opening. "We must have had three or four hundred feet of wire in that coil. Fasten the end to the transceiver and let's see if we can hear anything."

This took only a minute, and the boys grinned triumphantly at each other in the yellow glow of the fading flashlight as Jerry tuned across the crowded 75-meter band and heard signal after signal coming in loud and clear. He threw the switch to "Transmit" and checked the transmitter loading; it wasn't too good, but splicing in some extra wire brought a current loop to the transmitter terminals and enabled the transmitter to draw its rated current.

By this time, their friend Chuck was already calling the roll of net stations. Jerry carefully zeroed on the frequency, and when Chuck stood by for "any station with traffic," Jerry broke in with a "QRRR."

Chuck acknowledged him instantly.

"How are we coming in?" Jerry asked.

"Like gang busters. What's wrong?"

Jerry explained the situation, and Chuck told him to stand by while he did some telephoning. In five minutes he was back with the news that the sheriff

and some other men were on their way.

The two boys sat in the darkness and listened to the net while they waited. It did not seem quite so lonely with the familiar voices of their ham friends echoing around the cave.

It was only a half hour later that they heard the voice of the sheriff calling down the shaft. A rope was lowered, and first Jerry and then Carl was pulled to the top.

When the boys tried to explain what they had been doing in the cave, the sheriff just shook his head in bewilderment and said, "Never mind. Just go on home *and stay there!*"

Minutes later, as Carl drove back along the river road, Jerry remarked, "Well, I'd not call 'Operation Worm Worming' a great success, would you?"

"No," Carl said with a shiver, "but I'm not complaining. For a while there I thought it was going to turn into 'Operation Worm Feeding,' with us on the menu. What say we leave underground radio communication experiments to Space Electronics and others?"

"Check!" Jerry solemnly agreed. -50-



Space Electronics

(Continued from page 76)

a later column) are being converted to receive 136-mc. signals.

Space Studies. Two frequencies have been allocated to the ITT Laboratories, Nutley, N. J., for study of space communications theory. The authorization is for 2120 and 2299.5 mc., although the latter channel will be the only one available after July 1.

According to reports, ITT will bounce signals from passive satellites (and possibly the moon) in order to study interference to conventional earthbound systems. All transmissions will be from Nutley, N. J., with a power of about 10 kw.

At Minus-One. Two California scientists have recommended that a special radio transmitter be included in our Mars and Venus probes. This transmitter would not be operated by any personnel sent on such expeditions, but would be a "last gasp" transmitter—should the probe be destroyed by intelligent beings!

-50-

NOT 1, NOT 2, NOT 3, BUT 4 of our most FAMOUS POLY PAKS®COMBINED IN A.....

VARIETY GIFT PAK

CONSISTING OF 4 DIFFERENT PAKS
• CERAMICS, DISCS, TUBULARS, RESISTORS •

TOTAL OF 400 PIECES

FREE WITH EVERY \$15 ORDER

- 40 TUBE SOCKETS \$1
1 to 12 prongs. Worth \$8.
- 125 RESISTORS
30 values. incl. 1% too. carbons! To 1 meg. 1/2. 1W. \$1
Worth \$10.
- 10 RCA PLUG-IN JACK
Sets for amps, tuners, etc. \$1
corders, etc. Worth \$2.
- 60 Insulated Resistors
1/2. 1/4. 1/2. 1 meg. \$1
5% too. Worth \$15.
- 100 1/2-Watt Resistors \$1
- 70 1-Watt Resistors \$1
- 40 2-Watt Resistors \$1
- 4 Output Transformers
1/4. 1/2. etc. Open frame \$1
types. Worth \$8.
- 35 POWER RESISTORS
Asst. to 500. to 10,000 \$1
ohms. Worth \$12.
- CRYSTAL PHONE \$1
Sensitive. cord & plug.
- 60 COILS & CHOKES
100. ant. osc. slug-tuned. \$1
L.F. Worth \$10.
- 10 "POLY" BOXES
Snap-top covers; sizes to \$1
1". Worth \$3.
- 70 TERMINAL STRIPS
1 to 10 the points. Worth \$1
85.
- \$25 SURPRISE PAK
Wide variety of usable ra- \$1
dio-TV-hobby parts.
- 65 CONDENSER SPECIAL
Incl: discs, ceramics \$1
moldeds, nich. Worth \$12.
- 60 Tubular Condensers
Papers, moldeds, oils, ce. \$1
ranged to 1 mf to 600V.
Worth \$16.
- 300-FT. HOOKUP WIRE
Asst. colors, insulation. \$1
sizes. Worth \$3.
- 8 TRANSISTOR SOCKETS
Fit all types of transistors \$1
and mini tubes. too.
- 50 DISC CONDENSERS
Asst. .0001 to .01 to \$1
1000. Worth \$10.
- 50-PC. COIL & MAGNET
SET for 100's of magnetic \$1
hobbies. For home & shop.
too.
- 1 1/2 LBS. HARDWARE
Nuts, bolts, etc. Wide vari- \$1
ety. Handy shop asst.
- 15 AC-DC LINE CORDS
2-cond. rubber, w/molded \$1
plugs, short lengths.
- 2000 OHM PHONE
With cord & plug, ear \$1
loop. Worth \$3.
- 15 ROTARY SWITCHES
Asst. sizes. contacts for \$1
pow circuit changing. Worth \$17.
- 10 Electrolytic C'nd'n'rs
Incl: can & paper types. \$1
Duals too! Worth \$12.
- 35 SILVER MICAS
1 & 5% asst. values. Finest \$1
mica made. Worth \$8.
- 60 MICA CONDENSERS
Incl: 800's, 1000's to \$1
.01 to 600V. Worth \$20.
- 60 Plugs & Receptacles
Incl: power, audio, bat- \$1
tery, etc. Worth \$8.
- 3 NPN TRANSISTORS \$1
Worth \$3 ea. 100's of uses.
- 100 Ceramic Condensers
Incl: discs too! Worth \$10. \$1
- 60 RADIO 'N' TV KNOBS
Asst: colors, sizes, shapes; \$1
some worth \$1 ea.
- 10 PANEL SWITCHES
Micros, power, rotary types. \$1
Exc. variety. Worth \$10.
- 10 VOLUME CONTROLS
Asst. 1 meg. Some with \$1
switch. Worth \$15.
- 12 GERMANIUM DIODES
Glass-sealed, like 1N43. \$1
- 2 SUN BATTERIES \$1
Lite sensitive cks. 2x1".
- 65 RESISTOR SPECIAL
Carbons, precision, W.W., \$1
to 50V. 1% 100. Worth \$10.
- 10 115V AC SWITCHES
Toggle type. SPST. DPDT. \$1
etc. A shop must. 115V AC.
- 30 PRINTED CIRCUITS
Resistor & condenser net- \$1
works.
- 50 HI-Q CONDENSERS
Asst. finest made. Force- \$1
main bodies.
- Transistor Radio Basic
Incl: transistor, socket, \$1
loopsticks, diode, case.
Worth \$3.
- 3 HOBBY TRANSISTORS
PNP's, etc. Similar to \$1
CK-72. Worth \$3.
- 2 PNP TRANSISTORS
Worth \$3. 100's of uses. \$1
- 2 POWER TRANSISTORS
For all types of audio use. \$1
- 2 SILICON RECTIFIERS
500 mls. top hat type. \$1
- 5 SELENIUM RECTIFIERS
115V AC. 65 mil rect. 1/2 \$1
wave.
- 25 PILOT LITES
Bay & screw types; 1.5 \$1
to 6V.
- 5 Micro Switches \$1
Rated 115V AC. SPST cont.
- \$25 RELAY SURPRISE \$1
Giant variety assortment.
- 50 Precision Resistors \$1
WW & carbon-min. val; 56
ohms to 1 meg. 1/2. 1. 2W. 1% tol.

BUY 'EM BY THE POUND

JUMBO PAKS \$3.00 PER POUND

MONEY BACK GUARANTEE—100's SOLD

- 1 POUND Precision Resistors (Worth \$100) ...now
- 1 POUND Disc Condensers (Worth \$80) ...now
- 1 POUND Ceramic Condensers (Worth \$85) ...now
- 1 POUND Discs & Ceramics (Worth \$75) ...now
- 1 POUND Discs, Ceramics, Precision (Worth \$70) ...now
- 1 POUND HI-Q Condensers (Worth \$85) ...now

AVERAGE COUNT 400 TO 1000 PCS PER PAK.

Buy 4 Paks For \$11.00

CUT OUT AND MAIL

LEKTRON

245 EVERETT AVE.
CHELSEA 50, MASS.
Write for Free Catalog

HOW TO ORDER: Avg. wt. per pak 1 lb. Return ad with check or M.O. including postage; excess returned. C.O.D. orders. 25% down; rated, net 30 days. Include Postal Zone in address.

Television RADIO-ELECTRONICS Electricity ELECTRONICS

IN NEW SHOP-LABS OF **COYNE**

TRAIN QUICKLY! OLDEST, BEST EQUIPPED SCHOOL of ITS KIND in U.S.

Get practical training in New Shop-Labs of Coyne. Prepare for a better job and a successful future in a top opportunity field. Advanced education or previous experience not needed. Employment service to graduates.

Enroll NOW—Pay Later

Finance Plan and Easy Payment Plan. Also Part Time Employment help for students.

FREE BOOK Clip coupon or write to address below for Free Illustrated Book. "Guide to Careers"—Describes all training offered. No obligation and No Salesman Will Call. Act NOW.

B. W. Cooke, Jr., President

CHARTERED
NOT FOR PROFIT
Established 1899
1501 W. Congress Pkwy.,
Chicago, Dept. 51-2C

COYNE
ELECTRICAL SCHOOL

COYNE Electrical School
1501 W. Congress Pkwy., Chicago 7, Ill.
Dept. 51-2C

Send FREE book "Guide to Careers" and details of all training you offer. However, I am especially interested in:

ELECTRICITY TELEVISION BOTH FIELDS

NAME.....

ADDRESS.....

CITY..... STATE.....

NEVER FAIL— ZONE YOUR MAIL

The Post Office has divided 106 cities into postal delivery zones to speed mail delivery. Be sure to include zone number when writing to these cities; be sure to include **your** zone number in **your** return address—after the city, before the state.

POLICE, CITIZENS BAND, AIRCRAFT



Monitor these and other signals, from any auto radio using the inexpensive and dependable Model 107 transistORIZED converter. Any SINGLE frequency between 25-50 and 108-175 mcs. Fully miniaturized, it can be installed in seconds. Designed to give years of dependable, trouble free service. Order now, or send for free information. State frequency. Guaranteed for one full year.

Model 107 \$14.95

ROBIN RADIO CO. 2408 Hemphill Greenville, Texas



Joint winners of the 1960 Edison Award, John T. Chambers (center) and Ralph E. Thomas (right) receive trophies from G.E.'s L. Berkley Davis.

DX'ers Win Edison Award

TWO radio amateurs have received the ninth annual Edison Award for their "significant addition to knowledge of radio-wave propagation."

Ralph E. Thomas, KH6UK, and John T. Chambers, W6NLZ, were named joint winners of this year's award for confirming the theory that u.h.f. communications are not limited to line-of-sight transmissions. Using low-power homemade and Army-surplus equipment, the two hams set distance records on 432, 220, and 144 mc. over the 2540-mile course between Hawaii and California.

The result of years of experimenting with the "tropospheric ducting" phenomenon, their record-setting transmissions proved conclusively that the troposphere can actually serve to route signals to distant points.

This is the first time in the nine-year history of the Edison Award—which is sponsored by General Electric Company—that it has been granted for "scientific achievement." It is also the first joint award. Previously, it had gone to a single amateur, usually for handling emergency communications during storms and disasters.

Described as "pioneers in the wilderness of radio-wave propagation" by FCC Chairman Frederick W. Ford, both award winners plan to continue their pioneering work. Scheduled for an early test: communication on 1296 mc., the next highest amateur frequency.

—50—

TRANSIDIP

(Continued from page 72)

easily determine the frequency of operation of the Transidip by listening for its oscillations.

Mark the temporary dial with all whole-number frequencies and at every $\frac{1}{2}$ -megacycle point on the three lower bands. The upper three bands can be marked at megacycle points or at whole-number frequencies, depending on the spacing.

Once the rough dial is made, trace the final version of the dial on a piece of thin white cardboard—using the paper dial as a guide.

Operation. To determine the frequency of a coil and capacitor combination in a tuned circuit, set bandswitch *S2* to a range estimated to include the unknown external frequency. Switch on the Transidip, and adjust sensitivity control *R1* so that meter *M1* reads about mid-scale. Hold loop *L1* near the coil in the external circuit and rotate capacitor *C5* in the Transidip. If no dip in the meter reading is observed, set *S2* to a higher or lower range, and retune *C5* until a dip is indicated on the meter. High-*Q* tuned circuits will cause a sharp dip, while a shallow dip is normal for low-*Q* circuits. The sharpness of the dip will also depend on the degree of coupling between *L1* and the coil in the unknown external circuit.

Since the Transidip is an oscillator, it can be used as a BFO with an all-band receiver—you simply tune the Transidip near the frequency of any c.w. station or carrier to which your receiver is tuned. The Transidip's oscillations will produce a beat frequency with the incoming signal rather than at the i.f. frequency of the receiver as is normally the case with a BFO.

As an absorption frequency meter, the Transidip can be used to measure the relative power output of a transmitter. In this application, switch off the Transidip and place coupling loop *L1* near the transmitter's antenna or lead-in. Then tune the Transidip near the transmitter's frequency. Any tuning changes made at the transmitter will be indicated by relative changes in the Transidip's meter reading.

-30-

CITIZENS BAND SALE!

Closing out our stock of CB kits. Nationally advertised at \$39.95 up. Complete with power supply, tubes, crystal, cabinet, coils, etc., less mike. Kit sales final. Rush your order today!

110 VOLT CB TRANSCEIVER KITS	PRICE \$19.95
12 VOLT CB TRANSCEIVER KITS	PRICE \$22.95
6 VOLT CB TRANSCEIVER KITS	PRICE \$22.95

<input type="checkbox"/> GROUND PLANE ANTENNA	\$8.99
<small>(Reg. Price \$15.95)</small>	
<input type="checkbox"/> 3-ELEMENT CB BEAM ANTENNA	\$11.99
<small>(Reg. Price \$29.95)</small>	
<input type="checkbox"/> CB FIELD STRENGTH METER KIT	\$6.99
<input type="checkbox"/> FAMOUS MAKE CB XMTG CRYSTALS	\$1.99
<small>(Reg. \$4.95)</small>	

Check items wanted. Return ad w/check or M.O. Include Postage. Excess returned. C.O.D. orders 25% down. (Note: Antennas must be shipped railway express or freight.)

GROVE ELECTRONIC SUPPLY COMPANY 4103 W. Belmont Ave., Chicago 41, Ill.

- RUSH items checked
 Send Free Catalog featuring CB values

Name.....
(please print)

Address.....

City..... Zone..... State.....

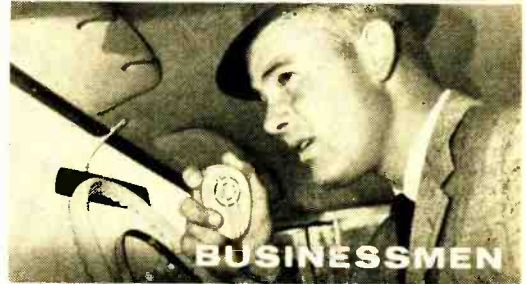

**2-WAY
RADIO**
from \$134.95

• Anyone can operate—
license issued on request!

Used by thousands of businessmen, salesmen, farmers, doctors, construction crews and sportsmen! Finest Citizens' Transceiver available—excellent range. Covers 23 channels. Maximum legal power—dozens of features—easy to install anywhere!



Delivery or servicing



Building or contracting



Boat-to-boat or ship-to-shore



Car-to-office or home



VIKING
Messenger

SEND FOR FREE COLOR BROCHURE!

Send full details on the "Messenger"

NAME.....
 ADDRESS.....
 CITY..... STATE.....



E. F. JOHNSON CO.
 2401 10 Av. SW, Waseca, Minn.

3-WAY INTERCOM

(Continued from page 54)

About the Circuit. The schematic diagram shows the wiring for one station only. Transistor *Q1* amplifies the signal picked up by the PM speaker in the same unit. When "talk" switch *S1* is thrown to either position, the speaker's voice coil is connected to *Q1*'s base and,

or increased in order to decrease or increase the output signal from it.

Resistors *R4* and *R6* provide the bias level for transistor *Q2*. The output signal for *Q2* is developed across *R7* and *L1*. The d.c. resistance of *L1* causes most of the a.c. signal to drop across it. Re-

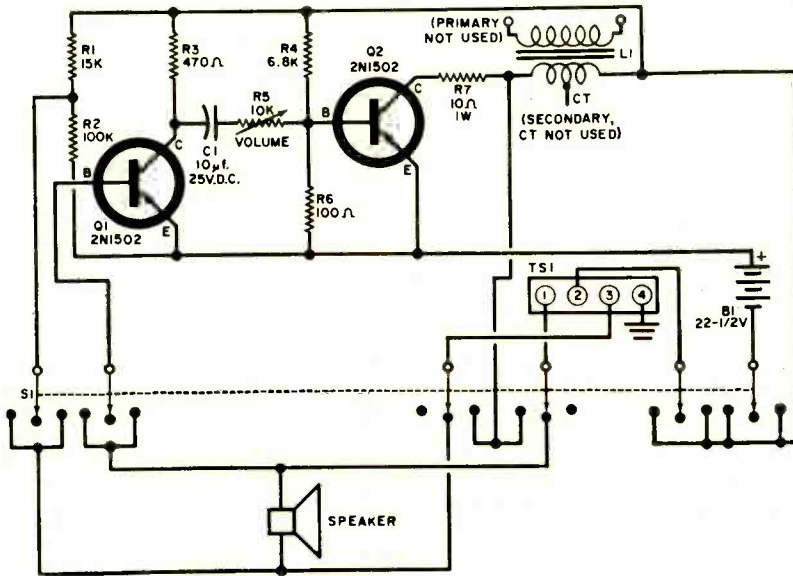

Two-stage transistorized amplifier above is heart of each of the three-way intercom units. External cable connections are made to terminal strip TS1.

Interconnection diagram shows how to hook up stations. If cables are shielded, connect shields to terminal 4 on each unit and to water pipe ground.

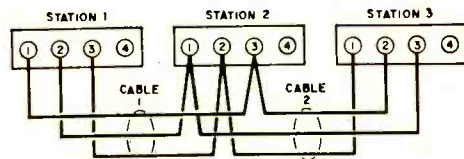

through *R2*, to its emitter. Resistors *R1* and *R2* provide the d.c. bias for the base of *Q1* to obtain the operating point for this amplifying stage. The amplified audio signal is developed across *R3* and coupled to the next stage through capacitor *C1* and volume control *R5*.

Note that *R5*, unlike volume controls in vacuum-tube circuits, is connected in series between transistors *Q1* and *Q2*. Since transistors are current amplifiers, the signal current supplied to a transistor amplifier stage must be decreased

or increased in order to decrease or increase the output signal from it. Resistor *R7* functions mainly as a current limiter for the second stage. The remote speaker in the intercom selected by switch *S1* is connected across *L1*; hence, it will convert the audio signal to sound. Using this technique to couple the speaker to the second amplifying stage limits the d.c. current passing through the voice coil of the remote unit to almost zero.

Introducing the IONOVAC

(Continued from page 57)

away with the conventional diaphragm. In its place is a volume of ionized air that expands and contracts at audio frequencies and thus produces sound. Here's how it works.

Quartz Cell Plus Horn. A tiny volume of air within the confines of a quartz cell is ionized by an r.f. voltage applied to the cell's inner and outer electrodes, and the audio signal from the amplifier modulates this r.f. voltage. As a result, the ionized air—the purple glow—within the quartz cell changes in volume at the same rate as the frequency of the audio signal.

Since the open end of the cell is very small, the Ionovac might be considered a rather inefficient sound producer. But coupled to a suitable horn, its efficiency level becomes comparable to that of a 12" cone-type speaker. With its present horn, the Ionovac's response soars upward smoothly and clearly from about

3500 to well over 20,000 cycles. As you might guess, both harmonic and inter-modulation distortion are low.

"Undistorted" Sound. Now manufactured by the Ionovac Division of the DuKane Corporation in St. Charles, Ill., today's Ionovac has been cured of many of the ills that plagued early models. Available either as a full-fledged speaker system complete with woofer or as a compact super-tweeter, it houses its own 27-mc. oscillator and power supply.

Like any crystal element, the quartz cell can't be expected to last indefinitely, but the Ionovac is guaranteed for a minimum of 1200 hours operation before a new cell is needed. Replacement is extremely simple, and a new cell costs only \$6.25—much less than a good diamond stylus.

And while the purple glow is somewhat hidden within the attractive cabinet, it's nonetheless very much in the picture. For it is the purple glow within the Ionovac that enables the tiny cell to deliver the speaker's all but distortionless sound.

—30—

new! 7-Band SWL/DX Dipole Kit for 11·13·16·19·25·31·49 meters

Here's a low cost 7-band receiving dipole antenna kit that will pick up those hard-to-get DX stations. Everything included . . . just attach the wires and you're on the air! Weatherproof traps enclosed in Poly-Chem for stable all-weather performance. Over-all length of antenna - 40 feet.

Complete with

8 Trap Assemblies

Transmission Line Connector

Insulators

45 ft. No. 16 Tinned Copper Wire

100 ft. of 75 ohm twin lead

WRITE FOR NAME OF NEAREST DISTRIBUTOR

SWL-7 \$14.75

Mosley Electronics, Inc. 4610 N. Lindbergh • Bridgeton, Missouri

Hear 'Em — Work 'Em Better with BROWNING CB Equipment

R-2700 CB
RECEIVER
\$149.00



S-NINE CB
TRANSMITTER
\$119.50

Make your CB base station a real communications center with this Browning team. Highly sensitive and selective R-2700 Receiver delivers sharp, noise-free reception on all CB channels. Overcomes even the most severe atmospheric and man-made interference. Browning S-NINE Transmitter allows full power transmission on all channels — introduces new features and advanced design never previously utilized in CB communications.

Also Available
R-2700 Receiver PLUS
T-2700 Transmitter
SPECIAL PACKAGE PRICE
Send for Free
Literature



browning
101 UNION AVE., LACONIA, N.H.

SATISFACTION GUARANTEED FOUR CONVENIENT PURCHASE PLANS



*Dramatic New Concept
in Radio-phones*

...THE NEW **Tel-Rad**
CITIZENS' BAND RADIO!
*6 colors to choose from... blend
with every interior.*

Slightly larger than a standard telephone this handsome citizens' band radio looks good anywhere . . . home, industry, mobile, marine, aircraft, etc. Engineered and designed for reliable continuous communication by experts in this field. Specs. exceed F.C.C. requirements . . . and it's priced in line . . . \$179.00 (A.C. only) \$169.00

**THE EXCLUSIVE Tel-Rad
OFFERS THESE FEATURES:**

- Normally requires no installation
- No license exam
- No special servicing
- Reliable diode power supply — 6 v., 12 v.D.C. and 117 v.A.C. or 117 v.A.C. only.
- Squelch control
- Range — 10 to 30 miles
- Choice of telephone or loudspeaker reception.

Receive or send on 3 channels with a flick of a switch. Covers all 22 citizens' band channels by changing crystals.

DISTRIBUTORSHIP INQUIRIES INVITED
Send coupon or write today for Free Brochure

Send Literature to:

Name

Address

State

TELEPHONE & ELECTRONIC CORP.

7 E. 42nd St., New York 17, N. Y. YUkon 6-2120

Getting Peak CB Performance

(Continued from page 61)

Adjusting the Antenna. If you have a ground plane antenna, you can simply change its characteristics by altering the "droop" of its horizontal elements. If they are exactly horizontal, bend them down about 20 degrees and take a reading. Keep bending them down until the reading is maximum. If the elements are already "drooping," they might require a slight upward readjustment. Generally, this change will make a perfect match.

To "shorten" an antenna *electrically*, simply connect a miniature variable capacitor of 365 $\mu\text{m.f.}$ maximum in series with the radiating element (the one connected to the center conductor of the coaxial cable). Mount the capacitor on a piece of polystyrene and make all connections as short as possible.

Again using the field strength meter to indicate the best power output, adjust the capacitor, using an insulated knob, until maximum indication is reached. If this reading is obtained with the capacitor plates fully meshed, the antenna must be "lengthened."

To "lengthen" the antenna *electricaly*, connect a small coil of about six turns of No. 16 tinned bare wire wound on a 1" form in series with the antenna, in the same way the capacitor was connected. Again using the field strength meter, short out turns in the coil, one at a time, until the meter reads maximum. With most manufactured antennas, only one turn or so will be left in the coil at the maximum point.

When the field strength meter reaches a maximum indication which is greater than the reading obtained before adjustments were begun, your transmitter is putting the maximum signal possible into the antenna and the antenna is radiating this signal as efficiently as possible. With the field strength meter and the dummy load, these adjustments actually become quite simple.

Continuous Monitoring. While the field strength meter is perhaps the best and easiest device to use to indicate when all transmitter adjustments are in order, the fact that it must be located remotely from both the antenna and transmitter

has some disadvantages. It is impossible to have a continuous monitor of your transmitter's output where you need it—in the "shack" at the operating position.

Several instruments that will serve this purpose are available, however, and although they are not actually field strength meters, they should be mentioned here. Called power output meters, they take off a small portion of the transmitter's output, rectify it, and apply it to a sensitive d.c. meter. While such an instrument uses up some of the precious power going to the antenna, this amount is on the order of a few milliwatts and can be disregarded. In one respect, though, these instruments are not as useful as the remotely operated field strength meters: under conditions of great mismatch between transmitter and antenna, false readings are possible.

Another instrument which tells the user when a proper match is obtained is a VSWR meter. But this meter is used only to make initial tests and cannot be kept in the transmission line during normal operation since it consumes one-half the output power when the antenna and coax are properly matched. Its usefulness is great, however, and it will be discussed in a future article.

-30-



"Mayday! Mayday! Please clear the 27.2-mc. band."

May, 1961

FREE ALLIED

SPECIAL MONEY-SAVING ELECTRONIC SALE BOOK



SAVE HUNDREDS OF BARGAINS!

SAVE MOST on Allied Summer Specials! Terrific closeouts on quality Stereo hi-fi systems and components, tape recorders, phonos, records and tape. Top values in Allied's own KNIGHT® products and exciting build-your-own KNIGHT-KITS®. Hundreds of specials in radios, cameras, TV accessories, Citizens Band radio, amateur gear, P.A. systems, test instruments, tools and electronic parts. Dozens of new products. Write today!

ONLY \$2 DOWN
on orders up to \$50; \$5 down up to \$200; \$10 down over \$200.



FREE SEND FOR VALUE-PACKED SALE BOOK

ALLIED RADIO, Dept. 54-E1
100 N. Western Ave., Chicago 80, Ill.

Send FREE Allied Sale Book No. 205

Name _____
Address _____
City _____ Zone _____ State _____



HEADS YOU WIN!

Yes, you'll be a winner every time by saving "heap plenty" on all of your high fidelity requirements. Write us and see! Ask too for audio discount catalog A-12.

KEY ELECTRONICS
120 Liberty St., N. Y. 6, N. Y.

WALKIE TALKIE RADIO SENDING SET

YOUR OWN POCKET SIZE RADIO STATION
Talk to any house or car radio without wires or hookups of any kind! Built-in antenna. Self-contained flashlight batteries—Power transistor! Talk to radios in the same building and to cars or between cars up to a mile or more away—depending on local conditions. No license or permit needed! **SEND ONLY \$3.00** (cash, ck, mo) and pay postman only \$3.95 plus COD postage or send \$12.99 for postpaid delivery. Shipped complete ready to operate. Order yours now—Telsy! Available only from: **WESTERN RADIO, Dept. TEL-5, Kearney, Nebr.**

SCIENCE ENGINEERING

B.S. Degree—36 mos. • B.E. degree—27 mos.
Accelerated year-round program. Aero., Chemical, Civil, Elec., Mech., Metallurgical; Math., Chemistry, Physics. Modest rate. Earn board. New classes start June, July, Sept., Jan., March. Catalog. 2351 E. Washington Blvd., Fort Wayne 2, Indiana.

INDIANA TECHNICAL COLLEGE

Short-Wave Report

(Continued from page 106)

Here is a resume of current station reports. At time of compilation all reports are as accurate as possible. However, stations may change frequency and/or schedule with little or no advance notice. All times are Eastern Standard and the 24-hour system is used. Please send your reports to P. O. Box 254, Haddonfield, N. J., in time to reach your Short-Wave Editor by the eighth of each month.

Angola—CR6RY, Novo Redondo, 4838 kc., has been noted from 1615 with native instrumental music, ID at 1630; s/off is at 1700 on Saturdays. CR6RI, Dondo, has moved from 9341 to 9475 kc., and was tuned at 1400-1430 with Portuguese instrumentalists and a few anmts. (WPE3NF)

R. Benguela, 5042 kc., has been heard at 0830 with news, dual to 7161 and 9502 kc. Reports go to *R. Clube de Benguela*, C.P. 19, Benguela, Angola. (WPE4COD)

Australia—Here is the complete new Eng. schedule from *R. Australia*, Melbourne. To S., S.E., and S.W. Asia: 1714-1915 on 15,210 kc. (VLG15); 1915-0100 on 17,840 kc. (VLB17); 1714-0100 and 0230-0415 on 21,540 kc. (VLD21); 1714-0800 on 25,735 kc. (VLY25); 0059-0445 on 15,180 kc. (VLE15); 0800-1230 on 11,740 kc. (VLA11); 0800-0830 and 0930-1230 on 7220 kc. (VLB7); 0458-1230 on 9580 kc. (VLE9); and 0930-1000 on 11,760 kc. (VLC11). To E. Asia and North Pacific Islands; 1559-1800 on 15,240 kc. (VLE15); 0244-0500 and 0600-0700 on 11,810 kc. (VLC11); and 0600-0900 on 9570 kc. (VLD9). To South Pacific Islands and New Zealand: 0059-0415 on 11,710 kc. (VLA11); 1500-1700 on 11,840 kc. (VLC11). To Mid-Pacific Islands: 2129-0230 on 21,600 kc. (VLG21); 0244-0700 on 7190 kc. (VLG7); and

QSL CARDS, ANYONE?

Your Short-Wave Editor has received QSL cards addressed to the following WPE call-signs. Check the list to see if your call is on it. If it is, please write and ask for your cards.

WPE1KG	WPE4MX	WPE9ATN
WPE2BNW	WPE5ACB	WPE9ATR
WPE3AU	WPE5FW	WPE9BOJ
WPE3BKI	WPE5RJ	WPE9KP
WPE3GA	WPE6AVO	WPE0AB
WPE3MC	WPE6AYE	WPE0ACM
WPE4AIX	WPE9ASN	VE2PE1F

Send your request, together with return postage, to Box 254, Haddonfield, N. J., and be sure to give your call-sign as well as your name and address.

1500-1700 on 15,315 kc. (VLA15). To Eastern N.A.: 0714-0815 on 11,710 kc. (VLC11). To Western N.A.: 1014-1115 on 11,810 kc. (VLC11). To Africa: 2329-0045 on 21,680 kc. (VLC21). To Europe and British Isles: 0244-0400 on 11,710 kc. (VLA11). (WPE1AAK, WPE4CON,

WPE4CRZ, WPE6OU, WPE8CKW, WPE0AE, WPE0BIV, KL7PE1K)

Bolivia—CP30, *R. Libertad de Santa Cruz de la Sierra*, 6235 kc., is a good catch for only 150 watts. It has been tuned from 1900 with a Spanish request program and from 2130 to 2200 s/off with concert music. Reports should be addressed to Sr. Antonio Santillan Escanante. (WPE3NF, PY1PE1D)

Brazil—What seems to be *R. Marajoara* has moved from 15,245 to 15,255 kc. and is heard very well at 1915 with Brazilian music. (WPE9KM)

The call "PR18" for Aracatuba on 2450 kc. (see Nov., 1960, issue) is incorrect; the correct call is ZYR231. (PY1PE1D)

British Honduras—Despite some claims that Belize is off the air, the present schedule is

SHORT-WAVE ABBREVIATIONS

anmt—Announcement	QRM—Station interference
B/C—Broadcasting	R.—Radio
Eng.—English	s/off—Sign-off
ID—Identification	s/on—Sign-on
kc.—Kilocycles	xmsn—Transmission
N.A.—North America	xmtr—Transmitter

0700-0830 and 1800-2315 on 3300 kc. It has been noted at 1915-2200 with music, news, talks, and classical music. (WPE4BWM, WPE6EZ, WPE8CKW, WPE0BCT)

Canada—Here is the complete schedule from Montreal. Australian Service: 0325-0405 daily in Eng. on 9630 kc. To Europe: 0625-0700 and 0800-0915 daily and 0730-0800 Monday to Saturday on 21,600 and 17,820 kc.; 0915-0930 daily on 17,820 kc. only; 0930-1330 daily on 17,820 and 15,320 kc. (Eng. news at 1030); and 1500-1635 daily on 15,320 and 11,720 kc. (Eng. at 1545). To Canadian Forces: 0700-0730 Monday to Saturday (to 0800 on Sundays) on 21,600 and 17,820 kc. To Africa: 1330-1445 daily on 17,820 and 15,320 kc. (to 1500 on 15,320 kc. only); Eng. at 1330. To Caribbean and Latin American areas: 1800-1945 daily on 15,190 and 11,760 kc. (Eng. at 1800). To Northern Canada: 1700-1745 daily in Eng. and French to East and Central areas; 2000-0210 daily in Eng. to Central and West areas; both on 11,720 and 9585 kc. (WPE1AEU, WPE1CEA, WPE111, WPE2DPS, WPE2DUP, WPE2E1W, WPE3BKT, WPE3BQL, WPE3BZR, WPE4BTY, WPE4BWR, WPE4HJ, WPE6AVU, WPE91P, WPE0AE, WPE0ARM, WPE0EW, VE3PE1E1, VE5PE2E, RA, CBC)

Chile—*R. Sociedad Nacional de Minería*, Santiago, 11,960 kc., is noted from 2100 with Spanish programming. Reports go to Casilla 2626, Santiago. (WPE3HP1)

Colombia—*R. Continental*, Bogota, has moved from 4835 to 6125 kc., where it has been noted with s/off at 0000. There is severe QRM from *R. Suyapa*, Honduras. (WPE2AXS)

Dahomey—*R. Dahomey*, Cotonou, verified quickly by airmail and sent this schedule: 4870 and 7190 kc. at 0000-0130, 0615-0715, and 1200-1630 on Monday, Tuesday, Wednesday, and Friday; Thursdays at 0000-0130 and 0615-0815; Saturdays at 0000-0130, 0700-0800, and 1000-1800; Sundays at 0200-0800 and 1000-1700.

Languages used include French (at 0115), Fon, Yoruba, Dendi, Bariba, and Minha. (PYIPE1D)

Denmark—OZF, Copenhagen, operates daily (except Sunday) to N.A. on 9520 kc. at 2100-2130 and 2230-2300. A "DX Bulletin" is given on Tuesdays at 2100 and 2230. (WPE9VZ)

Germany—Deutsche Welle, Cologne, has altered part of the schedule to read as follows: to Japan at 0445-0745 on 17,815 and 21,735 kc.; to Middle East areas at 0745-1045 on 21,730 and 17,875 kc.; to Africa at 1215-1515 on 15,275 and 11,895 kc. Two new channels observed in use are 11,925 kc. at 1630 with Eng. ID, and 6145 kc. at 2200 with German ID. (WPE2AXS, WPE2EIW, WPE3BXX, WPE4BNW, WPE7AIU, WPE8B0I, WPE9KM)

Goa—Emissora de Goa has started an experimental xmsn to Africa in the 13-meter band on 21,580 kc. at 1030-1130 in Portuguese and at 1130-1230 in Concani. Reports go to Emissora de Goa. C. De Goa, Goa (Portuguese India). (WPE0TA)

Guatemala—R. Club, Guatemala City, announces a frequency of 3355 kc. as well as 6167 kc., with the calls TGZA and TGZB, but the lower channel has not been heard as yet. They seem to operate regularly until at least 0300. (WPE6BP)

Editor's Note: Other club sources list TGZB as R. Programas de Guatemala, Guatemala City, 3355 kc.; and TGZA as R. Club, Zacapa, 6165 kc. Both outlets have been reported. These two listings may be subject to revision.

Haiti—Cap Haitien, 21,520 kc., replaces the former 21,525-kc. outlet. The newest schedule as given by "Bulletin Board" at 0445 is: 0900-0930 to Europe; 1200-1400 to Southern points; 1745-2330 to Western areas. (WPE3NF, WPE4BC, WPE6EZ)

India—All India Radio, Delhi, was noted on 9640 kc. with a program to the United Kingdom from 1500 to 1545/close; Indian classical and light music. (BB)

Japan—A rarely reported outlet for R. Japan, Tokyo, is 6080 kc., noted at 1200 in Oriental language and in Eng. from 1240. This channel is also used to Western N.A. at 1700-1900, dual to 11,800, 15,235, and 17,825 kc. (WPE6EZ, WPE9CCO)

Liberia—ELBC, Monrovia, was tuned on 3255 kc. at 1630 with music; news at 1645. The signal is good but there is QRM from Buzards Bay Lightship station. (WPE1AAK)

Monaco—Trans-World Radio, Monte Carlo, has been testing on 6120 kc. from 1530 to 1600 s/off with organ music and Eng. anmts. Reports go to P. O. Box 141, Monte Carlo. They are also reported to be operating on 9703 kc. to England at 1430-1745, with Eng. and religious programs. (WPE1AAC, WPE1BY, WPE3BXX)

Mozambique—CR7BV, R. Clube de Mozambique. Lourenco Marques, is tuned on 4840 kc. at 2237 with popular music and anmts in Afrikaans; an Eng. ID at 2300 is followed by more music. (WPE0VB)

Netherlands—The "Happy Station Program" is now being broadcast to Africa, Middle East, and Europe on Sundays at 1100-1230 on 6020,

TV PICTURE TUBES AT LOWEST PRICES

ALL ALUMINIZED GLASS TYPES					
Tube Type	Price With Old Tube	Tube Type	Price With Old Tube	Tube Type	Price With Old Tube
10BP4	7.95	17BJP4	11.50	21CEP4	21.00
12LP4	8.95	17CDP4	11.50	21CXP4	15.75
13AJP4	14.00	17CK/CA/BZ/		21DEP4	21.00
13ATP4	14.00	BRP4	17.00	21DFP4	21.00
13B/E/CP4	10.00	17DP4	17.00	21LFP4	21.00
14HP4	11.00	17H/RP4	12.50	21DSP4	21.00
14QP4	11.00	17L/VP4	12.50	21EP4	14.25
14RP4	11.00	17QP4	11.50	21FP4	14.50
14W/ZP4	11.00	20C/DP4	13.50	21WP4	16.00
15XP4	11.00	20H/MP4	14.50	21XP4	16.50
16DP4	12.00	21AC/BS/AMP4	15.00	21YP4	16.00
16K/RP4	9.95			21ZP4	15.50
16LP4	12.50	21AL/ATP4	16.75	24C VP4	23.50
16TP4	9.95	21AU/AVP4	13.75	24AEP4	21.50
16WP4	12.00	21AWP4	15.75	24AHP4	26.50
17AT/AVP4	12.50	21BTP4	16.75	24DP4	24.50
17BP4	9.95	21CBP4	16.75	27EP4	39.95
				27RP4	39.95
				27SP4	40.95

METAL TYPES			
Tube Type	Price With Old Tube	Tube Type	Price With Old Tube
12UP4	12.00	16GP4	14.50
16AP4	13.50	17CP4	17.00
16EP4	14.00	17GP4	17.60
		17TP4	17.60

TEST TUBES
8XP4 16.07 8YP4 16.07

1 year warranty
Prices include the return of an acceptable similar tube under vacuum. These tubes are manufactured from reprocessed used glass bulbs. All parts and materials including the electron gun are brand new.
ALL PRICES FOB CHICAGO, ILLINOIS. Deposit required, when old tube is not returned, refundable at time of return. 25% deposit required on COD shipments. Old tubes must be returned prepaid. Tubes shipped Rail Express. Shipped only to Continental U.S. and Canada.

WRITE FOR COMPLETE LIST
—PICTURE TUBE OUTLET—
2922 MILWAUKEE AVE., CHICAGO 18, ILLINOIS
Dickens 2-2048

LEARN ALL ABOUT TRANSISTORS

Get FREE details on NEW 10-lesson home course from CBS Electronics

Learn all about transistors with a new, 10-lesson CBS Electronics Home Study Course. You use transistors while you learn and get basic theory in a clear, easy-to-grasp way. You perform practical experiments, become familiar with transistor parameters, learn servicing techniques, transistor theory and application for Amplifiers (all fundamental circuits), Oscillators (a-f, r-f, relaxation, multivibrator, special TV), Rectifiers and Detectors (diode and transistor), Radio and TV (circuits), Power Supplies and Special and Industrial Applications. Text contains more than 240 circuit diagrams, pictures, graphs and charts.



Send Coupon for Free Details

CBS Electronics
111 Endicott Street, Danvers, Mass.

Send me FREE descriptive folder completely outlining your new expanded 10-lesson Transistor Course, including cost information.

NAME _____
ADDRESS _____
CITY _____ ZONE _____ STATE _____

21,480, and 21,565 kc.; the Thursday Concert to Africa and Europe at 1325-1425 on 17,810 and 15,425 kc. A new unlisted outlet on 11,710 kc., heard around 1830 in Dutch, appears to

SHORT-WAVE CONTRIBUTORS

Stan Schwartz (WPE1AAC), Bridgeport, Conn.
 Bradley Graham (WPE1AAK), Black Rock Light-house, Conn.
 John Doan (WPE1AEU), Westover Air Force Base, Mass.
 Richard White (WPE1BBB), Pawtucket, R. I.
 Alan Roth (WPE1BY), Bridgeport, Conn.
 Fred Wasti (WPE1CEA), Brockton, Mass.
 Thomas Cardullo (WPE1CHS), Somerville, Mass.
 Gregory Killam (WPE1H1), Reading, Mass.
 Robert Newhart (WPE2AXS), Merchantville, N. J.
 Albert Mencher (WPE2BRH), Bayside, N. Y.
 Ed Seeger (WPE2DPS), Haddonfield, N. J.
 David Deutsch (WPE2DUP), New York, N. Y.
 Roger Gale (WPE2E1W), Brooklyn, N. Y.
 Steven Meltzer (WPE2FK), New York, N. Y.
 Steven Wasserstrom (WPE3BKT), Wilkes-Barre, Pa.
 Paul Kirkpatrick (WPE3BQL), Souderton, Pa.
 David Levin (WPE3RXX), Silver Spring, Md.
 Howard Halverson (WPE3BZR), Sharon Hill, Pa.
 Richard Morcroft (WPE3HP/1), New Haven, Conn.
 George Cox (WPE3VF), New Castle, Del.
 Grady Ferguson (WPE4BC), Charlotte, N. C.
 James G. Poore (WPE4BNW), Byrdstown, Tenn.
 Jimmy Smith (WPE4BTY), Milledgeville, Ga.
 Mike Vanacore (WPE4BWM), Tampa, Fla.
 Guy Ingram, Jr. (WPE4BWR), Danville, Ky.
 A. V. Dunaway (WPE4CGX), Mableton, Ga.
 Tommy Roderick, III (WPE4CHR), Atlanta, Ga.
 Treacy Lanciano (WPE4CLF), Hayes, Va.
 Paul Parker (WPE4COD), Alexandria, Va.
 Geoffrey Ashford (WPE4CON), Raleigh, N. C.
 Johnny White (WPE4CRZ), Birmingham, Ala.
 Jim Maynard (WPE4FY), Lexington, Ky.
 Alan Knapp (WPE4H1), Roanoke, Va.
 Victor Norwood (WPE6AVU), Wilmington, Calif.
 Shaler Hanisch (WPE6BPN), Pasadena, Calif.
 Bill Aidacushion (WPE6BWK), Bell, Calif.
 J. Art Russell (WPE6EZ), San Diego, Calif.
 Laurence Hansford (WPE6OU), Modesto, Calif.
 Carlton L. Tanner (WPE6UK), Monterey, Calif.
 Wayne Fagerberg (WPE7AIU), Powell, Wyo.
 Dale Porray (WPE7PK), Las Vegas, Nev.
 Pat Bailey (WPE7YQ), Las Vegas, Nev.
 David Hillenbrand (WPE8AI), Columbus, Ohio
 John Kennedy, Jr. (WPE8BO), Shelby, Ohio
 Dana Hartwig (WPE8CCA), Ironton, Ohio
 Joseph Bove (WPE8CKW), Ironwood, Ohio
 Richard England (WPE8FV), Columbus, Ohio
 Chuck Rotch (WPE8CCO), Lansing, Ill.
 Bob Bensen (WPE9CFW), Joliet, Ill.
 Robert Frey (WPE9IP), Niles, Ill.
 A. R. Niblack (WPE9KM), Vincennes, Ind.
 Howard Nagle, Jr. (WPE9VZ), Midlothian, Ill.
 John Beaver, Sr. (WPE0AE), Pueblo, Colo.
 Dallas William (WPE0ARM), Sedwick, Colo.
 Bill Holscher (WPE0ATE), Webster Groves, Mo.
 Don Stitt (WPE0BCT), Hastings, Nebr.
 Creath Fletcher (WPE0BIV), Lakewood, Colo.
 James Howard (WPE0FW), Kansas City, Mo.
 Gerhardt Martens (WPE0TA), Frazee, Minn.
 George Buchanan (WPE0VB), Webster Groves, Mo.
 Jeffrey S. Greenstein (VE3PE1E1), Toronto, Ont.
 Donald Golding (VE3PE6D), Oshawa, Ont.
 Garfield Challoner (VE5PE2E), Norquay, Sask.
 Klaus Ziermaier (KA2PE1AG), U. S. Army, Japan
 Ed Tilbury (KL7PE1K), Anchorage, Alaska
 Giacomo Perolo (PY1PE1D), Bauru, Brazil
 Ron Anderson (RA), Duluth, Minn.
 Bernard Brown (BB), Derby, England
 Charles Boehnke (CB), Reno, Nevada
 Canadian Broadcasting Corporation (CBC), Montreal, Quebec

be a fundamental and not a harmonic. The N.A. Service is currently using 6020 kc. as well as 9590 and 11,730 kc. (WPE1BBB, WPE2BRH, WPE9KM)

New Caledonia—R. Noumea, 6035 kc., s/on at 0200, heard to 0331 with music, news, features, native items; all in French. There is

some QRM from Germany. (WPE1BY, WPE6UK)

New Zealand—ZL2, Wellington, 9540 kc., is heard very weakly at 2200 with Eng. news. The signal is much better during the Pacific Islands xmsn at 0130-0345 (a change from the previous 0100 s/on) parallel to 6080 kc. (not heard). (WPE9CEW, WPE0ATE)

Philippines—Far East Broadcasting Co., Manila, was noted from 0700 to past 0800 in Eng. on DZH7, 9730 kc. (good), and DZH6, 6030 kc. (fair). (WPE6OU, KL7PE1K)

South Africa—The South African B/C Corp., Johannesburg, is heard well afternoons until 1500 s/off on 17,850 kc. with many newscasts; all Eng. on this Home Service channel. Another all-Eng. program has been heard on 7185 kc. around 0013; this is the Commercial Service. (WPE3HP/1, WPE0VB)

South Korea—The Voice of Free Korea, Seoul, is scheduled to N.A. at 0030-0130 on 9640 and 11,925 kc., and at 0930-1030 on 9640 kc.; and to Hawaii at 0230-0330 on 11,925 kc. and at 1100-1200 on 9640 kc. All programs are in Eng. and Korean. Reports should be sent to Korean Central Broadcasting Station, 8-Yejang-dong Choong-ku, Seoul, Korea. (WPE6BWK, KA2PE1AG)

Switzerland—The Swiss B/C Corp., Berne, has made some frequency changes. They now broadcast to Eastern Australia at 0215-0400 on 21,605 kc., replacing 21,520 kc.; to Western Australia at 0400-0445 on 17,720 and 11,865 kc., replacing 17,785 and 21,520 kc.; and to S. E. Asia and Japan at 0745-0930 on 17,720 and 21,605 kc., replacing 17,785 and 21,520 kc. (WPE1CHS, WPE2AXS, WPE4CGX, WPE4CHR, WPE4CLF, WPE8CCA, VE3PE6D)

Tanganyika—Dar-es-Salaam was noted on 5050 kc. at 2245-2300 with American music, news at 2300 in either Kiswahili or Swahili, Eng. news at 2310, and more music from 2315. Fade-out at 2330 prevented further listening. (WPE4FY)

Thailand—Bangkok is scheduled as follows: to N.A. at 2315-0015 (Eng. news at 2325); to Thai Forces in Korea (in Thai) at 0430-0520; General Overseas Service at 0525-0657; Home Service Relay at 0800-0900; all on 11,910 kc. The National Home Service is aired at 0700-1020 and 1900-2000 on 4830, 6070, and 7140 kc. Reports are cordially invited, and return postage is not required. Address: The Overseas Broadcasting Division, Public Relations Department, Bangkok, Thailand. (WPE7PK, WPE7YQ)

United Arab Republic—Cairo has Eng. on 11,915 kc. from 1630 to 1730 daily; Oriental music at 1632-1645 and news at 1645-1655. Noteworthy programs include "Music from the Films" on Sundays at 1700, and "With the Listeners" on Mondays at 1700. (WPE2FK)

Windward Islands—St. Georges, Grenada, scheduled for 15,390 kc., is still wandering to as high as 15,400 kc. The 11,715-kc. outlet is noted to 2115 s/off, dual to 3365 kc. (WPE6OU, WPE8AIJ, WPE8CKW, WPE8FV, CB)

Unidentified—A Russian station has been noted on 4825 kc. with s/off at 1605 after bells and the Red Anthem. Is this Ashkabad? (WPE1BY)

Short-Wave Monitor Registration

If you haven't registered for your Short-Wave Monitor Certificate and call letters, fill out this form and mail it with ten cents in coin to: Monitor Registration, POPULAR ELECTRONICS, One Park Ave., New York 16, N. Y. Include *stamped, self-addressed* envelope so we can mail your certificate at once. If you live outside the United States, send two International Reply Coupons or equivalent value postage stamps. Canadians may send fifteen cents in coin.

(Please Print)

Name

Address City State

Receiver Make Model

 Make Model

Principal SW Bands Monitored Number of QSL Cards Received

Type of Antenna Used

Signature Date



TRU-VAC 1-YEAR GUARANTEED RADIO and TV TUBES

Factory Used or Factory Second Tubes! TRU-VAC will replace FREE any tube that becomes defective in use within 1 year from date of purchase! All tubes individually boxed, code dated & branded "TRU-VAC". Partial Listing Only—Thousands More Tubes in Stock!

SPECIAL!		6SN7GT 30¢		6W4GT 30¢					
024	4858	6AH6	6BC5	6CD6G	6J7	6W6GT	7F8	12AV7	12K7
1A7GT	48Z7	6AK5	6BC8	6CF6	6K6GT	6X4	7G7	12AK4GT	12L6
1B3GT	4C86	6AL5	6B06	6CG7	6K7	6X5GT	7H7	12AK7	12Q7
1H5GT	5AM8	6AM8	6BE6	6CG8	6N7	6X8	7N7	12A27	12R5
1R5	5AN8	6AN8	6BF5	6CH8	6Q7	6Y6G	7Q7	12B4	12SA7
155	5AT8	6AQ5	6BG6	6CL6	6S4	7A4/XXL	757	12BA6	12SJ7
174	5AV8	6AQ6	6BH6	6CM6	6S8GT	7A5	7X6	12BA7	12SK7
1U4	5AZ4	6AQ7	6BJ6	6CM7	6SA7	7A6	7X7	12B36	12SN7GT
1U5	5CG8	6AR5	6BK5	6CN7	6SD7GT	7A7	7Y4	12BE6	12SQ7
1V2	5R4	6AS5	6BK7	6CQ8	6SF5	7B4	7Z4	12BF6	12V6GT
1X2	5T8	6AT6	6BL7GT	6CR6	6SG7	7B5	12AB	12B17	12W6GT
2AF4	5U4	6AU4GT	6BN6	6CS7	6SH7	7B6	12AB5	12B36	12X4
2BN4	5U8	6AV5GT	6BO6GT	6CU5	6SJ7	7B7	12AQ5	12B37	19AU4GT
2CY5	5V4G	6AU6	6BQ7	6CU6	6SK7	7B8	12AT6	12B77	19BG6G
3AL5	5V6GT	6AUB	6BR8	6DE	6SL7	7C4	12AT7	12CA5	19T8
3BC5	5X8	6AV5GT	6BS8	6DE6	6SQ7	7C5	12AV6	12C45	25Z6GT
3BN6	5Y3	6AV6	6BY5G	6DGGGT	6SR7	7C6	12AU7	12D4	35A5
3BZ6	6B84	6AW8	6BZ6	6DQ6	6T4	7C7	12AV7	12F3	35B5
3CB6	6AC7	6AX4GT	6BZ7	6DF	6TB	7E5	12AV6	12K5	35C5
354	6AF4	6AX5GT	6CA	6HG	6US	7E6			35W4
3V4	6AG5	6BR	6CAB	6J5	6UB	7E7			
4BQ7A	6AH4GT	6BA6	6CB6	6J6	6V6GT	7F7			

\$33
Per 100 TUBES

BRAND NEW 1-YEAR GUARANTEED TV PICTURE TUBES
Below Listed prices do not include tax. Add Additional \$5.00 Deposit on tube sizes to 20", on 21" and 24" tubes—\$7.50. Deposit refunded immediately when dud is returned prepaid. Aluminized tubes—\$4.00 extra. Picture tubes shipped only to continental USA and Canada—All tubes F.O.B. Harrison, N. J.

10BP4	7.99	17CP4	16.99	21AMP4	17.99	21KP4	18.39
16CP4	16.09	17TP4	16.99	21AVP4	18.79	21YP4	18.39
16RP4	11.99	20CP4	15.89	21AWP4	17.49	21WP4	17.49
17AVP4	15.49	20HP4	17.89	21EP4	17.29	21VP4	18.39
17BP4	13.49	21ALP4	18.79	21FP4	18.39	24CP4	27.79

ATTENTION QUANTITY USERS! Big Discounts Are Yours... Call or Write For Our 1961 "Value-Private Label" Special!
Money cheerfully refunded within five (5) days, if not satisfied!
SHIPPING INSTRUCTIONS: TRU-VAC® PAYS YOUR POSTAGE on orders of \$5 or more in USA and Territories. Send approximate postage on Canadian and foreign orders. Any order less than \$5 requires 25¢ handling charge. Send 25¢ on C.O.D.'s.
ANY TUBE NOT LISTED ALSO AVAILABLE AT 35¢ EACH!

Sensational Offer!
"Self Service"
TUBE CHECKERS
\$37.95 FOB Our Warehouse

Let your customers test their own tubes! These reliable, checkers will return your investment in one week your in- with little or no effort on your part! Handsome, field- tested console model. COM- PLET W/T™ KEY FOR LIGHTED HEAD!

LOOK! 1000 USED TV'S
Costly, famous make console models with little or no tube replacement! Require only minor adjustments. Perfect for resale, or as your own second set! 16", 17" and 19" screens... none smaller! Sets shipped FOB, Harrison, N. J.

\$16.95 (As Is)

TRU-VAC

Harrison Avenue • Box 107 • Harrison, N. J. Humboldt 4-9770

Transistor Topics

(Continued from page 104)

mass-produced silicon transistors to be manufactured using epitaxial techniques. Type numbers are 2N743 and 2N744, with switching times of 24 and 29 millimicroseconds respectively (at 100 ma.). A significant characteristic of these two units is that their saturation resistance is practically insensitive to temperature. As both of them have extremely low interelectrode capacities, they are suitable for use as high-frequency amplifiers and oscillators. Prices are competitive with conventional silicon mesa and micro-alloy switching transistors.

Radio Corporation of America (30 Rockefeller Plaza, New York 20, N.Y.) has started pilot production of a double or "Siamese-twin" transistor which combines two virtually identical silicon power transistors in a single package sharing a common collector element. This new device, called a "twin planar" transistor, has potential applications as a d.c. chopper amplifier, a d.c.-to-a.c. inverter, or a differential amplifier. In space vehicles, it could make possible a substantial step-up of the power from a solar cell to transmit back to earth information on radiation, temperature, atmosphere density and other subjects. In industry, it could be used in production controls. Consumer applications include the operation of remote car-radio speakers, and the transformation of d.c. battery power to 117 volts a.c. for the operation of small appliances. Initially, the selling price will be about \$25 each in production quantities.

Overseas News. A study of the European semiconductor industry by Dr. Dennis P. Riley, president of Intertechnical Consultants, Inc., Geneva, Switzerland, indicates that over 85% of Europe's semiconductor production is concentrated in the United Kingdom, France, and Germany. Most European production goes to fill the needs of the entertainment industry, with military requirements negligible. In the U.S., on the other hand, the highest volume (dollar-wise) of semiconductor production goes to the military/industrial users.

Ericsson Telephone, Ltd., of London, England, has developed a series of tran-

sistorized telephone handsets for use both by the hard-of-hearing and by people with normal hearing in areas where reception is difficult. The amplifiers used are built into the handle and employ a single junction transistor to provide a gain in excess of 20 db. A small knob permits adjustment of listening volume.

According to "Japan Electronics," a monthly publication published by Television and Radio Press, Inc. (33 Shiba Kotohira-Cho, Minato-Ku, Tokyo, Japan), Japan's transistor exports total 500,000 units monthly, with approximately 200,000 units being shipped to the United States. The next largest buyers are Hong Kong and West Germany.

Product News. General Electric Company (Syracuse, N.Y.) has announced a number of price reductions for their semiconductor products. A 41% reduction has been made on three industrial types of silicon Unijunction transistors, and reductions of from 22% to 46% have been made on all 22 models comprising two lines of its silicon low-current potted rectifier circuit assemblies.

Jettron Products, Inc. (56 Route 10, Hanover, N.J.) is now producing two types of transistor test sockets. One type has three contacts, the other four.

The Electro Products Division of Itek (Cambridge, Mass.) plans to market a FM transistorized wireless microphone which utilizes only six components. The pocket-sized instrument has a range of 1500 yards and will operate in the Citizens Band.

That covers the semiconductor front for now, fellows. We'll be back next month with more news and circuits.

—Lou

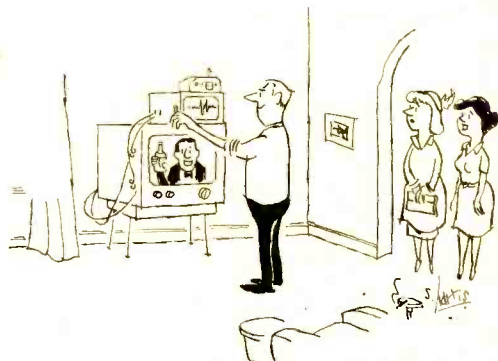

"Henry checks all the commercials with his lie detector."

Explaining Tuned Circuits

(Continued from page 67)

a tuned circuit. Look at these curves. The top one shows a low- Q tuned circuit in operation. You can see how broad the curve is. If you tune the receiver

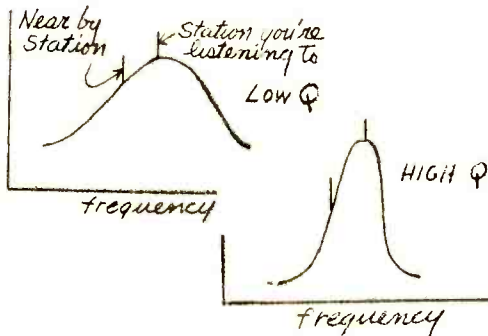

correctly, the station you want to listen to will be right on top of the curve. But note that a nearby station, which you don't want to hear, will have almost the same signal strength—the tuned circuit will not reject it. This shows poor selectivity." Pointing to the top drawing, Ken added, "That's *your* receiver!"

"I see *yours* right below it," Larry said. "The curve is more peaked, so the tuning is sharper. Also, the nearby station is almost rejected. In fact, I bet it won't be heard at all."

"You get the point, Larry. So the Q is only a means of expressing the quality of the tuned circuit. To compute it, you divide the inductive reactance by the resistance in the circuit.

"You can see that the less resistance, the higher the Q ; and the higher the Q , the more selective the circuit. When you're building a set, you should be careful to keep leads as short as possible, make good solder joints, and do everything possible to keep the resistance down and the Q up."

"I guess that's a lesson I'll remember the next time I heat up the old soldering iron." Larry tried to hide a yawn.

"If that's a hint you've had enough, I can take it, buddy." Ken laughed as he got up. "Let's call it a session. But before you run off, let me remind you to go over what we've talked about. You took such a big bite of theory, you'd better chew on it a while."

-30-

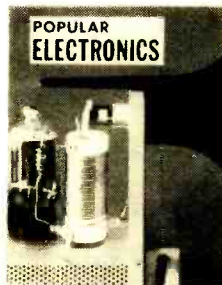

Send POPULAR ELECTRONICS Every Month

NAME

ADDRESS

CITY ZONE STATE

3 years for \$10

Check one: 2 years for \$7

1 year for \$4

Payment Enclosed Bill Me

In the U. S., its possessions and Canada. Foreign rates: Pan American Union countries, add .50 per year; all other foreign countries, add \$1 per year.

Mail to:

POPULAR ELECTRONICS

Dept. PE-561 H, 434 S. Wabash Ave.,

CHICAGO 5, ILL.

Across the Ham Bands

(Continued from page 87)

cedure below, but take extra care to keep all leads as short as possible.

Construction. The idea is to break the original lead between the input tuned circuit (C_3 , L_3) and the 100- μ f. fixed capacitor (C_4), then install the circuit shown on page 87 between them.

Begin by drilling a $\frac{3}{8}$ "-diameter hole in the converter chassis in a clear spot about $1\frac{1}{2}$ " from the edge and 1" from the front. Place the tube socket in the hole from the top and hold it in place by bending over the mounting tabs underneath. Finally, drill a $\frac{1}{4}$ " hole near the socket of the 6U8A (V_1) to accommodate coil L_6 .

To wire up the stage, ground terminal 10 of V_3 's socket, and connect the "hot" filament (pin 12) to the 6.3-volt power source. Ground the cathode (pin 8) through a $\frac{1}{2}$ -watt, 120-ohm resistor. Bypass both pins 8 and 12 to ground with ceramic capacitors—any value from 0.001 to 0.005 μ f. should be satisfactory; and connect the wire from the input-tuned circuit previously disconnected from the 100- μ f. capacitor C_4 to the grid terminal (pin 4) of the socket.

Bypass the terminal of L_6 closest to the chassis to ground with C_{14} , a 47- or 50- μ f. mica or ceramic unit. Connect neutralizing capacitor C_{11} between this terminal and the grid terminal (pin 4) of the 6CW4 socket. In addition, connect an 1800-ohm, $\frac{1}{2}$ -watt resistor from this coil terminal to pin 5 (plate) of the OB2 voltage regulator socket. Finally, connect the plate (pin 2) of the 6CW4 and lead from C_4 to the remaining terminal of L_6 .

Operation. Set up the converter and companion receiver for normal operation in the 50-mc. band. Peak C_3 , which will tune very close to its original setting, and adjust the slug in L_6 for maximum output from the speaker.

At some setting of the slug, the 6CW4 will probably break into sustained oscillation, as evidenced by a loud, steady squeal from the speaker or by the receiver S-meter suddenly jumping up to a steady high value. If this occurs, adjust neutralizing capacitor C_{11} to kill the oscillation. Then, continue to adjust

L_6 for maximum output, adjusting C_{11} as necessary to prevent self-oscillation. Once set, C_{11} should require no further adjustment.

After this preliminary tune-up, peak the slug in L_6 on a weak signal in the most-used segment of the 6-meter band. The 6CW4 should increase the apparent strength of received signals about three "S" units.

News and Views

J. P. Savard, VE2BBF, 23 Parissi Blvd., Laval des Rapides, P. Q., Canada, has been on the air three months and has 60 contacts. Paul is thrilled with the friendships that exist between hams without regard to age (he is 40) or other boundaries. He uses a Heathkit DX-35 transmitter and VF-1 VFO, and receives on a Trio 9R-4 aided by a Q-multiplier. His present antenna is a 100' end-fed wire, but he will soon have an "all-band trap" doublet. Paul uses the T/R switch described in our August, 1960, column to switch the antenna from receiver to transmitter. . . .

Ken Levy, KN5FLA, 6438 Lupton, Dallas, Texas, has worked 33 states, 26 confirmed, in three months with his Globe Scout feeding a Quad antenna, 50' high; he receives on a Hallcrafters S-85. Ken's DX list shows 13 countries, including such "juicy" ones as VR6 and CR5! . . . **Bob Erdmann, Jr., K9TQJ**, (17), 7805 E. 50th St., Lawrence 26, Ind., got his Novice license in 1959 and his General in 1960. As a Novice, he worked 25 states on 80 meters. He obtained his WAS using a Johnson Viking II his grandfather gave him when his General ticket arrived. Bob receives with an SX-110 and spends most of his time chasing DX on 10- and 15-meter c.w.

Horace Clark, K1LJG, Wilton, Maine, credits our column for getting him started and keeping him going in ham radio until he got his big ticket. After wheeling and dealing with his equipment, Horace now has an EICO 720 transmitter and modulator and VFO to feed a Hornet tri-band beam on a 50' tilt-over tower—hurricane "Donna" tilted it. This equipment, plus a Hallcrafters SX-99 and Heathkit QF-1 Q-multiplier, has worked all states except Idaho, and 24 countries. Fifteen of the latter are confirmed. . . . the best-equipped hams have trouble getting QSL's.

Ken Lappe, KN1QGC, 73 Pine Lane, Windsor, Conn., QSL's 100% and considers himself lucky if he gets a 25% return. But Ken has been on the air only five weeks; so his percentage will undoubtedly improve. His EICO 720 transmitter, feeding a 40-meter dipole, 15' high, has already worked 38 states. Twenty-eight of them are confirmed. . . .

Thomas A. Whitely, WA6FCO/4, Box A 992, Orlando A.F.B., Florida, is 18 and a radio operator at the Orlando Air Force Base. Over the New Year weekend, he spent 22 hours and 30 minutes on the air with his Johnson Adventurer transmitter, and worked 30 states and three countries. Tom needs lots of "O's" and "7's" for his WAS; he will sked you if you need Florida.

Guy B. Young, K3DKO, 221 Edgewood Ave., New Castle, Pa., started out as a Novice in 1957 and is now about ready to take his Extra Class exam. He works all bands, 80 meters through 6 meters, with a Globe Scout 680A transmitter agitating the electrons in a 40-meter doublet 50' high. He receives on a Heathkit AR-3, but did not mention what type of converter he uses for "6." More of a rag-chewer than a DX chaser, Guy has only 39 states worked. He will assist anyone needing help to obtain a ham license. . . .

Ray Strobel, KN9ZGU, Arlington Hts., Ill., who has been a ham for just one month, has quite a shackful of equipment—a Heathkit DX-40 transmitter, Hallicrafters S-85 receiver, Gotham V-80 vertical antenna, Heathkit "Tenner" transceiver, a borrowed 2-meter Gonsset Communicator, and a 10-element, 2-meter beam. Result: 100 contacts in 14 states.

Mike Coffey, KN45YA, 302 Hancock House, Charlottesville, Va., feels that ham radio is what you get out of it, not what you spend on your equipment. He uses a "surplus" ARC-5 receiver powered by parts he scrounged from old TV chassis, and he transmits on a second-hand Heathkit AT-1. His 80-meter antenna is constructed of clothes-line wire. In six months, Mike has worked 31 states, Canada, Mexico, Puerto Rico, and England. He is an electronics engineering student at the University of Virginia. . . . I neglected to credit

Steve Spehger, K9OJ1, for taking the picture of Kent, W9AYW, which appeared in the February column. . . . **Wayne Bailey, K5ZJK**, RFD 1, Box 54-A, Jasper, Texas, worked 45 states, 43 confirmed, in his Novice year. He sprinkled in contacts with 10 foreign countries for flavor. His equipment then included a National NC-109 receiver, and a DX-40 transmitter. Now he has a VF-1 VFO, an Astatic JT-30 microphone, and a "bug" key to go with his General license. Come summer, Wayne hopes to be climbing something to install a tri-band beam antenna. Call on him for a schedule on any frequency on which the DX-40 will work if you need Texas.

That uses up our space for this month. I hope I will hear from you before the next issue goes to press. 73,

Herb, W9EGQ

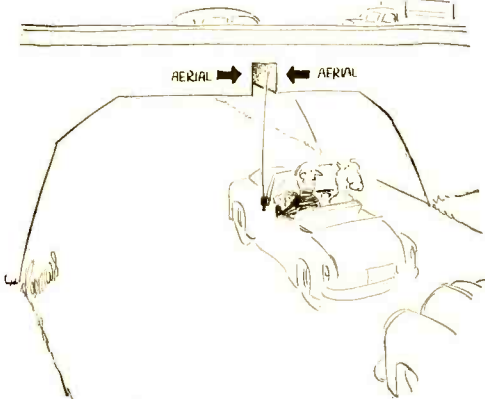

"Awfully considerate of the Highway Commission, isn't it?"

May, 1961

New!

EASY
WAY
TO
LEARN



12 in.
3 3/4" LP
RECORD

THE ONLY RECORDING that tells you how to repair your record playing system

- ★ **EDUCATES.** Describes in simple terms how your system operates and how to apply step by step trouble shooting methods.
- ★ **DEMONSTRATES.** Plays more than 20 different examples of hum, distortion, background noises and other faults.
- ★ **EXPLAINS.** Tells you how to pin point and repair troubles in your system.
- ★ **SAVES TIME AND MONEY.**

ORDER TODAY! -- We pay postage.

Send Check or Money Order for **\$5.98**

(Ohio residents add 3% Sales Tax. Send \$6.16)

Available only by mail from:

MARIETTA APPARATUS CO., MARIETTA, OHIO

twenty to one dividend . . .

that's the return you can receive from your investment in your college education in engineering or business. Faster advancement. too. Important firms like Tri-State College graduates . . . return regularly to our campus to interview seniors. Become an Electronics Engineer. Qualify faster here.

BACHELOR OF SCIENCE DEGREE IN 27 MONTHS

in Electrical (Electronics or Power major), Mechanical, Chemical, Aeronautical, Civil Engineering. IN 36 MONTHS B.S. in Business Administration (General Business, Accounting, Motor Transport management majors). For earliest, capable, mature students. Small classes. More professional class hours. Beautiful campus. Well-equipped labs. modernized buildings, new dorms. Year-round operation. Enter June, Sept., Jan., Mar. Founded 1884. Write J. D. McCarthy, Director Admissions, for Catalog and "Your Career in Engineering and Commerce" Book.

TRI-STATE COLLEGE

3651 College Avenue
Angola, Indiana

Experimenters • Amateurs • Hobbyists

Extraordinary values await you in government surplus electronic components. Don't buy anything until you have our "Bargain Bulletin"; new material for mere dimes on the dollar. Remember, everything is brand new; here are typical values:

40 meter, 75 watt plug in RF coil, type OEL	12 oz.	\$0.95
Scope xfrmr, 115 v pri, 2500/3 and 2.5/1.75	5 lbs.	1.95
Selsyns, Husky (type II-4, C56701), 115 v/60 cyc.	15 lbs.	7.95
Differential relay, one mil operates, 9000 ohm x 2	1 lb.	3.39
Pwr xfrmr for 1.3M freq meter, 510/25, 12.6/0.9 6.3/0.5	5 lbs.	2.19
Choke, 5 hy/105 mils, 100 ohm, double shell vert.	3 lbs.	.95
Pwr xfrmr, 115/220/60 cyc, 600 ct/350 & 12.6 ct/11	18 lbs.	4.29
Oil cond., 4 mfd/1650 dc, HV terminals	3 lbs.	2.29
6SN7GT vacuum tubes, a dozen for	3 lbs.	5.95
Output xfrmr, 8000 to 15/125/250, 25 watts, compact	4 lbs.	1.95

WRITE TODAY FOR FREE GOVERNMENT SURPLUS BARGAIN BULLETIN

JOE PALMER

P.O. Box 6188 CCC,
Sacramento, California

GET INTO ELECTRONICS

V.T.I. training leads to success as technicians, field engineers, specialists in communications, guided missiles, computers, radar, automation. Basic & advanced courses in theory & laboratory. Assoc. degree in 29 mos. B. S. obtainable. (ECPD) accredited. G.I. approved. Graduates with major companies. Start Sept., Feb. Dorms, campus. H. S. graduates or equivalent. Catalog.

VALPARAISO TECHNICAL INSTITUTE
Dept. PE VALPARAISO, INDIANA



ELECTRONICS MARKET PLACE

RATE: 60¢ per word. Minimum 10 words prepaid. July issue closes May 5th. Send order and remittance to Martin Lincoln, POPULAR ELECTRONICS, 1 Park Ave., New York 16, N. Y.

FOR SALE

16 TESTED Transistor plans—25¢, with experiments, catalog, Laboratories, 1131-L Valota, Redwood City, California.

BEFORE You Buy Receiving Tubes or Hi-Fi Components send now for your giant Free Zalytron current catalog—featuring nationally known Zalytron First Quality TV-Radio Tubes, Hi-Fi Stereo Systems, Kits, Parts, etc. All priced to Save You Plenty—Why Pay More? Zalytron Tube Corp., 220 W. 42nd St., NYC.

SEND \$5.00 for manufacturers surplus radio parts grab bag. Guaranteed \$25.00 value. Skycrafters, 1365 Gladys, Long Beach, Calif.

MORSE Code Copier. Automatic like teletype. Costs less than \$45 to build. Complete construction details. \$4.75. DB Enterprises, 8959 Wonderland Ave., Hollywood 46, Calif.

ELECTRONICS By Sleep Teaching. \$12.00 per lesson, 15 lessons. The thorough way to train. Tape recorder included at no extra cost. Catalog 25¢. Electro-Sleep, 8959 Wonderland Ave., Hollywood 46, Calif.

SOUND Operated Relay—For dictating or private use—Actuate recorder only when sound is present—literature and price. WJS Electronics, 1130 North Highland Ave., Hollywood 38, Calif.

ELECTRONICS By Correspondence. Includes 2 texts, Study Guide, Quiz Service & Slide Rule. \$12.75. Seaway Electronics, 5880 Hollywood Blvd., Hollywood 28, Calif.

COLOR TV. Convert your black and white TV to color. Completely Electronic. No mechanical gadgets. Costs about \$35. Complete construction details \$4.75. DB Enterprises, 8959 Wonderland Ave., Hollywood 46, Calif.

JUNK Your Distributor and Voltage Regulator. Improve automobile mileage and performance. Construction details for transistorized distributor and voltage regulator. \$4.75. No moving parts. DB Enterprises, 8959 Wonderland Ave., Hollywood 46, Calif.

GOVERNMENT Sells Surplus: Electronics; Oscilloscopes; Transceivers; Test Equipment; Radar; Sonar; Walkie-Talkies; Boats; Jeeps; Aircrafts; Misc.—Send for "U.S. Depot Directory & Procedures"—\$1.00—Brody, Box 425/PE, Nanuet, New York.

SOMETHING for sale? Place a classified ad in this section. Low-cost, fast results. It's easy.

TV Tuners—Rebuilt or Exchanged \$9.95 complete—all types—fast, guaranteed service. Send tuner with all parts to: L.A. Tuner Exchange, 4611 West Jefferson Blvd., Los Angeles 16, California.

TV Camera. Build for less than \$50. Construction Details \$4.75. DB Enterprises, 8959 Wonderland Ave., Hollywood 46, Calif.

INVESTIGATORS! Do your own sound work. Write for free brochure of latest electronic equipment. WJS Electronics, 1130 N. Highland Ave., Los Angeles 38, Calif.

GOVERNMENT Surplus Receivers, Transmitters, Snooper-scopes, Parabolic Reflectors, Picture Catalog 10¢. Meshna, Malden 48, Mass.

TELEPHONE Extension In Your Car. Answer your home telephone by radio from your car. Complete diagrams and instructions \$2.00. C. Carrier Co., 5880 Hollywood Blvd., Hollywood 28, Calif.

EAVESDROP with a pack of cigarettes. Miniature transistorized FM Radio Transmitter. Complete diagrams and instructions \$2.00. C. Carrier Co., 5880 Hollywood Blvd., Hollywood 28, Calif.

WPE-SWL-CB-QSL Cards — Samples 10¢ — "Brownie" W3CJ1, 3110A Lehigh, Allentown, Penna.

DIAGRAMS for repairing radios or television \$2.00. Give make, model. Diagram Service, Box 672-PE, Hartford 1, Conn.

POLICE Radar Detector. Stop before those radar speed traps. Fool proof, legal system. Complete diagrams and instructions \$2.75. C. Carrier Co., 5880 Hollywood Blvd., Hollywood 28, Calif.

BALANCE Your Stereo from Across the Room—How it sounds where you sit—that's what counts! Remote volume and balance control works with any system using separate preamplifier and power amplifier or any tape deck with cathode follower outputs. Small control (5 x 3 x 2 inches) can be placed as far as 30 feet away. \$19.95 in walnut or mahogany housing, \$15.95 in metal. Sun Radio Service, 320 Chestnut Street, Kearny, New Jersey, WY 1-0564.

AUTO Radio Distributor, Selling, Servicing, Becker Blaupunkt, FM-AM, other European, American Sets. Save 30%+ Square Electronics, 150-60 Northern Blvd., Flushing, N. Y.

CITIZENS' BAND! Add a Hushpuppy noise suppressor to your Heathkit, Lafayette, Globe, etc. transceiver. Squelch Action! Completely Wired. Guaranteed. \$4.98. Western Mass. Electronics, Great Barrington 1, Mass.

"GIANT 128 Page Wholesale Catalog, over 800,000 items. \$1.00 deductible First Order. P. Adger Co., 112 Belmont Ave., Brooklyn 12, N. Y.

TELEPHONE Voice Switch (LS-500). Actuates automatically and unattended any tape or wire recorder. Pictorial installation instructions included. \$23.75. Post paid US. WJS Electronics, 1130 N. Highland Ave., Los Angeles 38, Calif.

BE A Spy. Correspondence course on wire tapping, bugging, telescopic sound pickup, recording techniques, microphotography, and invisible photography. Lessons in surveillance, tailing, and use of equipment. Complete course \$22.50. C. Carrier Co., 5880 Hollywood Blvd., Hollywood 28, Calif.

UNUSUAL Electrical Devices Wholesale. Literature 25¢. Wellco Products, Box 3055, North Hollywood, California.

SOUND operated equipment. Complete circuits with applications for building inexpensive sound operated unit to control tape recorders, alarms, garage doors, and others. \$1.95. Electrosience, Box 1041, Dept. A, Portland 7, Oregon.

EXPERIMENTERS! 4 transistors, 15 circuit diagrams. \$3.95 Fay Co. 8275 Del Drive, Minneapolis 27, Minn.

SERVICEMEN: T V and Radio Tubes all top name brands 60-10-5 o/o New, First Quality, regular boxed. No job lots, closeouts or pullouts. Send for Catalog. Representatives wanted for all states. High Commission, Radio Tube Specialists, 397-B 7th Ave., Brooklyn 15, N. Y.

GARAGE Door Operator Kits—Edwards famous KR-50 kit. Easily assembled and installed. Available with or without remote car control. Thousands sold. Priced from \$64.95. Write for literature. Edward T. Fink Co., Inc., 284 Nepperhan Ave., Yonkers, N. Y. Dept. PE

SPECIAL! WPE-SWL-CB-QSL, cards, 3 colors—\$2.50 per 100—Free Samples. Garth, Jutland, New Jersey.

CITIZEN-Band Crystals—Direct From Manufacturer. Guaranteed .005% Tolerance. Send Only \$1.75 For Each Crystal With Equipment Mfg. Name, Model No. And Channel No. To Michigan Crystal Co., Inc., Box 413, Lansing, Michigan.

CITIZEN'S Band! Special for summer C.B. picnics and visiting clubs. Your name, address and call in plastic badge. Each \$.75 or \$.50 each in lots of 4 or more. Bernard Osborn, 16 Woodlawn St., Bluffton, Ind.

GOVERNMENT Surplus Receivers, Transmitters, Walkie-Talkies, Tech Manuals, Schematics, Tubes, Over 5000 Items, 1961 Catalog 10¢. Bill Slep Company, Drawer 178, Ellenton, Florida.

CITIZENS Band; Lafayette HE-15, 15A owners, hear only the channel you tune. Dual Conversion Adapter reduces bandwidth to 5KC @ 6DB, 12KC, @ 20Db. Send your unit (in working order) and \$39.95 check or money order. We will promptly install and return prepaid. Or send no money and we will return C.O.D. \$39.95 plus postage. Adapter fully guaranteed. Adapter in kit form and modifications for other units available. Send for free literature. Bainbridge Radio, 2649 Bainbridge Ave., New York 58, N. Y.

MAKE Extra Money—Service Class "D" Citizens Equipment. Wattmeter 0-5 watts \$18.75. Free literature. S/NECO, Box 226, Bakersfield, Calif.

PROFESSIONAL Quality aluminum dials and nameplates. Make your own. Kits—\$7.75. Custom Electronics, GPO Box 1249, Brooklyn 1, New York.

CITIZENS Band—Amateurs! Add squelch action to your transceivers. OZCO "Snoozer" quiets beyond belief! Compact, completely wired, guaranteed. Easily installed! Only \$2.00 each, \$3.95 pair, postpaid, tax included. OZCO Sales, Canaan, Connecticut.

WANTED

1 RCA Type WR39 or WR89 Television Calibrator. Popular Electronics, Box 106, One Park Avenue, New York 16, N. Y.

QUICKSILVER, Platinum, Silver, Gold, Ores Analyzed. Free Circular, Mercury Terminal, Norwood, Massachusetts.

WANT to buy good equipment and accessories? Place a low-cost classified ad in this space. For information, write: Martin Lincoln, Popular Electronics, One Park Avenue, New York 16, N. Y.

TRIGGER-W9IVJ. We Buy Short-Wave Equipment For Cash, 7361 W. North Ave., River Forest, Ill. Phone PR.1-8616. Chicago # TU 9-6429. Mon-Fri 12N-9PM. Sat 9AM-5PM.

WANTED Circulated Indian Cents, Liberty V-Nickels And Buffalo Nickels Before 1936. 10¢ each In Large Quantities No Mutilated Coins Send To John J. Firpo, 2107 Van Ness Avenue, San Francisco 9, California.

HIGH-FIDELITY



DISGUSTED with "Hi" Hi-Fi Prices? Unusual discounts on your High Fidelity Requirements. Write Key Electronics, 120 Liberty St., New York 6, N. Y. Cloverdale 8-4288.

DON'T Buy Hi-Fi Components. Kits, Tape, Tape Recorders until you get our low, low return mail quotes: "We Guarantee Not To Be Undersold." Wholesale Catalog Free. Hi-Fidelity Center, 220 PCE-23 St., New York 10, N. Y.

PRICES? The Best! Factory-Sealed Hi-Fi Components? Yes! Send for free catalog. Audion, 25P Oxford Road, Massapequa, N. Y.

RECORDERS, Components. Free wholesale catalogue. Carston, 125-P East 88. N. Y. C. 28

PROMPT Delivery, We Will Not Be Undersold. Amplifiers, Tape Recorders, Tuners, Etc. No Catalogs, Air Mail Quotes. Compare. L. M. Brown Sales Corp. Dept. P, 239 E. 24 St., N.Y. 10, N.Y.

SOUNDTASTIC! That's what our customers are saying upon receiving our prices on our latest High Fidelity Stereo and Monaural, Amplifiers, tuners, turntables, speakers, tape recorders, kits. All brand new with factory guarantee. Individual quotations only. No catalogues. Audio World, 2057 Coney Island Avenue, Brooklyn 23, New York, Dept. HR.

HI-FI From Japan. Finest imported tuners, amplifiers, recorders, etc. Free catalog. KPJ Sales, Box 1252-K, Studio City, California.

TAPE & RECORDERS

AMPEX, Concertone, Magnecord, Presto, Bogen, Tandberg, Pentron, Sherwood, Rek-O-Kut, Scott, Shure, Dynakit, others. Trades. Boynton Studio, Dept. PE. 10 Pennsylvania Ave., Tuckahoe, N. Y.

TAPE Recorders, Hi-Fi, components. Sleep Learning Equipment, tapes, Unusual Values. Free Catalog, Dressner, 1523F Jericho Turnpike, New Hyde Park, N. Y.

SOMETHING for sale? Place a classified ad in this section. Low-cost, fast results. It's easy.

RENT Stereo Tapes—over 2,000 different—all major labels—free catalog. Stereo—Parti. 811-G Centinela Ave., Inglewood 3, California.

WRITE Martin Lincoln, Popular Electronics, One Park Avenue, New York 16, N. Y. for information on how to place a classified ad in this section.

REPAIRS and SERVICING

LET us wire and test any kit for you. Naczas Kit Service, 18 Wolfe Street, Manchester, New Hampshire.

WRITE Martin Lincoln, Popular Electronics, One Park Avenue, New York 16, N. Y. for information on how to place a classified ad in this section.

DIAGRAMS, servicing information, practically any radio, television, \$1.00, postpaid. Specify manufacturer, model. Supreme Publications, 1760 Balsam, Highland Park, Illinois.

ELECTRONICS Kits Wired And Tested, Write J. R. Simpson, 46A Cedar St., Waltham 54, Mass.

INSTRUCTION

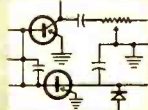

DATA Processing. Become acquainted with this modern world of automation. Send \$1.00 for details. Automation—Box 333, Natick, Mass.

SPECIAL Home Study course; end unemployment worries; prepare for FCC exams, TV servicing, Citizens Radio; Increase your income; 60 lessons, \$5 down, \$5 month. Experimental Kits. Write for Free booklet and sample lesson. Florida Technical Schools, Box 8145A, Jacksonville 11, Fla.

ENGINEERING Education for the Space Age. Northrop Institute of Technology is a privately endowed, nonprofit college of engineering offering a complete Bachelor of Science Degree Program and Two-Year accredited technical institute curricula. Students from 50 states, many foreign countries. Outstandingly successful graduates employed in aeronautics, electronics, and space technology. Write today for catalog—no obligation. Northrop Institute of Technology, 1179 West Arbor Vitae Street, Inglewood 1, California.

EXPERIMENT with nature's electronics. Instructions—Stillwater, Box 337E, Morris Plains, New Jersey.

SCHEMATICS, Blueprint Reading Courses \$2.00. Special Edition Encyclopedia Drawing Design \$9.00. Louis Prior, 23-09 169th Street, Whitestone 57, New York.

PHOTOGRAPHY For Pleasure or profit. Learn at home. Practical basic training. Long established school. Free booklet. American School of Photography, 835 Diversey Parkway, Dept. 2535, Chicago 14, Illinois.

LEARN Calculus. Easy, Practical, Trial 4 lessons \$1. Mathco, 4256-8 Minmor, Cincinnati 17, Ohio.

BOOKS

FREE, amazing new book of money making opportunities and mail order bargains. Write today! Mail Order Buyer's Guide, Dept. PE, P.O. Box 5954, Chicago 80, Ill.

BOOKS—All 10¢. 2000 titles, all subjects, catalog free. Cosma, Clayton, Ga.

BUSINESS OPPORTUNITIES

I WANT A MAN who wants a business of his own. I will train you, supply the equipment, give you credit, help you get rolling. This is not a risky get-rich-quick scheme. It is a legitimate business, exclusive protected franchise, proved successful by hundreds throughout the country. Write for an interview. Marion Wade, 2117 North Wayne, Dept. 25M, Chicago 14, Illinois.

WRITE Martin Lincoln, Popular Electronics, One Park Avenue, New York 16, N. Y. for information on how to place a classified ad in this section.

SOMEONE "borrowing" your personal copy of Popular Electronics each month? You ought to be taking advantage of Popular Electronics' convenient re-sale plan. Sell copies in your store . . . perform a good service for your customers . . . with no risk involved. For details, write: Direct Sales Department, Popular Electronics, One Park Avenue, New York 16, New York.

\$12,500 Yearly Income! Sell your own Tape Recordings as Freelance International Recording representatives. Present equipment sufficient. Only \$1.00 brings copy-righted comprehensive plan. International Recording, Box 202 P., Irvington, New Jersey.

WHATEVER your needs, Popular Electronics classified can solve them. Simply place an ad in these columns and watch your results pour in.



SHOPPING GUIDE

Classified

A HANDY REFERENCE TO PRODUCTS AND SERVICES NOT NECESSARILY ELECTRONIC, BUT OF WIDE GENERAL INTEREST

PHOTOGRAPHY—FILM EQUIPMENT, SERVICES

OPTICAL-Science-Math Bargains—Request Free Giant catalog "CJ"—144 pages—Astronomical Telescopes, Microscopes, Lenses, Binoculars, Kits, Parts. Amazing war surplus bargains. Edmund Scientific Co., Barrington, New Jersey.

FREE! New 1961 catalog of all photographic books available. For your copy, send postcard with name and address to Catalog Popular Photography Book Service, One Park Ave., New York 16, N. Y.

PLASTICS

NEW Liquid Casting Plastic, clear, colors. Embed real flowers, butterflies, photos, coins. Send 25¢ for two handbooks "How to Cast Liquid Plastics" and "How to Make Extra Money at Home." Castolite, Dept. E-108, Woodstock, Illinois.

LEATHERCRAFT

FREE "Do-It-Yourself" Leathercraft Catalog. Tandy Leather Company, Box 791-H-39, Fort Worth, Texas.

STAMPS & COINS

200 Different U.S. Stamps \$1.00 Approvals included. Shelron, Box 907-H, New York 8, N. Y.

OVER 400,000 buyers and sellers will read your ad when placed in this space. It costs only 60¢ per word; minimum of 10 words including your name and address. Send order and remittance to: Martin Lincoln, Popular Electronics, One Park Avenue, New York 16, N. Y.

GIGANTIC Collection Free! Includes triangles, early United States, animals, commemoratives, British Colonies, high value pictorials, etc. Complete collection plus big illustrated magazine all free. Send 5¢ for postage. Gray Stamp Company, Dept. Z2, Toronto, Canada.

1960 United Nations commemorative stamps, all mint 4c and 8c commemorative sets only one dollar with request for approvals. Adults Only. Martin Stamp Co., Box 12-A, Gravesend Sta., Brooklyn 23, New York.

INVENTIONS WANTED

INVENTIONS wanted. Patented; unpatented. Global Marketing Service, 2420-P 77th, Oakland 5, Calif.

INVENTIONS Wanted for immediate promotion! Patented, unpatented. Outright cash; royalties! Casco, Dept. BB, Mills Building, Washington 6, D.C.

WRITE Martin Lincoln, Popular Electronics, One Park Avenue, New York 16, N. Y. for information on how to place a classified ad in this section.

EDUCATIONAL OPPORTUNITIES

BE A Real Estate Broker. Insure security for yourself and your family. Study at home. Prepare for state examination. GI approved. Write for free book today. Weaver School of Real Estate, 2024 J. Grand, Kansas City, Missouri.

FREE L.P. Record and book gives instructive facts about Sleep-Education and the Audio Educator—the short cut method to learning and self-development—no obligation—SDRF—Dept. L 5, 104 East 40th Street, New York 16, N. Y.

DETECTIVE Profession. Home Study, Badge, Certificate. Future 4563-AG York, Los Angeles 41, Calif.

AMATEUR radio. Interested in learning? For educational information, write Jondra, Department B-4, Box 733, Lincoln, Nebraska.

JOB in Electronics? Fix your own TV? Sample employment tests? Everything you need . . . \$1.95. EFCO, Box 1158, Torrance, California.

EMPLOYMENT INFORMATION

HIGH Paying Jobs in Foreign Lands! Send \$2.00 for complete scoop! Foreign Opportunities, Box 172, Columbus 16, Ohio.

EARN Extra money selling advertising book matches. Free samples furnished. Matchcorp, Dept. MD 51, Chicago 32, Illinois.

BUSINESS OPPORTUNITIES

AMAZING Spare Time Profits Selling Sleep Teaching Recordings By Mail Or Direct. Details. Stanford, Box 4344E, Cleveland 32, Ohio.

FREE Book "990 Successful, Little-Known Businesses." Work home! Plymouth-455Y, Brooklyn 4, New York.

A Second Income From Oil Can End Your Toil! Free Book and Oilfield Maps! No Obligation. National Petroleum, Pan American Bank Bldg—PE, Miami, Fla.

GROW Mushrooms. Cellar, shed and outdoors. Spare, full time, year round. We pay \$4.50 lb. dried. We have 29,000 customers. Free Book. Mushrooms, Dept. 334, 2954 Admiral Way, Seattle, Wash.

MAKE \$25-\$50 Week. clipping newspaper items for publishers. Some clippings worth \$5.00 each. Particulars free. National, 81-DG, Knickerbocker Station, New York.

BUY Direct from factories. Appliances, cameras, watches! Free details! Cam Co., 6810PE 20th Ave., Brooklyn 4, N. Y.

VENDING Machines—No Selling. Operate a route of coin machines and earn amazing profits. 32-page catalog free. Parkway Machine Corporation, Dept. 12, 715 Ensor St., Baltimore 2, Md.

WHATEVER your needs, Popular Electronics classified can solve them. Simply place an ad in these columns and watch your results pour in.

FREE Book "990 Successful, Little-Known Businesses." Work home! Plymouth—455Y, Brooklyn 4, New York.

DAMASCENE Earrings! Exotic Orientalism. Huge Profit. OHGA, ZD-277, Sigakenkusatu, Japan.

MISCELLANEOUS

"MAKE Your Will!" Two Will Forms, \$1.00. National, Box 48313PE, Los Angeles 48, Calif.

WRITERS! Request Free sample Pink Sheets listing markets USA. Literary Agent Mead, 915 Broadway, N. Y.

SOMEONE "borrowing" your personal copy of Popular Electronics each month? You ought to be taking advantage of Popular Electronics' convenient re-sale plan. Sell copies in your store . . . perform a good service for your customers . . . with no risk involved. For details, write: Direct Sales Department, Popular Electronics, One Park Avenue, New York 16, New York.

RARE old Wine Recipes from Penn. of the 1800. Grape, Blackberry and Loganberry. Copy of any recipe for \$1.00 or three for \$2.00. John Snider, P.O. Box 822, Guthrie, Oklahoma.

"WINEMAKING," "Beer, Ale" Strongest methods. Illustrated. \$2.20. Eaton Bookstore (Supplies), Box 1242-C, Santa Rosa, California.

SENSATIONAL Electric Wristwatch available under \$100. Other bargains. Catalog Free. Long's, Box 7943, Portland 12, Oregon.



SELL YOUR USED EQUIPMENT Through POPULAR ELECTRONICS' Classified Columns!

The 400,000 purchasers of **POPULAR ELECTRONICS** are always interested in good used equipment or components. So, if you have something to sell, let PE readers know about it through our classified columns. It costs very little: just 60¢ a word, including name and address. Minimum message: 10 words.

For
further
information
write:

Martin Lincoln
POPULAR ELECTRONICS
One Park Avenue
New York 16, N. Y.

POPULAR ELECTRONICS

Advertisers' Index

MAY 1961

ADVERTISER	PAGE NO.	ADVERTISER	PAGE NO.
Airex Radio Corporation	22	Lektron	113
Allied Radio	13, 119	Marietta Apparatus Co.	127
Bailey Technical Schools	24	Milwaukee School of Engineering	30
Blonder-Tongue	12	Mosley Electronics, Inc.	117
Browning	117	Moss Electronic, Inc.	3rd, 4th COVER
Bud Radio, Inc.	38	National Radio Institute	33, 34
Burstein-Applebee Co.	22	National Technical Schools	7
CBS Electronics	121	North American Philips Co., Inc.	14
Cadre Industries Corp.	SECOND COVER	Paco Electronics Company, Inc.	18, 19
Capitol Radio Engineering Institute	11	Palmer, Joe	127
Cleveland Institute of Electronics	21	Peterson Radio Company	24
Coyne Electrical School	36, 114	Picture Tube Outlet	121
DeVry Technical Institute	5	Progressive "Edu-Kits" Inc.	31
EICO	40	RCA Institutes, Inc.	98, 99, 100, 101
Electro-Voice, Inc.	1	Rad-Tel Tube Co.	132
Electronics Book Service	26, 27, 37	Radio-Television Training School	17
Grantham School of Electronics	15	Robin Radio Co.	114
Greenlee Tool Co.	20	SoNar Electronic Tube Co.	38
Grove Electronic Supply Company	115	Springfield Enterprises	28
Heath Company	110, 111	Standard Kollsman Industries Inc.	9
Holt, Rinehart and Winston, Inc.	10	Telephone & Electronics Corp.	118
Hy-gain Antenna Products	28	Tri-State College	127
Indiana Technical College	119	Tru-Vac	123
International Crystal Manufacturing Co., Inc.	23	U. S. Air Force	97
Johnson Co., E. F.	20, 115	University Loudspeakers, Inc.	16
Key Electronics	119	Valparaiso Technical Institute	127
Lafayette Radio	3	Western Radio	119

BEFORE You Buy Tubes . . .

COMPARE

Rad-Tel's money-saving low prices . . .

UP TO **75% OFF**

COMPARE

Rad-Tel's dependability . . .

BRAND NEW TUBES

COMPARE

Rad-Tel's reliable . . .

ONE FULL YEAR GUARANTEE

COMPARE

Rad-Tel's . . .

RELIABLE PERFORMANCE

SERVICEMEN: Now speedy one-day service.

Rad-Tel sells only Brand New Tubes, not used, not pulled out of old sets . . . reduce costly call backs.

THE SIGN OF RAD-TEL'S RELIABILITY



Qty. Type	Price
___OZ4M	.79
___1AX2	.62
___1B3GT	.79
___1DN5	.55
___1G3	.79
___1I3	.79
___1K3	.79
___1LN5	.59
___1R5	.62
___1S5	.51
___1T4	.58
___1U4	.57
___1U5	.50

Qty. Type	Price
___5CL8	.76
___5E8	.80
___5EU8	.80
___5J6	.68
___5T8	.81
___5U4	.60
___5U8	.81
___5V6	.56
___5X8	.78
___5Y3	.46
___6AB4	.46
___6AC7	.96

EACH TUBE INDIVIDUALLY & ATTRACTIVELY BOXED

Qty. Type	Price	Qty. Type	Price	Qty. Type	Price
___6AU7	.61	___6SK7	.74	___12CN5	.56
___6AU8	.87	___6SL7	.80	___12CR6	.54
___6AV6	.40	___6SN7	.65	___12CU5	.58
___6AW8	.89	___6SQ7	.73	___12CU6	1.06
___6AX4	.65	___6T4	.99	___12CX6	.54
___6AX7	.64	___6U8	.78	___12DB5	.69
___6BA6	.49	___6V6GT	.54	___12DE8	.75
___6BC5	.54	___6W4	.54	___12DL8	.85
___6BC7	.94	___6W6	.69	___12DM7	.67
___6BC8	.97	___6X4	.39	___12DQ6	1.04
___6BD6	.51	___6X5GT	.53	___12DS7	.79
___6BE6	.55	___6X8	.77	___12OZ6	.56
___6BF6	.44	___7AU7	.61	___12EL6	.50
___6BG6	1.66	___7A8	.68	___12EG6	.54
___6BH6	.65	___7B6	.69	___12EZ6	.53
___6BH8	.87	___7Y4	.69	___12F8	.66
___6BJ6	.62	___8AU8	.83	___12FM6	.45
___6BK7	.85	___8AW8	.93	___12K5	.65
___6BL7	1.00	___8BQ5	.60	___12SA7M	.86
___6BN4	.57	___8CG7	.62	___12SK7GT	.74
___6BN6	.74	___8CM7	.68	___12SN7	.67
___6BQ5	.65	___8CN7	.97	___12SQ7M	.73
___6BQ6GT	1.05	___8CX8	.93	___12U7	.62
___6BQ7	.95	___8EB8	.94	___12V6GT	.53
___6BR8	.78	___11CY7	.75	___12W6	.69
___6BU8	.70	___12A4	.60	___12X4	.38
___6BY6	.54	___12AB5	.55	___17AX4	.67
___6BZ6	.54	___12AC6	.49	___17BQ6	1.09
___6BZ7	.97	___12AD6	.57	___17C5	.58
___6C4	.43	___12AE6	.43	___17CA5	.62
___6CB6	.54	___12AF3	.73	___17D4	.69
___6CD6	1.42	___12AF6	.49	___17DQ6	1.06
___6CF6	.64	___12AJ6	.46	___17L6	.58
___6CG7	.60	___12AL5	.45	___17W6	.70
___6CG8	.77	___12AL8	.95	___19AU4	.83
___6CM7	.66	___12AQ5	.52	___19BQ6	1.39
___6CN7	.65	___12AT6	.43	___19T8	.80
___6CR6	.51	___12AT7	.76	___21EX6	1.49
___6CS6	.57	___12AU6	.50	___25BQ6	1.11
___6CU5	.58	___12AU7	.60	___25C5	.53
___6CU6	1.08	___12AV5	.97	___25CA5	.59
___6CY7	.71	___12AV6	.41	___25C06	1.44
___6DA4	.68	___12AV7	.75	___25C06	1.11

RAD-TEL TUBE CO.

NOT AFFILIATED WITH ANY OTHER MAIL ORDER TUBE COMPANY

Qty. Type	Price
___1X2B	.82
___2AF4	.96
___3AL5	.42
___3AU6	.51
___3AV6	.41
___3BA6	.51
___3BC5	.54
___3BE6	.52
___3BN6	.76
___3BU8	.78
___3BY6	.55
___3BZ6	.55
___3CB6	.54
___3CF6	.60

Qty. Type	Price
___3CS6	.52
___3DK6	.60
___3DT6	.50
___3Q5	.80
___3S4	.61
___3V4	.58
___4BC8	.96
___4BN6	.75
___4BQ7	.96
___4BS8	.98
___4BU8	.71
___4BZ6	.58
___4BZ7	.96

Qty. Type	Price
___4CS6	.61
___4DE6	.62
___4DK6	.60
___4DT6	.55
___5AM8	.79
___5AN8	.88
___5AQ5	.52
___5AT8	.80
___5BK7A	.82
___5BQ7	.97
___5BR8	.79
___5CG8	.76

Qty. Type	Price
___6AF3	.73
___6AF4	.97
___6AG5	.65
___6AH6	.99
___6AK5	.95
___6AL5	.47
___6AM8	.78
___6AQ5	.50
___6AR5	.55
___6AS5	.60
___6AT6	.43
___6AT8	.79
___6AU4	.82
___6AU6	.50

Qty. Type	Price
___6DB5	.69
___6DE6	.58
___6DG6	.59
___6DQ6	1.10
___6DT5	.76
___6DT6	.53
___6EU8	.79
___6EA8	.79
___6HG6T	.58
___6J5GT	.51
___6J6	.67
___6K6	.63
___6S4	.48
___6SA7GT	.76

Qty. Type	Price
___12AX4	.67
___12AX7	.63
___12AZ7	.86
___12B4	.63
___12BA6	.50
___12BD6	.50
___12BE6	.53
___12BF6	.44
___12BH7	.73
___12BL6	.56
___12BQ6	1.06
___12BY7	.74
___12BZ7	.75
___12C5	.56

Qty. Type	Price
___25DN6	1.42
___25EH5	.55
___25L6	.57
___25W4	.68
___25Z6	.66
___35C5	.51
___35L6	.57
___35W4	.52
___35Z5GT	.60
___50B5	.60
___50C5	.53
___50DC4	.37
___50EH5	.55
___50L6	.61
___117Z3	.61



SEND FOR FREE TROUBLE SHOOTER GUIDE AND NEW TUBE & PARTS CATALOG

RAD-TEL TUBE CO.

DEPT. PE-561 55 CHAMBERS STREET, NEWARK 5, N. J.

TERMS: 25% deposit must accompany all orders, balance COD. Orders under \$5; add \$1 handling charge plus postage. Orders over \$5; plus postage. Approx. 8 tubes per 1 lb. Subject to prior sale. No COD's outside continental USA.

QUANTITY USERS • MACHINE OPERATORS • MANUFACTURERS • EXPORTERS

HUGE STOCKS !! OVER 175 TYPES SPECIALLY PRICED !

All tubes fully Guaranteed — Brand New!
 MINIMUM ORDER . . . 500 PER TYPE . . . NO ASSORTMENT
 Write, Wire, Types Needed; get our Low "Large Quantity" price

SHIPPED ON APPROVAL NO MONEY WITH ORDER — NO C.O.D.

Superior's New Model 85—a DYNAMIC type TRANS-CONDUCTANCE

TUBE TESTER

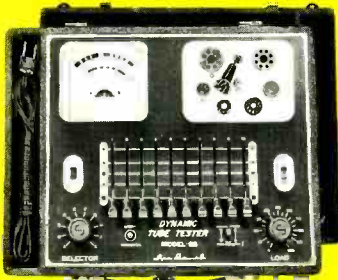

Model 85—Trans-Conductance Tube Tester. Total Price—\$52.50.

Terms: \$12.50 after 10 day trial, then \$8.00 monthly for 5 months if satisfactory. Otherwise return, no explanation necessary.

● Employs latest improved TRANS-CONDUCTANCE circuit. Tests tubes under "dynamic" (simulated) operating conditions. An in-phase signal is impressed on the input section of a tube and the resultant plate current change is measured as a function of tube quality. This provides the most suitable method of simulating the manner in which tubes actually operate in radio, TV receivers, amplifiers and other circuits. Amplification factor, plate resistance and cathode emission are all correlated in one meter reading.

● **SYMBOL REFERENCES:** For the first time ever in a trans-conductance tube tester, Model 85 employs time-saving symbols (★, ♀, ●, ▲, ■) in place of difficult-to-remember letters previously used. Repeated time studies proved to us that use of these scientifically selected symbols speeded up the element switching step. As the tube manufacturers increase the release of new tube types, this time-saving feature becomes more necessary and advantageous.

● **THE "FREE-POINT" LEVER TYPE ELEMENT SWITCH ASSEMBLY** marked according to RETMA basing, permits application of test voltages to any of the elements of a tube. The addition of an extra switch position permits the application of the necessary grid voltage needed for dynamic testing and insures against possible obsolescence due to changes in basing design.

● **NEW IMPROVED TYPE METER** with sealed air-damping chamber provides accurate, vibrationless readings.

● **FREE FIVE (5) YEAR CHART DATA SERVICE.** The chart provided with Model 85 includes easy-to-read listings for over 1,000 modern tube types. Revised up-to-date subsequent charts will be mailed to all Model 85 purchasers at no charge for a period of five years after date of purchase.

● **SPRING RETURN SAFETY SWITCH** guards Model 85 against burn-out if tube under test is "shorted."

● **7 AND 9 PIN TUBE STRAIGHTENERS** have been included on the front panel to eliminate possibility of damaging tubes with bent or out-of-line pins.

● **AN ULTRA-SENSITIVE CIRCUIT** is used to test for shorts and leakages up to 5 megohms between all tube elements.

Model 85 comes complete, housed in a handsome portable cabinet with slip-on cover. Only

\$52.50



Model 79—Super Meter
Total Price \$38.50

Terms: \$8.50 after 10 day trial, then \$6.00 monthly for 5 months if satisfactory. Otherwise return, no explanation necessary.

SUPERIOR'S
NEW MODEL 79

SUPER-METER

WITH NEW 6" FULL-VIEW METER

A Combination VOLT-OHM MILLIAMMETER

Plus CAPACITY, REACTANCE, INDUCTANCE & DECIBEL MEASUREMENTS

Also Tests SELENIUM & SILICON RECTIFIERS, SILICON & GERMANIUM DIODES

The model 79 represents 20 years of continuous experience in the design and production of SUPER-METERS, an exclusive SICO development. It includes not only every circuit improvement perfected in 20 years of specialization but, in addition includes those services which are "musts" for properly servicing the ever-increasing number of new components used in all phases of today's electronic pro-

duction. For example with the Model 79 SUPER-METER you can measure the quality of selenium and silicon rectifiers and all types of diodes — components which have come into common use only within the past five years, and because this latest SUPER-METER necessarily required extra meter scale, SICO used its new full-view 6-inch meter.

SPECIFICATIONS:

● D.C. VOLTS: 0 to 7.5 15/75/150/750/1,500 ● A.C. VOLTS: 0 to 15/30/150/300/1,500/3,000 ● D.C. CURRENT: 0 to 1.5/15/150 Ma. 0 to 1.5/15 Amperes ● RESISTANCE: 0 to 1,000/100,000 Ohms. 0 to 10 Megohms. ● CAPACITY: .001 to 1 Mfd. 1 to 50 Mfd. ● REACTANCE: 50 to 2,500 Ohms. 2,500 Ohms to 2.5 Megohms. ● INDUCTANCE: .15 to 7 Henries. 7 to 7,000 Henries. ● DECIBELS: —6 to +18, +14 to +38, +34 to +58. The following components are all tested for QUALITY at appropriate test po-

tentials. Two separate BAD-GOOD scales on the meter are used for direct readings. All Electrolytic Condensers from 1 MFD to 1000 MFD. All Germanium Diodes. All Selenium Rectifiers. All Silicon Diodes. All Silicon Rectifiers.

Model 79 comes complete with operating instructions, test leads, and streamlined carrying case. Use it on the bench—use it on calls. Only **\$38.50**

We invite you to try before you buy any of the models described on this page and the following page. If after a 10 day trial you are completely satisfied and decide to keep the Tester, you need send us only the down payment and agree to pay the balance due at the monthly indicated rate.

NO INTEREST OR FINANCE CHARGES ADDED!

If not completely satisfied, you are privileged to return the Tester to us, cancelling any further obligation.

SEE OTHER SIDE

CUT OUT AND MAIL TODAY!

MOSS ELECTRONIC, INC.

Dept. D-876 3849 Tenth Ave., New York 34, N. Y.

Please send me the units checked on approval. If completely satisfied I will pay on the terms specified with no interest or finance charges added. Otherwise, I will return after a 10 day trial positively cancelling all further obligation.

Model 79 Total Price \$38.50
\$8.50 within 10 days. Balance \$6.00 monthly for 5 months.

Model TV-50A Total Price \$47.50
\$11.50 within 10 days. Balance \$6.00 monthly for 6 months.

Model 85 Total Price \$52.50
\$12.50 within 10 days. Balance \$8.00 monthly for 5 months.

Model 70 Total Price \$15.85
\$3.85 within 10 days. Balance \$4.00 monthly for 3 months.

Name

Address

City

Zone

State

All prices net, F.O.B., N. Y. C.

SHIPPED ON APPROVAL NO MONEY WITH ORDER — NO C.O.D.

Superior's New Model 70 UTILITY TESTER®

FOR REPAIRING ALL ELECTRICAL APPLIANCES and AUTOMOBILE CIRCUITS



As an electrical trouble shooter the Model 70:

- Will test Toasters, Irons, Broilers, Heating Pads, Clocks, Fans, Vacuum Cleaners, Refrigerators, Lamps, Fluorescents, Switches, Thermostats, etc.
- Measures A.C. and D.C. Voltages, A.C. and D.C. Current, Resistances, Leakages, etc.
- Will measure current consumption while the appliance under test is in operation.
- Incorporates a sensitive direct-reading resistance range which will measure all resistances commonly used in electrical appliances, motors, etc.
- Leakage detecting circuit will indicate continuity from zero ohms to 5 megohms (5,000,000 ohms).

As an Automotive Tester the Model 70 will test:

- Both 6 Volt and 12 Volt Storage Batteries • Generators • Starters • Distributors • Ignition Coils • Regulators • Relays • Circuit Breakers • Cigarette Lighters • Stop Lights • Condensers • Directional Signal Systems • All Lamps and Bulbs • Fuses • Heating Systems • Horns • Also will locate poor grounds, breaks in wiring, poor connections, etc.

Model 70—UTILITY TESTER
Total Price...\$15.85—
Terms: \$3.85 after 10 day trial,
then \$4.00 monthly for 3 months,
if satisfactory. Otherwise return, no
explanation necessary.



INCLUDED FREE This 64-page book—practically a condensed course in electricity. Learn by doing.

Just read the following partial list of contents: What is electricity? • Simplified version of Ohms Law • What is wattage? • Simplified wattage charts • How to measure voltage, current, resistance and leakage • How to test all electrical appliances and motors using a simplified trouble-shooting technique. • How to trace trouble in the electrical circuits and parts in automobiles and trucks.

Model 70 comes complete with 64 page book and test leads

\$15.85
only

Superior's New Model TV-50A **GENOMETER**

7 Signal Generators in One!

- ✓ R.F. Signal Generator for A.M.
- ✓ R.F. Signal Generator for F.M.
- ✓ Audio Frequency Generator
- ✓ Marker Generator
- ✓ Bar Generator
- ✓ Color Dot Pattern Generator
- ✓ Cross Hatch Generator

This Versatile All-Inclusive GENERATOR Provides ALL the Outputs for Servicing:

• A.M. RADIO • F.M. RADIO • AMPLIFIERS • BLACK AND WHITE TV • COLOR TV

R. F. SIGNAL GENERATOR: 100 Kilocycles to 60 Megacycles on fundamentals and from 60 Megacycles to 180 Megacycles on powerful harmonics.

VARIABLE AUDIO FREQUENCY GENERATOR: Provides a variable 300 cycle to 20,000 cycle peaked wave audio signal.

MARKER GENERATOR: The following markers are provided: 189 Kc., 262.5 Kc., 456 Kc., 600 Kc., 1000 Kc., 1400 Kc., 1600 Kc., 2000 Kc., 2500 Kc., 3579 Kc., 4.5 Mc., 5 Mc., 10.7 Mc., (3579 Kc. is the color burst frequency)

BAR GENERATOR: Pattern consists of 4 to 16 horizontal bars or 7 to 20 vertical bars.

DOT PATTERN GENERATOR (FOR COLOR TV): The Dot Pattern projected on any color TV Receiver tube by the Model TV-50A will enable you to adjust for proper color convergence.

CROSS HATCH GENERATOR: The pattern consists of non-shifting horizontal and vertical lines interlaced to provide a stable cross-hatch effect.

Complete with shielded leads

\$47.50
Net



Model TV50-A—Genometer
Total Price \$47.50
Terms: \$11.50 after 10 day trial,
then \$6.00 monthly for 6 months
if satisfactory. Otherwise return,
no explanation necessary.

TRY FOR 10 DAYS BEFORE you buy! THEN if satisfactory

pay in easy, interest free, monthly payments. See coupon inside.

We invite you to try before you buy any of the models described on this and the preceding page. If after a 10 day trial you are completely satisfied and decide to keep the Tester, you need send us only the down payment and agree to pay the balance due at the monthly indicated rate. (See other side for time payment schedule details.)

**NO INTEREST
OR FINANCE
CHARGES ADDED!**

If not completely satisfied, you are privileged to return the Tester to us, cancelling any further obligation.

**SEE OTHER
SIDE**

CUT OUT AND MAIL TODAY!

FIRST CLASS

Permit No. 61430

New York, N. Y.

VIA AIR MAIL

BUSINESS REPLY CARD

No Postage Stamp Necessary if Mailed in the U. S.

POSTAGE WILL BE PAID BY —

MOSS ELECTRONIC, INC.

3849 TENTH AVENUE

NEW YORK 34, N. Y.