

How to Fix Your Auto Radio

POPULAR ELECTRONICS

MAY
1959

35
CENTS

HI-FI · HAM RADIO · SWL · TEST GEAR



**Large-Screen
Color-TV Projector**
(see page 45)

**How to Build:
6-Meter Ham Station • Ele**

E 20S106811
LOUIS HOFFART
18108 WINDWARD
CLEVELAND 19 OHIO

BUILD 125 COMPUTERS AT HOME WITH GENIAC®

ONLY
\$19⁹⁵

With the 1959 model GENIAC®, the original electric brain construction kit including seven books and pamphlets, over 400 parts and component rack, and parts tray, and all materials for experimental computer lab plus DESIGN-O-Mat®.

A COMPLETE COURSE IN COMPUTER FUNDAMENTALS

The GENIAC Kit by itself is the equivalent of a complete course in computer fundamentals, in use by thousands of colleges, schools and industrial training labs and private individuals. Includes everything necessary for building an astonishing variety of computers that reason, calculate, solve codes and puzzles, forecast the weather, compose music, etc. Included in every set are seven books described below, which introduce you step-by-step to the wonder and variety of computer fundamentals and the special problems involved in designing and building your own experimental computers—the way so many of our customers have.

ANYONE CAN BUILD IT!

You can build any one of these 125 exciting electric brain machines in just a few hours by following the clear cut step by step directions given in these thrilling books. No soldering required . . . no wiring beyond your skill. But GENIAC is a genuine electric brain machine—not a toy. The only logic and reasoning machine kit in the world that not only adds and subtracts but presents the basic ideas of cybernetics, boolean algebra, symbolic logic automation, etc. So simple to construct that a twelve year old can build what will fascinate a PhD. In use by thousands of schools, colleges, etc., and with the special low circuitry you can build machines that compose music, forecast the weather, which have just recently been added.

TEXT PREPARED BY MIT SPECIALIST

Dr. Claude Shannon, known to the readers of *Popular Electronics* for his invention of the electronic mouse, that runs a maze, learning as it goes, formerly a research mathematician for Bell Telephone Laboratories is now a research associate at MIT. His books include publications on Communication theory and the recent volume "Automat Studies" on the theory of robot construction. He has prepared a paper entitled "A Symbolic Analysis of Relay and Switching Circuits" which is available to purchasers of the GENIAC. Covering the basic theory necessary for advanced circuit design it vastly extends the range of our kit.

The complete re-designing of the 1958 kit and the manual as well as the special book DESIGN-O-MAT® was created by Oliver Garfield, author of "Minds and Machines," editor of the "Gifted Child Magazine" and the "Review of Technical Publications."

KIT IS COMPLETE

The 1959 GENIAC comes complete with seven books and manuals and over 400 components.

- 1) A sixty-four page book "Simple Electric Brains and How to Make Them."
- 2) **Beginners Manual**—which outlines for people with no previous experience how to create electric circuits.
- 3) "A Symbolic Analysis of Relay and Switching Circuits" By Dr. Claude Shannon provides the basis for new and exciting experimental work by the kit owner who has finished book No. 1.
- 4) **DESIGN-O-MAT®** introduces the user to over 50 new circuits that he can build with GENIAC and outlines the practical principle of circuit design.
- 5) **GENIAC STUDY GUIDE** equivalent to a complete course in computer fundamentals, this guides the user to more advanced literature.
- 6) **A Machine to Compose Music** shows in an actual circuit what other GENIAC owners have been able to do on their own in designing new devices.
- 7) **A Machine to Forecast the Weather**—again a new adventure in scientific thinking created by one of our users who was trained on his GENIAC Kit.

Plus all the components necessary for the building of over 125 machines and as many others as you can design yourself.

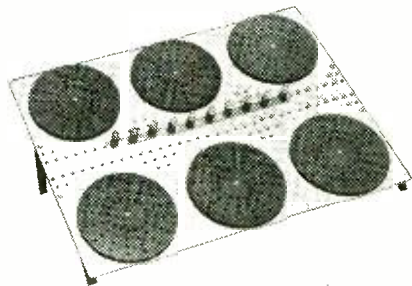

OVER 20,000
SOLD

We are proud to announce that over 20,000 GENIACS are in use by satisfied customers—schools, colleges, industrial firms and private individuals—a tribute to the skill and design work which makes it America's leading scientific kit. People like yourself with a desire to inform themselves about the computer field know that GENIAC is the only method for learning that includes both materials and texts and is devoted exclusively to the problems faced in computer study.

You are safe in joining this group because you are fully protected by our guarantee, and have a complete question and answer service available at no cost beyond that of the kit itself. You share in the experience of 20,000 kit users which contributes to the success of the 1959 GENIAC—with DESIGN-O-MAT® the exclusive product of Oliver Garfield Co., Inc., a Geniac is truly the most complete and unique kit of its kind in the world.

COMMENTS BY CUSTOMERS

We know the best recommendation for GENIAC is what is has done for the people who bought it. The comments from our customers we like best are the ones that come in daily attached to new circuits that have been created by the owners of GENIACS. Recently one man wrote: "GENIAC has opened a new world of thinking to me." Another who designed the "Machine that Forecasts the Weather" commented:

"Several months ago I purchased your GENIAC Kit and found it an excellent piece of equipment. I learned a lot about computers from the enclosed books and pamphlets and I am now designing a small relay computer which will include arithmetical and logical units . . . another of my pet projects in cybernetics is a weather forecaster. I find that your GENIAC Kit may be used in their construction. I enclose the circuits and their explanation."
Eugene Darling, Malden.

Oliver Garfield Co., Inc.

Dept. PE-59

108 East 16th St., N. Y. 3, N. Y.

Please send me at once the GENIAC Electric Brain Construction Kit, 1959 model. I understand that it is guaranteed by you and may be returned in seven days for a full refund if I am not satisfied.

- I have enclosed \$19.95 (plus 80¢ shipping in U. S., \$1.50 west of Miss., \$2.00 foreign), 3% New York City Sales Tax for N.Y. City Residents.
- Send GENIAC C.O.D. I will pay postman the extra C.O.D. charge.

Name

Address

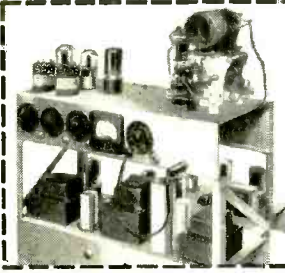

YOU BUILD Broadcasting Transmitter

As part of N.R.I. Communications Course you build this low power Transmitter; use it to learn methods required of commercial broadcasting operators, train for FCC license.

YOU BUILD Signal Generator

N.R.I. sends kits of parts to build this Signal Generator. You get practical experience, conduct tests to compensate Radio frequency amplifiers, practice aligning a typical I.F. video amplifier in TV circuit, many other experiments.

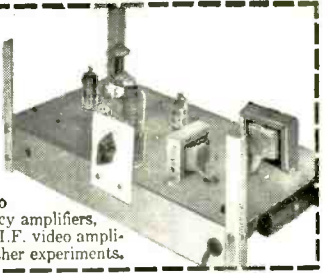

YOU BUILD Vacuum Tube Voltmeter

Use it to get practical experience, earn extra cash fixing neighbors' sets in spare time, gain knowledge to help you work in Radio, Television, Color TV. With N.R.I. training you work on circuits common to both Radio and TV. Equipment you build "brings to life" things you learn in N.R.I.'s easy-to-understand lessons. 64 page Catalog FREE, shows all equipment you get.

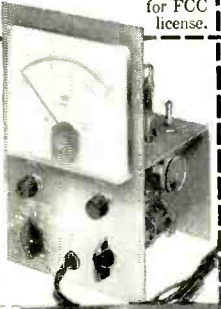

YOU BUILD AC-DC Superhet Receiver

N.R.I. servicing training supplies all parts, everything is yours to keep. Nothing takes the place of practical experience. You get actual servicing experience by practicing with this modern receiver; you learn-by-doing.

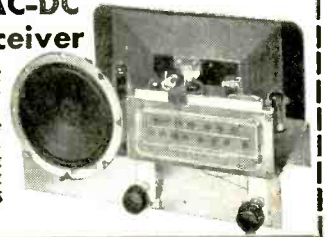

Learn RADIO TELEVISION by Practicing at Home

WHAT GRADUATES DO AND SAY NEED FOR TECHNICIANS INCREASING Fast Growing Field Offers Good Pay, Bright Future

Chief Engineer

"I am Chief Engineer of Station KGCU in Mandan, N. D. I also have my own spare time business servicing high frequency two-way communications systems." R. BARNETT, Bismarck, North Dakota.

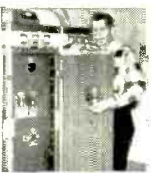

Paid for Instruments

"I am doing very well in spare time TV and Radio. Sometimes have three TV jobs waiting and also fix car Radios for garages. I paid for instruments out of earnings." G. F. SEAMAN, New York, N. Y.



Has Own TV Business

"We have an appliance store with our Radio and TV servicing, and get TV repairs. During my Army service, NRI training helped get me a top rated job." W. M. WEIDNER, Fairfax, South Dakota.



Today's OPPORTUNITY field is Radio-Television. Over 125 million home Radios plus 30 million sets in cars and 40,000,000 Television sets mean big money for trained Radio-TV Technicians. More than 4,000 Radio and TV Broadcasting stations offer interesting and important positions for technicians, operators. Color television, portable TV sets, Hi-Fi, other developments assure future growth.

It's the trained man who gets ahead. The fellow who uses his spare time to develop knowledge and skill gets the better job, drives a better car, lives in a better home, is respected for what he knows

and can do. So plan now to get into Radio-TV. Keep your job while training with N.R.I. You learn at home in your spare time. N.R.I. is oldest and largest home study Radio-TV School. Our methods have proved successful for more than 40 years, provide practical experience.

Soon after enrolling, many N.R.I. students start to earn \$10, \$15 a week extra in spare time fixing sets. Many open their own full time Radio-TV shops after getting N.R.I. Diploma. Find out more. Mail Coupon. Cost is low, terms easy; includes all equipment. Address: **National Radio Institute, Dept. 9ED4, Washington, D.C.**

Send for
LESSON
and **CATALOG**
FREE

VETERANS
Available under
G.I. Bills



MAIL COUPON NOW

NATIONAL RADIO INSTITUTE
Dept. 9ED4, Washington 16, D. C.

Mail me Sample Lesson and 64-Page Catalog, FREE. (No Salesman will call. Please write plainly.)

Name _____ Age _____

Address _____

City _____ Zone _____ State _____

ACCREDITED MEMBER, NATIONAL HOME STUDY COUNCIL

POPULAR ELECTRONICS is published monthly by Ziff-Davis Publishing Company, William B. Ziff, Chairman of the Board (1948-1953), at 434 S. Wabash Ave., Chicago 5, Ill. Second-class postage paid at Chicago, Illinois. Authorized by Post Office Department, Ottawa, Canada as second-class matter. **SUBSCRIPTION RATES:** One year U.S. and possessions, and Canada \$4.00; Pan-American Union countries \$4.50, all other foreign countries, \$5.00.

POPULAR ELECTRONICS

MAY

1959



VOLUME 10

NUMBER 5

Special Features

POPULAR ELECTRONICS Recommended Tool List.....	82
Build a Modular 6-Meter Station..... <i>Donald L. Stoner, W6TNS</i>	93

Construction Projects and New Circuits

Electrostatic Tweeter..... <i>Paul Silverstein</i>	56
Crystal Oscillator Circuits..... <i>Roy Freeland</i>	76
Vacuum-Tube Voltmeter.....	79
Circuit Designs for Audio Amplifier Tube.....	92
Perplexual Motion..... <i>R. Zarr</i>	112
Sun-Operated Power Supply..... <i>George Pearce</i>	112
RF-AF Signal Generator.....	117

Audio and High Fidelity

Inside the Preamplifier (Part 4)..... <i>Joseph Marshall</i>	49
Kits! The New Revolution in Turntables.....	60
Build a Stereo Power Amplifier.....	64
Check Your Damping Factor..... <i>James A. Fred</i>	77
Hi-Fi Guest List..... <i>Carl Kohler</i>	120
First Crop of Multiplex Stereo Adapters..... <i>Mike Bienstock</i>	122

Electronic Features and New Developments

Doppler Radar Charts the Airlines..... <i>Art Zuckerman</i>	41
New Color-TV Projection System..... <i>Furman Hebb</i>	45
Bright Future for Cold Cathodes..... <i>Homer Williams</i>	53
Electronics Probes Secrets of the Brain..... <i>R. E. Atkinson</i>	67
Hot and Cold Electronics..... <i>Simon Dresner</i>	72
Ohm's Law Wheel..... <i>Henry L. Weisberg</i>	81
Electronic Sticklers.....	88
Test Instruments (Part 5)..... <i>Larry Klein</i>	100
Electronics in the News.....	106
How to Repair Auto Radios..... <i>Jack Darr</i>	108

Amateur and SWL

Antenna Load Box..... <i>Don Lewis</i>	70
Bandspread..... <i>Tom Kneitel</i>	85
Build a Variable Frequency Oscillator.....	97
Three Thousand Short-Wave Monitors Registered.....	105

Departments

Notes from the Editor.....	8
Letters from Our Readers.....	10
POP'tronics Bookshelf.....	16
New Products.....	22
Tips and Techniques.....	32
Transistor Topics..... <i>Lou Garner</i>	89
Short-Wave Report..... <i>Hank Bennett, W2PNA</i>	104
After Class..... <i>Harvey Pollack</i>	113
Among the Novice Hams..... <i>Herb S. Brier, W9EGQ</i>	115
Carl & Jerry..... <i>John T. Frye, W9EGV</i>	124

Copyright © 1959 by Ziff-Davis Publishing Company. All rights reserved.

INTERNATIONAL'S NEW

TRANSCEIVER

at home...work...or play here is

2-WAY RADIO for everyone!



MEETS ALL FCC REQUIREMENTS

for the Class "D"

CITIZEN BAND

CHECK THESE ADDED FEATURES!

- ✓ Choice of tunable or crystal controlled receiver
- ✓ BUILT-IN Squelch
- ✓ Add a crystal & switch for second transmit channel

- CUSTOM, 117V AC, all channel receiver \$94.95
- DELUXE, 117V AC or 6/12V DC 124.50
- COMMAND, 117V AC or 6/12V DC fixed channel receiver 149.50

FOR BUSINESS



Ideal for office-to-field communication. Also for office to trucks operating within restricted area or for office and factory liaison.

FOR THE FARM



The solution to fast communication from the farm home to the field. Wonderful in an emergency.

FOR SPORTS



From ship-to-shore or from base camp to the scene of the hunt... an enjoyable accessory to any sport!

FOR THE HOME



From the kitchen to the den, workshop or sickroom... the Transceiver will save you many steps.

SEND FOR FREE BROCHURE

**INTERNATIONAL
CRYSTAL MFG. CO., INC.**

18 N. Lee
Oklahoma City, Okla.

Dept. PE, International Crystal Mfg. Co., Inc.
18 N. Lee,
Oklahoma City, Okla.

GENTLEMEN:

Please send me my copy of your free brochure on the Transceiver. Also your new 1959 Catalog.

NAME _____

ADDRESS _____

CITY & STATE _____

POPULAR ELECTRONICS

World's largest-selling Electronics Magazine

This month's cover photo courtesy
of CIBA Pharmaceutical Products Inc.

Editor & Publisher
OLIVER READ, W1ETI

Assistant Editor
JULIAN M. SIENKIEWICZ, WV2CQL

Technical Editor
LARRY KLEIN

Art Editor
ALFONS J. REICH

Associate Editors
SIMON DRESNER
FURMAN HEBB
MARGARET MAGNA

Editorial Assistant
DOLORES GIMBEL

Contributing Editors
H. BENNETT, W2PNA
H. S. BRIER, W9EGG
J. T. FRYE, W9EGV
L. E. GARNER, Jr.
T. KNEITEL
H. POLLACK
D. L. STONER, W6TNS

Art and Drafting Dept.
J. A. ROTH
S. SOLOMAN
M. WHELPLEY

Advertising Director
JOHN A. RONAN, Jr.

Advertising Manager
WILLIAM G. McROY

COMING NEXT MONTH

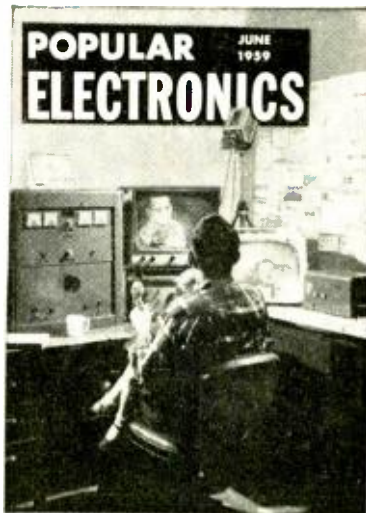

(ON SALE MAY 21)

ZIFF-DAVIS PUBLISHING COMPANY,
One Park Ave., New York 16, N. Y.
William B. Ziff, Chairman of the Board
(1946-1953); William Ziff, President;
W. Bradford Briggs, Executive Vice
President; Michael Michelson, Vice
President and Circulation Director; Hersh-
el B. Sarbin, Secretary; Howard Stough-
ton, Jr., Treasurer; Albert Gruen, Art
Director.



BRANCH OFFICES: Midwestern Office,
434 S. Wabash Ave., Chicago 5, Ill.,
Jim Weakley, advertising manager;
Western Office, Room 412, 215 W. 7th
St., Los Angeles 17, Calif., James R.
Pierce, advertising manager.

Foreign Advertising Representatives:
D. A. Goodall Ltd., London; Alber Mil-
hado & Co., Antwerp and Dusseldorf.

Next month's cover will picture a typical ham-TV set-up. A feature article describing the fascinating new hobby of ham TV tells how to become a video ham and all about the special components used. One company is already marketing the equipment for putting together a complete ham-TV station.

A special "bonus" in June will be a 16-page section entitled "Stereo Records: Fad or Fulfillment?" If you're at all interested in stereo, you'll want to read this authoritative, up-to-the-minute report on the technical progress of the stereo record.

See pages 146 and 147 of this issue for a description of some of the construction projects that will be presented in the June issue.

SUBSCRIPTION SERVICE: Forms 3578 and all subscription correspondence should be addressed to Circulation Department, 434 South Wabash Avenue, Chicago 5, Illinois. Please allow at least four weeks for change of address. Include your old address as well as new—enclosing if possible an address label from a recent issue.

CONTRIBUTORS: Contributors are advised to retain a copy of their manuscripts and illustrations. Contributions should be mailed to the New York Editorial Office and must be accompanied by return postage. Contributions will be handled with reasonable care, but this magazine assumes no responsibility for their safety. Any copy accepted is subject to whatever adaptations and revisions are necessary to meet the requirements of this publication. Payment covers all author's, contributor's and contestant's rights, titles, and interest in and to the material accepted and will be made at our current rates upon acceptance. All photos and drawings will be considered as part of material purchased.

NOW Men 17 to 55 who want to earn MORE MONEY!

GET THIS VALUABLE

FREE POCKET GUIDE

THAT'S PACKED WITH
TIPS FOR EARNING
Real Money!

Looking for an *unusual chance* to prepare to bring home a **REAL PAY CHECK**? Like to have what it takes to drive home a sleek new car? Want a job that's **REALLY INTERESTING**—that has a **GREAT FUTURE**? Or perhaps you want to **ADD TO YOUR PRESENT INCOME**?

Then mail the coupon today. Get the **SURPRISING FACTS** about one of the most remarkable opportunities of its kind to prepare in your spare time at home for a real job in the vast, multi-billion dollar field of

RADIO-TELEVISION-ELECTRONICS

where so many exciting . . . marvelous things are happening.

See how you can get the **VERY HELP YOU NEED**—easy-to-read, picture-illustrated lessons . . . fascinating "learn-by-seeing" movies . . . even a home laboratory of equipment for "do it yourself" experience. And to top it all, the **BEST IS YET TO COME!**

OFTEN MORE JOBS FOR OUR GRADUATES THAN WE CAN FILL



This remarkable industrial training organization has already recommended graduates to **OVER 8,000 companies** in the Radio-Television-Electronics field. Upon graduating, you get the same effective **EMPLOYMENT HELP** that has already enabled thousands of men to enjoy **REAL EARNINGS**.

"BUT WHAT DO ALL OF THESE WONDERFUL ADVANTAGES COST?"

Here's more **GOOD NEWS!** The plan is operated to make it convenient for almost any ambitious man to get started! The cost is nominal—in fact, a happy surprise to many men. So much is happening you should know about, **MAIL THE COUPON TODAY!**

If you leave home, you can get all of your training in some of the finest training laboratories of their kind—in Chicago or Toronto. Write for details.

DEVRY TECHNICAL INSTITUTE

4741 BELMONT AVENUE CHICAGO 41, ILLINOIS
formerly DeFOREST'S TRAINING, Inc.

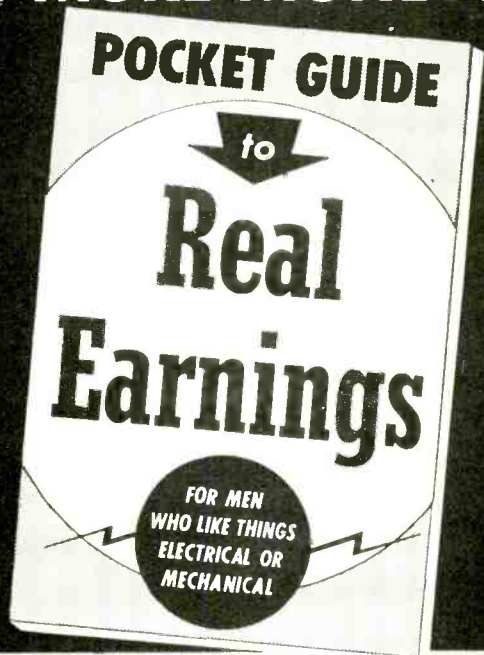

Nothing Else Like It!

"Wonderfully helpful" . . . "Some of the best tips on earning **REAL MONEY** I've ever come across." That's what many men are saying about this remarkable free guide.

- ★ **YOU'LL DISCOVER** the **TEN LITTLE WORDS** THAT MAY BOOST YOUR INCOME.
- ★ **YOU'LL SEE** that if you're an average, normal man, you have **MORE THAN ENOUGH BRAINS** to prepare to earn and enjoy some **REAL MONEY**—and likely in the very area you live.
- ★ **YOU'LL FIND OUT** about some amazing new job developments in one of the greatest opportunity fields of our time—wonderfully interesting, down-to-earth, **REAL MONEY JOBS** you may readily train for in your spare time at home.
- ★ **YOU'LL SEE** that you **DON'T HAVE TO BE TOPS IN MATH** . . . that you **DON'T NEED AN ADVANCED EDUCATION**.
- ★ **IN FACT**, if there are a lot of things you want these days but just **DON'T HAVE THE MONEY**—fill in, mail the coupon below **NOW!** I think what we have for you will really surprise and please you—including this valuable new **POCKET GUIDE TO REAL EARNINGS**.

MAIL TODAY FOR FREE FACTS

DeVry Technical Institute
4141 Belmont Ave., Chicago 41, Ill., Dept. PE-5-P
Please give me a **FREE** copy of your unusual booklet, "Pocket Guide to Real Earnings," and tell me how I may prepare to enter one or more branches of Electronics.

NAME _____ AGE _____
STREET _____ PLEASE PRINT _____ APT. _____
CITY _____ ZONE _____ STATE _____

Check here if subject to military training.

DeVry Tech's Canadian Training Center is located at
626 Roselawn Avenue, Toronto 12, Ontario

2052

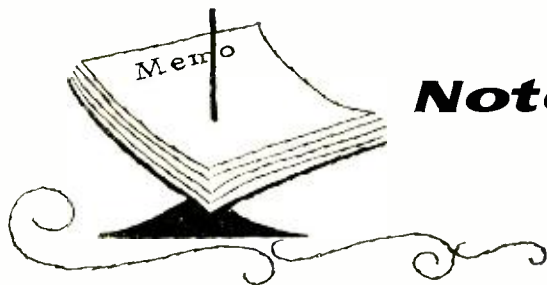

Notes from the Editor

TO CALIFORNIA AND BACK. We always look forward to the annual combination Audio Engineering Society convention and hi-fi show in Los Angeles, not only for a first peek at the latest developments but, being human, because we always welcome an opportunity to get out of the office and see the country.

We took the first morning jet flight to Los Angeles ever scheduled out of New York, and the trip was really fantastic. Imagine leaving cold and dreary New York in the morning, enjoying a leisurely lunch at 38,000 feet, reading a magazine article or two, and before you know it, there you are—setting down in sunny California.

In addition to coming into contact with new products and ideas, we came up with something, or somebody, that really made the trip worth while. Our ham readers should be very familiar with the work of Don Stoner, W6TNS, who has written for practically every magazine in the ham field. While we were in California, Don agreed to join us in the capacity of contributing editor. We are certainly more than happy to have him aboard. Don's first article in his new capacity details the construction of a complete six-meter modular station, which begins on page 93.

BELL LABS STEREO. The great problem of stereo broadcasting has always been that of making each stereo channel satisfactory for the person who listens to only one side of the stereo broadcast. This requirement of compatibility has forced broadcasters to "water down" the stereo effect, with the result that neither the stereo nor the monophonic listener receives a first class program.

Bell Laboratories, one of the great names in electronic research, has come up with a compatible stereo system which is based on a "quirk" of the human hearing apparatus. When two sounds of the same intensity are played through dual channels and one of them is delayed by about 10 milliseconds, the sound will apparently come from the "undelayed" speaker only. Thus, if we take the left channel and mix it with a delayed right channel, and simultaneously mix the right channel with a delayed left, the undelayed channel in each speaker will override the other—and stereo results. However, the person listening to either speaker alone ignores the delay of the second channel and hears what is apparently a balanced, complete monophonic program. Ergo—compatibility!

Used commercially for the first time on the "Perry Como" show late in February, the Bell stereo system seems to be especially well suited for TV/radio stereocasts.

Oliver Read

POPULAR ELECTRONICS

**GREATEST
ADVANCE IN
SHOP-METHOD
HOME TRAINING**

EARN MORE MONEY... GET INTO TELEVISION ELECTRONICS-RADIO

Learn **ALL 8 PHASES** in ONE **MODERN HOME-STUDY COURSE**
At Home — In Spare Time

YOU GET ALL THIS NEWEST PRACTICAL EQUIPMENT

- Parts to build a modern TV set, including all tubes plus a large screen Picture Tube
- Parts to build a powerful Superhet Receiver, standard broadcast and short wave
- Parts to conduct many experiments and build Continuity Checker, RF Oscillator, TV Circuits, Audio Oscillator, TRF Receiver, Signal Generator
- A Valuable Professional Multitester

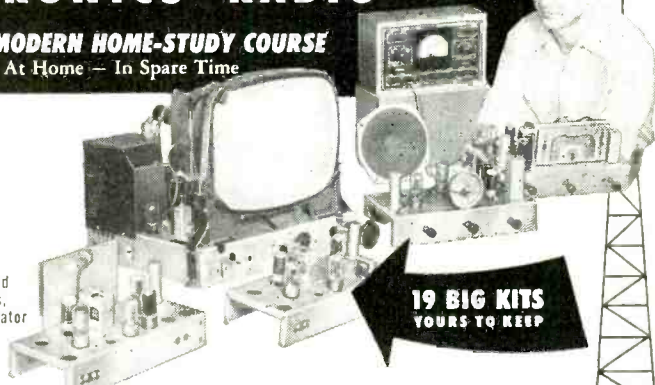

**19 BIG KITS
YOURS TO KEEP**

YOUR NATIONAL SCHOOLS TELERAMA COURSE COVERS ALL 8 PHASES

- | | |
|------------------------------------|--------------------------------|
| 1. TELEVISION, INCLUDING COLOR TV | 5. PREPARATION FOR FCC LICENSE |
| 2. RADIO, FM AND AM | 6. AUTOMATION |
| 3. INDUSTRIAL ELECTRONICS | 7. RADAR AND MICRO WAVES |
| 4. SOUND RECORDING AND HI FIDELITY | 8. COMMUNICATIONS |

YOU ARE NEEDED IN THE TELEVISION-ELECTRONICS-RADIO INDUSTRY! You can build a secure future for yourself if you get into Electronics NOW! Today's shortage of trained technicians creates tremendous opportunities. National Schools Shop-Method trained technicians are in constant and growing demand for high-pay jobs in Broadcasting and Communications, Electronic Research, Servicing and Repair, and many other branches.

Let National Schools, a Resident Technical School for over 50 years train you for today's unlimited opportunities in electronics! Our Shop Method trains you to be a MASTER-TECHNICIAN. Completely up to date, developed by experienced instructors and engineers, your Telerama Course will teach you all phases of the industry quickly, clearly and correctly. You can master the most modern projects, such as Color TV, printed circuits — even prepare for FCC License without taking a special

course. You can handle sales, servicing, manufacturing, or make good money in your own business. SEND FOR FACTS TODAY!

EARN AS YOU LEARN. Many of our students earn their entire tuition and more in Spare Time jobs we show them how to do while learning.

YOU GET EVERYTHING YOU NEED — Clear, profusely illustrated lessons, shop-tested manuals, modern circuit diagrams, practical job projects — all the valuable equipment shown above

— many other materials and services — consultation privilege with our qualified staff, and Graduate Employment Service. **EVERYTHING YOU NEED** for outstanding success in Electronics.

RESIDENT TRAINING AT LOS ANGELES

If you wish to take your training in our Resident School at Los Angeles, the world's TV capital, start NOW in our big, modern Shops, Labs and Radio-TV Studios. Here you work with latest Electronic equipment—professionally installed—finest, most complete facilities offered by any school. Expert, friendly instructors. Personal attention. Graduate Employment service. Help in finding home near school—and part time job while you learn. Check box in coupon for full information.



FREE!

Fully illustrated "Career" Book in TV-Radio-Electronics. PLUS actual sample lesson—yours at no cost, no obligation. CLIP COUPON NOW... MAIL IT TODAY!



NATIONAL SCHOOLS

4000 S. FIGUEROA ST., LOS ANGELES 37, CALIF.

APPROVED FOR G. I. TRAINING

NATIONAL SCHOOLS

TECHNICAL TRADE TRAINING SINCE 1905
LOS ANGELES 37, CALIFORNIA

GET FAST SERVICE — MAIL NOW TO

NATIONAL SCHOOLS, DEPT. R2G-59
4000 S. FIGUEROA ST.
LOS ANGELES 37, CALIF.

Rush free TV-Radio "Opportunity" Book and sample lesson. No salesman will call.

NAME _____ AGE _____
ADDRESS _____
CITY _____ ZONE _____ STATE _____

Check if interested ONLY in Resident School training at Los Angeles.
VETERANS: Give date of Discharge _____

Attention,
*all
 two-eared
 music
 lovers!*



Stereo is here to stay. Sooner or later, you will need a minimum of two loudspeakers. And when you decide on that extra expenditure, you will insist on the most for the least. That's where the new **NORELCO** speaker line comes in. Engineered by Philips of the Netherlands, **NORELCO** speakers are the only units in their price range with that subtle "imported" sound — suave, undistorted, unexaggerated. What's more, the entire new line of 5" to 12" speakers now comes with the new, improved **TICONAL VIII** alloy magnets. (Means more gauss per ounce, man!) And all the new speakers now have standard EIA mounting holes for easy installation! For further details, write to High Fidelity Products Division, Dept. 3F5, North American Philips Company, Inc., 230 Duffy Avenue, Hicksville, L. I., N. Y.

A complete line of 5" to 12" high-fidelity speakers and acoustically engineered enclosures



LOUDSPEAKERS



NORELCO®

Now with new **TICONAL VIII** alloy magnets

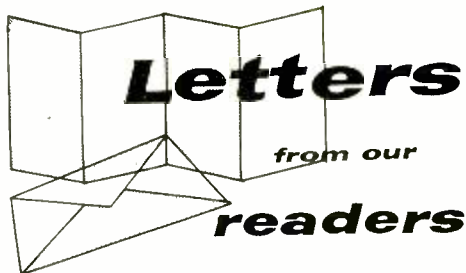

Tech Schoolin'

■ Brother Dresner's article in the January '59 POP'tronics, "Wanted, 100,000 Technicians," came as a very welcome shot in the arm. I have been studying via correspondence school for the past year and have had theory pounded into me up to my ears. After so long a time, a fellow sort of loses his fire and enthusiasm. Then I read Mr. Dresner's article and it started the ol' ball rolling again (if you know what I mean).

I'm a truck driver, not one with a big, shining West Coast tractor with two-banger smoker under his feet, but one of the lowly jockeys commonly called a "bull hauler."

FRED W. MITCHELL
 Oskaloosa, Iowa

Glad to hear Reader Mitchell is back on the road to a career in electronics—it's the industry with the most opportunities for anyone with a little learning under his hat.

Electronic Sticklers

■ I read and still have, in an honored place on my bookshelf, ALL 53 issues of POPULAR ELECTRONICS. Of the many articles I have enjoyed through the



years. "Electronic Sticklers" may prove to be one of the most fascinating.

DAVID LAURENCE
 Rochester, N. Y.

See page 88 of this issue for another set of these thought-twisters.

Coast Guard QSL's

■ As a member of the U. S. Coast Guard, I enjoyed your article on "QSL'ing the Coast Guard" immensely. I am a Radioman 2nd Class stationed at Galveston, Texas (NOY), and I think being a Coast Guard Radioman beats all the other

Do you WISH you were EMPLOYED in ELECTRONICS?

F.C.C. LICENSE—THE KEY TO BETTER JOBS

An F.C.C. *commercial* (not amateur) license is your ticket to higher pay and more interesting employment. This license is Federal Government evidence of your qualifications in electronics. Employers are eager to hire *licensed* technicians.

WHICH LICENSE FOR WHICH JOB?

The **THIRD CLASS** radiotelephone license is of value primarily in that it qualifies you to take the second class examination. The scope of authority covered by a third class license is extremely limited.

The **SECOND CLASS** radiotelephone license qualifies you to install, maintain and operate most all radiotelephone equipment except commercial broadcast station equipment.

The **FIRST CLASS** radio telephone license qualifies you to install, maintain and operate every type of radiotelephone equipment (except amateur) including all radio and television stations in the United States, its territories and possessions. This is the highest class of radiotelephone license available.

GRANTHAM TRAINING PREPARES YOU

The Grantham course covers the required subject matter completely. Even though it is planned primarily to lead directly to a first class FCC license, it does this by **TEACHING** you electronics. Some of the subjects covered in detail are: Basic Electricity for Beginners, Basic Mathematics, Ohm's and Kirchhoff's Laws, Alternating Current, Frequency and Wavelength, Inductance, Capacitance, Impedance, Resonance, Vacuum Tubes, Transistors, Basic Principles of Amplification, Classes of Amplifiers, Oscillators, Power Supplies, AM Transmitters and Receivers, FM Transmitters and Receivers, Antennas and Transmission Lines, Measuring Instruments, FCC Rules and Regulations, and extensive theory and mathematical calculations associated with all the above subjects explained simply and in detail.

OUR GUARANTEE

If you should fail the F.C.C. exam after finishing our course, we guarantee to give additional training at **NO ADDITIONAL COST**. Read details in our free booklet.

Get Your First Class Commercial F.C.C. LICENSE QUICKLY!

CORRESPONDENCE OR RESIDENCE CLASSES

Grantham School of Electronics *specializes* in F.C.C. license preparation. Correspondence training is conducted from Washington, Hollywood, and Seattle; also, resident **DAY** and **EVENING** classes are held in all three cities. Either way, by correspondence or in resident classes, we train you quickly and well.

This booklet **FREE!**

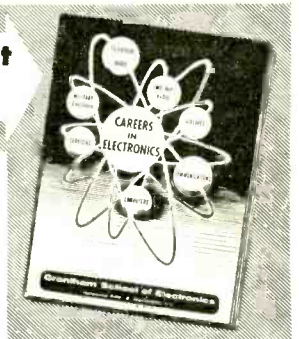

This free booklet gives details of our training and explains what an F.C.C. license can do for your future.

HERE'S PROOF...

that Grantham students prepare for F.C.C. examinations in a minimum of time. Here is a list of a few of our recent graduates, the class of license they got, and how long it took them:

	License	Weeks
Roy E. Alexander, Pikeville, Kentucky	1st	12
Robert J. Conley, 129 W. 46th St., New York 36, N. Y.	1st	14
W. R. Smith, 1335 E. 8th St., Long Beach, Calif.	1st	12
Howard E. Martz, 301 S. Penn. St., Fairmount, Ind.	1st	24
John W. Dempsey, Box 55, Rising Sun, Md.	1st	12
Donald H. Ford, Hyannis Rd., Barnstable, Mass.	1st	12
Richard J. Falk, 2303 Holman St., Bremerton, Wash.	1st	22
Oenson D. McNully, 1117 N. Houston St., Amarillo, Texas	1st	9
James D. Hough, 400 S. Church St., East Troy, Wis.	1st	12
Oaie B. Perry, Jr., Rt. #3, Zebulon, N. C.	1st	12
Milton C. Gee, Rt. #1, Washington, N. J.	1st	11

Grantham School of Electronics

Hollywood Division

1505 N. Western Ave.
Hollywood 27, Calif.
(Phone: HO 7-7727)

Washington Division

821-19th Street, N.W.
Washington 6, D. C.
(Phone: ST 3-3614)

Seattle Division

408 Marion Street
Seattle 4, Wash.
(Phone: MA 2-7227)

MAIL COUPON TO SCHOOL NEAREST YOU

(Mail in envelope or paste on postal card)



To: **GRANTHAM SCHOOL OF ELECTRONICS**

821-19th, NW • 1505 N. Western • 408 Marion
Washington • Hollywood • Seattle

Gentlemen:

Please send me your free booklet telling how I can get my commercial F.C.C. license quickly. I understand there is no obligation and no salesman will call.

Name _____ Age _____

Address _____

City _____ State _____

I am interested in: Home Study, Resident Classes 93-E

Letters

(Continued from page 10)

branches of service for excitement. I have been in the Coast Guard for four years and seven months, one year and seven months as a radioman.

Helping to save personal life and property on our inland waterways and the high seas is a worthwhile job. Each man plays a part when we go on a rescue mission, but I think a radioman plays the most important part of all because he is the one who hears the call for help and gets all the info on the case.

We haven't received reception reports from any SWL's yet, but your article should bring a few in. I read your articles every month and enjoy them all, so keep up the good work.

CHARLES E. HOLMS, RM2, USCG

Building It Better

I built the "One-Tube Hi-Fi Tuner" in your June 1958 issue. However, I wondered why you used such a large tube as the 6SK7. I changed the tube to a 6BD6 and had wonderful results. In fact, I built the tuner at my shop and only had it on for a little while when a customer came in and commended the sound quality.

GEORGE A. LEAVER
Louisville, Ky.

Test Instruments

I believe there is an error on page 72 of the "Test Instruments" article, Part 3 (March '59). Under the paragraph heading "The Suspects," you state, "We set the VOM to its lowest ohmmeter

range and take a reading between the plate of V5 and ground." I think you mean "V4" and ground. From this point on to the end you refer to V5, when it should be V4. No?

CARL W. BOSWELL
Hobart, Ind.

You're right, Carl. Gremlins do get into the copy—no matter what we do, or how hard we try to keep them out.

What's With Watts

In the January issue of POPULAR ELECTRONICS Brice L. Ward, Jr., registered his vote for "High Power for Hi-Fi." Please cast my vote to the contrary, lest readers about to purchase amplifiers make drastic changes in their budgets.

Mr. Ward compares the distortion of two amplifiers rated at 10 watts and 60 watts, each driven to an average level of 8 watts, and with identical proportional-power vs. distortion curves (low-power amplifiers generally do not have curves with such a severe elbow). A loud passage, he says, may demand that each amplifier provide 12 watts, driving the little unit into distortion. Actually, a loud passage will usually demand that each amplifier provide 25, 100, or even 1000 watts (a short burst only 20 db above the average of 8 watts). There will be no difference in distortion if the volume of the large amplifier is raised a mere 7 db. This represents about two twists of the volume control, each twist giving an increase in volume that is just noticeable.

Mr. Ward's argument for wide frequency re-

MICRO

ELECTRON TUBE

INTRODUCES FOR THE FIRST TIME
ANYWHERE A SELECT STOCK OF USED
TUBES AT A FABULOUS LOW PRICE

37¢

ea.

FOR ANY TUBE LISTED

\$35 PER HUNDRED ASSTD.

ALL TUBES SEMI POSTAGE PAID
Please send 25¢ handling for orders under \$5. Send 25% deposit on C.O.D. orders. Send approximate postage on Canadian and foreign orders.

MICRO

ELECTRON TUBE CO.

P.O. BOX 55 Park Station, Paterson 3, N. J.

Each and every tube is tested in our own laboratory for mutual conductance and life test.

We guarantee FREE replacement for one year of any tube purchased from us which fails to function efficiently under any or all operating conditions. Prompt refunds are made on any defective merchandise.

The advertised tubes are not necessarily new, but may be electrically perfect factory seconds or used tubes—each is clearly so marked.

0A2	6X8	6BH6	6SF5	7Z5	19BG6G
0Z4	6Y3GT	6BJ6	6SF7	12A8	1916
1A7GT	6Y4Q	6BK5	6SK7	12AQ5	1918
1B2GT	6A7	6BK7	6SK7	12AT6	1918
1N4GT	6A8	6BL7GT	6SL7GT	12AT7	2A6
1N5GT	6A8B	6BN8	6SN7GT	12A77	25AV5
1L8	6AC7	6B98GT	6SQ7	12A8	25B06
1N8GT	6AF4	6B9GT	6SS7	12A87	25D06
1J9GT	6AG5	6B9SQ	6T4	12AV6	25L6GT
1R5	6A07	6BZ6	6T8	12AX4GT	25W4GT
1S5	6AH4GT	6BZ7	6U8	12AX7	25Z5
1T4	6AH6	6C4	6V6	12A77	25Z6
1U4	6AK5	6C5	6W4GT	12B4	26
1UR	6AL5	6C6	6W6GT	12B4	26
1V2	6AL7	6C6	6W6GT	12B4	26
2A3	6AM8	6C8G	6X5	12B4	26
2F4	6AN8	6C8G	6X5	12B4	26
3C5	6AO8	6C7	6X8	12B4	26
3BN8	6A07GT	6CL6	6Y8	12B4	26
3C5B	6A8B	6CM6	7A4/XXL	12B4	26
3C5E	6A5E	6CM7	7A8	12B4	26
3C6	6A7E	6CN7	7A8	12B4	26
3C5E	6A7E	6CG	7A8	12B4	26
3L4	6A4GT	6CUG	7B4	12CA5	39/44
304	6A5GT	6DE6	7B4	12J8	42
354	6AUS	6DQ6	7B5	12K7	43
3V4	6AUS	6F6	7B5	12K7	43
4B2T	6AV5GT	6H6	7B7	12L6	45
4B2T	6AV6	6J4	7B8	12M7	50A8
5B5B	6AW8	6J5	7C4	12S47	50R5
5A7B	6AX4GT	6J7	7C5	12S47	50L6GT
5AV8	6AX5GT	6K6GT	7C6	12S47	50X6
5AW4	6A8	6K7	7C7	12SN7GT	56
5B7	6BA6	6K8	7C7	12V6GT	57
5J6	6BC5	6L7	7E7	12V6GT	57
6T6	6BD6	6N7	7F7	12W6GT	71A
6U4G	6BE6	6O7	7F8	12X4	71
6U4	6BF5	6P4	7H7	12Y4	76
6V4Q	6BF5	6P4	7H7	14A7/12B7	77
6V6GT	6BF5	6P4	7H7	14B6	78
	6B9GT	6SA7	7Q7	14Q7	84/6Z4
	6B9GT	6SA7	7X7/XXFM	19	117Z3
	6B9GT	6SC7	7Y4	19A4GT	117Z6

HOW WOULD YOU LIKE TO BREAK INTO ENGINEERING STARTING NEXT MONTH?

Your start in Engineering could mean higher pay, more interesting work, a real chance for advancement. Here's how to do it—fast!

A career in Engineering may be closer than you think, whatever your age or education or present job.

You know about the tremendous demand for engineers and technicians. But do you know how easy it is to get the training that will qualify you for this vital work, and how quickly you can advance?

First Step Wins Job Consideration

The moment you enroll for a course in Engineering you're in a position to change your job. I.C.S. Engineering Courses, for example, start you off with Basic Mathematics and Drafting. Most employers are quick to accept men who start technical training.

Your Advancement Is Rapid

Your interest, your determination, your willingness to spend free hours improving

yourself all work in your favor. But your mastery of engineering subjects is what wins you the biggest boosts.

The I.C.S. method makes it possible for you to learn while you earn, to qualify yourself for upgrading step by step—from Draftsman to Detail Designer to Engineering Technician to full-fledged Engineer. It's a plan fitted to your needs, with personalized instruction and guidance, and, if you like, regular progress reports to your employer.

Mail Coupon for Free Books

If you are seriously interested in a fresh start in an opportunity-packed field, then mark and mail the coupon today. We'll send you *three* free books—(1) the 36-page career guide "How to Succeed," (2) Opportunity outlooks in your field of interest, (3) sample lesson (Math) demonstrating I.C.S. method.

For Real Job Security—Get an I. C. S. Diploma!

I. C. S., Scranton 15, Penna.

Accredited Member,
National Home Study Council

INTERNATIONAL CORRESPONDENCE SCHOOLS



BOX 14622D, SCRANTON 15, PENNA.

(Partial list of 259 courses)

Without cost or obligation, send me "HOW TO SUCCEED" and the opportunity booklet about this field BEFORE which I have marked X (plus sample lesson):

- | | | | | |
|--|--|--|--|---|
| <p>ARCHITECTURE and BUILDING CONSTRUCTION</p> <ul style="list-style-type: none"> <input type="checkbox"/> Air Conditioning <input type="checkbox"/> Architecture <input type="checkbox"/> Arch. Drawing and Designing <input type="checkbox"/> Building Contractor <input type="checkbox"/> Building Estimator <input type="checkbox"/> Carpenter Builder <input type="checkbox"/> Carpentry and Millwork <input type="checkbox"/> Carpenter Foreman <input type="checkbox"/> Heating <input type="checkbox"/> Painting Contractor <input type="checkbox"/> Plumbing <input type="checkbox"/> Reading Arch. Blueprints <p>ART</p> <ul style="list-style-type: none"> <input type="checkbox"/> Commercial Art <input type="checkbox"/> Magazine Illus. <input type="checkbox"/> Show Card and Sign Lettering <input type="checkbox"/> Sketching and Painting <p>AUTOMOTIVE</p> <ul style="list-style-type: none"> <input type="checkbox"/> Automobile <input type="checkbox"/> Auto Body Rebuilding and Refinishing <input type="checkbox"/> Auto Engine Tuneup <input type="checkbox"/> Auto Technician | <p>AVIATION</p> <ul style="list-style-type: none"> <input type="checkbox"/> Aero-Engineering Technology <input type="checkbox"/> Aircraft & Engine Mechanic <p>BUSINESS</p> <ul style="list-style-type: none"> <input type="checkbox"/> Accounting <input type="checkbox"/> Advertising <input type="checkbox"/> Business Administration <input type="checkbox"/> Business Management <input type="checkbox"/> Cost Accounting <input type="checkbox"/> Creative Salesmanship <input type="checkbox"/> Managing a Small Business <input type="checkbox"/> Professional Secretary <input type="checkbox"/> Public Accounting <input type="checkbox"/> Purchasing Agent <input type="checkbox"/> Salesmanship <input type="checkbox"/> Salesmanship and Management <input type="checkbox"/> Traffic Management <p>CHEMICAL</p> <ul style="list-style-type: none"> <input type="checkbox"/> Analytical Chemistry <input type="checkbox"/> Chemical Engineering <input type="checkbox"/> Chem. Lab. Technician <input type="checkbox"/> Elements of Nuclear Energy <input type="checkbox"/> General Chemistry <input type="checkbox"/> Natural Gas Prod. and Trans. <input type="checkbox"/> Petroleum Prod. and Engr. <input type="checkbox"/> Professional Engineer (Chem) <input type="checkbox"/> Pulp and Paper Making | <p>CIVIL ENGINEERING</p> <ul style="list-style-type: none"> <input type="checkbox"/> Civil Engineering <input type="checkbox"/> Construction Engineering <input type="checkbox"/> Highway Engineering <input type="checkbox"/> Professional Engineer (Civil) <input type="checkbox"/> Reading Struct. Blueprints <input type="checkbox"/> Sanitary Engineering <input type="checkbox"/> Structural Engineering <input type="checkbox"/> Surveying and Mapping <p>DRAFTING</p> <ul style="list-style-type: none"> <input type="checkbox"/> Aircraft Drafting <input type="checkbox"/> Architectural Drafting <input type="checkbox"/> Drafting & Machine Design <input type="checkbox"/> Electrical Drafting <input type="checkbox"/> Mechanical Drafting <input type="checkbox"/> Sheet Metal Drafting <input type="checkbox"/> Structural Drafting <p>ELECTRICAL</p> <ul style="list-style-type: none"> <input type="checkbox"/> Electrical Engineering <input type="checkbox"/> Elec. Engr. Technician <input type="checkbox"/> Elec. Light and Power <input type="checkbox"/> Practical Electrician <input type="checkbox"/> Practical Lineman <input type="checkbox"/> Professional Engineer (Elec) <p>HIGH SCHOOL</p> <ul style="list-style-type: none"> <input type="checkbox"/> High School Diploma | <ul style="list-style-type: none"> <input type="checkbox"/> Good English <input type="checkbox"/> High School Mathematics <input type="checkbox"/> High School Science <input type="checkbox"/> Short Story Writing <p>LEADERSHIP</p> <ul style="list-style-type: none"> <input type="checkbox"/> Industrial Foremanship <input type="checkbox"/> Industrial Supervision <input type="checkbox"/> Personnel-Labor Relations <input type="checkbox"/> Supervision <p>MECHANICAL and SHOP</p> <ul style="list-style-type: none"> <input type="checkbox"/> Diesel Engines <input type="checkbox"/> Gas-Elec. Welding <input type="checkbox"/> Industrial Engineering <input type="checkbox"/> Industrial Instrumentation <input type="checkbox"/> Industrial Metallurgy <input type="checkbox"/> Industrial Safety <input type="checkbox"/> Machine Shop Practice <input type="checkbox"/> Mechanical Engineering <input type="checkbox"/> Professional Engineer (Mech) <input type="checkbox"/> Quality Control <input type="checkbox"/> Reading Shop Blueprints <input type="checkbox"/> Refrigeration and Air Conditioning <input type="checkbox"/> Tool Design <input type="checkbox"/> Tool Making <p>RADIO TELEVISION</p> <ul style="list-style-type: none"> <input type="checkbox"/> General Electronics Tech. | <ul style="list-style-type: none"> <input type="checkbox"/> Industrial Electronics <input type="checkbox"/> Practical Radio-TV Eng'g <input type="checkbox"/> Practical Telephony <input type="checkbox"/> Radio-TV Servicing <p>RAILROAD</p> <ul style="list-style-type: none"> <input type="checkbox"/> Car Inspector and Air Brake <input type="checkbox"/> Diesel Electrician <input type="checkbox"/> Diesel Engr. and Fireman <input type="checkbox"/> Diesel Locomotive <p>STEAM and DIESEL POWER</p> <ul style="list-style-type: none"> <input type="checkbox"/> Combustion Engineering <input type="checkbox"/> Power Plant Engineer <input type="checkbox"/> Stationary Diesel Engr. <input type="checkbox"/> Stationary Fireman <p>TEXTILE</p> <ul style="list-style-type: none"> <input type="checkbox"/> Carding and Spinning <input type="checkbox"/> Cotton Manufacture <input type="checkbox"/> Cotton Waring and Weaving <input type="checkbox"/> Loom Fixing Technician <input type="checkbox"/> Textile Designing <input type="checkbox"/> Textile Finishing & Dyeing <input type="checkbox"/> Throwing <input type="checkbox"/> Waring and Weaving <input type="checkbox"/> Worsted Manufacturing |
|--|--|--|--|---|

Name _____ Age _____ Home Address _____
 City _____ Zone _____ State _____ Working Hours _____ A.M. to P.M. _____
 Occupation _____
 Canadian residents send coupon to International Correspondence Schools, Canadian, Ltd., Montreal, Canada. . . . Special tuition rates to members of the U. S. Armed Forces

From the pioneer
in ceramics for electronics

STEREO

the new single
ceramic element
Stereophonic
cartridge

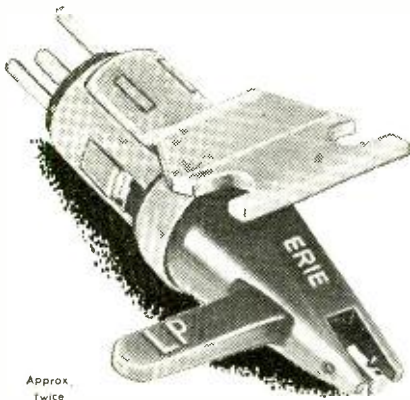

Approx.
twice
Size

DYNAMIC BALANCING MAKES THE DIFFERENCE

DYNAMIC BALANCING during manufacture provides full stereo reproduction. SINGLE ELEMENT DESIGN offers balanced outputs; excellent separation of 20 db over full audio-frequency range, with equal outputs from both channels. Compatible with stereo and monophonic discs.

SPECIFICATIONS

RESPONSE: 20 to 16,000 cps. **OUTPUT VOLTAGE:** 0.5 vrms. at 1 KC each channel. **COMPLIANCE:** 3×10^{-6} cm/dyne, vertical & lateral. **RECOMMENDED LOAD:** 2 megohms. **RECOMMENDED TRACKING PRESSURE:** 5-6 grams. **CHANNEL SEPARATION:** 20 db. **STYLUS:** dual tip; 0.7 mil diamond or sapphire, and 3 mil sapphire. **MOUNTING DIMENSIONS:** EIA Standard $\frac{1}{4}$ " & $\frac{1}{2}$ " centers.

For additional information, see your Authorized ERIE Distributor



Letters

(Continued from page 12)

sponse involves "the special sound character of a musical instrument due to both its overtones and harmonics (different names for the same thing) and the rate of attack." Now, no common musical instrument can produce a fundamental pitch above 4000 cycles, and seldom is this limit approached. Overtones extend ever upward, but with decreasing amplitude and importance, and even in an excellent recording, noise will overshadow the overtones above 15,000 cycles. Furthermore, distortion is usually high in this range.

As for the transient response of an amplifier, a requirement of 10 microseconds rise and fall time is justified if you have a pickup, speaker, and ear to match. The attack and release times of the instruments mentioned in the article are related to their respective frequencies, incidentally.

In conclusion, there's a slight difference, performance-wise, between two amplifiers rated at 10 watts and 60 watts, and a much greater difference in price.

DAVE BECK
Yellow Springs, Ohio

Help, Please!

■ I wonder whether any of your readers can help me. I am repairing a Heathkit O-7 oscilloscope, and I need the instruction manual. I have written Heath but they do not have a manual because the



scope is a discontinued model. If someone could lend me a copy, I would be very grateful, and of course I would return it.

STEPHEN LEWIS
108-56 Jewel Ave.
Forest Hills 75, N. Y.

Duo-Flex Speaker System

■ Could you please tell me the thickness of the wood (and also the type of wood) to use in building the Duo-Flex Speaker System described in your February 1959 issue?

CHARLES ZANATY
Birmingham, Ala.

Use 1" common pine shelving for the 4 sides, $\frac{3}{8}$ "- $\frac{3}{4}$ " plywood for front and back panels. —30—

These men are getting practical training in **ELECTRONICS**

ELECTRICITY

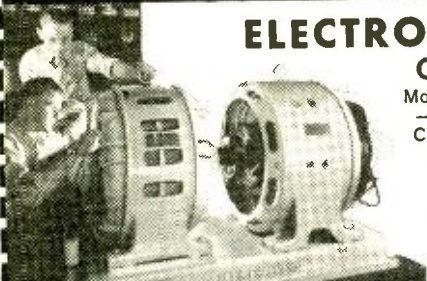

ELECTRONICS

ON REAL

Motors—Generators
—Switchboards—
Controls—Modern
Appliances—
Automatic
Electronic
Control Units

TELEVISION



RADIO ELECTRONICS ON REAL

TV Receivers—
Black and White
and Color
AM-FM and
Auto Radios
Transistors
Printed Circuits
Test Equipment

Train in NEW Shop-Labs of COYNE

in Chicago—prepare for today's TOP OPPORTUNITY FIELD. Train on real full-size equipment at COYNE where thousands of successful men have trained for over 60 years—largest, oldest, best equipped school of its kind. Professional and experienced instructors show you how, then do practical jobs yourself. No previous experience or advanced education needed. Employment Service to Graduates.

START NOW—PAY LATER—Liberal Finance and Payment Plans. Part-time employment help for students. **GET FREE BOOK**—"Guide to Careers" which describes your training in **ELECTRICITY-ELECTRONICS and TELEVISION-RADIO ELECTRONICS**—no obligation; **NO SALESMAN WILL CALL.**

Coyne Electrical School, 1501 W. Congress Parkway
Chartered Not For Profit Chicago 7, Dept. 59-2A

MAIL COUPON OR WRITE TO ADDRESS BELOW

COYNE ELECTRICAL SCHOOL
Dept. 59-2A—New Coyne Building
1501 W. Congress Pkwy., Chicago 7, Ill.
Send **BIG FREE** book and details of all the training you offer.

Name _____
Address _____
City _____ State _____



**COYNE offers
LOW COST**

TELEVISION RADIO - COLOR TV

Training in
Spare Time **AT HOME**

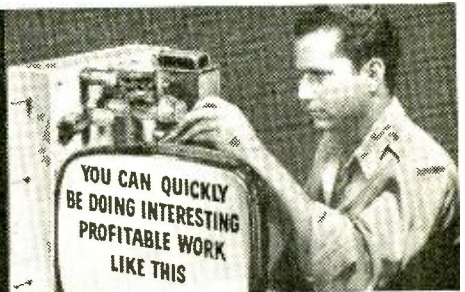

The future is **YOURS** in **TELEVISION!**

A fabulous field—good pay—fascinating work—a prosperous future in a good job, or independence in your own business!

Coyne brings you **MODERN-QUALITY Television Home Training**; training designed to meet Coyne standards at truly lowest cost—you pay for training only—no costly "put together kits." Not an old Radio Course with Television "tacked on." Here is **MODERN TELEVISION TRAINING** including **Radio, UHF and Color TV.** No Radio background or previous experience needed. Personal guidance by Coyne Staff. **Practical Job Guides** to show you how to do actual servicing jobs—**make money early in course.** Free Lifetime Employment Service to Graduates.

COYNE
ELECTRICAL SCHOOL

CHARTERED AS AN EDUCATIONAL INSTITUTION
NOT FOR PROFIT

1501 W. Congress Parkway • Chicago 7, Dept. 59-H2



B. W. COOKE, Jr., President
Coyne—the institution behind this training... the largest, oldest, best equipped residential school of its kind. Founded 1899.

Send Coupon or write to address below
for Free Book

and full details,
including easy
Payment Plan.
**No obligation, no
salesman will call.**



**COYNE Television
Home Training Division**
Dept. 59-H2, New Coyne Building
1501 W. Congress Pkwy., Chicago 7, Ill.

Send Free Book and details on how I can get
Coyne Quality Television Home Training at
low cost and easy terms.

Name _____
Address _____
City _____ State _____

Save Half ASSEMBLING

ONE OF THESE TWO

Schober

ELECTRONIC ORGANS in KIT form

"CONCERT" "CONSOLETTA"

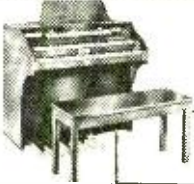

**NO SPECIAL SKILLS
PAY KIT-BY-KIT**

CONSOLETTA MODEL
Occupies only 2' x 3'2"
Floor Space

- HANDSOME ASSEMBLED CONSOLES
 - DOUBLE KEYBOARDS — 122 KEYS
 - ABOVE-KEYBOARD TABS
 - CONCERT MODEL CONFORMS TO A G O SPECIFICATIONS. Occupies 3'5" x 4'7" Floor Space
 - BUILT-IN SPEAKERS OPTIONAL (For Consoletta Model only)
 - COMPLETE DETAILED INSTRUCTIONS
 - FREE—NEW 1959 EDITION of 16-page BOOKLET DESCRIBING BOTH MODELS
 - 10" LP RECORD DEMONSTRATING BOTH MODELS available for \$2; refundable on receipt of order
- Write today—see what fine instruments you can have at such great savings.*

The SCHOBER ORGAN CORP.
2248-X Broadway, New York 24, New York

IT'S QUALITY FOR STEREO! QUAL-KITS are EASIEST!



Model
STA-36 \$49.95

COMPLETE 36-Watt STEREO 2 CHANNEL AMPLIFIER... with the smart, slim look in Hi-Fi. 2 preamps, 2 power amps. Controls all stereo/monaural sources (tapes, records, tuners). Separate ganged base and treble controls, balance control, mode switch, rumble filter, speaker phasing switch, 6 dual inputs, tape output, etc.



24 WATT STEREO AMPLIFIER
complete 2 amps and 2 preamps
Model STA-24 \$39.95

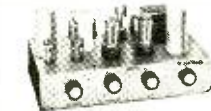

IDEAL SECOND AMPLIFIER
for stereo—12 watt Williamson type
Model 2200 \$22.75

Model 1000 AM-FM Tuner \$31.85
STEREO TWINS
Model 1100 FM Tuner \$25.50
Model 1200 AM Tuner \$19.95

MODEL 2000
12 Watt Amp and Preamp... \$28.50
Radios Complete with Tubes & Cabinet
Model 250—Superhet, AC-DC \$16.45
Model 350—2 band, BC & SW \$19.75

And they have the best features and more. Fully illustrated step-by-step 28-page manual, tubes assembled & shipped. WRITE FOR FREE CATALOG! 10% Fed. tax included in all prices. Covers and legs optional.

QUALITY-ELECTRONICS

319 Church St. Dept. P-3, New York 13, N. Y.

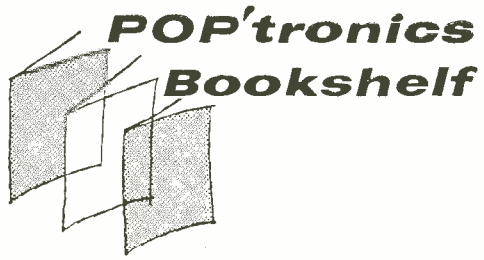

"THE RADIO-ELECTRONIC MASTER" published by United Catalogue Publishers, Inc., 60 Madison Ave., Hempstead, N. Y. 1536 pages.

The 1959 edition of this mammoth catalogue contains descriptions, specifications, and prices for over 150,000 standard items sold through electronic parts distributors. Its 18 product sections cover tubes, transistors, printed-circuit components, silicon rectifiers, audio and recording equipment, test equipment, relays, coils, antennas, transformers, wire, speakers, ham gear, etc. More than 11,500 illustrations are included. Copies may be purchased at local electronics parts distributors.



"AUDIO MEASUREMENTS" by Norman H. Crowhurst. Published by Gernsback Library, Inc., 154 West 14th St., New York 11, N. Y. 224 pages. Paper cover edition, \$2.90. Hard cover edition, \$5.00.

Norman Crowhurst's latest audio book fills a long-empty gap in the field of hi-fi literature. Measurement techniques for hi-fi are described and evaluated, and test equipment, basic measurements and amplifiers are treated in detail. Mr. Crowhurst goes on to describe measurements of output transformers, preamplifiers, pickups and arms, turntables and changers, tape recorders and microphones. The systems and techniques demonstrated are accurate and complete. This is recommended as a book that will solve many of the problems encountered by hobbyists, technicians and engineers.



"KNOW YOUR OSCILLOSCOPE" by Paul C. Smith. Published by Howard W. Sams and Co., Inc., Indianapolis, 6, Ind. 151 pages. \$2.00.

The oscilloscope is one of the most valuable tools yet designed for trouble-shooting

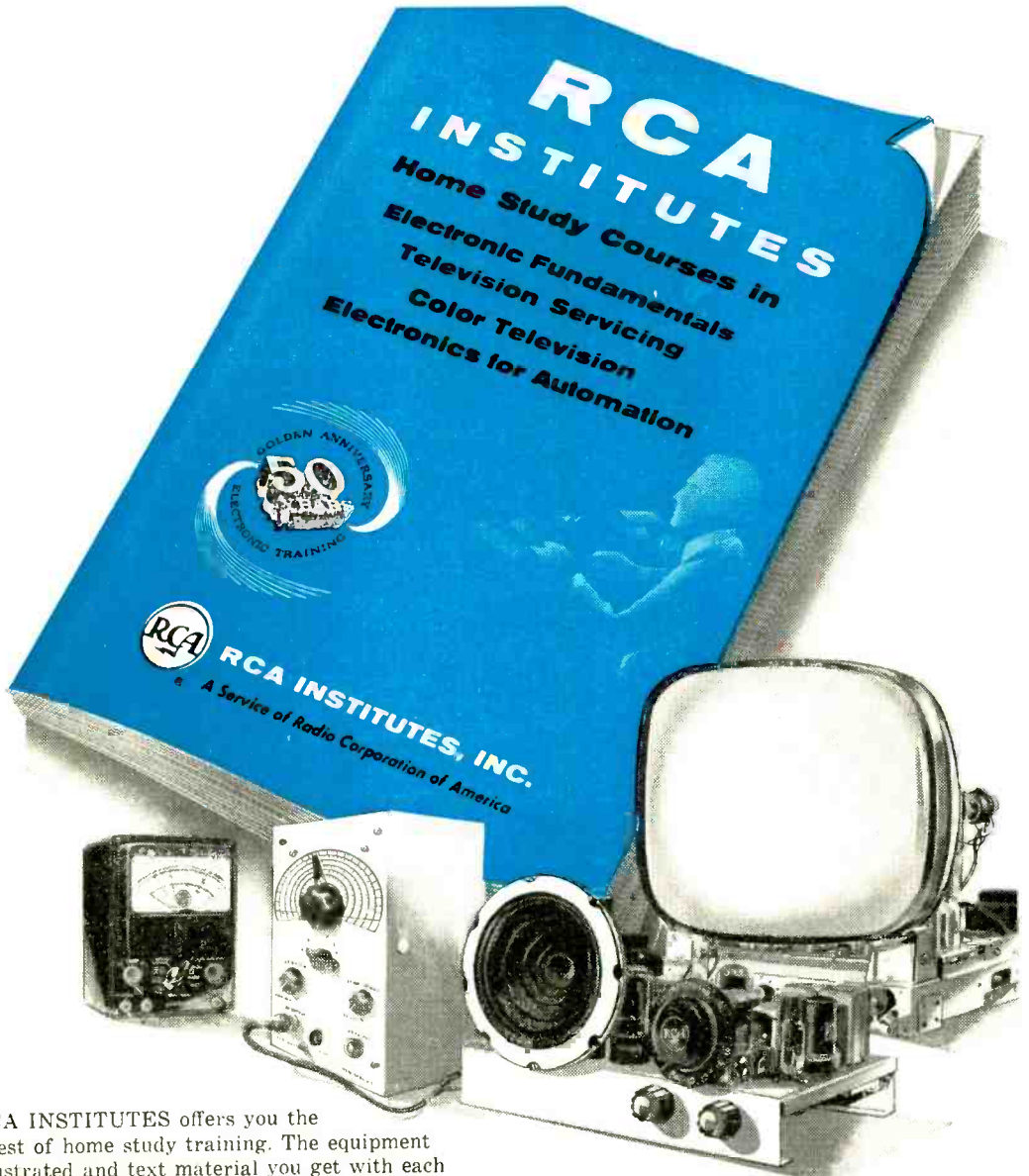

RCA INSTITUTES offers you the finest of home study training. The equipment illustrated and text material you get with each course is yours to keep. Practical work with very first lesson. Courses for the beginner and the advanced student. Pay-as-you-learn. You need pay for only one study group at a time.

Send for this FREE Book Now 

RESIDENT SCHOOL offers Technical Institute and Vocational School Courses in Electronics. Day and Evening classes. Resident School Catalog sent free on request.

RCA INSTITUTES, Inc. Home Study School
 A Service of Radio Corporation of America Dept. SPE-59
 350 West Fourth Street, New York 14, N. Y.

Without obligation, send me FREE 64-page CATALOG on Home Study Courses. No salesman will call.

Name..... please print
 Address.....
 City..... Zone..... State.....
 Korean Vets! Enter discharge date.....

CANADIANS — Take advantage of these same RCA courses at no additional cost. No postage, no customs, no delay. Send coupon to: RCA Victor Company, Ltd., 5001 Cote de Liesse Rd., Montreal 9, Quebec
 To save time, paste coupon on postcard.

AT BETTER ELECTRONIC PARTS JOBBERS



**Electro
Kit**
KPS-2
Best of all—
and costs less
\$39.95
(wired \$49.95)

NEW DC POWER SUPPLY
operates 6/12 v. auto sets, transistor
portables, experimental transistor circuits

Will charge batteries, operate model railroads, relays. Ideal for laboratory work, electroplating and many other low voltage applications.

2 output ranges: 0-16 V. 5 amps, 0.5% maximum ripple; 0-20 V. 75 MA. 0.15% ripple • Separate meters for each output • Patented conduction cooling • Easy-to-follow instructions.

Send for **FREE** literature, name of your jobber!

Electro Products Laboratories
4501-P Ravenswood, Chicago 40, Ill.

Name _____

Address _____

City _____ Zone _____ State _____



"It's really just a pizza pie, but of course a **JENSEN NEEDLE** makes *anything* sound better."

Bookshelf (Continued from page 16)

and electronic design work. Unfortunately, however, many scopes just sit on shelves and are seldom used. This book will do a lot towards getting these scopes into action and have them start earning their keep.

The reader is first introduced to the principal circuits in an oscilloscope and the function of each. One chapter is devoted to maintenance and repair, and the last four chapters describe the countless applications of oscilloscopes. "Know Your Oscilloscope" is recommended to any scope owner.



"GUIDE TO MOBILE RADIO" by Leo G. Sands. Published by Gernsback Publications, Inc., 154 West 14th St., New York 11, N. Y. 160 pages. \$2.85.

The growing popularity of mobile radio has prompted Mr. Sands to write this excellent book on the subject. It covers the general types of systems, including paging, dispatching, industrial, railroad, and citizens band applications. Also discussed are mobile and base station operation, types of receivers and transmitters, power supplies, antenna systems, remote controls, portable equipment, maintenance, and licensing. The "Guide to Mobile Radio" is recommended to technicians, sales engineers, and purchasers and operators of mobile equipment.



"HIGH QUALITY SOUND REPRODUCTION" by James Moir. Published by The Macmillan Company, 60 Fifth Ave., New York, N. Y. 583 pages. Hard cover. \$14.00.

James Moir, noted acoustic designer, provides a clearly written, coherent account of the reasons behind the choice of designs for reproducing high-fidelity sound, and the data for these designs.

Almost every aspect of the sound reproduction field is comprehensively covered. Special sections are devoted to the design of amplifiers, loudspeaker mountings and enclosures, and valuable lists of references to published papers are included. Mathematical insertions are concentrated in an appendix for each chapter so that those interested only in the "why" and "how" of the designs may read without interruption.

This thick volume is about as indispensable as an electron tube manual for anyone

**WE'RE MAKING IT EASIER THAN EVER TO BECOME A WELL PAID
RADIO-TELEVISION SERVICE TECHNICIAN**

**NOW - Just \$6 Starts You Training in
RADIO-TELEVISION
the SPRAYBERRY "Learn-by-Doing" Way . . .**

**25 BIG, COMPLETE KITS
of PARTS & EQUIPMENT**

To help you learn fast the practical side of Radio-Television, we send you expertly engineered training kits to test and assemble for interesting, valuable shop-bench practice!



• The new Sprayberry Training Television Receiver, built and tested in 5 sections.

• Now offered . . . this fine modern oscilloscope:

• You build this powerful two-band superheterodyne radio receiver.



**Big New
CATALOG
AND
Sample Lesson
FREE!**

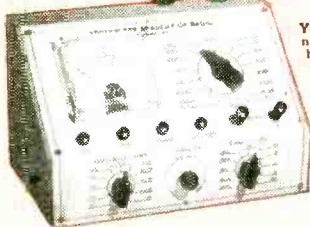
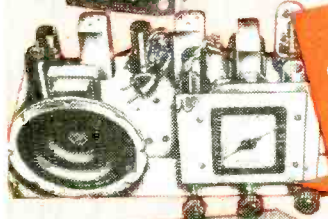

You build the new Sprayberry tester—a complete 18-range Volt-Ohm-Milli-ammeter test meter.

*** This great industry is begging for trained men . . . to step into good paying jobs or a profitable business of their own! Our new plan opens the doors of Radio-Television wide to every ambitious man who is ready to act at once!

Men by the thousands . . . trained Radio-Television Service Technicians . . . are needed at once! Perhaps you've thought about entering this interesting, top paying field, but lack of ready money held you back. Now—just \$6 enrolls you for America's finest, most up to date home study training in Radio-Television! Unbelievable? No, the explanation is simple! We believe Radio-Television *must* have the additional men it needs as quickly as possible. We are willing to do our part by making Sprayberry Training available for less money down and on easier terms than ever before. This is your big opportunity to get the training you need . . . to step into a fine job or your own Radio-Television Service Business.

Complete Facts Free—Act Now; Offer Limited

Only a limited number of students may be accepted on this liberal and unusual basis. We urge you to act at once . . . mail the coupon below and get complete details plus our big new catalog and an actual sample lesson—all free. No obligation . . . no salesman will bother you.

HOME STUDY TRAINING IN SPARE TIME

Under world-famous 27-year old Sprayberry Plan, you learn entirely at home in spare time. You keep on with your present job and income. You train as fast or as slowly as you wish. You get valuable kits of parts and equipment for priceless shop-bench practice. And everything you receive, lessons and equipment alike, is all yours to keep.

LET US PROVE HOW EASILY YOU CAN LEARN!

Radio-Television needs YOU! And Sprayberry is ready to train you on better, easier terms, than any ambitious man can afford. *Just \$6 starts you!* Mail coupon today . . . let the facts speak for themselves. You have everything to gain. Let us prove the kind of opportunity in store for you!

SPRAYBERRY Academy of Radio-Television

1512 Jarvis Avenue, Dept. 105-V, Chicago 26, Illinois

Mail This Coupon Now—No Salesman Will Call

Sprayberry Academy of Radio-Television
Dept. 105-V, 1512 W. Jarvis Ave., Chicago 26, Ill.

Please rush all information on your ALL NEW Radio-Television Training Plan. Understand this does not obligate me and that no salesman will call upon me. Include New Catalog and Sample Lesson FREE.

NAME Age

ADDRESS

CITY ZONE STATE



Who's the "traffic cop" in your stereo cartridge ?

A stereo record "stores" two separate sounds in its grooves. A single needle picks up both. How to separate them? Sonotone designed a pantagraph yoke for its "8T" ceramic stereo cartridge. It acts like a traffic cop to direct the two sounds on their proper routes.

The pantagraph yoke (a Sonotone exclusive) gives wider separation of channels for superior stereo sound. It assures *equal* output level from both sound channels. Cartridges without this yoke often have unbalanced output... poor stereo sound.

Sonotone's "traffic cop" is one more reason why you'll hear the difference when you get Sonotone's ceramic stereo cartridge. Prices of Sonotone stereo cartridges start at only \$6.45 (including mounting brackets).

FREE! "Stereo Simplified" booklet—tells you how stereo operates. Write to:

Sonotone

Electronic Applications Division, Dept. CC-59

ELMSFORD, NEW YORK

ALL NEW 20-POUND MYSTERY PACKAGE

BRAND NEW U.S. AIR FORCE B-29 BOMBSIGHT
Cost U.S. Govt. \$25,000.00
YOU PAY \$2950

INCLUDES:
22H x 13W x 17D STEEL STORAGE CASE WITH KEY LOCK

- Contains Over 100 Precision Bearings
- Ground Optic Lenses
- Gyroscopes
- Motors • Gears
- Switches • Relays

AND THOUSANDS OF OTHER USEFUL PARTS!
SHIPPED ANYWHERE IN U.S.A. FREE!

OF ELECTRONIC PARTS



Worth \$40.00 **\$395**

It's Another **THRILLING HERSHEY SURPRISE**. 20 pounds of **BRAND NEW** usable Govt. Surplus. Perfect gift for Hams, etc.

PRECISION BUTTERFLY CONDENSERS

YOUR CHOICE \$495

TYPE A 4 1/2" Dia.
TYPE C 2 1/2" Dia.

TYPE B 4 1/2" Dia.
TYPE D 2 1/2" Dia.

These units make the finest tuners for Ultra-high frequency transmitters, receivers, frequency meters, and oscillators.

HERSHEL RADIO CO. Phone TVler 8-9400
5249 GRAND RIVER Detroit 8, Michigan

TERMS: Cash with Order, or 25% Down, BALANCE C.O.D. ALL PRICES F.O.B. DETROIT

Bookshelf (Continued from page 18)

going deeply into the "why's" and "wherefore's" of high-fidelity sound reproduction.



"RADIOACTIVITY MEASURING INSTRUMENTS" by M. C. Nokes. Published by Philosophical Library, Inc., 15 East 40th St., New York 16, New York. 75 pages. Hard cover. \$4.75.

There is no doubt that there is great public interest in radioactivity and its measurement today, but few people are aware that these measurements can be made at small cost with apparatus that can largely be made in any ordinary laboratory. The components required are now easily obtainable. As very little power is necessary, many of the instruments can be made fully portable. The degree of accuracy obtainable with them is quite sufficient for an introduction to the basic study of radioactivity.

This book gives detailed instructions for making a number of the simpler radioactivity measuring instruments, and includes an idea of the cost. The requirements for successful construction are an elementary knowledge of electricity and an ordinary measure of manual dexterity.



"REFLEX KLYSTRONS" by J. J. Hamilton. Published by The Macmillan Company, 60 Fifth Ave., New York, N. Y. 260 pages. Hard cover. \$9.00.

Rapid development of microwave oscillators and amplifiers has created an ever-expanding area of activity in the tube industry. The reflex klystron, by reason of its simple design and effective performance, has been among the first microwave oscillators to reach the manufacturing stage. At the present time, a considerable proportion of technical effort is directed towards the design, development, production, and application of this device.

The information in this volume, selected from numerous authoritative sources on velocity modulated tubes, is intended to give the reader a grasp of the essentials of reflex klystrons, and an account of their history, position and scope in the field of microwave electronics. It will also serve as a guide for advanced study.

-30-



The data that Launched Thousands of Careers is yours FREE

Tells how you can be successful in **ELECTRONICS**

Send for your Free Copy today!

This is a brand new edition of the book which has launched thousands of men on good-paying careers in electronics.

It brings you completely up to date—answers important questions on newest career developments in electronics, including AUTOMATION, INSTRUMENTATION, INDUSTRIAL ELECTRONICS, AERONAUTICAL ELECTRONICS, GUIDED MISSILES, RADAR, SERVO-MECHANISMS, COMPUTERS, ASTRONAUTICS, TELEMETERING, COMMUNICATIONS, MANUFACTURING.

Since its founding in 1927, CREI has provided thousands of professional electronics men with technical education. During World War II, CREI trained thousands for the Armed Services. Leading firms recommend CREI training for their own personnel. Among them: All American Cables and Radio, Inc.; Canadian Broadcasting Corporation; Columbia Broadcasting System; Gates Radio Company; Federal Electric Corp.; The Martin Company; Douglas Aircraft Co.; U. S. Information Agency (Voice of America); Canadair Limited; Trans-Canada Air Lines; United Air Lines. Their choice of training for their own personnel is a good cue for your choice of a school.

You don't have to be a college graduate. You do have to be willing to study—at home. You can do it while holding down a full-time job.

Thousands have. Since 1927 CREI has provided alert young men with the technical knowledge that leads to more responsibility, more job security, more money. And CREI has constantly kept pace with the rapid expansion and progress in electronic achievement. Remember this: CREI starts with fundamentals and takes you along at your own speed. You are not held back by a class, not pushed to keep up with others. You set your own pace. CREI instructors guide you through the lesson material and grade your written work personally. You master the fundamentals, then get into more advanced phases of electronics engineering principles and practice.

Brand-New Course Added: Automation and Industrial Electronics Engineering Technology: Complete course, covers all phases of automation. Special emphasis on theory, functioning and applications of servo-mechanisms and computers. Also note-worthy: Lessons on machine control, instrumentation, data processing and telemetry.

CREI ALSO OFFERS residence training in Washington, D. C. ...at the same high technical level. Day and evening classes start at regular intervals. Qualified residence school graduates earn degree as "Associate in Applied Science." You can qualify for CREI home study training if you have had electronic education, or experience in electronics—and realize the need of a high level technical knowledge to make good in the better electronic jobs. (Electronics experience is not required for admission to CREI Residence School.)

What's the next step? Certainly to get more information than we can cram into one page. Fill out and mail coupon today, or write Capitol Radio Engineering Institute, Dept. 125-F, 3224 - 16th St., N.W., Wash. 10, D. C.

MAIL THIS COUPON—TODAY!

CAPITOL RADIO ENGINEERING INSTITUTE

ECPD Accredited Technical Institute Curricula—Founded 1927
Dept. 125 F 3224 Sixteenth St., N.W., Washington 10, D. C.

Please send me your course outline and FREE illustrated Booklet "Your Future in the New World of Electronics" ... describing opportunities and CREI Home Study courses in Practical Electronic Engineering Technology.

- CHECK FIELD OF GREATEST INTEREST
- Radar, Servo and Computer Engineering Technology
 - Electronic Engineering Technology
 - Broadcast (AM, FM, TV) Engineering Technology
 - Television Engineering Technology
 - Aeronautical Electronic Engineering Technology
 - Automation and Industrial Electronics Engineering Technology

B³

Name _____ Age _____
 Street _____
 City _____ Zone _____ State _____
 CHECK: Home Study Residence School Korean Veteran



To obtain fast, immediate service, and to avoid delay it is necessary that the following information be filled in:

Employed By _____
 Type of Present Work _____
 Education: Years High School _____
 Other _____
 Electronics Experience _____

ASSEMBLE YOUR OWN
**WALKIE-TALKIE
RADIOPHONES**



**New Model for 27 mc
Citizens Band**

Electronic Chassis ONLY **\$18⁹⁸** post-paid

- Meets FCC requirements for new class "D" citizens band radio-telephone.
- License easily obtained on application by any U. S. citizen 18 years or over. No tests to take.
- Transmits and receives one to several miles depending on obstructions and elevation.
- Assembled unit is completely portable and requires no external connections. Operates from self contained batteries obtainable at your local radio store.
- Electronic chassis is wired, tested, guaranteed and includes crystal controlled oscillator, R.F. power amplifier, audio modulator, receiver with R.F. stage, and a new transistorized audio booster stage for extra loud reception plus a complete set of tubes and transistor.
- Radio receiver is tunable to any of the 22 channels by a single control knob. Features ultra-high amplification, automatic volume control and noise clipping.
- Instructions and photographs are supplied with each chassis for completing the walkie-talkie as illustrated. Accessories are not included but are available at low cost.

FREE R.F. power indicator kit with each order.

SEND YOUR ORDER TODAY. INCLUDE PDSTAL MONEY ORDER FOR FAST DELIVERY. C.O.D.'s REQUIRE \$5.00 DEPOSIT. N. Y. City residents add sales tax.

SPRINGFIELD ENTERPRISES

Box 54E-5

Springfield Gardens 13, N. Y.

**BACH
OR
BE-BOP**



**On patio, lawn, or pool...
enjoy outstanding
high fidelity sound with
University's weatherproof
dual-range 'LC' speaker systems**

The exceptionally efficient 'LC' speakers connect to your amplifier, phonograph, radio, or TV...to cover any area you desire with high volume quality sound. Leave in place rain or shine, season after season... they're rugged and dependable. Each model is a true coaxial speaker with separately driven woofer and tweeter. For complete details, write Desk A-1, University Loudspeakers, Inc., White Plains, N.Y.



Model MLC: compact, fiberglass reinforced polyester. \$34.50



Model BLC: for wider coverage. All metal construction. \$53.70



**NEW
products**

STEREO CONVERSION KITS

Kits for converting the Rek-O-Kut A-120 and A-160 monophonic tone arms to stereo are now available. Included in the kits are all necessary parts and tools for making

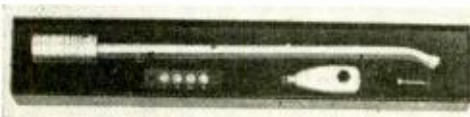

the conversion. Model SC-12 (for converting the A-120) is priced at \$17.95; Model SC-16 (for the A-160) is \$19.95. (Rek-O-Kut Co., Inc., 38-19 108th St., Corona 68, N. Y.)

TV ANTENNA MOUNT

Antenna installation can be greatly simplified with a "Fast Mount" TV antenna holder. This mount does away with chimney mounts and guy wires on antennas, and can be installed on any roof regardless of pitch. The manufacturer claims that one

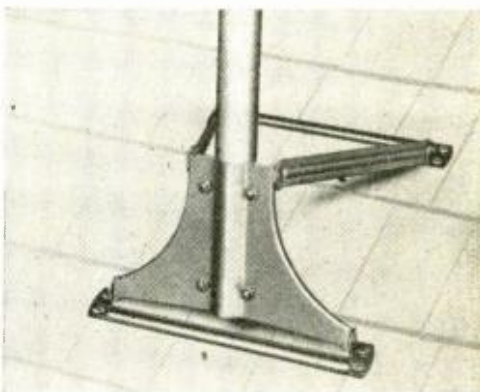

man can install the "Fast Mount" in less than half an hour. List price, \$1.95. (Vokor Products, Inc., 201 E. Catherine St., Ann Arbor, Mich.)

HI-FI EQUIPMENT CONSOLE

All the components of a hi-fi system (except the speakers) can be accommodated in the "Boulevard" equipment console. Recently made available by Concert Cabinetry, 1630 West Granville Ave., Chicago 26, Ill., the "Boulevard" can be obtained in a variety of finishes, including walnut,

**CAN YOU QUALIFY
FOR THIS SELECT CIRCLE?**

*Graduate
Specialist,
U.S. Army*



CHOOSE YOUR TECHNICAL SCHOOLING BEFORE ENLISTMENT

For high school graduates and seniors only...

Developed for you by today's Army . . . a special educational program for high school graduates and seniors *only*. If you qualify for the Army Graduate Specialist Program, you can *choose* the exact technical schooling you want . . . and have your choice guaranteed *before* you enlist.

Technical training worth thousands of dollars!

Graduate Specialists study and work with the select circle of Army technicians who are *pioneering* many of the exciting technological advances of our times. That's why Army Graduate Specialist schools can offer you the finest technical schooling and equipment—at no cost to you!

Pick from 107 courses . . .

Successful candidates can choose from 107 valuable Graduate Specialist courses. Up-to-the-minute technical schooling in electronics, accounting, automotive repair, guided missiles, finance, atomic weapons and many more.

Here's a chance to get a *real* headstart in the field that interests you most.

Seniors have unusual option . . . To become a Graduate Specialist, you must pass certain qualification and aptitude exams—and be a high school graduate. But seniors can apply *before* graduation and enlist *after* . . . choosing from the *widest* range of available courses.

Course guaranteed without obligation . . .

When you're accepted as a Graduate Specialist, you receive a letter guaranteeing your assignment to the course you've chosen—when and if you enlist. Remember! Even with this written guarantee in your hand, you still don't have to enlist. That means you *get* the course you want . . . or you *don't* enlist!

Don't miss out! Graduate Specialist appointments in each course are *limited* and quotas for popular courses fill up quickly. *This week*, get details from your local Army recruiter.

GET CHOICE, NOT CHANCE . . .

Graduate Specialist, United States Army

products

(Continued from page 22)

mahogany, oak, and korina. A line of matching loudspeaker enclosures is also



being offered. The "Boulevard" is priced at \$164.50. Matching bass reflex speaker enclosures are \$95.00, or \$180.00 for two.

INT'L REPLY-PAID QSL CARDS

Unique double postcards have been devised to make it easier for radio amateurs to obtain written confirmation of two-way contacts. Available from *Hart Industries*, 467 Park Ave., Birmingham, Mich., these

cards consist of a front section on which the sender writes the name and address of the operator with whom contact was made, and a rear section which—when filled out and returned by the recipient—becomes the sender's QSL.

A five-cent stamp may be used by the sender to prepay return postage from practically any foreign country. Instructions for using the cards are written in English, French, and Spanish.

STEREO AMPLIFIER KIT

The Arkay Model CS-28 stereo amplifier kit offers dual 14-watt amplifiers for

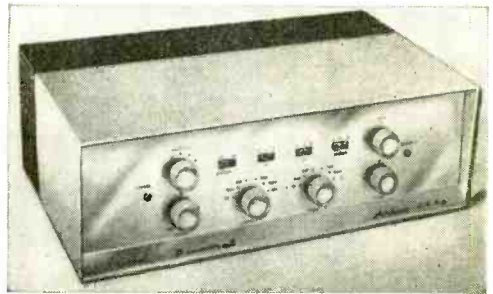

stereo. It can also be used for 28-watt monophonic output. Featured are a stereo

NOW YOU CAN SECURE A HIGH SALARIED • TOP PRESTIGE CAREER IN ELECTRONICS IN ONLY ONE YEAR!

ELECTRONICS is the fastest growing industry in America today, creating unlimited opportunities for high salaries, with rapid advancement in **INDUSTRY AND THE ARMED FORCES** for Bailey Trained electronic engineering technicians.

LARGE CORPORATIONS from coast to coast, and **BRANCHES OF THE ARMED FORCES** send recruiters to visit each graduating class at Bailey Tech, offering unusually high starting salaries.

BAILEY GRADUATES ARE BEING HIRED for such fascinating and interesting work as technical salesmen, research and development of guided missiles, electronic business machines and automatically controlled manufacturing plants, etc., also good **RATINGS IN THE ARMED FORCES**.

UP TO SEVEN TECHNICIANS are needed for every engineer... this, plus superior training is why Bailey Graduates are being paid more to start, and are advancing more rapidly than many men who have spent four years in training.

Resident training is easier and costs less than you may think! We provide housing and part-time jobs while in school, plus free nationwide employment service for graduates. If you want to quickly enter America's fastest growing and most exciting industry, write for free booklet... no obligation.

VETERAN APPROVED
BAILEY TECHNICAL SCHOOLS
1625 S. Grand • St. Louis 4, Mo.



This Minneapolis-Honeywell system controls hundreds of automatic manufacturing operations. Experience on live equipment is emphasized at Bailey and is another reason for the tremendous backlog of high pay positions waiting **BAILEY GRADUATES**.

MAIL TODAY

Please mail immediately this free booklet without obligation

Name _____

Address _____

City _____ State _____



BUD 16 RADIO

Reg. U. S.
Pat. Off.

CIRCUITS AT HOME

ONLY
\$ **29.95**

with the New Deluxe 1959
PROGRESSIVE RADIO "EDU-KIT"®

A Practical Home Radio Course

- Now Includes
- ★ TRANSMITTER
 - ★ SIGNAL TRACER
 - ★ SIGNAL INJECTOR
 - ★ CODE OSCILLATOR
 - ★ No Knowledge of Radio Necessary
 - ★ No Additional Parts or Tools Needed
 - ★ EXCELLENT BACKGROUND FOR TV
 - ★ School Inquiries Invited
 - ★ Sold in 79 Countries

**YOU DON'T HAVE TO SPEND
HUNDREDS OF DOLLARS FOR A RADIO COURSE**

The "Edu-Kit" offers you an outstanding PRACTICAL HOME RADIO COURSE at a rock-bottom price. Our Kit is designed to train Radio & Electronics Technicians, making use of the most modern methods of home training. You will learn theory, construction practice and servicing. THIS IS A COMPLETE RADIO COURSE IN EVERY DETAIL. You will learn how to build radios, using regular schematics; how to wire and solder in a professional manner; how to service radios. You will work with the standard type of punched metal chassis as well as the latest development of Printed Circuit chassis. You will learn the basic principles of radio. You will construct, study and work with RF and AF amplifiers and oscillators, detectors, rectifiers, test equipment. You will learn and practice code using the Progressive Code Oscillator. You will learn and practice trouble-shooting, using the Progressive Signal Tracer, Progressive Signal Injector, Progressive Dynamic Radio & Electronics Tester and the accompanying instructional material. You will receive the services of a Radio Technician and General Classes of F.C.C. Radio Amateur Licenses. You will build 16 Receiver, Transmitter, Code Oscillator, Signal Tracer and Signal Injector circuits, and learn how to operate them. You will receive an excellent background in Radio, Hi-Fi and Electronics.

Absolutely no previous knowledge of radio or science is required. The "Edu-Kit" is the product of many years of teaching and engineering experience. The "Edu-Kit" will provide you with a basic education in Electronics and Radio, worth many times the complete price of \$22.95.

THE KIT FOR EVERYONE

You do not need the slightest background in radio or science. Whether you are interested in Radio & Electronics because you want an interesting hobby, a well paying business or a job with a future, you will find the "Edu-Kit" a worthwhile investment. Many thousands of individuals of all

ages and backgrounds have successfully used the "Edu-Kit" in more than 79 countries of the world. The "Edu-Kit" has been carefully designed, step by step, so that you cannot make a mistake. The "Edu-Kit" allows you to teach yourself at your own rate. No instructor is necessary.

PROGRESSIVE TEACHING METHOD

The Progressive Radio "Edu-Kit" is the foremost educational radio kit in the world, and is universally accepted as the standard in the field of electronics training. The "Edu-Kit" uses the modern educational principle of "Learn by Doing." Therefore you construct, learn schematics, study theory, practice trouble-shooting—all in a closely integrated program designed to provide an easily-learned, thorough and interesting background in radio. You begin by examining the various radio parts of the "Edu-Kit." You then learn the function, theory and wiring of these parts. Then you build a simple radio. With this first set you will enjoy listening to regular broadcast stations, learn theory, practice testing and trouble-shooting. Then you build a more advanced radio, learn more advanced theory and techniques. Gradually, in a progressive manner, and at your own rate, you will find yourself constructing more advanced multi-tube radio circuits, and doing work like a Professional Radio Technician.

Included in the "Edu-Kit" course are sixteen Receiver, Transmitter, Code Oscillator, Signal Tracer, and Signal Injector circuits. These are not unprofessional "breadboard" experiments, but genuine radio circuits, constructed by means of professional wiring and soldering on metal chassis, plus the new method of radio construction known as "Printed Circuitry." These circuits operate on your regular AC or DC house current.

THE "EDU-KIT" IS COMPLETE

You will receive all parts and instructions necessary to build 16 different radio and electronics circuits, each guaranteed to operate. Our Kits contain tubes, tube sockets, variable, electrolytic, mica, ceramic and paper dielectric condensers, resistors, tie strips, coils, hardware, tubes, punched metal chassis, Instruction Manuals, hook-up wire, solder, etc. In addition, you receive Printed Circuit materials, including Printed Circuit chassis, special tube sockets, hardware and instructions. You also receive a useful set of tools, a professional electric soldering iron, and a self-powered Dynamic Radio and Electronics Tester. The "Edu-Kit" also includes Code Instructions and the Progressive Code Oscillator, in addition to F.C.C.-type Questions and Answers for Radio Amateur License training. You will also receive lessons for servicing with the Progressive Signal Tracer and the Progressive Signal Injector, a High Fidelity Guide and a Quiz Book. You receive Membership in Radio-TV Club, Free Consultation Service, Certificate of Merit and Discount Privileges. You receive all parts, tools, instructions, etc. Everything is yours to keep.

PRINTED CIRCUITRY

At no increase in price, the "Edu-Kit" now includes Printed Circuitry. You build a Printed Circuit Signal Injector, a unique servicing instrument that can detect many Radio and TV troubles. This revolutionary new technique of radio construction is now becoming popular in commercial radio and TV sets.

A Printed Circuit is a special insulated chassis on which has been deposited a conducting material which takes the place of wiring. The various parts are merely plugged in and soldered to terminals.

Printed Circuitry is the basis of modern Automatic Electronics. A knowledge of this subject is a necessity today for anyone interested in Electronics.



FREE EXTRAS

- SET OF TOOLS
- SOLDERING IRON
- ELECTRONICS TESTER
- PLIERS-CUTTERS
- ALIGNMENT TOOL
- WRENCH SET
- VALUABLE DISCOUNT CARD
- CERTIFICATE OF MERIT
- TESTER INSTRUCTION MANUAL
- HIGH FIDELITY GUIDE + QUIZZES
- TELEVISION BOOK + RADIO TROUBLE-SHOOTING BOOK
- MEMBERSHIP IN RADIO-TV CLUB
- CONSULTATION SERVICE + FCC AMATEUR LICENSE TRAINING
- PRINTED CIRCUITRY

SERVICING LESSONS

You will learn trouble-shooting and servicing in a progressive manner. You will practice repairs on the sets that you construct. You will learn symptoms and causes of trouble in home, portable and car radios. You will learn how to use the professional Signal Tracer, the unique Signal Injector and the dynamic Radio & Electronics Tester. While you are learning in this practical way, you will be able to do many a repair job for your friends and neighbors, and charge fees which will far exceed the price of the "Edu-Kit." Our Consultation Service will help you with any technical problems you may have.

J. Stalatis, of 25 Poplar Pl., Waterbury, Conn., writes: "I have repaired several sets for my friends, and made money. The "Edu-Kit" paid for itself; I was ready to spend \$240 for a Course, but I found your ad and sent for your Kit."

FROM OUR MAIL BAG

Ben Valerio, P. O. Box 21, Maun, Utah: "The Edu-Kits are wonderful. Here I am sending you the questions and also the answers for them. I have been in Radio for the last seven years, but like to work with Radio Kits, and like to build Radio Testing Equipment. I enjoyed every minute I worked with the different kits; the Signal Tracer works fine. Also like to let you know that I feel proud of becoming a member of your Radio-TV Club."

Robert L. Shuff, 1534 Monroe Ave., Huntington, W. Va.: "Thought I would drop you a few lines to say that I received my Edu-Kit, and was really amazed that such a bargain can be had at such a low price. I have already started repairing radios and phonographs. My friends were really surprised to see me get into the swing of it so quickly. The Troubleshooting Tester that comes with the Kit is really swell, and finds the trouble, if there is any to be found."

UNCONDITIONAL MONEY-BACK GUARANTEE

ORDER DIRECT FROM AD—RECEIVE FREE BONUS
RESISTOR AND CONDENSER KITS WORTH \$7

- Send "Edu-Kit" postpaid. I enclose full payment of \$22.95.
- Send "Edu-Kit" C.O.D. I will pay \$22.95 plus postage.
- Rush me FREE descriptive literature concerning "Edu-Kit."

Name

Address

PROGRESSIVE "EDU-KITS" INC.

1186 Broadway, Dept. 556D, Hewlett, N. Y.

BUILD YOUR OWN AMATEUR TRANSMITTER!



ANOTHER FEATURE BOTH DRIVE ANY OF THE POPULAR KILOWATT TUBES!

BOTH ARE EFFECTIVELY TVI SUPPRESSED AND OPERATE BY BUILT-IN VFO OR CRYSTAL CONTROL!

LATER SAY! STEP BY STEP INSTRUCTIONS! EVERYTHING IS SUPPLIED!

THE "RANGER" RATES AT 75 WATTS CW INPUT... 65 PHONE. THE "VALIANT" IS RATED AT 275 WATTS CW AND 55B ... 200PHONE. BOTH FEATURE TIMED SEQUENCE KEYING AND THE "VALIANT" HAS SPEECH CLIPPING, MODULATION LIMITING, AND "PUSH-TO-TALK."

MAIL TODAY FOR YOUR FREE CATALOG

E. F. JOHNSON COMPANY
2714 Second Ave., S. W., Waseca, Minnesota

Name _____
Address _____
City _____ State _____

CUT HOLES IN 1-1/2 MINUTES (OR LESS)

with Greenlee Chassis Punches

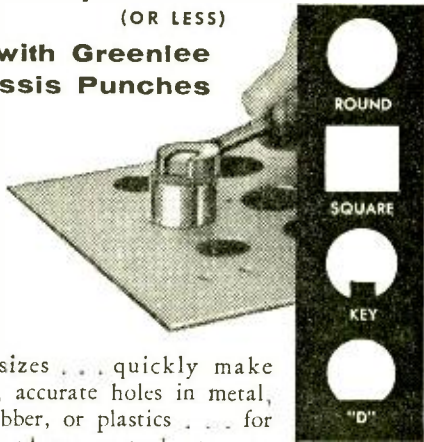

Many sizes . . . quickly make smooth, accurate holes in metal, hard rubber, or plastics . . . for sockets, plugs, controls, meters, panel lights, etc. Easy to use, simply turn with a wrench. Write today for free literature.



GREENLEE TOOL CO.
1783 Columbia Avenue, Rockford, Ill.



products

(Continued from page 24)

reverse switch, a balance control, and a master gain control. Frequency response is 20-20,000 cps, IM distortion 1% at 14 watts, 0.5% at 10 watts. Speaker outputs: 4, 8, 16, and 32 ohms. Price, in kit form \$64.95; factory-wired, \$99.95. (Arkay, Inc. 88-06 Van Wyck Expressway, Richmond Hill 18, N. Y.)

SPHERICAL LOUDSPEAKER

A spherical loudspeaker system has been designed by *Molded Insulation Co.*, 335 East Price St., Philadelphia, 44, Pa. Weighing only six pounds, the "Sonosphere" is easily transported from room to room. It cancels all rear sounds, and it is simple to adjust for best results in any area. System impedance is 8 ohms. Available in four different colors, the "Sonosphere" is 18" in diameter and 21" high. Price, \$39.95.



STEREO TAPE HEAD

The Nortronics Co., Inc., 1015 S. Sixth St., Minneapolis 4, Minn., is offering a quarter-track stereo record/playback head,

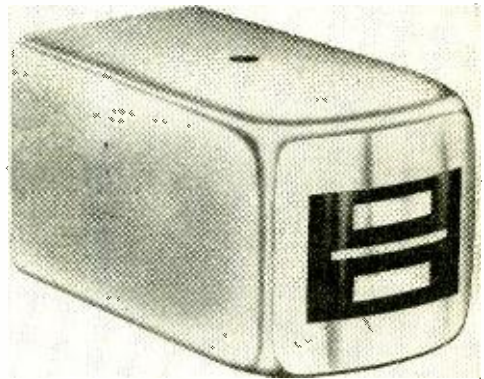

the TLD-L. This head will play both half-track and quarter-track tapes and has a frequency response from 30 to 12,000 cps ± 3 db at 3 3/4 ips. A high-impedance model,

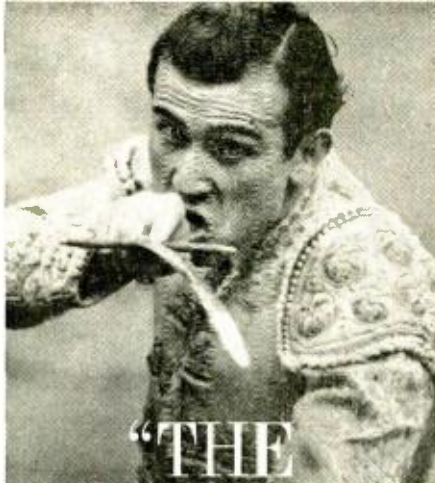

Juan Montero, matador.
From *BULLFIGHT*, by permission of
Simon and Schuster, Publishers.
Copyright © 1958 by Peter Buckley.

“THE
MOMENT
OF
TRUTH”



... for the matador — it comes when he can no longer play at the game of bravery, but must at last face up to the supreme test of his courage and greatness — when he must conquer or be conquered.

... for the turntable or changer — it comes when the stylus descends to the groove of a stereo record, to track as never before required ... vertically as well as laterally, with lighter pressure, greater accuracy, less distortion and far more sensitivity—when the operation must be silent, smooth and flawless to permit the music to emerge with clarity, purity and distinction.

Shorn of pretension and mere

paper claims, every brand, every product of old must now face up to the *new* challenge wrought by stereophonic sound. Regardless of past laurels, it is *today's* performance that counts.

The United Audio DUAL-1006 ... totally new, significantly different ... is the *only* combination professional turntable and deluxe changer created for uncompromised stereo and monophonic reproduction.

We invite you to visit your authorized United Audio dealer ... to submit the DUAL-1006 to the most demanding of tests ... to see and hear it in *its* “moment of truth.”

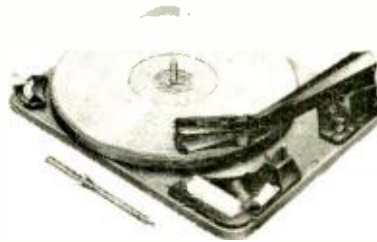

The DUAL-1006

combination professional turntable | deluxe changer for uncompromised stereo and mono reproduction

Actually tracks and operates automatically or manually with only 2 grams stylus pressure.

Choice of heavy, large diameter turntables* — new laminated concentrically-girded design retains dynamic balance and plano surface.

Rigid equipoise motor suspension principle eliminates vertical rumble.

Built-in direct reading stylus pressure/tracking force gauge.

Totally new design one-piece tonearm — provides perfect vertical and lateral tracking — no multiple arm resonance or cartridge vertical amplitude distortion.

Truly freefloating tonearm — unique clutch disengagement for complete freedom.

Multiple transmission motor drive uses individual gears for each speed — automatic disengagement makes “flat spot thumping” impossible.

St-rr-mono switch has Phase-ceiling feedback circuit to remove vertical noise signal from mono records played with stereo cartridge.

Obsolescence proof intermix for present or future record sizes.

Elev. tor action changer spindle safeguards record grooves and centers.

True manual or automatic single play — permits setting tonearm on rotating or motionless turntable.

united  audio

PRODUCTS OF DISTINCTION
Desk 4 202-4 East 19th St., New York 3, N. Y.

Please send full details to:

NAME

ADDRESS

CITY.....ZONE.....STATE.....

*3½ lb. standard; 5½ lb. optional at small extra cost.



Artisan
ELECTRONIC ORGAN
for your **HOME!**
BUILD-IT YOURSELF SAVE!

Now you can own a professional electronic organ and save up to 50% on an easy pay-as-you-build plan... The world famous ARTISAN ORGAN—in 14 models from the popular 2-manual Home entertainment style to the majestic 4-manual Theatre and Church style is now available in kit form. Simple step-by-step instructions, pictorial diagrams and schematics make this an ideal spare-time project for anyone.

SEND FOR THIS FREE LITERATURE TODAY!

Get ALL the facts on the magnificent 20th Century Successor To The Pipe Organ—The ARTISAN! Gives you information you should know before you purchase ANY organ—kit or commercial model.

ELECTRONIC ORGAN ARTS, INC.
4949 York Blvd., Dept. PE-5
Los Angeles 42, California



NOW...G-11
2-way radio
for your
personal use,
business or
pleasure

GONSET

Citizens' Communicator
FOR 11-METER CITIZENS' BAND

No exam for license... no code. U. S. Citizens required only to complete simple F.C.C. form. Write today for free booklet giving all details.

MEETS ALL F.C.C. REGS. . . 5 WATTS INPUT POWER. BOTH TRANSMITTER AND RECEIVER QUARTZ CRYSTAL CONTROLLED. RELIABLE! NO TUNING!

COMPLETE 2-WAY STATION "PACKAGE" INCLUDES PRESS-TO-TALK MICROPHONE, QUARTZ CRYSTALS FOR ONE CHANNEL.

TWO MODELS AVAILABLE. SPECIFY NO. 3303 FOR 115V AC OPERATION... NO. 3304 FOR 12V DC OPERATION.

124⁵⁰

WRITE TODAY FOR FREE BOOKLET!

GONSET DIVISION OF YOUNG SPRING & WIRE CORPORATION.
Burbank, Calif.

products

(Continued from page 26)

the TLD-L2, has an output of 2 millivolts and is available for general-purpose uses. Also offered is a low-impedance model, the TDL-L4, for use with transistor inputs and special recording applications. Each model, \$21.60 net.

TWO-TRANSISTOR RADIO

The "Sporte Aire" is a fully assembled two-transistor radio manufactured by Educational Electronics Co., 1227 West Loyola Ave., Chicago 26, Ill. Housed in a "hi-impact" plastic case, it features a bike mount, an extendable antenna, and a personal ear speaker. The "Sporte Aire" is powered by two 1 1/2-volt batteries. Price, \$8.98.



ANTENNA CALCULATOR

The Gabriel Electronics Division of The Gabriel Company, 135 Crescent Rd., Needham Heights 94, Mass., has developed an improved version of the "Antenna Calculator." It simplifies computations for de-



termining the parabolic antenna parameters for microwave antenna systems. The calculator scales include frequency, wavelength, beamwidths, gain, return loss, VSWR, windloading, and focal length, as well as a spectrum scale for band designation. Price, \$2.00.

-30-



HOW TO MAKE STEREO RECORDINGS OFF-THE-AIR with the Bell Tape Transport: Model shown here in portable carrying case has Record Pre-Amps already installed, is all set to record stereo broadcast from Pacemaker Stereo

Tuner. With these components you can keep your favorite performances permanently on tape, then playback through the matching Pacemaker Stereo Amplifier. Smart lookin' . . . and a smart way to save money, too.

With this *Bell* Tape Transport you can now RECORD STEREO BROADCASTS!

Add it to your hi fi system. Costs less than \$300, including Add-On Record Pre-Amps

For quality reception of FM-AM Stereo, use the Pacemaker Stereo Tuner, only 109.95*

Match it with a Pacemaker Stereo Amplifier. Model 2221 shown is only 99.95*

Rated best for stereo recording, this Bell Tape Transport is definitely your best buy when you make your own stereo tapes.

New Models now available for 1/2-track or 1/4-track stereo recording . . . all with convenient Auto-Stop Switch and professional three-motor drive for positive tape control.

Easy to operate . . . you simply connect your stereo tuner, record player or other tape recorder. Recording level on each channel can be accurately set with Cathode Ray indicators. It's that easy!

Start now to build your own stereo tape library. It costs so little . . . and it's loads of fun. Ask your Bell dealer for a demonstration of this new Bell Stereo Tape Transport; and be sure to see the outstanding values in Pacemaker components, also on display.

*Prices shown include decorative cover. Slightly higher West of Rockies

Bell Sound Division • THOMPSON RAMO WOOLDRIDGE INC.
555 MARION ROAD • COLUMBUS 7, OHIO

IN CANADA: Thompson Products, Ltd., Toronto • EXPORT OFFICE: 401 Broadway, New York 13, N. Y.



LAFAYETTE'S
1959 CATALOG
260 GIANT-SIZE
PAGES
FREE!

Complete listings of the **NEWEST** in Stereo and Monaural Hi-Fi, Short Wave, Audio, Transistor, and many other Lafayette electronics kits as well as thousands upon thousands of standard brand nationally advertised kits and electronic parts and components are described in LAFAYETTE'S GIANT NEW 260-PAGE CATALOG. SEND FOR IT—IT'S FREE! Just fill in coupon below and present it at any Lafayette store, or paste it on a postcard and send it to us. **THAT'S ALL YOU HAVE TO DO** to get your **FREE 1959 LAFAYETTE CATALOG!**

ELECTROSTATIC 3 ELEMENT TWEETER

27.50

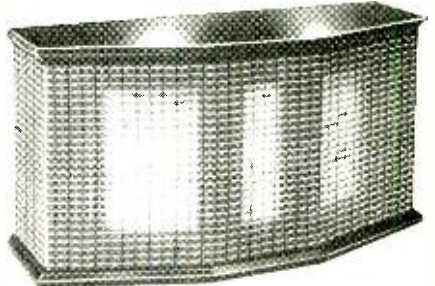

THE FINEST HI-FI TWEETER AVAILABLE

Leave it to Lafayette to bring you the "hottest" tweeter—the superlative electrostatic 3 element tweeter, rated best regardless of price. This smooth performing tweeter—superior to units costing many times more—improves ANY speaker system, bringing forth the realism and acoustic brilliance of the high frequencies. Simple to connect and use, comes complete with detailed instructions. In mahogany, walnut or blonde finishes with attractive plastic grilles. Size 1 1/4" x 6" x 4 1/4". Shpg. wt., 7 lbs.
 SK-150 Electrostatic 3 Element Tweeter Mahogany Finish **27.50**
 SK-151 Same in Walnut Finish
 SK-152 Same in Blonde Finish

- **BUILT-IN CROSSOVER NETWORK**
3000 Cycle Crossover Frequency
- **WIDE 120° DISPERSION ANGLE**
Achieved by 3 Electrostatic Element Design
- **MEASURABLY IMPROVES ANY SPEAKER SYSTEM**
Superb High Frequency Response from 5000 Cycles to Beyond 25,000 Cycles
- **BUILT-IN AC POWER SUPPLY**
Supplies High Voltage Necessary For True Electrostatic Speaker Operation
- **AVAILABLE IN MAHOGANY, WALNUT OR BLONDE ENCLOSURE**

NEW! "STEREO ANALYST"
Single Needle
VU Balance
Meter



The Most Versatile Instrument Offered The Hi-Fi Enthusiast

only **11.95**

- **UNIQUE 2 COIL GALVANOMETER-TYPE PRECISION METER MOVEMENT**
- **7 RANGES OF METER SENSITIVITY**
- **EFFORTLESS BALANCING OF STEREO SYSTEMS**
- **MAY BE USED AS VU METER AND TAPE RECORDER LEVEL INDICATOR**

Solves all stereo balancing problems. Each stereo channel feeds a separate coil through a full-wave bridge rectifier. Balanced signals result in a 0 deflection. 2 slide switches permit individual channel measurements. Metal case, silver gold finish. Size: 4 1/2" x 5 1/4" Shpg. wt., 3 lbs.
 TM-66 Stereo Balance Indicator Net 11.95

SPECIAL MONEY-SAVER COMBINATION



SHURE M3D with diamond stylus



PK-270

99.50

SAVE 26.60

PK-245 hysteresis-synchronous turntable with new Lafayette PK-270 12" professional stereo tone arm plus Shure M3D Dynamic Compatible Stereo Cartridge with .7 mil diamond stylus. Shpg. wt. 19 lbs. Special. Net 99.50

SPECIAL SALE!

GARRARD RC121/II WITH SHURE M3D DYNETIC STEREO CARTRIDGE WITH DIAMOND STYLUS



RC121/II

52.50

MONEY-SAVER COMBINATION

Garrard latest model RC121/II with Shure model M3D professional Dynamic Compatible Stereo cartridge with .7 mil diamond stylus. Regular \$2.15 value. Shpg. wt., 15 lbs. Net 52.50



SHURE M3D with diamond stylus

GARRARD RC-88

Garrard RC88 and Shure M3D Cartridge Net 62.50

FREE

CUT OUT AND PASTE ON POST CARD

LAFAYETTE RADIO, Dept. 1E-9
 P.O. Box 511, Jamaica 31, N. Y.

SEND FOR THE WORLD'S LEADING ELECTRONICS, RADIO, T.V., INDUSTRIAL, AND HI-FI GUIDE

Send FREE LAFAYETTE Catalog 590

Name

Address

City..... Zone..... State.....

Lafayette
Radio

"Everything in Electronics"

New!
YEARS AHEAD!

Lafayette STEREO TUNER KIT

**THE MOST
FLEXIBLE TUNER
EVER
DESIGNED**

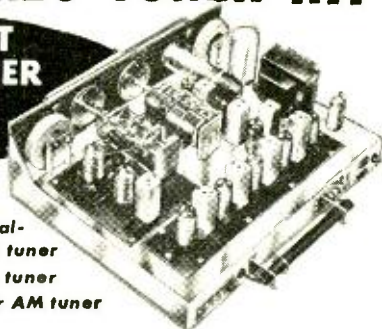
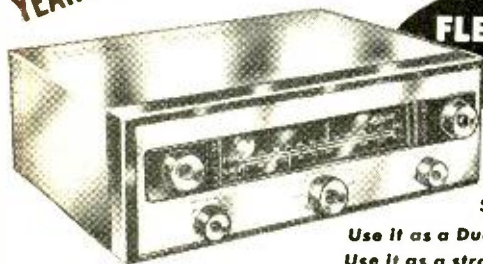

Use it as a Binaural-
Stereophonic FM-AM tuner

Use it as a Dual-Monaural FM-AM tuner

Use it as a straight Monaural FM or AM tuner

- MultiFlex Output for New Stereo FM
- 11 Tubes (including 4 dual-purpose) + Tuning Eye + Selenium rectifier Provide 17 Tube Performance
- 10KC Whistle Filter • Pre-aligned IF's
- Tuned Cascade FM • 12 Tuned Circuits
- Dual Cathode Follower Output
- Separately Tuned FM and AM Sections
- Armstrong Circuit with FM/AFC and AFC Defeat
- Dual Double-Tuned Transformer Coupled Limiters.

More than a year of research, planning and engineering went into the making of the Lafayette Stereo Tuner. Its unique flexibility permits the reception of binaural broadcasting (simultaneous transmission on both FM and AM), the independent operation of both the FM and AM sections at the same time, and the ordinary reception of either FM or AM. The AM and FM sections are separately tuned, each with a separate 3-gang tuning condenser, separate flywheel tuning and separate volume control for proper balancing when used for binaural programs. Simplified accurate knife-edge tuning is provided by magic eye which operates independently on FM and AM. Automatic frequency control "locks in" FM signal permanently. Aside from its unique flexibility, this is, above all else, a quality high-fidelity tuner incorporating features found exclusively in the highest priced tuners.

The 5 controls of the KT-500 are FM Volume, AM Volume, FM Tuning, AM Tuning and 5-position Function Selector Switch. Tastefully styled with gold-brass escutcheon having dark maroon background plus matching maroon knobs with gold inserts. The Lafayette Stereo Tuner was designed with the builder in mind. Two separate printed circuit boards make construction and wiring simple, even for such a complex unit. Complete kit includes all parts and metal cover, a step-by-step instruction manual, schematic and pictorial diagrams. Size is 13 3/4" W x 10 3/8" D x 4 1/2" H. Shpg. wt., 22 lbs.

The new Lafayette Model KT-500 Stereo FM-AM Tuner is a companion piece to the Models KT-600 Audio Control Center Kit and KT-310 Stereo Power Amplifier Kit.

KT-500.....Net **74.50**

LT-50 Same as above, completely factory wired and tested.....Net **124.50**

KT-500 IN KIT FORM
74.50
ONLY 7.45 DOWN
7.00 MONTHLY

NEW! LAFAYETTE PROFESSIONAL STEREO MASTER AUDIO CONTROL CENTER



KT-600
79.50
IN KIT FORM

ONLY 7.95 DOWN

Solves Every Stereo/Monaural Control Problem!

- UNIQUE STEREO & MONAURAL CONTROL FEATURES
- AMAZING NEW BRIDGE CIRCUITRY FOR VARIABLE 3d CHANNEL OUTPUT & CROSS-CHANNEL FEED
- PRECISE "NULL" BALANCING SYSTEM

A REVOLUTIONARY DEVELOPMENT IN STEREO HIGH FIDELITY. Provides such unusual features as a Bridge Control, for variable cross-channel signal feed for elimination of "ping-pong" (exaggerated separation) effects and for 3d channel output volume control for 3-speaker stereo systems; 3d channel output also serves for mixing stereo to produce excellent monaural recordings. Also has full input mixing of monaural program sources, special "null" stereo balancing and calibrating system (better than meters), 24 equalization positions, all-concentric controls, rumble and scratch filters, loudness switch. Clutch type volume controls for balancing or as 1 Master Volume Control. Has channel reverse, electronic phasing, input level controls. Sensitivity 1.78 millivolts for 1 volt out. Dual low-impedance outputs (plate followers), 1300 ohms. Response 10-25,000 cps \pm 0.5 db. Less than .03% IM distortion. Uses 7 new 7025 low-noise dual triodes. Size 14" x 4 1/2" x 10 1/4". Shpg. wt., 16 lbs. Complete with printed circuit board, cage, profusely illustrated instructions, all necessary parts.

LAFAYETTE KT-600 — Stereo Preamplifier Kit.....Net **79.50**

Lafayette LA-600 —Stereo Preamplifier, Wired.....Net **134.50**

NEW! LAFAYETTE STEREO/MONAURAL 36-WATT BASIC AMPLIFIER

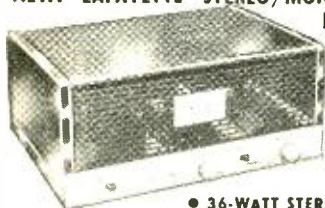

KT-310
47.50
IN KIT FORM

ONLY 4.75 DOWN

- 36-WATT STEREO AMPLIFIER
- 4 PREMIUM-TYPE 7189 OUTPUT TUBES
- RESPONSE 35-30,000 CPS \pm 1/2 DB
- 18 WATTS PER STEREO CHANNEL OR 36 WATTS MONAURALLY
- 2 PRINTED CIRCUIT BOARDS FOR NEAT, EASY WIRING

A superbly-performing basic stereo amplifier, in easy-to-build kit form to save you lots of money and let you get into stereo now at minimum expense! Dual inputs, each provided with individual volume control. The unit may be used with a stereo preamplifier for 2 18-watt stereo channels, or at the flick of a switch, as a top-quality 36-watt monaural amplifier; or, if desired, it may be used as 2 separate monaural 18-watt amplifiers! **CONTROLS** include 2 input volume controls, channel reverse switch (AB-BA), monaural-stereo switch. **DUAL OUTPUT IMPEDANCES** are: 4, 8, 16 and 32 ohms (permitting paralleled monaural operation of 2 speaker systems of up to 16 ohms). **INPUT SENSITIVITY** is 0.45 volts per channel for full output. **TUBES** are 2-6AN8, 4-7189; GZ34 rectifier. **SIZE** is 9-3/16" d (10-9/16" with controls) x 5 1/4" h x 13 1/4" w. Supplied complete with perforated metal cage, all necessary parts and detailed instructions. Shpg. wt., 22 lbs.

KT-310 Stereo Power Amplifier Kit.....Net **47.50**

Lafayette Radio 165-08 Liberty Ave.
JAMAICA 33, N. Y.

NEW YORK 13, N. Y. 100 6th Ave.
BRONX 58 N. Y. 542 E. Fordham Rd. BOSTON 10, Mass. 110 Federal St.
PLAINFIELD N. J. 139 W. 2nd St. NEWARK 2, N. J. 24 Central Ave.
PLEASE INCLUDE POSTAGE WITH ORDER

free

Send for the money-saving

ALLIED 1959

ELECTRONIC SUPPLY CATALOG

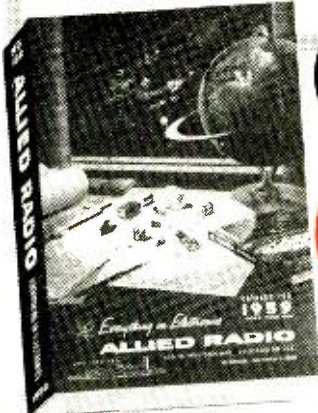

452
value-packed
pages

SAVE
ON EVERYTHING
IN ELECTRONICS

EASY TERMS
AVAILABLE

WORLD'S LARGEST STOCKS

Send for the most widely used buying guide to everything in Electronics for Experimenters, Builders, Amateurs, Servicemen, Engineers and Hi-Fi enthusiasts:

- KNIGHT-KITS—Best in Build-Your-Own
- Everything in STEREO Hi-Fi
- Hi-Fi Music Systems and Components
- Recorders & Phono Equipment
- Public Address & Paging Systems
- TV Tubes, Antennas, Accessories
- Amateur Station Equipment
- Latest Test & Lab Instruments
- Industrial Electronic Supplies
- Parts, Tubes, Transistors, Tools & Books

SAVE on everything in Electronics at ALLIED—get fastest service, expert personal help, guaranteed satisfaction. Send today for your FREE 1959 ALLIED Catalog.

Send for
FREE
Catalog

Everything in Electronics
from One Reliable Source

OUR 38th
YEAR

ALLIED RADIO

ALLIED RADIO CORP., Dept. 79-E9
100 N. Western Ave., Chicago 80, Ill.
 Rush FREE 1959 ALLIED 452-Page Catalog

Name _____

Address _____

City _____ Zone _____ State _____

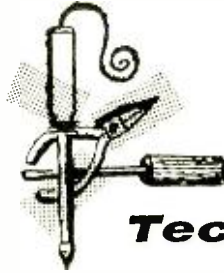

**Tips
and
Techniques**

REPAIR FOR PENCIL IRON TIPS

If you have one of those compact "pencil" soldering irons with interchangeable tips, and the shank becomes loose in its ceramic



insulator, repair it with asbestos furnace cement. Pack the cement in tightly between the shank and insulator and let it harden before you use the iron. This will fix it in a jiffy.—*John A. Comstock, Wellsboro, Pa.*

SMALL PARTS VISE

A handy small parts vise can easily be made from a pair of photographic print

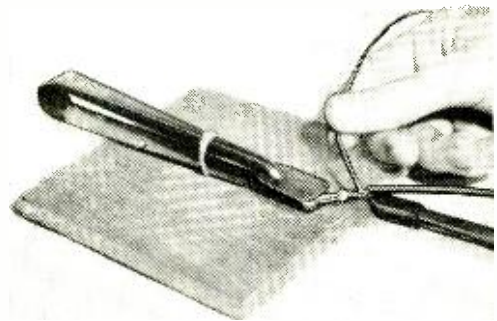

tongs. Simply fasten the tongs to a scrap of wood and wrap a rubber band tightly around the tongs as shown in the photograph.—*Jerome Cunningham, Chicago, Ill.*

FOR SCRATCHES ON METER FACES

Scratches on the plastic face of a meter make accurate meter readings difficult. To

Always say you saw it in—POPULAR ELECTRONICS

Want To Double Your Pay

Get into Radio-TV-Electronics

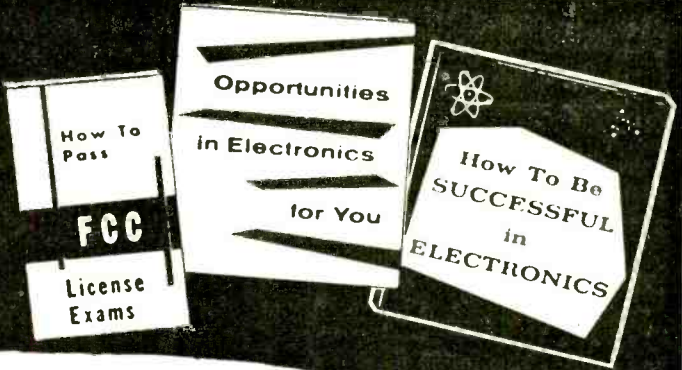

Get all 3 FREE

FIND OUT what the FCC license means

Your FCC license is recognized by employers as proof of your technical ability.

FIND OUT how the FCC license helps you get a better job or increase your pay on your present job

"License and \$25 raise due to Cleveland Institute training."

"I sat for and passed the FCC exam for my second class license. This meant a promotion to Senior Radio Technician with the Wyoming State Highway Department, a \$25 a month raise and a District of my own for all maintenance on the State's two-way communication system.

"I wish to sincerely thank you and the school for the wonderful radio knowledge you have passed on to me. I highly recommend the school to all acquaintances who might possibly be interested in radio. I am truly convinced I could never have passed the FCC exam without your wonderful help and consideration for anyone wishing to help themselves."

Charles C. Roberson
Cheyenne, Wyoming

MAIL
COUPON
TODAY

You'll Be Glad You Did

good training doesn't cost ... it pays!



Accredited by the National Home Study Council

Cleveland Institute of Radio Electronics

Desk PE-51 4900 Euclid Avenue Cleveland 3, Ohio

FIND OUT how we guarantee your FCC license

The Master Course in Electronics will provide you with the mental tools of the electronics technician and prepare you for a First Class FCC License (Commercial) with a radar endorsement. When you successfully complete the Master Course, if you fail to pass the FCC examination, you will receive a full refund of all tuition payments.

FIND OUT how employers make job offers like this to our graduates every month

RADIO OPERATOR: Capital Airlines (Ohio) is looking for a radio operator. A touch typing speed of 40 wpm is necessary. Must have at least a restricted operator's permit, but a radio-telephone 2nd or 1st class license is desirable.

CLEVELAND INSTITUTE OF RADIO ELECTRONICS
Desk PE-51 4900 Euclid Avenue Cleveland 3, Ohio

Please send Free Booklets prepared to help me get ahead in Electronics. I have had training or experience in Electronics as indicated below:

- | | |
|---|---|
| <input type="checkbox"/> Military | <input type="checkbox"/> Broadcasting |
| <input type="checkbox"/> Radio TV Servicing | <input type="checkbox"/> Home Experimenting |
| <input type="checkbox"/> Manufacturing | <input type="checkbox"/> Telephone Company |
| <input type="checkbox"/> Amateur Radio | <input type="checkbox"/> Other |

In what kind of work are you now engaged?

In what branch of Electronics are you interested?

Name

Address

City Zone State

Desk PE-51

Which twin has the Audiotape?

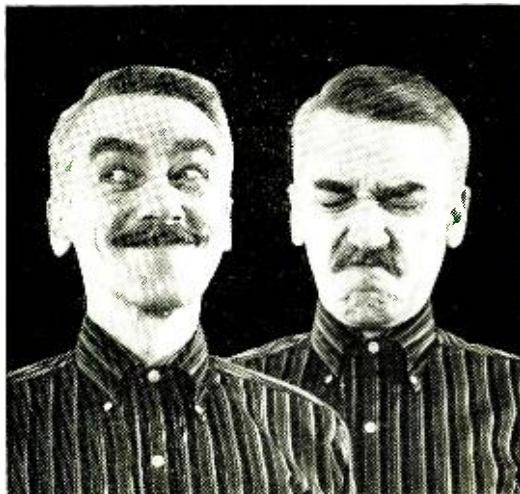

Like twins, different brands of recording tape often look the same, but are seldom exactly alike. The discriminating tape recordist wants the very finest sound reproduction he can get. And he wants *consistent* performance — so that he'll get *identical* results from every reel he buys. For this combination — top quality plus consistent uniformity — he chooses Audiotape. Audiotape has *only one* standard of quality: the finest possible. And that's true regardless of which of the eight types you buy. Don't settle for less. Insist on Audiotape.

audiotape
TRADE MARK

Manufactured by AUDIO DEVICES, INC.
444 Madison Ave., New York 22, New York
Offices in Hollywood & Chicago

Tips

(Continued from page 32)

remove minor scratches, make a paste of a small amount of ordinary toothpowder and water and apply it with a tuft of cotton or piece of felt. Then rub the face with a cir-

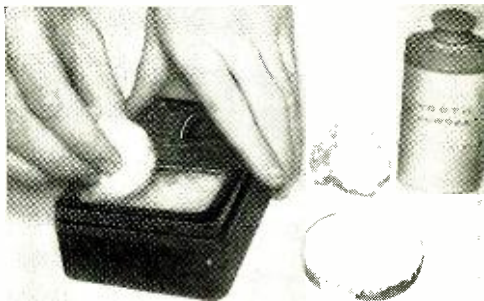

cular motion. After the scratches disappear, apply a daub of toothpaste to some cotton or felt, dip it in water, and use it to finish buffing.—Charles A. Lang, San Francisco, Calif.

BOOST HEADPHONE VOLUME

Is the volume low when headphones are plugged into your receiver? This is sometimes caused by an impedance mismatch between the phones and the output transformer. If your trouble is the result of a mismatch, there are a number of ways of remedying it. One way is to use an impedance-matching transformer. However, this has the disadvantage of cost (if a junk

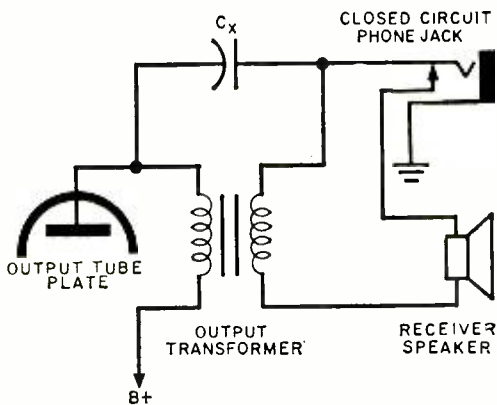

box is not handy) and large size. The simplest method requires but a single capacitor, as shown in the diagram. Capacitor C_x may have a value of from .002 μ fd. to .1 μ fd. at 400 volts. This allows the a.c. audio component to pass while blocking the d.c. plate voltage, and thus will provide greatly increased volume when high-im-

KIT BUILDERS EVERYWHERE ASKED FOR IT!

Completely new edition of
ELECTRONIC KITS on sale
at newsstands now...
or use coupon below!

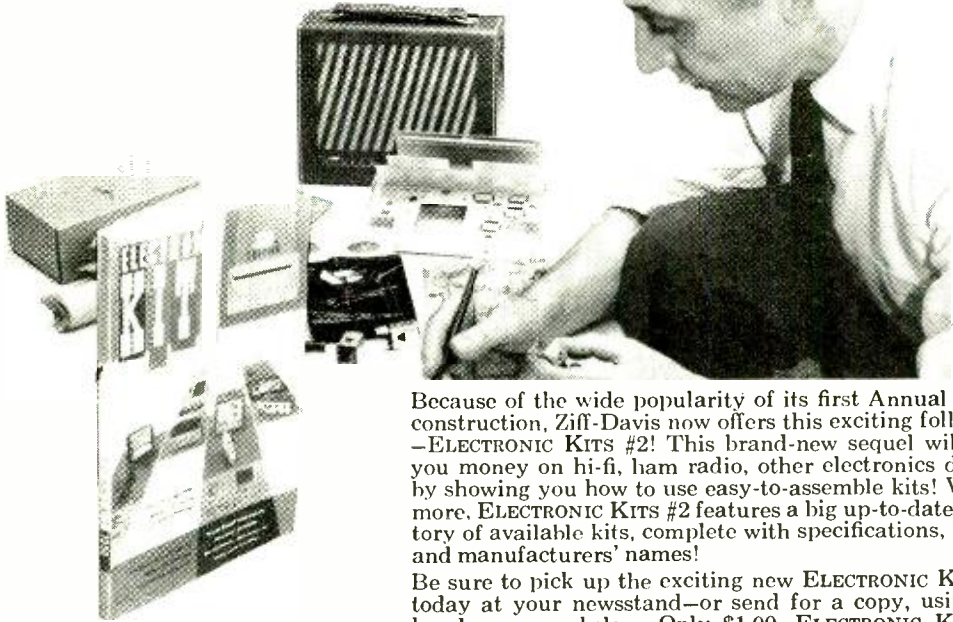

over 160 pages—600 illustrations

HOW TO BUILD A KIT—Learn what's involved in building a kit, and pick up tips on good construction practices.

KIT CONSTRUCTION CHECK LIST—Here's a summary of important steps in assembling a kit, enabling you to get it right the first time.

HOW NOT TO MAKE MISTAKES—Pick up tricks to simplify work and reduce the chance of error.

WORKING WITH WIRE—For rapid assembly and reliable opera-

tion, you should know how to handle various types of wire. You'll find out here.

FOR YOUR HI-FI—How to construct a Stereo Preamplifier • Stereo Adapter • Tape Recorder • Turntable • AM-FM Tuner • Book Shelf Speaker Enclosure • Integrated Stereo Amplifier • Monaural Amplifier • Record Changer • Tone Arm • Speaker Enclosure.

FOR YOUR SHOP—How to build a Vacuum Tube Volt Meter • Sig-

nal Generator • Oscilloscope • Tube Tester • Multitester • Transistor Tester.

FOR YOUR HAM SHACK—Transmitter • Receiver • Grid-dip Meter • Modulator • Single-sideband Converter • Mobile Transmitter.

FOR YOUR HOME—Table Radio • Transistor Pocket Radio • Junior Electronics Experimenter's Kit • Clock Radio • Radio Control Transmitter.



Ziff-Davis Publishing Company
Department E5/9
434 South Wabash Avenue
Chicago 5, Illinois

Please send me a copy of the new ELECTRONIC KITS #2. I enclose \$1.00, the cost of KITS #2, plus 10c to cover mailing and handling charges. (Canada and Foreign, \$1.25 plus 10c postage).

Name.....
Address.....
City.....Zone.....State.....

SHIPPED ON APPROVAL

an IN-CIRCUIT CONDENSER TESTER THAT DOES THE WHOLE JOB!

The CT-1 actually steps in and takes over where all other in-circuit condenser testers fail. The ingenious application of a dual bridge principle gives the CT-1 a tremendous range of operation . . . and makes it an absolute 'must' for every serviceman.

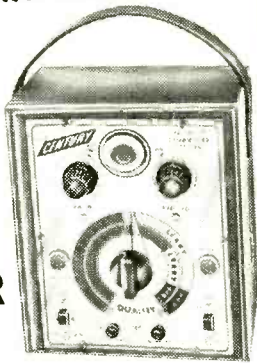

IN-CIRCUIT CONDENSER TESTER Model CT-1

Model CT-1—housed in sturdy hammertone finish steel case complete with test leads only **\$34⁵⁰** Net

in-circuit checks:

- ✓ Quality of over 80% of all condensers even with circuit shunt resistance present . . . (leakage, shorts, opens, intermittents)
- ✓ Value of all condensers from 200 mmfd. to .5 mfd.
- ✓ Quality of all electrolytic condensers (the ability to hold a charge)
- ✓ Transformer, socket and wiring leakage capacity

out-of-circuit checks:

- ✓ Quality of 100% of all condensers . . . (leakage, shorts, opens and intermittents)
- ✓ Value of all condensers from 50 mmfd. to .5 mfd.
- ✓ Quality of all electrolytic condensers (the ability to hold a charge)
- ✓ High resistance leakage up to 300 megohms
- ✓ New or unknown condensers . . . transformer, socket, component and wiring leakage capacity

OUTSTANDING FEATURES

- Ultra-sensitive 2 tube drift-free circuitry
- Multi-color direct scale precision readings for both quality and value . . . (in-circuit or out of circuit)
- Simultaneous readings of circuit capacity and circuit resistance
- Built-in hi-leakage indicator sensitive to over 300 megohms
- Cannot damage circuit components
- Electronic eye balance indicator for even greater accuracy
- Isolated power line

TRANSISTOR TESTER Model TT-2

Every day more and more manufacturers are using transistors in home portable and car radios . . . in hearing aids, intercoms, amplifiers, industrial devices, etc. Since transistors go bad the need for TRANSISTOR TESTER is great. They can

develop excessive leakage, poor gain, shorts or opens. The TT-2 is an inexpensive quality instrument designed for accurate and dependable tests of all transistors and diodes — quickly and accurately.

OUTSTANDING FEATURES

- Checks all transistors, including car radio, power output, triode, tetrode and unijunction types for current gain, leakage, opens, shorts, cut-off current
- Checks all diodes for forward to reverse current gain
- All tests can be made even if manufacturers' rated gain is not available
- Less than half a minute required for tests of either transistors or diodes
- Large 3" meter is extremely sensitive . . . yet rugged . . . with multi-color scales designed for quick easy readings
- Power is supplied by an easy to replace 6-volt battery — current drain so small, service life almost equal to shelf life. Battery cannot be drained due to accidental shorting of test leads
- Cannot burn-out its own meter or damage transistor or diode under test
- Long test leads and insulated test clips enable tests without entirely removing the transistor from circuit
- Test leads are identified by E.T.A. color code so that connection to the correct terminal is assured
- Comes complete with replaceable transistor set-up chart that fits into a special rear compartment

IMPORTANT FEATURE: The TT-2 cannot become obsolete as the circuitry is engineered to enable you to check all new type transistors as they are introduced. New listings will be furnished at no cost.



Model TT-2 — housed in sturdy hammertone finish steel case complete with test leads . . . only **\$24⁵⁰** Net

Check all power rectifiers in-circuit

whether SELENIUM, GERMANIUM, SILICON, etc.

with the

IN-CIRCUIT RECTIFIER TESTER Model SRT-1

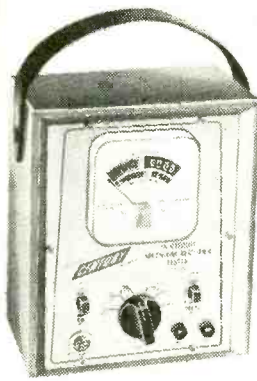

Model SRT-1—housed in sturdy hammertone finish steel case complete with test leads only **\$29⁵⁰** Net

With the growing trend towards compactness, portability and low price, TV manufacturers are resorting more and more to producing series-string TV sets employing selenium, germanium or silicon power rectifiers. Now the need for an in-circuit rectifier tester is greater than ever.

THE SRT-1 CHECKS ALL POWER RECTIFIERS IN-CIRCUIT AND OUT-OF-CIRCUIT WITH 100% EFFECTIVENESS FOR:

- ✓ Quality ✓ Fading ✓ Shorts ✓ Opens ✓ Arcing ✓ Life Expectancy

OUTSTANDING FEATURES

- Checks all types of power rectifiers rated from 10 ma. to 500 ma. (selenium, germanium, silicon, etc.) both in-circuit or out-of-circuit.
- Will not blow fuses even when connected to a dead short.
- Large 3" highly accurate multi-color meter . . . sensitive yet rugged.
- Separate meter scales for in-circuit and out-of-circuit tests.
- Cannot damage or over heat rectifier being tested.

SIMPLE TO OPERATE

Just clip SRT-1 test leads across rectifier under test right in the circuit without disconnecting rectifier from circuit. Press test switch and get an instant indication on the easy-to-read three-color meter scales . . .

ALL CENTURY INSTRUMENTS ARE GUARANTEED FOR ONE FULL YEAR

The extremely low prices are made possible because you are buying direct from the manufacturer.

EASY TO BUY IF SATISFIED
see order form on facing page

FOR 10 DAY FREE TRIAL

try them for 10 days before you buy . . . only then, when satisfied, pay in easy-to-buy monthly installments — without any financing or carrying charges added.

STILL THE BEST SELLING TUBE TESTER IN THE FIELD FAST-CHECK TUBE TESTER

Model FC-2

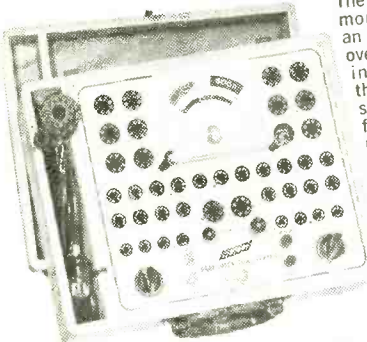

The greatest testimonial ever paid an instrument . . . over 20,000 sold in a little more than a year—and still selling as fast as we can produce them. See for yourself at no risk why so many servicemen choose the FAST-CHECK above all other tube testers—regardless of price.

Model FC-2 — housed in hand-rubbed oak carrying case complete with CRT adapter . . . only

\$69.50
Net

SIZE: W: 14 1/2"
H: 11 1/4" D: 4 3/8"

Just 2 settings on the FAST-CHECK TUBE TESTER tests over 700 tube types completely, accurately — AND IN SECONDS!

PICTURE TUBE TEST ADAPTER INCLUDED WITH FAST-CHECK

Enables you to check all picture tubes (including the new short-neck 110 degree type) for cathode emission, shorts and life expectancy . . . also to rejuvenate weak picture tubes.

No other tube tester made at any price can match the value of the FAST-CHECK.

RANGE OF OPERATION

- ✓ Checks quality of over 700 tube types, employing the time proven dynamic cathode emission test. This covers more than 99% of all tubes in use today, including the newest series-string TV tubes, auto 12 plate-volt tubes, OZ4s, tubes, auto 12 plate-volt tubes, special magic eye tubes, gas regulators, special purpose hi-fi tubes and even foreign tubes.
- ✓ Checks for inter-element shorts and leakage.
- ✓ Checks for gas content.
- ✓ Checks for life-expectancy.

IMPORTANT FEATURES

- No time consuming multiple switching . . . only two settings are required instead of banks of switches on conventional testers • No annoying roll chart checking . . . tube chart listing over 700 tube types is located inside cover. New listings are added without costly roll chart replacement • Checks each section of multi-section tubes and if only one section is defective beryllium tube sockets never need replacement • 41 phosphor bronze straighteners mounted on panel • Large 4 1/2" D'Arsonval type meter is the most sensitive available, yet rugged • Fully protected against accidental burn-out • Special scale on meter for low current tubes • Compensation for line voltage variation • 12 filament positions • Separate gas and short jewel indicators • Line isolated — no shock hazards • Long lasting etched aluminum panel.
- NOTE: The Fast-Check positively cannot become obsolete . . . as circuitry is engineered to accommodate all future tube types as they come out. New tube listings are furnished periodically at no cost.

NEW . . .

For those looking for a real ECONOMY MULTIPLE SOCKET TUBE TESTER without sacrificing ACCURACY, SPEED and VERSATILITY MINI-CHECK TUBE TESTER

Model MC-1

Here is a multiple socket tube tester designed to meet limited budgets. Although low in price it boasts a unique circuitry that enables you to check over 600 tube types — and has a range of operation that far exceeds others in its price class.

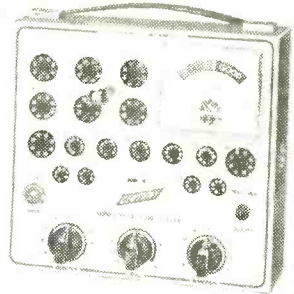

Model MC-1 — housed in sturdy wrinkle finish steel case . . . only

\$39.50
Net

SIZE: W: 9"
H: 8 1/2"
D: 2 3/4"

OUTSTANDING FEATURES

- Checks emission, inter-element shorts and leakage of over 600 tube types. This covers OZ4s, series-string TV tubes, gas regulators, auto 12 plate volt, hi-fi and foreign tubes • 3 settings enable a test of any tube in less than 10 seconds • Employs dynamic cathode emission test principle • 3 1/2" greater sensitivity means more accuracy . . . its jewel bearing sockets • 17 long lasting phosphor bronze tube filament positions • Handy tube chart contained in special back compartment • New tube listings furnished periodically at no cost • Detachable line cord

plus these BONUS FEATURES . . . found in no other low price tube tester

- ✓ Checks for cathode to heater shorts ✓ Checks for gas content ✓ Checks all sections of multiple purpose tubes . . . will pickup tubes with one "Bad" section ✓ Line isolated — no shock hazard ✓ Variable load control enables you to get accurate results on all tubes ✓ Positively cannot become obsolete as new tube types are introduced.

CONVENIENT TIME PAYMENT PLAN — NO INTEREST OR FINANCING CHARGES

CENTURY ELECTRONICS CO., INC.

CHECK INSTRUMENTS DESIRED

- Model CT-1 In-Circuit Condenser Tester . . . \$34.50 \$9.50 within 10 days. Balance \$5 monthly for 5 months.
- Model SRT-1 In-Circuit Rectifier Tester . . . \$29.50 \$4.50 within 10 days. Balance \$5 monthly for 5 months.
- Model TT-2 Transistor Tester . . . \$24.50 \$4.50 within 10 days. Balance \$5 monthly for 4 months.
- Model FC-2 Fast-Check Tube Tester . . . \$69.50 \$14.50 within 10 days. Balance \$11 monthly for 5 months.
- Model MC-1 Mini-Check Tube Tester . . . \$39.50 \$9.50 within 10 days. Balance \$6 monthly for 5 months.

Prices Net F.O.B. Mineola, N. Y.

111 Roosevelt Avenue, Dept. 305, Mineola, New York

Please rush the instruments checked for a 10 day free trial. If satisfied I agree to pay the down payment within 10 days and the monthly installments as shown. If not completely satisfied I will return the instruments within 10 days and there is no further obligation. It is understood there will be NO INTEREST or FINANCING charges added.

Name _____ Please print clearly
Address _____
City _____ State _____

The specs are the proof... now your
BEST BUY in
ham gear is

EICO®

New

90-WATT CW TRANSMITTER . . #720
KIT \$79.95 WIRED \$119.95

Conservative, highly efficient design plus stability, safety, and excellent parts quality. 80 thru 40, 20, 15, 11, 10 meters (popular operating bands) with one knob band-switching. 6146 final amplifier for full "clean" 90 W input, protected by clamper tube. 6CL6 Colpitts oscillator, 6AQ5 clamper, 6AQ5 buffer-multiplier, G234 rectifier. "Novice limit" calibration on meter keeps novice inside FCC-required 75W limit. No shock hazard at key. Wide range, hi-efficiency pi-network matches antennas 50-1000 ohms, minimizes harmonics. EXT plate mod. terminals for AM phone modulation with 65W input. Excellent as basic exciter to drive a power amplifier stage to max. allowable input of 1KW. Very effective TVI suppression. Ingenious new "low silhouette" design for complete shielding and "living room" attractiveness. Conservatively rated parts, copper-plated chassis, ceramic switch insulation. 5" H, 15" W, 9 1/2" D.

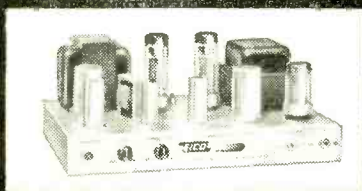

NEW UNIVERSAL MODULATOR-DRIVER #730
KIT \$49.95 WIRED \$79.95 Cover E-5 \$4.50

Superb, truly versatile modulator at low cost. Can deliver 50 W of undistorted audio signal for phone operation, more than sufficient to modulate 100% EICO #720 CW Transmitter or any xmitter whose RF amplifier has plate input power of up to 100W. Multi-match output xmr matches most loads between 500-10,000 ohms. Unique over-modulation indicator permits easy monitoring, no need for plate meter. Lo-level speech clipping & filtering with peak speech freq. range circuitry. Low distortion feedback circuit, premium quality audio power pentodes, indirectly heated rectifier filament. Balance & bias adj. controls. Inputs for xtal or dynamic mikes, phone patch, etc. Excellent deluxe driver for high-power class B modulation. ECC83/12AX7 speech ampl., 6AL5 speech clipper, 6AN8 ampl. driver, 2-EL34/6CA7 power output, EMB4 over-mod. indicator, G234 rect. Finest quality, conservatively rated parts, copper-plated chassis. 6" H, 14" W, 8" D.

NEW GRID DIP METER #710
KIT \$29.95 WIRED \$49.95 including complete set of coils for full band coverage.

Exceptionally versatile. Basically a VFO with microammeter in grid; determines freq. of other osc. or tuned circuits; sens. control & phone jack facilitate "zero beat" listening. Excellent absorption wave meter. Ham uses: retuning & neutralizing xmitters, power indication, locating parasitic osc., antenna adj., correcting TVI, debugging with xmitter power off, determining C.L.Q. Servicing uses: alignment of filters, IF's; as sig. or marker gen. Easy to hold & thumb tune with 1 hand. Continuous 400 kc-250 mc coverage in 7 ranges, pre-wound 0.5% accurate coils. 500 ua meter movement. 6AF4(A) or 614 Colpitts osc. Xmr-operated sel. rect. 2 1/2" H, 2 1/4" W, 6 1/4" L. Satin deep-etched aluminum panel, grey wrinkle steel case.

NOW IN STOCK!

Compare & take them home—right "off the shelf"—from 1900 neighborhood EICO dealers. For free catalog mail coupon in EICO ad 2 pages forward. In the West, add 5%. Over 1 MILLION EICO instruments in use throughout the world.

33-00 Northern Blvd., Copr. © 1958,
Long Island City 1, N.Y. Electronic Instr.
Co., Inc.

EICO®

See EICO's other ad on page 40.

Tips

(Continued from page 34)

pedance or crystal headphones are used.
—J. D. Hegseth, KN7DBU/7, Du Pont, Wash.

TEMPORARY ANTENNA COUPLER

When you want to connect two or more TV sets to the same antenna and there's no coupler available, just tape about 6" of each set's ribbon lead-in to the main ribbon lead-

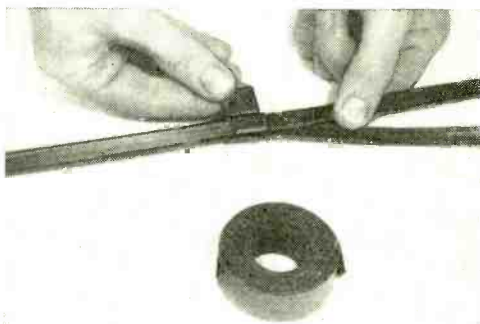

in coming in from the antenna. Don't bare the wires for the direct connection—let the signal be induced from one lead-in to the next. Usually, two or more sets can be coupled together in this manner without adversely affecting reception. If the main lead-in is coax cable or shielded wire, this trick won't work.—Joseph A. Carroll, Brooklyn, N. Y.

HANDY RESISTOR RACK

A handy rack made of corrugated cardboard will aid in keeping track of resistors. Cut several pieces of cardboard, the first

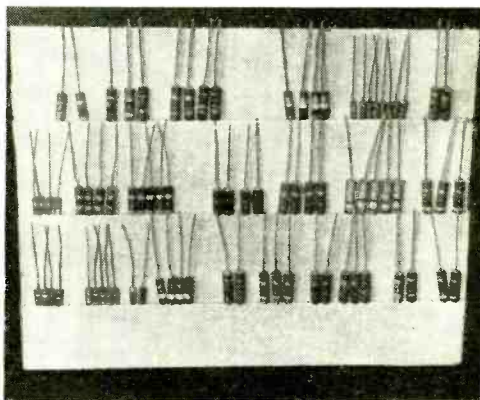

piece 1 1/2" wide and each of the others 2" wider than the last. Glue these pieces together and you'll have a neat rack that will hold several rows of resistors.—J. F. McCleary, San Diego, Calif.

—30—

"MEN WHO DO-IT-YOURSELF" **YOUR
SKILLS
CAN MEAN
AN
IMPORTANT
FUTURE
IN THE
NEW
AGE OF SPACE**

If you like to build transmitters...or hot rods...or models...you can also build a real future for yourself by training in the U.S. Air Force. For in today's new Age of Space, it is the man with technical ability who will be the important man. *Only in the Air Force*, however, will you find so broad and complete a range of Space Age specialty training. In the Air Force, *the Age of Space* is now. For full details on your training opportunities see your local Air Force Recruiter now, or mail the coupon.



**TRAIN
IN
THE
U.S. AIR
FORCE**

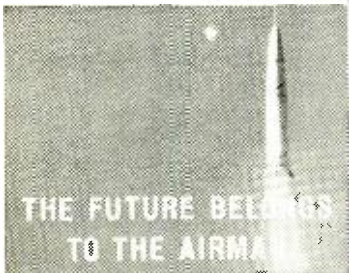
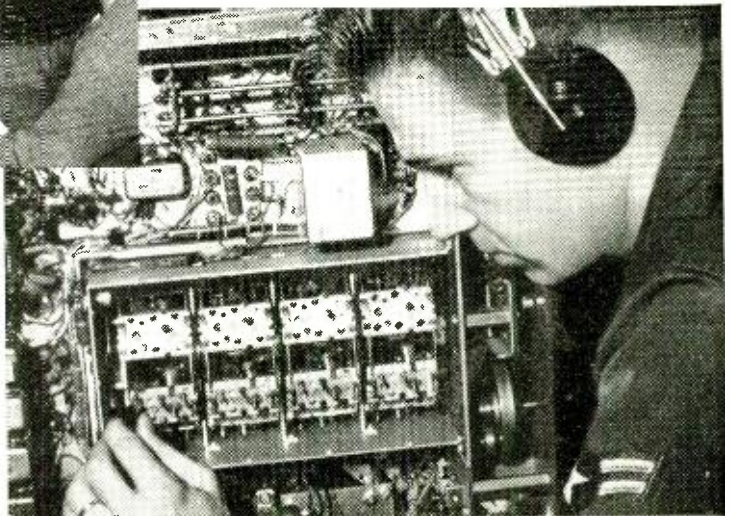

PASTE COUPON ON POSTAL CARD AND MAIL TO:

Airman Information, Dept. MP-95
Box 7608, Washington 4, D. C.

Please send me information on my opportunities in the U.S. Air Force. I am between the ages of 17-34 and reside in the U. S. A. or possessions.

Name _____

Address _____

City _____ Zone _____ State _____

the experts say

your BEST BUY

is **EICO**...

EICO, 33-00 Northern Blvd., L.I.C. 1, N.Y. PE-5
Show me HOW TO SAVE 50% on 65 models of top-quality:

HI-FI TEST INSTRUMENTS "HAM" GEAR
Send FREE catalog & name of neighborhood EICO dealer.

NAME.....

ADDRESS.....

CITY..... ZONE..... STATE.....

ADD 5% IN THE WEST

...in
STEREO and MONO HI-FI



STEREO Dual Amplifier-Preamplifier HF81
Kit \$69.95.
Wired \$109.95.
"Excellent" —

SATURDAY REVIEW:
HI-FI MUSIC AT HOME.



STEREO Dual Preamplifier HF85
Kit \$39.95.
Wired \$64.95.
"Extreme flexibility... a bargain" — HI-FI REVIEW



STEREO Dual Power Amplifier HF86
Kit \$43.95.
Wired \$74.95.



Mono Preamplifier HF65A:
Kit \$29.95.
Wired \$44.95.
With Power Supply HF65:
Kit \$33.95. Wired \$49.95.



Mono Power Amplifiers (60, 50, 35, 30, 22, 14-Watt; use 2 for Stereo) from Kit \$23.50. Wired \$41.50.



Mono Integrated Amplifiers (50, 30, 20, 12-Watt; use 2 for Stereo) from Kit \$34.95. Wired \$57.95.



FM Tuner HFT90
Kit \$39.95*.
Wired \$65.95*.
Cover \$3.95.
"One of the best buys you can get in high fidelity kits" — AUDIOCRAFT Kit Report.
AM Tuner HFT94
Kit \$39.95. Wired \$65.95. incl. Cover & F.E.T.

*Less Cover, F.E.T. incl.



2-Way Bookshelf Speaker System HFS1 complete with factory-built cabinet: \$39.95.



Omni-directional Speaker System HFS2 completely factory-built, \$139.95. 36" H, 15 1/4" W, 11 1/2" D. "Eminently musical" HIGH FIDELITY. "Fine for Stereo" — MODERN HI-FI.

...and in
TEST INSTRUMENTS



New Transistorized Power & Bias Supply #1020
Kit \$19.95.
Wired \$27.95.



New Battery-Powered Filament Continuity Tester #612. Kit \$3.95. Wired \$5.95.



RF Signal Generator #324
Kit \$26.95.
Wired \$39.95.



Miniaturized Multi-Signal Tracer #145A
Kit \$19.95.
Wired \$28.95.



1000 Ohms/Volt V.O.M. #536
Kit \$12.90.
Wired \$14.90.



Series/Parallel R-C Combination Box #1140
Kit \$13.95. Wired \$19.95.
1350 Combinations!



Vacuum Tube Voltmeter #221
Kit \$25.95.
Wired \$39.95.



5" Push-Pull Scope #425
Kit \$44.95.
Wired \$79.95.



DC-5 MC 5" Scope #460
Kit \$79.95.
Wired \$129.50.



Peak-to-Peak VTVM #232 & Uni-Probe (pat. pend.)
Kit \$29.95.
Wired \$49.95.



Tube Tester #625
Kit \$34.95.
Wired \$49.95.



R-C Bridge & R-C-L Comparator #950B
Kit \$19.95.
Wired \$29.95.

IN STOCK! Compare, take them home — right "off the shelf" — from 2000 neighborhood dealers. Over 1 MILLION EICO instruments in use throughout the world.

© 1959, ELECTRONIC INSTRUMENT CO., INC., 33-00 N. BLVD., L.I.C. 1, N.Y.

◀ See Page 38 for EICO's BEST BUYS in "HAM" GEAR.

Doppler Radar Charts the Airlines



New navigational system gives pilots instant indication of ground speed and location

THE JET AIRLINER strains against its wheel brakes at the end of one of International Airport's busy runways, its engines building up power for the New York-to-Paris hop. Waiting for his control tower clearance, the captain scans the dials of a special instrument assembly. Among other things, they tell him his present longitude and latitude and the number of miles he must fly to reach Paris. Hearing the tower controller clear him for take-off, he releases the brakes and catapults down the runway.

Once airborne, the captain sets his course by compass and heads out to sea. For the next six or seven hours, he listens for no radio beacons, and there is no navigator to calculate the plane's position. Instead the captain keeps checking that special instrument grouping. It tells him exactly where he is at all times, exactly what path he is making over the faceless ocean, thousands of feet below. It tells him exactly how many miles he has to go before he lets down at Paris. It even tells him whether he's riding a tailwind or bucking a headwind.

With no other guide, he brings the plane down through a cur-

**By
ART ZUCKERMAN**

DETERMINING SPEED. Signal is beamed at ground ahead of plane. Reflected signal is then received. Ground speed is a function of shift between frequencies of beamed and received signals, together with depression angle. Measurement of reflected signal's Doppler shift gives ground speed. (Diagram at right and diagrams on following page through the courtesy of the Canadian Marconi Company).

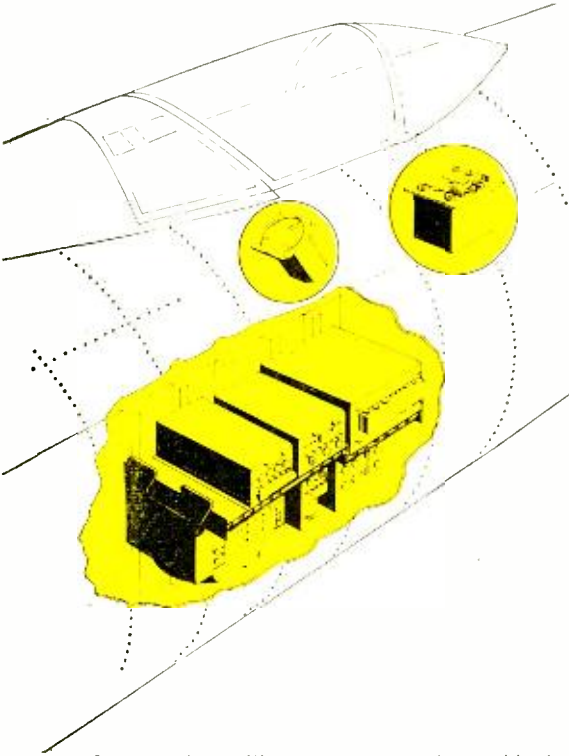
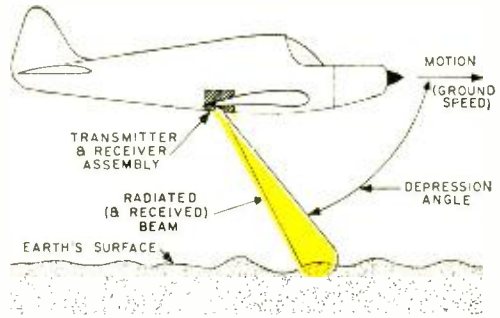

HOMING PIGEON. Thanks to Doppler radar, Navy flyers find their way home to their carrier. Here, pilot of A3D bomber adjusts Ryan Aeronautical unit. Instruments show latitude, longitude, ground speed, drift, etc.

SAMPLE LAYOUT. Arrangement of assembly designed by Laboratory for Electronics, Inc., for use in a jet plane. Combined antenna-transceiver-computer package is mounted in plane's belly, while ground-speed and drift-angle indicator (circular dial) and control panel are in cockpit. Control panel indicates plane's exact longitude and latitude.

tain of clouds at the end of his journey, within five miles of the Paris airport. Had he been using conventional navigating techniques, he would have considered himself doing well to come within 25 miles of his destination.

Such an incident is not far from becoming commonplace in transoceanic and transcontinental airline flying. It is already an ordinary occurrence in military navigation. The equipment that makes such spectacular accuracy possible is the Doppler radar navigation system.

Doppler radar provides exact ground speed and angle-of-drift information which is continuously fed into a computer

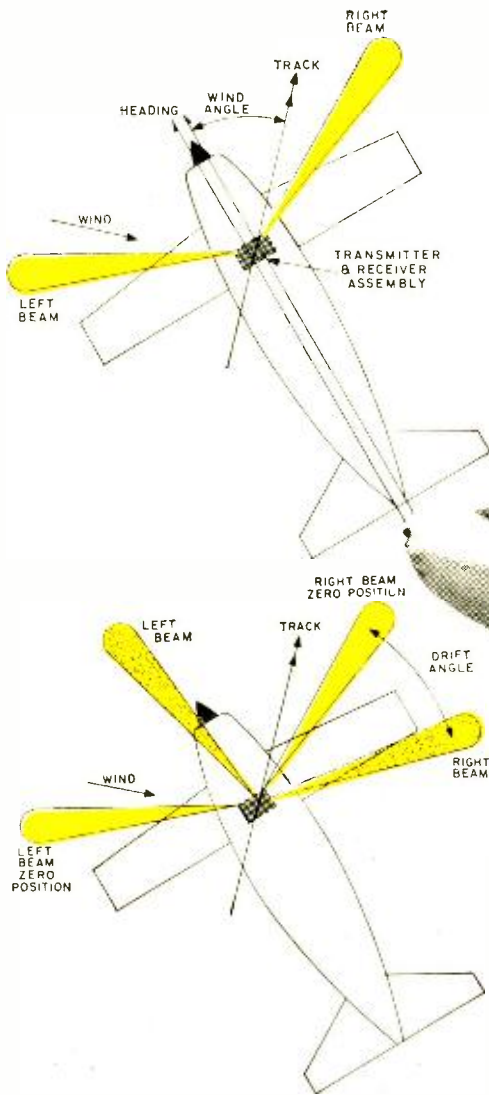

DETERMINING DRIFT. In zero position (diagram at left), twin radar beams straddle plane's nose, one aimed to the left and one to the right. When wind causes plane to move in direction different from heading (direction in which nose is pointed), Doppler frequency shift of right beam is greater than that of left beam and antenna swings until frequency shifts are equal again (diagram below, left).



HURRICANE HUNTER. Doppler equipment installed in this B-47 by General Precision Labs enables it to find the eye of a hurricane and determine its exact speed.

previously primed with basic position and distance data. The computer digests this information and the results of the computer's celebration appear as meter readings. Everything a pilot needs to know for pinpoint accuracy is contained on one easily read instrument panel.

Ocean of Air Currents. Before Doppler radar was developed, a flyer had no way of knowing his exact ground speed and angle of drift. He did know his approximate airspeed, which is literally the speed of the air moving past his airplane. If the air were dead calm, an airspeed indication would give him a reasonably good idea of how fast he was actually going. But the air is never

completely still. It is really an ocean of gas with currents flowing in many different directions at varying speeds. It can change speed and direction in an instant.

Let's say, for example, that a plane flies through a 50-mile-an-hour headwind. The airspeed indicator reads 300 miles an hour. Actually, though, the plane is traveling at a ground speed of only 250 miles an hour. Now suppose the wind suddenly slacks off to 10 miles an hour. The airspeed indicator will still show 300 miles an hour, because this is the speed at which the plane continues to fly through the surrounding air. But, in reality, it is now going over the ground at 290 miles an hour. The pilot has

no way of knowing that he's picked up ground speed unless he later times himself between two check-points.

Drift is the second great problem in aviation navigation. Suppose an airplane is pointed due north and flying at a fair clip. Now suppose a strong wind is blowing from the west. Obviously, the wind will tend to push the plane sideways. Thus, the plane's true course over the earth will be roughly northeast. The difference between the true course and the direction in which the plane is heading is the angle of drift.

If a pilot or navigator knows the exact direction and speed of the wind, he can compute his ground speed and path—or track—across the earth with some accuracy. But when either the speed or the direction of the wind changes, his calculations are thrown off.

Older Systems. For years we've had a number of radio and radar aids to help pilots on over-water flights or in conditions of poor land visibility. They are great helps, but they suffer from limitations.

There are many radio ranging and beacon devices for overland flying. A radio beacon serves as a check-point, but it is useless unless a plane flies over or very near it. The various ranges tell whether a plane is on or off course—provided the course and range coincide—and give some idea of the degree of error. But, even when a range is available, a certain amount of calculating is involved.

"Loran" is one of the most widely used over-water navigation systems. It depends on a number of transmitters scattered around the world which send out arch-shaped signals. A plane receives these signals as distinctive blips on a radar-type scope. With the help of special charts, the intersecting blips from neighboring Loran transmitters are interpreted by a trained navigator. It is possible for the navigator to locate his plane on an intersection and determine the direction of flight. By timing the flying time from one intersection to another, he can also compute his true surface speed.

This procedure takes time, obviously, time in which errors can pile up—particularly at today's jet speeds. Correcting an error takes time, too. And whenever the wind changes, the navigator must start from scratch. On the other hand, with a Doppler computer, the pilot always knows his true location and direction, and how fast he's

really going. He can make a correction instantly, and if the plane is on autopilot, the correction will be made automatically.

Frequency Changes. Doppler radar is based on an 1842 discovery by Christian Johann Doppler, an Austrian physicist. In essence, Herr Doppler found that the pitch of a given sound is relative to the movement of its source with respect to an observer.

Imagine that you are standing by a railroad track listening to the whistle of an approaching train. If the speed of the train is constant, the pitch of the whistle will seem higher to you than it does to a passenger on the train. As the train passes by, you'll hear a sudden drop in frequency. That's because the sound waves are "stretched" when the locomotive moves away from you. In a similar manner, when the train was coming towards you, they were compressed (and raised in frequency).

This same phenomenon occurs with radio waves. If we put a radar set in an airplane and beam it at the ground ahead as we fly, the faster we fly, the higher will be the frequency of the signal reflected from the ground. If we beam a signal at the ground behind us, an increase in the plane's speed makes the returning signal drop to a lower frequency.

Unlike conventional radar systems, Doppler radar doesn't measure the *time* a transmitted signal takes to bounce back. Instead it measures the *frequency shift* between the transmitted signal and the reflected signal.

In actual practice, at least two radar beams are used. A simple Doppler system has a dual antenna sending out two beams, one forward and to the left, the other forward and to the right. A servo motor turns the antenna assembly automatically.

Let's say a plane is heading due north, but because of a crosswind, it is actually moving northwest. The frequency shift of the left-hand beam will be greater than that of the right-hand beam, since it is aimed more nearly in the actual direction of the plane's movement. Instantly, the computer will command the servo motor to turn the antenna until the frequency shift for each beam is the same. The beams are now straddling the desired flight path.

The Doppler navigator computer then "takes out its slide rule" and calculates the difference between the planned flight path and the plane's actual heading and shows this difference on an indicator as the drift

(Continued on page 140)



New Color-TV Projection System

Swiss-made video projector
sets color quality standards

By **FURMAN HEBB**
Associate Editor

A NEW color-TV projector capable of producing a 20 x 16 foot picture with the sharpness and color fidelity heretofore possible only with high-quality film projection has recently been demonstrated in this country. Designed and manufactured in Switzerland, the projection system is known by the trade name "Eidophor"—pronounced *Eye-doe-for*.

The first Eidophor unit in this country is being used by CIBA, an international chemical company which has U. S. subsidiaries in the pharmaceutical, plastics, and dyestuffs fields. It has been employed successfully at medical scientific conventions to project full-color closed-circuit telecasts of medical and scientific techniques to large groups.

The complete CIBA system is housed in a 35'-long motor trailer which includes four television cameras, two projectors, a complete p.a. system, two projection screens, and the necessary control equipment. An eight-man crew is required to operate the \$336,000 mobile unit.

Design of the Eidophor. Invented in 1939 by Dr. Fritz Fischer of Zurich, subsequent development on the Eidophor system was carried out with the backing of CIBA.

The projection system of the Eidophor is

quite different from that of the better known Schmidt system, which is used in theater-TV presentations of championship boxing matches, etc. In the Schmidt system, the image is picked up from a special high-intensity cathode-ray picture tube and is simply magnified and projected by optical means.

On the other hand, the Eidophor uses controlled modulation of an *external* light source. Since a CRT, with its inherent limitations as a light source, is not required, the Eidophor's picture is capable of high resolution and brilliance.

How It Operates. Let's get an over-all idea of how the Eidophor works and then go into its operation in more detail. Briefly, a television camera is connected to the Eidophor in a closed circuit. The Eidophor takes the video output of the TV and runs it through some special deflection circuits. The swept video signal is then projected by an electron gun onto a concave mirror covered with a thin layer of oil. Distortion of the oil layer over the mirror caused by the impact of electrons modulates the external light source which is reflected off the mirror and then projected through a lens onto the viewing screen.

Now we'll go into the details. First,

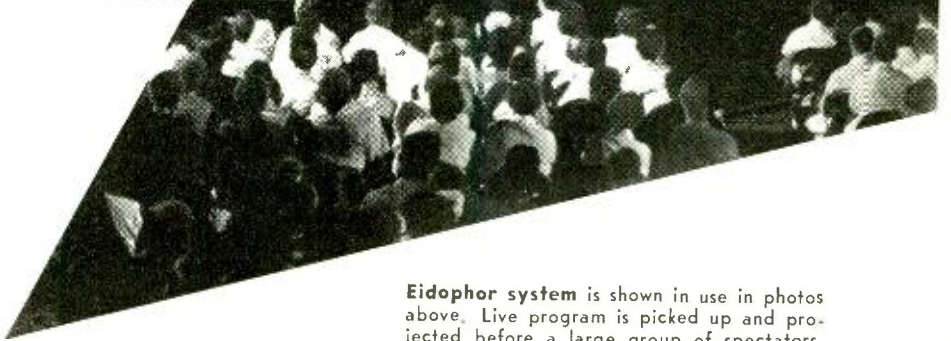

Eidophor system is shown in use in photos above. Live program is picked up and projected before a large group of spectators.

let's take a look at Fig. 1 to see what takes place inside the Eidophor. The light from a 2000-watt xenon bulb is focused by two lenses and then falls on a special slotted mirror which is composed of a series of bar-shaped mirrors arranged like a Venetian blind. This device reflects the light from the xenon bulb into the thin film of oil on the concave mirror.

Now follow the paths of the light as indicated in Fig. 1. You will see that the arrangement and angle of the slotted mirrors redirects all the light back to the light source. Thus, no light is projected onto the viewing screen and there is no picture.

How do we project a picture onto the viewing screen? This is where we call electronics into action. Remember that a uniform layer of oil covers the entire surface of the concave mirror. If this layer of oil is left alone, it will have no effect on the optics of the system. All the light from the light source will be directed back to

the light source by the slotted mirrors.

But suppose we project electrons in the pattern of a video picture onto the concave mirror. What happens to the oil? Due to electrostatic attraction between the electron particles that strike the oil's surface and the mirror itself, at every point where electrons hit the oil's surface, the oil will be attracted to the mirror and its surface will be deformed. Since the oil is practically nonconductive, various degrees of local deformation are produced over the oil's surface.

This is all we need to go into action and produce a picture. When we disturb the even surface of the oil, it no longer allows light to be reflected evenly. The slight deformation of the oil's surface changes the reflection angle just enough to cause the light from the main light source to be reflected *between* the "Venetian blinds" of the slotted mirror. (See Fig. 2.)

Thus, it is possible to project a complete

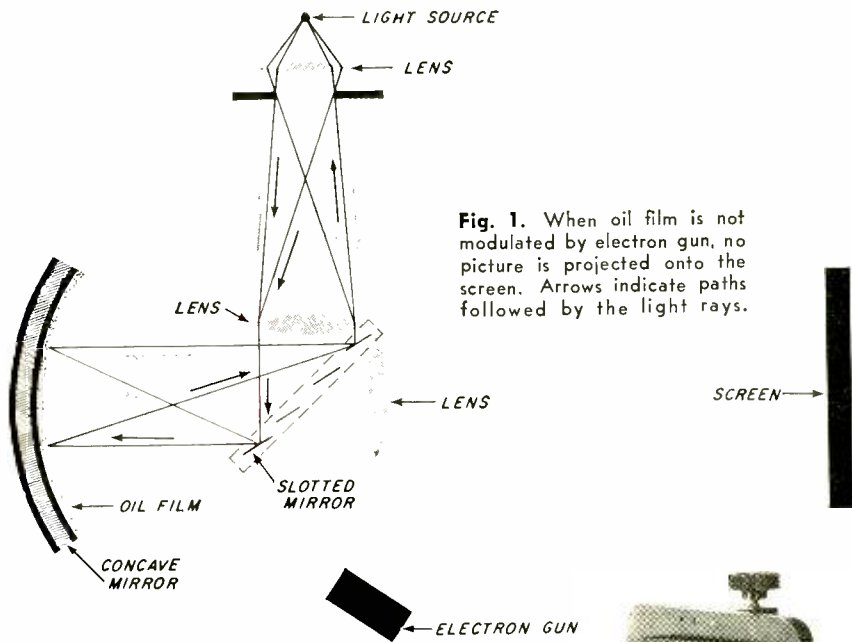

Fig. 1. When oil film is not modulated by electron gun, no picture is projected onto the screen. Arrows indicate paths followed by the light rays.

Slotted mirror device at right is composed of a series of bar-shaped mirrors. Compare photo with its representation in the sketches.

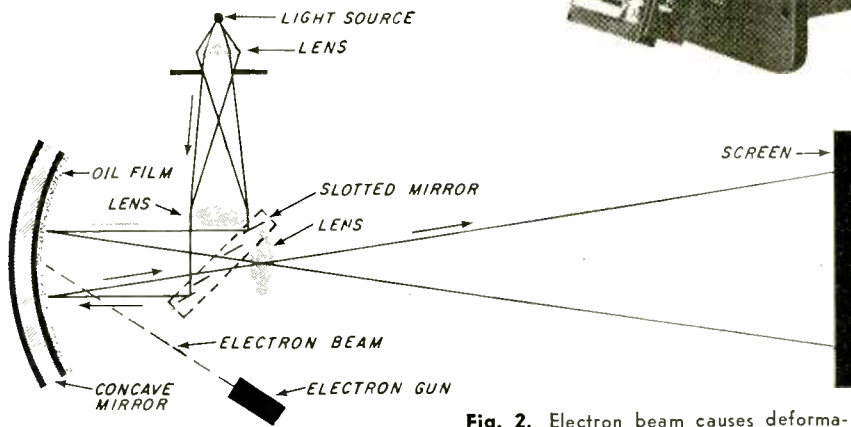
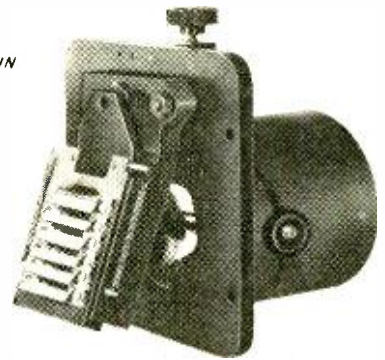

Fig. 2. Electron beam causes deformation of the oil film's surface, thus changing reflection angle of light from the light source. Picture is projected between the elements of the "Venetian blind" mirror.

picture *between* the elements of the slotted mirror. The electron gun uses scanning methods similar to those used in the CRT's of TV sets.

Naturally, the entire unit in which the process takes place (with the exception of the final projection) must be sealed in a vacuum. The Eidophor design makes pro-

vision for a vacuum-tight exchangeable cassette.

How About Color? We've got a black and white picture—now how do we get a color picture? After we've gone this far, it's really not too hard to convert to color;

Mobile unit houses complete Eidophor system. At right is view of control room in the 35'-long motor trailer.



all that's necessary is to incorporate a field sequential color system similar to the old CBS color-TV system. By producing three different color impressions of an image in rapid succession, the over-all impression of their superimposition will be that of a full color picture.

The addition of color complicates operation in only two ways. Color wheels in front of the camera and the projector must be installed and synchronized, and the scanning speed of the electron beam must be tripled to avoid decreased picture resolution.

In addition to the electronic and optical refinements, the Eidophor also features some clever mechanical design. Oil, as you know, is notoriously uncooperative when you want it to remain in one place. If the projection is to be of good quality, the layer of oil must always be absolutely uniform in thickness and have a completely smooth surface. This problem is solved by having the entire concave mirror rotate continuously. Fresh oil is constantly applied through a pump, while a smoothing bar maintains the layer at an even thickness of one-tenth of a millimeter. Excess oil is filtered and run through a recirculating system.

Electrical conductivity of the oil must be kept at a constant value. Although the oil's conductivity is determined mainly by its viscosity, its temperature must also be maintained evenly. This is accomplished by a small refrigeration unit mounted on shock absorbers.

Compact Unit. The entire Eidophor projection system is housed in a frame about 2' wide by 4' deep which stands a little over 5' high. Besides the equipment mentioned before, it also contains associated electronic circuitry such as a d.c. voltage supply, a filament and high-voltage supply, deflection circuits, a focusing unit, and a video amplifier. Focusing is quite critical since, unlike in a conventional TV set, if the size of the spot varies, the picture brightness is markedly altered.

Operating requirements demand a 2500-watt electrical power source, water for the cooling system, a d.c. supply for the xenon lamp, and a good-quality video signal.

Production models of the Eidophor are expected to cost about \$13,000 for the black-and-white projector, and about \$16,000 for the color projector. CIBA is now working with 20th Century Fox Film Corporation on the broad commercial use of Eidophor.

-50-

By
JOSEPH MARSHALL

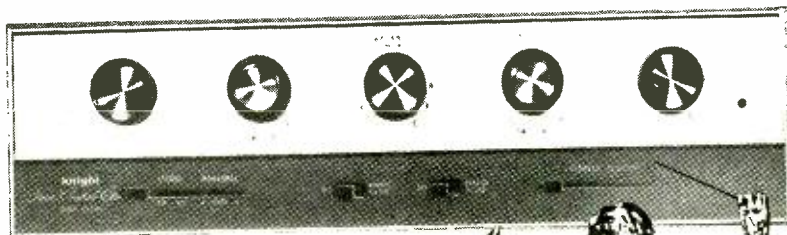

INSIDE *the* **PREAMPLIFIER**

Part 4:

The Stereo Preamp

AS we have discussed in the previous articles in this series, a preamplifier-control unit must provide preamplification, equalization, tone and volume control facilities. A stereo preamplifier, as we might expect, has to serve up a double order of these functions.

In addition, stereo has its own special requirements which call for additional controls, such as stereo function selection, channel and phase reversal, stereo balance, and master volume and tone controls. Let's

consider the various stereo controls in more detail.

Stereo Function Selection. On occasion we may want to use our stereo system with monophonic records, tapes, or radio broadcasts. When a monophonic program source is played through a stereo system, although lacking right and left directionality, the sound quality is markedly superior to that possible with only a single speaker. Consequently, a switch or function selector must be included in the stereo

preamp's design that will allow us to use both channels at all times, whether the program material be stereo or monophonic.

But a switching system that will do this does not solve all our problems. Stereo pickups may be used to play back mono records. However, in order to obtain maximum cancellation of distortion and noise—

the selector switch, and sometimes it is separate.

There is some question as to whether it is necessary to have a "phase reversal" switch, and if so, whether it should be in the preamp or the amplifier. Ordinarily, it is necessary to phase the system only when it is first set up, and this is easily done by

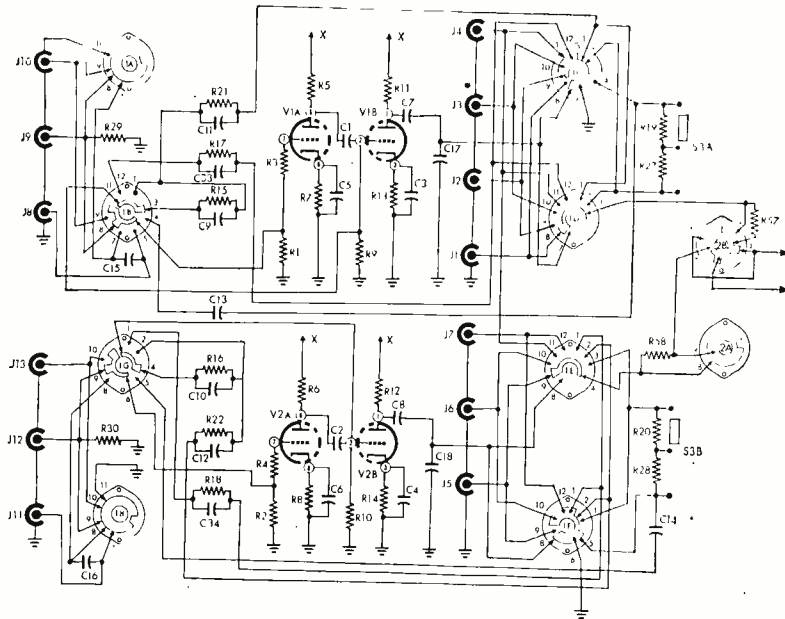

Complexity of stereo switching facilities is illustrated at right by partial schematic of Eico HF85.

particularly rumble—the two outputs from the stereo cartridge should be paralleled when we play a mono disc.

Since at the time of this writing no stereo pickup is as good on mono records as are the best mono pickups, critical listeners may want to use a stereo pickup for stereo records, and a mono model for standard LP's. This further complicates our switching problems.

You can get an idea of just how involved switching can become, in pursuit of flexibility, by taking a glance at the schematic of one of the new stereo preamps such as the Eico HF85.

Channel and Phase Reversal. It is desirable for a stereo preamplifier to provide facilities for reversing the two stereo channels. Normally, the channel A input is fed into the channel A amplifier and input B into amplifier B. By using a double-pole double-throw switch, input A can be fed into amplifier B and input B into amplifier A. Sometimes this switch is combined with

reversing the leads to one speaker until both speakers are pushing and pulling the air together. However, although the RIAA has established standards for stereo records, it sometimes happens that an occasional disc will be issued with the phasing reversed. In such cases, a phasing switch on the preamplifier or amplifier switch is very handy.

Some stereo preamps, notably the McIntosh and the Lafayette KT-600, provide a means of phase reversal in the preamp. Since, in the preamplifier, phase can not be changed by simple switching arrangements, the phase reversal must be done electrically, thus necessitating the addition of another tube.

The principle is very simple. In an RC-coupled amplifier, there is an 180° phase difference between the signal at the grid input and the plate output. If there are the same number of stages in both channels, phase of both outputs will be the same; but if one channel has one more or

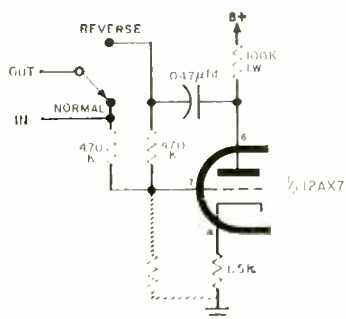

Electronic phase reversal can be accomplished by the circuit shown above. Switched output from grid and plate is 180° out of phase.

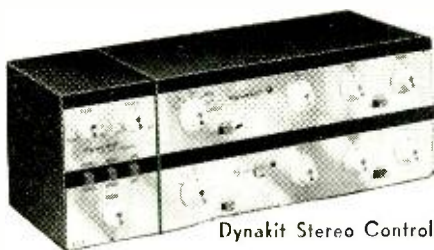

Dynakit Stereo Control

one less stage, its output will be 180° out of phase with the output of the other channel. Thus, to obtain phase reversal, one channel has a "plate follower" (an RC-coupled amplifier with a gain of 1) in addition to the other stages. For normal phase, this "follower" is switched out of the circuit; to reverse phase, it is switched in.

The same effect can also be achieved by using a split-load inverter in the output stage of one channel instead of a cathode follower. Coming from the cathode, we have inphase output; but when the switch is thrown to the plate, we have a 180° phase reversal.

Stereo Balance. One of the most important considerations in stereo reproduction is that of obtaining and maintaining good balance between the two channels. It is not difficult to balance a stereo amplifier which provides separate volume controls for each channel, but it is certainly handier if only one control is needed.

The solution is to gang two volume controls in such a way that, as the gain of one channel is increased, the gain of the other channel is decreased. Rotation of the ganged control causes the over-all loudness to remain the same, but the stereo balance can be shifted from one speaker to the other. Proper balance occurs, of course, when the speakers produce equal volume.

In some stereo preamps, the balance control is a ganged pair of volume controls; in others, it is a pair of special rheostats in series with the independent or ganged volume controls. In the latter case, the range of the balance control is limited. In the former case, the control provides a whole range of balance from complete

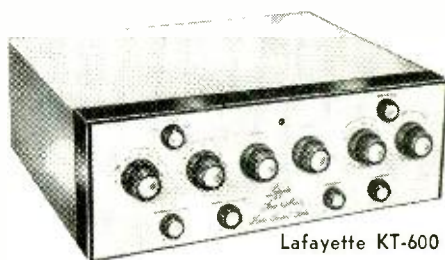

Lafayette KT-600

dominance of either speaker to a true stereo balance between both. The wide-range type is preferable where dissimilar channels are used; the narrow-range type is usually quite satisfactory when components with similar gain or efficiency are used in both channels.

Volume Controls. Obviously it is desirable to be able to control the over-all loudness of a stereo system with a single control. Otherwise it would be necessary to re-balance every time the volume level were raised or lowered. Hence, stereo preamplifiers have a ganged volume control which controls the gain of both channels simultaneously. This is not as simple as theory might indicate, however, as it is very difficult to gang two controls in such a way that they "track" and both produce the same percentage of attenuation at all settings.

The simplest solution is found in the Marantz stereo preamp, where two precision-made individually calibrated controls are used. Although this method works very well, it costs about three or four times as much as an ordinary ganged control.

In the new McIntosh stereo preamp, tracking error is minimized by using four ganged potentiometers, two in each channel. One pair of pots has a 20% log taper, the other a linear taper. One pair is in-

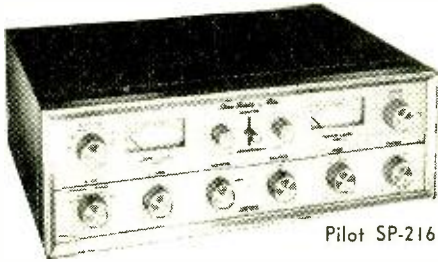

Pilot SP-216

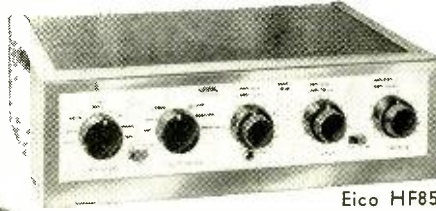

Eico HF85

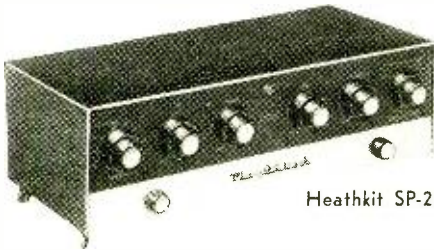

Heathkit SP-2

serted in the front end of the preamp, the other at the output. The tracking errors therefore tend to be cancelled out, resulting in a high degree of linearity.

Other stereo preamps use networks of fixed resistors in various conformations around the volume controls to reduce tracking error.

Simplification. If we add stereo controls to the number of controls needed for other functions, we could end up with anywhere from 10 to 14 controls on a stereo preamp. A great deal of engineering thought is currently being expended in trying to simplify and reduce the number of controls. There are three possible approaches:

1. The most versatile setup (if not the most convenient to operate) has independent preamps for each channel, each offering a full complement of monophonic controls. The special stereo controls can be added by means of a stereo adapter unit. This is the best approach for the many people who already own single-channel systems and want to convert to stereo. Once the system is adjusted, routine adjustments can be made with the controls on the stereo adapter.

2. The other extreme is to gang the controls so that one control knob simultaneously adjusts both channels for bass, treble, function, etc. This results in the simplest operation and it can be satis-

factory with identical systems. But it poses problems when the two channels are dissimilar.

3. Most stereo preamps today effect a compromise between these two approaches—a mixed system in which some controls are ganged and others are individual.

It is common to gang the source selector, the equalization, and the function selector switches; in many preamps, these three are further combined into only two switches or even a single switch. Similarly, it is convenient to gang the volume, balance, and loudness controls, with the volume and loudness functions frequently being combined in one control.

Current practice is to provide some degree of independence in the tone controls for the two channels. Some preamps have entirely independent tone controls for both channels, while others have ganged bass and treble controls with additional bass and treble controls for one channel on the back of the chassis.

Clutch-Type Controls. The physical problem of mounting control knobs is being simplified by the recent availability of "clutch"-type concentric pairs of controls. These controls have two knobs, one small and one large, each of which can be used independently. Both can be used together, however, by pressing one knob in, thus actuating a clutch which locks both controls into a ganged pair.

This type of control is particularly useful in tone control circuits. With the clutch "out," the tone balance of each channel can be adjusted by the individual knobs. Once a balance is achieved, the two controls are

(Continued on page 143)

**New tube development
may radically change
electronic circuit
design**

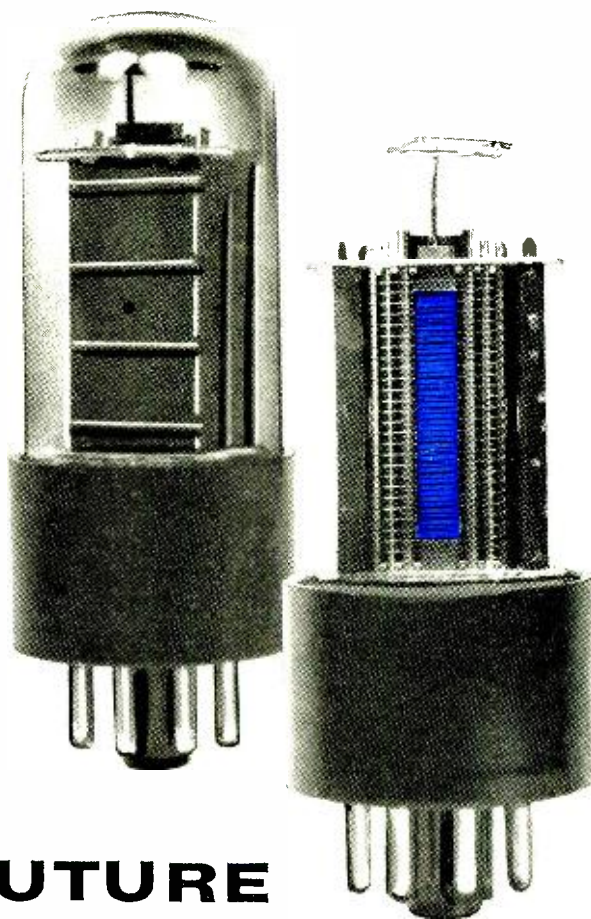

BRIGHT FUTURE for COLD CATHODES

THE RECENT DEVELOPMENT of the "cold-cathode" vacuum tube promises to cause a revolution in electron tube manufacturing and in every type of tube-using electronic equipment. The cold-cathode tube, developed jointly by Tung-Sol Electric, Inc., and the U. S. Army Signal Corps, is considered the first major breakthrough in tube design since the addition of the suppressor grid.

Until now, practically every vacuum tube ever made has contained a hollow cylinder of nickel coated with oxides of barium and strontium. Inside the nickel cylinder is a tungsten filament which, when subjected to a flow of current, radiates heat. After about thirty seconds, the whole cathode structure is brought to a "red-hot" heat and electrons are literally boiled out of the

**By
HOMER WILLIAMS**

oxide coating. The "hot-cathode" system consumes a considerable amount of power, accelerates the breakdown of tube elements, and necessitates special filament circuits.

As its name implies, the "cold-cathode" tube operates without heater circuits. When it is completely perfected, it will require no filament wiring at all. Gone will be filament transformers and filament windings on power transformers. And since there will be no filaments, there will be no warm-up time; the cold-cathode tube will go into operation within one second after

the power is turned on. Filament burn-outs will be a thing of the past; tubes might well last indefinitely. In fact, Tung-Sol now has under test a cold-cathode vacuum tube which has been emitting electrons for over 14,000 hours with no apparent deterioration.

The design of the cold-cathode vacuum tube was made possible by the discovery of a startling electron emission phenomenon. While performing experiments on the secondary emissive qualities of magnesium oxide (more familiar to most of us as the

leave the magnesium oxide coatings, a positive charge is developed at the surface of the coatings. Since the coatings are very thin, a high electrical field is created across them. It is assumed that when electrons begin to leave the coating, the resulting field liberates more and more electrons. This action continues in a sort of avalanche process until the liberated electrons apparently gain enough energy to leave the coating and enter the vacuum. As the electrons pass through the various layers of magnesium oxide, they cause the emission

Fur-bundled young lady at right displays sample of cold-cathode vacuum tube. The power required for one hot cathode will run ten magnesium oxide cold-cathode tubes.



chief ingredient of milk of magnesia), scientists at the Signal Corps Research and Development Labs observed to their amazement that, even with no external stimulus, a nickel cathode coated with magnesium oxide continued to give off electrons as long as a voltage potential was applied. It was natural that this phenomenon should soon find practical application. After extensive work was done to determine the best means of preparing the oxide and how to apply it to a cathode, workable cold-cathode tubes were produced by Tung-Sol under a contract with the Signal Corps.

"Avalanche" Process. Although the phenomenon of self-sustained emission is not fully understood, the action is thought to be as follows. When the first electrons

of a peculiar cold blue light which is the identifying mark of the cold cathode.

When plate voltage is first applied to a cold-cathode vacuum tube, the cathode coating is not positively charged and emission does not take place. At the present time, the initial cathode emission is accomplished by the inclusion of a tiny tungsten starter filament. Thus, today's cold-cathode tubes are not truly self-starting, and a satisfactory starting means must yet be developed. The present cold-cathode tubes should be considered as relatively crude models of more sophisticated designs which will undoubtedly evolve as time goes on and techniques improve.

Basic advantages of the cold-cathode vacuum tube are long life, low power con-

sumption, and simplification of related circuit design and manufacturing techniques. But what are the disadvantages? Disregarding the fact that the self-starting feature must somehow be built in, the cold-cathode tube suffers from the disadvantage of requiring a minimum operating voltage of about 300 volts. This will preclude its use in a.c./d.c. equipment and other types of circuits which operate on low B+ voltages. The tubes are also slightly more complex internally than comparable hot-cathode types. With respect to

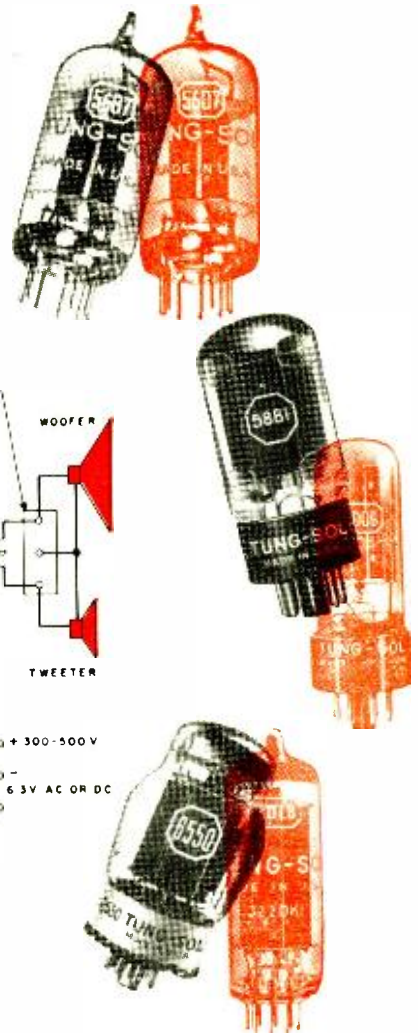

Typical circuit for a cold-cathode vacuum tube.

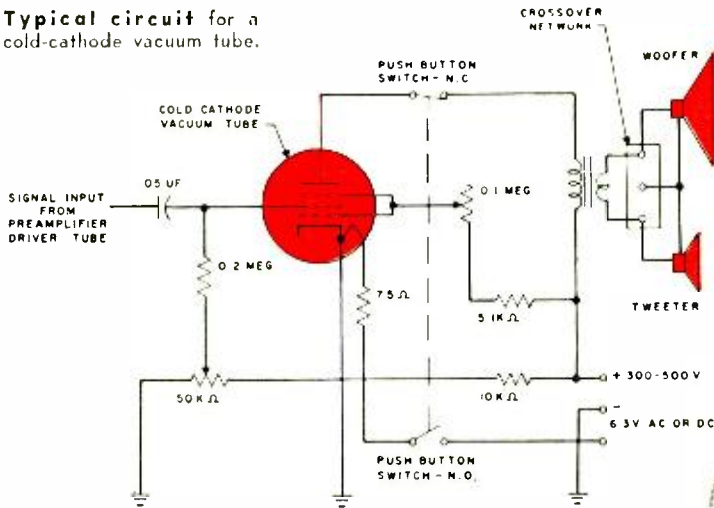

cost, noise level, and other characteristics, the two types are about equal.

Practical Applications. The first operational cold-cathode tube made was an audio output tube. Development work is now being done on other types of tubes. The changeover in tube manufacturing techniques is not complicated. The basic processing is so similar to hot-cathode tube manufacture that the same factory machines can be used.

Cold-cathode tube research being conducted by Tung-Sol is expected to lead to:

- A preamplifier tube using the principle of secondary emission. This should be the world's highest gain amplifier tube.
- Cold-cathode electron guns for use in cathode-ray tubes.
- General illumination lamps that will operate as efficiently at 50° below zero as they do at 100° F. No commercial fluorescent

lamp will operate satisfactorily over such a wide temperature range.

- Ultra-reliable tubes for computers which consume little power.
- Tubes for undersea cables or other devices which are difficult to service.

All these and many more possible applications of the cold-cathode tube forecast a bright future for it . . . so bright a future, in fact, that some wags have been heard to remark, "I wonder if the cold-cathode tube will ever replace the transistor." In the many areas where neither hot-cathode tubes nor transistors have proved adequate, cold cathodes will doubtless find a broad field of usefulness. -30-

By
PAUL SILVERSTEIN

Build an Electrostatic



Tweeter



*An experimental speaker you can make for
only three dollars*

SINCE loudspeaker design is generally acknowledged to be one of the toughest jobs around, the average person seldom dreams that he can build his own. But it is entirely possible for the home experimenter to make a satisfactory speaker—and an electrostatic one at that!

And best of all: the electrostatic tweeter system described in this article can be built for a total cost of about three dollars! While this tweeter is presented basically as an experimental project, its performance will meet minimum high-fidelity standards.

Special Materials. The theory of the electrostatic tweeter is quite simple if we think of it as a talking capacitor. If we can make a capacitor with a flexible plate

that will move in accordance with variations of an applied audio signal, we will have an electrostatic tweeter.

In this case we use a piece of steel for the fixed plate of the capacitor (see Ⓐ); for the moving plate we use a diaphragm of—you'll never guess—Saran Wrap! The Saran Wrap is painted with a thin coat of silver conductive paint (General Cement Silver Print). When a polarizing or bias voltage is applied to the two plates, an audio signal of sufficient amplitude impressed onto the polarizing voltage will cause the Saran Wrap diaphragm to move in accordance with the audio signal.

A connection from the plate of the output tube of an audio amplifier (see Ⓑ and Ⓒ) will provide the necessary polarizing volt-

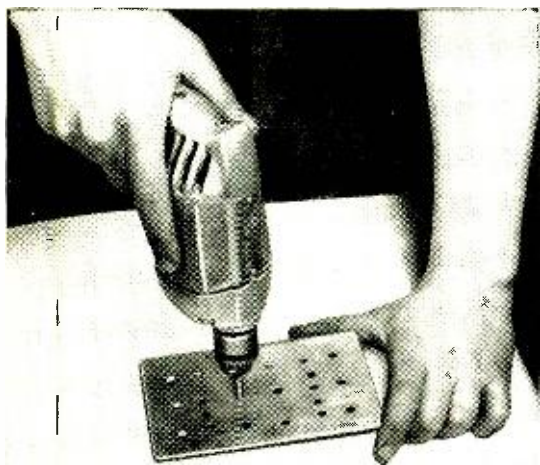

1



2

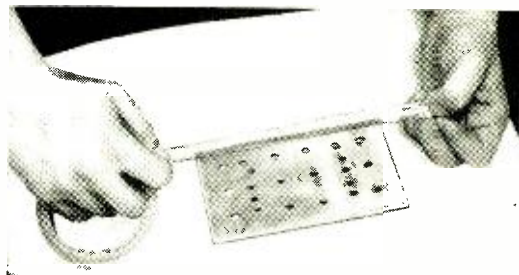

3

Template for making the fixed plate of the tweeter. Use a $\frac{1}{4}$ " bit to drill the $\frac{1}{8}$ " steel plate. Two holes must be countersunk for heads of bolts to fit flush.

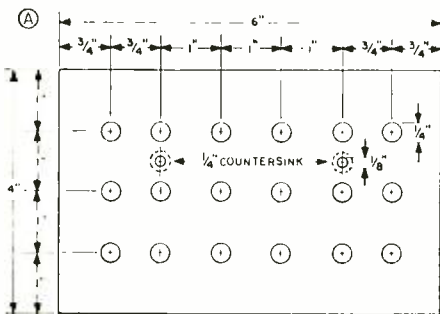

age (350 volts is about right, but experimentation may prove that either a higher or lower voltage will work better) and the a.c. signal voltage.

The direct-to-plate hookup will work well if your speakers are near your amplifier. If your speakers are located some distance from your amplifier, the length of the plate leads may cause the amplifier to oscillate. Should this occur, the alternate hookup shown in © should be used.

In ©, an inexpensive single-ended output transformer (Stancor A-3879 or equivalent) is *hooked up in reverse* to the secondary of the amplifier's output transformer. Polarizing voltage can be furnished either from the amplifier or from a separate power supply. Any standard sup-

1 Drill holes in $\frac{1}{8}$ " steel plate as indicated in (A). Use a $\frac{1}{4}$ "-high speed drill. One-eighth-inch holes are drilled and countersunk to receive the 6-32 x $1\frac{1}{4}$ " flat-head mounting bolts. File off all burrs and make sure plate is smooth.

2 The flat-head bolts and nuts are screwed through the plate to serve as mountings for the tweeter when installed in an enclosure. Heads of the bolts must be flush with or below plate surface.

3 Scotch cellophane tape, $\frac{3}{4}$ " wide, is applied to the four edges of the steel plate. The tape will act as the spacer between steel plate and the Saran Wrap.



4

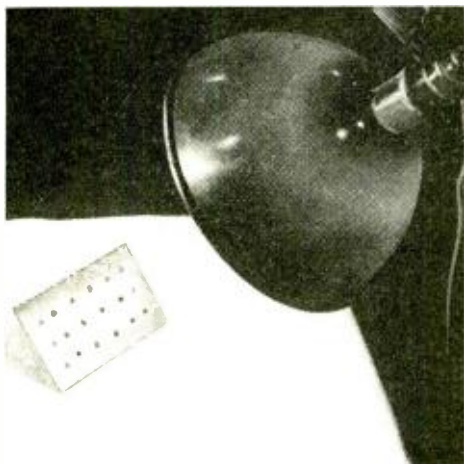

5

4 Saran Wrap is cut to overlap the steel plate slightly on all edges. Tape is applied first to the Saran Wrap "diaphragm" and then is used to fasten the Saran Wrap to the back of the steel plate. Another layer of tape is applied on all the edges of the Saran Wrap overlap as additional insulation to prevent the silver paint from shorting out at back of the steel plate.

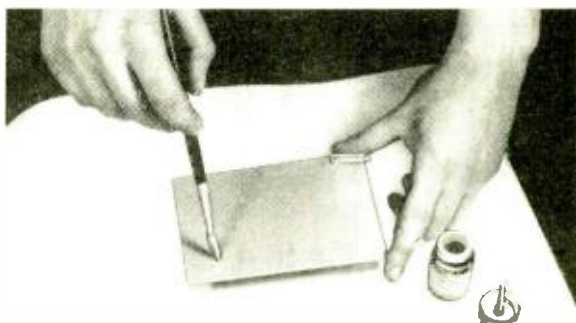

6

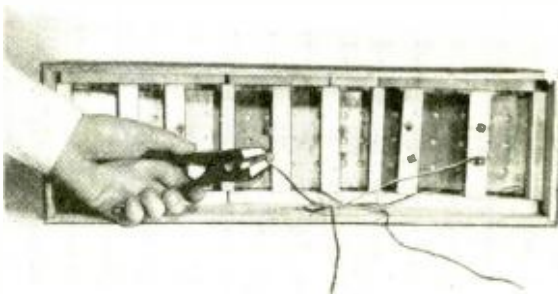

7

5 The diaphragm is heated with a sun lamp or 150 - 200 watt light bulb until all wrinkles are flattened and the Saran Wrap begins to smoke slightly. (Five to 10 minutes at a distance of about 12".)

6 Silver conductive paint is lightly brushed onto the diaphragm after a paper clip has been fastened to one corner of the tweeter. The paper clip is used as the contact point to the diaphragm. One of the mounting bolts serves as the contact to the steel plate. Paint is applied sparingly.

ply that provides from 250 to 350 volts d.c. can be used.

Since electrostatic speakers, by their nature, tend to be low-efficiency devices, it may be necessary to "pad down" your woofer to the efficiency level of the electrostatic tweeter. An 8- or 16-ohm L-pad is recommended for this purpose.

Try and Try Again. The amount of undistorted output available from the system depends to a great extent on the relationship between the polarizing voltage and the

7 The three radiators are mounted in any sort of framework or cabinet desired. Your skill in woodworking will determine the design, but be sure not to obstruct front radiation of the tweeters. If desired, up to six plates can be used to eliminate any tendency toward point source effect.

8 Completed tweeter assembly cannot be effectively tested by playing unless connected to another speaker. Because of the high crossover point, the tweeter will sound thin and weak if operated by itself. It works best with a full-range speaker or woofer.

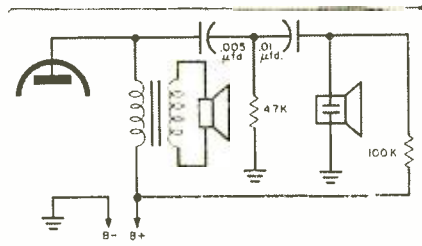

Hookup for connecting the electrostatic tweeter directly to output tubes of a single-ended amplifier.

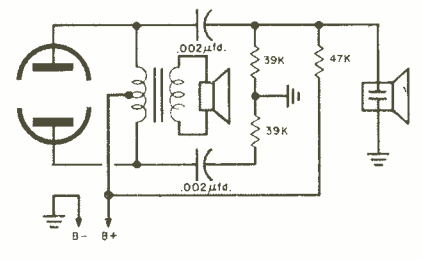

Direct connection of the electrostatic tweeter to the output tubes of an amplifier with push-pull output.

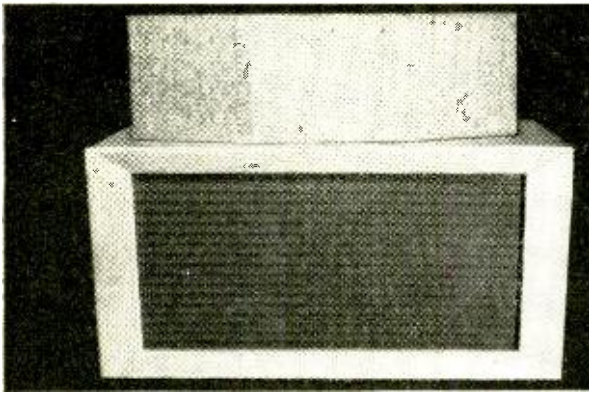

8

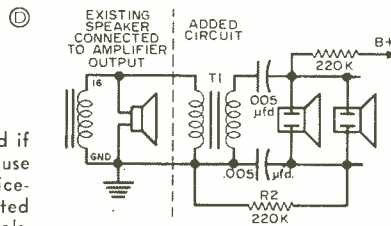

Alternate circuit to be used if the circuits of **B** and **C** cause the amplifier to oscillate. Voice-coil leads of T1 are connected to amplifier output terminals.

audio voltage. If the audio voltage is too high in relation to the polarizing voltage, the tweeter will overload and distortion will occur. On the other hand, if the polarizing voltage is made too high, the moving diaphragm will be out to the fixed plate. The experimenter may burn out several diaphragms before coming up with the optimum arrangement. Luckily, Saran Wrap is not expensive.

The author made three radiating elements at a cost of about \$1.00 each, and

mounted them in an enclosure as shown. Multiple radiators connected in parallel help reduce the point source effect inherent in flatplate electrostatic tweeters.

Remember that individual problems of matching impedances from amplifier to speaker must be solved by the person who builds the system. Experimentation is necessary to get optimum results. When the system is working at its best, however, it can be compared with commercial tweeters costing considerably more.



KITS!

The New Revolution in Turntables

POPULAR ELECTRONICS checks out

hi-fi turntable kits

THE TEN-YEAR PERIOD starting with 1950 may go down in history as the era of the do-it-yourselfer. Today you can buy kits for building everything from tea tables to boats and houses. Cartoonists have satirized, and psychologists have analyzed—but the fact remains that the average man is becoming interested in mastering at least a small section of his technological environment.

Since the kit boom coincided perfectly with the hi-fi boom, it was perhaps natural that the biggest impact of the kit craze should be felt in the hi-fi field. Starting with a modest selection of 6-10 watt amplifiers, the hi-fi kit market was rapidly swelled by 20-70 watters, tuner kits, speak-

er and equipment cabinet kits, and tone arm kits. It wasn't long before you could build a complete "kit-built" hi-fi system, excluding the speaker, turntable, and the pickup.

Although no reasons were given for the lack of turntable and speaker kits, knowledgeable audiophiles felt that the precision assembly required for these components would forever bar them from the do-it-yourselfer's workshop. Consequently, it was a shock to many last year when Weathers Industries announced the intro-

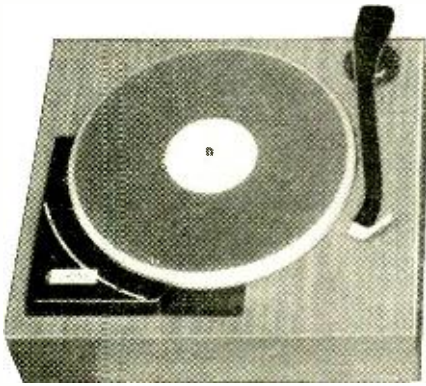

Gray HSK-33 features belt drive, hysteresis motor, and 6½-pound platter with 7/8" shaft. These features insure wow-free operation.

duction of a kit version of its turntable.

"Oh, well," said the startled audiophile, "the only reason Weathers can do it is because they have a special design." And then the roof fell in! Rek-O-Kut, Gray, and Thorens have all recently announced their own turntable kits and Heath is even marketing a *changer* kit.

Types of Motors. Hysteresis motors are featured in three of the five available turntable kits—the Rek-O-Kut K-33H (\$49.95), the Gray HSK-33 (\$49.50), and the Weathers KL-1 (\$34.50). The main advantage of the hysteresis motor is, of course, that its speed is determined basically by frequency of the power line voltage and not by the voltage itself.

This means that a hysteresis motor is worth almost any price to those audiophiles who live in rural areas or in houses with inadequate wiring. At times, due to the load on a power line, the voltage may drop from 115 volts to 90 volts. When a turntable with a 4-pole motor is connected to 90 volts, it won't run at its regular speed and records tend to sound pretty sick.

The Thorens TKD-101 (\$47.50) doesn't use a hysteresis motor; minor variations in line voltage can be compensated for by a variable speed control—a feature which no other turntable kit offers. This control allows a $\pm 3\%$ speed variation—a total of about one musical semitone. The variable-speed feature is also of importance to listeners who, for various musical reasons, want to adjust the pitch of their records on playback.

In addition to its hysteresis model, Rek-



Special woven-fabric belt used by Gray is slightly elastic to prevent the transmission of any vibrations from the motor to the platter.

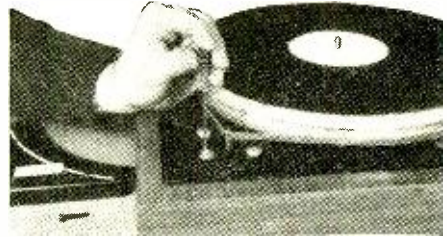

Position of drive belt on the platter of Gray HSK-33 is adjusted by loosening or tightening one of the three motor mounting bolts.



Rek-O-Kut K-33H provides a spring-loaded screw adjustment to increase or decrease tension on the belt which drives the platter.



Completed Rek-O-Kut turntable kit presents clean functional appearance. Stereo tone arm shown in photo is also made by Rek-O-Kut.

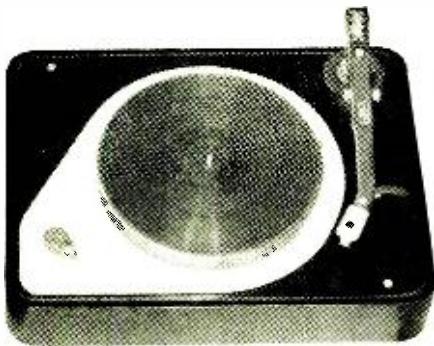

Thorens TDK-101 is the only turntable kit featuring a variable speed control. Speed can be adjusted over a range of $\pm 3\%$.

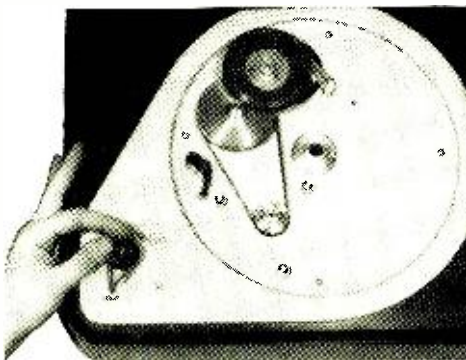

Unusual combination belt-idler wheel drive system of the Thorens is shown here. Speed adjustment knob is concentric with on/off switch.

O-Kut also offers a kit, the K-33, with a 4-pole induction motor. This model is ten dollars less than its hysteresis-powered big brother, the K-33H. For the purposes of this report, Rek-O-Kut supplied us with the more expensive K-33H. In all respects other than the motor, however, the two Rek-O-Kut turntables are identical.

Partly because they are all single-speed ($33\frac{1}{3}$ -rpm) units, all the turntables except the Weathers KL-1 use belt drive, a system which provides mechanical filtering of vibration from the motor and is ideally suited to single-speed operation. The KL-1 has a rather unusual drive system which we will discuss more fully later on.

Gray HSK-33. Considering the turntable kits in alphabetical order, let's first take a look at the Gray HSK-33. A company long renowned for professional broadcast equipment, Gray has chosen to use a simple mechanical design combined with precision machinery. A high-quality hysteresis motor runs at a single fixed speed (1800 rpm) and is coupled by means of a special woven-fabric belt to the outside rim of a $6\frac{1}{2}$ -pound platter. This motor, which is imported from western Germany, is mechanically isolated from the baseplate by rubber shock mounts. The $\frac{7}{8}$ " shaft of the turntable rests in an oilite bearing well on a nylon underfacing.

The Gray should be "run in" for about ten hours before it is used, to allow the nylon underfacing to form a smooth bearing surface. After the break-in period, the turntable runs noiselessly and smoothly. The combination of a hysteresis motor, belt drive, and a heavy platter insures exceptional speed constancy. Gray provides a Formica-veneered base for the HSK-33 which will accept any 12" tone arm.

Rek-O-Kut K-33H. Rek-O-Kut's entry in the turntable kit race is a sleek-looking belt-drive unit. The drive system of the K-33H is in essence the same as Gray's, but there is a different type of motor mounting and platter shaft bearing.

Rek-O-Kut prefers a hard ground shaft rotating in an oil-filled well and riding on a single precision ball bearing. This is the same setup used through the years in the very popular Rondine line, and can be considered a time-tested and proven design. The hysteresis motor itself seems to be quite similar to the motor used in the Gray HSK-33. Both are German-made and of excellent quality.

A screwdriver and pliers will enable you to assemble the K-33H in less than an hour and the job can be tackled in perfect confidence by a rank amateur.

In the model sent to us for test assembly, there was a slight tendency for the drive belt to rub on the belt shield. This was quickly cured by trimming the shield slightly with a kitchen knife—the metal is soft enough to cut easily. Other than this minor problem, assembly was simple and straightforward. After the belt tension and the motor-mount adjustments were made, operation was smooth and quiet.

Thorens TDK-101. A somewhat different approach to the turntable kit problem is taken by Thorens, a Swiss manufacturing firm. The factory-assembled Thorens turntables have a number of interesting features, not the least of which is their unique drive system. The TDK-101 kit "borrows" the drive of these more expensive turntables and scales it down to kit size.

All of the current Thorens models, including the TDK-101, use a combination of both belt and idler drive. A rubber belt couples the precision-ground motor shaft pulley to a speed reduction pulley. The speed reduction pulley has a tapered shaft in its center on which the idler rises and transmits the drive torque to the inner rim of the platter. In conjunction with the rubber idler, the speed reduction pulley makes possible the variable speed control adjustment. Movement of the rubber idler wheel up or down on this tapered shaft varies the speed within the $\pm 3\%$ limits mentioned before.

Because of the special speed adjustment and drive systems, assembly of the TDK-101 kit takes a little longer than do the other kits. Still, assembly time should run under an hour, and this should not be considered as an important factor in deciding which turntable kit to buy.

Care should be used in assembling the speed adjustment linkages below the base plate. Look twice before installing any of the levers and arms. Not that any damage will result from error (other than to your ego), but a lot of time will be lost after

(Continued on page 134)

Gum rubber drive wheel of the Weathers couples motor directly to the inside rim of the platter. Drive system is simple and trouble-free.

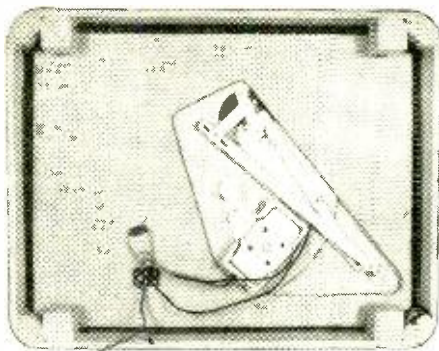

Underside view of the Thorens shows lever system that links the variable speed mechanism to its control, which is on top of turntable.

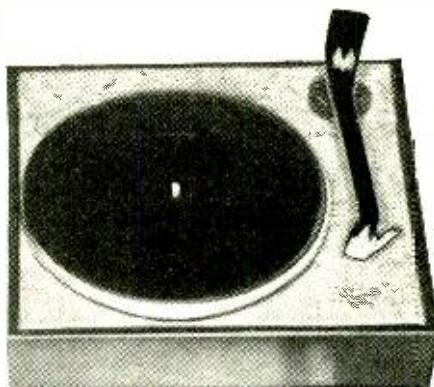

Weathers KL-1 violates all the "rules" of turntable design and still provides top quality. Both the motor and the platter are very light.

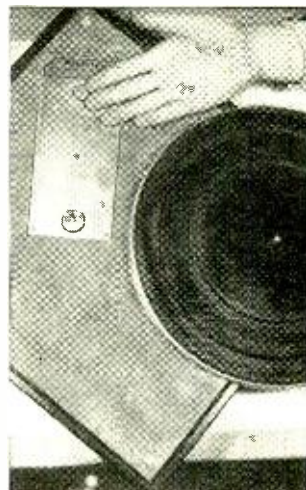

Builds a

Stereo Power Amplifier

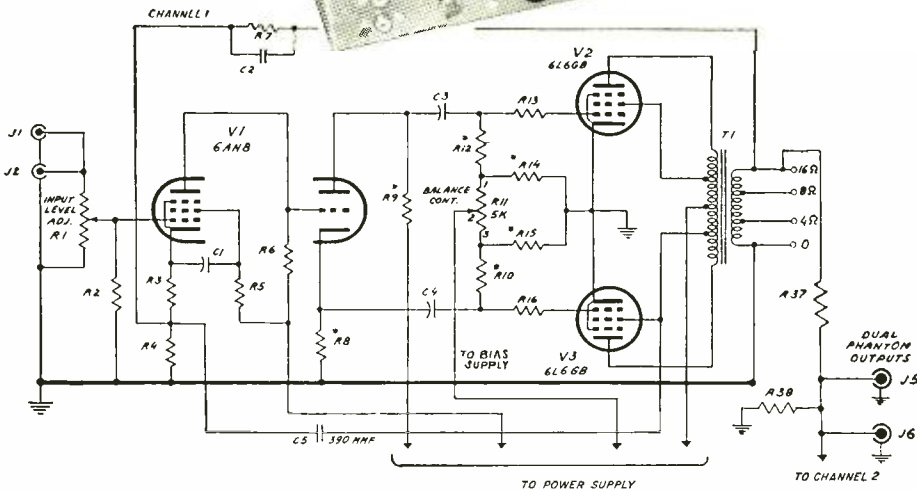

HERE is a fine dual power amplifier for your hi-fi stereo setup. The SPA-55, made by Arkay Radio Kits, Inc., 88-06 Van Wyck Expressway, Richmond Hill, N. Y., offers the hi-fi beginner a top-notch 60-watt monophonic amplifier. And when transition to stereo is desired, dual 30-watt identical amplifiers are available.

Two 30-watt power amplifiers are mounted on a single chassis. Except for the use of a common high-stability power supply, each channel is an entirely separate unit containing its own driver, voltage and

power amplifiers. Dual phantom outputs are included in the design, which enables you to mix the outputs of channel 1 (left) and channel 2 (right) to form a third (center) channel. In a monophonic bi-channel system, both inputs are used after a high-impedance crossover, and each output is fed to its own speakers.

Each power amplifier channel may, in addition to the stereo-monophonic feature, be used as a separate power amplifier when the inputs are fed with unrelated or completely separate program material. No in-

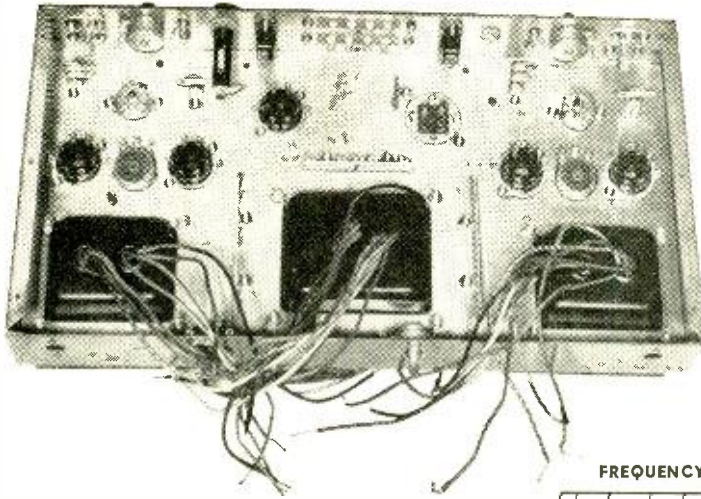

Mount all parts and hardware before wiring. Note symmetry of part locations.

Arkay's SPA-55
dual hi-fi amplifier
is designed for
monophonic or stereo use

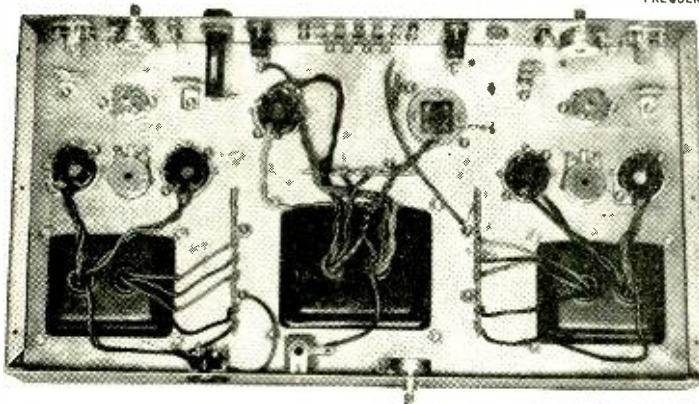
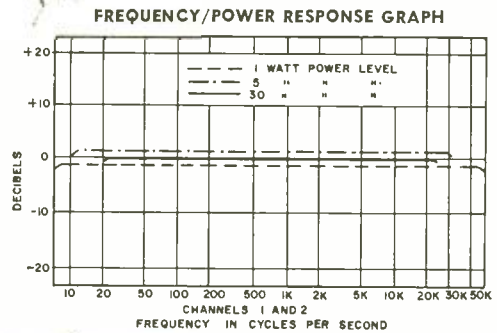

Wire transformer leads in place first. Leads are cut to size and pressed flush with chassis.

teraction or crosstalk exists between channels 1 and 2 of the SPA-55.

Putting It Together. Each of the four basic construction divisions is adequately described in the instruction manual. As a bonus, the construction details of each division are completely illustrated on separate 17" x 22" pictorials of the chassis underside.

Each assembly and wiring step is numbered. Perform the construction following each step in order, checking each step off after it is completed. At several intervals

throughout the manual there are caution notes advising rechecking of prior steps before continuing. This is good advice. Mistakes are easily found if you look for them right after they are made.

Also, check the quality of your work. Sloppiness in the beginning will only result in a hodge-podge of wires when you are finished. And keep an open eye for cold-solder joints.

A resistance chart is provided for checking the resistances at all tube socket pin connections. Make good use of this chart,

All wiring is in place in the photo at right, prior to connecting the resistors and capacitors. Completed power amplifier is shown in photo below.

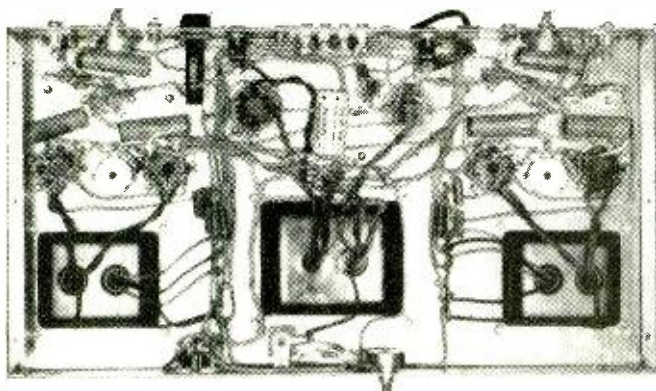
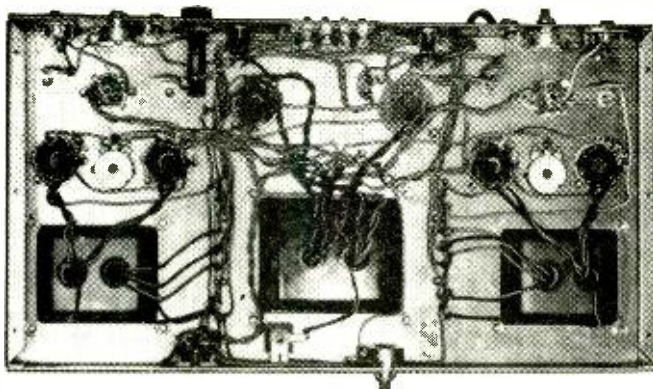

and check the resistances before turning the power on. Very often wiring errors and cold-solder joints can be discovered and corrected before they can cause any harm or grief.

The Circuit. Arkay has chosen a 6AN8 tube for its voltage amplifier-phase inverter. This circuit, basically an adaptation of the Williamson, consists of a high-gain pentode direct-coupled to a triode split-load phase inverter. The 6L6 output tubes operating with fixed bias work into a "Super Linear" (screen-tapped) output transformer.

The design of the output stage incorporates *both* a bias and a balance control, thus insuring optimum adjustment of the individual tube currents. Bias is set with a meter, as is usual practice, and balance is set by ear. Simply set the input level controls on the SPA-55 to minimum, adjust the balance control for lowest hum level in your speaker—and you're pretty darn close to optimum balance. What could be simpler?

After the amplifier has been in service 50

MANUFACTURER'S SPECIFICATIONS (for each channel)

Power Rating	30 watts
Peak Power	50 watts
Frequency Response	$\pm 1/2$ db, 20-20,000 cps at rated output ± 1 db, 10-50,000 cps at 5-watt level
IM Distortion	1.5% @ 25 watts
Harmonic Distortion	.9% @ 25 watts
Damping Factor	16
Output Impedance	4, 8, 16 ohms
Hum	Virtually unmeasurable
Sensitivity	1-volt r.m.s. input for full output

and 100 hours, repeat this adjustment procedure. There may be some drift as the tubes are broken in.

The Arkay SPA-55 can be connected to any conventional mono or stereo preamplifier. The results obtained should encourage you to get out and build the rest of your hi-fi equipment from kits, too. -50-

Electronics Probes the Secrets of the Brain

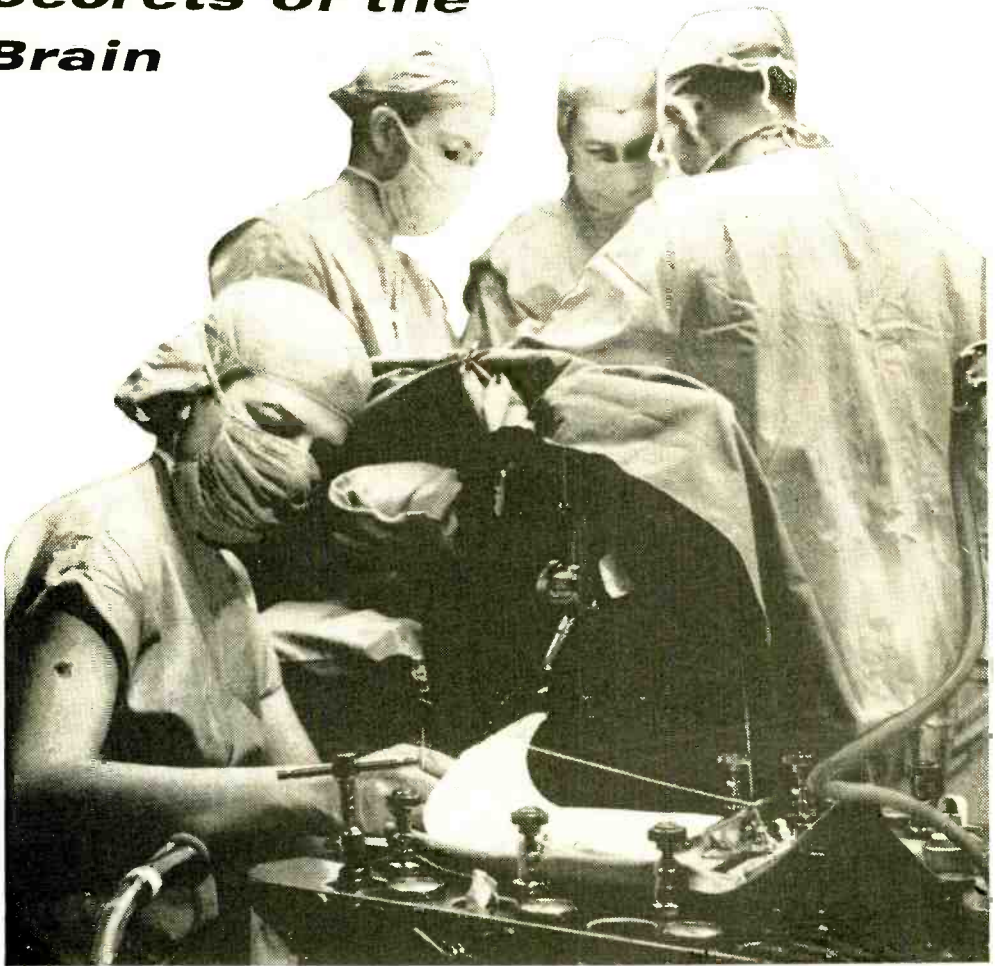

By
R. E. ATKINSON

ONLY THIRTY YEARS AGO the German neurologist, Hans Berger, placed electrodes to the scalp and measured the electrical voltages produced by the brain. He found potentials of about 30 millionths of a volt. The output was in wave form now called *alpha* rhythm. Later other rhythms were discovered, called *beta*, *delta*, *kappa*, and *theta*. These are the coded messages of the brain.

Researchers were trying to unravel the complex workings of the brain with only about 1%, or less, of the brain mechanism open to their inspection. At that time, con-

ventional surface-of-the-scalp-recordings provided only very limited access to the electrical activity of the brain.

Now, with the growing science of "depth electrography," this is no longer true. Scientists are learning to probe the inner brain itself by the use of delicate, hair-thin microelectrodes. This penetration of the brain, with its constellations of 10 billion nerve cells, is hardly less dramatic than the

Conventional electroencephalography, as shown here, will continue to be useful. However, depth electrography provides much better information concerning the operation of the brain.

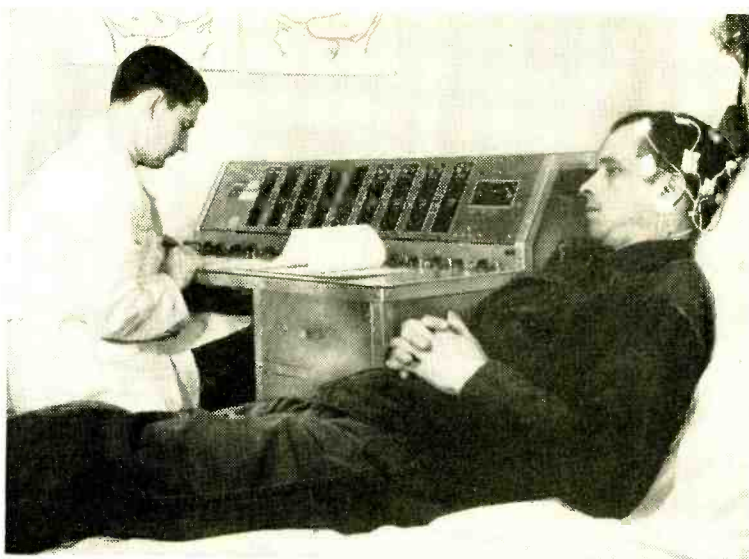

probes of outer space, for no universe is more important to man than the inner universe of his mind.

Work on depth electrography started, of course, with animal experimentation, and this is still continuing. One laboratory, for example, has fed a monkey a miniature radio receiver and a system devised to stimulate electrodes in the animal's brain. With the radio receiver in the monkey's abdomen and a stimulating electrode in the brain, a localized epileptic seizure can be produced at will by pulsing the transmitter. It is sometimes possible to locate the origin of certain types of epilepsy in the brain. This experimental work with monkeys should bring a new understanding of epilepsy in humans and may one day enable this dread affliction to be eliminated.

Application to Humans. As familiarity with the techniques of depth electrography has increased, work has been extended to include human patients. The Rochester State Mental Hospital reported several months ago, for example, that depth electrography had been employed with 90 psychotic patients and the electrical activity of the brain had been recorded through 3254 intracerebral micro-contacts. The findings are important to the understanding of the mechanisms of the central nervous system of healthy people as well as those who are ill.

Some researchers use 40-gauge stainless steel wires, since both copper and silver

may be toxic to the brain. As many as 12 such wires can be stranded together, the tip of each wire being bared. A commonly employed electrode has eight such contacts. Maps showing location of internal brain structures aid in the placing of the electrodes. When the electrodes have been implanted, recordings are produced with a conventional electroencephalograph. The various waveshapes include spikes, sinusoidal waves, spike-and-wave patterns and rhythmic repetitive waves of frequency ranging from 2 to 20 cps, and to amplitudes up to 1000 microvolts.

In one series of tests, investigators found that the brain of one psychotic female patient produced unusual patterns of electrical activity which always indicated that she was having an imaginary discussion with General MacArthur, or with Napoleon, and she was urging him not to do violence to her doctors.

Slow *delta* and *theta* rhythms (4 to 7 cycles) peculiar to infants and children may be recognized in an adult whose mental development has remained at a child's level. Perhaps, in time, it will be possible to know what many more patterns of electrical signals from the brain actually mean.

Feedback Circuits. As a step toward understanding the functions of various areas of the brain, scientists at Johns Hopkins University have been employing depth electrography to chart the feedback circuits involved in the coordination of electronic

messages between the cerebellum and corresponding control centers in the cerebral cortex. They report that these circuits seem to have much in common with man-made electronic brain systems. Cybernetics, the comparative study of the control system of the brain and electronic communication and control equipment, will undoubtedly benefit by the detailed tracking of neural-electrical pathways being accomplished at Johns Hopkins.

The action of stimulants and tranquilizers on the brain can sometimes be inter-

preted by means of the signal patterns picked up by micro-electrode brain contacts. Small plastic skull "buttons" have been used to keep electrodes available for two years or more in some patients to aid in such studies.

that she was actually seeing herself give birth to her baby girl more than twenty years before. Since then many patients have reported what apparently has been the direct stimulation of different memory centers and the release of energy—in the form of recollections.

The new frontier in brain wave recording is opening an almost infinite universe for exploration. New findings should improve the accuracy of brain surgery, and lead to an understanding, perhaps not of *what* we think, but of *how* we think. —50—

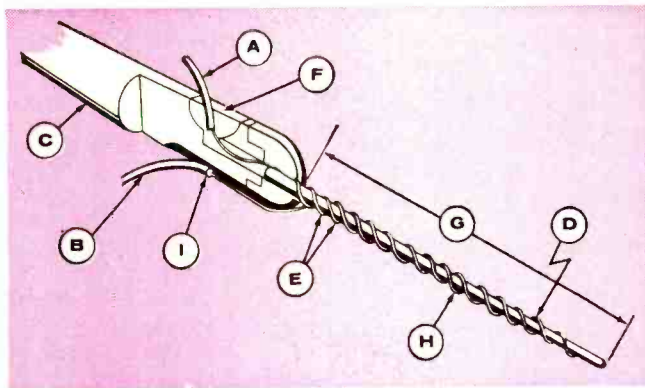

The micro-electrode is a quartz rod in Plexiglas holder. Two wires are used, one to measure voltage, the other to apply current. Components: (A) current wire, (B) voltage wire, (C) plastic handle, (D) quartz rod, (E) wire, 20 microns in diameter. Current wire is joined to heavier wire at (F). Quartz rod is 6 cm. in length (G), its maximum diameter (H) 130 microns. At point (I), 20-micron wire connects to heavier wire.

Currents Induced. When, instead of measuring the electrical impulses coming out of the brain, the scientists have introduced man-made currents into the brain, strange things have happened. One patient heard music—the same tune each time the stimulus was applied. And a child reported that he heard his playmates calling for him to come and play.

One of the leaders in the use of cerebral stimulation studies in probes of the physiology of memory is Dr. Wilder Graves Penfield of the Montreal Neurological Institute, Canada. He found that stimulation of the temporal cortex led to highly complicated and organized thought patterns involving memory. During an operation Dr. Penfield used electrical stimulation in an attempt to find the abnormal area involved in a focal epileptic seizure. The patient exclaimed

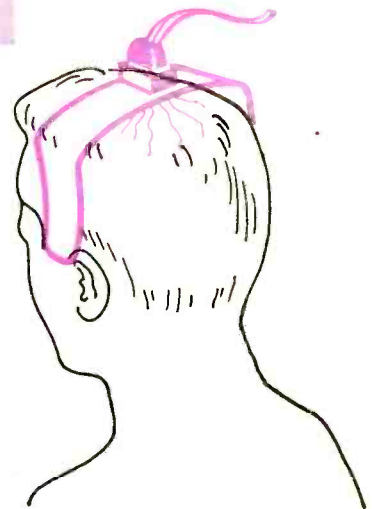

Plastic headpiece with miniature connector is used to facilitate the study of brain-wave activity over a period of time. Headpiece is taped to scalp for support. Sometimes connector is attached to head by means of a cloth stocking.

By
DON LEWIS

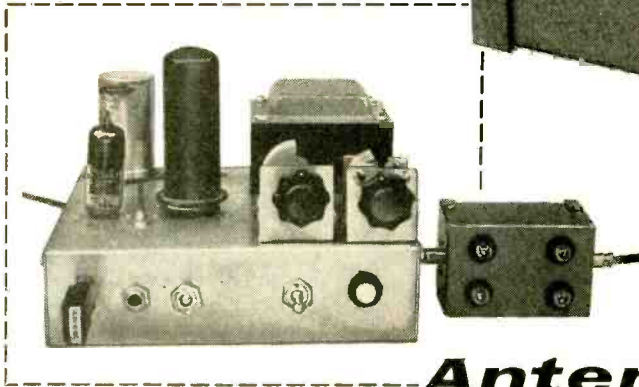

Antenna Load Box

**Tune your rig
with this simple
antenna current indicator**

DID YOU EVER call "CQ" until you were blue in the face without getting a single answering peep? Probably every ham in the call book, not excluding myself, has had this unhappy experience. You get to wondering after a while whether your signal has halitosis or your antenna has "bitten the dust."

There are several reasons for not "getting out," among them: (1) poor band or weather conditions; (2) stations on your frequency causing QRM (interference); (3) incorrect transmitter tuning. In addition, Mother Nature can be fickle at times and arrange the ionosphere so that you couldn't even twitch local S-meters with "lebenty-zillion" watts shooting up your antenna. When this happens, better turn off the gear and catch up on your studies!

The "Load Box" is intended to take at least one of the unknowns out of the situation. When you make friends with this amazing device, and learn to understand what it is telling you, I am sure the number of your QSO's (contacts) will go up rapidly. The Load Box can tell you exactly when your transmitter is properly tuned, and if the antenna is taking power from the transmitter and radiating it.

Looking at the Load. Ideally, your antenna should look like a perfect resistance to your transmitter. If you have a dipole (any band) and feed it with 72-ohm coaxial cable, it will act like a 72-ohm resistor connected across your transmitter's antenna terminals. To check antenna performance, purchase or make up a 72-ohm resistor whose wattage is equal to half the power input of your transmitter. For a rig similar to the DX-35 (or DX-40), ten 1000-ohm, 2-watt resistors connected in parallel would be about right.

Connect your antenna feeder to either jack of the Load Box and plug in the re-

sistor load to the other. Then energize the transmitter and load the dummy antenna (the resistors) by dipping the plate current as you ordinarily do. Mark down the settings of the plate and antenna tuning knobs and note the brilliancy of the bulbs.

Now remove the resistors, reconnect your

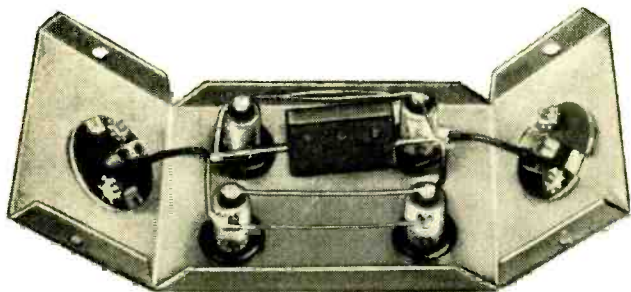

Side panels of cabinet have been folded down only to show internal wiring of Load Box. Note use of rubber grommets to hold pilot lamps and how the wires are soldered directly to the bulbs.

antenna, and fire up the transmitter again. Check to see if the knobs must be reset for proper tuning, and if the bulbs are noticeably dimmer than before. If things haven't changed too much, it indicates that the antenna is working properly. If the settings and bulb intensity do change, it indicates that the antenna is too short, too long, or that the transmission line is of the wrong impedance.

Tuning the Transmitter. The greatest value of the Load Box is in tuning up the transmitter. Two or three more "S" units can be obtained by tuning the entire transmitter for maximum bulb brilliancy—which indicates that all the available power is going up to the antenna.

Often you will find that maximum power output occurs at an entirely different power input than the one specified in the instruction manual. One particular brand of transmitter puts out 25% more power when run at 10 watts less than the specified power input! That extra 25% might make the difference between a solid QSO and a lost contact.

If you prefer, the Load Box can be left in your transmission line circuit to indicate when something goes wrong. I remember one time when my signal reports dropped off abruptly but the meter on the transmitter indicated that everything was normal. A check of the Load Box showed the bulbs

PARTS LIST

- C1—.01- μ fd. mica capacitor (see *How It Works*)
- PL1, PL2, PL3, PL4—#44 pilot lamp
- 1—1 $\frac{1}{8}$ " x 2" x 3 $\frac{1}{4}$ " chassis box (Bud C-2101 or equivalent)
- 2—Phono jacks (RCA type)
- 4— $\frac{1}{2}$ " rubber grommets
- 4—4-40 nuts, bolts, and lock washers

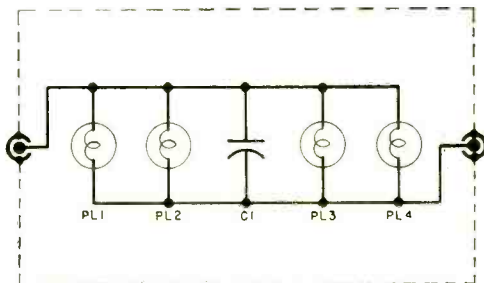

to be considerably dimmer, and inspection of the antenna immediately revealed the source of the trouble. The branch of a tree was rubbing on one side of the dipole. A tree-trim job brought the signal reports back up to normal fast—thanks to the Load Box.

—30—

HOW IT WORKS

The Load Box consists of four pilot lamps connected in series with your antenna transmission line. The "juice" that you are pumping up to the antenna must pass through these bulbs. When it does, it causes them to light and hence provides a continuous indication of the amount of power going up to and being radiated by the antenna.

Capacitor C1 detours some of the power around the bulbs so that they will not overload. The size of C1 will be determined by the power input of your transmitter. If the Load Box is used in conjunction with 65-watt rigs, such as the Heath DX-35, an .01- μ fd. mica capacitor is about right. For transmitters in the 30-50 watt class, a .005- μ fd. disc ceramic should be used. For less than 30 watts, a .001- μ fd. disc ceramic will do.

Remove the Load Box from the transmission line once your transmitter has been adjusted if your power input is less than 10-20 watts. It takes about 2 watts to light the bulbs to full brilliancy and this power will do more good in the antenna than in the bulb filaments.



HOT
and
COLD

ELECTRONICS

New applications for thermoelectricity

A REFRIGERATOR that can fit into a car's glove compartment, a cold drawer in the night table to store those evening snacks, an air conditioner no thicker than a window frame, a silent vibrationless kitchen refrigerator that never wears out—these dreams of the future may soon become reality to every housewife, thanks to the first practical application of an old principle: thermoelectricity.

Thermoelectricity, as used in electronic refrigeration, is a new approach to cooling. Gone will be the bulky kitchen refrigerator, with its current-consuming electric motor, compressor, and coils. In its stead will come thermoelectric cooling junctions, small ceramic units which will chill silently and instantaneously at the flick of a switch.

Other completely new housewares which thermoelectricity may make possible are: a combination electric heating or cooling pad

or blanket, a refrigerated mixing bowl, a portable refrigerator, cooling coasters, photo developing trays, water coolers, cooled drawers for storing vegetables and other foods, frozen storage drawers and cabinets, mothproof drawers and closets for furs and woolens, and combination freezer-cookers. Also possible is a design for an air dehumidifier working on the thermoelectric principle.

Refrigerator . . . or Oven. Locked in the laboratory since its theoretical discovery in 1834, a practical method of electronic refrigeration has long been the goal of scientists throughout the world. The principle is simply that passing electricity through a junction of two different materials creates a cold section at the junction. Only recent research by the Westinghouse Electric Corporation has produced semiconductor materials efficient enough



Refrigerator of the future (on facing page) draws cold directly from electricity with no moving parts, noise or vibration. The new thermoelectric cooling device allows separate temperature drawers for frozen foods and vegetables, as well as a regular refrigerator compartment.

Patterned wall panels will heat, cool, and light tomorrow's home. The anodized aluminum patterns are thermoelectric heating-cooling surfaces, superimposed on an electroluminescent light screen. Both color and temperature can be selected just by the twist of a knob.

by
SIMON DRESNER
Associate Editor

for practical applications. Simple to control, and with no moving parts to cause noise or vibration, the newly developed thermoelectric junctions are capable of instant temperature change.

But most amazing of all is the fact that if the current is reversed, the junction material *heats* instead of cools, turning a refrigerator into an oven.

Thermoelectric Power. The most important use of thermoelectricity may be in generating electric power for homes and industry. The new thermoelectric materials which become hot or cold when electrified can also generate electricity when heated by some outside source. The heat from a coal fire or nuclear reactor may heat thermoelectric junctions, which would in turn generate electricity. There would be no intermediate mechanical apparatus to waste energy and wear out.

Thermoelectric power can be considered as electrons pumped by heat, just as thermoelectric refrigeration is heat pumped by electrons. The thermoelectric generator may find its best application where simplicity, ruggedness, and high-temperature operation are more important than top efficiency. New materials have been developed which promise thermoelectric power generation at temperatures up to 2000°F. At present, efficiencies of 10% have been realized, with 20 to 30% anticipated.

Electron Distribution. Thermoelectricity is made possible when two different materials are joined together and subjected to a temperature difference. The junction of the two materials must be able to conduct electricity as well as the flow of heat. When such a junction is heated so that the two materials are at different temperatures, the distribution of electrons at the junction

changes, and an electric current will flow across it.

Figure 1 shows the distribution of electrons in an ideal material heated at one end. Electrons are normally evenly distributed but when one part of the material is heated, the electrons tend to leave the warmer side

used to pump heat, because each electron carries with it a certain fraction of the heat contained in the entire material. As it moves from the warmer portion to the cooler, it carries with it a quantity of heat as well as its unit of charge.

If an electric current is forced through

Photographs and Diagrams Courtesy of Westinghouse Electric Corporation

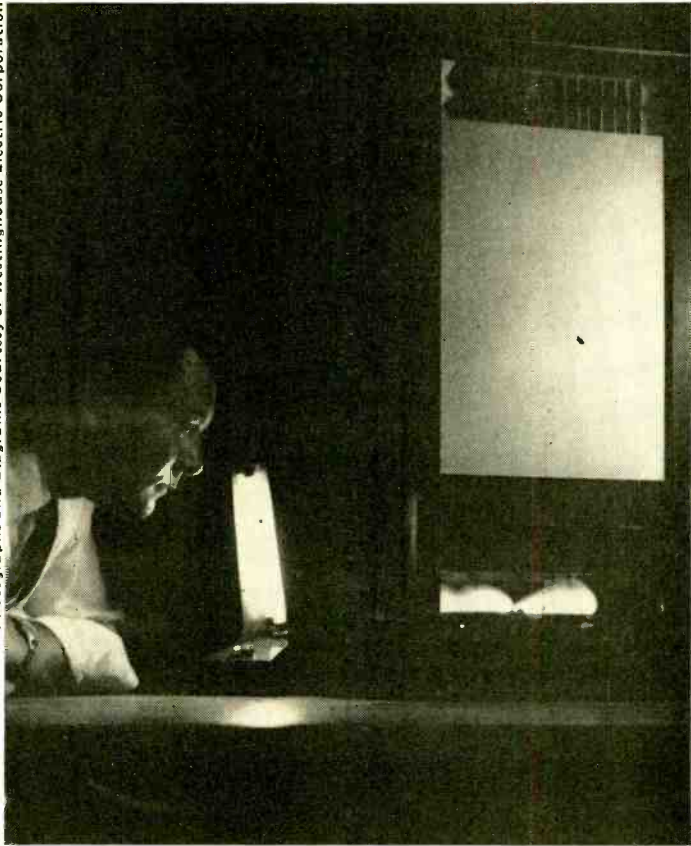

Thermoelectric generator delivers electric power directly from heat. The heat from two gas burners generates ten watts of power in the thermoelectric cells above them, enough to light the fluorescent lamp.

and concentrate in the cooler portion. This means the material is now electrically polarized, with the cooler side negative due to the excess of electrons.

If two materials in which electrons move at different rates are joined together and the circuit closed by a wire, as in Fig. 2, then heating the junction will cause electron flow.

The Electron Pump. Now thermoelectricity is a reversible phenomenon. This means that if heat can be used to pump electrons, then moving electrons can be

the junction, by means of a battery, as in Fig. 3, heat will be pumped. The electrons carrying heat from one place to another will result in a cooling effect across the junction, and the heat that they carry will ultimately be delivered to the opposite ends of the materials.

This describes thermoelectric power—electrons pumped by heat, and thermoelectric refrigeration—heat pumped by electrons.

Simple Semiconductors. There are three types of materials which show thermo-

electric properties; metals, which have a sufficient number of free electrons to be good electrical conductors; semiconductors, where the number of electrons is intentionally restricted; and insulators, where there are so few electrons that electrical conduction is poor. However, the insulators have

Fig. 1. Thermoelectric action occurs when thermoelectric material is heated. The electrons move and accumulate on the cooler portion.

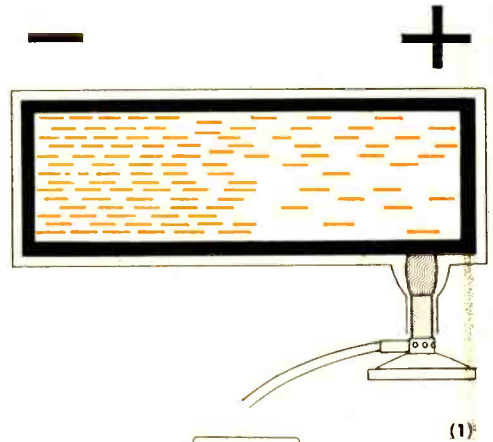
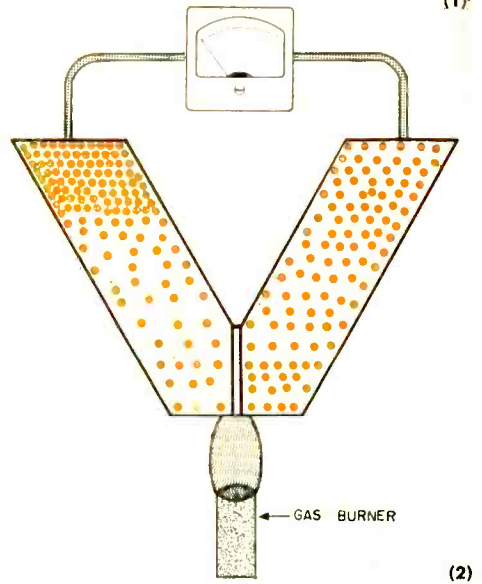

Fig. 2. Thermoelectric junction is between two materials which move electrons at different rates. When junction is heated and the circuit closed by a wire, current will flow.

Fig. 3. Thermoelectric refrigeration occurs when the current is forced through the junction by a battery. The moving electrons carry heat, cooling the junction and heating the ends of the material.



the highest thermoelectric voltage, definitely a desirable trait for power generation.

The best materials for thermoelectric refrigeration are the semiconductors, the same class of materials that transistors are made of. They include compounds of such common metals as iron, nickel, and manganese. In fact, the essential ingredients in these new thermoelectric compounds are as common and easy to obtain as those in a dinner plate. Being ceramics, they are chemically stable and inactive even at very high temperatures. They can be heated indefinitely in air without deteriorating, they are simple to prepare, and their practical use requires only the simplest electrical circuits.

Hot, Cold, and Bright. The house of the future will be heated, cooled, and lit, by a single hot-cold panel. Such a panel will combine electroluminescent materials which glow when electrified with thermoelectric materials which both heat and cool. Without moving parts, a one-square-foot panel will produce as much light as a 25-watt bulb, maintain a temperature approaching that inside a household refrigerator and, by the flick of a switch, raise that surface temperature to about 130°F—for radiant heating.

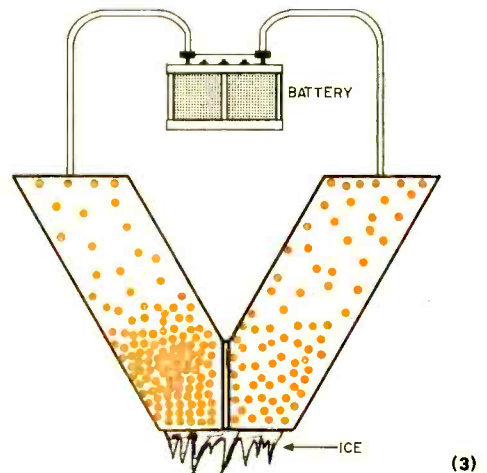

Crystal Oscillator Circuits

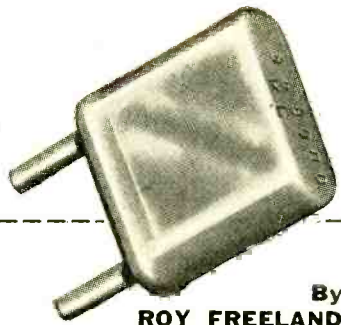

By
ROY FREELAND
Chief Ham Engineer
International Crystal Mfg. Co.

Here are three selected and pre-tested r.f. oscillator circuits which are guaranteed to work. These are good basic circuits to use in transmitter oscillators and VFO circuits. Care should be used during construction and wiring. Keeps leads short, and shield adequately.

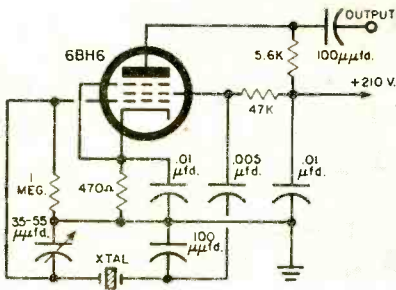

70-200 KC:

This circuit includes a variable capacitor for precise adjustment of the crystal frequency. It offers a load capacitance of 32 μfd . to the crystal and may be used for frequencies up to 10 mc.

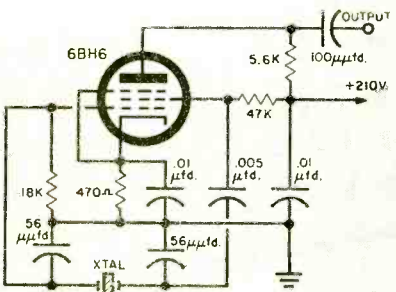

200-20,000 KC:

Room temperature stability of a few cycles can be obtained with this circuit. Driving power will average about 5 milliwatts.

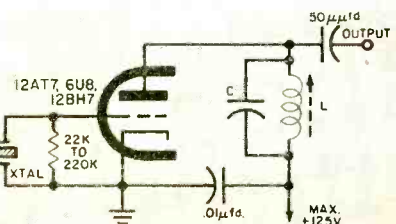

10-60 MC:

Third mechanical overtone operation requires a tuned output circuit. This circuit is simple to construct and will operate up to 60 mc. on third overtone crystals with reasonable output. Compute C and L using the equation: $f = 1/2\pi\sqrt{LC}$.

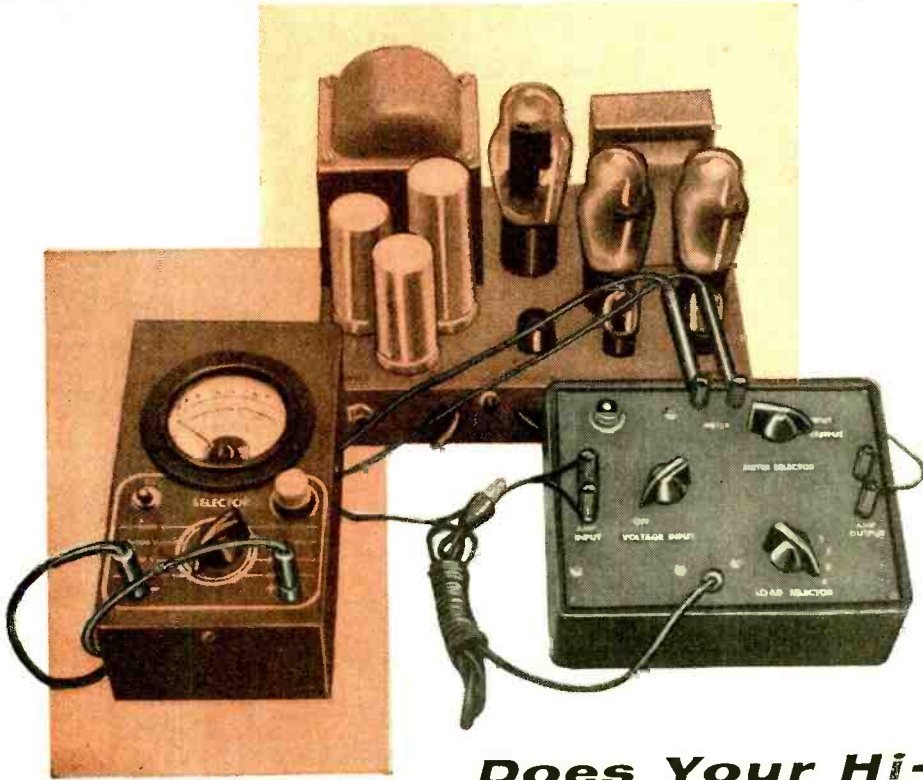

Does Your Hi-Fi Sound Too Soggy or Crisp?

Check Your **DAMPING FACTOR**

NO ONE in hi-fi seemed to care very much about amplifier damping factor until Mr. Villchur of Acoustic Research specified that his AR-1 speaker system worked best with a damping factor of 1. Then the storm broke! All the experts—the hi-fi writers, the manufacturers of amplifiers and the designers of loudspeakers—each contended that he had the truth of the matter within his grasp and the proper damping factor was, variously, “1,” “15,” or even “-10.” Variable damping factor controls appeared as an integral component on some chassis, or were available as accessories on others. And the controversy still rages. . . .

We do not propose to debate damping factor now (see July 1957 issue of POPULAR

May, 1959

By
JAMES A. FRED

ELECTRONICS), but we are going to describe a small test unit that makes it *quite* easy to measure the “DF” of any amplifier.

The DF test unit contains a voltage source which connects to the input of the amplifier and a variable load that connects to the output of the amplifier. A separate a.c. voltmeter is used to measure “full” and “no load” voltages. Since the input to the amplifier is shunted by a 500-ohm control (R_1), and the output is low impedance, use either a VTVM or standard VOM.

When the DF unit is completed, connect

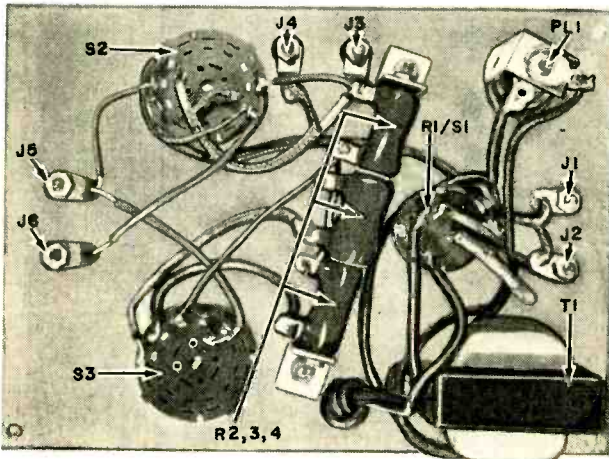
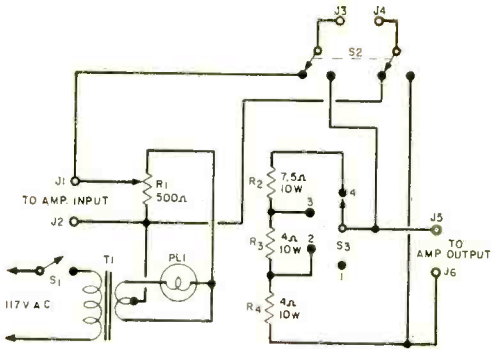

PARTS LIST

- J1-J6—Five-way insulated binding posts (three red and three black)
- PL1—Pilot light assembly with #47 bulb
- R1—500-ohm potentiometer (with s.p.s.t. switch)
- R2—7.5-ohm, 5-10 watt wire-wound resistor
- R3, R4—4-ohm, 5-10 watt wire-wound resistor
- S1—On-off switch (on rear of R1)
- S2—D.p.d.t. rotary switch (Mallory 3222J)
- S3—S.p.s. 5-pos. rotary switch (Mallory 3215J)
- T1—Filament transformer, 6.3-volt, 1-amp., center-tapped secondary
- 1—5 1/4" x 6 3/4" x 2 1/4" Bakelite cabinet with panel

the voltmeter to the meter terminals. Turn the *Meter Selector* switch to the input position. Plug the line cord into a wall socket and turn the instrument on. The *Voltage Input* control (R1) should give you a range of zero to about 4 volts a.c. To check the load resistors and switch wiring, connect an ohmmeter to the *Amp. Output* terminals; you should read 4, 8, and 16 ohms as the *Load Selector* switch is rotated.

You can measure the damping factor of an amplifier by the following steps:

Step 1. Using a shielded lead, connect the input jack of your basic amplifier to the

Amp. Input terminals of the DF unit. If an integrated amplifier is to be tested, plug into the *Tuner* jack and set tone controls for "flat."

Step 2. Connect the 16-ohm output terminals of your amplifier to the *Amp. Output* terminals of the DF unit.

Step 3. Connect an a.c. voltmeter to the *Meter* terminals. Set the *Meter Selector* switch to *Output* and the *Load* switch to position 1. Turn on the amplifier and set its gain control, if present, about half-way up. Allow the amplifier to heat.

Step 4. Turn on the DF unit and slowly advance the *Voltage Input* control until the voltmeter reads one volt.

Step 5. Connect a 20-ohm variable resistor across the *Amp. Output* terminals and adjust it until the meter reads 0.5 volt. Disconnect the resistor and measure it with an ohmmeter. This resistance equals the internal impedance of the amplifier.

Step 6. To convert this figure into the damping factor of the audio amplifier, divide 16 (the output impedance of the amplifier) by the internal impedance of your amplifier (found in *Step 5*). The answer will be the damping factor of the amplifier.

There is another method for measuring DF that will crosscheck your results.

Steps 1 through *3* are the same as above.

Step 4. With the *Meter Selector* switch set to *Output*, turn the *Voltage Input* control until the voltmeter reads 2 volts. Label this voltage *E1*.

Step 5. Turn the *Load Selector* switch to the position that corresponds to the impedance of the amplifier tap you are using. Now, record the new voltmeter reading as *E2*.

Step 6. The formula for DF is: $DF = E2 / (E1 - E2)$

Several amplifiers were checked using both methods, and the results were nearly the same. Effects of different audio test frequencies were also checked. The same results were obtained with 60-cycle line frequency and 8000 cycles.

This DF unit won't resolve the high vs. low damping factor argument, but it will let you know what position *your* amplifier holds in the controversy.

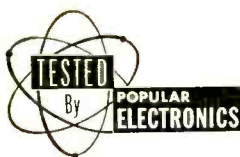

**POPULAR
ELECTRONICS**

**Builds a
Vacuum-Tube Voltmeter**

**Printed-circuit board makes the RCA VoltOhmyst
an easy-to-assemble kit**

THE FIRST PIECE of quality electric test equipment you should have for your test bench is a vacuum-tube voltmeter. A VTVM found in service shops and industrial plants throughout the country, the RCA "VoltOhmyst," Type WV-77EK, is now being offered in kit form.*

What It Can Do. The VoltOhmyst WV-77EK measures a.c. (r.m.s.) and d.c. voltages up to 1500 volts, peak-to-peak voltages to 4000 volts, and resistance up to 1000 megohms. There is a high input impedance on all d.c. and a.c. voltage ranges, allowing the use of this VTVM in circuits where VOM's with a lower input impedance would result in loading of the circuit under test—and a resultant error in voltage reading.

The VoltOhmyst utilizes a push-pull balanced d.c. bridge with the meter in the

plate circuit, which affords excellent linearity of response, good stability, and very high input impedance. Additional features include: provision for zero-center indication, useful in discriminator and bias meas-

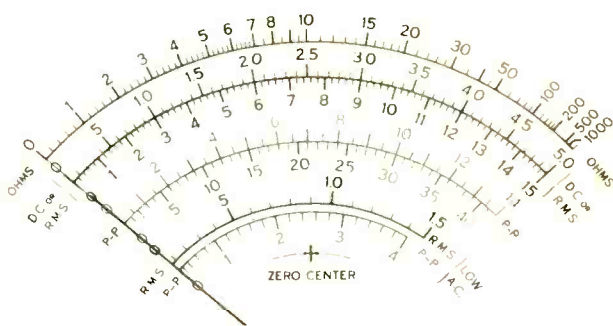

Large, clear meter face permits quick, accurate readings.

urements; separate scales for low a.c. voltage measurements to assure accurate readings; a circuit design which allows measurement of a.c. in the presence of d.c. and vice versa; a separate d.c. probe with a 1-megohm resistor which minimizes capacitance-loading effects; and electronic

* For complete information on the VoltOhmyst, write to Radio Corporation of America, Commercial Engineering Dept., Section PE-10, Harrison, N. J.

protection against meter burn-out. Also, the resistors in the ohmmeter ranges are protected by a separate fuse.

Putting It Together. The WV-77EK utilizes a printed-circuit board to facilitate assembly. This board provides a rugged, pre-wired mounting for the components and, if the parts are properly inserted and soldered, makes for a neat and trouble-free assembly.

The symbol number of the part to be mounted is printed on one side of the board,

the leads to the copper foil, cut them to 1/8" from the board.

Recommendations. The instructions for assembling and wiring the VoltOhmyst have been carefully thought out and presented in seven major construction steps. The POPULAR ELECTRONICS editor who assembled the VoltOhmyst makes the following recommendations.

- Insert *R14* as the first substep in Step 2. This section of the printed circuit is crowded. Installing *R14* first will permit you to

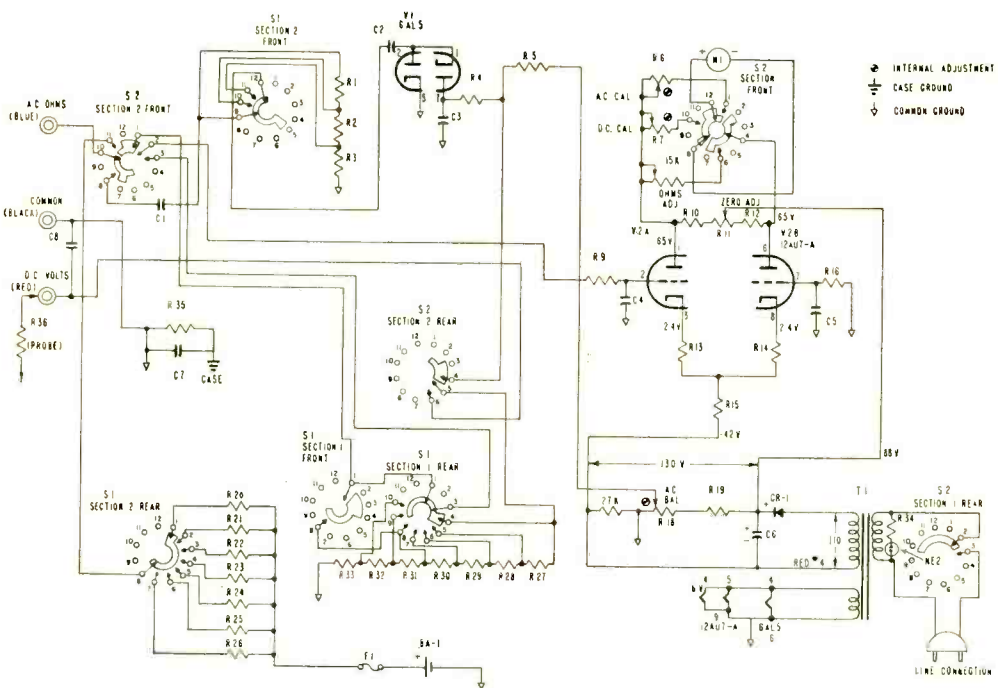

The VoltOhmyst uses a time-proven RCA circuit for optimum results.

and the copper wiring is etched on the other side. When the assembly instructions call for mounting a part, make sure the leads of the component form a right angle to the body of the part. The leads, when properly bent, form the two long portions of a "U" shaped unit, the bottom of the "U" matching the dimension between the two holes. Some parts, such as the disc capacitors, tube sockets and the selenium rectifier, do not require bending.

Place the leads in the holes provided and pull the part snug to the board, so that the leads protrude on the etched side of the board. Spread the leads slightly to prevent the part from falling out. After soldering

mount the adjoining components with ease.

- After mounting the two snap-in sockets on the printed-circuit board as instructed in Step 2, be sure to solder each connection point as instructed. Do not be fooled into thinking that these connection points make a good electrical connection.
- When connecting *R10* to the printed-circuit board in Step 4, do not cut the leads. Otherwise, wire must be added to reach a connection point later on.
- In Step 4, the instructions call for tinning the negative and positive terminals of the dry cell. When doing this, be careful not to apply too much heat with the soldering iron. Excessive heat will damage the cell.

Calibration. The instructions state exactly how to calibrate the VoltOhmyst.

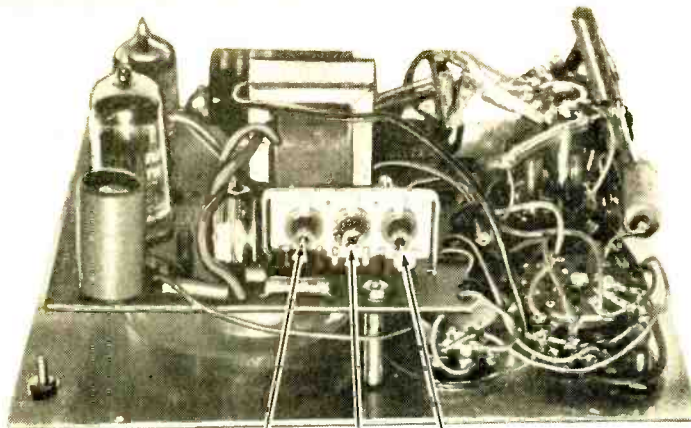

R18 AC BAL R7 DC CAL R6 AC CAL

After calibration, our model was checked against laboratory standards. All scales except the a.c. ranges were found to be accurate to within 3%. The a.c. ranges were off because the home 117-volt a.c. power line was used as an a.c. calibration voltage. Unfortunately, home a.c. power line fluctuates throughout the day. Night voltage could be as high as 122 volts, but when the power demand is high, the line voltage often drops to 105 volts.

In general, the calibration procedure permits satisfactory calibration for most servicing purposes.

Comment. The VoltOhmyst assembles without difficulty, works nicely, is fairly rugged, and has ample accuracy for most practical work. The meter face is large, calibrations are fairly easy to read, and the

Completely wired unit is at left. Note the three internal adjustment potentiometers. Diagram below is from the construction sheet. Well planned illustrations reduce complex wiring to a simple task.

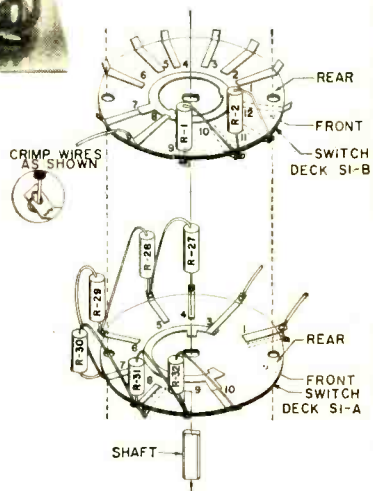

knife-edge pointer permits readings with good accuracy. This reliable measuring device will prove extremely useful in television and hi-fi repair as well as in many industrial applications.

-50-

Ohm's Law Wheel

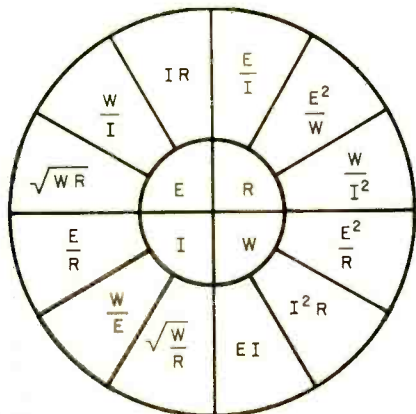

Has Ohm's law got you going around in circles? Take a look at the wheel at left and rotate no more. All of the Ohm's law equations are arranged in one simple, easy-to-read grouping. Simply select the desired unknown (E , I , R or W) from the inner circle of the wheel, then scan its quarter of the outer circle for the one of the three available equations that applies.

Of course, you can work in the other direction if you have any two known values. For example, if I and R are known, then the wheel indicates that the equation with which to find W is I^2R . If you want to find E , it's IR .

—Henry L. Weisberg

Popular Electronics

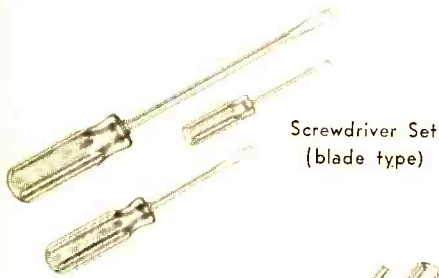

Screwdriver Set
(blade type)

Phillips Screwdriver

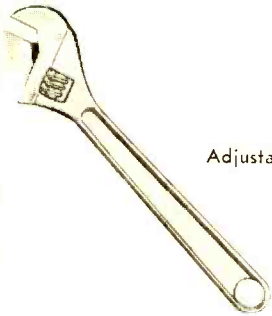

Adjustable End Wrench

Needle-Nose Pliers

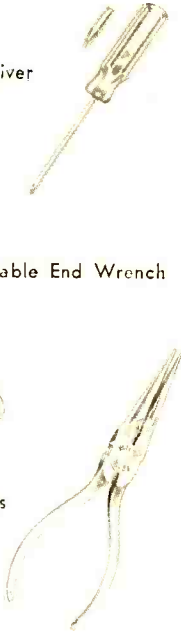

Diagonal-Cutting Pliers

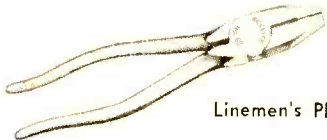

Linemen's Pliers

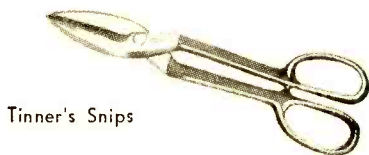

Tinner's Snips

FAR TOO OFTEN tools are acquired in a haphazard manner without thought for quality or future needs. POPULAR ELECTRONICS has prepared a recommended tool list for the four basic groups who work or experiment in electronics. They are: (1) the kit builder who requires only a few basic tools; (2) the project builder who constructs the P.E. do-it-yourself items; (3) the radio-television service technician; and (4) the electronic experimenter who designs and constructs electronic gear. Each group has its own requirements.

TOOLS RECOMMENDED

Needle-Nose Pliers

Bent Long-Nose Pliers

Linemen's Pliers

Diagonal-Cutting Pliers

Slip-Joint Pliers

Wire and Cable Stripper

Screwdriver Set (blade type)

Phillips Screwdriver

Offset Screwdriver

Jeweler's Screwdriver Set

Locking Plier Wrench

Adjustable End Wrench (open to $\frac{7}{8}$ ")

Combination Wrench Set ($\frac{7}{16}$ " - $\frac{3}{4}$ ")

Socket Wrench Set ($\frac{1}{4}$ " - $\frac{7}{16}$ ")

Setscrew Wrench Set (Allen type)

Hand Drill

Electric Drill, $\frac{1}{4}$ " Geared-Key Chuck

Electric Drill, $\frac{3}{8}$ " Geared-Key Chuck

Drill Set, High-Speed

Electric Drill Stand

Circle Cutter (for drill)

Center Punch

Recommended Tool List

When purchasing tools to satisfy your workshop needs, always remember that quality tools will do a quality job—for a lifetime. Far too often, a hacksaw, pair of pliers or a drill purchased for 88 cents does a grand job—for about a week. Then the dented dull tool is dropped to the bottom of the junk box as a memento of 88 cents dropped down the drain.

The following tool list gives both essential tools and optional tools for each group of users. The essential tools are shown in color, the optional ones in black.

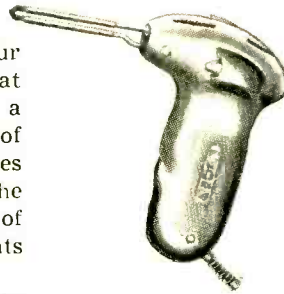

Soldering Gun



Slip-Joint Pliers

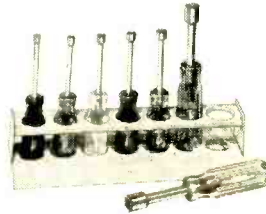

Socket Wrench Set

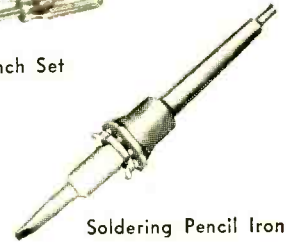

Soldering Pencil Iron

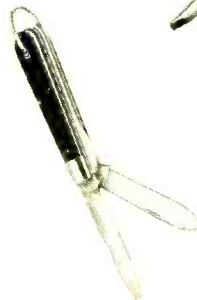

Electrician's Knife



Tweezers



Chassis Punches

Kit Builder	Project Builder	TV-Radio Service Technician	Electronics Experimenter
●	●	●	●
	●		●
●	●	●	●
●	●	●	●
●	●	●	●
●	●	●	●
●	●	●	●
●	●	●	●
	●	●	●
	●	●	●
	●	●	●
	●	●	●
●	●	●	●
	●	●	●
●	●	●	●
●	●	●	●
●	●	●	●
	●	●	●
	●	●	●
	●	●	●
	●	●	●
●	●	●	●
	●	●	●
	●	●	●
	●	●	●
	●	●	●

Recommended Tool List

TOOLS (continued)	Kit Builder	Project Builder	TV-Radio Service Technician	Electronics Experi- menter
Chassis Punches		●	●	●
Plastic Alignment Tools	●	●	●	●
Allen (Hex) Wrench Set	●	●	●	●
Bench Vice, Swivel Base		●	●	●
Bench Vice, Clamp-On Base		●	●	●
Drill Press Work Holder			●	●
Flat Bastard 8" File	●	●	●	●
Round Bastard 6" File	●	●	●	●
Slim Taper 6" File	●	●	●	●
File Cleaning Brush		●	●	●
Hacksaw (for 10-12" blades)		●	●	●
Hacksaw Blade (32 teeth/inch)		●	●	●
Try and Miter Square		●		●
Scratch Awl		●	●	●
Dividers (6" wing)		●		●
Tinner's Snips		●	●	●
Reamer (1/4"-1/2")		●	●	●
Electrician's Hammer		●	●	●
Steel Tape, Power Return	●	●	●	●
Soldering Gun	●	●	●	●
Soldering Iron (100-150 watts)	●	●	●	●
Soldering Pencil Iron (30-40 watts)	●	●	●	●
Inspection Mirror	●	●	●	●
Tweezers	●	●	●	●
Straight-Cut Snips		●	●	●
Electrician's Knife	●	●	●	●
Bench Brush	●	●	●	●
Soft Brush	●	●	●	●
Tool Box	●	●	*	●

*For home calls, a radio-television serviceman requires a tube caddy case.

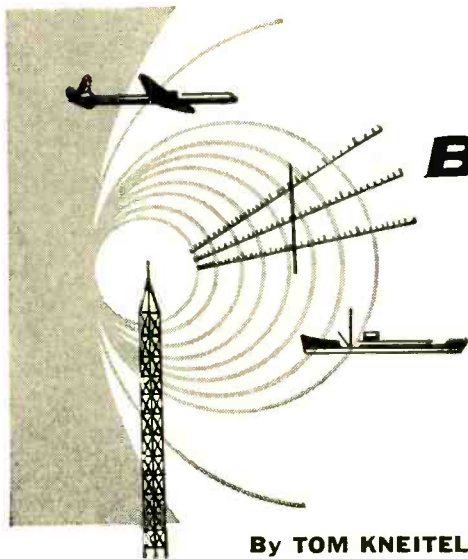

Bandspread

By TOM KNEITEL, WPE2AB

Exploring the corners of the DX bands

WHENEVER some poor guy wants to pep up his c.w. copying speed, he invariably gives his crystal filter and his patience a good workout by squinting and straining to knock out the four stations calling "CQ-DX AC4" on top of his favorite c.w. practice drill station, which happens to be located in "QRM Alley."

Feeling pity for him, his helpful wife tries her fist on his 1944-vintage army key and buzzer set, tapping out a wrist-wrenching 2 wpm. Little does our friend suspect that he can practice-copy every day on the same high-powered, clear-channel commercial station, a station using an automatic tape which sends at a fixed speed every time.

For example, a "regular" who gives out with 16 or 17 wpm is Station WNY, operated by Radiomarine Corp. of America in New York City. This station transmits at 10 minutes past every even hour on 6519.5 kc. and 13,060.5 kc.

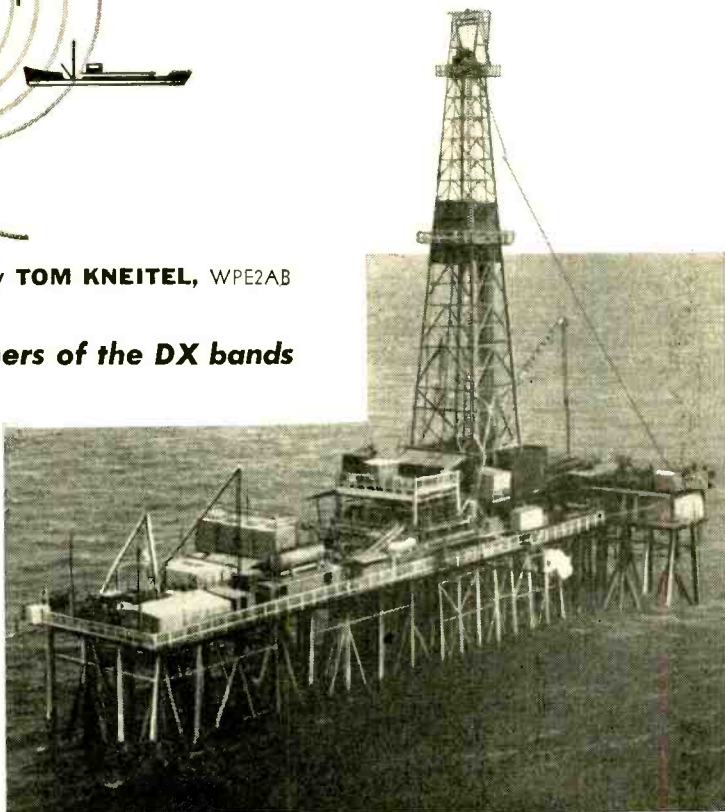

Oil drilling rigs in Gulf of Mexico QSO on FM at 25 mc., and can be heard throughout the United States. Normal power: 50 watts into a whip antenna.

Another old reliable in the 16-17 wpm family is Station WCC, also operated by Radiomarine Corp., but located in South Chatham, Mass. You can snag this station at 50 minutes past each fourth hour, starting at 0050 GMT (1950 EST) on 2036, 4268, 6505.5, 8586 and 12,925.5 kc. They drop the 4268-kc. channel and add 17,271.2 kc. for their 1250, 1650, and 2050 GMT broadcasts. You can't miss their ten-ton signal; it stands out like a basketball player at a midget's convention.

For those ready for a slightly higher speed, a dandy station to copy is WHD,

Old-time radio shack aboard tanker is typical of the shipboard stations QSO'ing the Marine Operators at Gulf and South Atlantic ports.

operated by *The New York Times*, which is on twice a day broadcasting news to ships at sea. They bounce along at a cool 22 wpm. The sked is: 0500 GMT (2400 EST)—6512 and 13,020 kc.; 1900 GMT (1400 EST)—13,020 and 16,968.8 kc. If you copy them, drop them a card and tell them all about it—they're interested.

Long-Wave Beacons. The long-lost cousin of short wave, long wave, has its share of interesting stations, and you might like to try a few on for size. Beacon Station NSC on 532 kc. (most broadcast-band sets will make it down to this frequency) uses only 25 watts and has been widely reported. This station is at Floyd Bennett Field, Brooklyn, N. Y., and uses a 250' inverted "L" antenna. They would like reception reports.

If your receiver barely makes it down to 532 kc., you can use a crowbar on the capacitor to get it down to 526 kc. where you can hear Station SSC. The U. S. Air Force operates this station at Shaw AFB, Sumter, S. C., and they throw their signal several thousand miles when conditions are good.

Collector's Item. One of the rarer countries, not heard on the air since Alf Landon was in knickers, is Lithuania. They can still be heard from time to time, however, with Station LYG in Kaunas doing the honors on 5940 kc. and approximately 8502 kc. evenings. Transmissions have been of the familiar automatic re-run c.w. call letter tape, at reasonably slow speeds.

Fingers were crossed the day our first reception report and prepared-reply-QSL was sent merrily on the way. The same fingers were also crossed on the occasions of the mailing of second, third, and fourth reports to LYG. Finally, in wild-eyed desperation, a report was sent to a local ham with a letter expressing the hope that he might be able to swing a QSL for us.

You can imagine the goings on here the day the officially stamped and signed paste-board was returned to us, with the words



"Thanks, Tom" scrawled across it in nothing less than Kelly green ink.

Cops and Robbers. It's really amazing how the Monmouth County, N. J., Police Department's radio station KEA317 gets out. Using a mere 500 watts on 2422 kc., they pack a signal so strong that they sound like a local when heard in locations many hundreds of miles distant. No welder's nightmare, their trim 156' antenna tower probably gives the signal that extra zing.

Hearty, QRM- numb old-timers may recall the days when 2-mc. police stations swarmed all over the place. All but a handful have now abandoned these channels for the 30 to 50 mc. and 150 to 170 mc. bands, and today you really feel embarrassed when a visitor to the shack asks the inevitable standard question, "Say Charlie, can you pick up police calls on that thing?"

If you live east of the Mississippi and north of the Mason-Dixon and can't hear this station, you'd best give up the idea of trying to hear DX on a crystal set.

All at Sea. While you are browsing around for KEA317, you will come across their neighbors in the 2400 to 2500 kc. band. The 2406-kc. frequency is busy on both coasts, what with ships QSO'ing the Boston, Eureka (Calif.), and San Francisco Marine Operators. Ships also QSO the

Mobile (Ala.) and Seattle Marine Operators on 2430 kc.

On 2450 kc., the Boston and Galveston Marine Operators hold down the fort. Tampa's Marine Operator comes in like a ton of bricks on 2466 kc., and likewise New Orleans on 2482 kc. The Miami Marine Operator does her operating on 2490 kc. And several other police stations can also be logged here.

As far as c.w. is concerned, there are a few Navy Reserve nets operating in this region, often transmitting practice drills which are very good for anyone trying to jazz up his wpm.

Oil Drilling Rigs. From time to time we are asked about the FM QSO's that are often heard in the 25-mc. range. These signals, which evidently are being received throughout most of the Western Hemi-

over the mumble-jumble, rewarding you not only with self-gratification, but with glimpses of the colorful QSO's between the trawlers.

If you live where 2830 kc. is a "local" frequency, you can take a crack at 2198 or 2126 kc., where ships work harbor telephone stations in the New York, Seattle, San Francisco and Los Angeles areas.

Canadian Clock. Just a stone's throw from the 80-, 40-, and 20-meter bands, many hams and SWL's have long noticed an odd-ball signal consisting of a series of rhythmic modulated "dots," interrupted each minute by a recorded announcement giving the correct EST. This is Station

Code practice at a cool 22 wpm can be had from The New York Times radio room, part of which is shown here. The latest news is broadcast to ships at sea twice a day.



sphere, are used by literally hundreds of oil companies who QSO their drilling rigs from the Gulf of Mexico. All that signal from just 50 watts fed into a whip antenna!

Shrimp Boats. Here's a chance to put that trusty receiver through its paces on some really low powered phone stations.

If you live in the Northern or Western United States, or Canada, tune to 2830 kc. some evening. This is the Gulf of Mexico intership frequency and it is chock full of 35-, 50-, and 75-watters, located on shrimp boats and the like. Through many receivers will come a noise that sounds like a 100-man Swahili talkathon, but a really "hot" set will be able to "sniff out" a better carrier and lay it on your doorstep, right

CHU, run by The Dominion Observatory, Dept. of Mines and Technical Surveys, Ottawa, Ont., Canada.

These signals are for the most part better for calibrating a ham-band bandspread than WWV as they are so much closer to the bands themselves. They are on continuously on 3330 kc. (300 watts), 7335 kc. (3 kw.), and 14,670 kc. (300 watts).

Station CHU is also interested in knowing the extent of its audience, and in lieu of taking a door-to-door poll to find out, they request that you send them reception reports. Recently they have gone "ham" and have started sending out a jaunty blue-and-white block-letter QSL.

-50-

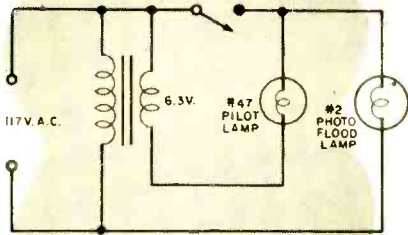

1 Happy Snap, having only an s.p.s.t. switch, wanted to turn on a flood-light and a pilot light on the control board at the same time. Expecting no trouble, he wired his setup as shown. After double-checking his connections, he held his breath and inserted the wall plug. Things didn't quite work out. Do you have any idea why?

—Robert L. Noland

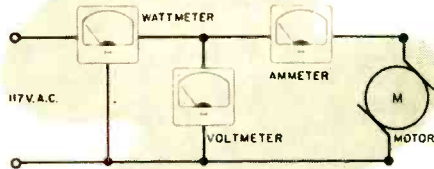

2 Dewey Dubblecheck, who believes in making all measurements twice, connected a voltmeter and an ammeter to measure the power drawn in this circuit. Using the formula: $W = E \times I$, he found that the motor drew 40 watts. He made the measurement again, this time using a standard wattmeter, and read only 30 watts. Dewey is puzzled—are you?

—Donald R. Wesson

Electronic Sticklers

These four thought-twisters are arranged
in order of increasing difficulty

(Answers on page 144)

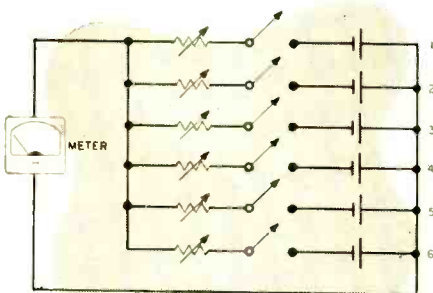

3 Sam Addit made this simple computer to add any numbers from 1 to 6. The resistors were adjusted so that if battery #1 were switched in, the 0-15 voltmeter would read 1, switching in battery #2 would give a reading of 2, and so on. He figured that if a combination like 2 and 5 were used, the meter would read 7. What did it actually read?

—Hal Carlson

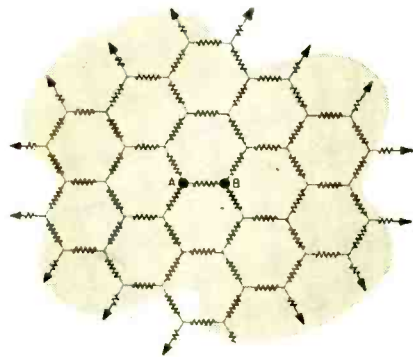

4 Ned Work has a mesh of 1-ohm resistors connected as shown and extending across his living room floor. Some day he hopes to extend the mesh all the way to infinity—and maybe even beyond. Can you calculate what the resistance will be between points "A" and "B" when his "tangled web" is finished?

—Roy S. Reichert

—Gene Harris

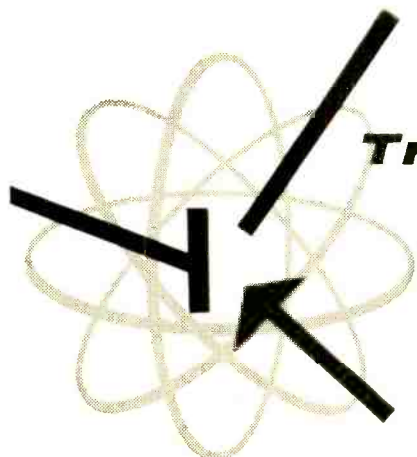

Transistor Topics

By **LOU GARNER**

BOTH the United States and the USSR have successfully launched a number of artificial earth satellites. The Russian Sputniks, in general, have been relatively large units, carrying comparatively heavy instrument "packages," while the American satellites have been fairly small, carrying compact and lightweight instrumentation. The relatively higher efficiency of the American satellite payloads in terms of transmitted information has been made possible by our lead in the design and production of transistors and related semiconductor devices.

Most of the Sputniks, for example, have used vacuum-tube operated instruments and transmitters requiring large, heavy, and short-lived battery power supplies. Our satellites have used transistorized instruments and transmitters, requiring relatively little in the way of battery power. But quite aside from lower power requirements, transistorized equipment is, by its very nature, compact, light, and extremely rugged—characteristics which are ideal for satellite applications.

With reader interest in satellites running

at fever pitch, your columnist has received a number of requests for information on the type of transistor circuitry used in our satellite instruments. In response to these requests, we've managed to dig up a moderate amount of data.

Perhaps the item of greatest interest is the type of radio transmitter used. Figure 1 is a schematic diagram of the 60-milliwatt "high-power" transmitter in the "Explorer I." It uses special high-frequency transistors *not* available to the general public. $Q1$, $Q2$ and $Q3$ are all *p-n-p* diffused-base germanium transistors; $Q1$ and $Q2$

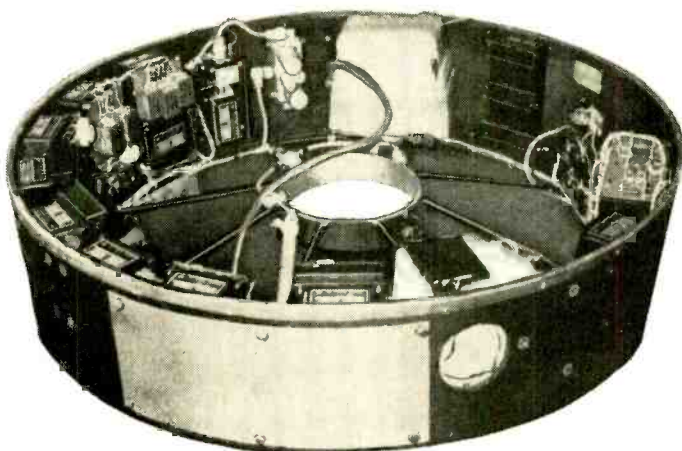

Instrumented payload of "Pioneer" moon rocket includes devices for measuring magnetic fields and the temperature of the vehicle's interior.

are used in the transmitter proper, while $Q3$ serves as a collector-modulator.

In operation, $Q1$ is connected as a crystal-controlled r.f. oscillator, operating at approximately 54 mc. The common-base circuit configuration is employed. A three-winding r.f. transformer, $T1$, serves both to provide the feedback necessary to start and sustain oscillation and as an impedance-matching device to couple energy from the

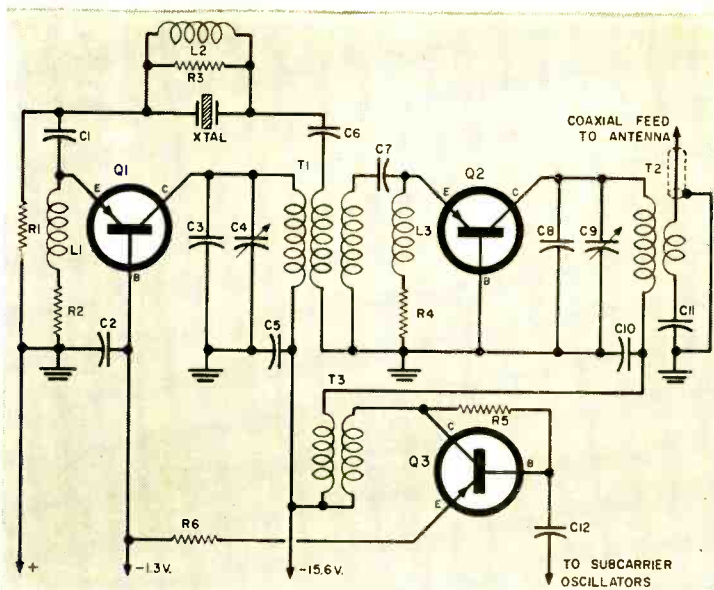

oscillator to the second stage. $T1$'s primary winding is tuned by $C3$ and $C4$. $C2$ and $C5$ are bypass capacitors.

The r.f. signal obtained from $T1$'s output winding is coupled through $C7$ to $Q2$'s emitter-base circuit, appearing across emitter load $L3-R4$. Transistor $Q2$, in turn, serves both as a frequency doubler and as a buffer amplifier, supplying a modulated r.f. signal at approximately 108 mc. to the antenna system through output matching transformer $T2$. $T2$'s primary winding is tuned by $C8$ and $C9$.

A common-emitter amplifier, $Q3$, is used as a collector-modulator, and is coupled to the buffer ($Q2$) collector circuit by matching transformer $T3$. $Q3$'s input signal, supplied through $C12$, is obtained from a number of subcarrier oscillators which, in turn, supply signals conveying information on satellite skin temperature, internal temperature, the impact of micrometeorites, and the intensity of cosmic ray radiation. Operating power is supplied by a set of long-life mercury batteries.

As space permits, and if your letters and postcards continue to indicate interest, we'll try to report on some of the other transistor circuitry used in our earth satellites and space vehicles.

Reader's Circuit. Until that happy day when v.h.f. and moderate-power r.f. transistors are available at reasonable cost, many types of low-voltage-powered mobile

equipment will continue to use vacuum tubes. Tubes, of course, generally require fairly high B+ voltages, and this necessitates the use of a low-to-high d.c. voltage power supply with the equipment.

In the past, mobile ham transmitters, short-wave receivers, portable p.a. systems, and similar boat, aircraft, and automobile electronic gear have used dynamotors or vibrator-operated units as B-voltage power supply sources. Such equipment is heavy, expensive, noisy, and relatively inefficient. Today, however, with high-power transistors readily available, it is possible to assemble a B-voltage power supply (or d.c.-to-d.c. converter) which is superior to a dynamotor or vibrator supply on almost every count.

The schematic diagram of a transistorized B supply capable of supplying up to 275 volts at 125 ma. is given in Fig. 2. Submitted by reader Lawrence Edwins (Wheaton, Md.), this easy-to-wire power supply uses standard, readily available components.

Capacitor $C2$ is a 1600-volt tubular "buffer" and $T1$ is a Chicago Standard "Transverter" transformer, Type DCT-1. $Q1$ and $Q2$ are Delco *p-n-p* power transistors. The full-wave rectifier is made up of four International Rectifier Type SD500 silicon diodes. A heavy-duty s.p.s.t. toggle switch should be used for $S1$. Choose the smallest fuse size you can use consistent with the anticipated load on the supply

Fig. 1. The 60-mw. transmitter used in the "Explorer I." Special high-frequency transistors are employed.

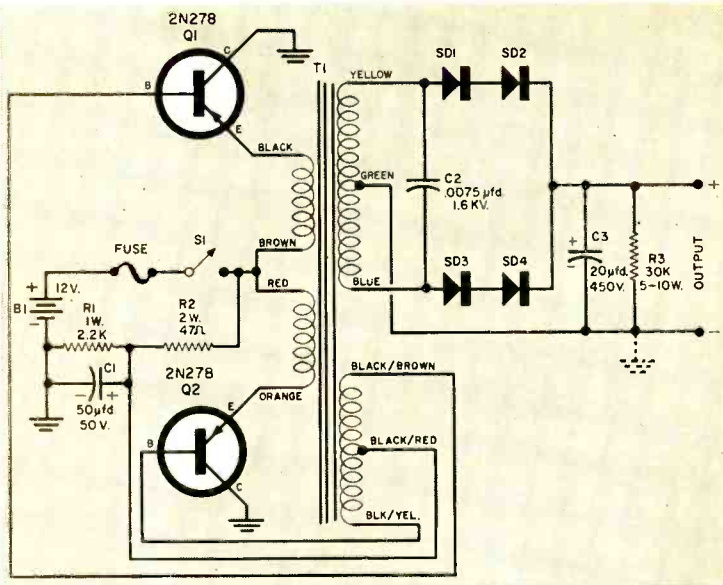

Fig. 2. Larry Edwins' transistorized B-voltage power supply for mobile transmitters, short-wave sets, p.a. systems, etc.

(input power will vary with load), but no larger than a 15-ampere unit. *B1* should be a 12-volt storage battery ("hot-shot" dry cells can be used for intermittent service).

In operation, *Q1* and *Q2* serve as a push-pull power oscillator, with *T1* used both to supply the feedback signal necessary to start and maintain oscillation and to step up the signal voltage. Base bias is supplied by voltage divider *R1-R2*, bypassed by *C1*. The high a.c. voltage appearing across the step-up secondary winding is rectified by the full-wave semiconductor rectifier (*SD1*, *SD2*, *SD3*, and *SD4*) and filtered by *C3*. A bleeder (*R3*) helps to regulate circuit operation by maintaining a minimum load on the unit.

Neither circuit layout nor lead dress is especially critical, and the power supply may be assembled on any standard chassis. Both power transistors are mounted directly against the metal chassis (note that their collector electrodes are connected to circuit ground) to improve heat dissipation—the chassis serves as a large "heat sink."

To minimize losses, use fairly heavy wire (12 or 14 gauge) for wiring the transistor circuit and for connections to *B1*. Standard hookup wire can be used in the high-voltage secondary circuit. Be sure that you observe electrolytic polarity and that you double-check all connections and wiring before applying power.

HO Hobbyists! For quite some time, model railroad enthusiasts specializing in HO gauge trains have used d.c. power supplies, with a large, expensive, and inefficient rheostat serving as a *speed control* or *throttle*. Recently, a relatively new firm, Peck Products (411 Mount Vernon Ave., Alexandria, Va.) introduced a fully transistorized speed control in kit form.

Selling for \$7.25 (plus postage), the Mark II Speed Control (see photo) features a special power transistor and extremely realistic throttle operation. It can be employed with any standard HO d.c. power supply. In addition to its application in model train work, the Mark II is an efficient

(Continued on page 136)

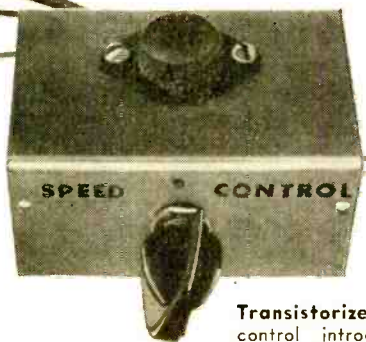

Transistorized speed control introduced as kit by Peck Products.

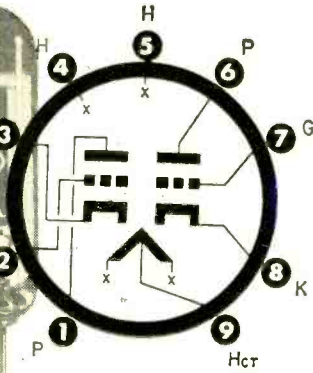

Circuit Designs

for the....

Hi-Fi Audio Amplifier 7247 Tube

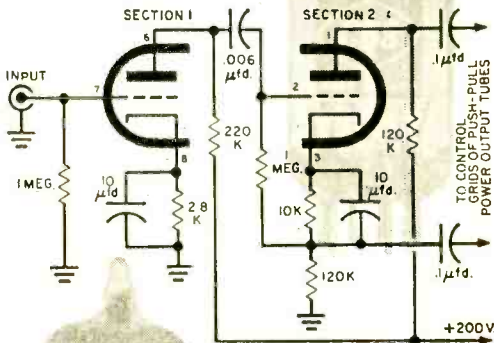

INTENDED for low-level audio use, the new CBS-Hytron 7247 tube is a dual triode designed especially for the "front ends" of audio amplifiers. Special techniques are employed in its manufacture to minimize hum and microphonics.

The first section is a high-mu triode which is electrically similar to a single section of the CBS 7025. It was designed for use as the input amplifier in hi-fi amplifiers.

The second section is a medium-mu triode similar to a 6C4. This section is suitable for use as a cathode follower or large-signal phase inverter.

Schematic diagrams of two circuit applications are shown on this page. At left, center, is a voltage amplifier/phase inverter circuit; below it is an audio preamplifier with cathode follower.

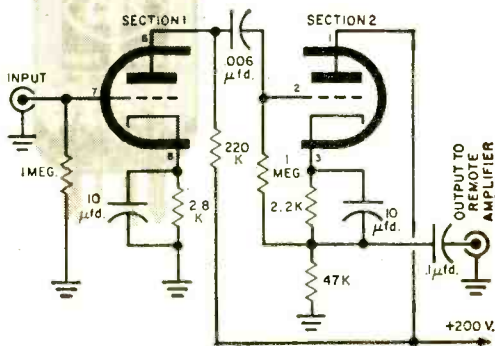

-30-



Schematics courtesy CBS-Hytron

Build a

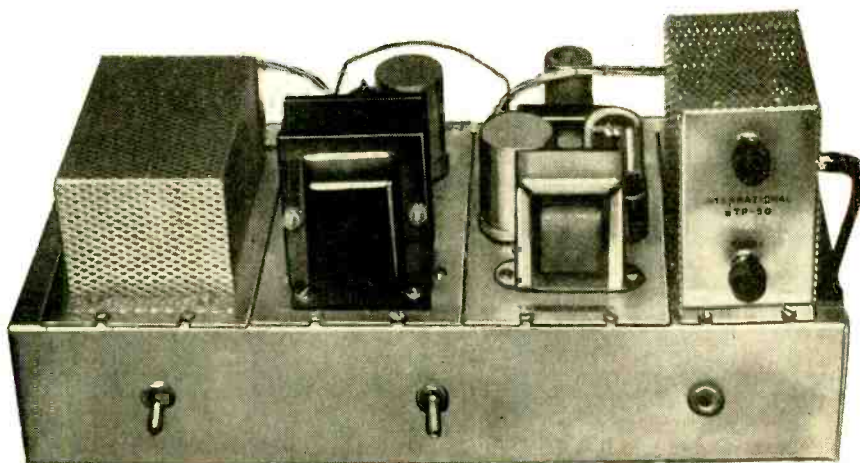

Modular 6-Meter Station

By

DONALD L. STONER, W6TNS

ORDINARILY, the construction of a six-meter station would be much too complicated for a beginner to tackle. And a station that a new ham could build would soon be discarded as too crude for serious six-meter work. Fortunately for you and me, however, International Crystal Mfg. Co., 18 N. Lee St., Oklahoma City, Okla., is marketing some simple and inexpensive—yet powerful—module gear for this band.

This station will appeal to both the beginner and advanced ham because of its fine performance. The receiving section is as sensitive as a hammer-hit thumb and the transmitter portion is capable of cross continental communications when weather conditions are favorable.

Four sub-sections—called modules—are used, which can be purchased from International Crystal in kit form or completely

wired and tested. Build-it-yourself'ers can save about 35% of the cost of the units. Wiring the modules together is a "snap" and can be completed on a lazy Sunday afternoon.

The "hearing aid" section consists of a converter, rather than a complete receiver—you can connect the converter to your regular broadcast band radio and use it to tune in the six-meter stations. Another feature that you "wallet watchers" will like is the single power supply which provides juice for both the transmitter and converter section.

You will notice from the schematic diagram and photographs that the modules are connected together with plugs and cables. The cable runs along the rear of the chassis and down into the chassis through the side apron lips. Coaxial cables to the con-

Complete six-meter rig features semi-kit construction

PARTS LIST

- F1—3-ampere "slo-blo" fuse with pigtail leads
- J1—Antenna connector (Amphenol u.h.f. type)
- PL1—#49, 2-volt, 60-ma. pink-bead pilot lamp
- R1—7500-ohm, 10-watt wire-wound resistor
- S1—S.p.s.t. toggle switch
- S2—D.p.d.t. toggle switch with metal frame
- 1—15" x 7" x 3" aluminum chassis
- 1—Line cord
- 2—Three-lug terminal strips

Modular Units

- 1—FCV-2 six-meter converter printed circuit and crystal (49.4 mc.)
- 1—STP-M1 mounting chassis for FCV-2
- 1—STP-2 power supply
- 1—STP-10 modulator
- 1—STP-50 six-meter transmitter and crystal (see How It Works)

Hardware

- 6—4-40 nuts, bolts and washers
- 8—6" x 1/4" self-tap screws (General Cement H-1362-F)
- 7—Spade bolts (General Cement 6081-C)
- 4—3/8" rubber grommets
- 1—1/2" rubber grommet
- 1—#4 solder lug

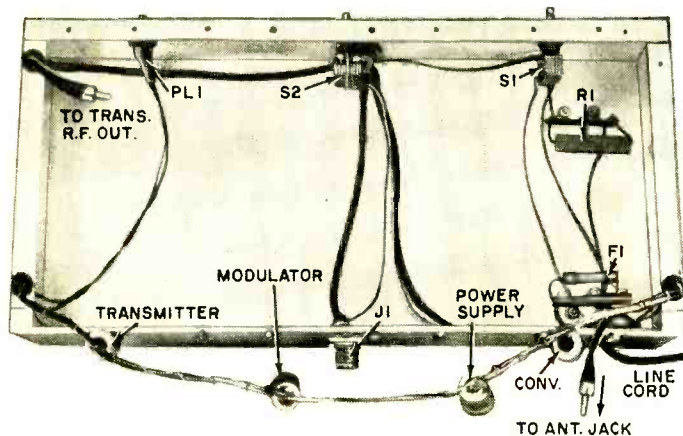

verter and transmitter also run inside the chassis through holes in the apron lips.

Construction technique is somewhat unusual since the modules are mounted by bolting down the front and rear, and the chassis must be modified accordingly. Actually, the chassis serves as a "pan" to hold the four units. Four rubber feet are installed on what would ordinarily be the top of the chassis.

About 1/4" of the rear apron lip must be cut away with sheet-metal shears to clear the rear of each module, as shown in the mechanical drawing. The front of each module is secured with 6 x 1/4" self-tapping screws in the holes (B) drilled in the front apron lip. Spade bolts are used at the rear of the module.

Once the chassis lips have been modified, drill the remaining holes as shown. Hole

(C) drilled on the rear apron below the converter accommodates the line cord and grommet. Grommets installed at three corners of the chassis lip (C) serve to insulate the coax, power cables, etc. Four holes (D) are drilled in the "top" of the chassis directly below the converter section to mount two terminal strips.

Mounting the components is your next job. Install the grommets and mount the coaxial connector (J1) with a solder lug under one nut. Solder two 12" lengths of hook-up wire to the pilot lamp (PL1), tape the connections, and insert the bulb into the rubber grommet in the right-hand hole (A) on the front apron.

Mount the d.p.d.t. switch (S2) so that the toggle arm moves up and down. The two lugs nearest the lip connect to the receiver section and the lugs nearest the bottom of

Aluminum chassis after holes are drilled for mounting the modules. Note how the internal wiring of the chassis is led through the 3/8" holes in chassis lip.

Schematic diagram shows the wiring of the interconnecting plugs of the module units. Follow pin numbers carefully to avoid errors. The d.p.d.t. transmit/receive switch should have shielded wires soldered to it as is described in the text.

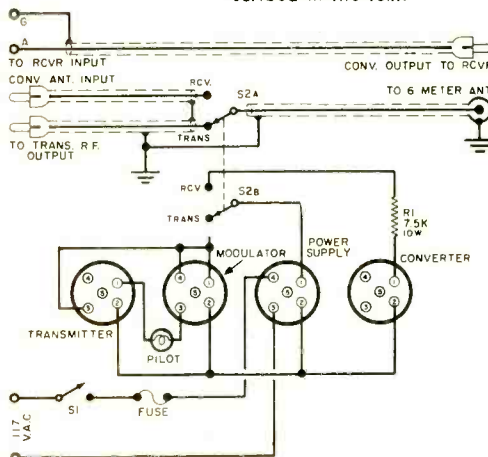

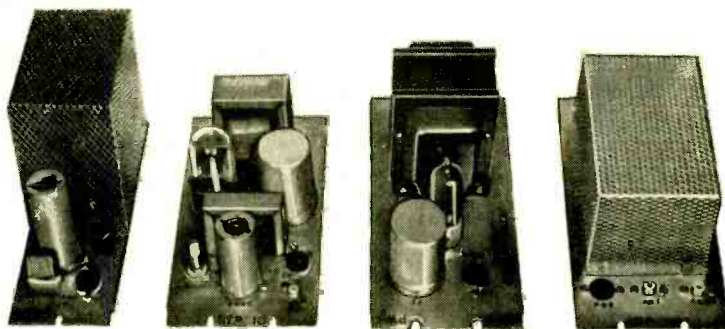

The four modular units in the order that they are installed in the chassis pan. Left to right: transmitter, modulator, power supply, and the converter.

Mechanical drawing showing holes to be drilled in chassis for module mounting. Drill the mounting holes for the spade bolts and self-tapping screws using the modules themselves as templates to insure accurate hole spacing.

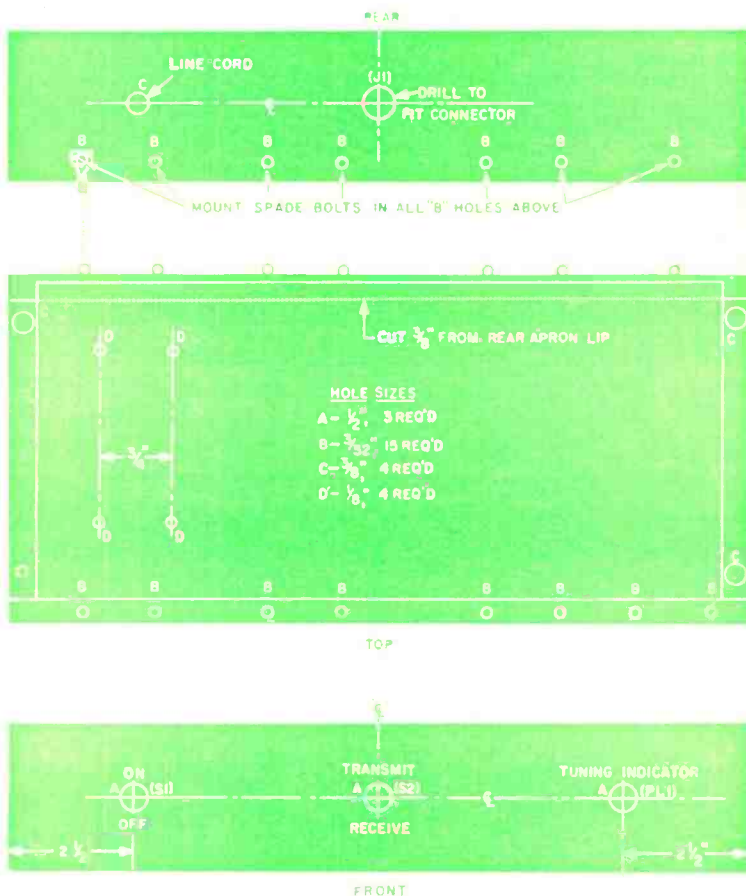

the chassis will be wired to the transmitter circuit.

Next, mount the s.p.s.t. toggle switch (S1) in a vertical position with its lugs toward the chassis bottom. Mount the two terminal strips using 4-40 hardware through holes (D) directly below the converter area.

Unit wiring starts with the cables. Cut a length of RG-58/U coax as shown in the photo to reach between the antenna connector (J1) and the transmit/receive switch

(S2). Ground the shielding of the coax at one end to the solder lug near J1 and at the other end to the metal frame of S2.

Solder one end of the center (hot) lead to J1's connector pin and the other to one of the center lugs of S2. Ground the braid of all coax cables connected to S2 by soldering to S2's frame. Wire the remaining lugs of S2, running the wires up through the grommets installed on the chassis lips.

Wire the line cord, S1, fuse and power

HOW IT WORKS

The six-meter station consists of four module sub-chassis. An antenna, microphone, and accessory broadcast-band radio are needed to complete the installation. The four modules comprise the converter, power supply, modulator, and transmitter.

Converter. This unit is designed to convert the 50-51 mc. frequencies down to the broadcast band between 600 and 1600 kc. Signals applied to the antenna input jack (*Ant.*) are greatly amplified in a 6BQ7 cascode r.f. stage. The amplified signal is applied to the mixer, which is the pentode section of a 6U8 tube. The triode section provides a local oscillator signal on 49.4 mc.

If a signal on 50 mc. reaches the mixer, it will combine with the 49.4-mc. oscillator and produce a "new" frequency of 600 kc. By the same means, a signal on 51 mc. would mix with the oscillator and produce a "new" frequency of 1600 kc. Output of the mixer is connected to a broadcast-band radio through a short length of coax cable. Thus, 50 mc. will appear at 600 on the radio dial and 51 mc. at 1600 kc.

Power Supply. This conventional unit consists of a power transformer supplying power to a 6BW4 full-wave rectifier. Output of the rectifier is filtered and supplies about 300 volts (under load) to the transmitter, modulator, and converter.

Transmitter. A quartz crystal determines the transmitter frequency and is connected in a Colpitts oscillator circuit. The crystal frequency is one-fourth the operating frequency, or between 12.5 and 12.75 mc. Thus, if you want your transmitter to operate on 50.8 mc., you would order a crystal for 12.7 mc. When ordering crystals, avoid the even frequencies, for these are heavily populated with transmitters using war surplus crystals.

Output from the oscillator is twice the crystal frequency (25 to 25.5 mc.) and drives the final amplifier which is also a frequency doubler. The knob marked *Grid* resonates the grid circuit of the 2E26 tube. Output from the 2E26 consists of a carrier on the six-meter band. This r.f. energy is coupled to the antenna through the 2E26 plate coil and *S2*.

Modulator. The modulator is basically a 10-watt audio amplifier. The microphone drives a 6AN8 triode/pentode tube which is transformer-coupled to the 1635 class "B" modulator tube. Modulation voltage is stepped up with another transformer and applied to the final amplifier.

The modulator causes variations in the power input (and output) known as amplitude modulation. These variations are coupled to the antenna and radiated through space. The pilot lamp on the front apron provides a continuous indication of the power input to the transmitter.

supply connector as shown in schematic. Complete the wiring of the modulator, converter, and transmitter connectors, and finish up by making a 2'-long coax cable to connect the converter output to the receiver.

Now install the modules, making sure that the power supply choke mounted beneath the chassis plate does not short out any of the contacts of *S2*.

For preliminary testing, first make a visual inspection of the completed unit. Then install the power supply module, plug in the five-prong connector, remove the 6BW4 tube, plug in the line cord, and switch the unit on. The a.c. voltage between the

2 pins of the three other plugs and ground should read approximately 7 volts (this will drop to 6.3 volts when all units are energized).

Insert the 6BW4 and set switch *S2* in the *Receive* position (up). The tube filaments should light up immediately. Measure the B+ voltage between pin 1 of the converter plug and chassis. It should read about 370 volts, d.c. When *S2* is placed in the *Transmit* position (down), this voltage should drop to zero.

Bolt the converter module in position, and wrap a thin wire around pin 1 of the converter plug so that the voltage can be measured with the plug partially inserted. As the converter tubes warm up, the B+ voltage should drop from 370 to about 300 volts.

So far so good. Now turn off the power, remove the plug, and install the modulator and transmitter module. Make a resistance check between pin 1 and 4 of the modulator socket and chassis. Both measurements should read higher than 20,000 ohms. Then make the same check at pin 1 of the transmitter socket which should also test higher than 20,000 ohms.

If all these tests are satisfactory, it is time to insert all plugs, connect an antenna, and connect the output (socket marked *Rec.*) of the converter to your receiver.

When the six-meter converter is energized, the noise level of the broadcast receiver used with it should increase noticeably. You should be able to tune in the six-meter band if the converter has been wired properly.

To tune the transmitter, three circuit adjustments must be made, at the grid, plate, and antenna. When the transmitter is energized (*S2* in the down position), the pilot lamp (*PL1*) should light. This 25-cent lamp, used instead of a \$10 meter, tells you if the transmitter is properly tuned.

Set the capacitor knob marked *Ant.* on the transmitter unit to minimum, and set the *Plate* knob for half capacity. Energize the transmitter and set the *Grid* knob for maximum brightness of *PL1*. Then adjust the *Plate* knob for minimum brightness—in fact, the bulb should almost be extinguished. Now, slowly rotate the *Ant.* knob until the bulb brightens up, and once again set the *Plate* knob for minimum light.

Keep repeating this process until you can just barely notice a dip in the brilliancy of the bulb. At this point you have arrived.

(Continued on page 142)

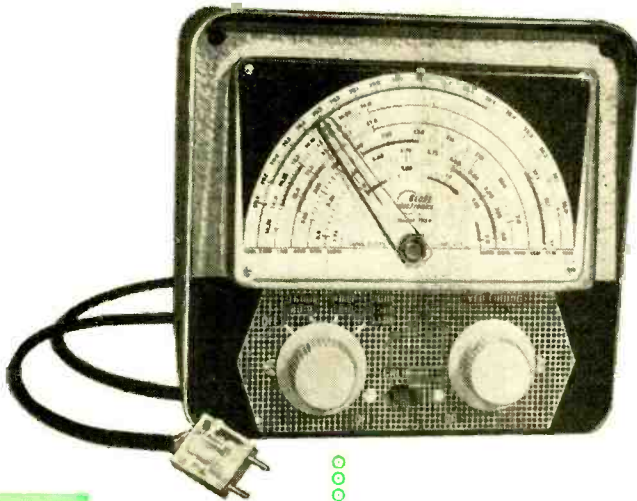

**POPULAR
ELECTRONICS**

Builds a
Variable Frequency Oscillator

... a ham shack must

THE FIRST UNIT to be purchased by most hams who graduate from Novice to General Class is the variable frequency oscillator. A VFO unstraps the ham from the fixed frequencies of crystal-controlled transmitters and permits transmission over the entire ham band. Compact, light in weight, and easy to use, it is a ham shack must.

One of the basic problems with VFO's is lack of long-term stability. Part value change due to heat broadens the frequency space occupied by the transmitted signal. It is unpleasant to hear, hard to copy, and illegal. The Model VFO 755A kit offered by Globe Electronics, Inc., Council Bluffs, Iowa, has been designed to avoid or eliminate all of these troubles and others, like TVI. Careful selection and placement of heat-stable components has made the VFO 755A a reliable kit to build and use.

How It Operates. The oscillator stage, utilizing a 6AU6 tube, is basically a series-

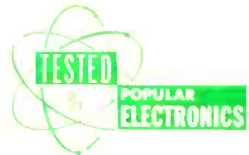

The Globe VFO 755A
*is easy to assemble
and simple to operate*

ELECTRICAL SPECIFICATIONS	
Band Coverage (mc.):	1.75 — 2.0
	3.5 — 4.0
	7.0 — 7.45
	14.0 — 14.3
	21.0 — 21.45
	27.0 — 27.2
28.0 — 29.8	
Output:	Coaxial cable
Power Requirements:	115 volts, 50/60 cycles, 10 watts

Cathode keying of the oscillator is employed because it is the easiest and most dependable type. The resulting transmitted signal is clean and crisp. A broadband load choke in the output circuit of the oscillator circuit supplies r.f. drive to the buffer amplifier stage through a small coupling capacitor.

The buffer stage employs a type 6CB6 tube operating as a class A r.f. amplifier. The plate circuit of this stage is band-

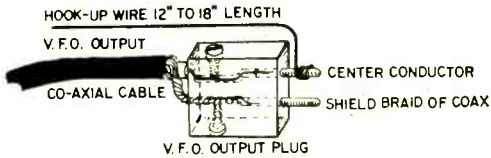
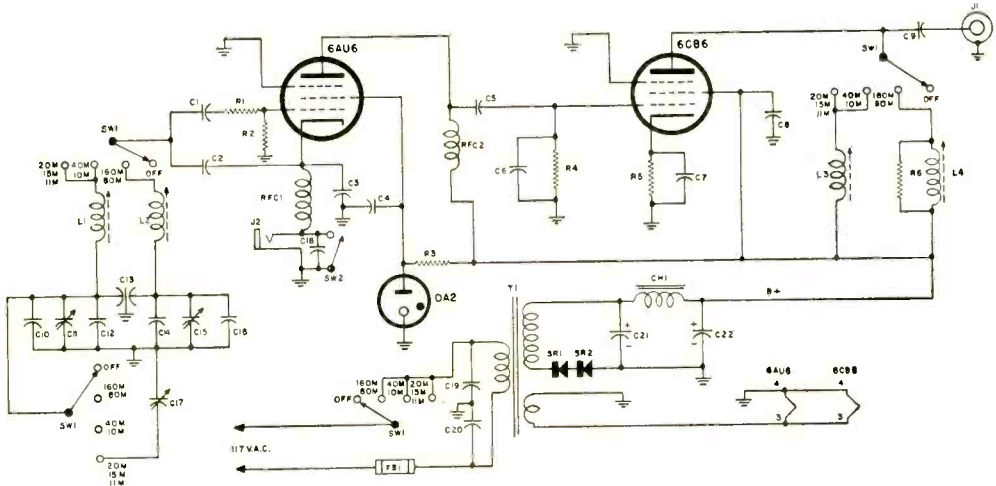

To increase the VFO output signal for frequency checking, add a 12" to 18" wire to the center conductor of the VFO output cable. The plug can be inserted into the crystal jack or the transmitter.

tuned Clapp oscillator with additional padding capacitors. This modification of the Clapp circuit provides better frequency stability and constant output without tube loading.

Frequency stability of the oscillator is maintained by voltage regulation and temperature-compensating capacitors at critical points in the circuit. The fundamental oscillator output frequency is in the 160- and 40-meter bands. Other ham bands, 80, 20, 15 and 10 meters, are available through frequency multiplication.

switched to broadband r.f. coils which supply r.f. output in the 160- and 40-meter bands through an output coupling capacitor to the crystal jack.

Of conventional transformer-selenium rectifier design, the power supply furnishes all high voltage without unnecessary heat. Screen voltage to the oscillator stage is held constant by a voltage regulator tube. In addition, the B+ output is stable because the buffer stage operates continuously and oscillator current drain is very low. As a result, keying characteristics are clean, and over-all stability is greatly improved.

Building the Kit. Globe Electronics has obviously taken great pains to prepare a top-notch instruction manual. Construction is divided into two parts; mechanical assembly and wiring. Each section is clearly written and easy to follow. An itemized correction sheet is included with the original instruction manual; just pen the suggested corrections into the manual and you'll have no trouble.

Due to the critical nature of wire location, you should follow the instructions and

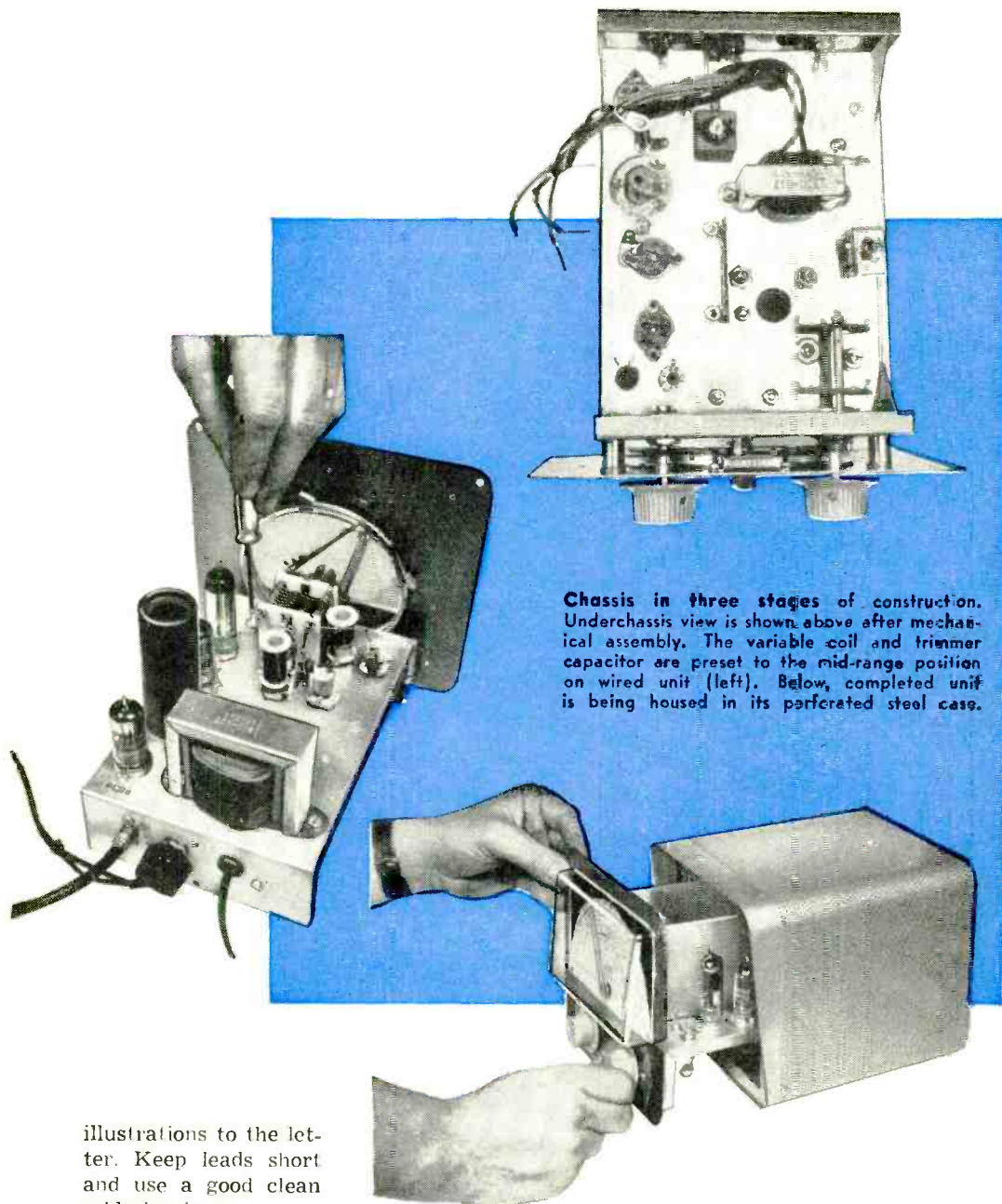

Chassis in three stages of construction. Underchassis view is shown above after mechanical assembly. The variable coil and trimmer capacitor are preset to the mid-range position on wired unit (left). Below, completed unit is being housed in its perforated steel case.

illustrations to the letter. Keep leads short and use a good clean soldering iron.

Calibration. The best technique for VFO calibration is to zero-beat the output signal against the harmonics of a 100,000-cycle crystal oscillator. Use a short-wave receiver to detect the zero-beat signal.

Complete calibration instructions are given in the manual. As a final check, zero-beat the output signal against your transmitter which uses a Novice crystal. Make

several spot-checks before placing the VFO in operation. The FCC will thank you by *not* sending violation notices.

We connected the completed VFO to the crystal jack on a 90-watt transmitter and put it on the air. After a minute of CQ'ing on 3510 kc., a 600-mile DX with a QRK5 report was received.

-50-

Test Instruments

Part 5

THE VACUUM-TUBE VOLTMETER—A.C. and Ohmmeter Ranges

LAST MONTH we looked into a vacuum-tube voltmeter, examined the bridge circuit and saw how it measured d.c. voltages. As a review, let's look at Fig. 5, a diagram of the d.c. measurement circuit. (Figures 1 to 4 appeared in April.)

The unknown d.c. voltage connected to the input terminals is applied across the entire range switch voltage divider. Maximum on-scale reading is obtained by setting the range switch at the proper voltage di-

By
LARRY KLEIN
Technical Editor

what the standard VTVM does. Unfortunately, however, a number of electronic bugs appear which prevent a simple diode circuit from being used, and the circuits in actual practice usually look like those in Fig. 6. Why the complications? Let's take a close look at Fig. 6 (A).

Fig. 5. A simplified d.c. voltage measuring circuit showing the range switch and bridge circuit.

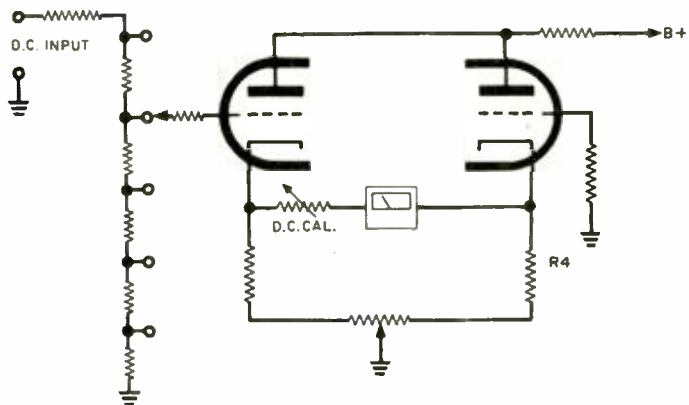

vider tap. The unknown d.c. voltage is now applied to the input grid of the bridge—unbalance of the triodes results and the meter deflects. So much for the d.c. bridge.

A.C. Voltage Measurement. What do we have to do to enable the d.c. bridge to respond to a.c.? Why not simply rectify the unknown a.c. voltage and then apply the resultant d.c. to the bridge input as we would any d.c. voltage? That's actually

On one half of the cycle, the a.c. voltage to be measured is fed through capacitor *C1* to the cathode of one diode of the 6H16 tube, and thence to ground. The capacitor, of course, gets charged in the process. On the positive-going part of the a.c. cycle, no current flows through the first diode. *C1* discharges and adds its voltage to that developed across the three resistors connected to the plate of the second, conducting diode.

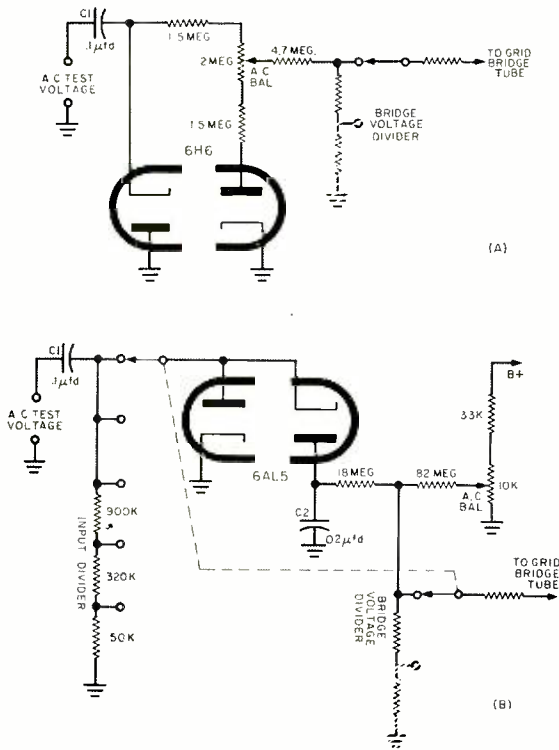

Fig. 6. Two typical voltage-doubling rectifiers used in VTVM's. The diodes' contact potentials buck each other in (A) and the "A.C. Bal" pot selects the zero point. In (B) the negative potential is bucked against B-plus voltage tapped off the "A.C. Bal" pot.

If we look carefully at the circuit, we'll recognize a type of voltage doubler. Why a voltage doubler? Well, remember we need to get a d.c. voltage out of the rectifier circuit which is at least as high as the a.c. input voltage. Taking into account the voltage drop across the various components in the circuit, obviously some technique is needed to soup up the d.c. output . . . and that's what the doubler does.

Further circuit complications arise from a phenomenon called *contact potential*. It seems that vacuum tubes, including diodes, tend to develop a small potential between the elements. If allowed to remain, this slight voltage in the 6H6 would cause a spurious reading on the low a.c. ranges. However, placing the a.c. balance control between the two oppositely connected diodes, exact compensation can be made by bucking out the opposing contact voltages.

Since the center contact of the a.c. bal-

ance potentiometer is also the take-off point for the d.c. output, about half the d.c. developed across the three resistors is lost by tapping off at this point. Actually, this is of small consequence, because the d.c. voltage across the three resistors is equal to more than the peak of the r.m.s. a.c. input voltage, so we have volts enough to spare to provide an r.m.s. reading.

R.M.S. and P-P. The key words in that last sentence were "r.m.s. reading," which brings us to Fig. 6(B). Slightly more complicated than the rectifier discussed above, this circuit also makes use of a doubler circuit.

Because of the low breakdown voltage of the 6AL5 tube, a voltage divider (in addition to the one in the grid of the bridge tube) is needed to prevent the tube from "arcing out" at the higher peak voltages. As shown, the a.c. input voltage divider is part of the range switch and is, therefore,

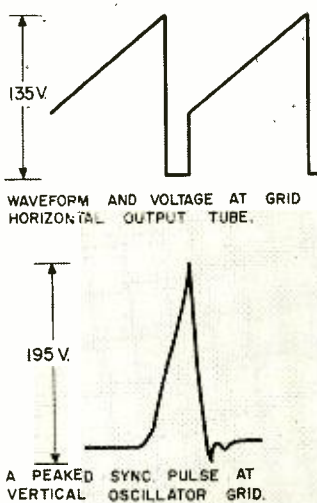
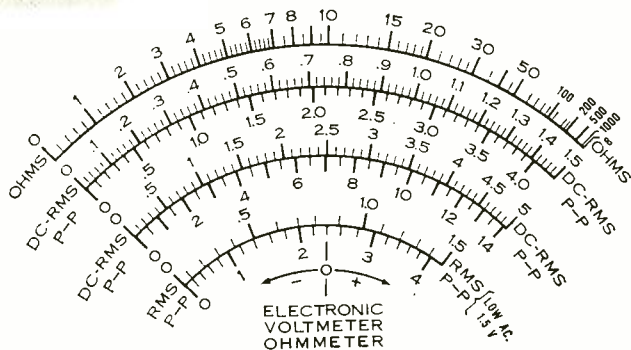

Fig. 7. Typical waveforms (above) from a standard television set.

Fig. 8. Note relationship between r.m.s. and P-P scales (at right). P-P scale is 2.83 times larger than r.m.s. scale.



mechanically coupled to the bridge divider.

Perhaps you're wondering why the extra resistors at the a.c. input don't cause a large difference in scale calibration between the a.c. and d.c. ranges. The VTVM takes care of that by switching the last three bridge voltage divider resistors out of the grid circuit when set up for an a.c. reading.

Whereas the job of the second diode in Fig. 6(A) is mainly to cancel out the contact potential of the first diode, the second diode of Fig. 6(B) has a different story to tell. Both diodes in Fig. 6(B) are used in a complete voltage-doubler hookup which charges C_2 to the full peak voltage of the incoming waveform. Contact potential cancellation voltage is obtained from a tap across the VTVM's B-plus supply.

The waveforms shown in Fig. 7 are taken from a standard TV set. You can imagine the difficulties an r.m.s. calibrated a.c. meter would have translating them to any sort of meaningful reading. Even putting a peak-to-peak reading scale on the meter

face (it would be the r.m.s. scale $\times 2.83$) wouldn't help much because the reading would still only be accurate for sine-wave inputs.

However, the P-P a.c. rectifier finds no difficulty in smoothing down these weird-looking spikey TV waveforms into an exact d.c. equivalent and then feeding them to the bridge circuit. The exact relationship between the P-P scales on a standard peak-reading VTVM is shown in Fig. 8.

Resistance Measurement. One of the first things that hits your eye in the ohmmeter section of the VTVM is the $R \times 1$ meg. range switch position. With the last scale division on the meter face marked 1000, this means that the VTVM can read

up to a 1000 \times 1 million or a billion ohms!

The ohmmeter section of the average VTVM resembles the one shown in Fig. 9. The string of seven resistors may differ in value somewhat depending on the exact scales used and whether they are arranged in series, as shown, or switched individually. But the principle of operation remains the same, as we shall see.

Suppose we redraw the range switch and input circuit of Fig. 9 into the form of Fig. 10. We will use only one range resistor (R_{range}) and connect the resistor to be measured (R_x) to the VTVM's input terminals. The bridge circuit remains the same and we will ignore it for now.

The first thing to do when using a VTVM ohmmeter is to "zero" it. Short the input leads together and adjust the *Zero Adj.* control for a zero reading on the meter scale. Then, unshort the leads of the VTVM and the needle will immediately swing to the right-hand side of the meter face. Now adjust the meter to ∞ (infinite) ohms.

Let's see what the preceding adjustments

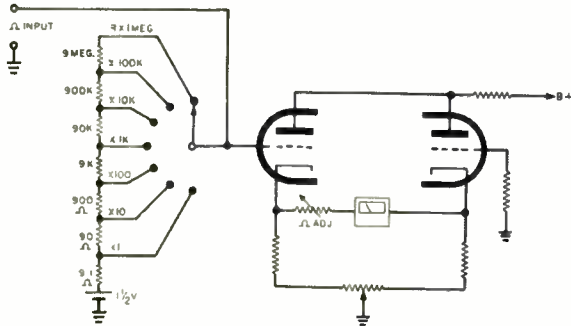

Fig. 9. Circuit diagram of an ohmmeter section of a vacuum-tube voltmeter.

have accomplished in terms of the internal electronics of the VTVM.

Zero-adjusting the meter with the leads shorted has shorted out the battery through resistor R_{range} to ground and removed the voltage from the grid of the bridge tube. Unshorting the test leads restores the battery voltage to the grid and the meter swings full scale. The *Ohms Adj.* knob, which is in the same spot as the *A.C.* and *D.C. Cal.* controls in the other circuits, adjusts the sensitivity of the meter so that the applied battery voltage swings the meter needle exactly to the infinite ohms scale marking on the meter face.

Suppose a 100-ohm resistor (R_x) is connected across the input leads and R_{range} is also set at 100 ohms. The voltage present at the grid of the bridge tube will be exactly halved, and the meter will read half scale. Now if you look at the top scale of the meter face shown in Fig. 8, you'll see that the center of the scale indicates exactly 10.

If R_x were a 30-ohm resistor, for example, the shunting effect across R_{range} would be increased and even less voltage would reach the bridge tube. A higher value resistor as R_x and a higher meter reading results. The only trick involved, and the reason why it's so difficult for some home constructors to build their own ohmmeters, is the scale calibration. As can be seen in Fig. 8, the scale divisions are widely spaced at the right side of the meter face and narrow down towards the left. A little thought as to how parallel resistors divide current will tell you why that is so.

The Function Switch. In talking about the VTVM, we've left out practically any reference to the function switch. Since these switches are so difficult to show schematically in an understandable way

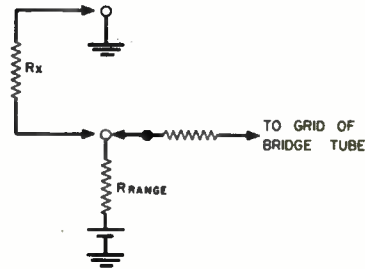

Fig. 10. Simplified input and range circuits of VTVM ohmmeter section.

without a prolonged discussion of each switch position and what it accomplishes, we thought it best to save them till last.

The function switch is usually specially made for each manufacturer's VTVM and, if analyzed, generally works out to be a five-pole, five-position unit. Some of its jobs include switching the input jacks to the proper circuit, connecting in the correct calibration control for each function, reversing the meter movement connections for plus and minus d.c. and, in some cases, even turning the VTVM on and off.

If you're curious, a complete schematic of the RCA "Volt-Ohmyst" VTVM kit is shown on page 79 of this issue and should answer any questions you may have about the specific connections of the function switch.

Next month we will put the VTVM to work in an area in which it's practically indispensable—repairing a hi-fi amplifier. The basic Williamson amplifier should be a good subject, and we will learn how to trouble-shoot one and what sort of measurements the VTVM will turn up in working and non-working models.



Short-Wave Report

By **HANK BENNETT**
W2PNA/WPE2FT

VOICE OF THE ANDES

FROM the heights of the Andes Mountains, in the midst of tall snow-capped peaks, and from the oldest capital city in the New World, comes the voice of HCJB, *The Voice of the Andes*, in Quito, Ecuador. A pioneer in the field of missionary radio, HCJB began broadcasting over a quarter of a century ago. From a baby station rated at 250 watts, it has now grown to the point where it is on the air with as much as 50,000 watts.

During the last three years, many addi-



tions and modernizations have been made to the studio and transmitting facilities. The New World Radio Chapel was inaugurated, a large studio, equipped with a new organ and piano, from which a good many of the religious programs originate. In neighboring Pifo, the home of the transmitters, a new diesel electric plant has been added, of sufficient size to meet all power requirements.

Future plans call for an addition to the

main transmitter which will enable HCJB to broadcast on two frequencies simultaneously with approximately 30,000 watts. Already under construction, this is expected to double the usefulness of the transmitter and permit many more listeners the world over to tune in on either the 16- and 25-meter bands or the 19- and 31-

HCJB's transmitters are located at Pifo, near Quito, Ecuador.



meter bands. Work is also being done on other transmitters, especially those used on the medium waves, for better coverage to Ecuador and neighboring republics.

HCJB is easily the most widespread reported station to the *Short-Wave Report* from South America and is one of the top stations in the world. You can find it on your receivers at 17,890, 15,115, 11,915, 9745, or possibly 6050 kc.

(Continued on page 152)

Three Thousand Short-Wave Monitors Registered

A FLOOD of applications for Short-Wave Monitor Certificates has come into the editorial offices of POPULAR ELECTRONICS during the past two months, reflecting the tremendous interest of SWL's in this important project.

By registering Short-Wave Monitors throughout the world and awarding certificates with individual station letters to all qualified monitors, POP'ronics hopes to give this growing and significant hobby the recognition it deserves. Only the acceptance of the project by all DX'ers can make it a complete success.

Every official registration form and individually assigned station letters are kept on permanent file here. Station letters are assigned according to equivalent amateur radio call areas (WPE1AA, WPE4AA, WPE9MR, etc.).

If you have not yet obtained your attractively printed 8½x11" certificate, fill out the official registration form below and mail it back to: Monitor Registration, POPULAR ELECTRONICS, One Park Avenue, New York 16, N. Y. Please include ten cents to help cover costs of mailing and processing your certificate.

-50-



Monitor registration program gets off to flying start with one of the first Short-Wave Monitor Certificates being presented to Murray Buitekant (center), Vice-President of Newark News Radio Club, by Oliver Read, Editor and Publisher of POPULAR ELECTRONICS, as Tom Kneitel, Director of Monitoring Station Registration, looks on.

SHORT-WAVE MONITOR REGISTRATION

(Please Print)

Name

Address City State

Receiver	Make	Model
	Make	Model

Principal SW Bands Monitored Number of QSL Cards Received

Type of Antenna Used

Signature	Date
-----------------	------------



◀ **Music in Stone**

Built in the Luray Caverns of Virginia, this stalactite organ brings forth tones out of stones. The hanging stalactites make musical tones when struck by solenoid-actuated plungers. Every octave has a separate amplifier which operates a relay that discharges a capacitor across a solenoid. Each stalactite is tuned to the proper pitch by grinding it down with an abrasive wheel.

Balloon Radar

The "Helisphere" radar antenna can scan a complete circle without mechanical rotation. This plastic balloon antenna has narrow spiral strips of metal wound around it. Polarized radar waves sprayed against the inside surface are reflected and focused into a narrow beam by the metal strips. The only rotating part is a short length of wave guide inside the sphere. Air pressure keeps the balloon inflated.

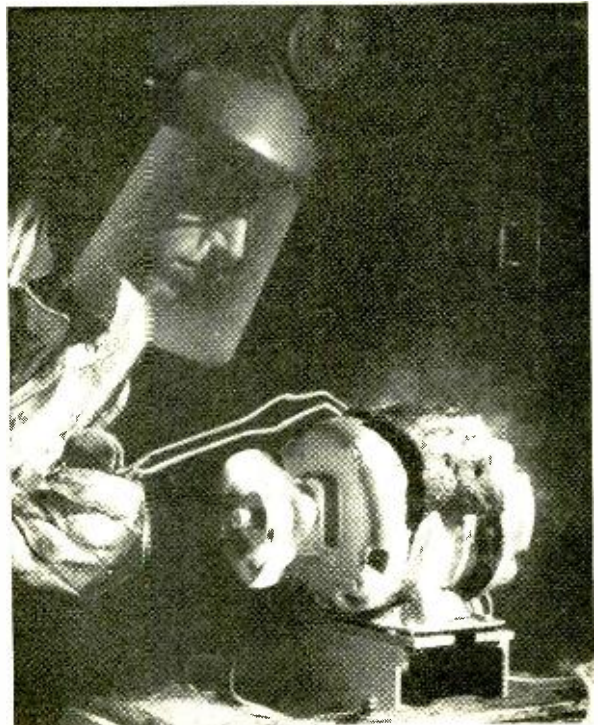

Red Hot Motor ▶

Hot enough to broil a steak, this Westinghouse motor operates at 1000° F. It was designed to meet the needs of red-hot supersonic aircraft. Special bearings, pure silver wire, and inorganic insulation kept the motor running for 100 hours. At such temperatures, copper wire oxidizes and becomes useless as a conductor of electricity, and ordinary plastic or cloth insulation melts or burns.

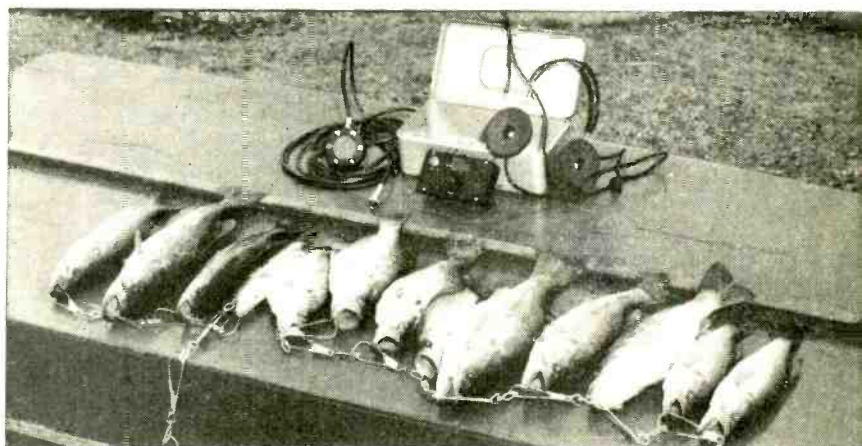

Listening to Fish Stories

Talking fish will no longer be able to carry on a private conversation when a fisherman eavesdrops with the "Fishfone" detecting device of Engineering Research Corp., Shreveport, La. A hydrophone lowered into the water picks up fish sounds, which are amplified to headphones. After a certain amount of practice, the fisherman can tell what kind of fish are doing the talking and how many are waiting for the bait.



Heated Carpet

Plugging right into an ordinary household outlet, this electrically heated carpet underlay uses low-temperature heater wire encased in waterproof plastic. The British "Thermalay" unit distributes warmth over a large area instead of concentrated heat. Cost of operation is competitive with central heating.



How to Repair AUTO RADIOS

THE MODERN automobile radio is a thing of beauty and a source of much entertainment. It is also very helpful in preventing accidents, by keeping the driver awake on long solo runs. However, there are few pieces of every-day electronic gear that are more difficult to repair!

This difficulty isn't due to the circuitry of the sets themselves, but to the almost complete concealment of the units when installed in the car! Many auto-radio technicians swear that manufacturers maintain a special "dirty-trick" department, whose sole purpose is to find more and more inaccessible places to hide the radio in each new model!

Automobile radio repairs can be made with comparative ease, however, if you'll take advantage of some of the quick-checks and tricks used by professional technicians.

Search for Symptoms. The most important single question is always, "Do I have to 'pull' the set to fix it?" Let's be sure to make all possible tests *first*, and exhaust all possibilities of repairing the receiver *in* the car before taking it out.

All tests needed on any auto-radio can be made with a standard VOM. However, most of the quick-checks can be made without any instruments at all. Remember, common sense is the best tool in your kit!

The first section to test is the power supply. Is the set getting primary power? Auto-radios now can be considered as falling into three separate types: older models with vibrator-rectifier power supply; "hybrid" sets with low-voltage tubes and power transistor audio output stage; and straight low-voltage tube sets. The last two types have no separate power supply at all, and use the 12 volts from the car battery for all operating potentials.

Finding the Fuse. When you switch on one of the older type sets, listen for the vi-

brator buzz. No buzz means one of three things: (1) the fuse is blown; (2) the vibrator won't start; or (3) the receiver's switch is bad. Check the easiest thing first—the fuse.

You can find the fuse holder in most cars under the dash and in the "hot" lead from the set. Some cars, however, such as the Pontiac, have all fuses on a "fuse-block" on the firewall just above the steering column. The radio fuse will be marked.

After you find the fuse, see if it is blown. Check Fig. 1(A). Watch out for the fuse which has opened up because of fatigue, as shown in Fig. 1(B). Most of these will have to be checked out with an ohmmeter, because the break in the fuse might be hard to find with the naked eye. If such a break has occurred, simply replace the fuse.

Although fuses used to be all alike, $\frac{1}{4}$ " in diameter and 1" long, the "SFE" series of fuses are all *different*. They vary in physical size according to their electrical rating. The shorter the fuse, the smaller its current rating. Special holders are used with these SFE's which have the advantage that they will not close properly on the wrong fuse. Too big a fuse (electrically) will be too long, and too small a fuse won't make contact. After a little practice, you'll be able to tell what size a fuse is by looking at it.

Vibrators—Open and Short. If the fuse shows signs of being blown out, take the holder apart by sliding the outer sleeves down the wires and expose the end-contacts. First, check for voltage on the lead from the ignition switch using a voltmeter or 12-volt light bulb. Remember that the auto chassis is ground, but not necessarily negative. If you don't get a voltage indication, check the wiring, the ignition switch, etc. There are no other fuses in this line.

Now, with the set turned on, touch the

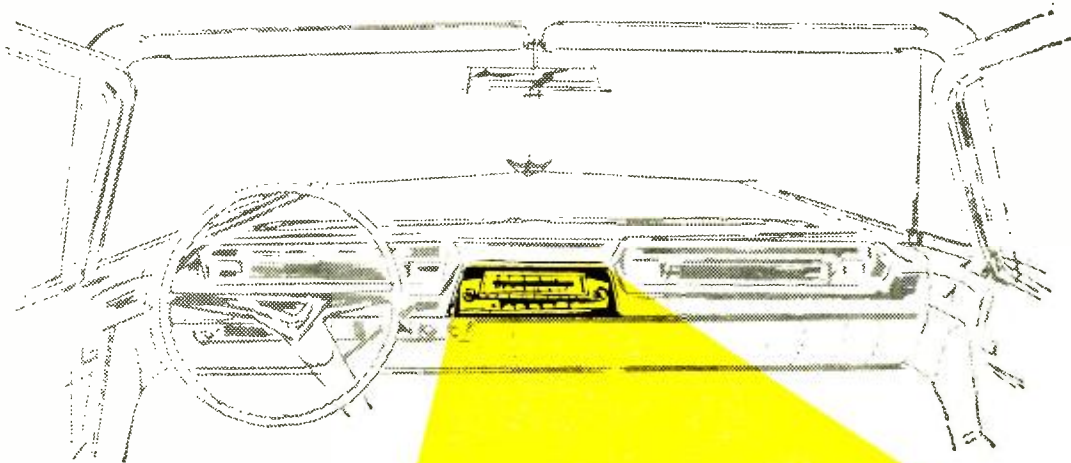

By
JACK DARR

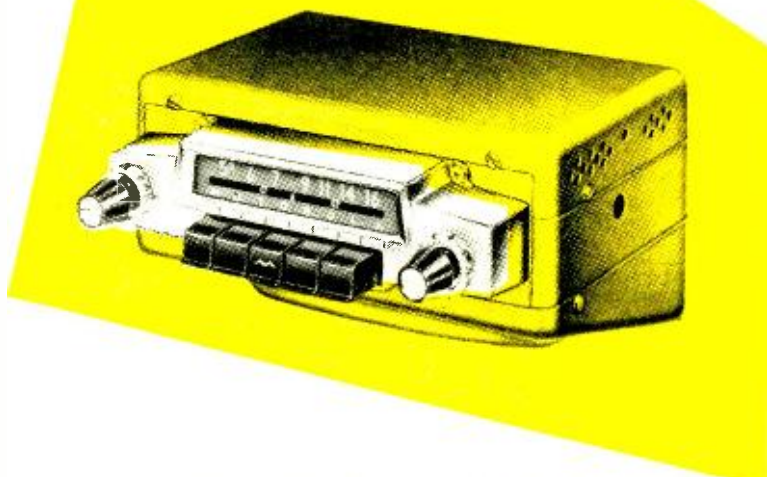

two exposed fuse contacts together. If the set now begins to buzz, and the tubes light, hold the connection for a few seconds, and see if the set will play. If you don't hear the vibrator, check for a tiny spark as the two contacts touch. Take a look through the ventilation holes in the case. If the set is getting power, you'll see at least one of the tubes light up, or maybe the dial-light. (Note: if there are *two* power leads coming out of the set, one will be a separate dial-light wire, and go to the dash-light connection on the light switch; it will *never* have a fuse holder in it.)

If the tubes light, but you hear no buzz, the vibrator is probably open. Take off the bottom lid of the set, and try a new vibrator. On some sets, the vibrator will be found on the outside of the case. If the receiver is of the 'two-unit' type, the vibrator is in the unit with the speaker, usually

found at the right side of the dash. (Hint: look for the speaker-grille.)

If you get a fat spark when you touch the ends of the wires, there is a short in the set. Take the vibrator out, and repeat the test. If the tubes light, then the vibrator is shorted. Replace it with a new one. Incidentally, the vibrator accounts for *99%* of *all short circuits* in an auto-radio! Always check it first; the quickest way is by replacement.

Vibrators will usually have metal "fingers" around their sockets (see photo) and can be difficult to remove. Rock them slightly back and forth, pulling straight out. Sometimes the vibrators will be "frozen" to the stiff metal clips; a pair of large pliers applied to the very top of the vibrator can will help to get them free.

When replacing a vibrator, be sure that the pins are lined up with the socket holes;

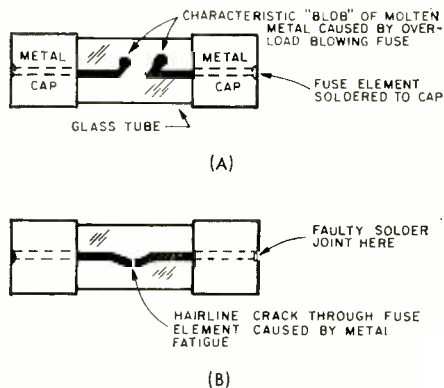

Fig. 1. Two types of fuse failure. The blown fuse (A) usually indicates excessive current drain due to momentary or permanent short circuit in the set. Fatigue failure of fuse (B) indicates only that a replacement is needed.

most vibrators use what the old-timers would call a "UX" base—a standard 4-pin type, with two pins bigger than the others. Unless you're very careful with the vibrator, it can be inserted improperly, causing more troubles.

Rectifiers—Gas and Filament. Practically all sets built with vibrator power supplies (in the last few years) use the gas-type rectifier tube—the OZ4. These are made in two types; the glass-bulb OZ4G and the metal OZ4. The glass tube is seldom used, due to the much better shielding of the metal tube.

Gas rectifiers don't weaken gradually as the hot-cathode types do but, like the little dog, they suddenly "die all over." To complicate matters, they will usually become highly intermittent before they go out. They will come on and play perfectly one time, refuse to come on at all the next two times, come on the following time, etc. until the end.

Here's a good check that will pinpoint an OZ4 problem fast. Turn the receiver on, and if it's dead, try revving up the car's motor. If the set starts playing the instant the gas pedal is hit, you can bet your OZ4 is the culprit.

Some sets use miniature glass rectifier tubes; the 6X4, and in the 12-volt sets, a 12X4, identical except for the filament voltage. Watch out for intermittent socket connections on these, as the miniature sockets used are prone to such troubles, and the tubes are almost always mounted upside-down.

Pickup and Pull. The average auto-radio should be able to pick up—in addition



Vibrator removal, shown below, may be a tough job. If necessary, pry back the metal "fingers" around the socket while rocking the vibrator and pulling upwards.

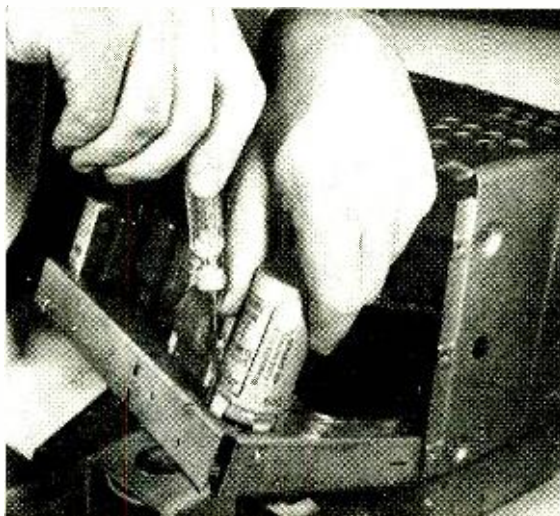

to the locals—at least four to five stations from 75 to 100 miles away. If it can pull in only the strong local stations, and without much volume on them, there is something wrong. This symptom, like the others, has many possible causes. A dead r.f. amplifier for example, won't kill the signal entirely, but it will "damage" it severely. The strong signals from the local stations will be fed through by the capacity of the tube elements into the still-operating remainder of the set, but distant stations won't be there.

The r.f. tube is usually easy to locate. It will be the tube nearest to the chassis-

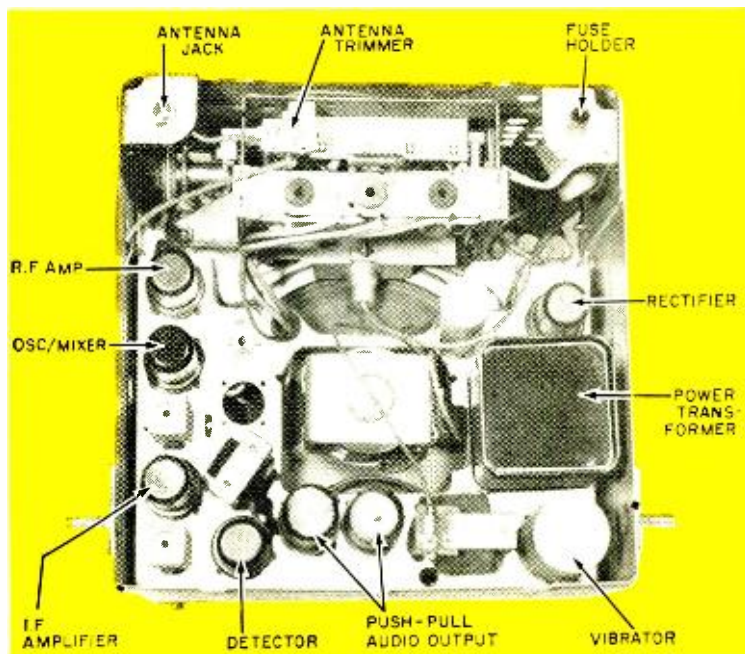

Typical receiver with cover removed. Tube function and major items of interest for repair purposes are noted. This is an all-tube, non-hybrid set.

mounted antenna socket. The quickest check here is replacement of the tube. Incidentally, don't be fooled by a tube which is lit; it may be shorted or very weak.

Figure 2 illustrates three antenna checks than can be made with an ohmmeter: (#1) continuity between antenna mast and plug tip; (#2) continuity between car chassis and coaxial shield; (#3) open circuit.

Notice that the antenna lead-in cable is coaxial. The outer braid of this shield must be well grounded, and the inner conductor must have continuity. The 3-4 ohm reading on the ohmmeter is due to the extremely small wire used as the 'hot' conductor.

Notice that little trimmer capacitor on the radio chassis? That's a very important part, and must be adjusted properly to get the most out of any set. It will usually be labeled "Ant. Trim." Such trimmers may have either a screwdriver adjustment or a shaft which can be turned with the fingers.

Now tune in a station near the high-frequency end of the dial, and adjust the antenna trimmer. You should be able to find a definite volume peak somewhere. This test ought to be made first; if you find the peak in the trimmer, then the

(Continued on page 136)

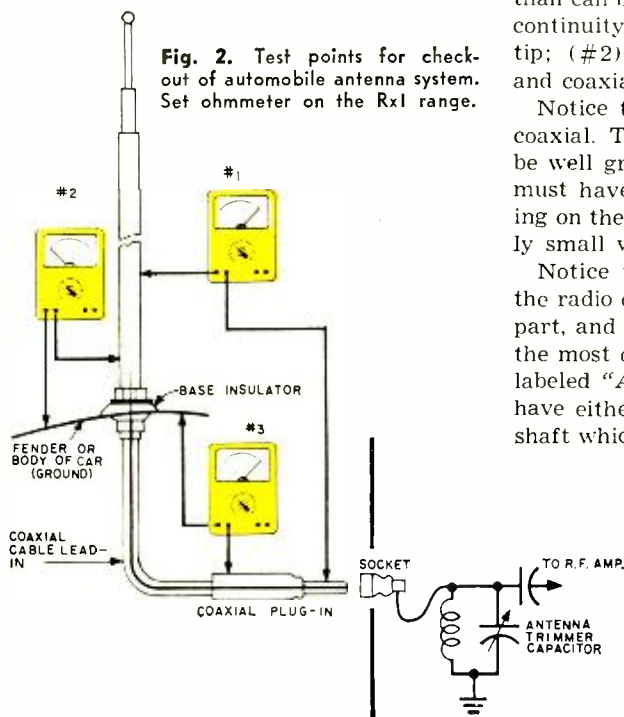

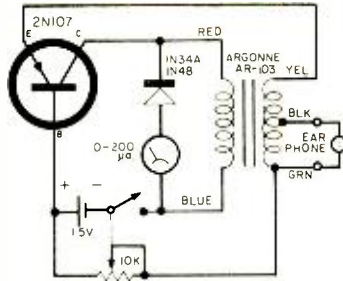
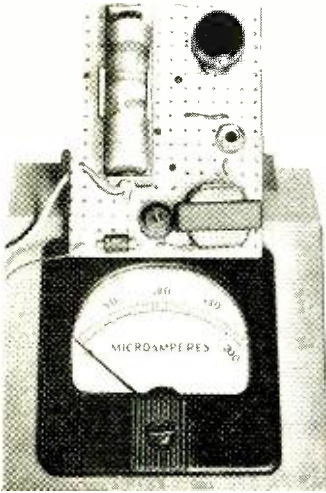

Perplexual Motion

Nearly every transistor experimenter has tried that old favorite, the audio oscillator. Here is a new and peculiar version of it—an oscillator that shuts itself off automatically and periodically about once each second. The meter deflects up and down scale indefinitely, making it an extremely simple and efficient novelty device and eye-catcher. An earpiece is not necessary to operation but it aids circuit adjustment.

The strange audio output (a series of dots followed by a pause) is synchronized with the needle swing. This occurs near the point at which the circuit just begins to oscillate. Incidentally, the gadget becomes an excellent audio generator when the meter load is removed. The tone can be varied from a high pitch to a slow series of dots.

Meters of 50- μ a., 100- μ a. and 200- μ a. sensitivity have been used successfully in this circuit. The latter may not give a full-scale deflection, however. The 1½" movements are not as suitable as the larger ones.

It is probable that the needle swing itself generates a pulse that initiates the reverse swing. At any rate, the meter seems to play an important role in all the circuits tried. Also, when the circuit is adjusted just below the oscillation point, it becomes very sensitive to external shock. A weak sound near the earpiece will start the meter swing. Then the needle returns to zero until the next sound.

—R. Zarr



Sun-Operated Power Supply

This little power supply is a convenient unit for operating transistorized radios, charging small dry cells, and supplying power for experiments with transistor circuits. Since it operates by means of sun batteries, it is practically everlasting and provides small amounts of electric power at no cost. As long as the cells are kept clean, the unit will always deliver the same amount of current for the same illumination.

Eight International Rectifier B2M sun batteries are connected in a simple switching circuit so that they may be used either in series or series-parallel operation. Series connection provides 3.1 volts open-circuit under bright sunlight. Series-parallel connection provides 1.55 volts open-circuit.

—George Pearce

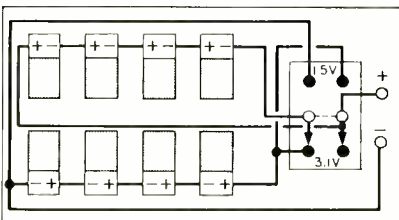

After Class

SERVO WITHOUT HUMAN OPERATORS

LAST MONTH we spoke of "open-loop" and "closed-loop" circuits—the two basic types of servo systems. In an open-loop type, a human operator is one of the links in the system, as in a TV antenna rotator. A human operator reads the antenna position on an indicating dial and sets a control knob for the desired direction, and the antenna rotator operates until the selected direction is achieved. On the other hand, a closed-loop system performs its function automatically, without human intervention, once it has been given proper instructions.

System Differential. A regular home-heating thermostat, as discussed in the April *After Class*, is a good example of a closed-loop system. Its action is *discontinuous*, however, i.e., it alternately shuts the furnace on or off. As a result, room temperature fluctuates over a range of several degrees, called the *differential* of the system.

If your thermostat is set at 70°F, the oil burner will shut off at this temperature, but the thermometer may have to drop down to 67°F before the thermostat again kicks the oil burner into operation. Thus, the differential in this case is 3°F.

In many thermostatic applications, a range of this magnitude would be intolerable. For example, the temperature of a silver-plating bath in an industrial plant must be held to much closer tolerances for consistently good results. How do we change our thermostatic servomechanism to accomplish this?

Any control system that has only two positions—*on* and *off*—cannot provide continuous control of the device it runs. That would be like trying to persuade a d.c. motor to run at half-speed by alternately turning it on and off. The *average speed* might be half that of the motor's normal

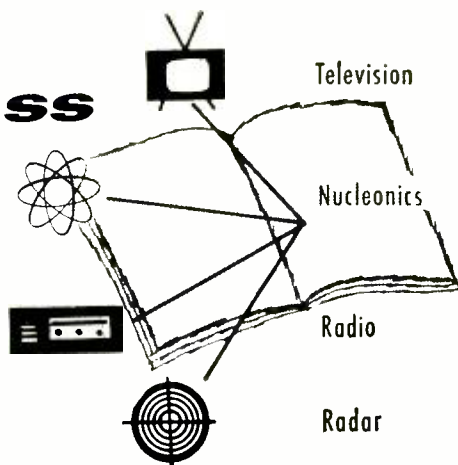

By HARVEY POLLACK

rate but the instantaneous velocity would vary between two well-defined limits—the differential again.

The problem of motor control immediately suggests that a potentiometer or rheostat be substituted for the on-off switch as a control unit. Surely, any electrical device can be brought under continuous control merely by varying the voltage or current supplied to it which, in turn, can be effected by varying the resistance in the circuit.

A Continuous Servo. Shown in Fig. 1 is a continuous servo control system for an

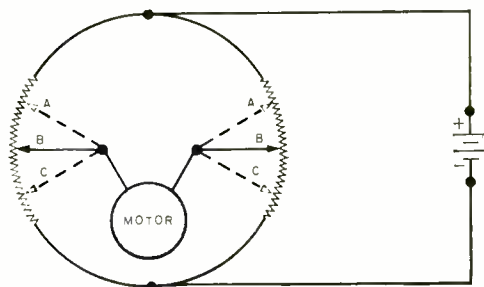

Fig. 1. Two potentiometers controlling a motor in this Wheatstone bridge circuit make for a continuous servo system. Whenever the two wiper arms are in different positions, the bridge is unbalanced and an error signal activates the motor.

antenna rotator. A close look will show that the two potentiometers and their wiper arms actually form a Wheatstone bridge circuit with the motor connected in the center of the bridge. Whenever the potentiometers are at identical positions, say *A*, or *B*, or *C*, the bridge will be balanced and no current will flow through the motor.

Suppose one potentiometer shaft is coupled to the antenna mast, and the other to the control knob. If the control is turned

the desired position must be set by an operator.

Continuous Closed Loop. The heat control mechanism for an electroplating bath in Fig. 2 illustrates a closed-loop continuous servomechanism. Control potentiometer *R1* is set for a specific temperature, say 125°F. The bi-metal strip which turns thermostat potentiometer *R2* is arranged so that when the bath is at 125°F, the thermostat wiper arm will be at the

(Continued on page 138)

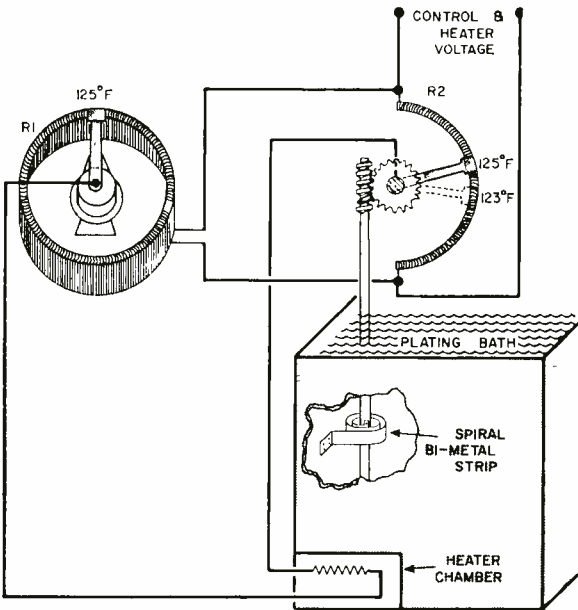
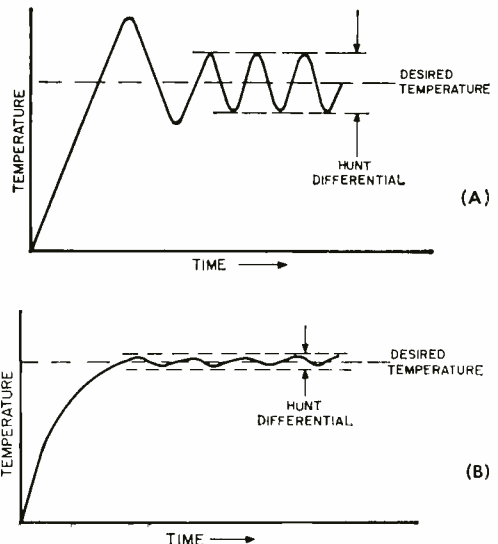

Fig. 2. Heated electroplating bath illustrates a closed-loop continuous servo system. This type of system controls heat much more accurately than the on-off thermostat type.

Fig. 3. The behavior of a discontinuous servomechanism, such as an off-on thermostat is shown in (A) while (B) shows the behavior of a continuous servo system, such as the one in Fig. 2. The temperature variation, or differential, is much less than in a discontinuous system.

to position *A* while the antenna mast is at position *B*, the bridge will be unbalanced and current (an *error signal*) will flow through the motor, turning the mast. As the mast turns, the potentiometer connected to it also turns, until it too, reaches position *A*. Then the bridge is once more balanced and no current (or error signal) flows through the motor. The servo system has automatically turned the antenna mast to the position shown set on the control knob.

This system is a *continuous* type servo—it can move the antenna to any one of an infinite number of positions by remote control. It is different from the *discontinuous* type described last month which involves a rotary switch, and which is capable of only half-a-dozen fixed positions. However, it is still an open-loop servomechanism since



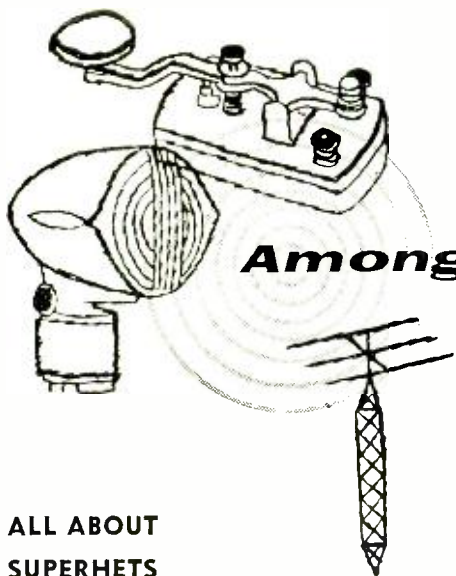

Among the Novice Hams

ALL ABOUT SUPERHETS

THE STATION RECEIVER is a most important piece of equipment in an amateur station—"you can't work them, if you can't hear them." A good ham receiver must meet the following requirements.

It must tune the desired frequencies, and it must be capable of receiving all modes of transmission commonly used by amateurs—continuous-wave telegraphy, conventional AM phone, and single and double sideband (SSB and DSB) suppressed-carrier phone. Also, it must be sensitive enough to receive the weakest signals and selective enough to separate individual signals from the thousands in the amateur bands. In addition, it must be stable and easy to tune.

Superhet Circuit. The superheterodyne receiver is the only one capable of satisfying the above requirements. In a superhet, the signals picked up by the receiving antenna are fed through a number of tuned circuits—which starts the process of separating the desired signal from the rest—and amplified.

The signals are then fed to a *mixer* or *first detector*, where they are combined with the signal from the receiver's "local" oscillator to produce an output signal equal in frequency to the difference between the frequency of the received signal and the frequency of the local oscillator signal. This difference signal is then fed to an *intermediate-frequency* (i.f.)



K5MDZ's station in Jacksonville, Arkansas.

WN6GZK is set up in a closet off the den.

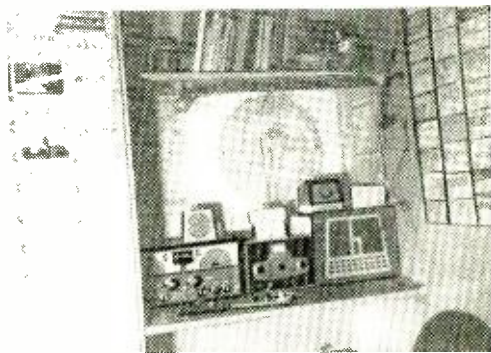

amplifier, where it is further amplified and the process of separating the desired signal from the rest is completed.

The high-frequency oscillator and the circuits between the mixer and the antenna are varied together to tune the receiver.

From the i.f. amplifier, the signal goes to the *second detector*, which removes the

audio information it contains and delivers it to loudspeaker or headphones via the receiver *audio-frequency* (a.f.) *amplifier*.

To receive continuous-wave code signals, the i.f. signal is combined with the signal from a *beat-frequency oscillator* (BFO) in the second detector. The BFO is tuned

receiver precisely. Therefore, a smaller, *bandspread* capacitor is connected in parallel with the main tuning capacitor.

Any portion of the band chosen by the main dial may be spread out on the bandspread dial for easy tuning. In operation, the main dial is set to a calibrated point

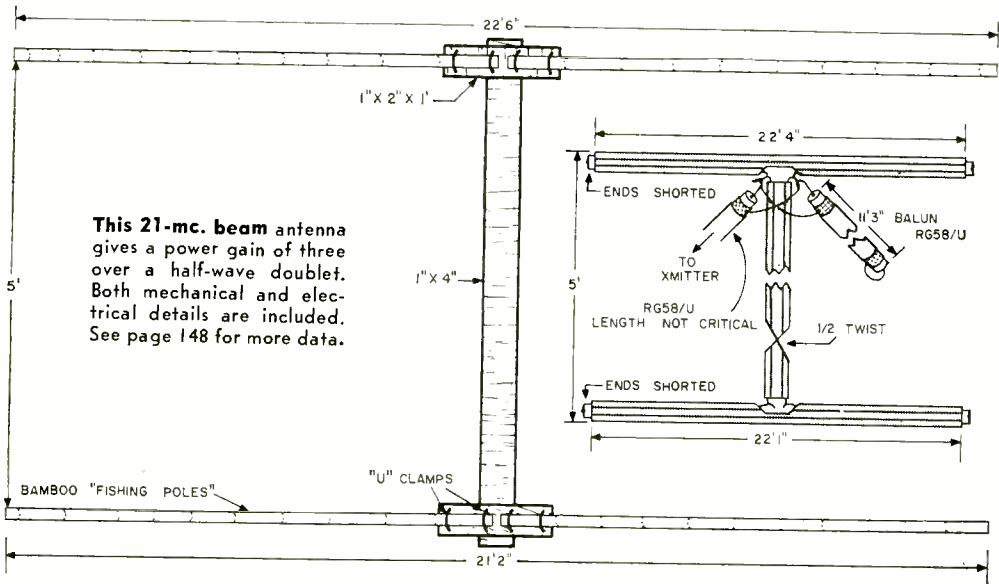

to a frequency about one kilocycle away from the intermediate frequency, and the resulting "beat note" between the two signals produces the characteristic "beep-beep" sound of code signals. The BFO usually has a panel control for varying its frequency.

The beat-frequency oscillator is also used to receive SSB or DSB signals by supplying the signal "carrier" suppressed at the transmitter, in order to change the received signals from unintelligible gibberish to sense. This must be done very accurately.

Tuning. A typical amateur receiver tunes from the broadcast band up to 30 or 54 mc., and converters or separate receivers are used for still higher frequencies. This wide frequency range is divided into several bands of frequencies selected with a *band-switch*.

In general-coverage receivers, after the desired band is selected with the band-switch, the exact frequency desired is chosen by adjusting the variable capacitors across the input tuned circuits. However, turning the main tuning dial a single division may shift the receiver tuning up to 200 kc., making it difficult to tune the

for each band, and all tuning for that band is done on the bandspread dial.

In receivers designed for the ham bands only, just a single dial is used, but each band is spread across the entire dial. Other things being equal, this results in a superior amateur receiver.

Selectivity. In the standard broadcast band, stations are spaced 10 kc. apart, and two strong signals are seldom heard on adjacent channels in a given listening area. Consequently, not too much selectivity is required to separate stations. But in the ham bands, signals are packed like sardines in a can, and to pick out the one you want without interference from the rest requires very great selectivity—as much as 2 or 3 kc. for phone reception and 500 cycles or better for continuous-wave reception.

One way to increase receiver selectivity is to lower its intermediate frequency, because the bandwidth of a tuned circuit varies directly with its resonant frequency. Other techniques include the use of many tuned circuits in the i.f. amplifier, a "mechanical" filter, or a crystal filter. All

(Continued on page 145)

Builds a

RF-AF Signal Generator

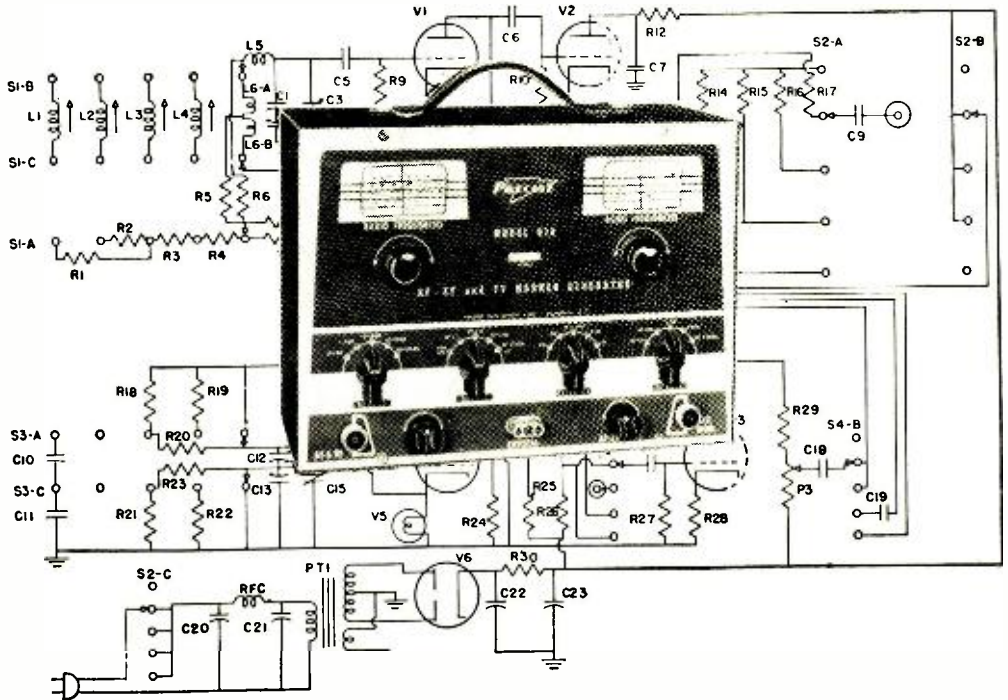

The Precise Model 630 is useful for all types of alignment and trouble-shooting

SOMETIMES one plus one equals more than two. For example, suppose you have a conventional r.f. generator. Then suppose you replace the usual fixed audio oscillator in the r.f. generator with a full-range variable audio generator, usually a separate instrument. You will have a combination whose versatility goes beyond the two separate instruments.

Alert to the potential of such a combination, Precise Development Corp., Oceanside, N. Y., has wedded these two generators in its RF-AF-TV Marker Generator, Model 630. Actually, this seemingly pretentious name is an understatement of what the device can do in all types of alignment and trouble-shooting of AM, F'M, and TV sets,

in audio work, and in many other applications. More on this score later.

Alternate Kits. The 630 kit is available in two forms. You can do all the work yourself or, for a slightly higher price, have the entire r.f. subchassis pre-wired, tested, and calibrated. We strongly recommend the latter choice, for two good reasons.

First, individual, small differences in wiring and soldering any wide-range r.f. oscillator can accumulate into problems of accuracy and calibration. Secondly, mechanical assembly of the r.f. and a.f. tuning units is on the tricky side. With the for-

Top view of main chassis shows sockets, major hardware, and electrolytic capacitor mounted at the left.

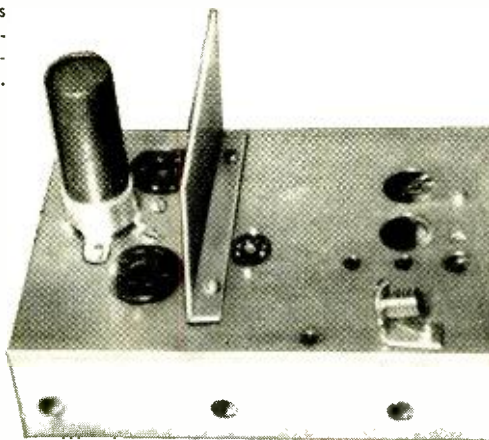

Accuracy calibration chart is made by beating r.f. output against short-wave radio stations or a crystal oscillator.

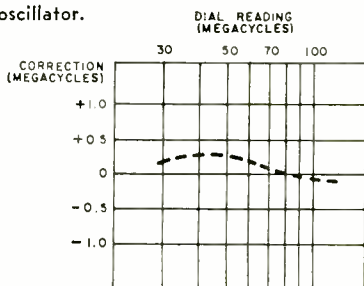

mer pre-built, you save time on the assembly of the a.f. section by using the r.f. section as a model.

Construction Hints. Construction manuals of most kit manufacturers tend to follow a similar plan. The somewhat different pattern used in the Precise manual, which has merits of its own, may at first puzzle kit builders used to other styles of presentation. Some precautions will guard against pitfalls. As for actual errors, there were none. The P.E. unit worked immediately after completion.

Every item down to the last washer was accounted for in the preliminary parts check. Right after this check we found it best to tag each group of similar parts with a slip of paper carrying its code number. Then, when the instructions said "place H51 through H34 and secure with H15," no time was lost leafing through the instructions to re-check part numbers.

If you are the cautious type who likes to check against the schematic when any doubt arises in a given step, some additional advance correlation will help. Since code numbers in the construction portion of the manual for certain parts and wiring points don't always correspond to schematic notation, it will help to mark con-

struction numbers on the schematic or, conversely, schematic numbers on the chassis.

If doubts still remain during wiring, you can skip some steps—but be sure to place a big, bold question mark beside them. Toward the end, when things begin to "fall into place," you can backtrack to pick up these question-marked steps.

Calibration. The alternate calibration procedures for r.f. suggested in the manual, depending on what facilities you may or may not have, are quite satisfactory. However, remember that the purpose of this check is to record frequency variations. Laboratory accuracy is only possible with laboratory generators, the cheapest of which costs far more than many service dealers or hobbyists can spend. Draw up a calibration chart showing actual frequency versus dial indication. This way you can tune the generator with the accuracy your work requires.

As to the audio generator, an inexpensive pitch pipe proved an excellent calibrator. Even one with a single, identified tone, usually "standard A (440 cycles)," is adequate—and you don't have to be a musician to use it. Feed a.f. signals into an amplifier and speaker. Rock the tuning dial back and forth in the vicinity of 440 cycles while blowing the pipe. The "zero-beat" point is where the two tones blend into one without a low-frequency beat note.

The same check can be made with generator harmonics and subharmonics of 440 cycles. Thus, you can calibrate the generator upward to 880 cycles, 1320, 1760, etc., or downward to such submultiples of 440 as

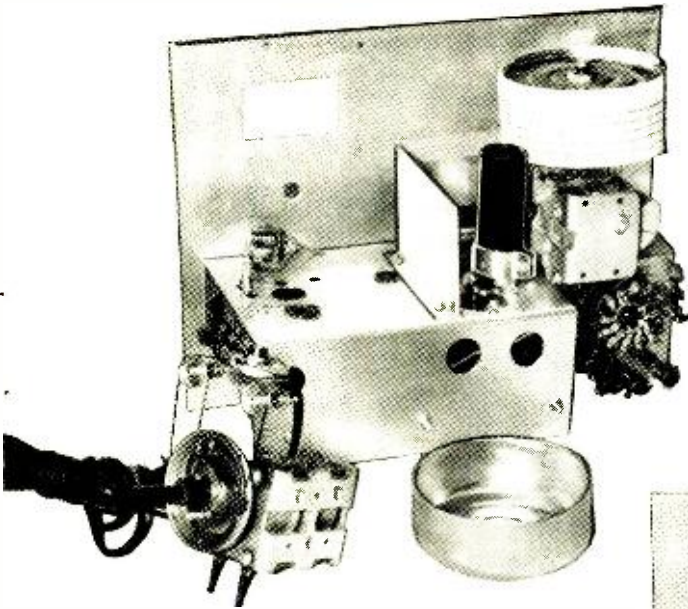
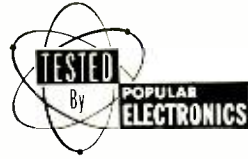

The r.f. assembly is shown mounted to the front panel, adjacent to the main chassis, in the above photo. The r.f. unit is at the right. The partially assembled a.f. tuning unit is in the left foreground, with the a.f. dial drum lying beside it.

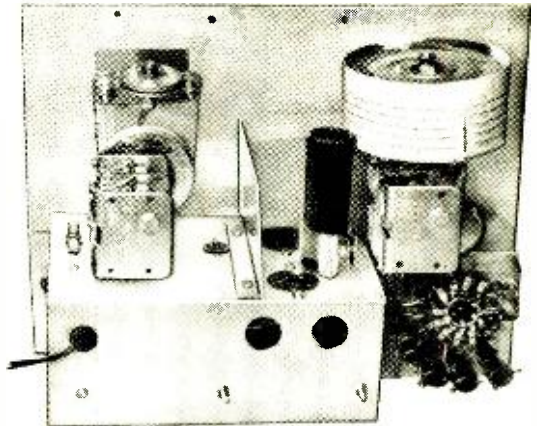

The a.f. unit minus the dial drum is mounted on the main chassis in this photo. Wiring has been completed. All that remains is final assembly.

220 cycles, 146.67, 110, 88, etc. You will probably find the a.f. section quite accurate without adjustments.

Applications. Coming back to the versatility we mentioned earlier, the 630 can be used—like any r.f. generator—for aligning the r.f. and i.f. portions of any type of receiver, or for trouble-shooting by signal injection.

In addition to such expected functions, it can be used for bandpass checks on AM receivers, e.g., when it may be desired to stagger-tune the i.f. system for improved fidelity. Feeding modulated r.f. into the receiver, you can run the audio generator through its range and note the frequencies at which audio level begins to drop off. You can check again after i.f. readjustment.

When the 630 is used as a bar generator in checking the linearity of a TV picture, a modulated r.f. signal is fed into the antenna input of the TV set, with the r.f. dial adjusted to the same frequency as the video channel to which the set is tuned. The

audio generator is then tuned to produce a convenient number of visible horizontal or vertical bars. Adjusting the TV receiver controls for bars of equal thickness and spacing produces good picture linearity.

Through the external-modulation input, you can amplify and modulate voice or other audio signals on the r.f. output. Thus, an inexpensive high-output microphone converts the instrument into a transmitter. Since such transmission on clear frequencies in the AM broadcast band is permissible over short, local distances, you now have a convenient "wireless baby sitter" when you visit nearby neighbors. Just put the 630 with the mike in the nursery, and tune your neighbor's radio to the frequency you have chosen.



EXHIBITIONIST

Becoming strangely affected the moment the music begins, this guest fancies himself something of an impromptu conductor. He sometimes breaks into interpretive dance routines ranging from quasi-ballet to the common waltz-clog, and has been known to do a fandango to locomotive sound recordings. He can be persuaded to sit still only if test tones are played.

hi-fi



Sooner or later the avid hi-fi and stereo enthusiast begins inviting friends over to admire his latest equipment acquisitions and enjoy his newest recordings. Portrayed here are a handful of guests any stereo-loving host may encounter to his bewilderment . . .



KILLJOY

He seems to derive an almost sadistic satisfaction from finding minor flaws in his host's equipment and pointing out that the same turntables, tuners and amplifiers are selling for half of what the host paid, elsewhere. A genius at discovering minute damaged areas on cabinets which have escaped the attention of his host.

By
CARL KOHLER



RESEARCHER

Caring little for his host's splendid library of recordings, he is quite impressed with the cataloging and cross-filing system. He has a dismal habit of insisting upon discussing record-classification methods in detail while his host's most enthralling musical selections are vainly being played for him.



CRITIC

This guest hasn't really approved of any recording since "Cohen On The Telephone" was issued. He listens to his host's latest and most unique records with utter dissatisfaction and frequent grunts of derision.

Always giving the strong impression that he has been shanghaied into lending ears (which may be true), he has been known to stalk out during the first bars of music which keeps other people rooted to their chairs.



TINKERER

If not closely watched, he will quietly begin "investigating" any piece of hi-fi stereo equipment he can put his paws on.

He can easily be spotted since he invariably carries a miniature tool kit in his hip pocket and is given to loitering around the backsides of cabinets.

SLOTH

Displaying a flattering interest in anything and everything his host may suggest be played, this type actually wants only background music so he can find the most comfortable chair in the room and take a nap. He demonstrates a weird ability to doze off no matter what kind of music is offered him.



Here's a Look at the First Crop of

Multiplex Stereo Adapters

By MIKE BIENSTOCK

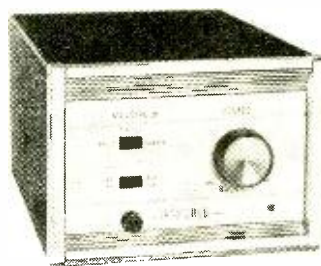

Sherwood SMXC

WITH STEREO by far the "hottest" thing in high fidelity today, audiophiles have been eyeing broadcast stereo with more than just passing interest. For a long time it has been obvious that this medium could offer the greatest opportunity for high-quality, inexpensive stereophonic listening.

With the advent of FM multiplex transmission tests by a number of stations, it appears that true high-fidelity stereo broadcasting is but a step away. That final step, however, may be a long time in coming, since it is uncertain when the Federal Communications Commission will finally approve a system of FM multiplexing for general use.

Multiplexing, of course, is the system

whereby both the left and right signals of a stereo broadcast are sent over the same FM frequency—both with a true high-fidelity frequency response—and can be received in the home with only the addition of a multiplex adapter or converter.

The advantages of such a system are manifold. For instance, the transmission is compatible; in other words, even without separating the two signals, listeners will be able to hear a complete monophonic high-fidelity broadcast. The cost of the adapters will not be prohibitive; one adapter on the market costs about \$50, others will sell from about \$35 to \$100. Compared to the cost of installing a stereo tape deck or stereo arm and cartridge, plus the cost of stereo discs or tapes, it can readily be ap-

Eico FMX-99

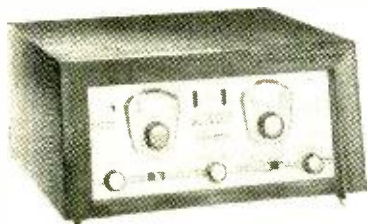
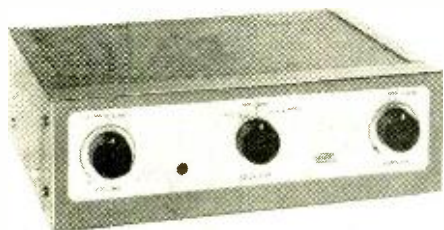

Calbest Tuner

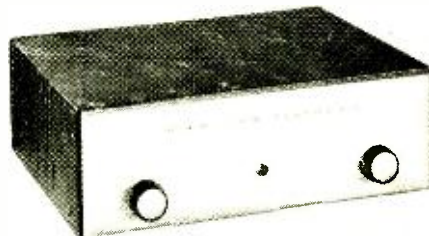

Madison Fielding
MX-100



Fisher MPX-10



Karg MX-1

preciated that multiplex will be the cheapest source of stereo program material available.

While industry is uncertain as to when the FCC will finally give the go-ahead, stations such as WBAI of New York City have been broadcasting multiplex stereo on an experimental basis. The author can attest to the fact that the quality of WBAI's stereo broadcasts has been superb and limited only by the quality of the stereo discs or tapes used.

There are at present several multiplex adapters on the market, including the Madison Fielding MX-100 (\$49.95), the Karg MX-1 (\$99.50 plus \$10.00 for walnut or birch cabinet), the Sherwood SMXC (\$55.50 plus \$4.00 for cabinet), the Fisher MPX-10

(\$79.95, plus \$12.95 for cabinet in mahogany, blonde, or walnut), and the Harmon Kardon MA-250 (\$49.95, for plug-in use with Harmon Kardon T-250 and F-250 tuners only).

An AM-FM stereo tuner which also incorporates a multiplex section is being produced by Calbest Electronics. This tuner thus can be used to listen to either AM-FM stereo or FM-FM multiplex stereo.

At least two multiplex adapter kits are in the works. Eico will shortly introduce an adapter kit for the home constructor which will sell for about \$35.00; the factory-wired version of the same model will go for about \$60.00. The Heath Company is also working on a kit-built adapter but has no information available on it at present. —30—

By
JOHN T. FRYE
W9EGV



Carl and Jerry

"BBI"

THE BAT met the ball with a thud and sent it almost straight up into the air. Jerry tore off his catcher's mask and ran around in a little circle as his eyes searched wildly for the ball against the bright blue sky. Just in time he spotted it and stepped forward to catch it neatly in the deep pocket of his mitt for a third out. His pal, Carl, stepped off the pitcher's mound and trudged wearily toward the Center City bench while the Cedar Creek Giants ran happily out onto the diamond.

They had something to be happy about. The score board announced it was the last of the seventh inning and that the Cedar Creek Giants had seven runs. Chalked up opposite the Center City Sluggers was a series of big fat goose eggs.

Jerry struggled out of his chest protector and sat down on the bench beside Carl.

"I just don't get it!" he said as he angrily drove his fist into his catcher's mitt. "They're not that much better than we are."

"It's not who wins that counts; it's how you play the game!" Carl chanted.

"Yeah, I know; but that's the trouble with being a good sport. You've got to lose to prove you are one. I'd like to demonstrate what gracious winners we can be."

"I'm with you! What really bugs me is the way they seem to know every move we're going to make. They seem to know what kind of ball I'm going to pitch, when I'm going to try to catch a runner off base, and exactly who is supposed to take a high fly. It's spooky in a sandlot team that doesn't get any more practice than we do."

"Maybe they're hep to my signals, but I'm doggone careful to conceal them from anyone on their bench. Do you suppose—"

He was interrupted by Kent, the youngest member of their amateur radio club.

This fourteen-year-old boy ate, drank, and slept radio. It was typical that he was tugging at Jerry's elbow with one hand and clutching a two-meter transceiver in the other.

"Hey, Jerry, listen to this!"

"Some other time, Kent," Jerry said impatiently as he shrugged off the "child"—who was a whole two years younger! "We've got a problem now."

"I *know* you have. That's why I want you to listen!" Kent insisted as he jiggled up and down in his impatience.

AT THIS MOMENT the Center City batter hit a high fly out into right center field. A faint voice came from the speaker of the transceiver: "Let Murphy have it, Jonesy. Take it Murph." Both the center-fielder and the right-fielder had been running toward the ball, but as the voice spoke the center-fielder stopped and let the right-fielder make an easy catch for a first out.

"Let me have that thing!" Jerry commanded. As the three of them listened intently, they could hear the same voice giving instructions to the pitcher: "This guy is a sucker for a slow ball. Try one. Thaaat's fine. Now he's crowding the plate. Put one over the inside corner and scare him back a little."

"See that guy sitting all by himself out at the edge of the trees in center field?" Kent asked. "He's the bird doing the talking. When I get close to him, the signal really booms in. His transmitter is pretty low-powered, for the signal falls off rapidly as you get away from the diamond. Jerry, he's been relaying to the batter every signal you gave to Carl."

Listening for the next few minutes revealed that the Giants didn't just *scare*

to know what the Sluggers were going to do next. They knew! It was apparent that each member of the team had some sort of miniature receiver—doubtless transistorized—concealed in his cap. A bone-conduction earphone attached to the skull enabled them to hear every word spoken by the sharp-eyed observer who was equipped with a miniature transmitter and a pair of high-powered binoculars. What's more, this observer knew the Sluggers' signals better than they knew them themselves!

"Why the dirty so-and-so's!" Carl exclaimed. "Here! Give me that transceiver microphone and let me tell them off."

"Hold on!" Jerry objected. "Maybe, if they don't know we're on to their electronic caper, we can turn it to our advantage. First off, we've got to cross up their intercepting my signals to you. We don't have time to make up a whole new set of signals, but suppose we do this: I'll make an ordinary signal that you can disregard; but then I'll wiggle my mitt up and down in Morse code. You know the way we send silent code in study hall just by tapping an imaginary key with our fingers. It will be the same except you will see me punching an imaginary key with the mitt. We can use initials. 'IC' will mean 'inside curve;' 'FB' will be 'fast ball;' 'W' will mean 'walk;' etc. Usually the false hand signal will be just the opposite of the real code signal. Dig me?"

"Yeah, I dig you; but it sounds pretty

tricky. I'll have to study it out as we go along. I'm going to be a very deliberate pitcher from here on in."

"Fine! Now let's pass the word along to the rest of the team."

WHEN the other boys learned about the electronic skullduggery afoot, they were properly indignant. This resentment actually worked to their advantage. Still seething, they stepped up to the plate one after another and angrily drove out solid



... "Give me that transceiver microphone" ...

hits. When the inning was over, the score stood 7 to 4.

And the first half of the eighth was a far different story from what the other innings had been. Jerry made sure the man with the binoculars got a good look at his false signal to Carl; then he casually called for the pitch he wanted by moving his mitt up and down. The effect was much more puzzling to the batter than if he had simply been allowed to go on his own. It was very disconcerting to be expecting a slow ball and then have one cross the plate like a rifle bullet. The net result of the double double-cross was three up and three down. The Giants never got a man on base.

During the last of the eighth the Sluggers picked up two more runs, making the score 7 to 6. Jerry spent every minute with his ear glued to the speaker of the transceiver trying to figure out a way to turn the Giants' trickery to the Sluggers' advantage; but no opportunity presented itself. The first of the ninth was a repetition of the first of the previous inning; three up and three down.

But fickle luck once more turned against the Sluggers as they came to bat. The first man up never touched the ball as three strikes were called on him in quick suc-

	1	2	3	4	5	6	7	8	9
CEDAR CREEK GIANTS	1	2	1	0	1	1	1		
CENTER CITY SLUGGERS	0	0	0	0	0	0			



... "I just don't get it!" Jerry said angrily ...

cession. The next man up drove a hot grounder to the shortstop that was rifled across to cut off the runner at first with seconds to spare. The third man, though, did barely manage to get on first with a drive just over the second baseman's head. It was Carl's turn to bat.

Carl was far and away the best hitter the Sluggers had, and at first it seemed that the pitcher intended to walk him. The first two pitches were wide of the



... "No, you take it, Murph; on second thought—" ...

plate. But the third drilled straight across the center to land in the catcher's mitt with a solid smack for a called strike. Jerry could see Carl's hands tightening on the bat handle as the pitcher started his wind-up, but once more the ball was wide of the plate.

The next one was too close to let pass, and Carl swung at it. His bat nicked the ball, but that was all. "Stri-i-i-ke Two!" the umpire cried as he held up three fingers on one hand and two on the other.

Carl pounded the plate savagely with his bat and tensed his lean body. The pitcher started a slow windup and then uncoiled to speed the ball straight across the rubber. It was now or never! Carl swung with all his might and there was a solid crack of wood meeting horsehide. But a groan arose from the Sluggers' bench as they saw the hard-hit ball sailing too high in the air as it went toward a point midway between

the stations of the right-fielder and the center-fielder. Both men started running toward it with their eyes on the ball.

"You take it, Jonesy. Let him have it, Murph," Jerry heard the voice saying in the speaker of the transceiver. In a flash Jerry pushed down the transmit switch on the transceiver and said loudly into the microphone: "No, you take it, Murph; you're closer. On second thought, you better get it after all, Jonesy."

He left the transmit-receive switch in the transmit position to block out the signal from the other transmitter and watched in fascination as the two outfielders hesitated a second, then went charging toward each other with their gloves outstretched. They came together with a crashing shock and then bounced apart to fall flat on their backs as the untouched ball bounced lazily along the ground.

It was several seconds before the two stunned boys rolled over and got painfully to their feet. In the meantime Carl had loped around the bases in hot pursuit of the other runner, and the game was over.

The Sluggers dashed out of their dugout to thump Carl on the back, but Jerry hung back to watch the man out at the edge of the trees. The two injured outfielders stalked over and towered threateningly over him as the rest of the Giants joined them. The man sitting on the ground waved his arms wildly and shook his head vigorously from side to side; but what he was saying seemed to carry little weight with the members of the team.

AS Carl and Jerry helped load the equipment into the back of the manager's station wagon, they grinned happily at each other. Winning the game was nice, of course; but winning it by outsmarting the tricky Giants at their own game—and doing it electronically—indeed made their cup runneth over.

"I'll bet that's the last time the Giants use that gadget," Carl said as he glanced across to the angry huddle at the edge of the trees.

"You can say that again," Jerry agreed. "And I was just thinking we've invented a new kind of interference. I've been accused of BCI, or broadcast interference; and TVI, or television interference; and I didn't like it a bit. But how I know I'm guilty of BBI, or baseball interference; and all I feel is a kind of warm, contented glow!" —50—

**AT
LAST!**

RADIO-TV and ELECTRONICS TRAINING

**.... AT A PRICE
YOU CAN AFFORD!**

***21 INCH**
Receiver Kit included

Yes, this great course costs far less than any training of its kind given by other major schools! Radio-Television Training School will train you for a good job in Television or Industrial Electronics — **AT HOME IN YOUR SPARE TIME.**

Think of it—a complete training program including over 120 lessons, Fourteen Big Radio-Television Kits, Complete Color-TV Instruction, Unlimited Consultation Service ... **ALL at a really big saving to you.** How can we do this? Write to us today ... and find out!

And what's more — you can (if you wish)
**OPEN YOUR OWN RTS-APPROVED AND
FINANCED RADIO-TV SERVICE SHOP**

We Want Many More Shops This Year
This 37 year old training organization — called RTS, that's Radio-Television Training School — wants to establish a string of Radio-TV Repair Shops in principal cities throughout the U. S. So far, a great many such shops are **NOW IN BUSINESS AND PROSPERING.** We are helping and training ambitious men to become future owners and operators of these shops in all areas.

**FOR UNSKILLED
INEXPERIENCED MEN ONLY —
WE TRAIN YOU OUR WAY!**

We must insist that the men we sign up be trained in Radio-TV Repair, Merchandising and Sales by our training methods—because **WE KNOW** the requirements of the industry. Therefore, we will **TRAIN YOU** ... we will show you how to earn **EXTRA CASH**, during the first month or two of your training period. **YOU KEEP YOUR PRESENT JOB. TRAINING TAKES PLACE IN YOUR OWN HOME. IN YOUR SPARE TIME!**

**ACT
NOW!**



**COMPLETE
COLOR
INSTRUCTION
INCLUDED**

**RTS
APPROVED
SERVICE
SHOP**

Get your free book on the
FAMOUS RTS BUSINESS PLAN
find out how you can open
A REPAIR SHOP OF YOUR OWN

We supply and finance your equipment

When you are ready and qualified to operate one of our RTS-Approved TV Repair Shops **WE WILL SUPPLY AND FINANCE EVERY BIT OF EQUIPMENT YOU NEED TO GET STARTED** plus an inventory of parts and supplies. In other words we will stake you ... **AN OFFER NEVER MADE BEFORE BY ANY TRAINING ORGANIZATION.** Under the RTS Business Plan you receive:

1. An electric sign for the shop front.
2. Radio and TV test Equipment.
3. Letterheads, calling cards, repair tickets, etc.
4. Basic inventory of tubes, parts, supplies.
5. Advertising and promotional material.
6. Plans for shop arrangement.
7. Instructions on how to go into business.
8. Continuous consultation and help.
9. The right to use RTS Seal of Approval, and the RTS Credo.
10. The right to use the Famous Trade Mark.



**you build these
and other units**

*tubes
excluded

**RADIO-TELEVISION
TRAINING SCHOOL**

5100 S. VERMONT AVENUE
LOS ANGELES 37, CALIFORNIA

Est. 1922



RTS' Membership in The Association of Home Study Schools is your assurance of Reliability, Integrity, and Quality of Training.

**ALL
THESE
FREE!**



CUT OUT AND MAIL — TODAY!

RADIO-TELEVISION TRAINING SCHOOL

5100 S. Vermont Avenue, Dept. PE-59,
Los Angeles 37, California

SEND ME FREE — all of these big opportunity books — "Good Jobs in TV-Electronics," "A Repair Shop of Your Own" and "Sample Lesson." I am interested in:

- Radio-Television Industrial Electronics (Automation)

Name _____ Age _____

Please Print Address _____

City & State _____

300



do-it-yourself kits put top quality within easy reach

With absolutely no previous experience or knowledge of electronics you can assemble your own HEATHKIT hi-fi system, Ham station, test equipment or marine gear. Easy to understand step-by-step instructions, along with large pictorial diagrams, guarantee your success—and you save 1/2 or more on the highest quality equipment available today at any price!

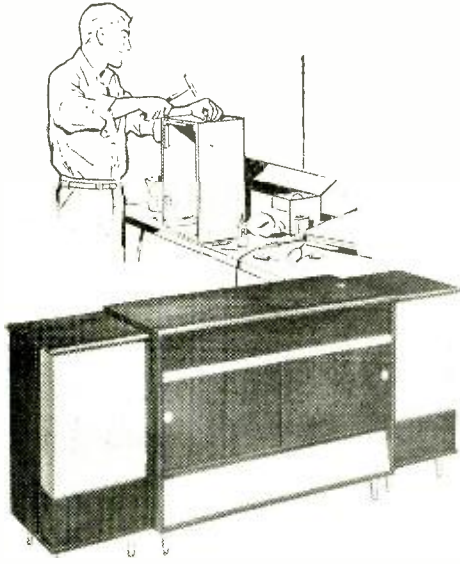

STEREO EQUIPMENT CABINET KIT

A thing of beauty as well as utility, this stereo equipment cabinet ensemble houses your complete stereo hi-fi system. It consists of a stereo equipment center flanked by two stereo speaker enclosures. The kit is supplied with mounting panels pre-cut to accommodate Heathkits and interchangeable blank panels are also furnished. The pre-cut panels accommodate the Heathkit AM-FM Tuner (PT-1), Stereo Pre-amplifier (SP-2), and Stereo Record Changer (RP-3-S). The changer slides out smoothly for easy record loading. Convenient record and tape storage space is provided. Ample room is provided in the rear of the center cabinet for a pair of matching Heathkit amplifiers from 12 to 70 watts. The stereo wing speaker enclosures are open-backed, cloth-grilled cabinets designed to hold the Heathkit SS-3 or similar speaker enclosures. The cabinets are available in beautifully grained 3/4" solid core Phillipine mahogany or select birch plywood suitable for the finish of your choice. Entire top features a shaped edge. Hardware and trim are of brushed brass and gold finish.

\$149⁹⁵

each
(shpg. wt. 162 lb*)

STEREO EQUIPMENT CABINET KIT

Model SE-1B (birch)
Model SE-1M (mahogany)

\$39⁹⁵

each
shpg. wt. 42 lbs.)

STEREO WING SPEAKER ENCLOSURE KIT

Model SC-1BR (birch—right end)
Model SC-1BL (birch—left end)
Model SC-1MR (mahogany—right end)
Model SC-1ML (mahogany—left end)

MODEL SF-1

\$39⁹⁵



DIAMOND STYLUS STEREO PICKUP CARTRIDGE

Enjoy the latest stereo records now. Fits all standard tone arms and features a .6 mill diamond stylus. Designed to Heath specifications by Fairchild Recording Equipment Corporation. Shpg. Wt. 1 lb.

MODEL MF-1

\$26⁹⁵



DIAMOND STYLUS HI-FI PICKUP CARTRIDGE

Get the most from your LP microgroove records. Designed to Heath specifications by Fairchild Recording Equipment Corporation, the MF-1 is one of the finest pickup cartridges on the market today. Shpg. Wt. 1 lb.

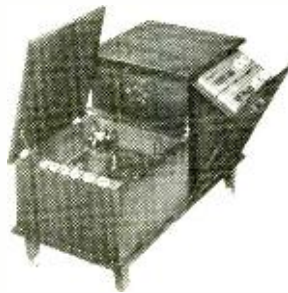

TRADITIONAL
Model CE-2T (mahogany)

CONTEMPORARY (not shown)

Model CE-2B (birch)
Model CE-2M (mahogany)

\$43⁹⁵
each

CHAIRSIDE ENCLOSURE KIT

Put your entire hi-fi system right at your fingertips with this handsome enclosure. Available in either traditional or contemporary models and constructed of beautiful veneer-surfaced plywood suitable for the finish of your choice. It is designed to house the Heathkit AM and FM Tuners (BC-1A and FM-3A), the WA-P2 Pre-amplifier, the RP-3 Record Changer, and adequate space is provided for any Heathkit amplifier designed to operate with the WA-P2. All parts pre-cut and predrilled for easy assembly. Shpg. Wt. 46 lbs.

Always say you saw it in—POPULAR ELECTRONICS



HEATHKIT EA-2
\$28⁹⁵

'BOOKSHELF' HI-FI 12 WATT AMPLIFIER KIT

True hi-fi performance is yours with this handsomely styled amplifier-preamplifier combination. With more than enough power for the average home hi-fi system it features a frequency response of ± 1 db from 20 to 20,000 CPS with less than 2% distortion at full output over the entire range. Inputs provided for tuner, xtal phono and mag phono. RIAA equalization, separate bass and treble tone controls, and a special hum control are provided. Shpg. Wt. 15 lbs.



HEATHKIT PT-1
\$89⁹⁵

MONAURAL-STEREO AM-FM TUNER KIT

This professional quality 16-tube tuner offers you outstanding AM, FM or stereo AM/FM performance at minimum expense. Features include individual flywheel tuning and automatic frequency control. A multiplex jack is also provided. Shpg. Wt. 24 lbs.



HEATHKIT SP-2
\$56⁹⁵

MONAURAL-STEREO (two channel mixer) PREAMPLIFIER KIT

Control your entire stereo system with this 2-channel preamplifier. A remote balance control with 20' of cable allows balancing the stereo system from listening position. Shpg. Wt. 15 lbs.



HEATHKIT SS-2
\$39⁹⁵

*Build it in
one Evening*

"BASIC RANGE" HI-FI SPEAKER SYSTEM KIT

With performance comparable to speakers costing many times more, the SS-2 employs a Jensen 8" woofer and compression-type tweeter to provide total frequency response of 50 to 12,000 CPS. Shpg. Wt. 26 lbs.

ATTRACTIVE BRASS TIP ACCESSORY LEGS: convert the SS-2 into handsome con-olette. Shpg. Wt. 3 lbs. No. 91-26. \$4.95.

BASIC FIR MODEL: same as SS-2 except constructed of non-1 premium plywood without trim or grille cloth. Shpg. Wt. 26 lbs. Model SS-3. \$34.95.



HEATHKIT TR-1A \$99⁹⁵

Includes turn deck, tape recorder electronics, microphone and roll of blank tape.



HIGH FIDELITY TAPE RECORDER KIT

Whether making your own recordings or playing pre-recorded tapes you'll enjoy the many fine features of this tape recorder kit. Included are fast forward and rewind functions and choice of 7 1/2 or 3 3/4 IPS tape speeds. Printed circuit boards simplify assembly. Shpg. Wt. 24 lbs.



HEATHKIT FM-3A \$26⁹⁵

HIGH FIDELITY FM TUNER KIT

The thrills of FM entertainment are yours at budget cost with this handsomely styled tuner. Featuring broad-banded circuits for full fidelity and better than 10 microvolt sensitivity for 20 db of quieting, the FM-3A pulls in stations with clarity and full volume. Shpg. Wt. 8 lbs.

HEATHKIT RP-3
\$64⁹⁵

(stereo model RP-3S \$74.95)



AUTOMATIC HI-FI RECORD CHANGER KIT

Combining the convenience of an automatic record changer with true turntable quality the RP-3 obtains full fidelity from your hi-fi and stereo records while treating them with the care they demand. A "turntable pause" feature prevents records from dropping on moving turntable or disk. Plays at 33 1/3, 45, 78 and 16 RPM. Shpg. Wt. 19 lbs.



HEATHKIT W-7M \$54⁹⁵

"EXTRA PERFORMANCE" HI-FI 55 WATT AMPLIFIER KIT

Offering full fidelity at less than a dollar per watt, the power output of this remarkable amplifier is conservatively rated at 55 watts from 20 CPS to 20 kc with less than 2% total harmonic distortion throughout this entire range. Shpg. Wt. 28 lbs.

HEATH COMPANY
Benton Harbor, Mich.

A Subsidiary of Daystrom, Inc.



HEATHKIT



HEATHKIT TX-1
\$234⁹⁵

"APACHE" HAM TRANSMITTER KIT

Features 150 watt phone input and 180 watt CW input. Provision for single-sideband transmission using the SB-10 External Adapter. Shpg. Wt. 110 lbs.



HEATHKIT RX-1
\$274⁹⁵

"MOHAWK" HAM RECEIVER KIT

Covers from 160 through 10 meters on 7 bands with an extra band calibrated to cover 6 and 2 meters using a converter. Outstanding SSB reception. Shpg. Wt. 66 lbs.



HEATHKIT SB-10
\$89⁹⁵

SINGLE SIDEBAND ADAPTER KIT

A compatible plug-in adapter unit for the "Apache" Transmitter, the SB-10 covers 80, 40, 20, 15 and 10 meter bands. Produces USB, LSB or DSB signals, with or without carrier insertion. Shpg. Wt. 12 lbs.



HEATHKIT DX-40
\$64⁹⁵

PHONE AND CW TRANSMITTER KIT

Providing phone and CW operation on 80, 40, 20, 15, and 10 meters, the DX-40 features built-in modulator and power supplies. Shpg. Wt. 25 lbs.



HEATHKIT MP-1
\$44⁹⁵

MOBILE POWER SUPPLY KIT

Furnishes all power required to operate both MT-1 Transmitter and MR-1 Receiver from 12-14 volt battery. Delivers full 120 watts continuously or 150 watts intermittently. Kit includes 12' battery cable, tap-in studs for battery posts, power plug and 15' connecting cable. Shpg. Wt. 8 lbs.

**Mobile Fun! With all New
Heathkit Mobile Ham Gear**



HEATHKIT MR-1
\$119⁹⁵

"COMANCHE" MOBILE HAM RECEIVER KIT

Handsome styling, rugged construction, top quality components and economy are all wrapped up in the "Comanche". It is an 8-tube superheterodyne receiver operating AM, CW and SSB on the 80, 40, 20, 15 and 10 meter amateur bands. Operates from 12 volt car battery through the MP-1 Mobile Power Supply. Can be converted in minutes to a fixed station unit by using an AC power supply. Shpg. Wt. 19 lbs.

MOBILE ACCESSORIES

Quality 5" PM speaker in rugged steel case with mounting brackets. Heathkit AK-7. \$5.95. Shpg. Wt. 4 lbs.

Mobile base mount holds both transmitter and receiver. Universal floor mounting bracket. Heathkit AK-6. \$4.95. Shpg. Wt. 5 lbs.



HEATHKIT MT-1
\$99⁹⁵

"CHEYENNE" MOBILE HAM TRANSMITTER KIT

The fun and convenience of mobile operation are yours with the compact and efficient "Cheyenne" Transmitter. Featuring high power with minimum battery drain, the unit provides up to 90 watts phone input and covers 80, 40, 20, 15 and 10 meters. Featured are a built-in VFO, modulator, 4 RF stages with a 6146 final amplifier pi network (coaxial) output coupling. The "Cheyenne" is designed as a companion to the "Comanche" receiver and is powered by the MP-1 Power Supply. Shpg. Wt. 19 lbs.



HEATHKIT VHF-1
\$159⁹⁵

"SENECA" VHF HAM TRANSMITTER KIT

General, technician or novice class hams wishing to extend transmission into the VHF region will find the "Seneca" ideal. A completely self-contained 6 and 2 meter transmitter, the VHF-1 features up to 120 watts input on phone and 140 watts input on CW in the 6 meter band. Included are controlled carrier phone operation, built-in VFO for both 6 and 2 meters, and four switch-selected crystal positions. Shpg. Wt. 56 lbs.



HEATHKIT V7-A
\$25⁹⁵

ETCHED CIRCUIT VTVM KIT

World's largest selling VTVM, the V7-A measures AC voltage (RMS), AC voltage (Peak-to-peak), DC voltage and resistance. Features 7 AC (RMS) and DC voltage ranges of 0-1.5, 5, 15, 50, 150, 500 and 1500. In addition there are 7 peak-to-peak AC ranges of 0-4, 14, 40, 140, 400, 1400 and 4000. Seven ohmmeter ranges are provided. Battery and test leads are included with kit. Shpg. Wt. 7 lbs.



HEATHKIT TC-3
\$39⁹⁵

TUBE CHECKER KIT

An invaluable aid to servicemen, the TC-3 tests for open, short, leakage, heater continuity and quality of all tube types commonly encountered in radio and TV servicing. Checks 4, 5, 6 and 7-pin large, 7 and 9-pin miniature, 7-pin sub-miniature, octal and loctal tubes and pilot lamps. A blank socket provides for future tube types. Shpg. Wt. 12 lbs.



Model 355.

TV PICTURE TUBE TEST ADAPTER

For use with TC-3 or earlier model TC-2. Includes 12-pin TV tube socket, 4' cable. Octal connector and data. No. 355. Shpg. Wt. 1 lb. \$4.50.

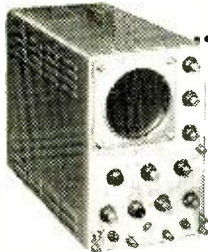

HEATHKIT OP-1
\$179⁹⁵

"PROFESSIONAL" 5" DC OSCILLOSCOPE KIT

Offering complete versatility, the OP-1 features DC coupled amplifiers and also DC coupled CR tube unblanking. Triggered sweep circuit operates on internal or external signals and may be either AC or DC coupled. Transformer operated power supply has silicon diode rectifiers. Shpg. Wt. 34 lbs.



HEATHKIT OM-3
\$39⁹⁵

"GENERAL PURPOSE" 5" OSCILLOSCOPE

Ideal in servicing as well as routine laboratory work, the OM-3 features wide vertical amplifier frequency response, extended sweep generator operation and improved stability. Vertical response is within ± 3 db from 4 CPS to 1.2 mc. Sweep range covers 20 CPS to over 150 kc. Shpg. Wt. 22 lbs.



HEATHKIT T-4
\$19⁹⁵

VISUAL-AURAL SIGNAL TRACER KIT

Doubling as a utility amplifier, test speaker, or substitution transformer, the T-4 represents an outstanding buy. Traces RF, IF and audio signals in AM, FM and transistor-type radios. Shpg. Wt. 5 lbs.



HEATHKIT SG-8
\$19⁵⁰

RF SIGNAL GENERATOR KIT

Aligns RF, IF and tuned circuits of all kinds. Provides extended frequency coverage in five bands from 160 kc to 110 mc on fundamentals and up to 220 mc on calibrated harmonics of the fundamental frequencies. Shpg. Wt. 8 lbs.



HEATHKIT CT-1
\$7⁹⁵

IN-CIRCUIT CAPACI-TESTER KIT

Check capacitors for "open" or "short" right in the circuit. Detects open capacitors from 50 mmf up and checks shorted capacitors up to 20 mfd. Checks all bypass, blocking and coupling capacitors of the paper, mica and ceramic types. Shpg. Wt. 5 lbs.



HEATHKIT TO-1
\$16⁹⁵

TEST OSCILLATOR KIT

Provides fast and accurate selection of test frequencies most used by servicemen in repairing and aligning modern broadcast receivers. Five fixed-tuned frequencies are quickly selected for trouble-shooting. Shpg. Wt. 4 lbs.

HEATH COMPANY
Benton Harbor, Mich.

A Subsidiary of Daystrom, Inc.





add that "extra" speaker

HEATHKIT US-1
\$750

12" UTILITY SPEAKER

This high quality auxiliary speaker offers many possibilities in audio, radio and TV work and will handle up to 12 watts with a frequency response from 50 to 9,000 CPS ± 5 db. Speaker impedance is 8 ohms and employs a 6.8 ounce magnet. Shpg. Wt. 7 lbs.



Fun for the whole family

HEATHKIT XR-1P
\$2995

6 TRANSISTOR PORTABLE RADIO KIT

This easy-to-build portable radio offers fun and enjoyment for the whole family. Features 6 transistors, large 4" x 6" PM speaker for "big-set" tone quality, and built-in rod-type antenna. Uses standard size "D" flashlight cells for extremely long battery life (between 500 and 1,000 hours). The modern molded plastic case with pull-out carrying handle is two-tone blue with gold inlay and measures 9" L. x 7" H. x 3 3/4" D. Shpg. Wt. 6 lbs.



HEATHKIT BR-2
\$1895
(less cabinet)

BROADCAST BAND RADIO KIT

Fun to build, and a fine receiver for your home. Covers complete broadcast band from 550 to 1600 kc. Built-in 5 1/2" PM speaker and rod-type antenna. Transformer operated power supply. Excellent sensitivity and selectivity. Shpg. Wt. 10 lbs.

Cabinet optional extra: No. 91-9A. Shpg. Wt. 5 lbs. \$4.95.

Tune-up your own Engine

ELECTRONIC IGNITION ANALYZER KIT

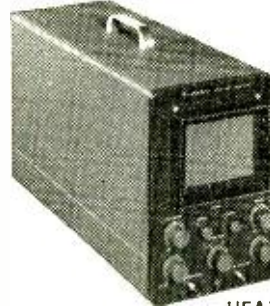

An ideal tool for the mechanic, tune-up man or auto hobbyist. Locates ignition system faults quickly without removing any parts and with the engine in operation (400 to 5000 RPM). Shows complete engine cycle or just one cylinder at a time. Use on all types of internal combustion engines where breaker points are accessible. 10' test leads supplied with kit. Shpg. Wt. 20 lbs.

HEATHKIT IA-1 \$5995

HEATHKIT AK-1
\$995



MICROPHONE ACCESSORY KIT

Useful in countless applications, this kit consists of a rugged high fidelity crystal mike and three holders; a mike stand adapter, a lavalier neck-band and desk stand. An 8' cable with phone plug is included. Shpg. Wt. 1 lb.



Let your boy learn radio

HEATHKIT CR-1 \$795

CRYSTAL RADIO KIT

Any youngster interested in radio or electronics will enjoy building and using this fine little crystal receiver. Frequency coverage is from 540 to 1600 kc. A sealed germanium diode is used for detection —no critical "cats whisker" adjustment. Headphones included. Measures 6" L. x 3" W. x 2 1/8" D. Shpg. Wt. 3 lbs.

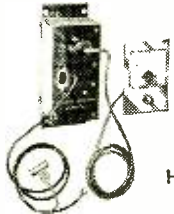

check engine RPM

HEATHKIT TI-1 \$2595

ELECTRONIC TACHOMETER KIT

Easy-to-build and simple to install. Operates directly from the spark impulse of any 2 or 4 cycle engine with any number of cylinders. Operates on 6, 8, 12, 24 or 32 volt DC systems and is completely transistorized. The easy-to-read indicator shows RPM from 500 to 6,000. A calibration control is also provided. Shpg. Wt. 4 lbs.



HEATHKIT TK-1
\$995

COMPLETE TOOL SET

This handy tool kit provides all the basic tools required for building any Heathkit. Includes pliers, diagonal sidecutters, screwdrivers, and soldering iron with holder. Pliers and sidecutters are equipped with insulated rubber handles that provide protection from electrical shock. All of the tools are of top quality case hardened steel for rugged duty and long life. Shpg. Wt. 3 lbs.

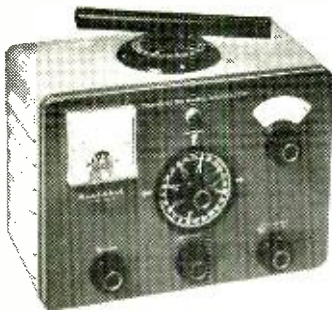

HEATHKIT DF-2
\$69⁹⁵

2-BAND TRANSISTOR RADIO DIRECTION FINDER KIT

Economically powered by 6 standard flashlight cells, the DF-2 provides you with a completely portable 6-transistor standard and beacon band receiver of unusual quality and performance. Covers the beacon band from 200 to 400 kc and broadcast band from 540 to 1620 kc. A tuning dial light is provided for night operation. Large 4" x 6" speaker provides superb tone reproduction. Shpg. Wt. 9 lbs.

HEATHKIT PC-1
\$24⁹⁵



12 VOLT POWER CONVERTER KIT

Household electricity right on your boat or in your automobile is yours with this 12-volt power converter kit. Operate your TV set, radio, electric razor, lights, etc., directly from your 12-volt boat or car battery. Power rating is 125 watts continuously and 175 to 200 watts intermittently. Note: not recommended for record players, tape decks, power tools or radio transmitters. Shpg. Wt. 8 lbs.



HEATHKIT MC-1
\$39⁹⁵

MARINE CONVERTER KIT

Charge your 6 or 12 volt batteries at dockside even while your boat's electrical system is in use. Provides up to 20 amperes continuously for charging 6-volt batteries or 10 amperes continuously for charging 12-volt batteries, regardless of type. Charging current is continuously monitored by a 25 ampere meter. Shpg. Wt. 16 lbs.

MARINE BATTERY CHARGE INDICATOR KIT

See at a glance the exact percentage of charge in your boat batteries. Checks from 1 to 8 storage batteries instantly. Operates on 6, 8, 12 or 32 volt systems. Note: for mounting on non-ferrous metals or wood only. Shpg. Wt. 3 lbs.



HEATHKIT CI-1
\$16⁹⁵



HEATHKIT FD-1-6
(6 volt)
FD-1-12
(12 volt)
\$35⁹⁵ each

FUEL VAPOR DETECTOR KIT

Protecting against fire and explosion on your boat, the FD-1 indicates the presence of explosive fumes and shows immediately if it is safe to start the engine. The kit is complete including spare detector unit. Shpg. Wt. 4 lbs.

Free Send now for latest Heathkit Catalog describing in detail over 100 easy-to-assemble kits for the Hi-Fi fan, radio ham, boat owner and technician.



HEATH

*pioneer in
do-it-yourself
electronics*

COMPANY BENTON HARBOR 10, MICH.

(D) a subsidiary of Daystrom, Inc.

Send latest Free Heathkit Catalog.

NAME _____

ADDRESS _____

CITY _____ ZONE _____ STATE _____

QUANTITY	KIT NAME	MODEL NO.	PRICE

All prices and specifications subject to change without notice. Please include postage on orders to be shipped parcel post. 20% deposit is required on all C. O. D. orders. All prices are NET F.O.B. Benton Harbor, Mich., and apply to Continental U.S. and Possessions only.

Revolution in Turntables

(Continued from page 63)

the final assembly figuring out where you went wrong.

Be exceptionally careful with the rubber components of this kit (and all others, too), to avoid getting any grease or oil on them. If an accident does occur, clean the parts with carbon tetrachloride (*not* Carbona) or denatured alcohol.

Careful assembly of the TDK-101 paid off for us; it ran smoothly the moment the switch was turned on. A neon light on the built-in strobe disc confirmed the efficiency of the speed adjustment and the long-time speed stability of the unit.

Weathers KL-1. Weathers has approached the problem of turntable design from a completely opposite direction than the other manufacturers. Although there have been disagreements in the past as to which drive system was best, a basic axiom of hi-fi turntable design has always been to make the platter heavy and have it act as a flywheel, smoothing out any irregularities in speed. But the very weight of a heavy platter is apt to cause bearing problems and rumble. In addition, a heavy platter requires a heavy motor to drive it.

Here's how Weathers turned the hi-fi experts on their ears. Weathers reasoned that if the platter were made very light and coupled directly to a light-duty hysteresis motor, speed stability would be achieved without the complications caused by using a heavy platter and motor. As proven both by their factory-assembled turntable and the KL-1 kit, this theory works out well in practice.

The KL-1 kit consists of a stamped aluminum platter, a thin oblong mounting plate, a tiny hysteresis motor, and a rubber drive wheel that fits over the $\frac{1}{16}$ " shaft of the motor. The rubber drive wheel rides directly against the inside rim of the platter, and thus the drive system is almost miraculously simple. Since the drive wheel is always in contact with the platter, it is made of pure gum rubber to prevent it from developing "flats." A couple of bugs, such as warped platters, in the early production runs of the kit have been eliminated and the KL-1 we assembled went together without a hitch and worked beautifully.

It's worth mentioning that Weathers has a speed control kit available. This kit pro-

vides variable frequency output for operating the turntable at speeds other than $33\frac{1}{3}$ rpm. The electronic speed control, Model KSC-1, sells for \$49.50 in kit form and is about as complicated to put together as a ten-watt basic amplifier. It can be used only with the Weathers turntable.

Which One Is Best? Without exception, each of the turntable kits tested worked well. Using the Components stereo test record, the measured rumble of each of the units was close enough to the manufacturer's advertised rumble levels that any slight deviations were insignificant. More practical tests involving the use of stereo records with musical content showed the rumble level of each of the turntables to be completely unobtrusive.

Rather than play steady-tone records for testing flutter and wow, a recording of a solo piano was used. Any speed variation in a turntable will cause a piano to assume a peculiar "fluttery" quality easily detectable by the average music listener. This test failed to turn up any cases of audible flutter and wow.

Now! Which one is best? As usual in comparisons of this kind, no one turntable has a monopoly on all the desirable features. For that matter, what may be a desirable feature to one person may be completely valueless to another. So here's a brief rundown of some of the more important features.

The Gray and the Rek-O-Kut kits are examples of "battleship" construction. They use heavy platters, belt drive, and the highest quality hysteresis motors. And they cost practically the same. As far as we can see, it's a tossup between these two units. If you're in an area where you can look at each of them, take a gander at the workmanship embodied in them. Then maybe you'll be able to make a choice between them (we couldn't).

The Thorens is an excellent performer and offers the advantage of a speed control. If this feature is important to you, the Thorens is probably your best buy. If it's not important to you, your choice will be further complicated because the Thorens is top-notch by any standards.

The Weathers KL-1 is an unconventional but extremely good solution to the problem of designing a quality turntable. Without considering its superb performance characteristics, it can be installed in places where other turntables could not possibly

MAIL SHOPPERS EVERYWHERE
SAVE DURING LEKTRON'S

**KRAZY
PRICE
DAZE!**



OUR USUAL \$1
POLY-PAKS[®]
88¢ EACH
ONLY
OVER 700,000 SOLD
AT ONE DOLLAR EACH!

FREE!

FULL YEAR'S
SUBSCRIPTION
to Lektron's 24-Pg.
"Family Shopper"

ELECTRONICS •
TOOLS • JEWELRY
• NOVELTIES • HI-
FI • HOUSEWARES
Write Today!

FREE! BUY ANY 10 POLY-PAKS,
PICK 11th FREE!

SAVINGS OF \$3 TO \$35 AND MORE ON EACH PAK!

MINI GEIGER COUNTER
Tube. Dozens of radiation, de-
tection uses! 2" long x 1/2"
dia. **88¢**

\$15 MOBILE RELAY
For GVLIC projects. BEST silver
contacts. Herm. sealed. **88¢**

2 P-N-P TRANSISTORS
Popular make! Hundreds of
hobby uses! \$5 value. **88¢**

8 RCA PLUG-N-JACK
Sets, matched. Most pop.
amps, tuners, phones. **88¢**

JEWELERS' PLIERS
Drop-forged, chrome plated. Pre-
cision diagonal or long-nose.
Reg. \$3.50. 1 lb. **88¢**

5 JWLR SCREWDRIVERS
Different sizes. Brass; chrome
plated, swivel heads. Reg. **88¢**
\$3.50.

2 VARI-LOOPSTICKS
Adj. 510-1500 kes. Trans-
istor radios, etc. 1 lb. **88¢**

WIRE STRIPPER
Strips, cuts #16 thru #22
hook-up wire. Wt. 1 lb. **88¢**

0-60 MINUTE TIMER
For darkness, lab, shop, kitch-
en. Loud alarm. 2 lbs. **88¢**
Reg. \$6.

0-15 VAC MINI-METER
Hundreds of uses! Only 1 1/2"
diameter. 1 lb. Reg. \$3.50. **88¢**

70 TUBULAR COND'N'S RS
Paper, milled, oil, pare; to
.5mf to 1000V. 2 lbs. Reg. **88¢**
\$14.

2 N-P-N TRANSISTORS
Used in many pop. make
radios. Worth \$5! **88¢**

2 TRANSISTOR IF'S
Detune-tuned. Only 1/2"
square. 430 kes. **88¢**

TEN 3-SECOND TIMER
MECHANISMS: precision
geared. 2 lbs. Reg. \$30. **88¢**

5" HOBBY SPEAKER
For radios, code osc, in-
tercoms. 2 lbs. Reg. \$5. **88¢**

40 SUB-MINI RESISTORS
1 1/2" long. 20 values: 1/3W
to 10 megs. Reg. \$6. **88¢**

15 INSTR. KNOBS
Knurled black bakelite, w/ point-
er; brass inserts, set-screws. **88¢**
Reg. \$5.

5-IN-1 DRILL BIT
Reams, saws, copes, shapes.
drills. Hand or power drill. **88¢**

15 ROTARY SWITCHES
Asstd. gangs. 3 lbs. Reg. **88¢**
\$12.

30 MOLDED COND'S RS
Asstd. Finest made; Wt. **2 88¢**
lbs.

100 HALF-WATTERS
Asstd. value carbon resist-
ors, incl. 5/76. Reg. \$12. **88¢**

300-FT. HOOKUP WIRE
Tinned, asstd. sizes, colors. **88¢**
2 lbs. Reg. \$7.

60 COILS, CHOKES
IF, RF, anL, slug-tuned, too. **88¢**
3 lbs. Reg. \$15.

70 TERMINAL STRIPS
Solder-bug & binding; to 20 **88¢**
terms. 2 lbs.

6-PC. HACKSAW SET
Six assorted blades. 1 lb. **88¢**

MINI-RADIO KIT
World's smallest! 2 x 1 x 1",
Loopstick, jacks, diode, etc.,
w/ instructions. 1 lb. Reg. **88¢**
\$3.

40 HI-Q CONDENSERS
Finest porcelain; NPO's too! **88¢**
1 lb. Reg. \$6.

35 POWER RESISTORS
WW, 5 to 50W, to 10,000 ohms.
Vitrous, too! 3 lbs. Reg. **88¢**
\$15.

70 ONE-WATTERS
Asstd. value carbon resist-
ors, 5/76, too! **88¢**

15 VOLUME CONTROLS
Incl. dials; some w/switch; **88¢**
to 1 meg. 2 lbs. Reg. \$12.

TV PIC BOOSTER
Parallel; 6-wire. Extends **88¢**
picture tube life. 1 lb.

8-PC. NUTDRIVER SET
\$3 value! Plastic handle; 3/16"
thru 7/16" socket wrenches. **88¢**
1 lb.

000-999 COUNTER
By Veeder-Root. For tape re-
corders, coils, motors; . . . hun-
dreds of uses. Wt. 1 lb. **88¢**
Reg. \$5.

6 SILICON DIODES
Sylvania 1N22, 1N23. Reg. **88¢**
\$36.

\$25 SURPRISE PACK!
Large, varied assortment radio,
TV parts. 3 lbs. **88¢**

60 PLUGS-n-RECEPT'LES
Audio, power, line, battery. **88¢**
spkr. 3 lbs. Reg. \$7.

8-SCREWDRIVER SET
8 Asstd. drivers w/wall rack.
Plastic handles. 1 lb. List **88¢**
\$3.50.

40 SUB-MINI COND'S RS
For transistor, printed cir-
cuit work. 1 lb. Reg. **88¢**

8 SUB-MINI SOCKETS
Mica-filled. For transistors, **88¢**
too!

40-RECORD CADDY
Wrought iron, holds 40 re-
cords & albums. 2 lbs. Reg. **88¢**
\$2.95.

70 HI-Q RESISTORS
Insulated, carbon; 1/2, 1/4, 1/8
& 1W, 10 ohms to 10 megs. **88¢**
2 lbs. Reg. \$13.

HOBBY BENCH VISE
Clamp type. Fits tables, too. **88¢**
Steel. 1 lb.

SYLVANIA TV MIRROR
10x12", stainless steel. **88¢**
lbs. Reg. \$1.

100 RADIO PARTS
Wide variety resistors, con-
densers, pots, turns. 3 lbs. **88¢**

5 ROLLS MICRO-WIRE
#24 thru #32; for transistor,
sub-mini circuits. 1 lb. **88¢**

30 PILOT LITES
Pop. flashlight size; mini
bay, type. Reg. \$9. 1 lb. **88¢**

16-END WRENCH SET
For home & auto. 10x & open;
15/64 thru 7/16". 16 **88¢**
sizes. Reg. \$2.50.

"1-POUNDER" HAMMER
Claw, 16-oz. steel, w/ 1 1/2"
formed handle. Reg. \$2.50. **88¢**

100 CERAMIC COND'S RS
Hi-Q discs, tubular; to .01 **88¢**
mf. 2 lbs. Reg. \$12.

40 TUBE SOCKETS
4 to 9-pin; ceramic, mica,
shield-based incl. 2 lbs. **88¢**
Reg. \$10.

10 POLY BOXES
Clear plastic, hinged, w/ **88¢**
snap locks. Asstd. sizes. 1 lb.

40 PRECISION RESISTORS
1/2, 1/4 to 1W; carbon; mica;
w/ to 10 megs. Reg. \$17. **88¢**

30 DISC CONDENSERS
Wafer-thin; up to 3000VDC. **88¢**
Reg. \$5.

8 GERMANIUM DIODES
Glass-sealed, w/long leads.
For all hobby projects. **88¢**

1500 PCS. HARDWARE
Nuts, screws, washers, etc. **88¢**
1 1/2 lbs. Reg. \$6.

7 ROLLS WIRE
25-ft. each. #18 thru #22.
Asstd. strandings, ins., col-
ors. 2 lbs. Reg. \$7. **88¢**

60 CONDENSER SPCL!
Molded, paper, ceramic, oil,
mica, discs, variable. 2 lbs. **88¢**

75 RESISTOR SPCL!
WW, precision, carbon, variable,
mini types. 3 lbs. Worth **88¢**
\$15.

15-PC. DRILL SET
1/16" thru 1/4" x 61ths
w/combined case. Reg. \$31. **88¢**

75 MICA CONDENSERS
.00025 to .01 to 1200V; sil-
ver, too. 25 values. Reg. **88¢**
\$28.

20 ARTISTS' BRUSHES
100% pure bristle; sizes
1-6. Reg. \$2.50. **88¢**

10 TUBULAR ELECTROS
Asstd. paper types. AC, DC.
Hobby. 3 lbs. Reg. \$12. **88¢**

4 POWER WOOD BITS
Hi-Q steel, 3/8, 1/2, 3/4, 1",
5" long. Reg. \$3. **88¢**

60 RADIO-TV KNOBS
Asstd. colors, insulation. Some
worth \$1 ea. 2 lbs. Reg. **88¢**
\$17.

10 ELECTROLYTICS
Radio, TV. 10-500mf to
450VDC. 3 lbs. Reg. \$12. **88¢**

75-FT. TV TWINLEAD
300 ohm, hanked, tinned,
3 lbs. Reg. \$3.50. **88¢**

POSTAGE STAMP MIKE
Crystal, 100 to 8,000 cps **88¢**
1 lb. Reg. \$7.

4 OUTPUT XFMRs.
501.6, etc. 3 lbs. Reg. **88¢**
\$8.

HEARING AID PHONE
Crystal, w/cord set & plug. **88¢**
Reg. \$5.

HOW TO ORDER:

ORDER BY "BLACK TYPE" HEADLINES, i.e.,
ONE GEIGER COUNTER TUBE, 88¢

LEKTRON 131-133 EVERETT AVE.
CHELSEA 50, MASS.

State price with each item. Send check or M.O. including sufficient postage;
excess returned. C.O.D. orders, 25% down; rated, net 30 days. INCLUDE
POSTAL ZONE in address. (Canada postage, 48¢ 1st lb.; 28¢ ea. add'l lb.)

May, 1959

135

fit. Since the motor is so small, only about 1½" space below the mounting board is required to install the KL-1.

Although the foregoing may not tell you precisely which turntable kit you should buy, it is our honest opinion that no matter which one you decide on, you will end up with a turntable of a quality previously unattainable for less than a \$50 bill.

As a note of interest to audiophiles who insist on the conveniences of automatic operation, next month we will review the only record changer kit on the market at the present time, the Heathkit RP-3. —30—



Transistor Topics

(Continued from page 91)

substitute for a heavy-duty rheostat in experimental work, electroplating, and industrial applications.

3D Photocells. Selenium photocells or "sun batteries" have been manufactured in the familiar flat "two-dimensional" shape for years. Recently, however, the International Rectifier Corporation (1521 E. Grand Ave., El Segundo, Calif.) announced that it can manufacture these photocells, on special order, in almost any form or contour.

This new manufacturing technique greatly increases the possible applications of the photocell in control and instrumentation equipment. Circular photocells, for example, can be mounted on a rotating shaft. Specially shaped cells may be used as function generators, for production flow processes, or in automatic sorting and inspection operations.

Military News. Transistors are continuing to find increasing use in military equipment. From the Bell Telephone Labo-



"Contour" photocells and sun batteries are now being made by International Rectifier. See text.

ratories comes news that there is a transistorized "fail-safe" circuit in the "Nike Hercules" guided missile which is equipped with a nuclear warhead. The circuit prevents complete arming of the warhead until the missile is safely on its way and provides a multipath control which prevents individual component failures from causing a premature explosion.

An order for a prototype transistorized ignition system was placed with Electric Auto-Lite Co. by the Detroit Arsenal.

The Army Combat Operations Research Group has developed a fully transistorized antitank mine "simulator" for training and maneuvers. In operation, when a tank runs over the mine pressure plate, the "mine" radiates a signal which is picked up by a receiver coil on the tank's underbelly. This signal, in turn, is amplified and used to stop the tank. Thus, a tank can be "destroyed" in training—but without damage.

That covers the news for now, fellows. See you next month.

Lou



How to Repair Auto Radios

(Continued from page 111)

antenna doesn't have to be tested, as it must be okay.

Late Model Symptoms. Lots of the old-timers were pretty perturbed when vibratorless auto-radios began appearing. Their best symptom was lost—the buzz of the vibrator! However, if the set has a power transistor in the output, as a great many do now, they've got a new test symptom just as good.

When the set is turned on, listen for a "thump" in the speaker. While the tubes have to warm up before they can draw current, the transistor is just sitting there all ready to go the moment the switch is closed. So, before the tubes warm up, a heavy pulse of current goes through the output transformer, resulting in the thump—assuming that the transistor is in good health, and that the fuse isn't blown out.

This symptom, of course, refers to the "hybrid" sets, which use low-voltage tubes and a power transistor. The all-transistor sets start playing as soon as the voltage is applied, just like the small portables.

A recent development has resulted in a whole new series of radio tubes which require only 12 volts on plates, screens, and

filaments. (See "No More Vibrators," *After Class*, March 1958). Sets using this new series require the customary 30-second or so warm-up time, and will *not* give you the thump in the speaker. If nothing is heard after warm-up, take the lid off the chassis and see if all tubes are lit.

This would be a good place for a warning. *NEVER insert these special tubes in any of the standard tube testers!* Due to their construction, even the voltage used for short-testing in a tube checker will cause them to burn out immediately. The manufacturers recommend testing by substituting a known good tube. Never jar these tubes, as you would the older types, to locate noisy ones. Their elements are extremely close-spaced, and a heavy jolt might cause an interelectrode short where none had been before!

Lifting the Lid. The mounting of the average auto-radio makes it very difficult to service. In many of the new cars, the radio is installed in the dash, *above* the glove compartment.

If it is a single-unit type, the glove compartment must be removed to get at it. Take out the small screws around the edge,

and slide the pocket down and back, exposing the bottom of the radio. A stubby 1/4" hex wrench will usually be all you need to get the lid off.

If the set is of the two-unit type, only the tuning, i.f. stages, and the detector will be mounted over the glove compartment. The speaker, power supply, and audio output tubes will be in the other unit. Fortunately, most of these models have the power transformer, vibrator, and a.f. output tubes mounted outside of the case, where they are comparatively easy to reach. In some cars, you may have to remove sections of the heater ducts, etc., in order to get at the radio.

And if the car has one of the "outboard" air conditioners installed in the center of the front seat floor, it may be difficult or even impossible to get to the radio at all. *Don't try it.* Take the car to an air-conditioning mechanic, and have the unit disconnected. If you try to do it yourself, you may break tubing, etc., and cause more damage than you can fix!

Proper Polarities. If the radio you're working on uses transistors in any circuit, it's very important to check the po-

Get This Valuable Book

FREE



Just For Examining COYNE'S New Set

"Applied Practical Radio-Television"
on 7 DAY FREE TRIAL!

Yes, you get our big Diagrams book, FREE! It's like a road-map that shows you the way to easier Radio-TV repair. Needed by every serviceman, Complete 11x22" Schematic Diagrams on many Radio and TV sets help cut servicing time. Includes simple instructions on how to use diagrams and picture patterns. This book is yours FREE for asking to see Coyne's great new 7-book set, "Applied Practical Radio-Television!"

AT LAST! MONEY-MAKING "KNOW-HOW" ON TRANSISTORS, COLOR TV AND SERVICING

Coyne's great 7-volume set gives you all the answers to servicing problems quickly! For basic "know-how" that's easy to understand you'll find everything you want in Volumes 1 to 5 on over 5000 practical facts and data. Every step from fundamentals to installing, servicing and trouble-shooting all types of radio and TV sets. So up-to-date it includes the latest on COLOR TV and UHF. All this plus Volume 7 - **TRANSISTOR CIRCUITS**, the most complete book ever published on the applications of transistors in electronics. **New! Set has colorful design, washable covers.**

EXTRA! 868 Page TV Encyclopedia Included! For speedy, on-the-job use, you also get Volume 6 - famous Coyne CYCLOPEDIA. Answers problems on servicing, alignment, installation, etc., in easy ABC order. Use this 7-volume TV-RADIO LIBRARY FREE for 7 days; get the Servicing Book FREE!

FREE!
5 YEARS
OF VALUABLE
SUPPLEMENTS



With your set you also get Coyne's annual Supplement Service FREE for 5 years. Keeps your set up-to-date on everything that will be new in radio, television, electronics and electricity.

NOW!
7 BIG
BOOKS
IN ONE
GREAT SET!



SEND NO MONEY!

Just mail coupon for 7-volume set on 7 days free trial. We'll include book of 150 TV-Radio Patterns & Diagrams. If you keep the set, pay \$3 in 7 days and \$3 per month until \$27.25 plus postage is paid. (Cash price, only \$24.95.) Or you can return the library at our expense in 7 days and owe nothing. YOU BE THE JUDGE. Either way, the book of TV-Radio Patterns is yours FREE to keep! Offer is limited. Act NOW!

FREE BOOK - FREE TRIAL COUPON!

Educational Book Publishing Division
COYNE ELECTRICAL SCHOOL, Dept. 59-PE
1501 W. Congress Pkwy., Chicago 7, Ill.

YES! Send 7-Volume "Applied Practical Radio-Television" for 7 days FREE TRIAL per your offer. Include TV-Radio Patterns & Diagram Book FREE.

Name Age

Address

City Zone State

Where Employed

Check here if you want library sent C.O.D. You pay postman \$24.95 plus C.O.D. postage on delivery. 7-day money-back guarantee.

Educational Book Publishing Division
COYNE ELECTRICAL SCHOOL
1501 W. Congress Pkwy., Dept. 59-PE Chicago 7, Ill.

larity of your battery or eliminator before connecting the power supply leads. Reversing battery polarity will quickly and permanently damage all power transistors; the tremendous reverse currents drawn will burn out the junction before you can say "p-n-p."

The polarity should be marked on the radio case. If it isn't, check the car battery polarity with your VOM and connect the bench battery in the same way. -30-

After Class

(Continued from page 114)

same position as that of the control potentiometer. The bridge will be balanced and no current will flow through heater. Suppose the bath temperature now cools. The bi-metal strip will move the arm of the thermostat potentiometer, so that the bridge will be unbalanced, and an error current will flow through the heater, bringing the bath back up to the required temperature.

As the difference in potentiometer positions gets smaller, so does the error signal,

and the heater will heat less and less as the bath approaches the required temperature. This is the big advantage of a continuous servo system—it gradually approaches a set value, instead of juggling back and forth between two fixed values. In an on-off or discontinuous thermostat, the temperature shoots past its mark, because the heater is always either fully on or off—this is known as *overshoot*.

Hunting. With the continuous heat control mechanism, if the temperature drops just a fraction of a degree, the heater starts up once again to bring the thermostat wiper to the desired position. Even here, oscillation around the correct temperature can still occur, although the differential is much less than it would be in a discontinuous system. This oscillatory behavior is called *hunting* and, in finely controlled servos such as fire-control and radar tracking devices, it is very objectionable despite the fact that the swing is small.

In future months, we will discuss servo amplifiers, servo motors, and *anti-hunt* circuits which remove the last objectionable feature of our fundamental system. -30-



ACCORDIONS 1/2 OFF!

FIVE DAY FREE TRIAL—Easy Terms

Buy direct from world's largest exclusive accordion dealer. *Save 50% or more.* Finest imported Italian makes: over 30 models. 5 DAY FREE TRIAL. Lifetime guarantee. Trade-ins accepted. Bonus gifts. Easy terms, low as \$10 monthly. Write today for Big Catalog and Low Wholesale Prices—FREE!

ACCORDION MANUFACTURERS & WHOLESALE OUTLET, 2003 West Chicago Avenue, Dept. PE-59 Chicago 22, Illinois

FREE Color Catalog

Please rush color catalog, wholesale price list.

Name _____

Address _____

City _____ State _____

ENGINEERING DEGREE IN 27 MONTHS

B.S. degree (27 mo.): Aero., Chem., Civil, Elec., Mech. & Electronics
 B.E. (36 mo.): Aero., Chem., Civil, Elec., Mech., Metallurgical
 B.S. (36 mo.): Math., Chem., Physics
 Preparatory courses. Demand for graduates. Campus 20 buildings, dorms, gym, low rate. Early term, G.I. apprx. Enter June, Sept., Dec., March. Catalog 2359 E Washington Blvd., Fort Wayne 2, Ind. Keeping pace with progress.

INDIANA TECHNICAL COLLEGE

MOVING?

Make sure you notify our subscription department about any change of address. Be sure to include your postal zone number as well as both old and new addresses. Please allow four weeks' time for processing.

POPULAR ELECTRONICS

434 South Wabash Avenue, Chicago 5, Illinois

DEPENDABLE TV-RADIO TUBES



1-YEAR GUARANTEE

ZALYTRON Tubes for TV-Radio Service-men, Dealers, Experimenters.

Nationally sold ZALYTRON Tubes are BRAND NEW Tubes • NOT USED • NOT REJECTS • NOT PULLED FROM EQUIPMENT • but ZALYTRON'S First Quality! Why pay more? Try them once, you'll buy them always. Every tube we ship is covered by our Full Refund Guarantee — YOU be the judge! Send today for new Price List "PE".

BE YOUR OWN BOSS

RUN A SELF-SERVICE TUBE BUSINESS

Get This Modern Sturdy Tube Tester

FREE

with "Package Deal" order for nationally sold ZALYTRON Quality Brand Receiving Tubes. We'll show you how to start a successful Tube Tester Route, and get YOUR share of today's Big Profits in Self-Service Tube Sales! This is no "Get-Rich-Quick" scheme but a solid, proven business that will reward you well — if you WORK at it. But, INVESTIGATE before you INVEST! Get full details on the best "Deal" now being offered, send today for our booklet "P".



ZALYTRON TUBE CORPORATION
 220 West 42nd St., N. Y. 36, N. Y.

build this great new **knight-kit**

A PRODUCT OF ALLIED RADIO

stereo hi-fi amplifier...save up to 50%

COMPARABLE IN EVERY WAY TO WIRED AMPLIFIERS COSTING TWICE AS MUCH



tremendous value at only

\$44.50

only \$4.45 down

never before such performance...

such styling...such quality

at so low a price...

knight-kit 20-watt stereo hi-fi amplifier

Newest complete Stereo high-fidelity amplifier at an amazing low \$44.50. Incomparable value: Includes two built-in preamps for magnetic cartridges. Single switch selects phono, tuner or auxiliary stereo inputs, plus stereo reverse on each; also switches monophonic input to both amplifier channels. Bass and treble controls boost and attenuate. Special clutch-type concentric volume control permits individual channel balancing, plus overall volume control. Total output is 20 watts (10 watts per channel at less than 1½% distortion). Response, 20-20,000 cps, ± 1.5 db. Hum and noise better than 85 db below full output. Has four pairs of stereo inputs: magnetic cartridge, ceramic cartridge, tuner, auxiliary. RIAA equalized for stereo discs. Expertly designed push-pull output circuitry. Beautiful custom-styled case, 4¼ x 13¼ x 9". With case, tubes, all parts, wire, solder and instructions. Shpg. wt., 27 lbs.

Model Y-773. Knight-Kit Stereo Amplifier, F.O.B. Chicago... **\$44.50**

EXCLUSIVE **knight-kit** MONEY-BACK GUARANTEE

Every KNIGHT-KIT meets or exceeds published specifications, or we refund your money.

ONLY **knight-kits** ARE CONVENIENCE ENGINEERED

for easiest building—no previous electronic experience needed...

see over 50 other fine **knight-kits**...write for catalog

HI-FI KITS

Stereo Amplifiers
Stereo Preamp
Stereo Control
Hi-Fi Tuners
Hi-Fi Amplifiers
Speaker Systems,
and others

HOBBY KITS

Short-Wave Radios
AC-DC Table Radios
Clock-Radio
Radio-Intercom
Transistor Radios
Electronic Lab Kits
and many others

INSTRUMENT KITS

VTVM
VOM's
Tube Checkers
Oscilloscopes
Signal Tracer
Audio Generator
Sweep Generator

Cap. Checker
R/C Tester, etc.

HAM KITS

Receiver
Transmitter
VFO, etc.

EASY TERMS ON ORDERS AS LOW AS \$20

1959 ALLIED **FREE** CATALOG

Send for this value-packed catalog featuring the complete KNIGHT-KIT line, as well as the world's largest stocks of everything in Electronics.

WRITE FOR YOUR COPY TODAY



ALLIED RADIO Dept. 19-E9

100 N. Western Ave., Chicago 80, Ill.

- Ship Model Y-773 Knight-Kit Stereo Amplifier. \$_____encl.
 Send FREE ALLIED 1959 Catalog

Name _____

Address _____

City _____ Zone _____ State _____

Doppler Radar

(Continued from page 44)

angle. At the same time, the frequency shift of the beams is measured and converted into a reading of true ground speed.

In some systems, the antenna does not move, and a computer determines drift angle by comparing the returning signals of the two beams. This complicates the electronics but cuts down antenna size and eliminates moving parts. In other rigs, such as the Janus System (named after the Greek god who could look forward and backward simultaneously), up to four beams may be used, two aimed forward and two behind.

Instead of comparing the reflected signal to the transmitted signal, the latter type of device usually compares the forward signal returns to those from the diagonally opposite beams. One of the big advantages of the four-beam system is that it is unaffected by the airplane's rolling and pitching. It also permits the use of a less accurately calibrated transmitter, since a change in transmitter frequency has little effect.

Military Uses. The introduction of Doppler radar navigators is generally credited to General Precision Laboratory, Inc. This company test-flew the first Doppler gear back in 1948. By 1954, it was in quantity production for the U.S. Air Force. A variation of the first Doppler system was put into production for the Royal Air Force by Marconi's Wireless Telegraph Co., Ltd., in England. In Canada, a corporate affiliate of the British firm, Canadian Marconi Co., began supplying the Royal Canadian Air Force with its own version of the Doppler system.

The U.S. Navy got into the act, too, and after breaking ground, retained Ryan Aeronautical Co. to continue development of its own system. Laboratory for Electronics, Inc., came out with several systems, one particularly suitable for helicopters. Other manufacturers include Collins Radio Co. and General Electric Co.

A prime reason why Doppler radar navigators are popular with the military is that they require no ground installation, which naturally would not be available in enemy territory.

Until fairly recently, the military kept Doppler radar devices all to itself. But in 1957 the security wraps were removed, and various manufacturers began to offer com-

YOUR COPIES of POPULAR ELECTRONICS ARE VALUABLE

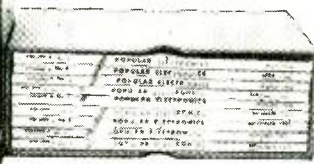

**KEEP THEM NEAT . . . CLEAN . . .
READY FOR INSTANT REFERENCE!**

Now you can keep a year's copies of POPULAR ELECTRONICS in a rich-looking leatherette file that makes it easy to locate any issue for ready reference.

Specially designed for POPULAR ELECTRONICS, this handy file—with its distinctive, washable Kivar cover and 16-carat gold leaf lettering—not only looks good but keeps every issue neat, clean and orderly.

So don't risk tearing and soiling your copies of POPULAR ELECTRONICS—always a ready source of valuable information. Order several of these POPULAR ELECTRONICS volume files today. They are \$2.50 each, postpaid—3 for \$7.00, or 6 for \$13.00. Satisfaction guaranteed, or your money back. Order direct from:

JESSE JONES BOX CORP., Dept. PE
(Established 1843)
Box 5120 Philadelphia 41, Pa.

TINY RADIO PLAYS FOR 10 YEARS!



**NO TUBES—TRANSISTORS—
BATTERIES OR "PLUG-INS" NEEDED**

Smaller than a pack of cigarettes. 1959 model never runs down or burns out. Guaranteed to receive local radio stations most anytime, anywhere—without EXTRA ANTENNA WIRES. Easy thumb station tuner—Perma wave detector. Chrome black plastic case. BUILT IN SPEAKERPHONE—NO SEPARATE DANGLING EARPHONE. American made and service guaranteed for 10 years.

SEND ONLY \$2.00 (cash, ch, mo) and pay

arrival or send \$6.99 for postpaid postman \$4.99 COD on
Ready to listen with 10 year guarantee. No extras to buy.
Free 1000 mile antenna enclosed if you order it once.

MIDWAY COMPANY Dept. TPL-5 KEARNEY, NEBR.

GET INTO ELECTRONICS

V.T.I. training leads to success as technicians, field engineers, specialists in communications, guided missiles, computers, radar, automation. Basic & advanced courses in theory & laboratory. Assoc. degree in 29 mos. B.S. obtainable. ECPD accredited. G.I. Approved—Graduates with major companies. Start Sept. Falls Dorms, campus. H.S. graduates or equivalent. Catalog.

VALPARAISO TECHNICAL INSTITUTE
Dept. PE VALPARAISO, INDIANA

mercial versions geared to the needs of civil aviation.

Commercial Applications. The first commercial purchase of Doppler equipment was made recently by Pan-American World Airways from Canadian Marconi Co. Six systems were ordered, to be installed in Pan-American's six-plane fleet of Boeing 707 jet clippers. By the time you read this, all of the jetliners will probably have the new systems aboard.

Other transoceanic airlines overseas are considering the purchase of Doppler equipment. British Overseas Airways Corp. has already piled up over 150,000 miles flight-testing the British Marconi system, and Air France is also evaluating it.

Airliners which are equipped with Doppler radar have several advantages over airliners using other types of navigation systems. Doppler-equipped airliners can sniff out favorable jet streams and latch onto them for free rides. They can also avoid speed-killing headwinds the same way. Combined with the ability to fly undeviatingly along the shortest possible route, this wind-sniffing talent spells much quicker flights and substantial fuel economy. It's been estimated that a Doppler navigation system can cut fuel consumption by at least 15%.

Still another dividend is offered by Doppler radar. It will allow pilots to report their exact position, flight path and speed to air traffic controllers. This means a much smaller likelihood of mid-air collisions, today's number one flying headache. Pilots will further appreciate Doppler radar since a de luxe Doppler navigational computer can be hooked to an autopilot—a plane so equipped will virtually navigate itself to any place on the globe without any hands on the controls.

With its purchase of the Canadian Marconi equipment, Pan-American World Airways has opened a new chapter in the story of aerial navigation. Other carriers are bound to follow the example as they replace their current propeller-driven planes with jet types. Most of these jetliners will have built-in provision for Doppler navigation systems.

It may not be long before you can take any airliner, secure in the knowledge that Doppler radar will help you get to your destination more quickly and safely than ever before.

Handle any Radio-TV Service Job

EASIER - BETTER - FASTER!

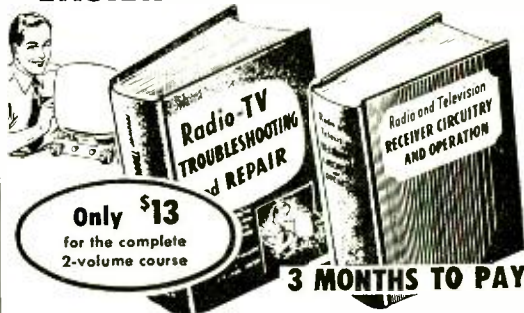

COMPLETE SERVICE TRAINING ... written so you can understand it!

No complicated theory or mathematics! These famous Ghirardi books get right down to brass tacks in showing you how to handle all types of AM, FM, and TV service work by approved professional methods. Almost 1500 pages and over 800 clear illustrations show how to handle every phase of troubleshooting and servicing. Each book is co-authored by A. A. Ghirardi whose manuals have helped train more servicemen than any other books or courses of their kind!

1—Radio and Television Receiver TROUBLESHOOTING AND REPAIR

A complete guide to profitable professional methods. For the beginner, it is a comprehensive training course. For the experienced serviceman, it is a quick way to "brush up" on specific jobs, to develop improved techniques or to find fast answers to puzzling service problems. Includes invaluable "step-by-step" troubleshooting charts that show what to look for and where. 820 pages, 417 illustrations, price \$7.50 separately.

2—Radio and Television Receiver CIRCUITRY AND OPERATION

This 669-page volume is the ideal guide for servicemen who realize it pays to know what really makes modern radio-TV receivers "tick" and why. Gives a complete understanding of basic circuits and circuit variations; how to recognize them at a glance; how to eliminate guesswork and useless testing in servicing them. 417 illus. Price separately \$6.75.

Special low price . . . you save \$1.25

If broken into lessons and sent to you as a "course," you'd regard these two great books as a bargain at \$75 or more! Under this new offer, you save \$1.25 on the two books—and have the privilege of paying in easy installments while you use them! No lessons to wait for. You learn fast—and right!

STUDY 10 DAYS FREE!

Dept. PE-59, RINEHART & CO., Inc.
232 Madison Ave., New York 16, N. Y.

Send books below for 10-day FREE EXAMINATION. In 10 days I will either remit price indicated plus postage or return books postpaid and owe you nothing.

Radio & TV Receiver **TROUBLESHOOTING & REPAIR** (Price \$7.50 separately)

Radio & TV **CIRCUITRY & OPERATION** (Price \$6.75)

Check here for **MONEY-SAVING COMBINATION OFFER**. Save \$1.25. Send both of above big books at special price of only \$13.00 for the two. (Regular price \$14.25 . . . you save \$1.25.) Payable at rate of \$1 plus postage after 10 days if you decide to keep books and \$3 a month for 3 months until the total of \$13.00 has been paid.

Name

Address

City, Zone, State

Outside U.S.A.—\$8.00 for **TROUBLESHOOTING & REPAIR**; \$7.25 for **CIRCUITRY & OPERATION**, \$14.00 for both. Cash only, but money refunded if you return books in 10 days.

-30-

for the camera fan . . .

**INTERESTING, INFORMATIVE
ZIFF-DAVIS PHOTO ANNUALS
YOU'RE SURE TO ENJOY!**



35-MM ANNUAL
now on sale
only \$1.00

(\$1.25 outside U.S.A.)

Here's a complete guide to 35-MM photography by the editors of *Popular Photography*, the world's largest selling photo magazine. It covers everything you want to know about miniature photography: how to use color, shooting techniques, the best in 35-MM pictures, facts on lenses, filters, film. Plus a buying guide to cameras and equipment. Be sure to get your copy of this valuable Annual!

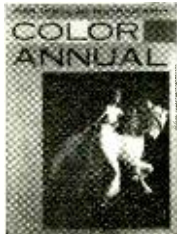

COLOR ANNUAL
now on sale
only \$1.25
everywhere

Popular Photography's 1959 **COLOR ANNUAL** is one of the outstanding photographic achievements of the year! Over 172 pages—including the year's best color shots, portfolios of leading pros, equipment and accessories review, a big International Portfolio. Don't miss the exciting 1959 **COLOR ANNUAL!**

Modular 6-Meter Station

(Continued from page 96)

Connect a microphone to the modulator and advance the *Gain* knob as you talk. You will notice that the bulb flickers brighter, indicating that you are modulating the transmitter.

Do not be tempted to advance the *Gain* knob too far or overmodulation will result. When the bulb gets slightly brighter, this is the correct setting for the gain control.

Your antenna system will determine the performance of this station. If you string up an indoor dipole, you will be lucky to work 15 or 20 miles. If the dipole is erected outdoors, above your house, you should be able to work 50 miles or so. And if you want to work stations 500 miles or more, you will need a beam antenna with a rotator. These high-gain antennas are described in amateur literature and you can either construct one or purchase a ready-made unit.

For local work, the antenna shown here is the simplest type you can build. It doesn't

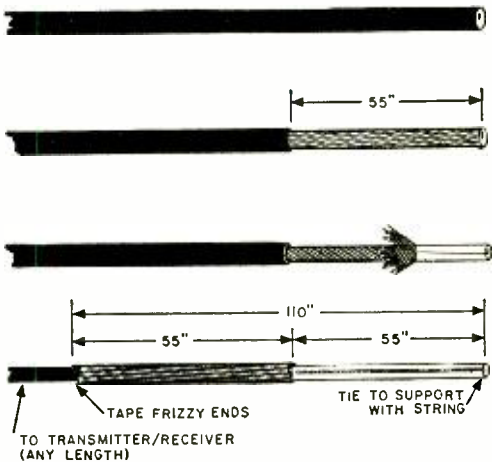

use the solder that most set makers use!

KESTER SOLDER

Make sure your soldering's the best . . . use the best—KESTER SOLDER. Send for FREE 16-page book that tells you how!

KESTER SOLDER COMPANY
4275 Wrightwood Avenue • Chicago 39, Illinois
OVER 60 YEARS' EXPERIENCE IN SOLDER AND FLUX MANUFACTURING

ELECTRIC WELD - BRAZE & CUT

REPAIR MOST EVERYTHING MADE OF METAL

Home Appliances, Auto parts, Farm-garden equipment, toys. Make and repair playground equipment, lawn chairs, tables, ornamental iron work gates, wagons etc. Solder, heat, bend, and straighten, with terrific heat from arc torch. Cut and weld up to 1/2" steel plate. A million uses for home, auto, farm, inventors, factories, etc. Works from any home 110 volt plug-in. Complete with dark welder's mask, arc torch, supply of carbon welding and brazing rods. Solder, flux, and complete Welding Instruction Book. Attractive—portable—efficient—durable—1 year guarantee. Wt. only 4 lbs.

SEND ONLY \$3.00 (cash, ok. mo.) and pay postman \$9.95 plus COD postage on arrival or send \$12.95 and we will send postpaid. Ideal gift for mechanically minded home owners, relatives, friends. Order now for early delivery. Available only from

MIDWAY WELDER Dept. DPL-5 Kearney, Nebraska

even require a soldered connection! It is called a coaxial ground plane and is constructed from a length of coaxial cable. When mounted in position, the tip of the antenna is suspended from a supporting structure by a length of cord or rope.

To make the antenna, first obtain a length of RG-58/U that is long enough to reach from the transmitter/receiver to the antenna site. At the antenna end, strip back 55" of the black insulation covering the copper braid. Be very careful not to nick or cut the braid. Loosen the braid by pulling it

"back over itself" towards the other end of the coax cable.

This braid must be pulled down over the black insulation below the point where insulation was removed. Because of the increased diameter below this point you will not be able to pull the braid down 55". You can do one of two things; either add some more braid to reach 55" or strip the cable back further and cut off the excess center conductor material.

Hang the antenna, using cord or rope tied to the tip of the center conductor insulation. Install a suitable connector at the transmitter end of the cable, and the antenna is ready for use.

-30-

Inside the Preamp

(Continued from page 52)

locked and thereafter both channels have the equivalent of one-knob control. Here, too, problems of linearity arise, but careful design of the controls and circuit makes acceptable linearity possible.

When we examine the various stereo preamps offered by various manufacturers, it is evident that many different combinations are being utilized as each designer tries to produce a preamp which he believes will meet the widest variety of needs. Although this may lead to some confusion, there is a clear dividend for the consumer: he is almost certain to find a model that meets his individual requirements precisely.

Next month we'll proceed into the realm where audio fans argue the question: "Are 60 watts output enough?" The first of two articles on *power amplifiers* will delve into the voltage amplifier section of the basic amplifier.

-30-

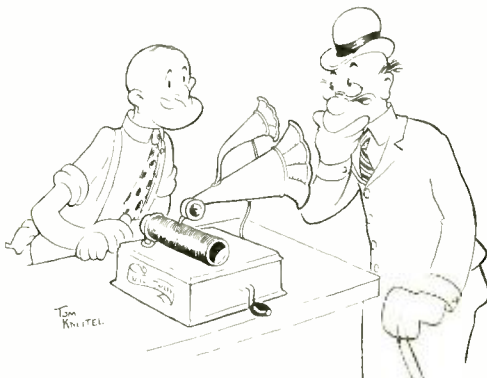

"But is it stereo?"

May, 1959

DEMAND QUALITY USE INTERNATIONAL HAM KITS!



**STP-50
6 METER
TRANSMITTER**

Kit, less tubes & crystal \$21.50.
Kit, with tubes less crystal \$26.50.
Wired, with tubes but less crystal \$32.50.
Crystal, FA-5, 12 MC \$4.00.

Shipping Weight 5 lbs.

**STP-10 10 WATT
MODULATOR**

Designed specially for International's STP-50 transmitter.
Kit, less tubes \$22.75. Kit, with tubes \$25.25. Wired and tested, with tubes \$30.50.
Shipping weight 3 lbs.





**FCV-2
CONVERTER**

Model 50, 6 Meters—Model 144, 2 Meters, Kit with crystal less tubes \$12.95. Wired with crystal and tubes \$17.95.
Shipping Weight 2 lbs.

**STP-PW-1
POWER SUPPLY**

300 VDC @ 100 ma.
For use with STP-10 or STP-50.
Kit with tube \$16.50.
Wired and tested, with tube \$21.75.
Shipping Weight 5 lbs.



HOW TO ORDER:
Order direct from International Crystal, address below. Terms F.O.B. Oklahoma City. Other shipments C.O.D. On C.O.D. orders of \$25.00 or more, 1/3 down payment with order is required.

**SEND FOR
YOUR
FREE
CATALOG
TODAY!**



**INTERNATIONAL
CRYSTAL MFG. CO., INC.**

18 N. LEE
OKLAHOMA CITY, OKLA.

WANTED!

Equipment, components or parts!

The 267,000 purchasers of POPULAR ELECTRONICS are always in the market for good used equipment or components. So, if you have something to sell, let PE readers know about it in our classified columns.

It costs very little: just 50¢ per word including name and address. Minimum message: 10 words. For further information write:

Martin Lincoln

POPULAR ELECTRONICS
One Park Avenue, New York 16, New York

LEARN

RADAR MICROWAVES COMPUTERS TRANSMITTERS

CODE • TV • RADIO

Phila. Wireless Technical Institute

1533 Pine St.

Philadelphia 2, Penna.

A Non-Profit Corp. Founded in 1908

Write for free Catalog to Dept. P-559

MOBILE-FIXED CONVERTER

POLICE • FIRE • CITIZENS' BAND

#315A is a practical converter for emergency use. Easily installed. Tuning range approximately 8' MC in the 26-50 MC band—15 MC in the 152-162 MC band. Designed for mobile or home use.

KIT also available..... \$13.95
ORDER TODAY or WRITE for LITERATURE

KUHN ELECTRONICS

20 GLENWOOD CINCINNATI 17, OHIO

MAIL ORDER BUSINESS

How to Start a Profitable Business of Your Own at Home or in a Small office. Amazing new instruction course shows you how to run a good mail order business, spare time or full time. 1 postcard, practical training—a treasure-house of the best plans and practices being used TODAY by successful operators. Only \$6.95. Complete-Satisfaction Guaranteed! This is BIG. You get 44 money-making business-to-consumer ventures, all in one shipment. You must be satisfied or your money back immediately. Full price only \$6.95 postpaid or \$4.00 plus postage. Nothing more to pay! Only "Mail Order Course" today.

Nelson-Hall Co., 210 S. Clinton St., Dept. ER-43, Chicago 6, Ill.



Answers to Electronic Sticklers

on page 88

1. With the switch off, the lights will be in series across 117 volts ± 6 volts. Pilot light will pop first, then the floodlight will go out.
2. Dewey failed to consider power factor when he made his original measurement with a voltmeter and ammeter. The wattmeter automatically took power factor into consideration. In this circuit the power factor is 0.75.
3. The reading would be 5 because the batteries are connected in parallel. Actually, unless the resistors are very large in value, the meter will read some value between 2 and 5 due to the loop current set up in the parallel circuit.

4. Although it is not practical to construct an infinite mesh, you can solve this problem by using a variation of the constant current method for solving network problems.

Assume that a battery is connected to the mesh in such a way that one terminal of the battery is connected to point "A" and the other terminal is connected at infinity. The size and polarity of the battery is such that 1 ampere of current flows "into the paper" at point "A". Since the three resistors connected to point "A" are all equal (1 ohm) and the surrounding mesh is symmetrical, the current divides equally in the three branches. Hence, the current in the resistor between "A" and "B" is $\frac{1}{3}$ ampere (i_a).

Now connect a second battery in a similar fashion, only in this case, while one terminal again connects at infinity, the other terminal is connected to point "B". The size and polarity of this battery is such that 1 ampere of current flows "out of the paper" at "B". Again, for the same reason, the current divides equally. Hence, an additional $\frac{1}{3}$ ampere (i_b) flows through the resistor between "A" and "B" in the same direction as the current from the first battery. Since one terminal of each battery is connected at infinity, the two currents at this point are equal and opposite; therefore, they cancel. The infinite extremes of the mesh may be neglected.

It can be seen that a total current through the resistor ($i_a + i_b$) is $\frac{2}{3}$ ampere. Since this resistor equals 1 ohm, the voltage drop across it will be $\frac{2}{3}$ volt. It follows then that since 1 ampere of current flows into point "A" and out of point "B," and the voltage drop from "A" to "B" is $\frac{2}{3}$ volt, the total mesh resistance is: $R = E/I$, or $\frac{2}{3}$ volt/1 ampere, or $\frac{2}{3}$ of an ohm.

If you know of a tricky Electronic Stickler, send it in with the solution to the editors of POPULAR ELECTRONICS. If it is accepted, we will send you a \$5 check. Write each Stickler you would like to submit on the back of a postcard. Submit as many postcards as you like but, please, just one Stickler per postcard. Send to: POPULAR ELECTRONICS STICKLERS, One Park Ave., New York 16, N. Y. Sorry, but we will not be able to return unused Sticklers.

Among the Novice Hams

(Continued from page 116)

of these methods are used in different amateur receivers.

Image Interference. A disadvantage of the superheterodyne circuit is the possibility of image interference. Assume that a 21-mc. signal is being heard on a receiver with a 455-kc. i.f. amplifier, requiring the receiver high-frequency oscillator to be tuned to 21,455 kc. to produce the 455-kc. i.f. signal.* But a 21,910-kc. signal will also produce a 455-kc. difference signal, if it reaches the mixer stage.

It is a function of the tuned circuits ahead of the mixer to keep image signals

Dayton HAMVENTION

On Saturday, May 9, at the Dayton-Biltmore Hotel, Dayton, Ohio, the Dayton Amateur Radio Association will hold its ninth annual HAMVENTION. The one-day program will feature outstanding speakers and demonstrations on many phases of ham radio. Forums will be held throughout the day on such subjects as DX, SSB, V.H.F. and others. Plan to bring the XYL. The HAMVENTION will be terminated by the Grand Banquet, which begins at 7:00 Saturday evening. Tickets purchased before May 5, 1959, are priced at \$5.50 and include registration and banquet. After May 5 the price will be \$6.00.

On Friday evening, May 8, there will be a S.S. Band dinner and a V.H.F. dinner at the hotel. Tickets *must* be purchased in advance and are priced at \$4.00. Reservations, more information, and an attractive brochure may be had by writing: D.A.R.A., P.O. Box 426, Dayton, Ohio.

from reaching the mixer. With a standard 455-465 kc. intermediate frequency, image interference is not much of a problem up to around 10,000 kc. But, at higher frequencies, it becomes more serious.

Dual Conversion. One way to improve the image suppression of a receiver is to raise its intermediate frequency, but this tends to decrease both the selectivity and "gain" of the receiver. Therefore, the usual method is first to convert the incoming signal to a frequency in the 2000-kc. region for good image suppression and then to a lower frequency to build up gain and selectivity.

Additional desirable features in a ham

* It is standard procedure to tune the oscillator to the high-frequency side of the received signal.

May, 1959



WE HIGHLY RECOMMEND FOR THE BEGINNER . . .

the **Globe Chief 90A** 90w CW for 10-80M
all bandswitching

Complete CW Xmtrr.

Compact and sturdy with well-filtered, built-in power supply. Pi-Net, 52-600 ohms. Modified Grid-Block Keying for maximum safety. Provisions for VFO input and operation. Convert to tone with Screen Modulator below. New Forward Look cabinet. Kit complete with all necessary parts, tubes, instructions.



Wired: \$74.50
\$7.45 down; \$6.15 per mo.

Kit only: \$59.95 \$6.00 down; \$5.00 per mo.

adding Globe's Screen Modulator Kit



With Globe Chief, permits radio-telephone operation at lowest cost. Completely self-contained. Also adaptable for other CW Xmtrrs. Kit contains: printed circuit, parts, etc.

Just \$11.95 Complete

or the new Globe Sidebander DSB-100

Complete Xmtrr. for AM; CW & DSB

Bandswitching: 80-10M; 100W DSB (PEP) Suppressed Carrier, 40W AM, 50w CW. Work all three modes at least cost. Automatic balancing and floating Grid circuit for 45db carrier suppression or better. Covers all pop. MARS & CAP frequencies. 3-stage RF section for max. efficiency. Speech clipping & filtering for powerful communication punch. Accessory socket at rear. Really the "All-in-One" Xmtrr.



Wired: \$139.95
\$14.00 down; \$11.55 per mo.

Kit: \$119.95

\$12.00 down; \$9.90 per mo.

SEND FOR BROCHURE ON COMPLETE
LINE OF GLOBE PRODUCTS AND
FREE 1959 CATALOG!



RUSH: () NEW CATALOG, () BROCHURE, AND MORE
INFO ON: _____

NAME: _____

ADDRESS: _____

CITY & STATE: _____

POPULAR
ELECTRONICS

JUNE
1969

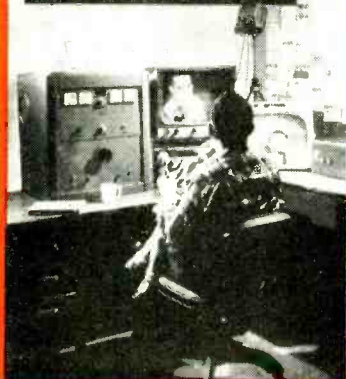

SHORT-WAVE RECEIVER FOR THE 30-50 MC BAND—Readers of *POPULAR ELECTRONICS* have been asking for this! Here are complete plans for an easy-to-build short-wave receiver in the most popular band for ham operators.



TRANSISTORIZED POWER CONVERTER—Follow PE's simple directions for converting your 12-volt car battery output to a 117-volt AC supply—providing house current in your car for shaving, ham equipment, etc.!



PATIO HI-FI EXTENSION SPEAKER—You can still enjoy your hi-fi set and the fun of sitting outside in summer—with this simple idea for a portable tripod!

**PLUS—SPECIAL
FEATURE ON *HAM TV***

Ham TV is a brand-new field for the SWL and ham operator that is gaining popularity fast! In this special PE feature, you'll find out how to get started in ham TV transmitting—so that you can actually see the person you are talking with!

Popular Electronics:

PLANS FOR 6 HOME CONSTRUCTION PROJECTS!

Next month, in the new, bigger-than-ever POPULAR ELECTRONICS, you'll find complete diagrams for building half-a-dozen useful, inexpensive projects:

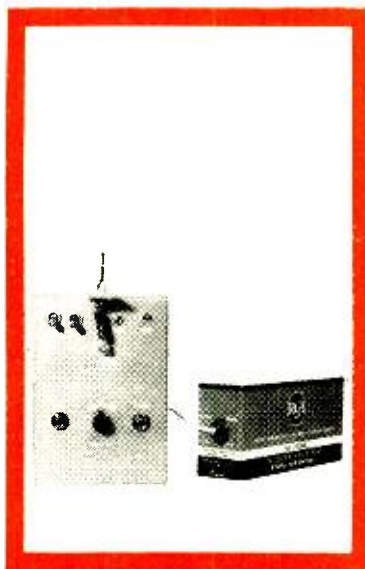

CITIZENS BAND—Because of recent FCC rulings easing controls on Citizens Band operations, you can now construct person-to-person communications equipment without a special license. Here's design data for building a short-wave transmitter and receiver station. Don't miss it!



TRANSISTORIZED METAL LOCATOR—Ever have the experience of breaking through a wide area of plaster before you found a faulty pipe? This novel gadget does away with that problem by enabling you to locate conduits and pipes in walls immediately.



TRANSISTOR SQUARE WAVE GENERATOR—This is an easily constructed piece of test gear that has many applications to the audio field. You'll find it's an efficient, cheap way to test circuits and amplifiers.

And, of course, there's plenty of good reading as well as these practical home construction projects in **JUNE POPULAR ELECTRONICS**—and in every issue in the months ahead. That's why so many elec-

tronic hobbyists read PE regularly... wouldn't miss a single issue. By subscribing now, you can make sure **POPULAR ELECTRONICS** is delivered to your doorstep each month—at money-saving rates. So act today!

REGULAR SUBSCRIPTION RATES:
one year \$4 two years \$7 three years \$10

POPULAR ELECTRONICS
434 South Wabash Avenue, Chicago 5, Illinois

TV PICTURE TUBES AT LOWEST PRICES

10BP4	\$ 7.95	16WP4	\$15.20	17TP4	\$19.30	21EP4	\$14.95
12LP4	8.95	16TP4	10.95	20AP4	19.30	21FP4	15.95
14B/CP4	9.95	17AVP4	15.20	20CP4	13.90	21WP4	17.30
16DP4	14.95	17BP4	10.95	20HP4	17.95	21YP4	15.95
16EP4	15.90	17CP4	17.00	21AP4	22.10	21ZP4	14.95
16GP4	15.90	17GP4	17.60	21ALP4	20.95	24CP4	23.95
16KP4	10.95	17HP4	13.60	21AMP4	19.95	24DP4	26.95
16LP4	10.95	17LP4	13.60	21ATP4	20.95	27EP4	39.95
16RP4	10.95	17QP4	11.95	21AUP4	20.95	27RP4	39.95

1 YEAR WARRANTY

Aluminized Tubes \$5.00 more than above prices. Prices include the return of an acceptable similar tube under vacuum. These tubes are manufactured from reprocessed used glass bulbs. All materials including the electron gun are brand new.

ALL PRICES FOR CHICAGO, ILLINOIS. Deposit required. When old tube is not returned, refundable at time of return. 25% deposit required on COD shipments. Old tubes must be returned prepaid. Tubes shipped Rail Express.

WRITE FOR COMPLETE LIST

—PICTURE TUBE OUTLET—
3032 MILWAUKEE AVE., CHICAGO 18, ILLINOIS
Dickens 2-2048

"The KENTRON" STEREO AMPLIFIER & PREAMP



**ONLY
\$59.95**

(postpaid)
(Calif. residents
add 4% tax)

At last! A FULL, HIGH FIDELITY, STEREO Power Amplifier and Pre-amplifier, with performance seldom found at this low price. Provides rich, full range sound from 20 to 20,000 cycles with full 10 watts output power. Variable frequency response on both channels allows compensation for all records. Ultra modern styling.

CAPRI ELECTRONICS
Division of J & J Machine Co.,
823 E. Jefferson Blvd.

Order from
this ad.
Los Angeles 11, Calif.

PORT ARTHUR COLLEGE ELECTRONICS COMMUNICATIONS

AM FM Television Broadcast Engineering
Marine Radio Radar

CHECK THESE FEATURES: Tuition \$34 per mo., room & board \$50 per mo. in dorm on campus. College operates 5 KW broadcast station. Students get on-the-job training at studios on campus. FCC license training with all courses. Well equipped classrooms & lab., am fm transmitters, radar & marine eqmt., television camera chain, experiment lab test eqmt., & other training aids. Our graduates in demand at good salaries. Free placement service. Have trained men from all 48 states. Approved for GI. Write to Dept. PE-5 for details.

PORT ARTHUR COLLEGE Port Arthur
Texas
Established in 1909

EASY TO LEARN CODE

Learn to increase speed with an Instructograph—the Radio-Telegraph Code Teacher that takes the place of an operator-instructor and enables anyone to master code without further assistance. Available tapes from beginners alphabet to typical messages on all subjects. Speed range 5 to 40 WPM. Always ready—no QRM. Thousands have "acquired the code" with the Instructograph System. Write today for convenient rental or purchase plans.

INSTRUCTOGRAPH COMPANY
4713 SHERIDAN ROAD, CHICAGO 40, ILLINOIS
357 West Manchester Ave., Los Angeles 3, California



receiver are an S-meter for measuring the relative strength of received signals, an antenna trimmer for matching the receiver to the antenna, a noise limiter to smooth off sharp, pulse-type noises, and a crystal frequency calibrator.

Selecting Your Receiver. Obviously, an amateur receiver with all desirable features can be quite expensive. The biggest disadvantage of those selling for less than \$100 is inadequate selectivity to cope with the interference during the busy operating hours, although they work quite well at other times. Receivers at about the \$150 level have sharply improved selectivity; and above \$250 most of them go to dual conversion. At the same price level, ham-band-only and special SSB receivers become available.

You probably get the most for your money in the \$250—\$350 price range, although there is no doubt that the higher priced ones do have their advantages.

In the kit line, there are about four amateur receivers available at prices from around \$35 to \$275. By assembling a receiver yourself, you can acquire a better one for the same price. Also, for less than \$50, you can build a better *amateur* receiver than you can buy for considerably more money. See the *Radio Amateur's Handbook*, or the *Radio Handbook* for constructional details.

However you do it, get the best receiver you can afford, even if it means skipping a bit on your transmitter. A good receiver will serve you well for many years and be a pleasure to operate.

TWENTY-ONE MC. BEAM

The 21-mc. beam used by Russ W. Coping, KN5PGM, 6425 Colbert St., New Orleans 24, La., is shown in the diagram on page 116. It gives a power gain of three over a half-wave doublet.

To construct it, trim four bamboo fishing poles to produce two 11' 3" long and two 10' 7" long. Russ supported his poles with broom handles, but the method shown here may be easier to duplicate. Screw a 1' x 1" x 2" crosspiece to each end of a 5' length of 1 x 4. Secure the bamboo poles to the crosspieces with TV antenna "U" bolts.

Cut one piece of 300-ohm TV flat lead-in to a length of 22' 4" and the other one to a length of 21' 1". Bare their conductors for a half inch at each end and twist and

solder together. Cut one conductor of each length at its exact center as shown in the diagram and expose $\frac{1}{4}$ " of the conductor on each side of the cut.

Fasten the lengths of 300-ohm line to the bamboo poles with a wrap of black plastic tape every few feet. Join the opened center leads with a 5' length of 300-ohm ribbon, giving it a half twist. Also connect the RG-58/U feed line and the 11' 3" "balun" to the radiator (longer element), with the center conductor of the feed line and the shield of the "balun" to one terminal and the shield of the feed line and the inner conductor of the "balun" to the other terminal. Connect the inner conductor and the shield of the "balun" together at the opposite end.

Mount the antenna as high as possible, aim it in the desired direction, and use it both for receiving and transmitting.

News and Views

Wayne Overbeck, K6YNB, (15), 1511 Ruhland Ave., Manhattan Beach, Calif., has been a General for quite a while, but he worked 45 states and eight countries in five months as a Novice, mostly on 15 meters. He now has all states and 45 countries. Wayne suggests replacing the 5U4G (A or B) rectifier used in the DX-35 and several other Novice transmitters at beyond its voltage ratings with a 5R4GY, which has a much higher voltage rating. No wiring changes are required. The change greatly reduces the danger of burning out the power transformer if the rectifier tube arcs over, as an overloaded 5U4— frequently does near the end of its useful life. He also found that a simple 6J6 converter and a preselector (POPULAR ELECTRONICS, October, 1956) really improved the performance of his Heathkit AR-3 receiver on 15 meters . . .

Chuck Mitchell, KN1KC, Sterling Rd., So. Lancaster, Mass., just passed his General Class examination. As a Novice he worked 25 states on 40 meters. His best DX is California. Chuck uses a Knight "Ocean Hopper" receiver fed into a phono amplifier and a Heathkit DX-20 transmitter; his father has promised him a Hammarlund HQ-110 when his school grades improve. Chuck is looking for dope on putting his DX-20 on six meters. So am I, for our new construction corner. Does anybody have any?

Peter Guidi, WA2BMB, P. O. Box 64, Croton Falls, N. Y., made 400 contacts, all on 40 meters, in four months as a Novice. They were divided between 40 states, Canada, Puerto Rico, and Austria. Thirty-eight of the states are confirmed. Pete receives with a Heathkit AR-3 sharpened up with a Q-Multiplier. He transmits with a WRL Globe Chief 90A, and his antenna is a 40-meter dipole, about 20 feet high. . . . **Bob Staib, KN4DFT**, 1434 Haskin Ave., Louisville 15, Ky., made only three contacts in his first three days on the air. Then he got rolling and made 70 con-

May, 1959

DUAL TRANSISTOR ELECTRONIC FLASH KIT



DO-IT-YOURSELF AND SAVE \$30! **\$39⁹⁵**

- ★ Operates on AC, flashlight or nickel-cadmium batteries or the new energizers
- ★ Wt. only 2¼ lbs.
- ★ 200+ flashes on four D batteries
- ★ 1/3000 sec. flash
- ★ 35 guide for Kodachrome
- ★ 5 to 7 second recycling
- ★ G.E. flash tube
- ★ Built-in charger for long-life batteries
- ★ Low drain dual transistor supply
- ★ Shatterproof lens
- ★ Universal clip fits all cameras

\$4 Down, \$5 Monthly

Radio Shack's MICROSTROBE-2 brings you the very latest electronic flash engineering at a low, low bargain price. Actually its the new \$69.95 DORMITZER "STAR-FIRE" . . . in kit form. And it comes to you complete . . . not even a piece of wire to buy . . . and with everything "eyeletted"! The assembly and operating instructions are easy to follow . . . so if you're handy with tools, here's an opportunity to own a modern, top quality strobe flash . . . and save \$30. Guaranteed by both Dormitzer and Radio Shack.



Ask for 32-page Bargain Bulletins

RADIO SHACK CORPORATION, Dept. 5b
730 Commonwealth Ave., Boston, Mass.

- Send me Microstrobe-2 kit at \$39.95
 Cash COD \$4 Down, Bal. Mthly.
 Send me 32-page Bargain Bulletins

Name _____
 Address _____
 City _____ Zone _____ State _____

RADIO SHACK CORPORATION

167 Washington St., Boston 8, Mass.
 730 Commonwealth Ave., Boston 17, Mass.
 230-234 Crowe St., New Haven 10, Conn.

HELP US OBTAIN OUR HAM LICENSES

K1/W1 CALL AREA

Wallace E. Kervian, 356 Newton St., So. Hadley Falls, Mass. Phone: JE 2-8709. (Code and theory)

Steve Case (18), 1018 St. George's Rd., Baltimore 10, Md. Phone: HO 7-4321. (Code and theory)

Raymond Midura, 1295 Bay St., Springfield 9, Mass. Phone: RE 4-7121. (Code and theory)

Peter D. Grainger, 300 Salisbury St., Holden, Mass. (Code and theory)

James E. McCobb (16), 3 Linsky Barry Ct., So. Boston 27, Mass. Phone: AN 8-6836. (Code and theory)

K2/W2 CALL AREA

Richard McCullers, 800 Home St., Bronx 56, N. Y. (Code, theory and regulations)

William R. Rattner, 138-17 78th Rd., Flushing 67, N. Y. Phone: OL 7-3558. (Code and theory)

Irv Grossman, 155 Kings Highway, Brooklyn, N. Y. (Code and theory)

Jon Friedman (15), 227 Scranton Ave., Lynbrook, L. I., N. Y. Phone: LY 9-6561. (Code and theory)

Alan I. Feiertag (16), 917 Lenox Rd., Brooklyn 3, N. Y. Phone: EV 5-9344. (Code and selection of equipment)

Billy Davis, 471 West Beach St., Long Beach, N. Y. Phone: GE 1-5276. (Code, theory and selection of equipment)

Marvin Gurlin, 111 White Horse Pike, Audubon 6, N. J. (For Technician license)

Kim Boriskin, 868 E. 7th St., Brooklyn 30, N. Y. (For Technician license)

Larry Horwitz, 8 Admiral Rd., Buffalo 16, N. Y. (Theory and selection of equipment)

Kalman Rothman, 41 Hutton Ave., Nanuet, N. Y. Phone: NA 3-2265. (Code and theory)

Charles Redman, 88-18 181 St., Hollis 23, N. Y. Phone: RE 9-3662. (Code and theory)

K3/W3 CALL AREA

Owen Cook, 611 Darlington Rd., Beaver Falls, Pa. (Code and theory)

Lee Kaufmar (18), 2726 N. 28th St., Philadelphia 32, Pa. Phone: BA 5-8353. (Code and theory)

Raymond Kibler, 3803 St. Margaret St., Baltimore 25, Md. (Code, theory and regulations)

Jeff Hallinger (15), Egypt Rd., Mont Clare, Pa. Phone: WE 3-9596. (Code)

Richard A. Fisher, 315 Audrey Lane, Washington 21, D. C. (Code and theory)

John D. Sancken, 12028 Millbrook Rd., Philadelphia 14, Pa. (Code, theory, regulations and selection of equipment)

Frank Lazorishak, Jr., 236 Superior St., Sharon, Pa. (Code and theory)

Michael Walsh, 459 Drycove St., Pittsburgh 10, Pa. Phone: EV 1-2878. (Code, theory and regulations)

K4/W4 CALL AREA

Tommy Campbell, R. #2, Box 13, Ehrhardt, S. C. (Code and theory)

Billy Price, Old Wilson Rd., Rocky Mount, N. C. Phone: 6-6797. (Theory and regulations)

Gerald Fiketich, 1010 Bruce St., Port Alberni, S. C. (Code, theory, regulations and selection of equipment)

Jack Howell, 191 S. Main St., Suffolk, Va. (Code and selection of equipment)

K5/W5 CALL AREA

Roger Wolfe, 136 Cedar, Hot Springs, Ark. (Code and theory)

Deral Kent, Box 622, Lockney, Tex. (Code)

Wayne Ridge, Box 291, Ripley, Miss. (General code and selection of equipment)

Mike Sammons (14), 7431 Baxtershire, Dallas 30, Tex. Phone: EM 8-7020. (Code, theory and selection of equipment)

Jimmy Cobb (12), 1600 Plantation Dr., Alexandria, La. (Phone: 3-9008. (Theory and selection of equipment)

K6/W6 CALL AREA

Bill Lapham (13), 2863 Muscupiabe Dr., San Bernardino, Calif. (Code, theory and regulations)

Tom Parker, 10405 LaCanada Way, Sunland, Calif. (Code, theory and regulations)

Brian R. Adams (14), 2212 Rainbow Ave., Sacramento 21, Calif. (Code, theory and selection of equipment)

Wayne Cobb, 1116 Highland Oaks Dr., Arcadia, Calif. (Code)

James McLaughlin, 995½ E. 49th St., Los Angeles 11, Calif. Phone: AD 3-5686. (Code, theory, regulations and selection of equipment)

K7/W7 CALL AREA

John M. McCarty, 1002 E. Bethany Home Rd., Phoenix, Ariz. (Code and theory)

Barry Dryden (14), 1941 S. E. 162nd Ave., Portland 33, Ore. Phone: AL 4-5777. (Code and theory)

Al Gillis (15), 780 N. Main Ave., Gresham, Ore. Phone: MO 5-2606. (Code and theory)

Mike Allen, Box 814, McCall, Idaho. (Theory and selection of equipment)

K8/W8 CALL AREA

John Champa, 1542 Wyandotte Rd., Columbus 12, Ohio. Phone: HU 8-1698. (Code and theory)

Warren Napier, Box 24, Rainelle, W. Va. (Code)

Frank Mynes, Rt. 2, Box 32, Hurricane, W. Va. (Code, theory and regulations)

Al Nicholas, 6206 Auburn, Detroit 28, Mich. Phone: TI 6-9087. (Code and selection of equipment)

Edward Carwan, 5657 15th St., Detroit 8, Mich. Phone: TY 6-4419. (Code and theory)

Frank Vargo, 1425 S. Liberty, Alliance, Ohio. (Code, theory and selection of equipment)

Arty Steiner, 19918 Winthrop, Detroit, Mich. Phone: VE 8-4866. (Code, theory, regulations and selection of equipment)

K9/W9 CALL AREA

Jack White (16), Bluford, Ill. (Code and theory)

Steve Hogan, 5422 S. Tripp Ave., Chicago 32, Ill. Phone: RE 5-4509. (Code)

Joe Johnson (16), 1111 Pearl St., Belvidere, Ill. Phone: LI 4-6691. (General code and theory)

John R. Larsen (16), 441 Whittemore Dr., S. Beloit, Ill. Phone: DU 9-2708. (Code and theory)

KO/WO CALL AREA

Don Lee Woods, 320 E. Washington, Sigourney, Iowa. (Code and theory)

James Wendel, Box 867, Thief River Falls, Minn. Phone: MU 1-3284. (Code, theory, regulations and selection of equipment)

VE AND OTHERS

Douglas Narynski, 440 Smithfield Ave., Winnipeg 4, Manitoba, Canada. (Theory and selection of equipment)

Arthur Skudikis (15), 73 Greenwood Ave., Toronto, Ont., Canada. Phone: HO 6-5552. (Code and theory)

Maurice Yunik, Box 122, Ethelbert, Man., Canada. (Theory and regulations)

tacts in 20 states in two weeks: twelve of the states are already confirmed. Bob operates on 80 and 15 meters. He has an 80-meter folded dipole antenna, and a 15-meter doublet. His transmitter is a Heathkit DX-40, and his receiver is an AR-3. . . . **Martell Bolden, KNØSAJ**, 1127 W. 13th St., Des Moines, Iowa, spent the six weeks he waited for his license to come, after taking the examination, practicing the code an hour a day. In six weeks on the air, he has made 175 contacts in 40 states, Canada, and Cuba. He has cards from 35 of the states.

James G. Edward, Jr., KN1IMJ, 18 Circle Drive, Middletown, R. I., offers to schedule anyone needing a Rhode Island QSO and QSL card. He works both 40 and 15 meters and has worked 42 states in three months. Jim transmits with a DX-20, and he receives on an Electro-Voice RME 4350A. . . . **Ken Anderson, KN8MTK**, (16), 525 McIntire Drive, Fairborn, Ohio, uses an AR-3 receiver and a DX-40 transmitter running 75 watts, and a 40-meter folded dipole antenna. He operates on both 40 and 15 meters, but he prefers 15. In three weeks on the air, he has had 100 contacts in 34 states and worked one very rare DX Station—MP4AOY in Asia. Ken has cajoled QSL cards from 21 states. . . . **Dick Klein, KN9OPF**, (14), 413 West Third St., Beaver Dam, Wis., made seven contacts in six months using a 45-watt "home-brew" transmitter. Six weeks ago, he got a Heathkit DX-35 and now has made 50 contacts in 12 states. His receiver is an AR-3 with an added Q-Multiplier.

Ray LaBar, K3BKL, R.D. No. 1, Canadensis, Pa., corrects my statement in the February column that applicants for an amateur license were eligible to take the Conditional class examination by mail if they lived over 50 miles from the nearest FCC examination point. The correct distance is 75 miles. Also, the ARRL packet of booklets on amateur radio, "Gateway To Amateur Radio," contains a free booklet called "Operating An Amateur Radio Station." . . . **Edward Cole, KN8MWA**, (15), 149 Brown Road, Mayville, Mich., prefers the "handle" of "Rusty," perhaps because it best describes his code speed. In about two months on the air, he has worked 23 stations in eight states feeding a dipole with a DX-35 transmitter on 40 meters and receiving with a Hallicrafters S-38B or an "Ocean Hopper." Rusty offers to help prospective amateurs get their licenses. . . . **Jim Applewhite, KN4ZQQ**, P.O. Box 332, Elizabethtown, Ky., and his son, **KN4YRB**, operate phone in the 145-137 mc. (2-meter) Novice band and like it better than the crowded, low-frequency Novice c.w. bands. They use a converted "surplus" T-23 transmitter, for which they built a power supply and a modulator, which feeds a 10-element beam they picked up second hand. Receiving is handled by an International Crystal Company FCV-2 converter, working into a broadcast receiver. Jim thinks more Novices should be told about two meters. He is doing his part.

We would all like to read about *your* station, record, and opinions next month. Pictures are always welcome, too. 73.

Herb, W9EGQ

FREE CAREER BOOKLET



To guide you to a successful future in

ELECTRONICS RADIO-TV COMPUTERS ELECTRICAL ENGINEERING

This interesting pictorial booklet tells you how you can prepare for a dynamic career as an Electrical Engineer or Engineering Technician in many exciting, growing fields:

**MISSILES • AVIONICS • AUTOMATION
SALES • DEVELOPMENT
ELECTRICAL POWER • ROCKETRY
RADAR • RESEARCH**

Get all the facts about job opportunities, length of study, courses offered, degrees you can earn, scholarships, part-time work — as well as pictures of the Milwaukee School of Engineering's educational and recreational facilities. No obligation — it's yours free.

MILWAUKEE SCHOOL OF ENGINEERING

MAIL COUPON TODAY!

Milwaukee School of Engineering
Dept. PE-559, 1025 N. Milwaukee St., Milwaukee, Wis.

Please send FREE "Your Career" booklet

I'm interested in

Electronics Radio-TV Computers
 Electrical Engineering Mechanical Engineering

Name..... Age.....

PLEASE PRINT

Address.....

City..... Zone..... State.....

I'm eligible for veterans education benefits.

Discharge date..... MS-117

EMERGENCY PORTABLE POWER PLANTS

Push Button Start — 115 V AC (and 12 V DC). Always available. Only unit at these low factory prices fully shielded and filtered for radio, and individually checked by scope. Brand new 4 cycle easy starting engines, fiber glass insulated generators, and control boxes with voltmeter. Conservatively rated. Just the generator for CD, Field Day, Camping and Boats.

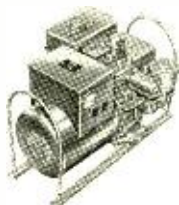

700 watt (A712) Shpg. wt. 77 lbs. \$143.50
 1000 watt (A1012) Shpg. wt. 90 lbs. 195.50
 2500 watt (A2512) Shpg. wt. 225 lbs. 325.50

Sizes to 3500 watts. F.O.B. factory
 Dual voltage models, automatic controls, etc., available.

GENERAL ELECTRONIC SERVICE CO.
 376 Wilmot Ave., Burlington, Wisconsin

Short-Wave Report

(Continued from page 104)

Their English schedule reads as follows: daily at 0130-0500 (Sundays to 0430) on 6050, 9745, 11,915, and 15,115 kc. and at 0530-0600 on 9745 and 11,915 kc. to the South Pacific and Europe; daily at 0900-1000 (Saturdays at 1000-1030) on 15,115 and 17,890 kc. to the Americas and daily except Mondays at 1400-1530 to Europe and 1830-1900 to the West Indies (on these transmissions, the 17,890-kc. frequency may be replaced by 11,915 kc. if conditions so warrant); and daily except Mondays at 2100-0000 on 9745, 11,915, and 15,115 kc. to North and South America. Other transmissions include programs in French, German, Russian, Spanish and Swedish.

Reports from listeners are invited. The engineers at HCJB make good use of your reports, so be sure to include all the necessary information. (Incidentally, your Editor has a leaflet available at no charge that explains the proper method of sending reports to stations and contains a general listing of the information that should be included.)

If requested, HCJB will verify a report with a QSL card, otherwise by letter. Their international program schedule is free on request. All reports and letters should be sent to: HCJB, *The Voice of the Andes*, Casilla 691, Quito, Ecuador.

Station Reports

The following is a resume of current reports. Times shown are Eastern Standard and the 24-hour system is used. Reports are correct at time of compilation but stations often change frequency and/or schedule with little or no advance notice.

Afghanistan—*Radio Kabul* has shifted from 4948 kc. to 4042 kc. for a temporary test during the period from 0830 to 1230. It has been noted in Cyprus at 1000. The schedule, which includes an Eng. period at 1150-1210, reads: 1000-1015 in Afghan-Persian or Pushtu, 1100-1115 in Persian, 1130-1140 in Urdu, and 1215-1225 in Arabic. The duration of the test period is unknown and they may try another frequency in this band. (488)

Another source lists an Eng. xmsn at 0945-1000 on 4660 kc. but this is not definitely confirmed. (378)

Barbadoes—ZNX32, Bridgetown, is noted at times from 1600 with cricket matches and s/off at 1630. (166, 240)

Bermuda—A good chance to log and verify this country is through the Kindley Air Force Base radio on 8913 kc. Tune for it between 2130 and 2230. The ID is usually given merely as *Kindley*. (476)

THERMO-ELECTRONICS

Successor to
Thermo-Electricity

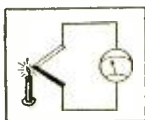

Change heat to electricity DIRECTLY—no acids, liquids, chemicals, moving parts or sunlight! Build or buy a thermo-electronic battery. Mail quarter today for information and sample thermo-electronic alloy.

HERMON E. COTTER

Dept. 5

15766 Blackstone

Detroit 23, Mich.

ZONE MAIL INDEED RESULTS IN SPEED

The Post Office has divided 106 cities into postal delivery zones to speed mail delivery. Be sure to include zone number when writing to these cities; be sure to include **your** zone number in **your** return address —after the city, before the state.

TELEPHONES



YOUR OWN • MODERN DIAL
 FOR PRIVATE CIRCUITS and extensions, easy to install, invaluable for residence—farm—estates or industrial purposes. Surplus phones—slightly used—fully standard, complete with dial, bell, cords, etc. With male 4-prong plug—add \$1.75. Instructions and diagram included.

GOV'T COST: \$32.50 each

NOW

10.50 each

Sorry, no C.O.D.'s

We pay postage anywhere in U.S.A.

FENNER SALES
 Dept. PE-2
 Hysiam, Mont.

100% Satisfaction Guaranteed

Ceylon—The Commercial Service of Radio Ceylon, Colombo, is noted on 15,265 kc. from 2020 to 2030 with tuning signal, 2030 opening with "Strike Up the Band" and "Good Morning." This Eng. xmsn. to S. E. Asia, runs to 2330 and is usually heard well during the first hour. News relayed from London is given at 2100. (*LJ, WP, BS, 353, 411, 432, 553*)

Costa Rica—TIQ. R. Casino, Limon, 5952 kc., is heard at 0000-0100 with music and commercials in Spanish. S/off is at 0100. (*557*)

An overseas source gives the call sign for TIDCR, *La Voz de la Victor*, San Jose, 9617

Popularity Poll

Here are the results of the popularity poll conducted recently by the International Shortwave Club (figures in brackets indicate the number of votes received): R. Australia (1303), Swiss S/W Service (1093), *Happy Station of R. Nederland* (890), BBC-London (579), R. Canada (551), V. of America (402), R. Luxembourg (325), R. Sweden (287), R. Japan (270), Armed Forces Radio Service (160), *Voice of the Andes* (144), *Deutsche Welle* (135), R. Nacional de Espana (120), Belgian National B/C Service (114), *Emissora Nacional* (Lisbon) (112), Danish State Radio (98), R. Brazzaville (90), R. New Zealand (83), R. Paris (75), Kol Israel (66), All India Radio and R. Prague (tied) (65), R. Moscow (8), R. Cairo (2), and R. Peking (1).

kc., as *TIRICA*. Has anyone received a verification on this call sign? (*396*)

Ecuador—New stations and frequency changes include: R. *Mundial*, Riobamba, now on 6255 kc. and tuned at 1900-2300; R. *Once de Noviembre*, Latacunga, 6257 kc., 1900-2300; R. *Ruta*, Riobamba, 4966 kc., 1900-2300; R. *Quito*, 5126 kc., Quito, 1900-2330 (when conditions are good); R. *Mercurio*, Cuenca, 5200 kc., 1900-2230; and HC2RL, R. *Quinta Piedad*, Guayaquil, 6633 kc., Tuesday only at 2100-2300 with classical music. (*100*)

The unidentified station on 8899 kc. is HCJC3, R. *Fenix. La Voz de la Sultana*, Zaruma, formerly on 9570 kc. It has been noted at 1900-2215. (*100, 477*)

HCGB1, R. *Nacional Espejo*, Quito, has moved from 4680 kc. to 4633 kc. and is heard fairly well at 1900-0100. (*100, 396*)

El Salvador—*La Voz de Comercio*, Santa Ana, is a new station on 9544 kc. and noted from 1900 to 2200 at fair level. (*100*)

Finland—The Finnish B/C Co. has suspended regular Eng. service to N.A. Regular xmsns in Swedish and Finnish may be tuned at 0630-0900 on 15,190 and 17,800 kc. (also on 9555 kc. at 0700-0800). A DX program in Eng. is beamed to Europe on the first Friday of each month at 1100-1120 on 6120, 15,190, and 17,800 kc., and to N.A. on the first Friday during the period from March 21 to Sept. 22 at 1530-1550, and from Sept. 23 to March 20 at 0630-0650, on 15,190 and 17,800 kc. (*MK, 499*)

French Guiana—Cayenne has moved to 6108

May, 1959



WALL FEED makes neat, weather-proof antenna lead-in to attic or crawl space. Easy to install.



2-SET COUPLER lets you operate two TV sets at one time, from one antenna. Install in attic or basement.

See the complete Mosley line of accessories for neat, flexible TV wiring. Send for Catalog 59.

Mosley Electronics, Inc.
St. Louis 14, Missouri

HAMS!

MAIL THIS  COUPON!

MOSLEY ELECTRONICS, INC.
ST. LOUIS 14, MISSOURI

Yes, I have a low-power transmitter and I'm cramped for antenna space. Tell me more about the MOSLEY TRAPMASTER V-3 Jr. vertical antenna for 10-15-20M, rated to 300W. I understand it is 11' 9" high . . . weighs only 2 lbs., and sells for only \$17.95 complete (in the USA). I want to know more.

NAME

ADDRESS

CITY

ZONE STATE

RADIO PARTS STORES & HI-FI SALONS!

Someone "borrowing" your personal copy of POPULAR ELECTRONICS each month? You ought to be taking advantage of POPULAR ELECTRONICS' convenient re-sale plan. Sell copies in your store . . . perform a good service for your customers . . . with no risk involved. For Details, write: Direct Sales Department, Popular Electronics, One Park Avenue, New York 16, New York.

AMAZING MINIATURE BROADCAST TRANSMITTER!



"Fool Your Friends" with this transmitter . . . by broadcasting on to any radio and watch their startled faces when they hear YOUR voice on THEIR radio . . . can also be used as a P.A. System!
Completely portable (5 3/8 x 3 1/4 x 1 3/8) . . . with self-contained batteries . . . NO ANTENNA or GROUND WIRES to hook up . . . Works up to ONE BLOCK OR MORE . . . with short whip antenna supplied.

SIMPLY push the button and talk!

This transmitter has a built-in station selector so you can tune in on any station you desire!

SEND ONLY \$1.00 CASH AND PAY THE POSTMAN THE BALANCE OF \$7.95 PLUS C.O.D. POSTAGE—OR

SEND JUST \$8.95 AND WE PAY THE POSTAGE. (BATTERIES \$2.50 EXTRA.)

HALCO ELECTRONICS

9211 Venice Blvd., Los Angeles 34, California

NEW MAGIC RADIO WALKIE TALKIE!

YOUR OWN POCKET SIZE RADIO STATION!
BROADCASTS TO ANY HOME OR CAR RADIO WITHOUT WIRES OR HOOKUPS! Wt. only 5 oz. Size only 1 1/2" x 2 1/2" x 4 1/2". Built-in telescoping antenna. Powerful Transistor—sensitive microphone. Frequency selector. "Push-to-talk" switch. Runs for weeks on self-contained flashlight batteries. Durable plastic case. With this Radio Talkie you CAN TALK TO YOUR FRIENDS UP TO A BLOCK OR MORE AWAY!
Talk between two automobiles—INSTANT OPERATION. Just push button to talk! No license needed. Uses inductive field magnetic radiation. Useful and real fun in a million ways! **GUARANTEED TO WORK!**
1 YEAR SERVICE GUARANTEE.
SEND ONLY \$3.00 postman \$9.98 C.O.D. postage or send \$12.99 for prepaid delivery. COMPLETE READY TO OPERATE with instructions and hundreds of ways and tricks for broadcasts thru any radio you desire. Get your NEW POWERFUL RADIO-VOX RADIO TALKIE NOW. Available only from: WESTERN RADIO, Dept. REL-5, Kearney, Nebr.

kc. where it is heard daily from 0515 s/on to 0600 fade. It is also noted Sundays at 1700-2005 and weekdays from 1730. (4, 166)

Honduras—A new station is HRXN, R. Concordia, Tegucigalpa, heard on 6142 kc. at 1900-2300 with a fair signal. (100)

Israel—The Voice of Zion, Tel-Aviv, 9009 kc., carries Hebrew at 1415-1445, French until 1515, and Eng. from 1515 to 1545 with news, talks, and some recorded music. (JE, CH, 533, 549, 556)

Luxembourg—R. Luxembourg, Villa Louvigny, is heard well after Moscow s/off at 1730 on 6090 kc. Programs are in Eng. with pop music to 1800; then a religious program follows. (541)

Mauritius—A DX'er in Rose Hill advises that work on the new xmtr at Curepipe is progressing rapidly and will open soon with increased power. This is the station that can be tuned in Eng. from 2300 to 2315 s/off on 14,980 kc. (varies to 15,020 kc.). (7A)

Nepal—R. Nepal is reported still using 7100 kc. to 0750 s/off. There is some indication that

With the Clubs

Your Editor has received numerous inquiries about the DXplorers Radio Club. This club is currently organized on a limited basis and membership is by invitation only.

The Bands and Frequencies Radio Club, with headquarters in Milwaukee, Wis., has been forced to disband due to illness of the club President.

the station is now on the air daily instead of Wednesdays only. (61A)

Nigeria—The West Regional program from Ibadan is now heard on 3204 kc. at 0000 and 1700 with Eng. ID and a weak signal. Never as strong as Kaduna on 3326 kc., Ibadan often has Morse interference. (166)

Pakistan—Karachi can be heard in Eng. on 11,674 kc. at 1340-1400 s/off, on 15,335 kc. at 1930-2015 with music and Eng. news. There is a period of dictation-speed news at 1030-1045 on 15,275 kc. (432, 440, 501)

Panama—HOLA, R. Atlantico, Colon, 9505 kc., carries an Eng. religious program at 2100. The station signs off at 2117 with a three-note chime. (541)

Peru—OAX8C, R. Nacional del Peru, Iquitos, has moved from 9335 to 9610 kc. and is heard at 2200-2300. OAX8E, R. Loreto, Iquitos, has moved from 9590 kc. to 9520 kc. and is heard at 1800-0000 with some QRM from Denmark until 2300. Other 9300-9500 kc. out-of-band Peruvian stations (OAX4J, OAX4W, OAX6H, OAX6L) are no longer being heard at the present time. (100)

OAX4G, R. Lima, Lima, s/on 0500, is heard until 0615/fade. (4)

OAX1B, R. Piura, Piura, 6197 kc., has been noted at 1930-2005 with rapid Spanish anmts and marimba records. Some QRM, possibly from Cayenne, was noted up to the time when Cayenne moved to 6108 kc. (61)

Another Peruvian, OAX1Z, R. Nacional del

**GET MORE
ENJOYMENT OUT
OF YOUR HI-FI
FOR ONLY
\$1.00!**



photo courtesy Electro-Voice, Inc.

that's the cost of the new 1959 edition of the

HI-FI GUIDE & YEARBOOK

ON SALE NOW AT NEWSSTANDS OR ORDER BY MAIL BELOW!

The authoritative Ziff-Davis Annual, HI-FI GUIDE & Yearbook, covers every facet of high fidelity enjoyment—shows you how to get more listening pleasure from your hi-fi set! Besides telling you how to use your equipment for the best possible reproduction, the 1959 HI-FI GUIDE & Yearbook presents a round-up of the trends in the hi-fi field . . . tells you how to save on repairs . . . guides you in the selection of records . . . gives you tips on tapes.

You'll find this Annual a wonderfully practical source of information on improving the sound output of your system. Articles are presented in easy-to-understand, non-technical language. It's like getting two books for the price of one:

GUIDE: Section 1: IMPROVING YOUR HI-FI
Section 2: INSTALLING YOUR HI-FI SYSTEM
Section 3: TAPE RECORDING

YEARBOOK: Trends in Hi Fi
Critics' Choice of Recordings
The Ultimate in FM Stations
Latest Report on Stereo

**PICK UP YOUR COPY OF THE 1959 HI FI GUIDE AND
YEARBOOK TODAY AT YOUR NEWSSTAND OR RADIO PARTS STORE—
OR ORDER BY MAIL USING HANDY COUPON. ONLY \$1.00**

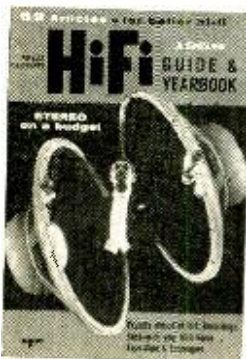

Ziff-Davis Publishing Company
Department E5/9
434 South Wabash Avenue
Chicago 5, Illinois

Please send me a copy of the 1959 HI-FI GUIDE AND YEARBOOK. I enclose \$1.00, the cost of the YEARBOOK, plus 10¢ to cover mailing and handling charges (Canada and Foreign, \$1.25 plus 10¢ postage).

NAME

ADDRESS

CITY..... ZONE..... STATE.....

ALL BAND TRAP ANTENNA!

Best for All-Band Receivers Low S.W. R. 80-40-20-15-10 5 1" — 3-ounce Molded Traps. No metal or losses in field.



For ALL Amateur Transmitters Guaranteed for 300-watts For P-Net or Link-direct feed Light — Neat — Weatherproof

Complete as shown with 87 ft. — 72 ohm feedline — 11 1/2 ft. copper-wire. Eliminates inefficient multiple antennas. Gets better results on 20, 15, 10. No tuners, loading troubles or hay-wire hoops at pearance. Excellent for shortwave listeners. Looks good, works good and lasts long. For voice and all class amateurs. 87-40-20-15-10 meter bands. Complete, assembled, \$11.95 41-20-15-10 meter bands, 21 ft. Antenna, assembled, \$18.95 20-15-10 Dual band, 21 ft. Antenna, assembled, \$18.95

SEND ONLY \$3.00 (cash, ck. and pay postman balance C.O.D. plus postage on arrival, or send full price for postpaid delivery. Available only from: WESTERN RADIO • Dept. AEL-5 • Kearney, Nebraska

ENGINEERING DEGREES

E.E. Option Electronics or Power



Earned through Home Study
Pacific International College of
Arts & Sciences
Primarily a correspondence School
Residence classes also available
5719-W Santa Monica Blvd.
Hollywood 38, California



LOOK

NO FURTHER . . . IF YOU'RE UNHAPPY WITH "HI" HI-FI PRICES. WRITE FOR OUR UNUSUAL AUDIO CATALOG. KEY ELECTRONICS CO. 120-B Liberty St., N. Y. 6

27 months for engineering degree

Realize your dream of a career: higher income, a better life. BACHELOR DEGREE in 27 months in Elec. (Electronics or Power major), Mech., Civil, Chem., Aero. Engineering. In 36 Months in Business Administration Gen. Bus., Aeron. Motor Transport Mgt.). For earnest, capable students. Small classes. Enrollment limited. More professional class hours. Well-equipped labs. Modest costs. Veteran approved. Year-round operation. Beautiful campus. Enter June, Sept., Jan., Mar. Write J. D. McCarthy, Director Admissions, for Catalog and "Your Career" Book.

TRI-STATE COLLEGE 3659 College Avenue
Angola, Indiana

INVENTORS

Send for
PATENT INFORMATION

Book and
INVENTOR'S RECORD
without obligation

GUSTAVE MILLER

59-PE WARNER BUILDING
WASHINGTON 4, D. C.

**REGISTERED PATENT
ATTORNEY**

ASSOCIATE EXAMINER
U. S. PAT. OFF. 1922-1929

Patent Attorney & Advisor
U. S. NAVY DEPT. 1930-1947
PATENT LAWYER

Say You Saw It in POPULAR ELECTRONICS

NEW Alnico Generator \$4.95!

With 10 ft. of wire and NEW telephone bell (Gov't Surplus). Crank Forward to generate up to 90 volts (will ring bell). Valued at more than \$15.00. All shipments FOB Waymart. Send orders and inquiries to:

SURPLUS SAVING CENTER

Dept. 5-PE
120 South Street, Waymart, Pa.

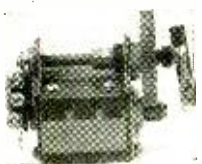

Peru, Tumbes, is found on 9549 kc. around 1900 with instrumentals and talks. (522)

South Korea—The current schedule reads: to N.A. at 2230-2300 in Eng. on 11,925, 15,410 kc., in Korean at 2330-0000 on the same frequencies; to Hawaii in Eng. at 0000-0030 and in Korean at 0030-0100 on 11,925 kc. and the General Overseas Service in Eng. at 0900-0930 on 7970, 7935, and 9640 kc.; to Japan in Japanese at 1600-1630 on 7935 and 9640 kc.; to Southeast Asia in Eng. at 1630-1700 and French at 1700-1730 on 9640 and 15,410 kc. The 7970-kc. xmtr is a 100-kw. unit, the 7935-

SHORT-WAVE ABBREVIATIONS

anmt—Announcement
BBC—British Broadcasting Corporation
Eng.—English
ID—Identification
kc.—Kilocycles
kw.—Kilowatts
N.A.—North America(n)
QRM—Station interference
QSL—Verification
s/off—Sign-off
s/on—Sign-on
xmsn—Transmission from station
xmtr—Transmitter used by station

kc. xmtr is a 1-kw. unit, and the rest are rated at 50 kw. This station verifies by QSL card. (541)

Surinam—PZC, Paramaribo, has moved from 15,406 to 15,227 kc. and is heard at 1630-2130, dual to 4848 kc. (59, 100, 166, 477)

Sweden—The current schedule from Stockholm reads: 0730-0800 to Far East on 15,250 and 9620 kc.; 0900-0930 to Eastern N.A. on 17,840 kc.; 0945-1015 to South Asia on 15,240 and 9620 kc.; 1115-1145 to Mid East on 15,240 and 11,705 kc.; 1245-1315 on 15,240 kc. and 1445-1515 on 11,705 kc. to Africa; 1530-1600 to Europe on 7210 kc.; 2045-2115 to Eastern N.A. on 11,810 kc.; and 2215-2245 to Western N.A. on 9620 kc. The "Sweden Calling DX'ers" program is broadcast on Mondays on the last half hour of each of the listed xmsns. (501)

Switzerland—A new station will be on the air shortly with the name *International Evangelical Radio Station*. It is tentatively scheduled for 0030-1800. The frequencies are not yet known. (378)

Thailand—Bangkok has replaced 11,670 kc. with 15,387 kc. and is heard at 2315-0015 to N.A. and at 0530-0700 and 0800-0900 to the Far East. (59, 100, 477)

Tibet—Lhasa, 9489 kc., is heard poor to fair in Europe at 0830-0900 with Tibetan news at 0830-0837. Station closes at 0900 after giving an extensive program preview. The schedule reportedly reads 1900-2000, 0030-0200, and 0600-0900. This one presents a *real challenge* to any DX'er. (488)

United Arab Republic—Damascus, 15,165 kc., s/on at 1430 with march music; French to 1500; Eng. to 1530 s/off. (522)

Cairo operates to Europe on 11,985 kc. at 1400 in French, at 1430 in Arabic, at 1500 in German, at 1600 in Italian, from 1630 to 1730 s/off in English; to N.A. on 9790 kc. in Ara-

bic and Eng. at 2045-2145. (GF, CH, AO, 39, 69, 242, 378, 440, 519, 541)

USSR—Regional Russian stations noted recently include: Magadan, 9500 kc., at 1405 and 0105 in dialect; Kiev, 7132 kc., excellent at 2030-2230 in Ukrainian, dual to 7150 and 9593 kc., also at 0100-0230 with a repeat program; Urumchi, 7054 kc., with a weak signal at 0700 in dialect; Kaunas, 6135 kc., fair daily to 1700 s/off; Petrozavodsk on 5065 kc., good at 2155, clock chimes at 2200, then a Moscow relay, dual to Tbilisi on 5040 kc. and Baku on 4958 kc.; Yuzhno-Sakhalinsk on 4634 kc. at 0715 with classical music and audible to fade at 0800; Gorki (?) on 4559 kc. at 2300 with exercises in language and piano accompaniment; Chimkent on 4310 kc. at 1952 with native vocals and instrumentals; Ashkabad on 4235 kc. from 1954 s/on; three time pips at 2000, then local news; and Vladivostok on 4040 kc. from

SHORT-WAVE CONTRIBUTORS

Jerry Egel (JE), Kenmore, N. Y.
 George Fichter (GF), Montville, N. J.
 Charles Hailer (CH), Washington, D. C.
 Lewis Johnson (LJ), Alliance, Ohio
 Mike Kander (MK), Dayton, Ohio
 Albin Olson (AO), St. Petersburg, Fla.
 William Pugh, Jr. (WPP), Charleston, W. Va.
 Bubba Simpson (BS), Greenwood, Miss.
 Stewart West (S), Union, N. J.
Universal Radio DX Club with Bill Flynn (7A), Pittsburg, Calif.
 J. Ross Brownell (39), Vancouver, B. C.
 Grady Ferguson (59), Charlotte, N. C.
 John Beaver (61), Canon City, Colo.
DXplorers Radio Ass'n with J. Beaver (61A), Canon City, Colo.
 Steve Smith (66), Binghamton, N. Y.
 Roger Legge (100), McLean, Va.
 Ed Kowalski (104), Philadelphia, Pa.
 George Cox (166), New Castle, Del.
 Bill Roemer (240), Bowling Green, Ky.
 Orval Oppertshauer (242), Toronto, Ont.
 Larry Kramer (353), Brighton, Colo.
 J. P. Arendt (378), Aurora, Ill.
 Bob Palmer (396), Spokane, Wash.
 Jimmy Cox (411), Gadsden, Ala.
 Bradley Graham (432), Fayerweather Island, Conn.
 James Howard (440), Kansas City, Mo.
 John Cullen (476), Springfield, Mass.
 Jerry Berg (477), West Hartford, Conn.
 A Middle Eastern Correspondent (488)
 Philip Barr (499), Culver City, Calif.
 Paul Buer (501), Harrison, N. Y.
 Howard Honig (519), Rockaway Beach, N. Y.
 David Baughman (522), Camden, N. J.
 Jon Groul (533), Woodmere, N. Y.
 Alan Roth (541), Bridgeport, Conn.
 Richard List (549), Pittsburgh, Pa.
 Gerald Lang (553), Detroit, Mich.
 Peter Katz (556), Lynn, Mass.
 Pete Kavaleski (557), Hancock, Mich.

1708 to 1800/fade. Many of these are very weak and require extremely careful tuning. (104, 166, 396)

Clandestine Stations—*Radio Espana Independiente* is on 6950 kc., not 6900 kc. as reported by an Overseas club; also on 8070 kc., not 8030 kc., and 7600 kc.; all frequencies vary by five kc. *Voce de Istria*, Trieste, has been heard here from 1545 with Italian talks and some music; s/off at 1601. *Radio Socialist Albania*, 4875 kc., is tuned from 1620 to 1630 s/off in Albanian; no other outlets are audible at present. (166)

—30—

May, 1959

Send POPULAR ELECTRONICS Every Month



name _____

address _____

city _____ zone _____ state _____

3 years for \$10

Check one: 2 years for \$7

1 year for \$4

In the U. S., its possessions and Canada. **Foreign rates:** Pan American Union countries, add .50 per year; all other foreign countries, add \$1 per year.

Mail to: POPULAR ELECTRONICS

Dept. E-5-9, 434 South Wabash Ave., Chicago 5, Ill.

EXPLAINS ELECTRICAL TERMS IN A JIFFY!

New Guide Gives Terms, Definitions, Formulas, Charts and Diagrams...

A quick easy way to put needed information at your fingertips. Examine this New Practical Dictionary of Electricity and Electronics FREE for 10 days at our risk.

THE WORKING VOCABULARY YOU MUST HAVE. Jam-packed with both standard electrical terms and the latest developments in the field, written clearly and simply for beginner and veteran alike. Terms essential in TV, Radio, X-Ray, Radar, Automation and all industrial applications are covered.

PACKED WITH DESCRIPTIVE PICTURES. Scores of photos, drawings, sketches so clear you can't go wrong. Help make terms like "amplidyne," "kinescope," "dynamotor" easy to grasp. Many tables, charts, graphs, most-used symbols.

SEND NO MONEY. JUST SEND NAME. Fill in coupon below and rec. The Practical Dictionary of Electricity and Electronics for FREE 10-day trial examination. Pay nothing now. Pay nothing to postman on delivery.

AMERICAN TECHNICAL SOCIETY, Dept. POA
 848 E. 58th Street—Chicago 37, Illinois

MAIL COUPON - FREE 10 DAY TRIAL

AMERICAN TECHNICAL SOCIETY, Dept. POA
 848 E. 58th Street, Chicago 37, Illinois

Send me THE PRACTICAL DICTIONARY OF ELECTRICITY AND ELECTRONICS for 10-day FREE EXAMINATION. If I keep the book I will send you \$5.95 plus shipping within 10 days. Otherwise, I will return it and owe you nothing.

MY NAME _____

ADDRESS _____

CITY _____ ZONE _____ STATE _____

We pay shipping costs if you enclose \$5.95 with this coupon. Same refund guarantee.



If You Keep It
Only \$5.95
 Others Cost up
 to \$20.00

INCLUDES HANDBOOK

Partial Contents:

- Formulas
- Electrical Electronics
- Inductance
- Capacitance
- Tables
- Measurement
- Letter Symbols
- Color Coding
- Diagrams
- Graphical Symbols

POPULAR ELECTRONICS

BARGAIN BASEMENT
 SAVE ON THESE SPECIAL BUYS OF THE MONTH

"TAB" FOR THE BEST KITS!

Send order for gift bonus—Turn over or stand on head

- Kit 4 Relays
- Kit 4 Asst'd Rectifiers
- Kit 8 Xtal Osc-Blanks
- Kit 3 Phone/Pitch Xfms
- Kit 10 Transistor Xfms
- Kit 10 Wheat Lamps
- Kit 5 Microswitches
- Kit 5 FT243 Xtal Holders
- Kit 100 Ceramic Condensers
- Kit 100 Tubes, assorted
- Kit 200ft Hook Up Wire Asst'd.
- Kit 75 Mica Condensers
- Kit 5 Smb-Min Tubes

Order Ten Kits **ONE EACH ABOVE 99c**
 We Ship Eleven!!! **KIT ONLY**

BATTERY CHARGER 6&12VOLT AT UP TO 2AMPS...\$9
 SEND 25c FOR BONUS CATALOG

"TAB", 111PH Liberty St., N. Y. 6, N. Y.

Contains The Finest Selection

DIAGNYZER \$9.95 COMPLETE
 ELECTRONIC TESTER

for DO-IT-YOURSELF SERVICING
 COMPLETE TRAINING COURSE AND SERVICE MANUAL
 INCLUDED FREE WITH EACH INSTRUMENT

INDISPENSIBLE—FOR TV, RADIO, Hi-Fi
 Appliances, Autos, Electrical Tools. Used in Home,
 Shop and Farm, Check Radio and TV Tubes, Components,
 Voltages and Circuits, etc.

INEXPENSIVE TO OWN, EASY TO USE
 Anyone can do servicing with this wonderful instrument,
 pays for itself the first time you use it. Best value
 for money, nothing else like it. Write Today.



APPARATUS DEVELOPMENT CO.
 Dept. K11 Wetherfield, Conn.

BUILD A TRANSISTOR SUPERHET RADIO!!!!

- Complete Set of Parts for a 4-Transistor Superhet.....\$ 9.99
- Complete Set of Parts for a 6-Transistor Superhet..... 16.99
- Complete Set of Parts for a 7-Transistor Superhet..... 19.99

SEND FOR FREE SCHEMATICS AND LAYOUTS FOR THE ABOVE RADIOS!!!

- Kit of 25 Molded Plastic Bypass Condensers.....\$1.99
- Kit of 50 IRC and A-B Resistors (1/2-1-2 Watt)..... 1.99
- Kit of 50 Assorted Ceramic Condensers..... 1.99
- Kit of 50 Assorted Mica and Silver Mica Condensers..... 1.99
- Kit of 100 Assorted Terminal Strips and Tie Lugs..... .99
- 12 Volt D.C. Relays—D.P.S.T.—Ceramic Standoffs..... \$-.99
- 10,000 OHM Plate Relays—D.P.S.T..... .99
- 10 Lb. Surprise Package of Condensers, Xfms, Etc..... \$9.99

SEND FOR OUR LATEST BARGAIN FLYER—LOTS OF TRANSISTOR SPECIALS!

GROVE ELECTRONIC SUPPLY COMPANY
 4103 W. BELMONT AVENUE CHICAGO 41, ILLINOIS
 Include Postage with Money Order—or 50% Deposit, Bal. C.O.D.

RADIO CONTROL Headquarters

PARTS FOR "SPARKY, ROBOT" Relay, 4PDT, 6V \$2.95; Aristo BATTERY \$1.75; #5 Motor \$4.95 #4; Motor \$2.45; All Parts

- For Models FREE Send for FCC Form 505 & Catalog "PT"
- R/C RECEIVER 27 1/4 Mc, Compl. w. Relay, Tube, Access. 1.35
- Wired \$8.61; CRYSTAL 27.25 Mc.
- R/C XMITTER Hi-Power HAND-HELD, compl., \$17.95; KIT 11.95
- R/C TRANSMITTER & RECEIVER KIT: 27 1/4 mc, 5 watt 2-Tube Simple Transm. & 2-Tube Rec. incl. Drilled Bases, Wound Coil, Res., Cond., SIGMA Relay, Instruc. 9.95

HANDIE-TALKIE Transmitter & Receiver Chassis, New, Wired, with tube—2 Triodes..... 7.65

2-6V Battery Charger Kit, \$4.95..... 6.95
 R/C BOOKS: Model Control \$1; Radio Control \$1; Handbook 2.25

RELAY CONTROL UNIT incl. Sensitive 10,000 ohm Sigma Relay (1 1/2 Ma) Thermal Bimetal Strip, Heating Element, Hi Z Audio Choke, Mini Alnico V Magnet, Neon Lamp, Resistors, Capacitors, only 99c

TUBES: XF61, RK61, 3A5, 1AG4; Avail. Transistor. .99
 RELAYS: 10K ohm, 2 Ma DC or 110V AC SPDT, 95c; SPST .85

GYRO ELECTRONICS 36 WALKER ST., NEW YORK 13, N. Y.

ONE CENT SALE

BUY ONE AT OUR REGULAR LOW PRICE AND GET THE SECOND FOR ONLY 1c MORE

- CITIZENS BAND TRANSMITTER (27 Mc) chassis complete with crystal, \$9.99 ea. two for \$14.00. CITIZENS BAND RECEIVER chassis tunable through all 22 channels. Complete with audio amplifier, \$9.99 ea. two for \$14.00. RADIOSONDE TELEMETERING TRANSMITTER complete with modulator, aneroid barometer, temperature and humidity sensing elements, tubes, relay, antenna, etc. A \$50.00 value for only \$4.99 ea. two for \$9.99.
- COILED CORD 4 conductor 11' telephone cord. Extends to over 4 ft. .99 ea. two for \$1.00. MICROPHONE High output 200 ohm carbon with terminal lugs. \$1.49 ea. two for \$1.50.
- TRANSISTOR AUDIO AMPLIFIER. Gives up to 50X voltage gain on low level signals. Operates on 1 1/2 volts. \$3.99 ea. two for \$4.00. KIT OF PARTS for VHF radio receiver. Tunable from 80 to 100 megacycles which includes U. S. satellite frequencies. \$6.99 ea. kit. Two for \$7.00.

LIMITED QUANTITY—NO LITERATURE OR CATALOG
 Remit in full. Include sufficient postage. No C.O.D.'s.
VANGUARD ELECTRONIC LABS Box 12-E5
 Holts 23, N. Y.

EXPERIMENTERS AMATEURS HOBBYISTS

We are again reducing a large inventory of brand new vacuum tubes and this "ret-acquainted" offer is limited to the stock on hand. All tubes in each assortment are different, and every tube is brand-spanking new.

- 10 electron tubes including 3" cathode ray tube only... \$1.95
- 15 including 5" CRT... \$2.95 20 including 7" CRT... \$3.95
- All three of the above assortments for Just... \$7.95

Order early and we will include in your assortment a special high voltage rectifier and famous WE-717-A tubes. Your order will be sent via insured parcel post; just pay postman postage plus small C.O.D. charge. We have many unbelievable values in government electronic surplus, much of it for sale at prices representing mere pennies on the dollar or cost.

WRITE FOR FREE GOVERNMENT SURPLUS BARGAIN BULLETIN
JOE PALMER
 P. O. Box 6188 CCC Sacramento, California

ATTENTION
 electronics schools *

* Is your School registered with Popular Electronics?
 As you probably know, Popular Electronics is eager to keep you advised whenever a special opportunity arises that would interest and benefit your School.

If you are not already on PE's School Announcements list—please send your name, address and the name of your School Secretary to: Popular Electronics, School Department, One Park Avenue, New York 16, N. Y.

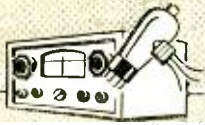

ELECTRONICS MARKET PLACE

RATE: 50¢ per word. Minimum 10 words prepaid. July issue closes May 4th. Send order and remittance to: POPULAR ELECTRONICS, One Park Ave., New York 16, N. Y.

FOR SALE

"RADIOBUILDER" Magazine. Experimenters' paradise! Transistor experiments. 12 issues \$2.50; copy 25¢. Radiobuilder, 1131-L Valota, Redwood City, California.

ANTENNA rotor motor and transformer both for \$1.50 postpaid. New photo electric kit \$5.95 limited quantity order today. Ernst Mfg. Co., Alger, Mich.

TELEVISION & Radio Tubes, Parts and Supplies. Guaranteed. Hi-Quality Tube Co., Inc., 284 Lafayette St., Rahway, New Jersey.

GOVERNMENT Surplus Receivers, Transmitters, Snooperscopes, Parabolic Reflectors, Picture Catalog 10¢. Meshna, Malden 48, Mass.

TRADE-IN TELEVISION Sets \$9.95 Plus Shipping. Jones TV, Sanatoga, Pa.

WHOLESALE Prices transistor supplies. Stereo, Hi-Fi amplifiers, changers, speakers, Eico Kits, Tubes. Schaak Electronics, 3867 Minnehaha Ave., Minneapolis 6, Minnesota. Pa 9-8382.

TUBES—TV, Radio, Transmitting and Industrial Types at Sensibly Low Prices. New, Guaranteed 1st Quality Top Name Brands Only. Write for Free Catalog or Call WALKER 5-7000. Barry Electronics Corp., 512 Broadway, New York 12N, N. Y.

SAVE time and money. Nationally advertised kits assembled, wired, tested. Send specifications. Free estimate. Naczas Kit Service, 273 Belmont St., Manchester, N. H.

DIAGRAMS for repairing radios \$1.00, Television \$2.00. Give make, model. Diagram Service, Box 672-PE, Hartford 1, Conn.

FREE Catalog—Inexpensive Fluorescent Fixture Kits, Parts, etc. Shoplite, 650E Franklin, Nutley 10, New Jersey.

SCHEMATIC, Repair Instructions, Hi-Fi's, T.V.'s, Radio's, Phonographs, Tape Recorders, 99¢. Send make, model number. "Radio Coop", Box 5938 K.C. 11, Missouri.

MILLIAMMETERS—Make your own for a few cents each! Plans, templates, details, \$1.00. L. Baker, 40 Schley Ave., New Rochelle, N. Y.

BUY Surplus tubes, electronic equipment, boats, jeeps, ham equipment, below wholesale direct from government. List of depots and procedure 75¢. King Research, Box 363, Asbury Park, New Jersey.

FM Tuners, 88-108 megacycles, 4 tubes complete, \$12.95. Grutman, 1 E. 167 St., New York 52, N. Y.

TELEVISION Sets \$9.95 Plus Shipping. Jones TV, Sanatoga, Pa.

KITS—Heath, Eico, Etc. . . . Wired and Tested, 35% of Cost. Davad Specialties, 180 Monroe St., Passaic, N. J.

GOVERNMENT Sells—Surplus Electronics; Walkie-Talkies; Test Equipment! Oscilloscopes; Radar; Sonar; Surplus Aircraft; Boats; Jeeps; Misc.—You buy direct now from U. S. Government Depots at fractions of Army and Navy costs—Send for bulletin "Depot List & Procedure," \$1.00. Box 8-PE, Sunnyside 4, N. Y.

PARABOLIC Concentrator! Build Powerful, inexpensive six-foot Reflector. Focus or Beam Light, Heat, Sound, or Radio Waves. Use as Solar Furnace, Solar Cooker, DX Mike Pickup, UHF Antenna, Etc. Includes Thermal Battery Plans for Free Electricity from Sun's Heat. Patterns and Instructions \$3.00. Sun Specialties, Box 1222, Hot Springs, Ark.

RELAYS—Switch Stacking and voltage to your specification: Switch stacking kits: Free Catalog "E2." Ranco. Box 6161 Chicago 80, Ill.

GET stereo from monaural sources with PS-101 Stereo Simulator! Can be built for less than \$9.00! Instructions and plans \$1.00. Patterson Enterprises, 3798 Avondale, Snyder, Texas.

PRINTED circuit kit complete \$1.00. Hazelton Scientific, 9611-P Hazelton, Detroit 39-A.

MAGNETIC Amplifiers—fastest growing field in electronics! A treatment anyone can understand and a "must" for the informed man. \$1.00 ppd. Minnetonka Engineering Co., R. 4, Excelsior, Minn.

BUILD Small Radios! Parts, Plans, Kits. Write: Electronix, 59-E, Howard City, Michigan.

TAPE & RECORDERS

RECORDERS, Tape Decks, Stereo Tapes, Accessories, Excellent Values, Catalogue. Efesco, 270E Concord, West Hempstead, N. Y.

TAPE Recorders, Hi-Fi Components, Sleep Learning Equipment, Tapes. Unusual Values. Free Catalog. Dressner, 69-02F, 174 St., Flushing 65, N. Y.

RECORDERS, Hi-Fi. Free Wholesale catalogue. Carston, 215-P East 88 St., N.Y.C. 28.

HIGHEST Trade-In Allowances Toward Ampex, Concertone, Crown, Ferrograph, Presto, Pentron, Components. Accessories. Catalog. Boynton Studio, 10-PE Pennsylvania, Tuckahoe, N. Y.

HIGH-FIDELITY



UNUSUAL Values. Hi-Fi components, tapes and tape recorders. Free catalogue PE. Stereo Center, 51 West 35th St., N. Y. C. 1.

LP RECORD Cleaning Cloth in Handy Case, Only 25¢! Cost \$1.00 in stores. To introduce "Record Collector's Catalog" included Free! Leslie Creations, Dept. PE-1, Lafayette Hill, Pa.

DISGUSTED with "Hi" Hi-Fi Prices? Unusual discounts on your High Fidelity Requirements. Write Key Electronics, 120 Liberty St., New York 6, N. Y. Evergreen 4-6071.

INSTRUCTION

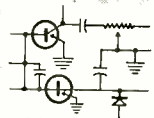

MENTAL Radio—Operate yourself as a transceiver. Landa, Clayton 2, Ga.

COMPLETE Correspondence Course in Radio, TV, & Electronics. Only 12 sections. Includes 1st Class License Prep. Very Low rates. Ascot School of Electronics, Box 29092, Los Angeles 29, Calif.

POLICE Radar Detector. Stop before those radar speed traps. Fool proof, legal system. Complete diagrams and instructions \$2.75. C. Carrier Co., 5880 Hollywood Blvd., Hollywood 28, Calif.

BE A Spy! Correspondence course on wire tapping, bugging, recording techniques, microphotography, invisible and remote photography, telescopic and aerial photography. Lessons in surveillance, tailing and use of equipment. Complete course \$22.50. C. Carrier Co., 5880 Hollywood Blvd., Hollywood 28, Calif.

AMAZING new television trouble shooting technique. Spots trouble quickly, easily. Thoroughly tested and proven on hundreds of repair jobs. Write for free brochure. National Technical Research Labs., 1118 W. Hadley St., Whittier, Calif.

CODE courses to enable passing Radio Amateur examinations. Designed and tape recorded by former U.S.N. Operator and R.R. Telegrapher. Both sides 7"1200' reels. Learning to Six W.P.M. or Six to Sixteen W.P.M. Response enables reduction to \$3.98 each. Postpaid in U.S.A. Elham Inc., P.O. Box 98, Hawthorne, California.

CODE remembered forever in minutes with amazing memory aid. \$1. McKenzie Enterprises, Box 245, Palo Alto, California.

MENTAL Radio—Operate yourself as a transceiver. Landa, Clayton 2, Ga.

1959 INDUSTRY Training. Home-Study Drafting, Design, Electronics. Aero Tech, 2162-ZD Sunset Blvd., Los Angeles 26, Calif.

CALCULUS, Practical, First Four Easy Lessons \$1. Mathco, 4256 Minnor, Cincinnati 17, Ohio.

LEARN code quickly to pass Novice exam. 12" microgroove record, \$3.50 postpaid. Kord-All, Box 444, Warren, Ohio.

TELEPHONE Extension In Your Car. Answer your home telephone by radio from your car. Complete diagrams and instructions \$1.25. C. Carrier Co., 5880 Hollywood Blvd., Hollywood 28, Calif.

EAVESDROP with a pack of cigarettes. Miniature transistorized radio transmitter. Complete diagrams and instructions \$1.25. C. Carrier Co., 5880 Hollywood Blvd., Hollywood, 28, Calif.

ELECTRONIC Hypnotiser. Simplifies the art of Hypnosis. Diagrams and operating instructions \$1.25. Kit \$16.50. Wired and Tested \$29.50. C. Carrier Co., 5880 Hollywood Blvd., Hollywood 28, Calif.

1959 INDUSTRY Training. Home-Study Drafting, Design, Electronics. Aero Tech, 2162-ZD Sunset Blvd., Los Angeles 26, Calif.

PREPARE For a Future in Radio-TV-Electronics, Repairman, Amateur and Commercial Licenses Optional. College A.A.S. Degree. Trinidad State Junior College, Department P.E., Trinidad, Colo.

BUSINESS OPPORTUNITIES

MAKE \$25-\$50 Week, clipping newspaper items for publishers. Some worth \$5.00 each. Particulars free. National, 81-PE, Knickerbocker Station, New York City.

VENDING Machines—No Selling. Operate a route of coin machines and earn amazing profits. 32-Page catalog free. Parkway Machine Corporation, Dept. 12, 715 Ensor St., Baltimore 2, Md.

EARN up to \$10,000 yearly selling shelving—parts bins—shop equipment. Write, BFC Corporation, 2806 E. Hedley, Phila. 37, Pa.

RADIO PARTS STORES & HI-FI SALONS: Someone "borrowing" your personal copy of Popular Electronics each month? You ought to be taking advantage of Popular Electronics' convenient re-sale plan. Sell copies in your store . . . perform a good service for your customers . . . with no risk involved. For details, write: Direct Sales Department, Popular Electronics, One Park Avenue, New York 16, New York.

OPERATE Profitable mailorder business!! Write: Bond, 1637-X, West Vernon, Phoenix, Arizona.

EMPLOYMENT INFORMATION

JOBS—High Pay; USA, So. America. The Islands. All trades. Many companies pay fare. Write Dept. 71N, National Employment Information, 1020 Broad, Newark, N. J.

WANT A Good Job?? High Pay?? Overseas-U.S.A. All Occupations. Free Information. Employment Headquarters, 79 Wall Street, Dept. 4-0, New York 5.

JOBS Overseas! Janacek Development Co., 109 Hub Station, New York 55, N. Y.

JOBS on Steamships and Yachts traveling Foreign Countries. Davenport's, GPO 1354, New York 1, N. Y.

WANTED

MERCURY, Platinum, Silver, Precious Metals. Ores Assayed. Mercury Refiners, Norwood, Massachusetts.

CASH Paid! Sell your surplus electronic tubes. Want unused, clean transmitting, special purpose, receiving, TV Types, magnetrons, klystrons, broadcast, etc. Also want military & commercial lab test and communications gear. We swap too, for tubes or choice equipment. Send specific details in first letter. For a fair deal write, wire or telephone: Barry, 512 Broadway, New York 12, N. Y. WAIKER 5-7000.

CYLINDER and old disc phonographs. Edison Conqueror, Idelia, and Oratorio models. Berliner Gramophones and Zono-o-phones, Columbia cylinder Graphophones, and Coin-operated cylinder Phonos. Want old catalogues and literature on early phonos prior to 1919. Will pay cash or trade late hi-fi components. Popular Electronics, Box 50, 1 Park Ave., New York 16, N. Y.

INVENTIONS WANTED

INVENTIONS wanted. Patented: unpatented. Global Marketing Service, 2420 77th, Oakland 5, Calif.

PLASTICS

NEW Liquid Casting Plastic, clear colors. Embed real flowers, minerals, biological specimens, delicate instruments, electronic parts. Also cold-setting resin and fiberglass for laminating, casting, molding, coating. Manual 25¢. Castolite, Dept. B-108, Woodstock, Illinois.

MISCELLANEOUS

ENGRAVED callplates for your Citizen's Band and Amateur station. Details free. The Radio Stationers, Brandywine, Maryland.

WINEMAKING: Beer, Ale Brewing. Illustrated. \$2.00. Eaton Books, Box 1242-C, Santa Rosa, California.

24" ROCKET—solid fuel, high altitude performance, will carry experimental transistor equipment, parachute return. Educational. Complete scale plans and instructions—\$1.00. Advance Engineering, P.O. Box 2274, Dallas 21, Texas.

SHOPPING GUIDE Classified

A HANDY REFERENCE TO PRODUCTS AND SERVICES NOT NECESSARILY ELECTRONIC, BUT OF WIDE GENERAL INTEREST.

PHOTOGRAPHY—FILM EQUIPMENT, SERVICES

SAVE \$\$\$ Fresh 8mm, 16mm B & W, and color film. Home Processing Equipment. Free Catalog. Superior Bulk Film Co., 458 N. Wells, Chicago 10.

POPULAR ELECTRONICS

STAMPS & COINS

AMAZING Profits made investing in unused commemorative Postage Stamps, with as little as \$2.50 weekly. No experience necessary. Professional advice Free to clients. Vatican City "Vacant Seat" (Stamps issued after death of Pope Pius XII) increased from 20¢ to \$1.50 in 30 days. Complete details \$1.00. Satisfaction or Refund. Columbia 8203—PE Grubb, Silver Spring, Maryland.

MISCELLANEOUS

SONGPOEMS And Lyrics Wanted! Mail to: Tin Pan Alley, Inc., 1650 Broadway, New York 19, N. Y.

SECRET of Success—Guide \$1.00, Gross Prices. Padgham, 213 W. Douglas, Midwest City, Oklahoma, Dept. 5.

OPTICAL Bargains—Request Free Giant Catalog "CJ." 96 pages—Astronomical Telescopes, Microscopes, Lenses, Binoculars, Kits, Parts. Amazing war surplus bargains. Edmund Scientific Co., Barrington, New Jersey.

BOOK Search Service! Any book located. Send want lists. Wormsley, 16 Duke St., Binghamton, N. Y.

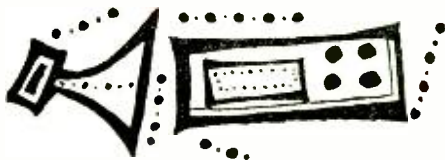

WANTED!

*Equipment,
components or parts!*

The 267,000 purchasers of POPULAR ELECTRONICS are always in the market for good used equipment or components. So, if you have something to sell, let PE readers know about it in our classified columns.

It costs very little: just 50¢ per word including name and address. Minimum message: 10 words. For further information, write:

Martin Lincoln
POPULAR ELECTRONICS
One Park Avenue
New York 16, New York

ADVERTISER'S INDEX

ADVERTISER	PAGE NO.	ADVERTISER	PAGE NO.
Accordion Manufacturers & Wholesalers	138	Lektron	135
Allied Radio Corp.	32, 139	Micro Electron Tube Co.	12
American Technical Society	157	Midway Company	140
Apparatus Development Co.	158	Midway Welder	142
Audio Devices, Inc.	34	Miller, Gustave	156
Bailey Technical Schools	24	Milwaukee School of Engineering	151
Bell Sound Division	29	Mosley Electronics, Inc.	153
Capitol Radio Engineering Institute	21	Moss Electronic, Inc.	162, 3rd & 4th Covers
Capri Electronics	148	National Radio Institute	3
Century Electronics Co., Inc.	36, 37	National Schools	9
Cleveland Institute of Radio Electronics	33	Nelson-Hall Co.	144
Cotter, Hermon E.	152	North American Philips Company, Inc.	10
Coyne Electrical School	15, 137	Pacific International College	156
DeVry Technical Institute	7	Palmer, Joe	158
Direct Sales Department	154	Phila. Wireless Technical Institute	144
EICO	38, 40	Picture Tube Outlet	148
Electronic Kits #2	35	Popular Electronics Classified	144, 152
Electro Products Laboratories	18	Popular Electronics Subscriptions	157
Electronic Organ Arts, Inc.	28	Popular Electronics Upcoming Contents	146, 147
Erie Resistor Corporation	14	Port Arthur College	148
Fenner Sales	152	Progressive "Edu-Kits" Inc.	25
Garfield Co., Inc., Oliver	2nd Cover	Quality-Electronics	16
General Electronic Service Co.	152	RCA Institutes, Inc.	17
Gonset	28	Radio Shack Corporation	149
Grantham School of Electronics	11	Radio-Television Training School	127
Greenlee Tool Co.	26	Rinehart & Co., Inc.	141
Grove Electronic Supply Company	158	Schober Organ Corp., The	16
Gyro Electronics	158	Sonotone Corp.	20
Halco Electronics	154	Sonotone Academy of Radio-Television	19
Heath Company	128, 129, 130, 131, 132, 133	Springfield Enterprises	22
Hershel Radio Co.	20	Surplus Saving Center	156
Hi-Fi Guide & Yearbook	155	"TAB"	158
Indiana Technical College	138	Tri-State College	156
Instructograph Company	148	U. S. Air Force	39
International Correspondence Schools	13	U. S. Army	23
International Crystal Mfg. Co., Inc.	5, 143	United Audio	27
Jensen Industries, Inc.	18	University Loudspeakers, Inc.	22
Jesse Jones Box Corp.	140	Valparaiso Technical Institute	140
Johnson Company, E. F.	26	Vanguard Electronic Labs	158
Key Electronics Co.	156	Western Radio	154, 156
Kester Solder Company	142	World Radio Laboratories	145
Kuhn Electronics	144	Ziff-Davis Photo Annuals	142
Lafayette Radio	30, 31	Zalzytron Tube Corporation	138

SHIPPED ON APPROVAL NO MONEY WITH ORDER — NO C. O. D.

Superior's New Model 76

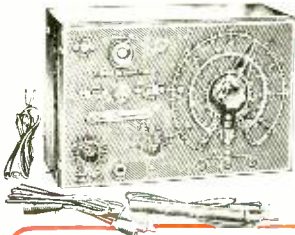

ALL PURPOSE BRIDGE

IT'S A CONDENSER BRIDGE

IT'S A SIGNAL TRACER

IT'S A RESISTANCE BRIDGE

IT'S A TV ANTENNA TESTER

✓ CAPACITY BRIDGE SECTION

4 Ranges: .00001 Microfarad to .005 Microfarad; .001 Microfarad to .5 Microfarad; .1 Microfarad to 50 Microfarads; 20 Microfarads to 1000 Microfarads. Will also measure the power factor of all condensers from .1 to 1000 Microfarads.

✓ RESISTANCE BRIDGE SECTION

2 Ranges: 100 ohms to 50,000 ohms; 10,000 ohms to 5 megohms.

✓ SIGNAL TRACER SECTION

With the use of the R.F. and A.F. Probes included with the Model 76, you can

make stage gain measurements, locate signal loss in R.F. and Audio stages, localize faulty stages, locate distortion and hum, etc.

✓ TV ANTENNA TESTER SECTION

Loss of sync., snow and instability are only a few of the faults which may be due to a break in the antenna, so why not check the TV antenna first? Locates a break in any TV antenna and measures the location of the break in feet from the set terminals.

Complete with R.F. and A.F. probes and test leads **\$26⁹⁵ Net**

Model 76 ALL PURPOSE BRIDGE
Total Price **\$26.95**
Terms: \$6.95 after 10 day trial, then \$5.00 per month for 4 months if satisfactory. Otherwise return, no explanation necessary.

Superior's New Model TV-50A GENOMETER

7 Signal Generators in One!

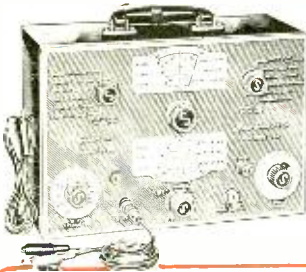

- ✓ R.F. Signal Generator for A.M.
- ✓ Bar Generator
- ✓ R.F. Signal Generator for F.M.
- ✓ Cross Hatch Generator
- ✓ Audio Frequency Generator
- ✓ Color Dot Pattern Generator
- ✓ Marker Generator

This versatile All-Inclusive GENERATOR Provides ALL the Outputs for Servicing:

A.M. Radio • F.M. Radio • Amplifiers • Black and White TV • Color TV

Model TV-50A GENOMETER . . .
Total Price **\$47.50**
Terms: \$11.50 after 10 day trial, then \$6.00 monthly for 6 months if satisfactory. Otherwise return, no explanation necessary.

R. F. SIGNAL GENERATOR: The Model TV-50A Genometer provides complete coverage for A.M. and F.M. alignment. Generates Radio Frequencies from 100 Kilocycles to 60 Megacycles on fundamentals and from 60 Megacycles to 180 Megacycles on powerful harmonics.

VARIABLE AUDIO FREQUENCY GENERATOR: In addition to a fixed 400 cycle sine-wave audio, the Model TV-50A Genometer provides a variable 300 cycle to 20,000 cycle peaked wave audio signal.

BAR GENERATOR: The Model TV-50A projects an actual Bar Pattern on any TV Receiver Screen. Patterns will consist of 4 to 16 horizontal bars or 7 to 20 vertical bars.

CROSS HATCH GENERATOR: The Model TV-50A Genometer will project a cross-hatch pattern on any TV picture tube. The pattern will consist of non-shifting, horizontal and vertical lines interlaced to provide a stable cross-hatch effect.

DOT PATTERN GENERATOR (FOR COLOR TV) Although you will be able to use most of your regular standard equipment for servicing Color TV, the one addition which is a "must" is a Dot Pattern Generator. The Dot Pattern projected on any color TV Receiver tube by the Model TV-50A will enable you to adjust for proper color convergence.

MARKER GENERATOR: The Model TV-50A includes all the most frequently needed marker points. The following markers are provided: 189 Kc., 262.5 Kc., 456 Kc., 600 Kc., 1000 Kc., 1400 Kc., 1600 Kc., 2000 Kc., 2500 Kc., 3579 Kc., 4.5 Mc., 5 Mc., 10.7 Mc., (3579 Kc. is the color burst frequency).

The Model TV-50A comes absolutely complete with shielded leads and operating instructions. Only **\$47⁵⁰**

USE APPROVAL FORM ON NEXT PAGE ►

NO INTEREST OR FINANCE CHARGES ADDED!

We invite you to try before you buy any of the models described on this and the following pages. If after a 10 day trial you are completely satisfied and decide to keep the Tester, you need send us only the down payment and agree to pay the balance due at the monthly indicated rate.

If not completely satisfied, you are privileged to return the Tester to us, cancelling any further obligation.

MOSS ELECTRONIC, INC.

Dept. D-591 3849 Tenth Avenue, New York 34, N. Y.

TRY FOR 10 DAYS

before you buy! then if satisfactory pay in easy, interest free, monthly payments. See coupon below.

Superior's New Model TD-55 EMISSION TYPE **TUBE TESTER**

For the Experimenter or Part-time Serviceman, who has delayed purchasing a higher priced Tube Tester.
 For the Professional Serviceman, who needs an extra Tube Tester for outside calls.
 For the busy TV Service Organization, which needs extra Tube Testers for its field men.

Speedy, yet efficient operation is accomplished by: 1. Simplification of all switching and controls. 2. Elimination of old style sockets used for testing obsolete tubes (26, 27, 57, 59, etc.) and providing sockets and circuits for efficiently testing the new Noval and Sub-Minar types.

You can't insert a tube in wrong socket. It is impossible to insert the tube in the wrong socket when using the new Model TD-55. Separate sockets are used, one for each type of tube base. If the tube fits in the socket it can be tested.

"Free-point" element switching system. The Model TD-55 incorporates a newly designed element selector switch system which reduces the possibility of obsolescence to an absolute minimum.

Checks for shorts and leakages between all elements

The Model TD-55 provides a super sensitive method of checking for shorts and leakages up to 5 Megohms between any and all of the terminals.

Elemental switches are numbered in strict accordance with R.M.A. Specifications.

The 4 position fast-action snap switches are all numbered in exact accordance with the standard R.M.A. numbering system. Thus, if the element terminating in pin No. 7 of a tube is under test, button No. 7 is used for that test.

Complete with carrying case **\$26.95** Net

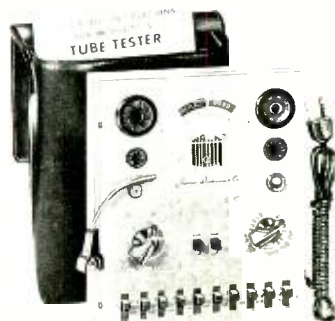

Model TD-55 - Tube Tester
 Total Price **\$26.95**
 Terms: \$6.95 after 10 day trial, then \$5.00 per month for 4 months.

Superior's **STANDARD PROFESSIONAL** New Model **TW-11** **TUBE TESTER**

- Tests all tubes, including 4, 5, 6, 7, Octal, Lockin, Hearing Aid, Thyatron, Miniatures, Sub-miniatures, Novals, Subminars, Proximity Fuse Types, etc.

- Uses the new self-cleaning Lever Action Switches for individual element testing. All elements are numbered according to pin-number in the RMA base numbering system. Model TW-11 does not use combination type sockets. Instead individual sockets are used for each type of tube. Thus it is impossible to damage a tube by inserting it in the wrong socket.

- Free-moving built-in roll chart provides complete data for all tubes. Printed in large easy-to-read type.

NOISE TEST: Phono-jack on front panel for plugging in either phones or external amplifier detects microphonic tubes or noise due to faulty elements and loose internal connections.

EXTRAORDINARY FEATURE

SEPARATE SCALE FOR LOW-CURRENT TUBES Previously, on emission-type tube testers, it has been standard practice to use one scale for all tubes. As a result, the calibration for low-current types has been restricted to a small portion of the scale. The extra scale used here greatly simplifies testing of low-current types.

Housed in hand-rubbed oak cabinet **\$47.50** Net



Model TW-11 - Tube Tester
 Total Price **\$47.50**
 Terms: \$11.50 after 10 day trial, then \$6.00 monthly for 6 months if satisfactory. Otherwise return, no explanation necessary.

We invite you to try before you buy any of the models described on this page, the preceding page and the following pages. If after a 10 day trial you are completely satisfied and decide to keep the Tester, you need send us only the down payment and agree to pay the balance due at the monthly indicated rate.

NO INTEREST OR FINANCE CHARGES ADDED!

If not completely satisfied, you are privileged to return the Tester to us, cancelling any further obligation.

SEE OTHER SIDE

CUT OUT AND MAIL TODAY! ▶

MOSS ELECTRONIC, INC.
 Dept. D-591 3849 Tenth Ave., New York 34, N. Y.

Please send me the units checked on approval. If completely satisfied I will pay on the terms specified with no interest or finance charges added. Otherwise, I will return after a 10 day trial positively cancelling all further obligation.

- | | |
|--|---|
| <input type="checkbox"/> Model 76 Total Price \$26.95
\$6.95 within 10 days. Balance \$5.00
monthly for 4 months. | <input type="checkbox"/> Model TW-11 Total Price \$47.50
\$11.50 within 10 days. Balance \$6.00
monthly for 6 months. |
| <input type="checkbox"/> Model TV-50A Total Price \$47.50
\$11.50 within 10 days. Balance \$6.00
monthly for 6 months. | <input type="checkbox"/> Model 77 Total Price \$42.50
\$12.50 within 10 days. Balance \$6.00
monthly for 5 months. |
| <input type="checkbox"/> Model TD-55 Total Price \$26.95
\$6.95 within 10 days. Balance \$5.00
monthly for 4 months. | <input type="checkbox"/> Model 80 Total Price \$42.50
\$12.50 within 10 days. Balance \$6.00
monthly for 5 months. |

Name

Address

City Zone State

All prices net. F.O.B., N. Y. C.

SHIPPED ON APPROVAL NO MONEY WITH ORDER — NO C. O. D.



Model 77—VACUUM TUBE VOLT-METER. Total Price . . . \$42.50
Terms: \$12.50 after 10 day trial, then \$6.00 monthly for 5 months if satisfactory. Otherwise return, no explanation necessary.

Superior's New Model 77 **VACUUM TUBE VOLTMETER**

WITH NEW 6" FULL-VIEW METER

Compare it to any peak-to-peak V. T. V. M. made by any other manufacturer at any price!

- Extra large meter scale enables us to print all calibrations in large easy-to-read type.
- Employs a 12AU7 as D. C. amplifier and two 9006's as peak-to-peak voltage rectifiers to assure maximum stability. • Meter is virtually burn-out proof. The sensitive 400

AS A DC VOLTMETER: The Model 77 is indispensable in Hi-Fi Amplifier servicing and a must for Black and White and color TV Receiver servicing where circuit loading cannot be tolerated.

AS AN ELECTRONIC OHMMETER: Because of its wide range of measurement leaky capacitors show up glaringly. Because of its sensitivity and low loading, Intermittents are easily found, isolated and repaired.

AS AN AC VOLTMETER: Measures RMS values if sine wave, and peak-to-peak value if complex wave. Pedestal voltages that determine the "black" level in TV receivers are easily read.

micro-ampere meter is isolated from the measuring circuit by a balanced push-pull amplifier. • Uses selected 1% zero temperature coefficient resistors as multipliers. This assures unchanging accurate readings on all ranges.

SPECIFICATIONS

- **DC VOLTS**—0 to 3/15/75/150/300/750/1,500 volts at 11 megohms input resistance.
- **AC VOLTS (RMS)**—0 to 3/15/75/150/300/750/1,500 volts. • **AC VOLTS (Peak to Peak)**—0 to 8/40/200/400/800/2,000 volts.
- **ELECTRONIC OHMMETER**—0 to 1,000 ohms / 10,000 ohms / 100,000 ohms / 1 meg-ohm / 10 megohms / 100 megohms / 1,000 meg-ohms. • **DECIBELS:** —10 db to + 18 db. + 10 db to + 38 db, + 30 db to + 58 db. All based on 0 db = .006 watts (6 mw) into a 500 ohm line (1.73v). • **ZERO CENTER METER**—For discriminator alignment with full scale range of 0 to 1.5/75/37.5/75/150/375/750 volts at 11 megohms input resistance.

Comes complete with operating instructions, probe leads, and stream-lined carrying case. Operates on 110-120 volt 60 cycle. Only **\$42.50**

SUPERIOR'S NEW MODEL 80

20,000 OHMS PER VOLT ALLMETER

THE ONLY 20,000 OHMS PER VOLT V.O.M. SELLING FOR LESS THAN \$50 WHICH PROVIDES ALL THE FOLLOWING FEATURES:

- ✓ **6 INCH FULL-VIEW METER** provides large easy-to-read calibrations. No squinting or guessing when you use Model 80.
- ✓ **MIRRORED SCALE** permits fine accurate measurements where fractional readings are important.
- ✓ **CAPACITY RANGES** permit you to accurately measure all condensers from .00025 MFD to 30 MFD in addition to the standard volt, current, resistance and decibel ranges.
- ✓ **HANDSOME SADDLE-STITCHED CARRYING CASE** included with Model 80 Allmeter at no extra charge enables you to use this fine instrument on outside calls as well as on the bench in your shop.

SPECIFICATIONS:

- D.C. VOLTAGE RANGES**
(At a sensitivity of 20,000 Ohms per Volt)
0 to 15/75/150/300/750/1500/7500 Volts.
- A.C. VOLTAGE RANGES:**
(At a sensitivity of 5,000 Ohms per Volt)
0 to 15/75/150/300/750/1500 Volts.
- RESISTANCE RANGES:**
0 to 2,000/200,000 Ohms. 0-20 Megohms.
- CAPACITY RANGES:**
.00025 Mfd. to 3 Mfd., .05 Mfd. to 30 Mfd.
- D.C. CURRENT RANGES**
0-75 Microamperes, 0 to 7.5/75/750 Milliamperes, 0 to 15 Amperes.
- DECIBEL RANGES:** — 6 db to + 18 db. + 14 db to + 38 db + 34 db to + 58 db.



Model 80 ALLMETER. Total Price . . . \$42.50
Terms: \$12.50 after 10 day trial, then \$6.00 monthly for 5 months if satisfactory. Otherwise return, no explanation necessary.

NOTE: The line cord is used only for capacity measurements. Resistance ranges operate on self-contained batteries.

Model 80 Allmeter comes complete with operating instructions, test leads and portable carrying case. Only **\$42.50**

TRY FOR 10 DAYS BEFORE you buy! THEN if satisfactory

pay in easy, interest free, monthly payments. See coupon inside.

We invite you to try before you buy any of the models described on this and the preceding pages. If after a 10 day trial you are completely satisfied and decide to keep the Tester, you need send us only the down payment and agree to pay the balance due at the monthly indicated rate. (See other side for time payment schedule details.)

NO INTEREST OR FINANCE CHARGES ADDED!

If not completely satisfied, you are privileged to return the Tester to us, cancelling any further obligation.

SEE OTHER SIDE

CUT OUT AND MAIL TODAY!

FIRST CLASS

Permit No. 61430
New York, N. Y.

VIA AIR MAIL

BUSINESS REPLY CARD

No Postage Stamp Necessary if Mailed in the U. S.

POSTAGE WILL BE PAID BY —

MOSS ELECTRONIC, INC.

3849 TENTH AVENUE

NEW YORK 34, N. Y.

