

**BONUS: 32 EXTRA PAGES**

# POPULAR ELECTRONICS

APRIL  
1959

35  
CENTS

HI-FI • HAM RADIO • SWL • TEST GEAR

## All About:

RUSSIAN JAMMING

•  
USING THE VTVM

•  
STEREO SIMPLEXING

•  
NOVICE XMITTERS

**Build This**

**LOW-COST SOUND LEVEL METER**

E 208106811  
LOUIS HOFFART  
18108 WINDWARD  
CLEVELAND 19 OHIO

# FIRST ALL-NEW, LOW-PRICED, SHORTWAVE RECEIVER

IN OVER TEN YEARS!!!

BURTON BROWNE/New York



Fred Shunaman  
Managing Editor, RADIO-ELECTRONICS...  
"Neat combination of design  
and technical features."



Charles Tepfer  
Editor, ELECTRONICS ILLUSTRATED...  
"It looks modern and pulls in the SW  
stations, a pleasure to recommend it."



Oliver Read, Ph.D.  
Publisher of Electronics Div.,  
POPULAR ELECTRONICS...  
"This looks like a real winner."



William A. Stocklin  
Editor, RADIO & TV NEWS...  
"Easily read dial, a boon to  
the shortwave listener."

**NEW NATIONAL NC-60 Special . . .** covers .54 to 31 mcs in 4 bands with full electrical bandspread on all frequencies. Features exceptional sensitivity with separate tuning coils for each band. Separate general coverage and bandspread tuning capacitors. Front panel phone-jack. Standard broadcast, civil defense, WWV, marine, aircraft, amateur and world-wide shortwave frequencies are clearly marked on dial. Built-in speaker.

**Only \$5.95 down\*** Suggested price only \$59.95\*\* (slightly higher west of the Rockies and outside the U.S.A.)\*  
\*Most National distributors offer budget terms and trade-in allowances.



Model NC-66 . . . use this rugged portable 4 ways: as a ham receiver, a 3-way portable, a marine receiver, and as an SWL receiver. Rugged and handsome, the NC-66 has a sturdy case with carrying handle. Only \$13.00 down\* Suggested price only \$129.95\*\*



Model NC-188 . . . a quality receiver for budget-conscious amateurs—featuring National's new styling. It is directly calibrated for the four general coverage ranges and five bandspread ranges for the amateur bands (80-10 meters). Only \$15.00 down\* Suggested price only \$159.95\*\*

**SEND 50¢ FOR EXCITING NEW BOOK ON SHORTWAVE LISTENING . . .**

tells when, where and how to tune over two million shortwave stations in over 250 foreign countries. Provides log for listing stations you hear. Send 50¢ to NATIONAL COMPANY, INC., Malden 48, Mass.

## National



NATIONAL COMPANY, INC., MALDEN 48, MASS.



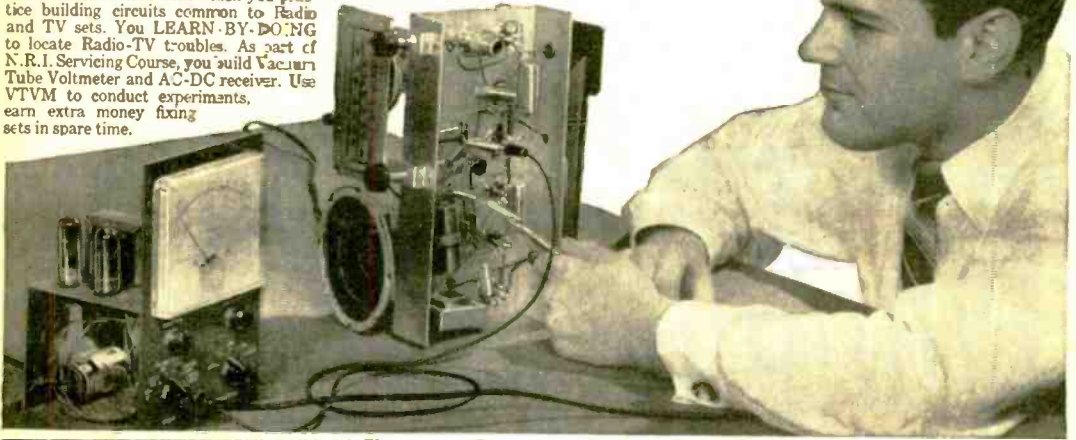
# Learn Radio-Television

## Servicing or Communications

### by Practicing at Home

### in Spare Time

N.R.I. SENDS kits with which you practice building circuits common to Radio and TV sets. You LEARN-BY-DOING to locate Radio-TV troubles. As part of N.R.I. Servicing Course, you build Vacuum Tube Voltmeter and AC-DC receiver. Use VTVM to conduct experiments, earn extra money fixing sets in spare time.



**RADIO-TV BROADCASTING** (see above) offers important positions as Operators and Technicians. **RADIO-TV SERVICING** Technicians (see below) needed in every community. Their services are respected, their skill appreciated.



## Fast Growing Field Offers You Good Pay, Success, Bright Future



**J. E. SMITH**  
founder

Bigger than ever and still growing fast. That's why Radio-TV has special appeal to ambitious men not satisfied with their job and earnings. More than 4,000 Radio and TV stations. More than 150 million home and auto Radios, 40 million TV sets. Color TV promises added opportunities. For the trained man, there are good jobs, bright futures in Radio-TV Servicing or Broadcasting. Training PLUS opportunity is the ideal combination for success. So plan now to get into Radio-TV. The technical man is looked up to. He does important work, gets good pay for it. Radio-Television offers that kind of work. NRI can supply training quickly, without expense of going away to school. Keep your job while training. You learn at home in your spare time. NRI is the **OLDEST** and **LARGEST** home study Radio-TV school. Its methods have proved successful for more than 40 years.

### Added Income Soon - \$10, \$15 a Week in Spare Time

Soon after enrolling, many NRI students start to earn \$10, \$15 a week in spare time fixing sets. Some pay for their training and enjoy extra luxuries this way. Some make enough to start their own Radio-TV shops. NRI training is *practical*—gets quick results. Easy to understand, well illustrated lessons teach you basic principles. And you LEARN-BY-DOING by practicing with kits of equipment which "bring to life" things you study.

### Find Out What NRI Offers

NRI has trained thousands for successful careers in Radio-TV. Study fast or slow—as you like. Diploma when you graduate. Mail coupon now. Paste it on a postcard or mail in envelope. **ACTUAL LESSON FREE**. Also 64 page catalog that shows opportunities, shows equipment you get. Cost of NRI courses low. Easy terms. **NATIONAL RADIO INSTITUTE, Dept. 9DD4, Washington 16, D. C.**

### N.R.I. TRAINED THESE MEN FOR SUCCESS



"I was repairing Radios by 10th lesson. Now I'm Engineer for WHEP." **M. R. LINDEMUTH**, Fort Wayne, Ind.



"Doing spare time repairs on Radio and TV. Soon servicing full time." **CLYDE HIGGINS**, Waltham, Mass.



"I had a successful Radio repair shop. Now I'm Engineer for WHEP." **V. V. WORKMAN**, High Point, N.C.



"There are a number of NRI graduates here. I can thank NRI for this job." **JACK WAGNER**, Lexington, N. C.



### VETERANS Approved Under G. I. Bills

## SEND FOR BOTH FREE

### National Radio Institute

Dept. 9DD4, Washington 16, D. C.

Mail me Sample Lesson and 64-Page Catalog FREE. (No salesman will call. Please write plainly.)

Name \_\_\_\_\_ Age \_\_\_\_\_

Address \_\_\_\_\_

City \_\_\_\_\_ Zone \_\_\_\_\_ State \_\_\_\_\_

Accredited Member National Home Study Council



POPULAR ELECTRONICS is published monthly by Ziff-Davis Publishing Company, William B. Ziff, Chairman of the Board (1944-1953), at 434 S. Wabash Ave., Chicago 5, Ill. Second-class postage paid at Chicago, Illinois. Authorized by Post Office Department, Ottawa, Canada, as second-class matter. **SUBSCRIPTION RATES:** One year U.S. and possessions, and Canada \$4.00; Pan-American Union countries \$4.00, all other foreign countries, \$5.00.

# POPULAR ELECTRONICS

APRIL

1959

VOLUME 10

NUMBER 4



## Special Features

RUSSIAN JAMMING—The Electronic Iron Curtain.....	<i>Will Bohr</i>	41
Stereo Simplexing Simplified.....	<i>Harry Kolbe</i>	45

## Electronic Construction Projects

The Stereoplex.....	<i>Harry Kolbe</i>	48
Measure R.P.M. with This Simple Tachometer.....	<i>Forrest H. Frantz, Sr.</i>	71
Transistorized Regenerative Receiver.....	<i>James E. Pugh, Jr.</i>	79
Eight-Sided Dice.....	<i>Ira Glickstein</i>	95
Black Box That Hears Missiles.....	<i>Charles H. Welch</i>	102
Clock Radio.....		113

## Audio and High Fidelity

Inside the Preamplifier (Part 3).....	<i>Joseph Marshall</i>	57
What You Should Know Before Buying Stereo.....	<i>Raymond E. Ward</i>	61
Build a Loudspeaker Enclosure.....		76
Transistorized Sound Level Meter.....	<i>R. Morrow</i>	86
Build a Stereo Control Unit.....		107

## Electronic Features and New Developments

Inside the Dry Cell.....	<i>Saunders Harris, W1NXL</i>	51
Test Instruments (Part 4).....	<i>Larry Klein</i>	54
A Transmitting Tube Is Born.....		63
How to Make Power Transformer Substitutions.....	<i>Eugene Richardson</i>	73
The Electronics of Fluorescent Lamps.....	<i>Edgar D. Morgan</i>	82
Soldering Without Tears.....	<i>Brice L. Ward</i>	90
Household Current Afloat.....		98
The Dielectric Pump... No Moving Parts!.....	<i>James G. Busse</i>	99
VLF Radio Can Detect Nuclear and Rocket Tests.....	<i>Charles H. Welch</i>	102
Electronic Sticklers.....		106
Plug-In Laboratory Standards.....		114

## Amateur and SWL

"Nifty Novice" 15-Meter Transmitter.....	<i>Donald L. Stoner, W6TNS</i>	67
DX'ing with Your TV Set.....	<i>Arnaldo Coro, Jr.</i>	78
Bandsread.....	<i>Tom Kneitel</i>	93
Short-Wave Monitor Registration.....		110

## Departments

Notes from the Editor.....	<i>Oliver Read</i>	8
Letters from Our Readers.....		10
POP'tronics Bookshelf.....		18
New Products.....		24
Tips and Techniques.....		32
Crossnumber Puzzle.....	<i>John A. Comstock</i>	108
Short-Wave Report.....	<i>Hank Bennett</i>	109
Among the Novice Hams.....	<i>Herb S. Brier, W9EGQ</i>	111
Transistor Topics.....	<i>Lou Garner</i>	115
After Class.....	<i>Harvey Pollack</i>	118
Carl & Jerry.....		122



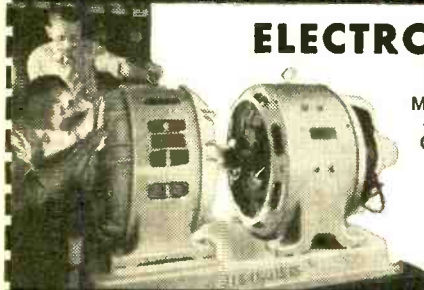
These men are getting practical training in **ELECTRONICS**

# ELECTRICITY

## ELECTRONICS

### ON REAL

Motors—Generators  
—Switchboards—  
Controls—Modern  
Appliances—  
Automatic  
Electronic  
Control Units



# TELEVISION

## RADIO ELECTRONICS

### ON REAL

TV Receivers—  
Black and White  
and Color  
AM-FM and  
Auto Radios  
Transistors  
Printed Circuits  
Test Equipment



# Train in NEW Shop-Labs of COYNE

in Chicago—prepare for today's TOP OPPORTUNITY FIELD. Train on real full-size equipment at COYNE where thousands of successful men have trained for over 60 years—largest, oldest, best equipped school of its kind. Professional and experienced instructors show you how, then do practical jobs yourself. No previous experience or advanced education needed. Employment Service to Graduates.

**START NOW—PAY LATER**—Liberal Finance and Payment Plans. Part-time employment help for students. **GET FREE BOOK**—"Guide to Careers" which describes your training in **ELECTRICITY-ELECTRONICS** and **TELEVISION-RADIO ELECTRONICS**—no obligation; **NO SALESMAN WILL CALL.**

Coyne Electrical School, 1501 W. Congress Parkway  
Chartered Not For Profit • Chicago 7, Dept. 49-2A

## MAIL COUPON OR WRITE TO ADDRESS BELOW

**COYNE ELECTRICAL SCHOOL**  
Dept. 49-2A—New Coyne Building  
1501 W. Congress Pkwy., Chicago 7, Ill.  
Send **BIG FREE** book and details of all the training you offer.

Name \_\_\_\_\_  
Address \_\_\_\_\_  
City \_\_\_\_\_ State \_\_\_\_\_

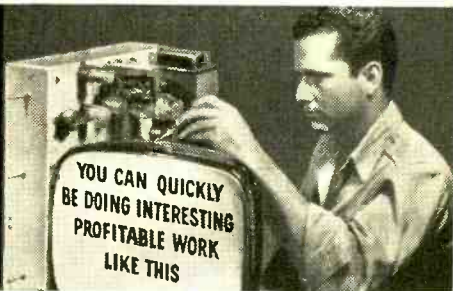


**COYNE offers**  
**LOW COST**

# TELEVISION

## RADIO - COLOR TV

Training in  
Spare Time **AT HOME**



The future is **YOURS** in **TELEVISION!**

A fabulous field—good pay—fascinating work—a prosperous future in a good job, or independence in your own business!

Coyne brings you **MODERN-QUALITY** Television Home Training; training designed to meet Coyne standards at truly lowest cost—you pay for training only—*no costly "put together kits."* Not an old Radio Course with Television "tacked on." Here is **MODERN TELEVISION TRAINING** including **Radio, UHF and Color TV.** No Radio background or previous experience needed. Personal guidance by Coyne Staff. **Practical Job Guides** to show you how to do actual servicing jobs—*make money early in course.* Free Lifetime Employment Service to Graduates.

## COYNE

### ELECTRICAL SCHOOL

CHARTERED AS AN EDUCATIONAL INSTITUTION  
NOT FOR PROFIT  
1501 W. Congress Parkway • Chicago 7, Dept. 49-H2



B. W. COOKE, JR., President  
Coyne—the institution behind this training... the largest, oldest, best equipped residential school of its kind. Founded 1899.

*Send Coupon or write to address below  
for Free Book*

and full details,  
including easy  
Payment Plan.  
**No obligation, no  
salesman will call.**



**COYNE Television**  
**Home Training Division**  
Dept. 49-H2, New Coyne Building  
1501 W. Congress Pkwy., Chicago 7, Ill.

Send Free Book and details on how I can get Coyne Quality Television Home Training at low cost and easy terms.

Name \_\_\_\_\_  
Address \_\_\_\_\_  
City \_\_\_\_\_ State \_\_\_\_\_

# POPULAR ELECTRONICS

**Editor & Publisher**  
**OLIVER READ, W1ETI**

**Assistant Editor**  
**JULIAN M. SIENKIEWICZ, WV2CQL**

**Technical Editor**  
**LARRY KLEIN**

**Associate Editors**  
**SIMON DRESNER**  
**FURMAN HEBB**  
**MARGARET MAGNA**

**Editorial Assistant**  
**DOLORES GIMBEL**

**Contributing Editors**  
**H. BENNETT**      **L. E. GARNER, Jr.**  
**M. S. BRIER**      **T. KNEITEL**  
**J. T. FRYE**        **H. POLLACK**

**Art Editor**  
**ALFONS J. REICH**

**Art and Drafting Dept.**  
**J. A. ROTH**  
**S. SOLOMAN**  
**M. WHELPLEY**

**Advertising Director**  
**JOHN A. RONAN, Jr.**

**Advertising Manager**  
**WILLIAM G. McROY**

ZIFF-DAVIS PUBLISHING COMPANY,  
One Park Ave., New York 16, N. Y.  
William B. Ziff, Chairman of the Board  
(1946-1953); William Ziff, President;  
W. Bradford Briggs, Executive Vice  
President; Michael Michaelson, Vice  
President and Circulation Director; Hersh-  
el B. Sarbin, Secretary; Howard Stough-  
ton, Jr., Treasurer; Albert Gruen, Art  
Director.



**BRANCH OFFICES:** Midwestern Office,  
434 S. Wabash Ave., Chicago 5, Ill.,  
Jim Weakley, advertising manager;  
Western Office, Room 412, 215 W. 7th  
St., Los Angeles 17, Calif., James R.  
Pierce, advertising manager.

**Foreign Advertising Representatives:**  
D. A. Goodall Ltd., London; Albert Mil-  
hada & Co., Antwerp and Dusseldorf.

**SUBSCRIPTION SERVICE:** Forms 3579 and all subscription correspondence should be addressed to Circulation Department, 434 South Wabash Avenue, Chicago 5, Illinois. Please allow at least four weeks for change of address. Include your old address as well as new—enclosing if possible an address label from a recent issue.

**CONTRIBUTORS:** Contributors are advised to retain a copy of their manuscripts and illustrations. Contributions should be mailed to the New York Editorial Office and must be accompanied by return postage. Contributions will be handled with reasonable care, but this magazine assumes no responsibility for their safety. Any copy accepted is subject to whatever adaptations and revisions are necessary to meet the requirements of this publication. Payment covers all author's, contributor's and contestant's rights, titles, and interest in and to the material accepted and will be made at our current rates upon acceptance. All photos and drawings will be considered as part of material purchased.

World's largest-selling Electronics Magazine

This month's cover photo by Joe Petrovec  
Hi-fi equipment courtesy of Garrard  
Sales Corp. (record changer), Strom-  
berg-Carlson (amplifier and tuner),  
and University Loudspeakers (speaker  
systems). Lamp courtesy of Arco  
Lighting Center.

COMING NEXT MONTH



(ON SALE APRIL 23)

Our May cover will picture a new Swiss-made color television projection system which is setting new standards of quality. A feature article describing this device, called the Eidophor, explores the technical details of its operation.

Ordinarily, a complete six-meter station would be a complicated construction task for the beginner. However, through the use of four commercial subassembly model kits a complete six-meter rig can be built at a substantial saving in time and money. Our May issue tells you how. And as a hi-fi bonus for those audiophiles who are wondering what this electrostatic tweeter business is all about—we have in the works a build-it-from-scratch three-element system with a total construction cost of under \$5.00.

POPULAR ELECTRONICS



# EARN WHILE YOU LEARN

**NOTHING ELSE LIKE IT!**

See How DeVry Tech Prepares You for a Good-Paying Career in

## TELEVISION RADIO ELECTRONICS

Hundreds of men, 17 to 55, started to make money in the Electronics field before they even finished their DeVry Tech program. Many made the training pay for itself as they learned! Because DeVry Tech's program is so practical, YOU should be able to do the same. You work scores of projects; you learn by watching home training movies; you follow clear, step-by-step instructions. You really learn principles and master many skills. No wonder DeVry Tech men are found in so many real-pay, bright-future jobs in this great, growing field!



**A BIG DeVRY EXTRA!**

### Build Your Own 6-Speaker Stereophonic & Hi-Fi Sound System

NOW, you may build and keep your own top quality High Fidelity 6-Speaker Stereophonic Sound System, as shown below. You Learn-By-Doing for a BETTER JOB or to ADD TO YOUR PRESENT INCOME. As a bonus, you and your family can enjoy the thrills of this marvelous sound system for years to come.

Special **SHORT COURSE** in High Fidelity Sound Reproduction including Stereophonic Systems also available. Ideal for hobbyists, music lovers and men seeking **NEW OPPORTUNITY**. Mail coupon.

## GET A BETTER JOB OR BE BOSS OF YOUR OWN BUSINESS

**NO ADVANCED EDUCATION OR PREVIOUS TECHNICAL EXPERIENCE**

**NEEDED!** At home in your spare time, you use the same basic method followed by students in our Chicago and Toronto laboratories. You learn to use tools, follow diagrams, when you build any or all of this valuable equipment: the **STEREO SYSTEM . . .** or a **5-INCH OSCILLOSCOPE** and **VACUUM TUBE VOLTMETER . . .** or a **21-inch TV SET**. You have many choices! DeVry Tech's program is so thorough that you will likely be surprised at your progress. Send the coupon for details.

#### EMPLOYMENT SERVICE



Frequently, we simply don't have enough graduates available to fill all the jobs on our list! DeVry Tech has an Employment Service that really works. It is available to graduates without additional cost.

#### MILITARY SERVICE

If you are subject to military service, you will find the information we have for you very helpful. Mail the coupon today and get the facts.

## GET TWO FREE Booklets!

"POCKET GUIDE TO REAL EARNINGS" and  
"ELECTRONICS AND YOU"



Real down-to-earth details are presented to help the man who wants to get ahead. Both booklets are yours FREE! Fill out coupon and mail today.



#### MAIL TODAY FOR FREE FACTS

DeVry Technical Institute  
4141 Belmont Ave., Chicago 41, Ill., Dept. PE-4-P  
Please give me your two FREE booklets, "Pocket Guide to Real Earnings" and "Electronics and You," and tell me how to prepare to enter one or more branches of Electronics.

NAME \_\_\_\_\_ AGE \_\_\_\_\_  
PLEASE PRINT

STREET \_\_\_\_\_ APT. \_\_\_\_\_

CITY \_\_\_\_\_ ZONE \_\_\_\_\_ STATE \_\_\_\_\_

Check here if subject to military training.

DeVry Tech's Canadian Training Center is located at  
2051 626 Roselawn Avenue, Toronto 12, Ontario

## DeVRY Technical Institute

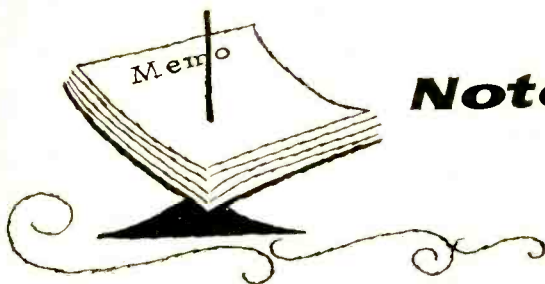
4141 BELMONT • CHICAGO 41, ILL. • Formerly DeFOREST'S TRAINING, Inc.

Accredited Member of National Home Study Council



"One of America's Foremost  
Electronics Training  
Centers"

**ONE OF THE BIGGEST OPPORTUNITY FIELDS OF THE CENTURY!**



## Notes from the Editor

**EVOLUTION OF A MAGAZINE.** In October of 1954, a new magazine appeared on the newsstands. Although many people doubted whether this magazine could survive the fierce competition for the attention of the American public, it not only survived, but it prospered--so much so, in fact, that it became the world's largest-selling magazine dealing with electronics. As you no doubt realize, the name of this magazine was, and is, POPULAR ELECTRONICS.

Through the years, one of our sorest points has been the use of a comparatively rough paper stock. You are now reading, for the first time, a copy of POPULAR ELECTRONICS which has been printed on a high-grade paper stock. You are also holding in your hands this month a magazine which contains a "bonus" of 32 extra pages of articles. We plan to continue this "bonus" feature indefinitely. And in the months ahead there will be more changes and improvements. We hope you will be as enthusiastic about their completion as we are about their inception.

**SIMPLEX STEREO.** A new circuit design from the laboratories of CBS should give another big boost to the stereo boom. This design, actually an improvement of an older circuit, makes it possible for what is basically a single amplifier to amplify two signals simultaneously, and each channel provides an effective power output equal to that supplied by the original amplifier.

For full information on how simplexing works, see "Stereo Simplexing Simplified" on page 45. Immediately following it, there is an article on how to build a simplexed amplifier.

**COMPLETE SIX-METER STATION.** Next month's issue of POPULAR ELECTRONICS will feature a project which should be popular with our ham readers. Don Stoner, W6TNS, has put together a complete six-meter station for us. This station, which consists of a 30-watt transmitter and a converter that connects to your regular broadcast receiver, is built in module form.

These modules are available either in kit form or as completed units, and the whole station fits on a 15" x 7" x 3" chassis. Sound interesting? Don't miss the May issue for all the details.

**CONSTRUCTION PROJECTS.** "Build-it-yourself" electronic gadgets are a very important part of our magazine. We're always on the lookout for good construction articles, so if you've worked up something that you think would be of interest to your fellow readers, drop us a line describing the unit.

If your gadget is "real hot," we will give you an assignment to write it up. You never can tell--you may see your name in print.

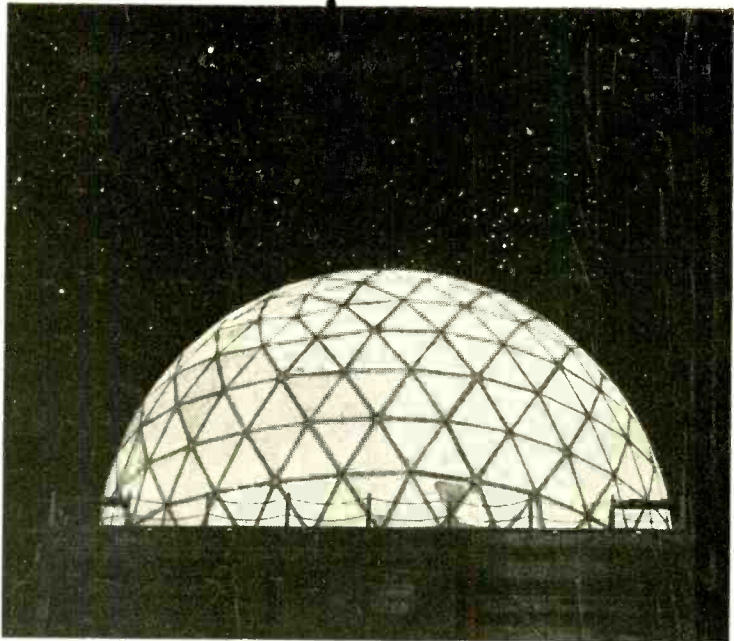
*Oliver Read*

POPULAR ELECTRONICS



## THE ARCTIC EYE THAT NEVER SLEEPS

---



This plastic radome houses a radar antenna constantly scanning the skies to detect the presence of aircraft. A long line of these radars provides early warning of any threatening approach to the North American continent.

The Distant Early Warning Line is now on perpetual guard duty. Spanning the Arctic from Baffin Island to Alaska, this great system was conceived at the Lincoln Laboratory of M.I.T. and produced under the leadership of Western Electric.

But first the DEW Line had to be engineered into a workable system. This was done at Bell Telephone Laboratories.

The obstacles were formidable. Conventional means of communication—telephone poles, cables and even line-of-sight microwave radio—weren't feasible. A complicated system had to be made to operate reliably in a climate so cold that outdoor maintenance is impracticable farther than a few hundred feet from heated habitation.

Whenever possible, Bell Laboratories engineers utilized well-proven art. But as it became necessary, they innovated. For example, they designed and directed the development of a new and superior radar which automatically scans the skies, pinpoints a plane and alerts the operator.

To reach around the horizon from one radar station to another, they applied on a massive scale a development which they pioneered—transmission by tropospheric scatter. Result: at a DEW Line Station you can dial directly a station more than a thousand miles away and converse as clearly as with your home telephone.

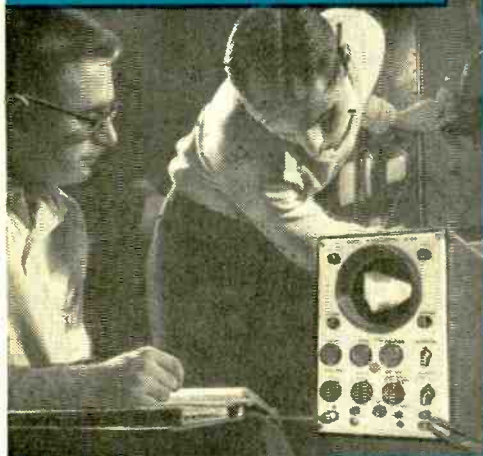
Bell Laboratories' contribution to the DEW Line demonstrates again how telephone science works for the defense of America.

**BELL TELEPHONE LABORATORIES**

WORLD CENTER OF COMMUNICATIONS RESEARCH AND DEVELOPMENT



RESIDENT SCHOOL COURSES



Industry needs Electronic Technicians!

# Let RCA train you in Advanced Electronics

This is the college-level training you need to work with professional engineers on research, development or production projects in such fields as: automation, guided missiles, radar, television, computers and other advanced electronic applications.

RCA Institutes Resident School in New York City offers this comprehensive course that prepares you for any field of electronics you may choose. Other courses in TV & General Electronics, Radio & TV Servicing, and Radio Telegraph Operating.

Classes start four times each year. Applications now being accepted. Approved for Veterans.



**RCA INSTITUTES, INC.**  
SCHOOL OF TELEVISION  
AND ELECTRONIC TECHNOLOGY  
A Service of Radio Corporation of America



RCA INSTITUTES, DEPT. PER-49  
350 W. Fourth St., N. Y. 14, N. Y.

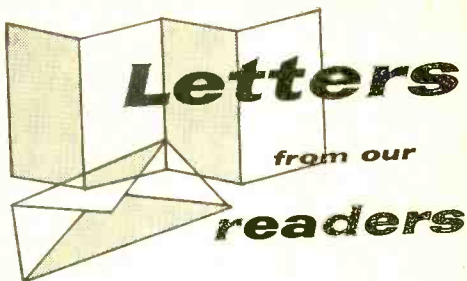
Please send me your FREE catalog of Resident School courses in New York.

NAME..... please print

ADDRESS.....

CITY..... ZONE..... STATE.....

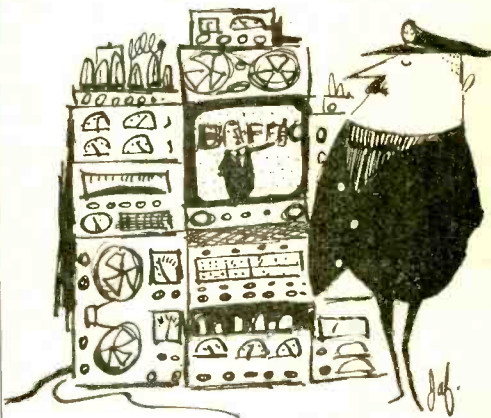
For Home Study Courses see ad on opposite page



### Attention, Circuit Designers

■ I am a radio officer aboard seagoing vessels, and would like to work out a system with my TV and recorder (tape) so that I can record TV pictures and sound on tape from my TV while in ports, and then play the taped TV programs back later while at sea.

I would be very grateful if your technical staff could design a small transistor transmitter to play the tapes back. Also, I would like to know how to build and wire into the TV set to convert the picture signals so that they can be recorded on tape—



would more than one recording head be required? Or would it be cheaper to wire into the same TV set for playback instead of a transmitter?

With this setup, one would make up his own TV tape library, and play the tapes years later if he wanted to. Any designs and suggestions from you and your staff will be appreciated very much.

RICHARD CARTER, W6JJY  
Fullerton, Calif.

*Since it took Ampex and RCA quite a while to develop the type of equipment you desire, we will have to admit that such design is beyond us. If you would like to buy one of these units prewired and tested, however, they can be had for about \$50,000.*

*If you need other design information, we suggest that you contact manufacturers of electronic parts. We regret that it is impossible for the staff of POPULAR ELECTRONICS to design specific items of electronic equipment for our readers.*

### Contra-Polar Energy

■ I recently read your article on Contra-Polar Energy in the April 1955 issue of POPULAR ELEC-

Always say you saw it in—POPULAR ELECTRONICS



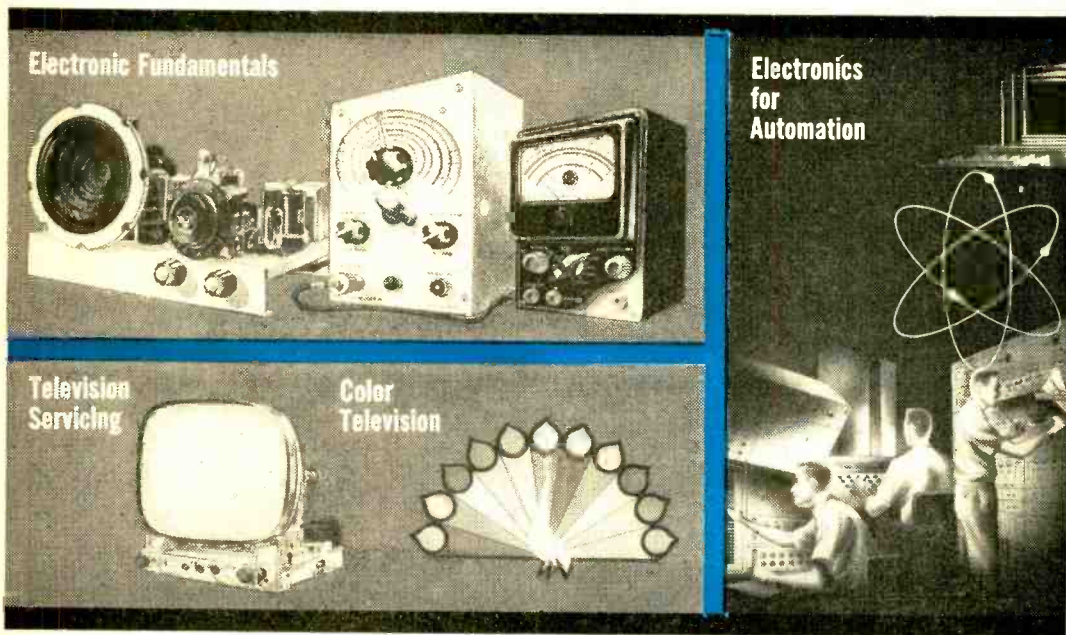


# LET RCA TRAIN YOU IN ELECTRONICS

RCA Institutes celebrates *Fifty Years of Electronic Training* by introducing its newest Home Study Course . . .

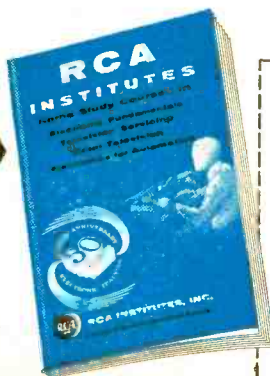
## ELECTRONICS FOR AUTOMATION

. . . Now you have *four* comprehensive courses for your electronic training . . . from basic electronic theory to the more advanced principles of color TV and Automation.



Send for our  
64 page Home  
Study Catalog

**FREE!**



FOR RESIDENT SCHOOL COURSES SEE AD ON OPPOSITE PAGE

Practical work with the very first lesson. Pay-as-you-learn. You need pay for only one study group at a time.

**RCA INSTITUTES, Inc.** Home Study School, Dept. PE-49

A Service of Radio Corporation of America

350 West Fourth Street, New York 14, N. Y.

Without obligation, send me the FREE catalog of Home Study Courses. No salesman will call.

Name .....

Please print

Address .....

City..... Zone..... State.....

Korean Vets! Enter Discharge Date.....

**CANADIANS**— Take advantage of these same RCA courses at no additional cost. No postage, no customs, no delay. Send coupon to: RCA Victor Company, Ltd., 5001 Cote de Liesse Rd., Montreal 9, Quebec  
To save time, paste coupon on postcard.



these 4 knobs provide unlimited control of frequency response



### New Blonder-Tongue Hi-Fi Amplifier

The Model A-1 Amplifier divides the audible spectrum into its *four* significant segments (BASS, LO-MIDDLE, HI-MIDDLE and TREBLE.) *Four* separate tone controls permit you to boost or attenuate any frequency range or combination of ranges. Solo instrumentalists or vocalists may be drawn out of the orchestral background to take their places in front of the orchestra. Correction for poor room acoustics, or for deficiencies in associated equipment, is instant and exact. Power output is 12 watts (music wave forms).

Frequency response:  $\pm \frac{1}{2}$  db from 30 to 15,000 cps; harmonic distortion, below 1% at 10 watts output. Magnetic and crystal cartridge; tape and tuner inputs. Complete function selection. Performance you'd expect to find only in amplifiers costing considerably more! 77.50

**MATCH THE A-1 WITH THE B-T TUNER AND SPEAKER—a versatile hi-fi system for under \$160**



**T-88 FM-AM TUNER**—Amazing sensitivity on FM and AM. Frequency response. 20–20,000 CPS. Built-in FM and AM antennas, with provision for external antenna. Accurate, stable slide-rule tuning. 64.50



**SS-2 Twin Speaker System**—Includes two matched 4" speakers with overlapping frequency ranges in an acoustically correct enclosure. Ideal as a multiple speaker system or for stereo conversion. 16-ohm impedance. 15.95



**R-98 FM-AM Radio**—The convenience of a complete FM-AM radio, with no sacrifice in quality. Superb interference-free reception, even in critical areas. Amazing sensitivity on FM and AM. Accurate, stable slide-rule tuning. 64.50

For complete details, write to Dept. PE-4



**BLONDER-TONGUE LABORATORIES**  
9 Alling Street, Newark 2, New Jersey

### Letters

(Continued from page 10)

TRONICS. I would like to know if this phenomenon has actually been produced or if it is purely theoretical. Also, if this is real, could you furnish information for obtaining a practical circuit. Finally, what are the properties of a negative frequency? Thank you for your trouble.

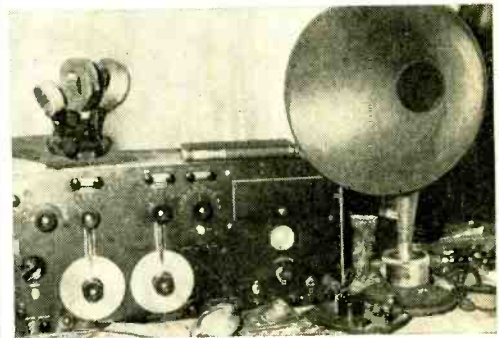
LAWRENCE JENKINS  
Cuyahoga Falls, Ohio

The subtitle with this article read: "In keeping with the first day of April." If any of our readers who own the April 1955 issue haven't yet debunked this article, please write in ink across page 27, "April Fool!"

### Quality Holds Out

■ In your December 1958 issue, the article on "The VLF Receiver" was very interesting. I have a receiver of about that vintage along with four honeycomb coils and an old speaker. The picture will show you what they look like.

The receiver in the picture is a Radiomarine Corporation of America Type 1P-501-A receiver amplifier—wavelength 300-8000 meters. Two of



the coils are Duo Lateral, dated June 1, 1920—April 3, 1923, manufactured by Electra Products Co.; a third coil is Type 500 by DeForest and another is Type Trs 35 by Giblin Remler. The speaker is a Rola Re-Creator by Rola Co. of Oakland, Calif.

I have used this receiver to pull in the local airways beacon, and it does very nicely. Also, it is interesting to know that a speaker horn of this type is actually an amplifier. The volume without the speaker is very low, but by adding the speaker it is amplified considerably.

Some of the older equipment is pretty hard to beat. I use a 1934 Sargent receiver when the going gets bad here, and seem to do better than with a lot of the newer equipment—less adjustments on parts going out and lining up.

E. MOLLOHAN  
Bristol Bay, Alaska

### Oops!

■ We have recently received requests which indicate that in your January 1959 issue you mentioned that our publication, Air Navigation Radio Aids, is obtainable free. It is issued on January 1, April 1, July 1 and October 1 each year, with correction supplements at the beginning of every intervening month, and is charged for as follows:

Always say you saw it in—POPULAR ELECTRONICS



# TAKE A LOOK AT YOUR FUTURE IN RADIO-TV-ELECTRONICS—FREE!

I.C.S. Career Kit tells you where the big-pay jobs are...who are the industry's most wanted men...how you can "cash in" in a big way on your own future.

Here's your chance to find out where you're going—fast! And it won't cost you a thing except the time it takes to clip and mail the coupon at the bottom of this page.

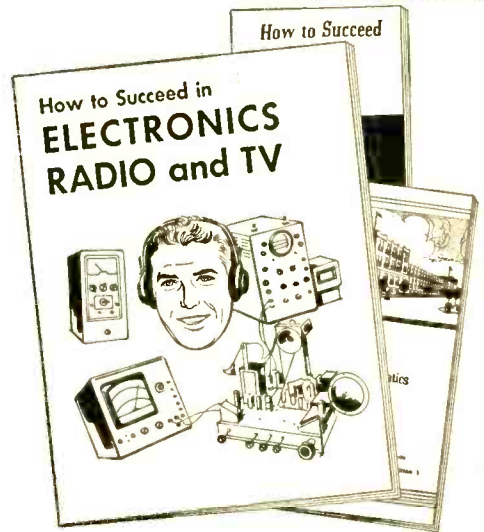
Radio-TV-Electronics is the fastest growing industry of all time. Opportunity for men in this field is almost unlimited. The rewards are great.

But to "cash in" you must be properly trained. You must know more than simply wires and tubes. You must be able to understand and apply the principles of Radio-TV-Electronics.

That's where I. C. S. comes in . . . the world's oldest and largest technical training school. Here are the people who know—who can tell you—what you need to go places in Radio-TV-Electronics.

You get the full story with your free I. C. S. Career Kit.

So take a minute now to get a look at your future in Radio-TV-Electronics. Send for your free I. C. S. Career Kit. You have nothing to lose. You can gain an exciting, well-paid career in a vital industry.



Send the coupon below for your free I. C. S. Career Kit!

- 1 "How to Succeed," 36-page guide to advancement
- 2 Electronics, Radio and TV handbook or the field of your choice
- 3 Sample lesson (Math) to demonstrate I. C. S. Method

For Real Job Security—Get an I.C.S. Diploma! I.C.S., Scranton 15, Penna.

Accredited Member,  
National Home Study Council

## INTERNATIONAL CORRESPONDENCE SCHOOLS



BOX 91622C, SCRANTON 15, PENNA.

(Partial list of 259 courses)

Without cost or obligation, send me "How to Succeed" and the opportunity booklet about the field BEFORE which I have marked X (plus sample lesson):

### RADIO TELEVISION ELECTRONICS

- General Electronics Tech.
- Industrial Electronics
- Practical Radio-TV Eng'r'g
- Practical Telephony
- Radio-TV Servicing

### BUSINESS

- Cost Accounting
- Managing a Small Business
- Purchasing Agent

### DRAFTING

- Electrical Drafting

### HIGH SCHOOL

- High School Diploma
- Good English
- High School Mathematics

### ELECTRICAL

- Electrical Engineering
- Elec. Engr. Technician
- Elec. Light and Power
- Practical Electrician
- Professional Engineer (Elec.)

### LEADERSHIP

- Industrial Foremanship
- Industrial Supervision
- Personnel-Labor Relations
- Supervision

Name \_\_\_\_\_ Age \_\_\_\_\_ Home Address \_\_\_\_\_

City \_\_\_\_\_ Zone \_\_\_\_\_ State \_\_\_\_\_ Working Hours \_\_\_\_\_ A.M. to \_\_\_\_\_ P.M. \_\_\_\_\_

Occupation \_\_\_\_\_

Canadian residents send coupon to International Correspondence Schools, Canadian, Ltd., Montreal, Canada. . . . Special tuition rates to members of the U. S. Armed Forces.

**Letters**

(Continued from page 12)

Yearly subscription (inc. supplements)  
or part year.....\$1.00  
Single copy (without supplements)..... .25

Requests for copies or subscriptions should be directed to the Queen's Printer, Department of Public Printing and Stationery, Ottawa, Ontario. Prepayment in Canadian funds is required and a cheque or money order payable to the Receiver General of Canada should accompany the request.

F. G. NIXON, Director  
Telecommunications Branch  
Department of Transport  
Ottawa, Canada

**Improved Electric Clown**

■ I have completed and given to my son the electric clown that was described on page 53 of the November 1958 issue of POPULAR ELECTRONICS.

I did not follow the schematic exactly. I substituted a 6-volt radio A battery for the current supply of 100 volts. I also used a #47 pilot lamp for the nose. Instead of painting the face as suggested, I used felts of various colors cut and glued to the box.

One correction I would like to make on Mr. Smith's diagram concerns using the case as half of the circuit. Standard bells and buzzers also have half their circuits grounded to their cases. This means that they would have to be insulated from the case to work. None of the available insulators I found were sufficiently child-proof. Instead, I

employed wiring as the case half of this circuit. My son is only eighteen months old, but he has used this toy quite a bit, and is fascinated by it.

EDWARD BRUTSCH  
Pittsfield, Mass.

**Tube Switch in Receiver**

■ In your December 1958 issue there is a very low frequency receiver circuit employing a medium-mu dual triode 6BK7A. If a high-gain dual triode is used, say a 12BZ7, much looser coupling in the receiver could be used for the same gain and greater selectivity would result. The lead dress would be more critical because of the higher gain of the 12BZ7 tube.

GEORGE MACHAMER  
Chicago, Ill.

*The 6BK7A was used in the basic design because of the non-critical wiring required. Feel free to experiment, however. This is one of the best ways to gain knowledge in electronics.*

**What's with Watts?**

■ Your article in January POPULAR ELECTRONICS titled "High Power for Hi-Fi" contains errors that should be corrected.

Mr. Ward compares 2% distortion of a 10-watt amplifier with 1/2 of 1% distortion of a 60-watt amplifier. At first glance, it seems obvious that 2% is greater than 1/2 of 1%—but it is not. Two percent means .02 x 10 watts, or .20. One-half of 1% means .005 x 60 watts, or .30. Arguments for

**VIDEO ELECTRIC COMPANY says: DOWN WITH RISING COSTS OF ELECTRON TUBES OVER ONE MILLION USED TUBES TO SELECT FROM**

only **40¢** each FOR ANY **TUBE**

**WE HAVE OVER 1000 USED TV SETS**

At All Times In Our Huge Warehouse Buy one or more of these WORKING TVs to sell or use as your own second set! All sets in GOOD WORKING condition!  
Your Choice—Console or Table Model  
10" ... \$23.00 17" ... \$46.00  
10" ... \$28.00 19" ... \$58.00  
14" ... \$33.00 20" ... \$64.00  
14" ... \$40.00 21" ... \$72.00  
16" ... \$40.00 24" ... \$99.00

When ordering TVs, state whether table model or console is desired. Also, preference on make of set. All TVs sent railway express F.O.B. Newark. On any quantity, WIRE or CALL today!

**\$37.00 PER HUNDRED**

**FREE Bonus Antenna** Given with Any TV Set Order!!

**FREE RCA "Cheater" Cord** Given with Any Tube Order of \$7.00 or More!!

SEND for our FREE complete TUBE & PARTS LIST and order blank.

Each and every tube is tested by our supplier under actual operating conditions in Radio, FM, Hi-Fi, Industrial Equipment and Television Chassis or Intricate Testing Equipment for Mutual Conductance and Life Test.

Below is a Partial List of Over Three Hundred Popular Types!

Write for Free Complete List and Order Blank!

6AV5CT	0A2	5AX4CT	6RC5	6L7	19
6AV6	0A4	5B7	6C7	6N7	19AUCT
6AX5CT	1A7CT	5BR8	6E8	6P7	19B5CT
6AX6	1A7CT	5B07	6B8	6A	70
6B6	10BCT	5C6	6B9	6B	70/XXFM
6B7	10BCT	5C6	6B5	6B1	70A
6B8	10BCT	5C6	6B6	6B2	70B
6B9	10BCT	5C6	6B7	6B3	70C
6C1	10BCT	5C6	6B8	6B4	70D
6C2	10BCT	5C6	6B9	6B5	70E
6C3	10BCT	5C6	6C0	6B6	70F
6C4	10BCT	5C6	6C1	6B7	70G
6C5	10BCT	5C6	6C2	6B8	70H
6C6	10BCT	5C6	6C3	6B9	70I
6C7	10BCT	5C6	6C4	6C0	70J
6C8	10BCT	5C6	6C5	6C1	70K
6C9	10BCT	5C6	6C6	6C2	70L
6D1	10BCT	5C6	6C7	6C3	70M
6D2	10BCT	5C6	6C8	6C4	70N
6D3	10BCT	5C6	6C9	6C5	70O
6D4	10BCT	5C6	6D0	6C6	70P
6D5	10BCT	5C6	6D1	6C7	70Q
6D6	10BCT	5C6	6D2	6C8	70R
6D7	10BCT	5C6	6D3	6C9	70S
6D8	10BCT	5C6	6D4	6D0	70T
6D9	10BCT	5C6	6D5	6D1	70U
6E1	10BCT	5C6	6D6	6D2	70V
6E2	10BCT	5C6	6D7	6D3	70W
6E3	10BCT	5C6	6D8	6D4	70X
6E4	10BCT	5C6	6D9	6D5	70Y
6E5	10BCT	5C6	6E0	6D6	70Z
6E6	10BCT	5C6	6E1	6D7	71A
6E7	10BCT	5C6	6E2	6D8	71B
6E8	10BCT	5C6	6E3	6D9	71C
6E9	10BCT	5C6	6E4	6E0	71D
6F1	10BCT	5C6	6E5	6E1	71E
6F2	10BCT	5C6	6E6	6E2	71F
6F3	10BCT	5C6	6E7	6E3	71G
6F4	10BCT	5C6	6E8	6E4	71H
6F5	10BCT	5C6	6E9	6E5	71I
6F6	10BCT	5C6	6F0	6E6	71J
6F7	10BCT	5C6	6F1	6E7	71K
6F8	10BCT	5C6	6F2	6E8	71L
6F9	10BCT	5C6	6F3	6E9	71M
6G1	10BCT	5C6	6F4	6F0	71N
6G2	10BCT	5C6	6F5	6F1	71O
6G3	10BCT	5C6	6F6	6F2	71P
6G4	10BCT	5C6	6F7	6F3	71Q
6G5	10BCT	5C6	6F8	6F4	71R
6G6	10BCT	5C6	6F9	6F5	71S
6G7	10BCT	5C6	6G0	6F6	71T
6G8	10BCT	5C6	6G1	6F7	71U
6G9	10BCT	5C6	6G2	6F8	71V
6H1	10BCT	5C6	6G3	6F9	71W
6H2	10BCT	5C6	6G4	6G0	71X
6H3	10BCT	5C6	6G5	6G1	71Y
6H4	10BCT	5C6	6G6	6G2	71Z
6H5	10BCT	5C6	6G7	6G3	72A
6H6	10BCT	5C6	6G8	6G4	72B
6H7	10BCT	5C6	6G9	6G5	72C
6H8	10BCT	5C6	6H0	6G6	72D
6H9	10BCT	5C6	6H1	6G7	72E
6I1	10BCT	5C6	6H2	6G8	72F
6I2	10BCT	5C6	6H3	6G9	72G
6I3	10BCT	5C6	6H4	6H0	72H
6I4	10BCT	5C6	6H5	6H1	72I
6I5	10BCT	5C6	6H6	6H2	72J
6I6	10BCT	5C6	6H7	6H3	72K
6I7	10BCT	5C6	6H8	6H4	72L
6I8	10BCT	5C6	6H9	6H5	72M
6I9	10BCT	5C6	6I0	6H6	72N
6J1	10BCT	5C6	6I1	6H7	72O
6J2	10BCT	5C6	6I2	6H8	72P
6J3	10BCT	5C6	6I3	6H9	72Q
6J4	10BCT	5C6	6I4	6I0	72R
6J5	10BCT	5C6	6I5	6I1	72S
6J6	10BCT	5C6	6I6	6I2	72T
6J7	10BCT	5C6	6I7	6I3	72U
6J8	10BCT	5C6	6I8	6I4	72V
6J9	10BCT	5C6	6I9	6I5	72W
6K1	10BCT	5C6	6I0	6I6	72X
6K2	10BCT	5C6	6I1	6I7	72Y
6K3	10BCT	5C6	6I2	6I8	72Z
6K4	10BCT	5C6	6I3	6I9	73A
6K5	10BCT	5C6	6I4	6I0	73B
6K6	10BCT	5C6	6I5	6I1	73C
6K7	10BCT	5C6	6I6	6I2	73D
6K8	10BCT	5C6	6I7	6I3	73E
6K9	10BCT	5C6	6I8	6I4	73F
6L1	10BCT	5C6	6I9	6I5	73G
6L2	10BCT	5C6	6L0	6I6	73H
6L3	10BCT	5C6	6L1	6I7	73I
6L4	10BCT	5C6	6L2	6I8	73J
6L5	10BCT	5C6	6L3	6I9	73K
6L6	10BCT	5C6	6L4	6L0	73L
6L7	10BCT	5C6	6L5	6L1	73M
6L8	10BCT	5C6	6L6	6L2	73N
6L9	10BCT	5C6	6L7	6L3	73O
6M1	10BCT	5C6	6L8	6L4	73P
6M2	10BCT	5C6	6L9	6L5	73Q
6M3	10BCT	5C6	6M0	6L6	73R
6M4	10BCT	5C6	6M1	6L7	73S
6M5	10BCT	5C6	6M2	6L8	73T
6M6	10BCT	5C6	6M3	6L9	73U
6M7	10BCT	5C6	6M4	6M0	73V
6M8	10BCT	5C6	6M5	6M1	73W
6M9	10BCT	5C6	6M6	6M2	73X
6N1	10BCT	5C6	6M7	6M3	73Y
6N2	10BCT	5C6	6M8	6M4	73Z
6N3	10BCT	5C6	6M9	6M5	74A
6N4	10BCT	5C6	6N0	6M6	74B
6N5	10BCT	5C6	6N1	6M7	74C
6N6	10BCT	5C6	6N2	6M8	74D
6N7	10BCT	5C6	6N3	6M9	74E
6N8	10BCT	5C6	6N4	6N0	74F
6N9	10BCT	5C6	6N5	6N1	74G
6O1	10BCT	5C6	6N6	6N2	74H
6O2	10BCT	5C6	6N7	6N3	74I
6O3	10BCT	5C6	6N8	6N4	74J
6O4	10BCT	5C6	6N9	6N5	74K
6O5	10BCT	5C6	6O0	6N6	74L
6O6	10BCT	5C6	6O1	6N7	74M
6O7	10BCT	5C6	6O2	6N8	74N
6O8	10BCT	5C6	6O3	6N9	74O
6O9	10BCT	5C6	6O4	6O0	74P
6P1	10BCT	5C6	6O5	6O1	74Q
6P2	10BCT	5C6	6O6	6O2	74R
6P3	10BCT	5C6	6O7	6O3	74S
6P4	10BCT	5C6	6O8	6O4	74T
6P5	10BCT	5C6	6O9	6O5	74U
6P6	10BCT	5C6	6P0	6O6	74V
6P7	10BCT	5C6	6P1	6O7	74W
6P8	10BCT	5C6	6P2	6O8	74X
6P9	10BCT	5C6	6P3	6O9	74Y
6Q1	10BCT	5C6	6P4	6P0	74Z
6Q2	10BCT	5C6	6P5	6P1	75A
6Q3	10BCT	5C6	6P6	6P2	75B
6Q4	10BCT	5C6	6P7	6P3	75C
6Q5	10BCT	5C6	6P8	6P4	75D
6Q6	10BCT	5C6	6P9	6P5	75E
6Q7	10BCT	5C6	6Q0	6P6	75F
6Q8	10BCT	5C6	6Q1	6P7	75G
6Q9	10BCT	5C6	6Q2	6P8	75H
6R1	10BCT	5C6	6Q3	6P9	75I
6R2	10BCT	5C6	6Q4	6Q0	75J
6R3	10BCT	5C6	6Q5	6Q1	75K
6R4	10BCT	5C6	6Q6	6Q2	75L
6R5	10BCT	5C6	6Q7	6Q3	75M
6R6	10BCT	5C6	6Q8	6Q4	75N
6R7	10BCT	5C6	6Q9	6Q5	75O
6R8	10BCT	5C6	6R0	6Q6	75P
6R9	10BCT	5C6	6R1	6Q7	75Q
6S1	10BCT	5C6	6R2	6Q8	75R
6S2	10BCT	5C6	6R3	6Q9	75S
6S3	10BCT	5C6	6R4	6R0	75T
6S4	10BCT	5C6	6R5	6R1	75U
6S5	10BCT	5C6	6R6	6R2	75V
6S6	10BCT	5C6	6R7	6R3	75W
6S7	10BCT	5C6	6R8	6R4	75X
6S8	10BCT	5C6	6R9	6R5	75Y
6S9	10BCT	5C6	6S0	6R6	75Z
6T1	10BCT	5C6	6S1	6R7	76A
6T2	10BCT	5C6	6S2	6R8	76B
6T3	10BCT	5C6	6S3	6R9	76C
6T4	10BCT	5C6	6S4	6S0	76D
6T5	10BCT	5C6	6S5	6S1	76E
6T6	10BCT	5C6	6S6	6S2	76F
6T7	10BCT	5C6	6S7	6S3	76G
6T8	10BCT	5C6	6S8	6S4	76H
6T9	10BCT	5C6	6S9	6S5	76I
6U1	10BCT	5C6	6S0	6S6	76J
6U2	10BCT	5C6	6S1	6S7	76K
6U3	10BCT	5C6	6S2	6S8	76L
6U4	10BCT	5C6	6S3	6S9	76M
6U5	10BCT	5C6	6S4	6T0	76N
6U6	10BCT	5C6	6S5	6T1	76O
6U7	10BCT	5C6	6S6	6T2	76P
6U8	10BCT	5C6	6S7	6T3	76Q
6U9	10BCT	5C6	6S8	6T4	76R
6V1	10BCT	5C6	6S9	6T5	76S
6V2	10BCT	5C6	6V0	6T6	76T
6V3	10BCT	5C6	6V1	6T7	76U
6V4	10BCT	5C6	6V2	6T8	76V
6V5	10BCT	5C6	6V3	6T9	76W
6V6	10BCT	5C6	6V4	6T0	76X
6V7	10BCT	5C6	6V5		



# Send For This **FREE** Booklet Today!

See how CREI  
home study prepares  
you for success in  
the expanding field of

## ELECTRONICS

including new opportunities in  
**AUTOMATION**  
AND INDUSTRIAL ELECTRONICS  
ENGINEERING TECHNOLOGY

Find out how CREI can help you to

- Better Job • Better Pay
- Promotion • Greater Security
- Better Way of Life for You and Your Family • Greater Confidence



All these benefits can be yours if you act now! Take that first big step this minute — No obligation whatsoever! Use coupon or write Capitol Radio Engineering Institute, Dept. 124 F, 3224 16th St., N.W., Wash. 10, D. C.

### TAKE A MINUTE TO MAIL THIS COUPON FOR FREE BOOKLET!

#### CAPITOL RADIO ENGINEERING INSTITUTE

ECPD Accredited Technical Institute Curricula • Founded 1927

Dept. 124 F, 3224 16th St., N.W., Washington 10, D. C.

Please send me your course outline and FREE illustrated Booklet "Your Future in the New World of Electronics" . . . describing opportunities and CREI home study courses in Practical Electronic Engineering Technology.

- CHECK FIELD OF GREATEST INTEREST
- Radar, Servo and Computer Engineering Technology
  - Electronic Engineering Technology
  - Broadcast (AM, FM, TV) Engineering Technology
  - Television Engineering Technology
  - Aeronautical Electronic Engineering Technology
  - Automation and Industrial Electronics Engineering Technology

F<sup>1</sup>

Name ..... Age .....

Street .....

City ..... Zone ..... State .....

CHECK:  Home Study  Residence School  Korean Veteran

TO OBTAIN FAST, IMMEDIATE SERVICE AND TO AVOID DELAY, IT IS NECESSARY THAT THE FOLLOWING INFORMATION BE FILLED IN:

Employed by .....

Type of Present Work .....

Education:

Yrs. High School .....

Other .....

Electronics Experience .....

Before I buy ANYTHING,  
I've got to have a reason, so...

## what's so good about Audiotape?



We'll give you seven reasons  
for buying Audiotape!

1. Excellent response at high and low frequencies. 2. Exceptionally low background noise, through better dispersion of finer oxide particles. 3. Increased output and reduced distortion because the oxides are magnetically oriented. 4. Unequalled uniformity of output — guaranteed not to exceed  $\pm 1/4$  db within a reel. 5. Continuous monitoring in production for output, uniformity and freedom from distortion. 6. No oxide rub-off because an improved drier-type formula prevents it, even on dirty heads. 7. The C-slot reel—fastest-threading reel ever developed.

# audiotape

TRADE MARK

Manufactured by AUDIO DEVICES, INC.  
444 Madison Ave., New York 22, New York  
Offices in Hollywood & Chicago

## Letters

(Continued from page 14)

oversized, overheated amplifiers are about as logical as using a 10-ton truck to carry a 10-pound package.

I enjoy your construction articles, and hope to see more of them.

KEN MADSEN  
Elmhurst, Ill.

*Common sense says you should trust your first reaction, or first glance. Percentage figures can only be compared to other percentage figures. If you can prove that  $1/2$  of 1% is more than 2%, you have pulled off the mathematical stunt of the century.*

## Novice Talk

■ We Novices often hear General Class amateurs complaining about our signal reports. If these Generals but knew that the Novice system of RST reporting is dissimilar to that of everyone else, maybe they wouldn't squawk so loud. With



three full months of Novice experience behind me I shall try to translate some typical reports.

299—Who knows how to give signal reports?

358—I didn't like your report.

477—My receiver driits.

489—This is the second time I've worked you.

539—My "S" meter is out of adjustment.

555—Five is the only number I can send with this bug.

579—We are on 15 meters.

589—We just changed to 80 meters.

599—You are my best DX, or, you and I have the same rig.

Keep this list on your wall at all times, Mr. General, and see if it doesn't give you a clearer picture of what's going on in the Novice bands.

ROBERT SALTZMAN  
WV2BWC—WA2BWC  
Great Neck, N. Y.

*Sooner or later every Novice plans to become a General Class amateur. For this reason we think all Novices should learn and stick to the Q-signals. This way everyone will be talking the same language.*

-30-



# UPGRADE YOUR INCOME

through Grantham Training and an F.C.C. License!

## What's in Your Future?

Are you *planning* your future or just drifting into it? Now is the time to get ahead in electronics—the world's fastest growing major industry. Now is the time to add technical knowledge and an F.C.C. license to your practical experience. Now is the time to prepare for higher pay—time to make your future secure.

## Grantham Training Prepares You

Grantham School of Electronics specializes in quality training in communications electronics, preparing students to pass F.C.C. operator license examinations. This training is available either by correspondence or in resident classes.

The Grantham Communications Course does not include actual work with practical kits or other equipment. That is, for example, it does not teach you how to solder or how to remove a TV chassis from the cabinet, etc. It is not a repair course but, instead, is bona fide technical training which teaches you to understand electronic theory—which teaches you the "why" of electronics.

If you are a beginner in this field, the Grantham course will give you the kind of detailed training in radio-electronics theory and operating practices that will enable you to obtain your first class F.C.C. license quickly. Then, this license plus your knowledge of theory will qualify you for certain types of employment, and you can improve your practical ability while on the job earning a salary.

If you already have practical experience in radio-electronics, the Grantham course can add a knowledge of theory and an F.C.C. license to that practical experience. This should qualify you for higher pay and greater job security.

## Train by Correspondence or in Resident Classes

**RESIDENT CLASSES**—The Grantham Communications Electronics Course is offered in both DAY and EVENING classes in Washington, Hollywood, and Seattle. The DAY course meets five days a week, from 9 a.m. until 1 p.m., and prepares you for a first class F.C.C. license in 12 weeks. The EVENING course meets two nights a week, from 6:30 p.m. until 10:30 p.m., and prepares you for a first class F.C.C. license in 30 weeks. All courses "begin at the beginning"—NO previous electronics training required or assumed.

**CORRESPONDENCE TRAINING**—The Grantham Communications Electronics Course is offered by correspondence from all Divisions of the School—Washington, Hollywood, and Seattle. The course has two major objectives—(1) to *teach* you a great deal of electronics, and (2) to prepare you to pass all F.C.C. examinations required for a first class license.

This course can prepare you *quickly* to pass F.C.C. examinations because it presents the necessary principles of electronics in a simple "easy-to-grasp" manner. Each new idea is tied in with familiar ideas. Each new principle is presented first in simple, everyday language. Then after you understand the "what and why" of a certain principle, you are taught the technical language associated with that principle. You learn more electronics in less time, because we make the subject easy and interesting.

## Which License for Which Job?

The THIRD CLASS radiotelephone license is of value primarily in that it qualifies you to take the second class

examination. The scope of authority covered by a third class license is extremely limited.

The SECOND CLASS radiotelephone license qualifies you to install, maintain and operate most all radiotelephone equipment except commercial broadcast station equipment.

The FIRST CLASS radiotelephone license qualifies you to install, maintain and operate every type of radiotelephone equipment (except amateur) including all radio and television stations in the United States, its territories and possessions. This is the highest class of radiotelephone license available.

## Here's Proof . . .

that Grantham students prepare for F.C.C. examinations in a minimum of time. Here is a list of a few of our recent graduates, the class of license they got, and how long it took them:

	License	Weeks
Walter Mengel, Jr., 423 James St., Crystal Lake, Ill. . . . .	1st	8
Serge G. Miller, 1315 W. 15th St., San Pedro, Calif. . . . .	1st	12
John A. Hayes, 1519 Madison Ave., Memphis, Tenn. . . . .	1st	14
Robert A. Morgan, 25 Barrow St., New York, N.Y. . . . .	1st	9
Hal Moon, Cook Hotel, 1334 Central, Kansas City, Mo. . . . .	2nd	5
W. R. Smith, 1335 E. 8th St., Long Beach, Calif. . . . .	1st	12
Erskin D. Davis, 4220 Clay St., NW, Washington, D.C. . . . .	1st	12
John R. Bahrs, 72 Hazelton St., Ridgefield Park, N. J. . . . .	1st	12
Earl A. Stewart, 3918 Modesto Dr., San Bernardino, Calif. . . . .	1st	14
Robert H. Moore, 807 Grace St., Baldwin, L.I., N.Y. . . . .	1st	12
Otis A. Towns, 3638 Bates St., St. Louis, Mo. . . . .	1st	12

**THREE COMPLETE SCHOOLS:** To better serve our many students throughout the entire country, Grantham School of Electronics maintains three complete schools—one in Washington, D.C., one in Hollywood, Calif., and one in Seattle, Wash. All schools offer the same rapid courses in F.C.C. license preparation, either home study or resident classes.

**MAIL COUPON FOR FREE BOOKLET:** Our free booklet, *Careers in Electronics*, gives details of how you can prepare quickly for your F.C.C. license. For your free copy of this booklet, clip the coupon below and mail it to the Grantham School nearest you.

## GRANTHAM

### SCHOOL OF ELECTRONICS

821-19th Street, N.W.      408 Marion Street      1505 N. Western Ave.  
 Washington 6, D. C.      Seattle 4, Wash.      Hollywood 27, Calif.  
 (Phone: ST 3-3614)      (Phone: MA 2-7227)      (Phone: HO 7-7727)

(Mail in envelope or paste on postal card)

TO: GRANTHAM SCHOOL OF ELECTRONICS

821-19th, NW      408 Marion      1505 N. Western  
 Washington      Seattle      Hollywood

Please mail me your free booklet telling how Grantham training can prepare me quickly for my commercial F. C. C. license. I understand there is no obligation and no salesman will call.

Name \_\_\_\_\_ Age \_\_\_\_\_

Address \_\_\_\_\_

City \_\_\_\_\_ State \_\_\_\_\_

I am interested in:  Home Study,  Resident Classes 93-1D

for

**LOWEST**  
microphonics...

hum...

noise

in a high- $\mu$   
dual triode



the

**Amperex®**

**ECC83** A PLUG-IN

REPLACEMENT FOR THE **12AX7**

**MICROPHONICS:**

Negligible in amplifiers requiring an input voltage of at least 50 mv for an output of 5 watts. No special precautions against microphonics necessary even though the tube is mounted in the near vicinity of a loudspeaker with 5% acoustical efficiency.

**HUM AND NOISE LEVEL:**

Better than -60 db relative to 50 mv when the grid circuit impedance is no greater than 0.5 megohms (at 60 cps), the center tap of the heater is grounded and the cathode resistor is by-passed by a capacitor of at least 100 mfd.

**OTHER Amperex TUBES FOR HIGH-FIDELITY AUDIO APPLICATIONS:**

- EL84/6BQ5 9-pin power pentode; 17 W PP
- 6CA7/EL34 High-power pentode; 100 W PP
- EF86/6267 Low-noise high- $\mu$  pentode
- ECC81/12AT7 Low-noise medium- $\mu$  dual triode
- ECC82/12AU7 Low-noise low- $\mu$  dual triode
- ECC85/6AQ8 High- $\mu$  dual triode for FM tuners
- GZ34/SAR4 Cathode-type rectifier; 250 ma.
- EZ80/6V4 9-pin rectifier; cathode; 90 ma.
- EZ81/6CA4 9-pin rectifier; cathode; 150 ma.

At All Leading Electronic Parts Distributors



**Amperex**  
**ELECTRONIC CORP.**

230 Duffy Ave., Hicksville, Long Island, N.Y.



**BOOKSHELF**

"TRANSISTORS, THEORY & PRACTICE" by Rufus P. Turner. Published by Gernsback Publications, Inc., 154 West 14th St., New York 11, N. Y. 160 pages. Paper cover. \$2.95.

One of the better transistor books available for the past four years has now come out in a revised edition. The enlarged and up-to-date version of Rufus P. Turner's transistor "Bible" includes the chapters on fundamentals that made the first edition so popular, but each chapter has been expanded to include some of the latest circuits and techniques. Mr. Turner also describes last-minute developments such as thyristors, four-layer diodes, spacistors, double-based diodes and phototransistors. Expanded bibliographies further extend the usefulness of the book which can be heartily recommended to all the transistor gadgeteers among our readership.



"TECHNIQUES OF MAGNETIC RECORDING" by Joel Tall. Published by The Macmillan Company, 60 Fifth Ave., New York, N. Y. 472 pages. Hard cover. \$7.95.

An excellent contribution to a fast developing field, this volume translates the complexities of tape recording and reproduction into practical, easy-to-follow techniques. It is a book for the professional who wants new ideas, and for the amateur just getting his feet wet in magnetic recording. The reader will gain "a working knowledge of both sound and magnetic recording theory" from this book, which provides an integrated, correlated description of the many ways in which recording is used to store and communicate sound, light and motion.



"A GUIDE TO NUCLEAR ENERGY" by R. F. K. Belchem. Published by Philosophical Library, Inc., 15 East 40th St., New



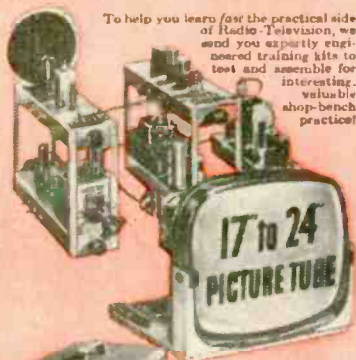
**WE'RE MAKING IT EASIER THAN EVER TO BECOME A WELL PAID  
RADIO-TELEVISION SERVICE TECHNICIAN**

**NOW - Just \$6 Starts You Training in  
RADIO-TELEVISION**

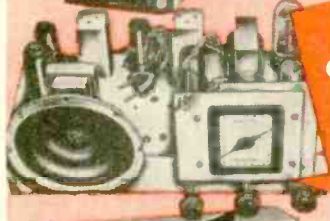
**the SPRAYBERRY "Learn-by-Doing" Way...**

**25 BIG, COMPLETE KITS  
of PARTS & EQUIPMENT**

To help you learn fast the practical side of Radio-Television, we send you expertly engineered training kits to test and assemble for interesting, valuable shop-bench practice!



- The new Sprayberry Training Television Receiver, built and tested in 6 sections.
- Now offered... this fine modern oscilloscope.
- You build this powerful two-band superheterodyne radio receiver.



**Big New  
CATALOG  
AND  
Sample Lesson  
FREE!**



You build the new Sprayberry tester—a complete 18-range Volt-Ohm-Milli ammeter test meter.



\*\*\* This great industry is begging for trained men... to step into good paying jobs or a profitable business of their own! Our new plan opens the doors of Radio-Television wide to every ambitious man who is ready to act at once!

Men by the thousands... trained Radio-Television Service Technicians... are needed at once! Perhaps you've thought about entering this interesting, top paying field, but lack of ready money held you back. Now—just \$6 enrolls you for America's finest, most up to date home study training in Radio-Television! Unbelievable? No, the explanation is simple! We believe Radio-Television *must* have the additional men it needs as quickly as possible. We are willing to do our part by making Sprayberry Training available for less money down and on easier terms than ever before. This is your big opportunity to get the training you need... to step into a fine job or your own Radio-Television Service Business.

**Complete Facts Free—Act Now; Offer Limited**

Only a limited number of students may be accepted on this liberal and unusual basis. We urge you to act at once... mail the coupon below and get complete details plus our big new catalog and an actual sample lesson—all free. No obligation... no salesman will bother you.

**HOME STUDY TRAINING IN SPARE TIME**

Under world-famous 27-year old Sprayberry Plan, you learn entirely at home in spare time. You keep on with your present job and income. You train as fast or as slowly as you wish. You get valuable kits of parts and equipment for priceless shop-bench practice. And everything you receive, lessons and equipment alike, is all yours to keep.

**LET US PROVE HOW EASILY YOU CAN LEARN!**

Radio-Television needs YOU! And Sprayberry is ready to train you on better, easier terms, that any ambitious man can afford. *Just \$6 starts you!* Mail coupon today... let the facts speak for themselves. You have everything to gain. Let us prove the kind of opportunity in store for you!

**SPRAYBERRY Academy of Radio-Television**

1512 Jarvis Avenue, Dept. 105-T, Chicago 26, Illinois

**Mail This Coupon Now—No Salesman Will Call**

**Sprayberry Academy of Radio-Television**

Dept. 105-T, 1512 W. Jarvis Ave., Chicago 26, Ill.

Please rush all information on your ALL-NEW Radio-Television Training Plan. I understand this does not obligate me and that no salesman will call upon me. Include New Catalog and Sample Lesson FREE.

NAME..... Age.....

ADDRESS.....

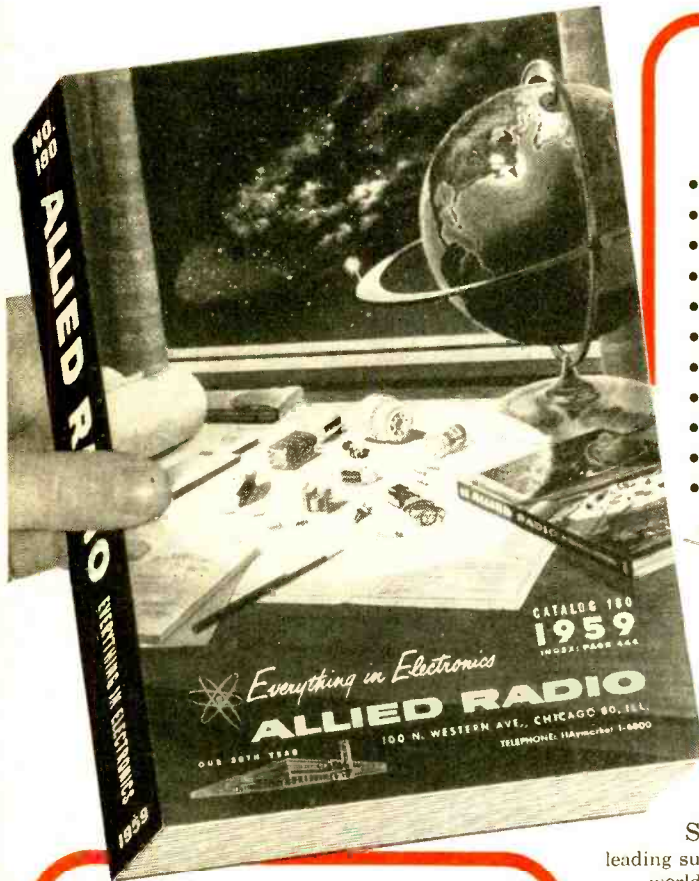
CITY..... ZONE..... STATE.....





# free! ALLIED'S 1959

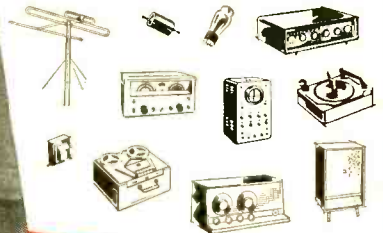
value-packed 452-page  
**ELECTRONIC SUPPLY CATALOG**



the only COMPLETE guide  
to everything in electronics

### WORLD'S LARGEST STOCKS

- Everything in STEREO Hi-Fi
- Hi-Fi Music Systems & Components
- Build-Your-Own KNIGHT-KITS
- Recorders and Supplies
- Public Address & Paging Systems
- Amateur Station Equipment
- Test & Lab Instruments
- Industrial Electronic Supplies
- TV Tubes, Antennas, Accessories
- Parts, Tubes, Transistors
- Tools, Hardware, Books



### featuring:

**MONEY-SAVING knight-kits:** The best you can build! Complete listing of Hi-Fi, Hobby, Test Instrument and Amateur kits—all with exclusive money-back guarantee. Build your own... save up to 50%!

**STEREO HI-FI!** World's largest selection of components and systems. First with the latest in STEREO. Own the best in Hi-Fi for less!

**EASY-PAY TERMS:** Only 10% down; available on orders of \$20 or more. Fast handling—no red tape.

## ALLIED RADIO



Send for ALLIED'S 1959 Catalog—it's the leading supply guide—452 pages packed with the world's largest selection of quality electronic equipment at lowest, money-saving prices. Get every buying advantage at ALLIED: fastest shipment, expert personal help, lowest prices, guaranteed satisfaction...

send for the leading  
electronic supply guide



ALLIED RADIO CORP., Dept. 153-D9  
100 N. Western Ave., Chicago 80, Ill.

Send FREE 452-Page 1959 ALLIED Catalog

Name \_\_\_\_\_

Address \_\_\_\_\_

City \_\_\_\_\_ Zone \_\_\_\_\_ State \_\_\_\_\_

a quarter century of **PRECISION**<sup>®</sup>  
know-how is yours in . . .

**PACO**

quality electronic  
equipment in **KIT FORM**

PACO is the only line of test instrument kits engineered and produced under the auspices of a leading test equipment and meter manufacturer.

and, you pay nothing extra for the convenience of buying PACO kits directly from your own local parts distributor.

COMPARE PACO against any other kits for performance, appearance, ruggedness, ease of operation and simplicity of assembly and wiring.

COMPARE PACO'S superbly detailed, step-by-step instruction manuals and giant size wiring diagrams, against any you have ever seen.

**MODEL B-10**  
BATTERY ELIMINATOR KIT  
KIT NET PRICE: \$41.95  
FACTORY WIRED: 49.50

**MODEL C-20**  
RES-CAP-RATIO BRIDGE KIT  
KIT NET PRICE: \$20.95  
FACTORY WIRED: 31.50

**MODEL G-30**  
RF SIGNAL GENERATOR KIT  
KIT NET PRICE: \$28.50  
FACTORY WIRED: 39.95

**MODEL M-40**  
HIGH SENSITIVITY V-O-M KIT  
KIT NET PRICE: \$31.50  
FACTORY WIRED: 37.50

**MODEL S-50**  
5" OSCILLOSCOPE KIT  
KIT NET PRICE: \$49.50  
FACTORY WIRED: 84.50

**MODEL S-55**  
WIDEBAND 5" OSCILLOSCOPE  
KIT NET PRICE: \$87.50  
FACTORY WIRED: 139.50

**MODEL T-60**  
TUBE CHECKER KIT  
KIT NET PRICE: \$38.75  
FACTORY WIRED: 54.50

**MODEL T-65**  
TRANSISTOR AND CRYSTAL  
DIODE TESTER KIT  
KIT NET PRICE: \$39.95  
FACTORY WIRED: 59.50

**MODEL V-70**  
VACUUM TUBE VOLTMETER KIT  
KIT NET PRICE: \$31.50  
FACTORY WIRED: 47.50

**MODEL Z-80**  
RF-AF SIGNAL TRACER KIT  
KIT NET PRICE: \$29.50  
FACTORY WIRED: 42.50

▶ Available and on display  
at leading electronic parts distributors.  
▶ Write for free descriptive bulletin



B-10



C-20



G-30



M-40



S-50



S-55



T-60



T-65



V-70



Z-80

**PACO** ELECTRONICS CO., INC.

70-31 84th Street, Glendale 27, L. I., N. Y.

Export: 458 B'way., N. Y. 13 • Canada: Atlas Radio Corp., Toronto 19

A DIVISION OF **PRECISION** Apparatus Company, Inc.

**Bookshelf**

(Continued from page 20)

a book to offer so much technical information and still be such easy reading. If you want to go single sideband, or, if you're already operating on SSB, this book will have plenty of information for you. It is highly recommended.



"MOST-OFTEN-NEEDED RADIO DIAGRAMS (1926-1938)" compiled by M. N. Beitman. Published by Supreme Publications, Highland Park, Ill. 240 pages. \$2.50.

From time to time we all run up against a radio which is really an old-timer. At such times a schematic would be most valuable, but one is rarely available. This book, a collection of 240 old-timers from 1926 to 1938, will fill in what is probably a big gap in your file of old schematics.



"UNDERSTANDING HIGH FIDELITY" published by Bogen-Presto, Box 500, Paramus, N. J. 64 pages. 25 cents.

This is the fourth revised edition of this inexpensive booklet, which has sold more than 250,000 copies in previous editions. The revisions made in this edition for the most part concern stereo. Results which may be expected from stereo and mono systems are discussed in detail, and lucid explanations of how to plan and install a stereo system are also presented. This "Stereo Edition" is highly recommended for the beginning stereophile.

**Free Literature Roundup**

Arnhold Ceramics, Inc., 1 East 57th St., New York 22, N. Y., is offering a new catalog which describes the "Isophon" line of hi-fi speakers. This attractive folder includes a special section explaining the factors that determine the performance of a good hi-fi speaker. All technical specifications of the Isophon speakers are given, including frequency response, power-handling capacity, resonance, impedance, gauss, etc.

The new Test Equipment Catalog No. 38-T, available from Triplett Electrical Instrument Co., Bluffton, Ohio, describes the latest electronic, electrical, radio, television, and industrial testers.



**AT  
LAST!**

# RADIO-TV and ELECTRONICS TRAINING

**.... AT A PRICE  
YOU CAN AFFORD!**



**\*21 INCH**  
Receiver Kit included

Yes, this great course costs *far less than any training* of its kind given by other major schools! Radio-Television Training School will train you for a good job in Television or Industrial Electronics — **AT HOME IN YOUR SPARE TIME.**

Think of it—a complete training program including over 120 lessons, Fourteen Big Radio-Television Kits, Complete Color-TV Instruction, Unlimited Consultation Service . . . **ALL at a really big saving to you.** How can we do this? Write to us today . . . and find out!

And what's more — you can (if you wish) **OPEN YOUR OWN RTS-APPROVED AND FINANCED RADIO-TV SERVICE SHOP**

**We Want Many More Shops This Year**

This 37 year old training organization — called RTS, that's Radio-Television Training School — wants to establish a string of Radio-TV Repair Shops in principal cities throughout the U. S. So far, a great many such shops are **NOW IN BUSINESS AND PROSPERING.** We are helping and training ambitious men to become future owners and operators of these shops in all areas.

**FOR UNSKILLED  
INEXPERIENCED MEN ONLY —  
WE TRAIN YOU OUR WAY!**

We must insist that the men we sign up be trained in Radio-TV Repair, Merchandising and Sales by our training methods—because **WE KNOW** the requirements of the industry. Therefore, we will **TRAIN YOU . . .** we will show you how to earn **EXTRA CASH**, during the first month or two of your training period. **YOU KEEP YOUR PRESENT JOB. TRAINING TAKES PLACE IN YOUR OWN HOME, IN YOUR SPARE TIME!**

**COMPLETE  
COLOR  
INSTRUCTION  
INCLUDED**

*you build these  
and other units*



\*tubes  
excluded

**RADIO-TELEVISION  
TRAINING SCHOOL**  
5100 S. VERMONT AVENUE  
LOS ANGELES 37, CALIFORNIA

Est. 1922



**ACT  
NOW!**

Get your free book on the  
**FAMOUS RTS BUSINESS PLAN**  
find out how you can open  
**A REPAIR SHOP OF YOUR OWN**

*We supply and finance your equipment*

When you are ready and qualified to operate one of our RTS-Approved TV Repair Shops **WE WILL SUPPLY AND FINANCE EVERY BIT OF EQUIPMENT YOU NEED TO GET STARTED** plus an inventory of parts and supplies. In other words **we will stake you . . . AN OFFER NEVER MADE BEFORE BY ANY TRAINING ORGANIZATION.** Under the RTS Business Plan you receive:

1. An electric sign for the shop front.
2. Radio and TV test Equipment.
3. Letterheads, calling cards, repair tickets, etc.
4. Basic inventory of tubes, parts, supplies.
5. Advertising and promotional material.
6. Plans for shop arrangement.
7. Instructions on how to go into business.
8. Continuous consultation and help.
9. The right to use RTS Seal of Approval, and the RTS Credo.
10. The right to use the Famous Trade Mark.



RTS' Membership in the Association of Home Study Schools is your assurance of Reliability, Integrity, and Quality of Training.

**ALL  
THESE  
FREE!**



**CUT OUT AND MAIL — TODAY!**

**RADIO-TELEVISION TRAINING SCHOOL**

5100 S. Vermont Avenue, Dept. PE-49,  
Los Angeles 37, California

SEND ME FREE — all of these big opportunity books — "Good Jobs in TV-Electronics," "A Repair Shop of Your Own" and "Sample Lesson." I am interested in:

- Radio-Television       Industrial Electronics (Automation)

Name \_\_\_\_\_ Age \_\_\_\_\_

Please Print

Address \_\_\_\_\_

City & State \_\_\_\_\_

300

# NOW The Short Cut to Learning You've Been Waiting for



Learn  
While You Sleep  
with the **DORMIPHONE**

The Scientific Discovery  
That Works FOR You . . .  
Awake and Asleep

Now, at last, science gives you an easy shortcut to learning. With university-tested Dormiphone, you "start" to learn while awake—then this amazing new tool takes over, continues the learning process for you while you sleep.

Do you want to learn a language—memorize a speech or an array of important facts, figures, formulas—Correct your speech—Break bad habits—Record and listen to music, spoken material? The Dormiphone is so simple to use, children benefit—so remarkable it is used by scientists, educators, psychologists, people of all ages and occupations for learning, teaching and entertainment.

## Break Down Barriers to Learning

Find out HOW the Dormiphone works FOR YOU—how it can help you learn in less time, without intensive self-application. Eliminate drudgery—SAVE YOUR TIME—EFFORT. Write for FREE Book, "A New Dimension in Learning," or call for FREE DEMONSTRATION—Get the Scientific Evidence Today.

### MODERNOPHONE, INC.

292-049 Radio City, New York 20, N. Y.

Gentlemen: Please send me your FREE Booklet. I am interested in learning more about the DORMIPHONE and what it can do for me. No obligation—no salesman will call.

If under 18, check here for Special Booklet A.

NAME .....

ADDRESS .....

CITY ..... ZONE ..... STATE .....

My main interest in the Dormiphone is for:

- |  |   |
|--|---|
| <input type="checkbox"/> Language Learning | <input type="checkbox"/> Speech Improvement     |
| <input type="checkbox"/> Memorization      | <input type="checkbox"/> Sleep Inducement       |
| <input type="checkbox"/> Habit Correction  | <input type="checkbox"/> School or College Work |



**NOW ... G-11**  
**2-way radio**  
for your  
personal use,  
business or  
pleasure



## Citizens' Communicator

FOR 11-METER CITIZENS' BAND

No exam for license . . . no code. U. S. Citizens required only to complete simple F.C.C. form. Write today for free booklet giving all details.

MEETS ALL F.C.C. REGS.  
... 5 WATTS INPUT POWER.  
BOTH TRANSMITTER AND RECEIVER QUARTZ CRYSTAL CONTROLLED. RELIABLE! NO TUNING!

TWO MODELS AVAILABLE. SPECIFY NO. 3303 FOR 115V AC OPERATION . . . NO. 3304 FOR 12V DC OPERATION.

COMPLETE 2-WAY STATION "PACKAGE" INCLUDES PRESS-TO-TALK MICROPHONE, QUARTZ CRYSTALS FOR ONE CHANNEL.

**124<sup>50</sup>**

WRITE TODAY FOR FREE BOOKLET!

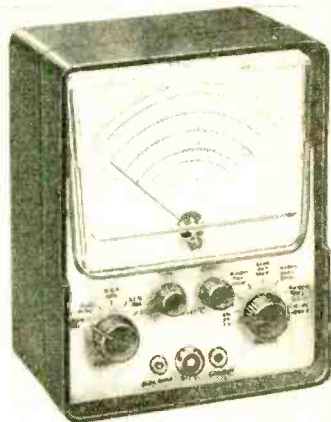
**GONSET**  
Burbank, Calif.

DIVISION OF  
YOUNG SPRING & WIRE  
CORPORATION.

# NEW products

## VACUUM-TUBE VOLTMETER

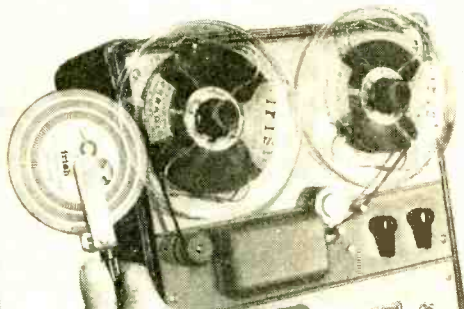
Available both in kit form and factory-assembled, the Arkay "VT-10" is a multi-purpose VTVM. It features a 400 micro-ampere movement, 1% precision resistors,



7 a.c. and d.c. ranges (plus a.c. peak-to-peak ranges), resistance from 0 to 1000 megohms, db, and other essential ranges. Price for the kit model, \$25.95; factory-wired, \$47.95. (Arkay, Inc., 88-06 Van Wyck Expressway, Richmond Hill 18, N. Y.)

## TAPE SPEED INDICATOR

A stroboscope designed for checking tape recorder speeds has been announced by the manufacturers of Irish tape, ORRadio In-



dustries, Inc., Shamrock Circle, Opelika, Alabama. The Irish stroboscope is held lightly against the surface of the moving



# 16 RADIO

Reg. U. S. Pat. Off.

## CIRCUITS AT HOME ONLY

with the New Deluxe 1959  
**PROGRESSIVE RADIO "EDU-KIT"®** \$22.95



- A Practical Home Radio Course**
- Now Includes**
- ★ TRANSMITTER
  - ★ SIGNAL TRACER
  - ★ SIGNAL INJECTOR
  - ★ CODE OSCILLATOR
  - ★ No Knowledge of Radio Necessary
  - ★ No Additional Parts or Tools Needed
  - ★ EXCELLENT BACKGROUND FOR TV
  - ★ School Inquiries Invited
  - ★ Sold in 79 Countries

**YOU DON'T HAVE TO SPEND HUNDREDS OF DOLLARS FOR A RADIO COURSE**

The "Edu-Kit" offers you an outstanding PRACTICAL HOME RADIO COURSE at a rock-bottom price. Our Kit is designed to train Radio & Electronics Technicians, making use of the most modern methods of training. You will learn radio theory, construction, practice and servicing. **THIS IS A COMPLETE RADIO COURSE IN EVERY DETAIL.**

You will learn how to build radios, using regular schematics; how to wire and solder in a professional manner; how to service radios. You will work with the standard type of punched metal chassis as well as the latest development of Printed Circuit chassis.

You will learn the basic principles of radio. You will construct, study and work with RF and AF amplifiers and oscillators, detectors, rectifiers, test equipment. You will learn and practice code, using the Progressive Code Oscillator. You will learn and practice trouble-shooting, using the Progressive Signal Tracer, Progressive Signal Injector, Progressive Dynamic Radio & Electronics Tester and the accompanying instructional material.

You will receive training for the Novice and Technician and General Classes of F.C.C. Radio Amateur Licenses. You will build 16 Receiver, Transmitter, Code Oscillator, Signal Tracer and Signal Injector circuits, and learn how to operate them. You will receive an excellent background for Television, Hi-Fi, and Electronics.

Absolutely no previous knowledge of radio or science is required. The "Edu-Kit" is the product of many years of teaching and engineering experience. The "Edu-Kit" will provide you with a basic education in Electronics and Radio, worth many times the complete price of \$22.95. The "Edu-Kit" alone is worth more than the price of the entire Kit.

### THE KIT FOR EVERYONE

You do not need the slightest background in radio or science. Whether you are interested in Radio & Electronics because you want an interesting hobby, a well paying business or a job with a future, you will find the "Edu-Kit" a worthy while investment.

Many thousands of individuals of all

ages and backgrounds have successfully used the "Edu-Kit" in more than 79 countries of the world. The "Edu-Kit" has been carefully designed, step by step, so that you cannot make a mistake. The "Edu-Kit" allows you to teach yourself at your own rate. No instructor is necessary.

### PROGRESSIVE TEACHING METHOD

The Progressive Radio "Edu-Kit" is the foremost educational radio kit in the world, and is universally accepted as the standard in the field of electronics training. The "Edu-Kit" uses the modern educational principle of "Learn by Doing." Therefore you construct, learn schematics, study theory, practice trouble-shooting—all in a closely integrated program designed to provide an easy-to-learn, thorough and interesting background in radio.

You begin by examining the various radio parts of the "Edu-Kit." You then learn the function, theory and wiring of these parts. Then you build a simple radio. With this first set you will enjoy listening to regular broadcast stations, learn theory, practice testing and trouble-shooting. Then you build a more advanced radio, learn more advanced theory and techniques. Gradually, in a progressive manner, and at your own rate, you will find yourself constructing more advanced multi-tube radio circuits, and doing work like a Professional Radio Technician.

Included in the "Edu-Kit" course are sixteen Receiver, Transmitter, Code Oscillator, Signal Tracer, and Signal Injector circuits. These are not unprofessional "breadboard" experiments, but genuine radio circuits, constructed by means of Professional wiring and soldering on metal chassis, plus the new method of radio construction known as "Printed Circuitry." These circuits operate on your regular AC or DC house current.

### THE "EDU-KIT" IS COMPLETE

You will receive all parts and instructions necessary to build 16 different radio and electronics circuits, each guaranteed to operate. Our Kits contain tubes, tube sockets, variable, electrolytic, mica, ceramic and paper dielectric condensers, resistors, tie strips, coils, hardware, tubing, punched metal chassis, Instruction Manuals, hook-up wire, solder, etc.

In addition, you receive Printed Circuit materials, including Printed Circuit chassis, special tube sockets, hardware and instructions. You also receive a useful set of tools, a professional electric soldering iron, and a self-powered Dynamic Radio & Electronics Tester. The "Edu-Kit" also includes Code Instructions and the Progressive Code Oscillator, in addition to F.C.C.-type Questions and Answers for Radio Amateur License training. You will also receive lessons for servicing with the Progressive Signal Tracer and the Progressive Signal Injector, a High Fidelity Guide and a Quiz Book. You receive Membership in Radio-TV Club, Free Consultation Service, Certificate of Merit and Discount Privileges. You receive all parts, tools, instructions, etc. Everything is yours to keep.

### PRINTED CIRCUITRY

At no increase in price, the "Edu-Kit" now includes Printed Circuitry. You build a Printed Circuit Signal Injector, a unique servicing instrument that can detect many Radio and TV troubles. This revolutionary new technique of radio construction is now becoming popular in commercial radio and TV sets.

A Printed Circuit is a special insulated chassis on which has been deposited a conducting material which takes the place of wiring. The various parts are merely plugged in and soldered to terminals.

Printed Circuitry is the basis of modern Automation Electronics. A knowledge of this subject is a necessity today for anyone interested in Electronics.

### FREE EXTRAS

- SET OF TOOLS
- SOLDERING IRON
- ELECTRONICS TESTER
- PLIERS-CUTTERS
- ALIGNMENT TOOL
- WRENCH SET
- VALUE DISCOUNT CARD
- CERTIFICATE OF MERIT
- TESTER INSTRUCTION MANUAL
- HIGH FIDELITY GUIDE & QUIZZES
- TELEVISION BOOK & RADIO TROUBLE-SHOOTING BOOK
- MEMBERSHIP IN RADIO-TV CLUB
- CONSULTATION SERVICE & FCC AMATEUR LICENSE TRAINING
- PRINTED CIRCUITRY

### SERVICING LESSONS

You will learn trouble-shooting and servicing in a progressive manner. You will practice repairs on the sets that you construct. You will learn symptoms and causes of trouble in home, portable and car radios. You will learn how to use the professional Signal Tracer, the unique Signal Injector and the dynamic Radio & Electronics Tester. While you are learning in this practical way, you will be able to do many a repair job for your friends and neighbors, and charge fees which will far exceed the price of the "Edu-Kit." Our Consultation Service will help you with any technical problems you may have.

J. Stataitis, of 25 Poplar Pl., Waterbury, Conn., writes: "I have repaired several sets for my friends, and made money. The "Edu-Kit" paid for itself. I was ready to spend \$240 for a Course, but I found your ad and sent for your Kit."

### FROM OUR MAIL BAG

Ben Valerio, P. O. Box 21, Magna, Utah: "The Edu-Kits are wonderful. Here I am sending you the questions and also the answers for them. I have been in Radio for the last seven years, but like to work with Radio Kits, and like to build Radio Testing Equipment. I enjoyed every minute I worked with the different kits; the Signal Tracer works fine. Also like to let you know that I feel proud of becoming a member of your Radio-TV Club."

Robert L. Shuff, 1534 Monroe Ave., Huntington, W. Va.: "Thought I would drop you a few lines to say that I received my Edu-Kit, and was really amazed that such a bargain can be had at such a low price. I have already started repairing radios and phonographs. My friends were really surprised to see me get into the swing of it so quickly. The Troubleshooting Tester that comes with the Kit is really swell, and finds the trouble, if there is any to be found."

### UNCONDITIONAL MONEY-BACK GUARANTEE

#### ORDER DIRECT FROM AD—RECEIVE FREE BONUS

#### RESISTOR AND CONDENSER KITS WORTH \$7

Send "Edu-Kit" postpaid. I enclose full payment of \$22.95.

Send "Edu-Kit" C.O.D. I will pay \$22.95 plus postage.

Rush me FREE descriptive literature concerning "Edu-Kit."

Name .....

Address .....

**PROGRESSIVE "EDU-KITS" INC.**

1186 Broadway, Dept. 555D, Hewlett, N. Y.

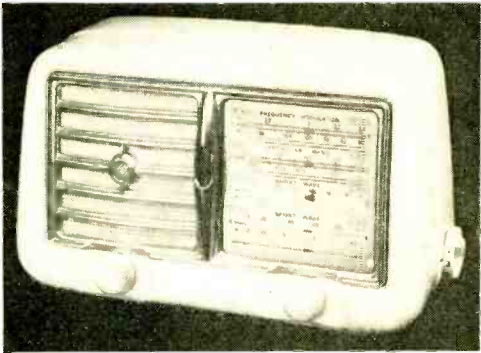
## products

(Continued from page 24)

tape on the recorder's supply reel. If the speed is accurate, the radial lines on the stroboscope will appear to be standing still when viewed under artificial light. The stroboscope may be used at 3¼ ips, 7½ ips, and 15 ips. Retail price, \$4.95.

### "FOUR-BANDER" RECEIVER

Model G-307, an AM/FM/short-wave receiver, has recently been introduced by American Gelo Electronics, Inc., 312 Sev-

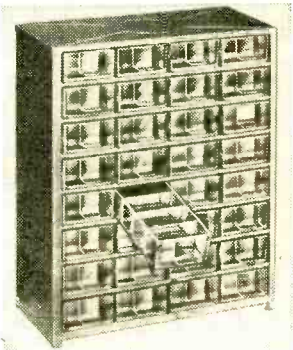


enth Ave., New York 1, N. Y. It features complete coverage of the AM and FM bands and covers the short-wave bands from 1.6 to 12 mc. Sensitivity is 3 microvolts for 20-db quieting and audio response is from 200 to 10,000 cps with built-in speaker. List price, \$79.95.

### SMALL PARTS CABINETS

"Haz-Bin, Jr." J-2 Series cabinets feature a molded plastic one-piece four-compartment drawer.

The compartments have cash-register-type bottoms so that parts too small to pick up with the fingers can be easily rolled out. Drawers are molded of clear styrene and have safety stops to prevent



accidental spilling and press-on labels to facilitate indexing contents.

These cabinets are made of welded steel with a baked-on silver-gray hammertone

**Choose XCELITE**  
*Hand Tools... the Professionals do!*

You need the **BEST TOOLS**  
to do the **BEST JOB** . . .

Your Radio, TV and  
Electronic Parts Distributor has them!

Select from the Complete XCELITE Line of  
Quality Tools and Handy Kits . . .

**XCELITE, INCORPORATED**  
ORCHARD PARK, NEW YORK  
Canada: Charles W. Pointon, Ltd., Toronto

**XCELITE**  
*Quality Hand Tools*  
PREFERRED BY THE EXPERTS

## Does your stereo have three sounds?

New stereo owners often hear a *third* sound: ugly turntable rumble. Here's why:

Most standard phonos were designed so that vibration was aimed in a vertical direction. The up-and-down movement is O.K. for *monophonic* cartridges. But in stereo, this vertical bucking makes your records sound as if they had acid indigestion.

What to do? You could purchase a very expensive turntable. Or, for a modest sum, you can get a Sonotone "8T" ceramic stereo cartridge. It has an exclusive vertical rumble suppressor...acts like the springs on your car to absorb vertical motion...and greatly reduce turntable noise.

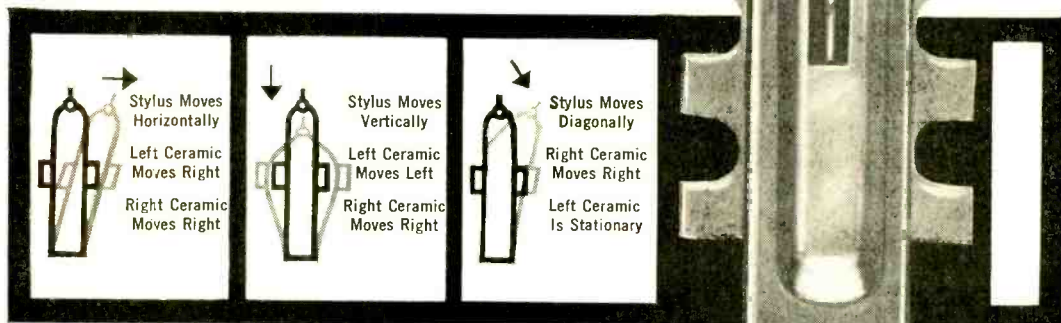
You'll *hear* the difference when you get Sonotone and prices of Sonotone stereo cartridges start at only \$6.45 (including mounting brackets).

**FREE!** "Stereo Simplified" booklet—tells you how stereo operates. Write to:

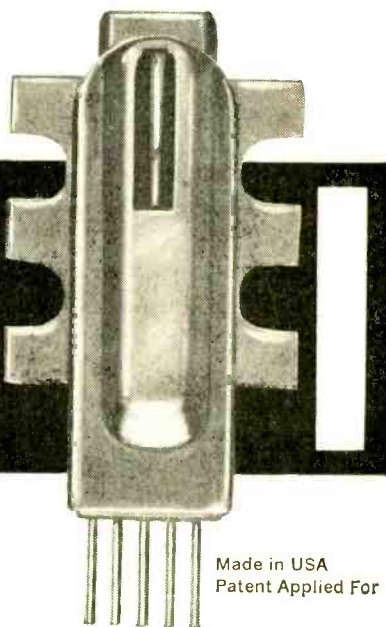
**Sonotone** CORP.  
Electronic Applications Division, Dept. CG-49  
**ELMSFORD, NEW YORK**



For Every Tonearm...  
The Professional Touch



This differential ring is the heart of Weathers Ring Filter Technique. The diagrams show how each component of the mixed signal is separated and delivered to its proper ceramic. Three relationships are shown: 180° out of phase; in phase; and a signal on one channel only.



Made in USA  
Patent Applied For

## The StereoRamic Cartridge

Here is a stereo cartridge unlike any cartridge you have ever seen—in performance, construction and design. It is smaller, lighter, and it fits your tonearm or changer without modification. Completely wired and ready for use, the Weathers StereoRamic Cartridge C-501 is shielded against hum, and plugs directly into the phono magnetic input of your preamplifier. It tracks with optimum compliance over a wide range of tracking forces and has a flat matched response on both channels from 15 to 30,000 cycles. But the biggest feature is its complete lack of cross talk. This is possible through the use of Weathers Ring Filter Technique, the simplest and most efficient means of securing positive separation between channels—better than 25 db. And it is exclusive with Weathers. Ask your dealer for a demonstration. He has it in stock.

C-501 D Diamond Stylus \$17.50

C-501 S Sapphire Stylus \$9.75

*Weathers Industries*  
DIVISION OF ADVANCE INDUSTRIES, INC.

66 E. Gloucester Pike, Barrington, N. J.

## Make over 150 Small Computing and Reasoning Machines with

# BRAINIAC®

### A BETTER ELECTRIC BRAIN CONSTRUCTION KIT

ONLY \$17.95—WHY PAY MORE?

**EQUALS THE ORIGINAL GENIAC®** electric brain construction kit (1955) **PLUS** many improvements and additions: over 600 parts—including 116 improved patented wipers so that all switches work well. Instead of covering only 33 machines, BRAINIAC gives full specifications for 151 computing, reasoning, arithmetical, logical, puzzle-solving and game-playing machines—all 33 GENIACS (1955), 13 TYNIACS (1956), and 105 BRAINIACS (1957-58), etc.



**THIS IS BRAINIAC!** With our Brainiac Kit K 17, you can build small electric brain machines and toys which "think," compute, reason, and display intelligent behavior. Each one works on a single flashlight battery. . . . is FUN to make, FUN to use and play with, and TEACHES you something new about electrical computing and reasoning circuits. All connections with nuts and bolts—no soldering required. Originated and produced exclusively by Berkeley Enterprises. Brainiac is the result of 8 years' design and development work with miniature mechanical brains including: Geniac (see "Geniacs: Small Electric Brain Machines and How to Make Them" by Edmund C. Berkeley, 64 pp., published by Berkeley Project, a partnership with Oliver Garfield discontinued September 1955); Tyniac (1956); Relay Moe (automatic relay machine playing tit-tat-toe—pictured in Life Magazine, March 19, 1956); Simon (miniature automatic digital computer with 129 relays—see "Simple Simon" by E. C. Berkeley in Scientific American, November 1, 1950); Squee (electronic robot squirrel—see "Light Sensitive Electronic Beast" by E. C. Berkeley in Radio Electronics, Dec. 1951), etc.

**WHAT CAN YOU MAKE WITH BRAINIAC KIT K 17?** Over 150 machines including: LOGIC MACHINES: Syllogism Prover, Intelligence Test, Boolean Algebra Circuits, Douglas MacDonal'd's Will Analyzer. A Simple Kallin-Burkhart Logical Truth Calculator, etc. GAME-PLAYING MACHINES: Tit-Tat-Toe, Nim, Wheeled Bandit, Black Match, Sunders 21, etc. COMPUTERS: To add, subtract, multiply or divide using decimal or binary numbers. Forty-Year Calendar, Prime Number Indicator, Money-Changing Machine, etc. CRYPTOGRAPHIC MACHINES: Coders, Decoders, Lock with 15,000,000 combinations, etc. PUZZLE-SOLVING MACHINES: The Missionaries and the Cannibals, Age-Guessing Machine, Submarine Rescue Chamber, Daisy Petal Machine, Fox-Hen-Corn & Hired Man, Uranium Space Ship and the Space Pirates, The Three Monkeys Who Spurred Etil, General Alarm at the Fortress of Dreadeerie, etc. QUIZ MACHINES: History, geography, trigonometry, grammar, statistics, calculus, etc.

**WHO IS EDMUND C. BERKELEY?** Author of "Giant Brains or Machines That Think," Wiley, 1949, 270 pp. (15,000 copies sold); author of "Computers: Their Operation and Applications," Reinhold, 1958, 398 pp.; Editor & Publisher of the magazine, *Computers and Automation*; Maker and Developer of small robots; Fellow of the Society of Actuaries; Secretary (1947-53) of the Association for Computing Machinery; Designer of all the Tyniacs and Brainiacs, more than half of the 33 Geniacs (1955); Designer of the Patented Multiple Switch Disc and other features in the 1955 Geniac kit.

#### WHAT COMES WITH YOUR BRAINIAC KIT . . .

##### Complete Plans, Instructions, Explanations & Hardware:

- Every part needed to build Geniacs, Tyniacs, Brainiacs—over 600 pieces including control panel, multiple switch discs, jumpers, improved wipers, bulbs, sockets, washers, wire, battery and special tools.
- Complete descriptions of 151 experiments and machines.
- Over 160 circuit diagrams including 46 exact wiring templates.
- Manual "Tyniacs: Small Electric Brain Machines and How to Make Them" by Edmund C. Berkeley, 1956, 48 pages—includes Introduction to Boolean Algebra for Designing Circuits.
- "How to Go From Brainiacs and Geniacs to Automatic Computers" by Edmund C. Berkeley.
- Dr. Claude E. Shannon's historic 1938 paper given before the American Institute of Electrical Engineers: "A Symbolic Analysis of Relay and Switching Circuits," 12 pages.

**BRAINIAC KIT (1958 Model) K 17** . . . the kit with limitless possibilities—backed by an organization of 10 years standing in the computer field. . . . **\$17.95**

(For shipment west of Mississippi, add 80¢; outside U. S., add \$1.80)

**7-Day Full Refund Guarantee If Not Satisfactory**

MAIL THIS COUPON

BERKELEY ENTERPRISES, Inc.  
85 Washington St., R 183, Newtonville 60, Mass.  
Please send me Brainiac Kit K 17, (returnable in 7 days for full refund if not satisfactory—if in good condition.) I enclose \$ . . . . . in full payment.  
My Name and Address are attached.

## products

(Continued from page 26)

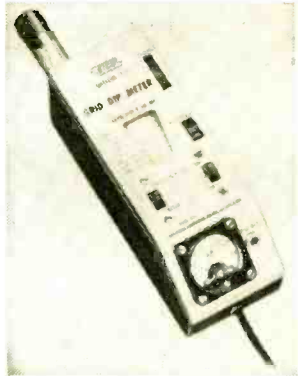
finish. They are available with 32, 48, 64, 96 or 128 drawers and have 128 to 512 permanently molded compartments. (Akro-Mils, Inc., Akron 9, Ohio)

### STEREO TAPE OFFER

Stereo tape enthusiasts will be interested to know that a special promotion offer by *Reeves Soundcraft* is still in effect. Whenever you buy two reels of Soundcraft tape, for only \$1.00 additional one blank tape may be exchanged for a prerecorded tape of "Sweet Moods of Jazz in Stereo," featuring Coleman Hawkins, "Red" Allen, Chubby Jackson, and other greats of the jazz world. This is a wonderful way to supplement your stereo tape library inexpensively. Your record dealer can fill you in on the details.

### GRID DIP METER

Basically a VFO with a microammeter in its grid circuit, the EICO Model 710 grid dip meter determines the frequency of other oscillators or tuned circuits. It features a sensitivity control and phone jack to facilitate "zero beat" listening. It is easy to hold and thumb-tune with one hand, and provides



continuous coverage of broadcast, FM, ham and TV bands in seven ranges (with a complete set of pre-wound, pre-calibrated, 0.5% accuracy coils supplied). In kit form, \$29.95. Factory wired, \$49.95. (EICO, 33-00 Northern Blvd., Long Island City 1, N. Y.)

### "HOBBYIST" TAPE SPLICER

The Gibson Girl "Hobbyist" is a low-cost tape splicer which consists of a tape alignment guide and a special curved blade. The tape guide has self-sticking adhesive on it for mounting directly on or near a tape recorder.

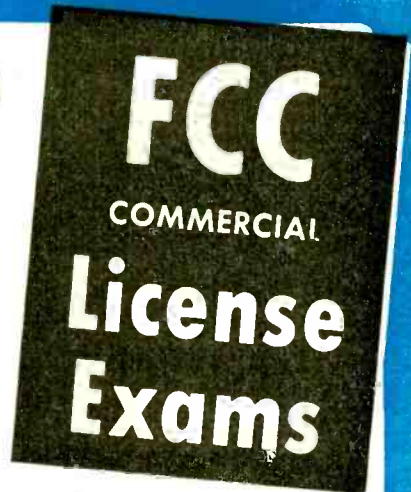
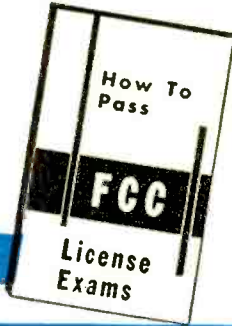
Tape to be spliced is placed in the tape guide in overlapping position. The blade is pressed down to cut a diagonal butt in the tapes. Splicing tape is applied and the





Accredited by the National Home Study Council

# How To Pass



Get Your FCC License Quickly

**We Guarantee** to train you until you receive **Your FCC License**

**We guarantee**  
to train you until you receive  
**Your FCC License**  
—or your money back

The Master Course in Electronics will provide you with the mental tools of the electronics technician and prepare you for a First Class FCC License (Commercial) with a radar endorsement. When you successfully complete the Master Course, if you fail to pass the FCC examination, you will receive a full refund of all tuition payments.

Cleveland Institute training results in job offers like these:

**Radio Operators & Technicians**  
American Airlines—Chicago, Detroit, St. Louis, Cincinnati and Cleveland—has openings for radio operators and radio mechanics. Operators must have a 2nd class FCC license and ability to type 40 wpm. Many company benefits.

**Service Technician**  
Man needed in Cleveland, Ohio, to service and maintain electronic medical instruments and equipment. Must have a solid knowledge of electronic fundamentals. A car is required. Company benefits include retirement plan.

**And our trainees get good jobs**

**"Investment in training really pays off"**

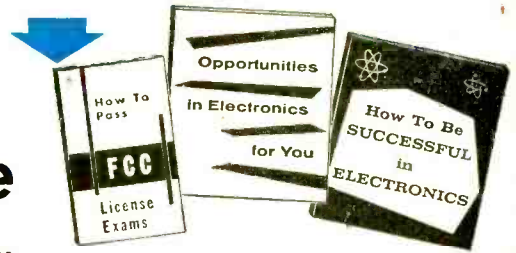
"Thought you would like to know that in almost two years since I completed your course and obtained my first phone license, my pay has increased \$5 per week every six months. I don't believe any other investment could pay off as well as this one did."

Harold E. Phipps, North Augusta, S. C.

**Cleveland Institute of Radio Electronics**

4900 Euclid Ave. Desk PE-50 Cleveland 3, Ohio

April, 1959



**Cleveland Institute of Radio Electronics**

Desk PE-50, 4900 Euclid Ave., Cleveland 3, Ohio

Please send Free Booklets prepared to help me get ahead in Electronics. I have had training or experience in Electronics as indicated below:

- |   |   |
|---|---|
| <input type="checkbox"/> Military           | <input type="checkbox"/> Broadcasting       |
| <input type="checkbox"/> Radio-TV Servicing | <input type="checkbox"/> Home Experimenting |
| <input type="checkbox"/> Manufacturing      | <input type="checkbox"/> Telephone Company  |
| <input type="checkbox"/> Amateur Radio      | <input type="checkbox"/> Other _____        |

In what kind of work are you now engaged?

In what branch of Electronics are you interested?

\_\_\_\_\_

Name \_\_\_\_\_ Age \_\_\_\_\_

Address \_\_\_\_\_

City \_\_\_\_\_ Zone \_\_\_\_\_ State \_\_\_\_\_

PE-50





**NOW!**  
at a price  
you can afford!

# MAKE MORE MONEY in TELEVISION RADIO-ELECTRONICS

**BETTER...MORE COMPLETE...LOWER COST...  
WITH NATIONAL SCHOOLS SHOP-METHOD  
HOME TRAINING!**

**BETTER...** Training that is proved and tested in Resident School shops and laboratories, by a School that is the **OLDEST** and **LARGEST** of its kind in the world.

**MORE COMPLETE...** You learn **ALL PHASES** of Television-Radio-Electronics.

**LOWER COST...** Other schools make several courses out of the material in our **ONE MASTER COURSE**... and you pay more for less training than you get in our course at **ONE LOW TUITION!**



These  
**two FREE** books will  
show you how!

You get all information  
by mail... You make  
your own decision... at  
home! **NO SALESMAN  
WILL CALL**

## TOP PAY... UNLIMITED OPPORTUNITIES LIFETIME SECURITY CAN BE YOURS!

You are needed in the Television, Radio, and Electronics industry! Trained technicians are in growing demand at excellent pay—in **ALL PHASES**, including Servicing, Manufacturing, Broadcasting and Communications, Automation, Radar, Government Missile Projects.

**NATIONAL SCHOOLS SHOP-METHOD HOME TRAINING**, with newly added lessons and equipment, trains you in your spare time at home, for these unlimited opportunities, including many technical jobs leading to supervisory positions.

**YOU LEARN BY BUILDING EQUIPMENT WITH KITS AND PARTS WE SEND YOU.** Your National Schools course includes thorough *Practical* training—**YOU LEARN BY DOING!** We send you complete standard equipment of professional quality for building various experimental and test units. You advance step by step, perform more than 100 experiments, and you build a complete TV set from the ground up, that is yours to keep! A big, new TV picture tube is included at no extra charge.

**EARN AS YOU LEARN.** We'll show you how to earn extra money right from the start. Many of our students pay for their course—and more—while studying. So can you!

### RESIDENT TRAINING AT LOS ANGELES

If you wish to take your training in our Resident School at Los Angeles, the world's TV capital, start **NOW** in our big, modern Shops, Labs and Radio-TV Studios. Here you work with latest Electronic equipment—professionally installed—finest, most complete facilities offered by any school. Expert, friendly instructors. Personal attention. Graduate Employment Service. Help in finding home near school—- and part time job while you learn. Check box in coupon for full information.

LESSONS AND INSTRUCTION MATERIAL ARE UP-TO-DATE, PRACTICAL, INTERESTING. Every National Schools Shop-Method lesson is made easy to understand by numerous illustrations and diagrams. All instruction material has been developed and tested in our own Resident School Shops, Laboratories and Studios.

**SEND FOR INFORMATION TODAY**... It can mean the difference between **SUCCESS** and failure for you! Send for your **FREE BOOK** "Your Future in Television-Radio-Electronics" and **FREE Sample Lesson**. Do it **TODAY**, while you are thinking about your future. It doesn't cost you anything to investigate!

### GET THE BENEFITS OF OUR OVER 50 YEARS EXPERIENCE

Approved for  
GI Training



**NATIONAL SCHOOLS**

Los Angeles 37, Calif.

### YOU GET...

- 19 Big Kits—**YOURS TO KEEP!**
- Friendly Instruction and Guidance
- Job Placement Service
- Unlimited Consultation
- Diploma—Recognized by Industry
- **EVERYTHING YOU NEED FOR SUCCESS!**

**SHOP-METHOD HOME TRAINING  
COVERS ALL PHASES OF INDUSTRY**

1. Television, including Color TV
2. Radio AM & FM
3. Electronics for Guided Missiles
4. Sound Recording and Hi-Fidelity
5. FCC License
6. Automation and Computers
7. Radar & Micro-Waves
8. Broadcasting and Communications

## NATIONAL TECHNICAL SCHOOLS

WORLD-WIDE TRAINING SINCE 1905

**MAIL NOW TO  
NATIONAL SCHOOLS, Dept R2G-49  
4000 S. FIGUEROA ST. LOS ANGELES 37, CALIF.**

Rush free TV-Radio "Opportunity" Book and sample lesson. No salesman will call.

NAME \_\_\_\_\_ AGE \_\_\_\_\_

ADDRESS \_\_\_\_\_

CITY \_\_\_\_\_ ZONE \_\_\_\_\_ STATE \_\_\_\_\_

Check if interested **ONLY** in Resident School training at Los Angeles

**VETERANS:** Give date of Discharge \_\_\_\_\_

# "The Capri"

## STEREO AMPLIFIER & PREAMP

"Tops In Quality & Fidelity"

LOW In PRICE... **\$3750**



For the First Time a stereo amplifier and preamp designed for eye and ear appeal for the particular audiophile

... yet at a price well below the cost of higher priced equipment without sacrifice of quality! "The Capri" provides rich, full range, high fidelity sound reproduction with low distortion and noise ... plus ultra modern styling. Frequency response 20 to 15,000 CPS ... Full power ... 10 watts. Variable frequency response on each section of amplifier allows compensation for all recordings. Place your order today! Satisfaction Guaranteed!

### CAPRI ELECTRONICS

Division of J & J Machine Co.

823 E. Jefferson Blvd.

Los Angeles 11, California

All orders prepaid ... Add 4% Sales Tax in California

*"Now, I must tell you, I have heard a speaker system that approaches the authenticity of concert hall performance"*

MISCHA ELMAN



## UNIVERSITY'S TOTALLY DIFFERENT STEREO SYSTEM—THE NEW 'TRIMENSIONAL' TMS-2

- Two complete speaker systems in one enclosure
- Unprecedented compactness—only 30" wide
- A third dimension to stereo sound ... DEPTH
- Placement anywhere in a room
- For monophonic and stereophonic reproduction
- Uncompromised quality at an attractive price

Send for **FREE 16 page brochure**. An informative guide to high fidelity stereo and monophonic speaker systems and components. Write Desk A-15, University Loudspeakers, Inc., White Plains, N. Y.



FAMOUS MEN OF MUSIC CHOOSE UNIVERSITY

# TIPS and TECHNIQUES

## REPAIRING MINIATURE EARPHONES

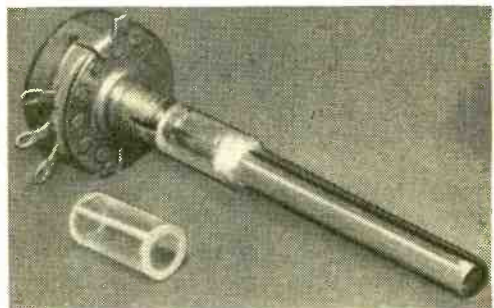
Occasionally the plastic plugs on miniature headphones become excessively loose after extended use. To remedy this, touch a hot soldering iron lightly to the threaded



portion of the plug. The heat will distort the surface sufficiently to form new, tighter fitting threads when the plug is replaced. —Peter Barna, Wilmington, Calif.

## TUBING COUPLES SHAFTS

If you ever find yourself in need of a control shaft coupler and discover that you don't have the needed size on hand, use plastic tubing. Just cut a length of tubing

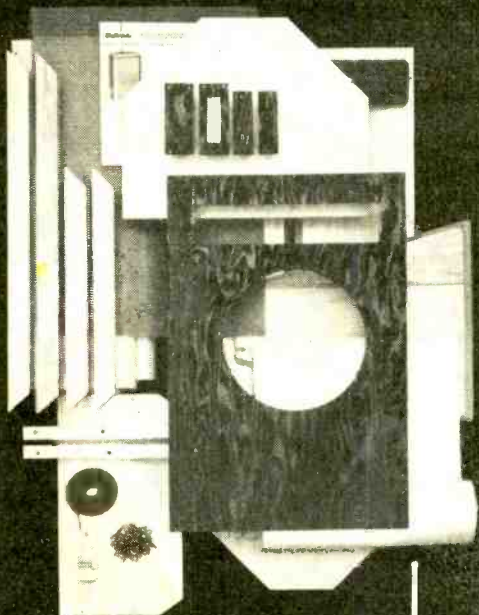


(with an appropriate inside diameter), force-fit it over the control shaft, and inset the extension as shown. If you need a reducer-type coupler, it's easy to cement a



# HEAR

## BASS NOTES DOWN TO 35 CPS... BUILD THE ELECTRO-VOICE ARISTOCRAT



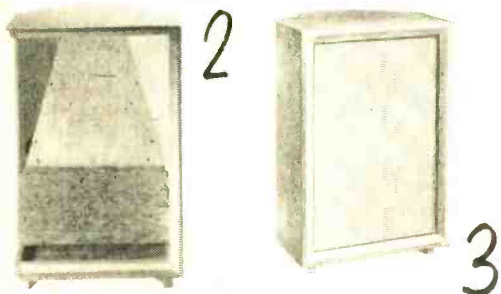
DRAMATIC PERFORMANCE has made the Electro-Voice Aristocrat the world's most popular enclosure for 12" loudspeakers. The Aristocrat will make an exciting difference in the performance of your loudspeaker—hear deep, extended bass response without annoying boom; sharp, well-defined low frequency transients, and all with greatly increased power handling capacity.


ASSEMBLE THE ARISTOCRAT YOURSELF AND SAVE 50%. When completed, the KD6 Aristocrat Kit interior construction is identical to E-V's factory-assembled Aristocrat enclosure, but with this difference: you save 50% and have an evening's fun.

AS EASY AS ONE . . . TWO . . . THREE. The KD6 Aristocrat Kit can be assembled in only one evening with E-V's exclusive pre-assembled parts and expanded view step-by-step instructions. All you need is a screw driver; the rest is in the box. And E-V's accurately milled, furniture grade woods and veneers plus a choice of six finishing kits create an enclosure that will match your finest furniture.

- Model KD6 Aristocrat Kit  
Audiophile Net. \$39.00
- Model FK Finishing Kits, each  
Audiophile Net. 5.00
- Factory Finished Aristocrat Enclosure, Mahogany  
Audiophile Net. 72.00
- Limed Oak or Walnut  
Audiophile Net. 79.00

Mail this coupon for free illustrated literature . . . see why more E-V Enclosure Kits have been built than all others combined.



 **Electro-Voice**®, INC.

BUCHANAN, MICHIGAN

**Superb New Products Through Research:**

- Microphones—Phono Cartridges—
- High Fidelity Loudspeakers and Enclosures—
- Public Address Speakers—
- Marine Instruments—Communication Equipment—
- Electronic Test Instruments and
- Material for Defense.

Electro-Voice, Inc.  
Buchanan, Michigan

Dept. PE-4

Gentlemen: Please send me free illustrated literature on E-V kits, enclosures and speakers.

NAME \_\_\_\_\_

ADDRESS \_\_\_\_\_

CITY \_\_\_\_\_ ZONE \_\_\_\_\_ STATE \_\_\_\_\_

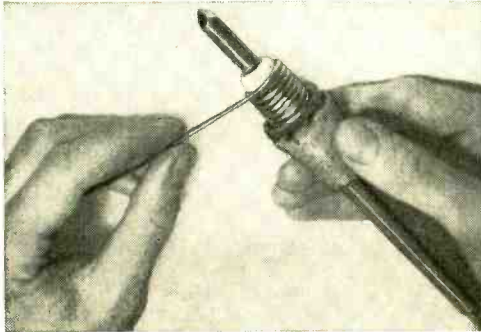
## Tips

(Continued from page 32)

small piece of tubing inside a larger size piece. A little solder on the control shaft will help assure a tight fit when the tubing tends to slip.—*Charles A. Lang, San Francisco, Calif.*

### LONGER LIFE FOR "PENCIL" IRONS

If you use a "pencil"-type soldering iron frequently or leave it plugged in for long periods of time, wrap some uninsulated,

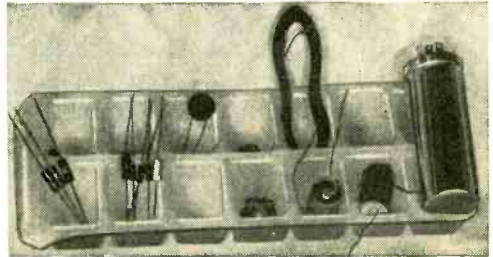


heavy solid-copper wire around the element's porcelain insulator. The coil of wire will act as a radiator to dissipate the excess

heat, thus increasing the useful life span of the iron.—*John A. Comstock, Wellsboro, Pa.*

### PARTS TRAY

Plastic ice cube trays make excellent containers for small parts. These inexpensive



multi-partitioned trays come in handy particularly when you are assembling kits and making the initial count of nuts, bolts, and electronic parts.—*Herman Landsman, Forest Hills, N. Y.*

### TROUBLE-SHOOTING ELECTRIC PADS

If you have an electric blanket or heating pad that operates intermittently, there is probably a break somewhere in the filament wires. But how does one go about lo-

## NOW YOU CAN SECURE A HIGH SALARIED • TOP PRESTIGE CAREER IN ELECTRONICS IN ONLY ONE YEAR!

**ELECTRONICS** is the fastest growing industry in America today, creating unlimited opportunities for high salaries, with rapid advancement in **INDUSTRY AND THE ARMED FORCES** for Bailey Trained electronic engineering technicians.

**LARGE CORPORATIONS** from coast to coast, and **BRANCHES OF THE ARMED FORCES** send recruiters to visit each graduating class at Bailey Tech, offering unusually high starting salaries.

**BAILEY GRADUATES ARE BEING HIRED** for such fascinating and interesting work as technical salesmen, research and development of guided missiles, electronic business machines and automatically controlled manufacturing plants, etc., also good **RATINGS IN THE ARMED FORCES.**

**UP TO SEVEN TECHNICIANS** are needed for every engineer... this, plus superior training is why Bailey Graduates are being paid more to start, and are advancing more rapidly than many men who have spent four years in training.

Resident training is easier and costs less than you may think! We provide housing and part-time jobs while in school, plus free nationwide employment service for graduates. If you want to quickly enter America's fastest growing and most exciting industry, write for free booklet... no obligation.

**VETERAN APPROVED**

**BAILEY TECHNICAL SCHOOLS**

1625 S. Grand • St. Louis 4, Mo.



This Minneapolis-Honeywell system controls hundreds of automatic manufacturing operations. Experience on live equipment is emphasized at Bailey and is another reason for the tremendous backlog of high pay positions waiting **BAILEY GRADUATES.**

### MAIL TODAY

Please mail immediately this free booklet without obligation

Name \_\_\_\_\_

Address \_\_\_\_\_

City \_\_\_\_\_ State \_\_\_\_\_





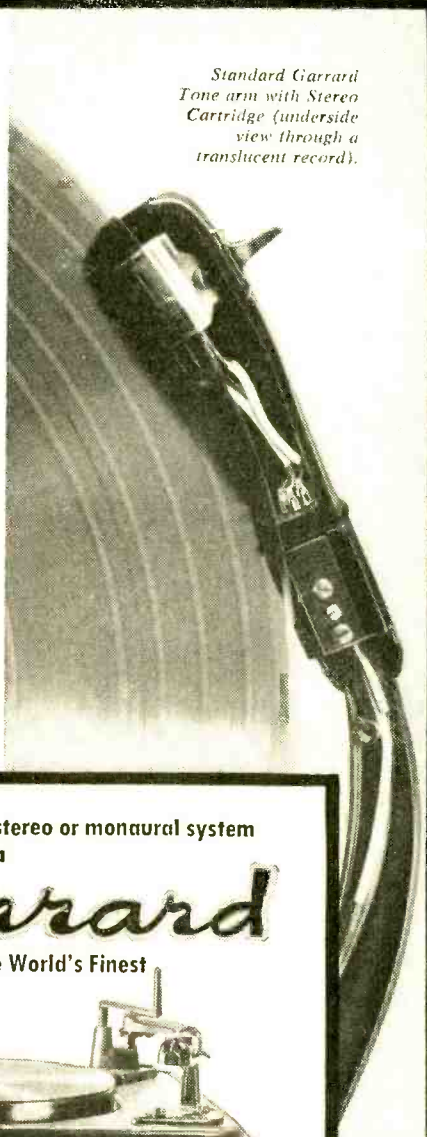
*For stereo  
and monaural,  
people who know  
high fidelity recom-  
mend this changer!*

**Confirm this with any  
experienced dealer!**

The Garrard changer reproduces music *precisely as recorded*, without introducing any distorting factors such as rumble or wow. A Garrard changer is actually a superb turntable combined with a scientifically engineered all-aluminum tone arm. This tracks at the *correct* stylus pressure without undesirable resonances.

When considering the claims of changers "specifically designed for stereo" or turntables "to play stereo properly", it is well to remember that for years Garrard changers have had *all* the qualities necessary for this type of sensitive reproduction.

*Standard Garrard  
Tone arm with Stereo  
Cartridge (underside  
view through a  
translucent record).*



For your stereo or monaural system  
insist on a  
**Garrard**  
The World's Finest



*There's a Garrard for every high fidelity system . . . all fully wired for stereo and monaural records. Six models: \$32.50 to \$89.00.*

*Mail this coupon for free Garrard Comparator Guide.*

**Garrard Sales Corp.,**

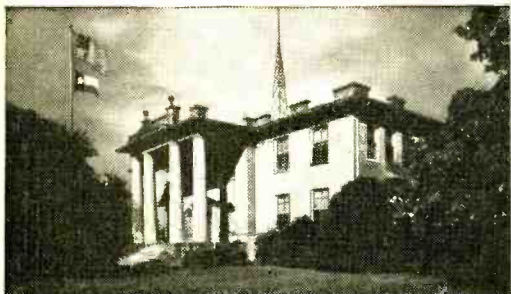
Dept. GD-359, Port Washington, N.Y.

Please send free Garrard Comparator Guide which compares all Garrard players and their advanced features.

Name

Address

City  Zone  State



# PORT ARTHUR COLLEGE

**ELECTRONICS • COMMUNICATIONS  
RESIDENT • CO-EDUCATIONAL  
AM-FM RADIO • TV STATIONS  
MARINE RADIO**

**TRAINING** Is the finest. Well equipped college classrooms and laboratories with AM, FM transmitters, radar and marine equipment, color fundamentals, transistors, television, camera chain, experimental laboratory test equipment, etc. used as standard part of curriculum.

**PRACTICAL** On-the-job-training program. College operates Radio Station KPAC, co-owner of KPAC-TV. You learn the interesting way. You learn by doing.

**G.I. APPROVED**

**CO-EDUCATIONAL** You enjoy the personal growth and cultural advantages that only the American co-educational college system can provide.

**LOW COST** Being a non-profit vocational institution explains our low tuition rates . . . \$36 per month. Room and board at campus dormitory only \$52 per month. Monthly payments accepted.

**FREE PLACEMENT** Our graduates are in demand at good salaries. We have trained men from all 49 states and abroad.

**INVESTIGATE** Write for illustrated booklet P-48 for further details. Classes now forming. Non high school graduates must pass entrance examination. Persons 21 years or older may be accepted on individual approval.

## PORT ARTHUR COLLEGE

PORT ARTHUR, P-481, TEXAS

Founded in 1909

## Tips

(Continued from page 34)

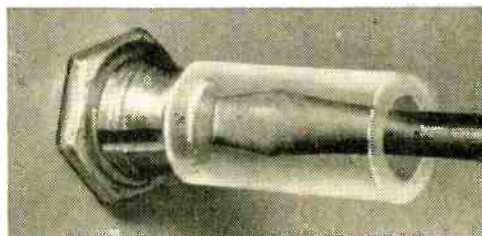
cating such a break without tearing the blanket or pad apart? Easily. Just plug in a nearby AM radio, turn it on, and turn up the volume. Now turn on the blanket or pad and start flexing it section by section



until you hear interference on the radio. The snapping and popping noises will indicate that you are near the place where the filament wires are broken.—*Jerome Cunningham, Chicago, Ill.*

### NO-SLIP FOR DRIVER'S TIP

It's time-consuming and frustrating to have the tip of your screwdriver or alignment tool slip from the screwdriver slot of a trimmer capacitor or service control when making adjustments. You can prevent this by slipping a  $\frac{3}{4}$ " length of clear plastic tubing with  $\frac{1}{4}$ "-inside diameter over



your screwdriver or alignment tool's tip as shown. Slide the tubing up the blade of the screwdriver when it isn't in use.—*John A. Comstock, Wellsboro, Pa.*

### USING BURNED-OUT FUSES

When a fuse burns out, most of us just toss it in the wastebasket and reach for another. But burned-out fuses can be used as miniature coil forms. They have excellent low loss characteristics. Just wind the coil on the glass portion and coat with dope or



# BUILD 125 COMPUTERS AT HOME WITH GENIAC®

ONLY \$19<sup>95</sup>

With the 1959 model GENIAC®, the original electric brain construction kit including seven books and pamphlets, over 400 parts and component rack, and parts tray, and all materials for experimental computer lab plus DESIGN-O-Mat®.

## A COMPLETE COURSE IN COMPUTER FUNDAMENTALS

The GENIAC Kit by itself is the equivalent of a complete course in computer fundamentals, in use by thousands of colleges, schools and industrial training labs and private individuals. Includes everything necessary for building an astonishing variety of computers that reason, calculate, solve codes and puzzles, forecast the weather, compose music, etc. Included in every set are seven books described below, which introduce you step-by-step to the wonder and variety of computer fundamentals and the special problems involved in designing and building your own experimental computers—the way so many of our customers have.

## ANYONE CAN BUILD IT!

You can build any one of these 125 exciting electric brain machines in just a few hours by following the clear cut step by step directions given in these thrilling books. No soldering required . . . no wiring beyond your skill. But GENIAC is a genuine electric brain machine—not a toy. The only logic and reasoning machine kit in the world that not only adds and subtracts but presents the basic ideas of cybernetics, boolean algebra, symbolic logic automation, etc. So simple to construct that a twelve year old can build what will fascinate a Ph.D. In use by thousands of schools, colleges, etc., and with the special low circuitry you can build machines that compose music, forecast the weather, which have just recently been added.

## TEXT PREPARED BY MIT SPECIALIST

Dr. Claude Shannon, known to the readers of Popular Electronics for his invention of the electronic mouse, that runs a maze, learning as it goes, formerly a research mathematician for Bell Telephone Laboratories is now a research associate at MIT. His books include publications on Communication theory and the recent volume "Automat Studies" on the theory of robot construction. He has prepared a paper entitled "A Symbolic Analysis of Relay and Switching Circuits" which is available to purchasers of the GENIAC. Covering the basic theory necessary for advanced circuit design it vastly extends the range of our kit.

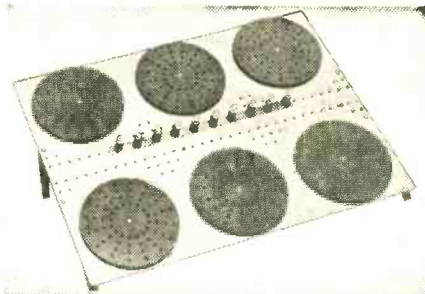
The complete re-designing of the 1958 kit and the manual as well as the special book DESIGN-O-MAT® was created by Oliver Garfield, author of "Minds and Machines," editor of the "Gifted Child Magazine" and the "Review of Technical Publications."

## KIT IS COMPLETE

The 1959 GENIAC comes complete with seven books and manuals and over 400 components.

- 1) A sixty-four page book "Simple Electric Brains and How to Make Them."
- 2) **Beginners Manual**—which outlines for people with no previous experience how to create electric circuits.
- 3) "A Symbolic Analysis of Relay and Switching Circuits" By Dr. Claude Shannon provides the basis for new and exciting experimental work by the kit owner who has finished book No. 1.
- 4) **DESIGN-O-MAT®** introduces the user to over 50 new circuits that he can build with GENIAC and outlines the practical principle of circuit design.
- 5) **GENIAC STUDY GUIDE** equivalent to a complete course in computer fundamentals, this guides the user to more advanced literature.
- 6) **A Machine to Compose Music** shows in an actual circuit what other GENIAC owners have been able to do on their own in designing new devices.
- 7) **A Machine to Forecast the Weather**—again a new adventure in scientific thinking created by one of our users who was trained on his GENIAC Kit.

Plus all the components necessary for the building of over 125 machines and as many others as you can design yourself.



OVER 20,000 SOLD

We are proud to announce that over 20,000 GENIACS are in use by satisfied customers—schools, colleges, industrial firms and private individuals—a tribute to the skill and design work which makes it America's leading scientific kit. People like yourself with a desire to inform themselves about the computer field know that GENIAC is the only method for learning that includes both materials and texts and is devoted exclusively to the problems faced in computer study.

You are safe in joining this group because you are fully protected by our guarantee, and have a complete question and answer service available at no cost beyond that of the kit itself. You share in the experience of 20,000 kit users which contributes to the success of the 1959 GENIAC—with DESIGN-O-Mat® the exclusive product of Oliver Garfield Co., Inc., a Geniac is truly the most complete and unique kit of its kind in the world.

## COMMENTS BY CUSTOMERS

We know the best recommendation for GENIAC is what is done for the people who bought it. The comments from our customers we like best are the ones that come in daily attached to new circuits that have been created by the owners of GENIACS. Recently one man wrote: "GENIAC has opened a new world of thinking to me." Another who designed the "Machine that Forecasts the Weather" commented:

"Several months ago I purchased your GENIAC kit and found it an excellent piece of equipment. I learned a lot about computers from the enclosed books and pamphlets and I am now designing a small relay computer which will include arithmetical and logical units . . . another of my pet projects in cybernetics is a weather forecaster. I find that your GENIAC kit may be used in their construction. I enclose the circuits and their explanation." Eugene Darling, Malden.

**Oliver Garfield Co., Inc.** Dept. PE-49  
108 East 16th St., N. Y. 3, N. Y.

Please send me at once the GENIAC Electric Brain Construction Kit, 1959 model. I understand that it is guaranteed by you and may be returned in seven days for a full refund if I am not satisfied.

- I have enclosed \$19.95 (plus 80¢ shipping in U. S., \$1.50 west of Miss., \$2.00 foreign), 3% New York City Sales Tax for N.Y. City Residents.
- Send GENIAC C.O.D. I will pay postman the extra C.O.D. charge.

Name .....

Address .....

The specs are the proof... now your  
BEST BUY in  
ham gear is

**EICO**®



New

**90-WATT CW TRANSMITTER . . #720**  
KIT \$79.95      WIRED \$119.95

Conservative, highly efficient design plus stability, safety, and excellent parts quality. 80 thru 40, 20, 15, 11, 10 meters (popular operating bands) with one knob band-switching. 6146 final amplifier for full "clean" 90 W input, protected by clamper tube. 6CL6 Colpitts oscillator, 6AQ5 clamper, 6AQ5 buffer-multiplier, GZ34 rectifier. "Novice limit" calibration on meter keeps novice inside FCC-required 75W limit. No shock hazard at key. Wide range, hi-efficiency pi-network matches antennas 50-1000 ohms, minimizes harmonics. EXT plate mod. terminals for AM phone modulation with 65W input. Excellent as basic exciter to drive a power amplifier stage to max. allowable input of 1KW. Very effective TVI suppression. Ingenious new "low silhouette" design for complete shielding and "living room" attractiveness. Conservatively rated parts, copper-plated chassis, ceramic switch insulation. 5" H, 15" W, 9½" D.



**NEW UNIVERSAL MODULATOR-DRIVER #730**  
KIT \$49.95      WIRED \$79.95      Cover E-5 \$4.50

Superb, truly versatile modulator at low cost. Can deliver 50 W of undistorted audio signal for phone operation, more than sufficient to modulate 100% EICO #720 CW Transmitter or any xmitter whose RF amplifier has plate input power of up to 100W. Multi-match output xmfr. matches most loads between 500-10,000 ohms. Unique over-modulation indicator permits easy monitoring, no need for plate meter. Lo-level speech clipping & filtering with peak speech freq. range circuitry. Low distortion feedback circuit, premium quality audio power pentodes, indirectly heated rectifier filament. Balance & bias adj. controls. Inputs for xtal or dynamic mikes, phone patch, etc. Excellent deluxe driver for high-power class B modulation. ECC83/12AX7 speech ampl., 6AL5 speech clipper, 6AN8 ampl. driver, 2-EL34/6CA7 power output, EM84 over-mod. indicator, GZ34 rect. Finest quality, conservatively rated parts, copper-plated chassis. 6" H, 14" W, 6" D.

**NEW GRID DIP METER . . . . . #710**  
KIT \$29.95      WIRED \$49.95 including complete set of coils for full band coverage.

Exceptionally versatile. Basically a VFO with microammeter in grid; determines freq. of other osc. or tuned circuits; sens. control & phone jack facilitate "zero beat" listening. Excellent absorption wave meter. Ham uses: pre-tuning & neutralizing xmitters, power indication, locating parasitic osc., antenna adj., correcting TVI, de-bugging with xmitter power off, determining C.L.Q. Servicing uses: alignment of filters, IF's; as sig. or marker gen. Easy to hold & thumb-tune with 1 hand. Continuous 400 kc-250 mc coverage in 7 ranges, pre-wound 0.5% accurate coils. 500 ua meter movement. 6AF4(A) or 614 Colpitts osc. Xmfr-operated sel. rect. 2¼" H, 2¼" W, 6¾" L. Satin deep-etched aluminum panel; grey wrinkle steel case.



**NOW IN STOCK!**  
Compare & take them home—right 'off the shelf'—from 1900 neighborhood EICO dealers. For free catalog mail coupon in EICO ad 2 pages forward. In the West, add 5%. Over 1 MILLION EICO instruments in use throughout the world.

**EICO**®

33-00 Northern Blvd.,  
Long Island City 1, N.Y.      Copr. © 1958.  
Electronic Instr. Co., Inc.

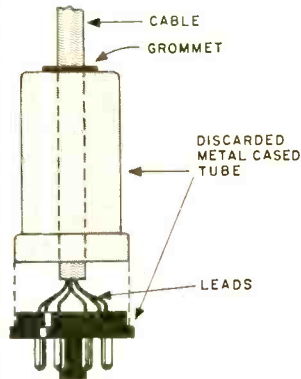
See EICO's other ad on page 40.

Tips (Continued from page 36)

varnish. Then solder the ends of the wires to the small metal ends of the fuse. It can now be mounted in fuse clips. Coils can be changed in a matter of seconds.—Bob Cutler, Oswego, Ore.

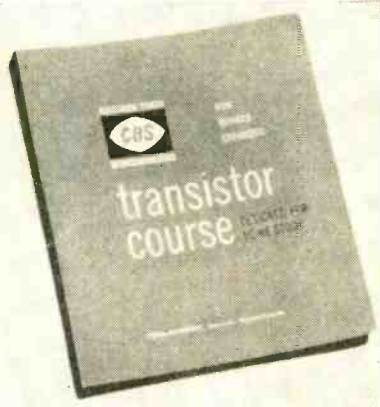
**OCTAL PLUG FROM TUBE**

An octal plug can be made from a discarded metal-cased tube. First, remove the metal shell by prying it loose with a screw-driver; the glass envelope and shell will come loose when the base pins are heated. Now drill a 3/8" hole in the top of the metal case and install a rubber grommet. The cable is then brought through the shell and soldered to the pins.—Edward Kuschner, New York, N. Y.



**TRANSISTOR COURSE**

The experimenter versed only in electron tubes can get on the transistor bandwagon with a completely revised and expanded edition of the CBS-Hytron Transistor Course. Said to be the first home-study course of its kind, it covers the latest, up-to-the-minute semiconductor devices and applications. This transistor course is avail-



able through your local CBS-Hytron distributor or from CBS-Hytron, Dept. T.C., Danvers, Mass. Why not investigate? Transistor knowledge can go a long way.





**Low Cost Stereo Starts Here**

LIFE OF THE PARTY: PACEMAKER MODEL 2212

# NOW... *Pacemaker Stereo* only \$69.95

**A complete 2-Channel Stereo Amplifier, rated at 14 watts.**

**Plays stereo records, stereo tape, stereo tuner -- and monaural, too!**

**All the convenience of one set of controls for both stereo channels.**

**Makes the perfect "stereo starter" set. A great gift idea.**

Looking for stereo on a small budget? Then listen to the new Pacemaker line of fine quality stereo components.

Shown above is the lowest cost stereo component of them all. The Pacemaker Model 2212 is a complete 2-Channel 14-Watt stereo amplifier with dual inputs for ceramic phono, FM-AM Stereo Tuner or Stereo Tape Transport Pre-Amplifiers.

One of four new Pacemaker components from Bell, this compact stereo amplifier is all you need to start your own stereo system. Fully assembled, it costs even less than "do it yourself" kits. Simply plug in your record changer, tuner or tape player, connect to your speakers—and you're all set.

Note the "inside" information on this low cost stereo amplifier: it has push-pull output stages and full AC Transformer operated power supply.

See it . . . hear it . . . your Bell dealer has Pacemaker stereo on display *now*.

*All these Pacemaker components are now available:*

*All prices shown include decorative cover. Slightly higher West of Rockies.*



New Stereo Tuner . . . only \$109.95  
Pacemaker Model 2222 FM-AM Stereo Tuner is the perfect match for your Pacemaker Stereo Amplifier.



Trade up to Pacemaker Stereo  
Another fine Pacemaker Stereo Amplifier . . . 10 Watts each Channel. Model 2221 . . . now only \$99.95 (With Trade-in).



Pacemaker FM Tuner Enjoy your favorite FM Broadcasts. Add this FM Tuner to your High Fidelity System today. Model 2216 . . . only \$69.95.

**Bell Sound Division • THOMPSON RAMO WOOLDRIDGE INC.**  
555 MARION ROAD • COLUMBUS 7, OHIO

In Canada: Thompson Products, Ltd., Toronto • Export: 401 Broadway, New York, N.Y.

The experts say...  
 in HI-FI and TEST  
 INSTRUMENTS your best  
 buy is **EICO**



33-00 Northern Blvd., L. I. C. 1, N. Y. PE-4

Show me HOW TO SAVE 50% on 63 models of top-quality equipment (in box I have checked here):

HI-FI  TEST INSTRUMENTS  HAM GEAR

Send FREE literature & name of neighborhood EICO dealer.

Name.....  
 Address.....  
 City..... Zone..... State.....  
 Add 5% in the West



**New!**  
 Miniaturized  
 MULTI-SIGNAL  
 TRACER #145A  
 KIT \$19.95  
 WIRED \$28.95



VACUUM TUBE  
 VOLTMETER #221  
 KIT \$25.95  
 WIRED \$39.95



PEAK-TO-PEAK  
 VTVM #232  
 & UNI-PROBE  
 (pat. pend.)  
 KIT \$29.95  
 WIRED \$49.95



**New!**  
 1000 OHMS/VOLT  
 V-O-M #536  
 KIT \$12.90  
 WIRED \$14.90



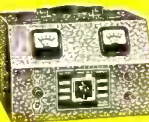
5" PUSH-PULL  
 SCOPE #425  
 KIT \$44.95  
 WIRED \$79.95  
 DC-5 MC 5" SCOPE  
 KIT \$79.95  
 WIRED \$129.50



TUBE TESTER #625  
 KIT \$34.95  
 WIRED \$49.95



**New!**  
 Series/Parallel  
 R-C COMBINATION  
 BOX #1140  
 KIT \$13.95  
 WIRED \$19.95



6V & 12V BATTERY  
 ELIMINATOR  
 & CHARGER #1050  
 KIT \$29.95  
 WIRED \$38.95  
 Extra-filtered for  
 transistor equip.  
 #1060 KIT \$38.95 WIRED \$47.95



R-C BRIDGE & R-C-L  
 COMPARATOR #950B  
 KIT \$19.95  
 WIRED \$29.95

1350 Combinations!

IN TEST INSTRUMENTS  
 IN HI-FI... STEREO and MONAURAL



**New!**  
 STEREO DUAL  
 AMPLIFIER-PREAMPLIFIER HF81  
 including cover:  
 KIT \$69.95. WIRED \$109.95  
 STEREO DUAL PREAMPLIFIER HF85  
 KIT \$39.95 WIRED \$64.95



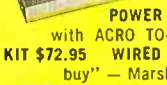
NEW STEREO POWER  
 AMPLIFIER HF86  
 KIT \$43.95  
 WIRED \$74.95  
 60-WATT  
 ULTRA LINEAR



12-WATT  
 WILLIAMSON-TYPE  
 INTEGRATED AMPLIFIER HF12  
 KIT \$34.95 WIRED \$57.95  
 "Packs a wallop" POP. ELECTRONICS  
 "First rate"—MODERN HI-FI



MASTER CONTROL  
 PREAMPLIFIER HF65A:  
 KIT \$29.95 WIRED \$44.95  
 with power supply HF65:  
 KIT \$3.95 WIRED \$49.95 Superb  
 new design... new "low sil-  
 houette" look.



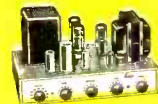
POWER AMPLIFIER HF60  
 with ACRO T0-330 Output Xfmr  
 KIT \$72.95 WIRED \$99.95 "excellent  
 buy" — Marshall, AUDIOCRAFT.



2-WAY  
 SPEAKER  
 SYSTEM HFS1  
 complete with  
 factory-built cabinet:  
 \$39.95



FM TUNER  
 HFT90  
 KIT, less cover \$39.95\*  
 WIRED, less cover \$65.95\*  
 COVER, \$3.95 \*FET incl.  
 NEW AM TUNER HFT94  
 KIT \$39.95 WIRED \$65.95  
 Includes cover & fet



50-WATT  
 ULTRA-LINEAR  
 INTEGRATED  
 AMPLIFIER HF52  
 KIT \$69.95 WIRED \$109.95  
 "Excellent value"—Hirsch-Houck Labs.



STANDARD SPEAKER  
 SYSTEM HFS2:  
 Completely factory-built  
 \$139.95 "would suggest  
 unusual suitability for  
 stereo... eminently  
 musical!"  
 —Holt, HIGH FIDELITY



20-WATT  
 ULTRA-LINEAR  
 WILLIAMSON-TYPE  
 INTEGRATED AMPLIFIER HF20  
 KIT \$49.95 WIRED \$79.95  
 "Well-engineered"  
 — Stocklin, RADIO TV NEWS

**IN STOCK!**

Compare, take them home—right "off the shelf"—from 1900 neighborhood EICO dealers. Over 1 MILLION EICO instruments in use throughout the world.

Fine for Stereo—  
 MODERN HI-FI

Copyright 1958 by Electronic Instr. Co., Inc.





## **RUSSIAN JAMMING**

### **The Electronic Iron Curtain**

It is nearly 0400 hours, Moscow time. In a corner of the Soviet capital everyone sleeps except for one family which is huddled over an ancient short-wave receiver. The operator adjusts the tuning dial.

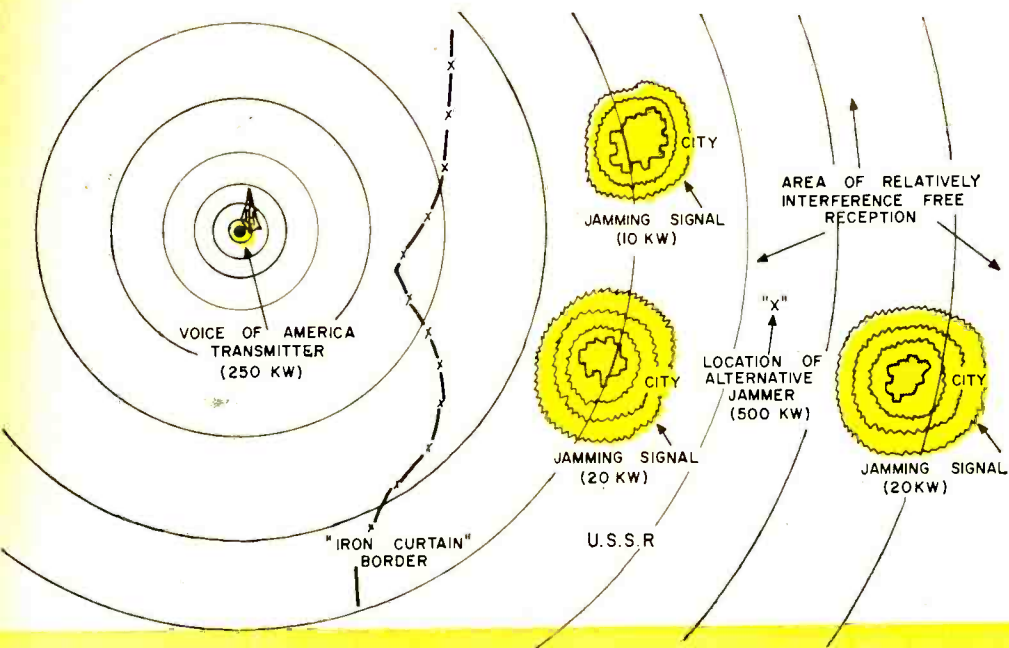
"Just one minute more," think the early-morning listeners.

The radio signal the Russians are listening to comes in loud and steady, with a clear rolling fade which indicates that there are thousands of miles separating these listeners from the transmitter about to speak. Everyone catches his breath as the voice from the loudspeaker comes to life:

"This program is coming to you from the United States of America. The following news program is brought to you in the Russian language . . ."

Suddenly the room is filled with a gathering roar that blots out the voice they are so eager to hear. The noise whipsaws across the signal and burns in their ears. Frantically the operator turns the dials of the receiver, trying to escape the unintelligible chaos of noise smothering the voice of the free world.

Sadly, the operator turns off the receiver, and the family disperses . . .



**T**HE Soviet Union started deliberate radio interference with the Russian language broadcasts of the United States and England shortly after the end of World War II. At the present time over 2500 separate jamming stations are scattered throughout the USSR and the satellites in an effort to blanket reception of the 85 transmitters of the Voice of America. They try to blot out all 16 frequencies used by the VOA.

When the Polish government ceased its radio jamming operations a few years ago, it informed the world of the cost of these operations. For every dollar spent by the Voice of America to produce the Polish language programs, the Polish government spent over one hundred dollars in a vain attempt to obliterate reception!

The total cost of the Communist jamming effort is estimated at over 100 million dollars. The evident fear of Voice of America operations is shown by the fact that the Soviets jammed the United Nations broadcasts over the VOA, even during the periods when the Soviet delegates were speaking!

**Jamming Techniques.** Jamming a high-power radio station is a complicated as well as an expensive job. The general jamming technique takes the form of superimposing random noises and sounds upon the identical carrier frequency of the offending trans-

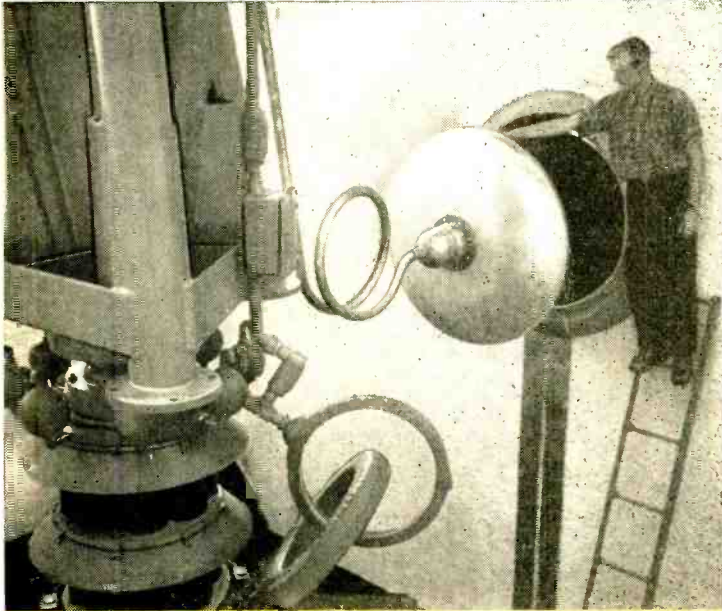
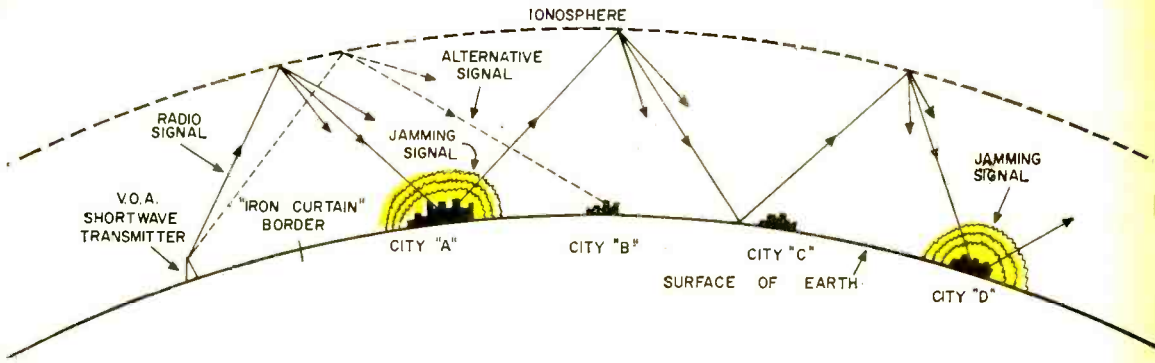
**Three separate** jamming transmitters must be employed to "protect" three cities from one Voice of America transmitter, as shown above. A single high-power jammer at point "X" wastes power over unpopulated areas. Separate jammers provide maximum suppression in the cities, but leave countryside free from interference.

mitter. Since it is usually impossible to locate the jamming equipment near the station to be jammed, the "jammer" is generally placed close to large population centers, where there are conceivably many receivers capable of tuning to the channel of the politically undesirable station.

The jamming signal usually consists of a buzz-saw-like noise, or random musical tones superimposed upon a steady buzz, much in the manner of a bagpipe. In rare instances, the jamming transmitter superimposes a program of its own atop the unwanted station. Jamming stations generally identify themselves by a two-character call sign, which may change frequently.

**Ground-Wave Jamming.** Radio communication during daylight hours in the broad-





Short-wave signals are reflected back to earth by the ionosphere so that cities "A" and "D" (in diagram above) must each have a jammer. A shift of frequency of the transmitter or a change in the ionosphere can project the signal to cities "B" and "C," so that all four cities must have separate jamming equipment to suppress a single transmitter completely.

**Antenna tower base** of the million-watt Voice of America transmitter in Munich, Germany (photo at left), showing the feedthrough insulator and lightning surge loop. The high-power broadcast station can override most jamming signals.

cast band (500-1600 kc.) normally takes place by means of the ground wave, that portion of the radio wave which travels along or over the surface of the earth. Its usable range is a hundred miles or so.

The power of many European broadcast stations is about 150,000 to 250,000 watts (compared to a maximum limit of 50,000 watts in the United States). These stations are capable of producing a strong signal on even the most primitive radio receiver. To obliterate this signal over a small area such as a single city, a jamming transmitter of 10,000 to 15,000 watts may be employed. However, when it is desired to jam a large area of several thousand square miles, it is either necessary to use many jamming transmitters of this power spread over the area, or else one or two high-powered jammers equal to or greater in strength than the undesired station.

In general, the former technique seems to be in use,

at the present time as twenty or thirty jammers are usually employed to block out the broadcast-band transmissions of the various VOA transmitters in Europe. The Soviets have found to their sorrow that a jammer signal weaker in strength than the undesired signal is worse than useless; it merely calls attention to the station that is condemned for obliteration!

**Sky-Wave Jamming.** During the evening hours, the characteristics of the broadcast band change, permitting excellent reception from stations many hundreds of miles away. This permits the VOA to reach deep within the Soviet Union with its programs of news and information.

Since the jamming equipment is not near the transmitting station, the jamming signal does not "overlap" the broadcast reception of the offensive station at points within Russia. This forces the Soviets to employ additional jamming equipment at various places. Dozens of jammers may be required to silence effectively a single radio station in a few populated areas, leaving relatively good reception of the unwanted station in sparsely settled areas.

**Short-Wave Jamming.** Due to the nature of short-wave propagation, a powerful short-wave transmitter is capable of blanketing tremendous areas of the Soviet Union, all of which must be covered by competing jammers in order to obliterate the signal. The action of short-wave "skip" is a result of the transmitted wave being radiated up into the ionosphere to be bent downward in a reflected ray returning to earth a considerable distance from the transmitter.

The amount of bending and distance covered depends upon many factors, most of which are uncontrollable. Separate jamming stations must be employed at each "skip point," since the "skip distance" of the jamming signal cannot be relied upon to be the same as that of the offending signal.

It can thus be seen that the problem of silencing literally hundreds of stations operating on various broadcast and short-wave frequencies is an extremely large operation.

**Equipment Used.** Special transmitting stations for jamming operations have been developed by Soviet engineers. These stations are designed for rapid frequency shifting and are capable of heavy noise modulation.

The usual modulation consists of a buzz-

saw noise that completely fills a band of five or six kilocycles each side of the carrier frequency. Jamming equipment of this type is known to have power levels up to 1,000,000 watts!

As auxiliary jamming equipment, the Soviets sometimes press broadcasting stations into use, transmitting noise and chaos instead of the usual programs.

**Anti-Jamming Techniques.** Well aware of the jamming operations, the VOA and the British Broadcasting Corporation have several techniques at their disposal to combat jamming.

The most obvious and effective technique is to increase the power and range of the existing stations, and to add more stations, thus improving the coverage of the USSR. The VOA, for example, now broadcasts about 500 "transmitter-hours" (hours of broadcast multiplied by number of transmitters) daily to the Soviet Union, the satellites, and Red China.

A second technique is to change the wavelength (frequency) of the transmitting station, thus evading the jammer. This is usually impractical, as the Russians monitor the station being jammed and are quick to retune the jamming equipment when any frequency change is noted. Also, abrupt frequency changes make reception difficult for the listener.

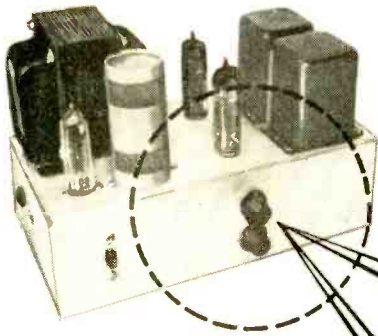
Another evasive action is to choose a transmitter frequency immediately adjacent to the frequency used by a Soviet broadcast station, so that the program cannot be jammed without jamming the Russian broadcast.

**Is Jamming Effective?** Proof that the VOA programs are penetrating the barrage of jamming is evident from the amount of abuse heaped upon this activity by the Soviet Government.

Careful screening of refugees pouring into Berlin from the east confirms the value of every dollar spent in the electronic war. Clandestine listening posts behind the Iron Curtain listen to the voices of freedom and report reception. Also letters smuggled out of the Soviet zones of influence attest to the impact these broadcasts have upon their audience.

It is therefore well known that the broadcasts do pierce the interference, and are successful in combating the efforts to prevent the flow of information and truth from reaching the citizens of the Soviet Union.





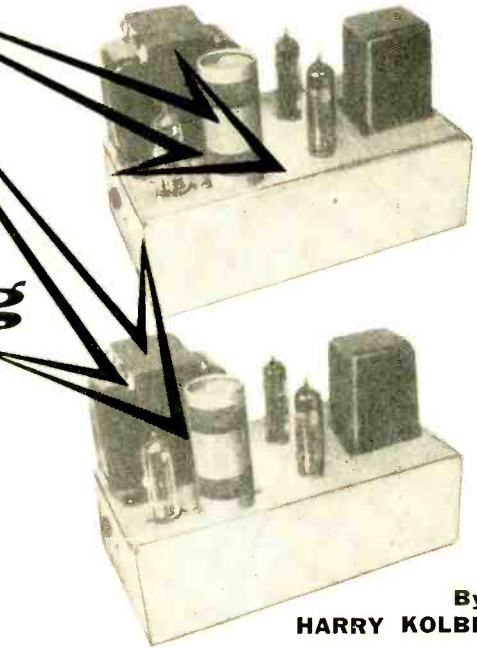
**New circuit  
converts standard amplifier  
to stereo operation**

## **Stereo Simplexing Simplified**

**T**HE AVERAGE PERSON who considers the purchase of a stereo sound system suddenly finds himself faced with two rather formidable obstacles—money and space. A complete stereo system, after all, requires at least two preamplifiers, two power amplifiers, two speaker systems, two tuners, and a tape or phono playback unit. Even assuming we are able to save enough lunch money to finance a stereo system, where will we find space to put it all?

To a great extent, the audio industry has successfully alleviated these problems. The two preamplifiers have evolved into the stereo preamp, which is less expensive and occupies much less space. With the advent of FM multiplex, only an FM tuner and a converter will be needed to receive broadcast stereo. The phonograph playback unit remains essentially the same as the monaural unit except that the monaural cartridge must be replaced by a stereo cartridge. As far as speaker systems are concerned, manufacturers have designed smaller systems that provide true hi-fi performance.

**Enter Simplex.** One of the most expensive links in the stereo chain is the power amplifier. We face the same problems of



**By  
HARRY KOLBE**

cost and space. But some scientists at CBS Laboratories have found a solution. They call it "The Two-Way Stereo Amplifier." This amplifier uses a *single* push-pull output stage plus an extra output transformer to amplify *two* independent signals. Space requirements and cost are only slightly greater than those of a single-channel amplifier.

This new development has aroused considerable interest and it is very probable that *simplexing*, as it is called, will revolutionize the design of stereo amplifiers. The Heath Company has recently announced that it will soon bring forth a stereo system using the CBS simplex system.

Operation of the stereo simplex amplifier is based on an old technique used by broadcast line engineers for years. The principle of simplex is best illustrated by Fig. 1. The circuit looks like a conventional push-pull output stage except for an additional transformer ( $T_2$ ), connected in series with

what would normally be the B-plus center-tap of push-pull output transformer  $T1$ .

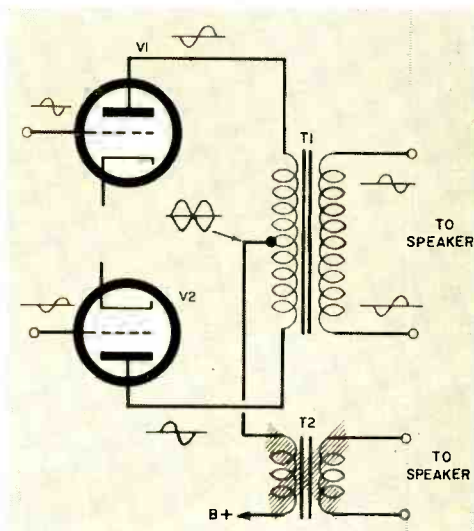
Let us consider what happens when two equal but *opposite* ( $180^\circ$  out-of-phase) signals are applied to the grids of the output tubes ( $V1$  and  $V2$ ). The two signals will appear at each end of the primary winding of the output transformer  $T1$ , and induce a signal into the secondary winding. Everything is working exactly as a push-pull output stage should. But what happens with  $T2$ ? The answer is—nothing, as long as the push-pull output stage is perfectly balanced. Since the signal currents at the center-tap of  $T1$ 's primary winding are equal and opposite, they cancel each other and no signal current flows through  $T2$ .

Now consider Fig. 2. If we apply two equal but *inphase* signals to the grids of  $V1$  and  $V2$ , the signal will be equal and inphase at the primary of  $T1$ . The induced signals in each half of the secondary winding will now be  $180^\circ$  out of phase and thus will cancel each other. Due to this cancellation, no signal will appear at the secondary winding of  $T1$ . But the signal *does* appear at the secondary winding of  $T2$ . How? Well, if the two signals from the plates of the output tubes are equal and inphase, the total inphase signal voltage will appear at the center-tap of  $T1$ 's primary winding. This voltage will be developed across the primary of  $T2$  and thus will be induced into the secondary of  $T2$ .

**CBS Simplex.** So far, what we have been describing is just plain "simplex." Since such a circuit can handle two independent signals with very little interaction, it could be used to amplify the left and right stereo channels independently and simultaneously. However, in such a setup, the stereo channel using the push-pull output transformer ( $T1$ ) channel would have greater power-handling ability than the channel using  $T2$ . Here is where the CBS modification of the simplex system comes to the rescue.

This modification is based on the relationships between the vertical and horizontal components of the 45-45 stereo record groove. Although the two channels of information in the stereo groove are usually thought of as being left and right, the channels can also be analyzed for the degree that they appear as vertical and horizontal motion. The horizontal swing of the groove contains information from both channels which we will refer to as left plus right, or

Fig. 1. Out-of-phase signal voltages applied to grids of output tubes cause a signal voltage to be developed across  $T1$ , but no voltage appears across  $T2$ .



( $L+R$ ).<sup>\*</sup> The vertical motion is equal to left minus right ( $L-R$ ), or the "difference" signal. In general, the sum signal ( $L+R$ ) carries the bulk of the power, while the difference signal ( $L-R$ ) carries the stereophonic information.

Each channel engraved on the stereo record contains portions of *both* the sum and the difference signals, but in different phase relationships. When the cartridge terminals are connected (phased) normally, one channel contains the difference signal *plus* the sum signal, or  $(L-R) + (L+R)$ ; the other channel contains the difference signal *minus* the sum signal, or  $(L-R) - (L+R)$ .

Let's see what happens when the cartridge connections are phased for use in the CBS simplex system.

Referring to Fig. 3, the output of one channel of the stereo cartridge,  $(L-R) + (L+R)$ , is applied to the grid of  $V1$ . The output of the other channel,  $(L-R) - (L+R)$ , is fed to  $V2$ . Since  $(L+R)$  and the  $-(L+R)$  are  $180^\circ$  out of phase, they will

<sup>\*</sup> This is evident since we know a monophonic cartridge can yield a balanced sum signal from a stereo record (not taking into consideration that most mono cartridges will damage the delicate grooves of a stereo record).



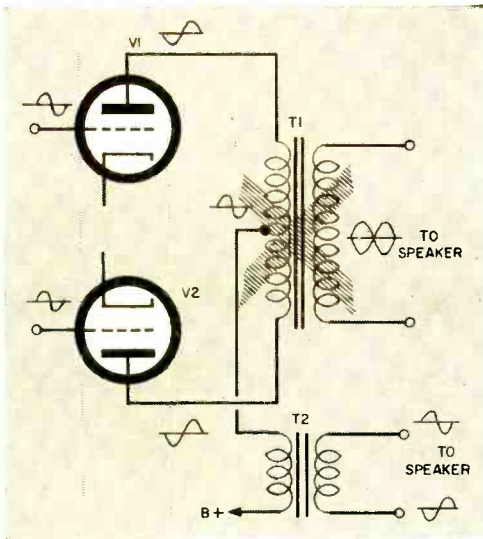


Fig. 2. Inphase signal voltages applied to grids of output tubes cause a signal voltage to be developed across T2, but no voltage appears across T1.

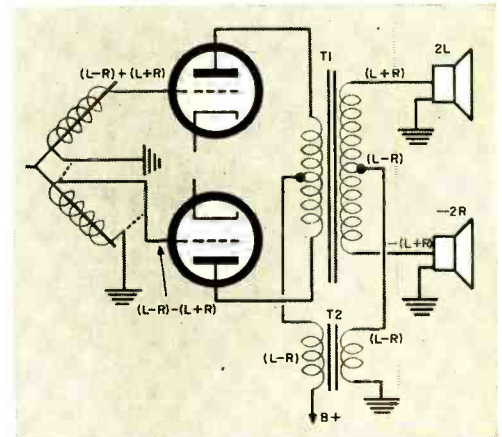
be amplified in push-pull. The (L-R) components are *inphase* and thus will be handled by transformer T2.

At the secondary of T1, we have at the top of its winding the induced signal (L+R); and at the bottom we have -(L+R). When the (L-R) signal is induced across T2 and is fed to the center-tap of the secondary of T1, it will combine with (L+R) at the top of T1 to form 2L, or the left channel:  $(L+R) + (L-R) = 2L$ . At the bottom of T1, (L-R) combines with -(L+R), or -L-R, to form -2R, or the right channel. The minus sign before the 2R means only that the speaker phasing must be reversed.

**Double Output.** Now what have we achieved by all these algebraic acrobatics? Plenty, because a stereo amplifier that employs the CBS simplex system, when used with a properly phased 45-45 stereo cartridge, will furnish two-channel operation with *each* channel providing an output as high as that achieved by a single standard push-pull amplifier. Naturally, full power won't be obtained from each channel simultaneously. But on most stereophonic program material simultaneous full power from both channels is rarely called for. Each channel of a CBS-simplaxed stereo amplifier will also provide the low-distortion operation characteristic of push-pull output circuits.

The necessary phasing relationships between the outputs of a stereo cartridge can easily be made with any four-terminal

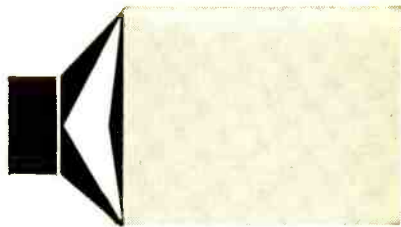
Fig. 3. The CBS simplex circuit uses a "45-45" stereo cartridge as a signal source. Conventional cartridge phasing is reversed. The dotted lines indicate conventional connections.



stereo cartridge merely by reversing the connections from *one* of the stereo output pairs. Stereo cartridges with three terminals pose a more difficult problem. If the manufacturer doesn't supply a three-terminal cartridge already phased for CBS simplex operation, there's not much you can do about it. At this writing, one manufacturer, CBS-Hytron, is supplying three-terminal stereo cartridges in two models, one for conventional hookup, and one for the CBS simplex hookup. Perhaps more manufacturers will follow suit in the near future.

Stereo program sources other than 45-45 records can be handled by a CBS-simplaxed amplifier, but the second channel will operate at a lower output level. If an amplifier has an effective output of 10 watts on each channel when playing 45-45 stereo records, the outputs per channel will be about 10 watts and 6 watts for the push-pull and the parallel channels, respectively, when playing stereo tapes, AM-FM broadcasts, FM-FM multiplex, etc.

A simplaxed stereo amplifier is presented with all necessary construction details in the article beginning on the next page. -30-



# Build the Stereoplex

By HARRY KOLBE

**T**HE AMPLIFIER to be described here was designed and built as a practical application of stereo simplex principles. High quality stereo at maximum economy was the goal, and anyone who has been reluctant to shell out the money for two amplifiers, or who would like a second stereo system for his playroom or summer house, will find that the "Stereoplex" is an excellent choice.

The Stereoplex consists of a simplex-connected push-pull feedback amplifier plus a power supply on a 5"x7"x3" chassis. It employs only three tubes: two 6BM8/ECL82 voltage amplifier-output tubes, and one 6X4 rectifier.

The compactness and low cost of the Stereoplex is made possible through the recent introduction of a new audio tube by Amperex and a recent modification of the simplex circuit by CBS. The new tube—the 6BM8/ECL82—is a 9-pin miniature tube combining a high-mu triode and a power output pentode in the same envelope. These combined characteristics of the 6BM8/ECL82 allow the design of a medium-power amplifier with but two tubes plus rectifier. The further advantages of simplex operation permit this amplifier to serve as a complete two-channel stereo amplifier.

**Features.** Despite its compactness and simplicity of construction, the Stereoplex boasts an effective output of 10 watts from

each channel. At an output level of one watt, the frequency response is flat within  $\pm 1$  db from 30 cps to 20,000 cps and is down only 1.8 db at 20 cps. Use of negative feedback results in a total harmonic distortion of only 1.5% at full output.

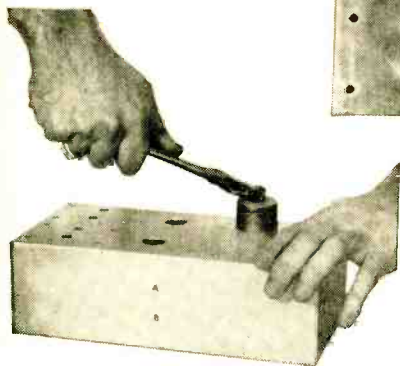
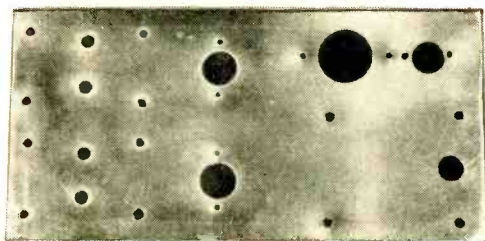
Channel separation is 25 db at 1000 cps; hum and noise is down 70 db. Each channel is equipped with its own volume control, and a power take-off socket may be added to provide power for auxiliary equipment.

The input sensitivity is high enough so that most ceramic or crystal stereo cartridges may be plugged in directly, thus eliminating the need for a preamplifier. These stereo cartridges usually have .25 to 0.5 volt output, and are relatively inexpensive. The author has had excellent results with the Sonotone 8T, the CBS-Hytron SC-2, and the Ronnette BF-40 stereo cartridges.

**Construction.** The first step in construction is the preparation of the chassis. A light aluminum chassis is recommended since it is easily worked and helps minimize stray hum paths. Lay out the chassis as shown. If you have a set of chassis punches, the task will be greatly facilitated. For a professional-looking job the drilled and punched chassis may be rubbed with fine steel wool, then sprayed with clear Krylon lacquer to preserve the luster. Application







The chassis as it appears after drilling and punching. Use of Greenlee punches greatly facilitates chassis preparation.

of Walsco audio decals will add the finishing touch.

Mount the tie points first since it may be awkward to do so later. No difficulty in wiring should be encountered if the usual wiring practices are followed. Be sure to twist all filament leads together tightly and keep the input and output wiring as far apart as possible. Use shielded wire between the input jacks and the volume controls and between the volume controls and the tube input grids.

Use three-lug screw-type terminal boards at the speaker outputs; only two lugs are required for each speaker, but the third provides a handy spot to mount the feedback resistor. It is of the utmost importance to follow the color coding and connection of

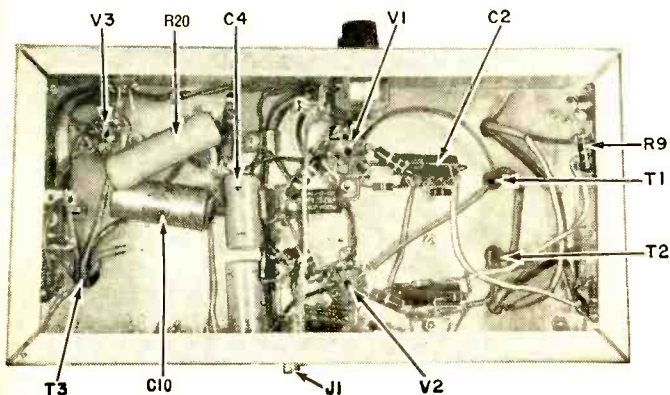
the output transformers as indicated on the schematic.

**Operation.** Proper operation of a simplex-connected amplifier is dependent on the phase relationships between the two input signals. A standard 45-45 stereo cartridge is capable of presenting this relationship to the amplifier if properly connected. Proper connection of the four-terminal stereo cartridge requires only the reversal of one set of leads. See "Stereo Simplexing Simplified" on page 45 for more information. In any case, to return the amplified signals to their proper phase relationship, simply change the phasing of one of the speakers.

This amplifier has been used with two "Duo-Flex" speakers (see POPULAR ELECTRONICS, Feb. '59) and the over-all quality from this small and inexpensive system is quite good. The highs are crisp and clean while the bass is present in ample quantity. And with more expensive speaker systems, results are excellent.

The sound output is more than adequate for the average living room. With the level controls cranked up only halfway, the room is filled with sufficient sound to drown out all conversation. Anyone who constructs the Stereoplex will be rewarded with many hours of pleasant listening.

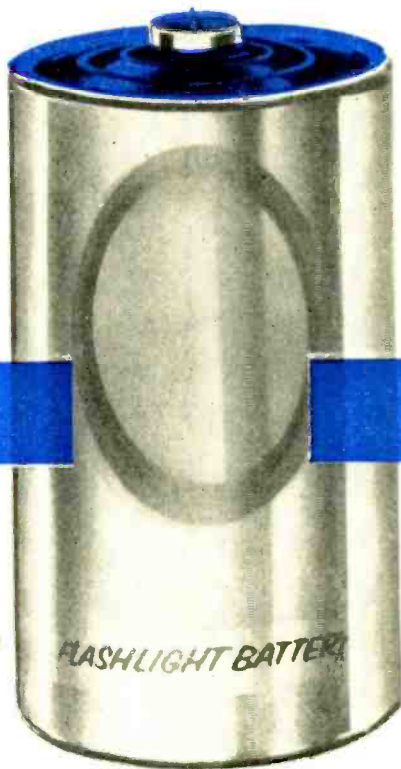
-30-



**Underchassis** view of completed amplifier. The high-voltage secondary winding of T3 may vary in value from the one specified. Also adjust R20 for about 250 volts at point A in the schematic.



# INSIDE the DRY CELL



A DRY CELL is a "package of electricity" which produces electrical energy by chemical means. A quick look inside a portable radio, a flashlight or a hearing aid will reveal one or more of these compact power sources ready to deliver the juice at the flip of a switch.

How does the dry cell produce electricity? Without going into chemical reaction formulas, let's take a look at what goes on inside a dry cell.

**What Goes On.** In Fig. 1, a typical dry cell is shown in cross section. Its zinc outer case serves as the negative electrode of the cell. The positive electrode is formed by a cylindrical carbon rod in the center of the cell. Separating the two electrodes is a pasty substance composed of an *electrolyte* and a *depolarizing mix*.

Due to chemical action between the electrolyte (ammonium chloride) and the zinc case, electrons pile up on the sides of the zinc container and bubbles of hydrogen gas travel through the electrolyte and cling to the sides of the carbon rod. As the bubbles pile up, they tend to choke off the action of the cell.

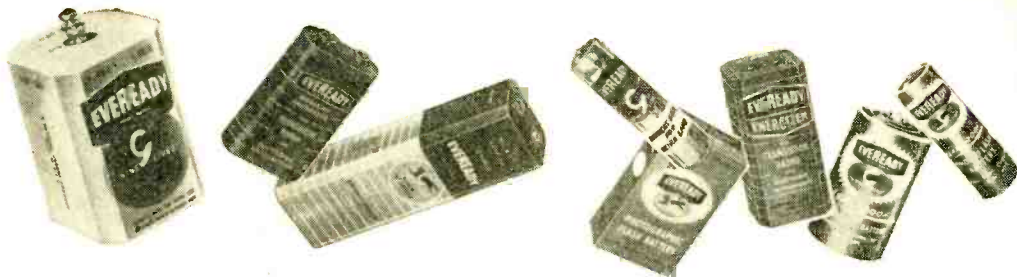
Here is where the depolarizing mix goes to work. Since it is composed of manganese dioxide, which has a high content of

oxygen, it mixes its oxygen with the hydrogen bubbles and water is formed. This gets rid of the unwanted hydrogen and also keeps the electrolyte from drying up.

When someone connects the battery into a circuit, the electrons leave the zinc and travel into the circuit in the form of an electrical current. Then they return through the carbon rod to complete the circuit. But what's happening to the zinc while all this is going on?

As the battery action takes place, the zinc is gradually eaten away. While the battery is in use, hydrogen bubbles are

By  
SAUNDER HARRIS  
WINXL



formed even faster than they can be removed by the depolarizing mix. This is why your battery must be given a rest every so often. The depolarizer must be allowed to catch up on its work.

Now let's see what happens when the battery is exhausted. The zinc walls of the cell get thinner and thinner, and the electrolyte—instead of being in paste form—dries out into powder. The depolarizing mix stops doing its job and the hydrogen bubbles around the positive carbon element just about stop all flow of electrons. Figure 2 will give you some idea of the condition of the cell at this point. This dry cell has had it.

**Life of a Battery.** Knowing what goes on inside the cell, it is now time to answer the question most important to you as a battery user. How long will your batteries last?

According to the National Bureau of Standards, in 1910, under standard testing procedures, a size "D" cell would give 260 minutes of service under intermittent use. In 1951, the testing of 12 to 15 brands of the same size "D" cell showed an average service life of over 800 minutes, with some cells giving 1000 to 1100 minutes of service. Today's batteries will do even better than that with proper care.

The five factors that determine the life of a dry cell battery are:

- (1) Initial current drain
- (2) Hours of use per day
- (3) End point voltage
- (4) Temperature
- (5) Storage period prior to use

It is impossible to say that any battery has an exact number of hours of service life. If a battery is operated under conditions which draw a large current from it in a short period of time, the depolarizing mix cannot do its job properly and the voltage will drop off very rapidly. This is the situation we have already discussed. On the other hand, if the battery is used

too slowly, its normal aging will cause the output to be reduced. The shelf life of a battery can range from a few months to as long as two years, depending upon the type of battery and the conditions of storage.

While in use, your battery should periodically be given "time off" to allow the depolarizing mix to work and remove the hydrogen and other waste products developed in the cell. This point is emphasized because it is so important in proper battery

**Fig. 1.** Cross-section view of a typical dry cell.



care. It will pay you to have two sets of batteries for frequently operated devices. By switching from set to set, you will increase the operating life of both sets.

The end point voltage is of interest mainly to the designer of the battery-operated device rather than the user, and so we will only touch on it here. The end point voltage is the voltage below which the battery can no longer operate the device in question. If it takes one volt per cell to operate





Photos courtesy National Carbon Co.

a radio receiver, the unit will not operate when the battery voltage goes to 0.9 volt per cell. The best designs make the end point voltage as low as possible to allow the maximum to be gotten from a battery as its voltage drops off with time and use. Figure 3 will give you some idea of the manner in which battery voltage drops off with time.

**The Temperature Story.** Dry cell batteries designed for normal use operate best at room temperature, about 70° F. When batteries are exposed to continual high temperatures, they will break down in a much shorter time due to increased chemical action and a drying up of the electrolyte. Low temperatures, however, are a different story.

From the standpoint of storage, a battery loves cold weather. For example, as you may know, batteries which were frozen in the Arctic ice on polar expeditions were thawed out years later by other explorers and found quite usable. Cold will slow up the chemical action within a dry cell battery and in some cases make it inoperative; but when it is brought back to room temperature, the battery will return to normal operation none the worse for the chilling.

If you are going to store a dry cell battery for any length of time, store it in a cool spot. A temperature of about 45° F is ideal, and a shelf in the refrigerator is an excellent storage spot (if you can get away with it). According to tests made by the National Carbon Company's Battery Engineering Department, a battery which has been stored in this manner for nine months will give as much useful service as will a battery stored at room temperature for three months. Just remember to take the battery out of the cold about six hours prior to using it, and allow it to get back to room temperature for normal operation.

**"Batteries" and "Cells."** Before we complete this discussion of basic dry cells, there are a few things which deserve clari-

fication. You will note that we have used the term "cell" and "battery." A *cell* is one unit consisting of positive and negative electrodes separated by an electrolyte. A *battery* is two or more cells, connected in series to add their voltage, and packaged in one container.

Actually, the "battery" you put in your flashlight is a cell, while the B+ unit you use in your portable radio is a true battery because it consists of more than one cell.

You should also be aware that every cell, no matter what its electrode materials, develops about 1½ volts. The physical size of the cell determines the amount of current that can be drawn from it.

There is, of course, much about dry cell

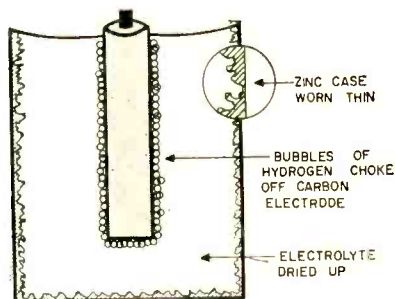
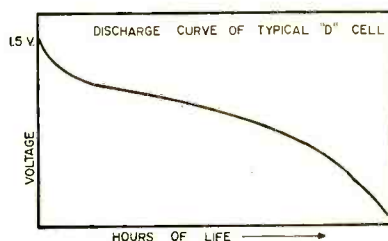


Fig. 2. Internal condition of dry cell at exhaustion.

Fig. 3. Gradual battery voltage drop with time and use.



batteries that we haven't discussed. There are also many new types of batteries such as the mercury battery, the solar battery and the new rechargeable dry cells, all of which are now important means of developing portable power. These we will cover in a future issue. However, the dry cells that we have considered are still the workhorses of the battery world and, with a little care, will pay you many dividend hours of extra, dependable service.

# Test Instruments

.....Part 4

## THE VACUUM-TUBE VOLTMETER — D.C. Ranges

THE LAST THREE installments of this series were devoted to the volt-ohm-milliammeter. Now let's take a look at its chief competition—the vacuum-tube voltmeter (or VTVM).

Why put tubes in a voltmeter? To answer this question, it is necessary to understand the exact meaning of "sensitivity." As we found when checking out the VOM, the accuracy of any voltmeter reading depends upon the extent to which it affects the circuit under measurement. After the voltmeter is connected, the voltage at a particular point in a circuit frequently no longer has the value it had before the instrument was attached.

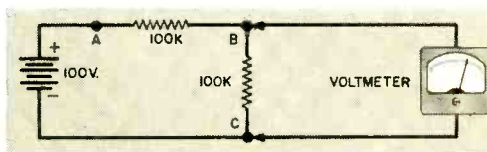
For example, with two equal-value resistors connected across a 100-volt source, the voltage across each resistor is 50 volts. (See Fig 1). However, a voltmeter connected across either resistor will read less than 50 volts. Why?

Well, if the VOM in Fig. 1 is a 1000-ohms/volt job, it has an internal resistance of 100,000 ohms (on the 100-volt range). Therefore, when the meter is connected, the total resistance between points *B* and *C* falls to 50,000 ohms. Since this is only half as great as the resistance between points *A* and *B*, the voltage divides unevenly and less voltage now appears between points *B* and *C*.

Of the total 100 volts, 66⅔ volts will appear from *A* to *B*, and 33⅓ volts will appear from *B* to *C*. The voltmeter therefore reads 33⅓ volts even though 50 volts was present before the measurement was made.

The higher the internal resistance of a voltmeter, the less current it will drain from the circuit under test and the more accurate the reading will be. This is the advantage of the VTVM. Because of its very high input impedance, the VTVM provides

By  
**LARRY KLEIN**  
Technical Editor



**Fig. 1.** Before measurement is taken, the voltage drops across the two 100,000-ohm resistors are equal. Shunting effect of meter causes an unequal voltage division and the meter reads less than half the voltage applied across *A* and *C*.

a reading practically identical to the voltage existing before the test leads were connected.

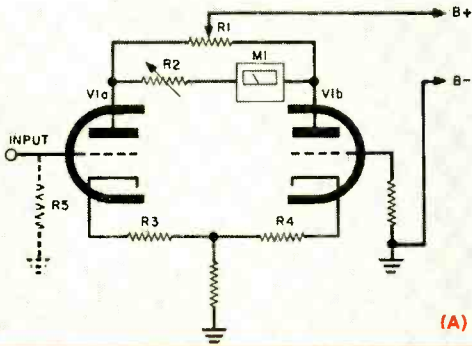
**Balanced Bridge.** A check of the VTVM circuits shows that most current models use one or the other of the two bridge amplifiers in Fig. 2. In both circuits vacuum tube *V1* serves as a d.c. bridge whose basic job is to effect an *increase* in the sensitivity of meter movement *M1*. Either circuit can also be considered as a means of *decreasing* the input current requirements for deflection of the meter—which comes down to the same thing. More on this point later.

Tube *V1* is usually a 6SN7 or 12AU7 dual triode, and the indicating meter (*M1*) is connected from plate to plate or from cathode to cathode of the triodes. In both circuits, *R1* adjusts for the normal differences between the operating currents of the two triodes and appears on the front panel of the VTVM as the *Zero Adjust* control.

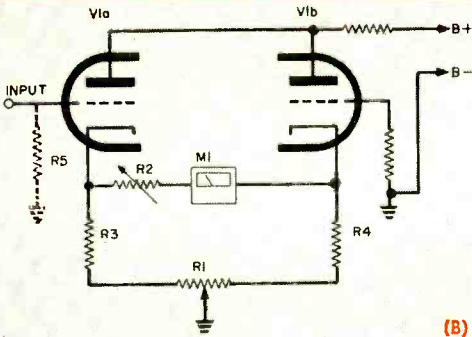
Calibration control *R2* is usually mounted inside the VTVM cabinet and adjusts for the small changes in *total* tube current over long periods of use.



**Zero adjust** control balances the bridge circuit in the Precise Model 9071 VTVM at right.

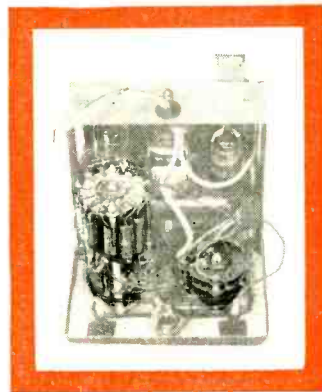


**Fig. 2.** Alternate versions of the VTVM bridge circuit. Their basic difference is mainly in the placement of the meter movement.



**Range switch** of the Eico Model 221 with precision divider resistors wired directly to the switch terminals for rigidity.

**Internal view** of the Heathkit V7A VTVM. The range switch is on the left, function switch on the right.

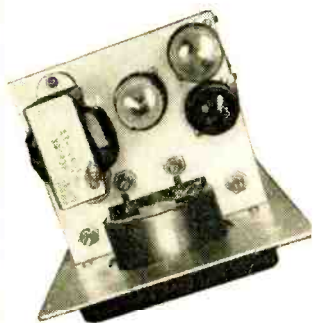


If you're wondering why the VTVM circuits is referred to as a "bridge," as you can see Fig. 2 (B) can be easily redrawn to the standard bridge configuration (Fig. 3) and may even be more easily understood that way.

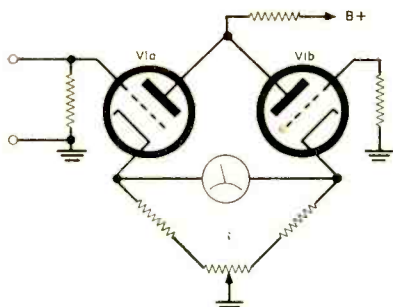
The theory of the bridge is quite simple. Triode *V1b* is the "reference" triode — in that its grid is grounded and the amount of current flowing through the tube is determined by the bias developed across cathode resistor *R4* and the plate voltage of about 100 volts d.c. Triode *V1a* is operating under the same conditions except that its input

grid is connected to a 5- or 6-resistor voltage divider which for the present discussion we will treat as a single resistor and call *R5*.

*Zero Adjust* control *R1* varies the plate voltages to tube *V1* in Fig. 2 (A) and varies



**Four calibration controls** of the Eico Model 221 are grouped around the meter movement as seen from the top of the chassis.



**Fig. 3.** The circuit of Fig. 2 (B) redrawn in the standard bridge configuration.

the cathode bias in the circuit of Fig. 2 (B). By adjustment of  $R1$ , the voltage differences between the two plates or two cathodes can be reduced to zero—and the meter therefore will also read zero. We have a balanced condition.

**Unbalancing the Bridge.** Now that we have a stable balanced bridge, how do we go about making practical use of it? Referring back to Fig. 2, let's apply 1 volt d.c. between the input grid of  $V1a$  and ground and see what happens. When the applied positive voltage reduces the bias on  $V1a$ , the tube immediately reacts with an increase in current flow through  $R3$ . This, in turn, as Ohm's law tells us, causes an increased voltage drop across  $R3$ . Meter  $M1$ , up to this moment, has been comparing the drops across  $R3$  and  $R4$  and—not finding any difference—read "0." Now, though,  $M1$  responds to the voltage difference between the plates or cathodes of  $V1$ , swings upscale—and we have a VTVM at work.

Let's take a look at  $R5$ . In a practical VTVM,  $R5$  appears as the voltage divider shown in Fig. 4. The total voltage to be measured is always applied across the complete string of resistors in the input circuit.

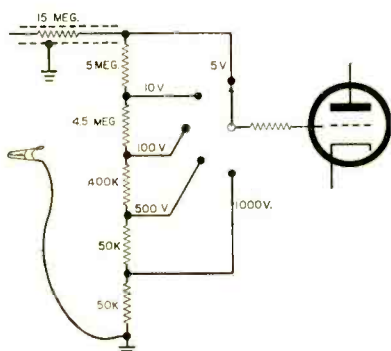
For higher voltage ranges, the input grid of  $V1$  is tapped farther down on the voltage divider circuit. Note that the input resistance remains constant and equals the total resistance of the voltage divider plus the isolating resistor in the d.c. probe. Adding up the resistances in the divider, you can see that the sensitivity of the VTVM is quite high.

The usual VTVM d.c. input resistance is 11 megohms and can be as high as 25 megohms. This is most important on the low voltage ranges of the VTVM which are often used for measurements in high impedance circuits. Note that, unlike the VOM, the input impedance of the VTVM remains constant regardless of which voltage range is used.

Next month we will continue our investigations and see what makes the VTVM able to respond to a million cycles a.c. and read up to a billion ohms resistance. —30—

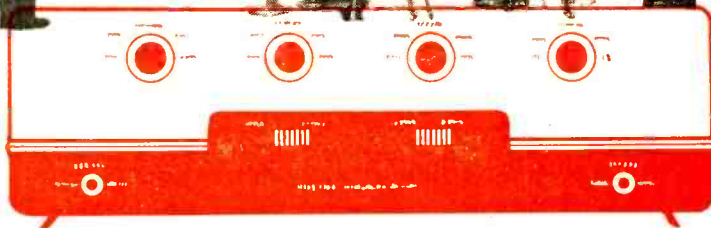


**The "active" elements** in the VTVM. Standard models usually have a lineup comprising (from left to right) a 50-ma. power supply selenium rectifier, a 6AL5 a.c. rectifier and a 12AU7 bridge tube. An alternate arrangement consists of a 6X5 power rectifier, a 6H6 a.c. rectifier and a 6SN7 bridge tube.



**Fig. 4.** Voltage divider which sets the amount of the input voltage reaching the grid of the input triode.





# **INSIDE** the **PREAMPLIFIER**

## **Part 3:**

### **Tone and Loudness Controls**

**I**F A high-fidelity system is flat from 20 to 20,000 cycles—as a hi-fi system is supposed to be—why is it necessary to have tone controls? After all, any change in the response from complete flatness is in itself a form of distortion; why, then, provide a deliberate means for creating distortion?

The trouble with this frequently asked question is that little word *if*, and the very big assumption behind it. The fact is that there are few, if any, hi-fi systems that are completely flat from 20 to 20,000 cycles.

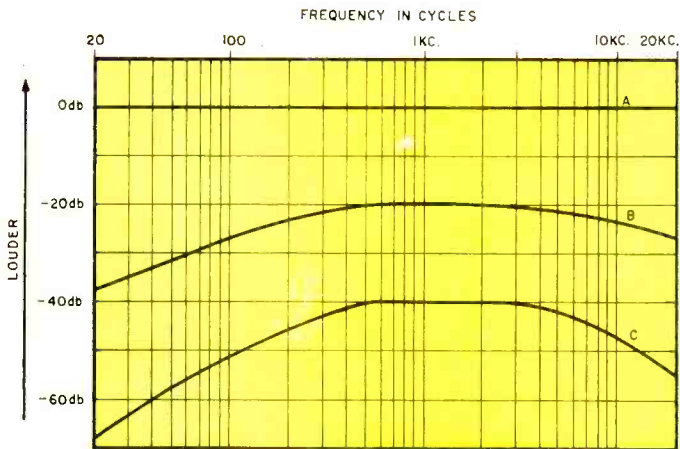
It is true that the *electronic* units of modern hi-fi systems—tuners, preamplifiers, and amplifiers—are capable of flat response, but transducers (microphones, pickups, and loudspeakers) and tape or disc recordings are another story. For example, there are few commercial speaker systems that cover the complete audio range with any real resemblance to flatness. And there are very few rooms which possess the acoustic properties that would be needed to reproduce the full 20-to-20,000 cps range faithfully

even if such a speaker system *were* obtainable.

**The Human Problem.** Even if the ideal system and room were available, we would still have a problem. The human ear itself is reasonably flat only at very loud volume levels. At lower levels the response of the ear slopes off both at the low and the high ends.

Suppose we record a symphony orchestra at its original volume level. The frequency balance of such a recording is represented by Curve A in Fig. 1. Very few of us could play this recording back at its original volume level in our homes. If we attempted to do so, it's probable that our neighbors would soon be paying us some rather unfriendly visits. Most of us must reduce the level to

By  
**JOSEPH MARSHALL**



**Fig. 1.** The natural frequency balance of a symphony orchestra at full volume is represented by Curve A. At one-tenth of the original volume, the response of the human ear is similar to that of Curve B. At one-one-hundredth of the original volume, the ear's response is that of Curve C.

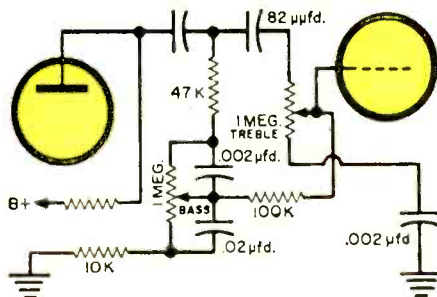
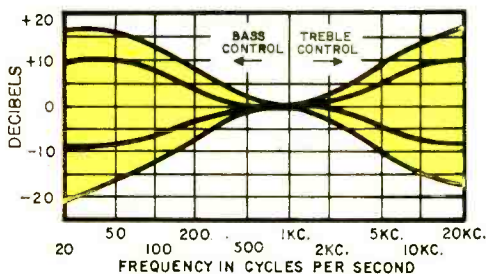
one-tenth or one-one-hundredth of the original.

But at one-tenth the original level (20 db down), the response of the average human ear is roughly that of Curve B. At one-one-hundredth of the original level (40 db down), the ear's response is that of Curve C. Thus, if the loudspeakers delivered the original frequency balance into a room at these lower levels, both the lows and the highs would seem much softer than they did in the concert hall—as if the instruments that played them were further back. The listener would not be given a good facsimile of the original tonal balance that existed in the concert hall.

In view of these and other factors, every hi-fi system must have some means of modifying the tonal balance. With few exceptions, the general practice is to permit adjustment of the extremes of the sound spectrum—the low bass and the high treble. In almost all preamplifiers this is done with separate and independent bass and treble controls, each providing about 15 db boost and cut.

**Losser Tone Controls.** Today's tone control circuits fall into two general types: the lossor-type and the Baxandall-type circuits, plus a number of special circuits. The lossor-type is used, with minor variations in the values of components, in a great many preamps.

It would take an article in itself to analyze the operation of these circuits in detail. In general, lossor-type circuits consist of two frequency-discriminating networks, one for bass and one for treble. These two networks are so designed that when



**Fig. 2.** Typical "lossor-type" tone control circuit. The tone control action of this circuit is depicted in the accompanying graph.

the potentiometer of each is at mid-position, the *entire* audio spectrum is attenuated from 15 to 20 db and the response is perfectly flat over the full range.

Referring to Fig. 2, when the bass control slider moves to the top, the loss for mid and high frequencies remains the same, but the loss for bass frequencies is reduced. Thus the bass receives special emphasis while the rest of the spectrum remains the



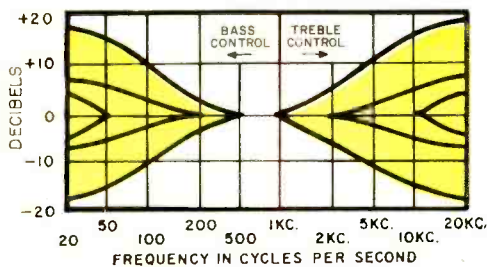
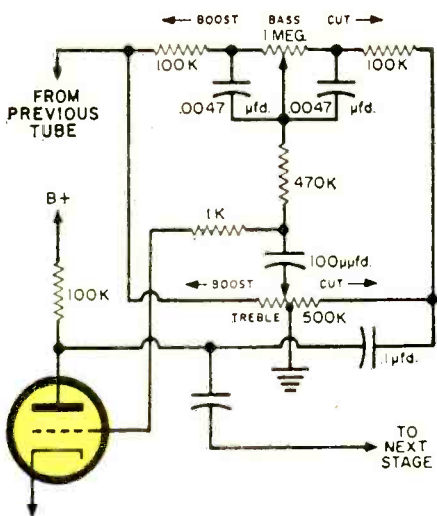


Fig. 3. Baxandall-type tone control circuit (below, left). Graph illustrates the "sliding" crossovers produced by this type of circuit.



same. On the other hand, when the control moves down, the mid- and high-frequency losses remain constant, but the loss for the bass is increased, thereby causing attenuation of the bass.

It took many years to develop this clever circuit which achieves so much with so relatively few parts, and it is no wonder that it has become fairly standard. Because there is a loss of about 20 db for all frequencies in the "flat" or middle setting, additional amplification must be provided. The circuit is therefore frequently preceded by one section of a twin-triode used as an amplifier and followed by the other section operating as a cathode-follower.

The bass and treble sections of lossier-type tone controls "hinge" at about 1000 cps. For example, as bass boost or cut is supplied, the frequency response begins to slope up or down below 1000 cycles and the maximum boost or cut occurs at some point between 20 and 50 cycles. On the treble end, the slope starts above 1000 cycles and maximum effect is achieved between 10,000 and 20,000 cycles.

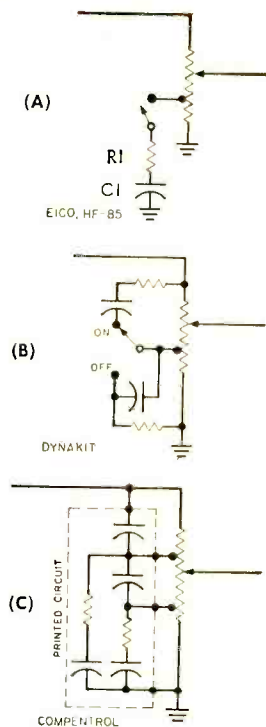
**The amplifiers**

above each have variable tone controls capable of about  $\pm 15$  db boost and cut. Loudness controls differ, however. The Knight KN700A (top) has three positions of compensation; the Bell "Carillon" (center) features a continuously variable control; and Stromberg-Carlson's ASR-433 has an in/out loudness switch.

This "hinge" arrangement at 1000 cycles is a good compromise for most applications. However, the very best speaker systems have a fairly even response below 200 cycles and do not require any bass boost above this point. Indeed, they sound boomy, especially on voice, if there is an appreciable boost of the bass frequencies above 150 cycles. For best results with these speakers, most of the boost should be concentrated at the *very* low end—below 50 cycles.

Similarly, the finest tweeters do not need much—if any—boost below 10,000 cycles. If boosted too much in this region, they will sound overly bright and shrill. Consequently, many of the recent preamps designed for use with high-quality speakers have a dif-





**Fig. 4.** Three commonly used loudness control circuits are: (A) the tapped volume control; (B) the tapped volume control with an additional high-frequency compensating network; and (C) the circuit used in the Centralab "Compen-trol" which features a dual-tapped volume control.

ferent type of tone control, the Baxandall-type control.

**Baxandall Tone Controls.** The Baxandall control setup permits "sliding" crossovers; the "hinging" points vary as the controls are adjusted. When only a little boost is applied, the bass crossover point may be at 125 cycles and the treble at 10,000 cycles; when medium boost is applied, the crossover points may be at 250 and 5000 cycles; and at full rotation, they may move to 500 and 1000 cycles.

In the Baxandall circuit (named for the gentleman who developed it), "variable crossover" tone control action is achieved through a frequency-discriminating network incorporated into a feedback loop, as in Fig. 3. Because of the feedback loop, the Baxandall circuit has a low output impedance and does not have to be followed by a cathode-follower to achieve a low output impedance. However, it works best if it is *preceded* by a cathode-follower. The use of feedback in the Baxandall circuit results in lower distortion than is achieved with loss-er-type circuits.

Baxandall-type controls may seem "slow-acting" when first tried. Although they deliver large boost at the extremes of the spectrum, the effect is not prominent until

the control approaches the maximum boost position.

Because there are almost as many theories as to what constitutes good tone control curves as there are concerning good speaker design, a number of combination loss-er and feedback type controls are available which are capable of producing a wide variety of curve shapes.

**Loudness Controls.** With the modern speaker systems, these tone control circuits provide adequate means for correcting various factors which influence tonal balance at a given level. But if we change the level substantially, the tonal balance will also change because the response of our ears changes. If we decrease volume and maintain the same tone control settings, the bass end will seem attenuated; if we increase the volume, it will seem boosted. Thus, to maintain the same apparent tonal balance at all levels, we would have to readjust the tone controls every time we changed the volume level significantly. As a matter of fact, some people prefer this method of compensating for the "loudness" effect; most, however, find it a nuisance. Consequently, it is general practice for a hi-fi system to provide some type of automatic or semi-automatic "loudness" control which compensates for the ear's frequency discrimination.

One relatively simple circuit which deals with the loudness compensation problem uses a tapped volume control. (See Fig. 4(A)). With a network consisting of a capacitor (CI) and a resistor (RI) connected between the tap and ground, we offer the incoming signal two paths—one of which is through the volume control itself to the grid of the following tube, the other through the network to ground. The impedance of the network to ground will vary with the frequency of the signals due to the capacitive reactance of the network. The high frequencies will find that CI and RI present an easy path and are partially bypassed to ground. But the low frequencies will find that the capacitor presents a high impedance and they will take the other path through the potentiometer to the grid of the tube. Thus, this simple network will boost the lows in relation to the mid and high frequencies.

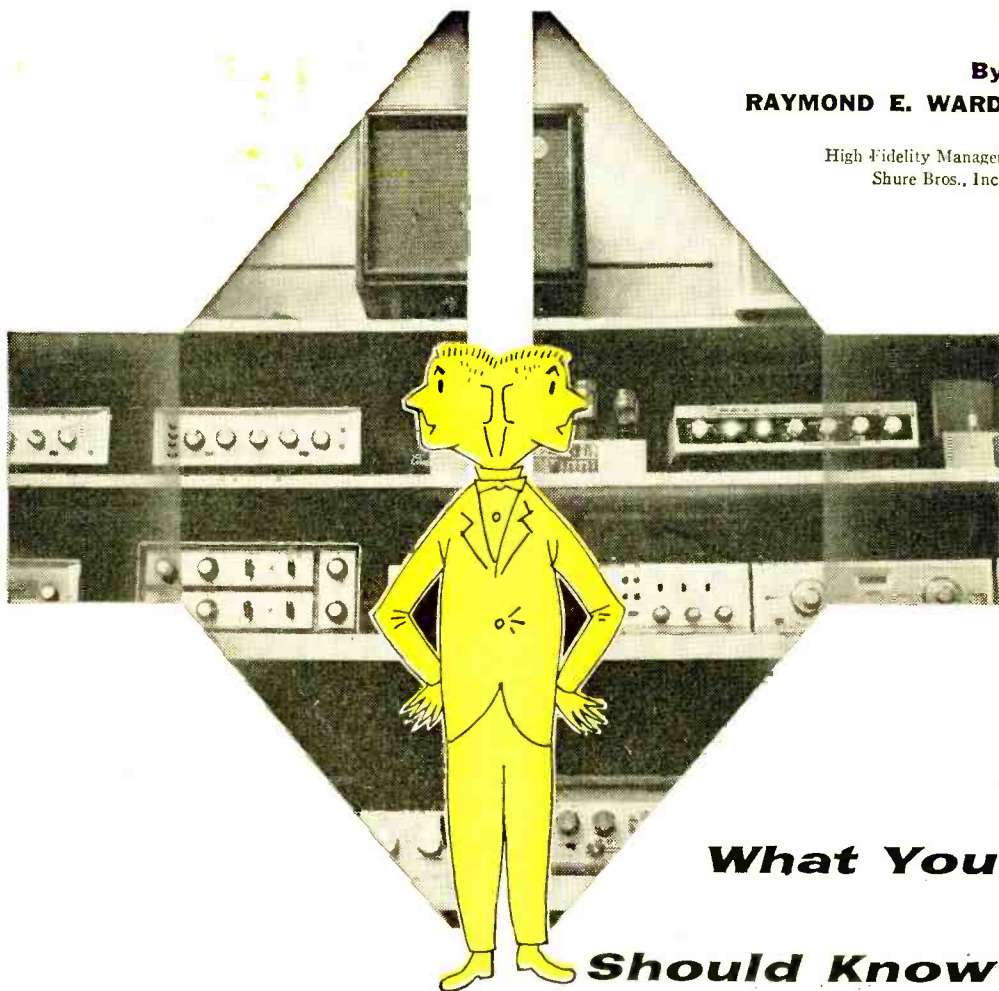
By choosing the proper values of capacitance and resistance and tapping the control at a proper point, we can achieve a curve which starts where we want it to and

(Continued on page 141)



By  
**RAYMOND E. WARD**

High Fidelity Manager  
Shure Bros., Inc.



**What You  
Should Know  
Before Buying Stereo**

**W**ITH great ballyhoo and hoopla the stereophonic record era is upon us. "If it isn't stereo, it isn't high fidelity," over-enthusiastic advertisers assert. But this statement is no more true than is its converse, "If it's stereo, it's got to be hi-fi." Let's take a more sober look at what's happening in stereo and try to appraise stereo in terms of what it actually does, and doesn't do, for sound reproduction.

When stereo is first heard, it usually has tremendous impact. A fascinating new dimension of "depth" is added to sound reproduction. After some experience with stereo however, the critical listener soon realizes

that the addition of a new "dimension" does not eliminate other requirements of high fidelity such as good frequency response and low distortion.

Consider the fact that it's possible to pump two channels of music through two table-model radios costing \$19.95 each. The result may be *stereo* but it won't be hi-fi. Two mediocre amplifier-speaker combinations do not equal one good amplifier-speaker any more than two bad singers equal one good one.

**Personal Taste Factor.** To some extent, the value of stereo to each individual depends on personal *musical* tastes. One of

the most effective uses of stereo is in opera or dramatic performances, where action shifts across a stage. A person who is an opera or theatre fan will find that stereo is tremendously effective in imparting to a recording a feeling of depth and spaciousness. On the other hand, stereo has much less to add to the performance of a single soloist or small ensemble.

Remember that stereo demands careful listening, and the place where you listen is critical and restricted. You must sit in the "stereo area" (see "Your Stereo Listening Area," P. E., November, 1958) or you will get over-emphasis of one channel. Music in the home is often background music, and while fidelity is important in heightening pleasure and reducing listener fatigue, stereo is mostly lost unless you are sitting in the right spot.

Much has been made of the fact that the stereo effect tends to "mask" inadequacies in equipment. This is true, but only in the same sense that color television "masks" inadequacies in programming. At first, a viewer is so interested in looking at the colors that he doesn't really care what's going on. But such a masking effect is hardly permanent. A danger in these times of stereo hoopla is that a hi-fi fan, in his excitement over this new development, may be persuaded to buy an inadequate stereo system and then, as the novelty wears off, may find himself stuck with a substantial investment in poor equipment.

**Stereo Cartridges.** The heart of any stereo record system is a stereo phono cartridge. One erroneous impression which has gained currency is that the new stereophonic phono cartridges are superior in every way to monophonic cartridges, even for monophonic records. Most of the time, your own two ears will tell you differently.

Manufacturers who assert that their stereo cartridges are better than their mono cartridges are probably not speaking about cartridges of equal quality in the first place. It is true that a stereo cartridge can be used to play monophonic records. It is also true that a fine stereo cartridge will

sound better in such use than a poor mono cartridge. But a cartridge especially designed for stereo records is seldom the equal of a really good mono cartridge.

For one thing, more muscle is needed to operate two electrical systems than one. This means that stereo cartridges tend to have less compliance and more dynamic mass than equivalent monophonic units. Decreased compliance necessitates increase in tracking force, with resulting wear and tear on the stylus and record. Increase in the dynamic mass of the needle cuts down on high-frequency response as the needle gets too heavy to follow the rapid groove wiggles above a certain frequency. Since a

stereo cartridge has to be sensitive to vertical movement, imperfections in mono records may show up as noise when played with a stereo cartridge.

The best mono cartridges feature wide frequency response, low distortion, and low record wear. Because of the peculiar problems involved in stereo cartridge design, no stereo pickup yet made quite comes up to the

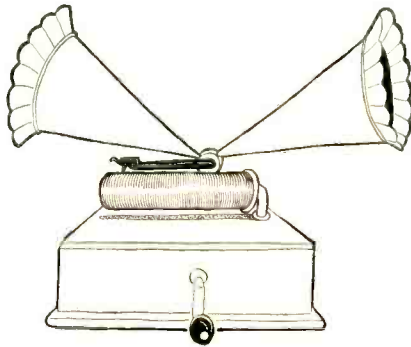
standards set by the best monophonic units now available.

Of course, a chain is no stronger than its weakest link. The quality of the final sound from your loudspeaker can be no better than the quality of the poorest component in your system. And so the imperfections of a stereo cartridge on a standard record may be entirely swamped out by the distortion, noise, etc., contributed by an inadequate turntable, amplifier or speaker.

If you have top components all along the line, and you are adding stereo, it is probably wisest to keep both a monophonic and a stereo cartridge in operation—at least for the time being.

**Preamps and Speakers.** A stereo preamp is a good investment even if you are going to stay with monophonic sound for the present. Then, when you decide to go stereo, you need only add the second amplifier and speaker. Get either a separate power amplifier and duplicate it later for stereo, or try one of the new single-chassis

*(Continued on page 147)*





POPULAR ELECTRONICS visits

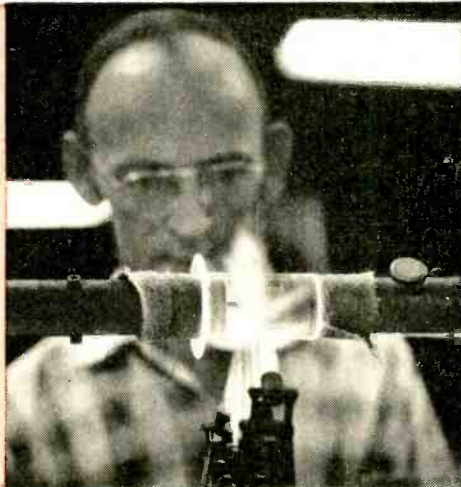
a tube manufacturer to observe while . . .

## A TRANSMITTING TUBE IS BORN

**T**HE MANUFACTURE of a high-power transmitting tube involves more than just assembling a number of metal and glass parts. In order to meet the demands of industry, the manufacturer must pay ever-increasing attention to reliability and long life. The manufacturing processes which most affect tube life are those relating to the precision with which the electrodes are manufactured and assembled, the extent to which all impurities and foreign particles have been eliminated, and the degree of vacuum obtained inside the tube.

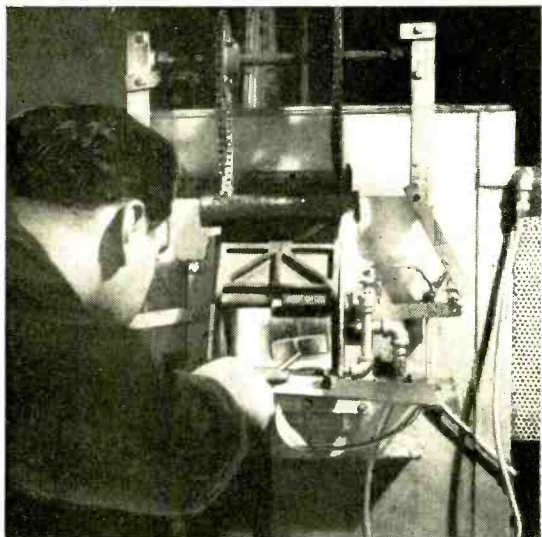
Recently POPULAR ELECTRONICS visited the Amperex Electronics Corporation plant in Hicksville, N. Y., to find out how a manufacturer of high-quality electron tubes handles the problem of building long life and reliability into a modern high-power, high-quality transmitting tube. A typical transmitting tube, the 5924A, was followed through the different stages of its manufacture, and photographs of each of the key steps were taken.

**1** Glass technology is an important aspect of tube manufacturing. The glass is softened by jets of flame from a specially designed fixture. When the glass is soft enough, the operator shapes it with special glass-shaping tools.



Photos by Joe Petrovco

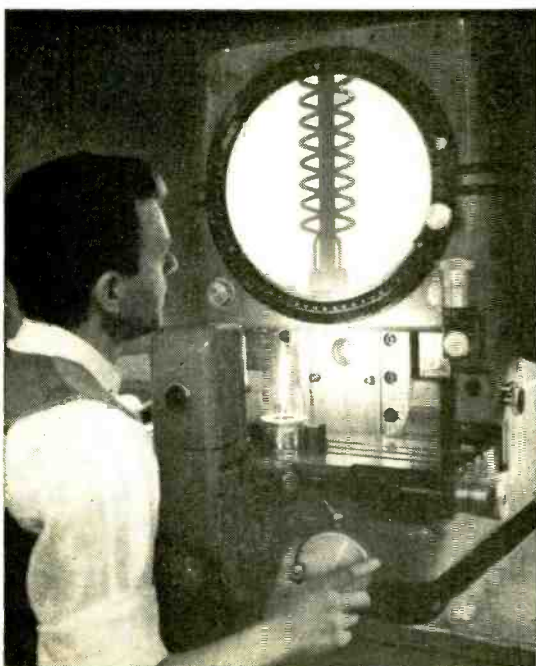
**2** Cleanliness is more than a byword to the tube manufacturer. Tube life and reliability are decreased when impurities, such as oxides, are deep within the metal elements. Here the electrodes are placed in a hydrogen atmosphere furnace to "reduce" oxides.



**3** The cleaning process goes on. The most modern and efficient cleaning equipment is used by Amperex at various stages of tube manufacture. Here an ultrasonic cleaner eliminates the last vestiges of surface contamination which may exist on the tube's metal electrodes or glass parts.



**4** The care exercised in fabricating and cleaning all the tube components naturally extends to the inspection procedures. Parts are projected many times their actual size on a screen so that even the slightest degree of misalignment is easily detectable.

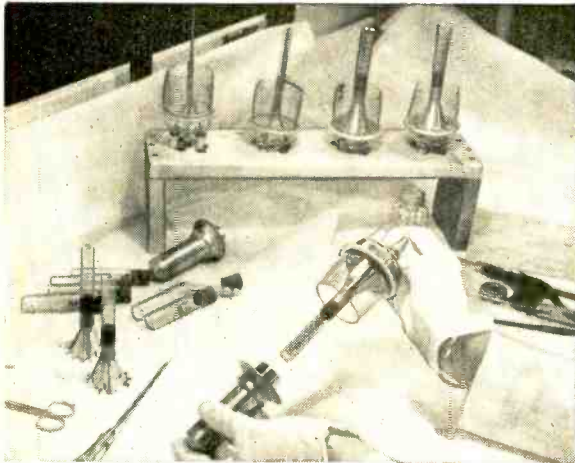
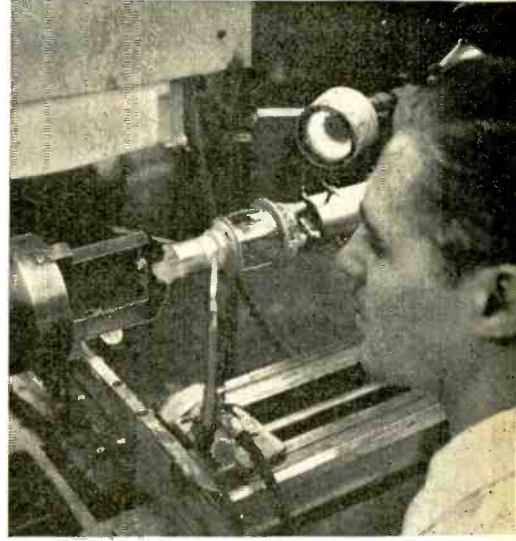






**5** Having insured the cleanliness and accuracy of all components of the tube, the assembly procedure begins. The first step is to assemble the delicate filament structure with hand tools.

**7** Anode is sealed to the grid and cathode mount. A highly skilled operator performs this exacting procedure on a lathe-like machine which was designed for this operation.



**6** The metal anode is now mounted. In background, note the different stages of assembly of the 5924A tube. The assembler always keeps the working area immaculately clean.

**8** Creating the vacuum inside a tube involves more than just pumping out gas. It also includes removing gas trapped within the tube elements. To do this, the electrodes are heated until the impurities are driven off. Here the gas is pumped out (through the horseshoe-shaped glass tubing) while the tube elements are heated.

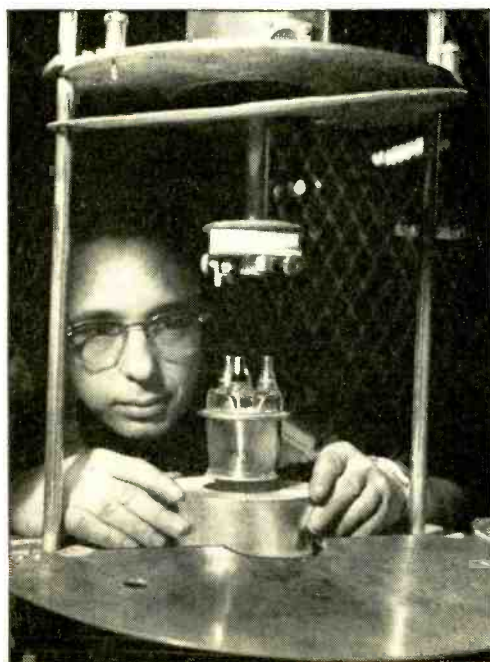




**9** After all gases and impurities are pumped out of the tube, it is necessary to make certain no other impurities enter. This is done by "sealing off" the opening through which the gas was evacuated. A 5868 tube is shown here.



**10** Now for the finishing touches. With the same care exercised in the internal fabrication and assembly, all the external surfaces are carefully silver plated and, at the same time, specific areas are painted for purposes of identification of tube elements.



**11** The final step is to "fire it up" and subject it to a thorough testing. All electrical characteristics are tested to insure that the tube will not only meet, but exceed, specified ratings.



**T**HE 15-meter band (21 mc.) holds a world of adventure for the Novice class radio amateur. It is possible for a Novice to communicate with hams all over the world on this band which is "open" to many countries during daylight hours. The "Nifty Novice" 15-meter transmitter is designed especially for the Novice and runs 25 watts input power.

Although operating only on this one band, the Nifty Novice has many features that will appeal to prospective operators. The transmitter circuits are pre-tuned as much as possible and only two adjustments are required to get on the air. No meters are used during adjustments, as an inexpensive pilot lamp serves quite well as a tuning indicator. The two controls are set for maximum lamp brilliancy, and the transmitter is ready to operate.

The 25-watt power level is high enough for world-wide communication, yet low enough to minimize television interference. Another feature of this rig, usually found only in very expensive transmitters, is the provision for keying of the oscillator stage only. This produces very good keying notes, and the rig never fails to get a T9 (tone) report. This same circuit also protects the final amplifier so that it is virtually impossible to damage the tube or components by mistuning the transmitter.

**Construction.** Cut and drill the chassis holes and the aluminum capacitor brackets for later mounting of the tuning controls *C10* and *C11* as required.

The sockets for the two r.f. tubes (*V1* and *V2*) should be the type with ground lugs on the mounting ring to facilitate wiring, with the associated components grouped tightly around the sockets to keep the leads short. Coil *L1* is located between the two tubes, and *L2* is located under the chassis, below *C10* and *C11*.

Coil *L2* is held in place by its own leads passing through the chassis (insulated by rubber grommets) and connected to *C10* and *C11*. *C9* is connected to *L2* at a point just before it passes through the chassis. In a similar manner, the wire to *PL1* is connected to the other end of *L2*. After all the wiring is completed, recheck all connections carefully.

**Testing the Transmitter.** Use a volt-ohm-milliammeter (or preferably a VTVM) for the following checks:

(1) Remove all the tubes and measure the resistance across the line cord plug. With power switch *S1* off, the VOM should read infinite ohms. With *S1* on, the ohmmeter should read about 4.2 ohms. If readings are incorrect, there is a short or open in the power supply circuits.

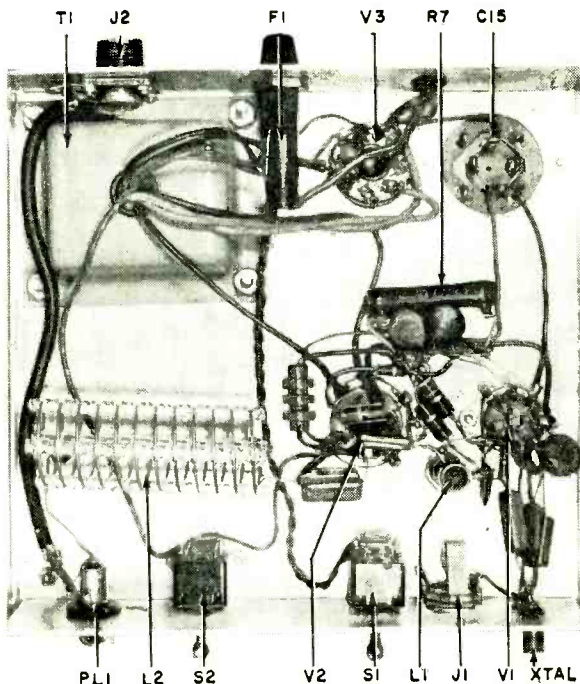
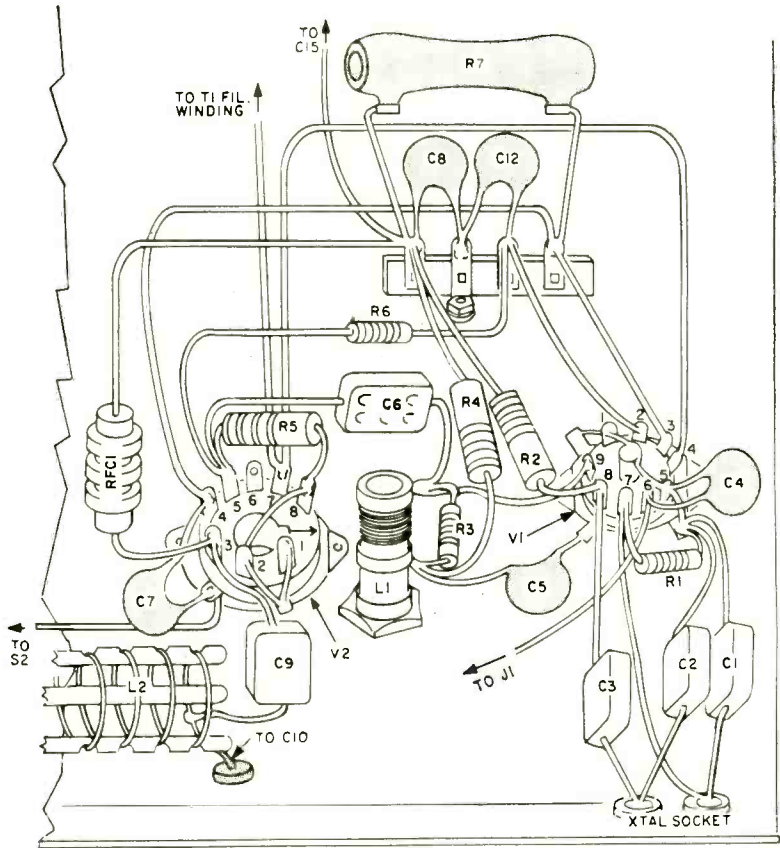
(2) Insert *V1* only and switch on the transmitter. The tube filament should

## **"Nifty Novice" 15-Meter Transmitter**



**Get on the air  
with this pretuned  
easily constructed rig**

**By  
DONALD L. STONER  
W6TNS**

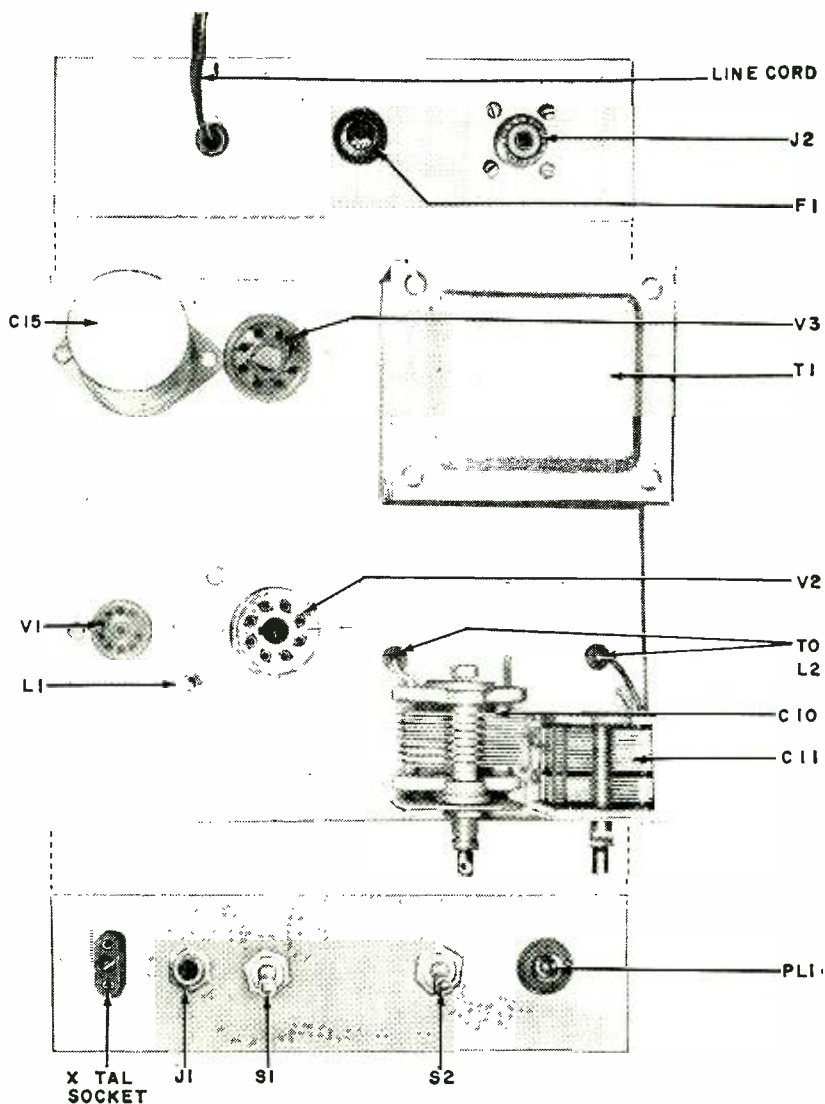


**Pictorial diagram** above details the connections to tube sockets V1 and V2. The leads need not be as long as this but should connect to points indicated.

**Underchassis view** at left shows general layout of completed transmitter. Capacitor C15 may have four 20- $\mu$ fd. sections or be a single 80- $\mu$ fd. unit.

**Chassis layout** on the facing page indicates convenient parts placement. Front and back aprons of the chassis have been "folded out" for clarity.





light. If it doesn't, check filament wiring.

(3) With the transmitter off, remove *V1* and measure the resistance from pin 2 of the 5Y3 rectifier (*V3*) socket to the chassis ground. The VOM should read close to zero ohms, and then slowly drift back to 50,000 ohms or higher.

(4) Place switches *S1* and *S2* in the "off" position and insert *V3*. Turn on *S1*, and *V3*'s filaments should light up immediately. Connect the meter (500 volts d.c. scale) from pin 2 of *V1*'s socket to chassis ground. Flip the *standby* switch on and read the B-plus voltage. It should read about 370 volts ( $\pm 10\%$ ).

(5) Install *V1* and *V2*, and again check

the B-plus voltage. It should drop to about 330 volts. If it does not, this may indicate that a connection has been omitted and the tubes are unable to draw power from the supply.

If these simple tests have produced satisfactory results, you are now ready to tune up the transmitter.

**Tune-Up Instruction.** Connect a key and crystal to the transmitter, and set *L1* fully counterclockwise so that the slug is all the way out of the coil. Set *C10* and *C11* at maximum capacity. Connect the negative lead of your voltmeter to pin 2 of *V1* and the positive lead to ground.

Switch on the transmitter, and observe

## PARTS LIST

- C1—47- $\mu$ fd. mica capacitor  
 C2—39- $\mu$ fd. mica capacitor  
 C3—.001- $\mu$ fd. mica capacitor  
 C4, C5, C7, C8, C12, C13, C14—.005- $\mu$ fd., 600-volt disc ceramic capacitor  
 C6—10- $\mu$ fd. mica capacitor  
 C9—.002- $\mu$ fd. mica capacitor  
 C10—100- $\mu$ fd. variable capacitor (E. F. Johnson 100R-12 or equivalent)  
 C11—365- $\mu$ fd. variable capacitor (J. W. Miller #2111 or equivalent)  
 C15—80- $\mu$ fd., 450-volt electrolytic capacitor (Sprague TVL-1735 or equivalent)  
 F1—3-ampere fuse and mounting assembly  
 J1—Open-circuit phone jack (key)  
 J2—Coaxial connector (Amphenol 83-1R or equivalent)  
 L1—18 turns of #26 enameled wire, wound on  $\frac{3}{8}$ " slug-tuned form (J. W. Miller #4405)  
 L2—12 turns of #18 tinned wire, 1" diameter, spaced  $\frac{1}{4}$ " between turns (Air Dux #408)  
 L3—6 turns of #22 enameled wire,  $\frac{1}{4}$ " diameter (see text)  
 PL1—#49, 2-volt, .06-amp. pilot lamp  
 R1, R6—100,000-ohm,  $\frac{1}{2}$ -watt resistor  
 R2—47,000-ohm, 1-watt resistor  
 R3—15,000-ohm,  $\frac{1}{2}$ -watt resistor  
 R4—1000-ohm, 1-watt resistor  
 R5—15,000-ohm, 1-watt resistor  
 R7—25,000-ohm, 10-watt wire-wound resistor  
 RFC1—2.5-mh. r.f. choke  
 S1, S2—S.p.s.t. toggle switch  
 T1—Power transformer, 525 volts ct., 90 ma.; 6.3 volts, 5 amp.; 5 volts, 2 amp. (Triad R-10B or equivalent)  
 V1—6AU8 tube  
 V2—6L6 tube  
 V3—5Y3 tube  
 XTAL—Quartz crystal, 7035 to 7080 kc.  
 1—Chassis or chassis box approx. 7" x 7" x 2" (L. M. Bender # 20—plain, or equivalent)  
 Misc. crystal socket, octal tube sockets (2), 9-pin socket, rubber grommets, knobs, 8" length of RG-59/U coaxial cable, 4-lug terminal strip

the d.c. reading while rotating the slug of L1. Set the slug for maximum voltage and glue it in place. Measure the power supply voltage, and set capacitor C10 at the point where maximum B-plus is obtained.

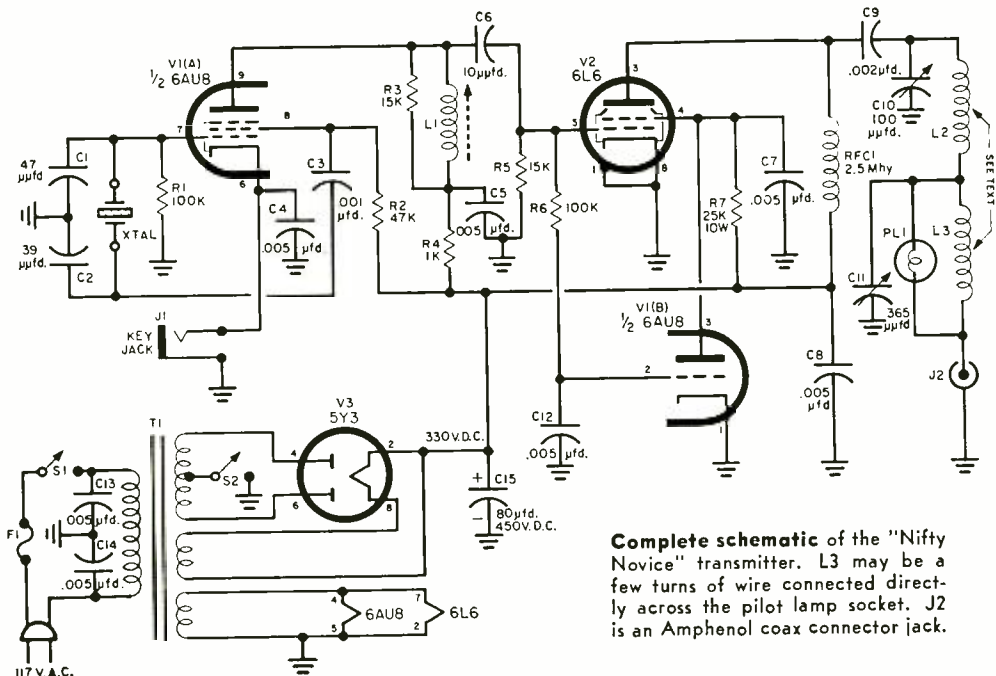
The coil (L3) across the pilot lamp (PL1) should be adjusted so that the bulb can be used as an antenna current reference. Connect a 75-ohm, 2-watt carbon resistor from the center pin of the antenna jack (J2) to chassis ground. If PL1 has not been lit before, it should light now. Adjust C10 and C11 for maximum brilliancy but do not leave the power on too long or the 75-ohm resistor will overheat.

If the bulb is extremely bright, spread or reduce the number of turns on L3. You won't want the bulb to be very bright for the power it uses up could be working for you in the antenna. Have it just bright enough so that it can be seen easily.

After these steps are completed, remove the 75-ohm resistor, and the transmitter is ready to connect to your antenna.

**Antenna System.** The antenna that you use with this transmitter will determine how successful you are on 15 meters. No matter how much power you run, you will not "get out" with a poor antenna. About the simplest antenna that will produce good results is the dipole.

(Continued on page 149)



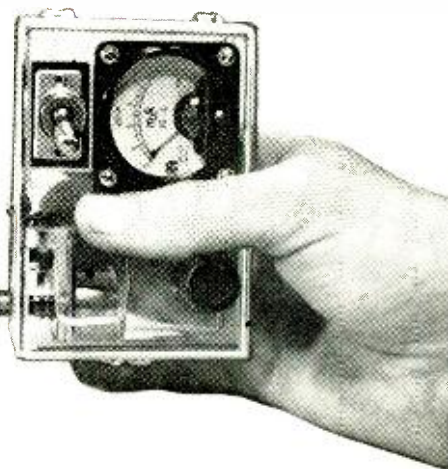
Complete schematic of the "Nifty Novice" transmitter. L3 may be a few turns of wire connected directly across the pilot lamp socket. J2 is an Amphenol coax connector jack.





—easy to build

—easy to use



**Measure**  
**R.P.M.**  
**with this**  
**Simple**  
**Tachometer**

By

**FORREST H. FRANTZ, Sr.**

**T**HE EXPERIMENTER and do-it-yourself'er will find that a tachometer is a handy instrument around the shop. This article describes a self-contained tachometer which can be built for about six dollars. An alternate version which works in conjunction with a multimeter can be built for less than three dollars.

Small, inexpensive, permanent-magnet d.c. motors such as the Supermite are available in most hobby shops for about a dollar. If a motor of this type is connected

to a miniature 0-1 ma. meter as shown in the schematic diagram, the voltage indicated by the meter is a function of the speed at which the shaft is rotated.

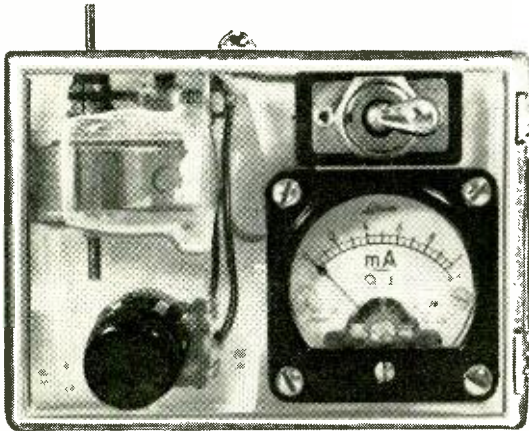
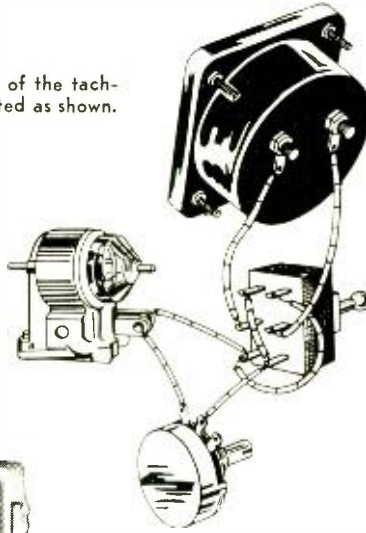
A miniature 10,000-ohm volume control connected as a rheostat is used as a calibration control. And since a tachometer may be required to measure rotational speed in either direction, a d.p.d.t. reversing switch is also included in the design.

**The tachometer is housed** in a small plastic case. It's a good idea to purchase all

The four components of the tachometer are interconnected as shown.

the components first and then use a case in which they will fit comfortably.

Mount the motor in the case with a right-angle bracket on the side and with Duco cement to the front. Before you apply the Duco, rough up the surface of the motor and the front of the case with coarse sand-



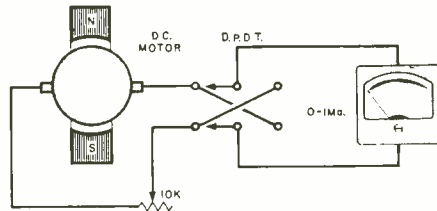
Meter polarity reversal switch shown in photo and in schematic diagram below may be either a toggle or a slide type.

paper. The meter terminals extend through holes in the back of the case.

After all wiring is completed, the meter leads (which must be pulled through the holes behind the switch when the back is put on) are connected. A piece of Scotch tape should be placed over the meter terminals. Rubber strips can be glued to the back of the case to keep the meter terminals from marring table surfaces.

The tachometer shaft is equipped with a collar  $\frac{3}{16}$ " in diameter and  $\frac{1}{2}$ " long (a small pulley obtained in a hobby shop was used on the model). This collar fits on the motor shaft, which is  $\frac{3}{32}$ " in diameter, with a set-screw. Take a rubber pencil slip-on eraser and place it on the collar. Flatten the end and round the sides of the eraser with sandpaper.

**You can calibrate** the tachometer by coupling its shaft to the shaft of a motor rotating at a known speed and setting the rheostat for the appropriate meter deflection. Thus, if the tachometer is coupled to



a 3600-rpm motor, the rheostat should be adjusted till the meter reads 0.36 ma. A 1-ma. deflection would then correspond to 10,000 rpm. Any reading of the meter multiplied by 10,000 gives the shaft speed in rpm.

After the 10,000-rpm range is calibrated, a second calibration mark for a 1000-rpm range may be placed on the front of the case. This range can be selected simply by adjusting the rheostat.

To use the tachometer, just set the rheostat to the appropriate range and push the eraser against a rotating shaft. If you need high accuracy, calibrate the tachometer on a variable speed motor against a laboratory stroboscope.



**P**OWER TRANSFORMERS—those bulky heavy, and expensive items—are found in all types of electronic equipment. Whatever your interest in electronics, you're sure to have noticed one or more of these steel-clad components quietly humming to itself off in a corner of the chassis. When a replacement is needed, or you're searching for a particular item for a construction project, it's necessary to know the inside story of the power transformers; how interchangeable are the units and what do the specs mean?

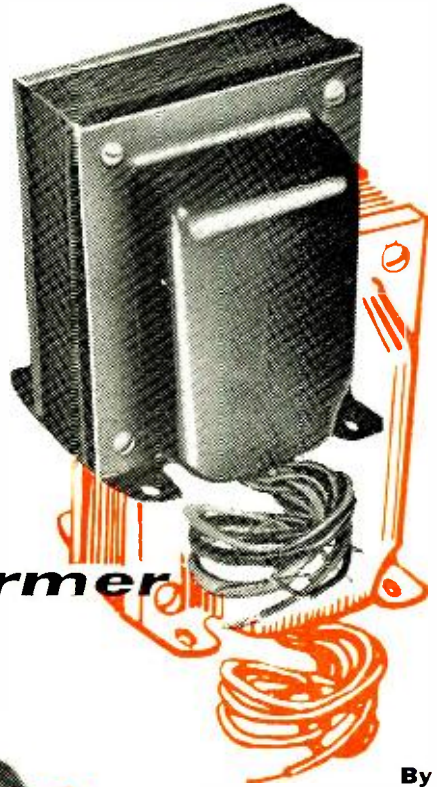
The purpose of a power transformer is

## How to Make Power Transformer Substitutions

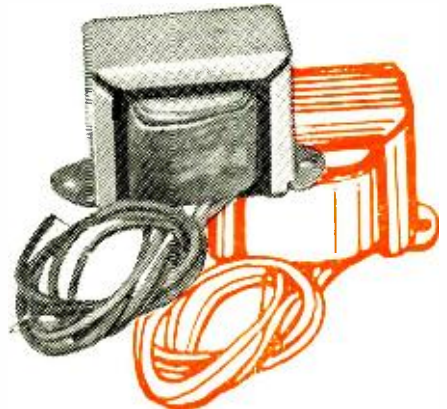
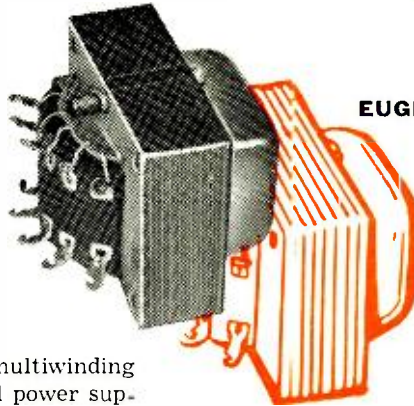
simply to convert the a.c. line voltage into the higher and lower voltages required by electronic circuits. The two types you'll come across are known as *high-voltage plate* and *filament* transformers. In receivers and amplifiers you'll find the functions of both combined in a single multiwinding general-purpose unit. A typical power supply is in Fig. 1.

**Size and Frequency.** Physical size of a power transformer depends upon both its power handling capacity and operating frequency. The higher the unit's power rating, the larger the diameter of the wire needed in its windings and the greater the amount of iron laminations in its core. A transformer designed to power a one-tube audio preamplifier may measure a little over an inch on each side and may weigh but a few ounces. However, the power transformer of a moderately large television receiver will measure several inches on each side and be quite heavy.

The lower the frequency, the more iron is needed in the transformer core to main-



By  
**EUGENE RICHARDSON**



tain operating efficiency. Hence, transformers designed for 25-cycle line operation are larger and heavier than the more familiar 50-60 cps units. Since higher frequency transformers require less iron, military equipment transformer frequencies may range from 400 to 1000 cps.

Unless you live in an area supplied with 25-cycle power (a common frequency of hydroelectric power plants), the chances are you use 60-cycle transformers in all your projects. However, 400-cycle (or other

load. If overloaded, the transformer will supply *more* than 2 amperes, but the voltage will be low and the unit may overheat. Conversely, if less than 2 amperes are drawn, the secondary voltage may be somewhat higher than 6.3 volts.

Frequently, the presence of a center tap is indicated in the secondary voltage specification rather than the abbreviation of "CT". For example, a transformer might carry the following specs: *Primary*, 105-120 volts, 60 cycles; *Secondary*, 350-0-350 volts,

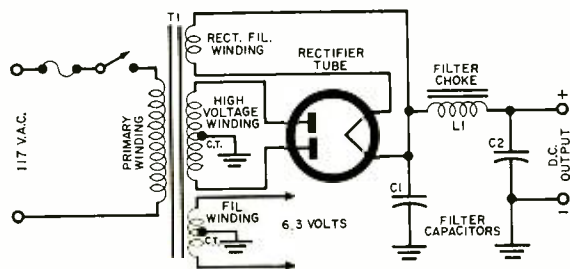


Fig. 1. Schematic wiring diagram of a typical power supply.

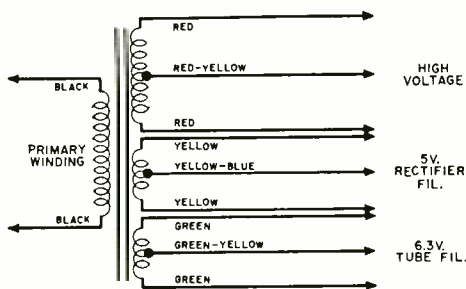
high frequency) transformers are encountered on the surplus market. As a general rule, a transformer will overheat, and may burn out, if used at frequencies appreciably lower than those for which it was designed. Thus, a 60-cycle transformer may overheat if connected to a 25-cycle line, as will a 400-cycle transformer connected to a 60-cycle source.

**Specifications.** Aside from operating frequency, a power transformer's electrical specifications are given in terms of primary voltage, secondary voltages and rated currents. In some cases, the unit's power-handling capacity may be indicated in watts or *volt-amperes* (*va.*=primary voltage multiplied by current in amperes).

A typical filament transformer may have the following specifications: *Primary*, 105-120 volts, 60 cycles; *Secondary*, 6.3 volts, CT, 2 amps. Such a transformer is designed for operation on a standard 60-cycle power line. Although line voltage is nominally 115 volts, it may vary from 105 to 120 volts, depending on local conditions.

This unit's center-tapped (CT) secondary winding has a nominal rating of 6.3 volts, and is capable of delivering a current of 2 amperes without overload. The exact secondary voltage will vary with the applied primary winding voltage and the secondary

Fig. 2. Standard color coding for power transformer leads.



50 ma. This transformer has a standard primary winding and a secondary winding delivering 350 volts *on each side* of its center tap; rated secondary current is 50 milli-amperes. The secondary winding could also be described as 700 volts—CT, 50 ma.

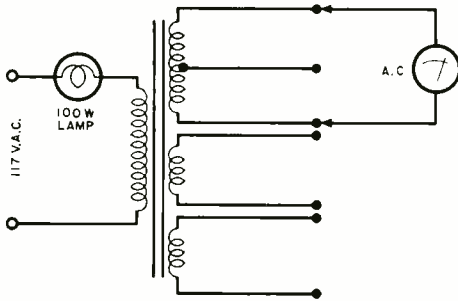
Where a multi-winding power transformer is used, such as in Fig. 1, the voltage and current rating of *each* secondary winding are listed separately. A typical set of specs reads as follows: *Primary*, 105-120 volts, 60 cycles; *Secondary No. 1*, 300-0-300 volts, 50 ma.; *Secondary No. 2*, 5.0 volts, 2 amps; *Secondary No. 3*, 6.3 volts, CT, 3 amps.

**Lead Identification.** Connections to fixed terminal transformers are made to fixed terminal

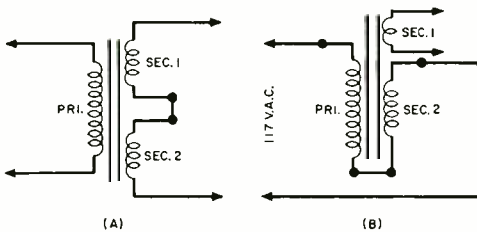


lugs or to wire leads. If you purchase a new transformer, you'll find that lead connection instructions are printed on the box, on a label on the transformer, or on a separate sheet. But if you have a transformer salvaged from another project or taken from a piece of used equipment, these connections probably will have to be determined anew.

If the unit is of recent manufacture, and equipped with color-coded leads, you can identify the leads by referring to the stan-



**Fig. 3.** Basic test which you can make to identify power transformer windings using an a.c. voltmeter.



**Fig. 4.** Two tricks to use in making emergency substitutions: (A) two filament windings can be connected in series to supply higher voltages; (B) a filament winding can be connected in series with the primary to lower all secondary voltages.

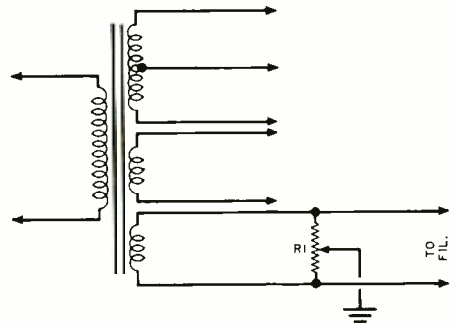
dard power transformer color code given in Fig. 2. Filament center taps are not included in all transformers.

If the transformer is not equipped with color-coded leads, a simple technique will indicate which is which. With the trans-

former disconnected, use an ohmmeter to determine pairs of leads and center-tap connections. Check the resistance of each winding. The winding having the highest resistance is usually the high-voltage secondary and may read from 25 to several hundred ohms. The winding having a medium resistance—generally from 5 to 25 ohms—is the primary. Finally, the lowest resistance windings, usually less than 1 ohm, are the filament windings.

Having made a tentative identification, connect a standard 100-watt lamp in series with the leads chosen as the primary leads and a source of line voltage as in Fig. 3. The lamp should light, but not at normal brilliance. If it lights to normal brightness, either the transformer is shorted (and should be discarded) or you've made an error in choosing the primary leads.

Next, using an a.c. voltmeter, check the



**Fig. 5.** How to obtain an "artificial" center tap on a filament winding.

voltage across each winding, including the primary. The ratios of these voltages will help you to identify the windings.

As a final step, remove the series lamp, applying full line voltage to the transformer primary. Use your a.c. voltmeter to check the unit's output voltages and to identify each winding positively. Remember that the voltage will read slightly higher than normal because of the absence of a load.

**Making Substitutions.** A substitute power transformer should be used *only* if the specified component is unobtainable.

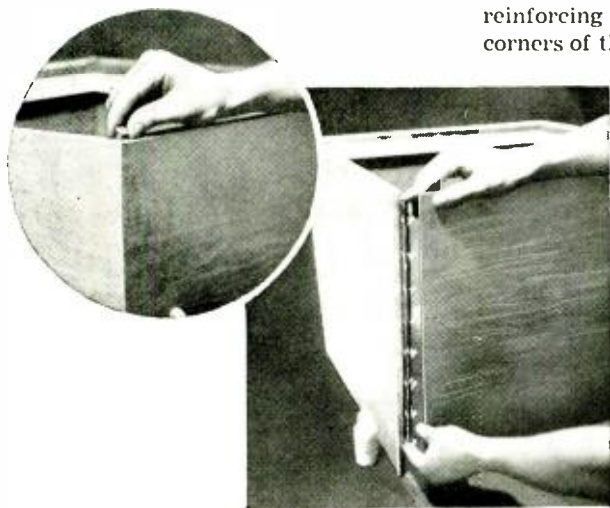
(Continued on page 145)

## *Builds a*

## *Loudspeaker Enclosure*



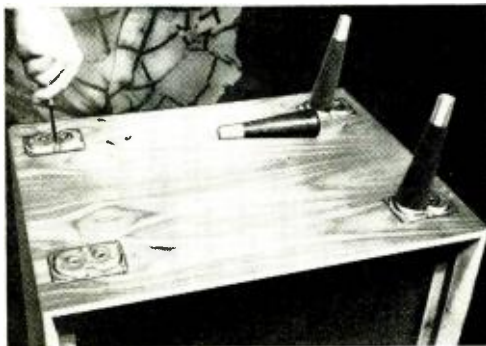
**F**OR the hi-fi'ers who assemble their rigs component by component, here is a new and economical solution to the choice between expensive custom cabinets and homemade boxes. The cabinet kits of Artizans of New England (Dept. 9A, Route 39 North, Sherman, Conn.) are noteworthy because of the new method of construction used. Ease of assembly is insured by utilizing hidden steel locking and reinforcing supports, which join the mitered corners of the cabinets without nails or screws.



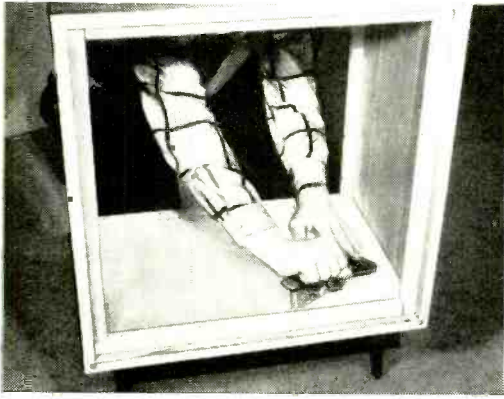
**2** After assembly of the four sides of the cabinet, the metal leg brackets are attached to the bottom. Since the four sides are equal size, choose the side with the best grain design as the top of the cabinet. The leg brackets permit either straight or tilted leg mounting to match your listening room decor.



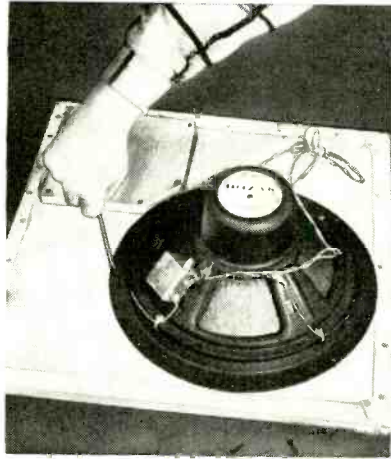
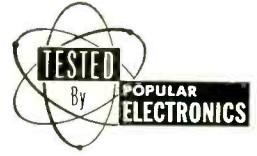
**1** The four sides of the Model 501 cabinet are fitted together with a metal "fishbone." The joint is then pressed together. As the "fishbone" is tightened with a screwdriver, the fishbone barbs pull the adjoining surfaces together. The assembled sides are then finished with the wipe-on oil stain provided and the front edges of the cabinet are trimmed in black varnish.







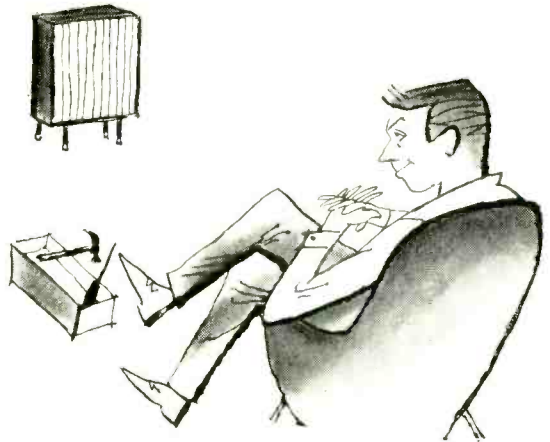
**3** Glass wool is stapled to all internal surfaces in the cabinet, except the speaker mounting board. Adequate cabinet damping is insured by the liberal use of acoustic absorbent material.



**4** A Bozak 207A loudspeaker is mounted on the front panel. The 8" hole intended for a tweeter or port is sealed with a  $\frac{3}{4}$ " plywood panel supplied with the kit, thus providing the infinite baffle required by the Bozak speaker. The grille cloth is stretched over front panel and tacked down inside.



**5** To install the front panel, prop up the speaker mounting board with books, then ease cabinet into position on board. The front panel now rests flush against the recessed cleats in the cabinet, and can be screwed into place from the rear. Install rear panel with cabinet upright. And, finally, hook the cabinet up to your hi-fi system and enjoy the fruits of your labor.





By  
**ARNALDO CORO, Jr.**

**A quick finger** on the camera shutter gives permanent proof of TV reception. The station at left was received in Havana, Cuba, with a standard conical antenna during peak sunspot activity.

## ***DX'ing With Your TV Set***



**Antenna rotators**, such as this Cornell-Dubilier unit shown with its control box, are useful in getting the best DX signals from different directions, especially when a high-gain directive antenna is employed.

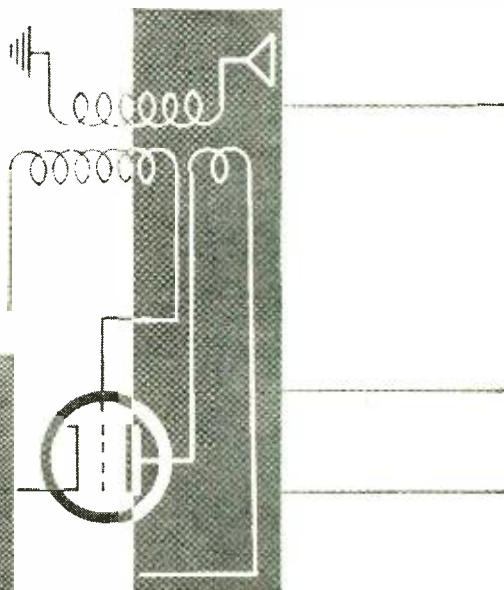
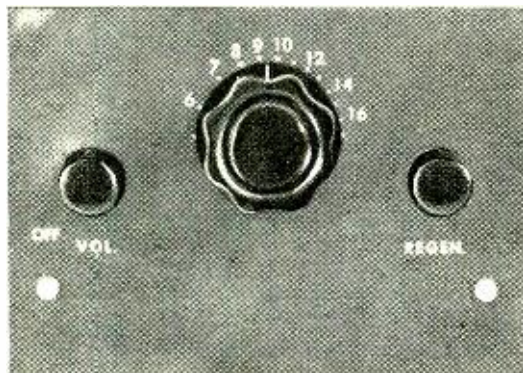
directivity. This is very helpful when you are trying to tune in a particular station, but it becomes a handicap when you want to tune in stations around the compass. To cover all possible signal sources, you'll need a rotator, so you can point the antenna in any direction. A signal booster can also be of great help on the weaker ones.

Television channels are divided into v.h.f. and u.h.f. channels. The former are the only suitable ones for DX'ing, the better ones being Channels 2 to 6. Channels 7 to 13 don't get as far as their lower frequency brothers, but even so they sometimes travel a neat 3000 miles.

Photographs of your best loggings will verify your program reception with the TV stations, which will gladly acknowledge your reports. Just keep a camera handy when you start your new adventures in DX.

-50-

**This two-transistor receiver  
features a.v.c.  
and tuning compensation**



## **Transistorized Regenerative Receiver**

By  
**JAMES E. PUGH, JR.**

**T**HE regenerative circuit is one of the simplest and most sensitive receiver circuits available. But, as you probably know if you've had any experience with these "squealers," it is necessary to re-adjust the regeneration control constantly over a fairly wide range when tuning from one end of the band to the other. The two-transistor receiver described below uses a very simple compensation circuit to overcome this weakness and provides nearly constant regeneration over the entire broadcast band.

The chassis and front panel can be aluminum or Bakelite, with aluminum preferred to eliminate hand capacity effects.

A 3¼" x 5" plastic chassis was used in the author's model with turret terminal lugs installed for parts mounting.

Various sections of the chassis are fastened together with small angle brackets, and the tuning capacitor is mounted to both the front and chassis panels for maximum panel rigidity. If a non-metallic front panel is used, ground the shaft of C3 to the frame of C4 with a flat metal grounding strip.

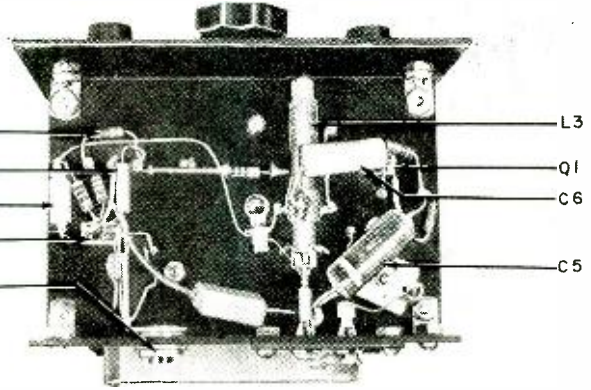
**A built-in ferrite rod antenna (L1)** provides good reception for portable use;



## PARTS LIST

- B1**—5.0-volt mercury battery (Mallory TR-134R or equivalent)  
**C1**—9-180  $\mu\text{fd}$ . trimmer capacitor (optional)  
**C2**—33- $\mu\text{fd}$ . ceramic or mica capacitor  
**C3**—10-365  $\mu\text{fd}$ . miniature variable capacitor (Lafayette MS-215 or equivalent)  
**C4a/C4b**—Two-gang variable capacitor, 365- $\mu\text{fd}$ . each section (Miller 2112 or equivalent)  
**C5**—0.5- $\mu\text{fd}$ . tubular capacitor  
**C6**—0.1- $\mu\text{fd}$ . tubular capacitor  
**C7**—2- $\mu\text{fd}$ ., 6-volt electrolytic capacitor  
**C8**—10- $\mu\text{fd}$ ., 6-volt electrolytic capacitor  
**C9**—0.01- $\mu\text{fd}$ . ceramic or mica capacitor  
**J1**—Phone jack  
**L1**—Ferrite core antenna (Lafayette MS-166 or equivalent)  
**L2**—10 turns of #30 enameled wire added to bottom end of L1  
**L3**—Adjustable ferrite core coil (Miller 2002 or equivalent)  
**Q1**—2N247 (or 2N274) transistor  
**Q2**—2N109 (or 2N217) transistor  
**R1**—15,000 ohms  
**R2**—5600 ohms  
**R3**—39,000 ohms  
**R4**—1800 ohms  
**R5, R7, R7**—3300 ohms  
**R6**—18,000 ohms  
**R8**—1000 ohms  
**R9**—10,000-ohm potentiometer (logarithmic taper) with S1  
**S1**—S.p.s.t. switch (part of R9)  
 1—5-pin transistor socket  
 1—3-pin transistor socket  
 1—Chassis and panel  
 1—Battery holder (Acme #69 or equivalent)  
 Misc. screws, nuts, lugs, washers, wire, terminal strip, knobs, etc.

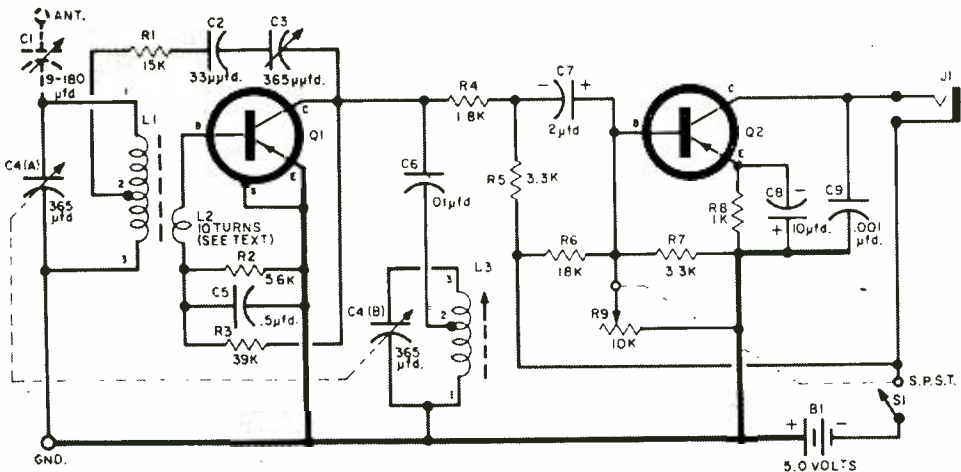
All resistors  
1/2-watt  
composition



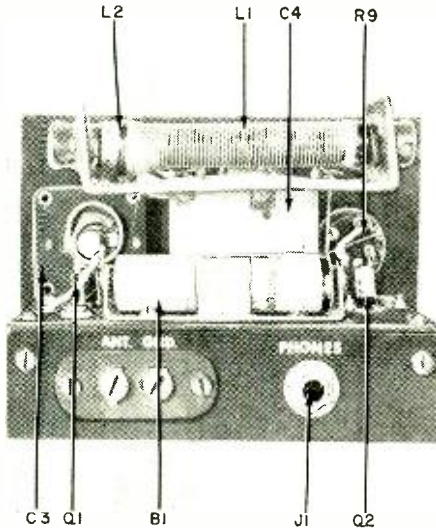
use the largest antenna that your chassis will accommodate (4" or more) and mount it as far away from any metal as possible. An external antenna and ground can be hooked up for peak performance.

Before mounting *L1*, wind 10 turns of #30 or #32 wire around the lower end of the present winding and fasten it with coil dope or wax. Leave the leads of the new winding (*L2*) about 6" long. They can be clipped to the correct length after you check to see which way they need to be connected in order to obtain regeneration.

Antenna *L1* can be mounted at the rear of the tuning capacitor (*C4*) with a small angle bracket and further supported with heavy (about #16) bus wire connections to *C4*. *L3* should be mounted at right angles



**Major parts placement** is shown in bottom and rear views of chassis. Phone jack J1 should be insulated if metal chassis is used. Note use of two-gang tuning capacitor (C4) and one-gang regeneration control (C3).



ohm headphones present the best match to Q2's output impedance.

**Receiver alignment** is achieved by varying the spacing of the L1 primary windings (near the #1 terminal end) at the low end of the broadcast band (530 kc.) and the setting of the trimmer on C4a at the high end of the band (1620 kc.) until the complete broadcast band can be tuned in.

Next, tune in a station at about 600 kc., and adjust the L3 core for maximum output. Adjust the C4b trimmer for maximum broadcast signal output at about 1500 kc. Repeat these two adjustments until maximum output is obtained at both frequencies. C3 should be set near optimum

### HOW IT WORKS

This receiver uses a modified class B detector (Q1), followed by a single-stage audio amplifier (Q2). Regenerative feedback variation is minimized by resistor R1 in series with C2 and regeneration control C3.

Resistor R4 is connected in series with R5 and the audio amplifier stage to reduce the effects of load variation with frequency. R4 reduces the signal fed to the audio stage but the improved performance more than compensates for the loss in gain.

The second tuned circuit (C4b and L3), ganged with the tuned-input circuit (L1 and C4a), is used to give an increase in selectivity. A small amount of automatic gain control has been provided by returning R3 to the collector of Q1.

to and as far as possible from L1. Place L3 so that you will have easy access to its adjustment screw. Other than this, parts layout is not critical.

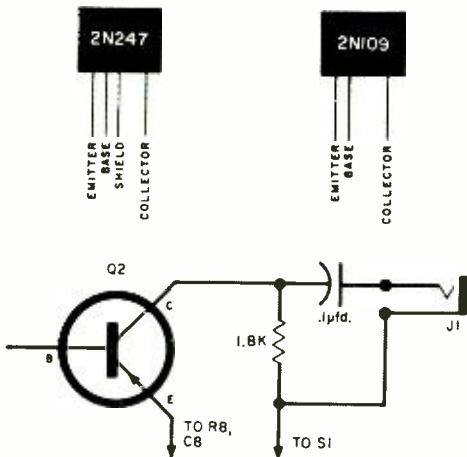
A large tuning dial should be used, since the high selectivity makes tuning somewhat critical on weak stations, and 20,000-

regeneration point for the adjustments.

Now, with the dial set at 600 kc., make sure that C3 is set just below the oscillation point. Reset the dial to 1500 kc. and note whether the regeneration control must be changed to obtain the same condition as at 600 kc. If not, you're ready to go.

If C3 must be increased to obtain optimum regeneration at 1500 kc., a higher value should be used for R4. If C3 must be backed off, reduce R4 slightly. The proper condition is obtained when the two ends of the band are balanced. A slight rise in regeneration will probably be noted as you turn toward the center of the band, as it is not possible to get perfect compensation.

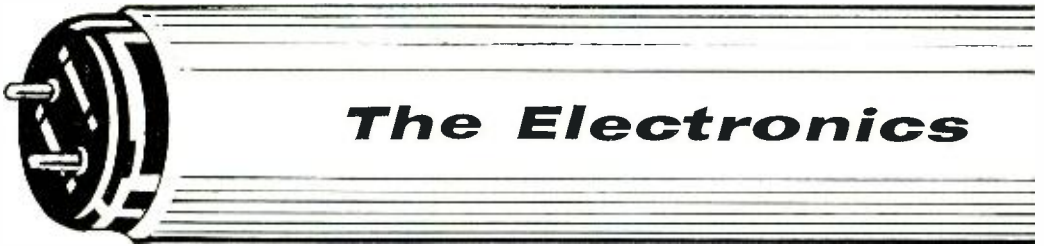
The receiver is tuned the same way as any other regenerator except that the regeneration control can be operated slightly above the oscillation point for maximum output.



**Complete schematic** is at far left. Alternate output circuit for use with crystal earphone is at left. A matching transformer can also be used with original circuit to match transistor to earphone.

**F**LUORESCENT LAMPS, once a novelty, are now an accepted part of the American scene. Their gentle blue-white glow is encountered everywhere, from the tops of skyscrapers to the depths of the New York subway system. However, the operating principles of fluorescent lamps are little understood even by technicians.

**Invisible Light.** Many people know that fluorescent lamps are among our most efficient light producers, and that they operate with a mercury vapor arc. But few realize that over 80% of the radiation produced by that arc is in the ultraviolet region and in-



## *The Electronics*

By  
**EDGAR D. MORGAN**

visible to the human eye, and that every effort is made to keep as much energy as possible in the invisible ultraviolet end of the spectrum. Sounds foolish, doesn't it?

The *visible* light actually comes from chemical compounds coated on the inside of the glass tube. Called phosphors, these compounds have the property of emitting visible light when they are excited by ultraviolet radiation. They have been termed "light transformers" because of their ability to absorb energy at one wavelength and radiate it at another.

The fluorescent lamp depends upon ionization for the production of the necessary ultraviolet arc. Here's how it's done. The free electrons in the gas are accelerated by an applied voltage, and each time a collision occurs between an electron and a gas molecule, one or more additional electrons are displaced. These electrons in turn, are accelerated enough to repeat the process on other molecules, and a chain reaction takes place.

As each molecule returns to a stable state, it gives off its excess energy in the form of radiation. It's the frequency of the radiation that determines whether visible



or invisible light will be obtained. In commercial lamps, the pressure of the gas sealed in the lamp is adjusted very carefully so that nearly all of the radiation occurs at one given ultraviolet wavelength, 2537 Angstrom units. This frequency is selected for optimum excitation of the tube's phosphor coating.

Each chemical compound in the phosphor coating radiates light at a certain wavelength. For instance, zinc silicate releases its radiation as green light, cadmium borate radiates a predominately pink color, and calcium tungstate when excited gives off

windings are placed in series across the applied voltage, and the filaments heat. When the switch is released a moment later, the inductive kick of the iron-core ballast coil causes a momentary voltage surge across the lamp which starts the arc. As the ballast is now in series with the lamp, the arc current is limited by the impedance of the ballast. This simple circuit is widely used on small desk lamps, but has too many disadvantages for general lighting use.

One of the disadvantages of the single lamp circuit is its poor power factor. As the circuit is primarily inductive, due to the

---



---

## of Fluorescent Lamps

---



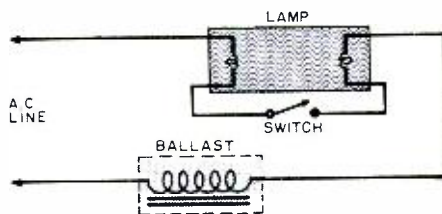
---

blue light. By carefully blending these and other compounds, almost any desired color can be obtained.

**Warming to the Job.** The electrons required to facilitate the starting of the arc are provided by coated tungsten filaments in the ends of the fluorescent tube—similar to the filament in an ordinary vacuum tube. Once the arc is achieved, the heated filaments are no longer required and are automatically switched off. A small amount of argon or krypton gas present in the tube facilitates the initial arcing, which also serves to evaporate the globule of mercury in the tube. From this point on, the arc is basically mercury vapor.

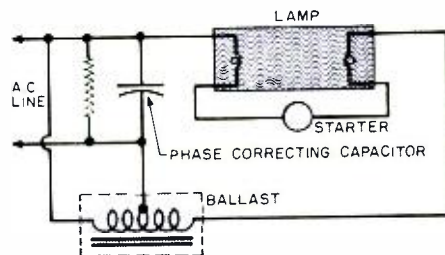
There are two pieces of auxiliary apparatus necessary to operate a fluorescent lamp. One of these is a starter which acts as the automatic filament circuit switch mentioned above. The second additional element required is the ballast, which serves as a choke coil to regulate arc current as well as an autotransformer to provide the high voltage kick needed to start the arc.

**An Inductive Kick.** The basic lamp circuit is shown in Fig. 1. When the switch is closed, the ballast and the two filament



**Fig. 1.** Basic fluorescent lighting circuit in general use only on small desk lamps. A manual switch performs the starting function.

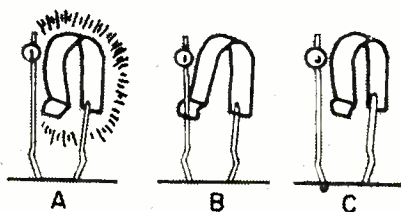
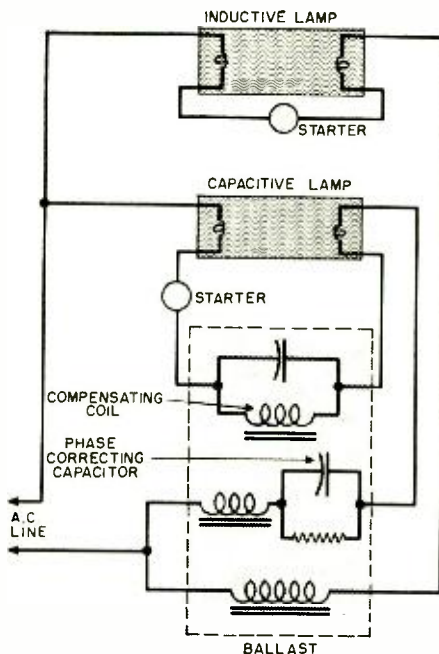
**Fig. 2.** This circuit is sometimes used to correct the poor power factor in the circuit of Fig. 1. The ballast is shown here functioning as autotransformer as well as choke coil.



**Fig. 3.** For the control of two lamps, this circuit is in widespread use and has excellent power factor characteristics.

ballast, the current and voltage have a phase relationship which makes for inefficiency in light output compared to current drawn. A partial solution to this problem is the circuit shown in Fig. 2.

Here the starter is an automatic device although its function is the same as the



**HOW GLOW STARTER WORKS**

The line voltage produces a glow discharge between the bimetallic strip and the fixed contact (A); the heat from the glow actuates the bimetallic strip, the contacts close and the filament preheating begins (B); this shorts out the glow discharge, the bimetallic strip cools and the contacts open (C). The resulting inductive kick from the ballast then starts the tube.

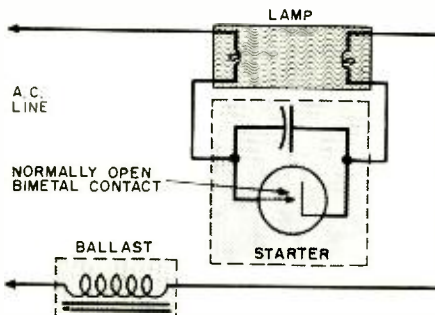
its flicker, due to the 60-cycle line. Since incandescent lamp filaments operate at a very high temperature, there isn't time for them to cool sufficiently from cycle to cycle for the variation of light to be seen. The fluorescent lamp must extinguish and restrike its arc 120 times per second as the voltage reverses polarity. This causes a disturbing stroboscopic effect around machinery with cyclical motion.

switch in Fig. 1. The power factor in this unit is improved by a shunt capacitor. As a capacitor and a coil have an opposite effect on power factor, one offsets the other; and the resistor serves to bleed off any charge which remains on the capacitor. The circuit of Fig. 2 has been drawn to indicate that the ballast is also serving as an auto-transformer. The number and size of the lamps used determines whether this is necessary or not.

**Factors and Flickers.** Another objectionable feature of the single lamp circuit is

Probably the most common circuit in use today is shown in Fig. 3. This is a two-lamp circuit and corrects several of the disadvantages inherent in single lamp setups. The lamp indicated as *inductive* is connected in the same way as the lamp in Fig. 1. The other lamp, however, has a capacitor in series with its ballast. This serves to

**Fig. 4.** Typical glow-type starting circuit used in home-type fluorescent circuits.



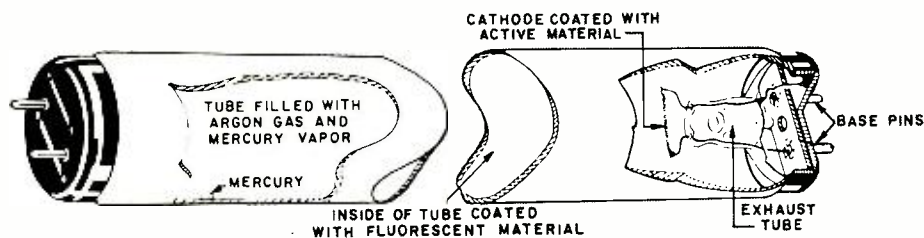
change its phase relations so that its current leads rather than lags the voltage, and corrects the over-all power factor. Thus, the two lamps operate more efficiently as a unit.

The addition of this series capacitor, though, produces another problem. When starting, the capacitive circuit sometimes limits the current required to preheat the filaments. This effect is overcome by adding another compensating coil in series with the starter on this lamp only.

Use of this type of two-lamp circuit is also beneficial in overcoming flicker. Because the lamps operate out of phase, they

gas to ionize and conduct. The heat of the ionized gas is sufficient to cause the bimetal strip to close the filament circuit. The contact closing shorts out the glow discharge and the bimetal begins to cool. After cooling (which takes long enough to preheat the filaments satisfactorily), the contact within the starter opens and the fluorescent lights. The starter is now across the lamp voltage, which is not enough to ionize the neon gas, and so the unit is inoperative as long as the lamp remains on.

The glow-type starter consumes no energy from the circuit after the starting period is over. Its timing is not accurate,



**Cutaway view** of a fluorescent lamp. All fluorescent lamps are constructed as shown here. Only the glass tube changes in size and shape from model to model.

reach their peaks of illumination at different times and the combined light is relatively free from disturbance.

**The Starter Story.** One of the most fascinating pieces of auxiliary equipment is the fluorescent starter. Its task is to close the circuit containing the filaments when voltage is first applied, and after a preheating period of several seconds, to open the filament circuit and keep it open as long as the lamp remains on. A bimetallic strip is used which bends when heated, and serves as sort of a time switch.

The most common type of starter is the glow starter. The entire unit is sealed within a small glass envelope containing neon or argon gas and connected as shown in Fig. 4. A bimetallic strip controls a contact which is normally open.

When first turned on, the full line voltage is applied across the glow lamp, causing the

however, and as it is difficult to maintain the proper gas pressure over a long period, sometimes the timing tends to become very erratic.

A great many of our present-day starters incorporate modifications such as a manual reset. If the lamp does not light after repeated attempts by the starter, it ceases functioning until the trouble is corrected and the starter is reset by pushing a spring-loaded button. There are others that use different contacts for restarting so that it isn't necessary to wait for a bimetal strip to cool completely before it can recycle.

The starter shown in Fig. 4 also contains a capacitor across the lamp contacts, which acts to suppress radio interference.

Manufacturers of fluorescent lamps publish handbooks which elaborate on these principles. They also give many more lighting circuits and their applications. The very fact that fluorescent lamps are so readily accepted and so seldom studied in detail is in itself a fine tribute to their efficiency and dependability.



**T**HE sound level meter is a device for measuring the intensity of sound. Typically, it consists of a microphone, a high-gain amplifier and an a.c. meter. The circuit is so designed that the deflection of the meter is proportional to the amount of sound reaching the microphone.

**For the audiophile** and experimenter, the sound level meter has innumerable applications. Here are just a few examples of the uses to which it may be put: (1) balancing the sound issuing from each speaker of a stereo system; (2) measuring the noise level in the listening room; (3) measuring the loudness of the hi-fi two rooms away;

By

**R. MORROW**



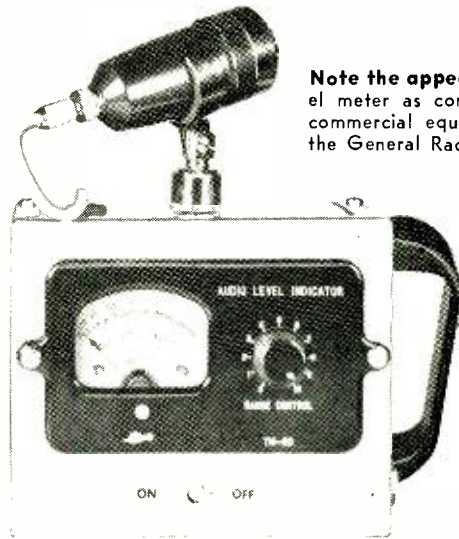
**Build This  
Transistorized  
SOUND LEVEL  
METER**

(4) determining the effectiveness of sound absorbent material on a wall; (5) measuring the noise output of a particular piece of machinery and determining how much lubrication decreases that noise output; (6) measuring the noise level inside the family car; (7) using it as an applause meter; and (8) determining the best speaker placement in the living room.

Commercial sound meters are high-precision, and therefore costly, instruments. Thus, their possession by an amateur is rare. However, the uses to which the average individual may put his sound meter will not demand the high precision of the professional instrument. It is not necessary for



Note the appearance of this sound level meter as compared to the precision commercial equivalent manufactured by the General Radio Co. shown at its left.



the non-professional to measure the absolute value of sound intensity; his concern is the measurement of relative differences between sound levels. In this area the inexpensive meter described here (total cost is about \$17.00) is more than adequate.

Completely contained in a 5"x4"x3" Bud Minibox, and battery-powered, this sound meter is portable and easy to operate. Use of a commercially available audio level indicator elimi-

nates a costly meter and meter rectifier, and has the added advantage of providing a built-in 20-db attenuation control. The cost is further reduced at the input end by using an inexpensive high-impedance dynamic type of microphone. Any one of a number of mikes can be tried.

Actually the only real construction involved in the assembly of the sound meter is the two-transistor amplifier strip. The two high-gain low-noise transistors provide enough output to peg the meter with a hoarse whisper two feet away from the microphone.

**Construction is started** by preparing the case. Placement of components is not

critical and you can use the photographs as a guide in cutting the chassis.

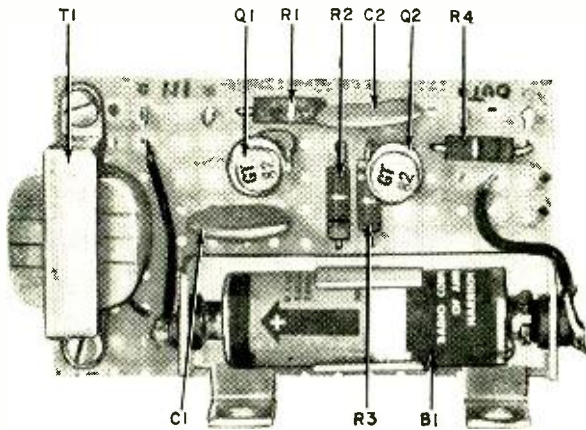
Lay out the 3 7/8"x2" rectangular hole on the larger section of the Minibox with a scribe. Drill a 1/2" hole in each of the corners of the rectangle and use a hacksaw blade and file to cut out the rest of the rectangle. (Use of Greenlee rectangular chassis punches would greatly facilitate this job and make for neater holes.) Then drill a 1/8" hole on each side of the rectangle for the mounting screws of the audio level indicator. (The indicator front panel is removed from the plastic cabinet.)

The on-off switch is mounted in a 1/2" hole centered directly beneath the audio level indicator hole. Provide two center-line 1/8" holes on one of the side panels for the mounting of the amplifier strip. On the other side panel drill a 3/8" hole for the phone jack and two 1/8" holes for the handle. Only two holes are drilled in the second section of the case: a centered 1/2" hole for the microphone and a 3/8" hole for the microphone cable.

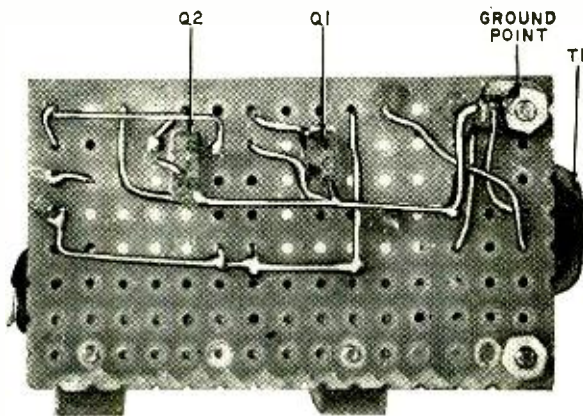
For that professional look, we painted the case and applied Walsco decals.

**The transistor amplifier** construction is clearly shown in the photographs. The base for the amplifier is a 2 7/8"x1 7/8" piece of perforated phenolic board. Simply mount the parts by running their leads through the perforations and solder the necessary connections on the reverse side.

We mounted sockets for the transistors



Front and back views of transistor amplifier board. The small brackets are used to mount it to the side of the cabinet. Parts placement is not critical but should follow a logical order from input to output. Certain microphones may not require transformer T1 for proper match to the input impedance of transistor Q1.



but they are not necessary. The leads of the transistors may be run through the holes in the board and connections soldered directly to them. Be sure to use a heat sink and solder as quickly as possible, since transistors are very easily damaged by excessive heat.

If transistor sockets are used, enlarge two adjacent board holes with a 1/8" drill and cut the proper size rectangle with a small file (a nail file will serve nicely). The two small mounting brackets are mounted with the same bolts used to hold the battery holder.

Be careful to observe the polarity of the battery to avoid damaging the transistors. Flea clips used at the amplifier input and output make for neater construction and facilitate connections to the microphone and audio indicator.

**Using the meter** is a simple operation. Just flip the switch to the "on" position

**PARTS LIST**

- B1—9-volt battery (RCA VS309)
- C1, C2—0.1- $\mu$ fd., 60-volt ceramic disc capacitor
- J1—Phone jack
- R1, R4—1 megohm                      All resistors
- R2—5600 ohms                          1/2-watt
- R3—6800 ohms                          composition
- Q1, Q2—GT-82 transistor
- S1—S.p.s.t. toggle or slide switch
- T1—Input transformer (Argonne AR-141)

- MIC.—High-impedance dynamic microphone (Lafayette PA-48 or equivalent)
- 1—Audio level indicator (Lafayette TM-20 or equivalent)
- 1—5" x 4" x 3" chassis (Bud Minibox)
- 1—2 7/8" x 1 7/8" perforated phenolic board
- 2—Transistor sockets
- 1—Battery bracket for B1

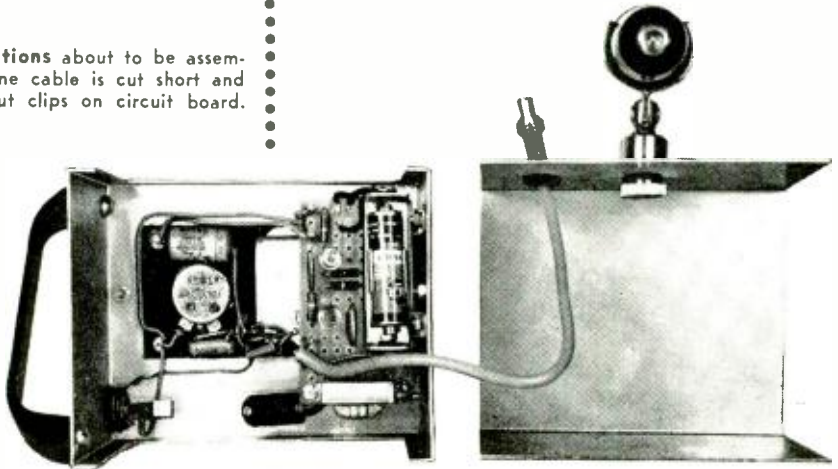
and point the microphone toward the sound source.

For example, to use it as an applause meter, point the microphone toward the audience and have everybody applaud as loudly and evenly as possible. Now adjust attenuation for full scale deflection, which corresponds to 100% audience response. Subsequent applause will correspond to meter deflection.

To balance a stereo system, feed a constant signal into one channel and note meter deflection at the desired listening level. Then feed the same signal into the



Completed sections about to be assembled. Microphone cable is cut short and soldered to input clips on circuit board.



other channel and adjust the second channel gain to give the same meter deflection as the first.

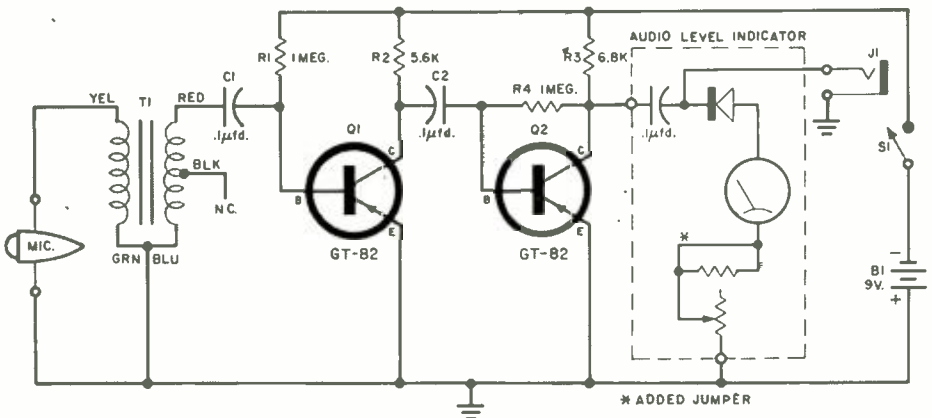
**To measure decibels**, the sound meter must be calibrated against another previously calibrated sound level meter (such as General Radio Type 1551-A). Place the two instruments as close together as possible with both microphones pointing toward an adjustable sound source. Set the standard meter to its lowest range and adjust the sound source for full scale deflection. Now adjust the attenuator of the second meter for full scale deflection, noting the attenuator setting and the db read-

ing on the standard meter to which it corresponds. The same procedure is repeated for the higher ranges of the standard meter.

As we mentioned earlier, calibration is not necessary for most applications. The meter's greatest value is realized in making comparative measurements. In order to do this, simply note meter deflection for each of the sound sources being compared. If you want to express the sound intensity of one source in terms of another, use the formula:  $D1/D2 \times 100 =$  the percentage  $D1$  is of  $D2$ ; where  $D1$  and  $D2$  are the meter deflections given by two different sound sources.

-30-

Part of schematic shown in white is audio level indicator described in text. Output jack J1 is optional; if used, connect it between the built-in 0.1- $\mu$ fd. capacitor and the rectifier.



**D**ANNY JABBED disconsolately at the tube socket connection with his soldering iron, the tip of which was pitted and black with a little solder shining resolutely through in a spot or two. Just then the door opened and Jim, his neighbor, walked in. Turning on his stool, Danny pleaded, "Jim, why can't I ever make a decent solder connection? I've been on this job for two hours and I'm not getting anywhere."

Jim stepped over and surveyed the job. The soldered connection was dull and crystallized, and a huge pitted, black and scarred tinsmith's iron was staring at him

bench vise, then proceeded to file the tip to a neat pyramid shape.

"What's that for?" Danny wanted to know.

"Well, Danny, one of the most important requirements in soldering is cleanliness. Second perhaps is plenty of heat delivered to the right spot. But let's go back a little.

**W**E HAVE in the radio industry many ways to connect conductors. But the average man's major resource is still the mechanically strong soft-solder connection.



from the bench alongside a little box labeled "Acid Core Solder."

He smiled ruefully, looked at Danny's dejected face and asked, "Where shall we start?"

"At the beginning, I guess," was Danny's reply. "From your expression I must need some instruction bad."

"Do you have a file?"

"Sure . . . here."

Jim took the file and looked at it. It was badly clogged and far too coarse. "Just a minute," he said, "I'll be right back."

Jim returned, carrying a tool box from which he took a file.

"Do you have an iron smaller than this monster here?" he asked.

"Sure," said Danny, "but I can't get anything hot with this, let alone the small one." He dug a smaller iron out of a bench drawer and handed it to Jim. This, too, though the right wattage, was pitted and scarred like an ancient warhorse. Jim clamped the iron gently but firmly between the jaws of a

Yet this is one of the most neglected and mistreated fields in electronics.

"First, as I mentioned, cleanliness is of utmost importance. All your soldering equipment should be kept clean. Let's consider the iron first.

"The iron should be filed clean with a medium file, using gentle forward strokes, lifting the file on return strokes." He continued to file the tip, one surface at a time, till it was clean, bright and free of pits . . . he plugged it in.

As the iron heated, Jim continued, "There are many ways to furnish the heat for soft soldering. For convenience we use the electric soldering iron, with or without some type of thermostatic control. If the iron has a thermostat, fine. If not, it is a good idea to buy or build a bench thermostat like the one published in the February '57 issue of POPULAR ELECTRONICS. It will prevent excess oxidation of the iron tip which causes pitting.

"Then there's the soldering gun. This

usually consists of a transformer, the tip forming the load for a high current secondary, which is made up of a few turns of heavy wire. The tip heats fast and the gun is normally equipped with an on-off trigger switch in the primary. The tip is hot only when needed, thus preserving it and saving on the electric bill.

"And let's not slight the small soldering 'pencils' which supply adequate heat for light general work. These are ideal for printed-circuit boards, transistors and instruments. With the right tips they can be used for anything, including soldering di-

By BRICE L. WARD



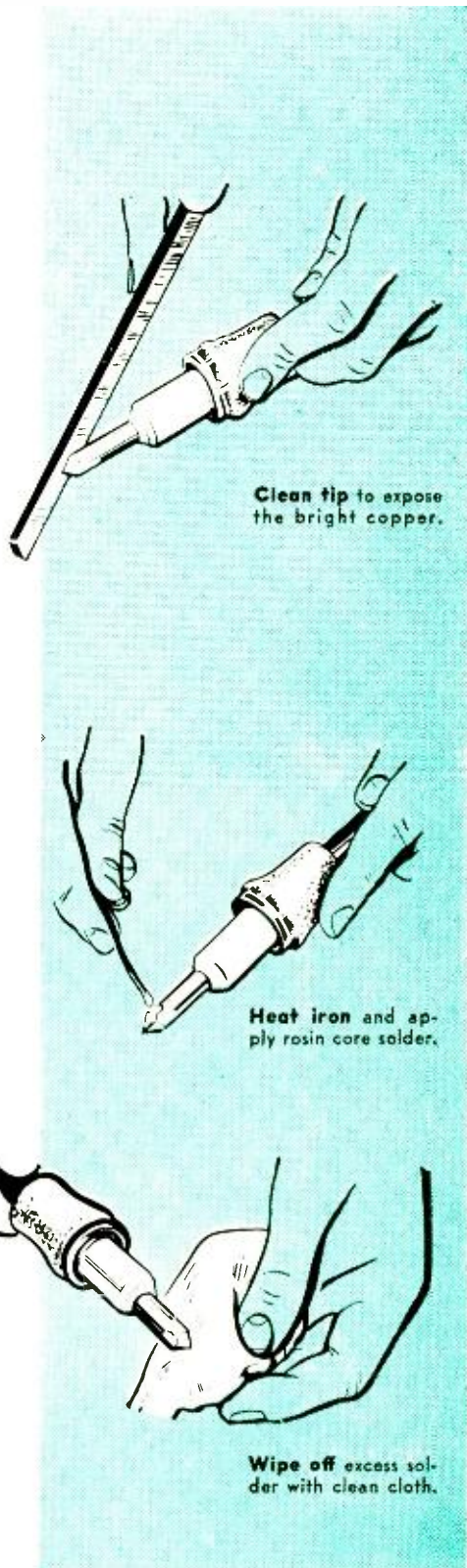
rectly to chassis. Some pencil soldering irons have several replaceable tip types."

**J**IM took a small can from his tool box and opened it. "Rosin solder paste," he said, answering Danny's unspoken question. Then he picked up the iron, which was just warm and dipped the tip in the mixture. The iron melted its way slowly into the paste and came out with a light coat of flux on the exposed copper.

"That," said Jim, "prevents oxidation of the copper until the tip is hot enough to tin. Fluxes in all types of welding, brazing and soldering have one to three purposes: they prevent excess oxidation of the materials during the heating process; they contribute to the cleaning of surfaces to be joined and, by reducing surface tension, they increase the wetting power of the solder.

"Fluxes can be broken down into two basic types, corrosive and non-corrosive. In the first category we find weak hydro-

April, 1959



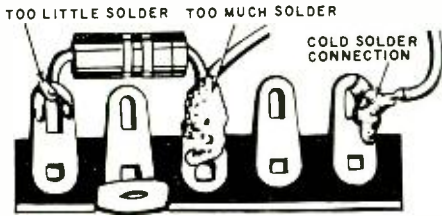
Clean tip to expose the bright copper.

Heat iron and apply rosin core solder.

Wipe off excess solder with clean cloth.



chloric acid, better known as muriatic acid, zinc chloride, borax and ammonium chloride, more commonly called sal ammoniac. Used mostly in hard soldering and welding, they have cleaning power due to their corrosive tendencies and must be washed away or the residues will tend to cause oxidation when they mix with moisture from the air. These fluxes should not be used in electronics for several reasons. Most important is



Learn to recognize bad soldering joints.

A good connection is bright and smooth.



the fact that they cannot be adequately removed. The residues tend to become conductive in the presence of water vapor and form low resistance paths on the surface of insulators.

"The non-corrosive fluxes are solid rosins and rosins mixed with alcohol or glycerine to form pastes. Non-corrosive fluxes have little or no cleaning power and, except for those pastes made with glycerine, they have no wetting power. They simply serve to prevent excessive oxidation. This is one of the biggest reasons for stressing cleanliness in radio soldering. One thing that makes our job much easier is pre-tinned leads and components. Most manufacturers pre-tin socket lugs, pigtailes, etc."

As the rosin on the iron began to smoke,

Jim removed a roll of rosin core solder from his tool box and started to apply it liberally to the iron tip. Danny watched, fascinated.

"I've never had that old iron looking that good before," he said. "What kind of solder is that?"

"Well, it's not just the solder . . ." Jim replied, looking critically at the iron, then brushing it lightly with a piece of dampened rag, ". . . but it does help a lot. That solder is composed of 60% tin and 40% lead with a rosin core, and is known as 60/40 rosin core solder.

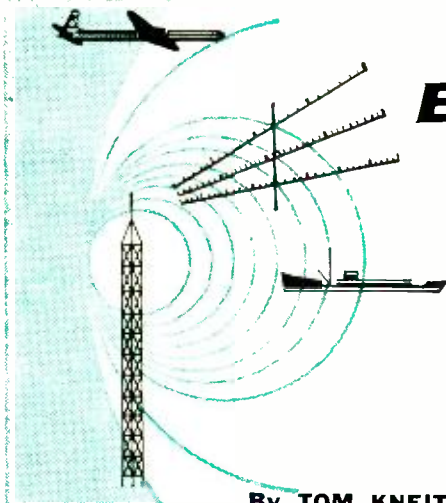
"SOFT soldering is, by definition, any job in which the solder melts at less than 800° F. In soft solders we have a mixture of tin and lead with the addition in some instances of antimony, silver or bismuth. As a rule, we don't use any of these latter materials in electrical solders. Antimony and bismuth, though they decrease the melting point of the solder, also decrease the wetting power. Silver raises the melting point and is normally used for solder of increased mechanical strength.

"Of interest from a technical point of view is the way solders melt. They begin usually in a solid state at room temperature, though there are some alloys using mercury and bismuth that are liquid at room temperatures. At some temperature known as the *solidus* temperature, solders go from a solid to a plastic state. You have probably noticed it in using that 40/60 solder on the bench. The solder does not flow but can be pushed around and molded like clay. This is the plastic state between the *solidus* and *liquidus* temperatures. At the *liquidus* temperature, solder will flow almost like water. To do a good solder job, the *liquidus* temperature *must* be reached.

"In the solders we use in electronics, the melting point of the alloy is lower than the melting point of either metal. For instance, pure tin melts at 450° F. Lead melts at a somewhat higher temperature, but a mixture of 62% tin and 38% lead melts at 361°. This is known as a *eutectic* mixture, because it melts at the lowest point of any combination of tin and lead.

"A 60/40 solder has a *solidus* temperature of 370°, a difference of only 9°. Practically, this means we can solder with less heat and burn up fewer components," Jim said.

"Incidentally, the lower melting point  
(Continued on page 148)



# Bandspread

By TOM KNEITEL

## Special Fare for DX'ers

WHAT MIGHT very well be considered a sort of Oriental WWV is Japan's Station JJY, which, like WWV, transmits standard frequency and time signals, and even radio propagation disturbance warnings to the world. Through several vertical antennas, they broadcast their 1000-cps time signal on six frequencies strung out between 2.5 and 15 mc.

This station is operated as a public service by The Radio Research Laboratories, Koganei-machi, Kitatama-gun, Tokyo, Japan. Not an easily heard station in the Eastern U. S., it nevertheless can be lured out from under the QRM by the diligent epicure of DX, wherever he may be located.

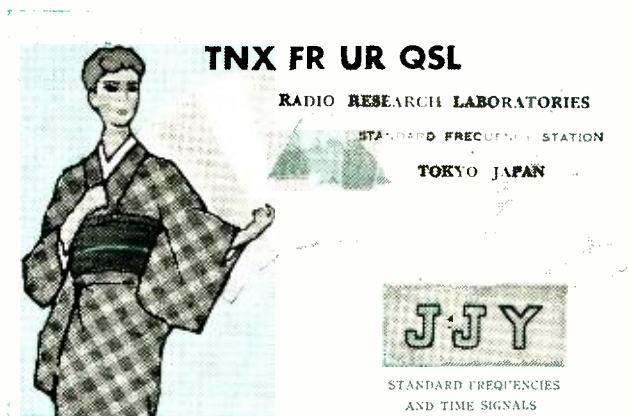
You boys with the high-powered receivers can try your hand at pulling JJY through WWV on the frequencies that both of these stations share.

In order to verify numerous reception reports, JJY has whipped up a novel QSL card with ham-talk written over a picture of a Geisha girl, in Technicolor!

Mr. Shiego Kurachi, top man in JJY-ville, eagerly seeks reception reports and has supplied the following schedule of his station's operations:

Frequency (kc.)	GMT	kW.
2500	0659 to 2259	1
4000	24 hours	2
5000	2359 Sun. to 2349 Mon.	1
8000	2059 to 1059	2
10000	2359 Tues. to 2349 Wed.	1
15000	2059 to 1059	1

**QSL'ing the "Nautilus."** We don't like to brag (much), but we have recently become the very proud possessor of a QSL from the U.S.S. "Nautilus," history making nuclear sub of the U. S. Navy that showed its stern to the walrus at the



An oriental version of WWV is Japan's station JJY, which sends out a kimono-clad QSL. They broadcast standard frequency and time signals, and warn of any radio propagation disturbances.

North Pole. They were heard on 2126 kc. calling the New York Marine Operator during their return voyage to the U. S. from "way up thar."

This QSL makes a nice companion for the card we collected from U.S.S. "Glacier," which was at McMurdo Sound, Ant-

et Telephones, Paris, France. Don't forget the reply card.

**Special Stations.** The Diana Moon Radar transmitter (Sept. '58 POP'tronics, p. 64) has been reported testing on 151.11 mc. with c.w. and pulse for about four hours a day, Monday through Friday.



**The U.S.S. "Nautilus"** was heard and QSL'd on its return voyage from the North Pole, calling the New York Marine Operator on 2126 kc.

arctica, when we listened in during 1956's "Operation Deepfreeze II."

**Scrambled Speech.** One of the most often asked questions about utility stations is: "How do you listen to scrambled speech (SSB) transmissions?" These are heard from commercial overseas telephone stations and sound somewhat like a chipmunk with his tail in Fido's incisors. Heard in all parts of the short-wave spectrum, they can provide you with some good DX'ing if you can unscramble them.

The generally accepted and recommended way of making sense out of these transmissions is as follows: (1) tune to a sideband of the signal; (2) pull your sensitivity control down a few pegs; and (3) fiddle around with the BFO (c.w. pitch) very slowly. If this doesn't work, try doing steps 2 and 3 on the other sideband. With some luck you should be able to get a fairly readable signal, sounding only slightly like "Robby the Robot."

Among the most commonly heard commercial telephone stations, heard on many frequencies using both scrambled and unscrambled speech, is the one in Paris, France. They announce "Ici Parea," followed by a racket that sounds like a one-armed marimba player with St. Vitus' Dance. They can be reached for QSL'ing at: Administration des Postes, Telegraphes

Power on this frequency is 50 kw. If you hear their transmissions on this channel, or on their 108-mc. channel, send a report to: Commanding Officer, U. S. Army Research & Development Laboratory, Ft. Monmouth, N. J. (Att: SIGFM/EL-SX). Their multi-colored glossy QSL is about as avant-garde as you can get!

The Burned-out 12SK7 Award for unusual-station-of-the-month goes to Station IRM, Rome, Italy. This station is operated by "Centre International Radio-Medical," Via Torino 122, Rome, Italy, for the sole purpose of providing medical advice to ships at sea which do not carry their own doctor. Aside from the advisory transmissions, they run regularly scheduled c.w. and phone broadcasts. Look for them on c.w. at 12,760 kc. on Tuesday, Thursday, and Sunday at 1130 to 1145 GMT, and 1830 to 1845 GMT. They also have a daily c.w. broadcast for five minutes at 0755 and 1955 GMT on the same frequency. Their regular phone transmission can be heard every Sunday on 12,643 kc. at 1850 GMT for ten minutes. This is an interesting catch, and a QSL from Station IRM will be a nice addition to your wall, especially if your XYL has put up floral design wall paper in the shack.

Are there any utility stations that you would like to see a photo story on? Let us know and we will start the wheels grinding in that direction.

-50-





## ***Eight-Sided Dice***

By  
**IRA GLICKSTEIN**

**T**his multi-purpose project can be used as eight-sided dice, or as a tester of extrasensory perception. As an added bonus, it will give you a chance to learn simple binary arithmetic as used in digital computers.

In a game of chance, you refer only to the top three flashing lamps of the BINARY DICE. At any instant some will be "on" and some "off." When the push-button switch is pressed, the lamps that were on at the instant of switching remain on, those that were off remain off. A little figuring will show that there are eight possible

***Electronic "DICE"***

***teaches binary arithmetic***

***and tests for***

***supernatural powers***

EXAMPLE	BINARY-DECIMAL	BINARY-DECIMAL
	001—1	101—5
	010—2	110—6
	011—3	111—7
	100—4	000—8*

(top line) 110 or 6

\*8 is actually 1000 but for BINARY DICE use 000 as 8

**How to convert binary numbers to the decimal system.** Only the top line of bulbs is read, giving eight possible "on-off" combinations.

combinations of the three lamps being on or off, and the lamps will indicate from 1 to 8 in the code of binary arithmetic.

**Binary Arithmetic.** Digital computers use a calculating system based on the number 2. This system is called "binary." Our ordinary number system is called a "decimal" system because it is based on 10.

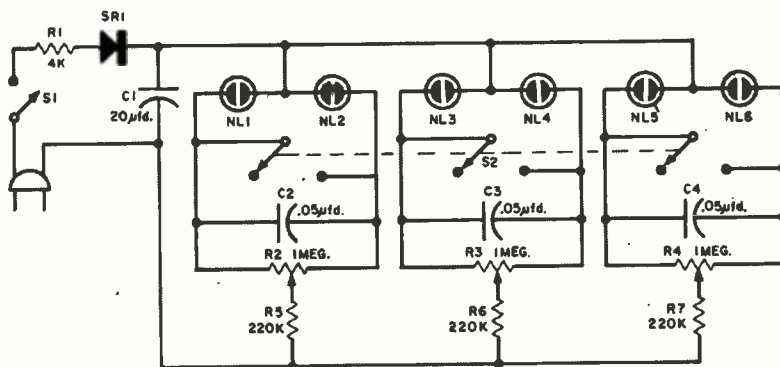
In the BINARY DICE, a lamp that is "on" represents the binary digit "1," a lamp that is "off" represents "0." Using the binary notations 1 and 0, read the top three lamps; then look up the resulting binary number in the chart shown above. After you use the device for a short time, you will

be able to recognize 101 as 5 and 110 as 6.

**Construction.** The BINARY DICE is built in a 5" x 7" x 3" aluminum box. For ease of wiring, a subchassis for the three calibrating potentiometers and associated capacitors and resistors is used. This small 4½" x 3" aluminum panel should be wired first; see the photo for details.

When constructing the main cabinet, the neon lamps are press-fit into rubber grommets and leads are soldered directly to them. The remainder of the construction is self-explanatory. Be careful *not* to ground any part of the circuit to the metal box.

Plug in the BINARY DICE to the 117-



### PARTS LIST

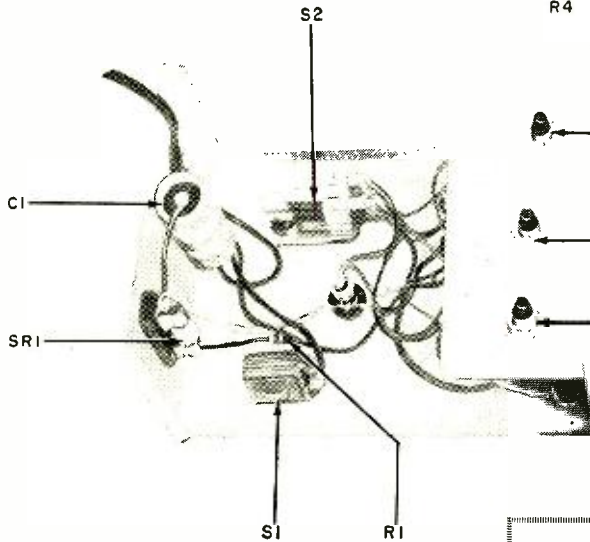
- C1—20-µfd., 250-volt d.c. electrolytic capacitor
- C2, C3, C4—0.05-µfd., 400-volt d.c. molded tubular capacitor
- NL1-NL6—NE-51 neon lamp
- R1—4000-ohm, ½-watt resistor (see text)
- R2, R3, R4—1-megohm linear taper potentiometer with slotted shaft (Mallory SU-54 or equivalent)
- R5, R6, R7—220,000-ohm, ½-watt, 10% resistor
- S1—S.p.s.t. toggle switch
- S2—3-p.s.t. push-button switch (Switchcraft 9001 or equivalent)
- SR1—150-ma. silicon rectifier (Sarkes Tarzian M-150)
- 1—4½" x 3" aluminum subchassis
- 1—3" x 5" x 7" metal box (Bud Minibox C8-2108)
- 6—3/8"-i.d. rubber grommets for ½" mtg. hole
- Misc. mounting clip for silicon rectifier, insulated lug, wire and hardware

volt line with the on-off switch to "on." All six lamps should start flashing at a rapid rate. Press the button and three lamps should remain on and three lamps should be off. If this doesn't happen, adjust each potentiometer to its approximate center position and/or change the value of R1. This resistor may be safely made as small as 100 ohms or as large as 6000 ohms. The optimum value is that at which the lamps flash so rapidly that you can just see the flicker.

**Calibration.** Because of inevitable differences between individual components, a

calibrating potentiometer has been built into each of the three random indicators. Calibration assures that each indicator will behave like a perfectly balanced coin, and the whole unit will behave like a perfectly balanced eight-sided die. Time, patience and a screwdriver are required.

Set each potentiometer to approximate center position. Observe neon lamp *NL1*

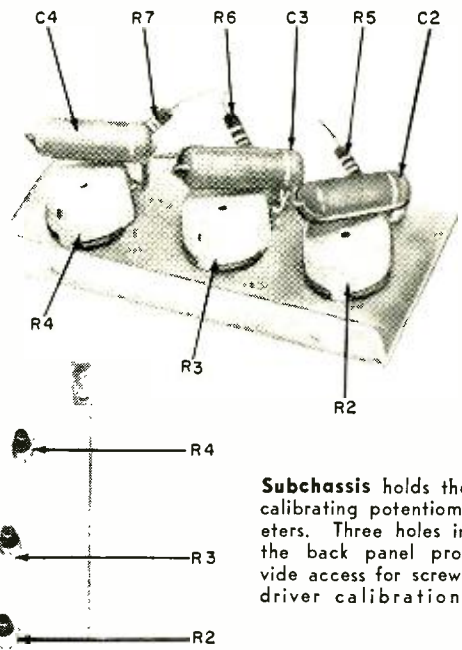


(top row, far left). Press the button (*S2*) 30 times and record how many times *NL1* stays lit. Twelve to 17 out of 30 is good—don't touch *R2*. If *NL1* stays on more often, turn *R2* (directly behind *NL1*) slightly counterclockwise. If it stays on less than 12 times, turn *R2* slightly clockwise.

Repeat this procedure. Don't stop until lamp *NL1* falls into the safe zone twice in succession. Calibrate *NL3* (top row, middle) with *R3*, and lamp *NL5* (top row, far right) with *R4*.

**Extrasensory Powers.** Some scientists contend that certain people can control the fall of dice or other chance occurrences by some type of mental energy. Others believe it may be possible to predict chance happenings. All of these special "talents" are lumped into the category of ESP or "extrasensory perception." Since BINARY DICE provides random selection and cannot be influenced, mechanically, by the person operating it, the unit is ideal for testing for presence of ESP.

April, 1959



**Subchassis** holds the calibrating potentiometers. Three holes in the back panel provide access for screwdriver calibration.

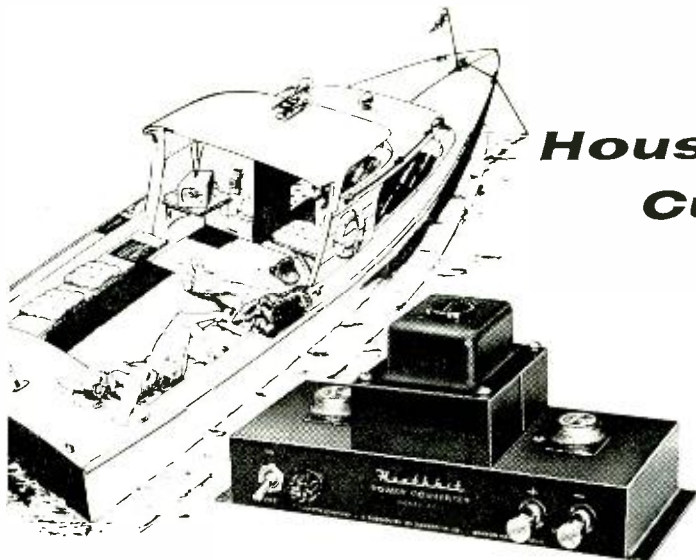
### HOW IT WORKS

The BINARY DICE is made up of three separate indicator circuits using a common d.c. power supply. Each circuit has a capacitor, a potentiometer and two neon lamps, which form a relaxation-type oscillator circuit. As one lamp of each pair goes on, the other goes off, and vice versa. When switch *S2* is pressed, the two neon lamps are connected in parallel, and the one which was on at the instant of switching will remain on, while the other remains off.

The second row of BINARY DICE is used for ESP testing. There are two lamps and the four possible combinations are: 00, 11, 10, 01. Blindfold your subject, ask him to pick one of the four combinations and concentrate on it. Press the button to see if he "guessed" right. Do not tell the subject if he was right or wrong. Ask him to pick again, then press the button. Run through it about 20 times. By the law of chance he will be right about 25% of the time. If your subject does better than 5 out of 20, he may have extrasensory powers . . . or he may be plain lucky!

If a subject *always* does much better than 5 out of 20, contact the psychology department of the nearest university . . . he's a mental miracle man!





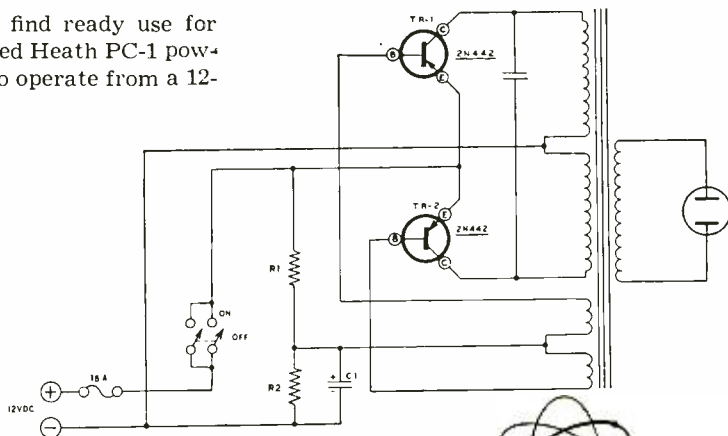
## Household Current Afloat

... with a Heath  
power converter kit

**B**OAT OWNERS will find ready use for the new transistorized Heath PC-1 power converter, designed to operate from a 12-volt storage battery. By means of electronic switching and without moving parts, this versatile unit will operate small television sets, hi-fi systems, or certain appliances while cruising.

The d.c. input, at a normal 12 volts, is electronically switched to and fro in the primary winding of the transformer by a pair of power transistors. These act as an automatic switch without moving parts, allowing the input voltage to pass first in one direction and then in the opposite direction through the transformer primary winding. This switching occurs approximately 60 times every second, thus effectively making 60-cycle a.c. out of the 12-volt d.c. input.

The transformer is so designed that the action of the switched input voltage in the primary is coupled to the much larger secondary winding via the magnetic field caused by the switched voltage. In effect, the voltage developed in the secondary winding is a much larger (115-volt) replica of the switched input (12 volts). This 115-volt, 60-cycle a.c. voltage is available for



use in powering numerous items of equipment normally requiring household or shore power.

On being tested under 125 watts load for eight hours continuously, the power converter operated without failure but heated considerably. The chassis acts as a heat sink and becomes hot to the touch after long use. This heat is not excessive and should be considered normal for the unit.

The output voltage of the PC-1 power converter is not a pure sine wave. Therefore, a D'Arsonval type a.c. voltmeter cannot be used to measure the output voltage. In its place, an iron vane voltmeter should be employed.

-50-

## A New Electronic Development

# The Dielectric Pump

ONE warm summer day, two years ago, two physical chemists stood behind a table in the General Electric Research Laboratory at Schenectady, New York. Before them lay a piece of experimental apparatus consisting of an ordinary glass containing two small wire screens separated by a short piece of glass tubing. The glass was filled with nitrobenzene, a highly insulating liquid. Each screen was connected to one side of a high-voltage d.c. power supply.

One of the men switched on the power supply and adjusted its output to 10,000 volts. The other injected a brightly colored dye solution into the glass on the far side of one of the screens. Suddenly, the dye began to swoosh through the screens. The liquid was moving!

The scientists were Dr. P. L. Auer and Dr. A. H. Sharbaugh. They were investigating some strange reports from a group of research workers at the University of Cincinnati concerning the behavior of insulating liquids in the presence of strong electric fields. Their research efforts led to the invention of a novel method of pumping liquids which involved no moving parts—the *dielectric pump*.

**Direct Energy.** Conventional electric pumps, such as the common "paddle-pump," mechanically push or pull liquids along with paddles or pneumatic pistons powered by electric motors. Since the efficiency of this type of pump can never exceed the effi-

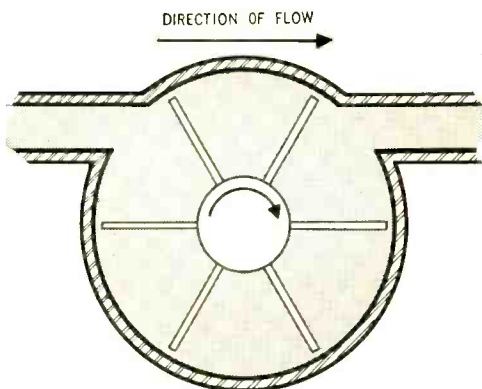
## ...No Moving Parts!

ciency of the electric motor operating it, as much as 80% of the electrical energy supplied to it is wasted.

Dielectric pumps use electrical energy *directly* to pump liquids. The simplest type consists of two wire-screen or perforated metal disc electrodes with a d.c. potential difference of about 10,000 volts between them. If the electrodes are placed parallel to each other in an insulating liquid, such as kerosene or mineral oil, the liquid will move slowly towards the positively charged electrode.

The reason for this is rather simple. If

By  
JAMES G. BUSSE

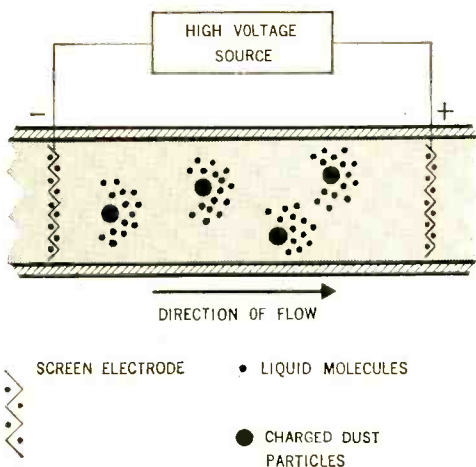


**"PADDLE-PUMP."** In the conventional electric pump, liquids are mechanically pushed along by paddles that are rotated by an electric motor.

the liquid were an ideal dielectric, there would be no movement at all, but ideal dielectric solutions are extremely difficult to obtain. Even liquids designated as chemically pure contain large amounts of suspended dust. As these dust particles move through a liquid, they become charged with static electricity. For some reason, they are more often charged negatively than positively.

**Pumping Action.** When a sufficiently high voltage is applied across the electrodes, the electrostatic field produced between them causes the charged dust particles to move toward the anode, where they are collected and discharged. As the particles move through the liquid, they drag along molecules of the liquid with them, producing a pumping action.

Unfortunately, as more and more dust particles are collected and discharged at the anode, the pumping action gradually ceases. However, since the strength of the pumping action in the dielectric pump depends upon the number of charged particles in the liquid, if a source of such particles could be found, the pumping action would continue indefinitely.



**SIMPLE DIELECTRIC PUMP.** Liquids are pumped electrostatically. Negatively charged dust particles, present in most liquid insulators, drag liquid molecules with them as they move through the electrostatic field between two screen electrodes.

One solution to this problem is to add small amounts of a chemical "dust" to the liquid being pumped. This keeps the pumping action going, but it eventually clogs the screen electrodes and the added impurities in the liquid are undesirable. A more efficient solution to the problem is to charge (ionize) some of the atoms of the liquid being pumped, with some sort of electrical device. Such a device is the corona discharge.

**Corona Discharge.** The amount of static electric charge on any conductor is proportional to the curvature of the surface of the conductor. That is why all high-voltage electrical apparatus have smooth, rounded surfaces. When a high voltage is applied to a conductor with a pointed surface, the electric charge concentrated at the point is so intense that air or liquid atoms near it are ionized. In air, the ionized air atoms near such a corona point cause a wind strong enough to blow out a candle. This is called a corona discharge.

In electrical transmission lines, a corona discharge represents wasted electrical power. In the dielectric pump, it is a convenient source of ions for pumping a liquid.

The improved dielectric pump, employing the corona discharge as an ion source, does not need to depend upon the number of dust particles in a liquid. In fact, with such





# VLF Radio Can Detect Nuclear and Rocket Tests

SCIENTISTS from East and West met in Geneva recently to discuss an international plan for detecting nuclear tests. They suggested four monitoring methods which might make world disarmament feasible. The most interesting system, from the standpoint of electronics, is the detection of nuclear explosions and the firing of heavy missiles by monitoring the very low frequency radio waves which such weapons generate. These radio signals can be detected readily over great distances.

Radio waves generated during a missile launching are due to the violent motion of

charged particles in the high-velocity exhaust of the rocket motor, and to a discharge of potential between the earth and the atmosphere by the vertical column of intensely ionized gasses which is left behind the missile. This column, which extends from the launching pad, also acts as an efficient vertical antenna at these very low frequencies. In the case of an atomic explosion, the radio waves produced are similarly due to the violent motion of particles in the actual blast, and to the column of ionized gasses which rises afterward.

Very low frequency signals travel great

By CHARLES H. WELCH

## Build The Black Box

MISSILEMEN, in the jargon of their trade, refer to a missile's guidance system as a "black box." The POP'tronics "black box" is really a very low frequency radio—it won't let you tell a missile where to go . . . but it will tell you when one went. Relying on ionization noise for its information, this little transistorized tuned preamplifier will not only indicate when one of the larger rockets takes off, but it will permit you to eavesdrop on the normal clicks, shrieks and whistles of the upper atmosphere's "dawn chorus."

The output of the black box is fed into an audio amplifier or a high-gain oscilloscope. Your tape recorder will serve nicely to give you a permanent record of upper atmosphere events, man-made—or otherwise.

The signals shown in the chart at right were detected with the black box during the firing of the lunar probe rocket "Pioneer" on October 11, 1958, at 3.42 a.m., EST. The monitoring site was at Orlando, Florida, and the time of the firing was confirmed

by radio reports and by visual sighting of the rocket's exhaust flare as it neared the top of the first stage of flight. Though Orlando is only 50 airline miles from Cape Canaveral, the excellent propagation conditions in the very low frequency band would have made these signals detectable over distances many times that great.

One of the big difficulties in missile monitoring is knowing when to listen, since the Defense Department is not prone to advertise its firings in advance. However, accurate advance information is frequently given out on firings of test vehicles such as the "Pioneer" and the "Vanguard." Even with military missiles, it is usually possible to confirm observations afterwards since the time of firing is often announced shortly after the test.

The loop-preamplifier combination has a frequency range between 4 and 16 kc. This response is a compromise between good sensitivity and wide coverage of the v.l.f. spectrum.

The loop antenna is 200 turns of #25

POPULAR ELECTRONICS

distances with little attenuation, because at these frequencies the surface of the earth and the ionosphere act as good reflectors and function as a sort of duct or wave guide. Most frequencies in the v.l.f. band are propagated through this wave guide with very little loss. There is a band of frequencies from 2 to 4 kilocycles where absorption is high, but in the vicinity of 10 kc. attenuation is only about 2 db per 1000 kilometers (about 621 miles). This means that any missile-generated v.l.f. radio waves which rise significantly above the noise level near the launching pad could be detected easily at great distances.

Unfortunately, these excellent propagation characteristics also apply to the noise generated by the 50,000 or so thunderstorms that occur every day, and this portion of the spectrum is rife with crashing static and eerie whistlers and chirps. In the

extremely low portion, the 50- and 60-cycle power line frequencies and their harmonics add to the noise level. All these signals have known characteristics, however, and can therefore be separated from the desired signal.

Since propagation characteristics of the v.l.f. band are so constant, the time required for a signal to cover a given distance can be predicted much more accurately than at the higher frequencies where ionosphere effect varies. For this reason, three or more monitoring stations could compare the time at which they received the same signal and pinpoint the location of its origin with extreme accuracy.

VLF radio may be our best bet for survival at present, either as part of a disarmament weapons-test monitoring project, or as our early warning system in a push-button war.

-30-

---

## That Hears Missiles

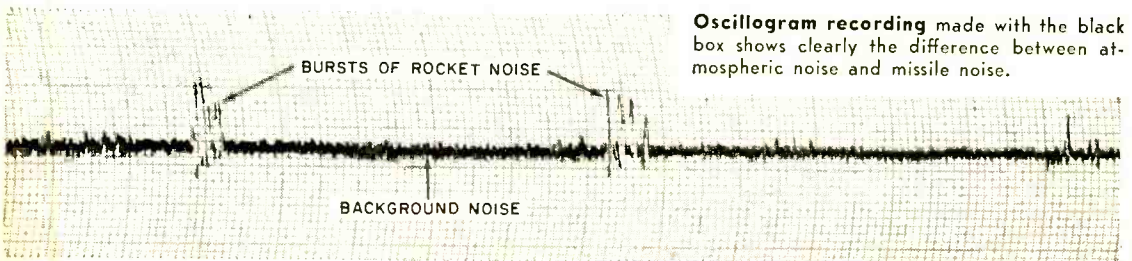
enamel-covered wire wound into a square loop on a wooden frame measuring 48" diagonally. The ends of the winding are brought up on two binding posts, and lamp cord is used to connect these terminals to the input jacks (*J1* and *J2*) of the preamplifier. Capacitor *C1* may be mounted on the terminals of the loop or within the preamplifier cabinet.

Since one of the big problems of this type of rig is power-line frequency hum, a battery-powered transistor amplifier was chosen. The two-stage resistance-coupled circuit used has a measured voltage gain of 1330 at 10 kc. and construction is

straightforward. Parts layout is not critical. The original unit was built on a 1" x 3" x 4" chassis and enclosed in a 3" x 4" x 5" steel utility box. Any small 6-volt battery can be used, as current drain is very low.

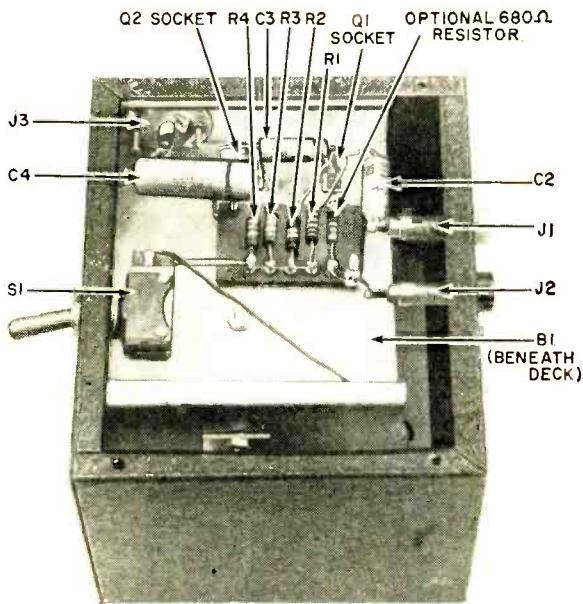
**Sensitivity** of the completed unit may be tested by listening in on thunderstorms. If you can hear "whistlers" with the unit, or if chirps and clicks from a thunderstorm which is miles away are loud and clear, then the sensitivity is adequate.

Of course, the best way to determine the exact bandpass of the unit is to run a curve with an audio oscillator and a VTVM, but a rough estimate of correct bandpass can



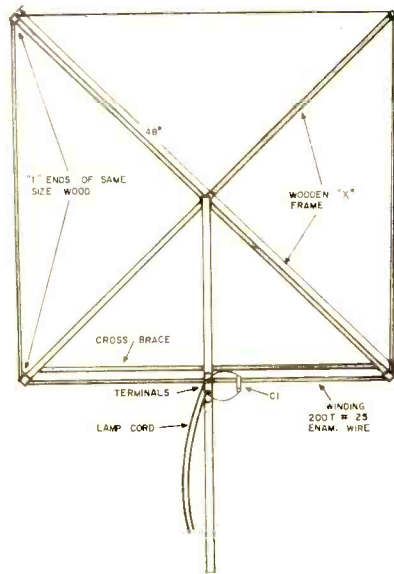
Oscillogram recording made with the black box shows clearly the difference between atmospheric noise and missile noise.





**Bottom view** of black box with cover removed. The two transistors and the battery are on the other side of the deck. A 680-ohm resistor can be wired across J1 and J2 to widen bandwidth, but sensitivity will be lost.

**Schematic** of the black box. C1 is mounted on the loop antenna. A line cord connects them to the black box through pin jacks J1 and J2. The output from J3 can plug into any good audio amplifier.



**Extra-large** loop antenna and capacitor C1 form a tuned circuit covering the very low frequency band. The antenna should be positioned for best sensitivity and least noise.

be made. The higher frequency harmonics of the 60-cycle power line will make a steady whine which is overridden by the pops and clicks of atmospheric from distant lightning. These clicks should be sharp, clear and unmuffled.

Remember that the characteristics of the v.l.f. band vary from one time of day to another and several tests should be made before any definite conclusion is reached.

The audio amplifier should be adjusted for flat response when the missile detection system is operating. The output of the audio amplifier may be fed into a speaker or viewed on a scope. If you have a tape recorder, it is a good idea to record the entire monitoring period, as this will enable you to reproduce any desired portion of the received signals later for detailed study.

The loop antenna should be rotated slowly until a sharp null in the hum level is apparent. When it is located, the antenna should be left in that position. However, if the antenna is not broadside to the noise source, there will be a large drop in gain. To prevent this, try a new site.

**Missile noise** and transient noise impulse interpretation is a study in itself, and

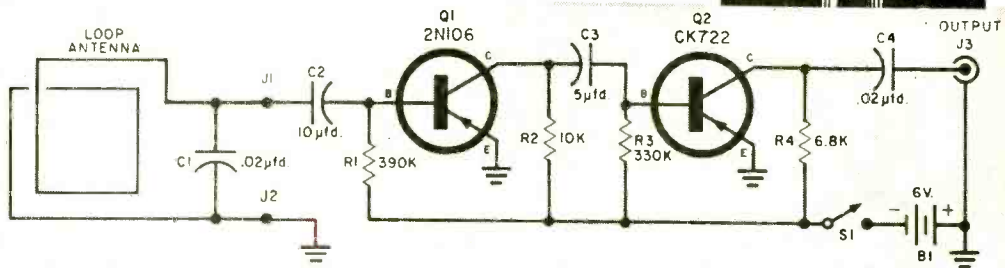
a great deal of elaborate and expensive equipment is involved. However, the experimenter with limited equipment can recognize the noise of a missile when he knows what he is looking for.

Unfortunately, describing the differences between noise produced by a missile and atmospheric noise is a little like trying to explain the differences between a Rebel yell and a Comanche warwhoop to someone who

## PARTS LIST

B1—6-volt battery  
 C1, C4—.02- $\mu$ fd. low-voltage paper or disc capacitor  
 C2—10- $\mu$ fd., 25-volt electrolytic capacitor  
 C3—5- $\mu$ fd., 25-volt electrolytic capacitor  
 J1, J2—Insulated pin tip jacks  
 J3—Phono jack  
 Q1—2N106 transistor  
 Q2—CK722 transistor  
 R1—390,000 ohms  
 R2—10,000 ohms  
 R3—330,000 ohms  
 R4—6800 ohms  
 S1—S.p.s.t. switch

All resistors  
 1/2-watt  
 composition



## HOW IT WORKS

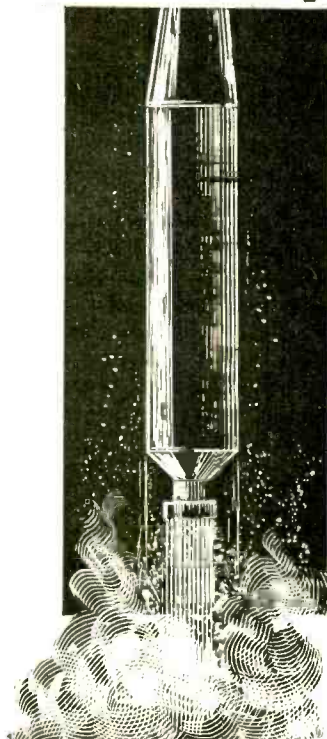
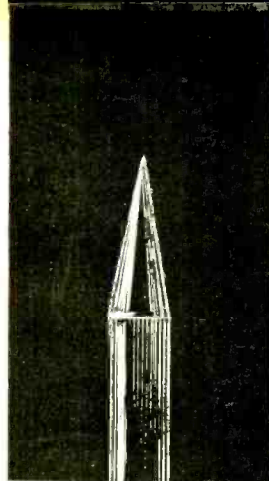
The loop antenna, with capacitor C1, makes a parallel-tuned circuit which is resonant at 4.85 kc. The impedance of this tuned circuit is considerably higher than the input impedance of low-noise transistor Q1 to which it is coupled. This deliberate mismatch loads the loop antenna and broadens its response to cover the desired portion of the v.l.f. band.

Transistors Q1 and Q2 make up a two-stage resistance-coupled preamplifier with a voltage gain of 1330 in normal operation, and with an over-all frequency response from 4 to 15 kc. The output of the unit may be plugged into the high-impedance input of a normal high-fidelity amplifier for further amplification to display, recording, or listening levels.

has heard neither. The key lies in the difference between the two. Become familiar with the sound of normal atmospherics, and their appearance on a scope, and the slightly different sounds of a missile will be easy to spot.

At the time of the "Pioneer" shot, oscillograph recordings of random noise taken just before the firing and about an hour afterwards showed spikes rising 3 db above the background, about one during each second. When the missile was under first-stage power, however, the noise peaks were 16 db above the background noise and occurred in bursts instead of at random. In addition, analysis of the individual noise peaks shows that they changed in character from the single spike of distant atmospherics to multiple oscillations several cycles in length. Such changes are easily detected when the signal is displayed on an oscilloscope.

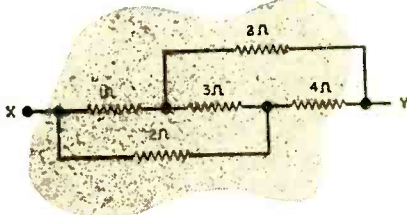
—30—



# Electronic Sticklers

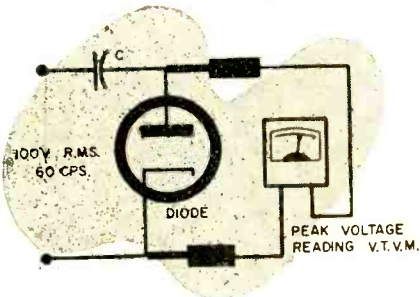
These four thought-twisters are arranged  
in order of increasing difficulty

(Answers on page 146)



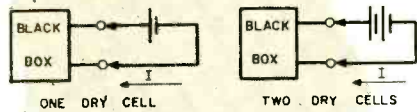
**1** Harvey Matrix discovered this network, covered with solder, in his junk box. Rather than trust his ancient ohmmeter, he tried unsuccessfully to compute the resistance mathematically. Show Harvey you are slicker and quicker by solving the problem in one minute.

—Dennis Wroblewski



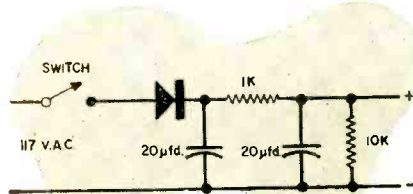
**4** With the setup shown, a diode in series with a capacitor, Harold Tinkertoy applied 100 volts r.m.s. across the circuit. Then he used his vacuum-tube voltmeter to measure the peak voltage across the diode. How much did he measure? To make the problem easy, assume that a sine wave is applied to the circuit.

—Louis E. Garner, Jr.



**2** Joe Whatsit had a black box with only two terminals showing. To find out what was in the box, Joe connected a 1½-volt dry cell to the two terminals and noted the current flow. He then connected a second identical dry cell in series with the first cell and repeated the experiment. The same current was noted. With this information, Joe figured out what was in the box. Can you?

David Borenstein



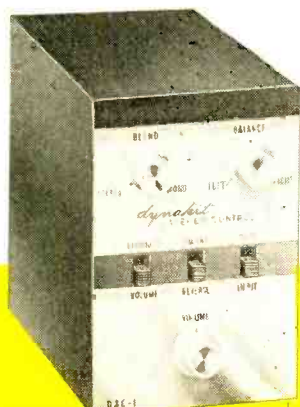
**3** Mr. Pennypincher, in order to save money on batteries for his portable radio, built this little voltage supply to substitute for the batteries. When he plugged in the unit, he was running a risk of a blown-out component. Any idea why?

—Ronald Wilensky



# POPULAR ELECTRONICS

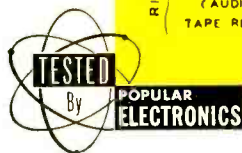
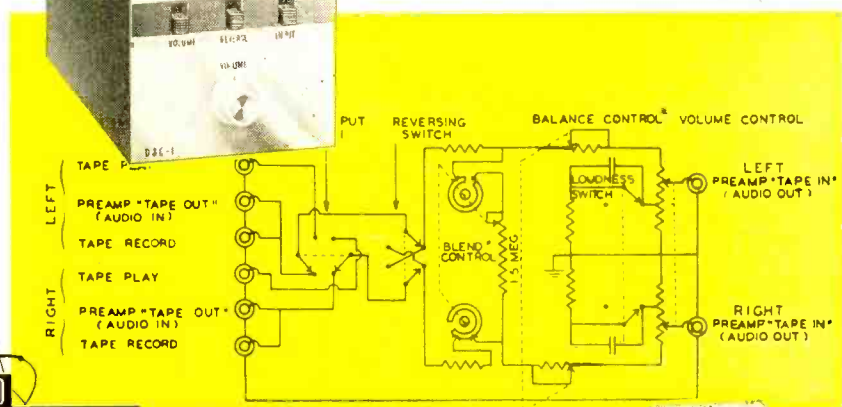
## Builds a Stereo Control Unit



**Dynakit DSC-1**

simplifies the switch

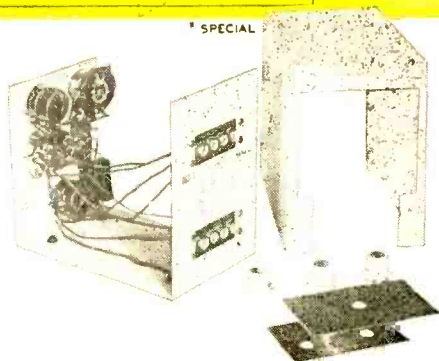
to stereo



**T**HE STEREPHONIC record brought a great number of changes into the world of hi-fi. Preamplifiers sprouted new controls, turntables were redesigned for lower rumble content, smaller speakers took the spotlight, and an entirely new type of unit hit the market.

Usually known as stereo adapters, these new units are designed to enable the owner of a hi-fi set to centralize the stereo control functions, such as *balance* and *master volume*, in one compact package. The Dynakit stereo control unit, Model DSC-1, a fine example of the species, is designed to operate with a pair of Dynakit preamps.

**Construction.** As can be seen from the schematic, the DSC-1 uses relatively few components. Construction is a start-after-supper, finish-before-bedtime deal. There



are a few tight corners met in the construction process but, in general, the U-type chassis layout prevents any wiring difficulties.

The Dynakit stereo control unit has a number of interesting features beside the *balance* and *master volume* control. For instance, there is a control in the upper left-hand corner labeled *blend* whose func-

tion is to compensate for the "ping-pong" or hole-in-the-middle effect.

A *loudness* switch permits a choice of a plain or compensated master volume control, and a *channel reverse* switch enables you to interchange right and left signals. A *tape input* switch is extremely useful to those of us who own a tape recorder with a separate monitoring channel, as direct comparison can be made between the input signal to the tape recorder and the output of the monitor head.

**The Circuit.** The *blend* control is a type of integrating network which mixes the input signals to the desired degree across a 1.5-megohm potentiometer. When set at one end of its rotation, the *blend* control enables full stereo reproduction. As the

control is turned, the channels are mixed, until at the full clockwise position mono reproduction results.

As is standard practice, the *balance* control is a ganged dual potentiometer in series with the ganged *volume* control. The balance control taper and internal connections are so arranged that in the center or balanced position there is no resistance in series with either control. Depending upon which direction the *balance* control is rotated in, a certain amount of resistance is put in series with the selected volume control section.

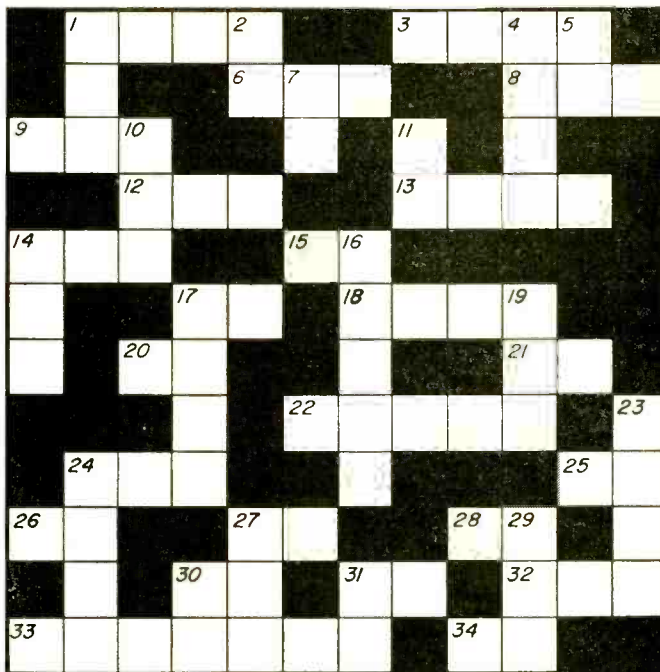
The Dynakit stereo control unit is a perfect physical and electronic match for the characteristics of the Dynakit preamplifiers and amplifiers. —30—

## CROSSNUMBER PUZZLE

By John A. Comstock

### ACROSS

- 1 Year Fleming invented diode vacuum tube.
- 3 This quantity multiplied by r.m.s. value of a.c. voltage will give peak voltage.
- 6 Slow record player speed.
- 8 Difference frequency in kilocycles produced by mixing 1000-kc. signal with 50-kc. signal.
- 9 Quantity by which peak value of a.c. voltage is multiplied to obtain r.m.s. value.
- 12 One-half kilowatt expressed in watts.
- 14 Output frequency in kc. of transmitter having crystal frequency of 2017.5 kc. and two doubler stages.
- 17 Lower limit of u.h.f. frequency band expressed in megacycles.
- 18 Large-size hi-fi woofer.
- 19 Very slow record speed.
- 20 Year tetrode (screen-grid) vacuum tube was developed, in reverse.
- 24 Mid frequency in megacycles of TV Channel 6 when lower frequency limit equals 76 mc.
- 21 Total resistance of two 44-ohm resistors connected in series.
- 22 Upper frequency limit in mc. of super-high-frequency band.
- 24 Voltage drop across 20-ohm resistor when current flow is 10 amperes.
- 25 Number of feet in 12 yards of hookup wire.
- 26 Mid frequency of TV Channel 2 when upper channel frequency limit is 60 mc.
- 27 Actual filament voltage rating of 6-volt vacuum tubes.
- 28 Popular-size TV screen.
- 30 Heater voltage of 35Z5 vacuum tube.
- 31 Separation in megacycles between TV sound and video carrier frequencies.
- 32 Number of zeros represented by letter K in stating resistor values.
- 33 Cycles in one megacycle.
- 34 Total voltage drop in series circuit when applied voltage equals 50 volts.



### DOWN

- 1 Degrees of phase shift in voltage fed back to produce degeneration in amplifier circuit.
- 2 TV aspect ratio; ratio of picture width to height.
- 4 Year Lee de Forest invented triode.
- 5 Voltage drop across 90-ohm resistor when current flow equals 1/2 ampere.
- 7 Tape recorder slow speed in ips.
- 10 Wavelength in meters of 400-kc. signal.
- 11 Fast record player speed in rpm (approx.).
- 14 Electrical degrees in one cycle of alternating signal.
- 16 In resistor color code, number represented by green, white and yellow.
- 17 Year pentode was developed.
- 19 Electrical degrees in one alternation of sine-wave signal.
- 23 Capacitance reactance of 1.0- $\mu$ fd. capacitor at frequency of 60 cps.
- 24 Express 0.00271 henrys in microhenrys.
- 27 Convert 650,000 watts to kilowatts.
- 29 Amount of capacitance in farads that will store 100 coulombs of electricity when applied voltage equals 1.0 volt.
- 30 This number means "the end."
- 31 Grade of solder often used in electronics work.

(Solution on page 144)



# Short-Wave Report

By HANK BENNETT

## RECEPTION VERSUS JAMMING

**F**OR SEVERAL YEARS one of the chief scourges of the short-wave broadcast bands has been the jamming stations. It is virtually impossible to tune across any of the main short-wave bands without hearing at least one jammer and often as many as a dozen.

These jamming stations are largely located behind the Iron and Bamboo Curtains and their purpose is to prevent listeners in those areas from hearing newscasts and commentaries beamed to them from outside

countries. (See article starting on page 41 of this issue.)

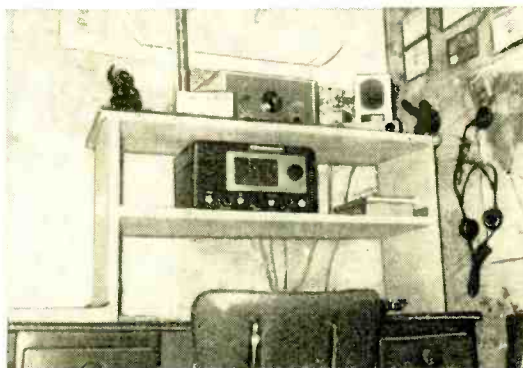
The jammers are often so strong that they also prevent listeners in the U.S.A. from tuning in on certain channels. Many readers report that this, alone, is enough to turn them away from their receivers in disgust.

The International Shortwave Club of London has, for months, been asking their members to avoid listening to stations that are located in countries responsible for jamming and, of course, to avoid sending reception reports to those stations. Whether this has or has not had any effect on the stations is difficult to ascertain.

On days when jamming signals blanket the regular short-wave bands, you might

**The receiver** at Kevin Jessup's listening post in Westville, Ill. (right), is a Hallicrafters S-53A. He uses a six-meter doublet antenna.

**Dave Lund**, of Holstein, Iowa, DX's with a Hallicrafters S-40B and a long-wire antenna.



try tuning in some of the off-beat channels where the jamming is almost non-existent (although you may run into a good bit of Morse code interference from time to time). These channels include many rarely heard stations that may prove to be new countries for your log. Let's check some of them.

If you want to snag a rare one, try for



V3USE, Forest Side, Mauritius. This station wanders from about 14,980 kc. up as high as 15,020 kc. and is currently being reported on 15,018 kc. at 2300 with English news. You may need a lot of patience with this one but it is being reported in Eastern states.

Another relatively clear channel is 9009 kc., where you can find Israel afternoons between 1400 and 1600. Reports indicate that it is well heard in most areas.

If you can understand Spanish, go after the Nicaraguans in the 7000-kc. band. Some of these are: YNMS, *R. Phillips*, Leon, 7650 kc.; YNCA, *R. Atlantico*, Bluefields, last reported on 7755 kc.; and YNRM, *R. Muson*, Matagalpa, 7593 kc. You may need a bit of extra tuning for them as they seem to wander around a bit. Try during mid-to-late evenings.

If you can tune above 40 megacycles (40,000 kc.), try for the British Broadcasting Corporation's television Channel I (audio only) on 41,500 kc. Two stations, Crystal Palace and Divis, can be heard late

mornings and they are just a few cycles apart although listed for the same frequency. (Your editor has both of them verified.) Another TV channel that is usually well heard at the same time is the French Channel II at Caen on 41,250 kc.

Other stations that can be found occasionally include: Beirut, Lebanon, on 8000 kc. (varies up to 8036 kc.); a station in Ecuador, as yet unidentified, on 8899 kc.; *Radio Espana Independiente* (Spanish Clandestine) on or near 6948 kc.; and JOZ, Tokyo, 3925 kc. A real tough one to log is the Falkland Islands station on 3958 kc., noted in Western areas around 1800-1900.

Check this list the next time you are baffled by the jammers. You'll find that you can have as much fun tuning the off-beat channels as you will have in the standard bands. Be sure to send reception reports; many of these stations are strictly regional and reports from outside areas enable their engineers to know where their signals are going. Let us know how you make out.

(Continued on page 155)

## SHORT-WAVE MONITOR REGISTRATION

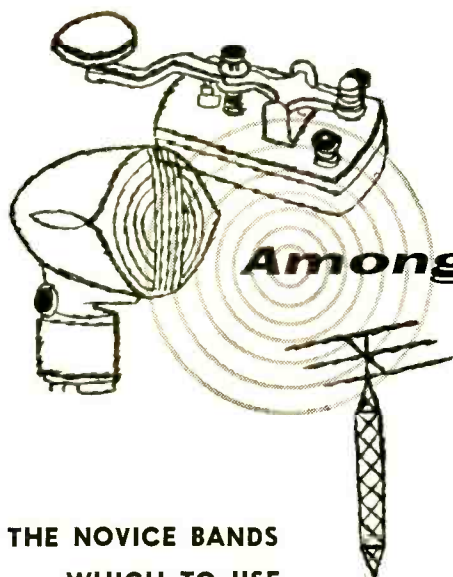
Register your monitoring station with POPULAR ELECTRONICS and receive an attractive Short-Wave Monitor certificate with your individual call letters.

To obtain your certificate, fill out the registration form below and mail it to The Editor, POPULAR ELECTRONICS, One Park Avenue, New York 16, N. Y.

Please include ten cents to help cover the cost of mailing and processing your certificate.

(Please Print)		
Name .....		
Address .....	City .....	State .....
Receiver	Make .....	Model .....
	Make .....	Model .....
Principal SW Bands Monitored .....		Number of QSL Cards Received .....
Type of Antenna Used .....		
Signature .....		Date .....

By  
**HERB S. BRIER**  
W9EGQ



## Among the Novice Hams

### THE NOVICE BANDS — WHICH TO USE

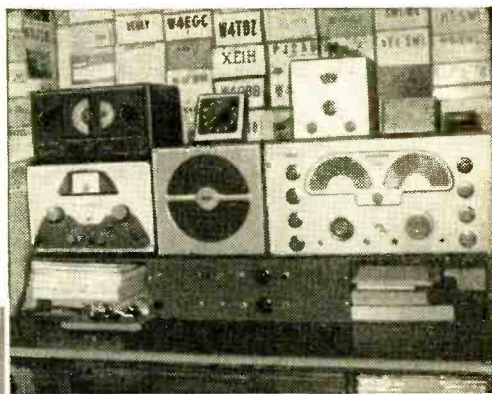
**W**HAT BAND should you operate on when you first get on the air? Should you use "voice" or should you use code? If you start your amateur career as a Novice, these questions are partially answered for you by the FCC.

A Novice may operate in segments of only four amateur bands: 3700 to 3750 kc. in the 80-meter band, 7150 to 7200 kc. in the 40-meter band, 21,100 to 21,250 kc. in the 15-meter band, and 145 to 147 mc. in the 2-meter band. You can use code, usually called "c.w." (for *continuous-wave telegraphy*), in the first three bands, and either phone or c.w. in the 2-meter band.

Most prospective amateurs are interested only in phone operation at first, because "it is more fun to talk than to learn the code and use the key." Then they discover that

they *must* learn the code to obtain an amateur license, whether they plan to use phone or not, at a speed of 5 wpm for the Novice and Technician licenses and 13 wpm for the General/Conditional Class licenses.

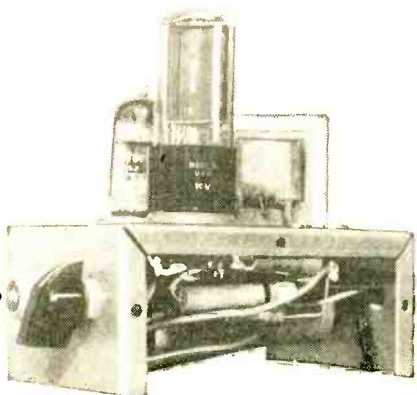
**Code vs. Phone.** Actually, code has quite a few advantages over phone, especially for beginners. A c.w. transmitter is simpler and far less costly than the equivalent phone transmitter. Watt for watt, a c.w. signal has a far greater communications range than a phone signal. A c.w. signal may occupy a bandwidth of 100 cycles compared to 3 or 6 kc. occupied by single-sideband or double-sideband phone signals; therefore,



KN4TSF's station, Chattanooga, Tenn.



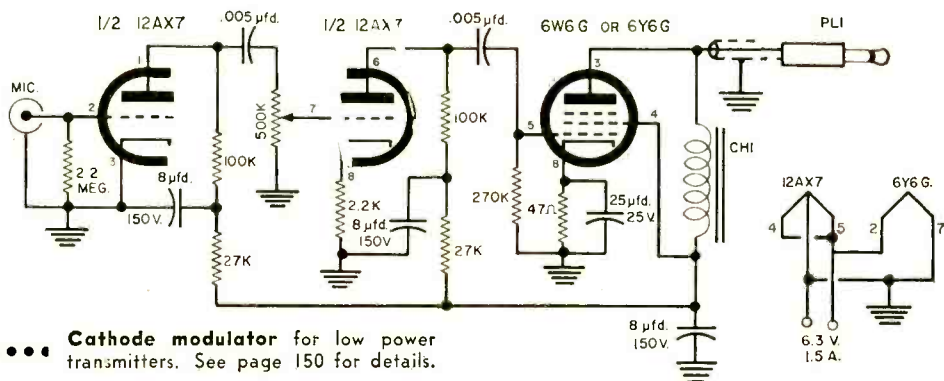
Nick, K9KLR, operates in Gary, Ind.



be pushed out to about 100 miles. Under certain atmospheric conditions, which occur fairly frequently in the warmer months, distances up to several hundred miles may be spanned for periods up to a couple of hours.

Because of its limited range, most 2-meter activity is concentrated in or near the larger cities, except for serious experimenters, who, by means of skilled operating and elaborate equipment, manage to cover amazing distances.

**Eighty Meters.** The 80-meter Novice band is the easiest one to get started on



**Cathode modulator** for low power transmitters. See page 150 for details.

many c.w. stations can operate in the space occupied by a single phone station.

The space factor is one reason why phone is not permitted in the lower frequency Novice bands. It also explains why interference is so bad in the low-frequency phone bands. This interference, combined with the superior "getting-out" ability of c.w., is why many General Class operators prefer c.w. to phone.

Of course, phone has its advantages, too, especially for casual rag-chewing. But there are a couple of other reasons why few Novices use phone. As a Novice, you must qualify for a higher class of license within the year that your license is valid or leave the air. By sticking exclusively to the c.w. bands, you give yourself the greatest opportunity to build your code speed up to the 13 wpm required for a General or Conditional Class license. And, besides, c.w. is fun.

**Two Meters.** The 2-meter band, the only one on which Novice phone operation is authorized, has a reliable range of about 25 miles with typical Novice equipment; with more elaborate rigs, this range may

with simple equipment. From sunset to sunrise, distances of 200 to 1000 miles can be readily achieved with a low-power transmitter and a simple antenna, although static sometimes limits range in the summer. On good nights, especially in the winter, much greater distances can be covered.

Daytime signals on 80 meters are usually quite weak, and the distance spanned may be less than 100 miles. However, the lack of interference during the day permits many excellent contacts.

**Forty Meters.** Daytime signals on 40 meters over distances up to 500 miles or more are usually possible with low power. As evening approaches, "skip" increases, often making it impossible to work nearby stations, but greater distances are easily covered. On many winter evenings, you can't work stations closer than about 1500 miles, except for "locals" within 25 miles; unfortunately, it may be very difficult to work anyone at all with low power then, unless you have a better-than-average antenna.

As on 80 meters, nighttime interference  
(Continued on page 150)



# POPULAR ELECTRONICS

## Builds a Clock Radio

### ...Knight-Kit "Ranger"

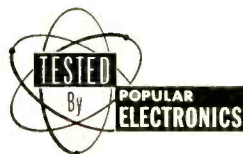
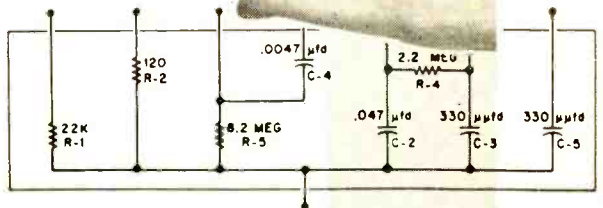
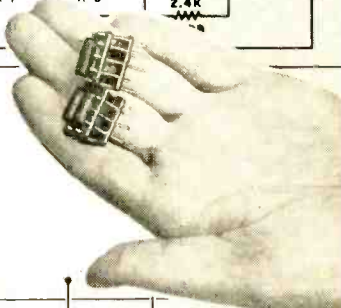
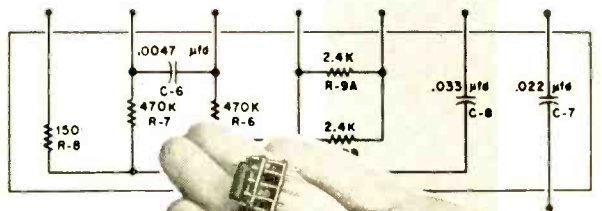
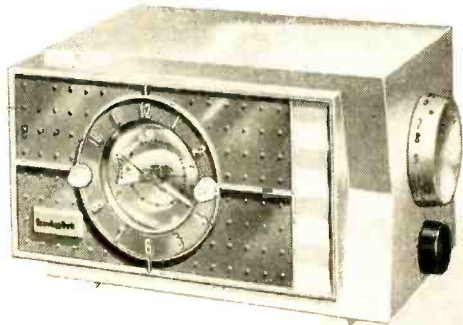
ONE of the finer quality clock-radio kits available, the Knight-Kit "Ranger" has an efficient superhet circuit which provides excellent reception of the entire broadcast band. In addition, the Telechron clock has a versatile sleep-switch timer plus an automatic wake-up alarm switch.

Besides providing listening pleasure and the correct time, here is what this clock radio can be set up to do for you:

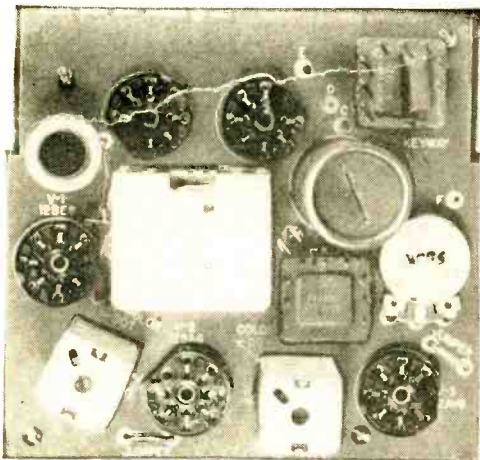
- Shut off the radio automatically after any interval up to one hour, so you can drift off to dreamland with music.
- Turn on the radio in the cold light of dawn to provide wake-up music.
- For heavy sleepers, sound an alarm 10 minutes after wake-up music comes on.
- Turn on your electric coffee-maker at the same time you wake up to music.

**Printed-Circuit Board.** Assembly is simplified by the use of a printed-circuit board. There's no chance for error here, since the component identification markings are stenciled directly on the board. Two special ceramic modules which incorporate all the resistors and capacitors used by the receiver are soldered on the board.

The Telechron clock and a.c. power circuits are wired as a unit. Then the clock power circuit and PM speaker are con-



Assembly is simplified by a printed-circuit board and two ceramic modules. The modules contain nine resistors and seven capacitors as shown in the schematic diagrams above.



All parts of the "Ranger" except the Telechron clock and speaker are mounted and soldered on the printed-circuit board. Square cardboard sleeves are slipped over the i.f. transformers to reduce shock hazards.

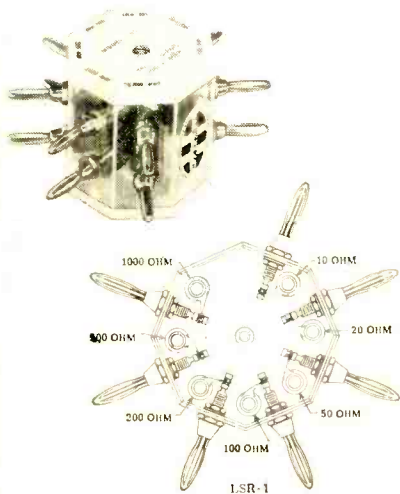
and clear. But as a check of the Knight-Kit instructions, the set was purposely misaligned. Using the plastic alignment tool supplied with the kit, the clock radio was successfully retuned in a matter of minutes.

**Comment.** The expertly designed module components and printed-circuit board reduced assembly time to two hours. No special tools were used—only pliers, cutters, screwdriver and soldering iron. The clearly written, step-by-step instructions and giant-size diagrams helped in assembling the professional-looking clock radio. Anyone can build this kit—try it, it's fun. —30—

needed to the printed-circuit board and the board is mounted in the plastic cabinet.

Alignment of the "Ranger" is no problem. When the set built by POPULAR ELECTRONICS was first turned on, it worked *without* alignment—all local stations came in clean

## Plug-in Laboratory Standards

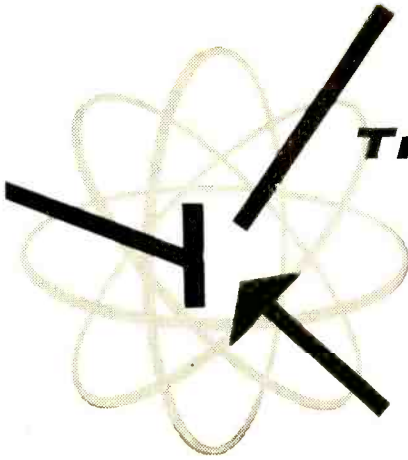


**I**N MANY stages of experimental circuit tinkering, the need arises for high-tolerance resistors and capacitors. The Heath Company now offers a resistance and capacitance plug-in laboratory standard in kit form. This kit consists of four separate units, each containing seven highly accurate precision standards. Banana pin connectors with standard  $\frac{3}{4}$ " spacing are used to enable the units to fit directly into most laboratory instruments.

These units are designed for calibrating or checking calibration of test equipment such as ohmmeters, capacity meters, impedance bridges, and other measurement equipment. They can also be used for determining circuit parameters, where precision components are necessary. —30—

UNIT	VALUES	TOLERANCE
LSR-1	10, 20, 50, 100, 200, 500 and 1000 ohm resistors	$\pm 0.5\%$
LSR-2	1000, 2000, 5000, 10,000, 20,000, 50,000 and 100,000 ohm resistors	$\pm 0.5\%$
LSC-1	100, 200, 500, 1000, 2000, 5000 and 10,000 $\mu\text{fd.}$ capacitors	$\pm 0.25\%$
LSC-2	.001, .002, .005, .01, .02*, .05* and 0.1* $\mu\text{fd.}$ capacitors	$\pm 0.25\%$ $\pm 0.5\%*$

All resistors are 1 watt and all capacitors are 350 volts, d.c., maximum.



# Transistor Topics

By LOU GARNER

**A**LTHOUGH not widely publicized, transistor applications in medical electronics are rapidly increasing in importance. The light weight and small size of the transistor make possible the design and manufacture of pocket-sized electronic stethoscopes, recorders, and similar gear needed for field tests and diagnosis. Its very low voltage and power requirements make possible the design of instruments which are safe to use in the explosive atmosphere of operating rooms, as well as shock-free equipment for use in close proximity to patients.

Since the transistor is basically a current amplifying device, it is ideally suited to the design of direct-current and low-frequency amplifier and measuring devices, thus simplifying the measurement of electrical signals produced by body muscles and organs. Most of these are very low frequency sig-

nals. The human pulse rate, for example, approaches *one cycle per second*.

But perhaps the most unusual use of transistors in medical research is in self-contained capsule-size radio transmitters. These can be passed through an animal's system, telemetering data on pressure, temperature and other internal conditions to the scientists, much like artificial earth satellites and moon probes telemeter data on the conditions in outer space—and all without injury to the subject.

Looking to the future, we can reasonably expect to see portable diathermy equipment, transistor-controlled servomechanisms for use in artificial limbs, and radically new types of diagnostic and treatment apparatus. The "telemetry capsule," for example, may one day be modified to act as a miniature drug carrier, holding a small

**In-Circuit Tester.** The first tester capable of checking the performance of a transistor while it is wired in a circuit is being produced by Philco for the Bureau of Ships. A commercial model should be available soon.





reservoir of a potent antibiotic or serum which can be released by remote control when the capsule reaches the proper point in the patient's body.

**Readers' Circuits.** It is no trick at all to pick up local broadcasts using a six-transistor factory-wired superhet. But to do the same job with a one- or two-transistor set—that requires ingenuity in design, skill in wiring, and patience in operation! The schematic diagrams of four simple one- and two-transistor receivers, submitted by as many readers, are given this month.

Optimum performance can be obtained from each of these receivers with a moderately long outside antenna. Standard crystal diodes (1N34A, 1N48, CK705, etc.), are used in all of them. Each circuit has some unique feature which distinguishes it from receiver circuitry of a completely conventional nature.

**Figure 1** was submitted by reader John Dunn. This circuit employs a standard loop

circuit *L1-C1* and coupled through blocking capacitor *C2* to diode detector *CR1*. Bias is provided by *B1* and voltage-divider *R1-R2*. The demodulated audio signal applied to the transistor is amplified and used to drive the magnetic headphones.

**Figure 2** was turned in by Bob Marty, K4SLU (1660 Old Shell Rd. Mobile, Alabama). At first glance, the set seems to use "conventional" circuitry, but closer inspection shows that a two-stage direct-coupled complementary amplifier is employed, with the second stage serving as an emitter-follower.

Standard parts are used. *L1* is an adjustable transistor loopstick coil (Lafayette No. MS-299), and *C1* is a fixed ceramic or mica capacitor. The 3-volt power supply (*B1*) is made up of two penlight cells connected in series.

Wiring and parts layout are non-critical, and the receiver can be assembled on a small metal, fiber or plastic board. Use magnetic headphones with an impedance of

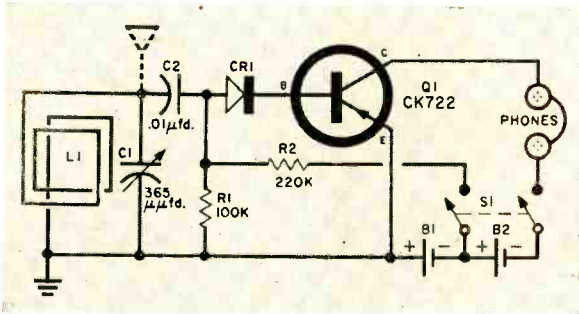


Fig. 1.

antenna (*L1*) instead of the more popular "loopstick." Two Burgess No. 7 penlight cells (*B1*, *B2*), controlled by a d.p.s.t. toggle or slide switch (*S1*), serve as the power supply.

John indicates that he wired his receiver directly on the flat-fiber loop-antenna board. He suggests that any reader duplicating his project might do the same . . . or might assemble the circuit on a small chassis or Bakelite board. It may be worthwhile to experiment with the values of *R1* and *R2*, choosing the final ratio which gives best operation. Magnetic headphones (4000 to 8000 ohms) should be used, and best results are obtained with both an external antenna and ground.

In operation, signals picked up by the antenna-ground system are selected by tuned

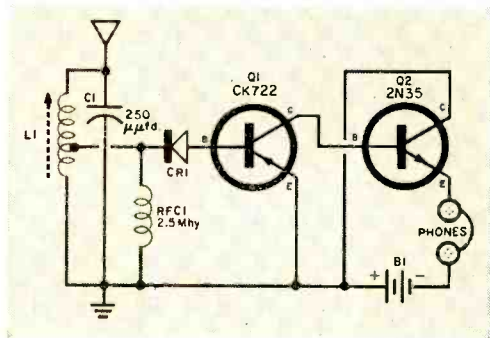


Fig. 2.

from 1000 to 4000 ohms. The set is tuned by adjusting *L1*'s slug.

**Figure 3** comes from Robert Bari (1580 President St., Brooklyn 13, N. Y.). This circuit has several interesting features: (1)

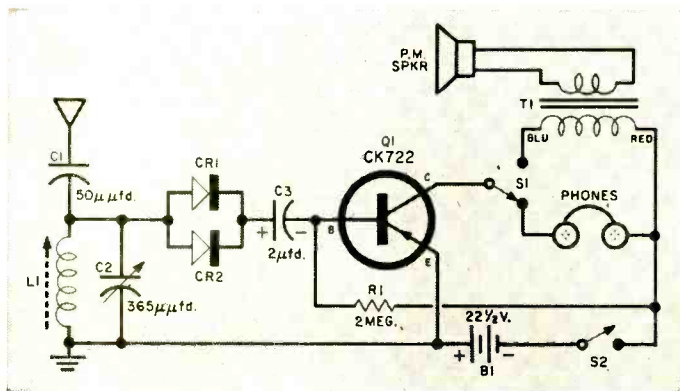


Fig. 3.

two diodes are used in parallel as a detector, (2) the circuit is wired for both earphone and loudspeaker operation, and (3) a moderately high operating voltage is used.

Capacitor  $C3$  is a 2.0- $\mu$ fd, 25-volt electrolytic and  $L1$  is a standard ferrite loopstick. Two switches are used in this circuit . . . a s.p.s.t. Power switch ( $S2$ ) and a s.p.d.t. Speaker-phones switch ( $S1$ ). Headphones of 1000 to 8000 ohms impedance should be employed.

Robert used a "universal" vacuum-tube output transformer, connecting to the primary's Blue and Brown leads, but somewhat better results may be had with a standard transistor transformer, such as an Argonne AR-164. The PM loudspeaker should have a 4 to 8 ohm voice coil and may be any convenient size. In general, the larger the speaker, the more efficient, and the better the tone quality. Finally, the power supply battery is a 22 1/2-volt B battery, such as a Burgess Type U15.

**Figure 4** was submitted by reader Walter Thompson. According to its designer, this circuit can be assembled in about an hour. It differs from the first three discussed in that a regenerative feedback arrangement is used for increased sensitivity and gain.

Referring to the diagram,  $L1$  is an adjustable transistor loopstick antenna coil,  $C2$  a 0.1- $\mu$ fd. ceramic or paper capacitor and  $C3$  a 6-8  $\mu$ fd., 15-volt electrolytic.  $L2$  consists of 8 turns of #28 enameled copper wire, scramble-wound on  $L1$ . Gain control  $R1$  is a standard 50,000-ohm carbon potentiometer. The power supply battery may be from

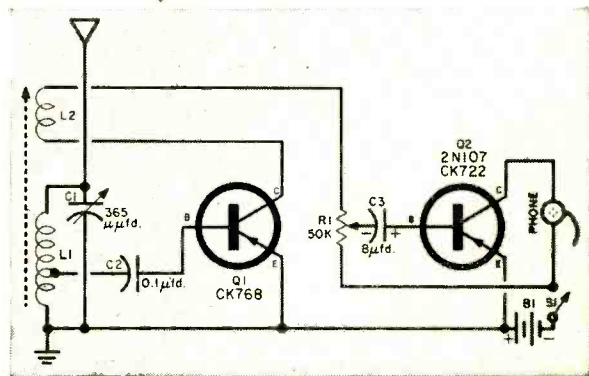


Fig. 4.

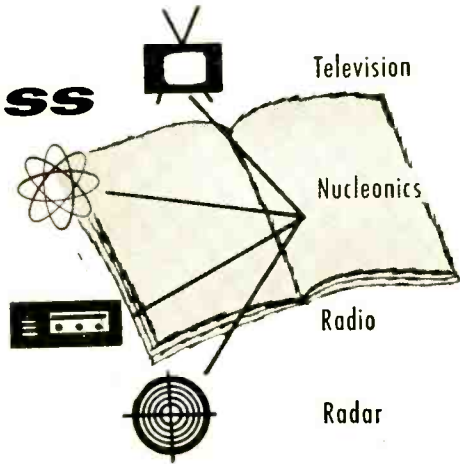
3.0 to 9.0 volts, and is made up by connecting penlight cells in series. Best results are obtained with 1000 to 4000 ohm magnetic earphones.

If you decide to assemble Walter's receiver, you may want to make one experimental change to insure best performance. Connect a moderate-length external antenna and good earth "ground," and turn the Gain control ( $R1$ ) full up. Next, gradually adjust  $C1$  to tune through the broadcast band, listening for a fairly weak station. With a weak station tuned in, try reversing the connections to feedback coil  $L2$ . Use the connections which provide maximum sensitivity.

**In-Circuit Tester.** Theoretically, transistors have an almost infinite service life. It is not surprising, then, that manufacturers of military and industrial gear as well as home entertainment devices will often solder transistor connections permanently in place.

Unfortunately, this theory doesn't always work out in practice. A transistor may fail if abused electrically (operated too close to  
(Continued on page 142).

# After Class



## WHAT IS A SERVOMECHANISM?

**B**EFORE the age of electronics, machinery was controlled directly by the hands of the operator—hands which would shift a gear, pull a lever, or apply a brake. Today's machinery is controlled by the push of a button or the twist of a knob, and many measurements and decisions are made automatically by electronic circuits. Wherever electronics and machinery work together we are apt to find some kind of servomechanism in operation.

An automobile driver is the human counterpart of a servomechanism—he watches and controls a machine. As he steers his car along a winding highway, he constantly makes small corrections on his steering wheel to keep the car on the road. His eyes measure distances, his brain makes simple decisions, and his arm muscles exert corrective pressures on the steering wheel. A servomechanism performs the same function, but it is faster, more sensitive, does not make mistakes in judgment, and operates continuously.

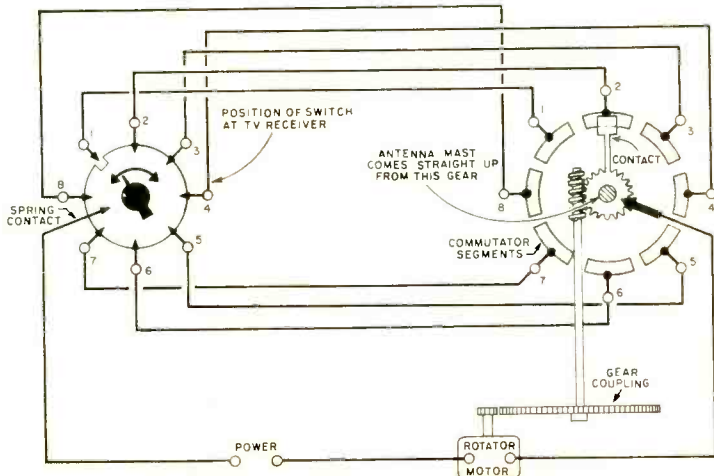
By HARVEY POLLACK

The definition of a servomechanism recommended by the Feedback Control Committee of the American Institute of Electrical Engineers is: "A feedback control system in which the controlled variable is mechanical position." Let's examine, in practical terms, what that means.

**The ABC's of Servos.** Consider our automobile driver again. From his reactions we can determine the requirements of a machine that could capably replace him.

Before the start of the drive, he accepts the fact that the road divider must always remain from six to fifteen inches from his

**Fig. 1.** Example of an "open-loop" type servomechanism. It serves practically as an antenna rotating mechanism for TV installations. "Open loop" refers to the need for a human control element in the servomechanism system.





front left wheel if he is to navigate the highway turns and straightaways safely. During the trip, he must be aware of the separation that actually exists during every instant of time. Then he must compare the actual separation between his wheels and the white line with the desired separation that was initially stipulated. This might be called the *error* in the car's path at that instant. Once the error is determined, he must then dictate a corrective order to his arm muscles so that they can apply a force in the proper direction to eliminate the error.

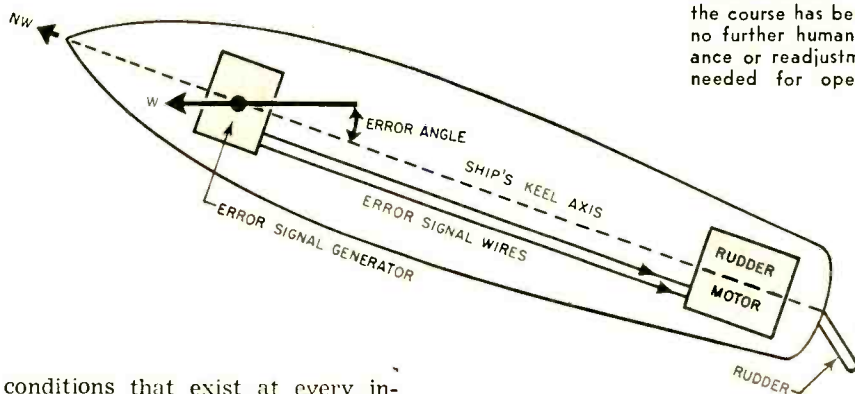
If we now analyze these steps, we can state the ABC's of servos. A servo must: (A) Accept instructions that tell it what should be done; (B) Be aware of the

Each time the commutator arrives at a new segment, the power flows uninterruptedly to the motor until it reaches segment 1, when the circuit is again opened and the motor stops, leaving the mast in the desired position.

Note that the human operator must dictate the necessary instructions to the servo by rotating the positional switch to the desired setting. In a "closed-loop" system, a human operator is totally unnecessary.

**Closed-Loop System.** Imagine that the course of a ship is to be due west and that

**Fig. 2.** A course control system as used in ocean-going vessels is a typical application of a "closed-loop" type of servomechanism. Once the course has been set, no further human guidance or readjustment is needed for operation.



actual conditions that exist at every instant; (C) Compare what is being done with what should be done; (D) Dictate orders that will correct the error noted by this comparison; and (E) Energize some mechanism that can follow these orders.

**Open-Loop System.** Consider the antenna rotator servo shown in Fig. 1. This is referred to as an "open-loop" servo system because a human operator is required as one of the links in the ABC chain. The knob at the TV set is secured to a disc in contact with all the contact points save the one that happens to be in line with the notch cut in the disc. A permanent spring contact is made to the disc as shown.

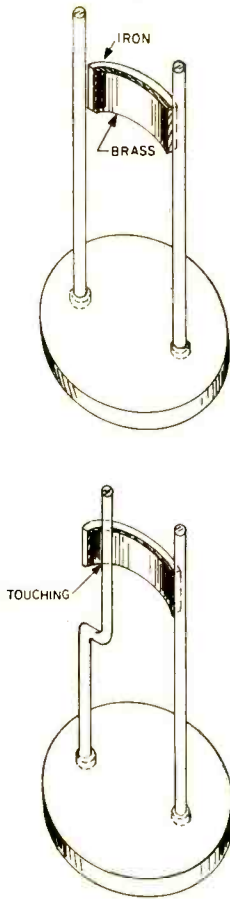
Suppose the TV viewer decides that he would like to rotate his antenna from position 2 to position 1. He turns the knob to position 1, bringing the notch in line with contact point 1 at the same time; but when he does this, contact point 2 touches the disc and feeds electrical energy to the motor through commutator segment 2.

its gyro-compass has been set for this direction. Along comes a gust of wind or an ocean current that tends to swing the prow of the ship to the north. The gyro-compass, of course, continues to point to the west as the boat turns under it, thereby producing an error angle between itself and the boat's axis.

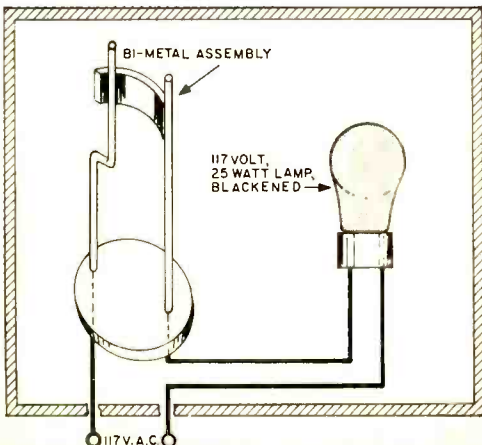
If the compass is coupled to an electrical generator of a suitable type which can feed an error signal proportional to the error angle to a rudder motor at the stern, then the rudder will swing over to an extent that will just correct the deviation from the proper course.

The error angle represents the comparison between what is actually being done and what *should* be done. Corrective orders

**Fig. 3.** Modification required to convert a fluorescent lamp starter into a sensing element of a thermostatic control circuit. "Before" view (top) shows internal assembly of starter after protective glass is broken. "After" view illustrates modification made to the contact to enable use of the starter as a thermostatic switch.



**Fig. 4.** Wiring and installation of modified bi-metallic element in a homemade experimental thermostatically controlled incubator or crystal (oscillator) oven.



are dictated by means of an electrical signal that varies with the amount and direction of the error; this order signal then energizes a rudder control motor which makes the necessary correction in course.

**Thermostat Control.** When you set the thermostat of your oil-burner, you have issued instructions that it keep the house at, say, 70°F. The bi-metallic strip inside the thermostat retains "awareness" of existing temperatures by bending toward an electrical contact as the house cools. When the contacts finally close as the temperature goes below 70°F, the thermostat issues a corrective signal in the form of a current to the relay of the oil burner.

If you would like to experiment with thermostatic control to get the "feel" of the ABC's of servos, you can pick up an old fluorescent starter and use it as the base for a thermostatically controlled chick incubator or a transmitter crystal oven. Pry up the four sheet-metal fingers that secure the disc base to the metal casing and lift out the whole inside structure. If a capacitor is present (some starters omit the capacitor), clip it out by cutting its leads close to the disc base.

Wrap a single layer of cloth around the glass tube, place it between the jaws of your vise, and apply pressure gradually until the glass just cracks. Be careful not to damage the bi-metallic assembly that is now exposed. The concave portion of the curved strip is brass and the convex section iron. Since brass has a higher coefficient of linear expansion than iron, this bar will tend to *straighten* when heated, i.e., it is normally off and makes contact when its temperature rises.

To reverse this action, bend the free vertical bar as shown in Fig. 3 so that the inner brass face of the strip barely touches the bent bar at room temperature. The temperature at which contact will be broken will then depend upon the extent to which the strip presses on the vertical bar. This can easily be adjusted experimentally by further bending either to the right or left.

An incubator or oven thermostat may be set up easily using the circuit of Fig. 4. The "heater" is a 25-watt incandescent lamp blackened with candle-black or sprayed lightly with flat black lacquer. The enclosure in which it is placed should be fairly well insulated so that it retains its heat.

# THERE'S AN IMPORTANT FUTURE AHEAD FOR THE MEN WHO WEAR THESE WINGS



The Air Force pilot or navigator is a man of many talents. He is, first of all, a master of the skies—and no finer exists. In addition, he has a firm background in astro-navigation, electronics, engineering and allied fields. Then, too, he must show outstanding qualities of leadership, initiative and self-reliance. In short, he is a man eminently prepared for an important future in the new Age of Space. Find out today if you can qualify as an Air Force pilot or navigator. Mail the coupon below now.



## GRADUATE THEN FLY

U. S. AIR FORCE  
AVIATION CADET PROGRAM

**PASTE COUPON ON POSTAL CARD AND MAIL TODAY**

Aviation Cadet Information, Dept. MP-94  
Box 7608, Washington 4, D. C.

Please send me details on my opportunities as an Aviation Cadet in the U. S. Air Force. I am single, between the ages of 19 and 26½, and a resident of the U. S. or possessions. I am interested in  Pilot  Navigator training.

Name \_\_\_\_\_

Street \_\_\_\_\_

City \_\_\_\_\_ Zone \_\_\_\_\_ State \_\_\_\_\_





HOW DO YOU LIKE MY VIKING "NAVIGATOR" WITH TIMED SEQUENCE KEYING?

BOY! IT'S REALLY SWEET! 40 WATTS INPUT—BUILT-IN WFO—TVM SUPPRESSED—IT'S EASY TO OPERATE AND PUTS OUT A SOLID SIGNAL!

WELL, NOW THAT YOU'VE OPERATED BOTH THE VIKING "ADVENTURER" AND "NAVIGATOR" TRANSMITTERS AT THE CLUB STATION—WHICH DO YOU LIKE BEST?

I'D RECOMMEND EITHER UNIT, THEY'RE BOTH AVAILABLE IN EASY-TO-BUILD KITS --BOTH PRODUCE A CLEAN CW NOTE-- AND THEY'RE PRICED RIGHT, TOO!

OUR COMMUNITY WANTS TO THANK YOU AND YOUR FELLOW AMATEUR OPERATORS FOR A JOB WELL DONE.

CIVIL DEFENSE

THANK YOU FOR THE PUBLIC SERVICE AWARD--BUT WE CAN'T TAKE ALL THE CREDIT. OUR VIKING TRANSMITTERS REALLY STOOD UP UNDER SEVERE CONDITIONS, PROVIDING US WITH CONTINUOUS AND RELIABLE COMMUNICATIONS!

E. F. JOHNSON COMPANY  
2713 Second Ave., S. W., Waseca, Minnesota

MAIL TODAY FOR YOUR FREE CATALOG

Name \_\_\_\_\_  
Address \_\_\_\_\_  
City \_\_\_\_\_ State \_\_\_\_\_

ASSEMBLE YOUR OWN  
**WALKIE-TALKIE RADIOPHONES**



New Model for  
**Citizens Band**

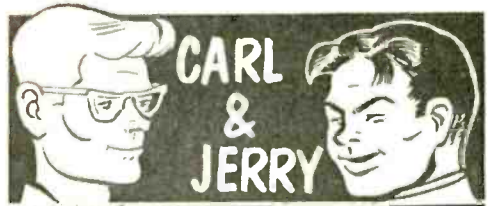
Electronic Chassis ONLY **\$18<sup>98</sup>** post-paid

- Meets FCC requirements for new class "D" citizens band radio-telephone.
- License easily obtained on application by any U. S. citizen 18 years or over. No tests to take.
- Transmits and receives one to several miles depending on obstructions and elevation.
- Assembled unit is completely portable and requires no external connections. Operates from self contained batteries obtainable at your local radio store.
- Electronic chassis is wired, tested, guaranteed and includes crystal controlled oscillator, R.F. power amplifier, audio modulator, receiver with R.F. stage, and a new transistorized audio booster stage for extra loud reception plus a complete set of tubes and transistor.
- Radio receiver is tunable to any of the 22 channels by a single control knob. Features ultra-high amplification, automatic volume control and noise clipping.
- Instructions and photographs are supplied with each chassis for completing the walkie-talkie as illustrated. Accessories are not included but are available at low cost.

FREE R.F. power indicator kit with each order.  
SEND YOUR ORDER TODAY. INCLUDE POSTAL MONEY ORDER FOR FAST DELIVERY. C.O.D.'s REQUIRE \$3.00 DEPOSIT.

**SPRINGFIELD ENTERPRISES**

Box 54E-4 Springfield Gardens 13, N. Y.



By JOHN T. FRYE

**How I Wonder What You Are!**

THE WEATHER was more like late June than early April, and even energy-conserving Jerry was under the exciting spell of the rising sap. He and the dog, Bosco, were romping gaily about the back yard; but he stopped in surprise as his friend, Carl, came slowly around the corner of the house. When bouncy, athletic Carl moved slowly, something was wrong.

"What's bugging you, Mopey?" Jerry demanded.

"Aw, I've just come from Grubers next door, and I'm worried about Mr. Gruber."

"What's wrong?" Jerry asked quickly. The elderly man with the youthful outlook was a great favorite of both boys.

"It's hard to believe, but he's lost interest in things. Mrs. Gruber tells me it all started last summer when that rocket launching stage went into orbit and was visible here for a few nights. Mr. Gruber tried to spot it but couldn't. Actually that's no wonder, for it was darned hard to see. As you remember, it turned end over end so that reflected light from it brightened and dimmed, leaving it visible only part of the time; and it took only about twenty minutes to go from horizon to horizon. You had to be looking at precisely the right point in the sky at the right time to see it at all. But Mr. Gruber is convinced that his failure to see it means his eyesight is failing and that he won't be able to follow the other thrilling events in the launching of the Age of Space Travel which interests him so deeply."

"You mean he's quit reading his science-fiction magazines, collecting stories about flying saucers, and writing peppery letters to Cape Canaveral?"

"Yep. Doesn't sound much like the lively old gentleman who told us that there are only two ways to live: either as though you're going to die tomorrow or live forever; and he chose the latter. Does it?"

"No," declared Jerry, "and this is serious.

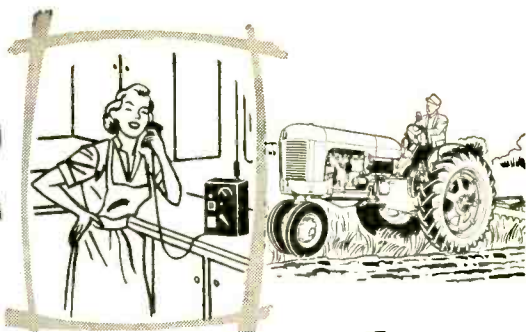
(Continued on page 130)

INTERNATIONAL'S NEW

# TRANSCEIVER

at home...work...or play here is

## 2-WAY RADIO for everyone!



MEETS ALL FCC REQUIREMENTS

### for the Class "D" CITIZENS BAND

The new class "D" citizens band is a new band of frequencies in the 27 megacycle range set aside by the FCC in Sept. 1958 for citizens radio service.

### LICENSE WITHOUT EXAMINATION

Any U. S. citizen can be licensed to operate a class "D" radio station by applying to the FCC on FCC Form 505D.

### 3 MODELS

- CUSTOM, 117V AC, all channel receiver ..... **\$94.95**
- DELUXE, 117V AC or 6/12V DC ..... **124.50**
- COMMAND, 117V AC or 6/12V DC  
fixed channel receiver ..... **149.95**

#### FOR BUSINESS



Ideal for office-to-field communication. Also for office to trucks operating within restricted area or for office and factory liaison.

#### FOR THE FARM



The solution to fast communication from the farm home to the field. Wonderful in an emergency.

#### FOR SPORTS



From ship-to-shore or from base camp to the scene of the hunt... an enjoyable accessory to any sport!

#### FOR THE HOME



From the kitchen to the den, workshop or sickroom... the Transceiver will save you many steps.

### SEND FOR FREE BROCHURE



18 N. Lee  
Oklahoma City, Okla.

Dept. PE, International Crystal Mfg. Co., Inc.  
18 N. Lee,  
Oklahoma City, Okla.

GENTLEMEN:

Please send me my copy of your free brochure on the Transceiver. Also your new 1959 Catalog.

NAME \_\_\_\_\_

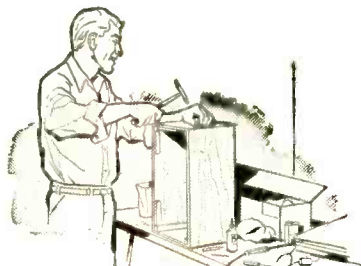
ADDRESS \_\_\_\_\_

CITY & STATE \_\_\_\_\_





## do-it-yourself kits put top quality within easy reach



With absolutely no previous experience or knowledge of electronics you can assemble your own HEATHKIT hi-fi system, Ham station, test equipment or marine gear. Easy to understand step-by-step instructions, along with large pictorial diagrams, guarantee your success—and you save 1/2 or more on the highest quality equipment available today at any price!



### STEREO EQUIPMENT CABINET KIT

A thing of beauty as well as utility, this stereo equipment cabinet ensemble houses your complete stereo hi-fi system. It consists of a stereo equipment center flanked by two stereo speaker enclosures. The kit is supplied with mounting panels pre-cut to accommodate Heathkits and interchangeable blank panels are also furnished. The pre-cut panels accommodate the Heathkit AM-FM Tuner (PT-1), Stereo Preamplifier (SP-2), and Stereo Record Changer (RP-3-S). The changer slides out smoothly for easy record loading. Convenient record and tape storage space is provided. Ample room is provided in the rear of the center cabinet for a pair of matching Heathkit amplifiers from 12 to 70 watts. The stereo wing speaker enclosures are open-backed, cloth-grilled cabinets designed to hold the Heathkit SS-3 or similar speaker enclosures. The cabinets are available in beautifully grained 3/4" solid core Phillipine mahogany or select birch plywood suitable for the finish of your choice. Entire top features a shaped edge. Hardware and trim are of brushed brass and gold finish.

**\$149<sup>95</sup>**

#### STEREO EQUIPMENT CABINET KIT

Model SE-1B (birch)  
Model SE-1M (mahogany)

each  
shpg. Wt. 162 lbs.)

**\$39<sup>95</sup>**

#### STEREO WING SPEAKER ENCLOSURE KIT

Model SC-1BR (birch—right end)  
Model SC-1BL (birch—left end)  
Model SC-1MR (mahogany—right end)  
Model SC-1ML (mahogany—left end)

each  
shpg. wt. 42 lbs.)

#### MODEL SF-1

**\$39<sup>95</sup>**



#### DIAMOND STYLUS STEREO PICKUP CARTRIDGE

Enjoy the latest stereo records now. Fits all standard tone arms and features a .6 mill diamond stylus. Designed to Heath specifications by Fairchild Recording Equipment Corporation. Shpg. Wt. 1 lb.

#### MODEL MF-1

**\$26<sup>95</sup>**



#### DIAMOND STYLUS HI-FI PICKUP CARTRIDGE

Get the most from your LP microgroove records. Designed to Heath specifications by Fairchild Recording Equipment Corporation, the MF-1 is one of the finest pickup cartridges on the market today. Shpg. Wt. 1 lb.



#### TRADITIONAL

Model CE-2T (mahogany)

#### CONTEMPORARY (not shown)

Model CE-2B (birch)

Model CE-2M (mahogany)

**\$43<sup>95</sup>**  
each

### CHAIRSIDE ENCLOSURE KIT

Put your entire hi-fi system right at your fingertips with this handsome enclosure. Available in either traditional or contemporary models and constructed of beautiful veneer-surfaced plywood suitable for the finish of your choice. It is designed to house the Heathkit AM and FM Tuners (BC-1A and FM-3A), the WA-P2 Preamplifier, the RP-3 Record Changer, and adequate space is provided for any Heathkit amplifier designed to operate with the WA-P2. All parts pre-cut and predrilled for easy assembly. Shpg. Wt. 46 lbs.

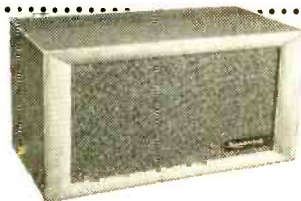




HEATHKIT EA-2  
\$28<sup>95</sup>

**"BOOKSHELF" HI-FI 12 WATT AMPLIFIER KIT**

True hi-fi performance is yours with this handsomely styled amplifier-preamplifier combination. With more than enough power for the average home hi-fi system it features a frequency response of  $\pm 1$  db from 20 to 20,000 CPS with less than 2% distortion at full output over the entire range. Inputs provided for tuner, xtal phono and mag phono. RIAA equalization, separate bass and treble tone controls, and a special hum control are provided. Shpg. Wt. 15 lbs.



*Build it in  
one Evening*

HEATHKIT SS-2  
\$39<sup>95</sup>

**"BASIC RANGE" HI-FI SPEAKER SYSTEM KIT**

With performance comparable to speakers costing many times more, the SS-2 employs a Jensen 8" woofer and compression-type tweeter to provide total frequency response of 50 to 12,000 CPS. Shpg. Wt. 26 lbs.

**ATTRACTIVE BRASS TIP ACCESSORY LEGS:** convert the SS-2 into handsome consolette. Shpg. Wt. 3 lbs. No. 91-26. \$4.95.

**BASIC FIR MODEL:** same as SS-2 except constructed of non-premium plywood without trim or grille cloth. Shpg. Wt. 26 lbs. Model SS-3. \$34.95.



HEATHKIT FM-3A \$26<sup>95</sup>

**HIGH FIDELITY FM TUNER KIT**

The thrills of FM entertainment are yours at budget cost with this handsomely styled tuner. Featuring broad-banded circuits for full fidelity and better than 10 microvolt sensitivity for 20 db of quieting, the FM-3A pulls in stations with clarity and full volume. Shpg. Wt. 8 lbs.



HEATHKIT W-7M \$54<sup>95</sup>

**"EXTRA PERFORMANCE" HI-FI 55 WATT AMPLIFIER KIT**

Offering full fidelity at less than a dollar per watt, the power output of this remarkable amplifier is conservatively rated at 55 watts from 20 CPS to 20 kc with less than 2% total harmonic distortion throughout this entire range. Shpg. Wt. 28 lbs.



HEATHKIT PT-1  
\$89<sup>95</sup>

**MONAURAL-STEREO AM-FM TUNER KIT**

This professional quality 16-tube tuner offers you outstanding AM, FM or stereo AM/FM performance at minimum expense. Features include individual flywheel tuning and automatic frequency control. A multiplex jack is also provided. Shpg. Wt. 24 lbs.



HEATHKIT SP-2  
\$56<sup>95</sup>

**MONAURAL-STEREO (two channel mixer) PREAMPLIFIER KIT**

Control your entire stereo system with this 2-channel preamplifier. A remote balance control with 20' of cable allows balancing the stereo system from listening position. Shpg. Wt. 15 lbs.



HEATHKIT TR-1A \$99<sup>95</sup>

Includes tape deck, tape recorder electronics, microphone and roll of blank tape.



**HIGH FIDELITY TAPE RECORDER KIT**

Whether making your own recordings or playing pre-recorded tapes you'll enjoy the many fine features of this tape recorder kit. Included are fast forward and rewind functions and choice of 7 1/2 or 3 3/4 IPS tape speeds. Printed circuit boards simplify assembly. Shpg. Wt. 24 lbs.

HEATHKIT RP-3  
\$64<sup>95</sup>

(stereo model RP-3S \$74.95)



**AUTOMATIC HI-FI RECORD CHANGER KIT**

Combining the convenience of an automatic record changer with true turntable quality the RP-3 obtains full fidelity from your hi-fi and stereo records while treating them with the care they demand. A "turntable pause" feature prevents records from dropping on moving turntable or disk. Plays at 33 1/3, 45, 78 and 16 RPM. Shpg. Wt. 19 lbs.

**HEATH COMPANY**

Benton Harbor, Mich.

A Subsidiary of Daystrom, Inc.





**HEATHKIT**



HEATHKIT TX-1  
**\$234<sup>95</sup>**

**"APACHE" HAM TRANSMITTER KIT**

Features 150 watt phone input and 180 watt CW input. Provision for single-sideband transmission using the SB-10 External Adapter. Shpg. Wt. 110 lbs.



HEATHKIT RX-1  
**\$274<sup>95</sup>**

**"MOHAWK" HAM RECEIVER KIT**

Covers from 160 through 10 meters on 7 bands with an extra band calibrated to cover 6 and 2 meters using a converter. Outstanding SSB reception. Shpg. Wt. 66 lbs.



HEATHKIT SB-10  
**\$89<sup>95</sup>**

**SINGLE SIDEBAND ADAPTER KIT**

A compatible plug-in adapter unit for the "Apache" Transmitter, the SB-10 covers 80, 40, 20, 15 and 10 meter bands. Produces USB, LSB or DSB signals, with or without carrier insertion. Shpg. Wt. 12 lbs.



HEATHKIT DX-40  
**\$64<sup>95</sup>**

**PHONE AND CW TRANSMITTER KIT**

Providing phone and CW operation on 80, 40, 20, 15, and 10 meters, the DX-40 features built-in modulator and power supplies. Shpg. Wt. 25 lbs.



HEATHKIT MP-1  
**\$44<sup>95</sup>**

**MOBILE POWER SUPPLY KIT**

Furnishes all power required to operate both MT-1 Transmitter and MR-1 Receiver from 12-14 volt battery. Delivers full 120 watts continuously or 150 watts intermittently. Kit includes 12' battery cable, tap-in studs for battery posts, power plug and 15' connecting cable. Shpg. Wt. 8 lbs.

**Mobile Fun! With all New  
Heathkit Mobile Ham Gear**



HEATHKIT MR-1  
**\$119<sup>95</sup>**

**"COMANCHE" MOBILE HAM RECEIVER KIT**

Handsome styling, rugged construction, top quality components and economy are all wrapped up in the "Comanche". It is an 8-tube superheterodyne receiver operating AM, CW and SSB on the 80, 40, 20, 15 and 10 meter amateur bands. Operates from 12 volt car battery through the MP-1 Mobile Power Supply. Can be converted in minutes to a fixed station unit by using an AC power supply. Shpg. Wt. 19 lbs.

**MOBILE ACCESSORIES.**

Quality 5" PM speaker in rugged steel case with mounting brackets. Heathkit AK-7. \$5.95. Shpg. Wt. 4 lbs.

Mobile base mount holds both transmitter and receiver. Universal floor mounting bracket. Heathkit AK-6. \$4.95. Shpg. Wt. 5 lbs.



HEATHKIT MT-1  
**\$99<sup>95</sup>**

**"CHEYENNE" MOBILE HAM TRANSMITTER KIT**

The fun and convenience of mobile operation are yours with the compact and efficient "Cheyenne" Transmitter. Featuring high power with minimum battery drain, the unit provides up to 90 watts phone input and covers 80, 40, 20, 15 and 10 meters. Featured are a built-in VFO, modulator, 4 RF stages with a 6146 final amplifier pi network (coaxial) output coupling. The "Cheyenne" is designed as a companion to the "Comanche" receiver and is powered by the MP-1 Power Supply. Shpg. Wt. 19 lbs.



HEATHKIT VHF-1  
**\$159<sup>95</sup>**

**"SENECA" VHF HAM TRANSMITTER KIT**

General, technician or novice class hams wishing to extend transmission into the VHF region will find the "Seneca" ideal. A completely self-contained 6 and 2 meter transmitter, the VHF-1 features up to 120 watts input on phone and 140 watts input on CW in the 6 meter band. Included are controlled carrier phone operation, built-in VFO for both 6 and 2 meters, and four switch-selected crystal positions. Shpg. Wt. 56 lbs.

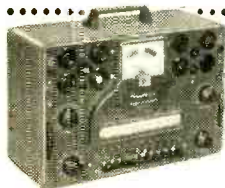




HEATHKIT V7-A  
\$25<sup>95</sup>

**ETCHED CIRCUIT  
VTVM KIT**

World's largest selling VTVM, the V7-A measures AC voltage (RMS), AC voltage (Peak-to-peak), DC voltage and resistance. Features 7 AC (RMS) and DC voltage ranges of 0-1.5, 5, 15, 50, 150, 500 and 1500. In addition there are 7 peak-to-peak AC ranges of 0-4, 14, 40, 140, 400, 1400 and 4000. Seven ohmmeter ranges are provided. Battery and test leads are included with kit. Shpg. Wt. 7 lbs.



HEATHKIT TC-3  
\$39<sup>95</sup>

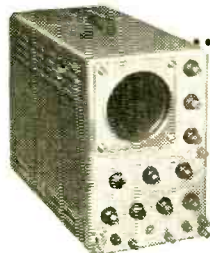
**TUBE CHECKER KIT**

An invaluable aid to servicemen, the TC-3 tests for open, short, leakage, heater continuity and quality of all tube types commonly encountered in radio and TV servicing. Checks 4, 5, 6 and 7-pin large, 7 and 9-pin miniature, 7-pin sub-miniature, octal and loctal tubes and pilot lamps. A blank socket provides for future tube types. Shpg. Wt. 12 lbs.



Model 355.

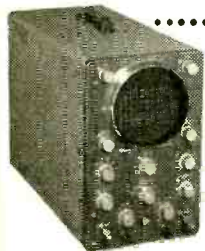
**TV PICTURE TUBE TEST ADAPTER**  
For use with TC-3 or earlier model TC-2. Includes 12-pin TV tube socket, 4' cable. Octal connector and data. No. 355. Shpg. Wt. 1 lb. \$4.50.



HEATHKIT OP-1  
\$179<sup>95</sup>

**"PROFESSIONAL" 5"  
DC OSCILLOSCOPE KIT**

Offering complete versatility, the OP-1 features DC coupled amplifiers and also DC coupled CR tube unblanking. Triggered sweep circuit operates on internal or external signals and may be either AC or DC coupled. Transformer operated power supply has silicon diode rectifiers. Shpg. Wt. 34 lbs.



HEATHKIT OM-3  
\$39<sup>95</sup>

**"GENERAL PURPOSE"  
5" OSCILLOSCOPE**

Ideal in servicing as well as routine laboratory work, the OM-3 features wide vertical amplifier frequency response, extended sweep generator operation and improved stability. Vertical response is within  $\pm 3$  db from 4 CPS to 1.2 mc. Sweep range covers 20 CPS to over 150 kc. Shpg. Wt. 22 lbs.



HEATHKIT T-4  
\$19<sup>95</sup>

**VISUAL-AURAL SIGNAL TRACER KIT**

Doubling as a utility amplifier, test speaker, or substitution transformer, the T-4 represents an outstanding buy. Traces RF, IF and audio signals in AM, FM and transistor-type radios. Shpg. Wt. 5 lbs.



HEATHKIT SG-8  
\$19<sup>50</sup>

**RF SIGNAL GENERATOR KIT**

Aligns RF, IF and tuned circuits of all kinds. Provides extended frequency coverage in five bands from 160 kc to 110 mc on fundamentals and up to 220 mc on calibrated harmonics of the fundamental frequencies. Shpg. Wt. 8 lbs.



HEATHKIT CT-1  
\$7<sup>95</sup>

**IN-CIRCUIT CAPACI-TESTER KIT**

Check capacitors for "open" or "short" right in the circuit. Detects open capacitors from 50 mmf up and checks shorted capacitors up to 20 mfd. Checks all bypass, blocking and coupling capacitors of the paper, mica and ceramic types. Shpg. Wt. 5 lbs.



HEATHKIT TO-1  
\$16<sup>95</sup>

**TEST OSCILLATOR KIT**

Provides fast and accurate selection of test frequencies most used by servicemen in repairing and aligning modern broadcast receivers. Five fixed-tuned frequencies are quickly selected for trouble-shooting. Shpg. Wt. 4 lbs.

**HEATH COMPANY**

Benton Harbor, Mich.

A Subsidiary of Daystrom, Inc.







add that "extra" speaker

HEATHKIT US-1  
\$7.50

### 12" UTILITY SPEAKER

This high quality auxiliary speaker offers many possibilities in audio, radio and TV work and will handle up to 12 watts with a frequency response from 50 to 9,000 CPS  $\pm 5$  db. Speaker impedance is 8 ohms and employs a 6.8 ounce magnet. Shpg. Wt. 7 lbs.



Fun for the whole family

HEATHKIT XR-1P  
\$29.95

### 6 TRANSISTOR PORTABLE RADIO KIT

This easy-to-build portable radio offers fun and enjoyment for the whole family. Features 6 transistors, large 4" x 6" PM speaker for "big-set" tone quality, and built-in rod-type antenna. Uses standard size "D" flashlight cells for extremely long battery life (between 500 and 1,000 hours). The modern molded plastic case with pull-out carrying handle is two-tone blue with gold inlay and measures 9" L. x 7" H. x 3 3/4" D. Shpg. Wt. 6 lbs.



HEATHKIT BR-2  
\$18.95  
(less cabinet)

### BROADCAST BAND RADIO KIT

Fun to build, and a fine receiver for your home. Covers complete broadcast band from 550 to 1600 kc. Built-in 5 1/2" PM speaker and rod-type antenna. Transformer operated power supply. Excellent sensitivity and selectivity. Shpg. Wt. 10 lbs.

Cabinet optional extra: No. 91-9A. Shpg. Wt. 5 lbs. \$4.95.

Tune-up your own Engine



### ELECTRONIC IGNITION ANALYZER KIT

An ideal tool for the mechanic, tune-up man or auto hobbyist. Locates ignition system faults quickly without removing any parts and with the engine in operation (400 to 5000 RPM). Shows complete engine cycle or just one cylinder at a time. Use on all types of internal combustion engines where breaker points are accessible. 10' test leads supplied with kit. Shpg. Wt. 20 lbs.

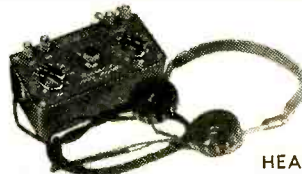
HEATHKIT IA-1  
\$59.95



HEATHKIT AK-1  
\$9.95

### MICROPHONE ACCESSORY KIT

Useful in countless applications, this kit consists of a rugged high fidelity crystal mike and three holders; a mike stand adapter, a lavalier neckband and desk stand. An 8' cable with phone plug is included. Shpg. Wt. 1 lb.



Let your boy learn radio

HEATHKIT CR-1  
\$7.95

### CRYSTAL RADIO KIT

Any youngster interested in radio or electronics will enjoy building and using this fine little crystal receiver. Frequency coverage is from 540 to 1600 kc. A sealed germanium diode is used for detection—no critical "cats whisker" adjustment. Headphones included. Measures 6" L. x 3" W. x 2 1/8" D. Shpg. Wt. 3 lbs.

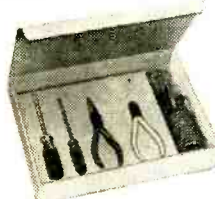


check engine RPM

HEATHKIT TI-1  
\$25.95

### ELECTRONIC TACHOMETER KIT

Easy-to-build and simple to install. Operates directly from the spark impulse of any 2 or 4 cycle engine with any number of cylinders. Operates on 6, 8, 12, 24 or 32 volt DC systems and is completely transistorized. The easy-to-read indicator shows RPM from 500 to 6,000. A calibration control is also provided. Shpg. Wt. 4 lbs.



### COMPLETE TOOL SET

This handy tool kit provides all the basic tools required for building any Heathkit. Includes pliers, diagonal sidecutters, screwdrivers, and soldering iron with holder. Pliers and sidecutters are equipped with insulated rubber handles that provide protection from electrical shock. All of the tools are of top quality case hardened steel for rugged duty and long life. Shpg. Wt. 3 lbs.

HEATHKIT TK-1  
\$9.95

Always say you saw it in—POPULAR ELECTRONICS



HEATHKIT DF-2  
\$69<sup>95</sup>

**2-BAND TRANSISTOR RADIO DIRECTION FINDER KIT**

Economically powered by 6 standard flashlight cells, the DF-2 provides you with a completely portable 6-transistor standard and beacon band receiver of unusual quality and performance. Covers the beacon band from 200 to 400 kc and broadcast band from 540 to 1620 kc. A tuning dial light is provided for night operation. Large 4" x 6" speaker provides superb tone reproduction. Shpg. Wt. 9 lbs.

HEATHKIT PC-1  
\$24<sup>95</sup>



**12 VOLT POWER CONVERTER KIT**

Household electricity right on your boat or in your automobile is yours with this 12-volt power converter kit. Operate your TV set, radio, electric razor, lights, etc., directly from your 12-volt boat or car battery. Power rating is 125 watts continuously and 175 to 200 watts intermittently. Note: not recommended for record players, tape decks, power tools or radio transmitters. Shpg. Wt. 8 lbs.

**MARINE CONVERTER KIT**



HEATHKIT MC-1  
\$39<sup>95</sup>

Charge your 6 or 12 volt batteries at dockside even while your boat's electrical system is in use. Provides up to 20 amperes continuously for charging 6-volt batteries or 10 amperes continuously for charging 12-volt batteries, regardless of type. Charging current is continuously monitored by a 25 ampere meter. Shpg. Wt. 16 lbs.

**MARINE BATTERY CHARGE INDICATOR KIT**

See at a glance the exact percentage of charge in your boat batteries. Checks from 1 to 8 storage batteries instantly. Operates on 6, 8, 12 or 32 volt systems. Note: for mounting on non-ferrous metals or wood only. Shpg. Wt. 3 lbs.



HEATHKIT CI-1  
\$16<sup>95</sup>



HEATHKIT FD-1-6  
(6 volt)  
FD-1-12  
(12 volt)  
\$35<sup>95</sup> each

**FUEL VAPOR DETECTOR KIT**

Protecting against fire and explosion on your boat, the FD-1 indicates the presence of explosive fumes and shows immediately if it is safe to start the engine. The kit is complete including spare detector unit. Shpg. Wt. 4 lbs.

**Free** Send now for latest Heathkit Catalog describing in detail over 100 easy-to-assemble kits for the Hi-Fi fan, radio ham, boat owner and technician.



**HEATH**

*pioneer in do-it-yourself electronics*

**COMPANY BENTON HARBOR 10, MICH.**

**D** a subsidiary of Daystrom, Inc.

Send latest Free Heathkit Catalog.

NAME \_\_\_\_\_

ADDRESS \_\_\_\_\_

CITY \_\_\_\_\_ ZONE \_\_\_\_\_ STATE \_\_\_\_\_

QUANTITY	KIT NAME	MODEL NO.	PRICE

**Correct  
TV Troubles  
Yourself**

with the aid of a  
**QUIK-CHEK** TROUBLE  
FINDER  
DIAL  
WHEEL

**SAVE HUNDREDS  
OF DOLLARS ON  
UNNECESSARY  
TV SERVICE CALLS**  
for just **39c**

Actually shows you which tube or tubes are causing your TV trouble! Every TV owner should have one!



**80% of your TV troubles are tubes**

to detect a troublesome tube, you just dial your trouble and test all the tubes concerned with the particular problem! Send for one today!

Quik-Chek Corporation  
5212 Pulaski Avenue  
Philadelphia 44, Penna.

Enclosed is 39c in coin. Please send a Quik-Chek Trouble-Finder postpaid.

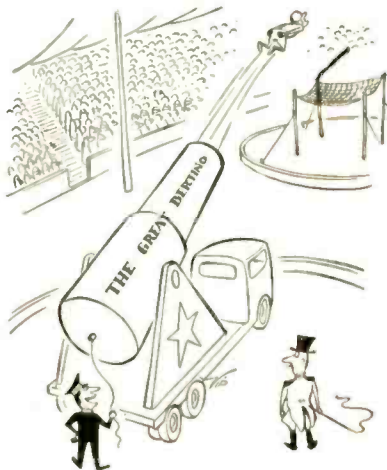
Name \_\_\_\_\_

Address \_\_\_\_\_

City \_\_\_\_\_

Zone \_\_\_\_\_

State \_\_\_\_\_



"Of course there's no smoke . . .  
I fired him off with a **JENSEN  
NEEDLE!**"

## Carl & Jerry

(Continued from page 122)

Mr. Gruber has always had such a wonderful outlook on life. At his age many people turn away from the world about them and live in the past—and then complain that the world is neglecting *them*; but Mr. Gruber is better informed about the present and the future than nine people out of ten of any age. We've got to help our friend."

"Any ideas?" Carl wanted to know.

"Well, since failing to see the rocket threw him into this mental tailspin, maybe seeing one will bring him out of it."

"You mean—"

"Right. Let's fix up one he *can see*."

"Okay, but it's got to look pretty authentic. He's a sharp old character and not easy to fool. I suggest we make it look as nearly like that thing he missed seeing as we possibly can."

"Check. Let's see now. If we string a wire from the peak of my house across to that big elm tree, it would just about follow the northwest-to-southeast path of the rocket stage as seen from Grubers' back yard, wouldn't it?"

"Right, but what are we going to use for a rocket?" Carl asked.

"All we need is a little light that waxes and wanes at the rate of the light from the orbiting stage. As I recall, that was about six complete cycles a minute, which happens to be the revolutions per minute we get when we power one of our tiny fractional horsepower motors with a couple of flashlight cells and run it through the speed-reducing gear train. We'll drive a low-ohmage, rotating, variable resistor with the gear train and insert this resistor in series with the two flashlight cells and a six-volt radio pilot lamp.

"We'll probably have to put some fixed resistance in series, besides," Jerry continued, "so that the maximum brilliance of the pilot lamp at the distance Mr. Gruber will be seeing it will be that of a fairly bright star. The rotating variable resistor will keep the lamp brightening and dimming. We'll put this stuff in a plastic bottle; and you, from a position up in the tree, can pull it along the wire at the proper slow rate by means of an endless loop of string running over a pulley up on my roof."

"What will you be doing?"

"I'll get Mr. Gruber out in his back yard and have him looking in the right direction



# 48¢ ea.

# for any tube

## \$45.00 Per Hundred

# STANDARD LINE

**ELECTRIC COMPANY**

**FREE TUBE BRIGHTENER ON ORDERS OF \$10.00 OR MORE**

FREE\* POSTAGE IN U.S.A. & TERRITORIES

### ANNOUNCING OUR NEW PRICE SCHEDULE

Effective July 25, 1958 all tubes (Radio & Television receiving) will be sold and shipped at the fantastic price of only .48c ea. or \$45.00 per hundred. Any "on hand" orders at that time will receive credit for future purchases.

THE TUBES ADVERTISED HEREIN ARE NOT NECESSARILY NEW TUBES BUT MAY BE ELECTRICALLY PERFECT FACTORY SECONDS OR USED TUBES AND ARE SO MARKED

All TV & Radio Tubes are tested by our supplier under actual conditions in Radio & TV chassis or in Hickock Tube Testers Model 533A.

And, of course, the famous Standard Line guarantee remains in effect: All tubes guaranteed to be replaced free if they fail to function efficiently within one year's time. (defective tubes must be returned intact, postage paid. Refunds will be cheerfully made within five (5) days if not completely satisfied.)

0B2	3A1S	5V6GT	6B66	654	7F7	12Q7	32L7GT
0Z4	3AU6	5W4GT	6BF5	658GT	7F8	12SA7	35/51
1A5GT	3AV6	5X4G	6B06G	65A7	7G7	12SG7	35A5
1A7GT	3BA6	5X8	6B06	65B7Y	7H7	12S17	35B5
1B3GT	3BC5	5Y3GT	6B08	65C7	7J7	12SK7	35C5
1C5GT	3BE6	5Y4G	6B16	65F5	7K7	12SN7GT	35L6GT
1C6	3BN6	5Z3	6BK5	65F765GT	7L7	12SQ7	35W4
1C7	3B08	5Z4	6BK7	65H7	7M7	12SR7	35Y4
1H4G	3BY6	6A8	6B17GT	65J7	7O7	12VA6GT	35Z4GT
1H5GT	3BZ4	6A8A	6B16	65K7	7R7	12WA6GT	35Z5GT
1L6	3C2	6AC7	6B06GT	65L7GT	757	12X4	#37
1LA4	3C86	6AF4	6B07	65N7GT	7V7	12Z3	#39/44
1LA6	3C6	6AG5	6B88	65Q7	7W7	14A7	#41
1L84	3C56	6AG7	6B58	65R7	7X6	14AF7	#42
1LCS	3D76	6AH4GT	6B5G	674	7X7	14B6	#43
1L6A	3D4	6AH6	6B2A	618	7Y4	14F7	#45
1LH4	3Q5GT	6AK5	6B27	6U4GT	7Z4	14F8	#47
1LNS	354	6AK6	6C4	6U5	8AW8	14M7	50A5
1M5GT	3V4	6AL5	6C5	6U8	12A8	14N7	50B5
1P5GT	4B8C	6AL7GT	6C35	6V3	12A85	14O7	50C5
1O5GT	4B07A	6AM8	6C86	6V6GT	12AD5	1457	50C6G
1B5	4B5A	6AN8	6CD4G	6W4GT	12AT6	17AX4GT	50L6GT
155	4B08	6AQ5	6C6F	6W4GT	12AT7	17DQ6	50Y6
1T4	4B27	6AQ6	6C6G	6X4	12AU6	19A4	50Y7
1T5GT	4C86	6AQ7GT	6C86	6X5GT	12AU7	19B6G	#57
1U4	5AM8	6AR5	6C8H	6X8	12AV6	19C8	#58
1U5	5AN8	6AS5	6C16	6Y6G	12AV7	19J6	#60
1V	5AQ5	6AS8	6CM6	7A4	12AX4GT	19I8	#61
1V2	5AS8	6AT6	6CM7	7A5	12AX7	19X8	117L7GT
1X2	5AT8	6AU4GT	6CN7	7A6	12AZ7	25AC5	117N7GT
2A3	5AV8	6AU5GT	6CU6	7A7	12B4	25AV5GT	117P7GT
2A5	5AW4	6AU6	6D06	7A8	12B6A	25AX4GT	117Z3
2A7	5AZ4	6A0B	6D06	7B4	12B6E	25BK5	117Z4GT
2A4A	5BK7	6AV5GT	6DT6	7B5	12B6	25D6	117Z6GT
2B7	5BR8	6AV6	6E5	7B6	12BH7	25CD0G	807
2B4A	5B07	6AW8	6M6	7B7	12BK5	25CU6	9002
2D21	5B27	6AX4GT	6J4	7B8	12B06	25L6GT	9003
2E5	5C8A	6AX5GT	6J5	7C4	12BR7	25W4GT	9006
2X2A	5J6	6A7B	6J6	7C5	12CA5	25Z5	
3A2	5T8	6B4A	6K4GT	7C6	12C16	25Z6	
3A3	5U8	6B5C	6K7	7C7	12D06	#27	
3A4	5U4G	6B8C	6L6	7E6	12J5	#30	
3A5	5V4G	6B06	6L7	7E7	12L6GT	#31	

## ALL TUBES GUARANTEED ONE FULL YEAR...

NOTE: When ordering receiving tubes be sure to enclose 48c for each tube or \$45.00 per hundred.

### Thousands of TRADE-IN TVs

Please Specify Console or Table Model When Ordering  
 Reconditioned By Factory Trained Technicians! Guaranteed  
 To Be In Working Condition When You Receive Them!

10"	\$25.00	19"	\$56.00
12"	\$30.00	20"	\$63.00
14"	\$35.00	21"	\$70.00
16"	\$42.00	24"	(when available) \$95.00
17"	\$49.00	27"	(available) \$129.00

Get yourself a second set or buy some for re-sale!  
 All TVs sent motor freight or Railway Express F.O.B. our warehouse. Sorry, no A.P.O. shipments.  
**FREE INDOOR ANTENNA with each TV Purchase**

below is our new price schedule of six tubes. These famous make tubes contain all new parts with the exception of the glass bulb which does not wear out.

Any 10" Tube	\$ 9.95	Any 16" Tube	15.95
Any 12" Tube	10.95	Any 17" Tube	18.29
Any 14" Tube	13.95	Any 19" Tube	20.29
		Any 21" Tube	24.29

Prices On Larger Tubes On Request

Remember  
**Only 48¢ ea.**  
**\$45 Per Hundred**  
 ANY TYPE  
 ANY QUANTITY

Remember — NO DUD Required.  
 All tubes guaranteed one year.  
 Picture Tubes shipped F.O.B. Harrison, N. J.

# STANDARD LINE

**ELECTRIC COMPANY**

422 HARRISON AVENUE, HARRISON, N. J. Phone: Humboldt 4-4997

# NEW! "Do-It-Yourself" LAFAYETTE Kits



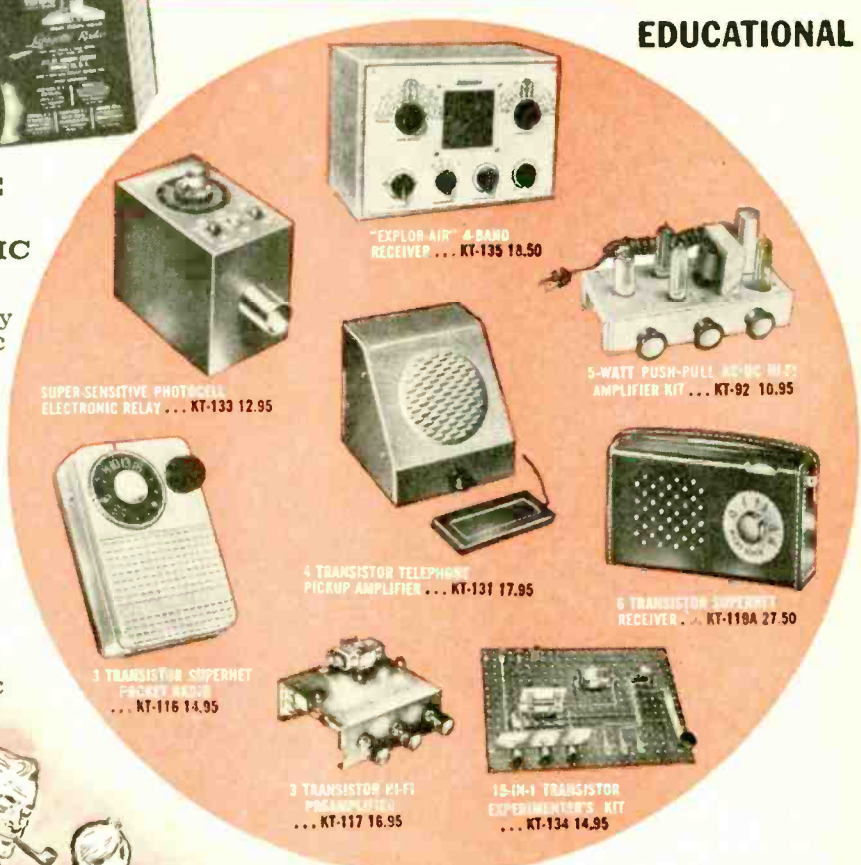
**LAFAYETTE'S**  
**1959 CATALOG**  
**260 GIANT-SIZE**  
**PAGES**  
**FREE!**

Complete listings of the **NEWEST** in Stereo and Monaural Hi-Fi, Short Wave, Audio, Transistor, and many other Lafayette electronics kits as well as thousands upon thousands of standard brand nationally advertised kits and electronic parts and components are described in LAFAYETTE'S GIANT NEW 260-PAGE CATALOG. SEND FOR IT—IT'S FREE! Just fill in coupon below and present it at any Lafayette store, or paste it on a postcard and send it to us. **THAT'S ALL YOU HAVE TO DO** to get your **FREE 1959 LAFAYETTE CATALOG!**

## LAFAYETTE RADIO ELECTRONIC KITS

- Include the very latest electronic advances.
- Are constantly being modernized by Lafayette's own Engineering Department, by a leading consulting engineering firm, and by your own recommendations.
- Are a product of Lafayette's 38 years of Electronic Leadership.

## EDUCATIONAL



**SUPER-SENSITIVE PHOTOCELL  
 ELECTRONIC RELAY ... KT-133 12.95**



**"EXPLOR AIR" 4-BAND  
 RECEIVER ... KT-135 18.50**



**5-WATT PUSH-PULL AC-DC HI-FI  
 AMPLIFIER KIT ... KT-92 10.95**



**3 TRANSISTOR SUPERHET  
 POCKET RADIO ... KT-116 14.95**



**4 TRANSISTOR TELEPHONE  
 PICKUP AMPLIFIER ... KT-131 17.95**



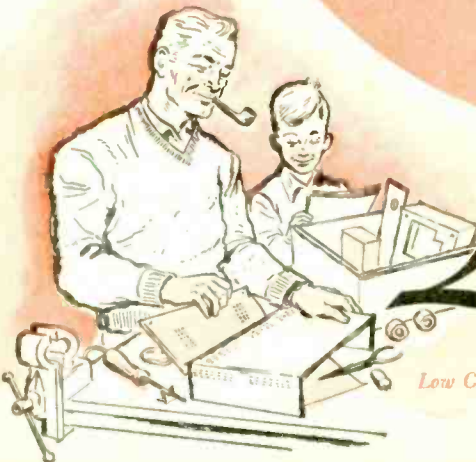
**6 TRANSISTOR SUPERHET  
 RECEIVER ... KT-119A 27.50**



**3 TRANSISTOR HI-FI  
 PREAMPLIFIER ... KT-117 16.95**



**18-IN-1 TRANSISTOR  
 EXPERIMENTER'S KIT ... KT-134 14.95**



*Low Cost Kits For Everyone!*

# Lafayette Radio

Always say you saw it in—POPULAR ELECTRONICS



# LAFAYETTE Kits Are FUN To Build!

## LEARN ELECTRONICS BY BUILDING A LOW COST LAFAYETTE KIT

**KITS FOR BEGINNERS** • 10-In-1 Lab Kit • Transistor Code Practice Oscillator • AC-DC Broadcast Receiver • 3-Way Broadcast Receiver • 5-Watt Push-Pull AC-DC Amplifier • 7-In-1 Radio Lab Kit • 2-In-1 Kit • Germanium Diode Radio • 1-Transistor Pocket Radio • 2-Transistor Pocket Radio

**HI-FI KITS** • Stereo Master Audio Control Center & Preamplifier • Stereo Remote Control Center—Electronic Stereo Adapter • 36-Watt Basic Stereo Amplifier • AM-FM Stereo Tuner • Preamp-Audio Control Center • 70-Watt Power Amplifier • 4-Watt Stereo Amplifier • Speaker Enclosure Kits

**ADVANCED KITS** • Broadcast-Shortwave Receiver • Electric Brain Kit • 10 Watt Push-Pull Hi-Fi Amplifier • 15-In-1 Transistor Experimenter's Kit • 4-Band Broadcast-Shortwave Receiver • Photocell Electronic Relay • 6-Transistor Super-net Receiver • 3-Transistor Pocket Radio • 3-Transistor Hi-Fi Preamplifier • 2-Transistor Reflex Radio with Sun Battery • Transistor Code Practice Oscillator • Radio Control Transmitter • Transistor-Diode Checker • Multitester Semi-Kit • 4-Transistor Telephone Pickup Amplifier

### PRACTICAL



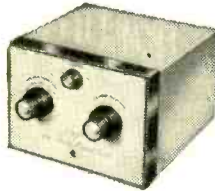
36-WATT STEREO BASIC POWER AMPLIFIER .... KT-310 47.50



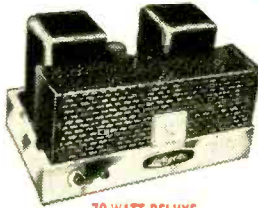
STEREO MASTER AUDIO CONTROL CENTER-PREAMP .... KT-600 79.50



STEREO AM-FM HIGH FIDELITY TUNER .... KT-500 74.50



STEREO REMOTE CONTROL CENTER ELECTRONIC STEREO ADAPTER .... KT-315 27.50



70-WATT DELUXE BASIC AMPLIFIER .... KT-400 69.50



4-WATT STEREO PHONO AMPLIFIER .... KT-126 18.95



DELUXE MASTER AUDIO CONTROL CENTER-PREAMPLIFIER .... KT-300 39.50

### EASY-TO-BUILD LAFAYETTE KITS

Enjoy and Save

**LAFAYETTE KITS SAVE YOU REAL MONEY.** You save up to 30% or more when you build a low-cost Lafayette kit as against factory-wired units of equal or even lesser quality. You save also because Lafayette manufactures these kits and sells them *direct to you*, eliminating the usual dealer's markup.

**LAFAYETTE KITS ARE YEARS AHEAD.** Every latest advance in electronics finds its way into educational Lafayette Kits. Lafayette was **FIRST** in TRANSISTORS, and Lafayette is now **FIRST** in **STEREO HI-FI!**

**LAFAYETTE KITS ARE EASY TO BUILD.** Whether you are a beginner or an engineer, a novice or advanced amateur, there are Lafayette kits you can build, learn from, and use. Detailed instructions with clear, large blow-ups and dozens of illustrations describe minutely every step of the kit assembly so that there are seldom any questions.

**LAFAYETTE KITS ARE AVAILABLE ON OUR EASY PAY PLAN. SEE OUR FREE GIANT-SIZED 260-PAGE 1959 CATALOG FOR DETAILS.**

### LAFAYETTE RADIO STORE LOCATIONS

**JAMAICA 33, N. Y.**  
165-08 Liberty Ave.  
AXtel 1-7000  
Open FRIDAY  
\*Hil 8:45 P.M.

**NEW YORK 13, N.Y.**  
100 6th Ave.  
WO:th 6-5300  
Open THURSDAY  
\*Hil 8:45 P.M.

**BRONX 58, N. Y.**  
542 E. Fordham Rd.  
FOrdham 7-8813  
Open THURSDAY  
\*Hil 8:45 P.M.

**NEWARK 2, N. J.**  
24 Central Ave.  
MArket 2-1661  
Open WEDNESDAY  
\*Hil 8:45 P.M.

**PLAINFIELD, N. J.**  
139 W. 2nd St.  
PlAinfield 6-4718  
Open THURSDAY  
\*Hil 8:45 P.M.

**BOSTON 10, Mass.**  
110 Federal St.  
HUbbard 2-7850  
Open MON.-WED.  
\*Hil 8:45 P.M.

ASK FOR THE FREE 260-PAGE GIANT NEW 1959 LAFAYETTE CATALOG Fill in and present the coupon below at any Lafayette store for your FREE Catalog, or simply paste the coupon on a postcard and mail it to the address on the coupon. Our catalog is FREE for the asking!

**FREE**



CUT  
OUT  
AND  
PASTE  
ON  
POST  
CARD

**LAFAYETTE RADIO, Dept. ID-9**  
P.O. Box 511, Jamaica 31, N. Y.

SEND FOR THE WORLD'S LEADING ELECTRONICS, RADIO, T.V., INDUSTRIAL, AND HI-FI GUIDE

Send FREE LAFAYETTE Catalog 690

Name .....

Address .....

City....., Zone.... State....



on the pretext of asking him something about the stars."

"Well, let's get going. I can't stand thinking about Mr. Gruber just sitting over there brooding."

**R**IGGING UP the "rocket" didn't take the boys long. Neither did stringing the thin copper-clad steel wire to serve as a trolley for the rocket. Since Carl and Jerry were constantly putting up and taking down all sorts of experimental transmitting and receiving antennas, stretching the wire



... "It must have just gone into orbit" ...

and the accompanying loop of string attracted no neighborhood attention.

The unseasonal warmth of the April day carried over into the evening; so when the boys finally decided it was dark enough for their rocket launching and stepped outside, the night was warm and thousands of stars were twinkling overhead.

"You go shinny up that tree and get all set," Jerry said to Carl. "When I see the little light start to blink, I'll know you're ready and I'll get Mr. Gruber."

"Aye, aye, sir; you can start the count-down now, sir," Carl answered.

It was only a few minutes until Jerry saw a slow pulsing of the tiny light high up in the branches of the tree, and he started for the back door of the Gruber house. Just as he reached it, the door opened and Mr. Gruber came out.

"Well, hi there, Mr. Gruber," Jerry said. "You're just the man I wanted to see."

"Is that right, Jerry?" Mr. Gruber replied as he sat down heavily on the back step. "What was on your mind?"

"I've become interested in the stars lately, and I wondered if you would help me spot some of the constellations I've been reading about. I get confused when I try to pick anything out of that twinkling mess."

"I don't know, Jerry; I don't know," Mr. Gruber said sadly, shaking his head. "I'd like to help you, but I'm afraid you asked me too late. My eyes are failing mighty fast."

"I'm sorry to hear that," Jerry said with brusque cheerfulness; "but maybe you can help me a little. For example, where is Ursus Major, or the Great Bear?"

"Blind as I am I can see that one," Mr. Gruber declared in a tone that sounded a bit more like his old self. "That's it right up there. Most people call it the Big Dipper because it looks like a dipper. Can you make it out?"

"Yeah!" Jerry said, "I sure can. My book says the two stars forming the side of the dipper farthest from the handle are pointer



... "All at once I saw the biggest owl" ...

stars to help locate the North Star. Is that right?"

"Look for yourself. Sight right along a line passing through those two stars. See; the North Star is almost exactly in line. It's not too bright, but you can't miss it because no other bright star is near it. But here's something else about the Great Bear that you may not have read in your books. Take a sharp look at the star in the handle, right where the handle bends. The name of that star is Mizar.

"Now if you'll look closely and if your eyesight is good," Mr. Gruber went on, "you'll see another faint star very near

Mizar. That's Alcor. Some say the Arabs used Alcor as a test of eyesight. If you could see it, your eyesight was good enough to permit you to be in the Bedouin cavalry. Hm-m-m—" Mr. Gruber's voice trailed off.

"What's the matter?" Jerry asked innocently.

"Don't you think it's a mite early for lightning bugs?" Mr. Gruber asked.

"Much too early," Jerry agreed. "We don't see them until June."

"Well," Mr. Gruber said, trying to keep a note of rising happy excitement out of his voice, "take a look right up there by Mizar and tell me if you see anything funny."

Jerry squinted his eyes obediently and stared up at the Big Dipper. "No, I don't see a thing—hey, wait a minute. I do see something. It looks like a moving star that keeps brightening up and fading out. It can't be a plane. They don't blink that slowly. Sure looks funny. I never saw anything like that before."

"Are you sure?" Mr. Gruber said, gripping Jerry's shoulder in his excitement. "Think hard. You saw that rocket launching stage in orbit last summer. Did it look like that?"

"It sure did!" Jerry exclaimed. "That's exactly how it looked."

"Yippee!" Mr. Gruber shouted as he pulled his derby hat far down on his head and capered wildly about the yard. "It must have just gone into orbit, and we're the first to spot it. Get on the phone, boy! Call Washington! Call Cape Canaveral! I'll stay here and track it."

"Now wait a minute," Jerry started to say; but he was interrupted by a screeching scream of terror and pain from the direction of the elm tree. At the same moment the "rocket," now directly overhead, plummeted down and hit Mr. Gruber's derby with a resounding thump.

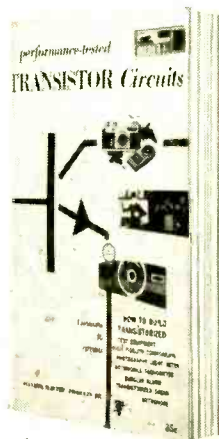
Before Jerry could find out if the old gentleman was injured, he saw a shadow half climb and half fall out of the tree; and Carl came running toward them.

"What on earth happened?" Jerry asked.

"That's what happened," Carl said dramatically as he directed the beam of a flashlight at a couple of deep scratches in his forearm. "I was sitting up there minding my own business when all at once I saw the biggest owl in the world flying straight at me. I threw up my arm just in time to keep him from sinking his claws directly into my face. He must have seen my eyes

## NEWEST EDITION!

### Performance —Tested **TRANSISTOR CIRCUITS** YOU CAN **BUILD**



Here are some of the interesting and practical transistor projects this new book outlines for you—complete from description of operation to parts lists. All parts are standard and readily available from your nearest Sylvania distributor.

- ★ Automobile tachometer
- ★ Remote temperature indicator
- ★ Burglar alarm
- ★ 30 MW audio preamp
- ★ Transistorized organ
- ★ Wireless phono oscillator
- ★ Timer circuit
- ★ Code practice oscillator
- ★ Photography light meter

**36 projects in all!**  
**Only 35¢**

Available from your Sylvania distributor  
or order direct.

# SYLVANIA

Sylvania Electric Products Inc.  
Dept. NH67, 1100 Main St.  
Buffalo 9, N. Y.

Please send the booklet, "Performance Tested Transistor Circuits." Enclosed is 35 cents in coin for each copy.

Name \_\_\_\_\_

Street Address \_\_\_\_\_

City and State \_\_\_\_\_

(please print clearly)

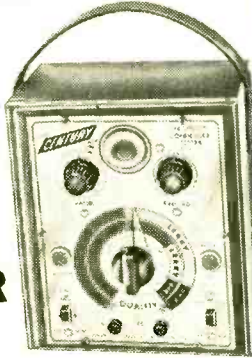


# SHIPPED ON APPROVAL

## an IN-CIRCUIT CONDENSER TESTER THAT DOES THE WHOLE JOB!

The CT-1 actually steps in and takes over where all other in-circuit condenser testers fail. The ingenious application of a dual bridge principle gives the CT-1 a tremendous range of operation . . . and makes it an absolute 'must' for every serviceman.

### IN-CIRCUIT CONDENSER TESTER Model CT-1



Model CT-1—housed in sturdy  
hammer-tone finish steel case  
complete with test leads only **\$34<sup>50</sup>**  
Net

#### in-circuit checks:

- ✓ Quality of over 80% of all condensers even with circuit shunt resistance present . . . (leakage, shorts, opens, intermittents)
- ✓ Value of all condensers from 200 mmfd. to .5 mfd.
- ✓ Quality of all electrolytic condensers (the ability to hold a charge)
- ✓ Transformer, socket and wiring leakage capacity

#### out-of-circuit checks:

- ✓ Quality of 100% of all condensers . . . (leakage, shorts, opens and intermittents)
- ✓ Value of all condensers from 50 mmfd. to .5 mfd.
- ✓ Quality of all electrolytic condensers (the ability to hold a charge)
- ✓ High resistance leakage up to 300 megohms
- ✓ New or unknown condensers . . . transformer, socket, component and wiring leakage capacity

#### OUTSTANDING FEATURES

- Ultra-sensitive 2 tube drift-free circuitry
- Multi-color direct scale precision readings for both quality and value . . . (in-circuit or out of circuit)
- Simultaneous readings of circuit capacity and circuit resistance
- Built-in hi-leakage indicator sensitive to over 300 megohms
- Cannot damage circuit components
- Electronic eye balance indicator for even greater accuracy
- Isolated power line

## TRANSISTOR TESTER Model TT-2

Every day more and more manufacturers are using transistors in home portable and car radios . . . in hearing aids, intercoms, amplifiers, industrial devices, etc. Since transistors go bad the need for TRANSISTOR TESTER is great. They can

develop excessive leakage, poor gain, shorts or opens. The TT-2 is an inexpensive quality instrument designed for accurate and dependable tests of all transistors and diodes — quickly and accurately.

#### OUTSTANDING FEATURES

- Checks all transistors, including car radio, power output, triode, tetrode and unijunction types for current gain, leakage, opens, shorts, cut-off current
- Checks all diodes for forward to reverse current gain
- All tests can be made even if manufacturers' rated gain is not available
- Less than half a minute required for tests of either transistors or diodes
- Large 3" meter is extremely sensitive — yet rugged . . . with multi-color scales designed for quick easy readings
- Power is supplied by an easy to replace 6-volt battery — current drain so small, service life almost equal to shelf life. Battery cannot be drained due to accidental shorting of test leads
- Cannot burn-out its own meter or damage transistor or diode under test
- Long test leads and insulated test clips enable tests without entirely removing transistor from circuit
- Test leads are identified by E.I.A. color code so that connection to the correct terminal is assured
- Comes complete with replaceable transistor set-up chart that fits into a special rear compartment.

**IMPORTANT FEATURE:** The TT-2 cannot become obsolete as the circuitry is engineered to enable you to check all new type transistors as they are introduced. New listings will be furnished at no cost.

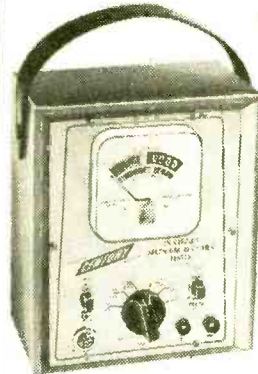


Model TT-2 — housed in sturdy hammer-tone finish steel case complete with test leads . . . only **\$24<sup>50</sup>**  
Net

### Check all power rectifiers in-circuit

whether SELENIUM, GERMANIUM, SILICON, etc.

## with the IN-CIRCUIT RECTIFIER TESTER Model SRT-1



Model SRT-1—housed in sturdy hammer-tone finish steel case complete with test leads . . . only **\$29<sup>50</sup>**  
Net

With the growing trend towards compactness, portability and low price, TV manufacturers are resorting more and more to producing series-string TV sets employing selenium, germanium or silicon power rectifiers. Now the need for an in-circuit rectifier tester is greater than ever.

### THE SRT-1 CHECKS ALL POWER RECTIFIERS IN-CIRCUIT AND OUT-OF-CIRCUIT WITH 100% EFFECTIVENESS FOR:

- ✓ Quality ✓ Fading ✓ Shorts ✓ Opens ✓ Arcing ✓ Life Expectancy

#### OUTSTANDING FEATURES

- Checks all types of power rectifiers rated from 10 ma. to 500 ma. (selenium, germanium, silicon, etc.) both in-circuit or out-of-circuit.
- Will not blow fuses even when connected to a dead short.
- Large 3" highly accurate multi-color meter . . . sensitive yet rugged.
- Separate meter scales for in-circuit and out-of-circuit tests.
- Cannot damage or over heat rectifier being tested.

#### SIMPLE TO OPERATE

Just clip SRT-1 test leads across rectifier under test right in the circuit without disconnecting rectifier from circuit. Press test switch and get an instant indication on the easy-to-read three-color meter scales . . .

### ALL CENTURY INSTRUMENTS ARE GUARANTEED FOR ONE FULL YEAR

The extremely low prices are made possible because you are buying direct from the manufacturer.

**EASY TO BUY IF SATISFIED** see order form on facing page



# FOR 10 DAY FREE TRIAL

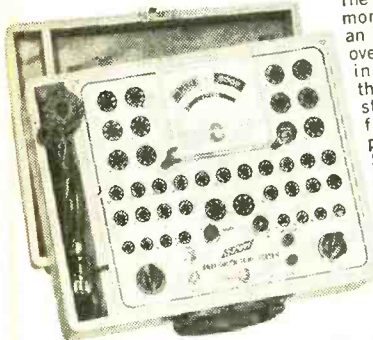
try them for 10 days before you buy . . . only then, when satisfied, pay in easy-to-buy monthly installments — without any financing or carrying charges added.

Convince yourself at no risk that CENTURY instruments are indispensable in your every day work. Send for instruments of your choice without obligation in easy-to-buy monthly installments — without any financing or carrying charges added.

## STILL THE BEST SELLING TUBE TESTER IN THE FIELD FAST-CHECK TUBE TESTER

Model FC-2

The greatest testimonial ever paid on an instrument . . . over 20,000 sold in a little more than a year—and still selling as fast as we can produce them. See for yourself at no risk why so many servicemen choose the FAST-CHECK above all other tube testers—regardless of price.



Model FC-2 — housed in hand-rubbed oak carrying case complete with CRT adapter . . . only

**\$69.50**  
Net

SIZE: W: 14 1/8"  
H: 11 1/4" D: 4 3/8"

Just 2 settings on the FAST-CHECK TUBE TESTER tests over 700 tube types completely, accurately — AND IN SECONDS!

### PICTURE TUBE TEST ADAPTER INCLUDED WITH FAST-CHECK

Enables you to check all picture tubes (including the new short-neck 110 degree type) for cathode emission, shorts and life expectancy . . . also to rejuvenate weak picture tubes. No other tube tester made at any price can match the value of the FAST-CHECK.

### RANGE OF OPERATION

- ✓ Checks quality of over 700 tube types, employing the time proven dynamic cathode emission test. This covers more than 99% of all tubes in use today, including the newest series-string TV tubes, auto 12 plate-volt tubes, OZ4s, tubes, auto 12 plate-volt tubes, special magic eye tubes, gas regulators, and even foreign hi-fi tubes and even foreign tubes.
- ✓ Checks for inter-element shorts and leakage.
- ✓ Checks for gas content.
- ✓ Checks for life-expectancy.

### IMPORTANT FEATURES

- No time consuming multiple switching . . . only two settings are required instead of banks of switches on conventional testers
  - No annoying roll chart checking . . . tube chart listing over 700 tube types is located inside cover. New listings are added without costly roll chart replacement
  - Checks each section of multi-section tubes and if only one section is defective the tube will read "Bad" on the meter scale
  - 41 phosphor bronze beryllium tube sockets never need replacement
  - 4 pin and 9-pin straighteners mounted on panel
  - Large 4 1/2" D'Arsonval type meter is the most sensitive available, yet rugged — fully protected against accidental burn-out
  - Special scale on meter for low current tubes
  - Compensation for line voltage variation
  - 12 filament positions
  - Separate gas and short jewel indicators
  - Line isolated — no shock hazards
  - Long lasting etched aluminum panel
- NOTE: The Fast-Check positively cannot become obsolete . . . as circuitry is engineered to accommodate all future tube types as they come out. New tube listings are furnished periodically at no cost.

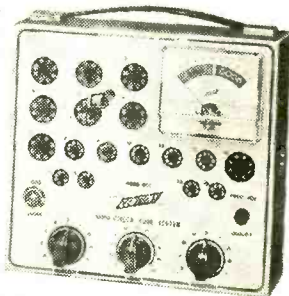
NEW . . .

For those looking for a real **ECONOMY MULTIPLE SOCKET TUBE TESTER** without sacrificing **ACCURACY, SPEED and VERSATILITY**

## MINI-CHECK TUBE TESTER

Model MC-1

Here is a multiple socket tube tester designed to meet limited budgets. Although low in price it boasts a unique circuitry that enables you to check over 600 tube types — and has a range of operation that far exceeds others in its price class.



Model MC-1 — housed in sturdy wrinkle finish steel case . . . only

**\$39.50**  
Net

SIZE: W: 9"  
H: 8 1/2"  
D: 2 3/4"

### OUTSTANDING FEATURES

- Checks emission, inter-element shorts and leakage of over 600 tube types. This covers OZ4s, series-string TV tubes, gas regulators, auto 12 plate volt, hi-fi and foreign tubes
- 3 settings enable a test of any tube in less than 10 seconds
- Employs dynamic cathode emission test principle
- 3 1/2" D'Arsonval type meter — most accurate type available . . . its greater sensitivity means more accuracy . . . its means longer life
- 17 long lasting phosphor bronze tube filament positions
- Handy tube chart contained in special back compartment
- New tube listings furnished periodically at no cost
- Detachable line cord

plus these BONUS FEATURES . . . found in no other low price tube tester

- ✓ Checks for cathode to heater shorts
- ✓ Checks for gas content
- ✓ Checks all sections of multiple purpose tubes . . . will pickup tubes with one "Bad" section
- ✓ Line isolated — no shock hazard
- ✓ Variable load control enables you to get accurate results on all tubes
- ✓ Positively cannot become obsolete as new tube types are introduced.

## CONVENIENT TIME PAYMENT PLAN — NO INTEREST OR FINANCING CHARGES

# CENTURY ELECTRONICS CO., INC.

### CHECK INSTRUMENTS DESIRED

- Model CT-1 In-Circuit Condenser Tester . . . \$34.50 \$9.50 within 10 days. Balance \$5 monthly for 5 months.
- Model SRT-1 In-Circuit Rectifier Tester . . . \$29.50 \$4.50 within 10 days. Balance \$5 monthly for 5 months.
- Model TT-2 Transistor Tester . . . \$24.50 \$4.50 within 10 days. Balance \$5 monthly for 4 months.
- Model FC-2 Fast-Check Tube Tester . . . \$69.50 \$14.50 within 10 days. Balance \$11 monthly for 5 months.
- Model MC-1 Mini-Check Tube Tester . . . \$39.50 \$9.50 within 10 days. Balance \$6 monthly for 5 months.

Prices Net F.O.B. Mineola, N. Y.

111 Roosevelt Avenue, Dept. 304, Mineola, New York

Please rush the instruments checked for a 10 day free trial. If satisfied I agree to pay the down payment within 10 days and the monthly installments as shown. If not completely satisfied I will return the instruments within 10 days and there is no further obligation. It is understood there will be NO INTEREST or FINANCING charges added.

Name \_\_\_\_\_  
Address \_\_\_\_\_  
City \_\_\_\_\_ State \_\_\_\_\_

Please print clearly

shining and thought I was some sort of goody. I don't know who was scared the most, but while I was threshing around up there trying to turn him loose, I must have unfastened the wire from around the trunk of the tree."

"Aha! So you young rascals were trying to fool a poor blind old man, were you?" Mr. Gruber said with a chuckle as he looked down at the still-blinking little bulb in the plastic bottle he held in his hand. "You ought to be ashamed of yourselves."

"Yeah, I guess we should," Jerry agreed; "but honestly, Mr. Gruber, we weren't just trying to fool you for the fun of it. We hoped that if you saw what you thought was a rocket you'd quit worrying about your eyesight and be the same cheerful, helpful pal to us you've always been. It seemed like a good idea at the time, but it seems a lot different right now. Will you forgive us?"

"Forgive you!" Mr. Gruber exclaimed. "I think that's the nicest thing anyone ever tried to do for me. I'm the one who should be ashamed, and I am. I've been a thoughtless old fool, wallowing in self-pity and bringing worry and concern to my friends."

"Then you'll quit worrying about your eyesight?" Carl asked hopefully.

"I sure will and for good reason. Jerry, do you remember when I was telling you how Alcor was a test of eyesight?"

"Yes."

"Well, all at once I realized I was seeing it! I didn't see it as well as I did when I was a boy, mind you; but I could still make it out. I made the happy discovery just before I spotted this orbiting rocket. Would either of you boys like to shake the hand of the first human being ever struck by a rocket that had been in orbit and who still lived to tell the tale?"

AS THE BOYS shook his hand in mock deference, Mr. Gruber came up with a final suggestion:

"Hey, guys, what say we raid the refrigerator for some cokes and fried chicken Martha has stashed away in there? Then I wish you'd look over some plans for assembling a space station I've worked out. I've got to get busy and make up the time I've lost these last few months!"

"Just lead the way!" Carl and Jerry chorused happily.

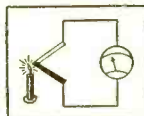
-30-

LEARN  
**RADAR MICROWAVES**  
**COMPUTERS**  
**TRANSMITTERS**  
**CODE • TV • RADIO**

Phila. Wireless Technical Institute  
 1533 Pine St. Philadelphia 2, Penna.  
 A Non-Profit Corp. Founded in 1908  
 Write for free Catalog to Dept. P-459

**THERMO-ELECTRONICS**

Successor to  
**Thermo-Electricity**



Change heat to electricity DIRECTLY—no acids, liquids, chemicals, moving parts or sunlight! Build or buy a thermo-electronic battery. Mail quarter today for information and sample thermo-electronic alloy.

**HERMON E. COTTER**

Dept. S  
 15766 Blackstone Detroit 23, Mich.

**DEPENDABLE TV-RADIO**  
**TUBES**



**ZALYTRON** Tubes for TV-Radio Service-men, Dealers, Experimenters.

Nationally sold ZALYTRON Tubes are BRAND NEW Tubes • NOT USED • NOT REJECTS • NOT PULLED FROM EQUIPMENT ... but ZALYTRON's First Quality! Why pay more? Try them once, you'll buy them always. Every tube we ship is covered by our Full Refund Guarantee ... YOU be the judge! Send today for new Price List "PE".

1-YEAR GUARANTEE

**BE YOUR OWN BOSS**  
 RUN A SELF-SERVICE TUBE BUSINESS

Get This Modern Sturdy Tube Tester

**FREE**

with "Package Deal" order for nationally sold ZALYTRON Quality Brand Receiving Tubes. We'll show you how to start a successful Tube Tester Route, and get YOUR share of today's Big Profits in Self-Service Tube Sales! This is no "Get-Rich-Quick" scheme but a solid, proven business that will reward you well—if you WORK at it. But, INVESTIGATE before you INVEST! Get full details on the best "Deal" now being offered, send today for our booklet "P"



**ZALYTRON** TUBE CORPORATION  
 220 West 42nd St., N. Y. 36, N. Y.



APRIL SHOWER OF SAVINGS  
FOR ALL LEKTRON SHOPPERS!

CASH DISCOUNT

SALE!



**NOTE TO BONUS CARD HOLDERS**

If you wish, purchases may be credited toward free Poly-Paks as usual. In that case, discount does not apply.



**Lektron's Exclusive POLY-PAKS®**  
SAVINGS FROM \$3 TO \$35 AND MORE! 88¢ EACH!

**MINI-RADIO KIT**  
World's smallest! 2 x 1 x 1". Loopstick, jacks, diode, etc., w/instructions. 1 lb. Reg. \$3. **88¢**

**40-RECORD CADDY**  
Wrought iron. 2 Holds 40 records & albums. 1 lb. Reg. **88¢** \$2.95.

**8 SUB-MINI SOCKETS**  
Mica-filled. For transistors. **88¢** too.

**40 SUB-MINI C'ND'S'RS**  
For transistor, printed circuit work. 1 lb. Reg. **88¢**

**8-SCREWDRIVER SET**  
8 asstd. drivers with well rack. Plastic handles. 1 lb. List **88¢** \$3.50.

**60 PLUGnRECEPTCLES**  
Audio. power, line, battery. sprk. 3 lbs. Reg. **88¢**

**\$25 SURPRISE PACK**  
Large, varied assortment radio, TV parts. 3 lbs. **88¢**

**6 SILICON DIODES**  
Sylvania 1N22, 1N23. Reg. **88¢** \$36.

**0-6 AMP. MINI-METER**  
AC. 1 1/4" diameter. 1 lb. Reg. **88¢**

**8-PC. NUTDRIVER SET**  
\$3 value! Plastic handle. 3/16" thru 7/16" socket wrenches. **88¢** 1 lb.

**TV PIC BOOSTER**  
Parallel; 6-wire. Extends picture tube life. 1 lb. **88¢**

**15 VOLUME CONTROLS**  
Incl. duals; some w/switch; to 1 meg. 2 lbs. Reg. **88¢** \$12.

**70 ONE-WATTERS**  
Asstd. value carbon resistors. 5% too! **88¢**

**35 POWER RESISTORS**  
WW. 5 to 50W to 10,000 ohms. Vitreous, too. 3 lbs. Reg. **88¢** \$15.

**40 HI-Q CONDENSERS**  
Finest porcelain; NPO's too! 1 lb. Reg. **88¢**

**8 GERMANIUM DIODES**  
Glass sealed, w/long leads. For all hobby projects. **88¢**

**30 DISC CONDENSERS**  
Wafers-thin; to .01 mf. Reg. **88¢** \$5.

**40 PRECISION RESISTORS**  
1%, 1/2 & 1 W; carboloy & WW. 100 ohms to 1 meg. Reg. **88¢** \$17.

**10 POLY BOXES**  
Clear plastic. hinged, w/ snap locks. Asstd. sizes. **88¢** 1 lb.

**40 TUBE SOCKETS**  
4 to 9-pin; ceramic, mica, shield-based incl. 2 lbs. **88¢** Reg. \$10.

**100 CERAMIC CONDENSERS**  
Hi-Q discs, tubular; to .01 mf. 2 lbs. Reg. **88¢** \$12.

**"1-POUNDER" HAMMER**  
Claw; 16-oz. steel, w/14" formed handle. Reg. **88¢** \$2.50.

**16-END WRENCH SET**  
For home and auto. Box and open 15/64 thru 7/16". 16 sizes. Reg. **88¢** \$2.50.

**30 PILOT LITES**  
Pop. flashlite size; mini bay. type. Reg. **88¢** \$9. 1 lb.

**5 ROLLS MICRO WIRE**  
#24 thru #32; for transistor, sub-mini circuits. 1 lb. **88¢**

**2 MIKE XFMRs.**  
Carbon. 100 to 100K ohms impedance. Leads: encased. **88¢** 2 lbs. Reg. \$10.

**100 RADIO PARTS**  
Wide variety resistors, condensers, pots, forms. 3 lbs. **88¢**

**SYLVANIA TV MIRROR**  
10 x 12" stainless steel. 2 lbs. Reg. **88¢** \$4.

**HOBBY BENCH VISE**  
Clamp type. Fits tables, too. Steel. 1 lb. **88¢**

**70 HI-Q RESISTORS**  
Carbon. IRC. Ohmmer; 1%, too! 1/2 & 1 W. 10 ohms to 10 megs. 2 lbs. Reg. **88¢** \$13.

**HEARING AID PHONE**  
Crystal, w/cord set & plug. **88¢** Reg. \$5.

**4 OUTPUT XFMRs.**  
50L6 etc. 3 lbs. Reg. **88¢** \$8.

**POSTAGE STAMP MIKE**  
Crystal 100 to 8,000 cps. **88¢** 1 lb. Reg. \$7.

**75-FT. TV TWINLEAD**  
300 Ohm. Hanked, timed. **88¢** 3 lbs. Reg. \$3.50.

**10 ELECTROLYTICS**  
Radio. TV. 10-500 mf to 450 VDC. 3 lbs. Reg. **88¢**

**60 RADIO-TV KNOBS**  
Asstd. colors, insulation. Some worth \$1 ea. 2 lbs. Reg. **88¢** \$17.

**4 POWER WOOD BITS**  
Hi-Q steel. 3/8, 1/2, 3/4, 1". **88¢** 5" long. Reg. \$3.

**10 TUBULAR ELECTROS**  
Asstd. paper types. AC DC. **88¢** Hobby. 3 lbs. Reg. \$15.

**20 ARTISTS' BRUSHES**  
100% pure bristle; sizes **88¢** 1-6. Reg. \$2.50.

**75 MICA CONDENSERS**  
.00025 to .01 to 1200V; silver too. 25 values. Reg. **88¢** \$28.

**15-PC. DRILL SET**  
1/16" thru 1/4" by 64ths. **88¢** w/calibrated case. Reg. \$3.

**75 RESISTOR SPECIAL!**  
WW. precision, carbon, variable, minitypes. 3 lbs **88¢** Worth \$15.

**60 CONDENSER SPECIAL!**  
Molded, paper, ceramic, oil, mica, discs. variable. 2 lbs. **88¢**

**7 ROLLS WIRE**  
25-ft each. #18 thru #22. Asstd. stranding, insulation, col. **88¢** ora. 2 lbs. Reg. \$5.

**1500 PCS. HARDWARE**  
Nuts, screws, washers, etc. **88¢** 1 1/2 lbs. Reg. \$6.

**6-PC. HACKSAW SET** **88¢**  
Six assorted blades. 1 lb.

**70 TERMINAL STRIPS**  
Solder lug & binding; to 20 **88¢** terms. 2 lbs.

**60 COILS, CHOKES**  
IF, RF, ant., slug-tuned. **88¢** too. 3 lbs. Reg. \$15.

**300-FT. HOOKUP WIRE**  
Tinned, asstd. sizes, colors. **88¢** 2 lbs. Reg. \$5.

**100 HALF-WATTERS**  
Asstd. value carbon resistors, incl. 5%. Reg. **88¢** \$12.

**30 MOLDED COND'S'RS**  
Asstd. Finest mate! Wt. **88¢** 2 lbs.

**15 ROTARY SWITCHES**  
Asstd. gangs. 3 lbs. Reg. **88¢** \$12.

**5-IN-1 DRILL BIT**  
Reams, saws, copes, shapes, drills. 1/8 or power drill. **88¢**

**15 INSTR. KNOBS**  
Knurled black bakelite, w/pointer; brass inserts, set-screws. Reg. **88¢** \$3.

**10 PANEL SWITCHES**  
Asstd. 115VAC. power, multi-circuit & SPST, DPST, **88¢** DPDT. 2 lbs. Reg. \$5.

**40 SUB-MINI RESIST'RS**  
1/4" long. 20 values; 1/5W to 10 megs. Reg. **88¢**

**8" HOBBY SPEAKER**  
For radios, code osc., inter-coms. 2 lbs. Reg. **88¢**

**TEN 3-SECOND TIMER**  
Mechanisms; precision **88¢** beared. 2 lbs. Reg. \$30.

**2 TRANSISTOR IF'S**  
Double-tuned. Only 1/2" **88¢** square. 456kcs.

**2 N-P-N TRANSISTORS**  
Used in many pop. make **88¢** radios. Worth \$5.

**2 P-N-P TRANSISTORS**  
Popular make! Dozens of **88¢** hobby uses. \$5 value.

**2 VARI-LOOPSTICKS**  
Adj. 540-1500 kcs. Transistor radios, etc. 1 lb. **88¢**

**RADIATION DETECTOR**  
World's smallest. 100's of Atomic and Radiation uses. **88¢** Reg. \$21.00.

**0-60 MINUTE TIMER**  
For darkroom, lab, shop, kitchen. Loud alarm. 2 lbs. **88¢** Reg. \$6.

**0-15 VAC MINI-METER**  
Hundreds of uses! Only 1 1/4" diameter. 1 lb. Reg. **88¢** \$3.50.

**70 TUBULAR COND'S'RS**  
Paper, molded, oil, porc., to 50W to 1000V. 2 lbs. **88¢** Reg. \$14.

**WIRE STRIPPER**  
Strips & cuts hook-up wire **88¢** #16 thru #22. Wt. 1 lb.

**10 RCA PLUG-N-JACK**  
SETS, matched. Most pop. **88¢** amps., tuners, phones.

**HOW TO ORDER:**

ORDER BY "BLACK TYPE" HEADLINES, i.e. ONE 40-RECORD CADDY, 88¢

State price with each item. Send check or M. O. including sufficient postage; excess returned. C.O.D. orders, 25% down; rated, net 30 days. INCLUDE POSTAL ZONE in address. (Canada postage, 48¢, 1st lb.; 28¢ ea. add'l. lb.)

**LEKTRON** 131-133 EVERETT AVE. CHELSEA 50, MASS.



**GET MORE  
ENJOYMENT OUT  
OF YOUR HI-FI  
FOR ONLY  
\$1.00!**

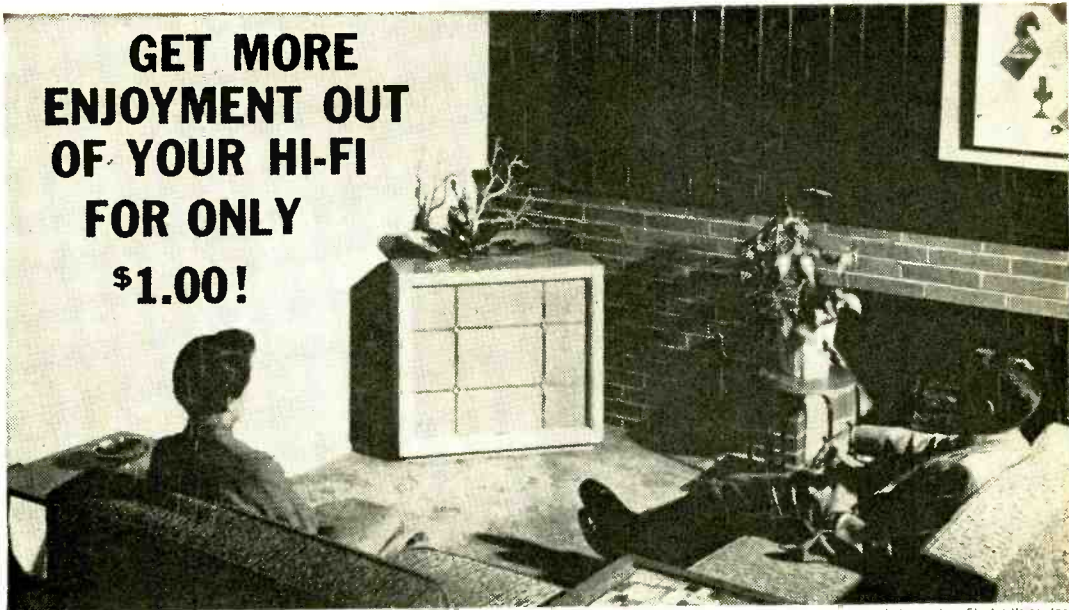


photo courtesy Electro-Voice, Inc.

Now—just \$1 can show you how to get more listening pleasure from your hi-fi set! That's the cost of the new 1959 edition of the HI-FI GUIDE & YEARBOOK—the authoritative Ziff-Davis Annual that covers every facet of high fidelity enjoyment. Besides telling you how to use your equipment for the best possible reproduction, the 1959 HI-FI GUIDE & YEARBOOK presents a round-up of the trends in the hi-fi field... tells you how to save on repairs... guides you in the selection of records... gives you tips on tapes.

You'll find this Annual a wonderfully practical source of information on improving the sound output of your system. Articles are presented in easy-to-understand, non-technical language. No wonder the HI-FI GUIDE & YEARBOOK has been a virtual sellout in other years! Be sure to pick up your copy of the 1959 edition now. It's like getting two big books for the price of one:

### GUIDE

Section 1: IMPROVING YOUR HI-FI—Strange Allergies of hi-fi. Square Waves Check Tone Controls. Give Your Pickup a Chance. Getting the Most from Your Tweeters. MX means Multiplex. Your Stereo Listening Area.

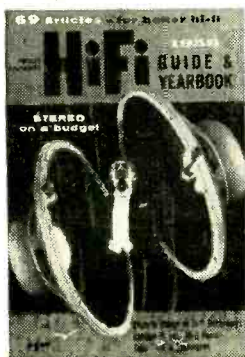
Section 2: INSTALLING YOUR HI-FI SYSTEM—Hi-ing the Fi to the Suburbs. Index Your Music. Ceiling Mounted Speaker.

Section 3: TAPE RECORDING—Getting the Most From Your Tape Records. Tips and Techniques. Don't Let Your Tapes Hiss at You. Make Your Own Stereo Tape Recordings.

### YEARBOOK SECTION

TRENDS IN HI-FI: developments in 1958 and what the future holds.

CRITICS' CHOICE OF RECORDINGS: a conductor, a music critic, and a sound engineer tell what records (classical and jazz) they would select—and why.



THE ULTIMATE IN FM STATIONS: Here's how an FM station in Chicago really caters to its hi-fi listeners—in what could be a nationwide trend in programming! Also gives you a listing of FM stations throughout the country.

STEREO: the latest report on what is happening in this big, exciting field. Plus a photo story showing what can be done to fit more equipment into less space. All told, the HI-FI GUIDE & YEARBOOK brings you a wealth of information to help you get the most out of your hi-fi listening hours. Only \$1.00 (\$1.25 outside U.S.A.), it's a fabulous buy! Make sure you pick up your copy at your newsstand.

Now on sale.

**ZIFF-DAVIS PUBLISHING COMPANY**

434 South Wabash Avenue, Chicago 5, Illinois



## Inside the Preamplifier

(Continued from page 60)

provides us with bass boost. The amount of boost will increase as the slider is moved downward. Thus, we will have a curve which compensates for the loudness effect at the bass end fairly adequately. We can boost the highs by installing a capacitor or capacitive network between the top of the volume control and the volume control tap, and so achieve a boost at both ends. This type of circuit is shown in Fig. 4(B) and is being used with success in the Dynakit preamplifier.

Figure 4(C) is a more elaborate configuration which is used in the Centralab "Compentrol." Here, two taps on the control give two different curves. Although this is a complicated network, it occupies little space since it is contained in a small printed circuit.

**Variable Loudness Controls.** A little reflection will indicate that no single fixed loudness compensation could serve all needs. First, not everybody has the same ear response. Second, almost everybody plays his hi-fi set at a different loudness level. Third, the loudness delivered by a hi-fi system depends on the amplifiers, loudspeakers and pickups used in the system.

An efficient speaker system will deliver a higher volume level with a given input signal than will an inefficient speaker system. Clearly, the same loudness control would deliver an over-boosted effect with the most efficient speakers and an under-compensated effect with the less efficient speakers. A high-level pickup would produce over-compensation and a low-level pickup would produce under-compensation. Room acoustics differ and so do personal tastes. For these reasons, a single unadjustable loudness curve will obviously not be equally satisfying for all people, all installations, and all circumstances.

The easiest means of providing a wide range of loudness control action is to add a simple volume or gain control ahead or after the loudness control. This two-control method will yield results which will suit the majority of needs.

A word of caution concerning the use of loudness controls would not seem to be out of place. The person whose set incorporates a loudness control must not forget that these controls were designed first and foremost for use at low volume levels. If the



*Any way you look at it!...*  
**EMC leads in Quality Electronic Test Equipment, at Lowest Prices!**

### NEW! EMC Model 301 Speedi Tube Tester

Precision crafted for checking tubes in seconds. Only 2 settings to make. Checks for shorts, leakages, and quality. Over 375 tubes now listed, including 024 tube. New listings available. Saves precious time and quickly pays for itself. Also available with 7½" meter.

Model 301P, illustrated with 4½" plastic front meter, in oak carrying case, \$47.50; In Kit Form, \$33.20.

Model 301C, Sloping Counter Case, \$46.50; Kit, \$32.60.  
 Model PTA, Picture Tube Adaptor (to check and rejuvenate picture tubes)..... \$4.50



### NEW! EMC Model 108 Handi Tester

The only appliance and auto battery tester in its price class to use a D'Arsonval, instead of an iron vane type meter. You get exclusive advantages of maximum accuracy, maximum scale length, and minimum battery replacement cost... at no extra cost. Complete with test leads and instruction manual. Wired, \$15.95; In Kit Form, \$12.95.

### NEW! EMC Model 905-6A Battery Eliminator, Charger, and Vibrator Checker

A MUST for auto radio service. Features continuously variable voltage output — in either 6 or 12 volt operation. Checks all 6 or 12 volt vibrators. Model 905-6A (Comb.) Wired, \$67.90; Kit, \$44.90. Model 905, Battery Eliminator and Charger (only) Wired, \$37.50; Kit, \$28.90. Model 906, Vibrator Checker (only) Wired, \$31.80; In Kit Form, \$17.05.

NEW! Model BEA, Battery Eliminator Adaptor (for Transistor Radio Checking)..... Wired, \$9.70



Yes, tell me more, send me—FREE—a detailed catalog of the complete EMC line. PE-49

NAME \_\_\_\_\_

STREET \_\_\_\_\_

CITY \_\_\_\_\_

STATE \_\_\_\_\_

**EMC**

Electronic Measurements Corp.  
 625 B'way • New York 12, N. Y.  
 Ex. Dept. 370 B'way, N. Y. 13





## The World's Only Correspondence Course in Wire Tapping

A complete course in Electronic and Photographic Surveillance Equipment illustrated with photographs, drawings, and schematics of special equipment.

This course, written for professional detectives, presents many new techniques in Wire Tapping and Bugging. A catalog of Electronics and Photographic Surveillance Equipment is included. Each lesson is concluded with a fiction story example showing the practical uses of the material of that lesson. Personalized Quizzes are given, and questions answered; a certificate of completion is awarded.

The following is an outline of the course:

- |   |  |
|---|--|
| LESSON I. "Wire Tapping"<br>The Wired Tap<br>Wireless Wire Tapping<br>Fiction "Tom Makes a Tap"   | LESSON III. "Micro & Infra Photography"<br>Microphotography<br>Film Processing<br>Invisible Photography<br>Remote Photography<br>Fiction "Tom and the Nude Spy"            |
| LESSON II. "Bugging"<br>Wired Bugs<br>Wireless Bugs<br>Directional Microphones<br>Recording Equipment and Techniques<br>Fiction "All Hell Breaks Loose" | LESSON IV. "Telescopic Photography"<br>Aerial Photography<br>Telescopic Photography<br>Geometric Ramifications of Aerial Photography<br>Fiction "Tom Spots An' Out' House" |
| LESSON V. "Tailing"<br>The Wireless Tail<br>Radio Direction Finders<br>Fiction "The Conned Con-Artist"  |  |

The FULL COURSE just \$22.50, Complete.

**C. CARRIER CO.**

Dept. AE 5880 Hollywood Blvd. Hollywood 28, Calif.

set is played at normal, or slightly higher than normal levels, and the loudness control is left in the circuit, the resulting sound will usually have a mushy character. As a consequence of this common misuse of loudness controls, many critical listeners have formed unfavorable opinions of them and decline to use them at any volume level. This is unfortunate because loudness controls, when properly used, can provide a semi-automatic tone control action which is very effective and easy to control.

Next month we'll go on to the consideration of the special problems of *stereo pre-amplifiers* and discuss the means that various manufacturers have devised to solve these problems.

-50-

## Transistor Topics

(Continued from page 117)

its maximum ratings) or if subjected to excessive temperatures or mechanical strain. This may pose a real problem to the serviceman called on to check the equipment. Unsoldering and removing components for test is not an easy task.

To help the serviceman, the Philco Corporation (Philadelphia, Pa.) is now producing the first transistor tester capable of checking the performance of a transistor while it is wired in the circuit. At present, Philco is assembling these units to fill a Bureau of Ships contract, but a commercial model of the tester will be introduced in the near future.

**Price Cuts.** As a famous radio news analyst might say . . . "There's good news tonight." Two major mail order distributors have announced special low prices on transistors having wide application in experimental circuits.

Lafayette Radio (165-08 Liberty Ave., Jamaica 33, N. Y.) is now offering *p-n-p* general-purpose audio transistor with characteristics similar to the famous CK722 for only 49c each, plus postage. Even lower prices apply to quantity sales. The catalog number is SP-146.

Olson Radio Warehouse (260 S. Forge St., Akron 8, Ohio) is offering Bendix high-power *p-n-p* transistors with characteristics similar to the Motorola 2N554, Sylvania 2N307, and CBS-Hytron 2N255 for only 99c each, plus postage. Again, even lower prices apply to quantity sales—three for \$2.50, ten for \$8.00, and so on. Olson's stock num-

## TV PICTURE TUBES AT LOWEST PRICES

10BP4	\$ 7.95	16WP4	\$15.20	17TP4	\$19.30	21EP4	\$14.95
12LP4	8.95	16TP4	10.95	20AP4	19.30	21FP4	15.95
14B/CP4	9.95	17AVP4	15.20	20CP4	13.90	21WP4	17.30
16DP4	14.95	17BP4	10.95	20HP4	17.95	21YP4	15.95
16EP4	15.90	17CP4	17.00	21AP4	22.10	21ZP4	14.95
16GP4	15.90	17GP4	17.60	21ALP4	20.95	24CP4	23.95
16KP4	10.95	17HP4	13.60	21AMP4	19.95	24DP4	26.95
16LP4	10.95	17LP4	13.60	21ATP4	20.95	27EP4	39.95
18RP4	10.95	17QP4	11.95	21AUP4	20.95	27RP4	39.95

1 Year Warranty

Aluminized Tubes \$5.00 more than above prices. Prices include the return of an acceptable similar tube under vacuum. These tubes are manufactured from reprocessed used glass bulbs. All materials including the electron gun are brand new.

ALL PRICES FOB CHICAGO, ILLINOIS. Deposit required when old tube is not returned, refundable at time of return, 25% deposit required on COD shipments. Old tubes must be returned prepaid. Tubes shipped Rail Express.

WRITE FOR COMPLETE LIST

## —PICTURE TUBE OUTLET—

3032 MILWAUKEE AVE., CHICAGO 18, ILLINOIS  
Dickens 2-2048

## GET INTO ELECTRONICS

V.T.I. training leads to success as technicians, field engineers, specialists in communications, guided missiles, computers, radar, automation. Basic & advanced courses in theory & laboratory. Assoc. degree in 29 mos. B. S. obtainable. ECPD accredited. G.I. approved. Graduates with major companies. Start Sept., Feb. Dorms, campus. H. S. graduates or equivalent. Catalog.

**VALPARAISO TECHNICAL INSTITUTE**  
Dept. PE VALPARAISO, INDIANA



# Build the best... build **knight<sup>®</sup>-kits**

A PRODUCT OF ALLIED RADIO



Featured in  
**ALLIED'S**  
1959 Catalog  
*free!*



with exclusive **"CONVENIENCE ENGINEERING"**

Send for catalog describing in detail the complete KNIGHT-KIT line. See everything in Hi-Fi, Hobby, Test Instrument and Amateur kits. KNIGHT-KITS are lowest in cost, "convenience engineered" for easiest building, latest in design—the kits with guaranteed specifications that assure superior performance. Get the latest Allied Catalog—see the new, outstanding 1959 KNIGHT-KITS...

SAVE UP TO

**50%**

EASY TERMS  
ON ORDERS  
AS LOW AS \$20

send for it... SEE DOZENS OF TYPICAL **knight-kit** VALUES LIKE THESE



### Top Value 12-Watt Complete Hi-Fi Amplifier Kit

Model Y-784

**\$19.95**

(less cover)  
\$2.00 down

Never before has there been so much solid hi-fi value and quality performance at such low cost. **Guaranteed specifications:** frequency response, 30-15,000 cps  $\pm 1\frac{1}{2}$  db at half power; less than 1% distortion at full power. **Has 15 db of inverse feedback.** With preamp stage equalized for magnetic cartridge; inputs for phono and tuner; separate bass and treble with boost and attenuation. 5 x 9 $\frac{1}{2}$  x 7" with cover (cover \$3.95 extra). 7 $\frac{1}{2}$  lbs.



### Thrilling "Space Spanner" Receiver Kit

Model Y-259

**\$18.95**

Thrilling 2-band receiver, easy to build, fun to operate—a terrific value. Bandswitch selects exciting short-wave, including foreign broadcasts, amateur, aircraft, police and marine radio (6.5 to 17 mc), and standard broadcast. Highly sensitive regenerative circuit. Built-in 4" PM speaker and beam power output for strong volume. Headphone jacks and switch to cut out speaker. Handsome cabinet, 7 x 10 $\frac{1}{2}$  x 6". AC or DC operation. 7 $\frac{1}{2}$  lbs.

there is a money-saving **knight-kit** for every electronic need

#### HI-FI KITS

60-Watt Stereo Amplifier  
Stereo Deluxe Preamp  
Stereo Control  
18-Watt Amplifier  
25-Watt Basic Amplifier  
30-Watt Amplifier  
FM-AM Tuner  
FM Tuner  
Hi-Fi Preamplifier  
Speaker Systems, etc.

#### HOBBY KITS

"Span Master" 4-Band Receiver  
"Ranger" Radios  
Clock-Radio  
Radio-Intercom  
"Ocean Hopper" Radio  
5-Transistor Portable  
2-Transistor Pocket Radio  
1-Transistor Radio  
Electronic Lab Kits  
Photoelectronic System, etc.

#### INSTRUMENT KITS

Tube Checkers  
5" Oscilloscopes  
VTVM  
VOM's  
RF Signal Generator  
Signal Tracer  
Audio Generator  
Sweep Generator  
Capacitor Checker  
R/C Tester

Transistor Checker  
Flyback Checker  
Battery Eliminator, etc.

#### AMATEUR KITS

Communications Receiver  
50-Watt Transmitter  
Self-Powered VFO  
100 kc Crystal Calibrator  
RF "Z" Bridge  
Code Practice Oscillator

**452 PAGE 1959  
ALLIED CATALOG**

**FREE**

Send for this value-packed catalog featuring the complete KNIGHT-KIT line, as well as the world's largest stocks of everything in Electronics. It's the leading, money-saving Buying Guide.

WRITE FOR YOUR **FREE COPY TODAY!**



## ALLIED RADIO

ALLIED RADIO CORP., Dept. 152-D9  
100 N. Western Ave., Chicago 80, Ill.

Ship the following KNIGHT-KITS \_\_\_\_\_ \$ \_\_\_\_\_ Enclosed

Send FREE 1959 ALLIED 452-Page Catalog

Name \_\_\_\_\_

Address \_\_\_\_\_

City \_\_\_\_\_ Zone \_\_\_\_\_ State \_\_\_\_\_

# Save Half ASSEMBLING

ONE OF THESE TWO

*Schober*

## ELECTRONIC ORGANS in KIT form

"CONCERT" "CONSOLETE"



**NO SPECIAL SKILLS  
PAY KIT-BY-KIT**

**CONSOLETE MODEL**  
Occupies only 2' x 3'2"  
Floor Space

- HANDSOME ASSEMBLED CONSOLES
- DOUBLE KEYBOARDS — 122 KEYS
- ABOVE-KEYBOARD TABS
- CONCERT MODEL CONFORMS TO A GO SPECIFICATIONS. Occupies 3'5" x 4'7" Floor Space
- BUILT-IN SPEAKERS OPTIMAL (For Consolete Model only)
- COMPLETE DETAILED INSTRUCTIONS
- FREE—NEW 1959 EDITION of 16-page BOOKLET DESCRIBING BOTH MODELS
- 10" LP RECORD DEMONSTRATING BOTH MODELS available for \$2; refundable on receipt of order

Write today—see what fine instruments you can have at such great savings.

**The SCHOBER ORGAN CORP.**

2248-X Broadway, New York 24, New York

ber is X-771. (Incidentally, this bears out one of our predictions made in January—that a power transistor selling for under one dollar would be offered this year.)

**Product News.** Want stereo at minimum cost? Then you'll be interested in a new device called the "Stereo-Bug." This little unit is basically a transistorized wireless phono oscillator and, in operation, it "broadcasts" the second channel of a stereo record through a nearby AM radio receiver. The "first" channel is played through the phonograph in conventional fashion. The "Stereo-Bug" nets for only about \$13.00.

Allied Radio Corporation (100 N. Western Ave., Chicago 80, Ill.) has a fully transistorized three-channel audio *mixer* in its latest catalog. Useful in p.a. and general audio work, this unit serves to combine the signals from three microphones into a single output, while maintaining individual control over each channel. It nets for \$14.95, plus postage.

RCA (Somerville, N. J.) has announced a number of new transistors: Types 2N647, 2N1010, 2N331, 2N561 and 2N1014. The 2N331, 2N561 and 2N1014 are *p-n-p* germanium units. The 2N647 and 2N1010 are *n-p-n* germanium alloy types. All except the 2N561 and 2N1014 are designed for a.f. amplifier applications; the latter are primarily for use in high-voltage, high-current industrial and military applications.

That's the transistor story for now, fellows. I'll be back with more news and circuits next month . . .

Lou

**NEW MAGIC RADIO WALKIE TALKIE!**

**YOUR OWN POCKET SIZE RADIO STATION!**  
BROADCASTS TO ANY HOME OR CAR RADIO WITHOUT WIRES OR HOOKUPS! Wt. only 5 oz. Size only 1 1/2" x 2 1/2" x 4 1/2". Built-in telescoping antenna. Powerful Transistor—sensitive microphone. Frequency setter, break-in switch! Runs for weeks on self-contained flashlight batteries. Durable plastic case. With this Radio Talkie you CAN TALK TO YOUR FRIENDS UP TO A BLOCK OR MORE AWAY! Talk between two automobiles.—INSTANT OPERATION. Just push button to talk! No license needed. Uses inductive field magnetic radiation. Useful and real fun in a million ways! **GUARANTEED TO WORK!**

1 YEAR SERVICE GUARANTEE.

**SEND ONLY \$3.00** (cash, c. m.) and pay postage or send \$12.99 for prepaid delivery. COMPLETE READY TO OPERATE with instructions and hundreds of ways and tricks for broadcasts thru any radio you desire. Get your NEW POWERFUL RADIO TALKIE NOW.

Available only from: WESTERN RADIO, Dept. REL-4, Kearney, Nebr.

1	9	0	4		1	4	1	4	
8			3	3	1/3		9	5	0
.7	0	7		3/4	7		0		
	5	0	0		8	0	7	0	
3	0	0		1	5				
6		1	6		9	2	9	1	
0		7	9		0		8	8	
		3		3	0	0	0	0	2
2	0	0		0				3	6
5	7			6	.3		2	1	5
1		3	5		4	.5	0	0	0
1	0	0	0	0	0	0		5	0

Solution to crossword puzzle on page 108.

**ENGINEERING  
DEGREE IN  
27 MONTHS**

**INDIANA TECHNICAL COLLEGE**

B.S. degree (27 mo.): Aero., Chem., Civil, Elec., Mech. & Electronics.  
B.E. (36 mo.): Aero., Chem., Civil, Elec., Mech., Metallurgical. B.S. (36 mo.): Math., Chem., Physics.  
Preparatory courses. Demand for graduates. Campus. 20 bldgs.; dorms. gym. Low rate. Earn board. G.I. appr. Enter June, Sept., Dec., March. Catalog.  
2349 E. Washington Blvd., Fort Wayne 2, Ind.  
Keeping pace with progress



## Transformer Substitutions

(Continued from page 75)

When choosing a substitute, make sure that its secondary voltage specifications are the same and that its current ratings equal or exceed those of the original.

For example, a transformer with a 250-0-250 volt, 60-ma. secondary may be used as a satisfactory replacement for a unit rated at 250-0-250 volts, 40 ma. Similarly, a filament transformer rated at 6.3 volts, 3 amperes, is a satisfactory substitute, electrically, for a unit rated at 6.3 volts, 1.5 amperes.

A 5% difference in secondary voltage ratings will usually not affect circuit operation. Thus, if a project calls for a transformer rated at, say, 360-0-360 volts, substitutes with ratings of either 375-0-375 or 350-0-350 generally will be satisfactory.

Where a special transformer having several secondary windings is required, and an exact duplicate is unobtainable, separate transformers can be used in place of the single multi-winding unit, provided that adequate mounting space is available. The transformer's 117-volt primary windings are connected in parallel.

If special filament or bias voltages are required, two (or more) windings can be connected in series to supply the necessary voltages, as shown in Fig. 4 (A). Connect adjacent winding leads together temporarily and check the output voltage obtained between the "free" leads, using your a.c. voltmeter. If the output voltage is less than expected, the windings may be "bucking." In this case, interchange the connections to one winding.

It may be necessary to reduce the circuit's B+ voltage after installing a substitute transformer. There are several ways of doing this. A small resistor (5 to 25 ohms, 10 watts) can be connected in series with one of the primary leads, or the effective turns ratio of the transformers can be reduced by connecting one of the filament windings in series with the primary, as shown in Fig. 4(B). The preferred methods would be to substitute a rectifier tube with a larger internal voltage drop or lower the value of the input filter capacitor (C1 in Fig. 1). If the hum level in the d.c. output goes up, raise C2's value.

Often, a center-tapped filament winding may be needed, but may not be available on the substitute transformer. In such a

prepare for your career in

# ELECTRONICS RADIO-TV COMPUTERS

and other fields of  
**ELECTRICAL ENGINEERING**

At MSOE, you can equip yourself for a career in many exciting, growing fields:  
**MISSILES • RADAR • AVIONICS  
AUTOMATION • RESEARCH  
DEVELOPMENT • ELECTRICAL  
POWER • ROCKETRY**

When you graduate from the Milwaukee School of Engineering, you are prepared for a dynamic career as an Electrical Engineer or Engineering Technician. Under a faculty of specialists, you gain a sound technical education in modern, completely equipped laboratories and classrooms. As a result, MSOE graduates are in great demand and highly accepted by industries nationally.

At MSOE, you will meet men from all walks of life and all parts of the country — some fresh out of high school or prep school, others in their twenties — veterans and non-veterans.

You can start school in any one of four quarters and begin specializing immediately. Engineering technicians graduate in 2 years with an Associate in Applied Science degree. For a Bachelor of Science degree in Engineering, you attend 4 years. A 3-month preparatory course also is available.



### FREE CAREER BOOKLET!

If you're interested in any phase of electronics, radio or television, be sure to look into the programs of study offered by the Milwaukee School of Engineering. Just mail the coupon.

## MILWAUKEE SCHOOL OF ENGINEERING

Dept. PE 459, 1025 N. Milwaukee St.  
Milwaukee, Wisconsin

Please send FREE Career Booklet. I'm interested in  
 Electronics  Electrical Power  Television  
 Mechanical Engineering  Radio  Computers  
 Electrical Engineering  Industrial Electronics

PLEASE PRINT

Name..... Age.....

Address.....

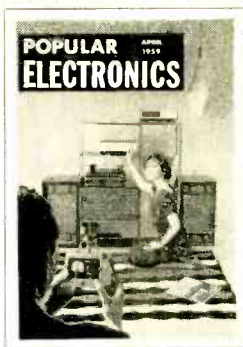
City..... Zone..... State.....

I'm eligible for veterans education benefits

MS-125



Send  
**POPULAR  
 ELECTRONICS**  
 Every  
 Month



name \_\_\_\_\_

address \_\_\_\_\_

city \_\_\_\_\_ zone \_\_\_\_\_ state \_\_\_\_\_

- Check one:  3 years for \$10  
 2 years for \$7  
 1 year for \$4

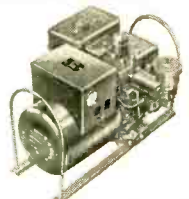
In the U. S., its possessions and Canada. Foreign rates: Pan American Union countries, add .50 per year; all other foreign countries, add \$1 per year.

**Mail to: POPULAR ELECTRONICS**

Dept. E-4-9, 434 South Wabash Ave., Chicago 5, Ill.

**EMERGENCY PORTABLE POWER PLANTS**

Push Button Start — 115 V AC (and 12 V DC). Always available. Only unit at these low factory prices fully shielded and filtered for radio, and individually checked by scope. Brand new 4 cycle easy starting engines, fiber glass insulated generators, and control boxes with voltmeter. Conservatively rated. Just the generator for CD, Field Day, Camping and Boats.



- 700 watt (A712) Shpg. wt. 77 lbs. .... \$143.50
- 1000 watt (A1012) Shpg. wt. 90 lbs. .... 195.50
- 2500 watt (A2512) Shpg. wt. 225 lbs. .... 325.50

Sizes to 3500 watts. F.O.B. factory

Dual voltage models, automatic controls, etc., available.

**GENERAL ELECTRIC SERVICE CO.**

376 Wilmot Ave., Burlington, Wisconsin

**ELECTRIC WELD - BRAZE & CUT**  
 REPAIR MOST EVERYTHING MADE OF METAL



Home Appliances. Auto parts. Farm-garden equipment. Toys. Make and repair playground equipment, lawn chairs, tables, ornamental iron work gates, wagons, etc. Solder, heat, bend, and straighten, with terrific heat from arc torch. Cut and weld up to 1/4" steel plate. A million uses for home, auto, farm, inventors, factories, etc. Works from any home 110 volt plug-in. Complete with dark welder's mask, arc torch, supply of carbon welding and brazing rods. Solder, flux, and complete Welding Instruction Book. Attractive—portable—efficient—durable—1 year guarantee. We only 4 lbs.

**SEND ONLY \$3.00** (cash, ok, mo.) and pay postman \$9.95 plus COD postage on arrival or send \$12.95 and we will send postpaid. Ideal gift for mechanically minded home owners, relatives, friends. Order now for early delivery. Available only from **MIDWAY WELDER** Dept. DPL-4 Kearney, Nebraska

case, an electrical "center-tap" can be obtained by connecting a 50-to-100-ohm adjustable wire-wound resistor across the filament winding, as shown in Fig. 5. The adjustable tap is centered on the resistor.

It is not necessary to use all the windings available on a multi-winding power transformer. For example, suppose you need a general-purpose power transformer, and find one with secondary specifications which match those of the needed unit but with an "extra" 6.3-volt filament winding. Simply ignore the extra winding, taping its leads to one side (taking care that they do not short together).

Mechanical specifications are important only when the substitute unit is used as a servicing replacement or in the construction of equipment where the component's physical size and shape are important. These specifications include over-all dimensions, weight, and type of construction or mounting.

-30-

**Answers to Electronic Sticklers**  
 on page 106

1. Two ohms. Redraw the network schematic in the form of a bridge circuit. You will find that the resistance values of the bridge legs result in a balanced bridge. Hence the 3-ohm resistor is an inactive component and can be omitted from the circuit. All that remains are two series resistance circuits in parallel.
2. A short circuit. The current remains the same since the two dry cells provide not only twice the voltage but also twice the internal resistance.
3. Since there is no surge resistor, the charging current of the capacitor would pull too much current through the rectifier. Without the surge resistor (20 cents), there's a good chance the rectifier (\$1.00) would burn out.
4. About 282 volts! How come? On one half-cycle, when the diode's plate is positive, the capacitor charges to peak line voltage . . . or about 141 volts (1.41 multiplied by line voltage). On the next half cycle, the capacitor's voltage is *in series* with the peak line voltage and thus adds to it . . . and 141 plus 141 equals 282! This arrangement, incidentally, is basic to voltage-doubler power supply design.

If you know of a tricky Electronic Stickler, send it with the solution to the editors of POPULAR ELECTRONICS. If it is accepted, we will send you a \$5 check. Write each Stickler you would like to submit on the *back* of a postcard. Submit as many postcards as you like but, please, just one Stickler per postcard. Send to: POPULAR ELECTRONICS STICKLERS, One Park Ave., New York 16, N. Y. Sorry, but we will not be able to return unused Sticklers.

## . . . Before Buying Stereo

(Continued from page 62)

stereo power amplifiers. Remember, the more separate units you have in your system, the more flexibility you will have in adjusting for new developments.

Dissimilar speaker systems pose a more difficult problem. Speaker systems of different manufacturers may be entirely different in coloration or "texture." Some make the listener feel as if he were in a fifth-row-center seat; others are known as "12th-row-balcony" speakers. Where you want to sit is your own business. But if one ear is "in the balcony" and the other is "in the orchestra," the result may be disquieting.

Don't be stampeded while purchasing a speaker. Take your time, listen, and compare. And never forget that human memory for sensory perceptions is short. You can't reliably compare a loudspeaker you hear today with one you heard yesterday any more than you can match a color today with one you saw yesterday.

**Buying Tips.** In general, you should be suspicious whenever someone says "Look here—stereo *really* isn't expensive." It is. Poor components are never a good buy for the person genuinely interested in high-fidelity music reproduction. If \$300 is what it costs to buy a monophonic high-fidelity outfit which you find satisfactory, you cannot expect to get a satisfactory stereo outfit for the same money.

One solution from a thoroughly practical standpoint is to build the best-quality monophonic system your budget and critical ear can agree upon. Then, at a later date, when you and your bank account have recovered from the initial investment, you can add stereo by duplicating your amplifier and speaker.

The following points should be of help in planning your stereo system:

- Stereo is not magic. It will tend to mask some imperfections in reproduction, but the ear of the critical audiophile is a quickly educated organ. Good reproduction depends, as always, upon good components.

- Monophonic reproduction has reached a high level of fidelity and standardization, and the wise buyer will take advantage of this whenever possible.

- Stereo is wonderful! Listen to it and consider buying it. But *don't* settle for low fidelity just to get stereo.

-50-

# Learn at Home in your spare time to Fix Electric Appliances



## Better Pay—More Opportunities

Get into a field where there is important work and opportunity for the trained man. Millions of electric appliances are sold every year. Every wired home now has an average of 8. Many of them need service and repair. Owners pay well to have them fixed quickly, properly. This is your opportunity for a better job, your own part time or full time business. NRI can give you the training you need, at home, in your spare time.

## Spare Time Earnings Start Soon

Soon after starting you will be able to earn extra cash fixing toasters, clocks, fans, vacuum cleaners, etc., for neighbors and friends. Keep your job while learning and earning. Put spare time to work for you. Work in your basement, garage, spare room. You'll be amazed how easily, quickly you, too, can start earning many extra dollars. NRI shows you how. Even before you finish training your spare time earnings may pay for the course and equipment.

## NRI Sends Tester to Learn and Earn

You need proper equipment to service today's automatic appliances. With this course you get parts to build professional type, multi-use Appliance Tester. You learn to use it. Takes guess work out of servicing. Mail coupon for FREE book and Sample Lesson. See how easy it is to learn. Find out about NRI—a school that for more than 40 years has been training men, through home study, for success, good pay jobs. Our reputation, record, experience back up this course. Address National Radio Institute, Dept. D4D9, Washington 16, D. C.



**FREE Lesson and Book  
Mail this NOW!**

**NATIONAL RADIO INSTITUTE**

Dept. D4D9, Washington 16, D. C.

Send me Lesson and Book Free. No Salesman will call.

Name ..... Age .....

Address .....

City ..... Zone ..... State .....

ACCREDITED MEMBER NATIONAL HOME STUDY COUNCIL



## IT'S QUALITY for STEREO! QUAL-KITS are EASIEST!



Model STA-36 \$49.95

COMPLETE 36 Watt STEREO 2 CHANNEL AMPLIFIER... with the smart, slim look in III-Fr. 2 preamps, 2 power amps. Controls all stereo (monaural sources (tapes, records, tuners). Separate Ranged base and treble controls, balance control, mode switch, rumble filter, speaker phasing switch, 6 dual inputs, tape output, etc.



24 WATT STEREO AMPLIFIER complete 2 amps and 2 preamps Model STA-24 \$39.95



IDEAL SECOND AMPLIFIER for stereo—12 watt Williamson type Model 2200 \$22.75

Model 1000 AM-FM Tuner \$31.85

### STEREO TWINS

Model 1100 FM Tuner \$25.50  
Model 1200 AM Tuner \$19.95

MODEL 2000

12 Watt Amp and Preamp \$28.50  
Radios Complete with Tubes & Cabinet  
Model 250—Superhet, AC-DC \$16.45  
Model 350—2 band, BC & SW \$19.75

And they have the finest features and specs. Fully illustrated step-by-step 28-page manual makes assembly a snap! **WRITE FOR FREE CATALOG!** 10% Fed. tax included in all prices. Covers and legs optional.

## QUALITY-ELECTRONICS

319 Church St. Dept. P-4 New York 13, N. Y.

use the solder  
that most  
set makers  
use!



## KESTER SOLDER

Make sure your soldering's the best... use the best—KESTER SOLDER. Send for FREE 16-page book that tells you how!

### KESTER SOLDER COMPANY

4275 Wrightwood Avenue • Chicago 39, Illinois

OVER 60 YEARS' EXPERIENCE IN SOLDER AND FLUX MANUFACTURING

## HI-POWER BINOCULARS

NOW ONLY

50¢

SEE UP TO 18 MILES

POST PAID LIMIT \$10 AUSTRIA

Powerful folding Opera Glasses fit into pocket or purse. Center eye piece adjustment. Worth many times low introductory price. Comparable to models selling for \$4.95.

BRUCE SALES CO.  
121 E. 24 St., Dept. B-518  
New York, N. Y.



Send cash, check or money order. Sorry, no C.O.D.'s.



## LOOK

NO FURTHER... IF YOU'RE UNHAPPY WITH "HI" HI-FI PRICES. WRITE FOR OUR UNUSUAL AUDIO CATALOG.

KEY ELECTRONICS CO.  
120-B Liberty St., N. Y. 6

## Soldering Without Tears

(Continued from page 92)

solders are much better for printed circuits. Their better wetting power means you need to apply heat for a shorter time, and are less likely to blister the foil or copper loose from the board.

JIM picked up the iron again and looked at it. The tip had discolored slightly and he again brushed it with the cloth and applied more solder. Then he placed it against the connection Danny had been soldering and touched solder to the connection. The solder softened and flowed onto the connection.

"Just a little solder is needed, but don't remove the heat until it becomes liquid and flows. And don't attempt to cool the connection in any way. Any artificial cooling method may cause the solder to crystallize, which may give you a cold solder joint. A good connection will appear somewhat bright and very smooth, a bad one dull, lusterless and gobby.

"Notice that I applied a little solder to the iron first. That gives the tip a chance to come in intimate contact with the terminal, delivering its heat much better. A physicist might say, 'Why, it's only a heat transfer problem'... which would be exactly right. The better heat conduction you achieve, the better the soldering job.

"Always heat the connection or wire till it will melt solder, and never carry solder to the work on the iron.

"We haven't said much about tinning. To tin an item means to put a thin coat of solder on it. Sufficient heat must be used to assure that the solder actually bonds to the metal. Just as glue should usually be applied to both surfaces of anything to be joined, so solder ideally should first be applied to both items to be joined even though it is only a very thin covering. The leads of most electronic components are pretinned by one technique or another.

"Once the connection is made physically secure, all that remains is to melt on a little extra solder to bond the two surfaces. Then let it cool naturally.

"Any questions?"

"Yes, one," Danny replied. "How about my borrowing some of your rosin core solder?"

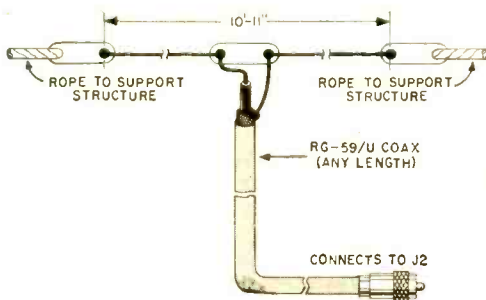
Jim grinned, took a spare roll from his tool box, and tossed it on the bench. —30—



## "Nifty Novice" Transmitter

(Continued from page 70)

A suitable dipole for 15 meters is shown below. The dimensions should be followed closely, with lengths cut to the nearest inch. Get the antenna up in the air, the higher the better. Face the broadside of the antenna in the direction you want to work (north-south-east-west, or in-be-



tween); for DX contacts, a north-east south-west direction would prove quite satisfactory. This antenna is simple enough so that you can erect two of them, 90° apart.

If you want to put up a real "performer," try the "Demi-Quad," described by William I. Orr in *POPULAR ELECTRONICS* (January, 1958). The DX stations will come rolling in so fast that you may need a secretary to keep the station log in order!

-30-

### HOW IT WORKS

The 15-meter transmitter uses a three-tube circuit, employing a 6AU8 oscillator/clamp (*V1*), 6L6 power amplifier (*V2*), and a 5Y3 rectifier (*V3*). Power input, when fully loaded, runs about 25 watts.

The oscillator circuit uses the pentode section (*A*) of *V1* in a modified Pierce connection. Feedback occurs between the screen and control grid, at the fundamental crystal frequency (7035-7080 kc.). The plate circuit of this stage is tuned to the third harmonic of the crystal (21.1-21.25 mc.). This r.f. energy is applied to *V2* for power amplification.

*V1*'s triode section (*B*) is used as a "clamp" tube and is connected between the screen grid of *V2* and ground. The control grid of *V1(B)* is connected to the control grid of *V2* through *R6*, causing *V1(B)* to act as a very low resistance from *V2*'s screen to ground, hence limiting the amount of current drawn.

When the oscillator is keyed and r.f. energy applied to *V2*, a negative voltage will develop across *R5* due to *V2*'s grid current. Since this negative voltage is also applied to *V1(B)*, it acts as a bias to cut the tube off. The effect is much the same as removing the low resistance between *V2*'s screen and ground. The screen voltage goes up and allows *V2* to amplify to full power.

The tank circuit is composed of *C10*, *C11*, and *L2*. Pilot lamp *PL1* is connected in series with *L2* and the antenna jack (*J1*) so that the antenna current flows through the bulb. Thus, the brilliancy of the bulb will indicate relatively how much power is being delivered to (and radiated by) the antenna. Coil *L3*, shunting the bulb, prevents burn out.

## GET MORE WORK OUT OF YOUR OSCILLOSCOPE!

Learn to service  
ANY radio or TV  
faster . . . with the  
handiest instrument of all!

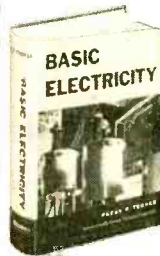


The book  
that tells you  
what you need to know  
about 'scopes!

Here, in a new 2nd edition, is THE book that really shows you how to use oscilloscopes! Clearly as A-B-C, MODERN OSCILLOSCOPES AND THEIR USES tells you exactly when, where and how. You learn to locate either AM or FM radio or television troubles in a jiffy. Tough realignment jobs are made easy. No involved mathematics! Every detail is clearly explained—from making connections to adjusting circuit components and setting oscilloscope controls. And you learn to analyze patterns fast and RIGHT!

Includes latest data on use of 'scopes in industrial electronics, teaching, atomic energy work—plus details on quantitative measurements—the slickest method of diagnosing many color TV troubles and aligning sets properly. Over 400 pages and over 400 clear pictures. Dozens of pattern photos make things doubly clear. Price only \$6.50. Use coupon for 10-day free trial.

## GET MORE FUN AND PROFIT OUT OF RADIO- ELECTRONICS!



—Complete BASIC  
"Know how"  
in one big, easily  
understood manual

Don't let modern circuits, equipment or components "stump" you! Get this complete new training in BASIC ELECTRICITY and see the difference it makes! See how it clears up problems—helps you understand things fully! Actually, this 396-page book is a complete training course in the fundamental "know-how" on which ALL radio-TV-electronic-electrical developments are based. Over 300 pictures, diagrams, and charts. Covers basic circuits, electro-magnetism, controls, capacitance, resistance, inductance, phase relations, generators, motors, rectifiers, transformers, wiring, instruments and measurements, tubes, transistors, amplifiers, power factor AND ALL THE REST

IT IS ABSOLUTELY ESSENTIAL FOR YOU TO KNOW. Includes a 61-page introduction to electronics. Price \$6.50. Read it 10 days at our risk!

— 10 DAYS' FREE TRIAL —

Dept. PE-49, RINEHART & COMPANY INC.  
232 Madison Avenue, New York 16, N. Y.

Send book(s) checked below for FREE EXAMINATION. In 10 days, I will either send price shown (plus a small postage charge) or return books and owe you nothing.

MODERN OSCILLOSCOPES AND THEIR USES  
Price \$6.50

BASIC ELECTRICITY  
Price \$6.50

SAVE! Send cash with order and we pay postage. Same 10-day return privilege with money refunded.

Name .....

Address .....

City, Zone, State .....

Outside U. S. A.—Add 50¢ to price of each book. Cash with order only. Same 10-day return privilege with money refunded.

# WANTED!

## Equipment, components or parts!

The 267,000 purchasers of POPULAR ELECTRONICS are always in the market for good used equipment or components. So, if you have something to sell, let PE readers know about it in our classified columns.

It costs very little: just 50¢ per word including name and address. Minimum message: 10 words. For further information write:

Martin Lincoln

## POPULAR ELECTRONICS

One Park Avenue, New York 16, New York



## TELEPHONE STEPPER

Western Electric 6 pole 22 position. 15 OHM. 12 to 28

VDC Coil—self stepping contacts. Same as used in Pop. Science, Sept. 57. Game and Computer. Good used condition . . . . . \$5.95 ea.  
STANDARD 10 HOLE Telephone Dial. Has extra make and break contacts . . . . . \$1.98 ea.



Add 25¢ for ea. item for postage anywhere in U.S. Send 10¢ for Giant Catalog listing hundreds more Electronic gadgets.

## SOUNDTRONICS LABS

630 Arch Street, Philadelphia 6, Pa.

## AMAZING NEW TINY RADIO



### NO TUBES—TRANSISTORS—BATTERIES OR "PLUG-INS" NEEDED

Smaller than a pack of cigarettes. 1960 model never runs down or burns out. Guaranteed to receive local radio stations most anytime, anywhere—without EXTRA ANTENNA WIRES. Easy thumb station tuner—Perma wave detector. Chrome black plastic case. BUILT IN SPEAKERPHONE—NO SEPARATE DANGLING EARPHONE. American made and service guaranteed for 10 years.

SEND ONLY \$2.00 (cash, ch. mo) and pay postman \$4.99 COD on arrival or send \$6.99 for postpaid delivery. Sent complete—Ready to listen with 10 year guarantee. No extras to buy. Free 1000 mile antenna enclosed if you order at once.

MIDWAY COMPANY Dept. TPL-4 KEARNEY, NEBR.

## MOBILE-FIXED CONVERTER

### POLICE • FIRE • CITIZENS' BAND

#315A is a practical converter for emergency use. Easily installed. Tuning range approximately 8' MC in the 26-50 MC band—15 MC in the 152-162 MC band. Designed for mobile or home use.

\$13.95

KIT also available. . . . . \$10.95

ORDER TODAY or WRITE for LITERATURE

KUHN ELECTRONICS

20 GLENWOOD CINCINNATI 17, OHIO

## EASY TO LEARN CODE

Learn to increase speed with an Instructograph—the Radio-Telegraph Code Teacher that takes the place of an operator-instructor and enables anyone to master code without further assistance. Available tapes from beginners alphabet to typical messages on all subjects. Speed range 5 to 40 WPM. Always ready—no QRM. Thousands have "acquired the code" with the Instructograph System. Write today for convenient rental or purchase plans.



INSTRUCTOGRAPH COMPANY

4713 SHERIDAN ROAD, CHICAGO 40, ILLINOIS  
357 West Manchester Ave., Los Angeles 3, California

## Among the Novice Hams

(Continued from page 112)

is very severe. Contributing to it are several foreign broadcast stations that operate (legally) in the 40-meter Novice band and often are very strong in the U. S.

As a result of these factors, many Novices who do well on 40 meters in the daytime find it difficult to make contacts at night, unless they shift to the 80-meter band.

**Fifteen Meters.** Fifteen meters is far more erratic than either 80 or 40 meters, but it is the Novice DX band. Normally, because of the skip effect, you can't work stations closer than 1000 miles. On very good days, you can make an occasional DX contact with almost any kind of antenna; but a good antenna, preferably a rotary beam, is essential for consistent results on 15 meters—much more so than on 80 or 40. Fifteen meters is normally a daytime band.

The average two- or three-tube Novice transmitter works well here. However, many low- and medium-priced receivers, which are reasonably satisfactory on the lower frequency bands, lose most of their sensitivity and stability on 15 meters. If your receiver is satisfactory on other bands, you can probably improve its 15-meter operation greatly with a 15-meter converter. (See POPULAR ELECTRONICS, July, 1958, page 61, or the *Radio Amateur's Handbook*.)

No matter which band you select, your receiver and antenna will be more important in determining your results than your transmitter power. And put operating skill ahead of power, too.

## Cathode Modulator

The cathode modulator shown on page 112 offers an easy method of putting a c.w. transmitter on phone when you get your General Class license. To use it, tune the transmitter for maximum c.w. output and plug PL1 into the transmitter key jack. Talk into the microphone, and adjust the volume control for best modulation. Ask a local amateur to check you.

The modulator may be built on an aluminum chassis about 4" x 5" x 2". No special precautions are required, except to keep the input and output terminals reasonably well separated and the leads short. Choke CH1 may be almost any replacement type filter choke with an inductance of seven henrys or more and a current rating of at least 10 milliamperes. You can obtain



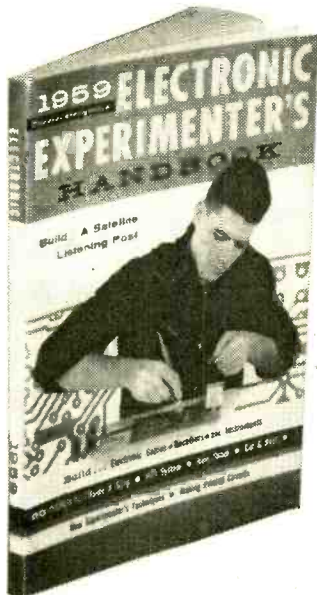
# AT NEWSSTANDS NOW... OR ORDER BY MAIL TODAY!

## ELECTRONIC EXPERIMENTER'S HANDBOOK FEATURES 50 NEW PROJECTS FOR DO-IT-YOURSELFERS!

If you like to build useful, money-saving electronic devices and experiment with new projects, the 1959 **ELECTRONIC EXPERIMENTER'S HANDBOOK** is for you. You'll find step-by-step instructions, hundreds of photos and illustrations, drawings and unique "pictorial diagrams."

Each project has been pre-tested and operated by readers of *Popular Electronics*. Last year's edition of the **ELECTRONIC EXPERIMENTER'S HANDBOOK** was a sellout at many newsstands.

Be sure to pick up the 1959 Edition today at your newsstand—or send for a copy, using the handy coupon below. Only \$1.00, the 1959 **ELECTRONIC EXPERIMENTER'S HANDBOOK** is a terrific buy!



over 160 pages...300 illustrations

**FOR YOUR HI-FI.** Transistorized pre-amp and control unit. One-tube hi-fi AM tuner. Tuner and audio radio. Make your own phonograph arm. Hi-fi slave. Switch to stereo. Slot-box your speaker. Personal stereo player. Suit your volume with a T-pad.

**FOR YOUR HAM SHACK.** Simple R.F. meter. The semi-conductor space spanner. Card file transmitter.

**FOR THE EXPERIMENTER.** How to make parts substitutions. How to use Decals. Put Pots to work.

**FOR YOUR CAR AND BOAT.** Transistors replace wall outlet. Convert transistor set for car. "Auto-Fi." Transihorn.

**RECEIVERS.** Build a "Half-Pack." Mono-receiver to pull in DX. Pocket FM receiver converter for daytime DX.

**ELECTRONIC GAMES.** The Quizzomat. A lively "Warmth Meter." Win at Nim with Debicon. Tic-Tac-Toe mate. Compute with Pots. Games with Nixie tubes. Bullets of light. Catch the vanishing ball.

**FOR YOUR WORKSHOP.** Pocket size test instrument. Square-wave generator for audio tests. Check your A.C. calibration. Transistor test power supply.

**FOR YOUR HOME.** Build a "conversation piece." Electronic secretary. Flash light with transistors. Trap unwanted stations. Conelrad your home. Battery-operated proximity relay. Make your own disc records. A clown for the kids. Two-set coupler. Simpla-timer. Transistorized photo-flash. Electric shutter release.

PICK UP YOUR COPY OF THE  
1959 EDITION OF THE ELECTRONIC  
EXPERIMENTER'S HANDBOOK TODAY  
AT YOUR NEWSSTAND OR RADIO  
PARTS STORE—OR ORDER BY MAIL,  
USING HANDY COUPON. ONLY \$1.00.

Ziff-Davis Publishing Company  
Department E49  
434 South Wabash Avenue  
Chicago 5, Illinois

Please send me a copy of the 1959 **ELECTRONIC EXPERIMENTER'S HANDBOOK**. I enclose \$1.00, the cost of the **HANDBOOK**, plus 10c to cover mailing and handling charges. (Canada and Foreign, \$1.25 plus 10c postage).

NAME.....

ADDRESS.....

CITY..... STATE.....



# HELP US OBTAIN OUR HAM LICENSES

## K1/W1 CALL AREA

**Jerry S. Richter** (24), Qtrs. 105-C, U. S. Naval Hosp., Chelsea 50, Mass. (General code and theory)

**Theodore DeGarmo**, Box 59, Putney, Vt. (Code, theory and selection of equipment)

**J. Clement Martin**, Van Buren, Me. (Code, theory and selection of equipment)

**Robert J. Naughton** (14), 59 Meagher Ave., Milton 87, Mass. Phone: CU 6-1668. (Code and theory)

**Edward Brunelle**, 54 Bennett St., Woonsocket, R. I. Phone: PO 9-6223. (Code and theory)

**Charles Butkus** (13), 7 Cutler St., Worcester 4, Mass. Phone: PL 2-9015. (Code, theory and selection of equipment)

## K2/W2 CALL AREA

**Bob Howatt** (14), 106 Valley Rd., Ithaca, N. Y. Phone: 7711. (Code and selection of equipment)

**Robert Fagan** (17), 142-14 116th Ave., So. Ozone Park, Jamaica, N. Y. Phone: TA 9-5576. (Code, theory, regulations and selection of equipment)

**Patrick McNulty** (13), 6 Grove Ave., Woodbridge, N. J. Phone: ME 4-3879. (Code, theory and regulations)

**Christopher K. Hunter**, 3214 Corlear Ave., New York 63, N. Y. (Code and theory)

**Joseph Morales**, 1018 E. 163rd St., Bronx 59, N. Y. (Code)

**Stephen Quigley**, 287 Conklin Ave., Hillside 5, N. Y. (Code, theory and regulations)

**Frank Fierro**, 2545 Laonia Ave., Bronx 69, N. Y. Phone: TU 2-5187. (Code and theory)

**Albert J. Pautler**, 44 Leonard St., Buffalo 15, N. Y. (General code and regulations)

**Peg Roy**, R. F. D. 1, Box 256, Berlin, N. J. (Code, theory and regulations)

## K3/W3 CALL AREA

**David Laman** (14), 124 E. Washington Ave., DuBoise, Pa. (Code, theory, regulations and selection of equipment)

**Guy C. Milne**, 514 Cambridge Rd., Cynwyd, Pa. (Code and selection of equipment)

**Joseph Stormer** (14), Equinunk, Pa. (Code, theory and selection of equipment)

**Michael Kane**, 4761 Doyle Rd., Pittsburgh 27, Pa. (Code and theory)

**George Caplan** (11), 1808 Robinson Ave., Havertown, Pa. (Code, regulations and selection of equipment)

## K4/W4 CALL AREA

**Harry Williams, Jr.**, Rt. #1, Box 197, Newport, N. C. (Code, theory and selection of equipment)

**Frank Robertson**, Rabun Gab Nacoochee School, Rabun Gab, Ga. (Code, theory and selection of equipment)

**Don Russell** (15), 616 Laurel St., Albemarle, N. C. (Code, theory and selection of equipment)

## K5/W5 CALL AREA

**George Huntington, Jr.**, 2219 Piedmont Pl., Wichita Falls, Tex. (Code, theory and selection of equipment)

## K6/W6 CALL AREA

**Adolf Gutohrlein** (14), 5821 Gardenia Ave., Long Beach 5, Calif. Phone: GA 3-6932. (Code)

**Walter Lund**, 10503 Alexander Ave., Southgate, Calif. Phone: LO 6-3935. (Theory)

**John Barnhill**, 356 Chamberlain Ave., Auburn, Calif. (Code, theory, regulations and selection of equipment)

**Tom J. Orzech**, 3 Bayview St., San Rafael, Calif. (Code and theory)

**Jeff Omodt**, 4782 Blue Ridge Dr., San Jose 29, Calif. Phone: AL 2-9526. (Code, theory, regulations and selection of equipment)

## K7/W7 CALL AREA

**Ken Wesche** (13), 2927 1st Ave., No., Seattle 9, Wash. (Code, theory and regulations)

**Al Mengon**, 125 W. 4th So., Salt Lake City 1, Utah. (Code and theory)

## K8/W8 CALL AREA

**Robert Brown**, 24 Country Club Dr., Battle Creek, Mich. (Code and theory)

**Clarence Mathis** (15), 7217 Hough Ave., Cleveland 3, Ohio. (Code, theory, regulations and selection of equipment)

**Mike Keyes** (16), 1802 McPherson Blvd., Fremont, Ohio. Phone: FE 2-0562. (Code and regulations)

**John Champa**, 1542 Wyandotte Rd., Columbus, Ohio. Phone: HU 8-1698. (Code)

**Walt Jones** (60), 140 Shirly Lane, Warren, Ohio. Phone: 7029-1. (Code and theory)

**Stephen Kalafus** (13), 1660 Preston Ave., Akron 5, Ohio. (Code and theory)

**Nelson L. Henderson**, Box 56, Roderfield, W. Va. (Code)

**Everett Tailer**, 1125 Highridge Ave., Dayton 20, Ohio. Phone: CL 2-2177. (Code and theory)

## K9/W9 CALL AREA

**Ronald S. Mandel** (12), 4908 W. Quincy St., Chicago 44, Ill. Phone: MA 6-8145. (Code, theory and selection of equipment)

**Richard Lain**, Suszyccki Dr., Mauston, Wis. Phone: 3-2685. (Code, theory, regulations and selection of equipment)

**Ed Skula**, 5500 Midlothian Tpk., Blue Island, Ill. Phone: FU 5-2067. (Code and theory)

**Carl Eugene Robinson**, 513 S. Graham St., Carbondale, Ill. (Theory and selection of equipment)

**Robert Selen**, 2045 W. Fullerton Ave., Chicago 47, Ill. (Code and theory)

**Geraldine M. Eastman**, 5836 W. Lake St., Chicago, Ill. Phone: MA 6-2993. (Code and theory)

**Reubin M. Smith**, 5071 S. Evans Ave., Chicago, Ill. Phone: OA 4-6213. (Code and theory)

**Gary Steele** (11), 2479 N. 64th St., Wauwatosa 13, Wis. Phone: SP 1-1155. (Code, theory and selection of equipment)

**Larry W. Bettenhausen**, 8600 W. 159th St., Tinley Park, Ill. (Regulations and selection of equipment)

**Robert Farkaly**, 2653 S. St. Louis, Chicago 23, Ill. Phone: BI 7-3368. (Code and theory)

## K0/W0 CALL AREA

**David Christensen**, Box 303, St. Ansgar, Iowa. Phone: 6-4822. (Code, theory, regulations and selection of equipment)

## VE AND OTHERS

**Kenny Welwood** (14), 1110 Morton St., Port Alberni, B. C., Canada. (Code, theory and regulations)

**John Stegman** (15), 805 11th No., Port Alberni, B. C., Canada. (Theory and regulations)

**Robert Newcombe** (16), 20 Admiral Rd., Brantford, Ontario, Canada. (Code and theory)

**David Marusczecka**, Box 34, Bruce, Alberta, Canada. (Code, theory and selection of equipment)

**Peter F. Armstrong**, 13 Cloverdale Rd., Halifax, N. S., Canada. Phone: 4-4451. (Code, theory and regulations)

**Martin Lonfat**, Ballater, Alberta, Canada. (Code, theory and selection of equipment)

**Francis C. Wedge**, 235 Union St., Bathurst, N. B., Canada. Phone: LI 6-3141. (Code and theory)

**Hughie Coulthard**, Flin Flon, Manitoba, Canada. (Code, theory and selection of equipment)

**Richard Finnie**, Kamsack, Sask., Canada. (Code, theory, and regulations)

**Don Boucher**, 671 Stella Ave., Winnipeg 4, Manitoba, Canada. Phone: JU 2-2104. (Code and theory)

the 6.3 volts for the filaments from the "accessory" socket of the transmitter. No external plate power is required.

Use a 6W6G as the modulator tube if your normal transmitter output tube plate current is no more than 125 ma. Use a 6Y6G for currents up to 200 ma. The current will drop 30% to 50% when the modulator is plugged in. A crystal, ceramic, or other high-impedance microphone will be satisfactory.

To work properly, the modulator output circuit must be connected in the cathode circuit of the transmitter output tube(s). If both the oscillator and amplifier tube cathodes are keyed in your transmitter (as they usually are in small transmitters), disconnect the lead from the oscillator cathode circuit to the key jack, and connect it to the transmitter chassis (B-) instead.

Also, if the transmitter does not have a "standby" switch, install one between the center-tap of the high-voltage winding of the power transformer and ground, to shut off the transmitter while you are listening.

#### News and Views

"Al" Johnson, KN1IK, 55 Pinnacle Rd., Newport, N. H., works 80, 40, and 15 meters, running 75 watts to a Heathkit DX-40 transmitter. He receives with a Hallicrafters SX-99 receiver and uses dipole antennas. But he may have a 15-meter beam up by the time you read this. Al's record is 25 states, Poland, and Puerto Rico. . . . Jim Lisson, WV2CEP, 47 Dean Rd., Depew, N. Y., stayed home from school to take his General exam—he passed, he thinks. In two months as a Novice, Jim's Heathkit DX-20, Hallicrafters SX-99 with Q-multiplier, and "all-band" Novice antenna (December, 1955, column) have accounted for 60 contacts. Jim's dad is sweating out his Novice license. . . . Incidentally, we would like to modify the statement made in the February *Among the Novice Hams* regarding the privileges granted by a Technician Class license. Such a license grants all amateur privileges on the frequencies above 50 mc., excluding the 144 to 148 mc. amateur band.

Dave Givens, KN5RSI, 414 Mulberry St., Charleston, Miss., uses a vertical antenna that will operate between 80 and 6 meters, since K5EXW got it to "load" properly on 40 meters. Dave's Heathkit DX-20 and Hallicrafters S-85 haven't worked any DX, but he has worked 31 states. Check with him, if you need Mississippi. . . . Stanley Head, Jr., KN8MMZ, 3942 Piedmont Rd., Huntington 4, W. Va., uses his father's Heathkit DX-100 transmitter running 75 watts. In nine weeks he has had 155 contacts, all on 80 meters. One contact lasted two hours and 15 minutes! Stan's antenna is a center-fed doublet, and he receives with a National NC-88, plus a Heathkit QF-1 Q-Multiplier. Stan will help anyone around Huntington obtain his Novice license. . . . Kenny

## RADIO SHACK SPEAKER SALE

# Magnavox HI-FI SPEAKER SYSTEM!

Custom Made for Costly Enclosure!  
Yours at a Fraction of Its Value!

**\$12.95**

Plus a Complete Crossover System

Here's one of the greatest speaker values Radio Shack has ever offered! If we told you the name of the famous make (and expensive) speaker enclosure for which this system was made, you'd wonder how we can sell it so low! Not just a 12" speaker but a real woofer . . . and a real tweeter too. The frequency response is essentially flat from 35 to 17,500 cps! 8 ohms. Sh. wt. 12 lbs. Order No. 90LX240 Woofer, Tweeter, X-Over. . . . \$12.95



## COMPLETE WITH HI-FI ENCLOSURE

We Don't Dare Tell You  
the Real Value!

You get the Magnavox system above and this handsome specially fitted mahogany-toned cabinet. It's modern in style. 3/4" stock. 19 1/4" W x 23 3/4" H x 13 1/2" D wt. 43 lbs. Order No. 90LX290Y. . . \$29.95



**\$29.95**

## FREE! Bargain Bulletin

RADIO SHACK CORPORATION Dept. 4B  
730 Commonwealth Avenue, Boston 17, Mass.

Please send me:  Magnavox Speaker System  
 Speaker System with Enclosure  
 Free Bargain Bulletin  
Enclosed find  Check;  Money-Order  
 Please send C.O.D.

Name \_\_\_\_\_

Address \_\_\_\_\_

City \_\_\_\_\_ Zone \_\_\_\_\_ State \_\_\_\_\_

## RADIO SHACK CORPORATION

STORES 167 Washington St., Boston 8, Mass.  
730 Commonwealth Ave., Boston 17, Mass.  
230-240 Crown St., New Haven 10, Conn.



# FREE

## GIANT NEW 1959 B-A CATALOG

A COMPLETE BUYING GUIDE FOR EVERYTHING IN

### RADIO TV

### ELECTRONICS

# BA 1959

ANNUAL CATALOG 591

SINCE 1927

**BURSTEIN-APPLEBEE CO.**

Dept. PE, 1012 McGee St., Kansas City 6, Mo.

Send Free 1959 B-A Catalog No. 591.

Name.....

Address.....

City.....State.....

SEND FOR IT TODAY

**180 KING-SIZED PAGES**

**EVERYTHING IN RADIO TV AND ELECTRONICS**

**100'S OF NEW ITEMS LISTED HERE FOR 1ST TIME**

**21 PAGES OF BARGAINS NOT IN ANY OTHER CATALOG**

## ENGINEERING DEGREES

**E.E. Option Electronics or Power**


Earned through Home Study

**Pacific International College of Arts & Sciences**

Primarily a correspondence School

Residence classes also available

5719-W Santa Monica Blvd.  
Hollywood 38, California



## INVENTORS

Send for **INFORMATION** Book and **INVENTOR'S RECORD** without obligation

**GUSTAVE MILLER**  
49-PE WARNER BUILDING  
WASHINGTON 4, D. C.

**REGISTERED PATENT ATTORNEY**

ASSOCIATE EXAMINER  
U.S. PAT. OFF. 1922-1929

Patent Attorney & Advisor  
U. S. NAVY DEPT. 1930-1947

**PATENT LAWYER**

## TELEPHONES



**YOUR OWN • MODERN DIAL**  
FOR PRIVATE CIRCUITS and extensions, easy to install, invaluable for residence—farm—estates or industrial purposes. Surplus phones—slightly used—fully standard, complete with dial, bell, cords, etc. With mate 4-prong plug—add \$1.75. Instructions and diagram included.

**GOV'T COST: \$32.50 each**

**Send Check or Money Order** **NOW** **We pay postage anywhere in U.S.A.**

**1050** each

Sorry, no C.O.D.'s

**FENNER SALES**  
Dept. PE-2  
Hysham, Mont.

**100% Satisfaction Guaranteed**

**Houtz, KN4VUZ**, 300 W. Church St., Elizabeth City, N. C., goes away to school; so he doesn't get much time to be on the air. Nevertheless, he has made 40 contacts in six states on 40 and 15 meters, using a Heathkit DX-40 transmitter running 40 watts, and a Hammarlund HQ-100 receiver.

**Tobe Carey, KNIGOP** (16), 4 Woodford St., Worcester 4, Mass., claims he has a "bailing-wire antenna." Yet, he has worked 23 states and Germany, France, Finland, and Puerto Rico. All the DX and 20 of the states are confirmed. Tobe transmits with a DX-40 and receives on an SX-99 receiver. He is also a short-wave listener, with 171 countries heard and 95 verified. Tobe has recently been appointed SWL Bureau Manager for the W1 area; he gets all the SWL cards for the first and second call areas which are sent to the ARRL QSL Bureaus, as the ARRL QSL Bureaus distribute only amateur QSL cards. . . .

**Wayne Dunlap, K5MDZ**, 136 Pike Ave., Jacksonville, Ark., will sked anyone needing an Arkansas contact on 40 meters on weekends. He also offers help to prospective amateurs around Conway, Ark., where he goes to college. His address there is Box 63, A.S.T.C. . . .

**Nick Lash, K9KLR**, 4360 Massachusetts St., Gary, Ind., uses a WRL Globe Scout 66, running 65 watts, and a Hallicrafters S-85 receiver with a Q-multiplier. He has two antennas, a 40-meter dipole, and a rotary 15-meter dipole, both about 45' high. Nick's record is 48 states worked, 47 confirmed, and 15 countries, 11 confirmed. He will be glad to help prospective amateurs get their licenses.

When **Dave Marks, KN8MRC**, (17), P. O. Box 124, 124 South High, Columbus Grove, Ohio, got his license, he expected his contacts and states total to be very low, because of his simple equipment—a Knight Space-Spanner receiver, a DX-20 transmitter, and a 17'-high antenna strung between two buildings. But in a couple of weeks on 40 meters he has worked around 20 states, including California five times. . . .

**Andy Metro, KN4BPU**, (16), 329 Euclid Ave., Daytona Beach, Fla., claims he operates on the QRM frequency of the year, "7162 kc." In two months of operation, he has ten states confirmed. He uses a Knight transmitter, running 50 watts and an S-85 receiver. His antenna is a doublet, 30' high, fed with 75-ohm twin lead, via a set of balun coils. . . .

**John Gately**, a short-wave listener in New Jersey, wishes phone hams would enunciate their call letters distinctly, so that they can be copied more easily. . . .

**Stephen Momo, KN3HBP**, 1126 Highland St., Chester, Pa., wants to thank all the hams and SWL's who answered his plea for help in POPULAR ELECTRONICS. In two weeks on the air, he has worked seven states and Canada, using a WRL Globe Chief 90A transmitter at 75 watts, a 65' antenna, and a Hallicrafters S-38E receiver.

We would like to have a report of *your* activities for the next column. And good, sharp pictures of hams at their stations are always welcome. Also, we can use short construction articles on equipment and gadgets useful around the ham shack. 73,

Herb, W9EGQ



## Short-Wave Report

(Continued from page 110)

At time of compilation all reports are correct. Stations often change schedules and/or frequencies with little or no advance notice. All times shown are Eastern Standard and the 24-hour system is used.

**Albania**—Tirana is heard with Eng. news, music, and commentary at 1530-1600 on 6900 kc. The 7850-kc. parallel channel is rarely noted here. (541)

**British Guiana**—R. Demerara is scheduled Sundays at 0445-2145, Saturdays 0415-2245, weekdays at 0415-2145 on 5981 and 3255 kc. Listeners in southern states might also try for this station on 660 kc. in the medium-wave band. (477)

**Cape Verde Islands**—CR4AC, R. Barlavento, St. Vincente, 3960 kc., may be noted from 1825 to 1900/close with typical native music. The anthem "A Portuguesa" is played just before close-down. (MS)

**Chile**—CE1196, R. Sociedad Nacional de Minería, Santiago, 11,960 kc., is often logged from about 2215 to 2230 with popular recordings. (420)

**Dominican Republic**—HI5B, Santiago de los Caballeros, is now noted on 4905 kc. at 1800-

### Write Us Again!

We have received mail from a few readers who have neglected to include return addresses. If the following correspondents will write in again, we will be glad to acknowledge their letters and reports:

Jack Carr	George Neumann
William Dickerman	Richard Shavel
William Doppel	Bruce Skogen
David C. Heckendorn	Richard Sullivan

2000. Previously it was covered by YVKB, Venezuela, on assigned 4890 kc. (100)

**Ecuador**—R. Mundial, Riobamba, has moved from 6295 kc. to 6218 kc. and can be noted at 1900-2300. (100)

**French Guiana**—Cayenne has moved back to 6195 kc. from 6215 kc. and is heard from 0515 s/on to 0600 when HJEZ, Colombia, blocks it out; also noted at 1730 in French, again badly cut up by HJEZ. (4, 166, 378)

**Germany**—Deutsche Welle (Voice of Germany) is currently scheduled as follows: to the Far East at 0200-0510 on 21,735, 21,650, and 11,795 kc.; to the Near East at 0930-1240 on 21,735, 21,490, and 17,875 kc.; to Africa at 1300-1610 on 17,815, 15,275, and 11,945 kc.; to South America at 1700-2010 on 15,375, 11,795, and 9735 kc.; and to N.A. at 2030-2340 on 15,405, 11,795, and 9640 kc. German-speaking listeners may receive the program schedule by airmail at no charge. (GN, 378, 474)

**Haiti**—The following list of active radio stations in Haiti was compiled with the help of PE reporter #4: 4VU, relay of 4VI, Cayes, on 3322 (or 3455) kc., 250 watts power; 4VGS, R. Independence, Gonaives, 5020 kc., 400 watts; 4VPM, La Voix du Nord-Quest, Port-de-Paix,

ALL NEW  
20-POUND

## MYSTERY PACKAGE

BRAND NEW  
U.S. AIR FORCE  
B-29 BOMBSIGHT

Cost U.S. Govt.  
\$25,000.00

YOU PAY

**29.50**

INCLUDES:  
224 x 13W x 17D  
STEEL STORAGE  
CASE WITH KEY LOCK

- Contains Over 100 • Cylinders
- Precision Bearings • Motors • Gears
- Ground Optic Lenses • Switches • Relays
- AND THOUSANDS OF OTHER USEFUL PARTS!

SHIPPED ANYWHERE IN U.S.A. FREE!

OF ELECTRONIC PARTS



Worth \$40.00 **\$39.50**

It's Another THRILLING  
HERSHEL SURPRISE.  
20 pounds of BRAND  
NEW Usable Govt.  
Surplus. Perfect gift  
for Hams, etc.

### 3-WAY HI-FI SPEAKER KIT

\$39.95 VALUE  
SALE PRICE **\$12.95**

Complete—Less Board

• Includes 12" Woofer—Two 3 1/2" Tweeters Choke Input  
with Cross-Over Condenser and Brilliance Control. Dia.  
Furnished. Freq-Response 40 to 18,000.

SHIPPED ANYWHERE IN U.S.A. FREE!



HERSHEL  
RADIO CO.

2429 GRAND RIVER Detroit 8, Michigan

Phone TYler 8-9400

PERMA-POWER  
with Order  
in 20% Down  
Balance C.O.D.  
ALL ORDERS  
P.O. ORDER

Save time and effort . . .  
simplify your work

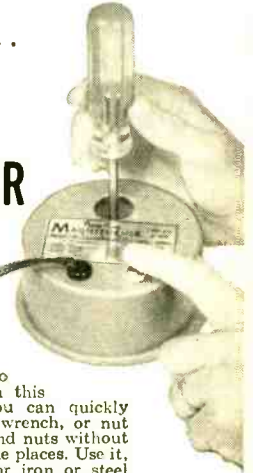
Perma-Power

## MAGNEFORMER

Instantly magnetizes  
and demagnetizes  
your small tools

Ideal for service technicians, repairmen, engineers, and hobbyists. MAGNEFORMER is indispensable to anyone who works with small parts. With this specially-developed device, you can quickly magnetize a screwdriver, hex wrench, or nut runner, easily remove screws and nuts without fear of dropping into inaccessible places. Use it, too, for demagnetizing tools or iron or steel parts. Easy to operate (simple instructions are supplied) and fully guaranteed. You'll wonder how you ever got along without it! Available from your electronic parts distributor.

MODEL F-100, LIST PRICE \$7.50



PERMA-POWER COMPANY

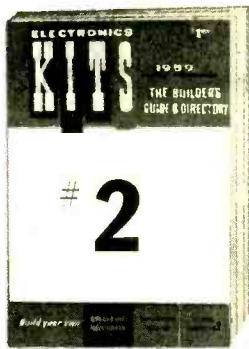
3110 N. ELSTON AVE., CHICAGO 18, ILL.

Please send me FREE descriptive literature about the  
PERMA-POWER MAGNEFORMER.

NAME \_\_\_\_\_  
ADDRESS \_\_\_\_\_  
CITY \_\_\_\_\_ STATE \_\_\_\_\_

out soon  
because of  
popular  
demand!

## ELECTRONIC KITS #2



Kit builders everywhere asked for it and now it's on the way—an exciting follow-up edition to Ziff-Davis' popular annual, ELECTRONIC KITS! This brand-new sequel will save you money on hi-fi, ham radio, other electronics devices by showing you how to use easy-to-assemble kits! What's more, ELECTRONIC KITS #2 features a big up-to-date directory of available kits, complete with specifications, prices, and manufacturers' names!

**over 160 pages—  
600 illustrations**

**HOW TO BUILD A KIT**—Learn what's involved in building a kit, and pick up tips on good construction practices.

**KIT CONSTRUCTION CHECK LIST**—Here's a summary of important steps in assembling a kit, enabling you to get it right the first time.

**HOW NOT TO MAKE MISTAKES**—Pick up tricks to simplify work and reduce the chance of error.

**WORKING WITH WIRE**—For rapid assembly and reliable operation, you should know how to handle various types of wire. You'll find out here.

**FOR YOUR HI-FI**—How to construct a Stereo Preamplifier. Stereo Adapter. Tape Recorder. Turntable. AM-FM Tuner. Book Shelf Speaker Enclosure. Integrated Stereo Amplifier. Monaural Amplifier. Record Changer. Tone Arm. Speaker Enclosure.

**FOR YOUR SHOP**—How to build a Vacuum Tube Volt Meter. Signal Generator. Oscilloscope. Tube Tester. Multitester. Transistor Tester.

**FOR YOUR HAM SHACK**—Transmitter. Receiver. Grip-dip Meter. Modulator. Single-sideband Converter. Mobile Transmitter.

**FOR YOUR HOME**—Table Radio. Transistor Pocket Radio. Junior Electronics Experimenter's Kit. Clock Radio. Radio Control Transmitter.

Be sure to reserve your copy  
of **ELECTRONIC KITS #2** today

only \$1.00

(outside USA, \$1.25)

**ZIFF-DAVIS PUBLISHING CO.**  
One Park Avenue, New York 16, New York

5040 kc., 225 watts; 4VRM, *La Voix des Gonaives*, Gonaives, 5060 kc., 400 watts; 4VBS, *La Voix du Sud*, Cayes, 5750 kc., 300 watts; 4VB, *R. Commerce*, Port-au-Prince, 5982 kc., 7500 watts; *La Voix de la Vie Marie*, Cap Haitien, 6100 kc., 540 watts; 4VE, *La Voix Evangelique*, Cap Haitien, 6138 kc., 50 watts; 4VWA, *R. Citadelle*, Cap Haitien, 6155 kc., 150 watts; 4VHW, *R. Haiti*, Port-au-Prince, 6200 kc., 1000 watts; 4VCP, *La Voix du Nord*, Cap Haitien, 6222 kc., 300 watts; 4VEH, *La Voix Evangelique*, Cap Haitien, 9770 kc., 4000

### SHORT-WAVE ABBREVIATIONS

Annt—Announcement	N.A.—North America(n)
B/C—Broadcasting	R.—Radio
Eng.—English	s/off—Sign-off
ID—Identification	s/on—Sign-on
kc.—Kilocycles	

watts; 4VWI, *La Voix Evangelique*, Cap Haitien, 11,850 and 15,390 kc., 300 watts.

**Honduras**—The call letters for *R. Tegucigalpa*, Tegucigalpa, 6035 kc., are HRTL and not HRCM as reported in other bulletins. The ID is plainly noted at 0100 s/off. (149)

**Indonesia**—The current Eng. schedule for *Voice of Indonesia*, Djakarta, reads: 0600-0700 (news at 0615) to Australia, New Zealand, and Pacific Islands on 9710 and 11,795 kc.; 0930-1030 (news at 0945) to S.E. Asia and Pakistan on 9710 and 11,795 kc.; 1400-1500 (news at 1415) to Western Europe and New Zealand on 9865 and 11,795 kc. The 1400 period is usually well heard in Eastern USA. Reports and suggestions about the programs are wanted and may be sent to P.O. Box 157, Djakarta. (501)

**Ivory Coast**—*R. Abidjan*, 4940 kc., is noted at 1700-1730 s/off and at 0200 in French. The "William Tell Overture" (a part) seems to be a trademark of this station for it is noted frequently. They verify promptly. (DR, 348)

**Lebanon**—Beirut has been found on exactly 8000 kc. at 0030 with Arabic chanting, French ID, news, but no English. (166)

**Mexico**—*La Voz de America* has replaced 15,160 kc. with 6165 kc. and is parallel to 9500 kc. at 0645-0100. (378, 474)

**Monaco**—Monte Carlo can be found on 6035 kc. at 1630-1730 with operatic music and at 0100-0105 with news in French, followed by a musical program. The 7140-kc. outlet carries Eng. and French at 2330-0000 with an excellent signal. (BW, 348, 541)

**North Vietnam**—Hanoi, 11,840 kc., has an Eng. ID at 0730, 0830, and 0930. English news is noted at 0930, with dictation-speed news at 0915. Parallel to 9840 kc. (166, 377, 420)

**Pakistan**—Karachi can be tuned in Eng. to Turkey at 1315-1400 (news at 1330) on 11,674 and 7010 kc.; to the United Kingdom on 11,674 and 9705 kc. at 1415-1500 (news at 1430); and with Eng. news at 2000 to S. E. Asia on 11,885 and 15,355 kc. Reports go to *R. Pakistan*, 71 Garden Road, Karachi. (WF, 61, 378, 541)

**Peru**—OAXIZ, *R. Nacional del Peru*, Tumbes, 9549 kc., is a new station and has been tuned at 0700 s/on; also at 1900-2300 when Prague is not too strong. (100)

**Philippine Islands**—The schedule for the new 50,000-watt Far East B/C Co. is: DZF2,



11,920 kc., at 0800-0900 in Hindi, 0900-0930 in Tamil, 0930-1000 in Telugu, 1000-1100 in Eng., 1100-1130 in Eng., 1130-1200 in Russian, 1600-1730 in Japanese, 1730-1830 in Mandarin; and DZF3, 15,385 kc., at 1830-1930 in English. All transmissions are beamed west except the 1100-1200 and 1600-1830 segments which are beamed north. (92)

**Saudi Arabia**—Tune for Djeddah on 11,950 kc. A tone signal is broadcast at 2230-2250, an interval signal to 2300 when Home Service in Arabic begins. Do not confuse this with London's Arabic service on 11,955 kc. (378)

**South Africa**—Johannesburg, 15,230 kc., has Eng. on Thursdays from 1200. News at 1200 is followed by old American recordings. (61)

**Tanganyika**—Dar-es-Salaam is scheduled in Eng. on 5050 kc. at 2315-0000 Sundays through Fridays, and at 1300-1430 (Saturdays to 1500). The 7167-kc. outlet carries Eng. at 0400-0615 Mondays through Saturdays, and Eng. and Swahili at 0300-0400. (LP, 44)

**Thailand**—The Thai National B/C Station, Bangkok, 11,670 kc., gives fair to good reception only at 0850-0900 with a brief Eng. anmt at 0900. This is a relay of the Home Service for overseas listeners. (378)

**United Arab Republic**—Cairo now carries Eng. dictation-speed news on 11,670 kc. at 0145-0205 closing. The 11,989-kc. outlet has

### SHORT-WAVE CONTRIBUTORS

Jerry Badurski (JB), St. Petersburg, Fla.  
 Johnny Dyer (JD), Cisco, Texas  
 Werner Funkenhauser (WF), Kingsville, Ont.  
 Richard Martin (RM), Pittsfield, Mass.  
 Eddie Nance (EN), Elizabethton, Tenn.  
 George Neumann (GV), Culver City, Calif.  
 Lary Page (LP), Rochester, N. Y.  
 Denny Reeves (DR), Peoria, Ill.  
 Dick Schreiber (DS), Wheat Ridge, Colo.  
 Manuel A. Sousa (MS), Braga, Portugal  
 Bill Waltz (BW), Dayton, Ohio  
 Stewart West (S), Union, N. J.  
 Anson Boice (44), New Britain, Conn.  
 Grady Ferguson (59), Charlotte, N. C.  
 John Beaver (61), Canon City, Colo.  
 Del Green (92), Salt Lake City, Utah  
 Roger Legge (100), McLean, Va.  
 Maynard Simperts (121), Jacksonville, Fla.  
 J. Art Russell (149), San Diego, Calif.  
 George Cox (166), New Castle, Del.  
 Austin Frazee (190), Point Pleasant, N. J.  
 William Bing (226), New Orleans, La.  
 Glenn Cuthrell (348), Maxton, N. C.  
 Ken Board (377), Morgantown, W. Va.  
 J. P. Arendt (378), Aurora, Ill.  
 L. E. Kunej (383), Detroit, Mich.  
 A. R. Niblack (420), Vincennes, Ind.  
 Robert Sabin (466), Wilmington, Ohio  
 Vernon Packard (474), Milwaukie, Wis.  
 Jerry Berg (477), W. Hartford, Conn.  
 Middle Eastern Correspondent (488)  
 Paul Buer (501), Harrison, N. Y.  
 Alan Roth (541), Bridgeport, Conn.

Eng. to Europe and the United Kingdom at 1600-1700 with news and commentary at 1615. (RM, EN, 61, 420)

**Windward Islands**—Grenada's new 15,086-kc. outlet is heard well at 1600-2115 in beam to Jamaica, dual to 5010 kc. News relay from London is noted at 2100; home news at 1900. (JB, JD, 44, 59, 166, 226, 383, 420, 466)

**Clandestine**—R. Liberacion, Honduras, is heard irregularly at 1900-2300 on 5810 kc. (varies) with anti-government broadcasts. (DS, 100, 121, 190, 420, 466)

-50-

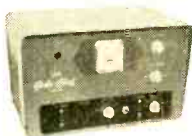
April, 1959



Leo I. Meyerson . . . says:

## WE HIGHLY RECOMMEND FOR THE BEGINNER . . .

the **Globe Chief 90A** 90w CW for 10-80M all bandswitching



Wired: \$74.50  
 \$7.45 down; \$6.15 per mo.

### Complete CW Xmtr.

Compact and sturdy with well-filtered, built-in power supply, Pi-Net, 52-600 ohms. Modified Grid-Block Keying for maximum safety. Provisions for VFO input and operation. Convert to phone with Screen Modulator below. New Forward Look cabinet. Kit complete with all necessary parts, tubes, instructions.

Kit only: \$59.95 \$6.00 down; \$5.00 per mo.

### adding Globe's Screen Modulator Kit



With Globe Chief, permits radio-telephone operation at lowest cost. Completely self-contained. Also adaptable for other CW Xmtrs. Kit contains: printed circuit, parts, etc.

Just \$11.95 Complete

### or the new Globe Sidebander DSB-100



Wired: \$139.95  
 \$14.00 down; \$11.55 per mo.

### Complete Xmtr. for AM; CW & DSB

Bandswitching 80-10M; 100w DSB (PEP) Suppressed Carrier, 40w AM, 50w CW. Work all three modes at least cost. Automatic balancing and floating grid circuit for 45db carrier suppression or better. Covers all pop. MARS & CAP frequencies. 3-stage RF section for max. efficiency. Speech clipping & filtering for powerful communication punch. Accessory socket at rear. Really the "All-in-One" Xmtr.

Kit: \$119.95  
 \$12.00 down; \$9.90 per mo.

SEND FOR BROCHURE ON COMPLETE LINE OF GLOBE PRODUCTS AND FREE 1959 CATALOG!



RUSH: ( ) NEW CATALOG, ( ) BROCHURE, AND MORE INFO ON:

NAME: \_\_\_\_\_

ADDRESS: \_\_\_\_\_

CITY & STATE: \_\_\_\_\_



**POPULAR ELECTRONICS**

**BARGAIN BASEMENT**  
**SAVE ON THESE SPECIAL BUYS OF THE MONTH**

**BASIC 6-TRANSISTOR SUPERHET RADIO KIT ! ! ! !**  
**CONSISTS OF:**

- 3—1-F. Transformers
  - 1—Oscillator coil
  - 1—Flat Loopstick
  - 1—Input Xformer
  - 1—2-Gang Var. Cond.
  - 1—Output Xformer
  - 6—Transistor Sockets
  - 1—Schematic
- Set of 6 Transistors for Above Kit..... ONLY \$ 6.99
- V-M 4-Speed Monaural Record Changers..... ONLY \$24.99
- V-M 4-Speed Stereo Record Changers..... ONLY \$27.99
- Hi-Fidelity 8-inch Coaxial Speakers (w/crossover)..... ONLY \$ 5.99
- Hi-Fidelity 12-inch Coaxial Speakers (w/crossover)..... ONLY \$ 8.99
- Hi-Fidelity 15-inch Coaxial Speakers (w/crossover)..... ONLY \$10.99

Write Us for Quotations on Complete Kits of Parts Needed for Your Constructional Projects. You Will be Amazed at our Low, Low Prices on Top Quality Components!!! Try Our New Rapid Service Today!!!!

**GROVE ELECTRONIC SUPPLY CO.**  
 4103 W. BELMONT AVE. CHICAGO 41, ILL.  
 Include Postage With Orders—Write Today for Our New Catalog

**ONE CENT SALE**

**BUY ONE AT OUR REGULAR LOW PRICE AND GET THE SECOND FOR ONLY 1¢ MORE**

**CITIZENS BAND TRANSMITTER** chassis complete with crystal, tunable through all 22 channels. Complete with audio amplifier. \$9.99 ea. two for \$10.00. **CITIZENS BAND RECEIVER** chassis complete with audio amplifier. \$9.99 ea. two for \$10.00. **RADIOSONDE TELEMETERING TRANSMITTER** complete with modulator, aneroid barometer, temperature and humidity sensing elements, tubes, relay, antenna, etc. A \$50.00 value for only \$4.99 ea. two for \$5.00. **COILED CORD** 4 conductor 11" telephone cord. Extends to over 4 ft. .99 ea. two for \$1.00. **MICROPHONE** High output 200 ohm carbon with terminal lugs. \$1.49 ea. two for \$1.50. **TRANSISTOR AUDIO AMPLIFIER**. Gives up to 50X voltage gain on low level signals. Operates on 1 1/2 volts. \$3.99 ea. two for \$4.00. **KIT OF PARTS** for VHF radio receiver. Tunable from 80 to 200 mc/cycles which includes U. S. satellite frequencies. \$6.99 ea. kit. two for \$7.00.

**LIMITED QUANTITY—RUSH YOUR ORDER TODAY**  
 Remit in full. Include sufficient postage. No C.O.D.'s.  
**VANGUARD ELECTRONIC LABS** Box 12-E4  
 Hollis 23, N. Y.

**DIAGNYZER \$9.95**  
**ELECTRONIC TESTER COMPLETE**

**for DO-IT-YOURSELF SERVICING**

COMPLETE TRAINING COURSE AND SERVICE MANUAL

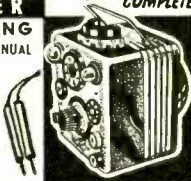
INCLUDED FREE WITH EACH INSTRUMENT

INDISPENSIBLE—FOR TV, RADIO, HI-FI

Appliances, Auto, Electrical Tools. Used in Home, Shop and Farm. Checks Radio and TV Tubes, Components, Voltages and Circuits, etc.

INEXPENSIVE TO OWN, EASY TO USE

Anyone can do servicing with this wonderful instrument, pays for itself the first time you use it. Best value for money, nothing else like it. Write Today.



**APPARATUS DEVELOPMENT CO.**  
 Dept. K111, Meridenfield, Conn.

**Say You Saw It in POPULAR ELECTRONICS**

**EXPERIMENTERS AMATEURS HOBBYISTS**

We are again reducing a large inventory of brand new vacuum tubes and this "get-acquainted" offer is limited to the stock on hand. All tubes in each assortment are different, and every tube is brand-spanking new.

10 electron tubes including 3" cathode ray tube only... \$1.95  
 15 including 5" CRT... \$2.95 20 including 7" CRT... \$3.95  
 All three of the above assortments for just... \$7.95

Order early and we will include in your assortment a special high voltage rectifier and famous WE-717-A tubes. Your order will be sent via insured parcel post; just pay postman postage plus small COD charge. We have many unbelievable values in government electronic surplus, much of it for sale at prices representing mere pennies on the dollar of cost.

**WRITE FOR FREE GOVERNMENT SURPLUS BARGAIN BULLETIN**

**JOE PALMER**

P. O. Box 6188 CCC

Sacramento, California

**"TAB" FOR THE BEST KITS!**

Send order for gift bonus—Turn over or stand on head

- Kit 4 Relays
- Kit 4 Ass'd Rectifiers
- Kit 8 Xtal Osc.-Blanks
- Kit 3 Transistor Xfms
- Kit 10 Wheat Lamps
- Kit 5 Microswitches
- Kit 5 FT-248 Xtal Holders
- Kit 100 Ceramic Condensers
- Kit 100 Fuses, assorted
- Kit 200FT Hook Up Wire Ass'd.
- Kit 75 Mica Condensers
- Kit 5 Sub-Min Tubes
- Kit 6 Insl'd Tuning Tools
- Kit 4 Ass'd Rectifier Lites
- Kit 4 A/N/Reflector Xfms
- Kit 3 Phone/Patch Xfms
- Kit 1 Gyr'd & Cement
- Kit 10 Transm/Mech Cond's
- Kit 5 Ass'd Switch Packages
- Kit 500 Lugs & Eyelets
- Kit 65 Tubular Condensers
- Kit 12 Electrolytic Cond's
- Kit 150 Carbon Resistors
- Kit 75 Resistors 1/2"/W
- Kit 95 Precision Resistors

Order Ten Kits  
 We Ship Eleven!!!

**ONE EACH ABOVE 99¢**  
**KIT ONLY . . . . .**

BATTERY CHARGER 6&12VOLT at UP TO 2AMPS....\$9  
 SEND 25¢ FOR BONUS CATALOG

**"TAB", 111PG Liberty St., N. Y. 6, N. Y.**

Contains The Finest Selection

**ADVERTISER'S INDEX**

ADVERTISER	PAGE NO.	ADVERTISER	PAGE NO.	ADVERTISER	PAGE NO.
Allied Radio Corp.	21, 143	Heath Company	124, 125, 126, 127, 128, 129	Picture Tube Outlet	142
Amperex Electronic Corp.	18	Hershel Radio Co.	145	Popular Electronics Classified	50
Apparatus Development Co.	158	Hi-Fi Guide & Yearbook	140	Popular Electronics Subscriptions	146
Arka	30	Indiana Technical College	144	Port Arthur College	36
Audio Devices, Inc.	16	International Correspondence Schools	13	Progressive "Edu-Kits" Inc.	25
Bailey Technical Schools	34	International Crystal Mfg. Co., Inc.	123	Quality-Electronics	148
Bell Sound Division	39	Instructograph Company	150	Quik-Chek Corporation	130
Bell Telephone Laboratories	9	Jensen Industries, Inc.	148	RCA Institutes, Inc.	10, 11
Berkeley Enterprises, Inc.	28	Johnson Company, E. F.	122	RCA Shack Corporation	153
Blonder-Tongue Laboratories	12	Key Electronics Co.	148	Radio-Television Training School	23
Bruce Sales Co.	148	Kester-Solder Company	148	Rinehart & Company, Inc.	149
Burstein-Applesbe Co.	154	Kuhn Electronics	150	Sobor Organ Corp., The	144
Capitol Radio Engineering Institute	15	Lafayette Radio	132, 133	Sonotone Corp.	26
Capri Electronics	32	Lektron	139	Soundtronics Labs	150
Carrier Co., C.	142	Micro Electron Tube Co.	20	Sprayberry Academy of Radio-Television	19
Century Electronics Co., Inc.	136, 137	Midway Company	150	Springfield Enterprises	122
Cleveland Institute of Radio Electronics	29	Midway Welder	146	Standard Line Electric Company	131
Cotter, Hermon E.	158	Miller, Gustave	154	Sylvania Electric Products Inc.	135
Coyne Electrical School	5	Milwaukee School of Engineering	145	"TAB"	158
DeVry Technical Institute	7	Modernophone, Inc.	24	U. S. Air Force	121
EICO	38, 40	Moss Electronic, Inc.	162	University loudspeakers, Inc.	32
Electronic Experimenter's Handbook	151	National Co.	2nd Cover	Valparaiso Technical Institute	142
Electronic Kits #2	156	National Radio Institute	3, 147	Vanguard Electronics Labs	158
Electronic Measurements Corp.	141	National Schools	31	Video Electronic Company	14
Electro-Voice, Inc.	33	Pacific International College	154	Weathers Industries	27
Fenner Sales	154	Paco Electronics Co., Inc.	92	Western Radio	144
Garfield Co., Inc., Oliver	37	Palmer, Joe	158	World Radio Laboratories	157
Garrard Sales Corp.	35	Perma-Power Company	155	Xceltite, Incorporated	26
General Electronic Service Co.	146	Phila. Wireless Technical Institute	138	Zalytron Tube Corporation	138
Gonset Co.	24				
Grantham School of Electronics	17				
Grove Electronic Supply Co.	158				



# ELECTRONICS MARKET PLACE

RATE: 50¢ per word. Minimum 10 words prepaid. June issue closes April 3rd. Send order and remittance to: POPULAR ELECTRONICS, One Park Ave., New York 16, N. Y.

## FOR SALE

**TUBES-TV, Radio, Transmitting and Industrial Types At Sensibly Low Prices.** New, Guaranteed 1st Quality Top Name Brands Only. Write For Free Catalog or Call WALKER 5-7000, Barry Electronics Corp., 512 Broadway, New York 12N, N. Y.

**DIAGRAMS** for repairing radios \$1.00, Television \$2.00. Give make, model. Diagram Service, Box 672-PE, Hartford 1, Conn.

**GOVERNMENT Surplus Receivers, Transmitters, Snooperscopes, Parabolic Reflectors, Picture Catalog 10¢.** Meshna, Malden 48, Mass.

**GOVERNMENT Sells**—Surplus Electronics; Walkie-Talkies; Test Equipment; Oscilloscopes; Radar; Sonar; Surplus Aircraft; Boats; Jeeps, Misc.—You buy direct now from U. S. Government Depots at fractions of Army and Navy costs—Send for bulletin "Depot List & Procedure" \$1.00. Box 8-PE, Sunnyside 4, N. Y.

**TRADE-IN** Television Sets \$11.95 Plus Shipping. Jones TV, Sana-toga, Pa.

**MAGNETIC Amplifiers**—fastest growing field in electronics! A treatment anyone can understand and a "must" for the informed man. \$1.00 ppd. Minnetonka Engineering Co., R. 4, Excelsior, Minn.

**TELEVISION & Radio Tubes, Parts and Supplies.** Guaranteed. Hi-Quality Tube Co., Inc., 284 Lafayette St., Rahway, New Jersey.

**WHOLESALE** Prices transistor supplies, Stereo, Hi-Fi amplifiers, changers, speakers, Eico kits, tubes. Schaak Electronics, 3867 Minnehaha Ave., Minneapolis 6, Minnesota. PA 9-8382.

**TRADE-IN TV \$6 up**, also color, write Justis, Newport, Delaware.

**CRYSTAL** Radio Experimenters, Write to Hulet, 305 Hope, Lakewood, New Jersey.

**200,000 VOLT** 1½ Microamperage D.C. Motor Generator Kits \$19.50. For Education Research or Display Purposes. Morris & Lee, 439 Elm, Buffalo 3, N. Y.

**ELECTRONIC** Projects—Organs, Timers, Counters, Etc. \$1 each. List free. Parks, Box 1665A, Lake City, Seattle 55, Wash.

**LABORATORY** Instruments, Surplus Electronics: Engineering, Farhills, Box 26X, Dayton 19, Ohio.

**FREE Catalog**—Inexpensive Fluorescent Fixture Kits, Parts, etc. Shoplite, 650E Franklin, Nutley 10, New Jersey.

**BUY** Surplus Jeeps, tractors, winches, pumps, tools, hydraulics, electronics, boats, typewriters, generators, wholesale direct from government. List and procedure \$1.00. Aviation Surplus, Box 8-2D, Thomasville, Penna.

**\$50 TRANSISTOR** Radio \$23.95, Soldering Gun \$8.95 C.O.D., Electronic Hypnotizer \$19.95. Transworld Export, Box 929, Indio, California.

**VOCALINE** radio transceivers provide low cost communications for home, office, industry, farm, boating etc. Operates in citizens radio band, station license easily obtained, no operators license required, write: House Distributing Co., Pukwana, S. Dak.

**EXPERIMENTERS' Parts, Supplies**—Bargains! Free Bulletin. Electronix Workshop, 49-E, Howard City, Michigan.

**FREE** Wholesale Watch Catalog. M. Darby, 243 Lincoln, Salisbury, Maryland.

**BUILD** Radio in Fountain Pen. This novel set really works. Plans 50¢. Matlaw, 253 Parkside Ave., Brooklyn 26, N. Y.

**"15 TESTED One-Tube Circuits,"** Transistor experiments and catalog—25¢. Laboratories, 1131-L Valota, Redwood City, California.

**SAVE** time and money. Nationally advertised kits assembled, wired, tested. Send specifications. Free estimate. Naczas Kit Service, 273 Belmont St., Manchester, N. H.

**FM Tuners, 88-108 megacycles, 4 tubes complete, \$12.95.** Grutman, 1 E. 167 St., New York 52, N. Y.

**SPECIAL Tester** for appliances & etc., \$1.79 DMJ Products, P. O. Box 1341, Arlington 13, Virginia.

**PHOTO** Electric cell, new government surplus, \$2.00. New 6 volt vibrators for hi-voltage portable or mobile power, Three for \$2.00. 15 new Octal tube sockets, \$1.00. All items postpaid. Order all 19 items and receive a valuable gift. All-Tronics, Box 1008, San Diego 12, Calif.

**RADIO** Workbench is devoted entirely to electronics for builder-experimenters. Latest issue 25¢. Radio Workbench, Carlsbad, New Mexico.

**SCHEMATIC, Repair Instructions, HiFi's, T.V.'s, Radios, Phonographs, Tape Recorders, 99¢.** Send make, model number. "Radio Coop," Box 5938, Kansas City 11, Missouri.

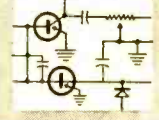
## WANTED

**CASH Paid!** Sell your surplus electronic tubes. Want unused, clean transmitting, special purpose, receiving, TV types, magnetrons, klystrons, broadcast, etc. Also want military & commercial lab test and communications gear. We swap too, for tubes or choice equipment. Send specific details in first letter. For a fair deal write, wire or telephone: Barry, 512 Broadway, New York 12, N. Y. WALKER 5-7000.

**MERCURY, Platinum, Silver, Precious Metals. Ores Assayed.** Mercury Refiners, Norwood, Massachusetts.

**WANTED, ARN-14c, ARN-30, ARC-15, OMNI** Sets, and components. CRT-3 Victory Girls, AS313B Loops, ARC-12, 51R2-3, 17L3-4, 18S2-3, R-388/URR, R-390/URR, BC-348, Testsets, "Top Dollar Paid." Bill Slep, W4FHY, Box 178, Ellenton, Florida.

## INSTRUCTION



**USED** Correspondence Courses, Educational Books Bought, Sold. Catalog Free. Vernon, Summerville, Ga.

**COMPLETE** Your High School at home in spare time with 62-year-old school. Texts furnished. No Classes. Diploma. Information booklet free. American School, Dept. X436, Drexel at 58th, Chicago 57, Illinois.

**MATHEMATICS.** Home Study. Elementary through university levels. UCSM, Philadelphia 26, Pennsylvania.

**WATCHMAKERS', Jewelers' requirements; Watchmaking** courses from \$25.00. Catalog (100-pages), 25¢. Bengale Wholesalers, Culver City, California.

**COMPLETE** Correspondence Course in Radio, TV, & Electronics. Only 12 sections. Includes 1st Class License Prep. Very low rates. Ascot School of Electronics, Box 29092, Los Angeles 29, Calif.

**MENTAL** Radio—Operate yourself as a transceiver. Landa, Clayton 2, Ga.

**ELEMENTARY** code course. 12" microgroove record, \$3.50 postpaid. Kord-Ail, Box 444, Warren, Ohio.

**AMAZING** new television trouble shooting technique. Spots trouble quickly, easily. Thoroughly tested and proven on hundreds of repair jobs. Write for free brochure. National Technical Research Labs., 1118 W. Hadley St., Whittier, Calif.



**CODE** courses to enable passing Radio Amateur examinations. Designed and tape recorded by former U.S.N. Operator and R.R. telegrapher. Both sides 7" 1200' reels. Learning to Six W.P.M. or Six to Sixteen W.P.M. Response enables reduction to \$3.98 each. Postpaid in U.S.A. Elham Inc., P.O. Box 98, Hawthorne, California.

**HAMS.** Calculate as Experts calculate. 10" Slide Rule Plus Instruction Booklet. Perfect for Electronics. 1 set \$1.50 Pal-Pak 2 sets \$2.50 Science Recruits, Box 575, Walla Walla, Washington.



## HIGH-FIDELITY

**HI-FI** interest you? Write for Free 20 page H. H. Scott Component Catalog. H. H. Scott Inc., Dept. PE-4, 111 Powdermill Road, Maynard, Mass.

**DISGUSTED** with "Hi" Hi-Fi Prices? Unusual discounts on your High Fidelity Requirements. Write Key Electronics, 120 Liberty St., New York 6, N. Y. EVERgreen 4-6071.

**HI-FI Haven**, New Jersey's newest and finest sound center. Write for information on unique mail order plan that offers professional advice and low prices. 28 Easton Avenue, New Brunswick, New Jersey.

**HI-FI AM Tuner Kits** \$14.90. Grindon, 7820 Murdoch, St. Louis, Mo.

**HI-FI Converter.** Console sound from your radio, television set, or record player, with new speaker system kit. Write for Free Folder. Windhaven Radio, Box 130-74, Baroda, Michigan.



## TAPE & RECORDERS

**RECORDERS**, Hi-Fi. Free wholesale catalogue. Carston, 215-P, East 88 St., N.Y.C. 28.

**HIGHEST Trade-In Allowances** Toward Ampex, Concertone, Crown, Ferrograph, Presto, Pentron, Components, Accessories. Catalog. Boynton Studio, 10-PE Pennsylvania, Tuckahoe, N. Y.

**RECORDERS**, Tape Decks, Stereo Tapes, Accessories, Excellent Values, Catalogue. Efsco, 270E Concord, West Hempstead, N. Y.

**TAPE** Recorders, Hi-Fi Components, Sleep Learning Equipment, Tapes. Unusual Values. Free Catalog. Dressner, 69-02F, 174 St., Flushing 65, N. Y.

**EXCHANGE Tapes**—Send Commercially Recorded Stereo or Monaural Tape and \$1.00 for Different Tape of Like Quality. Satisfaction Guaranteed, Our Choice. Selected Tape Exchange, Box 424, Hagerstown, Maryland.



## EMPLOYMENT INFORMATION

**JOBS**—High Pay; USA, So. America, The Islands. All trades. Many companies pay fare. Write Dept. 71N, National Employment Information, 1020 Broad, Newark, N. J.

**AMERICAN Overseas Jobs.** High Pay. Men, Women. Transportation Paid. Free Information. Write: Transworld Information Service, Dept. AZ, 200 West 34th St., New York 1.

**WANT A Better Job??** High Pay?? Overseas—U.S.A. All Occupations. Free Information. Employment Headquarters, 79 Wall Street, Dept. 3-G, New York 5.

**JOBS** on Steamships and Yachts traveling Foreign Countries. Davenport's, GPO 1354, New York 1, New York.

**JOBS Overseas!** Janecek Development Co., 1093 Hub Station, New York 55, N. Y.

**WANT a Good Job??** High Pay?? Overseas—U.S.A. All Occupations. Free Information. Employment Headquarters, 79 Wall Street, Dept. 4-0, New York 5.

**FOREIGN** Employment Information—\$1. Parks, Box 1665A, Lake City, Seattle 55, Wash.

## PLASTICS

**NEW** Liquid Casting Plastic clear, colors. Embed real flowers, minerals, biological specimens, delicate instruments, electronic parts. Also cold-setting resin and fiberglass for laminating, casting, molding, coating. Manual 25¢. Castolite, Dept. D-108, Woodstock, Illinois.



## INVENTIONS WANTED

**INVENTIONS** wanted. Patented: unpatented. Global Marketing Service, 2420—77th, Oakland 5, Calif.



## MISCELLANEOUS

**LEARN** While Asleep with amazing new Electronics Educator endless tape recorder. Details free. Research Association, Box 24-S, Olympia, Wash.

**WORLD'S** Largest Electronic Parts Catalog. 1,536 pages. New 1959 edition. Over 150,000 standard items sold through parts distributors at your fingertips. Complete product descriptions, specifications, prices; 11,500 illustrations. Used by hams, hobbyists, experimenters everywhere. Only \$3.50 from local radio-TV parts distributors, or send check/money order direct. Radio-Electronic Master, 60 E. Madison Avenue, Hempstead, N. Y. Free 24-page Panel-Flashlight Lamp Chart with Direct Order.

**CODE** Remembered forever in minutes with amazing memory aid. \$1. McKenzie Enterprises, Box 245, Palo Alto, California.

**3 LINES** 1.00 Rubber Stamps. Box 66, Mt. Holly Springs, Pa.

**24" ROCKET**—solid fuel, high altitude performance, will carry experimental transistor equipment, parachute return. Educational. Complete scale plans and instructions \$1.00. Advance Engineering, P. O. Box 2274, Dallas 21, Texas.

**HAVING** trouble getting ahead? Read "Gems of Wisdom." \$1.00. Frazier Enterprises, 201 Delaware Circle, North West, Huntsville, Ala.

**POCKET-SIZE** Ventilator, world's smallest. Own this amazing new gadget this summer. De-Luxe brass finish. Imported. Order now. Complete with standard batteries and leather bag. Only \$12.95 postpaid. E. T. Schilling, P. O. Box 623, San Francisco 1, California.

**LP Records.** Stereodiscs, Stereotapes, 20% Discount Catalog 30¢. SWRS, 1108 Winbern, Houston, Texas.



## SHOPPING GUIDE Classified

A HANDY REFERENCE TO PRODUCTS AND SERVICES NOT NECESSARILY ELECTRONIC, BUT OF WIDE GENERAL INTEREST.



## PHOTOGRAPHY—FILM EQUIPMENT, SERVICES

**FREE!** Blackhawk's big sale catalog 8mm. 16mm. movies, 2 1/2" color slides. Biggest selection anywhere! Projectors, cameras, supplies—big discounts! Get free, every three weeks, 12-page newspaper size bargain list! Blackhawk Films, Davenport 24, Iowa.

Always say you saw it in—POPULAR ELECTRONICS



**CODE** remembered forever in minutes with amazing memory aid. \$1. McKenzie Enterprises, Box 245, Palo Alto, California.

**COLOR Economy!** Anscochrome, Ektachrome film developing, 80¢ (20 exp. 35 mm rolls mounted). Color prints from transparencies—2 1/2x3 1/2 six for \$1.00, 3 1/2x5 six for \$1.50, 5x7 each 75¢, 8x10—\$1.50. Lee-Jan-Lab., Box 382, LaGrange, Illinois.

**ABSOLUTELY** highest quality professional double weight enlargements at dealers prices. 5x7, 32¢; 8x10 41¢; 11x14, 85¢. No extra charge for cropping or dodging. New negative from your photo 60¢; Minimum order \$1.00. 25% discount on Kodacolor processing. 20% discount on Developing By Kodak. Foto Portrait Co., 1172-E Ogdan Ave., New York City 52.

**5,000 8mm.-16mm. Films, Equipment.** Free catalogues. International, Greenvale, New York.

**HOBBIES, Industries, Sports, Travel!** Meston's 35mm Color Slides of over 16,000 subjects. Send \$1.00 for Exciting Preview Package four slides hermetically sealed in plastic plus 80 page catalog. Meston's Travels, Dept. PE, 3801 N. Piedras, El Paso, Texas.

**COLORFUL Autumn**—New York State. Eight Colorslides \$1.00. Edgings, Roberts Avenue, Corning, N. Y.

## BUSINESS OPPORTUNITIES

**SSAVE!** \$Save! \$Save! Statistics prove television repaired without technical knowledge. Guaranteed, money back, method. Only \$1.00. Electronic Research Foundation, Box 301, Orange, New Jersey.

**MEN**—Women Agents: sensational new money-makers—Beautifully hand-painted plastic personalized photo enlargements, compacts, rings, bracelets, lockets, etc. Simply take orders, pocket 40% commission—we deliver and collect. Sales outfit free. Novelco, 3341 North Ave., Chicago 47.

**PHOTOGRAPHY** for Pleasure or profit. Learn at home. Practical Basic training. Long established school. Free booklet. American School of Photography, 835 Diversey Parkway, Dept. 2254, Chicago 14, Illinois.

**DETECTIVES**—Experience unnecessary. Detective Particulars. Wagoner, 125-Z West 86th, N. Y.

**OPERATE** Profitable mailorder business!! Write: Bond, 1637-X West Vernon, Phoenix, Arizona.

**EXTRAORDINARY Opportunity!** Retire Now! Lead leisurely Life. Remarkable Book Shows How. Free Details. Belmont, Wyckoff 177, New Jersey.

**MAILMAN** Brings us \$150 Daily. Operate home Mail Order Business. Write Publicity, Box 727ZE, Kalamazoo, Michigan.

**MAKE \$25-\$50 Week,** clipping newspaper items for publishers. Some clippings worth \$5.00 each. Particulars free. National, 81-DG, Knickerbocker Station, New York.

**AMATEURS and Professionals**—Extra Cash from your photos. Become a member of our world wide photo agency and enjoy innumerable benefits. Send your 8x10 photos for presentation to world markets and only \$1.00 for membership number and informative letter. Limited offer. Photo-World, 538 North Federal, Fort Lauderdale, Florida.

**VENDING Machines**—No Selling. Operate a route of coin machines and earn amazing profits. 32-page catalog free. Parkway Machine Corporation, Dept. 12, 715 Ensor St., Baltimore 2, Md.

**MAKE \$25-\$50 Week,** clipping newspaper items for publishers. Some worth \$5.00 each. Particulars free. National, 81-PE, Knickerbocker Station, New York City.

**FREE Book** "505 Odd Successful Businesses." Work home. Pacific-PPY, Oceanside, California.

**YOUR Own Income Tax Business Tax Service.** Licensed training. Union Institute, Hoboken 3V, N. J.

**EARN extra cash!** Prepare advertising postals. Langdon's, Box 41107Z, Los Angeles 41, California.

**EARN Extra money** selling advertising book matches. Free samples furnished. Matchcorp, Dept. MD-49, Chicago 32, Ill.

**YOUR Own home-operated business!** Take over your area as our Service Distributor keeping stores supplied. Nationally advertised 29-year-old line pays you 66 2/3% mark-up. Less than \$100 for merchandise starts you. For samples, highly successful plan, write Novo, Inc., 1168-P Milwaukee, Chicago 22, Ill.

**FREE-Lance Photographers** register now. No obligation. For application write Accredited Press, Inc., Lawrence 6, New York.

**\$30-\$60 WEEKLY** Addressing Envelopes at home. Instructions \$1. (refundable). Reiss, 210 Fifth Ave., Suite 1102-M, New York 10.

**SELL Stereo Hi-Fi** by home demonstration, full or part time, direct from factory. Al Cloutier, Dept. PE, 11143 Orville St., Culver City, California.

**EARN Up to \$10,000** yearly selling shelving—parts bins—shop equipment. Write, BFC Corporation, 2806E. Hedley, Phila. 37, Pa.

## STAMPS & COINS

**COIN Magazine.** 200 pages. Sample 40¢. Scrapbook, 7328 Milwaukee, Chicago 48.

**1000 DIFFERENT** Worldwide Stamps \$1.25. Valued over \$20.00. Universal, Box 6, Kenosha 18, Wisconsin.

**100 LARGE U.S. Commemoratives**—only 25¢ with approvals. Wm. Rice, 87 Washington Ave., Kingston 41, N. Y.

**UNITED Nations.** Five different 10¢. Approvals. Anderson, 1112 Harrison, San Francisco 3, Calif.

**77 DIFFERENT U.S., 100 Different China, 25 Different Czechoslovakia,** all 60¢ Approvals. Leonards, 1143M, North Keeler, Chicago 51.

**NEW!** 1959 Bargain American Coin Catalogue! Revised Prices! Only 25¢. Write! Sullivan, 128EC East Fourth St., St. Paul 1, Minnesota.

**508 DIFFERENT** Worldwide from Madagascar, Macao, Guinea, etc., cataloging over \$15.00 on 35¢. Approvals. Littleton Stamp Company, Littleton Q17, New Hampshire.

**U.S. Stamps.** Giant Bargain Catalog—15¢. Raymax, 35-VZD Maidenlane, NYC 38.

**427 STAMPS 10¢,** Catalogue Value \$10.00. Mystery Mixture including U. S., Ireland, Asia, Africa, Pictorials, Commemoratives, Air Mails. WorldOStamps, 8203 Grubb-PE, Silver Spring, Maryland.

**GIGANTIC Collection Free!** Includes triangles, early United States, animals, commemoratives, British Colonies, high value pictorials, etc. Complete collection plus big illustrated magazine all free. Send 5¢ for postage. Gray Stamp Company, Dept. 22, Toronto, Canada.

**307 WORLDWIDE** Different stamps only 35¢. Approvals. Niagara-stamp, St. Catherines 690, Ontario.

## MISCELLANEOUS

**WHY** not be the person you wish to be, realizing the fulfillment of your desires? Good things are attracted to you when you know and apply the rules. Read: Man, God's Helpmate \$1.25; Using The Magnetic Forces of Your Mind \$3.00 postpaid. I.P. Society, Dept. Z, P.O. Box 42187, Los Angeles 42, California. (In Calif. add 4% sales tax.)

**BARBELLS.** Courses, Apparatus. Catalogue 10¢. Good Barbell Co., Dept. D, Siloam Springs, Arkansas.

**THE Law of Life Revealed and How to Apply It,** \$1.00. The Open Way, Celina, Tennessee.

**"WINEMAKING; Beer, Ale Brewing."** Illustrated. \$2.00. Many others. Eaton Books, Box 1242-C, Santa Rosa, California.

**PRINTING** Presses, Type, Supplies, Lists 4¢. Turnbaugh Service, Mechanicsburg, Pa.

**FLYING Saucers** Latest Reports, Articles. Subscribe for "The Saucerian" magazine. Six issues \$2.00. Saucers, Dept. 5, Box 2228, Clarksburg, West Va.

**ENGINES OHV V8's.** All Popular Makes. 1956, 1959. Ledbetter Enterprises, 1015 West 17th, Texarkana, Texas.

**HYPNOTIZE** . . . One Word . . . One fingersnap, on stage. Satisfaction—or refund. \$2. Hypnomaster, 846-S8 Sunnyside, Chicago 40.

**COBRA.** Self-Defense street-fighting tricks. Designed to help peaceful adults. \$2. Gaucho, 846-S8 Sunnyside, Chicago 40.

**SONGPOEMS** And Lyrics Wanted! Mail to: Tin Pan Alley, Inc., 1650 Broadway, New York 19, N. Y.

**PHONOGRAPH** Records cheap, postpaid. Catalogue. Paramount, Box 242-R, Williamsport, Penna.

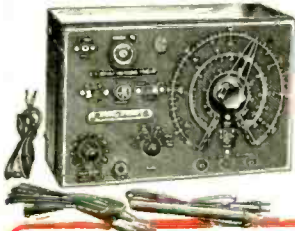
**BINOCULAR** specialists, all makes repaired. Authorized Bausch Lomb, Zeiss, Hensoldt, Bushnell dealer. Tele-Optics, 5514 Lawrence, Chicago 30, Illinois.

**OPTICAL Bargains**—Request Free Giant Catalog "CJ." 96 pages—Astronomical Telescopes, Microscopes, Lenses, Binoculars, KIts, Parts. Amazing war surplus bargains. Edmund Scientific Co., Barrington, New Jersey.

# SHIPPED ON APPROVAL NO MONEY WITH ORDER — NO C. O. D.

Superior's New Model 76

## ALL PURPOSE BRIDGE



**Model 76 ALL PURPOSE BRIDGE**  
Total Price . . . . . \$26.95  
Terms: \$6.95 after 10 day trial, then \$5.00 per month for 4 months if satisfactory. Otherwise return, no explanation necessary.

IT'S A CONDENSER BRIDGE  
IT'S A RESISTANCE BRIDGE

- ✓ **CAPACITY BRIDGE SECTION**  
4 Ranges: .00001 Microfarad to .005 Microfarad; .001 Microfarad to .5 Microfarad; .1 Microfarad to 50 Microfarads; 20 Microfarads to 1000 Microfarads. Will also measure the power factor of all condensers from .1 to 1000 Microfarads.
- ✓ **RESISTANCE BRIDGE SECTION**  
2 Ranges: 100 ohms to 50,000 ohms; 10,000 ohms to 5 megohms.
- ✓ **SIGNAL TRACER SECTION**

With the use of the R.F. and A.F. Probes included with the Model 76, you can

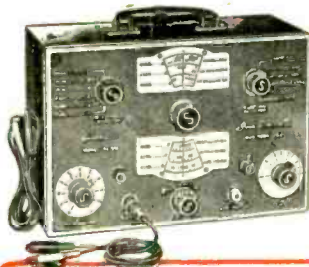
IT'S A SIGNAL TRACER  
IT'S A TV ANTENNA TESTER

- make stage gain measurements, locate signal loss in R.F. and Audio stages, localize faulty stages, locate distortion and hum, etc.
- ✓ **TV ANTENNA TESTER SECTION**  
Loss of sync., snow and instability are only a few of the faults which may be due to a break in the antenna, so why not check the TV antenna first? Locates a break in any TV antenna and measures the location of the break in feet from the set terminals.

Complete with R.F. and A.F. probes and test leads **\$26.95** Net

## Superior's New Model TV-50A GENOMETER

### 7 Signal Generators in One!



**Model TV-50A GENOMETER** . . .  
Total Price . . . . . \$47.50  
Terms: \$11.50 after 10 day trial, then \$6.00 monthly for 6 months if satisfactory. Otherwise return, no explanation necessary.

- ✓ R.F. Signal Generator for A.M.
- ✓ R.F. Signal Generator for F.M.
- ✓ Audio Frequency Generator
- ✓ Bar Generator
- ✓ Cross Hatch Generator
- ✓ Color Dot Pattern Generator
- ✓ Marker Generator

This versatile All-Inclusive GENERATOR Provides ALL the Outputs for Servicing:

A.M. Radio • F.M. Radio • Amplifiers • Black and White TV • Color TV

**R. F. SIGNAL GENERATOR:** The Model TV-50A Genometer provides complete coverage for A.M. and F.M. alignment. Generates Radio Frequencies from 100 Kilocycles to 60 Megacycles on fundamentals and from 60 Megacycles to 180 Megacycles on powerful harmonics.

**VARIABLE AUDIO FREQUENCY GENERATOR:** In addition to a fixed 400 cycle sine-wave audio, the Model TV-50A Genometer provides a variable 300 cycle to 20,000 cycle peaked wave audio signal.

**BAR GENERATOR:** The Model TV-50A projects an actual Bar Pattern on any TV Receiver Screen. Patterns will consist of 4 to 16 horizontal bars or 7 to 20 vertical bars.

**CROSS HATCH GENERATOR:** The Model TV-50A Genometer will project a cross-hatch pattern on any TV picture tube. The pattern will consist of non-shifting, horizontal and vertical lines interlaced to provide a stable cross-hatch effect.

**DOT PATTERN GENERATOR (FOR COLOR TV)**  
Although you will be able to use most of your regular standard equipment for servicing Color TV, the one addition which is a "must" is a Dot Pattern Generator. The Dot Pattern projected on any color TV Receiver tube by the Model TV-50A will enable you to adjust for proper color convergence.

**MARKER GENERATOR:** The Model TV-50A includes all the most frequently needed marker points. The following markers are provided: 189 Kc., 262.5 Kc., 456 Kc., 600 Kc., 1000 Kc., 1400 Kc., 1600 Kc., 2000 Kc., 2500 Kc., 3579 Kc., 4.5 Mc., 5 Mc., 10.7 Mc., (3579 Kc. is the color burst frequency).

The Model TV-50A comes absolutely complete with shielded leads and operating instructions. Only

**\$47.50**

# USE APPROVAL FORM ON NEXT PAGE ▶

**NO INTEREST OR FINANCE CHARGES ADDED!**

We invite you to try before you buy any of the models described on this and the following pages. If after a 10 day trial you are completely satisfied and decide to keep the Tester, you need send us only the down payment and agree to pay the balance due at the monthly indicated rate.

If not completely satisfied, you are privileged to return the Tester to us, cancelling any further obligation.

MOSS ELECTRONIC, INC.

Dept. D-585 3849 Tenth Avenue, New York 34, N. Y.



# TRY FOR 10 DAYS

**before** you buy!

**then** if satisfactory pay in easy, interest free, monthly payments. See coupon below.

SUPERIOR'S NEW MODEL 82A

A truly do-it-yourself type

# TUBE TESTER

## TEST ANY TUBE IN 10 SECONDS FLAT!



Model 82A — TUBE TESTER . . . Total Price \$36.50 — Terms: \$6.50 after 10 day trial, then \$6.00 monthly for 5 months if satisfactory. Otherwise return, no explanation necessary.

- ① Turn the filament selector switch to position specified.
- ② Insert tube into a numbered socket as designated on our chart (over 600 types included).
- ③ Press down the quality button—**THAT'S ALL!**

Read emission quality direct on "BAD-GOOD" meter scale.

### Specifications

- Tests over 600 tube types.
- Tests OZ4 and other gas-filled tubes.
- Employs new 4" meter with sealed air-damping chamber resulting in accurate vibrationless readings
- Use of 22 sockets permits testing all popular tube types and prevents possible obsolescence
- Dual Scale meter permits testing of low current tubes
- 7 and 9 pin straighteners mounted on panel.
- All sections of multi-element tubes tested simultaneously.
- Ultra-sensitive leakage test circuit will indicate leakage up to 5 megohms.

Model 82A comes housed in handsome, portable Saddle-Sitched Texon case. Only \$36<sup>50</sup> (Picture Tube Adapter available for \$5.50 additional)

**\$36<sup>50</sup>**

Production of this Model was delayed a full year pending careful study by Superior's engineering staff of this new method of testing tubes. Don't let the low price mislead you! We claim Model 82A will outperform similar looking units which sell for much more—and as proof, we offer to ship it on our examine before you buy policy.

To test any tube, you simply insert it into a numbered socket as designated, turn the filament switch and press down the quality switch—**THAT'S ALL!** Read quality on meter. Inter-element leakage if any indicates automatically.

We invite you to try before you buy any of the models described on this page, the preceding page and the following pages. If after a 10 day trial you are completely satisfied and decide to keep the Tester, you need send us only the down payment and agree to pay the balance due at the monthly indicated rate.

**NO INTEREST OR FINANCE CHARGES ADDED!**

If not completely satisfied, you are privileged to return the Tester to us, cancelling any further obligation.

**SEE OTHER SIDE**

CUT OUT AND MAIL TODAY! ▶

MOSS ELECTRONIC, INC.

Dept. D-585 3849 Tenth Ave., New York 34, N. Y.

Please send me the units checked on approval. If completely satisfied I will pay on the terms specified with no interest or finance charges added. Otherwise, I will return after a 10 day trial positively cancelling all further obligation.

- |  |   |
|--|---|
| <input type="checkbox"/> Model 76.....Total Price \$26.95<br>\$6.95 within 10 days. Balance \$5.00 monthly for 4 months.     | <input type="checkbox"/> Model 82A.....Total Price \$36.50<br>\$6.50 within 10 days. Balance \$6.00 monthly for 5 months. |
| <input type="checkbox"/> Model TV-50A....Total Price \$47.50<br>\$11.50 within 10 days. Balance \$6.00 monthly for 6 months. | <input type="checkbox"/> Include Model 82A Picture Tube Adapter at \$5.50.  |
| <input type="checkbox"/> Model 77.....Total Price \$12.50<br>\$12.50 within 10 days. Balance \$6.00 monthly for 5 months.    | <input type="checkbox"/> Model 80.....Total Price \$12.50<br>\$12.50 within 10 days. Balance \$6.00 monthly for 5 months. |

Name .....

Address .....

City ..... Zone ..... State .....

All prices net, F.O.B., N. Y. C.



# SHIPPED ON APPROVAL NO MONEY WITH ORDER — NO C. O. D.



**Model 77—VACUUM TUBE VOLT-METER.** . . . Total Price . . . \$42.50  
Terms: \$12.50 after 10 day trial, then \$6.00 monthly for 5 months if satisfactory. Otherwise return, no explanation necessary.

Superior's  
New  
Model 77

## VACUUM TUBE VOLTMETER WITH NEW 6" FULL-VIEW METER

Compare it to any peak-to-peak V. T. V. M. made by any other manufacturer at any price.

- Extra large meter scale enables us to print all calibrations in large easy-to-read type.
- Employs a 12AU7 as D. C. amplifier and two 9006's as peak-to-peak voltage rectifiers to assure maximum stability. • Meter is virtually burn-out proof. The sensitive 400

**AS A DC VOLTMETER:** The Model 77 is indispensable in Hi-Fi Amplifier servicing and a must for Black and White and color TV Receiver servicing where circuit loading cannot be tolerated.

**AS AN ELECTRONIC OHMMETER:** Because of its wide range of measurement leaky capacitors show up glaringly. Because of its sensitivity and low loading, Intermittents are easily found, isolated and repaired.

**AS AN AC VOLTMETER:** Measures RMS values if sine wave, and peak-to-peak value if complex wave. Pedestal voltages that determine the "black" level in TV receivers are easily read.

micro-ampere meter is isolated from the measuring circuit by a balanced push-pull amplifier. • Uses selected 1% zero temperature coefficient resistors as multipliers. Th assures unchanging accurate readings on a ranges.

### SPECIFICATIONS

- DC VOLTS—0 to 3/15/75/150/300/750/1,500 volts at 11 megohms input resistance
- AC VOLTS (RMS)—0 to 3/15/75/150/300/750/1,500 volts. • AC VOLTS (Peak to Peak)—0 to 8/40/200/400/800/2,000 volts
- ELECTRONIC OHMMETER—0 to 1,000 ohms/10,000 ohms/100,000 ohms/1 meg ohm/10 megohms/100 megohms/1,000 meg ohms. • DECIBELS—-10 db to +18 db +10 db to +38 db, +30 db to +58 db All based on 0 db = .006 watts (6 mw) into a 500 ohm line (1.73v).
- ZERO CENTER METER—For discriminator alignment with full scale range of 0 to 1.5/7.5/37.5/75/150/375/750 volts at 11 megohms input resistance.

Comes complete with operating instructions, probe leads, and streamlined carrying case. Operates on 110-120 volt 60 cycle. Only **\$42.50**

SUPERIOR'S NEW MODEL 80

## 20,000 OHMS PER VOLT ALLMETER

THE ONLY 20,000 OHMS PER VOLT V.O.M. SELLING FOR LESS THAN \$50 WHICH PROVIDES ALL THE FOLLOWING FEATURES

- ✓ 6 INCH FULL-VIEW METER provides large easy-to-read calibrations. No squinting or guessing when you use Model 80.
- ✓ MIRRORED SCALE permits fine accurate measurements where fractional readings are important.
- ✓ CAPACITY RANGES permit you to accurately measure all condensers from .00025 MFD to 30 MFD in addition to the standard volt, current, resistance and decibel ranges.
- ✓ HANDSOME SADDLE-STITCHED CARRYING CASE included with Model 80 Allmeter at no extra charge enables you to use this fine instrument on outside calls as well as on the bench in your shop.

- SPECIFICATIONS:
- 7 D.C. VOLTAGE RANGES (At a sensitivity of 20,000 Ohms per Volt 0 to 15/75/150/300/750/1500/7500 Volts.
  - 6 A.C. VOLTAGE RANGES (At a sensitivity of 5,000 Ohms per Volt 0 to 15/75/150/300/750/1500 Volts.
  - 3 RESISTANCE RANGES: 0 to 2,000/200,000 Ohms. 0-20 Megohm.
  - 2 CAPACITY RANGES: .00025 Mfd. to .3 Mfd., .05 Mfd. to 30 Mf
  - 5 D.C. CURRENT RANGES 0-75 Microamperes 0 to 7.5/75/750 Milliamperes. 0 to 15 Amperes
  - 3 DECIBEL RANGES: -6 db to +18 db. +14 db to +38 db +34 db to +58 db

Model 80 Allmeter comes complete with operating instructions, test leads and portable carrying case. Only **\$42.50**



**Model 80 ALLMETER** . . . Total Price . . . \$42.50  
Terms: \$12.50 after 10 day trial, then \$6.00 monthly for 5 months if satisfactory. Otherwise return, no explanation necessary.

NOTE: The line cord is used only for capacity measurements. Resistance ranges operate on self-contained batteries.

## TRY FOR 10 DAYS BEFORE you buy THEN if satisfied

pay in easy, interest free, monthly payments. See coupon inside.

We invite you to try before you buy any of the models described on this and the preceding pages. If after a 10 day trial you are completely satisfied and decide to keep the Tester, you need send us only the down payment and agree to pay the balance due at the monthly indicated rate. (See other side for time payment schedule details.)

**NO INTEREST OR FINANCE CHARGES ADDED!**

If not completely satisfied, you are privileged to return the Tester to us, cancelling any further obligation.

**SEE OTHER SIDE**

CUT OUT AND MAIL TODAY!

FIRST CLASS

Permit No. 61430

New York, N. Y.

BUSINESS REPLY CARD

No Postage Stamp Necessary if Mailed in the U. S.

VIA AIR MAIL

POSTAGE WILL BE PAID BY —

MOSS ELECTRONIC, INC.

3849 TENTH AVENUE

NEW YORK 34, N. Y.