

Hi-Fi Report on 16-RPM Records

POPULAR ELECTRONICS

AUGUST
1957

35
CENTS

'Phone Completes Kit Station

(see page 53)

Build Your Own

- \$5 Coax Speaker
- Etched Circuit Receiver
- Penlite Cell Rejuvenator
- AM Reception Booster

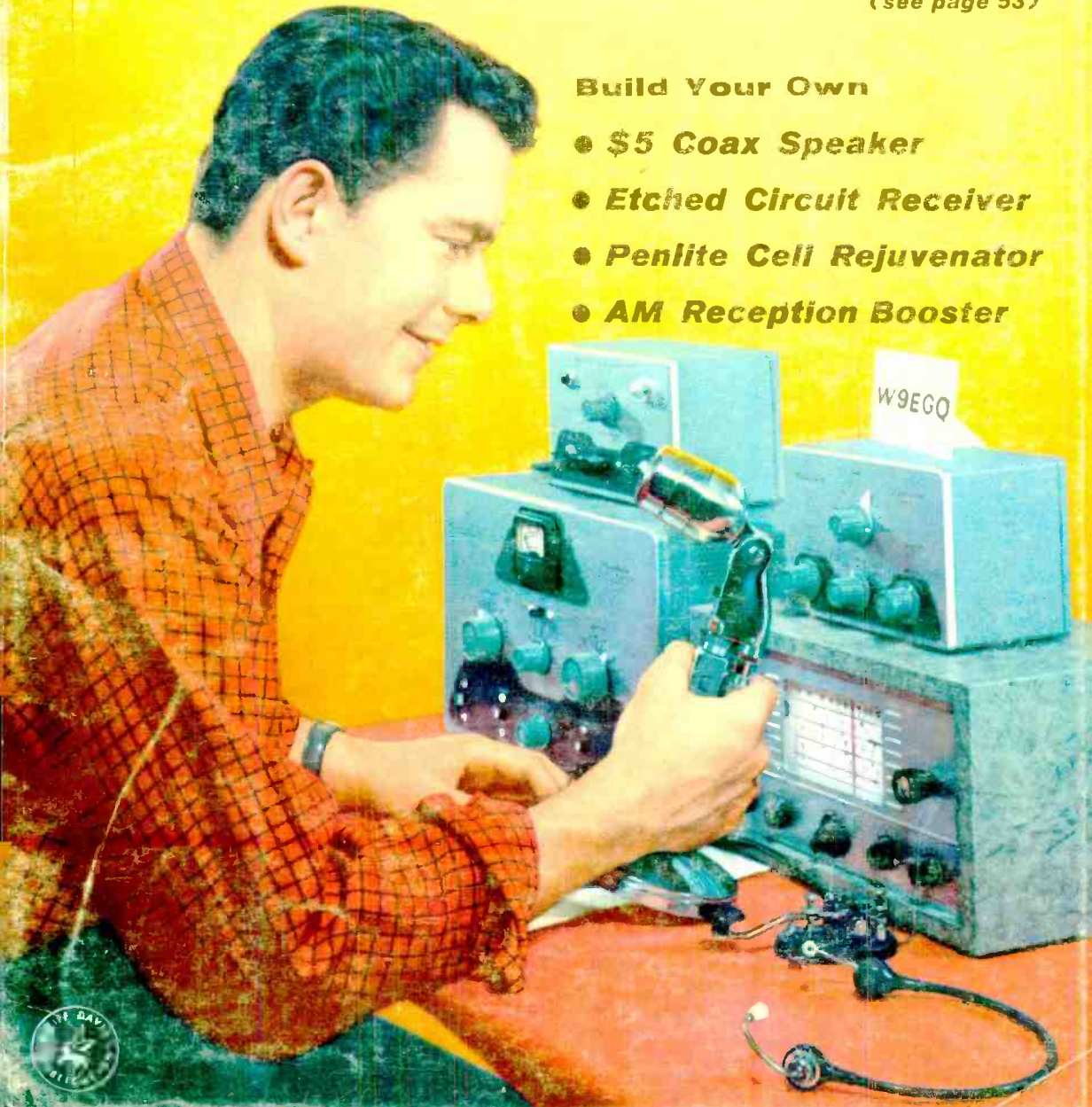



NC-66 is shown with RDF-66 Direction Finder Accessory



PORTABLE RECEIVER

for home and away—indoors and outdoors



WORLD'S MOST VERSATILE RECEIVER! . . . a ham receiver, a 3-way portable, a marine receiver, and an SWL receiver.

For home and away—indoors and out.

National's new NC-66 offers you AC/DC-battery operation, five-band coverage from 150 kc to 23 mc, electrical bandsread with logging scale, plus a fixed-tuned CW oscillator. Housed in a handsome, rugged metal cabinet with a carrying handle, National quality is evident throughout this great new portable. You'll find it attractively functional with a long "Full-Vue" slide rule dial, a quality 5" PM speaker, and a phone jack. It also has *two* antennas: whip and loop stick.

For boat owners a special marine band from 150 kc to 400 kc covers maritime DF beacon service. And, of course, CD positions are clearly marked.

FEATURES:

- ★ Continuous coverage of DF beacons, AM broadcast, amateur and world-wide shortwave bands. 150-400 kc, .5 to 23 mc.
- ★ Operates on 115 volt AC or DC or self-contained batteries, or 220 volt AC with accessory adaptor.
- ★ Full electrical bandsread.
- ★ Provisions for external direction finder for marine use.
- ★ Salt spray tested.
- ★ Built-in ferrite loop antenna for DF and BC bands.
- ★ Built-in whip antenna for shortwave bands.
- ★ Receives voice or code. Has CW oscillator; and provision for phones.
- ★ "Full-Vue" slide-rule dial with easy-to-read scale. Amateur and principal shortwave bands as well as CD positions clearly marked.
- ★ Logging scale provided.
- ★ Complete with built-in speaker.
- ★ Separate switch for stand-by operation.
- ★ Handsome, modern styling: two-tone metal cabinet, chrome trim, with carrying handle, and enclosed back.

*BAND	COVERAGE
DF	150-400 KC
BC	.50-1.4 MC
1	1.40-4.05 MC
2	4.0-11.4 MC
3	11.0-23 MC

TUNING SYSTEM: Separate general coverage and bandsread tuning capacitors connected in parallel on all bands. Three gang capacitors tune antenna, RF and oscillator circuits. Bandsread knob can be used as a vernier on all frequencies.

AUDIO SYSTEM: Two-stage audio amplifier with 3V4 output tube. Has speaker and phone output jack.

CONTROLS: Main tuning; bandsread; volume control; band selector switch; AM-CW switch; stand-by-off—receive switch.

TUBE COMPLEMENT:

RF	1U4	Audio output	3V4
Converter	1L6	Rectifier	Selenium
CW on-IF Amp.	1U4		
2d Det. — AVC — 1st audio	1U5		

OTHER SPECIFICATIONS:

Antenna input: 50-300 ohms, unbalanced.

Size: 12-5/16" wide x 9-11/16" high x 10" deep (overall).

Finish: two-tone gray.

Shipping weight: 16 lbs. less batteries.

Optional accessories: RDF-66 Loop, 220V. adaptor.

Only \$12.95* down

Up to 20 months to pay at most Receiver Distributors.

*Suggested Price: \$129.95**
RDF-66 Direction Finder Accessory available at additional cost

**Prices slightly higher west of Rockies and outside U.S.A.

NC-66

Eight out of 10 U.S. Navy ships use National receivers

SINCE **National** COMPANY, INC., Malden 48, Mass.

tuned to tomorrow





I WILL TRAIN YOU AT HOME FOR GOOD PAY JOBS IN RADIO-TELEVISION

J. E. SMITH has trained more men for Radio-Television than any other man. OUR 40th YEAR.

America's Fast Growing Industry Offers You Good Pay—Bright Future—Security

I TRAINED THESE MEN

 "Started to repair sets six months after enrolling. Earned \$2 to \$15 a week in spare time."—A. J. Krandik, Jr., Sunneystown, Pennsylvania.

 "Up to our necks in Radio-Television work. Four other NRI men work here. Am happy with my work."—Glen Peterson, Bradford, Ont., Canada.

 "Am doing Radio and Television Servicing full time. Now have my own shop. I owe my success to N.R.I."—Curtis Stath, Ft. Madison, Iowa.

 "Am with WCOC. NRI course can't be beat. No trouble passing 1st class Radio-phone license exam."—Jesse W. Parker, Meridian, Mississippi.

 "By the time I graduated I had paid for my course, a car and testing equipment. Can service toughest jobs."—E. J. Streitenberger, New Boston, Ohio.

AVAILABLE TO VETERANS UNDER G.I. BILLS

Training plus opportunity is the PERFECT COMBINATION for job security, good pay, advancement. In good times, the trained man makes the BETTER PAY, GETS PROMOTED. When jobs are scarce, the trained man enjoys GREATER SECURITY. NRI training can help assure you more of the better things of life.

Start Soon to Make \$10, \$15 a Week Extra Fixing Sets

Keep your job while training. I start sending you special booklets the day you enroll, that show you how to fix sets. Multitester built with parts I send helps you make \$10, \$15 a week extra fixing sets while training. Many start their own Radio-Television business with spare time earnings.

My Training Is Up-To-Date
You benefit by my 40 years' experience training men at home. Well illustrated lessons give you basic principles you need. Skillfully developed kits of parts I send (see below) "bring to life" things you learn from lessons.

You Learn by Practicing with Parts I Send



Nothing takes the place of PRACTICAL EXPERIENCE. That's why NRI training is based on LEARNING BY DOING. You use parts I furnish to build many circuits common to Radio and Television. As part of my Communications Course, you build many circuits, including low power transmitter shown at left. You put it "on the air," perform procedures required of broadcast operators. With my Servicing Course you build modern Radio, etc.; use Multitester you build to make money fixing sets in spare time while training. You can stay at home, keep your job, learn Radio-TV in spare time at low cost. Mail coupon for book showing other equipment you build and keep.

The Tested Way To Better Pay!

2 FREE BOOKS SHOW HOW MAIL COUPON



Television Making Good Jobs, Prosperity—Even without Television, Radio is bigger than ever. 115 million home and auto Radios are big market for servicing. 3000 broadcasting stations use operators, technicians. Government, Aviation, Police, Ship, Micro-wave Relay, Two-way Radio Communications for buses, taxis, trucks, R. R. are growing fields. Television is moving ahead fast.

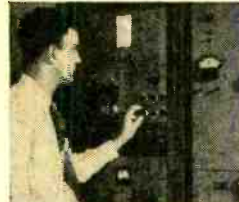

About 200 Television stations are now on the air. Hundreds of others being built. Good TV jobs opening up for Technicians, Operators, etc.

25 million homes now have Television sets. Thousands more are being sold every week. Get a job or have your own business selling, installing, servicing.

Radio-TV Needs Men of Action—Mail Coupon

Without obligating you in any way, I'll send an actual lesson to prove that my training is practical, thorough; 64-page book to show good job opportunities for you in Radio-TV. Terms for NRI training are as low as \$5 a month. Many graduates make more in two weeks than total cost of training. Mail coupon now. J. E. SMITH, President, National Radio Institute, Dept. 7HD4, Washington, D. C. OUR 40TH YEAR.

Good for Both—FREE

The ABC's of Servicing

Job and Career Opportunities for RADIO-TV TECHNICIANS

NATIONAL RADIO INSTITUTE, Dept. 7HD4
Washington 16, D. C.

Mail me Sample Lesson and 64-page Book, FREE,
(No salesman will call. Please write plainly.)

Name..... Age.....

Address.....

City..... Zone..... State.....

ACCREDITED MEMBER NATIONAL HOME STUDY COUNCIL

POPULAR ELECTRONICS is published monthly by Ziff-Davis Publishing Company, William B. Ziff, Chairman of the Board (1946-1953), at 64 E. Lake St., Chicago 1, Ill. Entered as second class matter August 27, 1954 at the Post Office, Chicago, Illinois. SUBSCRIPTION RATES: One year U.S. and possessions, and Canada \$4.00; Pan-American Union countries \$4.50, all other foreign countries \$5.00.

POPULAR ELECTRONICS

VOLUME 7

NUMBER 2

CONTENTS

FEATURE Articles and Electronic Developments

Home-Built Model Spaceship.....	Louis E. Garner, Jr.	35
Stereo Hi-Fi Hearing Aid.....		38
New Era in Eating.....		39
Airborne Electronics.....		44
The Germans Have a Way With It.....		48
Oscilloscope Traces—Probing the Power Pack.....	Howard Burgess	55
Crossword Puzzle.....	Arthur L. Branch	69

ELECTRONIC Build-It-Yourself Projects

Booster for Your AM Radio.....	Donald H. Rogers	45
Modulating Your Heathkit Transmitter.....	Jay Stanley	53
Subminiature Code Practice Set.....	E. G. Louis	59
"Bridge" Your Way Out of the Junk Box.....	Rufus P. Turner	67
Sensitive Light-Operated Relay.....	Frank H. Tooker	70
Photographer's Light Distributor.....	Louis E. Garner, Jr.	76
Building an Etched Circuit Receiver.....	Donald A. Smith	79
Miniature Dry Cell Rejuvenator.....	Frank H. Tooker	91

AUDIO and Hi-Fi Features

Midsummer Hi-Fi Roundup.....		41
Pity the Poor Loudspeaker.....	Leonard Feldman	49
The Fourth Speed.....	Norman Eisenberg	63
Building a "Spare" Amplifier.....	Alan M. Grant	93
Make Your Own \$5 Coax Speaker.....	Luis Vicens	98

Experimenter's Workshop

Buzzer-Type Power Supply.....	Rufus P. Turner	61
Versatile Banana Plugs Simplify Connections.....	Art Trauffer	62
Drill, Cut and Smooth.....	Glenn A. Wagner	73
Adapter Quickly Connects Phone Tips to Miniature Jack.....	Carl Dunant	81
Housewife's Helper or Who Has My Soldering Gun?.....	Walker A. Tompkins	96

Miscellaneous Electronic News

Atom Power for Sale.....		40
"Midget" Electronic Brain.....		40
Miss TV? Never!.....		40
Shorty Packs a Real Big Wallop.....		47
Guided Missile Is Antenna Farm.....		52
His Guests Get Hi-Fi Treatment.....		52
R/C Safety Traffic Lights.....		58
Sardine-Can Beacon.....		58
Shock in Stock.....		58
Tasty Ladder.....		58
"Robbie" the Robotester On the Job.....		60
One At a Time!.....		66
Keeping Tabs on a "Dreamboat".....		72
Your Teeth on TV.....		72

(Also see page 6 for DEPARTMENTS)

Cover photo by Maynard Frank Wolfe

Copyright © 1957 by Ziff-Davis Publishing Company.
All rights reserved.

Average Net Paid Circulation 236,551

AUGUST

1957

Publisher

OLIVER READ, WIETI

Managing Editor

OLIVER P. FERRELL

Technical Editor

CHARLES S. TEPFER

Associate Editors

MIKE BIENSTOCK
HANS H. FANTEL
MARGARET MAGNA

Editorial Assistant

ARDEANE TRATZKI

Contributing Editors

H. BENNETT L. E. GARNER, JR.
H. S. BRIER H. POLLACK
N. EISENBERG R. P. TURNER
J. T. FRYE

Art Editor

ALFONS J. REICH

Art and Drafting Dept.

J. A. GOLANEK M. WHELPLEY
W. K. VAHLSING J. A. ROTH

Advertising Director

L. L. OSTEN

Advertising Manager

WILLIAM G. McROY



ZIFF-DAVIS PUBLISHING CO., 366 Madison Ave., New York 17, N. Y. B. G. Davis, President; William Ziff, Administrative Vice President; H. J. Morganroth, Vice President; Michael H. Froelich, Vice President; Michael Michaelson, Vice President and Circulation Director; George Carney, Secretary-Treasurer; Albert Gruen, Art Director.



Member
Audit Bureau
of Circulations



BRANCH OFFICES: Midwestern Office, 64 E. Lake St., Chicago, Ill., John A. Ronan, Jr., manager; Western Office, Room 412, 215 W. 7th St., Los Angeles 17, Calif., John E. Payne, manager.

SUBSCRIPTION SERVICE:

All communications concerning subscriptions should be addressed to Circulation Dept., 64 E. Lake St., Chicago 1, Ill. Include your old address as well as new—enclosing if possible an address label from a recent issue of this magazine. Allow at least 4 weeks for change of address.

CONTRIBUTORS:

Contributors are advised to retain a copy of their manuscripts and illustrations. Contributions should be mailed to the New York Editorial Office and must be accompanied by return postage. Contributions will be handled with reasonable care, but this magazine assumes no responsibility for their safety. Any copy accepted is subject to whatever adaptations and revisions are necessary to meet the requirements of this publication. Payment covers all author's, contributor's and contestant's rights, titles, and interest in and to the material accepted and will be made at our current rates upon acceptance. All photos and drawings will be considered as part of material purchased.

POPULAR ELECTRONICS

These men are getting practical training in . . .

ELECTRICITY

ELECTRONICS

ON REAL

A.C. and D.C. Motors
Generators
Switchboards
Controllers
Appliances
Electronic Units

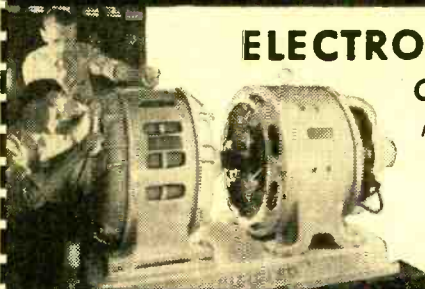

TELEVISION

COLOR-TV

ON REAL

Television
Receivers
Including Color TV
AM and FM Radios
Auto Radios
Test Equipment



Train in Great Shops of COYNE

in Chicago—Prepare for a better job and a real future in **TOP OPPORTUNITY FIELDS**. Train on real full-size equipment at **COYNE** where thousands of successful men have trained for nearly 60 years—*largest, oldest, best equipped school of its kind*—est. 1899. Trained instructors show you how, then do practical jobs yourself. No previous experience or advanced education needed. Employment Service to Graduates.

START NOW—PAY LATER—Liberal Finance and Payment Plans. Part-time employment help for students. **GET FREE BOOK**—"Guide to Careers in **ELECTRICITY -ELECTRONICS and TELEVISION-RADIO**"—no obligation; no salesman will call. Vets and Non-Vets get vital facts now.

Coyne Electrical School 500 So. Paulina Street
Chartered Not For Profit Chicago 12, Dept. C7-71H



MAIL COUPON TODAY!

COYNE ELECTRICAL SCHOOL
500 S. Paulina St., Chicago 12, Ill., Dept. C7-71H

Send **BIG FREE** book and details of your training offer by return mail. I am interested in:

Electricity-Electronics Television-Radio

Name _____

Address _____

City _____ State _____

**COYNE offers
LOW COST**

TELEVISION RADIO - COLOR TV

Training in
Spare Time **AT HOME**



The future is **YOURS** in **TELEVISION!**

A fabulous field—good pay—fascinating work—a prosperous future in a good job, or independence in your own business!

Coyne brings you **MODERN-QUALITY** Television Home Training; training designed to meet Coyne standards at truly lowest cost—you pay for training only—no costly "put together kits." Not an old Radio Course with Television "tacked on." Here is **MODERN TELEVISION TRAINING** including **Radio, UHF and Color TV**. No Radio background or previous experience needed. Personal guidance by Coyne Staff. **Practical Job Guides** to show you how to do actual servicing jobs—*make money early in course*. Free Life-time Employment Service to Graduates.

**COYNE
ELECTRICAL SCHOOL**

A TECHNICAL TRADE INSTITUTE OPERATED
NOT FOR PROFIT

600 S. Paulina Street, Chicago 12, Dept. C7-HT7

B. W. COOKE, JR.
President



Coyne—the Institution behind this training... the largest, oldest, best equipped residential school of its kind. Founded 1899.

Send Coupon for Free Book

and full details,
including easy
Payment Plan.
No obligation, no
salesman will call.



COYNE Television Home Training Division

500 S. Paulina St., Chicago 12, Ill.
Dept. C7-HT7

Send Free Book and details on how I can get
Coyne Quality Television Home Training at
low cost and easy terms.

Name _____

Address _____

City _____ State _____

**HOBBYISTS • ENGINEERS
EXPERIMENTERS
VOLUME TWO
IS THE BOOK
FOR YOU**



APPLICATIONS BOOK VOLUME TWO

It contains a wide variety of new designs never before published. More than a collection of circuits, it contains complete construction information including wiring diagrams, illustrations and parts lists. It has complete sections on receivers, amplifiers, ham gear, test equipment and a full section on other useful transistorized gadgets.

There is a full section on basic transistor theory and circuit design, too, plus a section of installation and wiring hints on transistors and information on printed circuitry.

Get Volume II from your Raytheon Tube Supplier or send 50¢ to Raytheon Dept. V2.



Excellence in Electronics

RAYTHEON MANUFACTURING COMPANY
Newton 58, Massachusetts

Tubes • Transistors • Military and Commercial Equipment

DEPARTMENTS

Carl & Jerry	John T. Frye 10
Letters from Our Readers	24
Tips and Techniques	28
POP'tronics Bookshelf	32
Tuning the Short-Wave Bands	Hank Bennett 78
After Class	82
The Transmitting Tower	Herb S. Brier 85
Transistor Topics	Lou Garner 88
Tools and Gadgets	106

**COMING NEXT MONTH
(SEPTEMBER)**



(ON SALE AUGUST 20)

Want to build a computer that really does something? Look for the "battle of numbers" in our September issue wherein the computer plays against the operator. It's hard to beat—unless you know how. You'll also find construction projects on a "frost sentinel"—an alarm setup with a thermistor—and a frequency standard for the ham or SWL which can be built with a minimum of effort. Part 2 in our series on oscilloscopes will deal with what happens when hum appears in an amplifier circuit, and there will be a special feature for the hi-fi fan—soundproofing the hi-fi equipment room so that the neighbors will stop that knocking!

**IN THIS MONTH'S
RADIO & TV NEWS
(AUGUST)**

- "Operation Jupiter"
- "Ultraflex" Speaker Enclosure
- Transistorized Intercom
- A New FM Kit for Hi-Fi
- High Power vs Low Power Amplifiers—
- Questions and Answers
- Rumble Filters for Hi-Fi Systems

New! A MACHINE THAT COMPOSES MUSIC

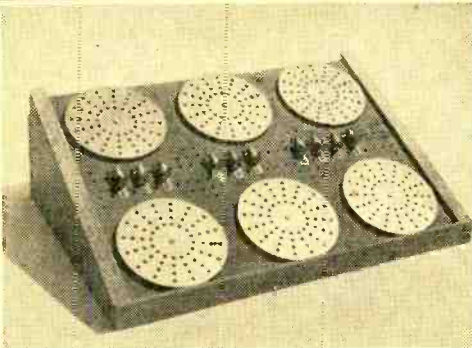

Actual tune composed on GENIAC

COMPUTES, "REASONS" PLAYS GAMES

GENIAC

ELECTRIC BRAIN

BUILD IT YOURSELF in a few hours!

Yes, you build any one of 33 exciting electric brain machines in just a few hours by following the clear-cut, step-by-step directions given in a thrilling booklet! No soldering required . . . no wiring beyond your skill! GENIAC is a genuine brain machine—not a toy. The **only** logic machine kit that not only adds, subtracts, etc., but presents the basic ideas of cybernetics, Boolean algebra, symbolic logic, automation, etc. So simple to construct that even a twelve-year-old can make a machine that will fascinate people with advanced scientific training! With the special circuitry of GENIAC, the Electric Brain Construction kit, you can compose tunes automatically. These new circuits were never available before!

OVER 400 COMPONENTS AND PARTS. Circuits operate on one flashlight battery, and the use of ingeniously designed parts makes building circuits one of the most fascinating things you've ever done! You set up problems in a variety of fields—and get your answers quicker than you can set them up! Play games with the machine—nim, tic-tac-toe, etc.—and pit your brain against its logic! Solves puzzles in a few seconds that would take you hours without the aid of the machine. You actually see how computing and problem-solving is analyzed with algebraic solutions transferred directly into circuit diagrams.

YOUR COST FOR GENIAC KIT: only \$19.95 postpaid. The 1957 Model GENIAC KIT contains: (1) a complete 200-page text, "Minds and Machines"—a basic introduction to computers. (2) "How to Construct Electrical Brains At Home"—a fully illustrated text book on basic computer design theory and circuits with specific instructions for building circuits. (3) Wiring Diagram Manual. A special booklet with full scale diagrams that you can tear out and place on your work bench for easy assembly. (4) Beginners' Manual. Starting from scratch, the manual adds extra experiments, thoroughly tested using GENIAC components to teach the basic symbols of electric circuits. (5) Over 400 components and parts.

So—mail the coupon for your GENIAC today! Your money back if not delighted!

Some Firms and Institutions that have ordered GENIAC:

Allis-Chalmers Remington-Rand International Business Machines Wneeldex Mfg. Co. Manuel Missionary College	Walter V. Clarke Associates Barnard College Westinghouse Electric Phillips Laboratories	General Insurance Co. of America Lafayette Radio Rohr Aircraft Co. Albert Einstein Medical College Naval Research Laboratories	Los Angeles Public Schools Kansas State University Duke University Coral Gables Bell Telephone Laboratories
--	---	---	--

KIT—Only
\$19⁹⁵

(Add \$1.00 W. of Miss.
\$2.00 Outside U. S.)

UP TO DATE?

Is your knowledge of these new technical fields rusty? Perhaps you never had time to study them but need to now. Write for free information about our new, modern, low-cost course. Work at your own speed at home. Check those that interest you.

- | | | | |
|---|---|---|--|
| <p>PHYSICS</p> <p><input type="checkbox"/> High School Physics</p> <p><input type="checkbox"/> Part 1—PIA</p> <p><input type="checkbox"/> Part 2—PIB</p> <p><input type="checkbox"/> College Physics</p> <p><input type="checkbox"/> Part 1—P2A</p> <p><input type="checkbox"/> Part 2—P2B</p> <p>MATHEMATICS</p> <p><input type="checkbox"/> Trigonometry</p> <p><input type="checkbox"/> Algebra</p> <p><input type="checkbox"/> Solid Geometry</p> <p><input type="checkbox"/> Calculus</p> <p><input type="checkbox"/> Statistics</p> <p><input type="checkbox"/> Please send me GENIAC Kit. \$19.95 (Add \$1.00 West of Mississippi or \$2.00 Outside U. S.)</p> | <p>ELECTRONICS</p> <p><input type="checkbox"/> Television P3A</p> <p><input type="checkbox"/> Radio P3B</p> <p><input type="checkbox"/> Radar—Theoretical P3C1</p> <p><input type="checkbox"/> Radar—Practical P3C2</p> <p><input type="checkbox"/> Musical Instruments P3D</p> <p>CHEMISTRY</p> <p><input type="checkbox"/> High School</p> <p><input type="checkbox"/> College</p> <p><input type="checkbox"/> Analytic</p> <p><input type="checkbox"/> Qualitative</p> <p><input type="checkbox"/> Quantitative</p> <p><input type="checkbox"/> Organic</p> <p><input type="checkbox"/> Physical</p> | <p>BIOLOGY</p> <p><input type="checkbox"/> High School</p> <p><input type="checkbox"/> Human Biology</p> <p><input type="checkbox"/> Zoology</p> <p><input type="checkbox"/> Botany</p> <p><input type="checkbox"/> Genetics</p> | <p><input type="checkbox"/> Acoustics Hi-Fi P4</p> <p><input type="checkbox"/> Nuclear Physics P5</p> <p><input type="checkbox"/> Analog Computer C3</p> <p><input type="checkbox"/> Digital Computer C2</p> <p><input type="checkbox"/> Memory Storage C1</p> <p><input type="checkbox"/> Construction of Robots P57</p> <p>PSYCHOLOGY</p> <p><input type="checkbox"/> Normal PS1</p> <p><input type="checkbox"/> Child PS2</p> <p><input type="checkbox"/> Abnormal PS3</p> <p><input type="checkbox"/> Mental Hygiene PS4</p> <p><input type="checkbox"/> Aptitude Test PS5</p> <p><input type="checkbox"/> Rapid Reading PS6</p> <p><input type="checkbox"/> Construction of Robots PS7</p> |
|---|---|---|--|

OLIVER GARFIELD CO., Dept. PE-87A, 31 Broadway, New Haven, Conn.

Name..... Age..... Occupation.....
City..... Zone..... State.....

BUILD THE BEST—

**BUILD ALLIED'S OWN
knight-kits[®]**

LOWEST COST because our giant buying power passes biggest savings on to you...you do the easy assembly, get professional results, and **SAVE!**



knight-kits

EASIEST TO BUILD because KNIGHT-KIT "Step-and-Chek" instruction manuals are marvels of clarity—it's just like having a good instructor at your side.



knight-kits

MONEY-BACK GUARANTEE: When properly assembled, KNIGHT-KITS fully meet published specifications, or we refund your money.

EASY TERMS AVAILABLE



FREE SUPPLEMENT

featuring knight-kits



Send for our special Supplement No. 165 featuring the complete line of KNIGHT-KIT Test Instruments, Hobby, Hi-Fi and Amateur Kits. Send for it today.

FASCINATING NEW TRANSISTOR KITS

knight-kit 10-CIRCUIT TRANSISTOR LAB KIT



Model Y-299

\$15.45

Sensational—work with transistors! Assemble the basic parts once, then complete project after project (10 in all), just by plugging leads into proper jacks on printed-circuit board—no wiring changes needed. Make the following: AM radio; amplifier; wireless broadcaster; code practice oscillator; electronic timer, switch, flasher; voice-operated, capacity-operated and photoelectric relays. Includes all parts, 2 transistors, battery, headphone, instructions for projects. Shpg. wt., 3 lbs.

Model Y-299. Net only.....**\$15.45**

knight-kit 2-TRANSISTOR POCKET RADIO KIT



Model Y-262

\$14.65

Build this pocket-size, two-transistor radio—enjoy loud, clear broadcast-band reception wherever you go! Completely self-contained with built-in ferrite loop antenna—no external antenna required. Printed-circuit board for easiest assembly. Highly efficient reflex-type circuit operates for months and months on long-life alkaline battery supplied. Super-sensitive miniature earpiece gives remarkably good tone. With all parts, including simulated leather case, earpiece and transistors. 4 x 3 3/4 x 1 3/4". Shpg. wt., 1 1/2 lbs.

Model Y-262. Net only.....**\$14.65**

knight-kit TRANSISTOR RADIO HOBBY KIT



Model Y-765

\$4.35

Experiment with the marvel of transistors! Printed circuit mounting board simplifies assembling. Just mount components, solder a few connections and enjoy excellent AM broadcast reception. Compact; fits in palm of your hand; operates from single penlight cell that lasts for months. Complete with all parts, transistor and penlight cell. Easy to assemble. Shpg. wt., 1 lb.

Model Y-765. Net only.....**\$4.35**
Y-266. Headset and Antenna Kit for above...**\$3.15**

FOR HOURS OF LISTENING PLEASURE

knight-kit "SPACE-SPANNER" BANDSWITCHING RECEIVER KIT



Model Y-243

\$15.95

Thrilling 2-band receiver, easy to build—a great value. Bandswitch selects exciting short wave, including amateur, aircraft, police and marine radio (6 to 18 mc), and standard broadcast. Highly sensitive regenerative circuit. Has 4" PM speaker and beam-power output for strong volume. Kit includes calibrated panel, punched chassis, all parts and tubes (less cabinet). Easy to build from step-by-step instruction manual. 7 x 10 1/2 x 6"; for 110-120 v. 50-60 cycle AC or DC. Shpg. wt., 5 lbs.

Model Y-243. Net only.....**\$15.95**
Y-247. Matching cabinet for above.....**\$2.90**

knight-kit "OCEAN HOPPER" RECEIVER KIT



Model Y-740

\$11.75

Tops for exciting broadcast, long wave and short wave reception. Covers 155 to 35.0 mc with plug-in coils (below). Sensitive regenerative circuit; band-spread; for headphone or speaker use. Complete with all parts, tubes and broadcast band coil (less cabinet). Shpg. wt., 5 lbs.

Model Y-740. Net only.....**\$11.75**
Y-746. Matching cabinet for above.....**\$2.90**
Y-741. Long Wave Coil (155-470 kc).....**79c**
Y-742. 1.65-470 kc coil. Y-745. 7-17.5 mc coil } Ea.
Y-743. 2.9-7.3 mc coil. Y-744. 15.5-35 mc coil } **65c**

ORDER FROM ALLIED RADIO 100 N. WESTERN AVE., CHICAGO 80, ILL.

Always say you saw it in—POPULAR ELECTRONICS

FAVORITE HOBBY KITS

knight-kit 2-WAY INTERCOM SYSTEM KIT



Model
Y-295
\$14⁷⁵

Easy to build—ideal for home or office. Consists of Master and Remote unit, each with press-to-talk switch. Remote can be left "open" for distant answering or baby-sitting. In "closed" position, Remote remains private, but can be called and can originate calls. High-gain 2-stage amplifier and 4" PM speakers. Delivers full volume from only a whisper. With tubes and 50-ft. cable. (Up to 200-ft. may be added.) Each unit 4 1/2 x 6 1/2 x 4 3/4"; antique white finish. For AC or DC. Easy to assemble. Shpg. wt., 8 lbs.

Y-295. Net only.....**\$14.75**

knight-kit PHOTO-ELECTRONIC RELAY KIT



Model
Y-702
\$13⁵⁰

Advanced-design, ultra-sensitive photo-electronic system at low cost. Covers 250 ft. with white light—125 ft. with "unseen" light. Consists of Relay kit and Light Source kit, below. Ideal as announcer, counter, burglar alarm (can be set to ring bell continuously when beam is broken). Hundreds of other uses. SPST relay contacts. 6.3-v. terminals provide power for accessories. For 105-120 v., 50-60 cycle AC. Shpg. wt., 6 lbs.

Model Y-702. Relay kit. Net only.....**\$13.50**
Model Y-703. Light Source kit. Net only.....**\$6.75**

EXCLUSIVE TEST EQUIPMENT VALUE

knight-kit "IN CIRCUIT" CAPACITY CHECKER KIT



Model
Y-119
\$12⁵⁰

Remarkable unit checks capacitors while they're still wired in the circuit! All you do is press a button—and the "magic eye" shows opens and shorts. Tests opens and

shorts on capacitors of 20 nmf or greater, even if in parallel with a resistance as low as 50 ohms. Complete; easy to build. Shpg. wt., 5 lbs.

Model Y-119. Net only.....**\$12.50**

SEND FOR FREE SUPPLEMENT!

SEE ALL THE GREAT KNIGHT-KITS

- 23 Test Instruments
- 17 Fascinating Hobby Kits
- 4 Top Value Hi-Fi Kits
- 5 Great Amateur Kits

SEND FOR IT TODAY



ALL PRICES NET F.O.B. CHICAGO
EASY TERMS AVAILABLE

BUILD YOUR OWN HI-FI AND SAVE!

SENSATIONAL knight-kit HI-FI FM TUNER KIT

Model
Y-751
\$37⁷⁵



The best-looking, best-performing tuner kit your money can buy. Covers 88 to 108 mc; features AFC (with special disabling feature); pre-adjusted RF coils; pre-aligned IF'S; cascode broadband RF amplifier; drift-compensated oscillator; fly-wheel tuning control; illuminated lucite pointer. Sensitivity is 10 microvolts for 20 db of quieting across entire band. Printed circuit—no critical wiring. Ideal for use with 20-Watt Knight-Kit amplifier below, or any amplifier with phono-tuner switch. Easy to build—a custom Hi-Fi Tuner you'll be proud of! Shpg. wt., 12 lbs.

Model Y-751. Basic FM Tuner Kit. Net only.....**\$37.75**

knight-kit 20-WATT HI-FI AMPLIFIER KIT

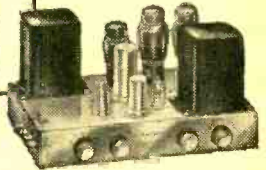

Model Y-750 **\$35⁷⁵**

Ideal for use with above tuner—delivers deluxe Hi-Fi sound. Includes built-in preamp; inputs for magnetic phono, mike, recorder and tuner; record compensator; bass and treble controls, etc. Response: ±1 db, 20-20,000 cps. Distortion: 1% at 20 watts. Outputs: 4, 8, 16, 500 ohms. Chrome-plated chassis, 7 x 13 x 8 3/4". With all parts, tubes and easy instructions. Shpg. wt., 20 lbs.

Model Y-750. Net only.....**\$35.75**
Y-758. Metal enclosure for above; black finish.....**\$4.15**

SAVE \$4.00 ON TUNER-AMPLIFIER COMBINATION

SPECIAL—own the FM Tuner plus the 20-watt Amplifier (including metal enclosure) for only \$73.65. Save \$4.00 on this matched combination. Shpg. wt., 32 lbs.

Y-761. Knight-Kit Tuner and 20-Watt Amplifier. Net. **\$73.65**
Only \$7.37 down on our Easy Pay Plan

ORDER FROM ALLIED RADIO

ALLIED RADIO CORP., Dept. 079-M7
100 N. Western Ave., Chicago 80, Ill.

Ship me the following KNIGHT-KITS:

Quantity	Model	Description

\$_____ enclosed. For parcel post, include postage (express is shipped collect).

Send me your FREE Supplement No. 165 describing all Knight-Kits.

Name _____

Address _____

City _____ Zone _____ State _____

OUR
36th
YEAR

Tom, Tom the Piper's son
Stole a pig and away he run.

He ran to a town near Baltimore
and sold the pig to a butcher store.

The pig changed hands
— and soon he possessed
A twin-coned Norelco — F.R.S.

His father was piping
when Tom returned home
Tom slipped inside — unseen and alone

The piping was tinny —
the music was weak
Tom quickly changed speakers —
and thus did he speak:

“Now play the pipes father
and notice the tone
Such fullness and quality
You have not known.

The reason — Norelco!
The speaker — Twin-Coned!
Both high notes and low notes
Are now fully grown.”

The father — enchanted —
continued to play
The Full Response Speaker
soon held full sway

The neighbors — attracted —
as gnats to a light
Gathered in groups and sighed
with delight

The pig was forgotten —
the theft was obscured
By the beautiful music that soared,
clung and cured.

There is a moral to this tale
Which we are pleased to give
To own and love Norelco
You need not steal a pig.

Norelco F.R.S. Speakers are available
in 5", 8" or 12" sizes in standard imped-
ances. Priced from \$6.75 to \$59.98.*

**ADD TO ... and improve any sound system
with Norelco* FULL RESPONSE SPEAKERS**

Write today to Dept. N8 for brochure
and prices of these unique speakers.

NORTH AMERICAN PHILIPS CO., INC.
High Fidelity Products Division
230 Duffy Ave. Hicksville, L. I., N. Y.

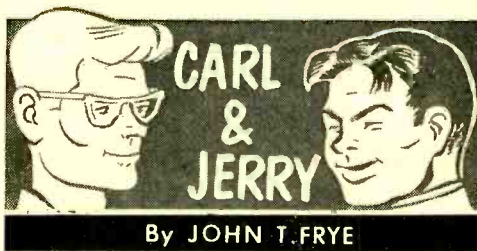
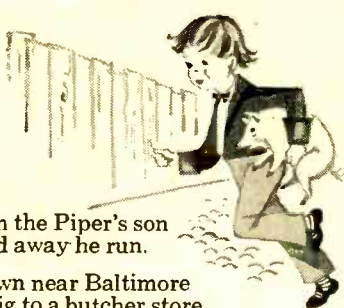

A Crusoe Caper

CARL AND JERRY were a long way from home. Just at daybreak they were in a boat heading out into the Indian River from Titusville, Florida. This so-called Indian River is actually a stretch of salt water between the mainland of Florida's east coast and sheltering Merritt Island. It is part of the Inland Waterway that varies greatly in width. At the point where the boys were, the "river" measured several miles across.

Jerry had come to Florida with Carl and his parents for a two-week vacation, and the boys had talked Carl's folks into letting them spend the day fishing in the salt water of the Indian River. Arrangements for the boat had been made the night before; so at "last dark," as it was known locally, they had loaded their tackle and lunch into the boat and pushed off. Carl sat in the stern operating his prized 25-hp. outboard motor, while Jerry occupied the combination seat-and-live-bait box in the middle of the sturdy wooden boat.

The broad expanse of water was quiet as a mill pond. Only the V-shaped ripples stirred up by the prow of the swiftly moving boat disturbed the waterfowl riding on the glassy surface. The boys headed for a series of low sand bars, spaced roughly a half-mile apart, out in the center of the river. These small artificial islands, produced when the channel was dredged out and the sand pumped into piles, varied widely in size and shape. Some were round; some were quarter-moon shaped; and some were long and narrow. The smaller ones could be crossed in a few steps, while the larger ones were the size of a city block and supported bushes and even small trees.

In about thirty minutes, the boys reached the first of the bars they wanted to fish. Carl throttled the motor down to an idle, and both boys put glistening artificial minnows on the filament lines of their spinning outfits and began to troll in a circle around the bar. Almost at once Jerry got a strike. Carl put the motor into neutral as his chum reeled in a fine sea trout.

"Watch it," Carl advised as Jerry started to remove his bait. "These salt water fish

**LET DeVRY TECH PREPARE YOU IN
SPARE TIME AT HOME AS AN**

ELECTRONICS TECHNICIAN



**NO PREVIOUS TECHNICAL EXPERIENCE
OR ADVANCED EDUCATION NEEDED!**

Laborers and bookkeepers, store clerks, shop men, farmers, salesmen — men of nearly every calling — have taken the DeVry Tech program and today have good jobs or service shops of their own in Electronics. You don't have to quit your present job. If you are 17 to 55, see how you may get yourself ready for a future in the fast-growing Electronics field.

Whether you prepare at home or in our well-equipped Chicago or Toronto Laboratories, you get sound, basic training in both principles and practice. At home, you use educational movies. You build actual circuits and test equipment. You read simple directions, follow clear illustrations. When you finish, you are prepared to step into a good job in an excitingly different field. You may even start a service shop of your own. Mail coupon for free facts today.

Live-Wire Employment Service



Puts you in touch with job opportunities—or helps you toward a better position in the plant where you are now employed.

Draft Age?

We have valuable information for every man of draft age; so if you are subject to military service, be sure to check the coupon.

A SAMPLE LESSON FREE

See for yourself how DeVry Tech trains you for real opportunities in Electronics. We'll also give you a free copy of an interesting booklet, "Electronics and YOU."



**AN INDEX
to a
BETTER JOB,
A BRIGHTER
FUTURE**

Electronics

Radar

Guided
Missiles

Television

Micro-Waves

Communications

Radio

Industrial
Electronics

Computers

Automation
Electronics

Remote Control
Systems

Broadcasting

Your Own
Service Shop

MAIL TODAY FOR FREE FACTS

DeVry Technical Institute

4141 Belmont Ave., Chicago 41, Ill., Dept. PE-8-M

Please give me a FREE Sample Lesson and your booklet, "Electronics and YOU."

NAME _____ AGE _____

STREET _____ Please print _____ APT. _____

CITY _____ ZONE _____ STATE _____

Check here if subject to military training.

#1090

DeVry Tech's Canadian Training Center is located at
626 Roselawn Avenue, Toronto 12, Ontario

"One of North America's Foremost Electronics Training Centers"



Accredited Member
of National
Home Study Council

DEVRY TECHNICAL INSTITUTE

CHICAGO 41, ILLINOIS

FORMERLY

DEFOREST'S TRAINING, INC.



Transistorized 6-Watt Hi-Fi

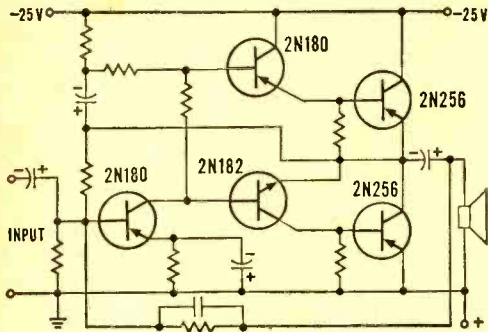

New experimental all-transistor hi-fi amplifier delivers 6 watts with: ± 1.5 db response from 30-15,000 cps, less than 1% harmonic and 2.5% intermodulation distortion, noise level 74 db down. Simple circuit features: pre-driver, driver, and final amplifier using low-cost CBS 2N256 power transistors . . . negative feedback . . . complementary-symmetry driver . . . direct coupling . . . economical power supply.

CBS alloy-junction germanium power transistors 2N255 (6-volt) and 2N256 (12-volt) are useful also in many other economical amplifiers . . . fixed or mobile . . . with up to 10 watts output Class B push-pull. Second Edition of CBS Power Transistor Applications, Bulletin PA-16, helps put them to work. Free, it gives complete data and circuits. Pick it up with your 2N255 and 2N256 transistors at your CBS Tube distributor's — today.



CBS-HYTRON

Semiconductor Operations, Lowell, Mass.
A Division of
Columbia Broadcasting System, Inc.

Carl & Jerry (Continued from page 10)

come bountifully equipped with teeth—some in the darndest places. If you stick your finger into the mouth of one of them, the way you do back home, you're likely to be wondering who caught whom."

"I see what you mean," Jerry said, as he gingerly removed the trout and threw it into the live-bait box. "But now it's your turn to catch a fish—or did you just come along for the ride?"

Jerry did not have long to gloat. Carl had scarcely started the boat before he, too, caught a trout. Time went swiftly for the boys as they continued moving from island to island, picking up three or four fish as they circled each one. The sun shone hotly for a while, but all at once a dark shadow moved across the water, and a sudden wind whistled through the lines stretched out tautly behind the boat.

"LOOKS AS THOUGH we might be going to have a little wind squall," Carl remarked, reeling in his line. "Anyway it's noon; so let's putter over to that next island, eat, stretch our legs, and see what happens."

As the boys headed for the next island, about a half-mile away, the whistling wind was directly at their backs; and when they moved out of the protection of the island they were leaving, they felt the full force of it. Hissing white-caps raced alongside. The surface of the water was puckered and cross-hatched by the rough brushing of the gale. Long swells began to form. The motor slowed down as it pushed the boat to the top of one of these, and then raced as the boat careened down the other side to bury its nose in a wave. Water came in over the sides of the boat in sheets.

Jerry shot a quick look at Carl's white face, then grabbed up the wooden water scoop in the bottom of the boat and began furiously bailing out the water which sloshed around his ankles. Carl scanned the waves that were growing larger by the minute, picked his time carefully, then opened up the motor and brought the boat about. Luck was with him, and they were not caught broadside by a wave. However, as the powerful motor started driving the boat into the wind, the waves crashed against its bottom with a pounding force that threatened to break it to pieces.

Carl throttled the motor back until he was just able to keep the boat heading into the wind. Even then the waves crashing against the bow sent sheets of spray over the two boys. The wind was so strong that it actually drove the boat backward past the island for which they were aiming. As



This man is a "security risk"!

Age, 29. Married. Two children. High school education. Active in local lodge, church, veterans' organization. Employed by large manufacturing concern. Earns \$82 a week.

SOUNDS like an Average Joe. And he is. Too average! He's got a job. It pays fairly well. He's satisfied.

But here's the catch. With the right kind of training, this young

man could be stepping into better jobs. He could be making \$7-8000 a year. He could be cashing in on those spare-time hours he now wastes.

As it stands now, he's stuck in his job. Can't seem to make any headway. He's reluctant to try. So he just hangs on.

This man is a "Security Risk" to his wife and children.

His family probably will never enjoy the comforts, the prestige, the good living that could be theirs. If hard times come, they are almost sure to be hurt. For an Average Joe can't expect to compete with trained men when the chips are down.

A man like this would do well to start a planned program of self-improvement. In his spare time. In a field related to his interests and abilities. Right NOW!

One good way to start—a way proved by hundreds of thousands of once-Average Joes who are making good today—is to enroll for special training with a recognized correspondence school. One like I. C. S., the oldest and largest in the world.

Don't you be a "Security Risk." Mail the coupon for full, free details while there is still time.

For Real Job Security—Get an I. C. S. Diploma!

I. C. S., Scranton 9, Penna.

Member, National Home Study Council

INTERNATIONAL CORRESPONDENCE SCHOOLS



BOX 93949G SCRANTON 9, PENNA.

(Partial list of 257 courses)

Without cost or obligation, send me "HOW TO SUCCEED" and the opportunity booklet about the field BEFORE which I have marked X (plus sample lesson):

ARCHITECTURE and BUILDING CONSTRUCTION

- Air Conditioning
- Architecture
- Arch. Drawing and Designing
- Building Contractor
- Building Estimator
- Carpentry and Millwork
- Carpenter Foreman
- Heating
- Interior Decoration
- Painting Contractor
- Plumbing
- Reading Arch. Blueprints
- ART**
- Commercial Art
- Magazine & Book Illus.
- Show Card and Sign Lettering
- Sketching and Painting

AUTOMOTIVE

- Automobiles
- Auto Body Rebuilding and Refinishing
- Auto Engine Tuneup
- Auto Technician

AVIATION

- Aero-Engineering Technology
- Aircraft & Engine Mechanic

BUSINESS

- Accounting
- Advertising
- Business Administration
- Business Management
- Cost Accounting
- Creative Salesmanship
- Managing a Small Business
- Professional Secretary
- Public Accounting
- Purchasing Agent
- Salesmanship
- Salesmanship and Management
- Traffic Management

CHEMICAL

- Analytical Chemistry
- Chemical Engineering
- Chem. Lab. Technician
- Elements of Nuclear Energy
- General Chemistry
- Natural Gas Prod. and Trans.
- Petroleum Prod. and Engr.
- Professional Engineer (Chem)
- Pulp and Paper Making

CIVIL ENGINEERING

- Civil Engineering
- Construction Engineering
- Highway Engineering
- Professional Engineer (Civil)
- Reading Struc. Blueprints
- Structural Engineering
- Surveying and Mapping

DRAFTING

- Aircraft Drafting
- Architectural Drafting
- Drafting Machine Design
- Electrical Drafting
- Mechanical Drafting
- Sheet Metal Drafting
- Structural Drafting

ELECTRICAL

- Electrical Engineering
- Elec. Engr. Technician
- Elec. Light and Power
- Practical Electrician
- Practical Lineman
- Professional Engineer (Elec)

HIGH SCHOOL

- High School Diploma

- Good English
- High School Mathematics
- Short Story Writing

LEADERSHIP

- Industrial Foremanship
- Industrial Supervision
- Personnel-Labor Relations
- Supervision

MECHANICAL and SHOP

- Diesel Engines
- Gas-Elec. Welding
- Industrial Engineering
- Industrial Instrumentation
- Industrial Metallurgy
- Industrial Safety
- Machine Design
- Machine Shop Practice
- Mechanical Engineering
- Professional Engineer (Mech)
- Quality Control
- Reading Shop Blueprints
- Refrigeration and Air Conditioning
- Tool Design
- Tool Making

RADIO, TELEVISION

- General Electronics Tech.

- Industrial Electronics
- Practical Radio-TV Eng'g
- Practical Telephony
- Radio-TV Servicing

RAILROAD

- Car Inspector and Air Brake
- Diesel Electrician
- Diesel Engr. and Fireman
- Diesel Locomotive

STEAM and DIESEL POWER

- Combustion Engineering
- Power Plant Engineer
- Stationary Diesel Engr.
- Stationary Fireman

TEXTILE

- Carding and Spinning
- Cotton Manufacture
- Cotton Warming and Weaving
- Loom Fixing Technician
- Textile Designing
- Textile Finishing & Dyeing
- Throwing
- Warming and Weaving
- Worsted Manufacturing

Name _____ Age _____ Home Address _____
 City _____ Zone _____ State _____ Working Hours _____ A.M. to P.M. _____
 Occupation _____

Canadian residents send coupon to International Correspondence Schools, Canadian, Ltd., Montreal, Canada. . . . Special tuition rates to members of the U. S. Armed Forces.

PRECISION

...manufacturers of fine electronic test instruments for over 25 years...

INTRODUCES

P A C O

quality test instruments
in KIT FORM

For the first time — a line of test instrument kits engineered and produced under the auspices of a major test equipment manufacturer... and conveniently available directly from your own local electronic parts distributor.

PRECISION's 25 years of experience is your assurance of PACO's superior quality, styling, performance and value.

COMING SOON...

Model G-30
RF Signal Generator

Model Z-80
Audio-RF Signal Tracer

Model M-40
High Sensitivity V-O-M



Model V-70
Vacuum Tube
Voltmeter Kit
Net Price: \$31.50



Model B-10
Battery Eliminator Kit
Net Price: \$41.95



Model S-50
5" Oscilloscope Kit
Net Price: \$47.50



Model C-20
Resistance—Capacity—
Ratio Bridge Kit
Net Price: \$20.95



Model T-60
Tube Checker Kit
Net Price: \$36.75

Available and on display at leading electronic parts distributors. Write for descriptive bulletin.

PACO ELECTRONICS CO., INC.

70-31 84th Street, Glendale 27, L. I., N. Y.

A Division of

PRECISION Apparatus Company, Inc.

Export: 458 Broadway, New York 13, New York

In Canada: Atlas Radio Corp., Ltd., Toronto 10, Ontario

Carl & Jerry (Continued from page 12)

they came into the lee of the island, Carl speeded up the motor and ran the prow of the boat up on the shelving beach.

"Whew! Am I ever glad to be on *terra firma* again!" Jerry exclaimed, throwing himself on the ground and affectionately clutching the coarse grass with both hands.

"That makes two of us," Carl said. "Landlubbers like us have no business out there in a small boat in this kind of weather. I don't mind admitting there was a moment or so there, just before we got headed into the wind, when I didn't think we were going to make it."

AS HE FINISHED SPEAKING, it began to rain. The only shelter the island afforded was a couple of scrub Australian pine trees, no taller than the boys themselves; so Carl and Jerry unloaded the boat, took off the motor, and then dragged the boat up on the shore, propping it on its side with the oars. Huddling underneath the shelter of the boat, they ate their lunch and stared morosely out across the marching white-caps.

"Listen to the wind whistling through the branches of those little pines!" Jerry exclaimed. "That sound gives me the all-overs. It reminds me of the sound effect for a blizzard scene in a Class B movie, and I'm already cold enough without that."

"So am I," Carl admitted, shivering in his wet clothing. "I've got a book of matches here, and we might start a fire if we can find anything dry enough to burn. The rain has slacked off a little; so let's

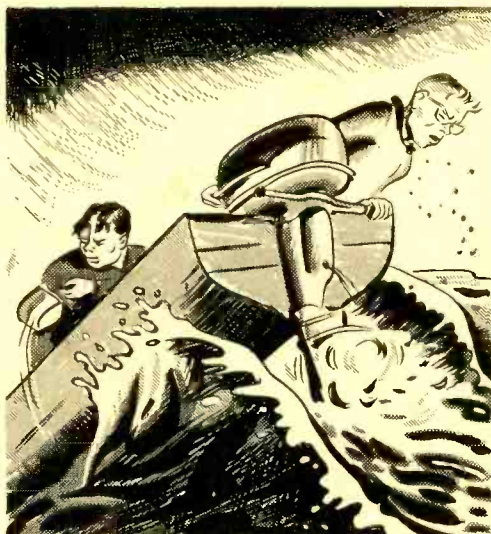

... Jerry shot a quick look at Carl's white face, grabbed up the wooden water scoop in the bottom of the boat, and began furiously bailing out water...

America's Fast Growing AIRLINES



NEED YOUNG MEN

as Communications Specialists

and as RADIO-RADAR-ELECTRONICS
TECHNICIANS

CENTRAL TECHNICAL INSTITUTE PREPARES YOU QUICKLY FOR AN AIRLINE CAREER!

In today's jet age, electronic communications and navigational aids are the vital nerve system of the world's fast-growing airlines. Demand for skilled young specialists who can operate and maintain complex radio-radar-electronic equipment greatly exceeds the supply! Positions include air/ground radio operators, installation and maintenance, airborne radar installation and maintenance, electronic technicians, etc.

The Airline Training Division of Central Technical Institute, world's leading and largest airline personnel school, can train you quickly to take advantage of this unusual career opportunity. Many fine non-technical airline jobs are also open to Central graduates. Free nation-wide placement service

PREPARE THROUGH HOME STUDY OR RESIDENT TRAINING

Whether you choose Central's home study course (with 9 kits of equipment) or resident training at our Kansas City School, you'll receive thorough, up-to-date, nationally-recognized training to qualify you for a rewarding career. Over 14,000 graduates placed with all major U. S. airlines since 1937—your assurance that Central training is effective, practical and profitable. Central's airline instruction is formulated under the guidance of an Airlines Advisory Board composed of representatives from 19 major airlines. Preliminary training need not interfere with present position

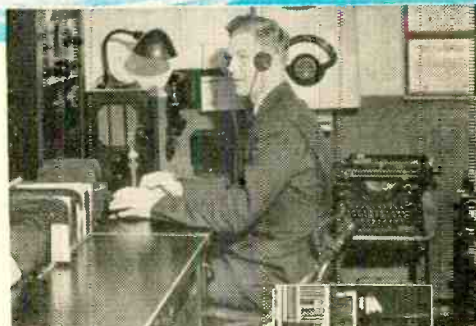

CENTRAL ALSO OFFERS
COMPLETE TRAINING IN
TELEVISION AND
ELECTRONICS

ENGINEERING TECHNOLOGY

Get full information on Central's home study and resident courses which have qualified thousands for well-paying careers in Radio & Television Stations—Radio-TV repair—Electronics Manufacturers—Guided Missiles—Automation—etc



VETERANS

Central offers courses approved under G. I. Bill

MAIL COUPON TODAY
FOR FREE INFORMATION



Member of
National Home
Study Council
and
National
Council
of Technical
Schools



CENTRAL TECHNICAL INSTITUTE

Dept. A-37, 1644 Wyandotte St., Kansas City 8, Missouri
Tell me more about your training program(s) which I have checked below:

- Airline Communications & Electronics
- Airline Station Agent (non-technical)
- Television and Electronics Engineering Technology

Name _____ Age _____

Address _____ Phone _____

City, State _____ County _____

If Korean vet., give approx discharge date _____

COMPACT, POPULAR, LOW COST...

THE RELIABLE

Globe Scout 680

Bandswitching 6-80M, Fone & CW

Only \$99.95

KIT: \$84.95



Wired, Only
\$810
per mo.
10% Down

Compact, completely bandswitching transmitter for 6-80 Meters; allows operation of 6 M band by technicians, novice CW hams, or use by advanced ham without becoming obsolete. Completely self-contained with built-in power supply, for 65 watts CW, 50 watts phone. High level modulation. TVI-shielded cabinet. Pi-Net output on 10-80M; link-coupled output on 6M, matching into low impedance beams. New-type shielded, full-range plastic meter for better readability. Adaptable for Mobile Operation.

Globe Scout 66, as shown, but for Range 10-160M, wired, Only: \$99.95

THE FAST-SELLING

Globe Chief 90

Only \$67.50

Kit: \$54.95

Wired, Only
\$547
per mo.
10% Down



Handsome 90 watt Xmtr. with meter indication at 75 watts, allowing the Novice all the power he can legally use. Self contained, completely bandswitching, 160-10M. Combination Pi-Net, with provisions for antenna changeover relay, speech modulator input, VFO input and operation. Modified Grid-Block Keying for max. safety. Has complete, well-filtered power supply. Kit contains pre-punched chassis, all parts and detailed assembly instructions.

THE TIME-TESTED

Screen Modulator Kit

Designed specifically for use with the above Globe Chief Transmitter, but may be used with similar CW transmitters such as the Heath AT-1, Johnson Adventurer, Knight 50 watt, etc. Permits radio-phone operation at minimum cost. Self contained. All parts, connections to transmitter, 2 dual purpose tubes and detailed assembly manual included.

Only \$13.95

For detailed brochures, write to

WORLD RADIO LABORATORIES

"The World's Largest Distributor of Amateur Radio Equipment"

3415 W. Broadway Council Bluffs, Iowa

Phone 2-0277

Carl & Jerry (Continued from page 14)

see what we can scare up. You go that way and I'll go this."

The island was small enough so that it did not take the boys long to scour it for fuel. Carl came back with a short length of blackened two-by-four and a worn-out broom with a broken handle. Jerry found only a few small branches.

"Next time we play Robinson Crusoe, let's pick a bigger island," he suggested.

Carl got a butcher knife out of his bait box and began whittling shavings from the creosoted two-by-four. When he had a sufficient number of dry shavings, he piled them in a little heap and set fire to them. They blazed up brightly, and he piled on the branches Jerry had gathered and placed the broken broom handle in the fire.

The little blaze, shielded from the wind, did throw a surprising amount of heat into the shelter of the boat; but the sight of the cheerful fire, man's ally against the elements since primitive days, did even more to comfort the boys. There was only one drawback. The smoke rising from the creosote-impregnated chips had a most acrid, eye-smarting quality to it.

"**T**HAT SMOKE is a real eye-getter," Jerry exclaimed, turning a tear-stained face toward his chum. "What do you think? Do you suppose the wind will quit when the sun goes down? What are we going to do if it doesn't?"

"I don't know about the wind," Carl confessed. "It's four o'clock now, and those waves are just as high as ever. But I can tell you one thing: we're not going out again in the boat until the wind does stop, even if we have to stay here all night. With luck, we just might be able to make it to shore without being swamped, but to attempt it would be stupid kid-stuff."

Jerry nodded glumly in agreement; then, as a sudden gust of wind wailed louder than usual through the pine branches behind the boat, a determined scowl crossed his round face. He grabbed up the butcher knife and disappeared around the end of the boat. There was a loud sound of mingled grunting and hacking, and the moaning of the wind in the pines gradually subsided.

"I'll not have to listen to *that* sound all night!" he said triumphantly, as he reappeared carrying a double armful of pine branches which he tossed to the ground beside the fire. Settling back under the shelter of the boat, he idly placed one of the branches on the fire. Almost instantly the green pine needles caught fire and began to burn with a hot, crackling flame. "Well,



Interested In Electronics-TV-Radio

CARL E. SMITH,
E. E., President

then you will want to know

What Is The FCC?

It's amazing what the future holds for you in this modern world of electronics. Let me send you the entire story—FREE!

- How to pass the FCC Exam
 - A sample FCC lesson
 - Money-making FCC License Information
- I can train you to pass the Valuable FCC exam in a minimum of time if you have any practical experience and a fair knowledge of mathematics.

CARL E. SMITH, E.E., President

How Can I Get a Valuable FCC COMMERCIAL LICENSE?

My Passport to Future Security
Get These Free



These Three Booklets Tell You

- 1 Where to apply to take FCC Examinations.
 - 2 Scope of knowledge required.
 - 3 Necessary FCC exam preparation.
 - 5 Positive knowledge check.
- And additional data of great value.

Join the List of Successful Electronic Technicians

	License	Time
John J. Johnson, Boise City, Okla.	1st	20 weeks
Prentice Harrison, Lewes, Delaware	1st	27 weeks
William F. Masterson, Key West, Fla.	2nd	24 weeks
J. A. Niedeck, Bethlehem, Pa.	2nd	8 weeks
Gerald J. Collier, Columbus, Ohio	2nd	16 weeks

And Thousands More!

Your Guarantee

If you fail to pass your Commercial License exam after completing our course, we guarantee to continue your training without additional cost of any kind until you successfully obtain your Commercial License.

Start Building
for a Lifetime
Profession

- Employers make job offers every month!
- Your FCC ticket is recognized by most employers in the Electronics field as proof of your technical ability.
- Pave the way for Your Share of the better things in life.

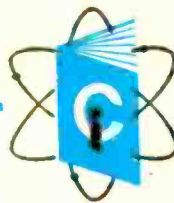

Cleveland Institute of Radio Electronics

Member National
Home Study Council

Desk PE-28, 4900 Euclid Ave., Cleveland 3, Ohio

Please send Free Booklets prepared to help me get ahead in Electronics.
I have had training or experience in Electronics as indicated below.

- | | | |
|---|---|--|
| <input type="checkbox"/> Military | <input type="checkbox"/> Amateur Radio | <input type="checkbox"/> Telephone Company |
| <input type="checkbox"/> Radio-TV Servicing | <input type="checkbox"/> Broadcasting | <input type="checkbox"/> Other..... |
| <input type="checkbox"/> Manufacturing | <input type="checkbox"/> Home Experimenting | |

In what kind of work are you now engaged?.....
In what branch of Electronics are you interested?.....

Name..... Age..... Address.....

City..... Zone..... State.....

Special Tuition Rates to Members of Armed Forces

Carl & Jerry (Continued from page 16)

what do you know!" he exclaimed in amazement. "Even green branches will burh down here."

"HEY, JER," Carl said suddenly, "there's a cabin cruiser out in the channel. Let's flag him down and hitch a ride back to shore."

Both boys scrambled out of their shelter and began to jump up and down and wave their arms at the man lolling in the glass-enclosed pilot house of the luxurious cruiser that was plowing through the waves a couple of hundred yards from the sand bar. The man glanced at the wildly gesticulating boys, lifted a hand in bored acknowledgment, and kept right on going.

"He thinks he's just receiving an admiring salute from friendly native peons," Carl said in disgust. "Hey, hold still a minute!"

He reached over and slapped Jerry lightly on the side of the face. A smear of blood trickled down from the mosquito he crushed.

"Oh, fine! That's all we need out here tonight: bloodthirsty mosquitoes!" Carl exclaimed.

"There's lots more where that one came

from," Jerry offered. "Right now they have to hang on by their toenails to keep the wind from blowing them away, but they'll be out in full force when it dies down a little."

"You know, maybe we're giving up too easily," Carl reflected. "Here we are, a couple of electronic geniuses, junior grade; and all we're doing is sitting around tamely waiting for someone to rescue us."

"Yeah, but let me point out that we don't have anything with us as electronic as even a flashlight—not a cotton-picking thing."

"EXCEPT the magneto of the outboard motor!" Carl cried out. "Remember that time we were trapped in the chimney and managed to send out an SOS with the induction coil of the model plane? Could we do something like that?"

"Hm-m-m-m! Can you get at the spark plugs of the motor while it's running?"

"Sure. All I have to do is take off this cover here."

"If we could attach some sort of radiating system to a spark plug, it might radiate the ignition noise over quite a distance. We could key it by touching the end of the antenna to a spark plug—if we had wire for an antenna."

Carl jerked the smouldering broom han-

the MOST WANTED TONE-ARM

New Audax in KIT Form—at HALF price!
accommodates ANY MAKE cartridge
including the famous AUDAX Hi-Q7

AUDAX KT-12: KIT, \$14.55 NET
Factory-assembled, \$24.00 NET

AUDAX KT-16: KIT, \$17.55 NET
Factory-assembled, \$30.00 NET

You do-it-yourself with no tools other than a nail-file or small screwdriver.



The new KT models exactly duplicate the Audax "Compass-Pivoted" transcription arm long recognized as top "blue chip." These new arms are the crowning achievement of a quarter-century of constant refinement and re-engineering of the very first commercial electronic pickup arm (Audax 1928) . . . to the fewest possible parts. It is this very *nth* degree engineered simplicity that makes the new KT arms possible.

Anyone can assemble a KT arm in about 10 minutes — and save 50%! The "Selector-Index" permits instant adjustment for any stylus-pressure. The newly-designed cartridge-housing enables checking of the all-important stylus-to-groove alignment at a glance.

No tone arm equals the new Audax KT—regardless of price! Read October 1956 "Popular Electronics," page 57. See the new KT arms at your dealer. Fill out the coupon.

Fine audio-electronic apparatus for 35 years

Audax

Div. of Rek-O-Kut Company, Inc.
 38-19 108th St., Corona 68, N. Y.

Audax, Inc. 38-19 108th St. Corona 68, N. Y. Att. Mr. P
 I enclose 25c for handling & postage. Please send FREE \$1.00, 22-page "ELECTRONIC PHONO FACTS" by pioneer Maximilian Weil.

Send FREE latest catalog.

Name.....

Address.....

City.....Zone.....State.....

Get into

TELEVISION RADIO-ELECTRONICS

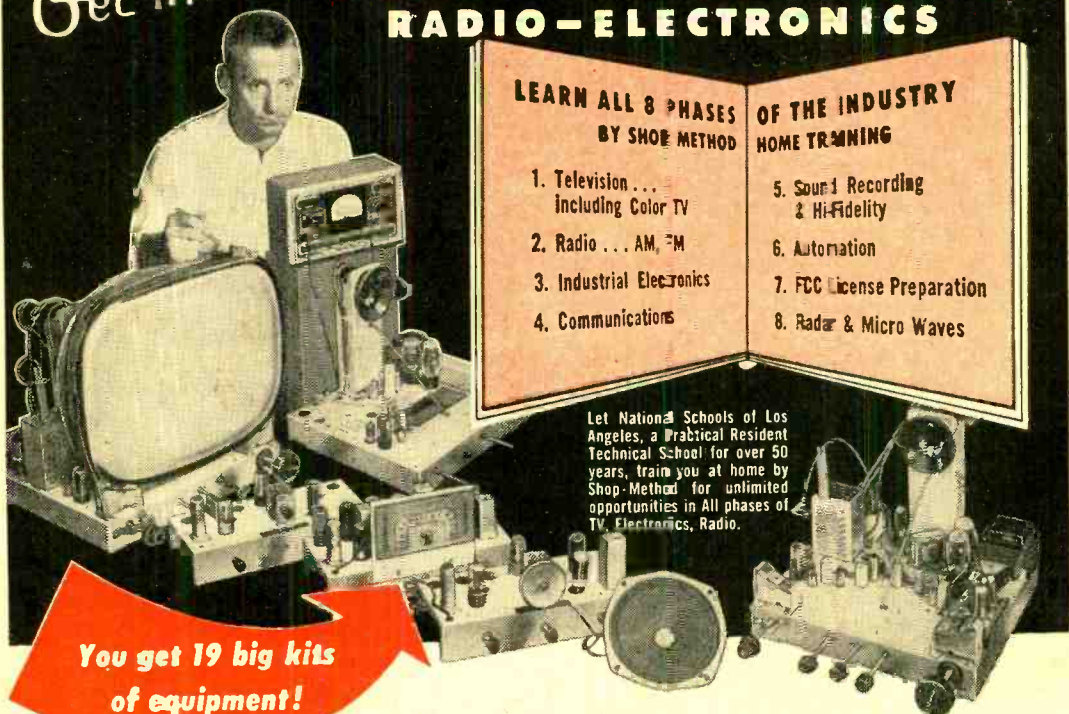

LEARN ALL 8 PHASES
BY SHOP METHOD

1. Television . . .
including Color TV
2. Radio . . . AM, FM
3. Industrial Electronics
4. Communications

OF THE INDUSTRY
HOME TRAINING

5. Sound Recording
& Hi-Fidelity
6. Automation
7. FCC License Preparation
8. Radar & Micro Waves

Let National Schools of Los Angeles, a Practical Resident Technical School for over 50 years, train you at home by Shop-Method for unlimited opportunities in All phases of TV, Electronics, Radio.

**You get 19 big kits
of equipment!**

**GOOD JOBS . . . MORE MONEY
SECURITY . . . ALL CAN BE YOURS**

YOU are needed in the great modern Television-Electronics industry. Trained technicians are in growing demand, at excellent pay, in sales and service, manufacturing, broadcasting, telecasting, communications, research, and many other important branches of the field. National Schools Master Shop-Method Training, with newly added lessons and equipment prepares you in your spare time right in your own home for these fascinating opportunities. **OUR OUTSTANDING METHOD IS PROVED BY THE SUCCESS OF GRADUATES ALL OVER THE WORLD!**

YOUR TRAINING IS ALL INCLUSIVE

We prepare you for a long list of job opportunities. Thousands of TV and Radio receivers are being sold every day—more than ever before. And, now, Color TV is here. Applications of Electronics in industry—**AUTOMATION**—are growing in tremendous strides. The whole field is alive—opening up new, important jobs rapidly. National Schools complete training program qualifies you in all phases of the industry.

YOU EARN WHILE YOU LEARN

Many students pay for their entire training— and more— with spare time earning. We'll show you how you can, too! Early in your course you receive material that shows you how to earn extra money servicing TV and Radio receivers, appliances, etc., for friends and acquaintances.

YOU GET EVERYTHING YOU NEED

Clear, profusely illustrated lessons, shop-tested manuals, modern circuit diagrams. Practical job projects—all the valuable equipment shown above—many other materials and services—consultation privilege with our qualified staff, and Graduate Employment Service. **EVERYTHING YOU NEED for outstanding success in Electronics.**

**INDUSTRY NEEDS YOU. NATIONAL SCHOOLS
WILL TRAIN YOU. SEND FOR FACTS TODAY.
NO OBLIGATION.**

YOU LEARN BY SHOP METHOD . . .

you do servicing, circuit analysis, and do over 100 down-to-earth experiments. You build a Superhet Receiver and a modern TV Receiver, from the ground up, including a new, big screen picture tube. You also receive a professional, factory-made **MULTI-TESTER**. All of this standard equipment is yours to keep . . . at just one low tuition.

RESIDENT TRAINING AT LOS ANGELES

If you wish to take your training in our Resident School at Los Angeles, the world's TV capital, start NOW in our big, modern Shops, Labs and Radio-TV Studios. Here you work with latest Electronic equipment—professionally installed—finest, most complete facilities offered by any school. Expert, friendly instructors. Personal attention. Graduate Employment Service. Help in finding home near school— and part time job while you learn. Check box in coupon for full information.

Approved for
GI Training



NATIONAL SCHOOLS

LOS ANGELES 37, CALIF

In Canada: 811 W. Hastings St., Vancouver, B. C.

**FREE!
VALUABLE BOOK
& SAMPLE LESSON
—Just Send
Coupon!**



NATIONAL SCHOOLS

TECHNICAL TRADE TRAINING SINCE 1905
LOS ANGELES 37, CALIFORNIA

GET FAST SERVICE—MAIL NOW TO OFFICE NEAREST YOU!

NATIONAL SCHOOLS, DEPT. R2G-87
4000 S. FIGUEROA ST. OR 187 N. LA SALLE ST
LOS ANGELES 37, CALIF OR CHICAGO 1, ILL
Bush free TV-Radio "Opportunity" Book and sample
lesson. No salesman will call.

NAME _____ AGE _____

ADDRESS _____

CITY _____ ZONE _____ STATE _____

Check if interested ONLY in Resident School training at Los Angeles.
Veterans' GI—date of Discharge _____

Carl & Jerry (Continued from page 18)

dle from the fire and began unwrapping the wire that bound the straw to the handle. This provided several feet of wire.

"Carl, in all the cartoons I ever saw of desert islands, there are always two bits of standard furniture: one, a lone palm tree; the other, a shapely blonde. I don't like to complain, but this island isn't properly furnished. What I mean," Jerry added hastily as Carl gave him a strange look, "is that we could use that palm to hold up our antenna!"

"We'll use oars stuck in the sand. Help me put the boat back in the water and fasten the motor to the stern. The motor has to have water circulating through it for cooling, and putting it in the river will provide a ground."

In just a few minutes the improvised "transmitter" was ready to go. The wire from the broom was suspended by bits of spinning filament from the oars stuck in the sand. Jerry had lashed the end of the wire to a dry sliver of wood so that he could touch it to the spark plug without being shocked. Carl gave the starting cord a jerk, and the motor took off with a roar.

"Rev it up pretty good so the noise will sound as much like a note as possible,"

Jerry instructed. Over and over he spelled out: "Help. Stranded on bar in Indian River five miles northeast of Titusville." He kept doggedly at this for a half hour. Then the boys decided that the remaining gas would be needed to take them back to shore if the wind died; so they shut off the motor and huddled around their smoking fire. Fortunately the rain had stopped, but the wind was as strong as ever.

BECAUSE of the clouds, darkness was falling early. Over the tops of the white-capped waves, the boys could see faint lights appearing on the distant shore. To the roar of the wind and the seething, hissing, splashing sound of the waves was added the shrill cries of gulls circling overhead.

"Say, Carl," Jerry said, staring up at the screaming birds, "you never heard of albino buzzards, did you?"

"Nope," Carl said with a grin. "Throw some more pine branches on the fire. We want to keep a light going to guide anyone who might try to find us."

The pine needles blazed up brightly, throwing a wide circle of light out across the restless waves; and suddenly, into this circle, there drove the white hull of a large launch. Without hesitation it came straight

INDUSTRIAL ELECTRONIC— AUTOMATION TECHNICIANS Desperately Needed!



Never in history has there been such a tremendous demand for Electronic technicians at the servicing, maintenance and assistant Engineering level, in all fields of electronics. Industries, Businesses, large and small are turning to Electronically controlled machinery ... **AUTOMATION!**

Whether it's a Robot airplane, an automobile plant with an integrated line of machines, a Sensing Device, Computing System or Communications—each re-

quire electric power applied through automatically controlled processes. This means there are positions open at all levels and phases for Electronic Technicians.

Bailey electronic students learn Industrial Television on specially designed equipment such as this panelboard, which is a multiple camera and screen control. The Bailey Electronic course includes an outstanding comprehensive program in radio and TV receiver servicing.

- TOP PAY
- UNLIMITED OPPORTUNITY
- SECURE FUTURE

Let us send you FREE, without obligation, complete details of our Resident Electronic Training Program—originated by Bailey Schools—acclaimed by Electronic Engineers. See how you save time as you learn-by-doing with intensive laboratory work on the most recently developed Electronic equipment, plus classroom required physics, mathematics, etc.

We help you find part time work while in our school—help place you with America's leading companies after graduation. Act now—mail coupon today!

VETERAN APPROVED

Bailey Technical Schools
1626 S. Grand • St. Louis 4, Mo.

MAIL TODAY

Please mail immediately this free booklet without obligation.

FREE BOOKLET

Name _____

Address _____

City _____ State _____





Giant over-the-horizon antenna designed by Bell Telephone Laboratories for "White Alice," Air Force Alaskan defense communications network.

How UHF radio got seven-league boots

THE huge antenna systems which project ultra-high frequency radio communications beyond the horizon began when a Bell Telephone Laboratories engineer became intrigued with a strange phenomenon. Although these radio waves were supposed to be useful only over line-of-sight distances, the waves displayed a mysterious tendency to take off in a giant stride to antennas beyond the horizon.

This phenomenon had been studied both here and abroad, but no practical use was seen until the engineer became interested and thoroughly sifted the experimental data. He came up with the stimulating conclusion

that over-the-horizon transmission is far stronger and much more dependable than was generally supposed. Further he predicted that it could be utilized to supply dependable broadband communications. He and his associates at Bell Laboratories confirmed the prediction experimentally, then drew up requirements for the first over-the-horizon UHF transmission system.

This pioneer work at Bell Telephone Laboratories has greatly increased the usefulness of UHF communications. For example, over-the-horizon transmission now provides critically important communications between remote military

outposts in the Arctic and in the far north.

For the Bell System it can provide important new links for telephone and television.

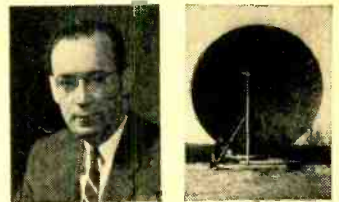

Left, Kenneth Bullington, B.S.E.E., University of New Mexico; M.S., Massachusetts Institute of Technology; recipient of the 1956 Morris Liebmann Memorial Prize and the 1956 Stuart Ballantine Medal for his contributions in the field of over-the-horizon UHF radio transmission.

Right, experimental antenna used in early over-the-horizon UHF radio transmission research. Research extended transmission reach from 30 miles line-of-sight to 200 miles.

BELL TELEPHONE LABORATORIES

WORLD CENTER OF COMMUNICATIONS RESEARCH AND DEVELOPMENT



Judge for yourself!



SAVE MORE! SERVICE BETTER!

EMC TEST EQUIPMENT

extra features ... • PRECISION CONSTRUCTION
• ADVANCE DESIGNS • LOWEST PRICES

NEW! Model 905-6A Battery Eliminator, Charger & Vibrator Checker

This combination housed in single sloping metal case, is a MUST for auto radio service. Features continuously variable voltage output . . . automatic overload relay-self resetting . . . in either 6 or 12 volt operation . . . checks all 6 and 12 volt vibrators.



Model 905-6A (Comb.) \$67.90 Wired
\$44.90 Kit Form

Model 905 Battery Eliminator
and Charger (only) \$37.50 Wired
\$28.90 Kit Form

NEW! Model 906 Vibrator Checker

Compact metal case unit. Checks both interrupter and self-rectifier type for proper starting point, as well as quality of operation. Reads condition of vibrator on "Bad-Good" scale of plastic front meter. Checks both 6 and 12 volt vibrators.



Used with any battery eliminator, such as Model 905.
Model 906 \$31.80 Wired
\$17.05 Kit Form

NEW! Model 210 Transistor Checker

Checks all PNP and NPN Transistors. Measures gain in 3 ranges. Measures leakage on 2 color "Poor-Good" scale. Supplied complete with batteries. Checks diodes.



Model 210 \$10.95 Wired
\$7.95 Kit Form

Yes, tell me more, send me—FREE—a detailed catalog of the complete EMC line.

NAME _____

STREET _____

CITY _____ STATE _____ PE-8

EMC Electronic Measurements Corp.
625 B'way • New York 12, N. Y.
Ex. Dept. 370 B'way, N. Y. 13

Carl & Jerry (Continued from page 20)

to the boys and ran up on the sand. A man dressed in oilskins stepped out on the shore.

"Guess you're the two I'm looking for," he said. "Are you the ones who have been tearing up all the TV sets on shore?"

It quickly developed that the ignition transmitter had got out surprisingly well. Several calls had come in to the Titusville police about the message. The fact that two large air bases were located not far away probably accounted for the fact that the code message was read. There are always some radiomen living near these bases. The police contacted the owner of a boat livery and asked him to check on the message. Since he had rented the boys the boat, he was glad to do so.

The boys loaded their motor, tackle, and fish into the large, glass-hulled launch. The owner decided to leave the wooden boat on the island, and pick it up when the wind was not blowing.

"Guess you two are in for a pretty good currying from your folks when we reach shore for getting into this little mess," the man said, as the launch went crashing through the waves. "But don't take it too hard. I think you used better judgment than lots of folks much older who come down here. That business about sending out an SOS was pretty doggone clever, but the really smart thing you did was keeping from getting panicky and just sitting tight until help arrived. Many people who have failed to do that in the same situation have lost their lives."

-50-



. . . In just a few minutes the improvised transmitter was ready to go. Carl gave the starting cord a jerk, and the sturdy motor took off with a roar . . .

RCA offers you the finest training at home in Radio-TV electronics, TV servicing, Color TV

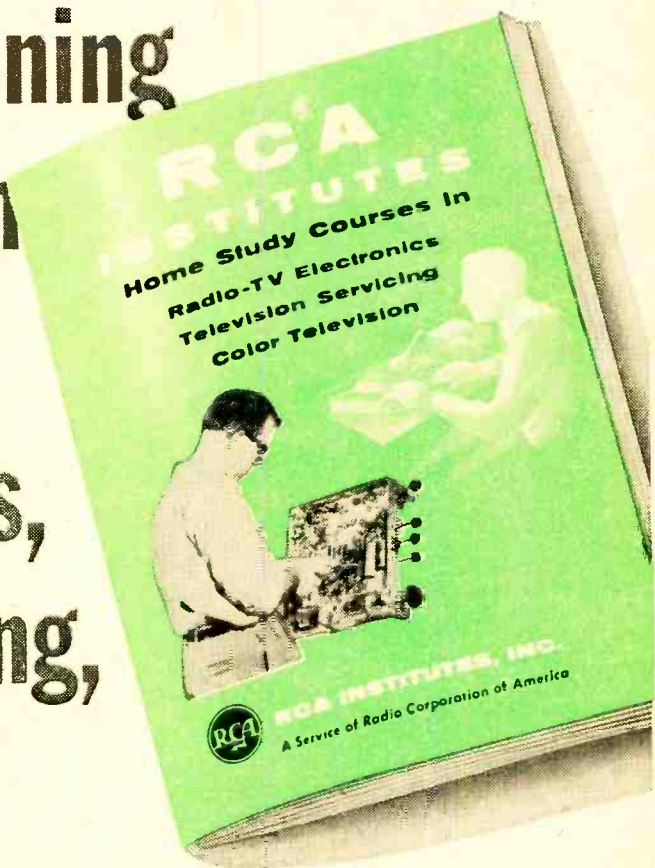

SEND FOR THIS FREE BOOK NOW!



RCA INSTITUTES, INC.
 A SERVICE OF RADIO CORPORATION OF AMERICA
 350 WEST FOURTH STREET, NEW YORK 14, N. Y.

In Canada—RCA Victor Company, Ltd.,
 5001 Cote de Liesse Rd., Montreal 9, Que.

Pay-as-you-learn. You need pay for only one study group at a time. Practical work with very first lesson. All text material and equipment is yours to keep. Courses for the beginner and advanced student.

RCA Institutes, Inc., Home Study Dept. P E-87.
 350 West Fourth Street, New York 14, N. Y.
 Without obligation, send me FREE 52 page CATALOG on Home Study Courses in Radio, Television and Color TV. No Salesman will call.

Name
 Please Print

Address

City Zone State

KOREAN VETS! Enter discharge date

To save time, paste coupon on postcard

LETTERS FROM OUR READERS

Mixed Opinions—All Favorable

■ Your "How It Works" paragraphs that accompany many articles lend greater appreciation and understanding. I'm sure that other readers, both amateur and professional, will agree.

MAX FARMER
Calgary, Alberta

■ In my opinion, the greatest asset to your magazine is the build-it-yourself projects with the pictorial diagrams.

HARRY RITCHIE
Elizabethton, Tenn.

■ I especially enjoy the informative feature section "After Class." My first love is physics and science. Perhaps some of your readers would also like to exchange ideas on tape recording, speaker systems, magnetism and electronics.

E. L. LOWE
517 Apple Ave.
Toledo 9, Ohio

■ I find POP'tronics an excellent value for the money. I have tried many other American periodicals, but they don't compare with yours. I would like to correspond with serious-minded constructors of amplifiers and tuners. This should

enable an exchange of ideas on design. I am a test engineer and am 27 years old.

JAMES MITCHELL
13 Cheviot Terrace
Scremerston, Berwick-on-Tweed;
England

Low-Cost Hi-Fi Cabinet

■ Your April issue contains an article on a hi-fi cabinet (p. 52) which the author built from a set of drawers. I recently completed a somewhat similar unit and have enclosed a photo. The piece of

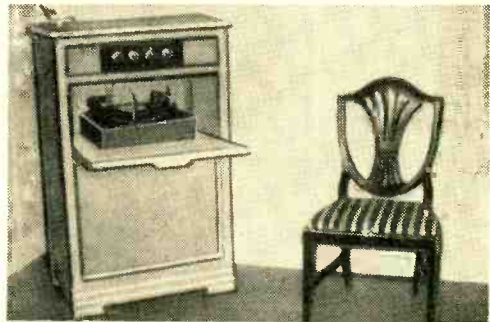

furniture I used was a drop-front desk-chest combination. I removed the drawers and installed a 20-watt amplifier where the top drawer had been. The drop-front portion houses my Garrard changer. The advantage here is that the changer is fixed and the shelf provides room to stack records. I reinforced the bottom drawer area and the back and mounted a 12" coaxial speaker on the

GIVES YOU WHAT YOU WANT IN A BATTERY HOLDER

POSITIVE CONTACT • POSITIVE INSULATION

ACME EXCLUSIVE FEATURES

- Spring Tempered Aircraft Aluminum
- Approved Fibre Insulation on all terminals
- Pretinned copper solder lugs at all terminals
- Every holder is electronically tested to guarantee insulation
- Mounting holes on all holders

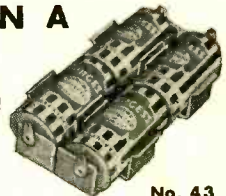

No. 43

Takes 4 "D" cells
dual-in-line 95¢

ACME battery holders have been proved positively . . . the BEST by far

No. 1 for 1 Min. penzell*	30c	No. 30 for 3 "D" cells in-line*	95c	No. 93 for 1 Polarized "D" cell*	45c
No. 2 for 2 Min. penzell**	50c	No. 31 for 1-15v. type Y-10*	40c	No. 100 for 1 type 904 radio "A" batt.*	65c
No. 3 for 3 Min. penzell**	65c	No. 32 for 2-15v. type Y-10*	50c	No. 101 for 1 Polarized, as above*	70c
No. 4 for 4 Min. penzell**	85c	No. 33 for 3-15v. type Y-10*	75c	No. 102 for 2 type 904 radio "A" batt.*	85c
No. 5 for 1 Reg. penzell*	30c	No. 34 for 2-type Y-10 in-line*	50c	No. 103 for 2 type 904 radio "A" batt.*	1.25
No. 6 for 2 Reg. penzell**	50c	No. 35 for 2 Min. penzell in-line*	50c	No. 104 for 1-1040 type*	40c
No. 7 for 3 Reg. penzell**	40c	No. 37 for 2 penzell in-line*	60c	No. 108 for 1 "C" w/switch and fahnestock clip,	60c
No. 8 for 4 Reg. penzell**	85c	No. 38 for 2 "C" cells in-line*	55c	No. 109 for 1 "D" as above	60c
No. 9 for 1 Med. "C" cell*	40c	No. 39 for 2 "D" cells in-line*	85c	No. 110 for 2 "C" w/fahnestocks**	50c
No. 10 for 2 Med. "C" cells*	50c	No. 41 for 4 Reg. penzell dual in-line*	80c	No. 111 for 2 "C" w/fahnestocks**	50c
No. 10A for 2 Med. "C" cells**	40c	No. 42 for 4 "C" cells dual in-line*	90c	No. 112 for 2 "C" w/fahnestocks**	70c
No. 11 for 1 large "D" cell*	40c	No. 43 for 4 "D" cells dual in-line*	95c	No. 113 for 2 "D" w/fahnestocks**	70c
No. 12 for 2 large "D" cells*	50c	No. 44 for 4 RM-12 or Y-15*	30c	No. 114 for 1 Min. penzell**	30c
No. 12A for 2 large "D" cells**	40c	No. 45 for 2 RM-12 or Y-15*	50c	No. 115 for 1 Reg. penzell**	30c
No. 13 for 1-22½ volt cell*	40c	No. 46 for 3 RM-12 or Y-15*	75c	No. 116 for 1 "C" cell**	35c
No. 14 for 2-22½ volt cells*	50c	No. 47 for 4 RM-12 or Y-15*	95c	No. 117 for 1 "D" cell**	35c
No. 15 for 3-22½ volt cells*	85c	No. 48 for 2 RM4 mercury cells*	45c	No. 118 for 1- RM601R*	40c
No. 16 for 1-227P1 3v. pack	45c	No. 49 for 2 RM4 mercury cells*	50c	No. 119 for 2- RM601R*	50c
No. 17 for 1-30v. type 506*	50c	No. 50 for 3 RM4 mercury cells*	55c	No. 122 for 1- TR 153R*	40c
No. 18 for 2-30v. type 506*	60c	No. 51 for 1-15v. type U10*	40c	No. 123 for 2- TR 153R*	50c
No. 19 for 1-30v. type 413*	40c	No. 52 for 2-15v. type U10*	50c	No. 126 for 1-401E type*	40c
No. 20 for 2-30v. type 413*	60c	No. 53 for 3-15v. type U10*	85c	No. 129 for 1- TR152R or RM401R*	40c
No. 21 for 2 Reg. penzell w/switch	75c	No. 55 for 1- TR 152R*	40c	No. 130 for 2- TR152R or RM401R*	50c
No. 22 for 2 Med. cells w/switch	75c	No. 56 for 1- TR 152R*	40c		
No. 23 for 2 "D" cells w/switch	75c	No. 58 for 2- RM11R*	50c		
No. 24 for 2 Min. penzell w/switch	65c	No. 59 for 3- RM11R*	65c		
No. 27 for 3 "C" cells, side by side*	85c	No. 90 for 1 Polarized min. penzell*	35c		
No. 28 for 3 "D" cells, side by side*	90c	No. 91 for 1 Polarized regular penzell*	35c		
No. 29 for 3 "C" cells in-line*	30c	No. 92 for 1 Polarized "C" cell*	45c		

* ALL TERMINALS INSULATED.
** ONE END DIMPLED.

If not available at your Dealer order by Mail. Add 5¢ for each holder for packing and shipping. Write for quantity discounts.



No. 39

Takes 2 "D" cells
in-line 65¢

ACME MODEL ENGINEERING CO. • 4703-E Third Avenue, Brooklyn 20, N. Y.

COMPLETE TV RECTIFIER INTERCHANGEABILITY?

**The New G-E 1N1008
Brings You Just About as
Close as You Can Come.**

With the introduction of its new Type 1N1008 germanium TV rectifier, General Electric offers you a miniature 400ma device which can be used as a replacement for just about any make of selenium rectifier now found in television power supplies.

The 1N1008 is a 130V-400ma half-wave rectifier. Twin 1N1008's can be used in a voltage doubler circuit.



RATINGS AND SPECIFICATIONS

	Recommended Design Center	Absolute Maximum
RMS Input Voltage	117	130 volts
Peak Inverse Voltage	340	380 volts
D-C Output Current	200-400	400 ma
Rectifier Full Load Voltage Drop*	0.28	0.30 volts
Series Surge Resistor	4	4 (min) ohms
Ambient Operating Temperature	40	55°C
Operating Fin Temperature	50	65°C

*Full Cycle Average

This represents General Electric's latest addition to its priced-right line of *snap-in* replacement TV rectifiers. Other easy-installation G-E TV rectifiers include the 1N1005 (250ma), 1N1007 (350ma), and 1N1013 (250ma). In most cases, the G-E snap-in design permits installation in the same chassis hole used for the selenium stud or bolt.

FREE...REPLACEMENT GUIDE

The General Electric Germanium TV Rectifier REPLACEMENT GUIDE tells you exactly which model fits your customer's set, and is the result of an analysis of all leading sets built since 1953. Only proved replacements are recommended. Get your copy, *free* . . . at your G-E tube distributor now. Or, write today to *General Electric Company, Semiconductor Products, Section S8187, Syracuse, New York.*

General Electric TV rectifiers are performance-tested by Howard W. Sams & Company, Inc. Check the low prices at your nearest G-E tube distributor. Just look for the new green & black cartons.



GENERAL ELECTRIC



IN ONLY 2 YEARS

he'll have an
ASSOCIATE of SCIENCE
DEGREE in...

ELECTRONICS ENGINEERING DESIGN

The increasingly acute shortage of engineering talent assures unlimited opportunities in electronic and aviation fields. A 2-year intensive course at Embry-Riddle—an approved technical institute—leads to a Degree and specialization in rewarding careers such as servo and instrumentation engineer, electro-mechanical engineer, electronic design engineer, and materials and process engineer.

Embry-Riddle's constant supervision, concentration on essentials, and minimum required instruction of 25 hours per week assures you the education your future requires.

You'll enjoy Miami's perfect year-round climate for study and training.

Take your big step now. Think BIG—think Aviation! Mail coupon for pictorial brochure and complete outline of curricula.



TRAINING
AUTHORIZED
UNDER
G.I. BILLS

MAIL THIS COUPON TODAY

DEAN OF ADMISSIONS, Dept. 47
Embry-Riddle Aeronautical Institute
Miami 30, Florida

Without obligation, please send FREE and post-paid full particulars.

- ELECTRONICS ENGINEERING DESIGN
 AERONAUTICAL ENGINEERING DESIGN
 A. & P. TECHNICIAN FLIGHT

Name..... Age.....

Address.....

City..... State.....

I am a (check one) Veteran Non-Veteran

Letters

(Continued from page 24)

new front panel—which is covered with a grille cloth.

JOHN KELLY
Springfield, Pa.

Curious About Women

■ Aren't there any women readers of POP'tronics? I have yet to see a woman's name in your "Letters" column. Nevertheless, keep up the good work—I enjoy all of your articles.

DAVE KAVANAGH
Troy, N. Y.

We don't have any figures on female readership, Dave, but we suspect that it is about 3 or 4% of our current 275,000 circulation. We do know that a lot of wives read the Kohler stories, "Carl & Jerry," and some of the basic hi-fi material.

Floodlight Control

■ I think that Harvey Pollack's simple use of a double-pole switch (April 1957, p. 56) for photo-flood control can be improved. The circuit below shows how I added a second switch. This permits the use of only two flood lamps instead of three. The small numbers show which lamps are oper-

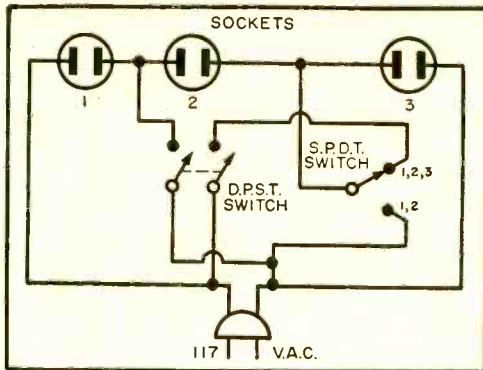

ating. Closing the double-pole switch puts the lamps in parallel; opening it puts them in series. Always dim the lights when switching between two and three bulbs.

CHAS. V. JOHNSON
Cincinnati, Ohio

Our thanks to you, Chas., for the idea on using but two of the three possible photo-floods. The number of POP'tronics readers interested in photography is surprising. We are starting up a series of articles on photography and electronics. The first article (also on floodlight control) appears on page 76 of this issue.

The editors regret that an impression may have been created in the article on Diathermy by Harvey Pollack and H. H. Fantel (July 1957, p. 35) that plane crashes had been caused by illegal diathermy equipment. Although there have been no actual plane mishaps, it was the intention of the authors to point out that illegal diathermy equipment could possibly cause plane crashes.

BUILD A RADIO

CIRCUITS AT HOME

only

with the New Improved PROGRESSIVE RADIO "EDU-KIT"

\$19.95

Reg. U.S.
Pat. Off.



A Practical Home Radio Course

Now Includes

- ★ TRANSMITTER
- ★ SIGNAL TRACER
- ★ SIGNAL INJECTOR
- ★ CODE OSCILLATOR
- ★ No Knowledge of Radio Necessary
- ★ No Additional Parts or Tools Needed
- ★ Excellent Background for TV
- ★ School Inquiries Invited
- ★ Attractively Gift Packed

WHAT THE "EDU-KIT" OFFERS YOU

The "Edu-Kit" offers you an outstanding PRACTICAL HOME RADIO COURSE at a rock-bottom price. Our Kit is designed to train Radio & Electronics Technicians, making use of the most modern methods of home training. You will learn radio theory, construction practice and servicing.

You will learn how to build radios, using regular schematics; how to wire and solder in a professional manner; how to service radios. You will work with the standard type of punched metal chassis as well as the latest development of Printed Circuit chassis. You will learn the basic principles of radio. You will construct, study and work with RF and AF amplifiers and oscillators, detectors, rectifiers, test equipment. You will learn and practice code, using the Progressive Code Oscillator. You will learn and practice trouble-shooting, using the Progressive Signal Tracer, Progressive Signal Injector, Progressive Dynamic Radio & Electronics Tester & the accompanying instructional material.

You will receive training for the Novice, Technician and General Classes of F.C.C. Radio Amateur License. You will build 16 Receiver, Transmitter, Code Oscillator, Signal Tracer and Signal Injector circuits, and learn how to operate them. You will receive an excellent background for Television.

Absolutely no previous knowledge of radio or science is required. The "Edu-Kit" is the product of many years of teaching and engineering experience. The "Edu-Kit" will provide you with a basic education in Electronics and Radio, worth many times the complete price of \$19.95. The Signal Tracer alone is worth more than the price of the entire K.E.

THE KIT FOR EVERYONE

You do not need the slightest background in radio or science. Whether you are interested in Radio & Electronics because you want an interesting hobby, a well paying business or a job with a future, you will find the "Edu-Kit" a worth-while investment. Many thousands of individuals of all

ages and backgrounds have successfully used the "Edu-Kit" in more than 79 countries of the world. The "Edu-Kit" has been carefully designed, step by step, so that you cannot make a mistake. The "Edu-Kit" allows you to teach yourself at your own rate. No instructor is necessary.

PROGRESSIVE TEACHING METHOD

The Progressive Radio "Edu-Kit" is the foremost educational radio kit in the world, and is universally accepted as the standard in the field of electronics training. The "Edu-Kit" uses the modern educational principle of "Learn by Doing." Therefore you construct, learn schematics, study theory, practice trouble-shooting—all in a closely integrated program designed to provide an easily-learned, thorough and interesting background in radio.

You begin by examining the various radio parts of the "Edu-Kit." You then learn the function, theory and wiring of these parts. Then you build a simple radio. With this first set you will enjoy listening to regular broadcast stations, learn theory, practice testing and trouble-shooting. Then you build a more advanced radio, learn more advanced theory and techniques. Gradually, in a progressive manner, and at your own rate, you will find yourself constructing more advanced multi-tube radio circuits, and doing work like a professional Radio Technician.

Included in the "Edu-Kit" course are sixteen Receiver, Transmitter, Code Oscillator, Signal Tracer, and Signal Injector circuits. These are not unprofessional "breadboard" experiments, but listening to regular broadcast stations, learn theory, practice testing and soldering on metal chassis, plus the new method of radio construction known as "Printed Circuitry." These circuits operate on your regular AC or DC house current.

THE "EDU-KIT" IS COMPLETE

You will receive all parts and instructions necessary to build 16 different radio and electronics circuits, each guaranteed to operate. Our Kits contain tubes, tube sockets, variable, electrolytic and paper dielectric condensers, resistors, tie strips, coils, hardware, tubing, punched metal chassis, Instruction Manuals, etc.

In addition, you receive Printed Circuit materials, including Printed Circuit chassis, special tube sockets, hardware and instructions. You also receive a full set of tools, a professional electric soldering iron, and a self-powered Dynamic Radio & Electronics Tester. The "Edu-Kit" also includes Code Instructions and the Progressive Code Oscillator, in addition to F.C.C.-type Questions and Answers for Radio Amateur License training. You will also receive guides for servicing with the Progressive Signal Tracer and the Progressive Signal Injector, a High Fidelity Guide and a Quiz Book. You receive all parts, tools, instructions, etc. Everything is yours to keep.

PRINTED CIRCUITRY

At no increase in price, the "Edu-Kit" now includes Printed Circuitry. You build a Printed Circuit Signal Injector, a unique servicing instrument that can detect many Radio and TV troubles. This revolutionary new technique of radio construction is now becoming popular in commercial radio and TV sets.

A Printed Circuit is a special insulated chassis on which has been deposited a conducting material which takes the place of wiring. The various parts are merely plugged in and soldered to terminals.

FREE EXTRAS

- SET OF TOOLS
- SOLDERING IRON
- ELECTRONIC TESTER
- TESTER INSTRUCTION MANUAL
- HIGH FIDELITY GUIDE • QUIZZES
- TELEVISION BOOK • RADIO TROUBLE-SHOOTING BOOK
- MEMBERSHIP IN RADIO-TV CLUB: CONSULTATION SERVICE • FCC AMATEUR LICENSE TRAINING
- PRINTED CIRCUITRY

SERVICING LESSONS

You will learn trouble-shooting and servicing in a progressive manner. You will practice repairs on the sets that you construct. You will learn symptoms and causes of troubles in home, portable and car radios. You will learn how to use the professional Signal Tracer, the unique Signal Injector and the dynamic Radio & Electronics Tester. While you are learning in this practical way, you will be able to do many a repair job for your friends and neighbors, and charge fees which will far exceed the price of the "Edu-Kit." Our Consultation Service will help you with any technical problems you may have.

J. Statalis, of 25 Poplar Pl., Waterbury, Conn., writes: "I have repaired several sets for my friends, and made money. The "Edu-Kit" paid for itself, I was ready to spend \$240 for a Course, but I found your ad and sent for your Kit."

FROM OUR MAIL BAG

Ben Valerio, P. O. Box 21, Magna, Utah: "The Edu-Kits are wonderful. Here I am sending you the questions and also the answers for them. I have been in Radio for the last seven years, but like to work with Radio Kits, and like to build Radio Testing Equipment. I enjoyed every minute I worked with the different kits; the Signal Tracer works fine. Also like to let you know that I feel proud of becoming a member of your Radio-TV Club."

Robert L. Shuff, 1534 Monroe Ave., Huntington, W. Va.: "Thought I would drop you a few lines to say that I received my Edu-Kit, and was really amazed that such a bargain can be had at such a low price. I have already started repairing radios and phonographs. My friends were really surprised to see me get into the swing of it so quickly. The Troubleshooting Tester that comes with the Kit is really swell, and finds the trouble, if there is any, to be found."

UNCONDITIONAL MONEY-BACK GUARANTEE

ORDER DIRECT FROM AD RECEIVE FREE BONUS RESISTOR KIT WORTH \$5

- Send "Edu-Kit" Postpaid. I enclose full payment of \$19.95.
- Send "Edu-Kit" C.O.D. I will pay \$19.95 plus postage.
- Send me FREE additional information describing "Edu-Kit."

Name

Address

PROGRESSIVE "EDU-KITS" INC.

497 Union Ave., Dept. 535D, Brooklyn 11, N. Y.

LEARN BASIC TELEVISION

The whole world of black and white television is before you for only \$10.00.



New 5-volume Rider "picture book" course by Dr. Alexander Schure teaches the complete basic principles and practices of black and white television easily, quickly and understandably. You can master the basics of television easily, rapidly and thoroughly with this "learn by pictures" training course.

It's so easy to learn

Here's how this easy, illustrated course works. Every page covers one complete idea! There's at least one big illustration on that same page to explain it! What's more, an imaginary instructor stands figuratively at your elbow, doing "demonstrations" that make the theory easy for you to follow and understand. Then, at the end of every section, you'll find a review that highlights the important topics you've just covered. You build a thorough, step-by-step knowledge at your own pace—as fast as you yourself want to go.

No experience, education needed

BASIC TELEVISION uses the same methods that have proven so successful in the famous Rider "picture books" on electricity and electronics. This comprehensive course presents Basic Television in simple, down-to-earth language that everyone can understand—regardless of previous education. All that is assumed is that you have a knowledge of radio. Every phase of television is made instantly clear—explained in plain English supported by carefully prepared, large and exciting drawings that make every idea crystal-clear.

5 complete volumes

It starts with the transmitter and discusses in detail the following subjects: Volume 1 deals with the transmitter; the handling and the operation of the camera; formation of the picture signal and the general content of the transmitter. Volume 2 covers the organization of the entire TV receiver treating each section individually from antenna to picture tube. Volumes 3, 4 and 5 contain the TV receiver circuit explanations. Each volume covers a specific number of sections in the receiver. In effect, the presentation is like a spiral—first an overall view of the whole, and then the detailed explanation of each part. The most perfect modern teaching technique. The result—maximum understanding.

Learn at home—no correspondence

This course is so complete, so different—there's no need for the usual letter writing, question and correspondence. You learn in the comfort of your home, in your spare time... at your own pace.

10-day examination—Money Back Guarantee

Send today for these exciting new training courses—you risk nothing! When you receive the volumes, examine them in your own home for 10 full days. If, at the end of that time, you're not completely satisfied, we will simply return your full purchase price! Total cost for this 5-volume course is only \$10.00! In Canada, prices approximately 5% higher.

ORDER TODAY

These books are sold by electronics parts jobbers and book stores. If YOUR dealer doesn't have these books, mail this coupon to us.

JOHN F. RIDER PUBLISHER, INC.
116 West 14th St., N.Y.C.

Dept. PE-8

I have enclosed \$_____ Please send me

5-vol. BASIC TELEVISION set (soft cover) at \$10.00 per set

Deluxe cloth bound edition all 5 vols. in a single binding \$11.50

I understand I may return the books in 10 days, and receive a complete refund of the full purchase price if I am not satisfied.

NAME _____

ADDRESS _____

CITY & STATE _____

TIPS and TECHNIQUES

SAW BLADE CUTS TAPE

A short piece of an old hacksaw blade makes a handy tool for cutting electrical or masking tape. The blade is stored under the end of the tape, so that the end is

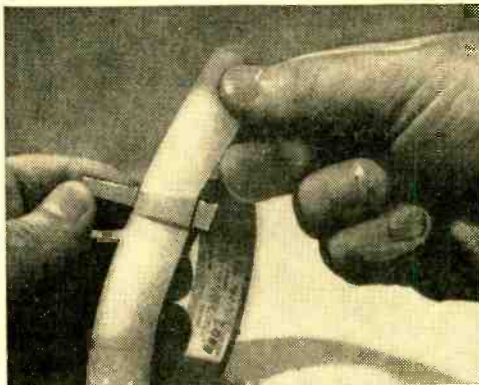

easily lifted. When a length of tape is to be removed from the roll, it is merely pulled out and torn off neatly against the teeth of the blade.

—K.M.

UNIVERSAL TEST LEADS

Don't clutter up your workshop with dozens of test leads to make sure you have the right one for a particular job. Borrow a trick from industrial laboratories and make up a few sets of "universal" leads.

To make such leads, you'll need lengths

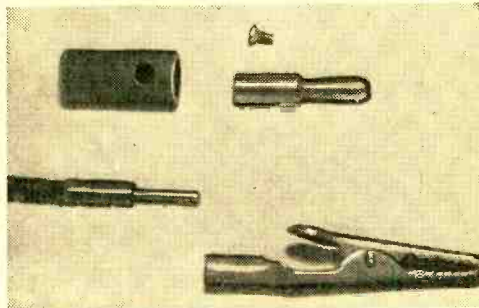

of red and black flexible wire, a handful of phone tips, a few solderless banana plugs, and a few medium-sized alligator

Always say you saw it in—POPULAR ELECTRONICS

STUDY AT HOME

for a career in radio-tv-electronics

CREI prepares you quickly for success in Radar, Guided Missiles, Servo-mechanisms, Computers, Aeronautical Electronics, Broadcasting (AM, FM, TV), Military, Navy, CAA Electronics, Communications, Electronics Manufacturing.

THE FUTURE IS IN YOUR HANDS!

The signs for the future are plain for trained men in the electronics industry. It is a tremendous industry, and—at the present time there are more jobs than there are trained men to fill them. But—when there's a choice between a trained and untrained applicant, the trained man will get the job.

CREI HOME STUDY . . . THE QUICK WAY TO GET THERE

Since 1927, CREI has given thousands of ambitious young men the technical knowledge that leads to more money and security. The time-tested CREI procedure can help you, too—if you really want to be helped. CREI lessons are prepared by experts in easy-to-understand form. There is a course of instruction geared to the field in which you want to specialize. You study at your convenience, at your rate of speed.

INDUSTRY RECOGNIZES CREI TRAINING

CREI courses are prepared, and taught with an eye to the needs and demands of industry, so your CREI diploma can open many doors for you. Countless CREI graduates now enjoy important, good-paying positions with America's most important companies. Many famous organizations have arranged CREI group training for their radio-electronics-television personnel. To name a few: Canadian Broadcasting Corp., Douglas Aircraft Co., Glenn L. Martin Co., All-American Cable & Radio, Inc., Federal Electric Corp., U. S. Information Agency (Voice of America). Their choice for training of their own personnel is a good cue for your choice of a school.

BENEFITS FELT RIGHT AWAY

Almost immediately, you feel the benefits of CREI training. Your employer, when informed of your step toward advancement (only at your request), is certain to take new interest in you and in your future. What you learn in CREI Home Study can start helping you do a better job immediately.

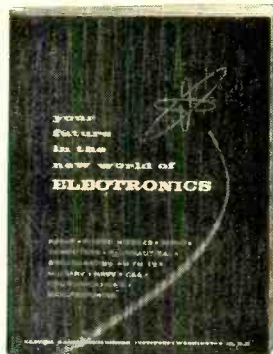

PAYS FOR ITSELF QUICKLY

Your very first raise could repay your investment in CREI training, and leave you a profit the very first year. Your increases in pay thereafter are all pure profit, and you'll be prepared for many more promotions and pay raises in the future years of your life.

CREI ALSO OFFERS RESIDENCE INSTRUCTION

at the same high technical level—day or night. In Washington, D. C. new classes start once a month. If this instruction meets your requirements, check the coupon for Residence School catalog.

VETERANS:

If you are eligible for training under the new G.I. Bill of Rights, check the coupon for full information.

GET THIS NEW FACT-PACKED BOOKLET—IT'S FREE

Called "Your future in the New World of Electronics," this free illustrated booklet gives you the latest picture of the growth and future of the gigantic electronics world. We'll promptly send your copy. The rest—your future—is up to you.

MAIL COUPON FOR FREE BOOKLET

To help us answer your request intelligently, please give the following information:

EMPLOYED BY
 TYPE OF PRESENT WORK
 SCHOOL BACKGROUND
 ELECTRONICS EXPERIENCE
 IN WHAT BRANCH OF ELECTRONICS ARE YOU MOST INTERESTED?

CAPITOL RADIO ENGINEERING INSTITUTE

ECPD Accredited Technical Institute Curricula—Founded in 1927

Dept. 128-D, 3224 16th St., N. W., Washington 10, D. C.

Send booklet "Your Future in the New World of Electronics" and course outline.

CHECK ELECTRONIC ENGINEERING TECHNOLOGY
 FIELD OF BROADCAST (AM, FM, TV) ENGINEERING TECHNOLOGY
 GREATEST AERONAUTICAL ELECTRONIC ENGINEERING TECHNOLOGY
 INTEREST TELEVISION ENGINEERING TECHNOLOGY

Name Age

Street

City Zone State

Check: Home Study Residence School Korean Veteran

Tips

(Continued from page 28)

clips (such as Mueller #60, for example).

Terminate each end of your leads with phone tips. If you need a banana plug, simply loosen the screw of the solderless banana plug and insert the narrow tip into the wire hole—you'll find that the phone tip gives a nearly perfect fit. Tighten the banana plug's screw and you have a "new" test lead.

On the other hand, if your job calls for a clip lead, simply slip your alligator clip over the wider body of the "universal" lead's tip. The natural spring of the alligator clip's metal will insure a snug and secure fit. —E.R.

LIQUID LOCK WASHERS

When constructing a compact piece of equipment, there is often insufficient space around a screw or nut for a lock washer. In such cases, a generous blob of plastic household cement over and around the screw head and nut will work to keep the assembly from becoming loose. —F.H.T.

CAPACITOR CHECKER MODIFICATION

Supplied with the Heathkit Model C-3 capacitor checker is a 200,000-ohm precision resistor to be used during calibration. To prevent this resistor from accidentally

finding its way into another unit, I mounted it on the instrument panel.

To accomplish this, mount two pin jacks, or binding posts midway between the *Normal-Leakage* switch and the printed *Benton Harbor, Mich.*, on the panel. Then solder the resistor to the jacks or posts—using a heat sink. —E.H.J.

WAXED PAPER PROTECTS FLASHLIGHT

When a flashlight is used infrequently, there is a danger with some types of dry



cells that they will swell inside the case. A simple precaution is to wrap them with several thicknesses of waxed paper before fitting them into the flashlight. If they (Continued on page 110)

ASSEMBLE YOUR OWN

WALKIE-TALKIE RADIOPHONES



for as little as

\$6.98

plus accessories

Specifications: Tunes 144-148 mc. 1 to 5 mile range (depending on terrain) with 18 inch antenna and much more with directional beam antenna. Variable frequency transmitter circuit. High level amplitude modulation. Silver plated tank circuit and many other exclusive features assure maximum efficiency and long battery life. Fully portable — no external connections ever needed. Meets FCC requirements for general class amateur license. No minimum age requirement.

The following components are all you need to assemble a complete walkie-talkie as illustrated:

Factory wired and tested transceiver chassis complete with VHF dual tube	\$6.98
High output carbon mike	\$1.49
Miniature mike transformer	\$.98
Powerful alnico magnet headphone	\$1.25
Strong 16 gauge aluminum case (7"x5"x3") with all holes punched, battery compartment, battery switch plus all hardware and fittings including 18" antenna	\$3.98
Case finished in gray hammer-tone if desired	\$.75

Both models use standard batteries available at your local radio store. All components guaranteed for one year against defects in manufacture.

HOW TO ORDER DIRECT FROM FACTORY:

Check each item desired and add 5% of total for postage and insurance.

Orders not paid in full will be sent C.O.D. for the balance due. All C.O.D. orders must include \$2.00 deposit.

MAIL TO:

All orders immediately acknowledged.



for as little as

\$14.98

plus accessories

Specifications: Tunes 50 to 54 mc. 1 to 5 mile range (depending on terrain) with 24" antenna and much more with directional beam antenna. Crystal controlled transmitter and variable frequency receiver with R.F. stage. Silver plated coils, highest quality components and exclusive design assure maximum efficiency and long battery life. Fully portable — no external connections ever needed. Meets FCC requirements for technician and general class amateur license as well as civil defense and other special services. Available also on neighboring frequencies at slight extra cost.

The following components are all you need to assemble a complete walkie-talkie as illustrated:

Factory wired and tested transmitter-receiver chassis complete with all tubes	\$14.98
Very active quartz transmitting crystal ground to .01% of your desired frequency and hermetically sealed	\$ 3.98
Western Electric communication type telephone handset with push-to-talk switch and standard cord	\$ 6.98
Coiled spring cord if desired	\$ 1.00
Handset input transformer	\$.98
Handset output transformer	\$.98
Strong 16 gauge aluminum case (8"x5"x3") with all holes punched, battery compartment, battery switch, telephone handset cradle plus all hardware and fittings including 24" antenna and loading coil	\$ 4.98
Case finished in gray hammer-tone if desired	\$.75
Adjustable shoulder strap (not shown) if desired	\$.50

SPRINGFIELD ENTERPRISES

Manufacturing division

Box 54-E Springfield Gardens 13, N. Y.

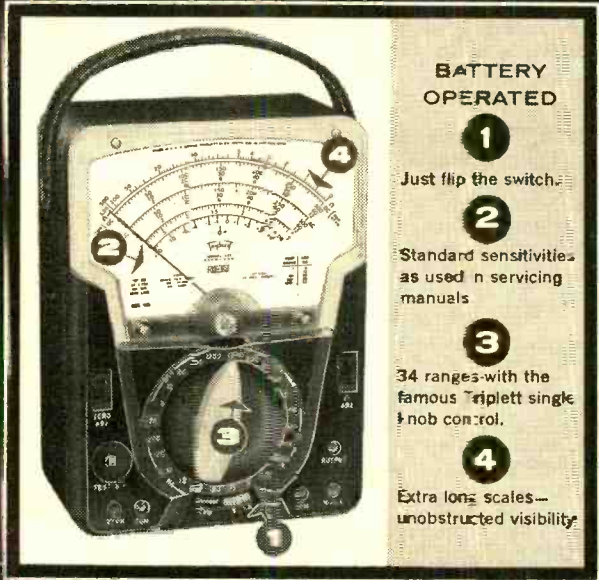

BATTERY OPERATED

- 1**
Just flip the switch.
- 2**
Standard sensitivities as used in servicing manuals.
- 3**
34 ranges with the famous Triplet single knob control.
- 4**
Extra long scales—unobstructed visibility.

double use...half the price

Triplet Model 631 the standard Combination VOM and VTVM \$64.50. Here's the one instrument which will do practically all the measuring in your electronic projects.

A VOM is essential equipment in electronics for measuring current, resistance and voltage. A VTVM is important for voltage measurements where it is desirable that the measuring instrument cause little or no current drain.

By using the Volt-Ohm-Milliammeter for all general testing (90% of your testing) and the Vacuum Tube Voltmeter only when you need it, you have the advantage of a VTVM with extremely long battery life. Batteries are used only about one-tenth as much as in the ordinary battery-operated VTVM.

Features: Ohms, 0-150-15,000 (5.8-68 center scale. First division is 0.1 ohm.)

Megohms: 0-1.5 (6,800-680,000 ohms center scale.)

Galvanometer center mark "0+" for discriminator alignment

RF Probe permits measurements up to 250 MC. \$7.00 net extra.

Featured by leading electronic parts distributors everywhere.



53 years experience

Do you WISH you were EMPLOYED in ELECTRONICS?

We can train you and place you in an electronics technician job in the short time of only 12 weeks!

F.C.C. License—the Key to Better Jobs

An FCC commercial (not amateur) license is your ticket to higher pay and more interesting employment. This license is Federal Government evidence of your qualifications in electronics. Employers are eager to hire licensed technicians.

More Jobs Than We Can Fill

Jobs in radio-TV-electronics are going begging. We train you quickly—then help you find the job you want!

Learn By Mail or in Residence

Correspondence training from Washington, D. C. and Los Angeles, Calif. Also, resident DAY and EVENING classes held in both cities.

Grantham Training Is Best

Grantham School of Electronics specializes in preparing students to pass F.C.C. examinations. We train you quickly and well. All courses begin with basic fundamentals—NO previous training required. Beginners get 1st class license in 12 weeks.

Here's Proof!

A few of our recent graduates, the class of license they got, and how long it took them:

	License	Weeks
Paul Schuett, 1314 20th Av., Longview, Wn.	1st	10
Robert Todd, 216 West End Av., Cambridge, Md.	1st	13
Dan Breece, Station KOVE, Lander, Wyo.	1st	12
Lawrence L. Alzheimer, Collins, Montana	1st	4
Joe C. Davis, Station WABO, Waynesboro, Miss.	1st	11
Paul Chuckray, 6874 Weber Rd., Affton, Mo.	1st	11
W. Reynolds, 238 1/2 Washington Bl., Venice, Cal.	1st	12

OUR GUARANTEE

If you should fail the FCC exam after finishing our course, we guarantee to give you additional training at NO ADDITIONAL COST. Read details in our free booklet.

FCC-TYPE EXAMS

FCC-type tests are used throughout the Grantham course. Constant practice with these FCC-type tests helps you prepare for the actual FCC examination.

Our free booklet, "Opportunities in Electronics," gives details, of how you can get your license quickly and make more money in the electronics industry. Send for your free copy today.

MAIL TO SCHOOL NEAREST YOU

GRANTHAM SCHOOLS, Desk 73-M

1505 N. Western Ave. OR 821—19th Street N.W.
Los Angeles 27, Calif. Washington 6, D. C.

Please send me your free booklet, telling how I can get my commercial FCC license quickly. I understand there is no obligation and no salesman will call.

Name..... Age.....

Address.....

City..... State.....

I am interested in: Home Study, Resident Classes



BOOKSHELF

"PRACTICAL RADIO AND ELECTRONICS COURSE" prepared under the direction of M. N. Beitman. Published by Supreme Publications, 1760 Balsam Rd., Highland Park, Ill. 268 pages. Soft cover, \$3.95.

The fourth edition of this popular course in radio and electronics is an up-to-date, fact-packed volume that covers the fundamentals of circuitry, radio servicing, and applied electronics. Designed as a self-study course, the book begins with "What Makes Up a Radio Receiver," and ends with "Transistor Testing." Between these two extremes, a tremendous amount of ground is covered in this "double-page-size" volume. Explanations are written in lay language; illustrations are plentiful and clear.

"ENERGY" by Sir Oliver Lodge, F.R.S. Published by John F. Rider Publisher, Inc., 116 West 14 St., New York 11, N.Y. 64 pages. Soft cover. \$1.25.

This is a modernized reprint of a book originally done by the world-renowned English physicist, Sir Oliver Lodge. Written in a style than can be appealing to both layman and scientist, the book's chief virtue is that it explains complex ideas in terms of daily experiences, so that the subject is made both understandable and interesting. Topics covered include energy and work, heat, storage and dissipation of energy, momentum, and matter as a form of energy.

"MOST-OFTEN-NEEDED 1957 RADIO DIAGRAMS AND SERVICING INFORMATION" compiled by M. N. Beitman. Published by Supreme Publications, 1760 Balsam Road, Highland Park, Ill. 192 pages. Soft cover. \$2.50.

Diagrams and data needed for servicing over 30 different makes of a.c.-d.c. receivers are provided in this manual—including some portables, clock radios, record changers, and FM sets. No theory or explanations are given; this is strictly a manual for the practicing and experienced service technician, although the general student of electronics might be interested in comparing circuits and design features of the new popular priced receivers.

-30-

IF YOU *like to build the models...*



*work on the big ones...and start
a great future...*



in the **U. S. AIR FORCE**

If you have mechanical ability, electronic ability—or both—the U.S. Air Force offers you unparalleled opportunities to develop your skills and train for an exciting and rewarding career. Whatever your future may be, *you'll go places faster* with the experience you gain in the U.S. Air Force. In addition, you will have the chance for interesting travel, further education and all forms of recreational activity. Get on the all-volunteer, *young men's team!* See your Air Force Recruiter, or mail the attached coupon, now.

Airman Information, P.O. Box 7608,
Washington 4, D.C.

M-96-P6

Please send me more information on my opportunities for enlisting in the U.S. Air Force. I am between the ages of 17-34 and reside in U.S.A. or possessions.

Name _____

Address _____ Age _____

City _____ Zone _____ State _____

FREE

1957
EICO[®]
CATALOG

**SAVES YOU 50% on your
TEST INSTRUMENT & HI-FI COSTS**
50 KITS & WIRED MODELS to choose from!

EICO[®]

33-00 Northern Blvd., L.I.C. N.Y.

Show me HOW TO SAVE 50% on Laboratory Precision test instruments & Hi-Fi. Send FREE catalog & name of neighborhood EICO Distributor. PE-8

Name

Address

City Zone State

Occupation

Prices 5% higher on West Coast



Home, car, TV, appliance repairs:
#340 NEW!
REDI-TESTER
KIT \$12.95
WIRED \$15.95



VACUUM TUBE
VOLTMETER
#221
KIT \$25.95
WIRED \$39.95



NEW! PEAK-TO-PEAK
VTVM
#232 & UNI-PROBE
(pot. pend.)
KIT \$29.95
WIRED \$49.95



1000 Ohms/Volt
MULTIMETER
#536
KIT \$12.90
WIRED \$14.90

You build EICO KITS in one evening — but they last a LIFETIME! OVER 1 MILLION in use today!



5" PUSH-PULL
SCOPE #425
KIT \$44.95
WIRED \$79.95

Lowest-priced professional Scope

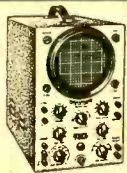

NEW! COLOR &
BLACK-&WHITE
S-MC TV
SCOPE #460
KIT \$79.95
WIRED \$129.50



TUBE TESTER #625
KIT \$34.95 WIRED \$49.95

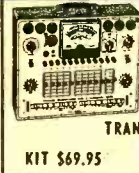

#666
NEW! DYNAMIC
CONDUCTANCE
TUBE &
TRANSISTOR TESTER
KIT \$69.95 WIRED \$109.95



NEW!
RF-AF SIGNAL
GENERATOR #324
(150 kc to 435 mc)
KIT \$26.95 WIRED \$39.95



TV-FM SWEEP
GENERATOR
#360
KIT \$34.95 WIRED \$49.95



MULTI-SIGNAL TRACER #145
KIT \$19.95 WIRED \$28.95

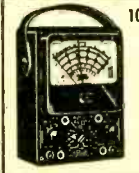

1000 Ohms/Volt
MULTIMETER
#556
(4 1/2" METER)
KIT \$16.90
WIRED \$23.50



6V & 12V
BATTERY
ELIMINATOR
CHARGER &
KIT \$29.95 WIRED \$38.95



R-C BRIDGE & R-C-L
COMPARATOR #950B
KIT \$19.95 WIRED \$29.95



Test radio, hearing aid,
flashlight, photo-flash,
electronic equipment
batteries:
BATTERY TESTER
#584
KIT \$9.95 WIRED \$12.95



RETMA Res. Sub.
Box #1100
KIT \$5.95 WIRED \$9.95



RETMA Cap. Sub.
Box #1120
KIT \$5.95 WIRED \$9.95

HIGHEST QUALITY HI-FI at the lowest prices...

only from

EICO



NEW
MASTER
CONTROL
PREAMPLIFIER #HF61
KIT \$24.95 WIRED \$37.95
with Power Supply:
KIT \$29.95 WIRED \$44.95



NEW!
60-WATT
Ultra-Linear
HIGH
FIDELITY
POWER AMPLIFIER
#HF60 with ACRO TO-330 OUTPUT XFMR
KIT \$72.95 WIRED \$99.95



NEW!
50-WATT
Ultra-Linear
POWER
AMPLIFIER
#HF50
with
CHICAGO OUTPUT XFMR
KIT \$57.95 WIRED \$87.95

- proven trouble-free designs
- superb listening quality
- unequalled circuit refinement
- unequalled component quality
- unmatched control facilities
- unmatched low distortion



NEW!
20-WATT
Ultra-Linear
Williamson-type
INTEGRATED AMPLIFIER
#HF20
KIT \$49.95 WIRED \$79.95



NEW!
50-WATT
Ultra-Linear
INTEGRATED AMPLIFIER
#HF52
KIT \$69.95 WIRED \$109.95



NEW! 12-WATT Williamson-type
INTEGRATED AMPLIFIER #HF12
KIT \$34.95 WIRED \$57.95



NEW!
COMPLETE with
FACTORY-BUILT
CABINET-2-WAY
HI-FI SPEAKER
SYSTEM #HF51
\$39.95

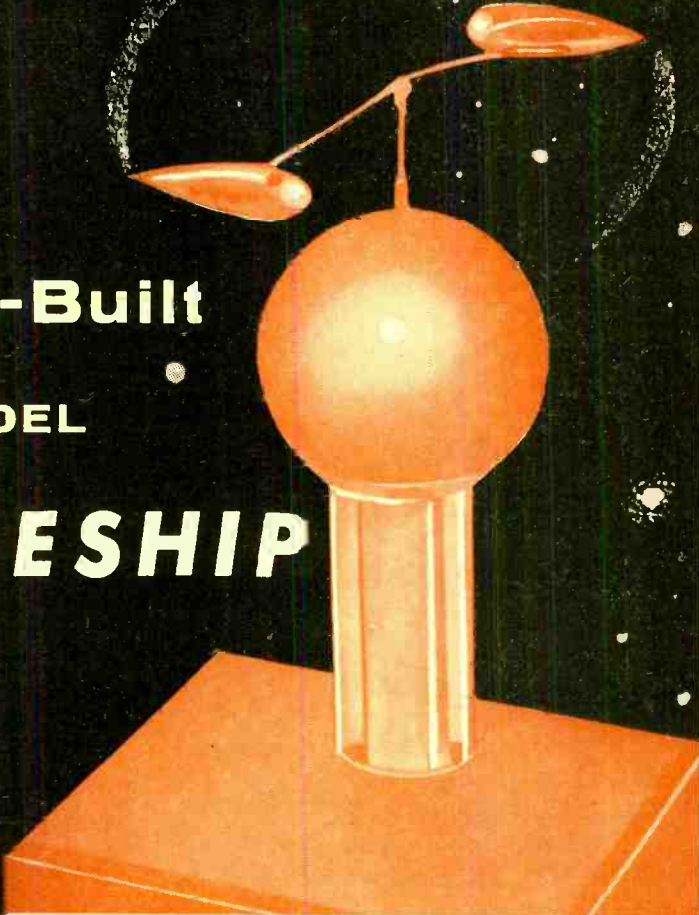

Home-Built MODEL SPACESHIP

Ionic drive is demonstrated by high-voltage generator

WHEN MEN FIRST stood in the night, looking up at the starry sky, ignorantly marveling at its ever-changing, endless mystery—that was the beginning of all science. Astronomy, the oldest of sciences, has always inspired dreams about travels to the moon, to Mars, Venus, and even beyond the planets to distant stars.

Modern technology has transplanted interplanetary travel from the world of dreams to the realm of mathematical calculation and even the engineer's drawing board. Travel to planets within the solar system now seems a sure bet.

Interstellar Distance. But it's a long way between the stars. On Earth, the mile is a convenient unit. A short voyage may

be only a few miles—a longer one, hundreds or even thousands of miles. The distance completely around the Earth is about 25,000 miles.

When we start dealing with the distances between the planets, however, we find that the mile is a rather poor yardstick—distances here are measured in the tens or hundreds of millions of miles. At its closest approach, Mars, for example, is 36 million miles away from Earth. Venus, our nearest planetary neighbor, at its closest point is 26 million miles away.

Distances between stars are generally measured in light-years. A light-year is the distance light can travel in a period of one year—at a speed of approximately

By **LOUIS E. GARNER, JR.**

REACTION MOTORS

Most suggested spaceship drive mechanisms are based on Newton's "Third Law of Dynamics"—to every action, there is an equal and opposite reaction. Drive mechanisms based on this principle are called reaction motors.

It is this physical law that causes a gun to "kick" or a cannon to recoil, and it is this same law that permits a rocket to operate. The rocket engine is a reaction motor. The action of the rocket's expanding gases is matched by the reaction of the rocket moving in a direction opposite to that of its exhaust gases.

A simplified diagram of one type of rocket motor is shown below. Liquid or gaseous fuel, mixed with oxygen, is "exploded" in a combustion chamber. The

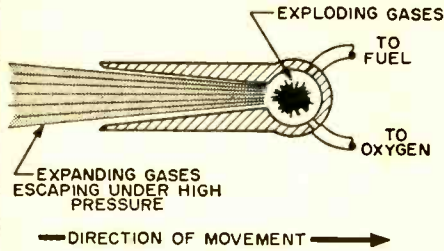

expanding gases escape through an exhaust port, developing a reaction or thrust that moves the rocket forward. This general type of reaction motor is used in ICBM guided missiles.

The amount of thrust, and hence the rate of acceleration, that can be developed by a reaction motor is dependent on the mass and velocity of the exhaust gas molecules. Such rockets have exhaust velocities from about 5000 to 10,000 feet per second, and, with reasonable fuel loads, can develop speeds on the order of 15,000 to 25,000 miles per hour.

186,000 miles per second, or nearly six million million (6,000,000,000,000) miles. And the nearest star, other than our Sun, is approximately four light-years away!

Such distances raise special problems. Travel in spaceships powered by conventional rockets is impractical because of the fuel loads needed. For example, suppose we had a ship capable of the (today) fantastic speed of 100,000 miles per hour. Such a ship could make the trip from here to the moon and back in about five hours. Yet it would require over 27 thousand years to reach the nearest star.

A radically new principle was needed to push our future spacecraft. To go from star to star and complete the trip in a human lifetime, we must develop some transportation close to the speed of light. Such velocity can be attained with a new type of motor, called the *ionic drive reaction motor*.

Build It Yourself. The basic principle of an "ionic drive" reaction motor—that of producing motion by the reaction of an accelerated stream of charged particles—can be demonstrated quite easily in the home. If you wish, you can even assemble your own model spaceship. A "working model" is easy to build.

The first thing you'll need is a safe

source of high voltage. An Atomotron electrostatic high voltage generator* is suitable and is completely safe to operate, even though it may develop voltages on the order of 50,000 to 75,000 volts. Its operation is very similar to that of the early "atom-smashers."

The Atomotron consists of a metal sphere about 2" in diameter and insulated above "ground" by a plastic support column. An insulated pulley is mounted at the inside top of the column. At the bottom of the column, a small a.c. motor has another insulated pulley attached to its drive shaft. A rubber belt is affixed between the two pulleys. Small brushes of fine wire are mounted close to the belt. One is mounted at the top and connects to the metal sphere. The second is mounted at the bottom and connects to the motor's frame.

As the motor moves the belt, it picks up a minute electrical charge from the lower brush and transfers it to the upper brush,

* Available both in kit form and factory-assembled. It may be ordered directly from the manufacturer, Atomic Laboratories, P. O. Box 343-C, Berkeley, Calif. It may also be obtained from some jobbers and distributors, e.g., Lafayette Radio, 165-08 Liberty Ave., Jamaica 33, N. Y.

IONIC DRIVE

To increase the rate of acceleration of a spaceship, we must develop more thrust in its drive motor. In a reaction motor, we can do this by increasing either the volume (mass) or the speed of the exhaust—or both.

But if we increase the mass of the exhaust, we will use fuel much more rapidly—an undesirable condition, since the greater mass of a typical rocket is already made up in fuel load. The alternative is

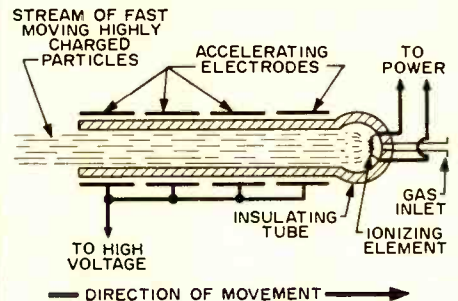

to increase the exhaust speed—preferably to a velocity approaching that of light.

In giant "atom-smashers," such as cyclotrons, betatrons, etc., charged particles (ions) can be accelerated to velocities close to that of light through the action of electric and magnetic fields. It follows, then, that we should be able to build a rocket motor utilizing accelerated ions instead of a chemical explosion. One possible form of such an ionic drive motor is shown above.

In operation, gas atoms are introduced into a chamber where they are ionized by an electric filament. These particles then are accelerated in a steady stream by a series of electrodes carrying high voltages—much in the same manner that the electron beam in a TV cathode-ray tube is accelerated forward to strike the fluorescent screen.

where the charge accumulates on the metal sphere. The charge on the sphere is built up, bit by bit, until the static voltage between sphere and "ground" is 50,000 to 75,000 volts.

Assembling the Spaceship. Relatively few materials are needed to assemble the spaceship itself. Construction details are shown in drawing at bottom of page.

A piece of #12 busbar serves both as the support rod and as the reaction motor. The length is not especially critical—4" to 6" is fine. Form a smooth right-angle bend at each end of the wire, with the bends facing in opposite directions. Use approximately a half-inch of wire for each bend. Both bends should be of equal length.

After forming the bends, use a flat ignition file to shape the two tips to needle points. The support rod is completed by soldering a small rivet to its *exact center*,

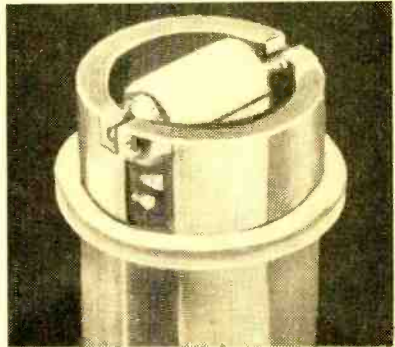
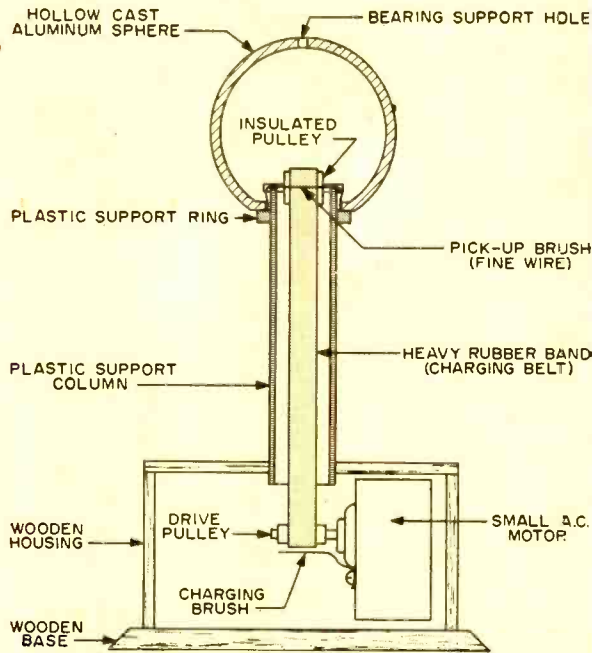
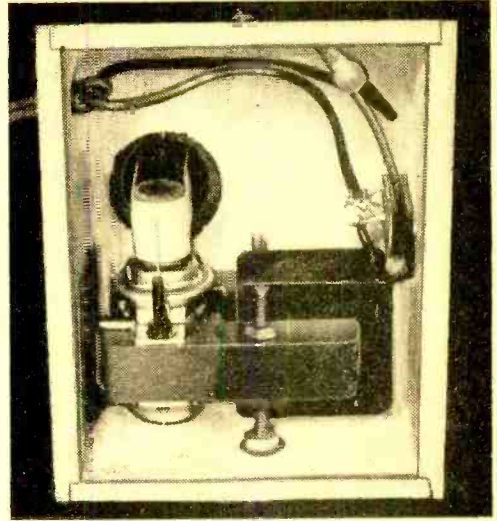

The photos above show both ends of the Atomotron's charging belt. At left is a cross section of the generator which will permit the constructor to build his own if he so desires. The spaceship operates as shown below. Ionic or corona discharge from sharpened points of the support rod makes the spaceship revolve rapidly around the aluminum sphere.

with the rivet at right angles to the two bends in the wire.

You can make the model spaceship from a piece of dowel or balsa wood approximately $\frac{1}{4}$ " in diameter and $1\frac{1}{2}$ " long. Two are needed. Form them to the characteristic torpedo shape with a pocket knife, small file, and sandpaper. Cut a small groove in one side of each ship just wide enough to permit a force fit on the bent ends of the support rod.

The only other thing you'll need is a small bearing to support the entire assembly on the metal sphere of the Atomotron.

(Continued on page 116)

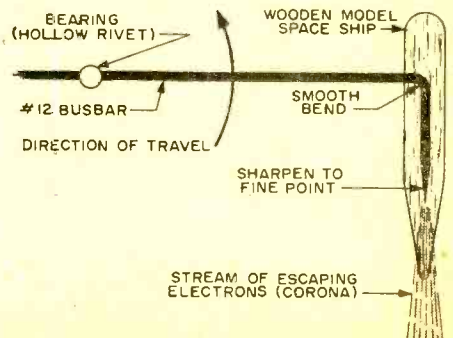

Stereo Hi-Fi Hearing Aid

... a new era dawns
for hard-of-hearing



Startled young lady wears binaural hearing aid with earpieces camouflaged by hair. Transparent version shows microminiature components in temples.

MILLIONS of the nation's hard-of-hearing are in for the surprise of their lives—they're about to get true hi-fi "stereophonic" sound. A new Acousticon hearing aid employs two separate sound amplifiers camouflaged in an ordinary-looking pair of eyeglasses. The flat-sounding monodirectional reception of the ordinary hearing aid is thus eliminated.

Binaural or stereo hearing aids are not new, but this is the first time stereo has been achieved with two separate microphones and amplifying systems. Others simply feed the sound through one channel into parallel earpieces.

Both Acousticon channels are powered by a single tiny mercury battery, with one on-off switch but two volume controls. A spare battery is carried in the other temple of the frame.

In order to cover all of the frequency loss patterns common to most of the hard-of-hearing, the company has developed 10 different earpieces, each modified to re-

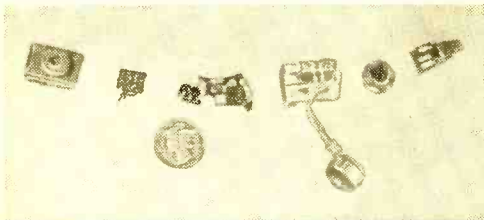

Exploded view of the component parts of one amplifying channel of binaural hearing aid (left to right): magnetic microphone, audio transformer, first stage of amplifier, receptacle and earpiece, mercury battery and second stage of amplifier. Dime shows comparative size of parts.

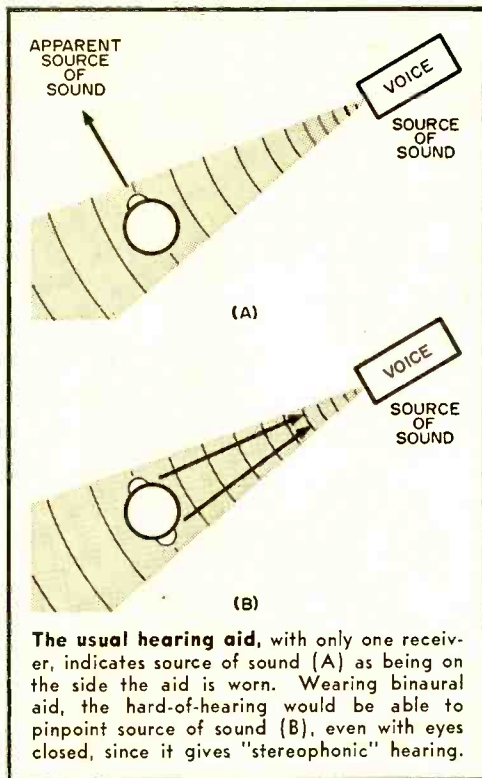

The usual hearing aid, with only one receiver, indicates source of sound (A) as being on the side the aid is worn. Wearing binaural aid, the hard-of-hearing would be able to pinpoint source of sound (B), even with eyes closed, since it gives "stereophonic" hearing.

spond to a specific frequency range. Thus, 100 possible combinations are offered to meet the needs of virtually any hearing defect.

In addition to giving directional hearing, the device eliminates another bugaboo of "flat" hearing—that of obtrusive background noises. Monodirectional hearing permits background noises to reach the ear at the same level as the message. There is no way for the brain to "separate" them. Binaural hearing puts background noise in its proper perspective and allows much more relaxed hearing.

New Era in Eating

KEEPING FOOD FRESH has been a persistent problem for mankind ever since man gave up the habit of roaming the woods and eating meat freshly killed. Electronics has now come up with a new method of preserving either fresh or cooked food indefinitely—and *without the need for refrigeration*.

A new era in eating has been heralded by the recent announcement that the Raytheon Company of Waltham, Mass., managed to dehydrate food by irradiation with microwaves. Along with the water content, the electronic waves also remove from 70 to 90% of the food's weight. All you need do to get a meal ready is to immerse the pre-cooked, electronically preserved food in water, which is then soaked back into the food. The flavor, experts say, is none the worse for the electronic treatment.

The U.S. Armed Forces are interested in this method to ease their food supply problem. Medicine also foresees in it an economical way of preserving large quantities of human tissue and blood for transfusions and skin grafts for the survivors of atomic bombardment.

-30-



Lobster tails are removed in tray from microwave irradiation chamber above. Steaks, strawberries and chicken lie prepared on table, ready for testing.



Food keeps fresh indefinitely on the shelf (above) after having been irradiated. Steaks at left illustrate 4:1 weight reduction of electronically treated food. The single untreated steak equals four irradiated steaks.



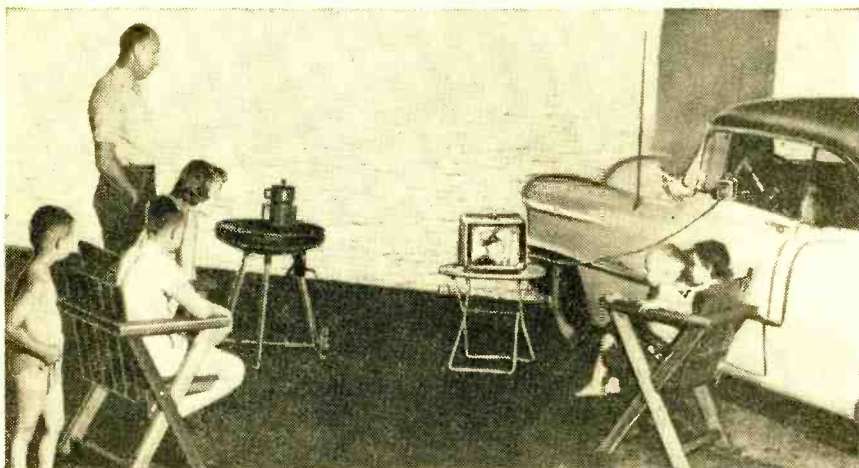

Miss TV?

Never!

So we went out for a weekend at the lake and had a wonderful time. What? Miss our favorite TV programs? I should say not! We took along our "Trav-Electric TV Chief," by Teradio Co. You see, the Trav-Electric converter supplies us with a constant 115 volts from our 12-volt car battery, whether the motor is running or not. It's designed to operate the new, smaller, portable television sets. The company says it will operate all appliances within its rated capacity of 125 watts. So why miss TV on your vacation? Start living again.



Atom Power for Sale

A family of light, small nuclear power packs developed by Patterson Moos convert nuclear energy directly into electrical energy. Sold under the name "Raypak," these tiny storehouses deliver a power punch of 5 to 5000 $\mu\mu\text{a}$. Suitable for weapons and ordnance systems as power sources for warheads, fuses, destructors, timers and programing devices, they have a use life of more than 25 years. The heart of each device is a nuclear battery. The packs range in size from less than one cubic inch to two cubic inches. Battery performance is not affected by environmental conditions.

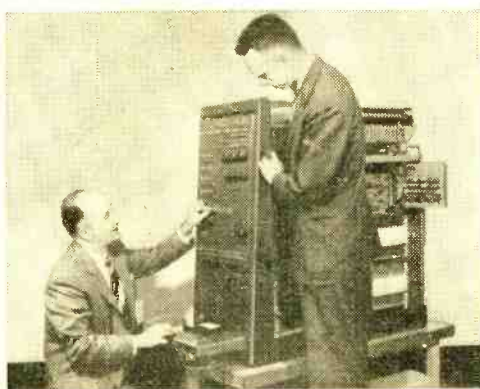

"Midget" Electronic Brain

A new high-speed digital computer developed by Bell Telephone Labs is not much larger than a television set, and requires less power to operate. It uses a drastically reduced number of components, only about 9000, half of which are transistors. Total power dissipation is 160 watts, less than 2.5 of which are used by the transistors. "Leprechaun," as the electronic brain is called, may be employed as a test model for research on computers, since its components can be easily reconnected to simulate the desired apparatus. The unit is still in the experimental stage.

The "Hartsdale," a new miniature speaker, provides clean, balanced sound at low cost for small hi-fi systems or as a secondary (extension) loudspeaker.

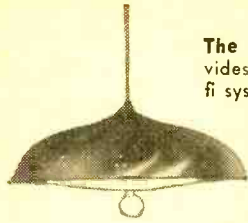

**Flood of new audio equipment proves
that good sound knows no season**

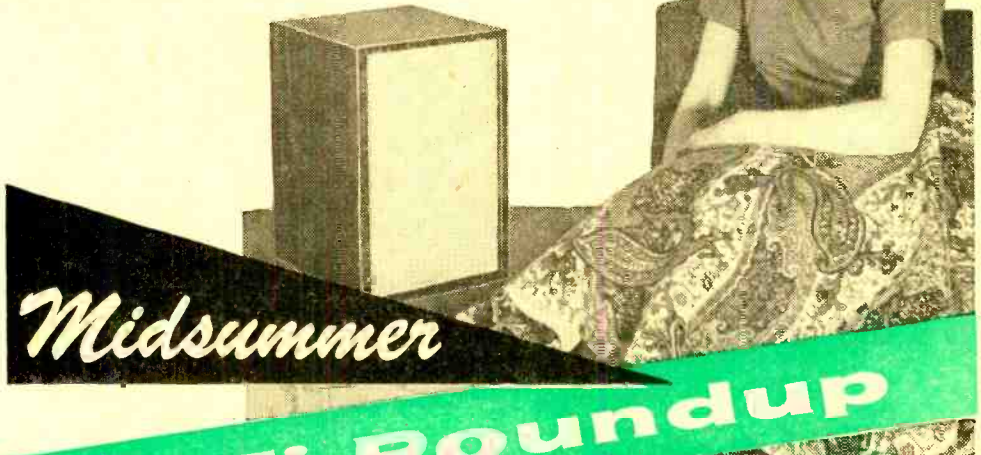

Midsummer

Hi-Fi Roundup



SUMMER used to be the time for going fishing—and nearly everything else just had to stop. But now it seems that even summer heat or the fattest fish can't tempt hard-bitten hi-fi fans away from their hobby. That audio knows no season proves, for one thing, that it is an absorbing activity which can be year-round fun. For another, it proves that the audio industry is constantly on its toes, gushing forth new ideas and equipment to keep the hi-fi hobby interesting.

At any rate, this year there seems to be no dog-day let-up in audio doings. Dealers and manufacturers who fancied themselves taking a long breather during the traditional summer slack find themselves working overtime instead. Apparently the hot season spawned some hot items—and POPULAR ELECTRONICS recently sneaked a few preview glances at what's coming up in the way of sound equipment.

Transistors, previously pretty much confined to pocket radios, have been trained

by fancy engineering to do the more exacting jobs demanded of them in high-quality audio. Two transistorized phono-preamps are now available, one made by REGENCY, the other by MADISON FIELDING. The REGENCY is an all-transistor job (also available as a printed-circuit kit) while the final stage of the FIELDING is a 12AX7 tube. The use of transistors in the super-sensitive high-gain input stages banishes some nasty old preamp bugaboos: hum and microphonics. These preamps feature the necessary volume, treble and bass controls. In conjunction with regular power amplifiers, they should bring about a noticeably quieter background.

MADISON FIELDING CORP. also pioneers the use of transistors in the hum-sensitive input stages of one-piece amplifier-preamp combinations. Their 16-watt pancake Model A-15 is the first all-in-one amplifier to employ transistors in the critical phono, tape and mike channels. Equalization for all these various inputs is built right into this



Madison Fielding's new Model A-15 amplifier has pioneered transistorized high-gain input stages.

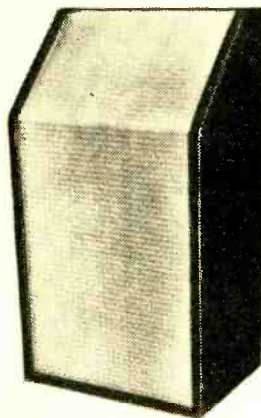

Slant front aids nearly omnidirectional sound spread from Madison Electronics' new loudspeaker kit, which features "retractable mid-range" to compensate for listening-room acoustics.

preamp stage, so that later circuitry could be designed for flat response.

Among power amplifiers, a new ACRO-SOUND ultra-linear 60-watt kit makes the most of the Acro transformer with its unique feedback winding. In the same heavy-caliber class, Eico offers a 60-watt unit of outstanding performance, either as a kit or ready-wired. Among its notable features is an indirectly heated British-type GZ34 rectifier, which delays full plate voltage until the tubes are warmed up. Tubes and electrolytic capacitors live longer that way. PILOR also packs a lot of muscle into a new 40-watt amplifier (Model AA-908) which has a special adjustment to give lazy loudspeakers an extra shove in the bass.

At the opposite pole from these high-powered giants is the little Eico 12-watt amplifier which—controls and all—comes either as a kit or ready-wired at a bargain basement price. Tight-fisted music lovers with a yen for high-quality can get a smooth earful and plenty for their money in a new line of kits by MADISON ELECTRONICS CORP., consisting of amplifier, preamp-

control unit, and a radically new loudspeaker design.

Loudspeakers remain at the focus of audio interest as perhaps the most crucial component of an entire audio system. The season's crop of new models includes a new 18" "Goliath" woofer by RACON. This giant pumps out the bass down to the all-time low of 10 cps—even beneath the limit of human hearing. At the opposite pole in

(Continued on page 112)

WANT TO KNOW MORE?

For full specifications on any of these new high-fidelity products, write to their manufacturers.

Regency, Inc.

7900 Pendleton Pike
Indianapolis 26, Ind.

Madison Fielding Corp.

863 Madison St.
Brooklyn 21, N. Y.

Acrosound

369 Shurs Lane
Philadelphia 28, Pa.

Eico

84 Withers St.
Brooklyn 11, N. Y.

Pilot Radio Corp.

37-06 36th St.
Long Island City 1, N. Y.

Madison Electronics Corp.

22 Rosedale
Madison, N. J.

Racon Electric Co.

1261 Broadway
New York, N. Y.

Hartsdale Products

24 Shaw Place
Hartsdale, N. Y.

General Electric Corp.

Syracuse, N. Y.

Stephens Mfg. Corp.

8538 Warner Drive
Culver City, Cal.

Electro-Voice, Inc.

Buchanan, Mich.

Allied Radio Corp.

100 N. Western Ave.
Chicago 80, Ill.

James B. Lansing Sound, Inc.

2439 Fletcher Drive
Los Angeles 39, Calif.

Ronette Acoustical Corp.

135 Front St.
New York 5, N. Y.

Pickering & Co., Inc.

309 Woods Ave.
Oceanside, L. I., N. Y.

Hegeman Laboratories

176 Linden Ave.
Glen Ridge, N. J.

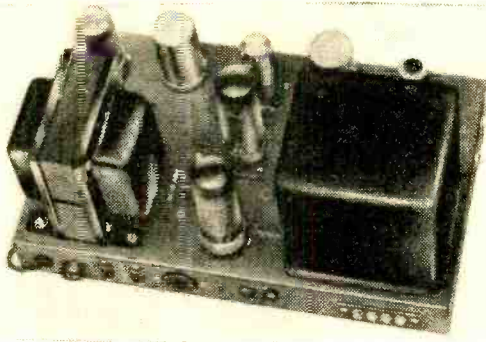

Heavyweight championship contenders in the power amplifier league are the Eico 60-watt kit at left and the ready-wired Pilot 40-watt amplifier shown below.

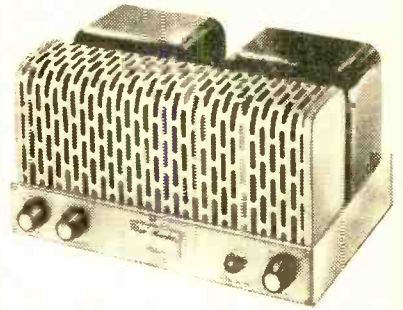

The decorative piece of furniture below comes as a kit from Electro-Voice and slips over their "Georgian" and "Patrician" baffles, acting as enclosure for the enclosure.

The girl will undoubtedly be wooed at as she cradles General Electric's new low-cost bass driver tenderly in her arms. Jealous onlooker from above is Allied Radio's new Knight "Tri-Fi" 3-way loudspeaker, showing off its three coaxially arranged elements—bass, mid-range and treble.

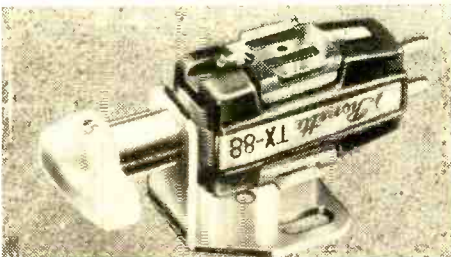

Ronette's new wide-range crystal cartridge flings a possible challenge at the supremacy of magnetic pickups in hi-fi applications.

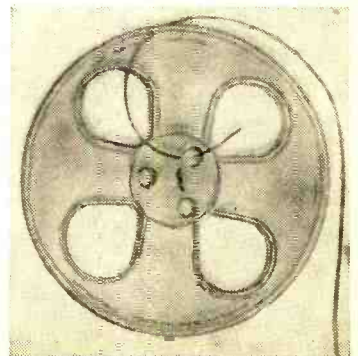

Audiotape slips into its new C-slot reel for firm anchorage without fuss. The new hub snubs snags while the tape itself has been improved to prevent "print-through" echoes between adjacent tape layers in long storage.

Airborne Electronics

SINCE the power supply will be the most important part of the forthcoming Earth Satellite, supplying current for the radio-sonde transmitter and the slew of data-gathering scientific instruments, it got top priority from research scientists. The new silicon solar battery may be the answer, tests by the High Energy Research Labs in cooperation with General Mills and the Office of Naval Research indicate. High-altitude tests using balloons showed that the battery's efficiency had almost doubled at 40,000 feet, and when the big gas bags hauled the battery to as high as 90,000 feet, scientists were able to check its operation with more than 90% of the earth's atmosphere below it—pretty close to outer space. The solar battery is the only power plant for which sunlight is the sole raw material needed to produce electricity.

It needs no maintenance of any kind; it can't wear out, and it will practically run forever! Space, here we come!

Meanwhile, the newest electronic "weather paratrooper," also known as "dropsonde," is capable of operating five miles higher than any previous sonde of this

type, according to General Instrument Corp., manufacturer. The AMT-6 uses precision electronic equipment that takes readings up to 60,000 feet—more than 11 miles—with 95% reliability. Contained in a tube-shaped case (see photo insert), the device weighs less than 10 pounds, is 22" long and 5" in diameter. It has a tiny parachute and pilot chute, electronic sensing elements to "read" temperature and humidity, an air pressure bellows, circuitry to convert readings to radio signals, and a miniature transmitter—with antenna—having a 250-mile range. Dry cells power it. The "paratrooper" is released from weather reconnaissance planes and transmits reports to plane or ground.

—30—

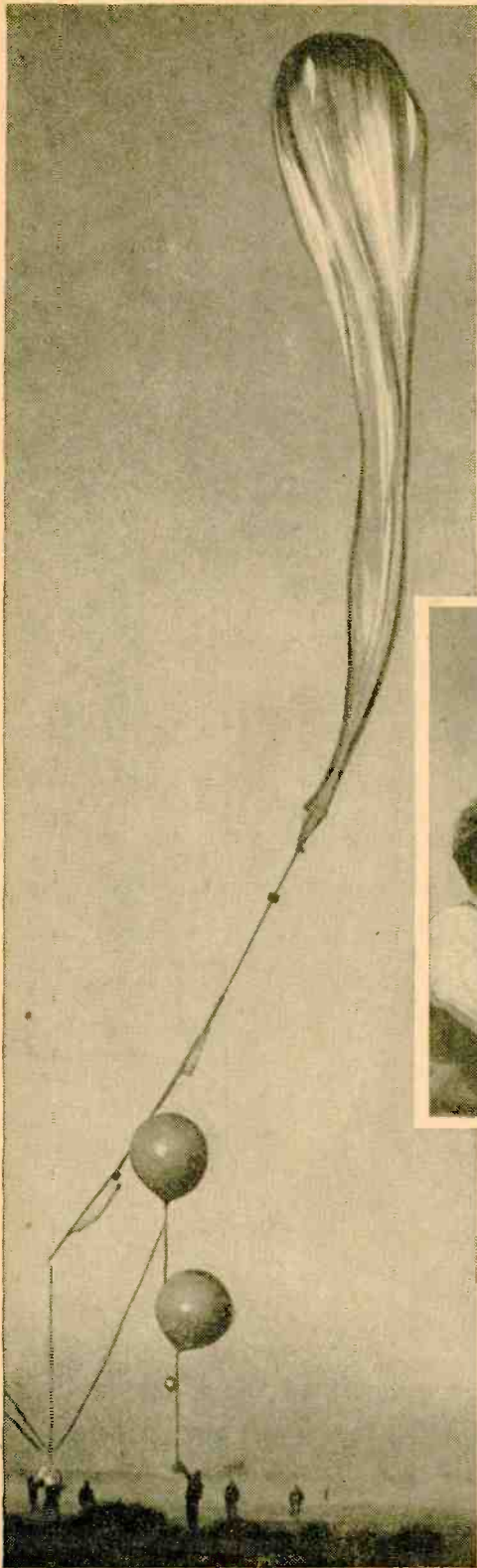

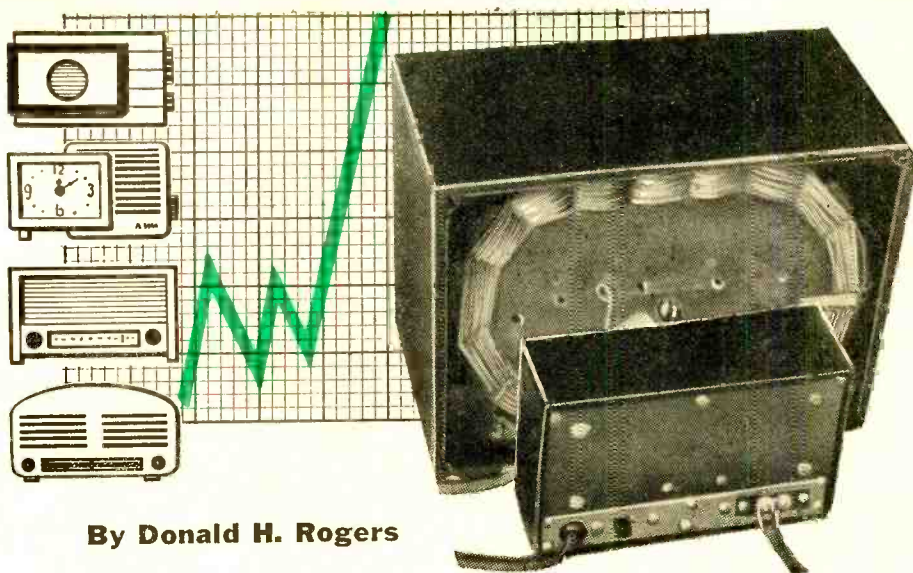

By Donald H. Rogers

BOOSTER FOR YOUR AM RADIO

Soup up that table-top AM receiver with this simple circuit

THAT RELIABLE five-tube a.c./d.c. AM receiver with a built-in loop is a good set, but in many parts of this country it is not quite good enough to get the program you want when you want it. Before the day of the built-in loop, it was possible to improve performance by connecting an outside antenna; now, practically none of the newer receivers provide for the addition of an outside antenna. If you are in a poor location for AM radio reception, i.e., in a basement, a valley, within a steel building frame or perhaps a full house shield of metallic insulation, you can solve your problem with an AM booster.

The booster is a simple, one-tube ampli-

fier which can be connected to as high and long an antenna as you wish to install. It requires no connection to the radio set; just place it behind the receiver where its miniature transmitting loop can relay the signals into the AM set.

Building the Booster. The chassis layout is straightforward. Beauty is not important here, because the booster will be concealed by the radio set.

Tube *V1* is a 12AT7 twin-triode arranged with both triodes in d.c. series. An r.f. choke (*RFC1*) and capacitor *C3* tune the booster for radio-frequency signals. Input is direct to one cathode, and output taken from the second triode is coupled mag-

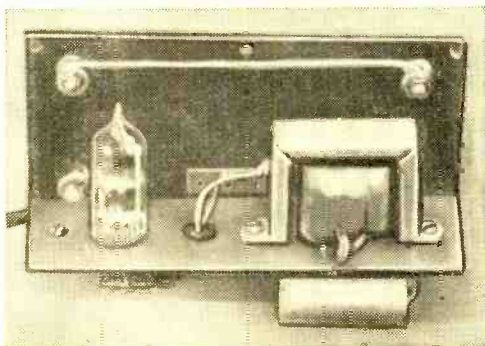

Looking down at the one-tube amplifier chassis.

August, 1957

HOW IT WORKS

This circuit is essentially a two-stage, grounded-grid r.f. amplifier. The antenna is coupled through *C1* to the cathode of the first triode section of *V1*. The plate output is then coupled to the cathode of the second section through a special tuned circuit consisting of *RFC1* and *C3*. No substitutions should be made for these two parts; *C3* is extremely low in capacity and the choke has a very low distributed capacity.

The output of the second triode appears in the field of the new loop antenna *L2*, and the field of this loop is coupled (by placing it within range) to the loop in the AM receiver. Thus, the amplifier acts as a miniature broadcast transmitter. Filament voltage is supplied by *T1* and rectified plate voltage by *R6*, *SRI*, *C5*, and *R5*.

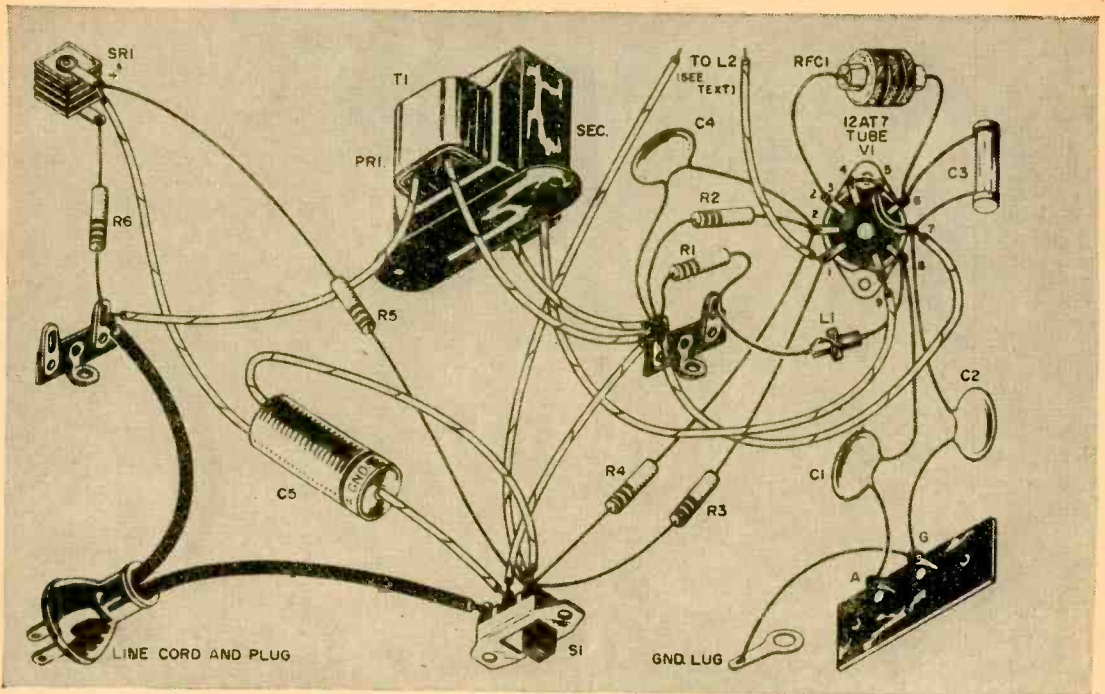

ductively to the loop antenna of the AM radio receiver.

Make loop *L2* by winding 100 turns of No. 30 wire around four insulated screws or pins, or a wooden block, arranged to give inside dimensions of 2" x 5". No metal should be used as it would upset performance of the loop. I wound the loop in my model around four machine screws insulated with small plastic coil bobbins, mounted on a sheet of $\frac{1}{16}$ " Bakelite. The terminals are also concealed for safety. Resistor *R3* shunts the loop to provide bandwidth and stability.

The power supply circuit is line-connect-

ed (a.c. only), but the chassis, antenna and ground are isolated from the line by capacitors *C1* and *C2*. The builder who wishes to do so may eliminate *T1* by series-connecting the heaters (use pins 4 and 5) and substituting a 700-ohm dropping resistor of 20-watt or higher rating.

Parts around the tube socket must be spaced out to avoid stray coupling. Choice of parts is not critical with the exception of r.f. choke *RFC1*.

Putting It to Work. If the booster is wired carefully, it can be expected to work on the first try. However, you should take the following two precautions.

From the bottom, the booster looks like this. It will amplify stations all over your dial.

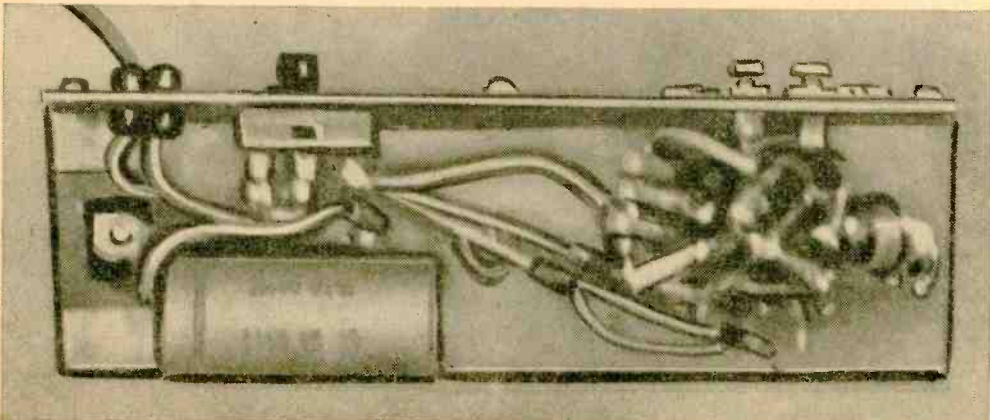

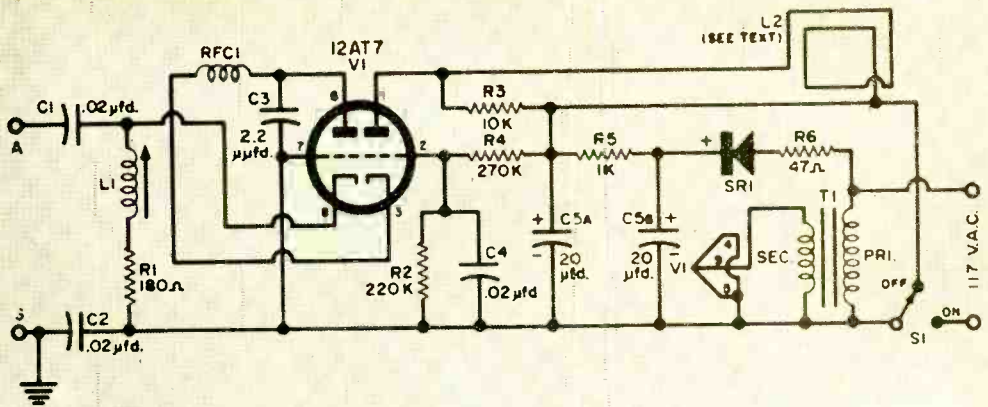

C1, C2, C4—0.02- μ d., 500-volt GMV ceramic disc capacitor
 C3—2.2- μ d. gimmick capacitor (Quality Components, Inc.)
 C5a/C5b—20-20 μ d., 150-volt elec. capacitor
 L1—250- μ h. peaking coil (Miller 6181-TV)
 L2—Radiating loop (see text)
 R1—180-ohm, $\frac{1}{2}$ -watt resistor
 R2—220,000-ohm, $\frac{1}{2}$ -watt resistor
 R3—10,000-ohm, $\frac{1}{2}$ -watt resistor

R4—270,000-ohm, $\frac{1}{2}$ -watt resistor
 R5—1000-ohm, $\frac{1}{2}$ -watt resistor
 R6—4"-ohm, $\frac{1}{2}$ -watt resistor
 RFC1—0.62-mh. r.f. choke (Miller 4650)
 S1—S.p.d.t. slide switch (one terminal used for tie point)
 SR1—130-volt, 20-ma. selenium rectifier
 T1—6.3-volt, 0.3-ampere filament transformer
 V1—12AT7 tube
 1—2" x 3 $\frac{3}{4}$ " x 6 $\frac{1}{4}$ " case (Waldom BC-138)

Hook up the booster's parts according to pictorial at left; schematic and parts list are above.

If your antenna lead is too close to loop L2, it will cause a signal to be fed back and create an unstable circuit. This dictates the use of 300-ohm twin-lead (TV type) lead-in. The antenna and ground, or antenna and counterpoise, are connected to the far end. I used two 30' pieces of wire attached to the end of a 40' lead-in. These can be strung out-of-doors or in the attic as long as the antenna ends do not come close to the booster.

The second precaution is to move the

booster back and forth or from side to side behind the receiver until a position is found which gives best results. It will usually be quite close and not exactly in the center.

This simple device will greatly amplify stations all over your AM dial. Of course, it will not eliminate whistles, birdies and interference, but will tend to amplify these right along with the stations. Using a better receiver is the only way to avoid such disturbances.

-30-

Shorty Packs a Real Big Wallop

A new version of the "Wamoscope," (wave-modulated oscilloscope) by Sylvania has been cut down in size and weight, but the versatile tube has lost none of its original usefulness. As a matter of fact, since it is now only 17" long (13" shorter) and weighs 2 $\frac{1}{2}$ pounds (compared to 11), its use has been extended to airborne equipment for radar, etc. Developed in cooperation with the Naval Research Lab, the Wamoscope combines most essential functions of a microwave receiving set in a single tube envelope, eliminating many tubes and components of conventional receivers.

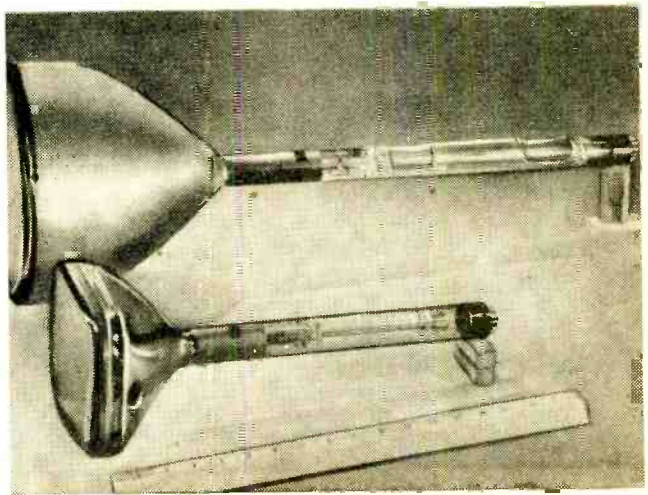



LIKE a spring well turned on, West Germany's electronics industry is bubbling over with ideas—some new, some reworked and improved. Here is a sampling of some of the cleverest in the latter category.

At left, a German cop, like his American counterparts, gives Telefunken's traffic radar the fish eye as a car whizzes past. Woe to the unwary motorist who exceeds 90 kilometers an hour, since this one-man operation not only detects speeders, but takes a photo of the culprit's license plate together with the speed. Just like the good old U.S.A.!

That speeder is no doubt hurrying out to the country on a picnic, where he and his girl will try out the new Metz purse-size radio-phonograph that weighs only 10 pounds with batteries. In the photo at the far left, the standard and short-wave "Baby-phone" is closed for carrying; in the one next to it, the radio phonograph is open for use. It plays 45-rpm discs, and has space to carry six. Happy picnic!

When our hero . . . oops . . . speeder, gets home this evening, doubtless he and his fraulein will continue

the picnic before his Grundig radio. Just so he won't have to rush over every so often to control the tone, he has a Grundig remote controller with volume and tone control (photo at left). Five keys handle 3D, Speech, Orchestra, Solo and Jazz, and the wheel at the top is used to vary the volume. The device hooks up to the radio by a cable.

And if they get tired of that, they can always attach the tape deck to the phonograph, by Artur Kidalla. The bottom photos show (at far left) the hinged deck lifted for phono play (note power take-off disc), and (directly at left) the deck in position to transcribe. Incidentally, our friend can tape records from the very same turntable, if he has a mind to! But then, by this time, he might be far, far busier with other things to worry about records and such mundane matters. —30—

The Germans Have a Way With It

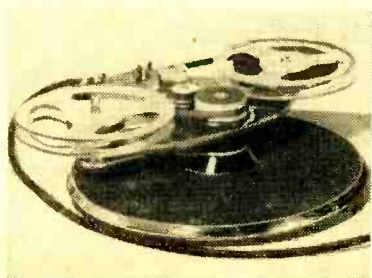

Pity the Poor Loudspeaker



Save your speaker from
"blow-outs" with a simple
"safety light" monitor

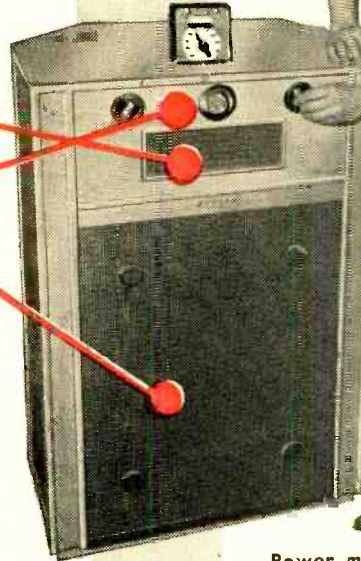

Power monitor atop enclosure protects all elements of this three-way system from overloads.

LOUDSPEAKERS and leather pants have one thing in common: supposedly they never wear out. Yet in either case, the claim to durability depends on the load that must be sustained.

Like every other engineered item, loudspeakers have ratings and specifications. The impedance rating tells you the proper baffle dimensions. Frequency response gives you an idea of how the speaker will sound. But just what does the power rating of the speaker tell you?

The power rating of a loudspeaker, stated in watts, reveals just how much the speaker can take. When audio fans assembling their own components overlook this vital limitation, the speaker, like the above-mentioned leather pants, splits at the seams. Such wrack and ruin can be prevented by a proper understanding of what the power rating means—and by the special "safety light" described in this article.

How to Ruin a Speaker. Suppose the spec sheet for your speaker says: "power-handling capacity 20 watts." This simply means that it should not be hooked up to an amplifier with a higher power output

than that. Yet there may still be situations in which you can use a speaker with a lower power rating than the amplifier. For example, you might want to have one speaker downstairs, one upstairs, and maybe one on the porch. Suppose each of these speakers is rated for 20 watts. This means that your amplifier could put out as much as $3 \times 20 = 60$ watts to keep all three speakers going without straining them.

Yet, suppose you want to shut off your porch speaker and your downstairs speaker and just listen in your upstairs room. There is nothing to keep the heavy punch of your high-power amplifier from ripping your speaker to bits because the other two speakers aren't there to take up the excess power. Of course, you could simply turn the volume down before switching off the other two speakers. But will you always remember to do that? For your upstairs speaker, the first accident will likely be the last.

Treble Trouble. There is an even more pernicious and tragic peril to loudspeakers:

amplifier oscillation. Quality amplifiers are thoroughly tested before they leave the factory, and one of the tests usually employed is a check for stability, or lack of oscillations. This test is necessarily conducted with a power load which only stimulates the average loudspeaker load. What's more, the test is conducted when the power

output tubes are properly balanced. With peculiar load conditions, such as unusually long lines from speaker to amplifier, or with aging of one or both output tubes, a condition of instability may be reached in the amplifier.

The pathetic part about all this is that the resulting oscillation will usually be beyond the range of human hearing, up around 100,000 cycles or more. What's worse, there's usually no audible clue present at normal listening levels. Usually, many oscillations reach nearly the full power output of the amplifier and cause almost instantaneous burn-out of the tweeter voice coil.

Tweeters rarely have as great a power-handling capacity as do their companion woofers. That is because, under *normal* conditions, the power requirements for reproducing high-frequency treble tones are far less than the power needed to produce extreme bass tones. Of course, such unstable oscillation is not a normal condition—but if and when it happens, it can be disastrous to the tweeter.

A similar difficulty can occur at the low end of the frequency range if turntable rumble runs a heavy low-frequency surge through the system. It may be below the range of your hearing—but the great power peak induced by the rumble may un-hinge your woofer.

Save That Speaker. We took a clue from car manufacturers, who incorporated a safety feature on speedometers which works like this. You set a pointer to the speed at which you feel you can travel safely. Every time you tend to edge over that limit, the entire speedometer takes on an ominous red glow. We decided to apply the same principle to protect the "lives" of loudspeakers. The "safety light" we built costs \$4.41—a mere fraction of the replacement cost of a quality loudspeaker.

The heart of the device is a neon indicator, completely enclosed in a plastic, flush-mounting holder. This type of indicator has a novel characteristic that causes it to glow when approximately 65 volts of a.c. are applied across its terminals. The problem, then, was to step up the voltage from the loudspeaker terminals so that even the voltage equivalent of only one-watt power (2 volts in the case of a 4-ohm speaker) could "trigger" the indicator light. This provides a choice of "alarm" settings from 1 watt upward.

Circuit Design. The circuit of the warning indicator is shown in Fig 1. Transformer *T1* is used as a voltage multiplier. What would normally be considered the secondary of this transformer (the 8-ohm winding) is connected to the terminals of

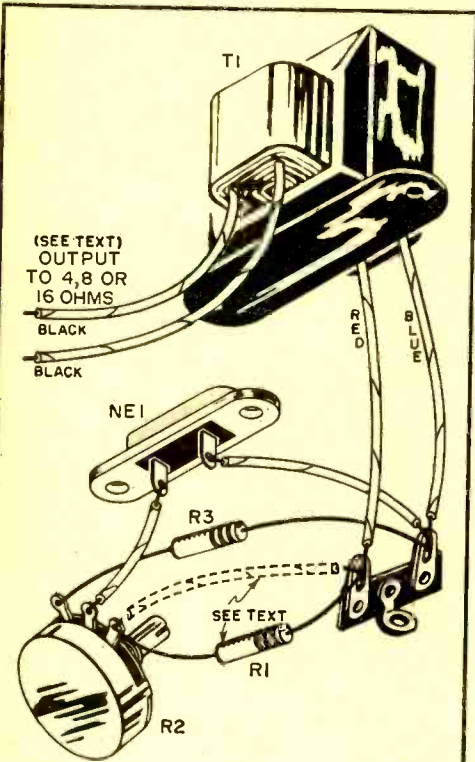

- NE1—Neon lamp (Drake Mtg. Flushlite Model 110)
- R1—47,000-ohm or 120,000-ohm, 1/2-watt resistor (omitted in 4-ohm operation—see text)
- R2—100,000-ohm audio taper potentiometer
- R3—18,000-ohm, 1/2-watt resistor
- T1—Audio output transformer, 8-ohm secondary, 7000-ohm primary (Stancor A-2213 or equivalent)
- 1—2" x 4" x 4" aluminum chassis
- 1—Large knob, preferably pointer type
- 1—Single insulated lug terminal strip
- 1—Two-terminal speaker terminal strip
- Misc. 6-32 machine screws and nuts, solder, wire, etc.

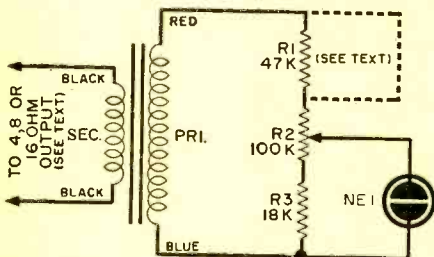

Fig. 1. Pictorial and schematic of the "safety light" illustrate its very simple design.

Physical layout of the monitor is shown at right. For 4-ohm speakers, omit resistor R1 and use jumper lead instead.

the loudspeaker to be protected. The primary winding multiplies the voltage applied to the secondary by approximately 30 times. (Thus, 2 volts across the secondary is stepped up to 60 volts across the primary, and 20-volts input would appear as 600-volts output on the primary side, etc.)

The value of R1 is determined by the voice-coil impedance of the loudspeaker used. In the case of a 4-ohm speaker, R1 is omitted. For 8-ohm speakers, R1 should be a 47,000-ohm, 10%, 1/2-watt resistor. If a 16-ohm speaker is to be safeguarded, R1 should be a 120,000-ohm, 10%, 1/2-watt resistor. Our unit was built for use with a 16-ohm speaker, but the addition of a three-position switch could make it usable with speakers of any impedance without altering the calibration of the wattage selector, R2.

Construction Tips. Follow the diagram of Fig. 1 *exactly*. Connections to R2 must be made as shown, because R2 is not a linear control. In other words, 1/2-turn of the shaft does not change the resistance by one-half. This was done deliberately, so as to give a more even, readable spread in the calibration of the various wattage points. If a linear-taper control had been used, the higher wattage points, such as 30, 40 and 50 watts, would have been "bunched together" at one end of the control, reducing the accuracy of settings and the usefulness of the instrument.

Actual wiring is not critical since we are dealing with high-level, low-impedance cir-

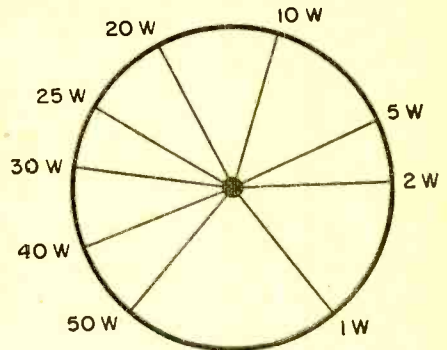
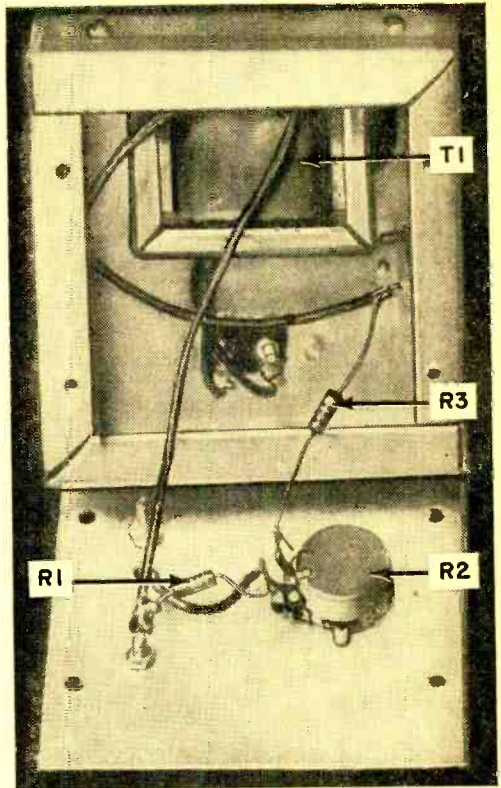

Fig. 2. Diagram shows calibration points. Radial lines hold true for dial plates of any diameter.

HOW WE CALIBRATE

The calibration in watts has already been worked out for you in Fig. 2. But here is how it's done—in case you would like to know.

Suppose you want to get a warning indication from your "safety light" when the power fed to your 16-ohm speaker reaches 25 watts. This wattage represents 20 volts at the 16-ohm voice coil terminals. T1 steps up this voltage to 600 volts (30:1 ratio) which is developed across a total resistance of about 240,000 ohms (=the series resistance of R1, R2 and R3). The neon lamp, however, needs only 65 volts to fire and should therefore be set part-way up on R2, so that only a bit more than 10% of the total voltage appears across the lamp.

In other words, the arm of R2 should be set about 7000 ohms up from the R3 end of R2, so that the total resistance of the indicator will be 25,000 ohms (7000 ohms plus the 18,000-ohm resistor R3). Other wattage settings of R2 are derived similarly.

cuts not particularly susceptible to hum and noise. Layout of parts can be seen in the photograph above. If desired, a terminal strip can be mounted at the rear of the unit for connecting the two leads from the speaker terminals. This makes the gadget a bit more "portable" in the sense that it can be easily disconnected and used for other speaker systems, provided that they have the same impedance.

"On Guard." Connect the unit to the speaker terminals of the speaker to be monitored. Install the pointer knob in such

(Continued on page 119)

His Guests Get Hi-Fi Treatment

When travelers pull up to the small Western Hotel in the middle of downtown Chandler, Arizona, they are in for the surprise of their lives. Once inside, visitors are greeted with a soft wave of classical and operatic music — floating from various sides of the main lobby.

Not only do *they* love it but so does the owner, A. W. Crookham, who boasts of the world's only hotel with closed-circuit high-fidelity music piped into each room. Of course, as he explains it, the mu-



Music-minded hotel owner is shown above with his record collection. At left, he checks the system which provides his guests with "hotel hi-fi."

sic really "soaks" into the rooms from the not-too-long lobby. The setup includes four speakers in the lobby and one more in his apartment.

To Crookham, who possesses a library of 1000 long-playing records built on a base of German and Italian opera and some famous Broadway musicals, the rock 'n' roll stuff is something for the jungle. Unless hotel dwellers request special numbers, he just piles the records into his player and lets the music roll. This seems to suit the guests as well, for on one occasion Crook-

ham fell asleep, allowing the speakers to play until 4:00 a.m.—without comment from the captive audience.

The hi-fi is on from 8:00 a.m. until about 9:00 p.m. and, according to Crookham, only one person has complained about the music since the system was installed two-and-a-half years ago.

As far as this hotel operator is concerned, the long-platters will go right on spinning, and the music of the masters will continue to find audience in the unlikely media of a small-town inn.

Guided Missile is Antenna Farm

A few years ago, aircraft antennas could be made up of masts and wires protruding from the plane. Today's guided missile needs streamlined antennas that work just as well but do not interfere with supersonic speed. Most of today's fighter planes carry up to seven antennas—serving the identification system, communication, radio navigation, radar, etc.—all of which must be buried inside the plane. The photo here shows a variety of antennas that have undergone rigid testing by Chance Vought Aircraft for use on its F8U-1 Crusader, or Regulus I and II. Visible are discons, dipoles, loops, etc.



**Plate-modulate the AT-1 and DX-20
with this single-tube unit**

By
JAY STANLEY

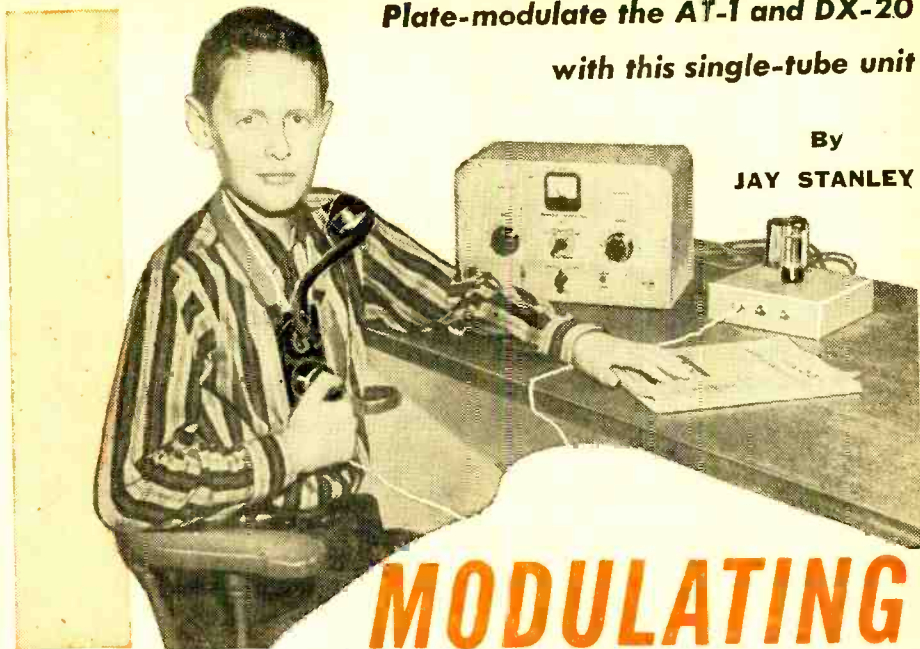

MODULATING Your Heathkit Transmitter

THERE are probably more Heath AT-1 and DX-20 transmitters operating in ham stations than any other transmitters ever designed. But both the AT-1 and its successor (the DX-20) are c.w. rigs. And many a ham—once he receives his General Class ticket—would like to put his transmitter on the air on phone, *without* spending a small fortune for a modulator. Now—thanks to two modest-priced transformers—it is possible to do so at a minimum of expense with a one-tube modulator which

draws plate current from the transmitter.

The modulator is simple to build and has been given a lot of "on the air" testing. Used in Denver, Colorado, with an AT-1 transmitter on 10-meter phone, it yields frequent "S-9 plus" signal reports from east coast stations 2000 miles away.

Addition to the AT-1. It can be added to the AT-1 without making any changes in the transmitter itself—the modulator simply plugs

In using the rig shown in these photographs, 3 volts of microphone voltage was found to be sufficient with a telephone mike, while a war surplus T-26 required 6 volts.

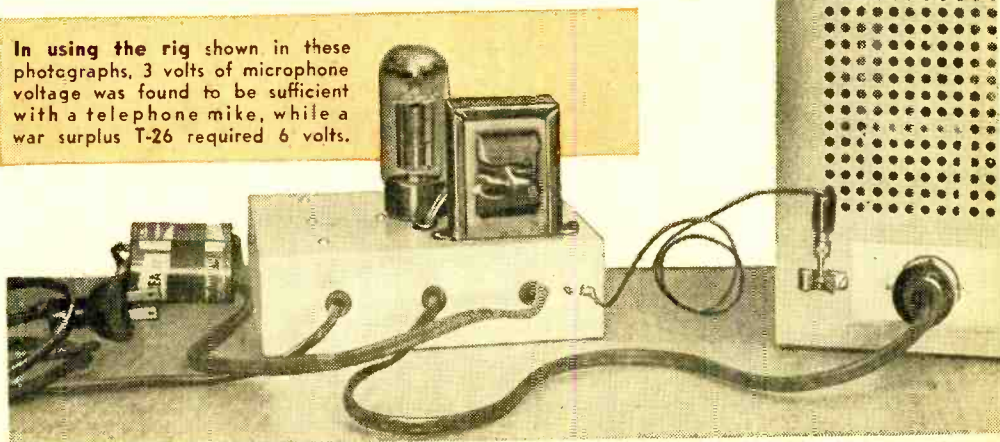

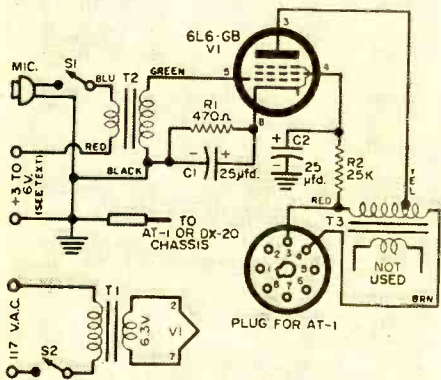
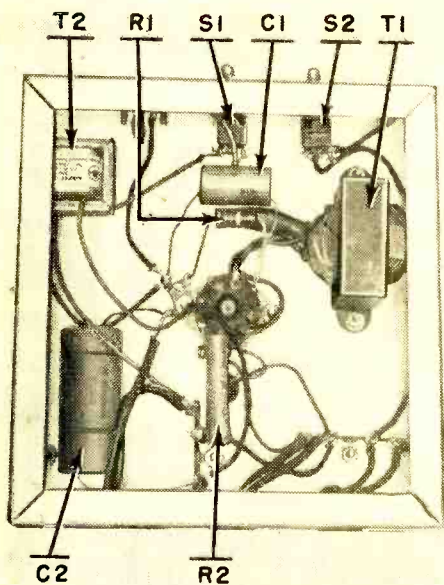

Simple layout and diagram of the modulator. Parts list and "How It Works" appear below.

- C1—25- μ fd., 50-volt capacitor
- C2—25- μ fd., 450-volt capacitor
- R1—470-ohm, 2-watt resistor
- R2—25,000-ohm, 10-watt resistor
- S1, S2—S.p.s.t. toggle switch
- T1—6.3-volt, 1-ampere filament transformer
- T2—High-imp. transformer (Stancor A-4747)
- T3—Modulation transformer (Triad M-4Z)
- V1—6L6-GB tube

MIC.—Single-button telephone mike (or T-26, Burnstein-Applebee Co., Kansas City, Mo.)

HOW IT WORKS

The Heising type plate modulator is coupled to the transmitter by means of a low-cost auto-transformer modulation transformer, T3, which gives a much better impedance match and higher percentage of modulation than is possible with the chokes sometimes used for the same purpose. The modulator tube, V1, is driven by a high-gain microphone transformer (T2) and a high-output carbon mike.

Resistor R1 (bypassed by C1) provides grid bias for the modulator tube. Resistor R2 (bypassed by C2) provides screen voltage. Transformer T1, a "filament" transformer, lights the heater of the 6L6-GB.

into the modulator plug socket at the rear of the AT-1. Modulator chassis and transmitter are "grounded" together by means of a lead which completes the "B minus" part of the circuit.

Looking at the chassis from the front, there is a phono input jack, and two switches for the 117-volt a.c. line and microphone batteries. Underneath the chassis, the layout is simple and clean. Just be careful when you hook up the modulation transformer—if the leads are reversed, the transmitter won't modulate.

Once the modulator is wired up, the next step is to test it with a dummy antenna. This can be a 25-watt light bulb, connected

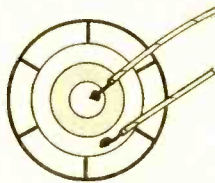

TELEPHONE MIC. BUTTON CONNECTION

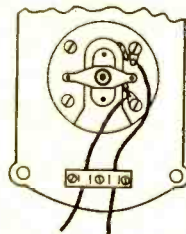

T-26 CONNECTION

to the antenna terminals of the transmitter.

Testing the Modulator. Turn on the modulator filament transformer switch, S2. Then plug the modulator into the AT-1 (or connect it to the DX-20 as described on page 116), connect the grounding lead which ties the two chassis together, and turn on the transmitter.

The microphone should be a high-output single-button type. The button from a standard home telephone is ideal. One of the drawings (above, left) shows how to make connections to this button. Be *very careful* in soldering, using a minimum of heat and a *low* melting point solder.

There are several other low-cost microphones available which are just as satisfactory, for example, the war surplus T-26. The other drawing (above, right) shows how to make connections to this microphone.*

Speak into the microphone. If all is well, the plate meter on the transmitter will move up slightly, and the dummy antenna light bulb will brighten somewhat.

Now, with the transmitter connected to your regular antenna, load it up until it is drawing approximately 55 to 60 ma. Test again, watching for the plate meter to

(Continued on page 116)

* In considering other single-button microphones, keep this in mind: most surplus aircraft-type microphones, for example, the T-17, are too low in output. But almost any of the military microphones which look like a telephone are fine—as are, of course, current-model high-output single-button carbon microphones made by several manufacturers.

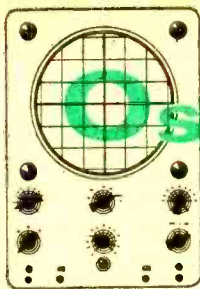

Oscilloscope Traces

Probing the Power Pack

The first of a series of articles on how to get the most from your 'scope

By HOWARD BURGESS

SOME thousand years ago, the art business got quite a lift from the old Chinese who said: "A picture is worth a thousand words." That slogan may be off the beam when you get down to cases—but electronics men, strictly "on the beam" with their oscilloscopes, swear by their own variant of the old saw: "A trace is worth a thousand meter readings."

What makes the 'scope unique is that all of these readings can be repeated thousands of times per second, if required. Unlike the pointer of a voltmeter, the 'scope has no inertia and can follow the rapid variations of almost any signal.

One of the oscilloscope's neatest tricks is the ability of the indicator beam to move in any direction. This allows it to read a varying voltage instantaneously and draw a graph of the result (see Fig. 1).

When a graph is drawn to show any event or value that changes with time

(such as temperature cycles, voltage variations or the seasonal price of frijoles), time is plotted along the horizontal axis and the quantity measured is represented as vertical distance. Waveforms are observed on oscilloscopes in the same manner.

These waveforms or traces, found only in research laboratories a few years ago, are now a common and necessary "service tool." Those with experience in the use of the 'scope will have little difficulty in interpreting the patterns. Yet, many new 'scope owners may be puzzled by the resulting curves.

To help the novice recognize 'scope patterns, we are presenting a series of articles, of which this is the first, that will show the basic traces encountered in power supplies, transmitters, receivers and square-wave testing. These traces can form a basis of comparison for you from which to do your own oscilloscope work. First, however we must understand how any graph is

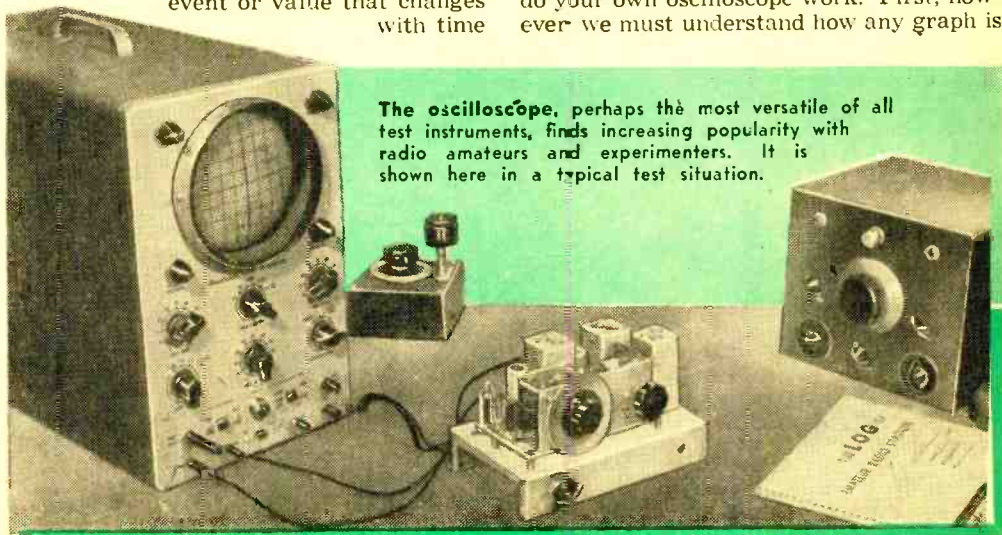

built up on the cathode tube screen by the interaction of two voltages. One of these usually represents time.

Time and Tooth. To give the time plot along the horizontal axis, a voltage is applied to the horizontal deflection plates to move the beam across the screen at a constant speed in a known amount of time. This type of sweep usually travels from left to right and is known as a time sweep or "linear sweep." Upon reaching the right edge of the screen, it starts the next left-to-right sweep with no visible backtrack or delay.

This time sweep, which corresponds to the X-axis on a graph, is produced on a 'scope screen by applying a "sawtooth" voltage to the horizontal deflection system. The voltage in a sawtooth-shaped wave in-

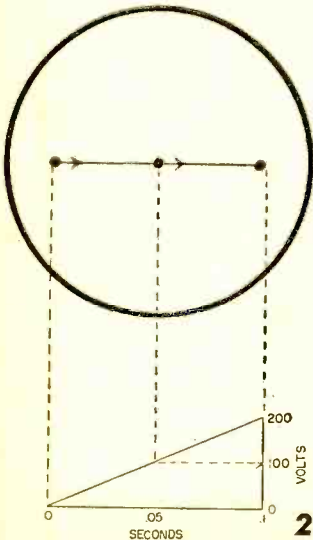
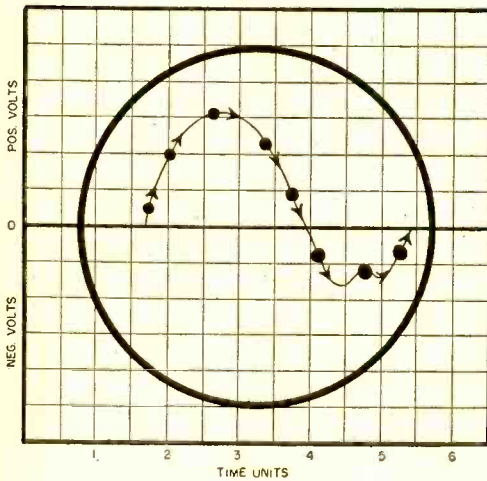

1 The dot formed by the beam can move in any direction and thus draws a graph as it moves.

2 As sawtooth voltage rises, the beam travels across screen to the right.

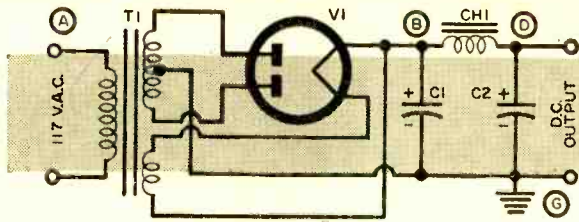

3 A full-wave rectifier power supply, such as is often encountered in radio work.

creases at a continuous rate until the beam has been moved across the screen, as shown in Fig. 2. When the beam reaches the far end of its travel, the voltage in the wave immediately drops to zero and begins all over again. During the instant that it takes for the voltage in the wave to drop to zero, the beam "flips" back to the left side of the screen to start the next sweep across, guided by the next "tooth" on the "saw" voltage.

The oscilloscope can be used to see its own sweep circuit at work and thus to verify this sawtooth pattern.

Telltale Tracks. To get the most from a 'scope, one should become familiar with the traces produced by various circuits under normal conditions. When troubles move in, it will then be easier to identify the villain.

One of the common workhorses in the communications and electronics business is the ever-present power supply. Chapters can be written on the proper design of power supplies and their operation. However, many of them seem to have been patched together with whatever the designer happened to have at hand. Even though the power supply may be simple, a defect in the unit can play hob with all the equipment drawing current from it.

Power supplies may or may not use a transformer, but nearly all of them use some form of rectifier, either half-wave or full-wave. The rectifier is followed by filter capacitors, chokes and resistors to smooth out the remaining a.c. ripple.

Figure 3 is typical of the usual small transformer supply.

Testing Power Packs. Test points for attaching the oscilloscope are marked by the letters A, B, D and G. V1 is the rectifier, C1 and C2 the filter capacitors, CH1 the filter choke, and T1 the transformer.

In all of the traces shown, the horizontal sweep voltage is adjusted to either 30 or 60 sweeps per second as desired. When the time sweep has the same frequency as the signal being observed, one full cycle is

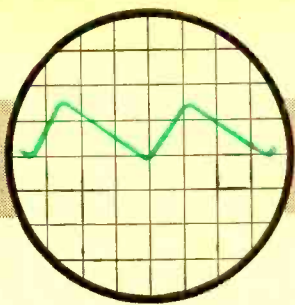

4

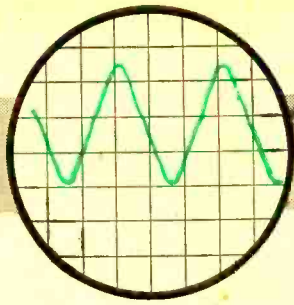

5

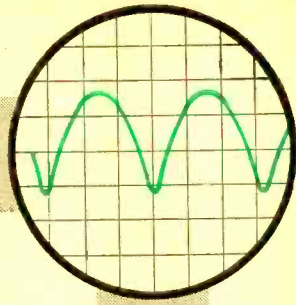

6

shown on the screen. When the sweep frequency is one-half of the signal frequency observed, two full cycles are displayed on the trace.

If the oscilloscope connects to points *A* and *G*, the wave-shape seen will be that of the 60-cycle line current. This only tells us that the unit is turned on. But as we move our pickup probe along to point *B* in the circuit, the voltage tapped from this point can give us considerable information. If the power supply is working properly, the resulting trace will resemble that of Fig. 4. The sharp rise indicates the charging of the input filter capacitor *C1*, while the long slope shows the slower discharge. This pattern was made using a full-wave circuit, as shown in Fig. 3, and a 60-cycle sweep as time base. Using the same sweep with a half-wave rectifier would give only one peak.

If the power supply does not have a capacitance at *C1* which is large enough, or if it is overloaded, the waveform at point *B* will be more like that of Fig. 5. No longer a sawtooth wave, the trace then becomes more triangular. This is ripple voltage that will show up as hum in the equipment supplied by the power pack.

If a trace like that in Fig. 6 is encountered when testing at point *B*, capacitor *C1* is probably missing or open. This trace was taken from a power supply using a full-wave rectifier.

If capacitor *C1* is open on a half-wave rectifier, a pattern like that in Fig. 7 will develop. It shows up the effects of half-wave rectification with alternate half-cycles missing. From such a trace, you can easily see why larger filter capacitors are needed to take up the slack during the off-cycle when the rectifier is not passing current.

(Continued on page 116)

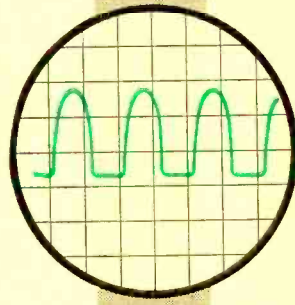

7

Typical 'scope traces obtained from power supplies are represented in this line-up. Figure 4 shows the normal waveform at the filter input. The ripple in Fig. 5 indicates overload. Figure 6 betrays an open input filter capacitor in a full-wave rectifier circuit, while Fig. 7 represents the same condition in a half-wave rectifier circuit. Figure 8 pictures the d.c. output of a normally operating power supply, showing that all is well. Normal output ripple amplified by high oscilloscope gain will present the pattern in Fig. 9. Yet the extreme asymmetry in Fig. 10 (also recorded at high gain) indicates a filter overload.

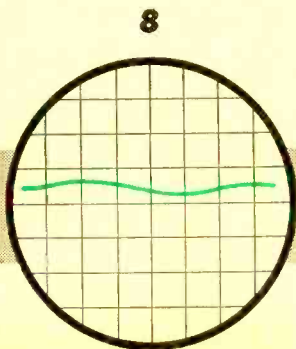

8

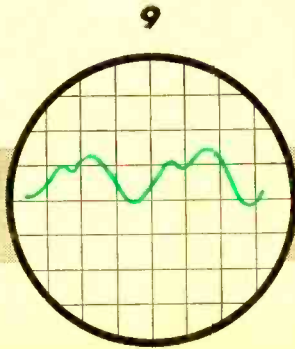

9

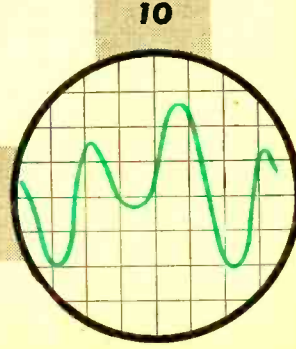

10



Shock in Stock

The girl in this stockroom (photo above) has quite a shock in store—about 200,000 volts d.c., to be precise, for she is casually fondling some of the huge high-voltage energy-storage capacitors made by Cornell-Dubilier Electric Corp., South Plainfield, N. J. The energy bursting from those capacitors suffices to knock apart atoms in a betatron. Since the girl is pretty, let's hope that in this particular case the capacitors aren't loaded.

Sardine-Can Beacon

It's difficult to guess the concern that a sardine can loaded with gunpowder which suddenly becomes a transistorized radio beacon might cause. But Fairchild Controls Corp. has built just such a unit. The trans-

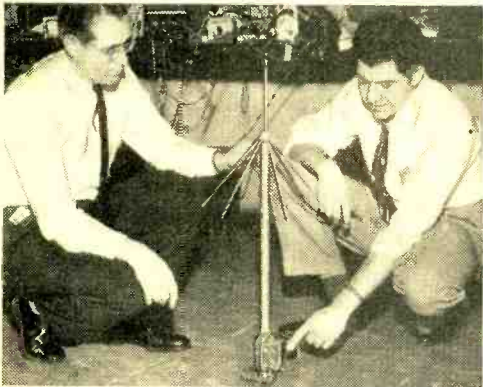

mitter will send a steady radio signal for a distance of 25 miles throughout a whole day. The gunpowder pops up the self-contained antenna which is shown in the photo in its fully extended position. Although operating above 280 mc., the circuit is printed on a special insulator, uses transistors and is really sealed in a standard sardine can.

R/C Safety Traffic Lights

If you see this radio antenna atop a traffic light standard, you can be sure you are in a progressive community. Forward-thinking city fathers have realized that traffic deaths due to collisions with fire engines, ambulances, and speeding prowl cars

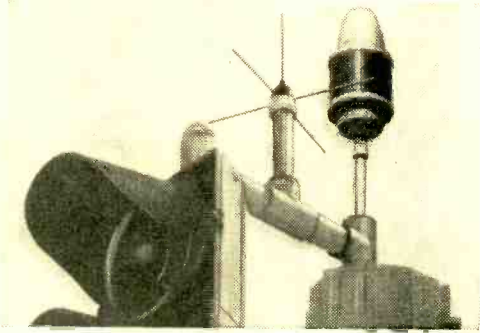

can be avoided. The solution has been provided by Electronic Protection, Inc., with a system of radio-controlled traffic lights. A signal from any emergency vehicle will turn all lights against traffic so that the vehicle can safely pass.

Tasty Ladder

A six-foot ladder (below) stood too close to a high-powered electron beam generator at General Electric Research Laboratory. Bombardment by the beam evidently made the ladder edible. "Tastes like toast," said engineer H. H. Fawcett when he took a bite out of it. His discovery now spurs G.E. to develop wooden cattle fodder by electronic radiation. It seems reasonable—but we wonder about Mr. Fawcett.



Subminiature Code Practice Set

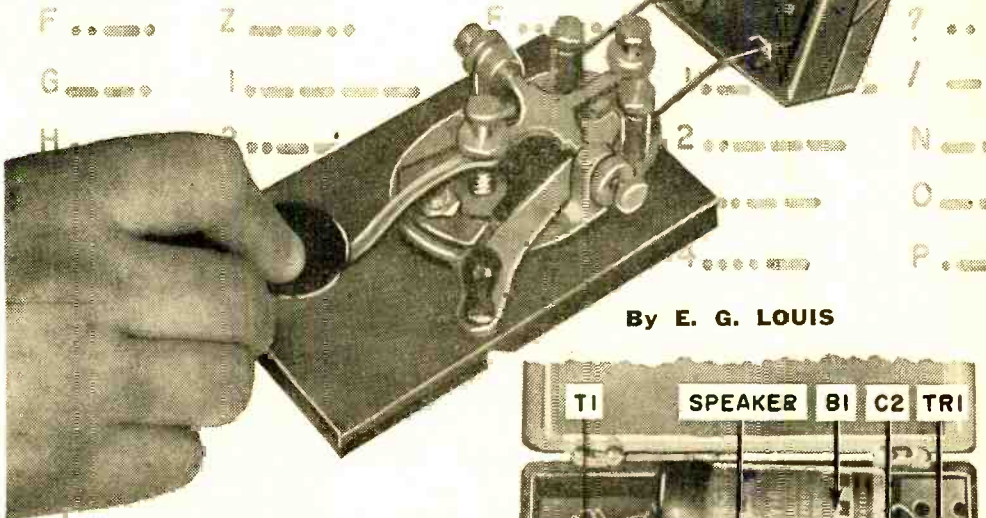

By E. G. LOUIS

Self-contained audio oscillator is built into miniature plastic case

WHETHER you're a prospective Novice or an old hand at pounding the brass, here's a versatile code practice oscillator which you should enjoy assembling and using. Pocket-sized—actually smaller than a package of cigarettes, it is completely self-contained, requiring neither external headphones, speaker, nor batteries. In fact, the only "accessory" needed is a standard hand key. What's more, the unit provides ample volume for both personal study and small class instruction through its own built-in subminiature loudspeaker.

Mounting and Wiring. Neither parts arrangement nor wiring is critical, and you can follow your own inclinations in assembling your model. Try to choose a layout which will permit easy replacement of the battery.

I mounted the transistor socket, resistor *R1*, and capacitors *C1* and *C2* on a piece of perforated Bakelite, which serves as a chassis. This chassis board, in turn, is fit-

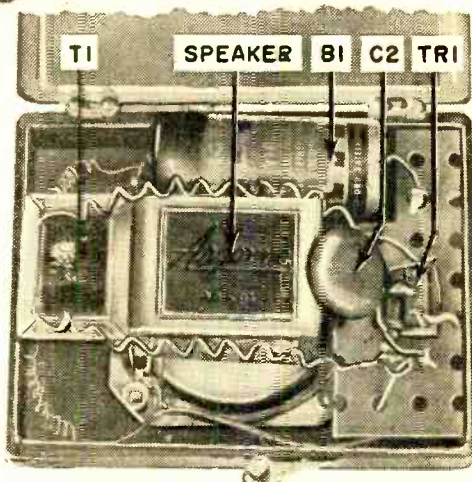

Layout of parts is not critical, but if you want to color the plastic case, don't mount the parts until after the paint has dried. Check all wiring before connecting the hand key or trying the unit.

HOW IT WORKS

A CK722 *p-n-p* junction transistor is wired as a "tickler feedback" audio oscillator. The oscillator is powered by a single battery, *B1*, with base bias current established by resistor *R1*, and bypassed by electrolytic capacitor *C1*. Capacitor *C2*, across the primary of transformer *T1*, forms a tuned circuit with the transformer's winding and helps determine the frequency of operation. *T1* provides a feedback path between collector and emitter circuits necessary to sustain oscillation.

The hand key connected to the phone tip jacks takes the place of a switch. When the hand key is depressed, the battery circuit is closed and oscillation can take place.

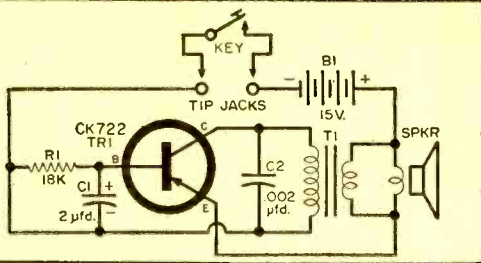
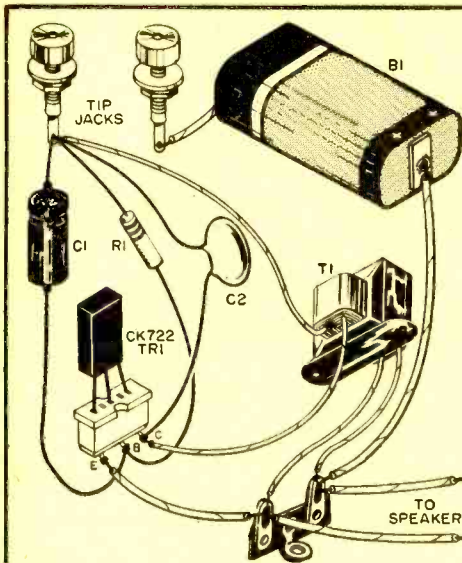

- B1**—15-volt miniature battery (Burgess No. Y10)
C1—2- μ fd., 15-volt electrolytic capacitor
C2—0.002- μ fd. disc ceramic capacitor
R1—18,000-ohm, $\frac{1}{2}$ -watt carbon resistor
T1—Miniature transistor transformer, 2000 ohms to 10 ohms (Argonne No. AR-96)
TR1—CK722 transistor (Raytheon)
SPKR—10-ohm v.c. subminiature PM loud-speaker (Argonne No. AR-95)
KEY—Standard hand key (accessory)
2—Phone tip jacks
1—Small plastic box
1—Transistor socket
1—Perforated Bakelite mounting board
 Misc. machine screws, nuts, wire, solder, etc.

Diagrams and parts list for code practice set.

ted over the ends of the phone tip jacks which serve as the hand key terminals. Transformer *T1* is mounted on the subminiature loudspeaker's frame.

An opening in the case is needed for the loudspeaker. One technique is to drill a

number of small holes in the case (as shown on the preceding page) arranged in a decorative pattern.

Mount the 15-volt hearing-aid-type battery, *B1*, by soldering a heavy piece of wire to its negative terminal and attaching this wire, in turn, to one of the phone tip jacks. Use care when soldering to the battery and complete each joint as quickly as possible to avoid excessive heating. The connection to the positive terminal is made with a small flexible wire.

Operation and Use. With the wiring completed and checked, depress the key. You should hear an audio note from the speaker. If no sound is heard other than, say, a "click," reverse *either* the primary or the secondary leads of transformer *T1*. Proper phasing is necessary for oscillation to take place, and this must be determined experimentally. Do *not* reverse both of the windings.

Although designed specifically for use as a code practice oscillator, chances are that you'll find many other uses for this gadget. For example, it can serve as a portable source of an audio tone . . . in this capacity, it's handy for checking microphones or for "one man" checks of p.a. installations and paging systems.

—50—

"Robbie" the Robotester On the Job

Automatic circuit testing takes a leaf out of science fiction with the development of "Robotester," by Lavoie, which helps the radio and TV manufacturing industry take a step forward on the road to complete automation. Robotester does the work formerly done by highly trained personnel more accurately and quicker. Essentially a resistance-measuring instrument, Robotester can measure from one ohm to ten megohms and, unlike other testers, it is programmed by a punched paper tape. It can select any two points out of a maximum of 240, in any order, and may be plugged into tube sockets of a chassis to check resistance or continuity between any pin and any other pin on the chassis.

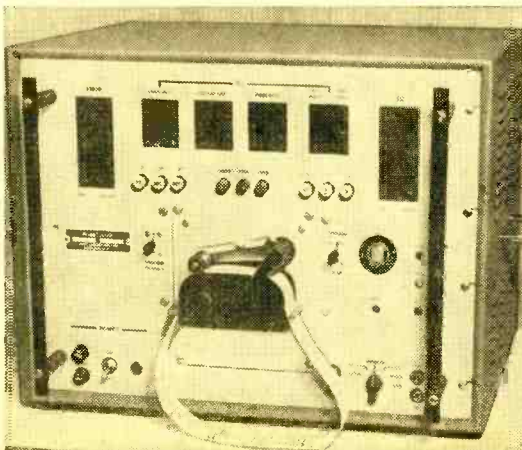

Buzzer-Type Power Supply

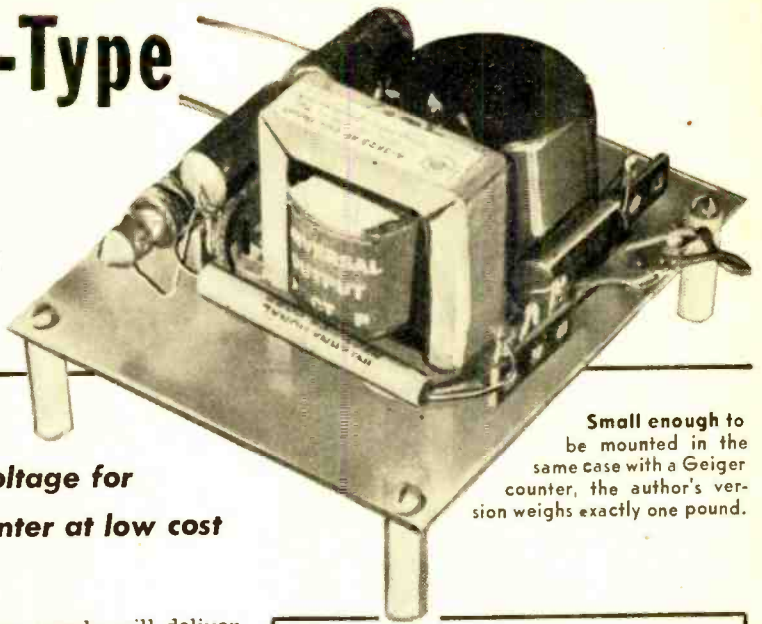

Maintain high voltage for your Geiger counter at low cost

Small enough to be mounted in the same case with a Geiger counter, the author's version weighs exactly one pound.

THIS 1000-volt power supply will deliver 60 to 70 microamperes d.c. It is a vibrator-type supply using a high-frequency buzzer as the vibrator and an output transformer connected backward to give a high step-up ratio. Cost of parts is \$13.00.

The unit is driven by a 6-volt battery comprised of four jumbo-size flashlight cells connected in series. Battery drain is 32 ma. You can expect the following operating life range if you use Eveready No. 950 Size D cells: 150 hours at 2 hours per day, 90 hours at 8 hours a day, and 60 hours at 24 hours a day.

There are no hard-and-fast rules for building this power unit, except to keep the entire circuit well insulated. The author mounted his on a 1/4"-thick polystyrene panel 5" long and 4" wide.

Adjust the buzzer for the highest-pitched sound so that you will obtain the highest possible output voltage. Further adjustment may be necessary after you wire the buzzer into the circuit.

When the wiring is completed, connect the 6-volt battery to the input terminals through a s.p.s.t. switch. Connect a VTVM (switched to its 1000-volt range) to the output terminals. Now close the switch and note the voltmeter reading. Adjust the buzzer, if necessary, then tighten firmly each of the two lock nuts on the adjustment screws and replace the cover.

Danger, High Voltage! A word of caution is in order regarding the handling of the unit. Remember that a 1000-volt supply is not a plaything. This one can give a nasty sting. Guard against coming into contact with the exposed portions of the circuit.

—Rufus P. Turner

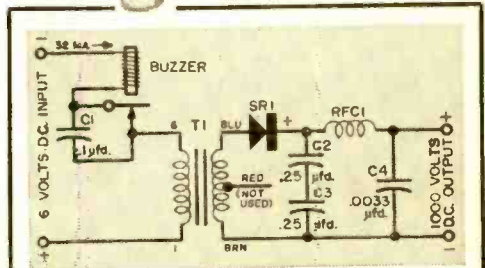

Schematic diagram and parts list for the power supply. See operating details below.

- C1—0.1- μ d., 600-volt metalized paper capacitor
- C2, C3—0.25- μ d., 600-volt metalized paper capacitor
- C4—0.0033- μ d., 1000-volt mica capacitor
- RFC1—2 1/2-mh. r.f. choke (National R-100)
- SR1—High-voltage, cartridge-type selenium rectifier (International Rectifier US0HP)
- T1—Universal output transformer (Stancor A-3823)
- BUZZER—High-frequency buzzer (Johnson Type 114-400)

HOW IT WORKS

The operating principle is fairly simple. Transformer *T1* is connected so that its normal low-turns secondary output winding is used as the primary. The entire center-tapped normal primary winding serves as the secondary. The buzzer, connected in series with the transformer primary and the battery, chops up the battery current flowing through the primary. This interrupted current sets up a high a.c. voltage across the secondary, which is converted to d.c. by the high-voltage selenium rectifier, *SR1*.

Capacitor *C1*, connected directly across the buzzer contacts, eliminates hash which, if it were not removed, would set up electrical noise in the counter circuit. Capacitors *C2* and *C3* provide filtering action, and stabilize the d.c. output voltage against fluctuations in the current through the buzzer. The choke, *RFC1*, and capacitor *C4* provide additional filtering to minimize the small amount of buzz remaining in the d.c. output of *C2* and *C3*.

Versatile Banana Plugs Simplify Connections

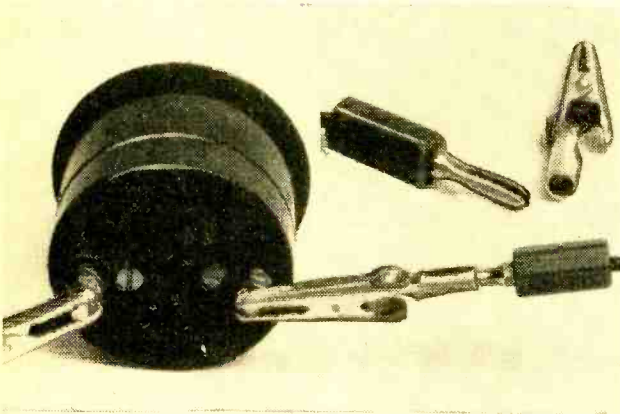

IN EXPERIMENTAL and test work, it is often handy to have a clip on a banana plug so that the plug can be quickly attached to a variety of terminals and wires. I find that a standard banana plug makes a perfect fit in the sleeve of a standard alligator clip, thus eliminating the need for an adapter. A standard banana plug (ICA Type 883R) and a standard alligator clip (Mueller Type 60S) are shown at left. Just insert the banana plug into the sleeve of the alligator clip—which may then be clipped onto a voltmeter terminal as shown.

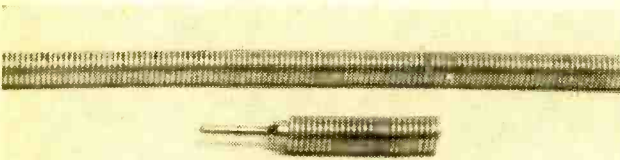

The center photos show how to make an adapter which allows a standard banana plug to be easily connected to a standard phone tip jack. Obtain a #42-S spring sash rod (10 cents at a five-and-dime store), clip off a 1" length, and force the sleeve of the phone tip into the spring. In the photo directly at left, the adapter fits a banana plug to a phone tip jack; next to it, a wire lead is connected to the adapter; you simply bend the spring so that a wire can be slipped between the coils, and let go.

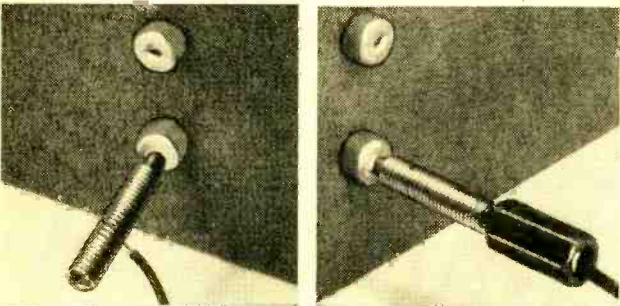

In the bottom photo are two simple adapters to connect phone tips and wire leads to apparatus using banana jacks. The one directly at left fits a standard phone tip to a standard banana jack. Remove the hardware from a phone tip jack, clip off the slugs to a length of about $\frac{1}{8}$ ", and file a little off the sides of the lugs so that they will fit into the sleeve of an ICA Type 419 banana plug; then solder the phone tip jack to the plug. To make the adapter at the far left, you simply fasten a medium-size Fahnestock clip between the two hexagon nuts on the threaded shank of an ICA Type 403 banana plug. This adapter will take either tip or lead. —Art Trauffer

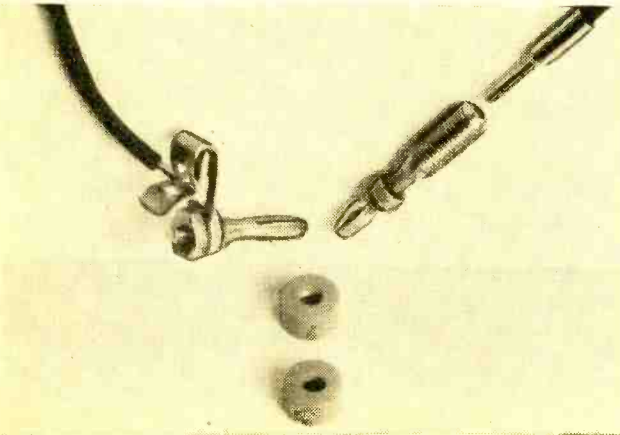

WHEN Chrysler announced, not so long ago, that its cars would be equipped with "highway hi-fi"—made possible by a new 16 $\frac{2}{3}$ -rpm record and player—audio enthusiasts drew their breaths in anticipation that this might have repercussions in hi-fi for the home.

What ensued, however, was not the expected sonic bonanza but a flabby fizz like a damped oscillation. POPULAR ELECTRONICS, poking among the available facts, discovered that the 16-rpm speed—though de-

auditions to find a "voice" for the Bible. The final choice was none other than Marvin Miller, known as the narrator of movie cartoon *Gerald McBoing-Boing* and other UPA features.

The talking book idea is not new. As far as the phonograph is concerned, it is literally true that "in the beginning was the word." Thomas A. Edison, in the 1870's, dreamed of putting literature on records. "Mary Had a Little Lamb" was, in fact, the first recording ever made when Edison

By NORMAN EISENBERG

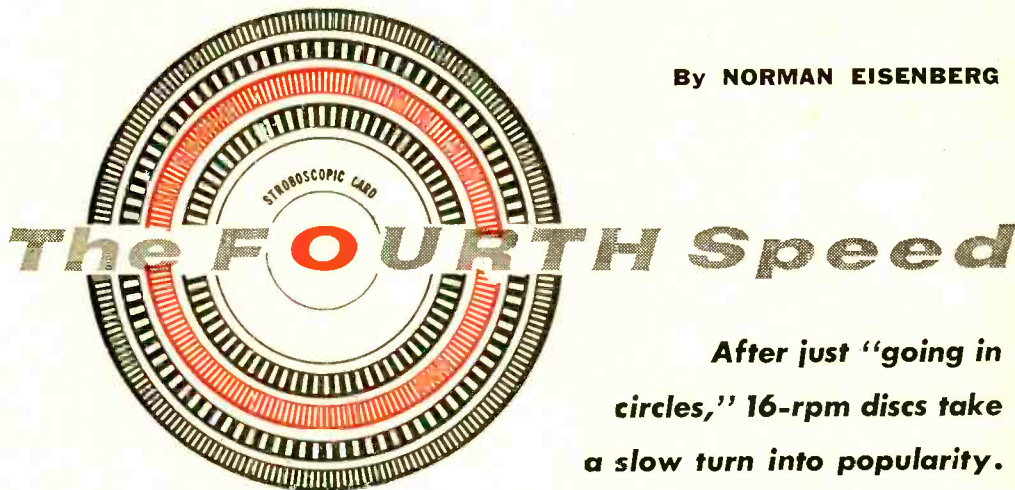

After just "going in circles," 16-rpm discs take a slow turn into popularity.

toured on the highways—never came to a dead stop for home audio.

The facts are: Aside from the dashboard version of 16 rpm, there is a growing library of these records available to the public. More and more record players are incorporating 16 rpm as a fourth speed. As "Talking Books," these discs are a boon to the blind—"The Lighthouse" of the New York Association for the Blind distributes them widely. Music, too, is now available on 16 rpm's. While admittedly not hi-fi, due to lack of high-frequency response, it sounds well as "mood music" and "background" in restaurants where mellowness is the keynote and trebled brilliance would only distract.

Biblical Turn. The Audio Book Company of St. Joseph, Mich., producer of these records—started the 16-rpm project way back in 1951. For a whole year they tried all kinds of slow speeds, as low as 4 $\frac{1}{2}$ rpm! In the fall of 1952, 16 rpm was picked as most practical because it would play on existing equipment.

The first "Talking Book" was a recording of the complete New Testament in the King James version, introduced in May, 1953, at department stores in California and New York. It took over a hundred

at last put his new invention to the test. The Library of Congress had, for years, offered recorded books for the use of the blind—but not in the convenient, lightweight, and inexpensive form of 16-rpm discs.

Coming to the Point. Recently, Audio Book introduced music on "compatible" 16-rpm records. "Compatible" means that the new 7" discs can be played on any phonograph having the fourth (16-rpm) speed;



"Highway Hi-Fi" was Chrysler's slogan for 16-rpm phonographs fitted under the dashboard. Actually, the "fi" was no higher than that of the car radio through which the music was reproduced.



Through the "talking book," classics of literature have joined those of music in the recorded medium.

no special stylus is needed. They can be played with a 1-mil (0.001") stylus, the same kind you use for regular micro-grooves. Previously, music recorded at the fourth speed could be played only with a ½-mil (0.0005") stylus, as on the special equipment used in cars.

The new "compatible" 16 rpm's contain a full 40 minutes of playing time on each 7" disc and list for \$1.69 per record. When more than one record is included in an album of a longer work, the price per disc is lower. This relatively low cost, combined with a widening repertory, will probably earn for these records growing popularity.

To clinch matters, the company making the 16-rpm discs has developed a speed-reducing adapter which fits—like a 45-rpm spindle adapter—over any 33½-rpm phonoplayer. Selling for \$1.95, this adapter not only accommodates the 1½" center hole—it also converts 33-rpm to 16-rpm speed.

Gradual Slow-Down. Reducing the speed of phonographs to gain playing time has always been an accepted and legitimate interest of audio technicians. Edison's first recording of the nursery rhyme was made at about 100 rpm. The high speed was necessary because of the narrow diameter of Edison's cylinder.

After Emile Berliner's invention of the flat disc with spiral groove, the turntable speed was internationally standardized at 78 rpm. This standard was observed for nearly half a century and the first great library of recorded sound was created at that speed—at a maximum of 4½ minutes playing time per side.

By 1948, searching for longer and uninterrupted play, Dr. Peter Goldmark of Columbia Records had developed the technique of cramming the full range of sound into narrower grooves. This new "micro-groove" technique permitted discs to turn more slowly without losing high-frequency response. Columbia's LP's thus set the new standard at 33½ rpm.

RCA Victor, concerned over having been "scooped," refused Columbia's generous invitation to jump aboard the LP bandwagon. Some years later they did so anyway—but not before they had involved the public

in a "speed war" in which they pitted their own new 45-rpm doughnuts against Columbia's LP's. After years of bewilderment and industrial "warfare" (at the record buyer's expense), RCA's management then agreed to a policy of "coexistence" by which all record speeds were allowed to survive—each serving the particular needs for which it is best suited.

Variable margin control, a recent electronic advance which allows each groove on the record only as much radial space as it needs—but no more, permitted closer "squeezing" of the soft passages without limiting the fullness of the loud ones. The space saving paid off in longer playing time per-unit-diameter and made it possible to get up to 10 minutes of music on a single side of a 45-rpm disc. In terms of cost per minute of music, this made the 45-rpm record comparable with the 33-rpm LP. Yet, in terms of hi-fi and musical possibilities, the 33-rpm disc is still the favored choice because its inherently longer playing time permits major works to be transcribed on a single disc without interruption.

On one point at least—that of playing time—the 33-rpm record is now rivaled by the 16-rpm record, which provides comparable playing time at half the size (and cost) of a 12" record. The 7" 16-rpm record runs at least 20 minutes per side. For this reason it is sometimes advertised as "ultra-microgroove," but this term is misleading because it implies grooves narrower than the 1-mil used on regular LP's. As stated before, only the 16 rpm's made for Chrysler cars used grooves narrower than 1 mil; the newer "compatible" 16 rpm's can be played with a standard 1-mil stylus.

Time vs. Fidelity. While the 16-rpm record certainly makes good the claim of "longer long play," it cannot aspire to "higher hi-fi"—at least not at the present state of the recording art. Many people have the mistaken idea that long play in itself means hi-fi. The truth is: all other things being equal, the greater the speed of a record, the greater the recordable frequency range—just as with tapes. In the case of tapes, narrow-gap magnet heads

and tapes with homogeneous oxide layers can provide wide range at the relatively slow speed of 7.5 ips. So it is with discs—the groove dimensions as well as the surface properties of the vinylite material permit wide range *despite* slower speeds—not *because* of them.

In the case of 16 rpm's, the question arises as to what extent this slowest of slow speeds (actually twice as slow as 33 rpm) impairs the sound. Most listeners agree that a new 16-rpm disc sounds somewhat better than a 78-rpm shellac recording but by no means as good as a top-quality 33-rpm or a 45-rpm disc. On this point, we are fortunate in having a remarkably objective statement direct from the people producing these records. A spokesman for Audio Book says: "At the present time 16-rpm records are not acceptable for hi-fi reproduction and the upper frequency limit is in the vicinity of 9000 cps." He adds, however: "There is no question but that improvements will be made. In the foreseeable future, a hi-fi record at 16 rpm will be a reality."

Slow-Turning Tide? Another hurdle that 16-rpm records must clear is playback equipment. How will such records sound on conventional phono players? At a speed as slow as 16 rpm, the average record player—although adequate for 33 rpm—runs the risk of increased flutter and wow. Small defects in motor or drive system, which may go unnoticed at 33 rpm, could become magnified at 16 rpm into marring noise.

Turntable manufacturers have thus found a new problem-child in their lap. For their new models, they have had to make good mechanisms better and include provisions for the fourth speed with no appreciable price rise. A phono player that features the fourth speed now needs a fourth transmission wheel added to a mechanism that previously had only three. As you select the fourth speed, the appropriate wheel snaps into position to engage the idler wheel which spins the turntable.

It sounds simple, but new product design is involved, as well as premature obsolescence of existing models. And they're still not sure of how well these units will handle 16 rpm.

Yet uncertainty never deters an industry which evidently regards any question mark as a prod to go ahead, seek new ways,



Hi-fi turntables featuring the fourth speed include (reading from top to bottom): the Fairchild Model 412-4, built to precision standards, with a hysteresis motor whose speed is controlled by a continuously variable frequency electronic oscillator; the Bogen B50 and the Metzner "Starlight," both featuring continuously variable speed adjustments over a mechanical transmission. The Garrard Model T "Mark II" turntable and the Collaro RC-456 automatic changer shown below are among the first low-priced equipment to feature 16 rpm.

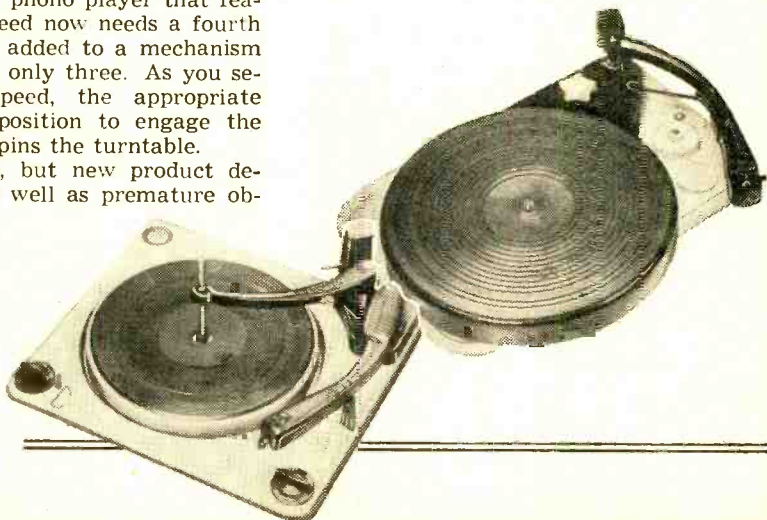



Adapter for 16 rpm fits over the spindle of any standard turntable. Made by Audio Book Company, this effective device costs only \$1.95. The low price is expected to hasten the widespread acceptance of the new phonograph speeds.

make new things, and generally succeed. Many "package" phono systems (including those decidedly low-fi) feature the fourth speed. Some hi-fi component firms also include it in new equipment. The Garrard Mark II manual player and RC-121 changer incorporate it. Similarly, it appears in the Collaro RC-456 changer, Bogen's B50 and B20 manual players, the Metzner "Starlight" professional-type turntable, and the brilliantly

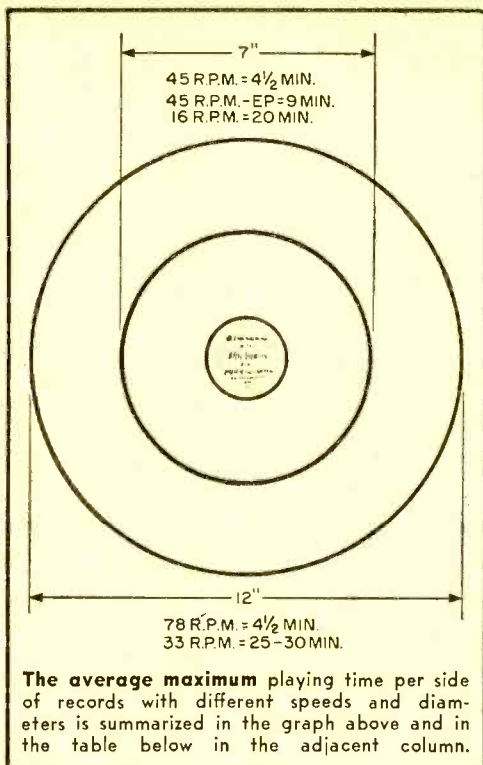

The average maximum playing time per side of records with different speeds and diameters is summarized in the graph above and in the table below in the adjacent column.

Playing Speed (rpm)	Average Playing Time (minutes)		
	12"	10"	7"
78	4 1/2	3	2
45	—	—	4 1/2
45 EP	—	—	9
33	25	15	10
16	40	30	20

engineered new Fairchild Model No. 412-4.

With components in this class, it is safe to assume that wow and flutter at 16 rpm are pretty well licked. It also means that, for better or worse, 16 rpm is here to stay. The growing catalog of recorded material and new playback equipment in all price ranges proclaim that the tide may yet turn to 16 rpm and roll into the arena with quite a splash.

-30-

One at a Time!

Our British cousins look grim and seem to be falling all over themselves—but it's just in fun at an automation exhibit in London. The little ball is electronically whisked away when someone tries to grab it. The capacitance of the human hand acts as remote trigger on the system. The same principle works as a safety device in machinery, dropping protective screens over dangerous areas at the approach of inexpert fingers, thus preventing injury.



"Bridge" Your Way Out of the Junk Box

EVERY experimenter owns a VOM or VTVM which is often used for checking resistors, batteries and coil continuity. The need for a capacitor tester is sometimes felt, but this need seldom becomes severe until the experimenter's junk box fills to the top with unmarked capacitors.

In this article, I will describe a simple capacitance measuring bridge that can be put together in a couple of hours and that costs well under \$10. With it, all capacitors having values between 100 micro-microfarads (100 $\mu\mu\text{fd.}$) and 100 microfarads (100 $\mu\text{fd.}$), including electrolytics, can be checked.

The bridge is operated from the 117-volt a.c. line and is connected to a VTVM (set to its *A.C. Volts* range). In a pinch, headphones may be used for null detection. While this is not a laboratory instrument by any means, you will find that it gives a capacitance reading close enough for most practical purposes.

Construction. Three standard capacitors are required: *C1* (0.001 $\mu\text{fd.}$), *C2* (0.1 $\mu\text{fd.}$), and *C3* (10 $\mu\text{fd.}$). The capacitor corresponding to the desired range is selected by the single-pole, 3-position switch, *S1*. *C1* is a mica capacitor, *C2* a miniature metalized paper tubular capacitor, and *C3* a 50-volt electrolytic unit.

Electrolytic capacitors usually are not employed as bridge standards, but they can be used in this particular tester because it is not intended to be a high-precision instrument. If you have plenty of space, and don't mind the higher cost, you can use a 10- $\mu\text{fd.}$ oil-filled capacitor in place of the electrolytic unit (*C3*) for greater accuracy and stability. In any event, select *C1*, *C2*, and *C3* as close as possible to the 0.001-, 0.1-, and 10- $\mu\text{fd.}$ capacitance values.

You can build the bridge into any 7" x 5" x 3" metal chassis. The two insulated binding posts for connection to the VTVM are located above the potentiometer dial, and another pair of insulated binding posts

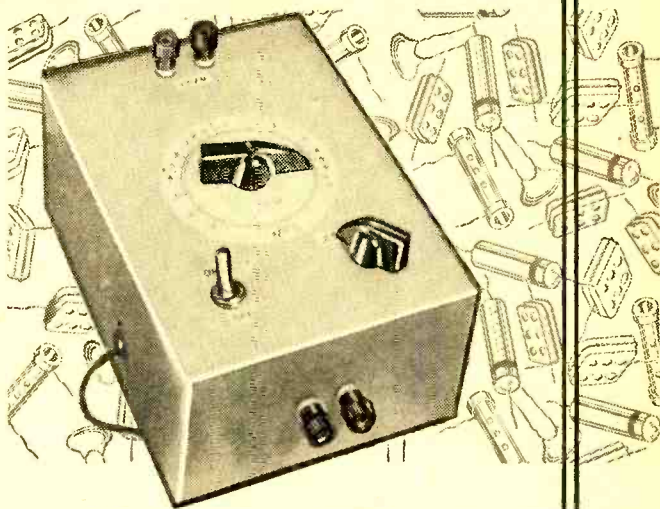

Simple circuit makes use of your existing test equipment

By RUFUS P. TURNER

for connection to the capacitor under test is mounted on the front lip of the chassis.

Mount potentiometer *R1* through a $\frac{3}{8}$ " hole directly at the center of the chassis. Switch *S1* is in one corner and *S2* is in the other corner. All leads must be kept as short and stiff as possible, and the a.c. line cord and transformer *T1* should be kept as far as possible from the rest of the wiring.

Make the dial scale for the potentiometer out of white cardboard or heavy drawing paper. First pencil in the calibration points and figures during the calibration procedure, then ink them in.

Calibration. There are two calibration methods possible, one making use of two capacitor decades—or a large number of accurate capacitors, and the other involving only the setting of potentiometer *R1* successively to various resistance values.

The *capacitor method* is perhaps the quickest one if you can borrow two capacitor decades (the first is 0.01 to 0.1 $\mu\text{fd.}$ in 0.01- $\mu\text{fd.}$ steps, and the second is 0.1 to 1 $\mu\text{fd.}$ in 0.1- $\mu\text{fd.}$ steps) or an equivalent group of 19 standard capacitors (0.01 through 1.0 $\mu\text{fd.}$). First connect the bridge to the a.c. power line and a VTVM (set to

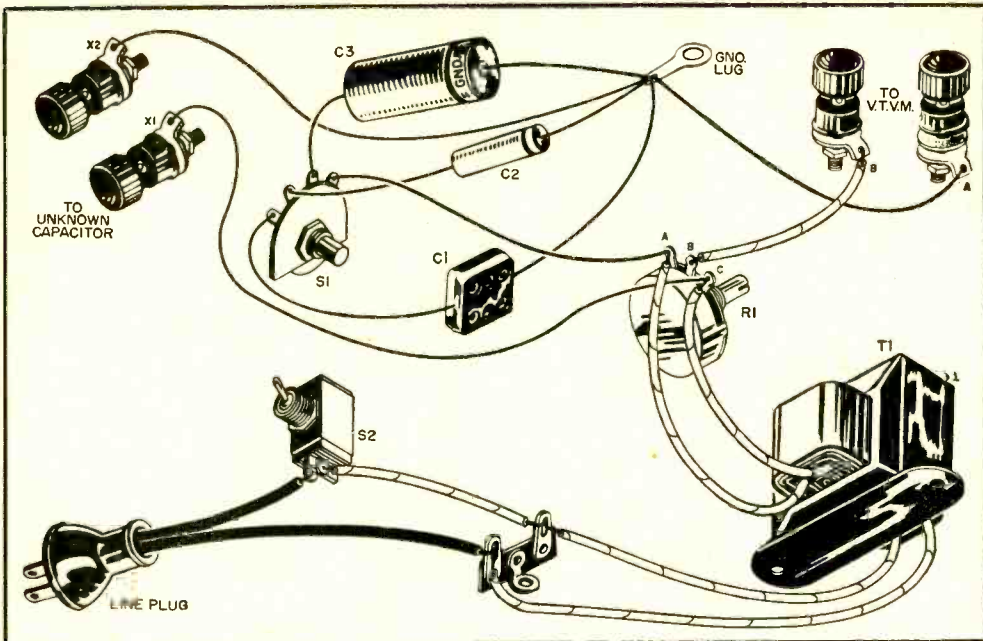

Follow the diagrams and text in assembling your capacitance bridge. See parts list below.

- C1—0.001- μ fd. mica capacitor
- C2—0.1- μ fd. miniature 200-volt metalized paper tubular capacitor
- C3—10- μ fd., 50-volt midget tubular electrolytic capacitor
- R1—10,000-ohm wire-wound potentiometer
- S1—Single-pole, 3-position, non-shorting rotary switch (Centralab 1461)
- S2—S.p.s.t. toggle switch
- T1—6.3-volt, 1-ampere filament transformer

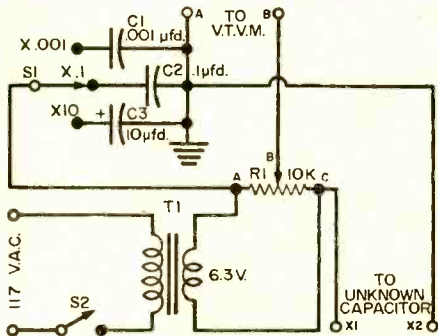

HOW IT WORKS

This is a slide-wire type of bridge circuit. Whenever the bridge is adjusted to null, the resistance between points *A* and *B* of potentiometer *R1* is in the same ratio to the resistance between *B* and *C* as the standard capacitor (*C1*, *C2* or *C3*) is to the unknown capacitor. At the mid-scale setting of potentiometer *R1*, the resistance from *A* to *B* equals the resistance from *B* to *C*, the ratio is 1, and the unknown capacitance equals the standard capacitance.

The unknown capacitor is connected to binding post terminals *X1* and *X2*, and the vacuum-tube voltmeter is connected to binding posts *A* and *B*. Transformer *T1* supplies 6.3 volts to the bridge circuit. As potentiometer *R1* is rotated, a null point will be found. Here, the meter reading deflection drops suddenly to zero or to a very low value. At the exact null point, the unknown capacitance is read from settings of the potentiometer dial (which has previously been calibrated) and multiplier switch *S1*.

its 3-volt range) to binding posts *A* and *B**. Then set switch *S1* to its X.001 position. With no capacitor connected to binding posts *X1* and *X2*, rotate potentiometer *R1*. If a null is obtained, reverse the a.c. line plug of either the meter or the bridge, but not both. Now set *S1* to its X.1 position and connect a 0.01- μ fd. capacitor to terminals *X1* and *X2*. Adjust *R1* for null and mark this point 0.1 on the dial. Repeat with a 0.02- μ fd. capacitor connected to terminals *X1* and *X2*, and mark this point 0.2 on the dial. Continue in the same manner with each of the remaining capacitors.

For the *resistance method* of calibration, a resistance bridge or a freshly calibrated ohmmeter is necessary. First disconnect the transformer lead temporarily from terminal *C* of potentiometer *R1*. Then connect the ohmmeter between terminals *A* and *B* of the potentiometer. Set *R1* to read 910 ohms and mark this point 0.1 on the dial. Move to 1670 ohms and mark this point 0.2. Continue to set the potentiometer successively to each of the other resistance values given in Table 1 and mark the dial with the corresponding figure. After all points are penciled in, line up the potentiometer with point 1 or 5000 ohms, and reconnect the transformer lead.

Using the Bridge. Whenever the bridge is set up with a VTVM preparatory to making capacitance measurements, switch on the a.c. power and test for *false null*. This is done by setting switch *S1* to

* If a meter is not available, use the vertical amplifier input of an oscilloscope, and switch on the internal sweep of the scope.

its X.001 position and, with nothing whatever connected to binding posts X1 and X2, adjusting R1 throughout its range. If a null occurs, reverse the line plug of the bridge or the meter, but not both. This will remove the false null.

After correcting false null, connect the unknown capacitor to terminals X1 and X2

Table 1. Calibration chart for use with bridge.

Resistance (ohms)	Dial Marking	Resistance (ohms)	Dial Marking
910	0.1	5000	1
1670	0.2	6700	2
2310	0.3	7500	3
2856	0.4	8000	4
3333	0.5	8334	5
3750	0.6	8570	6
4123	0.7	8750	7
4440	0.8	8890	8
4734	0.9	9000	9
		9090	10

and rotate R1, with switch S1 in its various positions, until a null is obtained. At null, read the unknown capacitance from the dial and the setting of S1. For example, if a null is obtained at 0.3 on the dial,

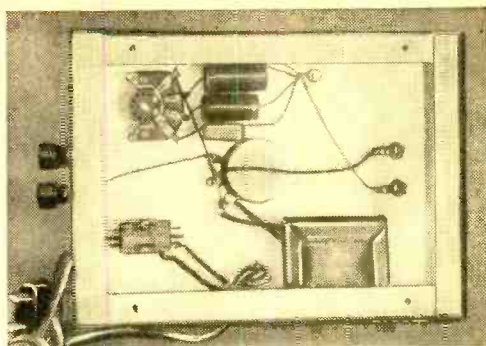

Inside view of bridge, showing wiring and layout.

with switch S1 set to X.1, the unknown capacitance equals $0.3 \times 0.1 = 0.03 \mu\text{fd.}^*$

High-impedance headphones can be used in place of the VTVM in quiet locations in an emergency. However, the accuracy will not be nearly as good because the 60-cycle hum signal is hard to hear.

-30-

* A capacitance lower than $100 \mu\text{fd.}$ sometimes can be measured with a bridge of this type by connecting the small capacitor in parallel with a known capacitor having a value between 100 and $500 \mu\text{fd.}$, measuring the combination, and subtracting the known capacitance value. Thus, a small capacitance is connected in parallel with a $500 \mu\text{fd.}$ capacitor and the combination measured on the bridge as $550 \mu\text{fd.}$ The small unknown then is equal to $550 - 500 = 50 \mu\text{fd.}$

CROSSWORD PUZZLE

By Arthur L. Branch

ACROSS

- 1 To repair or adjust.
- 3 Charged particle in operating thyatron.
- 6 Steering device of a fish.
- 7 Arabic: Abbr.
- 8 Period of time.
- 9 Magnetic metal used in speakers.
- 11 Chemical symbol for radium.
- 12 Broadcast-band interference.
- 15 Units of electron flow.
- 16 Prefix denoting to go down.
- 17 Vase.
- 19 Vegetable.
- 21 River in Egypt.
- 22 Effect of coil on power factor.
- 23 Height: Abbr.
- 24 A public notice.
- 25 Create.
- 26 Pronoun.
- 27 To deaden or soften the sound of an instrument.
- 28 Measuring instruments.
- 29 To make a mistake.

DOWN

- 1 Load for A battery.
- 2 Tavern.
- 3 Magnetic conductor.
- 4 Chemical symbol for gas used in glow lamps.
- 5 Propagated periodic effect of an oscillator.
- 6 Capacitance unit.
- 7 Type of current.
- 10 To isolate an electrical conductor.
- 13 From.

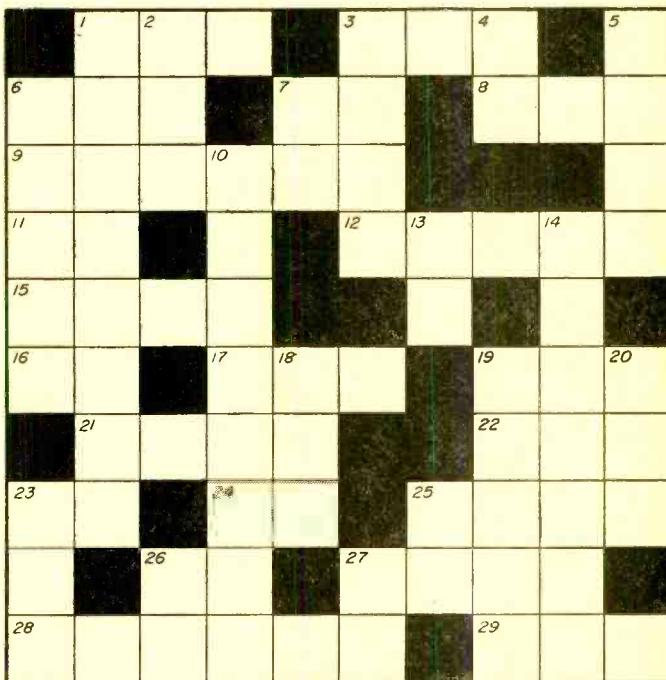

- 14 Audio output transformer load.
- 18 Color representing 2 in resistor color code.
- 19 Positive part of a vacuum tube.
- 20 To grow old.

- 23 Amateur radio operator.
 - 25 Amplification factor.
 - 26 Mediterranean country: Abbr.
 - 27 Degree given by colleges: Abbr.
- (See page 118 for solution)

Sensitive Light-Operated Relay

A flashlight beam will pull it in from
20 feet away—without a magnifying lens

HOW IT WORKS

The coupling between transistors is actually a Wheatstone bridge. Resistors R_4 and R_5 make up two of the bridge arms. The third arm consists of R_1 in series with the emitter-to-collector resistance of TR_1 , and the fourth is composed of R_2 and R_3 in series.

If the bridge is balanced, the voltage drop across R_2 plus R_3 will equal the voltage drop across R_4 . With the circuit in this condition, the base current of TR_2 will be zero. In actual practice, the bridge is not operated in a balanced condition. Instead, R_3 is set to allow a small bias current to flow to the base of TR_2 .

When light strikes SP_1 , the base of TR_1 is driven in the forward-current direction, causing the emitter-to-collector resistance to decrease. This further unbalances the bridge. A large part of the current which flows through TR_1 is fed directly to the base of TR_2 . Here it is amplified again and fed to the relay, RL_1 , causing the relay to close.

Note that, even though the base of TR_2 is connected to the emitter of TR_1 , both transistors are operated in the common-emitter connection for maximum gain.

HERE IS a light-operated relay circuit that has wide application. It uses a pair of inexpensive transistors, yet is so sensitive that the beam of an ordinary flashlight will operate the relay at a distance of 20 feet—without a lens in front of the photocell!

You will probably want to feed a 117-volt power line, as I have, to the contacts of relay RL_1 to operate a lamp, fire or burglar alarm, bell, gong, or a counter. A miniature power source, employing an Argonne AR-100 transistor transformer (T_1), a tiny germanium diode (CR_1), and a miniature filter capacitor (C_1), is incorporated to supply the operating current.

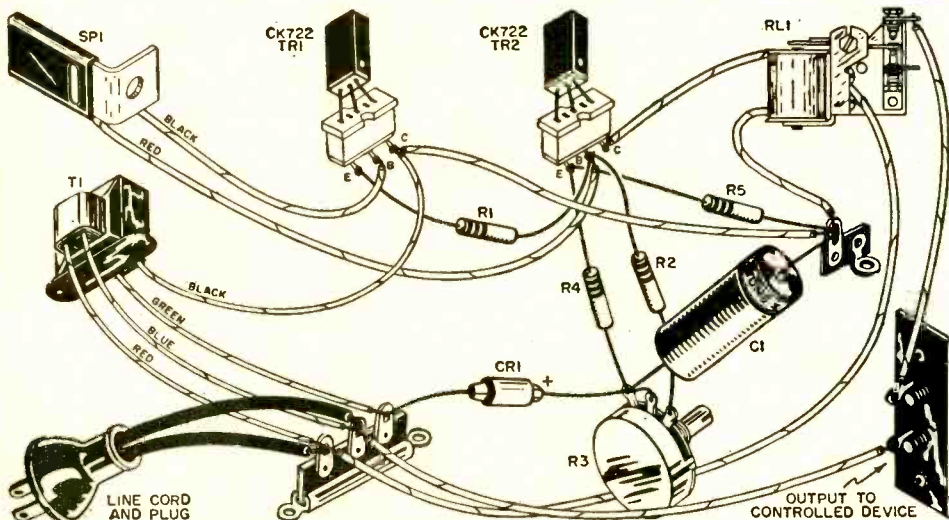

Check these diagrams in building the relay. Parts layout need not follow photo above; you may

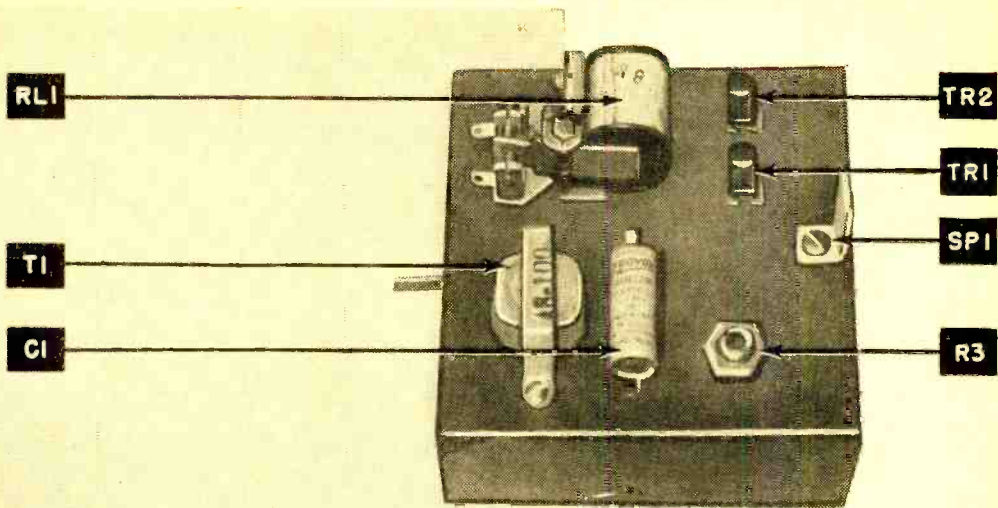

Since this relay is suitable for many uses, each setup will be best determined by the constructor. The one shown in the photo is an experimental hookup with plenty of open space, although it is assembled on a chassis measuring only $3\frac{1}{2}'' \times 3\frac{1}{2}'' \times 1''$. The photocell should be thoroughly shielded by a hood or a suitable length of cardboard tubing to prevent extraneous light from entering the cell.

With the photocell in total darkness, adjust sensitivity control $R3$ in the direction of increasing resistance until the relay pulls in. Then, *very slowly and carefully*, rotate $R3$ in the opposite direction (decreasing resistance) until the relay just

drops out. This is the point of maximum sensitivity. For applications requiring a lower sensitivity, adjust $R3$ in the direction of decreasing resistance until the desired sensitivity is obtained.

If you want to use a magnifying lens in front of the photocell for weak-light or long-distance operation, choose a lens that is 2" to 3" in diameter and, with the lens aimed at your light source, adjust the spacing between the lens and the photocell until a circle of light just covers the width of the cell. Inexpensive magnifying lenses well suited for this purpose are available from Edmund Scientific Corp., Barrington, N. J.

—Frank H. Tooker

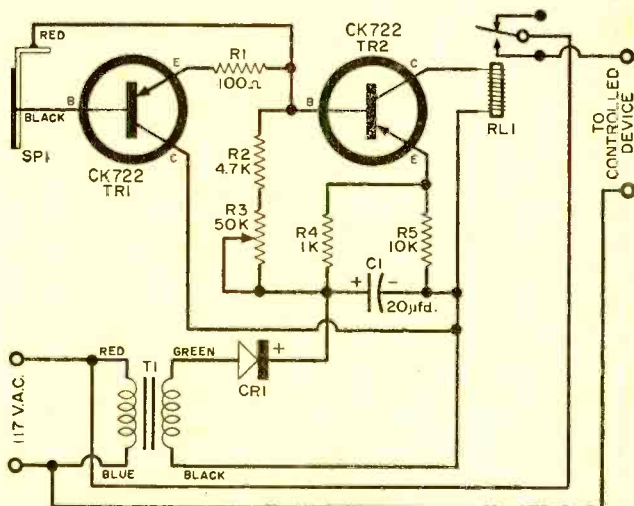

prefer more compact construction, depending on the application.

PARTS LIST

- C1—20- μ fd., 15-volt, miniature, transistor-type electrolytic capacitor (Lafayette)
- CR1—1N66 or 1N34 crystal diode
- R1—100-ohm, $\frac{1}{2}$ -watt resistor
- R2—4700-ohm, $\frac{1}{2}$ -watt resistor
- R3—50,000-ohm potentiometer (sensitivity control)
- R4—1000-ohm, $\frac{1}{2}$ -watt resistor
- R5—10,000-ohm, $\frac{1}{2}$ -watt resistor
- RL1—8000-ohm sensitive relay (Sigma 4F/3000-S/SIL or equivalent)
- SPI—Selenium photocell (International B2M)
- T1—Transistor transformer (Argonne AR-100)
- TR1, TR2—CK722 transistor
- 2—Transistor sockets
- 1—Metal or plastic miniature chassis (if metal is used, insulate SPI from the chassis)
- 1—Power cord and plug
- 2—Terminals (or 1 outlet receptacle) for relay connections to the controlled device
- Misc. hardware, wire, solder, etc.



Keeping Tabs on a "Dreamboat"

This beauty is having her beauty sleep checked to find out what makes it tick. Technicians of the Sleep Research Foundation—endowed by a mattress manufacturer—record brain activity, heart rate, skin temperature and body movement on an Offner Type D electroencephalograph. Electrodes are attached to our gal's forehead, arms, legs, cheek and head to determine "depth of sleep." Tests initiated by the mattress firm and run on hundreds of men and women—for more than 20,000 sleeping hours over 3000 nights—determined that moderately deep and the deepest possible sleep provide the best rest. The

equipment, adapted for the first time to this type of test, as demonstrated in the photo at right, showed that the blood pressure drops and the heart rate slows as much as 20 to 30 beats a minute during sleep. It noted that the average person moves one or two times an hour, with greater movement taking place at the end of the night as the depth of sleep grows less. The Foundation learned that length of sleep is not what counts. Five or six hours of good deep sleep will do more good than eight hours of poor sleep. We have one question, though. Does our sleeping beauty always retire with her lipstick on?



Your Teeth on TV

Better brush up on that smile, folks. It might win your teeth an audition on TV. Of course, there should be one or two good cavities in them, since the opening is on a closed-circuit system at NYU's College of Dentistry. Students are learning their chairside manners by watching live demonstrations on the system installed by General Electric. Use of closed-circuit TV saves many hours of instruction because a large group can watch the ways and means of excavating and filling a cavity. Heretofore, the instructor could only demonstrate to a small group gathered about the chair and repeat the lecture many times over. Cavity empor!

POPULAR ELECTRONICS

Drill, Cut and Smooth

How to make chassis holes for mounting tube sockets and other components

By GLENN A. WAGNER

1 Two types of drills can be used for making small holes: a hand drill (left) or a power drill (right). Between them is a set of 13 drill-bits, ranging in size from 1/16" to 1/4" in diameter. Chuck capacity of either drill is 1/4" but holes larger than this diameter may be drilled by auger bit or expansion bit. Either of these bits is available in 1/4" shank size to fit the 1/4" chuck.

2 Tools for sawing, punching and cutting larger holes. At the left is a hole saw, available with interchangeable blades of different diameters. Center, three popular sizes of punches: 5/8", 3/4", and 1 1/8". At right, a hole cutter with adjustable fly cutter. The hole saw may be used in a power drill, drill press, or flexible shaft. The fly cutter is used best in a drill press (see page 75).

3 These tools are for enlarging holes. Lower right, a small drum sander; aluminum oxide and garnet sleeves are available for this unit. Next, two files—rat-tail (across the bottom of the group), and round (at the top). Left, hand reamer, and right, pipe reamer; both are available in various sizes.

4 The chassis worker's collection should include hammer and punch used for starting a hole in metal. Note that the exact center of the hole-to-be has been previously located by two intersecting lines. These markers may be made with pencil, but the exacting craftsman will use a metal scribe. The starting hole helps the drill, or other cutter, to get a good bite into the chassis. It also keeps the tool from "wandering" off during the job.

Now, to see these tools in action,
turn the page.....

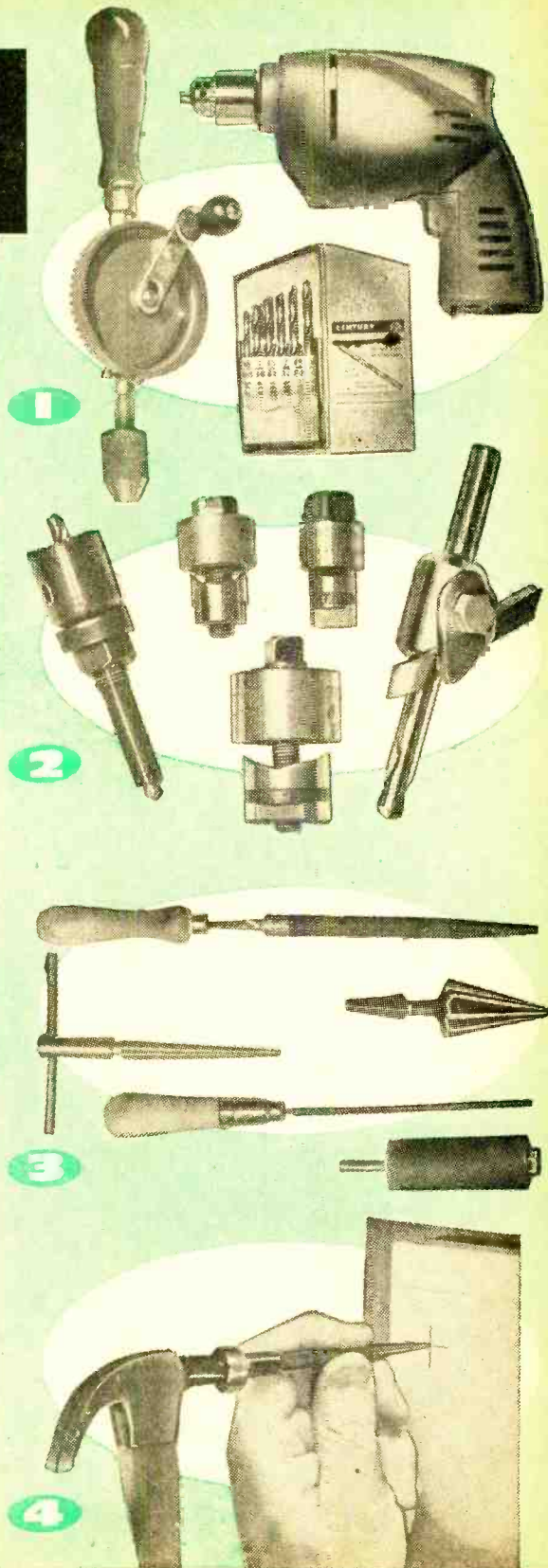



Hand drill, very useful in radio and electronic work, is shown cutting a hole in previously scribed sheet metal. . . .

or



Portable electric drill may be used for same purpose. You can hold and guide it with one hand. Take care when starting the drill so that it doesn't jump or "walk" on surface of work. When using either hand or power drill, support work with wood block to prevent bending metal as well as to assure a clean hole. And—watch those fingers!



Hand reamer is a tool for enlarging a hole that is a bit too tight to receive a component. With its long and gradual taper, the hand reamer will enlarge holes to micrometer precision and keep them perfectly round. . . .

or



Pipe reamer fits into a brace and is used as if it were a drill bit, by turning the brace. This type of reamer is built for speed, but its taper is not as fine as that of hand reamer, which is more of a "precision" tool.

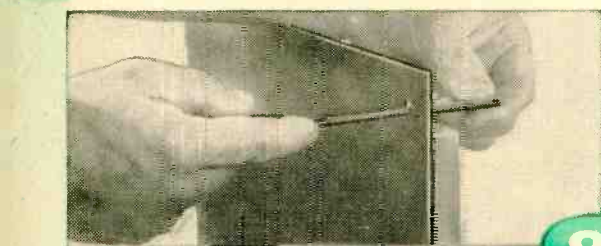

Rat-tail files are a good substitute for a reamer on small-diameter holes. Half-round files are used for larger holes. Be careful to keep hole as round as possible. Cut on forward stroke of file only. . . .

or



Drum sander can enlarge previously made holes 1" and larger in diameter. It may be used with a power drill, flexible shaft, or in a drill press. Latter method provides greatest control, frees both hands to hold and guide the work. Sleeves of aluminum oxide and garnet of various grits fit these sanders and will cut aluminum with great ease. For best results, place the work on a supporting wood block, as shown in the photo at left.

Chassis punch is excellent tool for making mounting holes for tube sockets, i.f. transformers, electrolytic can capacitors, phono jacks, auto radio antennas, and the like. First step is to drill a starting hole in the metal the size of the bolt. Then, assemble the upper two parts of the punch—the bolt and a socket the size of the hole to be made. Third part is the actual cutter, shown in photo at right resting on work table.

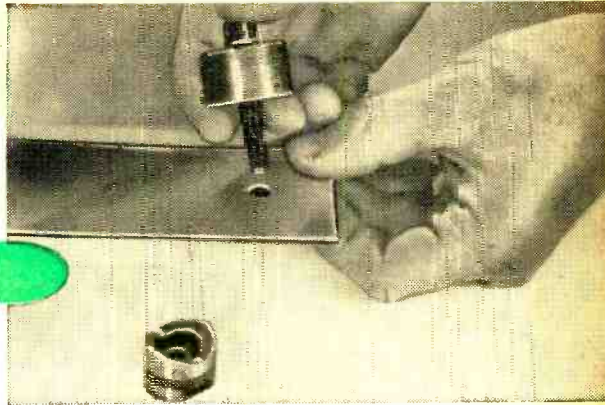

Cutting element of chassis punch is threaded onto the bolt from below the chassis. Bolt is now turned a few times with a wrench (photo at right). This action draws the cutter through the metal and into the socket. Result is a perfectly round, very clean-cut hole. These tools come in numerous diameters. . . .

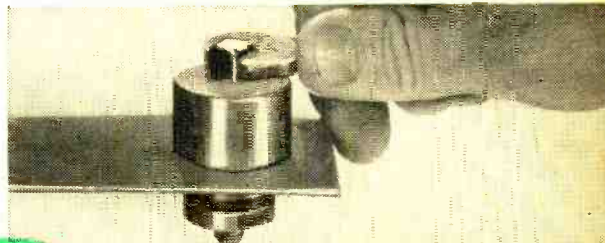

or

Hole saw at right is actually a round hacksaw which can be used on sheet metal as well as aluminum. It may be fitted into a power drill, flexible shaft, or drill press. The pilot drill centers the saw and guides it through the metal. Work should be supported with—or clamped to—wood block. Blades are replaceable and come in many diameters.



Fly cutter at right can make large-diameter holes. Although it may be used in a portable drill, best results are achieved with drill press, especially for thin sheet metal. The fly cutter bar is adjustable for any diameter hole and may be set with micrometer precision. A pilot drill locates the position of the hole and guides the cutter. Clamp work securely. . . .

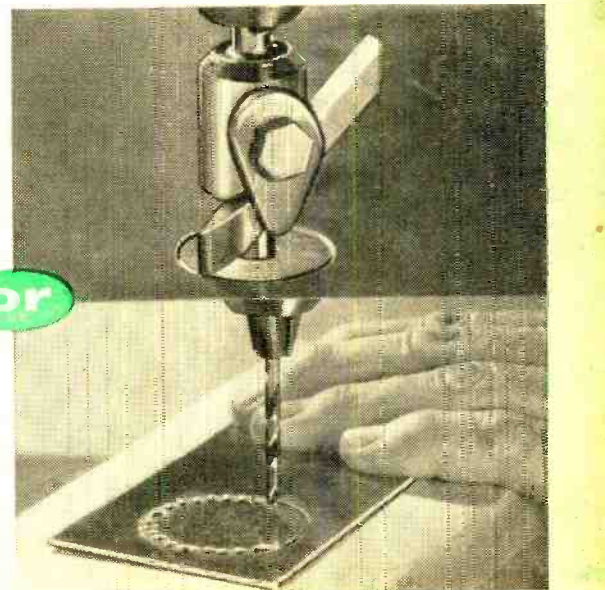

or

If you lack hole saws, punches, and fly cutters, here's a neat dodge to make large-diameter holes. First, scribe a circle the size of the diameter of the finished hole. Inside this circle, scribe a second circle to act as a guide for drilling a series of closely spaced holes. Then drill the holes. The metal can be knocked or chiseled out, then the circle cleaned up with a file. This method may be used for any shape of hole. Support work on wood block.



Photographer's Light Distributor

A photographer's "friend" controls floodlights right from the tripod

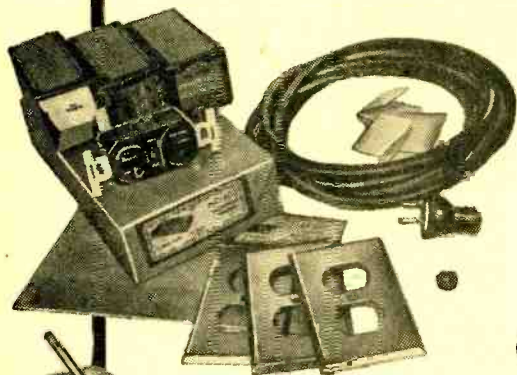

1

THOSE OF YOU who are indoor "shutter-bugs" as well as electronic hobbyists will want to assemble and use this convenient, inexpensive light distribution panel. With it, you can control your floods and spotlight right from your camera position. It eliminates the need for a tangle of assorted extension cords on the floor.

You should be able to duplicate this light distributor for less than five dollars—an equivalent commercial unit would cost two or three times as much. It's easy to assemble—just follow the captions and diagram on the next page. All the parts you will need are shown in the photographs. You can put it together in a single evening—even if you're just a beginner.

With the spring clips on the back of the panel box, snap the unit in place on one of the legs of your camera tripod. Plug the panel's line cord into a wall receptacle and your floodlight and spotlight cords into the switch receptacles on the panel. Simply by manipulating the switches on the panel box, any part of the subject can be thrown into shadow, highlighted or "flatlighted" as desired. You won't have to take your eyes off your model as you change the lighting for just the right effect.

—Louis E. Garner, Jr.

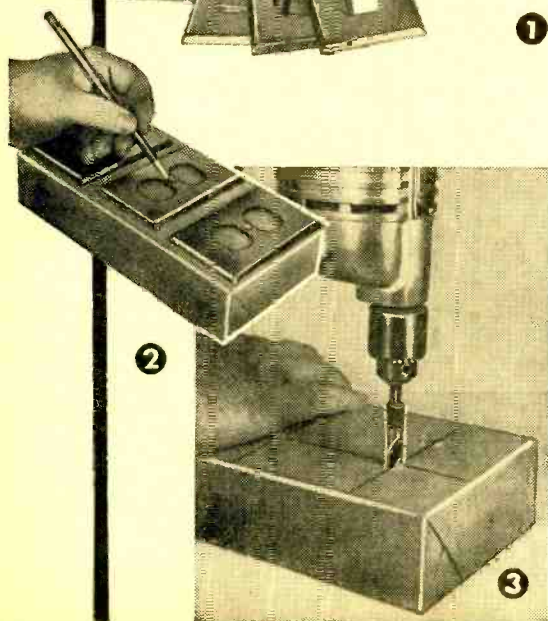

2

3

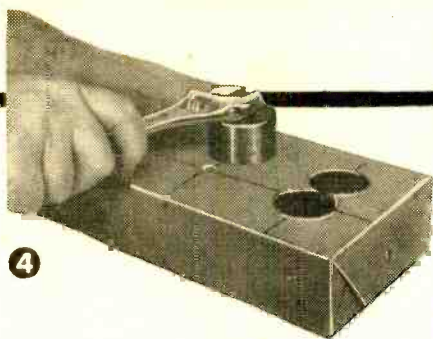

4

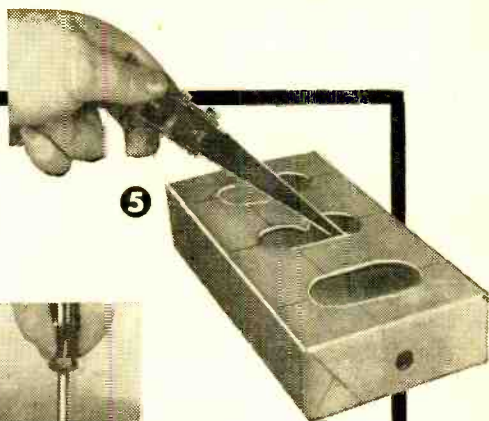

5

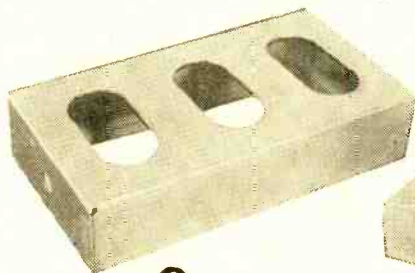

6

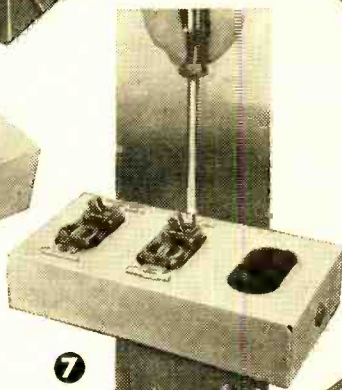

7

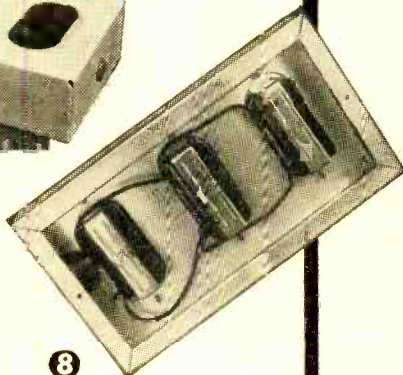

8

1 Parts include a 5" x 9 1/2" x 2" aluminum chassis (Bud AC-403), a 5" x 9 1/2" chassis bottom plate (Bud BP-667), and three combination s.p.s.t. switches and receptacles (Eagle 798). Receptacle cover plates may be either plastic or metal. (If you wish, you can substitute a cigar box for the metal chassis.)

2 Place cover plates in position. Mark location of all holes and cutouts on chassis' paper wrapping. Don't remove paper until machine work is finished.

3 Drill starting holes at points marked on layout.

4 To make large cutouts for the receptacles, punch out 1 1/2" holes using a screw-type chassis punch.

5 Cut between the holes with a small hacksaw. Then drill a 1/2"-diameter hole in end of chassis for the 1/2" rubber grommet and line cord. Use 12 to 15 feet of heavy-duty line cord (# 16, rubber-covered).

6 All burrs can be removed with a small file.

7 Mount switch-type receptacles with screws supplied. Squeeze rubber grommet into end of chassis.

8 Wire the receptacles in parallel (see diagram) with # 18 or larger insulated wire. Secure the line cord by tying a knot in it or using cable clamp.

9 To use the panel on your camera tripod, mount two spring-type tool holder clips under bottom plate. Mount plate to chassis with four 1/4" #6 sheet metal screws (wood screws for a cigar box). Connect heavy-duty line plug to free end of panel's line cord.

10 Completed unit mounted on tripod, ready for use.

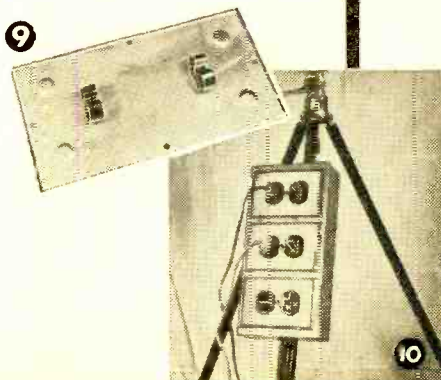
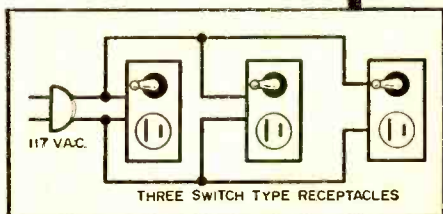

9

10

Tuning the Short-Wave Bands

with Hank Bennett

THE DISTINCTION of currently being POP'tronics' most distant reporter goes to Ha Chung-kwan of Kowloon, Hong Kong. A high-school student, Ha was 17 years old on June 25th. He lives at 21-23 Carnarvon Road.

The listening post of our Far East reporter is highlighted by a nine-tube Philips BX755A home receiver, ahead of which he has installed a two-tube homemade pre-selector. Coupled to the receiving equipment is an inverted "L" antenna, 60' long, 50' high. Ha is hoping to add a new National NC-125 receiver this year.



Ha Chung-kwan, PE reporter.

Since he began SWL'ing just one year ago, Ha has compiled a log of 65 countries heard, 55 verified. His most prized veri is a QSL from the South African B/C Corp. for reception of its 80-meter outlet.

When asked about his favorite bands, Ha picked 31 meters. *Radio Switzerland* and *Radio Australia* are his favorite stations because of their excellent programming. His best DX catch is a code station located in Central America but not fully identified.

Ha made the suggestion that we include a "QSL Exchanger's Page" in this column so that our readers and reporters could exchange cards with one another. We must regretfully state that to do so would mean curtailing many station listings. Perhaps at a later date, if we find more space forthcoming, we might include this listing.

A member of the Japanese Shortwave Club, Ha's hobbies—in addition to radio—include astronomy, classical music, phys-

ics, and correspondence. He asks for letters from the world over and guarantees that every one will be answered.

Believing in the SWL philosophy that "to become an SWL is the best way to make friends"—Ha feels that the spirit of the SWL is a wonderful thing. Your editor is sure that this spirit is shared by all.

SWL and DX News. Stewart West of Union, N. J., one of our regular reporters, has left on a visit to Haiti for one year. While there, "Stew" will be heard over stations 4VEH, 4VWI, and 4VE during their DX sessions.

An invitation is extended to everyone interested in SWL and DX to attend the annual convention of the Newark News Radio Club on August 10 at Shady Rest Park, Route 33, just east of Freehold, N. J. It's free, but bring your own lunch. Games, working radio demonstrations, gab-sessions, and prizes make up the order of the day.

Your Editor would like to remind you that we have plenty of report cards, letter-size report sheets, DX logs, monitor identification cards, "hi-voltage" decals, and amateur radio reference sheets available, at no charge. Just drop us a card.

(Continued on page 122)



The equipment of David Kimpton, Cobourg, Ontario, includes seven-tube Stromberg-Carlson and a BC-348-0 receiver, plus a QF-1 multiplier.

**Low-cost two-tube,
mounted in file box,
can be assembled
in a single evening**

**By
DONALD A. SMITH**

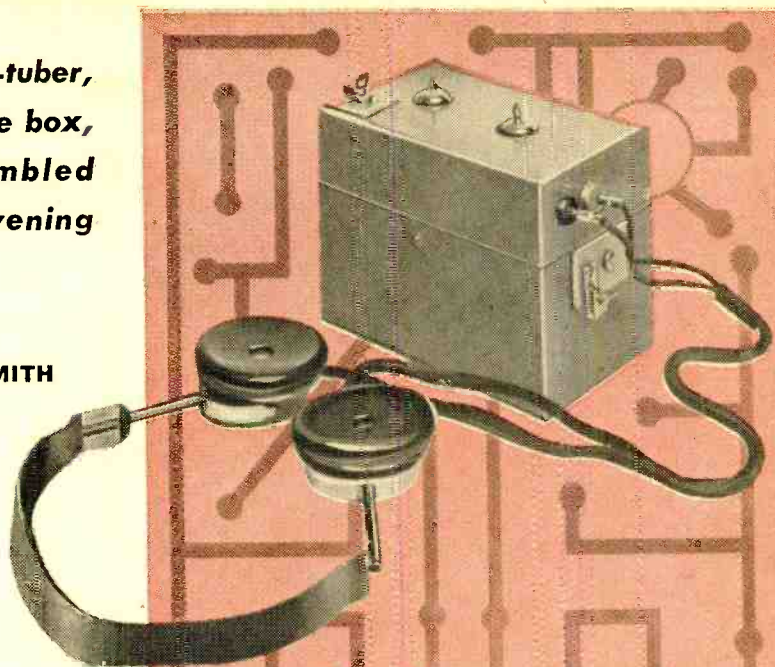

Building an ETCHED CIRCUIT Receiver

THERE are two reasons why electronics experimenters should seriously consider building this two-tube receiver. First, it provides a good example of elementary printed circuit techniques, and second, it is a useful Civilian Defense project.

Even the most inexperienced builder should have no trouble with this project. In spite of the fact that the receiver is preset to a fixed frequency in the AM broadcast band, there is no reason why it cannot be taken on picnics or beach parties. I have not built in a variable tuning capacitor, although one of the midget transistor variety could be added without upsetting the circuit. There is no volume control since signal pickup will depend largely upon the length of the antenna you use. The cost has been kept as low as possible, and I judge it to be about \$5.50 plus the batteries.

Construction. First obtain the material for the printed circuit board. This will consist of one piece of single-faced copper board, a roll of pressure-sensitive tape resist, and a small quantity of etchant.*

Put the tape resist on all the shaded areas drawn full scale on page 81. The tape resist goes on the copper side of the board. Make sure that it adheres to the

board. Then mix the etchant solution, following the manufacturer's instructions.

Place the board into the solution and rock the tray back and forth until all of the visible copper is removed. This will usually take 15 to 20 minutes. Remove the board and wash it with water until all of the etchant has disappeared.

After the board has dried, the tape covering the remaining copper can be removed. Clean this copper lightly with fine steel wool, so that good electrical connections can be made.

Now the necessary holes should be drilled through from the copper side of the board. Drill all holes with a small drill first and then enlarge them as needed.

After all holes are drilled, the various radio parts can be mounted. Force the tube sockets through the openings you have drilled for them, from the bare side of the board through to the copper side. Align

*See "Simplified Etched Circuits," Garner, POPULAR ELECTRONICS, June, 1957, p. 67.

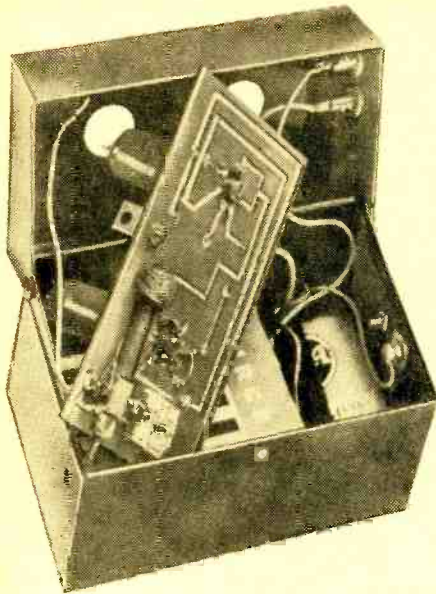

and bend the pins of the sockets down against the board so that each socket pin touches the correct corresponding copper strip. Then solder each of the socket pins to the copper strip under it.

Force the leads of *C2* through holes *B* and *F*, then squeeze the leads of *R1* through the same holes. Cut off the leads close to the board, and solder. Be sure to insert the leads on the bare side of the board so that they come through on the copper side.

The leads of *C3* go through holes of the board. *H* and *D*. Do *not* solder. Leads of *R2* go through *H* and *G*. Now solder hole *H*. Place the leads of *C4* through holes *J* and *K*. Do *not* solder *K*. Then place *R3* through *K* and *L*, and solder both. Take a small piece of wire and connect holes *M* and *N*; this is a jumper wire to connect pin 5 of the 3S4 to the ground line.

Take capacitor *C1* and bend the ends so that one end will touch hole *C* and the other end will touch hole *D*. This is mount-

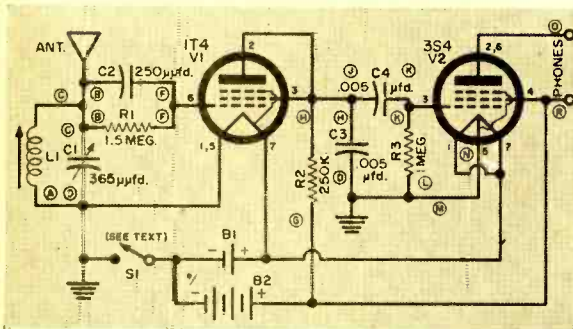

PARTS LIST

- B1—1.5-volt "D" cell
- B2—67.5-volt battery
- C1—365- μ fd. variable capacitor
- C2—250- μ fd., 300-volt capacitor
- C3, C4—0.005- μ fd., 300-volt capacitor
- L1—Feri-Loopstick
- R1—1.5-megohm resistor
- R2—250,000-ohm resistor
- R3—1-megohm resistor
- S1—"On-off" switch (see text)
- V1—1T4 tube
- V2—3S4 tube

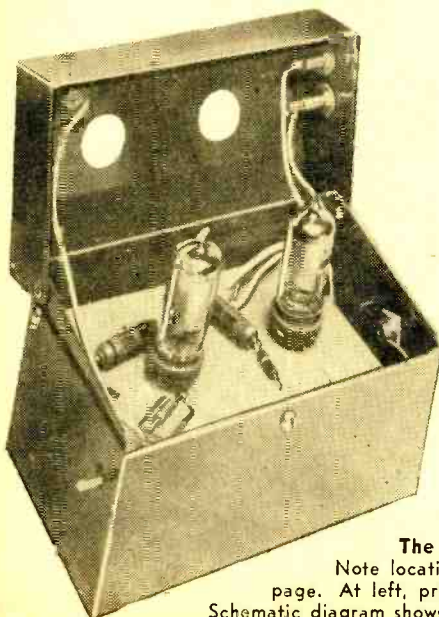

ed on the copper side of the board. When you have adjusted the capacitor in the above manner, solder it in place.

Now look at the Feri-Loopstock, find the connection marked "Gnd" and solder it directly to hole *A*. Then take a scrap piece of wire and connect the terminal marked "Ant" on the coil to hole *C*. Connect a 6" length of wire to hole *P* and solder. The board is finished!

Installation. The cabinet I used in this model is a metal index file card box. Holes are drilled in the cabinet to ventilate the tubes and provide earphone, antenna, and ground connections. The photos show the approximate positions of the holes. The "on-off" switch (see photo on preceding page) is a homemade plastic job using two nuts and a bolt separated by a clip.

Before placing the batteries in the bot-

The photos show completed receiver with cabinet open. Note location of phone jacks, batteries, etc., in view at top of page. At left, printed circuit board has been inserted into position. Schematic diagram shows where printed wiring is incorporated in the circuit.

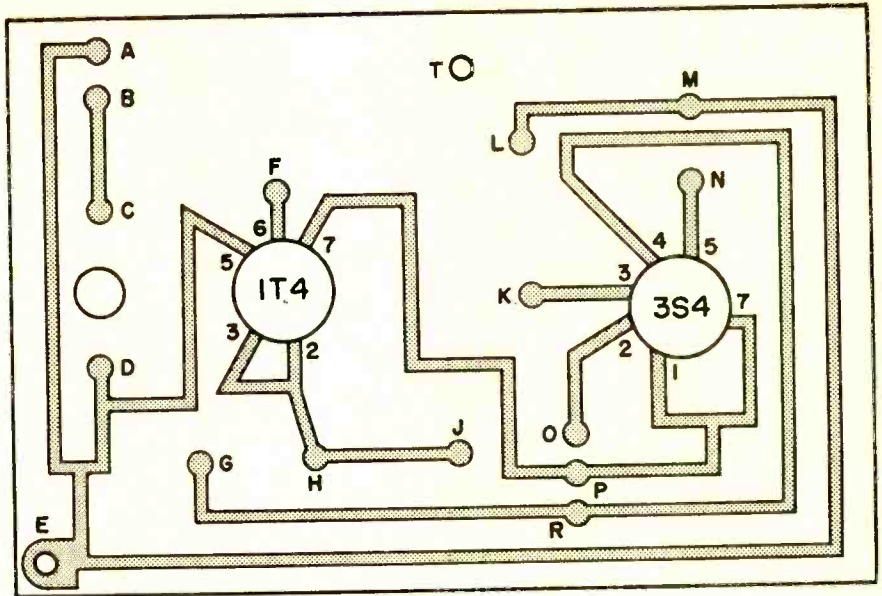

Full-scale layout of the printed circuit board. Tape resist goes on all shaded areas.

tom of the cabinet, first solder the lead coming from hole *P* of the board to the positive terminal of *B1*. Solder a 6" length of wire to the case of *B2* and take a turn or two of tape around the battery so that there will be no chance of either terminal shorting out to the cabinet. Connect the wire coming from the negative terminal of *B2* to the wire coming from the negative terminal of *B1*.

With short 6-32 screws, attach two L-brackets to the printed circuit board (holes *E* and *T*). Now mount the board in the cabinet and secure it to the cabinet walls with two 6-32 screws through the L-brackets.

Mount two insulated phone jacks in their holes as shown in the photo on page 79. When they are installed, connect the wire from the plus terminal of *B2* to one of them, and run another wire from this jack

to hole *R* in the circuit board. Connect the other jack to hole *O* in the board with a short length of wire.

Operation. You should have no difficulty in getting the set tuned and ready for use. Plug earphones into the two jacks, connect an antenna and turn on the "switch." You will hear a local station which is quite strong in your location.

There are two methods for tuning the receiver to Conelrad. If a signal generator is available, it should be adjusted for 640 or 1240 kc. Work first with the slug adjustment of the coil and then *C1*. Peak up the signal with the *L1* coil adjustment and tune to the generator frequency with *C1*. The other method is to follow the same procedure as above, except that instead of employing a signal generator to locate the proper frequency a local station close to the Conelrad frequencies can be used. -30-

Adapter Quickly Connects Phone Tips to Miniature Jack



This simple adapter allows a standard headset having standard phone tips to be connected to a radio or other apparatus with a miniature jack output. To make it, first strip the hardware off two standard phone tip jacks. Spread the split-lugs apart and slip them over the lugs on a miniature plug. (The plug and jack used here are Lafayette Radio MS-281 and MS-282.) Now run enough solder over the lugs to provide a rigid assembly, but don't let it run over the end of the plug and cause a short. Insulate the two tip jacks by wrapping a few turns of 3/4"-wide tape around each one. Then wrap narrow tape tightly around the threaded part of the plug and around the soldered lugs, and wrap wide tape around the shanks of the tip jacks.

—Carl Dunant

AFTER CLASS



Special Information on Radio, TV,

Radar and Nucleonics

TRICKS WITH TRANSFORMERS

ELECTRICITY has often been likened to a viper with a lightning-fast thrust. Quiet and deadly, it lies in wait for a careless move or an ignorant blunder. Given the opportunity, it strikes with venomous and terrifying swiftness. It can strike in just that way through a device which works directly from the a.c. line without benefit of an isolation transformer.

In such equipment, the metal chassis and the control shafts are at the potential of one of the legs of the a.c. line. Since there is always an even chance that this is the ungrounded or "hot" leg, contact of any

power. In addition, it provides primary voltage for a second 6.3-volt transformer *connected backwards*. The output of *T2* is approximately the same as the 120-volt line voltage—give or take a few volts—but is isolated from it. With this arrangement, the chassis may be safely grounded without fear of baiting the grim reaper. The current ratings for the particular transformers you use apply equally as well to this "back-to-back" circuit.

Multiple Low Voltages. Another useful transformer trick involves connecting heater windings in series-aiding or series-opposing to obtain a variety of output voltages. Almost any discarded TV power transformer is excellent for this purpose since most of them have two 6.3-volt heater windings and a 5.0-volt section in addition to the high voltage secondary. If the latter is not to be used, tape the ends of the wire leads and stow them out of the way. This leaves the three heater windings, which may be connected to binding posts or Fahnestock clips after the transformer is mounted on a wood board.

Before wiring in the heater windings,

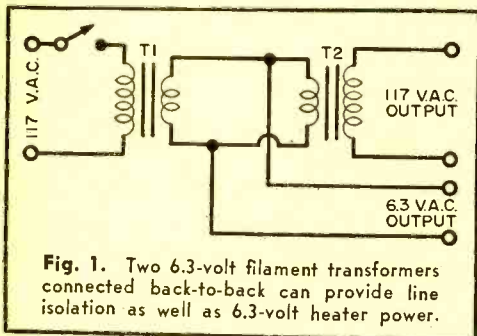

Fig. 1. Two 6.3-volt filament transformers connected back-to-back can provide line isolation as well as 6.3-volt heater power.

part of the body with the chassis and a grounded object, such as a pipe or radiator, at the same time *may have fatal results!*

There is absolutely no excuse for working with line-connected gadgets. Isolation is easy enough!

Simple Isolation. There are several excellent and relatively inexpensive isolation transformers with a 1:1 turns ratio available on the market. Many have an additional 6.3-volt secondary winding capable of handling the heater power requirements of one or two receiving type tubes. Should these be unobtainable when you need them, however, a very satisfactory substitute may be assembled quickly with the aid of two 6.3-volt heater transformers of almost any variety (Fig. 1).

T1 reduces the line voltage from the nominal 120 volts to 6.3 volts. Its output is used as a source of heater voltage for the tubes in the device to which it supplies

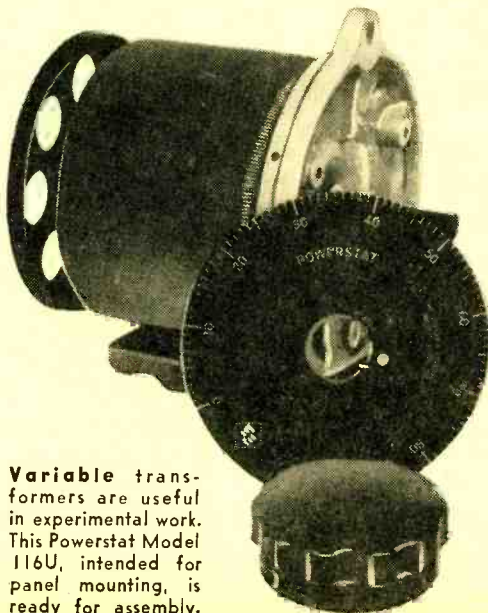

Variable transformers are useful in experimental work. This Powerstat Model 116U, intended for panel mounting, is ready for assembly.

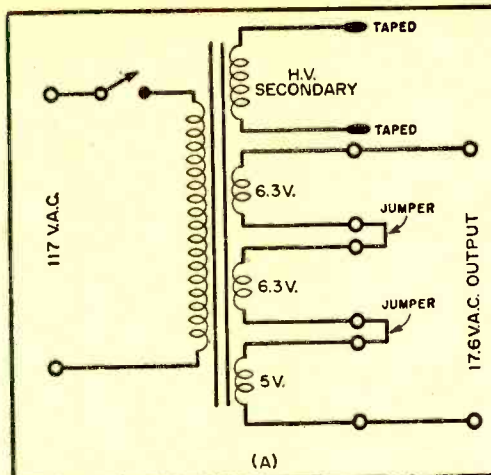

Fig. 2. An old television power transformer can provide multiple low output voltages: (A) three windings in series-aiding will supply 17.6 volts, a.c.; (B) 6.3-volt and 5.0-volt windings in series-aiding give 11.3 volts, a.c.; (C) two 6.3-volt windings in series-aiding connected to one 5.0-volt winding in series-opposing yield 7.6 volts, a.c.; (D) two 6.3-volt windings in series-aiding give 12.6 volts, a.c.; and (E) one 6.3-volt winding and one 5.0-volt winding in a series-opposing setup provide 1.3 volts, a.c.

however, it is necessary to determine their *phasing*. For instance, if a 6.3-volt winding is connected to a 5.0-volt secondary in *series-aiding*, their output voltages are in phase and add up to yield a total voltage of 11.3 volts. On the other hand, reversing one connection places the secondaries in *series-opposing*. In this condition, the voltages are 180° out-of-phase and subtractive, giving an available potential of 1.3 volts.

Five distinct output voltages are thus placed at your disposal: 17.6, 12.6, 11.3, 7.6 and 1.3 volts a.c. This is a very good range for many experiments. For work with transistors, the output voltage will have to be rectified. In this connection, the 1.3-volt output will not be useful because selenium rectifiers are virtually ineffective at such a low potential.

The output taps should be laid out on the board so that the secondaries are connected in series-aiding when straight short jumpers are used to join adjacent windings, as shown in Fig. 2. Use an a.c. voltmeter to determine which leads must be connected for the aiding or opposing conditions. When you have done so, number the output terminals and draw up a simple chart showing interconnections and output taps for each voltage. Thumbtack it to the board, protect it with a piece of plastic film, and you'll have a piece of equipment you will use again and again.

Variable Power. Although all of us have not yet reached the stage where we consider a variable transformer vital to our experimental work, it's a good thing to know its capabilities. The excellent unit shown in the photo on page 82 (Superior Electric's Powerstat Model 116U) will provide any voltage from zero to 140 volts at 7.5 amperes in continuous values over the range. One of the most efficient instruments for supplying any voltage to a circuit directly or to the primary winding of

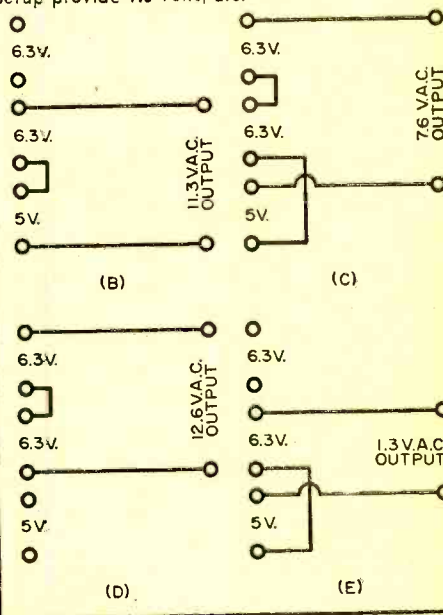

a high-power transformer, the Powerstat is excellent for controlling the power input to the final stage of an amateur radio transmitter, the intensity of stage lights and house lights in theaters, and any other device where variable power is a requirement.

When a variable transformer is connected in the primary circuit of the final am-



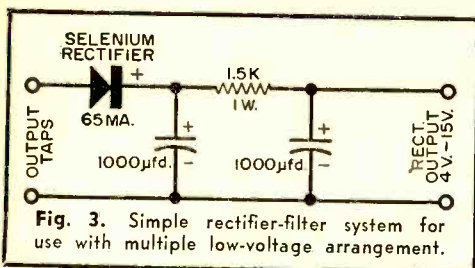

Fig. 3. Simple rectifier-filter system for use with multiple low-voltage arrangement.

plifier plate power transformer of an amateur transmitter, for example (Fig. 4), the operator can *really* conform with the FCC regulation which stipulates that stations must employ minimum power for reliable communication.

Final Amplifier Protection. Speaking of radio amateur equipment, the final amplifier tuning process often endangers the power output tube if the tuning capacitor is allowed to remain in the off-resonance condition for an appreciable time. If you do not have a Powerstat or its equivalent, you will still want to incorporate a fuse in the primary winding of the plate transformer.

As an aid in the tuning-up procedure and as a positive protection for your final amplifier tube, wire in a s.p.d.t. heavy-duty toggle switch and a cleat socket to take a

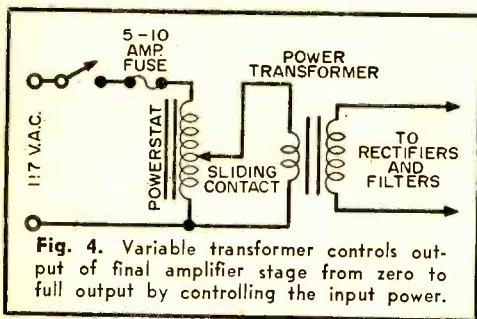

Fig. 4. Variable transformer controls output of final amplifier stage from zero to full output by controlling the input power.

standard incandescent lamp (Fig. 5). With the switch in the "tune-up" position, the lamp is in series with the primary of the power transformer and the power dissipation in the circuit is thus limited to the wattage of the lamp you use.

With a properly selected wattage, even a sustained off-resonance setting will not harm the transmitting tube. Remember, though, that this protective scheme is practical only if heater power is taken from transformers other than the one being controlled. These voltages will be affected by the presence of the lamp resistance in the primary if they are taken from windings on the same core.

Adapting Transformers. As a final transformer trick, this is a good one to know: audio output transformers often

may be adapted for use as heater or filament power sources. When the normal primary winding is connected across the 120-volt line, the secondary may yield any voltage from a few volts to 20 volts, de-

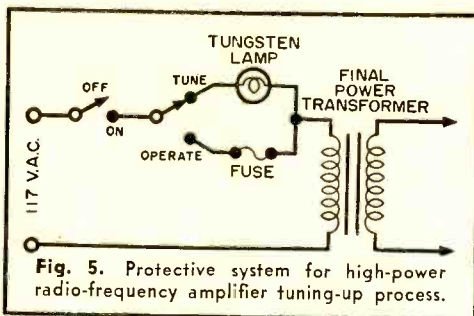

Fig. 5. Protective system for high-power radio-frequency amplifier tuning-up process.

pending upon the design of the unit, as well as the load placed across it. As such discarded units appear on your workbench, you can rate them as filament transformers by setting up a simple jig consisting of a variable load resistor and an a.c. voltmeter.

First measure the no-load output voltage with *S1* open; starting with maximum load resistance (wiper all the way down as in Fig. 6), adjust the resistance so that the output voltage is some standard heater value like 12.6 or 6.3 volts (or 5.0 volts), *whichever is closest to the no load voltage*. Don't attempt to run a transformer whose no-load voltage is 17 volts down to 5 volts by loading it down. This may overheat the windings. Remove power and measure the resistance, then substitute this value in the

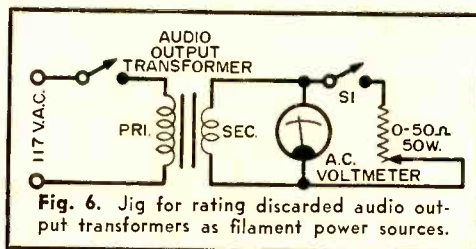
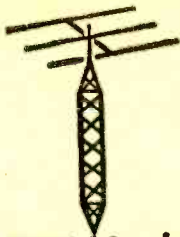

Fig. 6. Jig for rating discarded audio output transformers as filament power sources.

basic Ohm's law equation: $I = E_{sec}/R_{load}$. The result will tell you the current rating of the tube for which the transformer may be used.

For example, say that the transformer voltage is 8.5 volts at no load. This might make a good 6.3-volt transformer, so you load it down and find that the resistance required to bring it down to 6.3 volts is 20 ohms. Substituting in the equation gives $I=0.3$ ampere approximately; hence the transformer may be used as a heater supply for any 6.3-volt, 0.3-ampere tube, such as the 6SA7, 6AU6, 6BA6, etc.



THE TRANSMITTING TOWER

Herb S. Brier, W9EGQ

SUMMER is a good time to work on antennas. So let's talk about some of the problems that are involved in erecting them.*

In amateur antennas, mechanical strength, rather than current-carrying capacity, determines the minimum wire size to be used. Number 14 solid-copper antenna wire is usually strong enough but it will stretch. Number 14 copper-clad steel wire, which is three times as strong, and #12 copper wire are better. The wire should be enameled for protection against corrosion. Be very careful to avoid kinking it as this will weaken the wire.

Use Antenna Insulators. For high strength and good insulating properties, use transmitting antenna insulators, such as the E. F. Johnson Type 136-104. To fasten the wire to the insulators, scrape its end clean for about four inches. Skip two inches and scrape clean another 2" space. Slip the wire through the hole in the insulator, double it back on itself, and wrap the end around the scraped section, with the insulator centered on the unscraped section. Solder and paint with Krylon, Glyptal, or other corrosion-preventing "dope."

When the feed line is a continuation of the antenna wire, slide the insulator along the wire to the proper point, and fasten it with a tie wire wrapped around the wire on each side of the insulator.

In antennas fed with polyethylene-insulated coaxial cable or "twin lead," the junction between the antenna and the feed line is frequently a trouble spot. With coaxial cable, one of the fittings designed especially for joining them (B & W CC-50, Ea-Z-On, Impedacoupler, etc.) eliminates the trouble neatly and permanently.

With "twin lead," the trick is to support its weight from the center insulator with the entire cable, not the conductors alone. An insulator which has a hole for anchoring the line, such as the Birnbach Model 468, helps to do this. Slip the end of the line through the hole and tape it firmly to

the insulator before baring the conductors to make the antenna connections. Wrap a few layers of tape around the line for several inches below the insulator to distribute the strain a bit.

Lacking a special center insulator, bare a few inches of the conductors at the end of the line, and bend them at right angles to the line. Tape them firmly to the insulator. Next, lay about a 12" length of polyethylene stripped out of a scrap of 300-ohm ribbon over the insulator and parallel to the line on each side. Tape together tightly. Make the connections to the antenna wires, and coat them and the tape with Glyptal or Krylon.

Choose a Support. If there is a tall tree in the right place to support your antenna, you are lucky. By wrapping a wire around the trunk with a few short sticks between it and the tree to prevent cutting the bark, and inserting a heavy coil spring between the wire and end insulators, you have a natural support.

When you have to furnish your own antenna supports from the ground up, a wooden utility pole has many advantages. Unfortunately, one long enough to be worth bothering at least 30' — is fairly expen-

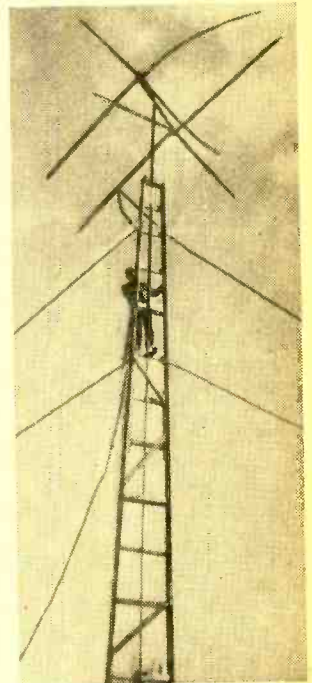

"Spike," K2OKG, constructed this 32' tower (from plans in POPULAR ELECTRONICS, November, 1956) to support his 15-meter rotary "quad" antenna.

*See *The Transmitting Tower*, January, 1957, November and December, 1955, for lengths and electrical design data.

HELP US OBTAIN OUR HAM LICENSES

In this section of the Transmitting Tower, the names of prospective amateurs requesting help and encouragement in obtaining their licenses are listed. To have your name listed, write to Herb S. Brier, W9EGQ, c/o POPULAR ELECTRONICS, 366 Madison Ave., New York 17, N. Y. Please print your name and address clearly. Names are grouped geographically by amateur call areas.

K1/W1 CALL AREA

John Lukas, 9 Hill St., Auburn Mass. (Code and theory)
Robert J. Riseman, 145 Pond Brook Rd., Chestnut Hill 67, Mass. (Code and theory)
Bennett Lubin, 5 Mt. Pleasant Pl., N. Brookfield, Mass. (General Class theory)
Frank Mullins (13), 37 Woodland St., R.F.D. #2, Woonsocket, R. I. (Code)
Martin Lewis (15), 25 Dickens St., Providence 8, R. I. (Code and theory)
Gary P. Cummings, 44 High St., Peterborough, N. H. (Code and theory)
Jeep Stone, 180 Ebin St., Newton Ctr., Mass.

K2/W2 CALL AREA

Eugene Acri, 40-42 193rd St., Flushing 58, N. Y. Phone: Flushing 7-8387. (Code and theory)
David Buchwalter, 146 Harding Place, Syracuse, N. Y. (Code)
Richard Kussman (12), 164 Church St., New Rochelle, N. Y.
James Heisler, 23 Joseph Ave., Albany, N. Y. (Code and theory)
John Olson, 97 Kent St., Albany 10, N. Y. (Code and theory)
Richard Brelia, 35 Crown St., Brooklyn 25, N. Y. Phone: MAin 2-4135. (Code and selection of equipment)
Freddy Marcus, 1269 E. 89th St., Brooklyn 36, N. Y. Phone: CL 1-8859.

K3/W3 CALL AREA

Philip Jones (15), 120 S. Wells Ave., Glenolden, Pa. Phone: LU 3-0147. (Theory)
Barry Rodkey, 3529 Brisban, Paxtang, Pa. Phone: CE 3-4370. (Code)
Richard A. Riley, 303 Northwind Rd., Towson 4, Md. (Code, theory and regulations)
Samuel Farrah, Box 225, Tarrs, Pa. (Theory)
Robert Turner (12), 937 Glen Terrace, Chester, Pa. (Code and theory)
David Krapp (13), 1286 Bingay Dr., Allison Park, Pa. (Code and theory)
Robert N. Cox (12), 1411 Medford Rd., Wynnewood, Pa. (Code and theory)

K4/W4 CALL AREA

Bill Richerson, 404 Park Ave., Tarboro, N. C. (Code; will give help in theory)
Raymond Wilder (18), R.R. #2, Box 23, Apopka, Fla. (Code and theory)
Wayne Helms (18), Box 1021, Apopka, Fla. (Code and theory)
Gary W. Lane (18), R.R. #3, Box 609, Orlando, Fla. (Code and theory)
Douglas Robinson (17), R.R. #1, Box 201, Apopka, Fla. (Code and theory)
Robert A. Rees (17), R.R. #1, Box 114, Apopka, Fla. (Code and theory)
Philip Korli (18), R.R. #2, Box 585, Apopka, Fla. (Code and theory)
Arthur Sandero (17), P. O. Box 956, Apopka, Fla. (Code and theory)
Ronnie Howell, Red Ash, Va. (Code)
Edmund H. Malski, "Casa Mia," Flat Rock, N. C. (Code and theory)

K5/W5 CALL AREA

Charles Lawson, 1411 E. 13th St., Austin, Tex. Phone: GR 6-9927.
Monroe Mitchell, 1905 Comal St., Austin, Tex. Phone: GR 7-7425.
Charles L. Price, Rt. #4, 37th Ave., Hattiesburg, Miss. (Code)
Cordell Williams, 1113 Angelina St., Austin, Tex. Phone: GR 7-2162.

James M. Soileau, 602 So. Chataignier St., Ville Platte, La. (Code and theory)
J. W. Singleton Jr., 410 Broadway St., Marked Tree, Ark. (Code and theory)
Jax Clarkson, 5170 Huckleberry, Houston, Tex. (Code and theory)

K6/W6 CALL AREA

Neil Kastner, 153½ Fano St., Arcadia, Calif. Phone: HI 7-7061. (Code and selection of equipment)
George Hansen (14), 215 Lobos Ave., Pacific Grove, Calif. Phone: FR 5-3598. (Code and theory)
David and Daniel Rodriguez, 3961 Ocean View, San Diego 13, Calif. Phone: CO 4-9003. (Code and selection of equipment)
George Ekins (14), 1957 Oak Crest Dr., Oakland, Calif. (Code, theory and selection of equipment)
Jacob Jacobs (12), 3019 El Monte Ave., Oakland, Calif. Phone: LO 8-3265. (General Class code and theory)

K8/W8 CALL AREA

Larry Snodgrass, 145 E. Michigan, Sebring, Ohio. (Code and theory)
Henry Carter, Jr., 20015 Monte Vista, Detroit 21, Mich. (Code)
Larry Dillinger, 2768 Queen City Ave., Cincinnati 38, Ohio. Phone: HU 1-6395.
Tom Kudza (15), 336 E. York Ave., Flint 5, Mich. (General code and theory)
Clyde Walter, Jr. (14), 110 Callahan Rd., Canfield, Ohio.
Kenny Hinkle, R.D. #1, Box 24, Mingo Jct., Ohio. Phone: 6279.
Paul Stempfly, R.R. #4, Holland, Mich. (Code and theory)
Dave Miller, 11565 Rossiter, Detroit 24, Mich. Phone: VE 9-2729. (Code and theory)

K9/W9 CALL AREA

Mr. and Mrs. Gerald Crystal, R.F.D. #1, LeLand, Ill. (Code and theory)
Tommy Kinney, 1344 E. 48th St., Chicago 15, Ill. Phone: Wagner 4-6698. (Code and theory)
James H. Pruet, 2635 W. 21st Pl., Chicago 8, Ill. Phone: CL 4-6748. (Code)
Bobby Loving, 9121 So. Troy, Evergreen Park 42, Ill. (Code and theory)
Paul Brietzke, 7035 W. Cleveland St., Niles 31, Ill. Phone: NI 7-7492. (Code and theory)
Charles Coyle (11), 514 Hillside Ave., Elmhurst, Ill.

K0/W0 CALL AREA

George Lemaster (10), Rt. 4, Box 188, Pittsburg, Kans. (Code and theory)
John C. Klobuchar, 422½ Third St. So., Virginia, Minn. (Code and theory)
Bill G. Calligan, 404½ Fifth Ave. So., Virginia, Minn. (Code and theory)
Clancy A. Graham, 408 Fifth Ave. So., Virginia, Minn. (Code and theory)
Stephen Mutchler, Aneta, N. D. (Code and theory)
Allan C. Mueller, P. O. Box 216, Arlington, Minn.
Jack Keller, 4410 W. 64th Terrace, Kansas 15, Mo. (Code, theory and regulations)

VE AND OTHERS

Hart North (13), 296 McMat St., Dundas, Ont., Canada. (Code, theory and regulations)
Bill Campbell (15), 11 Murray Dr., Trail, B. C., Canada. (Theory)
Winston Lydiatt, 95 Riverdale Ave., Toronto 6, Ont., Canada. (Code)

To help prospective amateurs obtain their Novice licenses, the Radio-Electronics-Television Manufacturers Association offers a set of code records (recorded at a speed of 33½ rpm) and a Novice Theory Course for \$10.00, post-paid. The complete course or more information on it is available from RETMA, 1721 DeSales St., N.W., Washington 6, D. C.

sive and difficult to install, except by experts; but so are other unguyed antenna supports.

For heights up to 40' or so, undoubtedly the most economical support for an antenna is a guyed mast. In its simplest form, it consists of a 20'- or 22'-long, painted and guyed yellow-pine or fir "2x2" on the roof of a garage or other building. Such a stick on top of even a small building will give a respectable antenna height of over 30 feet.

Number 12 galvanized iron wire is suitable for the guys. To prevent them from accidentally becoming resonant at the transmitter output frequency, and thereby distorting the radiation pattern of the antenna, they should be broken up into shorter lengths with insulators. In this application, an insulator near the top, bottom, and center of each guy will be sufficient.

Use strain ("egg") insulators, not regular antenna insulators, for this purpose. Such insulators are very strong because they are constructed so that the load on them is in compression. Also, even if they are crushed by overload, the guy wire cannot fall apart and drop your mast.

Wrap the guy wires around the mast to avoid weakening it, and put a single $\frac{1}{4}$ " bolt through the mast to prevent them from slipping down. Put them about two feet from the top, so that they will not be in the way of the antenna.

In screwing the guy-wire anchors into the corners of the roof, be sure to put them into the roof joists, rather than into the thin boards between the joists. Douse the area around each one liberally with roofing compound to prevent leakage.

Make a Halyard. This is convenient for raising and lowering the antenna. To avoid the difficult problem of getting pulleys that will not soon corrode and jam, substitute glazed, porcelain stand-off insulators normally used to anchor utility wires to buildings and poles. They are available with either a bolt or screw in the bottom for mounting (the bolt type is preferred here). Their smooth surfaces and rounded construction permits the halyards to slide through the holes easily, without fraying.

Don't use cheap clothesline for the halyard as it will rot under long and hard

usage. Sash cord is all right if it is first boiled in paraffin or soaked in waterproofing compounds to extend its life and to reduce shrinking when wet. A better material is $\frac{3}{8}$ " Manila rope designed for outdoor use. Nylon or orlon parachute-rigging cable (Army/Navy surplus) is good, too.

Make the halyard slightly less than twice the height of the mast and tie its ends together so that it cannot pull out of the pulley-insulator, and so its end will not flip up out of reach.

Install the Mast. If your mast is going on a flat roof, first lay about a 3' length of "1 x 12"—with a cushion layer of roofing



Station W3TKQ not only has "worked all states" but over 100 different countries as well. Located in a world-famous science museum, the Franklin Institute in Philadelphia, it is operated by Mason Frank- enfield, W3PBR, during museum hours to demonstrate amateur radio.

paper under it—in the center of the roof, and set the "2 x 2" on it. "Toe-nail" the "2 x 2" into position after the guy wires have been fastened. Six-inch turnbuckles in each guy will help keep the mast vertical.

On a peaked roof, two "1 x 12's" can be joined together with long garage-door hinges and hung over the peak. Then, two more hinges or a "universal" TV mast base can be used to fasten the "2 x 2" to the "1 x 12's."

Once the antenna is in the air, bring the feedline away from it at right angles for as great a distance as possible, supporting it at the nearest point in this direction at which a standoff insulator may be mounted. This will reduce the likelihood of the line breaking in the wind, especially if it is reinforced with a layer of tape for a few inches at this point.

(Continued on page 120)

Transistor Topics

By LOU GARNER

"POWER" is rapidly becoming the "key word" in transistor design. The majority of the new auto receivers introduced this fall will use one or more power transistors. And a number of optional automobile accessories, including some types of fuel injection systems, will also use them.

In 1956, power transistors represented 15% of all types produced. If the same ratio holds for 1957, total production should be well over 4.5 million units; and in 1958 we may expect something like 20 to 30 million units.

For some time now, power transistor applications have been limited to audio frequencies and to relatively low operating temperatures. But both limits have been extended considerably by recent developments.

Bell Telephone Laboratories (where the transistor itself was invented) has announced the development of a high-frequency power transistor. Rated at 5 watts, this silicon unit can be used as an oscillator

or amplifier as high as 10 megacycles. It should be of real interest to hams for their mobile and field rigs. Don't dash over to your nearest parts distributor to buy one, though . . . they are still in the developmental stage and may not be available as commercial products for some time.

Another development to watch comes from G.E.'s Research Lab . . . a semicon-



Experimental power transistors at Bell Telephone Laboratories, such as the silicon unit being checked here, can provide a 5-watt output at 10 mc.

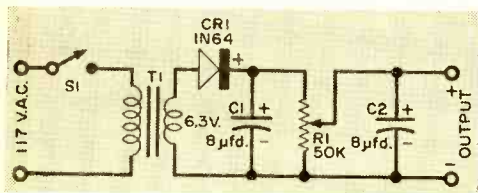

Fig. 1. Ron Wilensky's simple power supply.

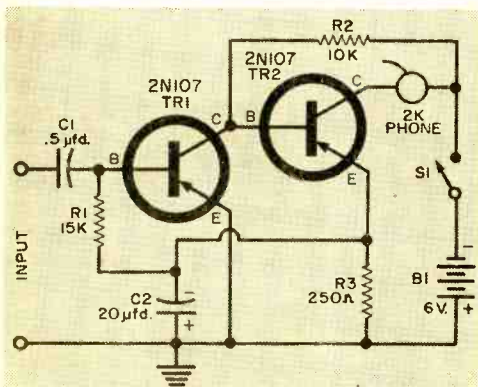
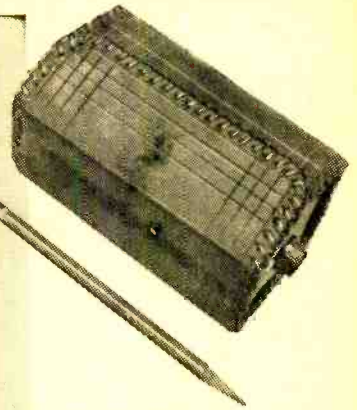
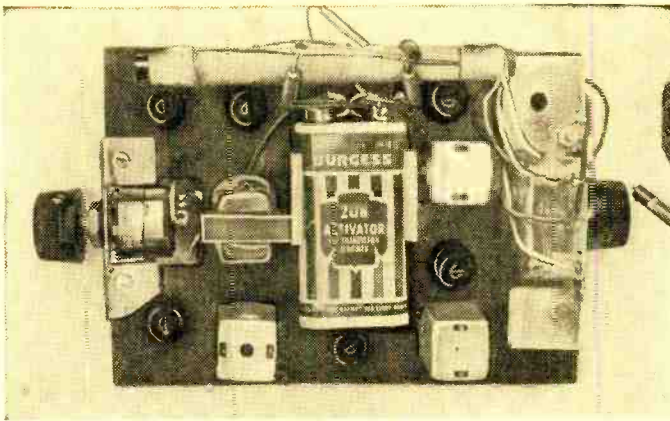

Fig. 2. Bill Evans' direct-coupled amplifier.

ductor rectifier capable of handling several amperes with over 90% efficiency at temperatures up to 1200° F. This particular unit uses a silicon-carbide semiconductor material. It may be the forerunner of other high-temperature semiconductor devices—including transistors which can work at red heat.

Readers' Circuits. In response to many requests that we feature a greater variety of circuits in this column, here are three different experimental circuits: a simple power supply, a direct-coupled audio amplifier, and another simple receiver. All are easy-to-build and use low-cost, readily available components.

Power Supply. An a.c.-operated power supply is useful for bench-testing experimental transistor amplifiers and oscillators. The circuit shown in Fig. 1, submitted by Ron Wilensky, Apt. 422, 920 E. 17th St.,



The six-transistor receiver at left was assembled by F. E.

Bassett and housed in this attractive leather case. Note its actual size in comparison with a pencil.

Brooklyn 30, N. Y., can supply small currents (up to a few ma.) at moderate and low voltages. Easy to use and completely shock-free, it is valuable for checking out one- and two-stage transistor circuits.

S1 is a s.p.s.t. toggle or slide switch . . . or it may be a "control type" switch attached to *R1*. *T1* is a standard 6.3-volt filament transformer (the secondary current rating is not too important). *C1* and *C2* are 25-volt electrolytic capacitors, rated at 8 μ fd. or higher . . . 20 to 50 μ fd. units are preferred. A 1N64 diode serves as a half-wave rectifier, and *R1*—a 50,000-ohm carbon potentiometer—serves as an output voltage control.

You can assemble the power supply on a small metal chassis or in a plastic or wooden box. Layout and lead dress are not critical. But be sure to provide suitable output terminals . . . either Fahnestock clips, binding posts, 'phone tip or banana jacks. And be sure to identify the output polarity . . . you can do this by marking the *positive* terminal with red fingernail polish.

Audio Amplifier. Most multi-stage transistor amplifiers require either large-value interstage coupling capacitors or special interstage matching transformers. Not so the circuit shown in Fig. 2. Sent in by C. W. (Bill) Evans, of 712 W. 22nd, Hutchinson, Kansas, this *direct-coupled* amplifier provides good gain using a minimum of parts.

R1, *R2*, and *R3* are $\frac{1}{2}$ -watt carbon resistors, *C1* a 0.5- μ fd., 200-volt tubular paper capacitor, and *C2* a 20- μ fd., 6-volt electrolytic. The 6-volt battery (*B1*) may be made up of four penlite cells in series. An s.p.s.t. toggle or slide switch (*S1*) serves as a "power" switch. Bill suggests the use of a 2000-ohm magnetic headphone (*Phone*).

According to Bill's calculations and tests, this circuit provides a gain of 54 db and

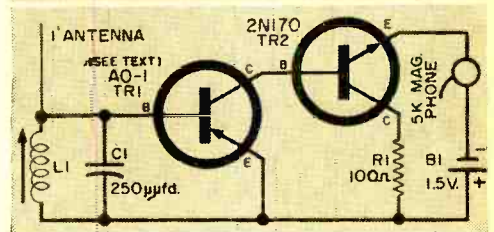

Fig. 3. Hugh Van Horn's two-transistor receiver. It is shown above assembled in a small plastic box.

an input impedance of 1000 ohms. The response is down 9 db at 200 cycles. Maximum undistorted power output (to *Phone*) is 4 milliwatts.

It can be assembled in a small plastic or metal case. A piece of Bakelite makes an excellent sub-chassis. Layout and wiring shouldn't be especially critical, but you should follow "good" practice . . . keep the "input" and "output" circuits reasonably well separated. The completed amplifier may be used for general-purpose work . . . as an audio signal tracer, headphone am-

plifier, or in similar types of applications.

Simple Receiver. Direct-coupling techniques seem to be growing in popularity among experimenters, for Hugh Van Horn, of 3096 Chadbourne Rd., Shaker Heights, Ohio, has sent us a simple two-transistor receiver circuit which uses direct coupling between stages (Fig. 3).

According to Hugh, his receiver has sufficient sensitivity to pick up all local stations in the metropolitan area in which he lives (Cleveland) when the set's 1' antenna is coupled loosely to a large metal object, such as a metal table lamp or similar item. The "loose coupling" is obtained sim-



Knight's pocket radio kit can be assembled in a few hours on its etched circuit board. See text.

ply by placing the receiver (and antenna) near the object.

L1 is a "loopstick" antenna coil, *C1* a 250- μ fd. mica or ceramic capacitor, and *R1* a 100-ohm, $\frac{1}{2}$ -watt resistor. Power is supplied by a single 1.5-volt penlite cell (*B1*). Hugh indicates that he used a Philco SB-100 surface barrier transistor for *TR1*, but believes that the lower priced AO-1 will give similar results. Different stations are tuned by adjusting *L1*'s powdered iron "slug."

If you want to duplicate Hugh's receiver, you should assemble the circuit in a plastic box measuring approximately 1" x 4" x $\frac{3}{4}$ ". Mount coil (*L1*) and output jack permanently on the box. Transistor sockets and other components are attached to the lugs of these two parts.

Hugh has a few suggestions on construction that you may find helpful in assembling the receiver. For *best* selectivity, Hugh says, use a *silver mica* capacitor for *C1*. Do not use more than 3 volts for operation. Magnetic headphones are essential—if a 'phone jack and plug are provided, disconnecting the headphones automatically opens the battery circuit and turns the set off when it is not in use.

Note that Hugh hasn't provided an "On-

Off" switch for his receiver. He feels that such a switch is unnecessary because of the low current drain of his circuit . . . his set has been operating continuously for a month without noticeable change in performance.

Reader's Project. From time to time we hear from a reader who has done an unusually neat job of assembling a piece of equipment . . . from either a "basic" kit, standard circuit, or an article in POP'tronics. Recently, F. E. Bassett, of 183 W. 234th St., Wilmington, Calif., sent us photos (see p. 89) of a six-transistor superhet receiver he had assembled from a "basic" Lafayette kit (Lafayette Radio, 165-08 Liberty Ave., Jamaica 33, N. Y.). He made up both the basic layout and the leather case himself. We are sure you'll agree that he has done an outstanding job of layout, wiring and assembly. Congratulations, Mr. Bassett!

If *you've* done a really good job on a project of your own—or of assembling a transistor circuit from a POP'tronics article—let us hear about it. We'll need *good-quality* (5" x 7" or 8" x 10") glossy

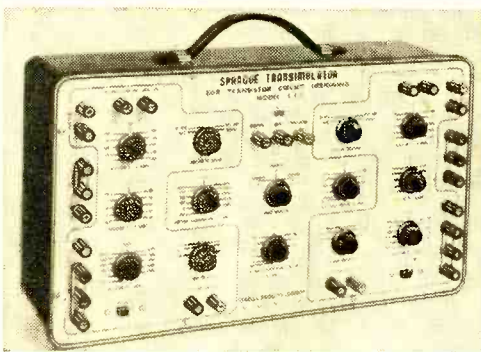

Sprague Products' "Transimulator" incorporates everything needed for breadboarding RC amplifiers.

photographs showing the interior and exterior views of your project—plus the schematic used. Such contributions cannot be acknowledged or returned, and there'll be no cash payment for material used . . . but if your project is featured, you'll receive a warm feeling from the admiration of your fellow readers.

Let's see some of your work, fellows!

The "Transimulator." Sprague Products Co. (395 Marshall St., North Adams, Mass.) has developed an instrument which should be welcomed by the transistor experimenter and circuit designer alike . . . and schools should find the device of real value in lab work involving transistor circuit study. Called the "LF1 Transimulator," it incorporates everything needed for

(Continued on page 118)

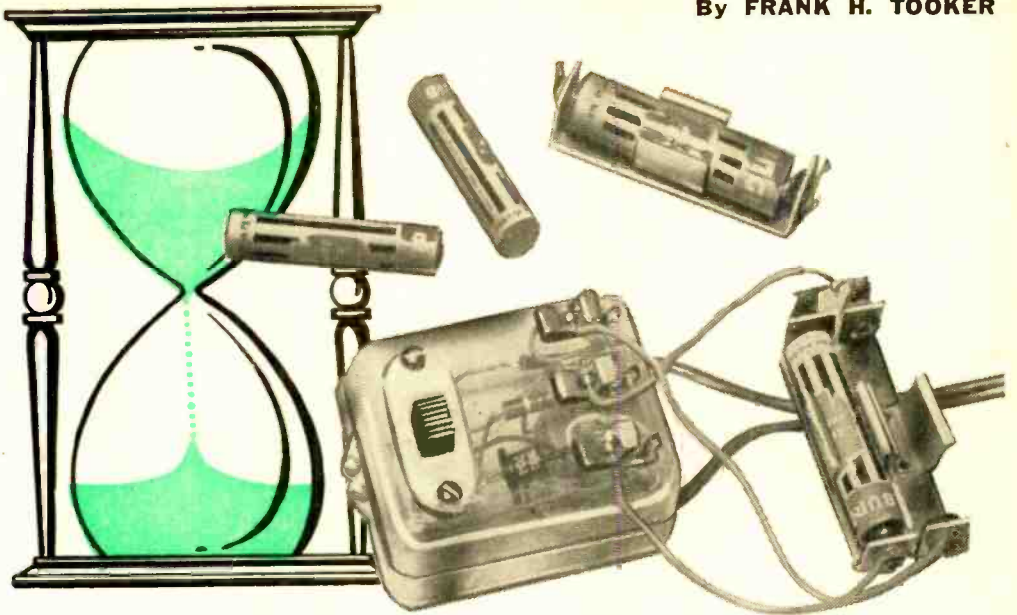

Miniature Dry Cell Rejuvenator

**You can double—or even triple—the life of
your flashlight batteries with this setup**

IF YOU USE an average number of ordinary zinc-carbon dry cells in flashlights and transistorized devices around your home, you'll find that either of the convenient rejuvenator circuits described in this article will soon pay for itself.

Many years ago I discovered that some dry cells would respond more readily to rejuvenation if they were "assaulted" at intervals with controlled amounts of semi-rare alternating current. This seemed to be more effective than straight d.c. or full half-cycles of pulsating d.c. Thanks to General Electric's diffused junction germanium rectifiers, it is now possible to obtain the same characteristics in simple battery rejuvenators.

Circuit Details. In the circuit of Fig. 1, a dry cell to be rejuvenated may be connected from the center output terminal to either side output terminal, *but not to both simultaneously*. In other words, this circuit should be used to rejuvenate only a single dry cell, and two connections giving identical results are available for the process.

If you want to rejuvenate two dry cells at the same time, use the circuit of Fig. 2. In this case, one dry cell is connected from the common (negative) center terminal to either side terminal. The second dry cell is connected from the common center terminal to the other side terminal. Either one or both connections may be used simultaneously, as desired.

If you aren't using many dry cells at present, and rejuvenating one cell at a time will fill your needs, build the circuit of Fig. 1. Then, if you require additional facilities later on, it's a simple matter to modify the setup to accommodate the extra rectifier and resistor required in the circuit of Fig. 2.

Construction. The rejuvenator shown in the photos is the assembled circuit of Fig. 1. Appearance of the setup for Fig. 2 would be identical except for the additional rectifier and resistor. Either unit may be assembled in the handy little plastic box in which the transformer, *T1*, is purchased.

Begin the assembly by cutting holes to

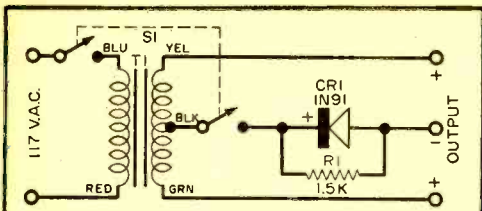

Fig. 1. Circuit for rejuvenating one dry cell.

PARTS LIST

CR1, CR2*—Type 1N91 diffused junction germanium rectifier (General Electric)

R1, R2*—1500-ohm, 1/2-watt resistor

S1—D.p.s.t. slide switch
T1—Transistor audio transformer used as voltage step-down transformer (Argonne AR-143)

3—Miniature Fahnestock terminal clips

1—Lightweight power cord and plug

1—Plastic box

Misc. hardware, plastic household cement, wire, solder, etc.

*CR2 and R2 are required only for the circuit of Fig. 2

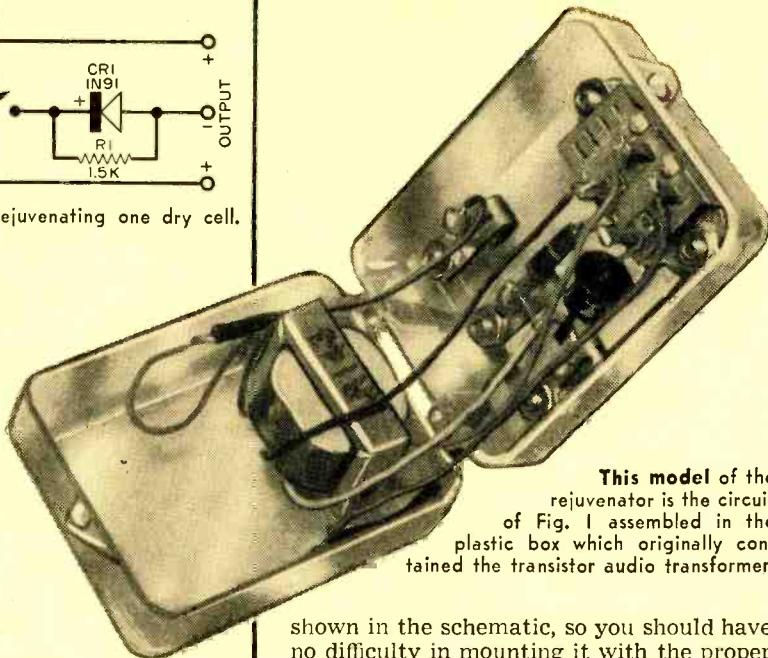

This model of the rejuvenator is the circuit of Fig. 1 assembled in the plastic box which originally contained the transistor audio transformer.

shown in the schematic, so you should have no difficulty in mounting it with the proper polarity.

Finally, solder the remainder of the connections between the transformer leads, the switch, and the power cord—and your rejuvenator is complete.

Using the Rejuvenator. Always make sure that the positive terminal (brass cap) of the dry cell is connected to a positive terminal of the rejuvenator. The bottom of the zinc can is the negative terminal of the dry cell. It should always be connected to the negative (center) terminal of the rejuvenator.

Don't try to rejuvenate two cells simultaneously with the circuit of Fig. 1. It won't work. The two positive terminals are provided on this unit merely for convenience. If you want to charge two cells at once, use the circuit of Fig. 2.

Connect a voltmeter, at intervals, across the dry cell being rejuvenated. If the cell voltage tends to go above 1.7 volts, turn the rejuvenator off and allow the cell to rest for a while. If the potential across the cell is 1.6 volts—or more—after several hours of rest, the cell is probably fully rejuvenated.

This increase above normal in cell voltage should not be taken as the sole indicator that a cell has been fully rejuvenated. A few cells will not go above 1.4 to 1.5 volts even after prolonged rejuvenation. In fact, it is not unusual for some cells of the same type and size to vary quite widely in their required periods of rejuvenation. Only experience can tell you how long to rejuvenate a particular cell.

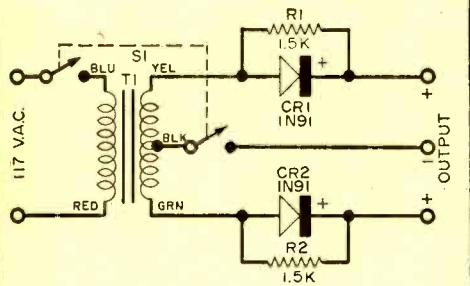

Fig. 2. Circuit for rejuvenating two dry cells of the same or different size and type simultaneously. It will also accommodate single cells.

mount slide switch S1 and the three Fahnestock clips on the cover. Then cement the transformer in the lower half at the hinge end. The red and blue leads should be toward the hinges.

Drill two holes in the lower half of the hinge end of the box (behind the transformer, to the left and right) to pass the leads of the power cord. These holes should be no larger than necessary. Cement the leads to the box with generous applications of household cement.

Solder the resistor and then the rectifier between the proper terminal on the switch (see diagram) and a lug under the center output terminal. Use pliers as a heat sink when soldering the rectifier leads. The rectifier is plainly marked with the symbol

Building a "Spare" Amplifier

Double performance with this two-tube
which does the work of four single tubes



By ALAN M. GRANT

THIS is a simple, low-cost amplifier that can be used with a crystal pickup or FM tuner. Although the circuit contains only two tubes, there is ample output for both of these applications. Utilizing dual-purpose tubes, a 6SL7 for two amplifying stages and a 117N7 as a rectifier and beam output tube, its performance is equal to that of a three- or four-tube unit.

Fidelity-wise, there are three applications of inverse feedback to make it nearly distortion-free. A tapped tone control boosts either the bass or the treble ranges, and can be used to equalize older records. But naturally, the 117N7 tube with its 1-watt output cannot be expected to rival a 40-watt "monster."

Circuit Details. In place of a "hot" chassis, found in most small amplifiers of the a.c./d.c. variety, all circuit grounds terminate at a single lug which is chassis-grounded through capacitor C2.

Voltage for the two tube filaments is obtained from two different sources. The 117N7 tube (V2) works right across the 117-volt a.c. line without a dropping re-

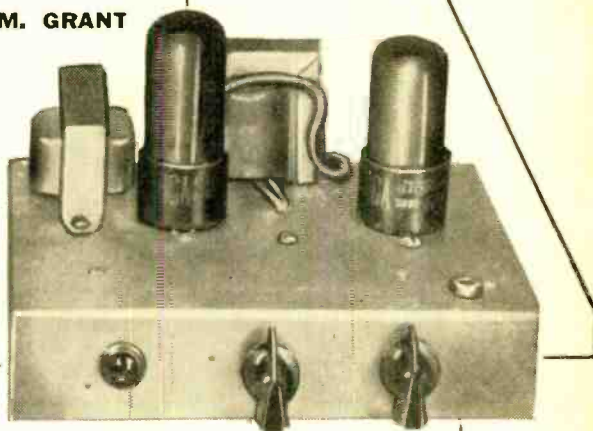

On the front of the amplifier are the pilot light, tone and volume controls. At top of page, the amplifier is connected to a triaxial speaker and 16" turntable.

sistor. To obtain the necessary voltage for the 6SL7 (V1), the author settled on a 290-ohm resistor line cord. Any resistance up to 350 ohms can be used with equal results.

The pilot light (PL1) is connected in series with the 6SL7 heater. Although a choke (CH1) is shown in the wiring diagram, the constructor may substitute a 450-ohm resistor (5 watts) if he wishes.

Construction Pointers. The author ran all leads as close to the chassis as possible. All high-level a.c. voltage leads were kept short. Because of the nature of the resistor line cord, the "on-off" switch (S1) is connected in the ground lead. The cord dis-

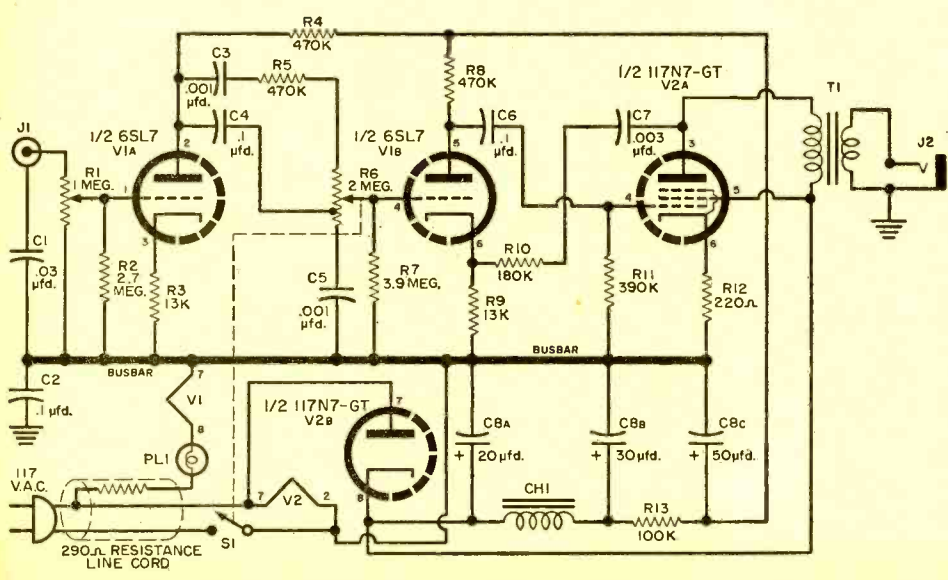
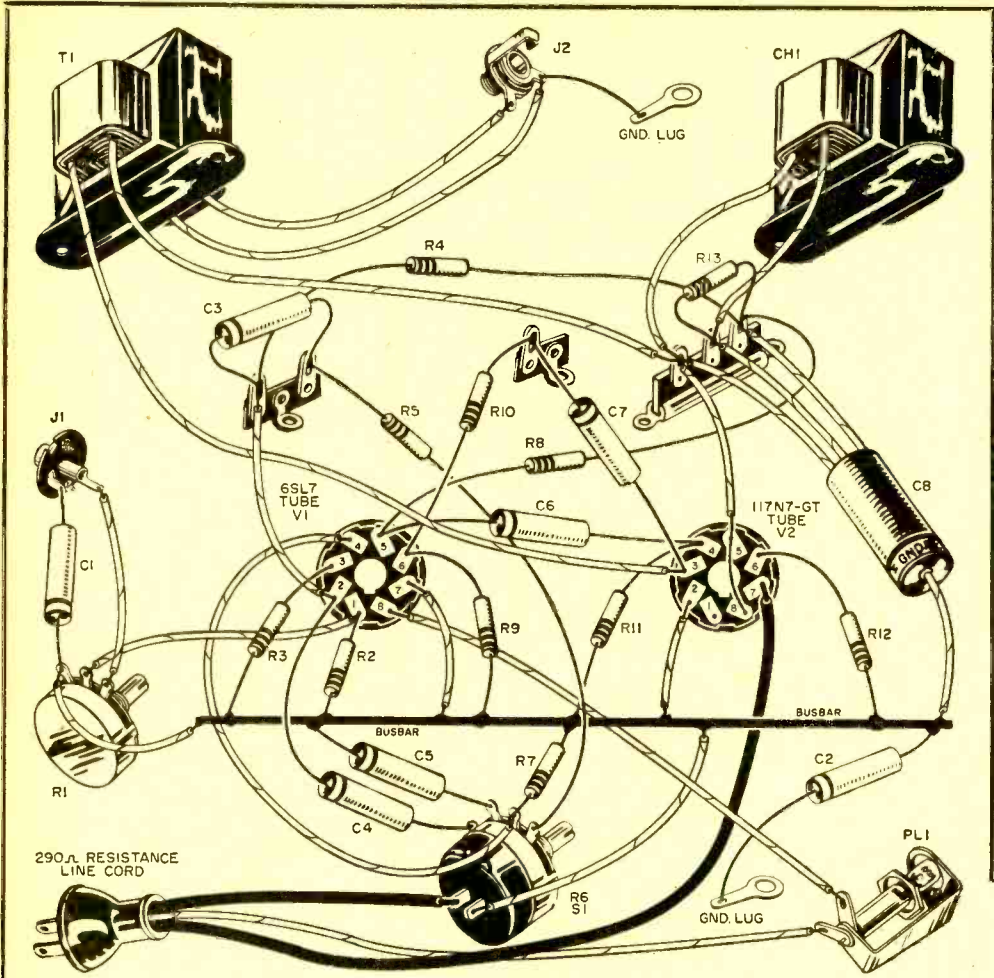

Underside of amplifier chassis, showing terminal board and point-to-point wiring. You will note that the major components are crowded to the back of the chassis. While this keeps hum away from the tone and volume controls, the top of the chassis looks somewhat unbalanced. You may want to experiment with alternate layouts to obtain a more balanced appearance while retaining minimum hum.

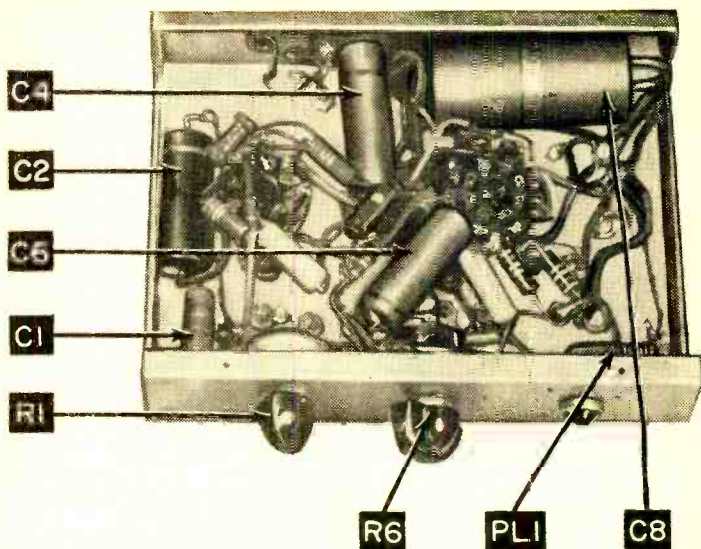

sipates quite a bit of heat when working normally. Don't be alarmed if it becomes quite hot to the touch.

Wire carefully and avoid large blobs of solder. In the case of the ground lug, use a two- or three-lug terminal strip and connect the lugs together with a heavy piece of bare copper wire. Avoid letting solder run down to touch the chassis—this could result in a direct short. And remember that when the line plug is inserted and the

switch is "off," the ground side of the circuit will be safe to touch but anything connected to the other side of the line definitely will not!

The output transformer is a high-quality universal type transformer such as the Stancor A-3856. Follow the manufacturer's instruction sheet in matching your speaker impedance to the 3000-ohm load resistance of the 117N7. For increased high-

(Continued on page 118)

Pictorial and schematic diagrams for the two-tube are at left, with parts list below. Circuit values were chosen with care for maximum performance. See description of how the unit operates at right.

- C1—0.03- μ d., 300-volt paper tubular capacitor
- C2, C4, C6—0.1- μ d., 300-volt capacitor
- C3, C5—0.001- μ d., 200-volt paper tubular capacitor
- C7—0.003- μ d., 200-volt paper tubular capacitor
- C8a/C8b/C8c—20-30-50- μ d., 150-volt d.c. electrolytic capacitor
- CH1—450-ohm, 50-ma. filter choke (see text)
- PL1—6.8-volt pilot light (screw base) and socket
- J1—Phono jack with insulating washer
- J2—Microphone type jack
- R1—1-megohm audio taper potentiometer (Mallory Midgetrol 1-meg. Taper 1)
- R2—2.7-megohm, $\frac{1}{2}$ -watt resistor
- R3, R9—13,000-ohm, 1-watt resistor
- R4, R5, R8—470,000-ohm, 1-watt resistor
- R6—2-megohm potentiometer, tapped at 500,000 ohms, with switch (IRC 2-meg. 13-139X)
- R7—3.9-megohm, $\frac{1}{2}$ -watt resistor
- R10—180,000-ohm, 1-watt resistor
- R11—390,000-ohm, $\frac{1}{2}$ -watt resistor
- R12—220-ohm, $\frac{1}{2}$ -watt resistor
- R13—100,000-ohm, $\frac{1}{2}$ -watt resistor
- T1—S.p.s.t. switch (on R6)
- T1—Universal output transformer (Stancor A-3856 or equivalent)
- V1—6SL7-GT tube
- V2—117N7-GT tube
- I—5" x 7" chassis (minimum)
- I—290-ohm resistor line cord
- Misc. tube sockets, wire, hardware, knobs

HOW IT WORKS

Signal from the pickup or tuner enters by way of phono jack J1. C1 isolates the shielded phono cable from the "hot" a.c. line, and C2 is connected from the chassis to the common ground lug. R1 serves as a volume control and grid resistor R2 prevents overloading of the grid of V1a. R2 also serves as a high resistance path to ground for the potentiometer and prevents noise from developing in the control.

The bypass capacitor usually found across R3 is omitted, introducing some degeneration (negative feedback) into the stage. A tone control, consisting of C3, C4, C5, R5 and R6, emphasizes either high or low frequencies. With the arm of potentiometer R6 toward R5, high frequencies predominate. The 1.5-megohm section of the control is in series with R5, blocking out the low frequencies. Response is "flat" when the arm is at the tap position; moving it to the low end of the control "cuts" the highs and boosts the lows slightly. R7 eliminates noise problems which often develop in tapped controls, and serves as a grid resistor for the second half of the 6SL7 (V1b) which is used to make up for the insertion loss of the tone control.

R9, the cathode resistor for V1b, is also left un-bypassed, because it serves as the connection for the inverse feedback loop consisting of R10 and C7. Plate voltage is supplied through R8. Blocking capacitor C6 keeps the d.c. component from the grid of the output tube.

The feedback loop returns a portion of the plate voltage to the cathode out-of-phase with the signal in V1b, canceling even-order harmonics and hum. C7 controls the amount of bass frequencies held back, and also blocks the plate voltage from the cathode. R10 controls the amount of feedback.

"Housewife's Helper"

or Who Has My Soldering Gun?

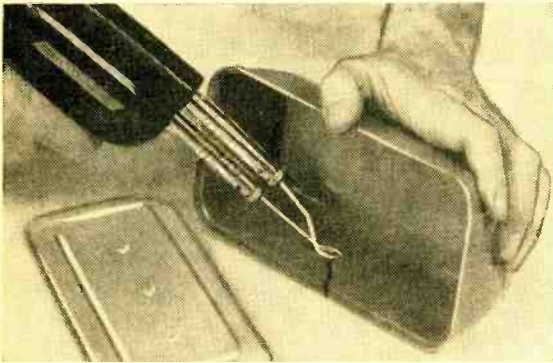
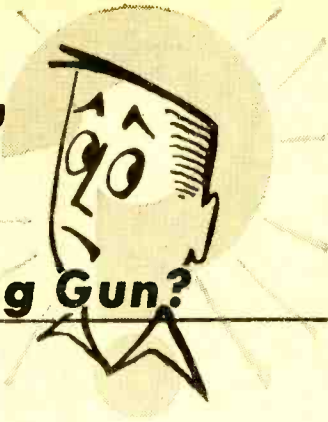

IF YOU HAVE a soldering gun around your workshop, this is a good article to keep hidden from your wife. But, on the other hand, if you want to make yourself appear a sterling hero, just drop the story casually into her lap.

A soldering gun heats up in a very few seconds and can often perform functions more handily than a soldering iron. Of course, there's no objection to using a soldering iron for the jobs illustrated on these pages. We're simply bringing to your attention the fact that certain possibilities exist.

The only unusual gadgets needed are the "smoothing tip" and the "cutting tip." An advantage of the "smoothing tip" is the application of heat over an area about as big as a dime. You can make your own by hammering a regular soldering gun tip flat. Since such tips only cost about 20 cents apiece, it is a worthwhile investment. A "cutting tip" can be made by hammering another tip into a knife edge.

—Walker A. Tompkins

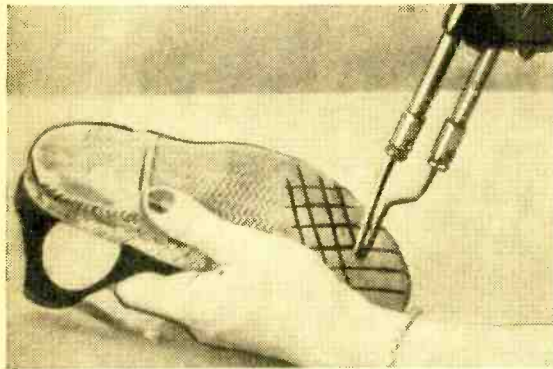

One of the uses of the smoothing tip is shown in the top photo. Cracked plastic dishes or trays can often be "fused" by running the soldering gun quickly over the break. In the middle photo, the cutting tip is scarring the sole of your son's tennis shoe. A crisscross pattern prevents the sole from slipping. Make the cuts about $\frac{1}{8}$ " deep. In the photo at right, the gun applies heat to a stuck lid on a glass jar.

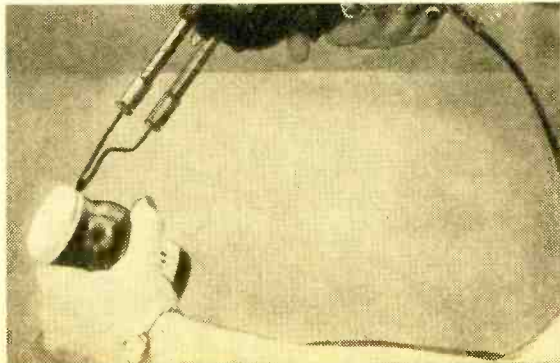

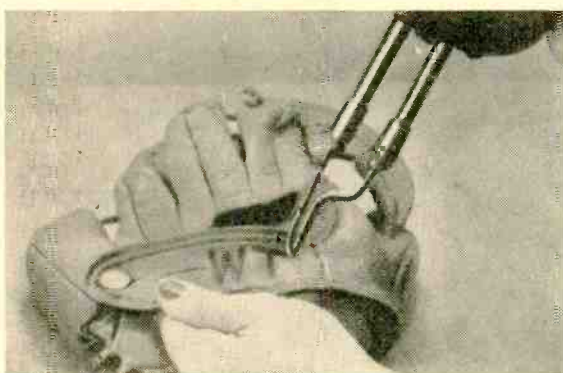
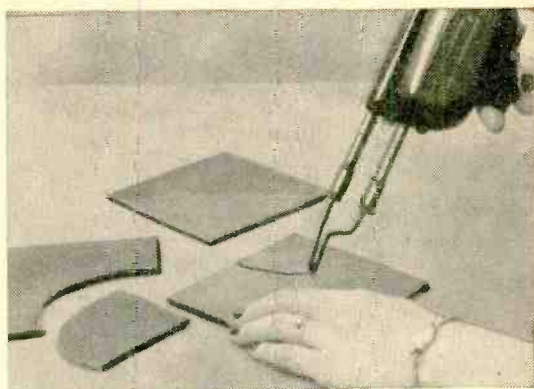

The gun can even be employed to boil water quickly—presuming that the tip is clean (see photo at upper left). Above, the wife can use a cutting tip to outline a fracture point for asphalt floor tile. In the photo at left, the gun burns the initials of the owner on a baseball mitt.

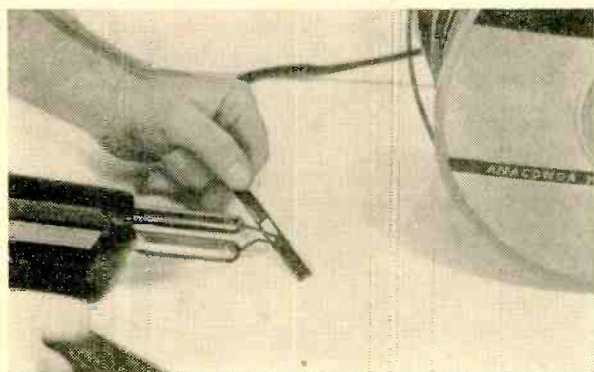

Two ways of using the smoothing tip are shown at right. To seal a patch on a pair of well-worn dungarees, stroke the smoothing tip around the edge of the patch; then crisscross it over the patch to insure a good seal. A plastic bag is being sealed airtight in the operation at the lower right. In the photo above, the regular tip melts the plastic binder which holds 300-ohm twin-lead wires in place.

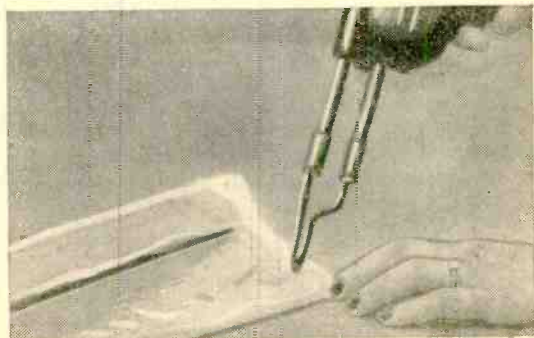

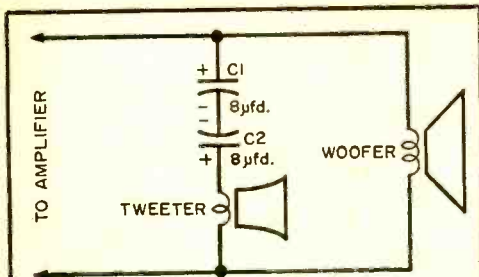

A simple crossover network . . .

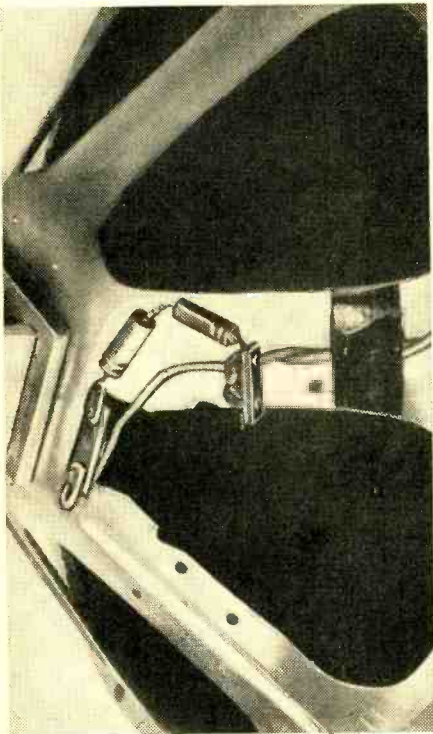

. . . using a series capacitor on woofer frame.

screen may be used. Copper or brass is preferred, but other materials such as aluminum or galvanized screen will work. After you've cut the screen to fit the front of the tweeter, run a small solder bead along each edge. This will reinforce and stiffen the screen and prevent raveling.

You'll need four mounting brackets for the tweeter. These can be bent from $\frac{3}{4}$ " wide strips of $\frac{1}{8}$ " thick aluminum or steel. They are cut and drilled to fit the mounting holes around the rims of the tweeter and woofer. Bend a small offset in the mounting brackets to provide clearance for the forward movement of the woofer cone.

Final Assembly. Before mounting tweeter on woofer, connect a pair of 18"

long hookup wires to the tweeter terminals. These are twisted together and later taped to one of the mounting brackets. Use machine nuts and bolts to fasten the brackets to the tweeter. The bolts are also used to hold the screen in place. Tighten them "finger-tight" until after you've mounted the tweeter on the woofer's frame with additional bolts.

If you find that the tweeter projects beyond the front of the woofer due to the offset bends in the mounting brackets, build up the outer mounting rim of the woofer with additional strips of felt until the front of the tweeter (including the diffuser screen) and the forward mounting rim of the woofer are flush.

Installation. For best results with your completed "\$5 Coax" you'll need a crossover network to insure feeding the proper high- or low-frequency signals to the tweeter and woofer. The simplest network is nothing more than a large-value capacitor connected in series with the tweeter speaker. The capacity is generally between 4 and 16 μ fd., depending on the speaker's voice coil impedance. A larger value is used for low-impedance (4-ohm voice coil) speakers, a smaller value for higher impedance (16-ohm) units. Paper capacitors are preferred, although you can connect two electrolytic capacitors "back-to-back." The two negative leads of the capacitors are connected, with the positive leads hooked to the speakers.

This type of crossover network, while inexpensive, will not give as good results as the more complex coil-capacitor type.* With the crossover connected, you should give your completed system a thorough bench test before installing it in a cabinet or enclosure. Connect it to your amplifier and try listening to several pieces of music through it. If you have a test record, so much the better.

Baffling. Any loudspeaker, whether a low-cost unit such as you built here or a multi-unit one costing several hundred dollars, will give you better results if mounted in a properly designed enclosure. You can mount your finished coaxial speaker in a plain baffle, bass-reflex cabinet, horn-type enclosure, or high-efficiency Karlson-type. Several low-cost enclosures have been described in past issues of POPULAR ELECTRONICS.**

If your fancy leans toward kits, you may buy suitable enclosure sets from manufacturers advertised in this magazine. —30—

* "See 'Hardware Store' Hi-Fi Crossover," May, 1957; "Double-Duty Crossover," March, 1957; "Crossovers Are the Answer," January, 1957.
** "Building a Sandwich Baffle," January, 1957; "Better Bass in Less Space," October, 1956.

HEATHKITS . . . are fun to build, and you save by dealing directly with the manufacturer!

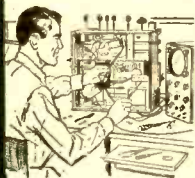

It's easy to follow simple step-by-step directions with large pictorial diagrams as your guide. You save labor costs and get more real quality for less money. Your greatest dollar value in fine kit-form equipment.

BUDGET YOUR PURCHASE . . .

We invite you to take advantage of the HEATH TIME PAYMENT PLAN on any order amounting to \$90 or more. Just 10% down, and the balance in twelve easy monthly payments. Write for complete details.



MODEL V-7A

\$24.50

Shpg. Wt. 7 lbs.

\$2.45 DWN.,
\$2.06 MO.

*Largest selling VTVM
in the world!*

. . . etched circuit board

HEATHKIT VACUUM TUBE VOLTMETER KIT

Sensitivity and reliability are combined in the V-7A. It features 1% precision resistors, large 4½" panel meter, and etched circuit boards. AC (RMS) and DC voltage ranges are 0-1.5, 5, 15, 50, 150, 500 and 1500. Peak-to-peak AC ranges are 0-4, 14, 40, 140, 400, 1400 and 4000 volts. Ohmmeter ranges provide multiplying factors of X1, X10, X100, X1000, X10K, X100K and X1 megohm.



*New
improved . . .
full 5" size
. . . etched
circuit
for only*

\$42.50

Shpg. Wt. 21 lbs.

\$4.25 DWN.,
\$3.97 MO.

MODEL OM-2

HEATHKIT 5" PUSH-PULL OSCILLOSCOPE KIT

This new and improved oscilloscope sells for less than the previous model. You can have a full 5" oscilloscope at the remarkably low price of only \$42.50. The OM-2 provides wider vertical frequency response, extended sweep generator coverage, and increased stability. Vertical channel is essentially flat to over 1 MC, and down only 6 DB at 1.5 MC. The sweep generator functions from 20 CPS to over 150 KC. Amplifiers are push pull, and modern etched circuits are employed in critical parts of the circuit. A 5BP1 cathode ray tube is used. The scope features external or internal sweep and sync, one volt peak-to-peak reference voltage, three-position step attenuated input, adjustable spot shape control, and many other "extras."



MODEL M-1

\$14.50

Shpg. Wt. 3 lbs.

\$1.45 DWN.,
\$1.22 MO.

*Compact, portable . . .
a favorite in the home
and in the service shop*

HEATHKIT HANDITESTER KIT

Measures AC or DC voltage at 0-10, 30, 300, 1000, and 5000 volts. Direct current ranges are 0-10MA and 0-100MA. Ohmmeter ranges are 0-3000 and 0-300,000 ohms. Sensitivity is 1000 ohms/volt. Features small size and rugged construction in sleek black bakelite case.

HEATH COMPANY • BENTON HARBOR 10, MICH.
A Subsidiary of Daystrom, Incorporated

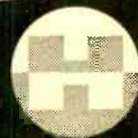



\$3.60 DWN.,
\$3.02 MO.

MODEL DX-20

\$35⁹⁵

Shpg. Wt. 18 lbs.

BRAND NEW MODEL

HEATHKIT

CW TRANSMITTER KIT

Here is a straight-CW transmitter that is one of the most efficient rigs available today. It is ideal for the novice, and even for the advanced-class CW operator. This 50 watt transmitter employs a 6DQ6A final amplifier, a 6CL6 oscillator, and a 5U4GB rectifier. It features one-knob band switching to cover 80, 40, 20, 15, 11 and 10 meters. It is designed for crystal excitation, but may be excited by an external VFO. A pi network output circuit is employed to match antenna impedances between 50 and 1000 ohms. If you appreciate a good signal on the CW bands, this is the transmitter for you!



MODEL SG-8

\$19⁵⁰

\$1.95 DWN.,
\$1.64 MO.

Shpg. Wt. 8 lbs.

POPULAR WITH SERVICEMEN

HEATHKIT

RF SIGNAL GENERATOR KIT

Produces RF signals from 160 KC to 110 MC on fundamentals on 5 bands, and covers 110 MC to 220 MC on-calibrated harmonics. Output may be pure RF, RF modulated at 400 CPS, or audio at 400 CPS. Preamplified coils eliminate the need for calibration after completion.



MODEL AR-3

\$29⁹⁵

HAM BANDS
CLEARLY MARKED

incl. Fed. Excise Tax
(less cabinet)
Shpg. Wt. 12 lbs.

\$3.00 DWN.,
\$2.52 MO.

HEATHKIT COMMUNICATIONS-TYPE

ALL BAND RECEIVER KIT

This receiver covers 550 KC to 30 MC in 4 bands, and is ideal for the short wave listener or beginning amateur. It provides good sensitivity and selectivity, combined with good image rejection. Amateur bands clearly marked on illuminated dial scale. Employs transformer-type power supply — electrical bandspread — antenna trimmer — separate RF and AF gain controls — noise limiter — head-phone jack — and automatic gain control. Built in BFO for CW reception.

CABINET: Fabric-covered cabinet with aluminum panel as shown. Part 91-15A. Shipping wt. 5 lbs., \$4.95 incl. Fed. Ex. Tax, \$.50 dn., \$.42 mo.

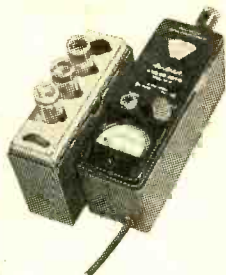

MODEL GD-1B

\$19⁹⁵

\$2.00 DWN.,
\$1.68 MO.

Shpg. Wt. 4 lbs.

FULL SET OF COILS INCLUDED WITH KIT HEATHKIT GRID DIP METER KIT

An instrument of many uses for the ham, experimenter, or serviceman. Useful in locating parasites, neutralizing, determining resonant frequencies, etc. Covers 2 MC to 250 MC with prewound coils. Use to beat against unknown frequency, or as absorption-type wavemeter.

HEATH COMPANY • BENTON HARBOR 10, MICH.

A Subsidiary of Daystrom, Incorporated



EASY TO BUILD
... A "LEARN-BY-DOING" EXPERIENCE
HEATHKIT BROADCAST BAND
RECEIVER KIT

You need no previous experience to build this table-model radio. It covers 550 KC to 1620 KC and features good sensitivity and selectivity. A 5½" speaker is employed, along with high-gain miniature tubes and a new rod-type antenna. The power supply is transformer-operated. The kind of a set you will want to show off to your family and friends. Construction is simple. You "learn by doing" as the project moves along.

CABINET: Fabric-covered plywood cabinet as shown. Shipping Wt. 5 lbs., .50 dwn., .42 mo., part No. 91-9A. \$4.95 incl. Fed. Excise Tax.

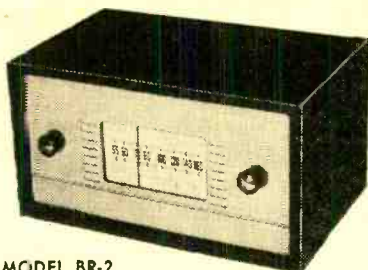

MODEL BR-2

\$18⁹⁵

incl. Fed.
Excise Tax
(less cabinet)

\$1.90 DWN.,
\$1.5⁹ MO.

Shpg. Wt. 10 lbs.

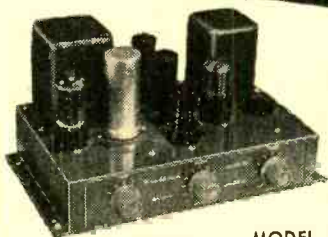

incl. Fed.
Excise Tax
\$1.80 DWN.,
\$1.51 MO.

MODEL A-7D

\$17⁹⁵

Shpg. Wt. 10 lbs.

REAL HI-FI PERFORMANCE
AT MINIMUM COST
HEATHKIT 7-WATT
AMPLIFIER KIT

This 7-watt amplifier is more limited in power than other Heathkit models, but still qualifies for high fidelity, and its capabilities exceed those of many so called "high fidelity" phonograph amplifiers. Using a tapped-screen output transformer, the model A-7D provides a frequency response of ± 1½ DB from 20 to 20,000 CPS. Total distortion is held to surprisingly low level. The output stage is push-pull, and separate bass and treble tone controls are provided.

Model A-7E: Similar to the A-7D except that a 12SL7 tube has been added for preamplification. Features two inputs, RIAA compensation, and extra gain. \$20.35, incl. Fed. Excise Tax, \$2.04 dwn., \$1.71 mo.

MODEL CR-1

\$7⁹⁵

incl. Fed.
Excise Tax
Shpg. Wt. 3 lbs.

\$.80 DWN.,
\$.67 MO.

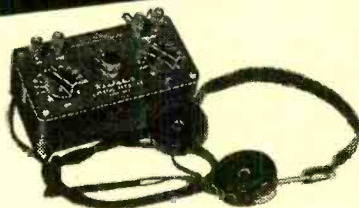

... INTERESTING PROJECT FOR ALL AGES

HEATHKIT
CRYSTAL RECEIVER KIT

The crystal radio of dad's day is back again, but with big improvements! Sealed diode eliminates "cats whisker." Uses two high-Q tank circuits to tune 540 to 1600 KC. No external power required. Easy to build.

FOR AMATEUR OR PROFESSIONAL
PHOTOGRAPHERS
HEATHKIT
ENLARGER
TIMER KIT

This is an easy-to-build device for use by photographers in controlling their enlarger. It covers the range of 0 to 1 minute with a continuously variable control. Handles up to 350 watts. Timing cycle controlled electronically for maximum accuracy.



MODEL ET-1

\$11⁵⁰

Shpg. Wt. 3 lbs.

\$1.15 DWN.,
\$.97 MO.

HEATH COMPANY • BENTON HARBOR 10, MICH.
A Subsidiary of Daystrom, Incorporated



**NEW EDGE-LIGHTED
TUNING DIAL FOR
IMPROVED READABILITY**

**HEATHKIT HIGH FIDELITY
FM TUNER KIT**

This FM tuner can provide real hi-fi performance at an unbelievably low price level. Covering 88 to 108 MC, the modern circuit features a stabilized, temperature compensated oscillator, AGC, broad-banded IF circuits, and better than 10 UV sensitivity for 20 DB of quieting. A ratio detector is employed for high efficiency, and all transformers are prealigned, as is the front end tuning unit. A new feature is the edge-lighted dial for improved readability, and a new dial cord arrangement for easier tuning. Matches the models WA-P2 and BC-1. Easy to build.



MODEL FM-3A

\$25⁹⁵

*incl. Fed.
Excise Tax
(with cabinet)
Shpg. Wt. 7 lbs.*

\$2.60 DWN.,
\$2.18 MO.

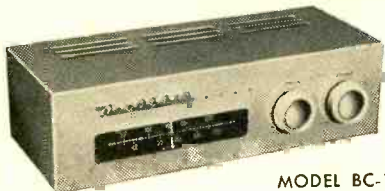

MODEL BC-1

\$25⁹⁵

*incl. Fed. Excise
Tax (with cabinet)
Shpg. Wt. 8 lbs.*

\$2.60 DWN.,
\$2.18 MO.

**NEW EDGE-LIGHTED TUNING
DIAL. MATCHES MODEL FM-3A**

**HEATHKIT BROADBAND
AM TUNER KIT**

The BC-1 was designed especially for high fidelity applications. It features a low-distortion detector, broad band IF's, and other characteristics essential to usefulness in hi-fi. Sensitivity and selectivity are excellent, and audio response is within ± 1 DB from 20 CPS to 2 KC, with 5 DB of pre-emphasis at 10 KC to compensate for station rolloff. 6 DB signal to noise ratio at 2.5 UV. Covers 550 to 1600 KC. RF and IF coils are pre-aligned, and the power supply is built in. Features AVC, 2 outputs, and 2 antenna inputs. Tuning dial is edge-lighted for high readability.

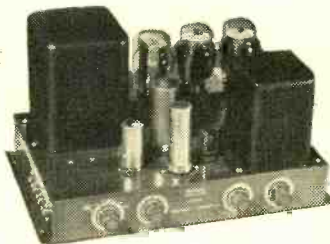

MODEL A-9B

\$35⁵⁰

*Shpg. Wt.
23 lbs.*

\$3.55 DWN.,
\$2.98 MO.

**FULL 20 WATTS FOR PA
OR HOME APPLICATIONS**

**HEATHKIT 20-WATT
AMPLIFIER KIT**

This high-fidelity amplifier features full 20-watt output using push pull 6L6 tubes. Built-in preamplifier provides 4 separate inputs, selected by a panel-mounted switch. It has separate bass and treble tone controls, each offering 15 DB boost and cut. Output transformer is tapped at 4, 8, 16, and 500 ohms. Designed primarily for home installation, but used extensively for public address applications. True high-fidelity performance with frequency response of ± 1 DB from 20 CPS to 20,000 CPS. Total harmonic distortion only 1% (at 3 DB below rated output).

HEATH COMPANY • BENTON HARBOR 10, MICH.
A Subsidiary of Daystrom, Incorporated

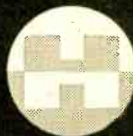

**FEATURES GOOD LOOKS
AND HIGH PERFORMANCE**

**HEATHKIT HIGH FIDELITY
SPEAKER SYSTEM KIT**

The model SS-1 covers 50 to 12,000 CPS within ± 5 DB, and can fulfill your present needs, and still provide for the future. It uses two Jensen speakers and has a cross-over frequency of 1600 CPS. The speaker system is rated at 25 watts, and the impedance is 16 ohms. The enclosure is a ducted-port bass reflex type and is most attractively styled. It is easy to build and can be finished in light or dark stain to suit your taste.



MODEL SS-1

\$39⁹⁵

\$4.00 DWN.,
\$3.36 MO.

5 Pgs. Wt. 30 lbs.



MODEL SS-1B

\$99⁹⁵

\$10.00 DWN.,
\$8.40 MO.

5 Pgs. Wt. 80 lbs.

**ATTRACTIVE STYLING
MATCHES MODEL SS-1**

**HEATHKIT HIGH FIDELITY
RANGE EXTENDING
SPEAKER SYSTEM KIT**

The SS-1B is designed especially for use with the model SS-1. It consists of a 15" woofer and a compression-type super tweeter to add additional frequency coverage at both ends of the spectrum. Cross-over frequencies are 600, 1600, and 4,000 CPS. Together, the two speaker systems provide output from 35 to 16,000 CPS within ± 5 DB. The kit is easy to assemble with precut and predrilled wood parts. Power rating is 35 watts, and impedance is 16 ohms.

Free 1957 CATALOG

Our new 56-page 1957 catalog describes more than 75 different kit models for experimenters, hams, students, engineers, industrial laboratories, etc. Send for your free copy now!

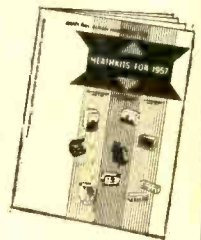

HOW TO ORDER

It's simple — just identify the kit you desire by its model number and send your order to the address listed below. Or, if you would rather budget your purchase, send for details of the Heath Time Payment Plan!

**ORDER
BLANK**

HEATH COMPANY • BENTON HARBOR 10, MICH.
A Subsidiary of Daystrom, Incorporated

Name _____

Address _____

City _____ Zone _____ State _____

SHIP VIA

- Parcel Post
- Express
- Freight
- Best Way

Quantity	Item	Model No.	Price

Enclosed find check money order for \$_____. Please ship C.O.D. postage enclosed for _____ lbs. On express orders do not include transportation charges — they will be collected by the express

agency at time of delivery. On parcel post orders include postage for weight shown. Orders from Canada and APO's must include full remittance. NOTE: All prices subject to change without notice.

POSTAGE

TOTAL

TOOLS and GADGETS



CYLINDRICAL SLIDE RULE

By spiraling the scales around a tube instead of in a straight line, this calculator



achieves graduations equal to those of a 66" slide rule. It is claimed to be more accurate than any slide rule currently on the market. The plastic-covered scales are fully resistant to wear and moisture, and since all parts

are made of metal, there is no possibility of warping or distortion usually found after a time in wooden slide rules.

Only 6" x 1 1/4" when closed, you can carry it in your pocket. Complete instructions included with each calculator explain the simple three-movement operation. Price, postpaid, is given as \$19.95, with a leather carrying case available at \$2.50 additional. (Arthur F. Smith Co., 311 Alexander St., Rochester, N. Y.)

HOOK-TYPE TEST PROBE

Equipped with a new and different type of self-holding connector, a fully insulated and hook-type design, the improved E-Z test probe is said to provide simple and safer test connections. Available in five colors, it can be used on such test equipment as 'scopes, meters, substitution boxes, test and jumper leads. The probe features a special built-in terminal board which makes it easier to build your own special test probe assemblies. (E-Z Hook Test Products, 1536 Woodburn Ave., Covington, Kentucky.)

MULTI-PURPOSE TEST INSTRUMENT

Besides checking and substituting for any speaker or output transformer in use today, the "SPEAK-CHECK" will signal-trace all audio and video circuits by signal injection, check for vertical and horizontal sweep voltages, check and measure B+

voltages as well as substitute power supply bleeder resistances.

Housed in a gray hammertone steel case, this versatile instrument is shatterproof and burn-out-proof. It comes with signal tracing probe, special connector plugs, and cables with alligator clips. \$22.50, net. (Century Electronics Co., Inc., 111 Roosevelt Ave., Mineola, N. Y.)

14-IN-1 HOLE-SAW SET

The "Arco Hole Saw" set combines 14 hole saws in one. Two tool heads hold seven blades each and are equipped with an automatic "slug-ejector" which pops out discs

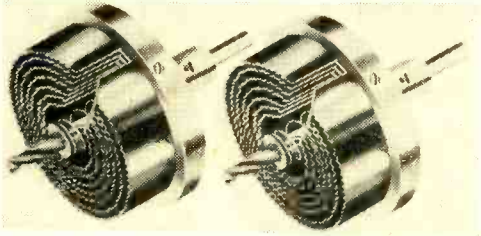

immediately. Powered by any electric drill, drill press, lathe, or motor, the set can cut 7/8" to 2 1/2" holes through any 3/4" stock in 1/8" steps. Known as No. 675, it retails at \$12.95, including the two tool heads, slug ejectors, 1/4" drill bits and 14 blades. (Arrow Metal Products Co., 140 W. Broadway, New York 13, N. Y.)

"LOW-OHM-METER"

You can make accurate measurements of low-resistance values with the Model 362 ohmmeter.

Called a "Low-Ohm - Meter," it gives readings from 0.1 to 25 ohms in two ranges with an accuracy of 3% of full scale value. Its circuit current is only 5 ma. maximum, which promotes long battery life and prevents damage to low-current

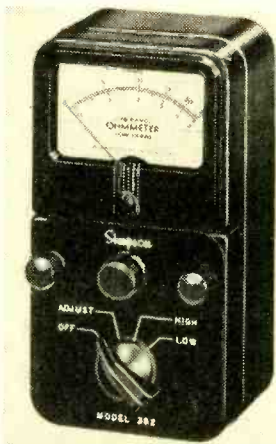

components. Model 362 may be used for checking wiring connections, contacts, transformers and other low-resistance components. The battery is self-contained. Price, \$24.95. (Simpson Electric Company, 5200 W. Kinzie St., Chicago 44, Ill.) -30-

STANDARD LINE

MANUFACTURERS
ORDERS INVITED
EXPORT ORDERS
INVITED

FEATURING
FAMOUS FACTORY

TUBES

- INDIVIDUALLY BOXED!
- GUARANTEED ONE YEAR!
- FACTORY BOXED • FACTORY IRREGULARS
- NEW JAN SURPLUS • EQUIPMENT TUBES

**ALWAYS 1000
TYPES IN STOCK**

FREE POSTAGE! On All Orders
Shipped in U.S.A., Territories and
A.P.O.'s. Send 25c for handling on or-
ders under \$5.00. Please send approx.
postage on Canadian and foreign
orders. Excess will be refunded.

Below Is A Partial List—Send For
FREE Complete List and Order Form

024	.42 5AT8	.79 6BK7	.75 7A4	.46 12J5	.39
1A7GT	.42 5JG6	.59 6BL7GT	.74 7A5	.52 12L6	.59
1B3GT	.66 5T8	.79 6B6	.57 7A6	.44 12SA7	.47
1C5GT	.40 5U4G	.48 6BQ6GT	.79 7A7	.44 12SG7	.54
1C6	.25 5U8	.79 6BQ7	.75 7A8	.69 12SJ7	.44
1C7G	.25 5V4G	.57 6BY5G	.57 7AU7	.43 12SL7GT	.59
1D5GP	.42 5V6GT	.49 6BZ7	.75 7B4	.43 12SN7GT	.56
1H4G	.46 5Y3	.79 6C4	.36 7B5	.41 12SQ7	.59
1J6GT	.45 5Y4G	.38 6CB6	.50 7B6	.42 12V6GT	.44
1L4	.54 5Z3	.42 6CD6	1.17 7B7	.46 12W6	.59
1L6	.55 6A7	.44 6CU6	.79 7B8	.40 12X4	.36
1LA4	.46 6A8	.56 6D6	.47 7C4	.41 14A7	.44
1LA6	.58 6AB4	.46 6E5	.43 7C5	.42 14B6	.44
1LC5	.48 6AC7	.44 6F5	.36 7C6	.44 14Q7	.44
1LC6	.45 6AF4	.66 6F6	.37 7C7	.44 19T8	.69
1LD5	.56 6AG5	.75 6H6	1.59 7E6	.48 19B6GT	.59
1LE3	.56 6AG7	.68 6J5	.38 7E7	.58 19G6GT	.44
1LH4	.63 6AH4GT	.69 6J6	.48 7F7	.65 25BQ6GT	.84
1LN5	.46 6AH6	.70 6K6GT	.38 7F8	.57 25CA5	.79
1NSGT	.49 6AK5	.53 6K7	.67 7N7	.58 25CD6	.69
1R5	.50 6AL5	.79 6N7	.59 7Q7	.34 25CU6	.99
1S5	.45 6AM8	.79 6O7	.39 7X7	.39 25L6GT	.42
1T4	.46 6AQ5	.45 6A4	.39 7Y4	.59 25W4GT	.36
1U4	.70 6AS7G	.47 658GT	.70 7Z4	.40 25Z6	.24
1U5	.45 6AS5	2.25 6SA7	.75 12A6	.59 27	.47
1V2	.66 6AT6	.79 6SC7	.47 12A85	.49 35B5	.47
2A3	.49 6AT8	.64 6SG7	.42 12A95	.40 35C5	.38
2A7	.54 6AU4GT	.60 6SH7	.42 12AT6	.65 35L6GT	.46
2D21	.95 6AUSGT	.62 6SJ7	.42 12AT7	.42 35W4	.38
2A4	.50 6AU6	.79 6SK7	.49 12AU6	.58 35Y4	.40
3A5	.52 6AV8	.42 6S7	.56 12AU7	.41 35Z3	.40
3A5	.50 6AV5GT	.64 6SL7GT	.56 12AV6	.66 35Z5GT	.25
3AL5	.52 6AV6	.38 6SN7GT	.40 12AV7	.64 39/44	.47
3AUG	.57 6AW8	.65 6SQ7	.40 12AVT	.62 50A5	.38
3BZ6	.57 6AX4GT	.56 6T4	.85 12AX7	.62 50D5	.47
3BC5	.57 6AX5GT	.46 6T5	.67 12AZ7	.47 50C5	.44
3BN6	.57 6BA6	.46 6U5	.54 12B4	.65 50L6GT	.39
3OB6	.55 6BC8	.89 6UR	.79 12BA6	.59 80	.45
3Q4	.46 6BD5GT	.52 6V3	.79 12BA7	.45 84/624	1.25
3Q5GT	.55 6BE6	.45 6V6GT	.45 12BB6	.59 117/7GT	1.25
354	.75 6BF5	.39 6V4GT	.39 12BH7	.63 117N7GT	1.25
3V4	.75 6BG6G	1.17 6V6GT	.52 12B7	.59 117P7GT	1.25
4BZ7	.79 6BH6	.50 6X4	.38 12CA5	.79 117Z3	.36
5AN8	.79 6BJ6	.46 6X5	.38 12CU6	.79 117Z6GT	.61
5AN8	.49 6BK5	.67 6X6	.74 12DQ6		
5A95					

Receiving Tubes Sent Parcel Post

Standard Line PICTURE TUBES	Guaranteed One Year
Any 10" Tube	\$10.75
Any 12" Tube	\$12.75
Any 14" Tube	\$14.75
Any 16" Tube	\$16.75
Any 17" Tube	\$17.75
Any 20" Tube	\$20.75
Any 21" Tube	\$20.75
Any 21" Tube	\$22.75

All Picture Tubes sent Rail-
way Express F.O.B. our
warehouse. Sorry, no A.P.O.
shipments.

Thousands of TRADE-IN TVs	Specify Console or Table Model When Ordering
10"	\$25.00
12"	\$30.00
14"	\$35.00
16"	\$42.00
17"	\$49.00
19"	\$56.00
20"	\$63.00
21"	\$70.00
21" (when available)	\$95.00
24" (when available)	\$129.00

Reconditioned By Fac-
tory Trained Techni-
cians! Guaranteed To
Be In Working Condi-
tion When You Receive
Them!

Get Yourself a second
set or buy some for re-
sale!
FREE BONUS
two set coupler
given with each set.
All TV's sent motor
freight or Railway Ex-
press F.O.B. our ware-
house. Sorry, no A.P.O.
shipments.

FREE 12" TV SET
with every re-
ceiving tube or-
der of \$100.00 or
more.

Free 16" TV SET
with every re-
ceiving tube or-
der of \$200.00 or
more.

FREE!
TWO SET
COUPLER WITH
EVERY ORDER
OF \$8.50
OR MORE!!

Bonus TV sets
are shipped com-
plete with cabinet
and picture tube
F.O.B. our ware-
house. Our ware-
house. With slight
adjustments and
minimum labor
they can be re-
stored like new.

We Are
Not Selling
Price—We
Sell Only
Quality

Remember—
You Buy Qual-
ity When You
Buy Standard.
Quality Never
Shouts—It Al-
ways Whispers

STANDARD LINE

ELECTRIC COMPANY

432 HARRISON AVENUE, HARRISON, N. J. • Phone: HUmboldt 4-4997

LAFAYETTE

6 TRANSISTOR SUPERHET RECEIVER KIT GIVES SUPERB PERFORMANCE . . . INCOMPARABLE VALUE

ONLY
33.50

- 100% SUBMINIATURE PARTS—NO COMPROMISES!
- LABORATORY DESIGNED—SENSITIVE, SELECTIVE, STABLE!
- CLASS B PUSH-PULL AMPLIFICATION—PLENTY OF POWER!

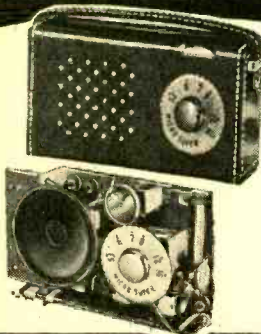

Lafayette is proud to present its 6 Transistor Superhet Receiver Kit KT-119. This kit represents the optimum in sensitivity, selectivity and stability. You'll be amazed at its superior commercial quality. You'll be elated with its surprising performance! The circuit uses 3 high frequency RF Transistors, 3 dependable audio Transistors and Crystal Diode and features a specially matched set of 3 I.F.'s, Oscillator, High-Q Loop, Class B Push-Pull Audio Amplification, and Transformer Coupling in audio and output stages. Special care has been taken in the design for exact impedance matching throughout to effect maximum transfer of power. Has efficient 2 1/2" speaker, and earphone jack for private listening. Complete with all parts, transistors, pre-punched chassis, battery and easy-to-follow step-by-step instructions. 6" x 3 1/2" x 1 1/2". Shpg. wt., 3 lbs.

KT-119—Complete Kit—Less Case.....Net 33.50
MS-339—Sturdy, attractive brown leather case with carrying strap for KT-119
Shpg. wt., 1 lb.....Net 2.95
MS-279—Sensitive matching earphone.....Net 2.39

CABINET AND SPEAKER COMBINATION SPECIALS

Your choice . . .

ELECTRO-VOICE 12TRXB
OR UNIVERSITY UXC-123
with BASS REFLEX CABINET

IN WALNUT, MAHOGANY OR BLONDE

WITH UNIVERSITY UXC-123

Another special high fidelity combination offer that saves you money—Famous University UXC-123 12" diffraXial speaker and Lafayette bass reflex enclosure. Here is an unbeatable combination that reproduces the entire audio spectrum at a power handling capacity of 25 watts. You'll thrill to the fine quality of these units and welcome the charming simplicity and compact design of the cabinet. Speaker is supplied with built-in brilliance control wired to 36" cable. Total shpg. wt., 37 lbs.

SY-111—With Mahogany or Walnut Cabinet (Specify).....Net 75.80
SY-112—With Blonde Cabinet.....Net 78.80
SY-132—With Unfinished Cabinet.....Net 72.80

LAFAYETTE BASS REFLEX

New, lowboy console bass reflex cabinet for 12" high fidelity speakers. Completely assembled and finished unit constructed of 3/4" stock of the finest genuine mahogany and walnut veneers. Solidly built and acoustically designed to provide wide range frequency response without reverbation or vibration. Cabinet is lined with acoustic material to prevent cabinet resonance. Front panel has picture frame molding and fine quality plastic

WITH ELECTRO-VOICE 12TRXB

Take advantage of tremendous savings on this combination offer including the popular Electro-Voice 12TRXB 12" 3-way speaker system and Lafayette's expertly engineered bass reflex enclosure. Cabinet and speaker are matched to give true high fidelity response with rich, full-bodied bass and crisp, clean highs. Response 35-15,000 cps, with built-in crossovers at 2000 and 3500 cps. Power 20 watts. Wired with high frequency control which can be mounted on outside of cabinet. Total shpg. wt., 43 lbs.

SY-105—With Mahogany or Walnut Cabinet (Specify).....Net 73.40
SY-106—With Blonde Cabinet.....Net 76.40
SY-131—With Unfinished Cabinet.....Net 70.40

CABINET ONLY

grille cloth that matches the finish. Baffle area approximately 4.3 cubic feet. Cutout for 12" speaker. Dimensions: 20" wide, 23" high, 16" deep. Shpg. wt., 27 lbs.

CAB-16—Specify Walnut or Mahogany.....Net 29.50
CAB-17—Same as above in Blonde Net 32.50
CAB-18—Above cabinet, assembled but unfinished.....Net 26.50

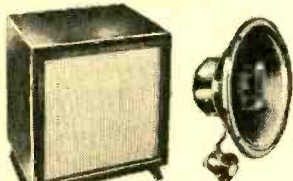

(Note: Speakers Unmounted)



FM-AM TUNER KIT

Basic FM-AM Tuner having outstanding specifications and delivering astonishing performance — all at a budget price in easily assembled kit form.

34.95

- AFC DEFEAT CIRCUIT WITH FRONT PANEL CONTROL
- FOSTER-SEELEY DISCRIMINATOR CIRCUIT
- GROUNDED GRID TRIODE AMPLIFIER
- 20-20,000 CPS RESPONSE

Choose this 7 tube compact high-fidelity FM-AM tuner whose characteristic features are found in units costing many times as much, and whose performance is unheard of at this low price. There are two front panel controls, a function control for AM, FM, PHONO, TV and a tuning/AFC defeat control. Features Armstrong FM circuit with limiter and Foster-Seeley discriminator. Simplified tuning with slide-rule dial and flywheel counter. Weighted mechanism, high impedance phono input and high impedance audio output.

SPECIFICATIONS

FREQUENCY RANGE: FM 88-108MC, AM, 530-1650 KC. ANTENNA INPUT: FM, 300 ohms, AM Ferrite loopstick and high impedance external antenna. DISTORTION: Less than 1% at rated output. FREQUENCY RESPONSE: FM, +.5 db 20 to 20,000 cps, AM ± 3 db 20 to 5000 cps. SENSITIVITY: FM, 5 UV for 30 db quieting, AM, Loop sensitivity 80 UV/meter. SELECTIVITY: FM, 200 KC bandwidth, 6 db down; 375 KC FM discriminator peak to peak separation, AM, 8 KC bandwidth, 6 db down. IMAGE REJECTION: 30 db minimum. HUM LEVEL: 60 db below 100% modulation; TUBE COMPLEMENT: 2-12AT7, 1-6BE6, 1-BA6, 2-6AU6, 1-6AL5 plus selenium rectifier. SIZE: 6 1/2" high x 9 3/4" wide x 9 1/2" deep (excluding knobs). CONSUMPTION: 30 watts. For 110-120V 60 cycles AC. Attractive etched copper-plated and lacquered finish. Less metal case. Shpg. wt., 9 lbs.

KT-100 A.....Net 34.95
ML-100.....Metal cage for above, Shpg. wt., 3 lbs. 5.00

TRANSCRIPTION-TYPE MANUAL PLAYER

PK-160

with TONE ARM and TWO PLUG-IN HEADS



NET ONLY 24.50
LESS BASE

- MAGNETIC BRAKE FOR FINE ADJUSTMENT OF EACH SPEED

- 4-POLE, HEAVY DUTY TRANSCRIPTION-TYPE MOTOR
- STYLUS WEIGHT ADJUSTMENT SCREW ON TONE ARM

All the important features of professional transcription players have been incorporated in this precision turntable. Extremely smooth and quiet heavy duty 4-pole motor plays 78, 45 and 33 1/3 RPM records. Exclusive magnetic brake, controlled by knob on base plate, permits instantaneous fine adjustment of each speed. Stroboscope disc included checks speeds. Speed selector safety switch protects mechanism by making it necessary to pass through OFF position when switching from one speed to another. 10" weighted turntable has rubber traction mat.

Mounting plate has pickup rest and ON-OFF switch. Size: 12-15/16 left to right, 10 1/2" front to rear. Requires 2 3/4" clearance below motor board and 3" above. With AC line cord, 2 plug-in heads, output cable, 45 RPM adapter. For 105-120V., 60 cycles AC. Shpg. wt., 12 lbs. (NOTE: For protection in shipping, tone arm is separate. Just fasten to mounting plate.)
PK-160—Less cartridge and base.....Net 24.50
PK-162—Wood base for PK-160. Shpg. wt., 5 lbs.....Net 3.95
PK-163—Unfinished mounting board only. Shpg. wt., 1 lb.....Net .95

Lafayette Radio

165-08 Liberty Ave.
JAMAICA 33, N. Y.

100 SIXTH AVE. NEW YORK, N. Y.
PLAINFIELD, N. J., 139 W. Second St. BOSTON 10, MASS., 110 Federal St.
BRONX 58, N. Y., 542 E. Fordham Rd. NEWARK 2, N. J., 24 Central Ave.
Include postage with order.

FREE! LAFAYETTE CATALOG



ELECTRONIC CATALOG PACKED WITH MONEY SAVERS

Packed with the largest selection of Electronic, Radio and T.V. Parts, and equipment, P.A. Hi-Fi systems, tubes, antennas, Transistor Kits, parts and components, Test Equipment, new build your own kits, tools, books, Microscope, drafting equipment, Binoculars, Telescopes, All Radio, TV and Ham supplies — ALL AT GREAT SAVINGS — For the economy minded serviceman, dealer, engineer and technician, **CHUCK FULL OF BUYS! SEND FOR YOUR FREE COPY TODAY.**

NEW DYNAMIC MICROPHONE



Reg.
Value 29.50
NOW! 9.95

For Desk-Top or Hand-Held
 • HIGH IMPEDANCE—50,000 OHMS
 • RESPONSE: 40-9,500 CPS

Beautifully designed and finished high impedance dynamic mike with ingenious swivel mounting that permits horizontal and vertical rotation for most convenient angle. Mike easily removed from base for holding in hand. Baked enamel case with chrome finish base, grille and fittings. Ruggedly constructed to withstand plenty of handling. 4" long x 1-3/16" diameter housing. With 5 ft. shielded cable.
 PA-39—Shpg. wt., 2 lbs.Net 9.95

CRYSTAL MICROPHONE



COMPARE WITH ANY MIKE AT 2 TO 3 TIMES THE PRICE

A quality crystal Microphone for PA systems, tape recorders, etc. Frequency response 30 to 10,000 cycles. Output level—52 db. Provides ample output for use with low gain amplifiers. Complete with 5 ft. of shielded cable. Shpg. wt., 3 1/2 lbs.

PA-24—In lots of 3, each 3.95, singly, 4.25

LAFAYETTE SIGNAL GENERATOR

COMPLETELY WIRED AND TESTED! ACCURACY AND QUALITY GUARANTEED!

22.50

- FREQUENCY 120KC to 260MCS
- 120KC to 120MC ON FUNDAMENTALS!
- 30 DAY TRIAL PERIOD! FULL REFUND IF YOU ARE NOT SATISFIED FOR ANY REASON



Completely wired and tested instrument. Do not confuse with kits sold in the same price range. Has the quality and accuracy of instruments selling for 3 to 4 times as much. Six overlapping ranges — 120KC to 320KC, 320KC to 1000KC, 1MC to 3.2MC, 3.2MC to 11MC, 11MC to 38MC, 37MC to 130MC — all on fundamentals — calibrated harmonics from 120MC to 260MC. Switch between internal modulation at 400 cps or any external source at other frequencies. 400 cps signal can be used separately. Outputs are unmodulated RF, modulated RF and 400 cps audio. RF output is in excess of 100,000 micro volts. Jacks are provided for high or low RF output.

Highly stable special circuit design. Fine adjust RF control. AF output 2-3 volts, input 4 volts, across 1 megohm. 5 inch etched dial plate — protected by clear plastic bezel. Common AF terminals for EXT-MOD input and INT-AF output eliminates need for special connectors. Gray metal case — carrying handle — complete with leads, line cord and plug. For 105-125V. 60-60 cycle A.C. Shpg. wt., 8 lbs.

LSG-10 — Signal Generator 22.50

NEW POCKET AC-DC VOM MULTITESTER

2,000 ohm per Volt on AC & DC

• Completely wired — Not a kit

Accurate VOM with a sensitivity of 2000 ohms per volt on both AC and DC. Single selector switch. 3" 160 amp. meter. Scales: DC Volts: 0-10-50-500-1000; AC Volts: 0-10-50-500-1000; Ohms: 0-10K, 0-1 Meg; DC Current: 500 ua and 500 ma; Decibels: -20 to +22, +20 to 36; Capacity: 250 mfd to .2 mfd and .005 to 1 mfd. Heavy plastic panel, metal bottom. 4 1/4" x 3 1/2" x 1 3/4". With batteries and test leads. Shpg. wt. 4 lbs.
 RW-27A 8.95



NEW! Mail Order Center ----->

3 TRANSISTOR SUPERHET POCKET RADIO KIT



• A TRUE POCKET SUPERHET RECEIVER—NO EXTERNAL ANTENNA • NO EXTERNAL GROUND!

A remarkable sensitive, super-selective pocket superhet receiver with astonishing performance over the complete broadcast band. Uses 2 high-frequency and one audio transistor plus efficient diode detector and features 2 specially matched IF transformers for maximum power transfer. The components are housed in a professional locking beige plastic case. The receiver's appearance enhanced by attractive maroon and silver station dial. Sensitive built-in ferrite antenna eliminates need for external antenna. A designer's dream of a true pocket superhet receiver! Complete with all parts, transistors, battery, case, dial and easy to follow step-by-step instructions. 4 1/2" x 2 1/2" x 1-1/16". Shpg. wt., 1 lb.

KT-116 — Complete Kit, less earphone.....Net 16.95
 MS-260 — Super Power Dynamic Earphone.....Net 3.95

New! ARGONNE WIRELESS BROADCASTER

For Use With Crystal Microphone or Record Player with Crystal Cartridge



Net 10.95

Completely enclosed and wired oscillator permits broadcasting through any standard AM radio up to 75 feet away, without connecting wires. Also permits playing a record player with crystal cartridge through any radio in the house. Carefully designed and constructed chassis with transformer for AC operation only, gives clear, well-modulated signal. Simple to operate. Connect crystal microphone or record player pickup leads to terminals on removable rear panel, tune radio to a frequency between 1100 to 1600 KC where there is no station, and then adjust oscillator screw to this frequency. Plug into 110-volt AC line. Attractive maroon colored plastic housing measures 4 7/8" W., 4 1/2" H., 3 3/8" D. Equipped with ON-OFF switch, power line cord and plug, and 10" removable mast. Full instructions. Shpg. wt., 2 lbs.

F-290 Wireless Broadcaster...Net 10.95

20,000 OHM PER VOLT MULTITESTER SEMI KIT



A new kind of kit—the difficult work is already done—you wire in only a few multipliers and mount the battery holder to complete the unit. A fine high sensitivity (20,000 ohms per volt DC — 5000 ohms per volt AC) instrument employing a 3" 40 microamp movement. Has 4 DC voltage, 4 AC voltage, 2 DC current, 3 resistance and 2 db ranges. Complete with test leads and detailed instructions. Size 3 3/8" x 4 3/8" x 1 3/8". Shpg. wt., 3 lbs.

KT-20—KitNet 11.95

Lafayette Radio 165-08 Liberty Ave.
 DEPT IH JAMAICA 33, N. Y.

SEND FREE CATALOG!

NAME -----
 ADDRESS -----
 CITY -----
 ZONE ----- STATE -----

CUT OUT AND MAIL TODAY!



Tips and Techniques

(Continued from page 30)

should swell, the waxed paper will make it easier to shake them from the case. If the flashlight case is made of metal, the waxed paper will help prevent the case from corroding.

—K. M.

INEXPENSIVE SPEAKER ENCLOSURE

The need often arises for a speaker enclosure that is both inexpensive and durable, as in the construction of intercoms. A simple way of building just such an enclosure is to use a pie plate. These are available in a wide variety of sizes. Obtain such a plate and perforate the bottom—with a chassis punch—to form an attractive



pattern of holes. Coat the inside and outside of the plate with an air-dry wrinkle varnish. Back the perforations with several thicknesses of bronze window screening. The mounting board may be simply a piece of wood to which the pie plate is screwed, or, preferably, it can be a disc of wood turned on a lathe to accept the lip of the pie plate.

—D. D. V.

SOURCE OF MINIATURE KNOBS

Experimenters often have difficulty in locating knobs small enough to be in scale with miniaturized equipment. Aerosol pressure cans are an excellent source of such knobs. These are threaded and may be removed by simply unscrewing them from the can.

If the knob is to be attached to the adjusting screw of a Loopstick, the simplest procedure is to thread a nut of suitable size on the shaft and tighten it against the bottom of the knob. For attachment to unthreaded shafts, the knob may be filled with liquid



solder, drilled and tapped for a small set screw.

—D. D. V.

KEROSENE FOR PLASTIC METER FACES

Many meter faces are now made of plastic materials instead of glass, and cleaning with the various solvents ordinarily used on glass will damage their faces. Kerosene, however, may be applied safely. It's easy enough to keep a small supply for this purpose, so the next time your plastic meters need their faces washed, get out the kerosene and avoid annoying damage.

—D. D. V.

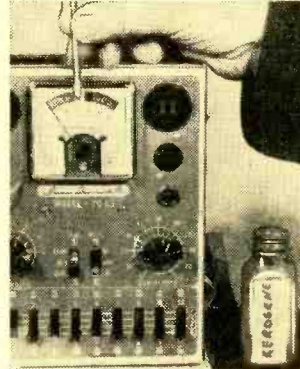

DOOR KNOB FOR REAMER HANDLE

I have found that an old door knob makes an ideal handle for a reamer. It permits me to get into smaller places on

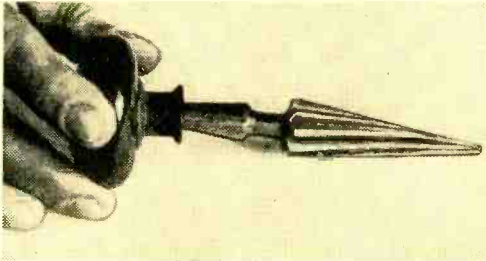

the chassis than if I were using a regular brace. The door knob permits a lot of pressure to be exerted right at the spot it is needed and only one hand is required to operate it properly.

—A. Z.

KIT WIRING

In the majority of construction kits, the step-by-step instructions specify the length of each connecting wire. You can

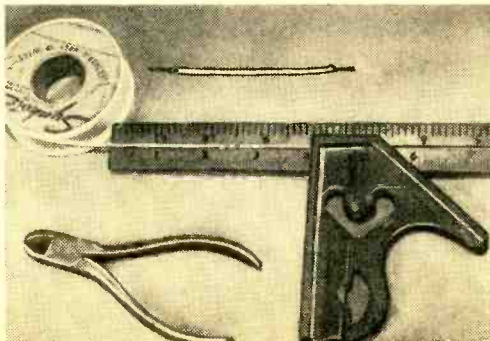

**earn
top salaries
build
an exciting
future!**

read:

**YOUR CAREER in
ELECTRONICS**

A NEW ZIFF-DAVIS PUBLICATION

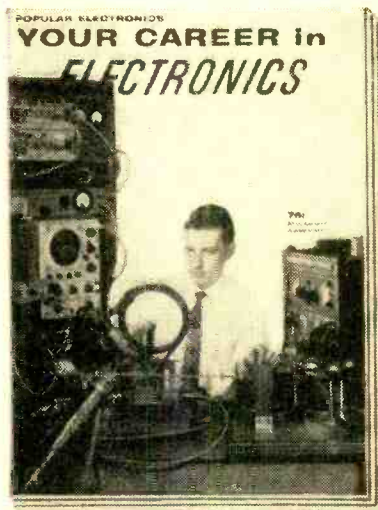

This fact-filled volume prepared by the combined staffs of RADIO & TV NEWS and POPULAR ELECTRONICS is written for men who have a stake in the fastest-growing industry in the world—electronics! If you're eager and ready to move into a more advanced, higher-paying electronics specialty or want to begin an electronics career, don't miss this informative 132-page publication.

IT TELLS YOU

- what job opportunities are available in electronics
- how to prepare for a job in electronics
- how to get a job in electronics

CONTENTS:

ELECTRONS, SLIDERULES AND YOU—Careers in Electronics . . . Am I Too Old to Learn Electronics? . . . Women in Electronics . . . What About Tech Writing? . . . Electronics Stands Guard.

CAREERS IN PROGRESS—I am an Atomic Engineer . . . I Ride the Satellites and Rockets . . . I Make Electronic Brains . . . Thank Me For Safe Air Travel . . . We Make Color TV . . . We're Looking for Tomorrow.

SURVEY OF THE JOB MARKET—Personnel requirements of the largest electronic manufacturing firms—number of technicians, engineers needed, kind of background required, salaries offered, training given and opportunities for advancement.

COURSES, CREDITS AND DEGREES—Training for a Career . . . Home Study . . . College Training . . . Resident Schools.

ELECTRONICS IS A PROFITABLE HOBBY—Spare Time TV Servicing . . . Use Your Hi-Fi Know-How . . . Build Gadgets for Money . . . Kits For Sale . . . Profit from P. A. rentals

BASIC ELECTRONICS—A brief course in the fundamentals of electronics. It gives the beginner a knowledge of the terminology and some familiarity with the electronics field.

BUY A COPY OF

**YOUR CAREER in
ELECTRONICS**



ON SALE SOON AT
ALL NEWS-
STANDS—only **75c**

MEN WANTED: TO BABY-SIT WITH COMPUTERS

Someone has to take care of the Computers, feed them the right programs. Will it be you?

In the last decade a new profession has grown up which is recruiting members so rapidly that newspapers are crowded with job offers and firms often have to delay installations for want of trained service and operating personnel.

Few Universities give a full program in computer maintenance design, programming and theory. Yet the demand for trained people is obvious.

In this rapidly changing field there is room for people with ability who know computers, with or without benefit of college degrees.

The techniques are not difficult for people who understand electronics and are willing to work hard to learn.

No matter what your age, if you are intrigued by computers and want to work you will benefit from our comprehensive low-cost courses covering the whole range of computer technology.

We will send you free a booklet describing the training program which you can do at home at your own pace. You solve actual problems, assemble simple—or complex computers. You study programming and the methods of entering data in the latest computers.

Write now for an exciting Introduction to computers in our free booklet.

**OLIVER GARFIELD CO., Dept. PE87D
31 Broadway, New Haven, Connecticut**

Please rush me detailed information about your Comprehensive, low-cost computer training program.

I am interested in
Analog Computers Programming Building small computers
Digital Computers Circuit Design Computer Mathematics

My name

My address

Age Occupation

who

is the most
photogenic
girl in the world?



ED SULLIVAN, famed CBS showman, picked her from more than a thousand photographs submitted by cameramen throughout the globe!

PETER GOWLAND, renowned glamour photographer, photographed her on the world's fastest color film—the new Super Anscochrome!

AND POPULAR PHOTOGRAPHY will include an actual color slide (ready to flash on your wall) of THE MOST PHOTOGENIC GIRL IN THE WORLD in its big September issue on 35mm photography.

It's typical of the extra features you'll enjoy in September POPULAR PHOTOGRAPHY's Special 35mm issue.

Look for it at your favorite newsstand.

On sale August 1—only 35¢

speed up assembly by pre-cutting each wire to length prior to actual wiring. A handy trick is to use a "Combination Square" as a wire length gauge. Adjust for desired length, then run a piece of hookup wire down the groove until it hits the stop, and cut with a pair of diagonal wire-cutters. Continue this step, resetting the Combination Square for each new length required, until the job is done.

—E. G. L.

Midsummer Hi-Fi Roundup

(Continued from page 42)

size and weight is the new HARTSDALE, a miniature speaker system complete with its own trim little enclosure. Hardly bigger than a table-top radio, it doesn't claim to reach frequency extremes, but it provides clean and balanced sound for budget hi-fi at the cost of only \$34.50.

GENERAL ELECTRIC has added a new 12" woofer to its line (Model A1-403) to provide bass down to 40 cps for less than \$30.00. This woofer features a built-in frequency divider for direct hookup of a tweeter to make a complete speaker system. Thanks to a special cloth-and-plastic cone suspension, the new STEPHENS Tru-sonic 80FR 8" speaker covers the entire range from 40 to 15,000 cps. Thoughtful engineering throughout makes this an excellent choice for smaller hi-fi systems where space-saving is a vital factor, or for an auxiliary speaker in larger systems.

The JAMES B. LANSING Model 130 12" woofer is not exactly a new entry into the hi-fi sweepstakes, having already earned itself an excellent reputation. But now there is a new version of the popular Model 130 equipped with a 32-ohm voice coil. This makes it possible to hook two of these woofers in parallel and feed them both from the 16-ohm amplifier output terminal.

Two new pickups were recently announced—each representing a different design philosophy. One is the RONETTE TX-88 Super-fluid cartridge, a high-quality crystal pickup which claims performance equal to the very best magnetics (range from 30 to 24,000 cps with negligible distortion) and is totally impervious to hum. The other is a new version of PICKERING's Fluxvalve, now available as a single cartridge rather than a turnover model, which nearly cuts the price in half. Both the RONETTE and the PICKERING are notable for ease of stylus replacement. No tools are needed.

With this much new audio in mid-summer, we look forward to a real avalanche in the fall. Arguments pro-and-con an en-

(Continued on page 116)



WRITE FOR FREE
FALL
BARGAIN
FLYER!

ELECTRONIC WORLD ACCLAIMS OUR DOUBLE BONUS OFFER!

FREE WITH EVERY \$10 ORDER

Your choice of
**1. ANY \$1 KIT
FREE!**

**2. \$15 worth of
RADIO PARTS
FREE!**

**DOUBLE BONUS
Sixteen Dollars
worth of parts free
with \$10.00 order!**

ANY SIZE ORDER ENROLLS YOU IN LEKTRON'S EXCLUSIVE "CREDIT-BONUS" PLAN

SIX DIODES. Crystal & silicon, assorted sizes. Reg. \$15. **\$1**

40 "POLY" BOXES. Ass'd. sizes. Clear plastic, hinged, w/ snap locks. Reg. \$2.50. **\$1**

WORLD'S SMALLEST RADIO KIT. 2 1/2 x 1 3/4 x 3/8" w/ permeability tuner, diode, all parts. Instructions. Reg. \$3.50. **\$1**

15 ROTARY SWITCHES. ceramic & bakelite: 1, 2, 3-gangs; gld. shafts. Wt. 3 lbs. Reg. \$11. **\$1**

40 PRECISION RESISTORS. Carbonim. Wilkors, etc. 1/2 & 1 lb. Ass'd. 1%. Wt. 1/2 lb. Reg. \$18. **\$1**

THREE MINI TUBES. Pick any 3: 6AK5 & 6AG5, RCA, etc. Reg. \$15. **\$1**

5 JEWELERS SCREWDRIVERS for sub-mini work. 5 different sizes. Reg. \$3. **\$1**

30 DISC CONDENSERS—transistor & printed circuit types. Reg. \$8. **\$1**

100 RADIO PARTS. Surprise assortment. Reg. Value \$15. Wt. 3 lbs. **\$1**

50 PLUGS & RECEPTACLES. Audio, power, chassis; panel & spkr. types. Wt. 2 lbs. **\$1**

15 VOLUME CONTROLS. Singles, duals to 1 meg. Wt. 1 lb. Reg. \$10. **\$1**

10 ELECTROLYTICS. Ass'd. can, tubular types to 500 mf. Wt. 3 lbs. Reg. \$14. **\$1**

125 RESISTORS. 1/2, 1w; 40 values: 5 ohms to 10 megs. 50%. too. Reg. \$15. **\$1**

20 PRINTED CIRCUITS. Ass'd. Top makes for transistor, radio, hobby circuitry. Reg. \$11. **\$1**

60 MICA CONDENSERS. 30 values. .00001 to .01mf to 1000V. Silver, 5% incl. Wt. 1 lb. **\$1**

60 STANDARD KNOBS. Ass'd. colors, bakelite & plastic. Set-screw types, too. Wt. 2 lbs. **\$1**

10 IF TRANSFORMERS. Metal can, ass'd. freqs. for radio, TV, hobby uses. Wt. 3 lbs. Reg. \$11. **\$1**

30 POWER RESISTORS. WW, condohm, sand-coated, vitreous. 15 values: 5 to 50 W. 35 to 11000 ohms. Wt. 2 lbs. **\$1**

40 POPULAR BULBS. Ass'd. min. screw & bayonet; to 6V. Wt. 1/2 lb. Reg. \$4. **\$1**

EMERSON TUNER. Hi-Q, permeability tuned ANT & OSC coils, w/padders on 2x4" plate; variable tuning mech. 500 to 16000 kes. Reg. \$5. **\$1**

SUB-MINI SOLENOID. 1x5/8x5/8"—changes elec. energy to mechanical. 12 VDC @ 300 ma. actuates plunger. Wt. 1 oz. **\$1**

3 AC-DC CHOKES. 800 ohms, 3H-50ma. Open frame mtg. for Reg. \$1 each. **\$1**

000-999 COUNTER. Veeder-Root reset type for all counting jobs. Reg. \$6. **\$1**

100 COIL FORMS. Wide variety sizes, insulation. Wt. 1 lb. **\$1**

15 PANEL SWITCHES. Push, momentary, power, thermal, ass'd. Wt. 2 lbs. Reg. \$18. **\$1**

100 CERAMIC CONDENSERS. Ass'd. types; top mfrs. 30 values, color-coded. Discs, too. Reg. \$15. **\$1**

3 lbs. HARDWARE. Approx. 2000 pcs. ass'd. screws, brackets, etc. Reg. \$8. **\$1**

3 OUTPUT XFMRs. Single & p/p tubes: 351B, 50B5, 50L6 & 6V6 to 5-4 ohm v.c. Wt. **\$1**

175-FT. HOOKUP WIRE in 25-ft. rolls. Ass'd. colors, stranding, insulation. #18 to 24. Wt. **\$1**

8-PC. NUTDRIVER SET. Plastic handle. 3/16, 7/32, 1/4, 5/16, 1/2, 5/8, 7/16" steel socket wrenches in plastic case. **\$1**

MINI-METER BUY! 1 1/4" round, chromed; 0-6 amps. AC. For model RR, power supplies. **\$1**

15-PC. TWIST DRILL SET. 1/16 thru 1/4" by 64ths in graduated plastic holders. Reg. \$4. **\$1**

R/C CONTROL SCOOP! Chassis incl. 300-ohm mini control relay, 115 to 6.3-1.5A fil. xfmr., resistors, cond., pot, sock-ets. Wt. 2 lbs. **\$1**

6 AC/DC LINE CORDS, ass'd. rubber, plastic. 6-ft. long, molded plugs, tinned ends. **\$1**

60 TERMINAL STRIPS. Ass'd. solder lug types. Wt. 1 lb. **\$1**

2 MIKE TRANSFORMERS, carbon, enameled. 200 ohms to grid. Wt. 1 lb. Reg. \$4. **\$1**

40 HI-Q CONDENSERS. Ceramic tubular cased, ass'd. pop. **\$1**

4 FERRI-LOOPSTICK cores, Hi-Q, ass'd. fat & tubular. 5 to 7" long. Wt. 1 1/2 lbs. **\$1**

2 TRANSISTOR XFMRs. UTC "ouner" types. Interstage, 1 x 3/4 x 3/8" 1 Imp. ratios unknown. Color coded leads. **\$1**

POSTAGE-STAMP MIKE. 3/4" sq. Crystal, crisp, clear to 8000 cps. **\$1**

SUB-MINI P-N-P TRANSISTOR. 1/2 pencil eraser size! Used in name transistor. W/spec. **\$1**

40 MINI CONDENSERS. Hobbyists NOTE! Ass'd. to 0.1 **\$1**

60 TUBULAR CONDENSERS. .0002 to 1 mf. to 2000V. Oils too. Wt. 2 lbs. Reg. **\$1**

40 MOLDED CONDENSERS. Black beauties, porcelain, etc. Oils. To 1 mf. to 1000V. Wt. 1 lb. Reg. **\$1**

60 RESISTORS—scoop! Many 1% & 5%. Insulated; 1/2 to 2W; 10 ohms to 10 megs. 30 values. Wt. 1/2 lb. Reg. **\$1**

30 TUBE SOCKETS, wide variety, 4 to 14-prong. 10 types incl. ceramic & mica filled. **\$1**

8 TRANSISTOR SOCKETS. for sub-mini tubes, too. Mica-filled. Reg. \$3. **\$1**

40 XFMRs. COILS. IF, RF, ant., slug-tuned coils, chokes. 25 types. Wt. 3 lbs. Reg. **\$1**

40 TRANSISTOR RESISTORS. Only 1/4" long. 20 values: 15 ohms to 10 megs, color-coded. Reg. \$6. **\$1**

5,000-OHM RELAY by Allied Control. 4PDT, for plate & control circuits. 15 ma. Reg. **\$1**

SIZZLING AUGUST SPECIALS!

SUB-MINI SPEAKER SALE!

Choice of 1 1/2" or 2" sq. 1 oz. magnet, 3-2 ohm v.c. **\$1.99**

SUB-MINI TRANSFORMERS

3 types: 20K:1K/10K:2Kc.t./500c.t.: 3.2 ohms. Color-coded leads. **\$1.49**

"POLYCASED" VARIABLE

Supernet. 5/8 x 1 1/16"—world's smallest! Ant. Sec.—10 to 208 mf; Osc. sect.—10 to 100mmf. **\$1.95**

CRYSTAL PHONE

Hearing-aid type w/cord. Hi-imp. Use as mike, too! **\$1.39**

2000-OHM HEARING AID

PHONE with cord **\$1.69**

CRYSTAL SET CONVERTER

Quickly, simply makes crystal set a transistor radio. W/transistor, all parts, instructions **\$1.99**

12" HI-FI PM SPEAKER

50 to 10,000 cps. Hvy Alnico magnet; 3.2 ohm v.c. Wt. 3 lbs. **\$3.99**

3-TUBE AC/DC AMPLIFIER

Fully wired! Sep. vol., tone controls. Lowest price ever! Reg. \$5. **\$2.99**

TUBES, \$1.91 extra

HI-IMP. MAGNETIC PICKUP

Cartridge, arm, stand. By Pacific Sound. Reg. \$8. **\$1.49**

HEAVY DUTY VISE

2 1/2" jaws. For all work benches. Wt. 4 lbs. **\$1.49**

3-SPEED RONETTE PICKUP

W/turnover cartridge, dual sap- phire, arm. Reg. \$8. **\$3.33**

SUPER SOLAR BATTERY

Outperforms B2M. Plug-in type; 2 1/4 x 1 3/4 x 1 1/2" plastic case. Reg. \$10. **\$2.88**

SCOOP! SOLDERING GUN

Lightweight, controlled heat for transistor & printed circuit work. Reg. \$8. **\$4.99**

THREE-IN-ONE MIKE

Hand, desk or stand. 60 to 8000cps, crisp, clear. Plastic case, grille; shielded cable. Reg. \$8. **\$3.69**

TRANSISTOR OSC. COIL

For superhets. World's smallest— 5/8 x 9/32". Reg. \$1.49. **59c**

ORDER BY "BLACK TYPE" HEADLINES, i.e. "One 3-SPEED RONETTE PICKUP, \$3.33"

Send check or MO including sufficient postage & excess returned. C.O.D. orders 25% down. Rated, net 30 days. (Canada postage—45¢ 1st lb., 28¢ ea. addl. lb.)



131-133 Everett Ave.

Chelsea 50, Mass.



How far can you go in Electronics without a Degree?



Bernie Roth examines ribbon from printer during Field Engineering Laboratory period.

Without a formal degree, 24-year-old Bernie Roth is already handling a key responsibility with IBM. At the McGuire Air Force Base, a directional control site for Project SAGE, Bernie is part of a team maintaining an entire electronic digital computer system. In this assignment, he must stay abreast of all the most advanced electronic concepts—developing his professional know-how every day. “That’s what’s different about IBM,” Bernie says. “The graduate engineer has an advantage anywhere—but here at IBM the technician also can grow into managerial positions.”

IBM instituted its program for specialized technical training many years ago. The theory behind this built-in educational system asked the question: Why should the capable man be denied the opportunity simply because he lacks a formal degree? The wisdom and foresight of IBM’s decision are reflected in the story of Bernie Roth—in the misgivings of his past—in the certainty of his future.

The Navy steers Bernie on the right course. When Bernie graduated from Flemington, N. J. High School in 1950, he received a general diploma—mathematics and science made up a small part of his curriculum.

Enlisting in the Navy in 1951, Bernie proved his aptitude for technical work and was assigned to the electronics preparatory school in Jacksonville, Fla. Later, he attended the Class A Aviation Electronics School in Memphis, Tenn., but, an event that occurred during a furlough in the spring of 1955 put a brand-new light on Bernie's future.

Reports for training. After reading an advertisement mentioning opportunities for IBM Kingston and Project SAGE, Bernie hopped a bus to Newark for an interview with the IBM representative. He took the required number of tests—talked over his hopes and ambitions, and "That's about all there was to it." In July, Bernie notified IBM that he was definitely available. Soon afterward he received

times, I have the chance to assist in systems and displays. Now displays really fascinate me. There's a kind of television screen on which you can detect a plane, determine whether it's friendly or hostile, and where it's headed. My work is always different, never routine, and that's very important to me."

How does the future look to Bernie? A happy and prosperous future is in the offing for Bernie Roth. Based on the records of his older associates, he's confident that in a short time he will qualify as a Systems Engineer, at the very least.* The next steps going up the ladder are Group Supervisor and then Group Manager. "IBM is quick to recognize and reward improved ability through greater knowledge."



Here, he scans the schematic of computer circuits.



Bernie checks a unit in one of the operating consoles.



An outdoor man, Bernie takes full advantage of the New Jersey game preserve.

instructions to report to Kingston to begin training in the applications of electronic computers.

The material he studied at Kingston. "The Kingston program is quite an eye-opener in electronic techniques. First of all, I studied basic circuitry. Then, I actually learned a new way to think—the ability to comprehend the whole from the assorted parts. Later on, I studied the various input-output devices which are used as auxiliary units to the central computer. Finally, I analyzed the methods that supply the power for this electronic giant. Millions of watts are needed—a phenomenal amount. In general, I'd say that you couldn't find a better training ground for understanding the uses of electronics as well as electro-mechanical equipment."

How does Bernie feel about his current assignment? "I'm responsible for the performance of the input-output devices—the auxiliaries that supply information to the central computer. The many Project SAGE outposts—picket ships, reconnaissance planes, Texas towers—flash their signals to the input devices which, in turn, correlate and compile the data. This, incidentally, is one of the world's largest computers, which is built and tested at Kingston, then disassembled and shipped to a directional control site such as McGuire. Some-

What about you? Since Bernie Roth joined IBM Military Products and the Project SAGE program, opportunities are more promising than ever. This long-range program is destined for increasing national importance, and IBM will invest thousands of dollars in the right men to insure its success.

If you have 2 years' technical schooling—or equivalent experience—IBM will train you for 6 months as a *Computer Units Field Engineer*.

If IBM considers your experience equivalent to an E.E., M.E., or Physics degree, you'll receive 8 months' training as a *Computer Systems Engineer*.

After training, you will be assigned to an area of your choice. You receive *salary*, not wages, plus overtime pay. In addition, every channel of advancement in the entire company is open, and IBM is a leader in a field that is skyrocketing in growth. Of course, you receive the famous IBM company-paid benefits that set standards for industry today.

WHY NOT WRITE—today—to Nelson Heyer, Room 12608, IBM Corp., Kingston, N.Y.? You'll receive a prompt reply.

**Note: Since this article was originally prepared, Bernie has been promoted to Computer Systems Engineer, with assignment to Santa Monica, California.*

DATA PROCESSING • ELECTRIC TYPEWRITERS
MILITARY PRODUCTS • SPECIAL ENGINEERING PRODUCTS
TIME EQUIPMENT

IBM

**MILITARY
PRODUCTS**

Prepare for a Good Paying Job — Or Your Own Business

Learn **PRACTICAL RADIO-TV**
with **25 BIG KITS**

of equipment I send you while
you train with me . . . for valuable
shop bench experience . . .

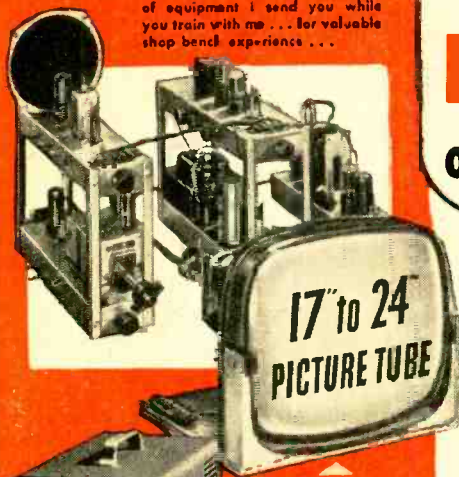

17" to 24"
PICTURE TUBE



The new Sprayberry Training Television receiver. Built and tested in sections. I now offer this fine modern oscilloscope.

You build this powerful 2 Band superhet radio receiver.

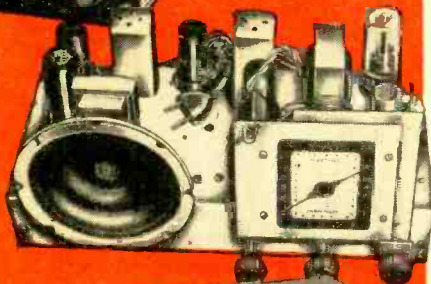

You build the new Sprayberry Tester . . . 13 range Volt-Chm-Mi kammeter readings.

In addition to modern lesson training, I also give you plenty of home practice on actual Radio-Television equipment . . . you will build and use the units shown here plus many more. All this equipment is yours to keep . . . keep everything you need to set up your shop.

**"I Will Train You at Home in
RADIO-TELEVISION
on Liberal No Obligation Plan!"**

New Equipment! New Lessons! Enlarged Course! The true facts are yours in my big new catalog . . . **YOURS FREE . . .**
JUST MAIL COUPON!



Frank L. Sprayberry
President, Sprayberry
Academy of Radio

I can train and prepare you in as little as 10 months to step into the big opportunity Radio-Television service field. Train *without* signing a binding contract . . . without obligating yourself to pay any regular monthly amounts. You train entirely at home in spare hours . . . you train as fast or as slowly as you wish. You'll have your choice of **THREE SPRAYBERRY TRAINING PLANS** . . . planned for both beginners as well as the more experienced man. Get the true facts about the finest most modern Radio-Training available today . . . just mail the coupon for my big new 56 page fact-filled catalog plus sample lesson—both **FREE**.

Train the Practical Way—with Actual Radio-Television Equipment

My students do better because I train both the mind and the hands. Sprayberry Training is offered in 25 individual training units, each includes a practice giving kit of parts and equipment . . . all yours to keep. You will gain priceless practical experience building the specially engineered Sprayberry Television Training Receiver, Two-Band Radio Set, Signal Generator, Audio Tester and the new Sprayberry 18 range Multi-Tester, plus other test units. You will have a complete set of Radio-TV test equipment to start your own shop. My lessons are regularly revised and every important new development is covered. My students are completely trained Radio-Television Service Technicians.

NEWEST DEVELOPMENTS!

Your training covers U H F, Color Television, F M, Oscilloscope Servicing, High Fidelity Sound and Transistors.

**See for Yourself . . . Make Your Own Decision
. . . Mail Coupon Today!**

The coupon below brings you my big new catalog plus an actual sample Sprayberry Lesson. I invite you to read the facts . . . to see that I actually illustrate every item I include in my training. With the facts in your hands, you will be able to decide. *No salesman will call on you.* The coupon places you under no obligation. Mail it now, today, and get ready for your place in Radio-Television.

SPRAYBERRY ACADEMY OF RADIO

1512 Jarvis Ave., Dept., 105-P, Chicago 26, Illinois

Mail This Coupon for Free Facts and Sample Lesson

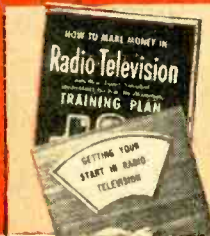

SPRAYBERRY ACADEMY OF RADIO
1512 Jarvis Ave., Dept. 105-P, Chicago 26, Illinois
Please rush all information on your **ALL-NEW** Radio-Television Training Plan. I understand this does not obligate me and that no salesman will call upon me. Include New Catalog and Sample Lesson **FREE**.

Name _____ Age _____
address _____
City _____ Zone _____ State _____

Transistor Topics

(Continued from page 90)

rapidly breadboarding any RC amplifier circuit using standard low- and medium-power transistors. By adding an additional special component or two, any a.c. or direct-coupled amplifier stage short of a high-power audio output stage can be simulated.

The LF-1 will duplicate common emitter, base, or collector circuits using *p-n-p*, *n-p-n* or surface barrier transistors. Multi-stage amplifier, multivibrator, switching, phasing, or push-pull circuits may be simulated by using cross-coupled LF-1's. The instrument nets at only \$79.50, less batteries.

Price Cuts. Reductions of up to 25% in the price to equipment manufacturers of several of its transistors have been announced by the General Transistor Corporation, Jamaica, L. I., N. Y. Other news from General Transistor which should be of interest to all readers is the availability of its entire line through local and mail order radio parts distributors; previously, these products could be purchased directly from the manufacturer only.

New Products. Your columnist was recently given the opportunity to check out the operation and performance of the Knight-Kit 2-transistor pocket radio (Model Y-262) available from Allied Radio Corp., 100 N. Western Ave., Chicago 80, Ill., at \$14.65, plus postage. Sold in kit form, this receiver can be assembled in a single evening on its etched circuit board. It incorporates several interesting features in circuit design, including a reflex-circuit—which permits two transistors to give the performance of three units—and the use of

the earphone cord as an antenna (through a network of r.f. chokes and coupling capacitors), eliminating the need for an external antenna. The kit includes a hearing-aid type earphone, battery, two transistors, simulated leather case, and all other components for assembling a working receiver.

Transvision, Inc. has announced the availability of a transistorized VTVM-VOM kit . . . Aircraft Radio Corporation, Boonton, N. J., is manufacturing an all-transistor high-voltage power unit which may be used as a direct replacement for the famous ARC D10A Dynamotor in aircraft receivers, giving high efficiency and a considerable savings in weight . . . Webster Electric Co., Racine, Wis., is now producing a fully transistorized high-power intercommunication system designed for offices, plants, schools, and other institutions.

That's it for now. See you next month . . .
Lou

Building a "Spare" Amplifier

(Continued from page 95)

frequency response, you might try the A-3850, a unit of slightly larger size.

Operation. When you first turn the amplifier on, a bright flash of light will be seen in the 117N7 tube, which will then heat up rapidly. The pilot light (if connected in series) should be operating near its maximum rating. With nothing connected to the input and the volume control in its loudest position, hum should be inaudible. (There will be a slight hum if you substitute a resistor for the filter choke.) If any hum is heard, reverse the line plug.

Connecting a record changer or tuner may produce some hum. If it does, reverse both plugs several times until an ideal match is indicated by an absence of hum.

For best operation, the constructor should adhere closely to all specified circuit values—with several exceptions. One is *R13*, in the power supply circuit. If for some reason you would like more gain, this resistor can be brought down to 50,000 ohms to supply more plate voltage to the 6SL7.

Other components open to change are *R10* and *C7*, which form the feedback loop. The over-all gain of the amplifier may be adjusted at this point. Decreasing the value of *R10* decreases the gain, and vice versa. *C7* controls the amount of feedback at lower frequencies. The larger the value, the more bass is fed back to the cathode, resulting in decreased bass response. If you have a highly efficient speaker enclosure, you may want to use a larger capacitor and decrease the amount of bass. *C7* can be varied up to 0.01 μ fd.

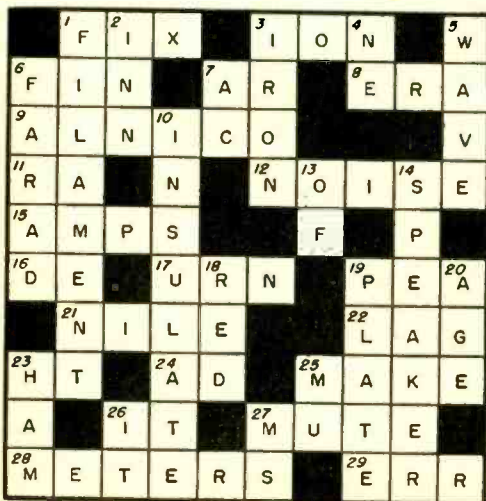

Solution to crossword puzzle appearing on page 69.

Pity the Poor Loudspeaker

(Continued from page 51)

a way that when the knob is rotated completely counterclockwise, it points directly to "50 watts." Now rotate the pointer until it indicates a wattage setting 10 to 20% lower than the maximum speaker rating.

If, when listening to music or other program material, the neon lamp ever glows—even if just in a flicker—you can be sure that you are reaching or exceeding the power limit of your loudspeaker. If the indicator lamp should glow continuously, even with no sound coming from the speaker, have your amplifier checked at once for possible oscillation troubles.

Music Monitor. Another interesting use of this circuit is immediately apparent. Suppose you are listening to music at a given volume and you'd like to know how great the power peaks are. Simply rotate the control slowly clockwise until the loudest bursts of music cause the indicator just barely to glow. Read the peak wattage directly on the calibrated scale. In connection with this last experiment, don't be too surprised if you turn the control fully clockwise (to 1 watt) and nothing happens. You'd be amazed just how loud one watt sounds on an efficient speaker system!

Since the indicating lamp operates equally well at all frequencies, still another use is possible. Suppose your system is composed of a woofer which can handle more power than your amplifier could ever supply, but your tweeter is rated at only a fraction of the maximum power from the amplifier. In that case, simply connect the "safety light" across the terminals of the tweeter itself, after any crossover components, and rotate the wattage control to a setting which is somewhat less than the maximum power rating of the tweeter. In this way, full power can be fed to the system as a whole, but the warning light will glow only if the treble portion of the total spectrum exceeds the rating of the tweeter. This condition rarely occurs in normal music, but it could easily happen if the amplifier were oscillating as described above.

A good loudspeaker is often the costliest of hi-fi components—and in terms of listening pleasure, well worth the price. The "safety light" described here will help protect the investment and is recommended for all cases where several loudspeakers are hooked up to a single amplifier and the amplifier output exceeds the power rating of any individual speaker. With such protection, your speakers will last indefinitely and be practically immortal. —30—

40¢ FOR ANY TUBE

WE WILL NOT BE UNDERSOLD

We Have OVER 1000 USED TV SETS

At All Times in Our Huge Warehouse. Buy one or more of these WORKING TV's to sell or use as your own second set! All sets in GOOD WORKING condition! Your Choice—Console or Table Model.

10"	\$23.00	19"	\$58.00
12"	\$28.00	20"	\$64.00
14"	\$33.00	21"	\$72.00
16"	\$40.00	24"	\$99.00
17"	\$46.00		

When ordering TV's, state whether table model or console is desired. Also preference on make of set. All TV's sent railway express F.O.B. Newark. On any quantity WIRE or CALL today!

PROMPT SHIPMENT OF ALL ORDERS!

FREE BONUS ANTENNA GIVEN WITH ANY TV SET ORDER!

SEND for our FREE complete TUBE & PARTS LIST and order blank.

FREE POSTAGE in U.S.A. and Territories on orders over \$3.00. 25¢ handling charge on orders under \$5.00. 25% deposit required on C.O.D.'s. Please send approximate postage or freight on Canadian and foreign orders. Subject to prior sale.

APOLOGY TO OUR READERS—Due to the tremendous response to our wonderful tube values, our huge staff was unable to adhere to our Same Day Shipment policy. We wish to offer our profound apologies for any inconvenience caused our customers.

DON'T PAY MORE FOR SET TESTED LONG LIFE DEPENDABLE HI-FI RADIO & TV TUBES • BUY VIDEO • INDIVIDUALLY BOXED—ALL GUARANTEED FOR ONE YEAR OR YOUR MONEY BACK WITHIN 5 DAYS—37.00 Per Hundred

Some Standard Brand—Others With Famous VIDEO Brand

0A2	2X2	6AC7	6BK5	6S7	7F8	12V6GT
0A3	3A4	6AQ5	6BK7	6SH7	7M7	12X4
0A4	3A5	6AF4	6BN6	6S7GT	7Q7	14A7
0B2	3AL5	6AH4GT	6BL7GT	6SK7GT	7Y4	14B6
0C3	3AU6	6AK5	6BQ6GT	6SL7GT	7Z4	14Q7
0Z4	3BC5	6AL5	6BQ7	6SN7GT	12A6	19B6GG
1A7GT	3CB6	6AM8	6BY5G	6S7	12AH7GT	19T8
1B3GT	3Q4	6AN4	6BZ7	6S7	12AT6	24A
1C7G	3Q5GT	6B8	6C4	6S7	12AT7	25AV5GT
1F4	3S5	6AQ5	6CB6	6T8	12AU6	25CQ6GT
1H4	3V4	6AQ7GT	6CDD6	6U4GT	12AU7	25CQ6G
1H5GT	4B27	6AS5	6CF6	6U7G	12AV6	25CUG
1I6GT	4B97	6AS7G	6CQ6	6UB	12AV7	25L6GT
1I4	5AM8	6AT6	6CU6GT	6V3	12AX4GT	25W4GT
1I6	5AN8	6AU4GT	6E5	6V6GT	12AX7	25Z6GT
1I4G	5A05	6AUSGT	6HG6T	6W4GT	12AZ7	35L6GT
1L3	5AT8	6AU6	6J4	6WG6T	12B4	35W4
1L4	5AW4	6BV5GT	6J5GT	6X4	12BA6	35Y4
1L5	5A24	6AV6	6J6	6X5GT	12BE6	35Z3
1I5GT	5J5GT	6AX6	6K6GT	6K8	12B7	35Z5GT
1S4	5T4	6BA6	6L6	6Y6G	12BY7	50A5
1S5	5T8	6AX5GT	6N7GT	7A5	12CUG	50B5
1T4	5U4G	6BC5	6S4	7A7	12E7	50C5
1U4	5UB	6B7	6S7G	7B5	12G7	50L6GT
1U5	5V4G	6BE6	6S7	7B7	12SH7	80
1V2	5V6GT	6BF5	6S7Y	7C5	12S7GT	117N7GT
1X2	5Y3	6BG6G	6S7	7C6	12TK7	117P7GT
2A7	5Y4G	6BH6	6SF5	7C7	12SN7GT	117Z3
2D21	6AB4	6BJ6	6SF7	7F7	12S7	

FREE RCA "CHEATER" CORD GIVEN WITH ANY TUBE ORDER OF \$7.00 OR MORE! PROMPT SHIPMENT OF ALL ORDERS.

Brand New Factory Seconds! Electrically Perfect Factory Second Use Tubes! New and Used Jan Surplus Tubes!

VIDEO ELECTRIC COMPANY

79 CLINTON PL. NEWARK, N. J. Phone Humboldt 4-9848

The Transmitting Tower

(Continued from page 87)

Where necessary, "twin lead" may be guided along the side of the building with the aid of additional stand-off insulators to the point where it enters the station. You can fasten coaxial cable directly to the wall with small cable clamps.

The neatest way to bring the feed line into the radio room is to drill a hole through the wall below a window or near the floor and put a TV lead-in bushing through it to accommodate the line. If necessary, the hole can be plugged later by driving a length of 3/4" wooden dowel rod into it. Drill the hole with a downward slant to the outside, so that moisture cannot run down the line into the room.

A less drastic method, if you have conventional wooden windows, is to obtain a length of window stock the width of the window from a lumber yard. Pull the window down from the top, insert the piece, and push the window back up. You now have a removable place for drilling the hole. A strip of weatherstripping to seal the gap in the middle of the window is available from any place selling or installing air conditioners.

In other types of windows, a shorter

piece of glass can be substituted for the regular pane and the gap filled at the top with a length of clear plastic to accommodate the line.

See the antenna chapter of the *ARRL Handbook* for data on a 40' "2 x 2" mast, and the TV antenna pages of any electronic parts catalog for various types of commercially available towers and accessories.

News and Views

Kent, W7VTI, using a *WRL* Globe Chief at 90 watts feeding a folded dipole antenna 40' high and an NC-88 receiver with a Q-Multiplier added, has worked 46 states and a little DX on 40 meters. In a month, he worked: Hawaii, KH6; Puerto Rico, KP4; Alaska, KL7; Mexico, XE1; Philippines, DU7; Barbados, VP6; Brazil, PY8; New Zealand, ZL3; Australia, VK34; Argentina, LU3; and Japan, JA1,3,7. He now has a new National NC-300 receiver and is planning a 10-, 15-, 20-meter "tri-band" beam! **Bob, WNTGKT**, also has an NC-300, which they both rate as a "fair" Novice receiver. . . **Cliff, K4ADU/DL4BL**, hears Novice RST599 in Germany at times. The Air Force moves him around all over Europe, so he cannot make schedules. At home in Columbus, Georgia, his 60 watts has made WAS (Worked All States) and contacts with over 60 countries, mostly on 40- and 20-meter c.w. **Ricky, KN4???**, went on 2 meters with a

GIGANTIC MAIL SALE

SAVE-TO-70%

DC MILLIAMETER

• Brand new genuine Weston 0-1 MA basic meter, 18.6 MV full scale with external precision multiplier. In square metal case with test lead. 3"x3"x2 1/2".
Cost Govt. \$50. SALE: \$4.49 Ppd.

FM TRANSMITTER

• New army surplus. Model BC-604. Freq. range 20-27.9 MC. Input 12 or 24-v DC. 1 1/2"x18"x10 1/4". Wt. 56 lbs. Less dynamotor, crystals. Cost Govt. \$504.00. SALE: \$17.95 FOB.
• DM-37 dynamotor for above \$5.95 FOB.
• Set 80 crystals 20 to 27.9 mc. \$19.95 FOB.

SIGNAL GENERATOR

• Army surplus. Model I-196-B. Contains 957 acorn tube. Frequency range. 150 to 225 MC. Battery operated. Wonderful exper unit. 8"x8"x13 1/2". Wt. 7 1/2 lbs.
SALE: \$3.99 FOB

WAR SURPLUS EXCESS INVENTORY BANKRUPT STOCK

99¢ . . . KITS . . . 99¢

Your Choice—
Prepaid in U.S.A.

- 11 Potentiometers. Good value. 99¢
- 26 Resistors. To 10-W. 99¢
- 5 Vacuum Tubes. A real buy. 99¢
- 14 Capacitors. Tubulars, bathtubs. 99¢
- 16 Tube Sockets. 4, 7, octals, etc. 99¢
- 1 Surprise Package. Min. value \$6. 99¢

POWER SUPPLY

• Navy model CIG211078. Uses dynamotor 4186. Voltage regulated input. 12 to 13-v at 27 amps. Output 250-v at 60 MA and 300-v at 225 MA. Contains midrect 13-v, 10 rpm motor. Dim. 11"x7 1/4"x8". Net wt. 34 lbs. Govt. cost over \$100.00.
SALE: \$9.95 FOB

RAL-8 RECEIVER

• Brand new Navy surplus precision monitor receiver. Complete with separate power supply. Range 0.3 to 23 MC. Input 115-v. 60-c AC. Wt. 300 lbs. Govt. cost \$960.00.
SALE: \$69.95 FOB

SPECIAL OF THE MONTH!

MIDGET ALNICO GENERATOR

• Hand operated AC generator. signal unit. Voltages up to 110. Ideal for signal bells, fish worm ketter, experiments, many other uses. Cost over \$18.00.
SALE: \$3.89 Ppd.

ELECTRONIC SPECIALS

• Last Minute Items New Surplus

- Dynamotor, DM-37 25-v/625-v. or 12-v/280-v. SALE: \$5.95 FOB
- Acorn Tubes, 955 or 954, Govt. cost \$3.60. SALE: .39 Ppd.
- Chrome 3" Bell, 15 to 25-v AC or DC. SALE: .99 Ppd.
- ARC-5 Transmitter, 3 to 4 MC, less dynamotor. SALE: 7.95 FOB
- Army Geiger Tube. Precision radiation detection tube. Full instructions. Make ultra sensitive uranium Geiger counter unit. Worth \$100.00. Cost \$8.50. SALE: \$2.95 Ppd.

ORDER FROM AD or write for big new FREE CATALOG 1000s items at tremendous savings. We pay frt. except where FOB.

SURPLUS CENTER

843 110th St., LINCOLN, NEBRASKA

LEARN

RADAR MICROWAVES TRANSMITTERS

CODE TV RADIO

Phila. Wireless Technical Institute

1533 Pine St. Philadelphia 2, Penna.

A Non-Profit Corp. Founded in 1908

Write for free catalog "P"

Write for complete FREE tube listing.

BRAND NEW TV PICTURE TUBES

GUARANTEED FOR 1 YEAR

RCA and DUMONT Licensed

10" Tube . . . \$10. ⁹⁵	17" Tube . . . \$17. ⁹⁵
12" Tube . . . \$12. ⁹⁵	19" Tube . . . \$20. ⁹⁵
14" Tube . . . \$14. ⁹⁵	20" Tube . . . \$20. ⁹⁵
16" Tube . . . \$16. ⁹⁵	21" Tube . . . \$22. ⁹⁵

Add \$4.00 to above prices for aluminized tubes

TERMS: 25% deposit on all COD's. Picture tubes F.O.B. Passaic, N. J. via Rail. w&Y Express.

TUBE MART DISCOUNT HOUSE

The Lokpet Bldg. Passaic, N. J.

LW-50 transmitter, running 15 watts, and a Tecraft CC5-144 converter in conjunction with his Hallicrafters SX-100. Results have been so good that he is glad he made the change. His antenna is a "Discone," fed with RG-8/U coaxial cable. Ricky offers to furnish details to anyone who requests them and also to help prospective amateurs to get their Novice licenses. . . . **Peter, KN1ADJ**, runs 75 watts to a Globe Chief and receives with a National NC-88, plus a Q-Multiplier. He has worked 41 states, Canada, England, French Morocco, Netherlands, Norway, Puerto Rico, Spain, and Sweden. He offers help to prospective amateurs in obtaining their licenses. . . . Since getting his General Class license, **Ray, K5GHP**, has worked seven new states and Canada with his Heath DX-35 on 15-meter phone. This brings his states-worked total up to 45, 40 confirmed. He uses a 40-, 20-meter dipole fed with a single length of RG-59/U

Code Practice

K6USN, Treasure Island, San Francisco, Calif., sends code practice for one hour the first four days of each week, starting at 6:30 p.m., local time. The first five speeds are 5, 7½, 10, 13, and 15 wpm. His sending speed then advances in 5-wpm steps up to 45 wpm. Frequencies used are 1978, 3590, and 7136 kc. Also on 4045 kc. (outside the high-frequency edge of the 80-meter band), two hours of code practice is sent at 8 wpm the first four days of the week, starting at 8:00 p.m., local time. Our thanks go to M. C. McKenna and Don Johnson, W6QIE, RMC, USNR, for this information.

coaxial cable on 40, 20, and 15 meters. In the wishing stage are plans for a rotary beam. Ray also offers help to prospective amateurs.

In five weeks on 80 meters, **Jim, KN1BEB**, has had over 200 contacts in 14 states and Canada. His home-built 6V6 transmitter runs 17 watts and feeds a 130' dipole antenna about 25' high. . . . **Chuck, KN4KYU**, recently took his General exam. A few days later, he received word from the district office of the FCC that he had passed—in the addressed and stamped envelope he had furnished for the purpose. Two months after that, he was notified from Washington that he had failed! Luckily, a phone call to the district office straightened out the mix-up. Chuck operates on 15 meters with a dipole antenna only 11' high. Everybody says it won't work, but Chuck just looks at his 33 states, Canada, Puerto Rico, Spain, and Alaska, and smiles. He runs up to 50 watts to a 1625 and receives on a Hallicrafters S-28.

With help received through "Help Us Obtain Our Ham Licenses," **Buddy, KN5JRI**, got his license and made a lot of friends. He uses a Lettine 240 transmitter and a Hallicrafters S-22R receiver on 40 meters. He would like to hear from others using a Lettine transmitter. . . . **Tom Tighe** reminds us that any receiver with a beat oscillator in it can be used as a code-practice oscillator. Tune in a steady signal with the beat oscillator "on." This will

WE DON'T NEED ENGINEERS

. . . but they write to us daily to order our
GENIAC Electric Brain Construction Kits

So do TEACHERS, SCIENTIFIC AMATEURS, INDUSTRIAL FIRMS and schools. (See list below.)

THOUSANDS OF SATISFIED CUSTOMERS have bought GENIACS on a 7 DAY REFUND guarantee

We are proud to offer our 1957 Model, with up to the minute improvements for the thousands of new customers who can use them.

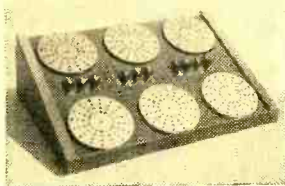

WHAT IS A GENIAC?

Here is a picture of the 1957 Model GENIAC in the display rack (\$3.00 separately) which comes with every kit. GENIAC stands for *Genius Semi-Automatic Computer*. A kit of specially designed switch decks and racks which permit the user to construct more than thirty different machines (following directions and wiring diagrams) and as many more as he is able to design himself. These machines demonstrate the applications of electric circuitry.

APPLICATIONS OF GENIAC

SIMPLE COMPUTER CIRCUITS of binary, decimal adding, subtracting, dividing, multiplying machines, PROBLEMS in symbolic logic, reasoning, comparing, PSYCHOLOGICAL TESTING and EXPERIMENT GAME PLAYING CIRCUITS for divination and num. ACTUARIAL ANALYSIS.

SOME OF OUR CUSTOMERS

Allis-Chalmers • Remington-Rand • International Business Machines • Manual Missionary College • Harvard College • Westinghouse Electric • Philip Laboratories • General Insurance Co. of America • Lafayette Radio • Rohr Aircraft Co. • Albert Einstein Medical College • Naval Research Laboratories • Board of Education, Tecumseh, Nebraska • Los Angeles Public Schools • Jefferson Union High School • Oklahoma A & M • Courtland Jr. High School • Bell Telephone Laboratories.

WHAT COMES WITH THE KIT?

BOOKS—1. SIMPLE ELECTRIC BRAINS, AND HOW TO MAKE THEM . . . 64 page experiment manual.—NEW! 2. MINDS AND MACHINES . . . 200 page text on computers, automation and cybernetics.—NEW! 3. WIRING DIAGRAMS for basic GENIAC circuits.—NEW! 4. Beginners Manual for the person who has little or no familiarity with electric circuits.—NEW! 5. GENIAC study guide . . . the equivalent of a full course in computer fundamentals. Lists additional readings.

PARTS—PANELS, DISCS, RACK (for easy assembly and display). Hardware, wire, tools, battery, holder, etc. for more than thirty machines.

SEND for your GENIAC now. At only \$19.95, a bargain, comes complete with over 400 parts and components. 7 books and manuals. We guarantee that if you do not want to keep GENIAC after one week you can return it for full refund.

Add 80¢ west of Miss. \$2 outside U.S. Mail Name & Address with check or Money Order to

OLIVER GARFIELD CO., DEPT. PE-87C

126 LEXINGTON AVE. NEW YORK 16, N. Y.

SPECIAL CATALOG BARGAIN!

ELECTRONIC MIX BARGAIN

We stripped the finest Gov't Surplus to bring you this Value. Includes solenoids, transformers, potentiometers, capacitors, switches, plugs, coils, rheostats, plus so many others we can't list them all. . . .

No. EL-MX100—100 POUNDS OF PARTS	\$19.95
No. EL-MX 50—50 pounds of parts	14.95
No. EL-MX 25—25 pounds of parts	9.95
No. EL-MX 10—10 pounds of parts	4.95

WORLD'S MOST AMAZING BARGAIN CATALOG

396 PAGES

The LARGEST COLLECTION OF BARGAINS
ever assembled in one catalog!

NATIONALLY ADVERTISED MERCHANDISE • NEW
AND USED GOV'T. SURPLUS • FACTORY CLOSE
OUTS • EXCITING IMPORIS!

From EVERYWHERE PALLEY'S now bring you items of every description! This fabulous catalog contains Hand & Power Tools, Microscopes, Binoculars, Industrial and Building Materials, Housewares, Office Equipment, Sport & Outdoor Equipment, Cameras, Photo Supplies, Hobby Kits & "Gadgets", Electrical & Radio Supplies, Motors & Generators and a HUGE selection of Surplus Hydraulic Cylinders, Pumps, Valves, etc. So many items it's impossible to list them all. You'll have to see it to believe it!

Send 50¢ — LIMITED EDITION! ORDER YOURS NOW!
(for handling & mailing) 50¢ REFUND on your first order of \$1.00 or more.

Palley's

2263 E. VERNON AVE., DEPT. PE-87
LOS ANGELES 58, CALIF.

ATTENTION MEN 8 to 80

Free Information On Ed-u-kits

Revolutionary training methods of educating yourself increase your knowledge in electronics for pleasure and profits. Write:

MacFarlane Industries

P.O. Box 33 Redondo Beach, Calif.

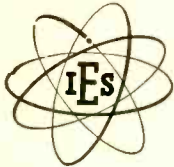

ELECTRONIC TECHNICIANS ARE IN DEMAND

TRAINED MEN ARE NEEDED NOW!

In just 18 months you can complete Electronic Technicians training to enter this ever-growing industry. Day or evening classes. Opportunity for employment in local industry. Approved for Korean Veterans.

Terms beginning September, January, April, July
Write for Catalog 224 TODAY

INDIANAPOLIS ELECTRONIC SCHOOL

312 E. Washington St. Indianapolis 4, Indiana

2 WAY PORTABLE RADIO SET

SENDS—RECEIVES UP TO 10 MILES AS SHOWN

with built-in antenna or hundreds of miles with outside antenna! Works on 80 and 40 meter (Novice) amateur radio bands—also Aircraft and overseas broadcast (3 to 8 mc). PORTABLE SELF-CONTAINED POWERED WITH STANDARD PORTABLE RADIO BATTERIES. NO AC PLUG-INS NEEDED! Take it with you everywhere you go—on trips, vacations, camping—Keep in contact with home, friends. Has 5 watt crystal controlled transmitter—Sensitive Regenerative Receiver. Send-Receive switch.



Wt. only 3 lbs. Size, only 6"x4"x4". TESTED!
—PROVEN—SIMPLIFIED—PRACTICAL—Full information given on quick easy to get license.
SEND ONLY \$3.00 (bill, ck, mo) and pay postman \$11.95 COD postage on arrival or send \$14.95 for postpaid delivery. Complete kit includes all parts, tube, coils, plastic cabinet, easy instructions. (Set of batteries \$2.95; crystal \$1.25.) COMPLETELY WIRED AND TESTED POSTPAID \$19.95. A regular \$49.95 value—Order now before price goes up.
GUARANTEED—AVAILABLE ONLY FROM:
WESTERN RADIO DEPT. BNE-8 KEARNEY, NEBR.

INVENTORS

Send for
PATENT INFORMATION
Book and
INVENTOR'S RECORD
without obligation

GUSTAVE MILLER
87-PE WARNER BUILDING
WASHINGTON 4, D. C.

REGISTERED PATENT
ATTORNEY

ASSOCIATE EXAMINER
U.S. PAT. OFF. 1922-1929

Patent Attorney & Advisor
U. S. NAVY DEPT. 1930-1947
PATENT LAWYER

EASY TO LEARN CODE

Learn or increase speed with an Instructograph—the Radio-Telegraph Code Teacher that takes the place of an operator-instructor and enables anyone to master code without further assistance. Available tapes from beginners alphabet to typical messages on all subjects. Speed range 5 to 40 WPM. Always ready—no QRM. Thousands have "acquired the code" with the Instructograph System. Write today for convenient rental and purchase plans.



INSTRUCTOGRAPH COMPANY
4713-F Sheridan Road, Chicago 40, Illinois

Please Be Sure to Mention

POPULAR ELECTRONICS

When Answering Advertisements

produce a steady whistle from the phones. Connect your key terminals in series with one phone lead. Result: a code practice setup.

For the information of the several hams who worried about **KN4LXT** running 85 watts (May, "News and Views"), this was a typographical error. Gerald runs 75 watts, maximum. . . . **Al, W8FRD**, assures us that there are some hams in Vermont with the news that he worked 17 of them in one day during a contest. Running 20 to 25 watts input, Al has worked all continents except Asia, on 80 meters, and he has the cards to prove it.

Contributors to News and Views: **Kent Angell, W7VTI**, 425 Thornwood Drive, American Forks, Utah; **Clifford Watson, A3/C, DL4BL/K4ADU, USAF**, 2nd AACS Mob Sqn., APO 109, C/O Postmaster, New York City; **Ricky Jorgenson, KN4777**, 1702 Wynnton Rd., Columbus, Ga.; **Peter Gruber, KN1ADJ**, 407 Ward St., Newton Centre 59, Mass.; **Ray L. Sullivan, K5GHP**, (14), 1011 Glasgow Drive, Dallas 23, Texas; **Jim Dolian, KN1BEB**, (15), Renovah Woods, Stamford, Conn.; **Charles Bradon, KN4KYU**, (13), 514 N. White Sta. Rd., Memphis 17, Tenn.; **"Buddy" Gilmore, KN5JRI**, P.O. Box 804, Agua Dulce, Texas; **Tom Tighe**, Baldwin Hill, Litchfield, Conn.; **Al Vasko, W8FRD**, Swanton, Ohio.

I'll be seeing you next month. Don't forget to write and send pictures of yourself and your station for use in *The Transmitting Tower*. 73,

Herb, W9EGQ

Tuning the Short-Wave Bands

(Continued from page 78)

The following is a compilation of the latest reports that have been received. All times shown are EST, based on the 24-hour system. Please bear in mind that stations often change schedules and/or frequency without advance notice and that the listings given here are correct at time of compilation. This month we are listing a number of new schedules.

Albania—*Radio Tirana*, 9700 kc., can be noted at 1930-2000 in the Albanian language. This outlet follows *Radio Moscova* and is in turn followed by *Radio Sofia*, Bulgaria. (223)

Belgium—A new program, "Stars From Belgium," is being noted from Brussels, Sundays, in English. It can be heard at 1730 on 15,335 and 9655 kc., with a repeat at 1930 on the same channels. The 9655-kc. outlet is the relay station in Leopoldville, Belgian Congo. The regular Saturday Eng. program, "World Fair Radio," is still being broadcast at 1815-2000 on 11,850 kc. (65)

British Honduras—**BHBS**, 3300 kc., signs on at 0500 in Spanish. English begins at 0600, classical music at 0630, with news and music to 0930. Many DX'ers list the call letters for this station, located in Belize, as "VPN." The call "VPN" is assigned to a coastal telegraph station in Nassau, Bahamas. (OS)

Burma—The new 50-kw. xmtr from Rangoon has been noted at 0620-0700 with test records, followed by the Home Service relay at 0700-0900. (100)

The *Voice of Burma*, XYZ, 6034 kc., has been noted in the west at 2030-2100 with native music and some QRM from *Radio Moscow*. (EB)

Canary Islands—*Radio Atlantico*, 9470 kc., is using a new xmtr at 1630-1700. Reception reports are wanted and they will reply with a handsome QSL card. (EB)

Ceylon—Colombo carries "Music USA" at 1400-1600 on 15,120 kc., replacing the 11,835-kc. channel. (100)

Chile—*R. La Americana*, Santiago, is now announcing as *R. Presidente Alma Cida*. CE960, 9600 kc., appears to have increased power output. (152)

Costa Rica—TIFC, *The Lighthouse of the Caribbean*, 9647 kc., has an Eng. period to N.A. at 2300-0000. This is at times QRM'ed by the *Voice of Germany* until 2330. (223)

Czechoslovakia—*Radio Prague* now broadcasts to N.A. daily at 1930-2000, 2200-2300, and 0000-0030 on 9550, 11,835, 11,935, 15,145, and 15,285 kc. (LL, 27, 59, 153, 166)

Ecuador—In the May '57 column, page 109, we listed a number of unknown stations from this country. The following are probably the unknowns: 4755 kc., HC6LJ, *Voz de Bolivar*; 4775 kc., HC5GB, *R. Cordillera*; 4870 kc., HC4DR, *R. Miramar*; 5202 kc., HC6GT, *R. Continental*; and 4490 kc. (4770 kc. ?) HC2MX, *R. Guayaquil*. These stations may also be on the air: 4750 kc., HC5HN, *R. Hermig*; and 4580 kc., HC4FF, *Voz de Esmeraldas*. (152)

Finland—The current schedule for Stockholm is: 1700-1800 to Europe and S.A. on 17,800 and 15,190 kc. (heard weekdays); 2200-0000 (until 2330, Sundays) to N.A. on 17,800, 15,190, and 9555 kc. (JC, RS)

Germany—Armed Forces Network (AFN), Frankfurt, 5470 kc., is scheduled at 2300-1800 with request programs at 2330-0000 and 0430-0500. They verify by letter and reports go to AFN, Frankfurt, APO 757, New York, N. Y. In a recent letter from them, it was stated that they had increased power from 250 to 500 watts. (KA, 23)

Ghana—Ghana B/C System, Accra, operates on: 3366 kc. (20 kw.) at 0555-0730, Sundays to 0600, and from 1525 to 2215; 4915 kc. (5 kw.) at 0555-0730 and 1200-2215, Sundays at 0555-2215; 9695 kc. (1.3 kw.) at 1200, Sundays at 0800-1815. English news is broadcast at 0600, 1300, 1745, 1800, and 2115. (152)

Greece—*Radio Athens* operates at: 0900-1000 (except Mondays) on 15,345 kc. to Egypt; 1030-1300 on 9607 kc. to Cyprus; 1330-1515 on 11,927 kc. to the Balkans; 1530-1545 on 15,345 kc. to the USSR; 1600-1700 on 9607 and 15,345 kc. to Cyprus and Near East; 1715-1745 (French at 1715, English at 1730) on 15,345 and 17,745 kc. to N.W. Europe; 1815 on 9607 and 11,718 kc. to Cyprus, and 0700 (Sundays from 0530 to 0815) on 9607 and 15,345 kc. (152)

Greenland—OZL, Angmagsalik, 7570 kc., has been noted at 0800 with Danish recorded music. Some code QRM. (EB) (Editor's Note: This station is heard at times in the east but reception is spotty. There is no English to my knowledge.)

Grenada—Windward Islands B/C Service

August, 1957

international short wave

reception from your car



Push Button Converter

Provides excellent SW reception when operated with 12 volt* auto radios having manual tuning dial.

At radio stores handling amateur equipment. Also many automotive parts stores.

Install it yourself! No need to open or alter auto set. Just connect leads provided to radio and to 12 volt* accessory terminal under dash. No fitting, no drilling, nothing else to buy.

Push button selection of 13, 19, 31 and 49 meter SW bands ensures daylight, night-time reception.

29.95

*(Usable only on cars having 12V battery systems.)



Can you think faster than this Machine?

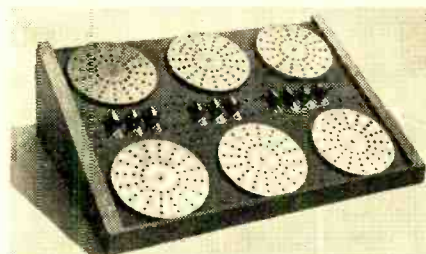

GENIAC set up to do a problem in check valve research. Be careful before you answer. GENIAC the first electrical brain construction kit is equipped to play tic-tac-toe, cipher and encipher codes, convert from binary to decimal, reason (in syllogisms) as well as add, subtract, multiply and divide. Specific problems in a variety of fields—actuarial, policy claim settlement, physics, etc.—can be set up and solved with the components. Connections are solderless and are completely explained with templates in the manual. This covers 93 circuits and shows how new ones can be designed. You will find building and using GENIACS a wonderful experience; one kit user wrote us: "this kit has opened up a new world of thinking to me." You actually see how computing, problem solving, and game play (tic-tac-toe, nimb, etc.) can be analyzed with Boolean Algebra and the algebraic solutions transformed directly into circuit diagrams. You create from over 400 specially designed and manufactured components a machine that solves problems faster than you can express them.

-----MAIL THIS COUPON-----
SCIENCE KITS, Dept. PE-87B, Oliver Garfield Company
126 Lexington Avenue, New York 16, N. Y.

Please send me:
1 GENIAC Electric Brain Construction Kit and Manual.
\$19.95 (East of Mississippi)
\$20.95 (Elsewhere in United States)
\$21.95 (Outside the United States)
Returnable in seven days for full refund if not satisfied.
I enclose \$..... in full payment.
My name and address are attached.

Shrinks Hemorrhoids New Way Without Surgery

Science Finds Healing Substance That
Relieves Pain—Shrinks Hemorrhoids

For the first time science has found a new healing substance with the astonishing ability to shrink hemorrhoids and to relieve pain—without surgery.

In case after case, while gently relieving pain, actual reduction (shrinkage) took place.

Most amazing of all—results were so thorough that sufferers made astonishing statements like "Piles have ceased to be a problem!"

The secret is a new healing substance (Bio-Dyne*)—discovery of a world-famous research institute.

This substance is now available in *suppository* or *ointment form* under the name *Preparation H*.* Ask for it at all drug counters—money back guarantee.
*Reg. U.S. Pat. Off.

MOVING?

BE SURE POPULAR ELECTRONICS
FOLLOWS YOU. PLEASE
SEND YOUR CHANGE OF
ADDRESS TO

POPULAR ELECTRONICS

CIRCULATION DEPARTMENT

64 E. Lake St. Chicago 1, Ill.



ROAD TO RICHES

You can be the next uranium millionaire! Government guarantees huge bonus! PRI instruments from \$29.95. See your local dealer today! FREE CATALOG!

Write PRI, 4223PT W. Jefferson
Los Angeles 16, California

DEALERS WANTED



Knock Out RADIO NOISE



Humm, buzz, scratch... caused by vacuum cleaners, shavers, power tools, and other appliances—FILTEROL 400 silences them all... and no foolin! ZERO length ground connection makes FILTEROL work where others fail. No wiring. Just plug it into any outlet... and then plug in your radio. Only \$7.45 with 10-day money-back guarantee. Send check or money order only to FILTEROL DIV., SPRAGUE PRODUCTS CO., N. Adams, Mass.

ENGINEERING DEGREE IN 27 MONTHS

INDIANA TECHNICAL COLLEGE

B.S. Degree, Aero., Chem., Civil, Elec., Mech. & Electronic Eng. (inc. Radio, TV), 36 mo. B.S. degree in Math., Chem., Physics. Prep courses. Demand for grads. Spacious campus, 20 bldgs; dorms, auditorium, gym. Low rate. Earn board. G.I. approved. Enter Sept., Dec., March, June. Catalog, 2387 E. Washington Boulevard Fort Wayne 2, Indiana Keeping pace with progress

has dropped the 17,805-kc. channel. (100)

Guatemala—Seldom-heard TGCX, *Radio Cristal*, 11,750 kc., 350 watts, can be noted at times from 1830 with music, commercial ads, and anmts in Spanish. The Far East Network, Camp Drake, Japan, usually overrides this station. (61)

R. Nacional, Guatemala City, now operates at 1100-0500 using 6180 and 9760 kc. continuously as well as the m.w. outlets on 640 and 1520 kc. Power has been increased to 20 kw. on all frequencies. (152)

Haiti—4VHW, *R. Haiti*, Port-au-Prince, has moved from 6195 kc. to 6200 kc. (100)

4VWI, Cape Haitien, is noted on 17,819 kc. at 1950-2235 s/off and often kills the #2 xmsn from Tokyo. (59)

India—*All India Radio* carries English to the United Kingdom at 1445-1545 and has been heard on 15,090 and 15,310 kc., dual with 11,710 kc. (AR, 11, 61)

Indonesia—The latest schedule from the *Voice of Indonesia* is as follows: English at 0600-0700 and 0930-1030 on 4910 and 9710 kc., 1400-1500 on 9865 and 11,770 kc.; French at 1030-1130 on 7270 and 3200 kc., 1200-1300 on 11,770 and 9860 kc. They send a QSL by air-mail. (37)

Israel—The *Voice of Zion* is still moving; latest reports have it on 9555 kc. from 1630 to 1718 s/off in Eng., and it has also been noted on 11,760 and 11,835 kc. (158)

Italy—RAI, Rome, operates at 1915-1935 and 2125-2145 in Eng. to N.A. on 9570 and 11,900 kc. French is noted at 1935-1955. (LD, AF, 98, 102, 156, 223)

The bird call used in the interval signal for *Radio Rome* (see May issue) has been identified as that of a nightingale. (Many)

Japan—The complete current schedule of *Radio Japan* reads: 1800-1900 on 17,825 and 15,325 kc. to Eastern N.A.; 0000-0100 on 17,795 and 15,325 kc. to Western N.A.; 0130-0330 on 17,795 and 15,225 kc. to Europe and USSR; 0200-0300 on 17,825 and 15,235 kc. to Hawaii; 0400-0500 on 11,705 and 9525 kc. to S.A.; 0400-0500 on 17,825 and 15,235 kc. to Australia and New Zealand; 0530-0730 on 11,705 and 9675 kc. to North and Central China; 0630-0730 on 17,825 and 15,225 kc. to Indonesia and the Philippines; 0800-1000 on 15,235 and 11,705 kc. to South China, Indo-China, Thailand, and Burma; 0800-0900 on 11,780 kc. to the East Asian area; 1030-1130 on 15,325 and 11,705 kc. to India, Pakistan, and Ceylon; 1230-1330 on 15,325 and 11,705 kc. to the Near East. The 1930-2000 xmsn to Eastern N.A. has been dropped and an additional half-hour added to the 1800-1830 xmsn. The xmsn to Europe and USSR will be extended from one to two hours. (AM, 92)

Jordan—The Jordan B/C Service has a new schedule: Arabic at 0000-0100, 0700-0800, and 1100-1500; English at 0630-0700 and 1015-1100. The frequency is 6060 kc. (EB)

Kenya—Forces B/C Service, East Africa, is presently operating at 2200-0000 on 3360 and 6112 kc., and at 0430-1500 on 6112 kc. (EB)

Liberia—ELWA, Monrovia, is widely reported on their N.A. broadcast from 2000 to 2130 s/off with religious and cultural programs on 9645 kc. (BC, BR, JM, JW, 173)

One of the best times to hear ELWA is on Sundays around 1715 on 4835 kc. with religious programs in English. (EV)

Another new outlet is noted on 15,197 kc. at 1815-1950 with music, answers to letters, and interviews. (59)

Libya—Forces B/C Service, Benghazi, is noted on 7220 kc. until 1830 s/off. Later it uses 3305 kc. until 2100 (Saturdays to 2200) when, after closing, the carrier remains on to begin an xmsn in Arabic at 2115 which ends irregularly between 2215 and 2245. This one is noted daily except Tuesdays and Thursdays. (152)

Mexico—XELZZ, Mexico City, 11,860 kc., is a new station, heard irregularly at 2200-0000, relaying XELZ. (100)

New Zealand—R. New Zealand is operating at 1445-0145 on 15,280 and 9540 kc. and at 1200-1430 on 11,780 kc. This apparently is in addition to their 0200-0545 xmsn. News is given at 1300 and 1400 on 11,780 kc., and at 1500, 1930, and 0130 on 15,280 and 9540 kc. A DX program is noted on the first Wednesday of the month at 0430. (KM)

Panama—R. Atlantico, Colon, is using a new outlet, HOLA, 9505 kc., with the following schedule: English at 1000-1200, 1300-1700,

TRANSISTORS

—in the new protective “skin pack”



Type 2N229
audio freq. 75¢ ea.

Type 2N233
radio freq. 90¢ ea.

Quality Sylvania transistors—at the lowest prices yet—you'll find both types displayed at your Sylvania parts supplier. See him for free application data or write directly.

SYLVANIA

SYLVANIA ELECTRIC PRODUCTS INC.
1740 Broadway, New York 19, N. Y.

SHORT-WAVE ABBREVIATIONS

anmt—Announcement
Eng.—English
kc.—Kilocycles
kw.—Kilowatts
m.w.—Medium wave
N.A.—North America(n)
QRM—Interference
QSL—Verification
R.—Radio
S.A.—South America(n)
s/off—Sign-off
s/on—Sign-on
xmsn—Transmission from station
xmtr—Transmitter used by station

and 1830-1900; Spanish at 1200-1300 and 1700-1830, with Spanish music from 1900 until s/off. (EB)

Saudi-Arabia—Jidda, 11,847 kc., is audible at 2200, dual with 11,948 kc., when European QRM is off. (100)

Spanish Guiana—R. Equatorial in Bata, Rio Muni, now operates over 7785 kc. at 2015-2200, with Spanish news being broadcast from 2033 to 2043. (152)

Surinam—AVROS, Paramaribo, has Eng. on Mondays only at 2030-2040 on 15,406 and 4852.5 kc. (25)

Sweden—R. Sweden is still carrying Swedish language programs on Fridays at 2030 on 11,810 kc., and at 0900 on 17,840 kc. (PE, RS)

Switzerland—The complete current schedule from R. Switzerland is as follows: 0015-0200, 0600-0800, and 1000-1740 Monday through Saturday (Sundays only 0110-1740) on 9535 and 6165 kc. to Europe; 0015-0200 on 17,784 kc. to Europe; 0215-0445 on 25,640, 17,784, and 11,865 kc. to Australia, New Zealand and Far East; 0500-0730 on 25,640 and 21,520 kc. to Africa; 0745-0930 on 21,520 and 15,305 kc. to S. E. Asia and Japan; 0945-1740 on 21,520 and 17,784 kc. to Africa; 0945-1130 on 17,720 and 11,865 kc. to India and Pakistan; 1145-1330 on 17,720 and 11,865 kc. to the Mid-East; 1345-1530 on 15,305 and 11,865 kc. to England and Ireland; 1545-1730 on 15,305

CUT CHASSIS HOLES FAST!



Smooth, accurate openings made in 1/2 minutes or less with Greenlee Radio Chassis Punch

Quickly make smooth, accurate holes in metal, bakelite, or hard rubber with a GREENLEE Chassis Punch. Easy to operate . . . simply turn with an ordinary wrench. Round, square, key, and “D” types . . . wide range of sizes to make openings for sockets, plugs, controls, meters, terminal strips, transformers, panel lights, etc. Assure perfect fit of parts and professional finish to every job. Write for descriptive literature. Greenlee Tool Co., 2388 Columbia Ave., Rockford, Ill.



GREENLEE

PORT ARTHUR COLLEGE ELECTRONICS COMMUNICATIONS

AM FM Television Broadcast Engineering
Marine Radio Radar

CHECK THESE FEATURES: tuition \$34 per mo., room & board \$50 per mo. in dorm on campus. College operates 5 KW broadcast station. Students get on-the-job training at studios on campus. FCC license training with all courses. Well equipped classrooms & lab., am fm transmitters, radar & marine eqmt., television camera chain, experiment lab test eqmt. & other training aids. Our graduates in demand at good salaries. Free placement service. Have trained men from all 48 states. Approved for GI. Write for details.

PORT ARTHUR COLLEGE
Established in 1909

Port Arthur
Texas

NEW MAGIC RADIO WALKIE TALKIE!

YOUR OWN POCKET SIZE RADIO STATION!
BROADCASTS TO ANY HOME OR CAR RADIO WITHOUT WIRES OR HOOKUPS! We only 5 oz. Size (1½x2½x4½"). Built-in telescoping antenna. Powerful Transistor-sensitive microphone. Frequency setter, break-in switch! Runs for weeks on self-contained flashlight batteries. Durable plastic case. With this Radio Talkie you CAN TALK TO YOUR FRIENDS UP TO A BLOCK OR MORE AWAY! Talk up to 1 mile or more between two automobiles! INSTANT OPERATION! Just push button to talk! No license needed. Uses inductive field magnetic radiation. Useful and real fun in a million ways. GUARANTEED TO WORK. 1 YEAR SERVICE GUARANTEE.



SEND ONLY \$2.00. (cash, ck, mo) and pay postman \$9.99 COD message or send \$19.99 for prepaid delivery. COMPLETE READY TO OPERATE WITH INSTRUCTIONS and hundreds of ways and tricks for broadcasts thru any radio you desire. Price may go up soon so get your NEW POWERFUL RADIO WALKIE TALKIE NOW. Available only from:
WESTERN RADIO, Dept. REL-8, Kearney, NEBR.

AMAZING NEW "LIFETIME" RADIO

"TI-NEE" RADIO IS GUARANTEED TO WORK FOR YOUR LIFETIME! USES NO TUBES, BATTERIES OR ELECTRICAL PLUG-INS. Never runs down! SMALLER THAN A PACK OF CIGARETTES! RECEIVES LOCAL RADIO STATIONS MOST ANYTIME, ANYWHERE WITHOUT EXTRA ANTENNA. Uses semi conductor crystal diode—Hi-Q Tuner. Beautiful black gold plastic cabinet. Built-in Speakerphone.



SEND ONLY \$2.00 (bill, ck, mo) and pay postman \$4.99 COD on arrival or send \$6.99 for postpaid delivery. SENT COMPLETE READY TO LISTEN—NOTHING EXTRA TO BUY EVER! (Extra long distance Aerial kit included free for stations up to 1000 miles away.) Available only from:
MIDWAY COMPANY, Dept. GPL-8, Kearney, Nebraska

GET INTO ELECTRONICS

Train for best technical positions in a top-flight school. Specialize in missiles, computers, radar, communications, industrial electronics, color TV, automation. Excellent program in theory, laboratory, mathematics. Major firms select our graduates as tech. reps., field engineers, specialists. Associate degree granted. 21 months' program. High school or equivalent required. Catalog.

VALPARAISO TECHNICAL INSTITUTE
DEPT. PE VALPARAISO, INDIANA

TRANSISTORS 2 for \$1.00

- Save dollars on experimenting by using quality surplus P-N-P audio transistors.
- Receive our regular customer bargain flyer by mailing your get-acquainted order today.

THE RESEARCHER

P. O. BOX 175 N. DAYTON STATION
DEPT. P DAYTON 4, OHIO

WANT A BETTER JOB: BECOME AN ELECTRONIC ENGINEER

ONLY 32 MONTHS TO EARN A BACHELOR OF SCIENCE DEGREE IN ELECTRONICS ENGINEERING. Class enrollment limited to allow for individual instructions. Chartered by state of California. Nonprofit-nonsectarian, co-educational—established 26 years.

APPROVED FOR VETS—ENROLL NOW!

SEND FOR FREE CATALOG

PACIFIC STATES UNIVERSITY

1516 S. WESTERN AVE. Dept. M. LOS ANGELES, CALIF.

and 11,865 kc. to Spain and Portugal; 1800-1945 on 15,305, 11,865, and 9535 kc. to South America; 2030-2215 on 15,305, 11,865, 9535, and 6165 kc. to East N. A.; 2230-2300 on 11,865 and 9535 kc. to Central America; and 2315-0000 on 15,305, 11,865, and 9535 kc. to West N. A. (LD, 20, 92, 156, 176, 208)

Another Swiss station, identifying as *R. Lausanne*, has been noted between 9500 and 9600 kc. at 1630-1700. From the anmts, it would appear that this is a local area station with a s.w. outlet. Further details are requested. (235)

Syria—SBS, Damascus, is well heard on 15,165 kc. in the 1430-1630 Eng. xmsn to Europe. This 20-kw. station verifies with a large-size QSL. (11, 124, 223)

Tangier—The Voice of Tangier, P.O. Box 2219, Tangier (SOCCO), Morocco, operates

SHORT-WAVE CONTRIBUTORS

Kenneth Akin (KA), APO 403, New York, N.Y.
Maurice Ashby (MA), Wichita, Kansas
Edward Bore (EB), N. Battleford, Sask.
Bert Cliff (BC), Birmingham, Mich.
James Carlile (JC), Columbus, Ga.
Les Downes (LD), London, England
Paul Edelson (PE), Brooklyn, N. Y.
Arno Feltner (AF), New Braunfels, Texas
Fjalur Hemming (FH), Helsingfors, Finland
Gerd Janzen (GJ), Ulm, Germany
Larry Lipson (LL), Philadelphia, Pa.
Andre Myron (AM), Valleyford, Wash.
John Mehigan (JM), Chicago, Ill.
Kenneth McCartney (KM), Toledo, Ohio
Adrian Rose (AR), London, England
Bernard Rachlin (BR), Ottawa, Ont.
Omar Sanchez (OS), Cienfuegos, Cuba
Robert Sibley (RS), Paradise, Calif.
Emil Vandevelde (EV), Oakland, N. J.
James Wade (JW), Saint John, N. B.
Chuck Maxant (11), Baldwin, N. Y.
Edwin Karl (20), New York, N. Y.
Peter Risse (23), Atlanta, Ga.
Francis Welch, Jr. (25), Worcester, Mass.
Gerry Dexter (27), Waterloo, Iowa
Stuart Fidler (37), Jordan, N. Y.
Grady Ferguson (59), Charlotte, N. C.
John Beaver (61), Pueblo, Colo.
Mary Iwai (65), Lombard, Ill.
Del Green (92), Salt Lake City, Utah
Tom Watkins (98), Mansfield, Ohio
Roger Legge (100), McLean, Va.
John Theobald (102), Skaneateles, N. Y.
Tom Thompson (124), Saginaw, Mich.
Roy Bugden (152), Fort Lauderdale, Fla.
Arthur Teal (153), Chester, Conn.
Bob Schwartz (156), Brooklyn, N. Y.
Albert K. Saylor (158), Quantico, Va.
George Cox (166), New Castle, Del.
Silas Dunn (173), Little Rock, Ark.
Eugene Simpson (176), Arlington, Mass.
Chris Bennion (208), Riverside, Conn.
David Crockett (223), Winston-Salem, N. C.
Frank Rochette (235), Trois Rivieres, Que.

as follows: Sundays at 0215-1130 and 1430-1630; Mondays, Tuesdays, Wednesdays and Saturdays at 0300-0400 and 1430-1700; Thursdays at 0330-0400 and 1430-1700; and Fridays at 0330-0400 and 1430-1715. All xmsns are in Eng. on 9485 kc. (LD)

R. Tangier is now known as *Dux-Radio* and carries commercial programs in Swedish on 9325 kc. at 1400-1600. Address is *DUX-Radio*, Stockholm-12, Sweden. (FH, GJ)

Uruguay—A new station is CXA71, *R. Sarandi*, Montevideo, noted on 9515 kc. irregularly at 1800-2100 with experimental programs in Spanish and French. (100)

Vatican City—This is *Vatican Radio* has Eng. news at 1000-1015 on 9550 and 11,865 kc. (KA, MA)

POPULAR ELECTRONICS

BARGAIN BASEMENT
SAVE ON THESE SPECIAL BUYS OF THE MONTH

19.95 LAFAYETTE SPECIAL
RADIO CONTROL TRANSMITTER



Completely assembled — tested — and guaranteed R/C transmitter. Includes tube and 27,255 MC crystal. 4 sect. telescoping antenna. Size: 4" x 4" x 12". Approx. 1 mile range. Shpg. wt., 3 lbs. Less batteries.
F-249 Net 19.95

Lafayette Radio DEPT PE-H
165-08 LIBERTY AVE., JAMAICA 33,
 include postage with order.

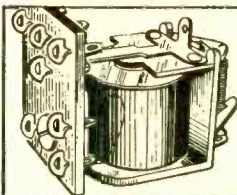

LITTLE "JEWEL"
R/C RELAY

The Mighty Mite of the R/C field. Weighs less than 1/2 oz. Only 3/4" H x 17/32" W x 1-1/16" L. Highly sensitive—extremely rugged. Pulls at 1.4 Ma—drops out 1.2 Ma D.C. S.P.D.T. 5000 ohm coll.

F-260 Net 2.75

Lafayette Radio DEPT PEH
100 SIXTH AVE., BOSTON 10, MASS., 110 Federal St. NEWARK 2, N. J., 24 Central Ave. PLAINFIELD, N. J., 139 W. Second St. BROOK 58, N. Y., 542 E. Fordham Rd.
 include postage with order

MAGNETIC GUITAR MICROPHONE

Complete with Individual Tone and Volume Controls

High impedance contact mike specially designed for use with guitar. Easily mounted under strings without special attachments. While in mounted position, mike can be raised or lowered easily on rod to create varying tonal effects. With 8 ft. cable and standard phone plug. Shpg. wt. 2 1/2 lbs.



PA-38 Net 9.95

Lafayette Radio DEPT PE-H
165-08 LIBERTY AVE., JAMAICA 33, N. Y.

RADIO CONTROL Headquarters

For model airplanes, boats, cars, etc. FREE CATALOG "P." No operator's license required. FREE—SEND FOR FCC FORM 505 Garage Door Radio Control Transmitting & Receiver Kits Available.

R/C TRANSMITTER & RECEIVER KIT: 27 1/2 mc. 5 watt 2-Tube Simple Transm. & 2-Tube Rec. incl. Drilled Bases, Wound Coil, Res., Cond., SIGMA Relay, Instruc. **\$9.95**

R/C Xmitter, Hi-Power HAND HELD, Compl \$17.95; KIT 11.95 SIGMA 4F RELAY; 8,000 ohm, \$3.85; 6 Reed Relay 14.95

2-6V Battery Charger Kit \$4.95 R/C BOOKS, Model Control \$1; Radio Control \$1; Handbook 2.25

CRYSTALS: 27,255 Mc. Peterson 29A, \$3.95; HOLDER 1.5 2" METERS, 0-1 Ma, \$3.65; 500 MicroA, \$3.95; 3 Ma 2.95

RELAY CONTROL UNIT incl. Sensitive 10,000 ohm Sigma Relay (1 1/2 Ma) Thermal Bi-metal Strip, Heating Element, Hi Z Audio Choke, Mini Alnico V Magnet, Neon Lamp, Resistors, Capacitors only .99

TUBES: XFG1, RK61, 3A4, 3A5, 1A04, 6K4 Transistor .99 Storage Cells, 4V 3A/Hr, \$1.95; Electric Motor 1.00 RELAYS, 10K ohm 2 Ma DC or 110V AC SPDT 95c; SPST .85

GYRO ELECTRONICS 325-P CANAL ST. NEW YORK 13, N. Y.

GOOD BUYS—ALL NEW

SCOPE TRANSFORMER SPECIAL—All your power needs for a scope wrapped up in one package. Dual primary for 115 or 230 volt. 50/60 cycle AC. Secondaries: 6.3 v/1.8 amp; 6.3 v/0.6 amp; 700 vct/30 mA; 525 v/5 mA; 2.5 v/1.75 amp; 6.3 v/0.6 amp; 2 and 3 Kv insulation. Series secondaries give 1225 volts for satisfactory operation of CRTs to 5", by Dumont, 5 lbs. **\$3.45**

50P1/5BPIXXX \$2.45 3FP7 \$1.00 ppd. 5FP7 \$1.29 ppd.

TRANSFORMERS—These all have 115 volt, 60 cycle primaries 1000 v/30 mA; 6.3 v/0.5 amp; HS 7 lbs. \$1.69. 2/\$2.95 4000 v/10 mA; potted 10 lbs. \$1.19

6.3 vct/1 amp; HV ins; Thordarson T48B50 3 lbs. \$1.45 2 x 120 vct/10 mA each winding; HS 1 lb. 3/\$2.45

2.5 v/10 amp; 6.3 vct/3.5 amp; 6.3 vct/1 amp. 11 lbs. \$2.29

ALL PRICES F.O.B. SACTO

SEND FOR FREE SURPLUS BARGAIN BULLETIN

JOE PALMER, 1440 Las Salinas Way, Sacramento, California

7.95 LAFAYETTE SPECIAL
R/C RECEIVER



Completely wired and assembled, with tube, ready to operate on exam free 27,255 MC remote control band. Size: 1 1/2" x 1-15/16" x 3". Weight 3.3 oz. Uses one 1.5 volt and one 46 volt battery. Less batteries. Shpg. wt., 6 oz.

F-208 Net 7.95

Lafayette Radio DEPT PE-H
100 SIXTH AVE., BOSTON 10, MASS., 110 Federal St. NEWARK 2, N. J., 24 Central Ave. PLAINFIELD, N. J., 139 W. Second St. BROOK 58, N. Y., 542 E. Fordham Rd.
 include postage with order

Classified

RATE: 50¢ per word. Minimum 10 words prepaid. October Issue closes August 2nd. Send order and remittance to: POPULAR ELECTRONICS, 366 Madison Avenue, N. Y. C. 17.

FOR SALE

EAVESDROP with a pack of cigarettes. Miniature transistorized radio transmitter. Complete diagrams & instructions. \$1.25. C. Carrier Co., 734 15th St., N.W., Washington 5, D. C.

2 WAY Wrist Radio with auxiliary long distance booster. Complete diagrams and instructions. \$1.25. C. Carrier Co., 734 15th St., N.W., Washington 5, D. C.

CAR Television. Television in your car. Easy to build and install. Complete Diagrams & Instructions. \$1.25. C. Carrier Co., 734 15th St., N.W., Washington 5, D. C.

WALKIE-TALKIE chassis \$6.98. See our display ad in this issue. Springfield Enterprises.

CITIZEN'S band radio plans for building your own receiver and information on transmitter design, FCC requirements, etc. plus special discount on type approved transceivers. All for \$1.00. Springfield Enterprises, Box 54-E8, Springfield Gardens 13, N. Y.

DIAGRAMS for repairing radios \$1.00, Television \$2.00. Give make, model. Diagram Service, Box 672-PE, Hartford 1, Conn.

WALKIE-TALKIE. Build wireless portable radio- phone for less than \$10.00. Plans for variable frequency and crystal control types, only 50¢ for both, including assembly photographs. Springfield Enterprises, Box 54-E8, Springfield Gardens 13, N. Y.

TUBES-TV, Radio, Transmitting And Industrial Types At Sensibly Low Prices. New, Guaranteed 1st Quality Top Name Brands Only. Write For Free Catalog or Call Walker 5-7000, Barry Electronics Corp., 512 Broadway, New York 12N, N. Y.

COMPLETE Television sets \$11.95. Jones TV, 1115 Rambler Avenue, Pottstown, Pa.

TELEPHONE Extension in your car. Answer your home telephone by radio from your car. Complete diagrams and instructions. \$1.25. C. Carrier Co., 734 15th St., N.W., Washington 5, D. C.

HAMS! Work-the-world Alcoa all-band vertical antenna for 80, 40, 20, 15, 10, 6 meters, \$16.95 shipped collect. Guaranteed, needs little space, no guy wires. Literature. Gotham, 1805A Purdy Ave., Miami Beach, Fla.

STEREOPHONIC Pocket AM-FM-Shortwave, Ekeradio, 646 North Fair Oaks, Pasadena, California.

NEW! Pocket radio transmitter uses transistor. Plans 25¢. Complete kit only \$7.98. Free literature on all our products available at factory prices. Springfield Enterprises, Box 54-E8, Springfield Gardens 13, N. Y.

MINIATURE Six Transistor Speaker-Radio, Completely Wired \$42.95 Postpaid. Electronic Outlet, Wolcott Ave., Lawrence, Mass.

"ONE Tube DX'er" Handbook 30¢. Laboratories, 328-L Fuller, Redwood City, California.

POLICE Radar Detector. Stop before those radar speed traps. Fool proof legal system. Complete diagrams & instructions. \$2.75 C. Carrier Co., 734 15th Street, N.W., Washington 5, D. C.

DIGITAL Computers & Data Processing. Complete correspondence course covering theory of operation & applications with a comparison of 10 different medium sized systems. Complete course. \$25.00 C. Carrier Co., 734 15th St., N. W., Washington 5, D. C.

ELECTRONIC Hypnotiser. Simplifies the art of Hypnosis. Diagrams & Operating Instructions \$1.25. Kit \$16.50. Wired & tested \$29.50. C. Carrier Co., 734 15th St., N.W., Washington 5, D. C.

BE A Spy! Correspondence course on wire tapping, bugging, telescopic sound pickup, recording techniques, microphotography, invisible & remote photography, telescopic & ariel photography. Lessons in surveillance, tailing, and use of equipment. Complete course \$22.50. C. Carrier Co., 734 15th St., N.W., Washington 5, D. C.

REPLENISHED "Dollar" Instructions! Listen "Yards" Away!—"January" Classified Beginning: "Remaining!"

RADIO Workbench—The magazine for builders-experimenters. Special Transistor Issue. 25¢. Smith Electronics, Box 907, Carlsbad, New Mexico.

WHOLESALE Catalog! Discounts to 80%! Clothing, Appliances, Tools, Housewares, Jewelry, etc! Midwest, EP-156, Pontiac, Illinois.

PRINTED Circuits: Design and construct your own. Wonderful for transistor units. Copper boards, etching compound, and all instructions \$2.00. Dawntronics, PEM, 2051 Lansing, Denver 8, Colorado.

ELECTRIC Guitars, amplifiers, wholesale, free catalog. Carvin PES, Covine, Calif.

SURPLUS Electronics parts, Equipment, etc. approximately 100 pounds, \$9.95 F.O.B. Dayton. Part assortments \$3.00 and \$5.00 postpaid. #5JP2 Cathode Ray Tube \$7.50 postpaid. Jumbo 4-pin Transmitting tube sockets 4 for \$1.00 postpaid. Remittance with order. Alpine Products, Dept. 8C, 2236 Hepburn, Dayton 6, Ohio.

DIAGRAMS! Service Data! Radios \$1.00. Televisions \$1.50. TV Tube Layouts, with First Aid Service Hints, 50¢. Give Make, Model. TV Militie, Box 101-RT, Hicksville, New York.

WANTED

CYLINDER and old disc phonographs. Edison, Conqueror, Idella, and Oratorio models. Berliner Gramophones and Zono-o-phones, Columbia cylinder Graphophones, and Coin-operated cylinder Phonos. Want old catalogues and literature on early phonos prior to 1919. Will pay cash or trade late hi-fi components. **POPULAR ELECTRONICS, Box 50.**

WANTED—50 Transformers 115V 60S to 24V A.C. 50 Pull in Solenoids 24V A.C. Newman, 103 Russell Ave., Buffalo 14, N. Y.

CASH Paid! Sell your surplus electronic tubes. Want unused, clean transmitting, special purpose, receiving, TV types, magnetrons, klystrons, broadcast, etc. Also want military & commercial lab test and communications gear. We swap too, for tubes or choice equipment. Send specific details in first letter. For a fair deal write, wire or telephone: Barry, 512 Broadway, New York 12, N. Y. WALKER 5-7000.

INVENTIONS WANTED

INVENTIONS wanted. Patented; unpatented. Global Marketing Service, 2420-77th, Oakland 5, Calif.

"WANTED"—Inventions of all kinds. Write Winsco Services, 6720 South Figueroa, Los Angeles.

HELP WANTED

\$1000.00 A Month Distributing VX. Restores Your Car's Battery Life. Wanted By Millions. Proven Terrific Seller. Free Kit. National Dynamics, 480-D Lexington Ave., N. Y. 17, N. Y.

EARN High Pay: Jobs in South America, the Islands, USA, Europe, Canada other foreign countries. All Trades, Mechanics, Truck Drivers, Laborers, Office Workers, Engineers, etc. Chance to travel. Fare paid if hired. Application forms. Free information. Write Dept. 112, National Employment Information, 1020 Broad, Newark, New Jersey.

BUSINESS OPPORTUNITIES

VENDING Machines—No Selling. Operate a route of coin machines and earn amazing profits. 32-page catalog free. Parkway Machine Corporation, Dept. 12, 715 Ensor St., Baltimore 2, Md.

MAKE \$25-\$50 Week, clipping newspaper items for publishers. Some clippings worth \$5.00. Particulars free. National, 81-PE, Knickerbocker Station, New York City.

HIGH FIDELITY

DISGUSTED of "Hi" Hi-Fi Prices? Unusual discounts on all high fidelity requirements. Write now. Key Electronics Co., 120 Liberty, New York 6, N. Y.

ELECTRONIC Guitars, amplifiers, wholesale, free catalog. Carvin PEH, Covina, Calif.

TAPE RECORDERS

RECORDERS, Hi Fi, Tapes. Free wholesale catalogue. Carston, 215-P E. 88 St., N.Y.C. 28.

TAPE Recorders, Tape. Unusual Values. Free Catalog. Dressner, 69-02 F, 174 St., Flushing 65, N. Y.

RECORDER Accessories. "Build-it-Yourself" plans and kits. Details free. Le Roi Engineering, Box 251X, Elmhurst, Illinois.

INSTRUCTION

LEARN While Asleep! Complete instructions \$2.00. Guaranteed. Research Association, Box 610-PE, Omaha, Nebraska.

CODE Courses Supreme on Magnetic Recording Tape. Results guaranteed. Novice tape-Basic instruction, practice material to 8 WPM, \$5.95. Advanced tape-practice material 9 to 18 WPM, \$4.95. Combination, \$9.95. 7" dual track, 3/4 IPS. Tapedcode, Box 31-B, Langhorne, Penna.

LEARN Electronics, Earn degree at recognized college. Catalog free. Electronics Dept., Trinidad, Colorado.

REPAIRS AND SERVICING

GET Information About How To Repair Your Own T.V. Set. Send Name And Address. Holly Electronics, 518 Rider, Pampa, Texas.

MISCELLANEOUS

SONGPOEMS and Lyrics Wanted! Mail to: Tin Pan Alley, Inc., 1650 Broadway, New York 19, N. Y.

"WINEMAKING: How To Make Beer, Ale." Illustrated. \$2.00. Eaton Publications, Box 1242-C, Santa Rosa, California.

**When you order
by mail...**

please print your name and address clearly, be specific in your order, enclose proper amount, allow ample time for delivery.

Always say you saw it in—POPULAR ELECTRONICS

ADVERTISERS INDEX

ADVERTISER	PAGE
Acme Model Engineering Co.	20
Allied Radio Corp.	8, 9
Audak Company	18
Bailey Technical Schools	24
Bell Telephone Laboratories	21
CBS-Hytron	12
Capitol Radio Engineering Institute	29
Central Technical Institute	15
Cleveland Institute of Radio Electronics	17
Coyne Electrical School	5
DeVry Technical Institute	11
Electronic Instrument Co., Inc. (EICO)	34
Electronic Measurements Corp.	22
Embry-Riddle Aeronautical Institute	26
Garfield Company, Oliver	7, 112, 121, 123
General Electric Company	25
Gonset	123
Grantham Schools	32
Greenlee Tool Co.	125
Gyro Electronics	127
Heath Company	101, 102, 103, 104, 105
Indiana Technical College	124
Indianapolis Electronic School	122
Instructograph Company	122
International Business Machines Corporation	114, 115
International Correspondence Schools	13
Lafayette Radio	108, 109, 127
Lektron Specialties	113
MacFarlane Industries	122
Midway Company	126
Miller, Gustave	122
Moss Electronic Distributing Co., Inc.	130, 3rd & 4th Covers
National Company, Inc.	Second Cover
National Radio Institute	3
National Schools	19
North American Philips Co., Inc.	10
Pacific States University	126
PACO Electronics Co., Inc.	14
Palley's	121
Palmer, Joe	127
Phila. Wireless Technical Institute	120
Popular Electronic's Your Career in Electronics	111
Popular Photography	112
Port Arthur College	126
Precision Radiation Instruments, Inc.	124
Progressive "Edu-Kits" Inc.	27
RCA Institutes, Inc.	23
Raytheon Manufacturing Company	6
Researcher, The	126
Rider Publisher, Inc., John F.	28
Sprague Products Co.	124
Sprayberry Academy of Radio	117
Springfield Enterprises	30
Standard Line Electric Company	107
Surplus Center	120
Sylvania Electric Products, Inc.	125
"TAB"	129
Triplett Electrical Instrument Company	31
Tube Mart	120
U. S. Air Force	33
Valparaiso Technical Institute	126
Video Electric Company	119
Western Radio	122, 126
Whitehall Pharmaceutical Co.	124
World Radio Laboratories	16

TRANSISTOR MATCHED IN&OUTPUT XFMR'S \$2
 SNOOPERSCOPE "SEE IN DARK" TUBE & DATA SS @ 2 for \$3
 BLOWER & MINIFAN 6 & 12VAC/OP QUIET \$1.50 @ 5 for \$5
 BC457/4 to 5.3 MC'S TESTED \$4.95, BC457 AS IS \$1.69
 BC458/5.3 to 7MC'S TESTED \$5.95, BC458 AS IS \$1.98
 AR-2 H/F RCVR L.N./less TUBES \$1.89 @ 4 for \$5
 AN-METER 30VDC/2% ACCY/2" \$1.98 @ 3 for \$5
 MINIATURE METER ONE/MADC/2% ACCY Rd or Sq. \$3.89
 SLIM-JIM HIGAIN DYNAMIC MIKE & TILT STAND&XFMR \$3.89
 MICROSWITCH B-1/30AMP & ALNICO AVC MAGNET 4 for \$1
 HIV/MICA .006 MFD @ 2500 WVDC 8 for \$1
 NEW T30 THROAT MIKE REG \$5 @. SPECIAL \$1 @. 3 for \$2
 SWEDISH STEEL WOOD SAW \$16 VALUE \$3 @. 4 for \$10

NEW IMPROVED "TAB" HI-FI SPEAKERS!

15" TRIAX, 25 WATT/20-20000 CYCS. #F15H3X \$37.50
 12" TRIAX, 20 WATT/40-20000 CYCS. #F1243K \$28.50
 12" COAX, 20 WATT/35-18000 CYCS. #F1242X 22.00
 SONOTONE CA12/COAX/12WATT 40-14000 CYCS. 19.11
 B4UBUY C "TAB" FOR ALL HI-FI!!!
 DYNA MARK II 50 Watt New Kit. \$69.75
 DYNA MARK II Demonstrators Pro-Wired. \$69

\$69 ELECTRONIC FLASH! 400-III SHAWLITE \$\$\$25

Assembled & ready to work! Not a Kit. Latest features SUPER CIRCUIT—Low cost flash less than 3/4c, inhibit AC & Batteries all in one case, powerful, compact. Guide # Color 60-+ B&W 200+. Recycles 3 seeds includes 60WS/ \$24/52mfd/450WV Flash condser. Special \$20 *Batteries not included. Two (2)/240V. \$10



NEW SHAWLITE AC & BATTERY 600B/120 W/5ECDS COLOR 75+; B&W 225+; RECYCLES 5 SEC'DS, WGT. UNDER 4 LBS., 115 VAC OPTAT. BATTERY & LINE AC OPERATION. \$49.50
 600B COMPLETE BATTERY & LINE AC OPERATION. \$49.50
 NEW AC&BATTERY 1000B/240W/SECDS, WGT UNDER 6 LBS, COLOR 150+; B&W 450+; RECYCLES 7 SECDS \$49.95
 1000B COMPLETE BATTERY & LINE AC OPERATION. \$49.95
 New Photoflash Condensers Low Leakage 525 mfd/450WV/ 53WScds. Gld Famous Mfr. \$6 @. 2/\$11, 6/\$30
 "TAB" PHOTO ELECTRONIC FLASH BOOK 50c
 ILLINOIS PHOTOFLASH HANDBOOK 50c

"TAB" FINEST HI-FI RECORDING TAPE
 7" Reel—1200 Ft. Per Reel \$1.45 Lots
 Sold on Money Back Guarantee

Highest quality HI-FI Precision Coated & Slit.
 "ERIN" MGFR. & PROCESS RECORDING TAPE. Frequency constant output, Noise FREE, Splice Free Plastic Tape. Freq. 7 1/2 IPS, 40-15KC Oxide-Wind-In. \$1.59 ea.; 3/\$1.50 ea.
 New 3 1/2" Quality "MYLAR" 2400 FT. 7" Reel \$4.49
 "ERIN" MGFR & PROCESS RECORDING TAPE @ \$4.49
 "TAB" SPECIAL @ 3/\$12; 12/\$45
 Guaranteed Replacement Needles—All Cartridges
 Single Diamond \$8.98; Dual Dia \$16.98; Dia-Sapphire \$10.98
 Please Send Cartridge Name & Number

TUBES "TAB" TESTED GUARANTEED

OUR 12th YEAR IN BUSINESS

0A2	.80	9LP7	2.00	6BQ6	2.00	7Q7	.79
0B2	.72	2C22	20/\$1	6BQ7	.99	12AT6	.59
0B3	.82	7193	20/\$1	6C4	.49	12AT7	.79
0C3	.84	434A	1.98	6CB6	.69	12AU7	.69
0D3	60	60	60	6D6	1.49	12AV6	.59
0Z4	.50	CK722	.99	6H6	.59	12A6	.59
1AX2	.98	5U4	.59	6J5	.59	12AX4	.79
1B3	.78	5V4	.89	6J6	.59	12AX7	.79
1L4	.62	5Y3	.59	6K6	.59	12BH7	.89
1R4	.88	6AB4	.59	6K7	.79	12BY7	.89
1R5	.78	6AC7	.79	6L6	1.19	12SA7	.69
1S4	.76	6A5	.97	6S4	.59	12X7	.69
1S5	.68	6AH4	.89	6SA7	.79	12Y7	.69
1T4	.69	6AH6	.95	6SH7	.69	12SQ7	.69
1U5	.59	6AK5	.59	6SJ7	.69	14AT7	.69
1X2	.66	6AL5	.59	6SK7	.69	198G6	1.69
2021	.68	6AQ5	.66	6SL7	.69	258Q6	1.29
2X2	.48	6AS5	.75	6SN7	.69	25Z6	.79
2V3	.48	6AT6	.69	6SQ7	.69	35C5	.59
3A5	.69	6AU4	.89	6T4	1.19	35L6	.59
954	10/\$1	6AU6	.59	6T8	.98	35W4	.59
955	.35	6AX4	.79	6U8	.98	35Z5	.55
957	.30	6BA6	.59	6V6	.59	50A5	.69
1619	4/\$1	6BC5	.59	6W6	.79	50B5	.79
1625	.29	6BE6	.59	6X4	.39	50C5	.69
1626	5/\$1	6BF5	.79	7A8	.79	50L6	.69
1629	4/\$1	6BG6	1.49	7C5	.79	75	1.00
807	1.15	6BK5	.89	7F7	.79	75	5/\$1
808	.89	6BL7	.99	7F8	.79	77	5/\$1
5BP1	1.49	6BN6	.89	7N7	.79	117L7	1.75

FREE! WRITE TODAY FOR OUR NEW CATALOGS

KITS! Each "TAB" Kit Contains The Finest Selection

35 Precision Resistors	40 Insulators
10 Switches	35 Power Resistors
75 Resistors 1ACet1/2/1/2W	75 Mica Condensers
150 Carbon Resistors	5 Crystal Diodes
45 Panel Lamps	250 ft. Hook Up Wire, Ass't'd
12 Electrolytic Cond's	100 Fuses, ass't'd all types
15 Volume Controls	100 Ceramic Condensers
36 Tube Sockets	150 Oil Forms
65 Tubular Condensers	5 Crystals & Holders
500 Lugs & Eyelets	65 Inductors & Coils
10 Bathub Oil Cond's	5 Microswitches
5 lbs. Surprise Package	10 Wheat Lamps
10 Transmit Mica Cond's	3 Transistor Xfms

Order Ten Kits ONE EACH ABOVE
 We Ship Eleven!!! KIT ONLY 99c

Every Kit Sold On "TAB" Money Back Guarantee!

"TAB" TERMS: Money Back Gtd. (order of Mds. only). \$2 min. order F.O.B. N.Y.C. Add ship. cost for C.O.D. 25% Dep. Tubes Gtd. via R-Exp. only. Prices shown are subject to change.

111PL Liberty St., N. Y. 6, N. Y., Receptor 2-6245

Superior's new Model
670-A



ADDED FEATURE:
Built-in ISOLATION TRANSFORMER reduces possibility of burning out meter through misuse.

SUPER-METER

A combination VOLT-OHM MILLIAMMETER PLUS Capacity Reactance, Inductance and Decibel Measurements.

SPECIFICATIONS:

D.C. VOLTS: 0 to 7.5/15/75/150/750/1,500/7,500 Volts
A.C. VOLTS: 0 to 15/30/150/300/1,500/3,000 Volts
OUTPUT VOLTS: 0 to 15/30/150/300/1,500/3,000 Volts
D.C. CURRENT: 0 to 1.5/15/150 Ma. 0 to 1.5/15 Amperes
RESISTANCE: 0 to 1,000/100,000 Ohms 0 to 10 Megohms
CAPACITY: .001 to 1 Mfd. 1 to 50 Mfd. (GOOD-BAD scale for checking quality of electrolytics)
REACTANCE: 50 to 2,500 Ohms 2,500 Ohms to 2.5 Megohms
INDUCTANCE: .15 to 7 Henries 7 to 7,000 Henries
DECIBELS: -6 to +18 +14 to +38 +34 to +58

The Model 670-A comes housed in a rugged crackle-finished steel cabinet complete with test leads and operating instructions.

\$28⁴⁰

The new Model
TV-50

GENOMETER

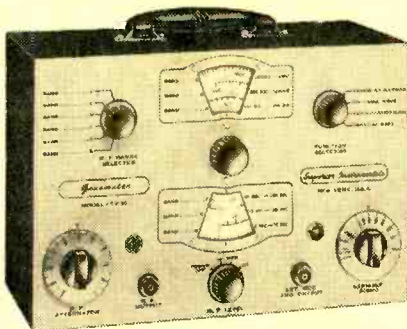

A versatile all-inclusive GENERATOR which provides ALL the outputs for servicing:

A.M. Radio • F.M. Radio • Amplifiers
Black and White TV • Color TV

7 Signal Generators in One!

- ✓ R. F. Signal Generator for A.M.
- ✓ R. F. Signal Generator for F.M.
- ✓ Audio Frequency Generator
- ✓ Bar Generator
- ✓ Cross Hatch Generator
- ✓ Color Dot Pattern Generator
- ✓ Marker Generator

R. F. SIGNAL GENERATOR: The Model TV-50 Genometer provides complete coverage for A.M. and F.M. alignment. Generates Radio Frequencies from 100 Kilocycles to 60 Megacycles on fundamentals and from 60 Megacycles to 180 Megacycles on powerful harmonics.

VARIABLE AUDIO FREQUENCY GENERATOR: In addition to a fixed 400 cycle sinewave audio, the Model TV-50 Genometer provides a variable 300 cycle to 20,000 cycle peaked wave audio signal.

CROSS HATCH GENERATOR: The Model TV-50 Genometer will project a cross-hatch pattern on any TV picture tube. The pattern will consist of non-shifting, horizontal and vertical lines interlaced to provide a stable cross-hatch effect.

DOT PATTERN GENERATOR (FOR COLOR TV): Although you will be able to use most of your regular standard equipment for servicing Color TV, the one addition which is a "must" is a Dot Pattern Generator. The Dot Pattern projected on any color TV Receiver tube by the Model TV-50 will enable you to adjust for proper color convergence.

MARKER GENERATOR: The Model TV-50 includes all the most frequently needed marker points. The following markers are provided: 189 Kc., 262.5 Kc., 456 Kc., 600 Kc., 1000 Kc., 1400 Kc., 1600 Kc., 2000 Kc., 2500 Kc., 3579 Kc., 4.5 Mc., 5 Mc., 10.7 Mc., (3579 Kc. is the color burst frequency).

BAR GENERATOR: The Model TV-50 projects an actual Bar Pattern on any TV Receiver Screen. Pattern will consist of 4 to 16 horizontal bars or 7 to 20 vertical bars.

THE MODEL TV-50 comes absolutely complete with shielded leads and operating instructions.

\$47⁵⁰

**SHIPPED ON APPROVAL
NO MONEY WITH ORDER — NO C.O.D.**

SEE FOLLOWING PAGE FOR COMPLETE DETAILS

For the first time ever: **ONE TESTER** **PROVIDES ALL THE SERVICES LISTED BELOW!**

Superior's

New Model
76



Specifications

✓CAPACITY BRIDGE SECTION

4 Ranges: .00001 Microfarad to .005 Microfarad; .001 Microfarad to .5 Microfarad; .1 Microfarad to 50 Microfarads; 20 Microfarads to 1000 Microfarads. This section will also locate shorts, and leakages up to 20 megohms. And finally, this section will measure the power factor of all condensers from .1 to 1000 Microfarads. (Power factor is the ability of a condenser to retain a charge and thereby filter efficiently.)

✓RESISTANCE BRIDGE SECTION

2 Ranges: 100 ohms to 50,000 ohms; 10,000 ohms to 5 meg-ohms. Resistance can be measured without disconnecting capacitor connected across it. (Except, of course, when the R C combination is part of an R C bank.)

As Design Engineers, we the undersigned would like to say that the Model 76 is in our opinion the best combination unit of its kind we have been privileged to design. Although it is comparatively a low-priced tester, it will, after you become acquainted with its multiple services, be your most frequently used instrument.

S. LITT
 L. MELENKEVITZ

IT'S A

CONDENSER BRIDGE

with a range of .00001 Microfarad to 1000 Microfarads (Measures power factor and leakage too.)

IT'S A

RESISTANCE BRIDGE

with a range of 100 ohms to 5 megohms.

IT'S A

SIGNAL TRACER

which will enable you to trace the signal from antenna to speaker of all receivers and to finally pinpoint the exact cause of trouble whether it be a part or circuit defect.

IT'S A

TV ANTENNA TESTER

The TV Antenna Tester section is used first to determine if a "break" exists in the TV antenna and if a break does exist the specific point (in feet from set) where it is.

✓SIGNAL TRACER SECTION

A built-in high gain pentode voltage amplifier, plus a diode rectifier, plus a direct coupled triode amplifier are combined to provide this highly sensitive signal tracing service. With the use of the R.F. and A.F. Probes included with the Model 76, you can make stage gain measurements, locate signal loss in R.F. and Audio stages, localize faulty stages, locate distortion and hum, etc. Provision has been made for use of phones and meter if desired.

✓TV ANTENNA TESTER SECTION

Loss of sync., snow and instability are only a few of the faults which may be due to a break in the antenna, so why not check the TV antenna first? The Model 76 will enable you to locate a break in any TV antenna and if a break does exist, the Model 76 will measure the location of the break in feet from the set terminals. 2 Ranges: 2' to 200' for 72 ohm coax and 2' to 250' for 300 ohm ribbon.

Model 76 comes complete with all accessories including R.F. and A.F. Probes; Test Leads and operating instructions. Nothing else to buy Only

\$26⁹⁵

SHIPPED ON APPROVAL NO MONEY WITH ORDER — NO C. O. D.

We invite you to try before you buy any of the models described on this page, the preceding page and the following pages. If after a 10 day trial you are completely satisfied and decide to keep the Tester, you need send us only the down payment and agree to pay the balance due at the monthly indicated rate.

NO INTEREST OR FINANCE CHARGES ADDED!

If not completely satisfied, you are privileged to return the Tester to us, cancelling any further obligation.

**SEE OTHER
 SIDE**

CUT OUT AND MAIL TODAY! ▶

MOSS ELECTRONIC DISTRIBUTING CO., INC.

Dept. D-360 3849 Tenth Avenue, New York 34, N. Y.

Please send me the units checked. I agree to pay down payment within 10 days and to pay the monthly balance as shown. It is understood there will be no finance or interest charges added. It is further understood that should I fail to make payments when due, the full unpaid balance shall become immediately due and payable.

- | | |
|---|--|
| <input type="checkbox"/> Model TW-11 . . . Total Price \$47.50
\$11.50 within 10 days. Balance \$6.00 monthly for 6 months. | <input type="checkbox"/> Model 670-A . . . Total Price \$28.40
\$7.40 within 10 days. Balance \$3.50 monthly for 6 months. |
| <input type="checkbox"/> Model TV-12 . . . Total Price \$72.50
\$22.50 within 10 days. Balance \$10.00 monthly for 5 months. | <input type="checkbox"/> Model TV-50 . . . Total Price \$47.50
\$11.50 within 10 days. Balance \$6.00 monthly for 6 months. |
| <input type="checkbox"/> Model 76 . . . Total Price \$26.95
\$6.95 within 10 days. Balance \$5.00 monthly for 4 months. | |

Name _____
 Address _____
 City _____ Zone _____ State _____

All prices net, F.O.B., N.Y.C.

Superior's New
Model TV-12

TRANS-CONDUCTANCE TUBE TESTER



TESTING TUBES

- **EMPLOYS IMPROVED TRANS-CONDUCTANCE CIRCUIT.** An in-phase signal is impressed on the input section of a tube and the resultant plate current change is measured. This provides the most suitable method of simulating the manner in which tubes actually operate in Radio & TV receivers, amplifiers and other circuits. Amplification factor, plate resistance and cathode emission are all correlated in one meter reading.
- **NEW LINE VOLTAGE ADJUSTING SYSTEM.** A tapped transformer makes it possible to compensate for line voltage variations to a tolerance of better than 2%.
- **SAFETY BUTTON** — protects both the tube under test and the instrument meter against damage due to overload or other form of improper switching.
- **NEWLY DESIGNED FIVE**

POSITION LEVER SWITCH ASSEMBLY. Permits application of separate voltages as required for both plate and grid of tube under test, resulting in improved Trans-Conductance circuit.

TESTING TRANSISTORS

A transistor can be safely and adequately tested only under dynamic conditions. The Model TV-12 will test all transistors in that approved manner, and quality is read directly on a special "transistor only" meter. The Model TV-12 will accommodate all transistors including NPN's, PNP's, Photo and fet's, diodes, whether made of Germanium or Silicon, either point contact or junction contact types.

ALSO TESTS TRANSISTORS!

Model TV-12 housed in handsome rugged portable cabinet sells for only

\$72⁵⁰

Superior's new Model TW-11 STANDARD PROFESSIONAL

TUBE TESTER

- Tests all tubes, including 4, 5, 6, 7, Octal, Lock-in, Hearing Aid, Thyratron, Miniatures, Sub-miniatures, Novals, Sub-minars, Proximity fuse types, etc.
- Uses the new self-cleaning Lever Action Switches for individual element testing. Because all elements are numbered according to pin-number in the RMA base numbering system, the user can instantly identify which element is under test. Tubes having tapped filaments and tubes with filaments terminating in more than one pin are truly tested with the Model TW-11 as any of the pins may be placed in the neutral position when necessary.
- The Model TW-11 does not use any combination type sockets. Instead individual sockets are used for each type of tube. Thus it is impossible to damage a tube by inserting it in the wrong socket.
- Free-moving built-in roll chart provides complete data for all tubes. All tube listings printed in large easy-to-read type.

- **NOISE TEST:** Phono-jack on front panel for plugging in either phones or external amplifier will detect microphonic tubes or noise due to faulty elements and loose internal connections.

EXTRAORDINARY FEATURE

- **SEPARATE SCALE FOR LOW-CURRENT TUBES** — Previously, on emission type tube testers, it has been standard practice to use one scale for all tubes. As a result, the calibration for low-current types has been restricted to a small portion of the scale. The extra scale used here greatly simplifies testing of low-current types.

The Model TW-11 operates on 105-130 Volt 60 Cycles A.C. Comes housed in a beautiful hand-rubbed oak cabinet complete with portable cover.



\$47⁵⁰

**SHIPPED ON APPROVAL
NO MONEY WITH ORDER — NO C. O. D.**

FIRST CLASS

Permit No. 61430

New York, N. Y.

BUSINESS REPLY CARD

No Postage Stamp Necessary if Mailed in the U. S.

VIA AIR MAIL

POSTAGE WILL BE PAID BY —

MOSS ELECTRONIC DIST. CO., INC.

3849 TENTH AVENUE

NEW YORK 34, N. Y.



We invite you to try before you buy any of the models described on this and the preceding pages. If after a 10 day trial you are completely satisfied and decide to keep the Tester, you need send us only the down payment and agree to pay the balance due at the monthly indicated rate. (See other side for time-payment schedule details.)

**NO INTEREST
OR FINANCE
CHARGES ADDED!**

If not completely satisfied, you are privileged to return the Tester to us, cancelling any further obligation.

**SEE OTHER
SIDE**

◀ CUT OUT AND MAIL TODAY!