

20 Pages Exclusively Hi-Fi

POPULAR ELECTRONICS

JULY
1957

35
CENTS

Listen While Flying

(see p. 41)

Feature Articles:

Diathermy (p. 35)

Plastic Cutter (p. 79)

Tape Recording (p. 91)

Stroboscope (p. 51)

Geiger Gun (p. 65)

E-27-11532-18
LOUIS HOFFART
18108 WINDWARD
CLEVELAND OHIO



NC-66 is shown with RDF-66 Direction Finder Accessory



PORTABLE RECEIVER
for home and away—indoors and outdoors



WORLD'S MOST VERSATILE RECEIVER! . . . a ham receiver, a 3-way portable, a marine receiver, and an SWL receiver.

For home and away—indoors and out.

National's new NC-66 offers you AC/DC-battery operation, five-band coverage from 150 kc to 23 mc, electrical bandsread with logging scale, plus a fixed-tuned CW oscillator. Housed in a handsome, rugged metal cabinet with a carrying handle, National quality is evident throughout this great new portable. You'll find it attractively functional with a long "Full-Vue" slide rule dial, a quality 5" PM speaker, and a phone jack. It also has two antennas: whip and loop stick.

For boat owners a special marine band from 150 kc to 400 kc covers maritime DF beacon service. And, of course, CD positions are clearly marked.

FEATURES:

- ★ Continuous coverage of DF beacons, AM broadcast, amateur and world-wide shortwave bands. 150-400 kc, .5 to 23 mc.
- ★ Operates on 115 volt AC or DC or self-contained batteries, or 220 volt AC with accessory adaptor.
- ★ Full electrical bandsread.
- ★ Provisions for external direction finder for marine use.
- ★ Salt spray tested.
- ★ Built-in ferrite loop antenna for DF and BC bands.
- ★ Built-in whip antenna for shortwave bands.
- ★ Receives voice or code. Has CW oscillator; and provision for phones.
- ★ "Full-Vue" slide-rule dial with easy-to-read scale. Amateur and principal shortwave bands as well as CD positions clearly marked.
- ★ Logging scale provided.
- ★ Complete with built-in speaker.
- ★ Separate switch for stand-by operation.
- ★ Handsome, modern styling: two-tone metal cabinet, chrome trim, with carrying handle, and enclosed back.

*BAND	COVERAGE
DF	150-400 KC
BC	.50-1.4 MC
1	1.40-4.05 MC
2	4.0-11.4 MC
3	11.0-23 MC

TUNING SYSTEM: Separate general coverage and bandsread tuning capacitors connected in parallel on all bands. Three gang capacitors tune antenna, RF and oscillator circuits. Bandsread knob can be used as a vernier on all frequencies.

AUDIO SYSTEM: Two-stage audio amplifier with 3V4 output tube. Has speaker and phone output jack.

CONTROLS: Main tuning; bandsread; volume control; band selector switch; AM-CW switch; stand-by-off — receive switch.

TUBE COMPLEMENT:

RF	1U4	Audio output	3V4
Converter	1L6		Rectifier
CW on-IF Amp.	1U4		
2d Det. — AVC — 1st audio	1U5		

OTHER SPECIFICATIONS:

Antenna input: 50-300 ohms, unbalanced.

Size: 12-5/16" wide x 9-11/16" high x 10" deep (overall).

Finish: two-tone gray.

Shipping weight: 16 lbs. less batteries.

Optional accessories: RDF-66 Loop, 220V. adaptor.

Only \$12.95* down

Up to 20 months to pay at most Receiver Distributors.

*Suggested Price: \$129.95**

RDF-66 Direction Finder Accessory available at additional cost

**Prices slightly higher west of Rockies and outside U. S. A.

BURTON BROS. NEW YORK

Eight out of 10 U. S. Navy ships use National receivers

SINCE 1914 **National**  COMPANY, INC., Malden 48, Mass.

tuned to tomorrow



YOU BUILD Broadcasting Transmitter

As part of N.R.I. Communications Course you build this low power Transmitter; use it to learn methods required of commercial broadcasting operators, train for FCC license.

YOU BUILD Signal Generator

N.R.I. sends kits of parts to build this Signal Generator. You get practical experience, conduct tests to compensate Radio frequency amplifiers, practice aligning a typical I.F. video amplifier in TV circuit, many other experiments.

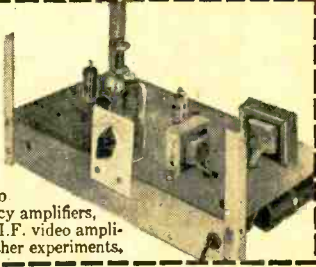

YOU BUILD Vacuum Tube Voltmeter

Use it to get practical experience, earn extra cash fixing neighbors' sets in spare time, gain knowledge to help you work in Radio, Television, Color TV. With N.R.I. training you work on circuits common to both Radio and TV. Equipment you build "brings to life" things you learn in N.R.I.'s easy-to-understand lessons. 64 page Catalog FREE, shows all equipment you get.

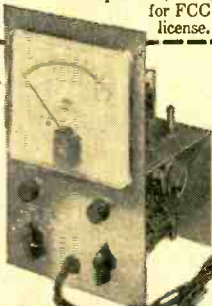

YOU BUILD AC-DC Superhet Receiver

N.R.I. servicing training supplies all parts, everything is yours to keep. Nothing takes the place of practical experience. You get actual servicing experience by practicing with this modern receiver; you learn-by-doing.



Learn RADIO TELEVISION by Practicing at Home

WHAT GRADUATES DO AND SAY

Chief Engineer

"I am Chief Engineer of Station KCCU in Mandan, N. D. I also have my own spare time business servicing high frequency two-way communications systems." R. BARNETT, Bismarck, North Dakota.



Paid for Instruments

"I am doing very well in spare time TV and Radio. Sometimes have three TV jobs waiting and also fix car Radios for garages. I paid for instruments out of earnings." G. F. SEAMAN, New York, N. Y.



Has Own TV Business

"We have an appliance store with our Radio and TV servicing, and get TV repairs. During my Army service, NRI training helped get me a top rated job." W. M. WEIDNER, Fairfax, South Dakota.



NEED FOR TECHNICIANS INCREASING Fast Growing Field Offers Good Pay, Bright Future

Today's OPPORTUNITY field is Radio-Television. Over 125 million home Radios plus 30 million sets in cars and 40,000,000 Television sets mean big money for trained Radio-TV Technicians. More than 4,000 Radio and TV Broadcasting stations offer interesting and important positions for technicians, operators. Color television, portable TV sets, Hi-Fi, other developments assure future growth.

It's the trained man who gets ahead. The fellow who uses his spare time to develop knowledge and skill gets the better job, drives a better car, lives in a better home, is respected for what he knows

and can do. So plan now to get into Radio-TV.

Keep your job while training with N.R.I. You learn at home in your spare time. N.R.I. is oldest and largest home study Radio-TV School. Our methods have proved successful for more than 40 years, provide practical experience.

Soon after enrolling, many N.R.I. students start to earn \$10, \$15 a week extra in spare time fixing sets. Many open their own full time Radio-TV shops after getting N.R.I. Diploma. Find out more. Mail Coupon. Cost is low, terms easy; includes all equipment. Address: **National Radio Institute, Dept. 7GD4, Washington, D. C.**

Send for
**LESSON
and CATALOG
FREE**

VETERANS
Available under
G.I. Bills



MAIL COUPON NOW

NATIONAL RADIO INSTITUTE
Dept. 7GD4, Washington, D. C.

Mail me Sample Lesson and 64-Page Catalog, FREE. (No Salesman will call. Please write plainly.)

Name _____ Age _____

Address _____

City _____ Zone _____ State _____

ACCREDITED MEMBER, NATIONAL HOME STUDY COUNCIL

POPULAR ELECTRONICS is published monthly by Ziff-Davis Publishing Company, William B. Ziff, Chairman of the Board (1946-1953), at 64 E. Lake St., Chicago 1, Ill. Entered as second class matter August 27, 1954 at the Post Office, Chicago, Illinois. SUBSCRIPTION RATES: One year U.S. and possessions, and Canada \$4.00; Pan-American Union countries \$4.50, all other foreign countries \$5.00.

POPULAR ELECTRONICS

VOLUME 7

NUMBER 1

CONTENTS

FEATURE Articles and Electronic Developments

What You Should Know About DIATHERMY . . . Harvey Pollack and H. H. Fantel	35
Pigantics	39
Dig That Crazy Ribbon Ron Anderson	43

ELECTRONIC Build-It-Yourself Projects

The V. H. F. Ear William I. Orr	41
Building a Sensitive "Comparator" I. C. Chapel	47
Junk Box BC Special W. C. Wilson	49
The "Varistrobe"—High Speed Stroboscope Freezes Motion	
Harvey Pollack	51
Double Your Heathkit AT1 Output Herb S. Brier	55
The "Economy" Transistor Checker Richard Graham	59
Geiger Gun John J. Borzner	65
Clean Out the Junk Box with a Capaci-Meter R. L. Winklepleck	67
The GP Amplifier Louis E. Garner, Jr.	73
Hot Wire Plastic Cutter Harvey Pollack	79

AUDIO and Hi-Fi Features

Damp Before Your Ears Leonard Feldman	57
First Steps in Record Player Maintenance D. C. Marshall	62
Hi-Fi Cabinets=Beauty + Utility	75
Lexicon of the Hi-Fi Builder Rodrigues	86
Shakeproof Your Hi-Fi Turntable Robert Sampson	87
How to Make GOOD Tape Recordings Jeanne Hickam	91
Reel Tricks for Tape Recordists Ron Anderson	95

Experimenter's Workshop

Rejuvenating Old Decals D. Derek Verner	48
Simplest Code Practice Set Art Trauffer	48
Vector-Type Plug-In Unit Jules O'Shea	48
Easily Made Adapters for Experimental Work Art Trauffer	61
Mounting Flat Ferrite Antenna Coils Frank H. Tooker	66
Air Cell Replaces Battery I. C. Chapel	72
Mirror Sees Around Corner Bob Curry	72
Transistor Identification Frank H. Tooker	72
Eye Brush/Needle Brush Andrew D. Setlow	90
Keep a Pencil Eraser Handy Art Trauffer	90
Shielded Radio Lead-In Reduces Noise Eugene F. Coriell	90

DEPARTMENTS

Carl & Jerry John T. Frye	10
Letters from Our Readers	22
POP'ronics Bookshelf	28
The Transmitting Tower Herb S. Brier	76
Kit Builder's Korner	81
After Class	82
Sound Impressions	84
Transistor Topics Lou Garner	97
Tools and Gadgets	99
Tuning the Short-Wave Bands Hank Bennett	101
Tips and Techniques	102

(Also see page 6 for MISCELLANEOUS ELECTRONIC NEWS)

Cover photo by Maynard Frank Wolfe

Copyright © 1957 by Ziff-Davis Publishing Company. All rights reserved.

Average Net Paid Circulation 236,551

JULY

1957

Publisher

OLIVER READ, W1ETI

Managing Editor

OLIVER P. FERRELL

Technical Editor

CHARLES S. TEPPER

Associate Editors

HANS H. FANTEL
MARGARET MAGNA

Editorial Assistant

ARDEANE TRATZKI

Contributing Editors

H. BENNETT L. E. GARNER, JR.
H. S. BRIER H. POLLACK
N. EISENBERG R. P. TURNER
J. T. FRYE

Art Editor

ALFONS J. REICH

Art and Drafting Dept.

J. A. GOLANEK M. WHELPLEY
W. K. VAHLSING J. A. ROTH

Advertising Director

L. L. OSTEN

Advertising Manager

WILLIAM G. McROY



ZIFF-DAVIS PUBLISHING CO., 366 Madison Ave., New York 17, N. Y. B. G. Davis, President; William Ziff, Administrative Vice President; H. J. Morganroth, Vice President; Michael H. Froelich, Vice President; Michael Michaelson, Vice President and Circulation Director; George Carney, Secretary-Treasurer; Albert Gruen, Art Director.



Member Audit Bureau of Circulations



BRANCH OFFICES: Midwestern Office, 64 E. Lake St., Chicago, Ill., John A. Ronan, Jr., manager; Western Office, Room 412, 215 W. 7th St., Los Angeles 17, Calif., John E. Payne, manager.

SUBSCRIPTION SERVICE:

All communications concerning subscriptions should be addressed to Circulation Dept., 64 E. Lake St., Chicago 17, Ill. Include your old address as well as new—enclosing if possible an address label from a recent issue of this magazine. Allow at least 4 weeks for change of address.

CONTRIBUTORS:

Contributors are advised to retain a copy of their manuscripts and illustrations. Contributions should be mailed to the New York Editorial Office and must be accompanied by return postage. Contributions will be handled with reasonable care, but this magazine assumes no responsibility for their safety. Any copy accepted is subject to whatever adaptations and revisions are necessary to meet the requirements of this publication. Payment covers all author's, contributor's and contestant's rights, titles, and interest in and to the material accepted and will be made at our current rates upon acceptance. All photos and drawings will be considered as part of material purchased.

POPULAR ELECTRONICS

Train in Great Shops of COYNE for better jobs in



TWO TOP OPPORTUNITY FIELDS

Whether 17 or up to 45 years of age, train the Coyne way for a better job and a real future in **ELECTRICITY-ELECTRONICS** or **TELEVISION-RADIO**, fields that offer a world of opportunities. Train on real, full-size equipment at COYNE where thousands of successful men have trained for nearly 60 years—largest, oldest, best equipped school of its kind—established 1899. No advanced education or previous experience needed. Employment service to graduates. **START NOW—PAY LATER**—Liberal Finance Plans and Easy Payment Plans. Also part-time employment help for students. Training in Refrigeration and Electric Appliances can be included.

B. W. COOKE Jr., President



FOUNDED 1899

A Technical Trade Institute Operated Not For Profit
500 S. Paulina Street, Chicago, Dept. B7-71H

ELECTRICITY • RADIO • TELEVISION • REFRIGERATION • ELECTRONICS

MAIL COUPON FOR FREE BOOK

Send coupon for 48-page illustrated book "Guide to Careers in Electricity-Electronics and Television-Radio." No cost; no obligation; no salesman will call. Vets and Non-Vets get vital facts now!



B. W. COOKE Jr., President
COYNE ELECTRICAL SCHOOL
500 S. Paulina St., Chicago 12, Ill., Dept. B7-71H

Send **BIG FREE** book and details of your training offer. This does not obligate me and no salesman will call. I am interested in:

() Electricity-Electronics () Television-Radio

Name _____

Address _____

City _____ State _____

COYNE offers
LOW COST
TELEVISION
RADIO - COLOR TV
Training in
Spare Time **AT HOME**



The future is **YOURS** in **TELEVISION!**
A fabulous field—good pay—fascinating work—a prosperous future in a good job, or independence in your own business!

Coyne brings you **MODERN-QUALITY** Television Home Training; training designed to meet Coyne standards at truly lowest cost—you pay for training only—no costly "put together kits." Not an old Radio Course with Television "tacked on." Here is **MODERN TELEVISION TRAINING** including Radio, UHF and Color TV. No Radio background or previous experience needed. Personal guidance by Coyne Staff. **Practical Job Guides** to show you how to do actual servicing jobs—*make money early in course*. Free Life-time Employment Service to Graduates.

COYNE
ELECTRICAL SCHOOL
A TECHNICAL TRADE INSTITUTE OPERATED
NOT FOR PROFIT
500 S. Paulina Street, Chicago 12, Dept. B7-HT7

B. W. COOKE, Jr.,
President



Coyne—the Institution behind this training... the largest, oldest, best equipped residential school of its kind. Founded 1899.

Send Coupon for Free Book

and full details, including easy Payment Plan. **No obligation, no salesman will call.**

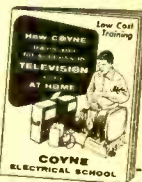

COYNE Television Home Training Division
500 S. Paulina St., Chicago 12, Ill.
Dept. B7-HT7

Send Free Book and details on how I can get Coyne Quality Television Home Training at low cost and easy terms.

Name _____

Address _____

City _____ State _____

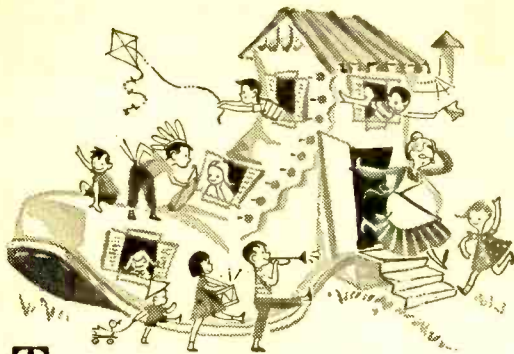

There was an old woman
Who lived in a shoe
Had so many children
She knew not what to do

The children were naughty
And so filled her with dread
That the little old woman
Wished she were dead

A simple solution
Which brought happiness
Was the prompt installation
of Norelco . . . F.R.S.

These wonderful speakers
(Twin-coned and true)
Produced marvelous music
Throughout the shoe

The effect . . . tranquilizing
The children . . . asleep
Now the little old woman
Good order can keep

For the full throated music
Resounds through the shoe
The children are spellbound
As you will be too

So go to your dealer
Do it today
And find out how "Hi-Fi"
Your victrola can play

*Norelco*F.R.S. Speakers are available in 5", 8" or 12" sizes in standard impedances. Priced from \$6.75 to \$59.98.*

ADD TO . . . and improve any sound system
with **Norelco® *FULL RESPONSE SPEAKERS**

Write today to Dept. N7 for brochure and prices of these unique speakers.

NORTH AMERICAN PHILIPS CO., INC.
High Fidelity Products Division
230 Duffy Ave. Hicksville, L. I., N. Y.



MISCELLANEOUS ELECTRONIC NEWS

"Spot Wobble" Unlines TV Picture	38
Stereoscopic TV for "Hot Stuff"	38
"Car Call" Receivers	40
Ninth ARRL Convention	40
Priest Chases Trains	40
Weathervision Forecasting	40
Chasing Sferics	46
Electronic Vacuum Pump	46
New Station Listing Out	46
No Light in Your Eyes	46
Landlocked Marine Laboratory Yaws and Pitches	50
Far Cry from the "Cuckoo" Clock	64
"Kid-Tested" Kit for Easy Audio	64
Kiss and Tell	64
Stereophonic Chair	64
Monitor System Saves \$\$\$	71
Sunspots Aid Reception	71
Telephoned "Spots"	71
Which End Is Up?	71
BIZMAC at Bat—"Brain" Predicts 1957 Averages	94

COMING NEXT MONTH (AUGUST)

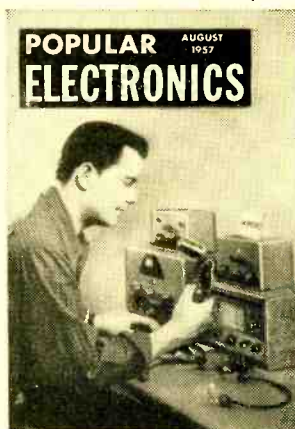

(ON SALE JULY 18)

These are some of the things to look for in August: the first in a new series of electronic games—a transistorized circuit for testing hand steadiness; a photo story on all the ways to use a soldering gun; another "first" in a series on oscilloscope uses; a gadget to protect loudspeakers; a two-tube amplifier with four-tube performance; predictions on the future of the "fourth speed" (16 $\frac{2}{3}$ rpm) in record changers and turntables; a simple method of identifying unmarked capacitors; how to build an etched circuit receiver; a booster for your AM radio; and a gadget that will permit photography enthusiasts to vary floodlights right from tripods.

IN THIS MONTH'S RADIO & TV NEWS (JULY)

Tracking the Man-Made Satellite
Portable Tape Recorder Amplifier
All About Audio and Hi-Fi—Room Resonance and Stereo
TV Sound Can Be Improved
Transistor Intercom System

New! A MACHINE THAT COMPOSES MUSIC

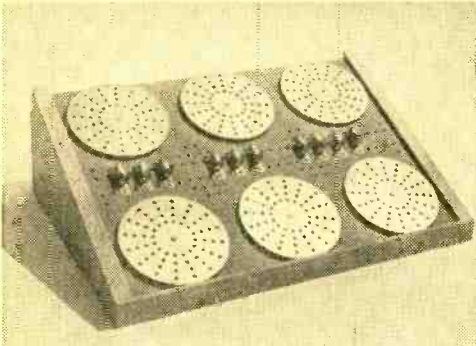

Actual tune composed on GENIAC

**COMPUTES, "REASONS"
PLAYS GAMES**

**GENIAC
ELECTRIC BRAIN**

BUILD IT YOURSELF in a few hours!

Yes, you build any one of 33 exciting electric brain machines in just a few hours by following the clear-cut, step-by-step directions given in a thrilling booklet! No soldering required . . . no wiring beyond your skill! GENIAC is a genuine brain machine—not a toy. The **only** logic machine kit that not only adds, subtracts, etc., but presents the basic ideas of cybernetics, Boolean algebra, symbolic logic, automation, etc. So simple to construct that even a twelve-year-old can make a machine that will fascinate people with advanced scientific training! With the special circuitry of GENIAC, the Electric Brain Construction kit, you can compose tunes automatically. These new circuits were never available before!

OVER 400 COMPONENTS AND PARTS. Circuits operate on one flashlight battery, and the use of ingeniously designed parts makes building circuits one of the most fascinating things you've ever done! You set up problems in a variety of fields—and get your answers quicker than you can set them up! Play games with the machine—nim, tic-tac-toe, etc.—and pit your brain against its logic! Solves puzzles in a few seconds that would take you hours without the aid of the machine. You actually see how computing and problem-solving is analyzed with algebraic solutions transferred directly into circuit diagrams.

YOUR COST FOR GENIAC KIT: only \$19.95 postpaid. The 1957 Model GENIAC KIT contains: (1) a complete 200-page text, "Minds and Machines"—a basic introduction to computers. (2) "How to Construct Electrical Brains At Home"—a fully illustrated text book on basic computer design theory and circuits with specific instructions for building circuits. (3) Wiring Diagram Manual. A special booklet with full scale diagrams that you can tear out and place on your work bench for easy assembly. (4) Beginners' Manual. Starting from scratch, the manual adds extra experiments, thoroughly tested using GENIAC components to teach the basic symbols of electric circuits. (5) Over 400 components and parts.

So—mail the coupon for your GENIAC today! Your money back if not delighted!

Some Firms and Institutions that have ordered GENIAC:

Allis-Chalmers
Remington-Rand
International
Business
Machines
Wheeldex Mfg. Co.
Manuel Missionary
College

Walter V. Clarke
Associates
Barnard College
Westinghouse
Electric
Phillips
Laboratories

General Insurance
Co. of America
Lafayette Radio
Rohr Aircraft Co.
Albert Einstein
Medical College
Naval Research
Laboratories

Los Angeles
Public Schools
Kansas State
University
Duke University
Coral Gables
Bell Telephone
Laboratories

K1—Only
\$19⁹⁵

(Add \$1.00 W. of Miss.
\$2.00 Outside U. S.)

UP TO DATE?

Is your knowledge of these new technical fields rusty? Perhaps you never had time to study them but need to now. Write for free information about our new, modern, low-cost course. Work at your own speed at home. Check those that interest you.

- PHYSICS**
- High School Physics
 - Part 1—P1A
 - Part 2—P1B
 - College Physics
 - Part 1—P2A
 - Part 2—P2B

- MATHEMATICS**
- Trigonometry
 - Algebra
 - Solid Geometry
 - Calculus
 - Statistics

- CHEMISTRY**
- High School
 - College
 - Analytic
 - Qualitative
 - Quantitative
 - Organic
 - Physical

- BIOLOGY**
- High School
 - Human Biology
 - Zoology
 - Botany
 - Genetics

- ELECTRONICS**
- Television P3A
 - Radio P3B
 - Radar—Theoretical P3C1
 - Radar—Practical P3C2
 - Musical Instruments P3D
- PSYCHOLOGY**
- Acoustics Hi-Fi P4
 - Nuclear Physics P5
 - Analog Computer C3
 - Digital Computer C2
 - Memory Storage C1
 - Construction of Robots PS7

- Normal PS1
- Child PS2
- Abnormal PS3
- Mental Hygiene PS4
- Aptitude Test PS5
- Rapid Reading PS6
- Construction of Robots PS7

Please send me GENIAC Kit. \$19.95 (Add \$1.00 West of Mississippi or \$2.00 Outside U. S.)

OLIVER GARFIELD CO., Dept. PE-77A, 31 Broadway, New Haven, Conn.

Name..... Age..... Occupation.....
City..... Zone..... State.....

BUILD THE BEST—

BUILD ALLIED'S OWN

knight-kits

LOWEST COST because our giant buying power passes biggest savings on to you... you do the easy assembly, get professional results, and **SAVE!**



knight-kits

EASIEST TO BUILD because KNIGHT-KIT "Step-and-Chek" instruction manuals are marvels of clarity—it's just like having a good instructor at your side.



knight-kits

MONEY-BACK GUARANTEE: When properly assembled, KNIGHT-KITS fully meet published specifications, or we refund your money.

EASY TERMS AVAILABLE



FREE SUPPLEMENT

featuring **knight-kits**



Send for our special Supplement No. 165 featuring the complete line of KNIGHT-KIT Test Instruments, Hobby, Hi-Fi and Amateur Kits. Send for it today.

FASCINATING NEW TRANSISTOR KITS

knight-kit 10-CIRCUIT TRANSISTOR LAB KIT



Model Y-299

\$15.45

Sensational—work with transistors! Assemble the basic parts once, then complete project after project (10 in all), just by plugging leads into proper jacks on printed-circuit board—no wiring changes needed. Make the following: AM radio; amplifier; wireless broadcaster; code practice oscillator; electronic timer, switch, flasher; voice-operated, capacity-operated and photoelectric relays. Includes all parts, 2 transistors, battery, headphones, instructions for projects. Shpg. wt., 3 lbs.

Model Y-299. Net only..... **\$15.45**

knight-kit 2-TRANSISTOR POCKET RADIO KIT



Model Y-262

\$14.65

Build this pocket-size, two-transistor radio—enjoy loud, clear broadcast-band reception wherever you go! Completely self-contained with built-in ferrite loop antenna—no external antenna required. Printed-circuit board for easiest assembly. Highly efficient reflex-type circuit operates for months and months on long-life alkaline battery supplied. Super-sensitive miniature earpiece gives remarkably good tone. With all parts, including simulated leather case, earpiece and transistors. 4 x 3 3/4 x 1 3/4". Shpg. wt., 1 1/2 lbs.

Model Y-262. Net only..... **\$14.65**

knight-kit TRANSISTOR RADIO HOBBY KIT



Model Y-765

\$4.35

Experiment with the marvel of transistors! Printed circuit mounting board simplifies assembling. Just mount components, solder a few connections and enjoy excellent AM broadcast reception. Compact; fits in palm of your hand; operates from single penlight cell that lasts for months. Complete with all parts, transistor and penlight cell. Easy to assemble. Shpg. wt., 1 lb.

Model Y-765. Net only..... **\$4.35**
Y-266. Headset and Antenna Kit for above... **\$3.15**

FOR HOURS OF LISTENING PLEASURE

knight-kit "SPACE-SPANNER" BANDSWITCHING RECEIVER KIT



Model Y-243

\$15.95

Thrilling 2-band receiver, easy to build—a great value. Bandswitch selects exciting short wave, including amateur, aircraft, police and marine radio (6 to 18 mc), and standard broadcast. Highly sensitive regenerative circuit. Has 4" PM speaker and beam-power output for strong volume. Kit includes calibrated panel, punched chassis, all parts and tubes (less cabinet). Easy to build from step-by-step instruction manual. 7 x 10 1/2 x 6"; for 110-120 v. 50-60 cycle AC or DC. Shpg. wt., 5 lbs.

Model Y-243. Net only..... **\$15.95**
Y-247. Matching cabinet for above..... **\$2.90**

knight-kit "OCEAN HOPPER" RECEIVER KIT



Model Y-740

\$11.75

Tops for exciting broadcast, long wave and short wave reception. Covers 155 to 35.0 mc with plug-in coils (below). Sensitive regenerative circuit; bandspread; for headphone or speaker use. Complete with all parts, tubes and broadcast band coil (less cabinet). Shpg. wt., 5 lbs.

Model Y-740. Net only..... **\$11.75**
Y-746. Matching cabinet for above..... **\$2.90**
Y-741. Long Wave Coil (155-470 kc)..... **79c**
Y-742. 1.65-470 kc coil. Y-745. 7-17.5 mc coil } **79c**
Y-743. 2.9-7.3 mc coil. Y-744. 15.5-35 mc coil } **65c**

ORDER FROM **ALLIED RADIO** 100 N. WESTERN AVE., CHICAGO 80, ILL.

FAVORITE HOBBY KITS

knight-kit 2-WAY INTERCOM SYSTEM KIT



Model
Y-295
\$1475

Easy to build—ideal for home or office. Consists of Master and Remote unit, each with press-to-talk switch. Remote can be left "open" for distant answering or baby-sitting. In "closed" position, Remote remains private, but can be called and can originate calls. High-gain 2-stage amplifier and 4" PM speakers. Delivers full volume from only a whisper. With tubes and 50-ft. cable. (Up to 200-ft. may be added.) Each unit 4 3/4" x 6 1/2" x 4 3/4"; antique white finish. For AC or DC. Easy to assemble. Shpg. wt., 8 lbs.

Y-295. Net only **\$14.75**

knight-kit PHOTO-ELECTRONIC RELAY KIT

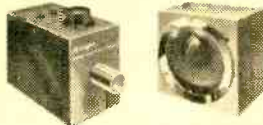

Model
Y-702
\$1350

Advanced-design, ultra-sensitive photo-electronic system at low cost. Covers 250 ft. with white light—125 ft. with "unseen" light. Consists of Relay kit and Light Source kit, below. Ideal as announcer, counter, burglar alarm (can be set to ring bell continuously when beam is broken). Hundreds of other uses. SPST relay contacts. 6.3-v. terminals provide power for accessories. For 105-120 v., 50-60 cycle AC. Shpg. wt., 6 lbs.

Model Y-702. Relay kit. Net only **\$13.50**
Model Y-703. Light Source kit. Net only **\$6.75**

EXCLUSIVE TEST EQUIPMENT VALUE

knight-kit "IN CIRCUIT" CAPACITY CHECKER KIT



Model
Y-119
\$1250

Remarkable unit checks capacitors while they're still wired in the circuit! All you do is press a button—and the "magic eye" shows opens and shorts. Tests opens and

shorts on capacitors of 20 mmf or greater, even if in parallel with a resistance as low as 50 ohms. Complete; easy to build. Shpg. wt., 5 lbs.

Model Y-119. Net only **\$12.50**

SEND FOR FREE SUPPLEMENT!

SEE ALL THE GREAT KNIGHT-KITS

- 23 Test Instruments
- 17 Fascinating Hobby Kits
- 4 Top Value Hi-Fi Kits
- 5 Great Amateur Kits

SEND FOR IT TODAY



ALL PRICES NET F.O.B. CHICAGO
EASY TERMS AVAILABLE

BUILD YOUR OWN HI-FI AND SAVE!

SENSATIONAL knight-kit HI-FI FM TUNER KIT

Model
Y-751
\$3775



The best-looking, best-performing tuner kit your money can buy. Covers 88 to 108 mc; features AFC (with special disabling feature); pre-adjusted RF coils; pre-aligned IF'S; cascode broadband RF amplifier; drift-compensated oscillator; fly-wheel tuning control; illuminated lucite pointer. Sensitivity is 10 microvolts for 20 db of quieting across entire band. Printed circuit—no critical wiring. Ideal for use with 20-Watt Knight-Kit amplifier below, or any amplifier with phono-tuner switch. Easy to build—a custom Hi-Fi Tuner you'll be proud of! Shpg. wt., 12 lbs.

Model Y-751. Basic FM Tuner Kit. Net only **\$37.75**

knight-kit 20-WATT HI-FI AMPLIFIER KIT

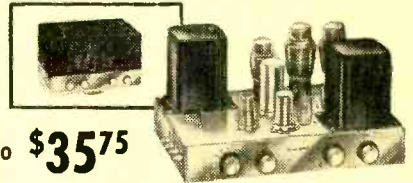

Model Y-750 **\$3575**

Ideal for use with above tuner—delivers deluxe Hi-Fi sound. Includes built-in preamp; inputs for magnetic phono, mike, recorder and tuner; record compensator; bass and treble controls, etc. Response: ±1 db, 20-20,000 cps. Distortion: 1% at 20 watts. Outputs: 4, 8, 16, 500 ohms. Chrome-plated chassis, 7 x 13 x 8 3/4". With all parts, tubes and easy instructions. Shpg. wt., 20 lbs.

Model Y-750. Net only **\$35.75**
Y-758. Metal enclosure for above; black finish **\$4.15**

SAVE \$4.00 ON TUNER-AMPLIFIER COMBINATION

SPECIAL—own the FM Tuner plus the 20-watt Amplifier (including metal enclosure) for only \$73.65. Save \$4.00 on this matched combination. Shpg. wt., 32 lbs.

Y-761. Knight-Kit Tuner and 20-Watt Amplifier. Net. **\$73.65**
Only \$7.37 down on our Easy Pay Plan

ORDER FROM ALLIED RADIO

OUR
36th
YEAR

ALLIED RADIO CORP., Dept. 079-G7
100 N. Western Ave., Chicago 80, Ill.

Ship me the following KNIGHT-KITS:

Quantity	Model	Description

\$ _____ enclosed. For parcel post, include postage (express is shipped collect).

Send me your FREE Supplement No. 165 describing all Knight-Kits.

Name _____

Address _____

City _____ Zone _____ State _____

COMPACT, POPULAR, LOW COST . . .

THE RELIABLE

Globe Scout 680

Bandswitching 6-80M, Fone & CW

Only \$99.95

KIT: \$84.95



Wired, Only
\$810
per mo.
10% Down

Compact, completely bandswitching transmitter for 6-80 Meters; allows operation of 6 M band by technicians, novice CW bands, or use by advanced ham without becoming obsolete. Completely self-contained with built-in power supply, for 65 watts CW, 50 watts phone. High level modulation. TVI-shielded cabinet. Pi-Net output on 10-80M; link-coupled output on 6M, matching into low impedance beams. New-type shielded, full-range plastic meter for better readability. Adaptable for Mobile Operation.

Globe Scout 66, as shown, but for Range 10-160M, wired, Only: \$99.95

THE FAST-SELLING

Globe Chief 90

Only \$67.50

Kit: \$54.95

Wired, Only

\$547
per mo.

10% Down



Handsome 90 watt Xmtr. with meter indication at 75 watts, allowing the Novice all the power he can legally use. Self contained, completely bandswitching, 100-10M. Combination Pi-Net, with provisions for antenna changeover relay, speech modulator input, VFO input and operation. Modified Grid-Block Keying for max. safety. Has complete, well-filtered power supply. Kit contains pre-punched chassis, all parts and detailed assembly instructions.

THE TIME-TESTED

Screen Modulator Kit

Designed specifically for use with the above Globe Chief Transmitter, but may be used with similar CW transmitters such as the Heath AT-1, Johnson Adventurer, Knight 50 watt, etc. Permits radio-phone operation at minimum cost. Self contained. All parts, connections to transmitter, 2 dual purpose tubes and detailed assembly manual included.

Only \$13.95

For detailed brochures, write to

WORLD RADIO LABORATORIES

"The World's Largest Distributor of Amateur Radio Equipment"

3415 W. Broadway Council Bluffs, Iowa

Phone 2-0277

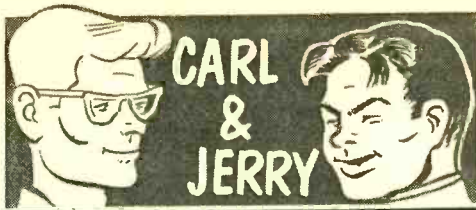

By JOHN T. FRYE

Brain Waves

SO FAR, July had been a real sizzler, and the basement laboratory was the coolest place Carl and Jerry could find. Jerry was stretched out on his favorite old leather couch along the wall, and Carl was sitting on the workbench swinging his long legs back and forth with the nervous energy that made it impossible for him to be perfectly still for long.

"Jer," he said impatiently, "let's do something."

"Such as what?" Jerry asked drowsily, without opening his eyes.

"I don't care what. I just want to do something interesting. Summer vacation is slipping away, and before you know it we'll be back in the brain factory."

"Hm-m-m, 'brain factory'," Jerry mused. "Now there might be an idea. Remember that article on 'Electronic Hypnosis' that appeared in the April issue of POPULAR ELECTRONICS?"

"Sure, I remember—the biocontrol story; but what are you thinking?" Carl asked suspiciously.

"I just thought we might fool around and see if we could detect the presence of those brain waves they mentioned," Jerry said with elaborate casualness.

"Hold it, Brother Bishop!" Carl exclaimed. "If you think for one cotton-picking minute that you're going to drill holes in *my* noggin and insert electrodes in *my* brain, you've got another think coming."

"Now don't talk as though you already had a hole in your head," Jerry said soothingly. "I've nothing like that in mind. I've been talking about this to Dr. Diamond out at the State Hospital, and he says that the modern encephalograph picks up brain waves through electrodes merely attached to the scalp. Eight electrodes are used, and the signal from each electrode drives a scribing pen which moves back and forth across a roll of paper which is itself moving at a uniform speed. This paper is marked off in fifth-of-a-second intervals for that speed. The end result is a permanent record of the amplitude, the frequency, and the waveshape—all of which may be important for diagnostic purposes—of the tiny volt-

DeVry Tech Specializes in Training Men

IN THEIR SPARE TIME AT HOME TO BECOME Electronic Technicians

Did you ever stop to think how much your happiness depends on having the right job? Getting your bills paid, living the life you want, doing the kind of work you like . . . ?

The right job (a promotion) with your present employer, or a good job with a new employer, would help solve such problems for you, wouldn't it?

DeVry Tech, with a successful 26-year record of training men for industry, offers you a real opportunity for a better job or your own profitable service shop . . . in one or more branches of the fast-growing field of Electronics.

We can show you a way to a more interesting and brighter future without interfering with your present job. We can give you all of this in your spare time at home . . . or in our well-equipped Chicago or Toronto training centers.

Find out how Electronics may give you a brighter and more profitable tomorrow. It will cost you nothing to get the facts. Fill in coupon below. We think this information is worth a postage stamp, don't you?

ELECTRONICS AT WORK AT DEVRY TECH

Jack Dempsey, T. J. Lafeber, President, watch student Joe Skala solve a problem with the Electronic Analog Computer in DeVry Tech's Chicago training center.



AN INDEX TO A BETTER JOB, BRIGHTER FUTURE

**NO PREVIOUS TECHNICAL EXPERIENCE,
NO ADVANCED EDUCATION REQUIRED**

Live-Wire Employment Service

DeVry Tech's Placement Department is in contact with some of the best-known employers in the Electronics field. The service is free to all graduates — and DeVry Tech's record in helping to place men has been outstanding.



DRAFT AGE?

We have valuable information for every man of draft age; so if you are subject to military service, be sure to check the coupon.

A SAMPLE LESSON FREE!

See for yourself how DeVry Tech trains you for real opportunities in Electronics. We'll also give you a free copy of an interesting booklet, "Electronics and YOU."



"One of North America's Foremost Electronics Training Centers"

Accredited Member of
National Home Study Council



DEVRY TECHNICAL INSTITUTE

CHICAGO 41, ILLINOIS

FORMERLY

DEFORST'S TRAINING, INC.



MAIL COUPON TODAY

DeVry Technical Institute
4 41 Belmont Avenue, Chicago 41, Ill., Dept. PE-7-N

Please give me a FREE Sample Lesson and your booklet, "ELECTRONICS AND YOU," and tell me how I may prepare to enter one or more branches of Electronics as listed above.

Name _____ Age _____

Please Print

Street _____ Apt. _____

City _____ Zone _____ State _____

Check here if subject to military training

#1022 DeVry Tech's Canadian Training Center is located at
626 Roselawn Avenue, Toronto 12, Ontario

Carl & Jerry (Continued from page 10)

ages produced by various parts of the brain."

"Interesting, but I don't see how we can do much with it," Carl remarked. "We've got no scribing pens or stuff like that."

"We don't need them. The doctor suggested that we could use an external amplifier and a 'scope to get a temporary display just for experimenting. While this would confine us to two electrodes, we could move them around to different parts of your—I mean of the person's scalp to observe the different waves produced. In fact, it just so happens that I've sort of half-way prepared some equipment for this experiment."

AS HE SAID THIS, Jerry rolled off the couch and came over to the bench.

"Dr. Diamond says we can use either uni-polar or bi-polar pickup," he explained, beginning to assemble equipment alongside Carl. "By that he means that we can place the two electrodes so as to display the shifting voltage differential existing between two different voltage-producing portions of the brain, or we can attach one electrode to a 'neutral' point, such as an ear lobe, and display the voltage rise and

fall of a particular portion of the brain with regard to this no-potential point. I decided it would be easier to secure needed shielding with the uni-polar method; so we'll attach the shield of this short coaxial lead to an ear lobe and the center conductor to a pickup electrode on the scalp."

"Since it's obviously taken for granted that I'm to be the guinea pig in this experiment, perhaps I may be excused for taking a very keen interest in the way you glibly talk about 'attaching the electrodes,'" Carl said drily. "For example, I notice you have a battery clamp big enough to double as a bear trap attached to the shield of that coaxial cable. Were you thinking of snapping that on my ear lobe?"

"Of course not!" Jerry said hastily, as he picked up a screwdriver and removed the clip. "It was just on there while I was testing things out. Actually there's no pain at all in connection with attaching the electrodes. One chap over east does it very simply by using phonograph needles that are just barely inserted in the scalp—"

"That's out!" Carl said positively. "How do the chaps out west do it?"

"I was afraid you'd want the more complicated method," Jerry said; "so I'm prepared. It's easier to do than talk about; so bend over while I use this electric razor to

the MOST WANTED TONE-ARM

New Audax in KIT Form—at HALF price!
accommodates ANY MAKE cartridge
including the famous AUDAX Hi-Q7

AUDAX KT-12: KIT, \$14.55 NET

Factory-assembled, \$24.00 NET

AUDAX KT-16: KIT, \$17.55 NET

Factory-assembled, \$30.00 NET

You do-it-yourself with no tools other than a nail-file or small screwdriver.

The new KT models exactly duplicate the Audax "Compass-Pivoted" transcription arm long recognized as top "blue chip." These new arms are the crowning achievement of a quarter-century of constant refinement and re-engineering of the very first commercial electronic pickup arm (Audax 1928) . . . to the fewest possible parts. It is this very *nth degree* engineered simplicity that makes the new KT arms possible.

Anyone can assemble a KT arm in about 10 minutes — and save 50%! The "Selector-Index" permits instant adjustment for any stylus-pressure. The newly-designed cartridge-housing enables checking of the all-important stylus-to-groove alignment at a glance.

No tone arm equals the new Audax KT — regardless of price! Read October 1956 "Popular Electronics," page 57. See the new KT arms at your dealer. (If shipped from New York City, add 40¢ for postage.) Fill out the coupon.

Fine audio-electronic apparatus for 35 years

Audax

AUDAX COMPANY
 500 Fifth Avenue, New York 36, N. Y.

AUDAX CO., 500-5th Ave., New York 36, N.Y. Attn: Mr. P.

I enclose 25c for handling & postage. Please send FREE \$1.00, 22-page "ELECTRONIC PHONO FACTS" by pioneer Maximilian Weil.

Send FREE latest catalog & name of nearest dealer.

Name.....

Address.....

City..... Zone..... State.....

HOW WOULD YOU LIKE TO BREAK INTO ENGINEERING STARTING NEXT MONTH?

Your start in Engineering could mean higher pay, more interesting work, a real chance for advancement. Here's how to do it—fast!

A career in Engineering may be closer than you think, whatever your age or education or present job.

You know about the tremendous demand for engineers and technicians. But do you know how easy it is to get the training that will qualify you for this vital work, and how quickly you can advance?

First Step Wins Job Consideration

The moment you enroll for a course in Engineering you're in a position to change your job. I. C. S. Engineering Courses, for example, start you off with Basic Mathematics and Drafting. Most employers are quick to accept men who start technical training.

Your Advancement Is Rapid

Your interest, your determination, your willingness to spend free hours improving your-

self all work in your favor. But your mastery of engineering subjects is what wins you the biggest boosts.

The I. C. S. method makes it possible for you to learn while you earn, to qualify yourself for upgrading step by step—from Draftsman to Detail Designer to Engineering Technician to full-fledged Engineer. It's a plan fitted to your needs, with personalized instruction and guidance, and, if you like, regular progress reports to your employer.

Mail Coupon for Free Books

If you are seriously interested in a fresh start in an opportunity-packed field, then mark and mail the coupon today. We'll send you *three* free books—(1) the 36-page career guide "How to Succeed," (2) Opportunity outlooks in your field of interest, (3) sample lesson (Math) demonstrating I. C. S. method.

For Real Job Security—Get an I. C. S. Diploma! I. C. S., Scranton 9, Penna. Member, National Home Study Council

INTERNATIONAL CORRESPONDENCE SCHOOLS



Box 14949F, SCRANTON 9, PENNA.

(Partial list of 257 courses)

Without cost or obligation, send me "HOW to SUCCEED" and the opportunity booklet about the field BEFORE which I have marked X (plus sample lesson):

ARCHITECTURE and BUILDING CONSTRUCTION

- Architecture
- Arch. Drawing and Designing
- Building Contractor
- Building Estimator
- Carpentry and Millwork
- Carpenter Foreman
- Heating
- Interior Decoration
- Painting Contractor
- Plumbing
- Reading Arch. Blueprints

ART

- Commercial Art
- Magazine & Book Illus.
- Show Card and Sign Lettering
- Sketching and Painting

AUTOMOTIVE

- Automobiles
- Auto Body Rebuilding and Refinishing
- Auto Engine Tuneup
- Auto Technician

AVIATION

- Aero-Engineering Technology
- Aircraft & Engine Mechanic

BUSINESS

- Accounting
- Advertising
- Business Administration
- Business Management
- Cost Accounting
- Creative Salesmanship
- Managing a Small Business
- Professional Secretary
- Public Accounting
- Purchasing Agent
- Salesmanship
- Salesmanship and Management
- Traffic Management

CHEMICAL

- Analytical Chemistry
- Chemical Engineering
- Chem. Lab. Technician
- Elements of Nuclear Energy
- General Chemistry
- Natural Gas Prod. and Trans.
- Petroleum Prod. and Engr.
- Professional Engineer (Chem)
- Pulp and Paper Making

CIVIL ENGINEERING

- Civil Engineering
- Construction Engineering
- Highway Engineering
- Professional Engineer (Civil)
- Reading Struc. Blueprints
- Structural Engineering
- Surveying and Mapping

DRAFTING

- Aircraft Drafting
- Architectural Drafting
- Drafting Machine Design
- Electrical Drafting
- Mechanical Drafting
- Sheet Metal Drafting
- Structural Drafting

ELECTRICAL

- Electrical Engineering
- Elec. Engr. Technician
- Elec. Light and Power
- Practical Electrician
- Practical Lineman
- Professional Engineer (Elec)

HIGH SCHOOL

- High School Diploma

- Good English
- High School Mathematics
- Short Story Writing

LEADERSHIP

- Industrial Foremanship
- Industrial Supervision
- Personnel-Labor Relations
- Supervision

MECHANICAL and SHOP

- Diesel Engines
- Gas-Elec. Welding
- Industrial Engineering
- Industrial Instrumentation
- Industrial Metallurgy
- Industrial Safety
- Machine Design
- Machine Shop Practice
- Mechanical Engineering
- Professional Engineer (Mech)
- Quality Control
- Reading Shop Blueprints
- Refrigeration and Air Conditioning
- Tool Design
- Tool Making

RADIO, TELEVISION

- General Electronics Tech.

- Industrial Electronics
- Practical Radio-TV Eng'r'g
- Practical Telephony
- Radio-TV Servicing

RAILROAD

- Car Inspector and Air Brake
- Diesel Electrician
- Diesel Engr. and Fireman
- Diesel Locomotive

STEAM and DIESEL POWER

- Combustion Engineering
- Power Plant Engineer
- Stationary Diesel Engr.
- Stationary Fireman

TEXTILE

- Carding and Spinning
- Cotton Manufacture
- Cotton Warming and Weaving
- Loom Fixing Technician
- Textile Designing
- Textile Finishing & Dyeing
- Throwing
- Warming and Weaving
- Worsted Manufacturing

Name _____ Age _____ Home Address _____
 City _____ Zone _____ State _____ Working Hours _____ A.M. to P.M. _____
 Occupation _____

Canadian residents send coupon to International Correspondence Schools, Canadian, Ltd., Montreal, Canada. . . . Special tuition rates to members of the U. S. Armed Forces.

CUT CHASSIS HOLES FAST!

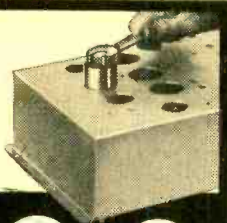

ROUND



SQUARE



KEY



"D"

Smooth, accurate openings made in 1½ minutes or less with Greenlee Radio Chassis Punch

Quickly make smooth, accurate holes in metal, bakelite, or hard rubber with a GREENLEE Chassis Punch. Easy to operate . . . simply turn with an ordinary wrench. Round, square, key, and "D" types . . . wide range of sizes to make openings for sockets, plugs, controls, meters, terminal strips, transformers, panel lights, etc. Assure perfect fit of parts and professional finish to every job. Write for descriptive literature. Greenlee Tool Co., 2387 Columbia Ave., Rockford, Ill.



GREENLEE

ASSEMBLE YOUR OWN WALKIE-TALKIE RADIOPHONE



for as little as

\$6.98

plus accessories

Specifications: 1 to 5 mile range with 18-inch antenna and much more with directional beam antenna. Tunes from 144 to 148 mcs. High level amplitude modulation. Silver plated tank circuit and many other exclusive features assure maximum efficiency and long battery life. Fully portable—no external connections ever needed. Meets FCC requirements for general class amateur license. No minimum age requirement.

The following components are all you need to assemble a complete walkie-talkie as illustrated. Factory wired and tested transceiver chassis complete with special dual tube \$6.98
High output carbon mike \$1.49
Miniature mike transformer \$.98
Powerful alnico magnet headphone \$1.25
Strong 16 gauge aluminum case (8" x 5" x 2") with all holes punched, battery compartment, battery switch plus all hardware and fittings including 18" antenna \$3.98

Uses standard batteries available at your local radio store.

All components except tube guaranteed for one year.

Include 5% for postage. COD's require \$2.00 deposit

SPECIAL: Limited quantity, brand new Western Electric telephone handsets \$6.98
Receiver impedance matching transformer for using handset with walkie-talkie \$.98

All orders immediately acknowledged

SPRINGFIELD ENTERPRISES

Box 54-B

Springfield Gardens 13, N. Y.

Carl & Jerry (Continued from page 12)

shave an itsie-bitsie place on your head."

"I don't know why I let you talk me into these things," Carl said resignedly as he leaned over; "but I'm warning you, that spot had better be 'bitsie' or you-know-who is going to be 'itsie'—right on top of his scheming head."

"Oh, take it easy," Jerry urged. "No-one's going to scalp you. Now just hold still for a minute."

Jerry touched the buzzing razor to his pal's scalp and then stepped back to admire his handiwork. "Fine, fine!" he said professionally, upending a small bottle on a wad of cotton and dabbing it on the shaved spot.

"Hey! That's cold. What is it?" Carl asked.

"Ether, and you should be able to stand it if I can. Ever since I had my tonsils out, the smell of the stuff gags me. Now we'll put a little of this 'contact salve' Dr. Diamond gave me on this tiny silver electrode, no bigger than a match head, and press it firmly against the shaved spot. You hold it there while I place some Duco cement around it and turn Mom's hair dryer on it. That ought to make the cement set up in short order."

In a minute or so the cement had set firmly, and Carl walked over to look at himself in the mirror. He nodded his head and watched the way the short length of wire sticking up from the electrode bobbed back and forth.

"I sure look like something right off Mars," he said admiringly. Then he dropped



... "I sure look like something off Mars," Carl said admiringly. Then he dropped his voice an octave and intoned: "Take me to your president!" ...

Always say you saw it in—POPULAR ELECTRONICS

If you thought Volume I was great...
You'd better rush out and get **VOLUME II**



TRANSISTOR APPLICATIONS BOOK

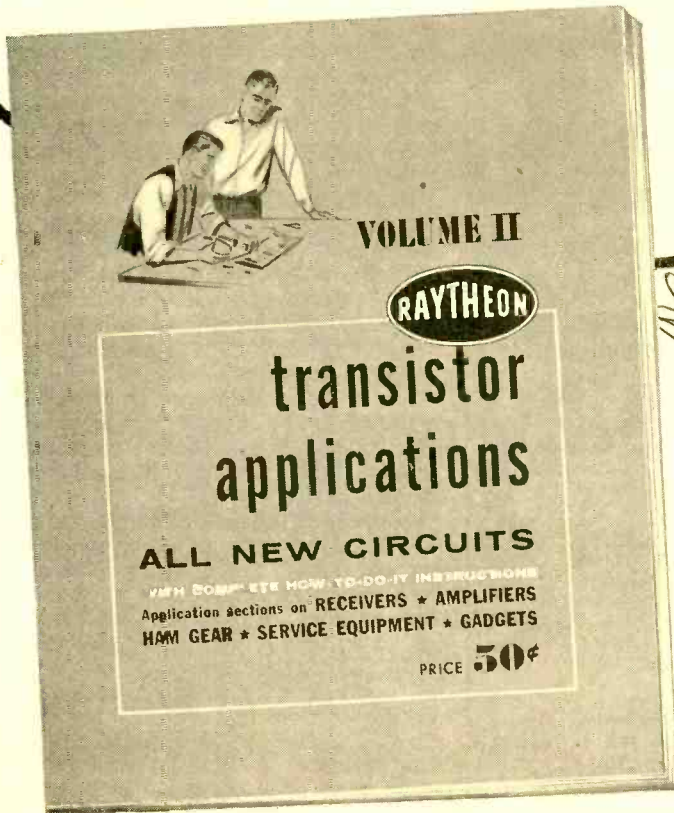

only
50¢



Volume II of the Raytheon Transistor Applications Book contains a *wide variety of new applications never before published*. And, like popular Volume I, it's more than a collection of circuits, it contains complete construction information including wiring diagrams, illustrations and parts lists. It has complete sections on receivers, amplifiers, ham gear, test equipment and a full section devoted to a number of interesting and

useful transistorized gadgets.

There is a full section on basic transistor theory and circuit design, too, plus a section of installation and wiring hints on transistors and a lot of information on printed circuitry.

Whether or not you have Volume I, if you experiment with transistors you should have Raytheon Transistor Applications Book, Volume II. Get it from your Raytheon Tube Supplier or send 50¢ to Raytheon, Department V2.



Excellence in Electronics

RAYTHEON MANUFACTURING COMPANY

Receiving and Cathode Ray Tube Operations

Newton 58, Massachusetts

avoid a costly mistake

in your high fidelity system



send for this new **REK-O-KUT** booklet colorfully illustrates...factually describes...the important advantages of playing your records on a precision turntable!

FREE — SEND COUPON TODAY!

NAME _____

ADDRESS _____

CITY _____ ZONE _____ STATE _____



REK-O-KUT COMPANY, INC.
38-01 Queens Blvd., Long Island City 1, N. Y. PE

Carl & Jerry (Continued from page 14)

his voice an octave or so and intoned in sepulchral tones: "Take me to your president!"

JERRY LED HIM back to the bench and attached another electrode in a similar manner to the lobe of his ear. The inner conductor of a short length of small-diameter coaxial cable was connected to the scalp electrode, and the outer shield was connected to the electrode fastened to the ear. The other end of the cable was attached to the input of a high-gain, low-noise pre-amplifier that in turn fed into the input terminals of the vertical amplifier of the oscilloscope—also having a very high gain.

"Well, we're about ready to examine your brain waves; so prepare to transmit," Jerry said, switching on the preamplifier and the 'scope.

"Just how do I do that?" Carl demanded.

"I dunno. I suppose you *think* about something."

"Okay; so I'll think about that cute little blonde that sat in front of me in trig class last year," Carl said, closing his eyes and allowing a blissful smile to settle on his usually serious features.

"Don't think about her so hard," Jerry commanded. "You're knocking the beam clear off the screen. And don't relax any more or you'll knock that electric clock off the wall behind you."

He reduced the gain of the 'scope amplifier and adjusted the sweep circuit to a low frequency. A pattern of badly distorted saw teeth moved across the screen. A touch of the synchronizing control was all that was needed to lock a pattern of two of these teeth steadily in place.

"I'll say this for you: you're a remarkably steady thinker," Jerry muttered, staring at the design. "I had imagined that brain waves would be a lot more irregular. These must be either *alpha* or *beta* waves. The former have a rhythm of 10 waves a second while the latter have a rhythm of 25 waves a second. Our sweep circuit won't go down low enough to display *delta* waves that take place in about one-sixth of a second. Now you keep right on thinking while I compare your brain waves with those in this book that Doc let me have. In the back of it he has sketched in a few that he recorded himself."

CARL DUTIFULLY remained quiet with his eyes closed while Jerry flipped the pages of the book in an attempt to find a pattern that looked similar to the one on the face of the oscilloscope. Finally he seemed to find one at the back of the book, for he glanced back and forth between it

Want To Double Your Pay

Get into Radio-
TV-Electronics

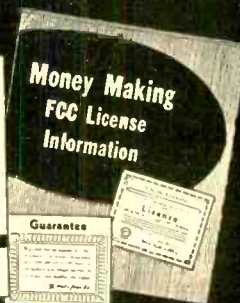
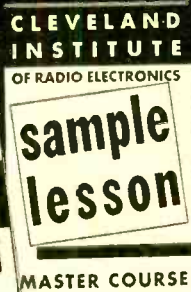
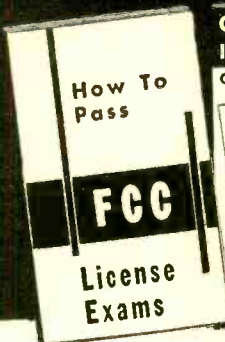

Get all 3 FREE

FIND OUT what the FCC license means

Your FCC license is recognized by employers as proof of your technical ability.

FIND OUT how the FCC license helps you get a better job or increase your pay on your present job

When Jim enrolled, he was a temporary employee of the City of Tacoma, Washington. He was helping wire and install an interoffice phone system. In the space of 14 months, he completed the Master Course and received his first class license. He is now installing and maintaining mobile and microwave equipment.

James S. Glen, Jr.,
2920 Knob Hill Rd., Tacoma, Wash.

"I am pleased to inform you that I recently secured a position as Test Engineer with Melpar, Inc. (Subsidiary of Westinghouse). A substantial salary increase was involved. My Cleveland Institute training played a major role in qualifying me for this position."
Boyd Daugherty, 105 Godwin Ct.,
Apr. C., Falls Church, Va.

**MAIL
COUPON
TODAY**
You'll Be
Glad You Did

Accredited by National Home Study Council

FIND OUT how to get your FCC license in a minimum of time

	License	Time
John H. Johnson, Boise City, Okla.	1st Class	20 weeks
Prentice Harrison, Lewes, Delaware	1st Class	27 weeks
Herbert W. Clay, Phoenix, Ariz.	2nd Class	22 weeks
Thomas J. Bingham, Finley, N. Dak.	2nd Class	9 weeks

FIND OUT how we guarantee your FCC license

WE GUARANTEE to train and coach you at home until you pass the all-important FCC examination . . . If you fail to pass after completing our course, we will continue your training without additional cost until you successfully obtain your commercial license.

FIND OUT how employers make job offers like this to our graduates every month

WEST COAST MANUFACTURER: "We are currently in need of men with electronics training or experience in radar maintenance. We would appreciate your referral of interested persons to us."

CLEVELAND INSTITUTE OF RADIO ELECTRONICS
Desk PE-27 4900 Euclid Bldg. Cleveland 3, Ohio

Cleveland Institute of Radio Electronics

Desk PE-27, 4900 Euclid Ave., Cleveland 3, Ohio

Please send Free Booklets prepared to help me get ahead in Electronics. I have had training or experience in Electronics as indicated below:

- | | |
|---|---|
| <input type="checkbox"/> Military | <input type="checkbox"/> Broadcasting |
| <input type="checkbox"/> Radio-TV Servicing | <input type="checkbox"/> Home Experimenting |
| <input type="checkbox"/> Manufacturing | <input type="checkbox"/> Telephone Company |
| <input type="checkbox"/> Amateur Radio | <input type="checkbox"/> Other _____ |

In what kind of work are you now engaged?

In what branch of Electronics are you interested?

Name _____ Age _____

Address _____

City _____ Zone _____ State _____

Special Tuition Rates to Members of Armed Forces

the Amazing *Carloma* "SOUND HUSHER"



- DOES NOT TURN SET OFF— JUST LOWERS VOLUME!
- NO ELECTRICAL CONNECTION TO TELEPHONE!
- SAFE! NO ELECTRICAL CURRENT
- EASY TO INSTALL—JUST "CLIPS" ON PHONE!
- COMPLETE WITH 30 FT. OF WIRE AND SIMPLE INSTRUCTIONS!
- GUARANTEED!

Just **\$2.25**

Post Paid in U. S. A.
send money order or check

Dealers — TV Servicemen

Write for special quantity discount deal!

CARLOMA CORPORATION
P.O. Box 43, Overland Branch
St. Louis 14, Missouri



Rush "SOUND HUSHER" Enclosed is check or M.O. for \$2.25.

Signed _____
Street _____
City _____ Zone _____
State _____



ATOMOTRON
First Model Atom Smasher

Now in use in hundreds
of America's leading
High Schools and Colleges

See and learn wonders of
Nuclear Physics and Elec-
tricity with miniature high-
voltage generator. Make arti-
ficial lightning . . . pitb
balls defy gravity, propel-
lers turn at a distance.
Only 7" high. Produces
75,000 volts on a 2-inch

diameter sphere, yet is absolutely safe for the youngest
child. Operated by sturdy 110 volt A. C. motor . . .
comes complete with Smog Control Unit, Field Reaction
Rotor, Plastic-encased Pitb-Ball, Paper Strand Cluster,
Electric Wind Unit, Neon Light Wand and Illustrated
Experiment Manual. Price assembled, \$19.95, post paid;
in kit form, \$14.95, post paid.

NEW 3-IN-1 ELECTROMAGNET

Insert D. C. coil, suspend 100 lbs. with only 1 flashlight
battery. Insert A. C. coil, push switch and levitate
aluminum ring 3 inches. Light bulb included to demon-
strate transformer action. Magnet & keeper precision-
machined of low carbon steel. Long-life coils wound
with Formvar-insulated copper wire. Complete with all
accessories & experiment manual, \$14.95 post paid.

Cash, check or money order. (In California, 4% Sales Tax.)



ATOMIC
LABORATORIES

P. O. Box 343-C, Berkeley, Calif.

World's Leading Manufacturers of new low-cost Educational Scientific Equipment

Carl & Jerry (Continued from page 16)

and the 'scope several times before he finally said hesitantly: "Say, Carl, you haven't been bitten by a dog lately, have you?"

"Why on earth would you ask a stupid question like that?" Carl wanted to know, his blue eyes popping wide open behind his horn-rimmed glasses.

"Well, it's kind of funny, but the only brain wave pattern I can find that looks like that one on the 'scope is a tracing Doc made that he says was produced by the brain of a rabid dog."

"Here, let me see that," Carl said abruptly, reaching for the book. He studied it intently, then cautiously turned his head, being careful not to put too much strain on the electrodes, and looked at the face of the oscilloscope. As he did so, the pattern increased noticeably in size.

"Now don't excite yourself!" Jerry admonished. "There's probably some perfectly sensible explanation. Anyway, it doesn't mean a thing if you haven't been bitten by a dog."

"But that's just it; I have," Carl said slowly. "About a week ago Bosco and I were clowning around out in the yard, and he got carried away a little and actually broke the skin on my hand. I put some antiseptic on it and forgot all about it—until now."

"It still doesn't mean anything," Jerry said hastily—a little too hastily. "You don't have any other symptoms."

"I don't know about that either," Carl said in a thin, strained voice. "I've heard that one symptom is an unnatural craving



. . . "Why on earth would you ask a stupid question like that?" Carl wanted to know, his blue eyes popping wide open behind his horn-rimmed glasses . . .

Always say you saw it in—POPULAR ELECTRONICS

**GREATEST
ADVANCE IN
SHOP-METHOD
HOME TRAINING**

EARN MORE MONEY...GET INTO

TELEVISION

ELECTRONICS-RADIO

Learn ALL 8 PHASES in ONE MODERN HOME-STUDY COURSE

At Home - In Spare Time

**YOU GET ALL THIS NEWEST
PRACTICAL EQUIPMENT**

- Parts to build a modern TV set, including all tubes plus a large screen Picture Tube
- Parts to build a powerful Superhet Receiver, standard broadcast and short wave
- Parts to conduct many experiments and build Continuity Checker, RF Oscillator, TV Circuits, Audio Oscillator, TRF Receiver, Signal Generator
- A Valuable Professional Mu tester

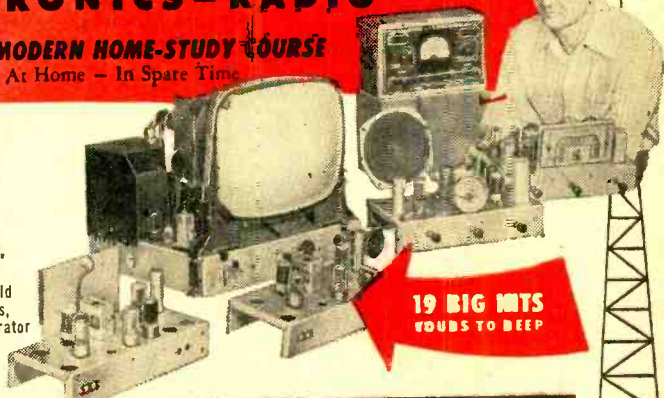

**19 BIG MTS
YOU'VE TO DEEP**

YOUR NATIONAL SCHOOLS TELERAMA COURSE COVERS ALL 8 PHASES

- | | |
|------------------------------------|--------------------------------|
| 1. TELEVISION, INCLUDING COLOR TV | 5. PREPARATION FOR FCC LICENSE |
| 2. RADIO, FM AND AM | 6. AUTOMATION |
| 3. INDUSTRIAL ELECTRONICS | 7. RADAR AND MICRO WAVES |
| 4. SOUND RECORDING AND HI FIDELITY | 8. COMMUNICATIONS |

YOU ARE NEEDED IN THE TELEVISION-ELECTRONICS-RADIO INDUSTRY!
You can build a secure future for yourself if you get into Electronics NOW! Today's shortage of trained technicians creates tremendous opportunities. National Schools Shop-Method trained technicians are in constant and growing demand for high-pay jobs in Broadcasting and Communications, Electronic Research, Servicing and Repair, and many other branches.

Let National Schools, a Resident Technical School for over 50 years train you for today's unlimited opportunities in electronics! Our Shop Method trains you to be a MASTER-TECHNICIAN. Completely up to instructors and engineers, your Telerama Course will teach you all phases of the industry quickly, clearly and correctly. You can master the most modern projects, such as Color TV, printed circuits - even prepare for FCC License without taking a special

course. You can handle sales, servicing, manufacturing, or make good money in your own business. SEND FOR FACTS TODAY!

EARN AS YOU LEARN. Many of our students earn their entire tuition and more in Spare Time jobs we show them how to do while learning.

YOU GET EVERYTHING YOU NEED - Clear, profusely illustrated lessons, shop-tested manuals, modern circuit diagrams, practical job projects - all the valuable equipment shown above

- many other materials and services - consultation privilege with our qualified staff, and Graduate Employment Service. **EVERYTHING YOU NEED** for outstanding success in Electronics.

RESIDENT TRAINING AT LOS ANGELES

If you wish to take your training in our Resident School at Los Angeles, the world's TV capital, start NOW in our big, modern Shops, Labs and Radio-TV Studios. Here you work with latest Electronic equipment - professionally installed - finest, most complete facilities offered by any school. Expert, friendly instructors. Personal attention. Graduate Employment Service. Help in finding home near school - and part time job while you learn. Check box in coupon for full information.



FREE!

Fully illustrated "Career" Book in TV-Radio-Electronics. PLUS actual sample lesson - yours at no cost, no obligation. **CLIP COUPON NOW... MAIL IT TODAY!**



APPROVED FOR G.I. TRAINING
NATIONAL SCHOOLS

4000 S. FIGUEROA ST., LOS ANGELES 37, CALIF.

NATIONAL SCHOOLS

TECHNICAL TRADE TRAINING SINCE 1905
LOS ANGELES 37, CALIFORNIA

GET FAST SERVICE—MAIL NOW TO

NATIONAL SCHOOLS, DEPT. R2G-77
4000 S. FIGUEROA ST.,
LOS ANGELES 37, CALIF.

Rush free TV-Radio "Opportunity" Book and sample lesson. No salesman will call.

NAME _____ AGE _____

ADDRESS _____

CITY _____ ZONE _____ STATE _____

Check if interested ONLY in Resident School training at Los Angeles. VETERANS: Give date of Discharge.

Carl & Jerry (Continued from page 18)

for water, and right now my mouth is as dry as cotton."

AS HE FINISHED SPEAKING, he leaned weakly back against the wall behind the bench, and the trace on the face of the 'scope promptly went clear off the screen.

"Hey, Carl, lean forward for a second," Jerry said with intense interest.

As Carl obeyed, the trace shrank to about a quarter of an inch in height and synchronization was lost.

"Now slide off the bench and move out here," Jerry said.

When Carl was as far from the bench as the short length of coaxial cable would permit him to go, the trace on the 'scope shrank to just a bumpy horizontal line with little ripples running up and down it. Without warning, Jerry suddenly disconnected the electrodes from his pal's flesh by the simple expedient of jerking them loose. He held the dangling electrodes close to the electric clock on the wall, and instantly the trace that had been on the 'scope screen reappeared. It varied in size as the electrodes were moved nearer or farther away from the clock face.

"It's the electric clock that has hydro-

phobia, not you!" Jerry announced happily. "I thought it was funny that we were getting such large traces from your brain waves, but I really didn't get hep to what was going on until you leaned back against the clock and the trace moved clear off the screen."

"Boy, am I relieved!" Carl said with a sheepish grin, as he tenderly rubbed the shaved spot on his scalp. "I feel so good that I'm not going to bust you one for pulling my scalp loose from my skull."

"I'm sorry about that, but I was in a hurry to see if my suspicions were correct," Jerry explained. "I've read that an electric clock puts out a tremendous magnetic field which is very hard to confine. In fact, I've heard that some electric clocks placed on top of a color TV set will upset the convergence of the beams. I believe it, too."

"I GUESS this experience shows just how dangerous a little knowledge can be," Carl reflected.

"It has repeated a lesson I should already know," Jerry admitted. "When you're conducting an experiment, you should make sure that only those factors you select, or at least recognize, enter into the results you obtain. Otherwise, you're not experimenting: you're just messing around."

-30-

40¢ FOR ANY TUBE

WE WILL NOT BE UNDERSOLD

We Have OVER 1000 USED TV SETS

At All Times in Our Huge Warehouse. Buy one or more of these WORKING TV's to sell or use as your own second set! All sets in GOOD WORKING condition: Your Choice—Console or Table Model.

10".....	\$23.00	19".....	\$58.00
12".....	\$28.00	20".....	\$64.00
14".....	\$33.00	21".....	\$72.00
16".....	\$40.00	24".....	\$99.00
17".....	\$46.00		

When ordering TV's, state whether table model or console is desired. Also preference on make of set. All TV's sent railway express F.O.B. Newark. On any quantity WIRE or CALL today!

PROMPT SHIPMENT OF ALL ORDERS!

FREE BONUS ANTENNA GIVEN WITH ANY TV SET ORDER!

SEND for our FREE complete TUBE & PARTS LIST and order blank.

FREE POSTAGE in U.S.A. and Territories on orders over \$5.00. 25¢ handling charge on orders under \$5.00. 25% deposit required on C.O.D.'s. Please send approximate postage or freight on Canadian and foreign orders. Subject to prior sale.

APOLOGY TO OUR READERS—Due to the tremendous response to our wonderful tube values, our huge staff was unable to adhere to our Same Day Shipment policy. We wish to offer our profound apologies for any inconvenience caused our customers. We are attempting to remedy the situation at once. **DON'T PAY MORE FOR SET TESTED LONG LIFE DEPENDABLE HI-FI RADIO & TV TUBES • BUY VIDEO • INDIVIDUALLY BOXED—ALL GUARANTEED FOR ONE YEAR OR YOUR MONEY BACK WITHIN 5 DAYS—37.00 Per Hundred** Some Standard Brand—Others With Famous VIDEO Brand

0A2	2X2	6AC7	6BK5	6SQ7	7F8	12V6GT
0A3	3A4	6AG5	6BK7	6SH7	7N7	12X4
0A4	3A5	6AF4	6BN6	6SJ7GT	7Q7	14A7
0B2	3AL5	6AH4GT	6BL7GT	6SK7GT	7Y4	14B6
0C3	3AU6	6AK5	6BQ6GT	6SL7GT	7Z4	14Q7
0Z4	3BC5	6AL5	6BQ7	6SN7GT	12A6	19BG6G
1A7GT	3CB6	6ANB	6BY5G	6SQ7	12AH7GT	19T8
183GT	3Q4	6AN4	6BZ7	6S7	12AT6	2A8
1C7G	3Q5GT	6NB	6C4	6SV7	12AT7	25AV5GT
1F4	3S4	6AQ5	6CB6	6TB	12AU6	25BQ6GT
1H4	3V4	6AQ7GT	6CD5G	6U4GT	12AU7	25CD6G
1H5GT	4B27	6A55	6CF6	6U7G	12AV6	25C6G
1J6GT	4B97	6A57G	6CS6	6UB	12AV7	25L6GT
1L4	5A8B	6AT6	6CU6GT	6V3	12AX4GT	25W4GT
1L6	5AN8	6AU4GT	6ES	6V6GT	12AX7	25Z6GT
1LA6	5AQ5	6AU5GT	6HG6T	6W4GT	12AZ7	35L6GT
1LC5	5AT8	6AU6	6JA	6W6GT	12B4	35W4
1LH4	5AW4	6BV5GT	6J5GT	6X4	12BA6	35Y4
1LN5	5AZ4	6AV6	6J6	6X5GT	12BE6	3Z3
1NSGT	5J6	6AX4GT	6K6GT	6X8	12BH7	3Z5GT
1S4	5T4	6BA6	6L4	6Y6G	12BY7	50A5
1S5	5T8	6AX5GT	6N7GT	7A5	12C6	50B5
1T4	5U4G	6BC5	6S4	7A7	12SA7	50C5
1U4	5U8	6BC7	6S7G	7B5	12SG7	50L6GT
1U5	5V4G	6BE6	6SA7	7B7	12SH7	80
1V2	5V6GT	6BF5	6SB7Y	7C5	12SJTGT	
1X2	5V3	6BQ6G	6SC7	7C6	12SK7	117N7GT
2A7	5Y4G	6B5G	6SF5	7C7	12SN7GT	117PTGT
2D21	6AB4	6BJ6	6SF7	7F7	12SQ7	117Z3

FREE RCA "CHEATER" CORD GIVEN WITH ANY TUBE ORDER OF \$7.00 OR MORE! PROMPT SHIPMENT OF ALL ORDERS.

Brand New Factory Seconds! Electrically Perfect Factory Seconds! Used Tubes! New and Used Jan Surplus Tubes!

VIDEO ELECTRIC COMPANY

79 CLINTON PL. NEWARK, N. J. Phone HUmboldt 4-9848

Join the Thousands of Central-Trained Technicians
Now Enjoying **HIGH-PAY CAREERS** in...

GUIDED MISSILES—AUTOMATION

**ELECTRONICS
TELEVISION
RADIO**



**Outstanding Employment
Opportunities Open to
Central Graduates!**

No matter what you're doing now . . . whether you've ever had previous technical experience or not, you can begin right now to prepare for a great career in these fascinating, rewarding fields!

Capitalize on the fact that Central's nationally recognized, proven training methods, top instructors and long record of educational achievement have put Central-trained men in high demand throughout America! . . . that Central's graduates are periodically interviewed and employed by many of the Country's foremost industrial giants and leading employers of electronics specialists. Hundreds of radio and TV stations look to Central as a reliable source for competent, thoroughly trained technicians . . . and the nation's major airlines and aircraft manufacturers have hired hundreds of Central-trained technicians for important communications and electronics positions.

3 Proven Training Plans

1. **HOME STUDY COURSE** (with 9 kits of equipment)—Qualifies you for diploma, FCC license exam, and a variety of electronics jobs (or transfer into advanced resident training).
2. **HOME STUDY—RESIDENT COURSE** (with 9 kits of equipment)—Home study, followed by short period of resident training. Qualifies you for diploma, FCC license exam, and a wide variety of positions (or continue with advanced resident training). An ECPD-accredited engineering technician program.
3. **FULL RESIDENT COURSE**—Qualifies you for Associate of Science (A.S.) degree and top-pay employment opportunities as Electronics Engineering Technician. An ECPD-accredited engineering technician program. Part-time employment opportunities available for students while training.

**How Central's "Progressive Plan"
Will Pay Off for YOU!**

Central's complete, accredited training is designed to get you the technical job you want . . . in the shortest possible time! Through Central's "Progressive Plan" of study, as you complete each phase of training your earning capacity goes higher! How far "up the ladder" you want to go is entirely up to you. A few short weeks of training prepares you for certain basic jobs. Then, with every additional phase of training you complete, you qualify for more advanced types of positions that command higher salaries. You can settle for any of a wide variety of well-paid, worthwhile jobs along the line . . . or you can use Central's complete training to advance right up to the top-level, top-pay positions! *Don't limit yourself!* Get the facts on Central's complete training. Mail the coupon today!

VETERANS Central offers courses approved under G. I. Bill

Mail Coupon for FREE BOOK

YOUR FUTURE IN ELECTRONICS

CENTRAL TECHNICAL INSTITUTE

Dept. A-77 1644 Wyandotte St.
Kansas City 8, Missouri

Tell me more about how you can qualify me for a high-pay Electronics career.

Name.....Age.....
Address.....Phone.....
City, State.....County.....
If Korean vet., give approx. discharge date.....



Prescribed for ...

**BEST SAVINGS
BEST SERVICE**

with our *New!*

EMC INSTRUMENTS

SAVE MORE! SERVICE BETTER!

EMC TEST EQUIPMENT

extra features ... • PRECISION CONSTRUCTION

• ADVANCE DESIGNS • LOWEST PRICES

NEW! Model 905-6A Battery Eliminator, Charger & Vibrator Checker

This combination housed in single sloping metal case, is a **MUST** for auto radio service. Features continuously variable voltage output ... automatic overload relay-self resetting ... in either 6 or 12 volt operation ... checks all 6 and 12 volt vibrators.

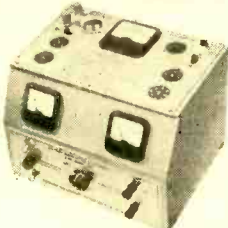

Model 905-6A (Comb.) \$67.90 Wired
\$44.90 Kit Form

Model 905 Battery Eliminator
and Charger (only) \$37.50 Wired
\$28.90 Kit Form

NEW! Model 906 Vibrator Checker

Compact metal case unit. Checks both interrupter and self-rectifier type for proper starting point, as well as quality of operation. Reads condition of vibrator on "Bad-Good" scale of plastic front meter. Checks both 6 and 12 volt vibrators.

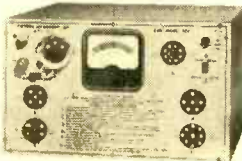

Used with any battery eliminator, such as Model 905.
Model 906 \$31.80 Wired
\$17.05 Kit Form

NEW! Model 210 Transistor Checker

Checks all PNP and NPN Transistors. Measures gain in 3 ranges. Measures leakage on 2 color "Poor-Good" scale. Supplied complete with batteries. Checks diodes.



Model 210 \$10.95 Wired
\$7.95 Kit Form

Yes, tell me more, send me—FREE—a detailed catalog of the complete EMC line.

NAME _____

STREET _____

CITY _____ STATE _____ PE-7

EMC Electronic Measurements Corp.
625 B'way • New York 12, N. Y.
Ex. Dept. 370 B'way, N. Y. 13

LETTERS FROM OUR READERS

R/C Driveway Lights

■ I would like to build a portable radio control that would turn on the floodlights over my driveway. When we come home at night, particularly in the winter, it would be convenient to be able to light them without leaving the car.

CHARLES BROWNELL
Detroit, Mich.

Well, Chuck, a lot of thought has gone into just this type of project. The other day we saw the models of an R/C transmitter and receiver that will turn on your lights and open the garage door, or even turn the lights off and close the door. According to present planning, we should have this ready for our September or October issue.

Carl & Jerry

■ The first thing I look at in each new issue is "Carl & Jerry." I have one question to ask. Where did these bright young lads get all their information? They must study every night of the week.

BILL HUGGINS, JR.
Philadelphia, Pa.

■ Of all the stories I read each and every month, the one I like best is John Frye's "Carl & Jerry." These stories are really great, and I've read them all. One of the best things about them is that John explains how the boys make their gadgets by referring to back issues.

BILL DORSEY
Kenosha, Wis.

Fellows, we know that John will be delighted to hear your comments. He spends a lot of time developing the plots of his stories and occasionally engages in a protracted argument with the editors on their validity—more often than not he is right.

Kit Builder's Korner

■ I think that "Kit Builder's Korner" is one of the best departments in your magazine. I am the proud owner of station KN9GSV, and my whole rig is made from kits.

How about reviewing the Knight VOM?

CHARLES HANUSIN
Whiting, Ind.

■ May I comment favorably on your new department, "Kit Builder's Korner"? Like others that have written in, I would enjoy seeing a write-up on the Precise Model III tube tester.

JAMES GILLARD
Oakland, Calif.

■ Could you review the Heath V-7A soon?

J. HACKETT
Rochester, N.Y.

Many thanks to all those who continue to write about potential items in KBK. We are attempting

Always say you saw it in—POPULAR ELECTRONICS

RCA offers you the
 finest training
 at home in
Radio-TV
electronics,
TV servicing,
Color TV



**SEND FOR THIS FREE
 BOOK NOW!**



RCA INSTITUTES, INC.
 A SERVICE OF RADIO CORPORATION OF AMERICA
 350 WEST FOURTH STREET, NEW YORK 14, N.Y.

In Canada—RCA Victor Company, Ltd.,
 5001 Cote de Liesse Rd., Montreal 9, Que.

Pay-as-you-learn. You need pay for only one study group at a time. Practical work with very first lesson. All text material and equipment is yours to keep. Courses for the beginner and advanced student.

RCA Institutes, Inc., Home Study Dept. PE-77.
 350 West Fourth Street, New York 14, N. Y.
 Without obligation, send me FREE 52 page CATALOG on Home Study Courses in Radio, Television and Color TV. No Salesman will call.

Name.....
 Please Print

Address.....

City..... Zone..... State.....

KOREAN VETS! Enter discharge date.....

To save time, paste coupon on postcard

TRANSISTORS

—in the new protective “skin pack”

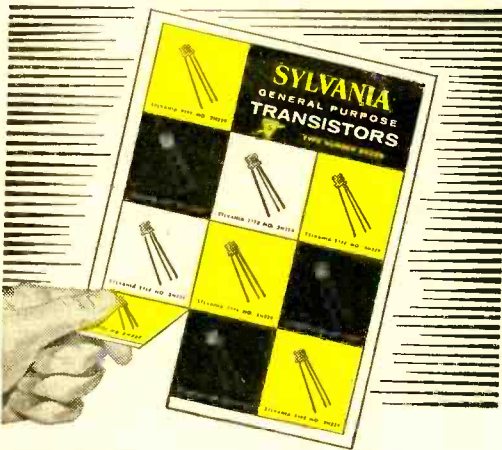

Type 2N229 audio freq. **75¢ ea.** Type 2N233 radio freq. **90¢ ea.**

Quality Sylvania transistors—at the lowest prices yet—you'll find both types displayed at your Sylvania parts supplier. See him for free application data or write directly.

SYLVANIA

SYLVANIA ELECTRIC PRODUCTS INC.
1740 Broadway, New York 19, N. Y.



pFK

pre-finished
Kits

designed by Paul Klipsch

Now you need only a screwdriver to put together a furniture-finished Klipsch speaker enclosure, indistinguishable from factory-assembled Rebel 3, 4 or 5. Also available as conventional, unfinished kits.

Write for
COMPLETE CATALOG!

- 36 pages
- 16 other hi-fi kits
- 29 equipment cabinets
- 4 matched speaker systems
- 20 hi-fi accessories



cabinart 57



99 North 11th Street
Brooklyn 11, N. Y.

largest manufacturer of cabinets and kits for hi-fi,
a division of G&H Wood Products Co., Inc.

Letters

(Continued from page 22)

to diversify the kits that will be reviewed. Some will have been on the market for quite a while and others will be brand-new. In any case, at least 20 more kits will be reviewed in the next six months. We think you'll find them interesting and valuable.

New Enclosures Coming Up

■ I built your Mark II \$3 speaker baffle (May, 1956, p. 48) and my family has spent many enjoyable hours listening to records and radio through this enclosure and cheap 12" speaker.

Now that we have another part of our hi-fi, we are trying to assemble a somewhat better system. Of course, this is on a limited budget, but I would like to build another enclosure for possible two-way sound—for example, mid-range or tweeter.

RAY ADAMS
Jewett City, Conn.

The author and builder of the Mark I and II enclosures has another hot one on the fire. It is a two-way system that can later on be changed to a three-way system. The enclosure is low-cost, easy-to-build, and best of all, is now scheduled for an early issue.

Big Ear—Big Noise?

■ I enjoyed the article by Robberson on constructing the "Big Ear" (May, 1957, p. 43). About the time I was getting interested, my wife commented that instead of picking out one sound it would pick up everything—including horns, machinery, power lawn mowers, etc. This makes sense to me and I was wondering if a "jumble" of sounds could result.

SAM WALK
Evanston, Ill.

There's no denying it, Sam; a "jumble" of sounds would be picked up by the "Big Ear." Your wife is right on the ball with that thought. In publishing those plans, we were thinking primarily of the fellow in the wide open spaces (for CD), or moderately residential areas—those building it for kicks.

Puzzles On The Way

■ I received a subscription to POP'tronics and was wondering if you have any more articles like "Puzzle-tronics" (Nov., 1955).

RICHARD E. GOBELI
Cascade Locks, Ore.

■ I've been watching recent issues of POP'tronics for electronic game articles such as the one published in 1955. Are there any more of these on the agenda? I'm sure other readers would be interested in this sort of thing.

BOB KNIGHT
Jacksonville, Fla.

Yes, Bob and Dick, there are. In fact, the first of a new series of games will be in our August issue—a hand-steadiness tester. In September, we'll have a game of numbers in which the operator plays against a robot machine. The machine can be beaten, but since it automatically adjusts to each situation more rapidly than the player, it has a better chance of winning.

ELECTRONIC EXPERIMENTER'S HANDBOOK

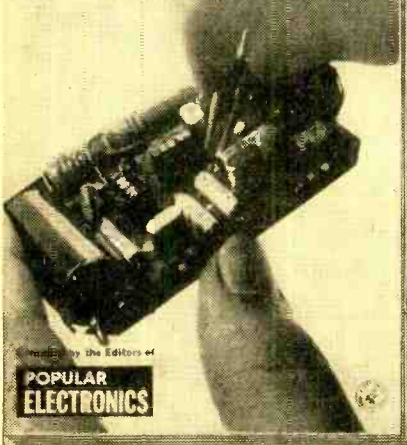

Compiled by the Editors of
POPULAR ELECTRONICS

HOBBYISTS ... EXPERIMENTERS!

LEARN HOW TO BUILD:

- Your Own AM Hi-Fi Tuner
- Thermistor Fire Alarm
- Electronic Gardening Gadgets
- A Device That Kills TV Commercials
- Electronic Toys
- Geiger Counter
- Transistorized Light Meter
- Your Own Lie Detector
- PLUS DOZENS OF OTHER HANDY, EXCITING
ELECTRONIC DEVICES

BUY YOUR COPY OF THE ELECTRONIC EXPERIMENTER'S HANDBOOK



ON SALE NOW

AT YOUR FAVORITE NEWSSTAND! PRICE: \$1.00

ZIFF-DAVIS PUBLISHING COMPANY, 366 MADISON AVENUE, NEW YORK 17, N. Y.

Give to each their own
front- or rear-seat pleasure

...with a **Centralab**
PK-300 dual-
speaker
switch kit



You please 'em all, including yourself, when you mount a Centralab PK-300 dual-speaker car-radio switch on your dashboard. Cuts in either speaker separately — or both.

This high-quality switch is built to last. It features silver-plated, double-wiping contacts and etched dial plate that stays new and legible long after usual painted types wear off.

You can install it yourself — or have a serviceman do it for you. The PK-300 kit is complete with parts and instructions for easy installation.

To please all the people in your car all of the time, pick up your PK-300 dual-speaker car-radio switch kit at your Centralab distributor. In fact, it's perfect for hi-fi—for any dual-speaker system.

Send for Catalog 30 showing the complete Centralab line.



PK-300 switch kit includes:

1. Dual-speaker switch
2. Etched mounting bracket and dial
3. Split-knurled pointer knob
4. Self-tapping screws
5. Easy-to-follow instructions

Centralab
®

A DIVISION OF GLOBE-UNION INC.
994 E. KEEFE AVENUE • MILWAUKEE 1, WISCONSIN

P-1858

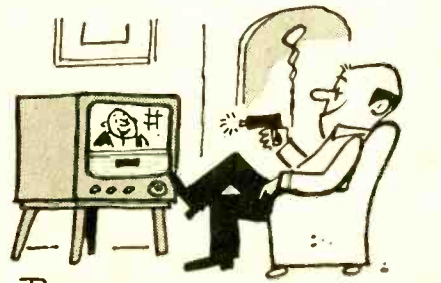
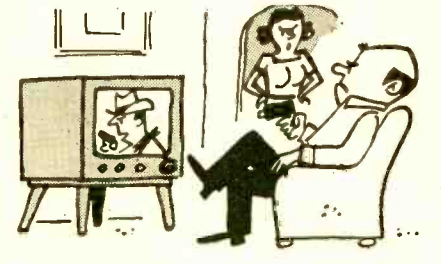
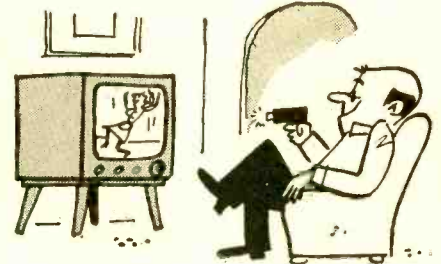
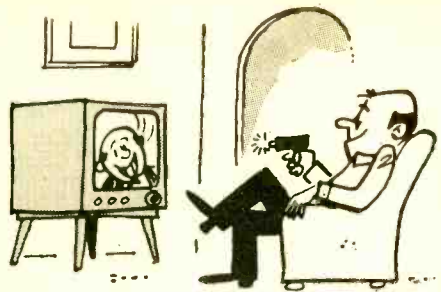

POLYART

Just printed! Send for this

FREE

booklet today!

see what
the rapidly
expanding field of

ELECTRONICS

offers you:

- BETTER JOB
- BETTER PAY
- PROMOTION
- GREATER SECURITY
- GREATER CONFIDENCE
- BETTER LIVING FOR YOU AND YOUR FAMILY

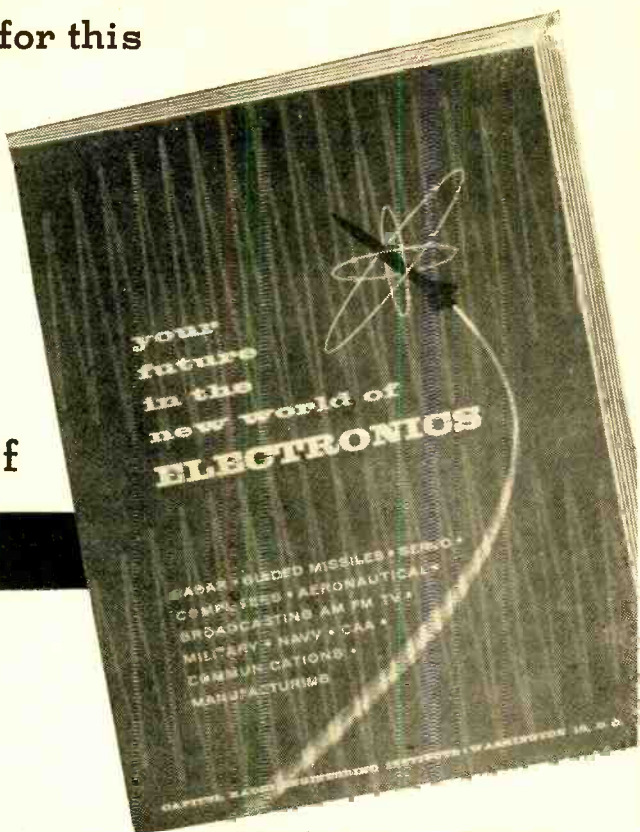

All these benefits can be yours if you act now! Take that first big step this minute—No obligation whatsoever!

TAKE A MINUTE TO MAIL THIS COUPON FOR FREE BOOKLET!

CAPITOL RADIO ENGINEERING INSTITUTE
 ECPD Accredited Technical Institute Curricula. Founded 1927
 Dept. 127-D 3224 16th St., N. W., Washington 10, D. C.

Please send me your course outline and FREE Illustrated Booklet "Your Future in the New World of Electronics" . . . describing opportunities and CREI home study courses in Practical Electronic Engineering Technology.

H

CHECK
FIELD OF
GREATEST
INTEREST

- Electronic Engineering Technology
- Broadcast (AM, FM, TV) Engineering Technology
- Television Engineering Technology
- Aeronautical Electronic Engineering Technology

Name.....Age.....

Street.....

City.....Zone.....State.....

Check. Home Study Residence School Korean Veteran

To help us answer your request intelligently, please give the following information:

EMPLOYED BY.....

TYPE OF PRESENT WORK.....

SCHOOL BACKGROUND.....

ELECTRONICS EXPERIENCE.....

IN WHAT BRANCH OF ELECTRONICS ARE YOU MOST INTERESTED?

POP'tronics

BOOKSHELF

"NOVICE AND TECHNICIAN HANDBOOK" by William I. Orr and Donald Stoner. Published by Radio Publications, Inc., Danbury Rd., Wilton, Conn. 150 pages. Soft cover. \$2.85.

The problem facing every potential Novice or Technician Class licensee is where to obtain information on equipment he is likely to need. Bill Orr and Don Stoner (two very well known hams) have put their heads together and come up with a handbook *par excellence*. It is a new approach in a book of this nature. All wiring diagrams have built-in check lists to enable the "newest" Novice to put the equipment together. The authors have described an all-band preselector (the SWL would like this), several transmitters, converters, and antennas. Then, to top it all off—and this is worth the price of the book alone, Don

has worked in conversions of surplus gear.

Recommended: to every POP'tronics reader either thinking of a ham license, possessing a ham license, or seriously interested in amateur radio.

"L-C OSCILLATORS" by Alexander Schure. Published by John F. Rider Publisher, Inc., 116 West 14th St., New York 11, N.Y. 72 pages. Soft cover. \$1.25.

Volume 13 in Rider's "Electronic Technology Series" is a compact and authoritative guide to the main features of inductive-capacitive oscillators, devices which are used widely in radio communications and industrial electronics. Points covered include: oscillator elements, energy conversion, frequency range and stability, power considerations, efficiency, harmonic generation, series and parallel resonances.

Recommended: to students.

"THE ELECTRICAL PRODUCTION OF MUSIC" by Alan Douglas. Published by Philosophical Library, Inc., 15 East 40 St., New York 16, N.Y. 223 pages. Hard cover. \$12.00.

Note that the title says "production" and (Continued on page 32)

The ALL NEW "20-POUNDER" MYSTERY PACKAGE

1 KW ANT. CHANGE-OVER 110 VAC RELAY

 60 Cycle 15 Amp. 2500 Volt P.P.D.T.
\$4.95

TUNING UNITS

 From BC 375 TRANS. YOUR CHOICE OF TU 2A, TU 85, or TU 10B. Wt. 12 lbs.
\$2.50
 Less Case

HI-FI CROSS OVER NETWORK KIT

\$2.95
 High Pass Filter Network Type. Extends HIGH FREQ. Range. Smooth Low Freq. Roll-off. Used with 8 or 16 ohms. speaker systems. No network loss in pass region.

OF ELECTRONIC PARTS

 Worth \$40.00

WILLARD BATTERY

 2 Volt. Wt. 20 AN.
\$1.65

ALL-PURPOSE FIL. TRANSFORMER

 PRI. 117 v. 40 circ. sec.
\$4.95

MODULATION AND DRIVER TRANSFORMERS

 Both Units Only
\$4.95

OUR PRICE ONLY \$3.95

BCA Output Transformer

 P.P. 3000 ohms. 2500 Volt. 15 Amp. 60 Cycle. 110 V. AC.
\$1.95

100 ASSORTED CRYSTALS

 FT. 143 FT. 241A FT. 171B Type Holders. FREQ. RANGE 2015 KC to 38.1 MC.
\$7.95

AUDIO CHOKE

 60W-1MA. 4,500 ohms. 15,000 turns of #44 wire. Size: 1 1/2" x 3/4" x 3/4". Used for radio control, planes, boats, etc.
95¢

It's Another THRILLING HERSHEL SURPRISE. 20 pounds of BRAND NEW usable Govt. Surplus. Perfect gift for Hams, etc.

PHOTO ELECTRIC CELL

 95% Selenium Cell used in camera. Also useful for operating garage doors and Alarm Systems.
\$1.95

SWING CHOKE

 2H-7H 530 MA. Transformer T8800.
\$3.95

CARRYING ALL-PURPOSE CASE

 Orig. Govt. Cost \$27.00
\$4.95

Perfect Gift for:

- Photographers
- Adjustable Strap • Made of HARD RUBBER
- WATERPROOF • Size: 11" x 10" x 6 1/2"
- Sturdily built to support 300 pounds.

KITS! KITS!

HERSHEL'S KITS ACCLAIMED BEST
 ALL KITS CONTAIN THE FINEST ASSORTMENTS. OVER 10,000 SOLD!

YOUR CHOICE ANY KIT LISTED IN THIS AD 97¢

- 30 TUBE SOCKETS
- 2 1/2 lbs. of HARDWARE
- 15 ROTARY SWITCHES
- 10 Electrolytic Condensers
- 40 Radio & TV KNOBS
- 40 BY-PASS Condensers
- 60 CARBON RESISTORS
- 60 MICA CONDENSERS
- 100 SET SCREWS
- 8 1N23 XTAL DIODES
- 50 Ceramic Condensers
- 15 Variable Condensers (Air and Mica)
- 50 RF CHOKES
- 20 POWER RESISTORS
- 1 Phone Motor 115 Vac.
- 50 TERMINAL STRIPS
- 200 ft. HOOK-UP WIRE
- 1 TRANS. 6.3V-110 Vac.
- 5 Meissner Plug-In COILS
- 5 PILOT PANEL LITES
- 50 FUSES 3AG UP
- 1 Meter Rectifier 0-1MA.
- 1 IGN. COIL 3V-15,000 VSEC.
- 25-Ft. Phono-Mike Cable
- 1 SELENIUM RECTIFIERS (150 MA. 110V.)
- 1 6 V-30 Amp. SOLENOID
- 10 STRAIN INSULATORS
- 1 TELEGRAPH KEY
- 5 MICRO SWITCHES
- 75-Ft. 300 OHM TV LEAD-IN
- 6 6-Ft. ac. LINE CORDS with PLUG
- 24 SHOCK MOUNTS
- 1 PHONO XTAL with NEEDLE
- 1 PIX TUBE BRIGHTENER
- 3 CONDENSERS (500 MMFD 20,000 Volt)
- 100 Ft. of SPAGHETTI
- 1 RCA Flyback Trans.
- 10 BATHUB CONDENSERS
- 10 GRAIN WHEAT LAMPS
- 5 RADIO-PHONO CHASSIS
- 4 LOOP-ANTENNAS (RADIO)
- 1 PHANTOM ANTENNA A-62
- 100 SPRINGS (RADIO-PHONO)
- 5 RADIO NOISE FILTERS
- 25-Ft. RG-58/U COAXIAL CABLE with PLUGS
- 2 Powerful ALNICO 5 Magnets

HERSHEL RADIO CO.
 5247 GRAND RIVER Detroit 8, Michigan. TYLER 8-9400

BUILD 16 RADIO

CIRCUITS AT HOME

with the New Improved 1957
PROGRESSIVE RADIO "EDU-KIT"

only

\$19.95



A Practical Home Radio Course

Now Includes

- ★ TRANSMITTER
- ★ SIGNAL TRACER
- ★ SIGNAL INJECTOR
- ★ CODE OSCILLATOR
- ★ No Knowledge of Radio Necessary
- ★ No Additional Parts or Tools Needed
- ★ Excellent Background for TV
- ★ School Inquiries Invited
- ★ Attractively Gift Packed

WHAT THE "EDU-KIT" OFFERS YOU

The "Edu-Kit" offers you an outstanding PRACTICAL HOME RADIO COURSE at a rock-bottom price. Our Kit is designed to train Radio & Electronics Technicians, making use of the most modern methods of home training. You will learn radio theory, construction practice and servicing.

You will learn how to build radios, using regular schematics; how to wire and solder in a professional manner; how to service radios. You will work with the standard type of punched metal chassis as well as the latest development of Printed Circuit chassis.

You will learn the basic principles of radio. You will construct, study and work with RF and AF amplifiers and oscillators, detectors, rectifiers, test equipment. You will learn and practice code, using the Progressive Code Oscillator. You will learn and practice trouble-shooting, using the Progressive Signal Tracer, Progressive Signal Injector, Progressive Dynamic Radio & Electronics Tester & the accompanying instructional material.

You will receive training for the Novice, Technician and General Classes of F.C.C. Radio Amateur License. You will build 16 Receiver, Transmitter, Code Oscillator, Signal Tracer and Signal Injector circuits, and learn how to operate them. You will receive an excellent background for Television.

Absolutely no previous knowledge of radio or science is required. The "Edu-Kit" is the product of many years of teaching and engineering experience. You The "Edu-Kit" will provide you with a basic education in Electronics and Radio, worth many times the complete price of \$19.95. The Signal Tracer alone is worth more than the price of the entire Kit.

THE KIT FOR EVERYONE

You do not need the slightest background in radio or science. Whether you are interested in Radio & Electronics because you want an interesting hobby, a well paying business or a job with a future, you will find the "Edu-Kit" a worth-while investment. Many thousands of individuals of all

ages and backgrounds have successfully used the "Edu-Kit" in more than 79 countries of the world. The "Edu-Kit" has been carefully designed, step by step, so that you cannot make a mistake. The "Edu-Kit" allows you to teach yourself at your own rate. No instructor is necessary.

PROGRESSIVE TEACHING METHOD

The Progressive Radio "Edu-Kit" is the foremost educational radio kit in the world, and is universally accepted as the standard in the field of electronics training. The "Edu-Kit" uses the modern educational principle of "Learn by Doing." Therefore you construct, learn schematics, study theory, practice trouble-shooting—all in a closely integrated program designed to provide an easily-learned, thorough and interesting background in radio.

You begin by examining the various radio parts of the "Edu-Kit." You then learn the function, theory and wiring of these parts. Then you build a simple radio. With this first set you will enjoy listening to regular broadcast stations, learn theory, practice testing and trouble-shooting. Then you build a more advanced radio, learn more advanced theory and techniques, in a progressive manner. In a progressive manner, you will find yourself constructing more advanced multi-tube radio circuits, and doing work like a professional Radio Technician.

Included in the "Edu-Kit" course are sixteen Receiver, Transmitter, Code Oscillator, Signal Tracer, and Signal Injector circuits. These are not unprofessional "breadboard" experiments, but genuine radio circuits, constructed by means of professional wiring and soldering on metal chassis, plus the new method of radio construction known as "Printed Circuitry." These circuits operate on your regular AC or DC house current.

THE "EDU-KIT" IS COMPLETE

You will receive all parts and instructions necessary to build 16 different radio and electronics circuits, each guaranteed to operate. Our Kits contain tubes, tube sockets, variable, electrolytic and paper dielectric condensers, resistors, tie straps, coils, hardware, tubing, punched metal chassis, Instruction Manuals, etc.

In addition, you receive Printed Circuit materials, including Printed Circuit chassis, special tube sockets, hardware and instructions. You also receive a useful set of tools, a professional electric soldering iron, and a self-powered Dynamic Radio & Electronics Tester. The "Edu-Kit" also includes code instructions and the Progressive Code Oscillator, in addition to F.C.C.-type Questions and Answers for Radio Amateur License training. You will also receive lessons for servicing with the Progressive Signal Tracer and the Progressive Signal Injector, a High Fidelity Guide and a Quiz Book. You receive all parts, tools, instructions, etc. Everything is yours to keep.

FREE EXTRAS

- SET OF TOOLS • RADIO & ELECTRONICS TESTER • ELECTRIC SOLDERING IRON • TESTER INSTRUCTION MANUAL • HIGH FIDELITY GUIDE • QUIZZES • TELEVISION BOOK • RADIO TROUBLE-SHOOTING BOOK • MEMBERSHIP IN RADIO-TV CLUB: CONSULTATION SERVICE • FCC AMATEUR LICENSE TRAINING • PRINTED CIRCUITRY

UNCONDITIONAL MONEY-BACK GUARANTEE

ORDER DIRECT FROM AD
RECEIVE FREE BONUS RESISTOR KIT WORTH \$5

- Send "Edu-Kit" Postpaid. I enclose full payment of \$19.95.
- Send "Edu-Kit" C.O.D. I will pay \$19.95 plus postage.
- Send me FREE additional information describing "Edu-Kit." Include FREE value Hi-Fi, Radio and TV Servicing Literature.

Name

Address

PROGRESSIVE "EDU-KITS" INC.

497 Union Ave., Dept. 534D, Brooklyn 11, N. Y.

FREE

- SET OF TOOLS
- SOLDERING IRON
- TESTER

SERVICING LESSONS

You will learn trouble-shooting and servicing in a progressive manner. You will practice repairs on the sets that you construct. You will learn symptoms and causes of troubles in home, portable and car radios. You will learn how to use the professional Signal Tracer, the unique Signal Injector and the dynamic Radio & Electronics Tester. While you are learning in this practical way, you will be able to do many a repair job for your friends and neighbors, and charge fees which will far exceed the price of the "Edu-Kit." Our Consultation Service will help you with any technical problems you may have.

J. Stataitis, of 25 Poplar Pl., Waterbury, Conn., writes: "I have repaired several sets for my friends, and made money. The "Edu-Kit" paid for itself, I was ready to spend \$240 for a course, but I found your ad and sent for your Kit."

FROM OUR MAIL BAG

Ben Valerio, P. O. Box 21, Magna, Utah: "The Edu-Kits are wonderful. Here I am sending you the questions and also the answers for them. I have been in Radio for the last seven years, but like to work with Radio Kits, and like to build Radio Testing Equipment. I enjoyed every minute I worked with the different kits; the Signal Tracer works fine. Also like to let you know that I feel proud of becoming a member of your Radio-TV Club."

Robert L. Shuff, 1534 Monroe Ave., Huntington, W. Va.: "Thought I would drop you a few lines to say that I received my Edu-Kit, and was really amazed that such a bargain can be had at such a low price. I have already started repairing radios and phonographs. My friends were really surprised to see me get into the swing of it so quickly. The Troubleshooting Tester that comes with the Kit is really swell, and finds the trouble, if there is any to be found."

PRINTED CIRCUITRY

At no increase in price, the "Edu-Kit" now includes Printed Circuitry. You build a Printed Circuit Signal Injector, a unique servicing instrument that can detect many Radio and TV troubles. This revolutionary new technique of radio construction is now becoming popular in commercial radio and TV sets.

A Printed Circuitry is a special insulated chassis on which has been deposited a conducting material, which takes the place of wiring. The various parts are merely plugged in and soldered to terminals.

LAFAYETTE

6 TRANSISTOR SUPERHET RECEIVER KIT GIVES SUPERB PERFORMANCE . . . INCOMPARABLE VALUE

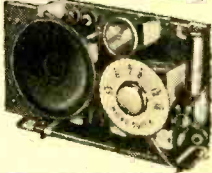

- ONLY 33.50
- 100% SUBMINIATURE PARTS—NO COMPROMISES!
- LABORATORY DESIGNED—SENSITIVE, SELECTIVE, STABLE!
- CLASS B PUSH-PULL AMPLIFICATION—PLENTY OF POWER!

Lafayette is proud to present its 6 Transistor Superhet Receiver Kit KT-119. This kit represents the optimum in sensitivity, selectivity and stability. You'll be amazed at its superior commercial quality! You'll be elated with its surprising performance! The circuit uses 3 high frequency RF Transistors, 3 dependable audio Transistors and Crystal Diode and features a specially matched set of 3 I.F.'s, Oscillator, High-Q Loop, Class B Push-Pull Audio Amplification, and Transformer Coupling in audio and output stages. Special care has been taken in the design for exact impedance matching throughout to effect maximum transfer of power. Has efficient 2 1/2" speaker, and earphone jack for private listening. Complete with all parts, transistors, pre-punched chassis, battery and easy-to-follow step-by-step instructions. 6" x 3 1/2" x 1 1/4". Shpg. wt., 3 lbs.

- KT-119—Complete Kit—Less Case.....Net 33.50
- MS-339—Sturdy, attractive brown leather case with carrying strap for KT-119
Shpg. wt., 1 lb.....Net 2.95
- MS-270—Sensitive matching earphone.....Net 2.39

LAFAYETTE MATCHED HI-FI PHONO SYSTEM

Nothing Finer at this Price!

NEVER—in the annals of HIGH-FIDELITY has a phono system of this quality—at this price—been offered. A Lafayette "best buy" system designed around the new Lafayette LA-59 amplifier. The performance of this Phono system surpasses the most critical requirements of music lovers. Twenty-four combinations of record equalization provide an almost endless variety of tone compensation to match varying recording characteristics. This system includes the famous Garrard RC-121 "Renown" 4 speed automatic and manual record changer, LAFAYETTE LA-59 18 watt amplifier with features found only in the most expensive amplifiers. G.E. triple-play—turnover cartridges with genuine G.E. DIAMOND SAPPHIRE STYLI, AND LAFAYETTE SK-58 12" coaxial HI-FI speaker. All units are supplied with plugs, jacks and prepared color-coded interconnecting cables for quick easy installation. For 110-125 volt, 60 cycle AC. Shpg. wt. 50 lbs

HF-154—Complete Phono System.....Net 119.50

Reg. Value
~~158.55~~
SALE!
119.50



Special!

FM-AM TUNER KIT

Basic FM-AM Tuner having outstanding specifications and delivering astonishing performance — all at a budget price in easily assembled kit form.

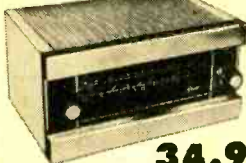

34.95

- AFC DEFEAT CIRCUIT WITH FRONT PANEL CONTROL
- FOSTER-SEELEY DISCRIMINATOR CIRCUIT
- GROUNDED GRID TRIODE AMPLIFIER
- 20-20,000 CPS RESPONSE

Choose this 7 tube compact high-fidelity FM-AM tuner whose characteristic features are found in units costing many times as much, and whose performance is unheard of at this low price. There are two front panel controls, a function control for AM, FM, PHONO, TV and a tuning/AFC defeat control. Features Armstrong FM circuit with limiter and Foster-Seeley discriminator. Simplified tuning with slide-rule dial and flywheel counter-weighted mechanism, high impedance phono input and high impedance audio output.

SPECIFICATIONS

FREQUENCY RANGE: FM 88-108MC, AM, 530-1650 KC. ANTENNA INPUT: FM, 300 ohms; AM, Ferrite loopstick; and high impedance external antenna. DISTORTION: Less than 1% at rated output. FREQUENCY RESPONSE: FM, +.5 db 20 to 20,000 cps, AM ± 3 db 20 to 5000 cps. SENSITIVITY: FM, 5 UV for 30 db quieting, AM, Loop sensitivity 80 UV/meter. SELECTIVITY: FM, 200 KC bandwidth, 6 db down; 375 KC FM discriminator peak to peak separation, AM, 8 KC bandwidth, 6 db down. IMAGE REJECTION: 30 db minimum. HUM LEVEL: 60 db below 100% modulation. TUBE COMPLEMENT: 2-12AT7, 1-6BE6, 1-BA6, 2-6AU6, 1-6AL5 plus selenium rectifier. SIZE: 6 1/4" high x 9 3/4" wide x 9 1/2" deep (excluding knobs). CONSUMPTION: 30 watts. For 110-120V 60 cycles AC. Attractive etched copper-plated and lacquered finish. Less metal case. Shpg. wt., 9 lbs.

KT-100 A.....NET 34.95
ML-100...Metal cage for above, Shpg. wt., 3 lbs. 5.00

TRANSCRIPTION-TYPE MANUAL PLAYER

PK-160

with TONE ARM
and TWO
PLUG-IN HEADS



NET ONLY 24.50
LESS BASE

- MAGNETIC BRAKE FOR FINE ADJUSTMENT OF EACH SPEED
- 4-POLE, HEAVY DUTY TRANSCRIPTION-TYPE MOTOR
- STYLUS WEIGHT ADJUSTMENT SCREW ON TONE ARM

All the important features of professional transcription players have been incorporated in this precision turntable. Extremely smooth and quiet heavy duty 4-pole motor plays 78, 45 and 33 1/2 RPM records. Exclusive magnetic brake, controlled by knob on base plate, permits instantaneous fine adjustment of each speed. Stroboscope disc included checks speeds. Speed selector safety switch protects mechanism by making it necessary to pass through OFF position when switching from one speed to another. Automatic shut-off at end of record. 10" weighted turntable has rubber traction mat. Mounting plate has pickup rest and ON-OFF switch. Size: 12-15/16" left to right, 10 1/2" front to rear. Requires 2 3/4" clearance below motor board and 3" above. With AC line cord, 2 plug-in heads; output cable, 45 RPM adapter. For 165-120V., 60 cycles AC. Shpg. wt., 12 lbs. (NOTE: For protection in shipping, tone arm is separate. Just fasten to mounting plate.)
PK-160—Less cartridge and base.....Net 24.50
PK-162—Wood base for PK-160, Shpg. wt., 5 lbs....Net 3.95
PK-163—Unfinished mounting board only. Shpg. wt., 1 lb.Net .95

Lafayette Radio 165-08 Liberty Ave.
JAMAICA 33, N. Y.

100 SIXTH AVE. NEW YORK, N. Y.
PLAINFIELD, N. J., 139 W. Second St. BOSTON 10, MASS., 110 Federal St.
BRONX 58, N. Y., 542 E. Fordham Rd. NEWARK 2, N. J., 24 Central Ave.
Include postage with order.

FREE!

LAFAYETTE CATALOG



ELECTRONIC CATALOG PACKED WITH MONEY SAVERS

Packed with the largest selection of Electronic, Radio and T.V. Parts, and equipment, PA, Hi-Fi systems, tubes, antennas, Transistor Kits, parts and components. Test Equipment, new build your own kits, tools, books, Microscope, drafting equipment, Binoculars, Telescopes, All Radio, TV and Ham supplies - ALL AT GREAT SAVINGS - For the economy minded servicemen, dealer, engineer and technician **CHUCK FULL OF BUYS! SEND FOR YOUR FREE COPY 10-DAY.**

NEW DYNAMIC MICROPHONE

For Desk-Top or Hand-Held

- HIGH IMPEDANCE—50,000 OHMS
- RESPONSE: 40-9,500 CPS

Beautifully designed and finished high impedance dynamic mike with ingenious swivel mounting that permits horizontal and vertical rotation for most convenient angle. Mike easily removed from base for holding in hand. Baked enamel case with chrome finish base, grille and fittings. Ruggedly constructed to withstand plenty of handling. 4" long x 1-3/16" diameter housing. With 5 ft. shielded cable. PA-39—Shpg. wt., 2 lbsNet 9.95



Reg. Value 29.50
NOW! 9.95

CRYSTAL MICROPHONE

COMPARE WITH ANY MIKE AT 2 TO 3 TIMES THE PRICE

A quality crystal microphone for PA systems, tape recorders, etc. Frequency response 30 to 10,000 cycles. Output level—32 db. Provides ample output for use with low gain amplifiers. Complete with 5 ft. of shielded cable. Shpg. wt., 3 1/2 lbs.

PA-24—In lots of 3, each 3.95, singly, 4.25



5 TRANSISTOR PUSH PULL AMPLIFIER KIT

- 1/2 WATT, CLASS B, PUSH-PULL OUTPUT
- CRYSTAL AND MAGNETIC INPUT
- SEPARATE BASS AND TREBLE CONTROLS

New 5 transistor audio amplifier for phones—microphones—tuners etc. Excellent for the experimenter—student—or any one desiring a good transistorized amplifier.

Uses new G.E. 2N189 and 2N186A transistor. Inverse feed back for reduction of distortion. Transformer coupled driver and output stages. Complete with punched chassis, knobs, transistors, all parts and detailed instructions and diagrams.

KT-104—3.2 ohm output.....Net 22.95
KT-105—8 ohm output.....Net 22.95

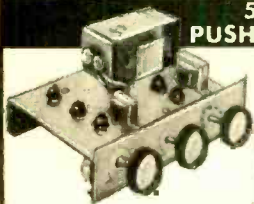

2 TRANSISTOR POCKET RADIO KIT

Packed into a 2 1/2" x 3 1/2" x 1 1/4" plastic case. This Two Transistor plus crystal diode radio kit offers many surprises, utilizing a regenerative detector circuit with transformer coupled audio stage, gives you high gain and excellent selectivity. Pulls in distant stations with ease with more than ample earphone volume. Kit comes complete with two transistors, crystal diode, inductor, Arzonne transistor audio transformer, resistors, condensers, plastic case, etc. Including schematic and instructions.

KT-98A Complete Kit less earphones. 10.95 Net.
MS-200 New Super Power Dynamic Earphone, ideal for Transistor Circuit Imp. 8000 ohm, D.C. 2000 ohm 3.95



NEW POCKET AC-DC VOM MULTITESTER 2,000 ohm per Volt on AC & DC

• Completely wired — Not a kit
Accurate VOM with a sensitivity of 2000 ohms per volt on both AC and DC. Single selector switch. 3" 160 amp. meter. Scales: DC Volts: 0-10-50-500-1000; AC Volts: 0-10-50-500-1000; Ohms: 0-10K, 0-1 Meg; DC Current: 500 ua and 500 ma; Resistor: — 20 to +22, +20 to 36; Capacity: 250 mmf to .2 mfd and .005 to 1 mfd. Heavy plastic panel, metal bottom. 4 1/4" x 3 1/2" x 1 1/4". With batteries and test leads. Shpg. wt. 4 lbs.
RW-27A8.95



3 TRANSISTOR SUPERHET POCKET RADIO KIT

- A TRUE POCKET SUPERHET RECEIVER—NO EXTERNAL ANTENNA!
- NO EXTERNAL GROUND!



A remarkable sensitive, super-selective pocket superhet receiver with astonishing performance over the complete broadcast band. Uses 2 high-frequency and one audio transistor plus efficient diode detector and features 2 specially matched IF transformers for maximum power transfer. The components are housed in a professional looking beige plastic case.

The receiver's appearance enhanced by attractive maroon and silver station dial. Sensitive built-in ferrite antenna eliminates need for external antenna. A designer's dream in a true pocket superhet receiver! Complete with all parts, transistors, battery, case, dial and easy to follow step-by-step instructions. 4 1/2" x 2 1/4" x 1-1/16". Shpg. wt., 1 lb.

KT-116—Complete Kit, less earphone.....Net 16.95
MS-260—Super Power Dynamic Earphone.....Net 3.95

1 AND 2 TRANSISTOR POCKET RADIO KITS

ONE TRANSISTOR POCKET RADIO KIT—KT-97

- IDEAL FOR STUDENTS, HOBBYISTS AND EXPERIMENTERS
- PRE-PUNCHED CHASSIS FOR ADVANCEMENT TO 2 TRANSISTOR KIT

Ideal, low-cost transistor pocket radio kit. Super-selective ferrite loop antenna permits good reception up to 50 miles radius with approx. 50 ft. antenna and good ground. Provisions for advancement to 2 transistor receiver. Complete Kit with simple detailed instructions. 3 3/4" x 2 1/4" x 1". Shpg. wt., 1 lb.

KT-97—Complete, less earphones.....Net 4.50

TWO TRANSISTOR POCKET RADIO KIT—KT-98

Contains all KT-97 components plus additional R-C coupled transistor stage for increased sensitivity and output. Complete with instructions. Shpg. wt., 1 lb.
KT-98 —Complete 2 Transistor Kit, less earphone.....Net 5.95
MS-111—Crystal earphone for KT-97 and KT-98.....Net 1.49
MS-260—Super power dynamic earphone.....Net 3.95



20,000 OHM PER VOLT MULTITESTER SEMI KIT

A new kind of kit—the difficult work is already done—you wire in only a few multipliers and mount the battery holder to complete the unit. A fine high sensitivity (20,000 ohms per volt DC —5000 ohms per volt AC) instrument employing a 3" 40 microamp movement. Has 4 DC voltage, 4 AC voltage, 2 DC current, 3 resistance and 2 db ranges. Complete with test leads and detailed instructions. Size 3 3/4" x 4 1/4" x 1 1/4". Shpg. wt., 3 lbs.

KT-20—Kit.....Net 11.95

Lafayette Radio 165-08 Liberty Ave.
DEPT IG-2 JAMAICA 33, N. Y.

SEND FREE CATALOG

NAME _____

ADDRESS _____

CITY _____

ZONE _____ STATE _____

CUT OUT AND MAIL TODAY!



Bookshelf (Continued from page 28)

not "reproduction" of music. This means, of course, that it is not—as you might think at first glance—a book on hi-fi, but rather a book on the electrical and electronic means of generating musical sounds. It is a thorough and erudite discourse, covering the physics of musical instruments, musical scales and intervals, transients, harmonic analysis, tone and waveform generators, and loudspeakers. This publication is really not so much a "do-it-yourself" book as a discussion—in non-mathematical terms—of the theory and circuitry involved in the making of music by electrical means. For those who are interested, the equations are neatly arranged in six appendices.

Recommended: to all readers interested in electronic musical instruments.



"**RESONANT CIRCUITS**" by Alexander Schure. Published by John F. Rider Publisher, Inc., 116 West 14th St., New York 11, N.Y. 72 pages. Soft cover. \$1.25.

Volume 16 in Rider's "Electronic Technology Series," this book deals with resistors, capacitors, and inductors found in various series, parallel, or series-parallel resonant combinations in electronic circuits.

Analyses are made of the elements comprising parallel resonant circuits, and of the circuits themselves. Distributed constants, resonant coupled circuits, and applications are also discussed.

Recommended: as a guide for engineering students and electronic technicians.



"**PIN-POINT TV TROUBLES IN 10 MINUTES.**" Published by Coyne Electrical School, 500 South Paulina St., Chicago, Ill. 308 pages. Spiral bound, semi-hard cover. \$3.95.

This handbook for service technicians describes a system for locating over 700 troubles which may cause 70 basic types of faulty pictures in television receivers. Simple check charts, along with cross references, guide the user to the most likely cause for each symptom of trouble. Explanations of circuits and designs used in most TV sets made since 1953 accompany the tables. Illustrated and described are methods for checking performance of components, as well as for making service adjustments. The book deals primarily with trouble location and correction rather than with principles and theory.

Recommended: for technicians with background in use of service instruments. —30—

INDUSTRIAL ELECTRONIC— AUTOMATION TECHNICIANS Desperately Needed!



Never in history has there been such a tremendous demand for Electronic technicians at the servicing, maintenance and assistant Engineering level, in all fields of electronics. Industries, Businesses, large and small are turning to Electronically controlled machinery ... **AUTOMATION!**

Whether it's a Robot airplane, an automobile plant with an integrated line of machines, a Sensing Device, Computing System or Communications—each re-

quire electric power applied through automatically controlled processes. This means there are positions open at all levels and phases for Electronic Technicians.

Bailey electronic students learn Industrial Television on specially designed equipment such as this panelboard, which is a multiple camera and screen control. The Bailey Electronic course includes an outstanding comprehensive program in radio and TV receiver servicing.

- TOP PAY
- UNLIMITED OPPORTUNITY
- SECURE FUTURE

Let us send you FREE, without obligation, complete details of our Resident Electronic Training Program—originated by Bailey Schools—acclaimed by Electronic Engineers. See how you save time as you learn-by-doing with intensive laboratory work on the most recently developed Electronic equipment, plus classroom required physics, mathematics, etc.

We help you find part time work while in our school—help place you with America's leading companies after graduation. Act now—mail coupon today!

VETERAN APPROVED

Bailey Technical Schools
1626 S. Grand • St. Louis 4, Mo.

MAIL TODAY

Please mail immediately this free booklet without obligation.

FREE BOOKLET

Name _____

Address _____

City _____ State _____



STANDARD LINE

MANUFACTURERS
ORDERS INVITED
EXPORT ORDERS
INVITED

FEATURING
FAMOUS FACTORY

TUBES

- INDIVIDUALLY BOXED!
- GUARANTEED ONE YEAR!
- FACTORY BOXED • FACTORY IRREGULARS
- NEW JAN SURPLUS • EQUIPMENT TUBES

**ALWAYS 1000
TYPES IN STOCK**

FREE POSTAGE! On All Orders
Shipped In U.S.A., Territories and
A.P.O.'s. Send 25c for handling on or-
ders under \$5.00. Please send approx.
postage on Canadian and foreign
orders. Excess will be refunded.

Below Is A Partial List—Send For
FREE Complete List and Order Form

024	.42 5AT8	.79 6BK7	.75 7A4	.46 12J5	.39
1A7GT	.42 5J6	.59 6BN6GT	.74 7A5	.52 12L6	.59
1B3GT	.66 5T8	.48 6BQGGT	.57 7A6	.44 12SA7	.47
1C5GT	.40 5U4G	.79 6BQ7	.75 7A8	.44 12SG7	.54
1C6	.25 5V3	.49 6BZ7	.57 7AU7	.44 12SK7	.47
1C7G	.42 5V6GT	.79 6C4	.50 7B6	.43 12SL7GT	.56
1D5GP	.45 5X8	.38 6C86	1.17 7B7	.40 12SN7GT	.39
1H4G	.46 5Y3	.42 6C96	.36 7B8	.41 12SQ7	.44
1J6GT	.45 5Y4G	.44 6CUG	.47 7C4	.42 12V6GT	.59
1L4	.54 5Z3	.56 6D6	.43 7C5	.46 12W6	
1L5	.55 6A7	.46 6E5	.36 7C6	.40 12X4	.36
1LA4	.46 6A8	.44 6F5	.37 7C7	.41 14A7	.44
1LA6	.58 6AB4	.66 6F6	.37 7E5	.42 14B6	.44
1L44	.48 6AF4	.75 6H6	1.59 7E6	.44 14Q7	.44
1LC5	.46 6AF4	.49 6J4	.38 7E7	.44 19T8	.69
1LC6	.56 6AG5	.68 6J5	.48 7F7	.58 25CA5	.79
1LD5	.56 6AG7	.69 6J6	.38 7F8	.74 25CUG	.84
1LE3	.46 6AH4GT	.70 6KGGT	.67 7G7	.57 25D6	.99
1LM4	.46 6AH6	.53 6K7	.59 7Q7	.34 25CUG	.46
1LNSGT	.49 6AK5	.41 6L6	.39 7X7	.39 25W4GT	.42
1R5	.50 6AL5	.79 6N7	.30 7Y4	.40 25Z6	.24
1S5	.50 6AN8	.45 6S4	.70 7Z4	.49 35B5	.47
1T4	.46 6AC5	.47 6S8GT	.47 12A4	.40 35C5	.46
1U4	.45 6AS5	2.25 6SA7	.75 12A6	.65 35L6GT	.46
1U5	.70 6AS7G	.38 6SB7Y	.47 12AB5	.41 35W4	.40
1V2	.66 6AT6	.79 6SC7	.40 12AQ5	.40 35Y4	.38
1X2	.49 6AT8	.64 6SG7	.42 12AT6	.66 35Z5GT	.38
2A3	.56 6AU4GT	.60 6SH7	.42 12AT7	.64 39A4	.25
2A7	.95 6AUSGT	.42 6SJ7	.49 12AU6	.62 50A5	.47
2D21	.50 6AU6	.79 6SK7	.56 12AU7	.67 50D5	.44
3A4	.50 6AUB	.64 6SL7GT	.56 12AV6	.67 50C5	.39
3A5	.52 6AV5GT	.38 6SN7GT	.40 12AV7	.45 50L6GT	.47
3AL5	.52 6AV6	.89 6SQ7	.40 12AX7GT	.59 80	.45
3AU5	.56 6AW8	.65 6SS7	.67 12A27	.45 84 6Z4	1.25
3B26	.57 6AX4GT	.56 6T4	.85 12BA7	.63 117N7GT	1.25
3BC5	.57 6AX5GT	.46 6TB	.54 12B4	.59 117P7GT	1.25
3BN6	.57 6BA6	.49 6U5	.79 12BA6	.79 117Z3	.36
3CB6	.55 6BC5	.89 6U8	.79 12BA7	.45 117Z6GT	.61
3Q4	.56 6BC8	.52 6V3	.45 12BE6		
3Q5GT	.46 6BD5GT	.45 6V6GT	.39 12BH7		
3S4	.55 6BE5	.39 6W4GT	.52 12BY7		
3V4	.75 6BF5	1.17 6W6GT	.38 12CA5		
4BQ7	.75 6BGG	.50 6X4	.38 12CU6		
4BZ7	.79 6BH6	.46 6X5	.74 12DQ6		
5ANB	.79 6BJ6	.67 6X8			
5A95	.49 6BK5				

Receiving Tubes Sent Parcel Post

Thousands of TRADE-IN TV'S

Please Specify Console or
Table Model When Ordering

10"	\$25.00
12"	\$30.00
14"	\$35.00
16"	\$42.00
17"	\$49.00
19"	\$56.00
20"	\$63.00
21"	\$70.00
24" (when available)	\$95.00
27" (when available)	\$129.00

Reconditioned By Fac-
tory Trained Techni-
cians! Guaranteed To
Be In Working Condi-
tion When You Receive
Them!

Get Yourself a second
set or buy some for re-
sale!

FREE BONUS . . .
two set coupler
given with each set.

All TV's sent motor
freight or Railway Ex-
press F.O.B. our ware-
house, sorry, no A.P.O.
shipments.

Any 10" Tube	\$10.75
Any 12" Tube	\$12.75
Any 14" Tube	\$14.75
Any 16" Tube	\$16.75
Any 17" Tube	\$17.75
Any 19" Tube	\$20.75
Any 20" Tube	\$20.75
Any 21" Tube	\$22.75

Standard Line PICTURE TUBES

Guaranteed One Year

All Picture Tubes sent Rail-
way Express F.O.B. our
warehouse. Sorry, no A.P.O.
shipments.

FREE Free

12" TV SET
with every re-
ceiving tube or-
der of \$100.00 or
more.

16" TV SET
with every re-
ceiving tube or-
der of \$200.00 or
more.

FREE!

**TWO SET
COUPLER WITH
EVERY ORDER
OF \$8.50
OR MORE!!**

Bonus TV sets
are shipped com-
plete with cabinet
F.O.B. our ware-
house. With slight
adjustments and
minimum labor
they can be re-
stored like new.

We Are
Not Selling
Price—We
Sell Only
Quality

STANDARD LINE

ELECTRIC COMPANY

432 HARRISON AVENUE, HARRISON, N. J. Phone: HUmboldt 4-4997

Remember—
You Buy Qual-
ity When You
Buy Standard.
Quality Never
Shouts—It Al-
ways Whispers

FREE

1957
EICO[®]
CATALOG

SAVES YOU 50% on your

TEST INSTRUMENT & HI-FI COSTS

50 KITS & WIRED MODELS to choose from!

EICO[®] 84 Withers St., Bklyn. 11, N. Y.

Show me HOW TO SAVE 50% on Laboratory Precision test instruments & Hi-Fi. Send FREE catalog & name of neighborhood EICO Distributor. PE-7

Name

Address

City Zone State

Occupation

Prices 5% higher on West Coast



Home, car, TV, appliance repairs:

#540 NEW!
REDI-TESTER
KIT \$12.95
WIRED \$15.95



VACUUM TUBE
VOLTMETER
#221
KIT \$25.95
WIRED \$39.95



NEW! PEAK-to-PEAK
VTVM
#232 & UNI-PROBE
(pat. pend.)
KIT \$29.95
WIRED \$49.95



1000 Ohms/Volt
MULTIMETER
#536
KIT \$12.90
WIRED \$14.90

You build EICO KITS in one evening — but they last a LIFETIME! OVER 1 MILLION in use today!



5" PUSH-PULL
SCOPE #425
KIT \$44.95
WIRED \$79.95

Lowest-priced Professional Scope



NEW! COLOR &
BLACK-& WHITE
5-MC TV
SCOPE #460
KIT \$79.95
WIRED \$129.50

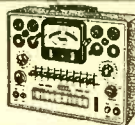

TUBE TESTER #625
KIT \$34.95 WIRED \$49.95



#666
NEW! DYNAMIC
CONDUCTANCE
TUBE &
TRANSISTOR TESTER
KIT \$69.95 WIRED \$109.95



NEW!
RF-AF SIGNAL
GENERATOR #324
(150 kc to 435 mc)
KIT \$26.95 WIRED \$39.95



TV-FM SWEEP
GENERATOR
#360
KIT \$34.95 WIRED \$49.95



MULTI-SIGNAL TRACER #145
KIT \$19.95 WIRED \$28.95



1000 Ohms/Volt
MULTIMETER
#556
(4 1/2" METER)
KIT \$16.90
WIRED \$23.50

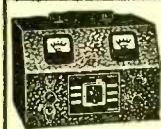

6V & 12V
BATTERY
ELIMINATOR
CHARGER &
KIT \$29.95 WIRED \$38.95



R-C BRIDGE & R-C-L
COMPARATOR #950B
KIT \$19.95 WIRED \$29.95



Test radio, hearing aid,
flashlight, photo-flash,
electronic equipment
batteries:
BATTERY TESTER
#584
KIT \$9.95 WIRED \$12.95



RETMA Res. Sub.
Box #1100
KIT \$5.95 WIRED \$9.95



RETMA Cap. Sub.
Box #1120
KIT \$5.95 WIRED \$9.95

HIGHEST QUALITY HI-FI at the lowest prices...

only from **EICO**



NEW
MASTER
CONTROL
PREAMPLIFIER #HF61
KIT \$24.95 WIRED \$37.95
with Power Supply:
KIT \$29.95 WIRED \$44.95



NEW!
60-WATT
Ultra Linear
HIGH
FIDELITY
POWER AMPLIFIER
#HF60 with ACRO TO-330 OUTPUT XFMR
KIT \$72.95 WIRED \$99.95

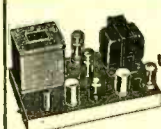

NEW!
50-WATT
Ultra-Linear
POWER
AMPLIFIER
#HF50
with
CHICAGO OUTPUT XFMR
KIT \$57.95 WIRED \$87.95

- proven trouble-free designs
- superb listening quality
- unequalled circuit refinement
- unequalled component quality
- unmatched control facilities
- unmatched low distortion



NEW!
20-WATT
Ultra-Linear
Williamson-type
INTEGRATED AMPLIFIER
#HF20
KIT \$49.95 WIRED \$79.95



NEW!
50-WATT
Ultra-Linear
INTEGRATED AMPLIFIER
#HF52
KIT \$69.95 WIRED \$109.95



NEW! 12-WATT Williamson-type
INTEGRATED AMPLIFIER #HF12
KIT \$34.95 WIRED \$57.95

NEW!
COMPLETE with
FACTORY-BUILT
CABINET-2-WAY
HI-FI SPEAKER
SYSTEM #HF51
\$39.95



EARLY IN 1954, a Chicago housewife innocently became responsible for the murder of a bank guard and the subsequent escape of the criminal with over \$10,000 in unmarked Federal bills. Her rented diathermy machine had jammed radio police calls emanating from a local police transmitter, preventing the prowl cars from receiving the robbery tip-off in time.

In the same year, the FCC published warnings that illegal diathermy machines had been known to interfere with instrument landing signals, causing the crash of at least one large airliner, and had blocked a nearby radar screen used by airports to prevent midair collisions. Another terrifying story was told of a doctor's ultra-short-wave machine which had thrown a guided missile—the new Army NIKE—off its course and started it homing toward the doctor's office itself. Only at the last moment was the

What You Should Know About **DIATHERMY**

**New rigid controls enforced by
FCC prevent communication snag**

tragedy averted by emergency control from the ground.

These machines that bedevil radio communications are strange crossbreeds between the dissimilar sciences of electronics and medicine. Their history and present use are filled with hopeful promise for the art of healing, yet clouded by so many false notions that it seems timely to sift fact from fancy and tell plainly what these machines can and cannot do.

"Live" Test Rig. The idea of beaming a concentrated field of radio waves into the

Backache due to muscular strain is frequently relieved by diathermy. Our photo shows the capacitor-type electrode of a G. E. diathermy unit being fitted to the small of the patient's back.



By **HARVEY POLLACK**

and **H. H. FANTEL**

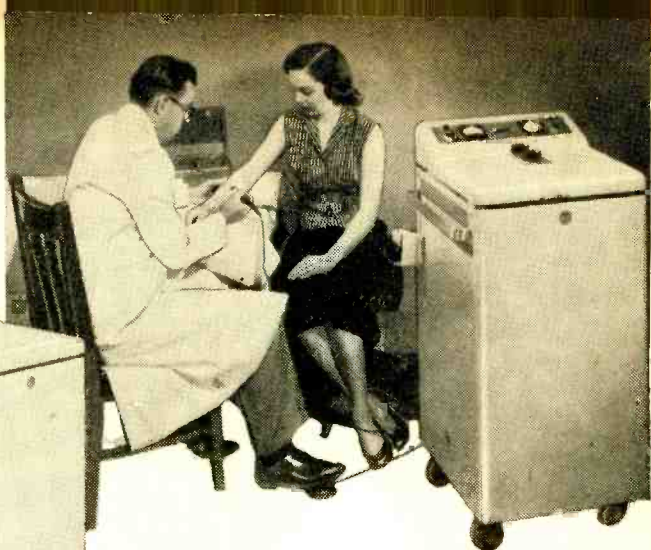

With electrode placed over forehead (as shown at left), diathermy alleviates sinus attacks. Above, the same G.E. machine is fitted with a small electro-cautery electrode for treating skin lesions or removing warts.

human body may seem odd at first. But we must remember that the science of electricity has from its beginnings been allied with biology. The twitching frog leg was the first indicator of electric current, long before the electroscope or other indicating instruments were invented. The effect of electricity on living organisms has ever since been a subject of research.

Convulsion—the sickening cramp most of us have experienced as an “electric shock”—was the only known human reaction to electricity. This occurred with direct current or with alternating current of low frequency, such as ordinary, 60-cycle house current. Toward the end of the last century, fast-turning generators made it possible to step up the alternating current to several thousand cycles per second. It was then discovered that such currents did not cause the familiar and often lethal convulsion.

The French scientist d'Arsonval (remembered chiefly for his invention of the modern meter movement) experimented courageously along these lines, with himself as chief guinea pig. In 1891, using a newly invented spark-gap generator, he revved up his a.c. to a million cycles. Then he did something seemingly suicidal. He hooked himself into the circuit, holding a light bulb to see if he was “drawing juice.” Everyone was shocked except d'Arsonval. When the bulb lit up, all he felt was a pleasant, relaxing warmth deep inside his body. D'Arsonval didn't know it, but he had just given himself the world's first diathermy treatment.

Brief Hope. Radio, the new wonder of the 1920's, provided the next big push.

Vacuum-tube oscillators made it possible to control the frequency used for medical treatment within narrow limits, rather than spray out a broad band as did the old spark generator. Particularly, the newly developed short-wave circuits suggested the possibility of aiming focused radio beams at diseased parts of the body.

In 1924, Dr. Schereschewsky succeeded in killing a malignant tumor with 150-megacycle waves. This announcement created a sensation. It was front-page news to the public. Even medical journals dreamed of bloodless surgery, in which the short-wave electrode would replace the knife. To doctors and the public alike, this seemed like the millenium of medicine. For the surgeon's knife, though it can halt decay and sometimes repair damage, can never accomplish positive good. Surgeons themselves, though confident and practiced in their art, often share their patients' sense of mystic dread—for cutting of the living body brings to mind that all flesh is mortal and that the realm of medicine is ultimately powerless against the greater domain of death.

Yet medical hope fell as quickly as it rose. It was simply impossible to focus radio waves sharply enough to localize their effect to knife-edge exactness. Instead of becoming a substitute for surgery, short-wave therapy or diathermy simply remained a means of internal heat treatment.

The Healing Wave. In effect, short-wave diathermy is like a heating pad wrapped around a distressed organ or muscle inside the body. Doctors use the expression “point heating in depth” to de-

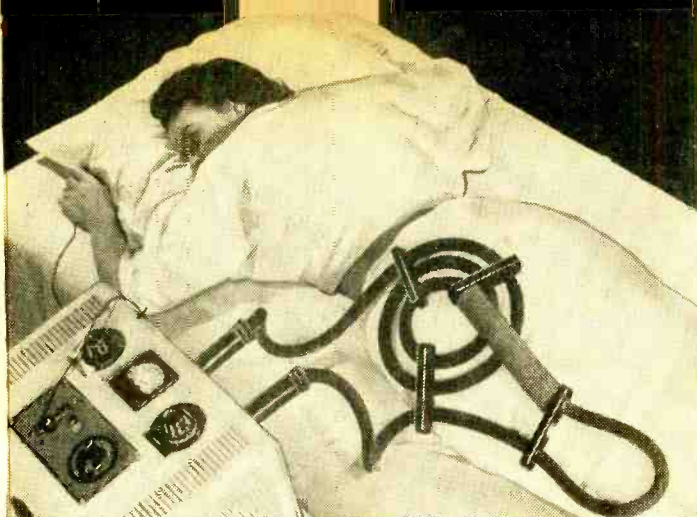

Inductive electrode in the form of a coiled cable is used for treatment of the sciatic nerve area of the patient shown at the left. The machine, operating at 27.12 mc. is a Burdick product. Another Burdick model, shown below, employs microwaves at 2450 mc. with a capacitive reflector electrode to obtain a focused deep-heating effect within the muscles of neck and shoulder.

scribe the action. Such diathermy is now widely used to reduce inflammations of the internal organs, ease the pain of neuritis, neuralgia and bursitis. It has also been applied successfully in cases of pneumonia, tuberculosis and heart disease.

Just how it works, nobody knows. The patient is placed between antenna-type electrodes—but what happens within the body is still a mystery. We know that heat is generated by the motion of molecules, and apparently the molecules of the body are stirred into a fast jig by the fluctuations of the high-frequency field. But aside from mere heat, there seems to be some unique organic effect having to do with still unknown forms of physiological energy transformation.

Only within recent years has the science of physical chemistry begun to investigate the action of complex organic molecules when placed within fields of electric energy. Much remains to be learned. Meanwhile, diathermy is prescribed by countless doctors as a welcome pain-reliever and accelerator of natural healing.

Pain in the Neck. The new pain-soothers, however, created a new pain—right in the neck of the FCC. Every day, thousands of these machines burst into the radio spectrum—into practically every part of it. From all over the country came a flood of complaints from the radio services that diathermy machines were jamming the communications frequencies.

The FCC took quick action. After consultation with medical authorities, the commission in 1947 assigned two specific frequencies to which the machines were to be confined: 27.12 mc. and 13.56 mc. At the same time, owners of existing machines were given until June 30, 1953, to

(Continued on page 115)



CHECK THESE ITEMS

On your doctor's advice, you may want to buy or rent a diathermy machine for home use. Check these factors before you buy.

Frequency. The only legal frequencies are 27.12 mc. and 13.56 mc. "On-frequency" operation should be guaranteed by either crystal control or other approved methods.

Seal of Approval. Be certain your machine is FCC-approved and endorsed with the seal of the American Medical Association.

Applicator Electrodes. Inductor or cable applicators are recommended for 13.56 mc. while capacitor applicators are better suited for 27.12 mc. Make sure that you have the right kind of electrodes.

Overload Protection. Fuses or circuit breakers should be provided as protection against overloads or short circuits.

Power Output. The medical profession recommends a minimum of 350 to 400 watts for certain types of treatment.



**F.C.C.
Approval
D 507**



"Spot Wobble" Unlines TV Picture

Vast improvement in TV pictures is predicted by Westinghouse if the "spot wobble" method of horizontal line scanning is introduced. TV viewers are all familiar with the black and white lines that make up the picture. A viewer too close to the receiver can see the lines (ten feet is optimum for a 24" screen). This can be remedied by slightly wobbling the scanning spot in the picture tube so that a broader line is rendered for better quality at a closer viewing distance.

Stereoscopic TV for "Hot Stuff"

The atomic age has raised a crop of problems literally "too hot to handle." Unfortunately, not all of them are amenable to such practical solutions as the stereoscopic TV system, developed by Marconi Company, Ltd., of England, which lets technicians see remotely controlled manipulations in three dimensions. The

bottom photo was taken inside the shielded "hot box" where dangerous materials are handled by mechanical arms. The twin-lens stereo TV system watches the process and projects a three-dimensional image on

the observation screen outside the shielded area. This 3-D screen helps the technician (center photo) execute delicate operations through his controls with unimpaired space perception.

The importance of space perception in remote-control handling of radioactive material was dramatically brought to public attention by an accident in the M. W. Kellogg Co. plant at Houston, Texas. A slip in remote manipulation caused a minor blast there. Though too weak to do physical damage, the radioactive dust stirred up endangered the plant temporarily.

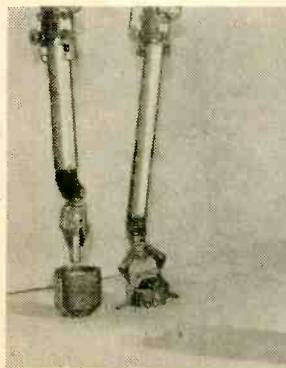
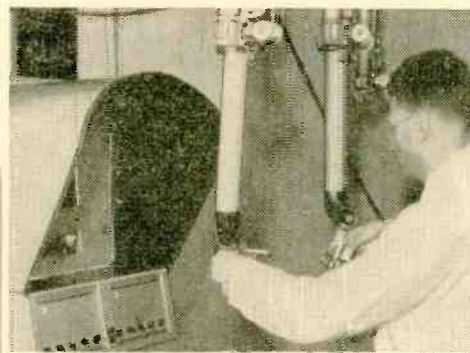

Pigantics

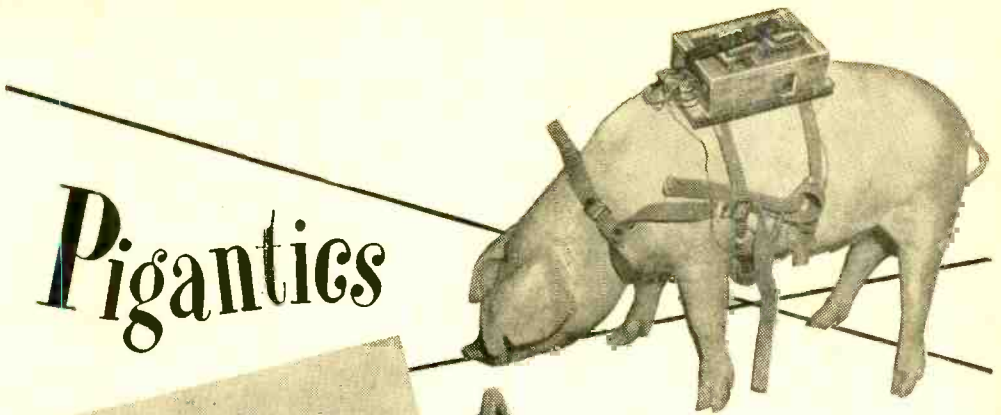

**Artificial jet thunder
storms the barnyard
to test effect of noise
on farm animals**



Experts from Dept. of Agriculture check loudspeaker and receiving equipment for pigs-versus-planes project.



OUR four-footed friend above is a principal participant in scientists' experiments to determine whether noisy jet aircraft, roaring over the barnyard all day, has any adverse effect on the milk and meat producing capacities of farm animals.

Aircraft sounds are beamed from a giant loudspeaker to our "victim," all decked out in amplifier and radio transmitter. Laboratory receiving equipment includes an electrocardiogram recorder, heart rate recorder and oscilloscope, which enable experts to study the animal's heart action and determine effects of noise.

Experiments conducted by the U. S. Department of Agriculture's Research Center have been going on for over a year. The "subjects," however, don't appear to be at all concerned over the earnest proceedings, and though they may pause momentarily while eating or wriggle their ears in response to the racket—so far, no noise nerves have been reported.

-30-





Priest Chases Trains

Father Clement C. Kubesh of Clarkson, Nebraska, tape-records the sounds of fast-vanishing steam locomotives. He has been chasing these dramatic toots since 1949, and has recorded over 1800 feet of locomotive "stack talk" and whistles. The priest's rectory has become the center for old-timer railroadmen who often cry as they listen to the recordings and comment: "It's just like being at the throttle again." Some of the prize sounds in his unusual collection include the 2400 Series GN Pacific struggling with 110 carloads of beets and potatoes and an 800 Series Northern UP pulling the fast mail through Valley, Nebraska, moving at 90 miles an hour, with the hogger hanging hard on the whistle cord.

—H. F. Unger

"Car Call" Receivers

Two novel mobile receivers (shown at right) are available from Seeley Electronics, 1060 S. La Brea Ave., Los Angeles 19, Calif. They are intended for use in radio paging, fire, forestry, mobile phone service, etc. Either receiver will operate on 6- or 12-volt ignition systems. One model is for AM stations, the other for FM stations. Both utilize regular auto antennas and have squelch facilities to cut out background noise while the car is in motion.

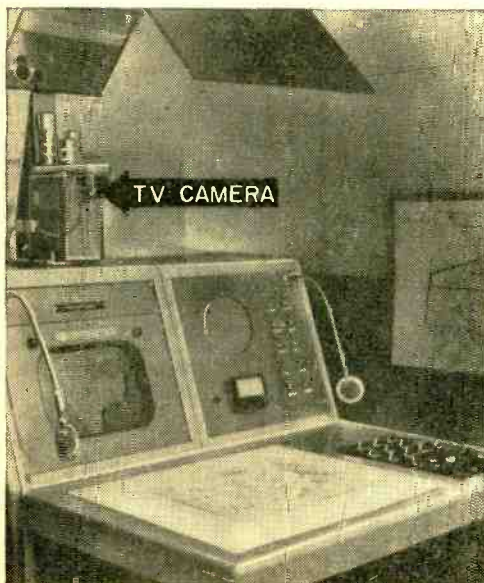
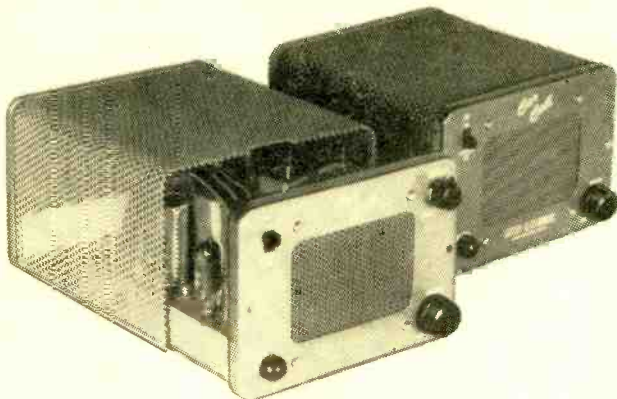

Weathervision Forecasting

The U. S. Air Force has adopted an industrial TV network, replacing duplicate forecasters at separate points, to speed up dissemination of weather forecasts. From the TV console (at left), a single forecaster monitors available weather sources, answers questions from pilots and briefs outgoing flights. The TV camera (note arrow in photo) views the forecasting map via a system of mirrors.

Ninth ARRL Convention

Big plans are being made for the annual convention of radio hams. It will be held at the Palmer House, Chicago, Ill., from Aug. 30 through Sept. 1. Sponsored by the ARRL, the convention will have exhibits on three floors. Preregistration fee is \$10.50 (including banquet). Further information is available from the Chicago Area Club Council, Box 6797, Chicago, Ill.

POPULAR ELECTRONICS

The V.H.F. Ear

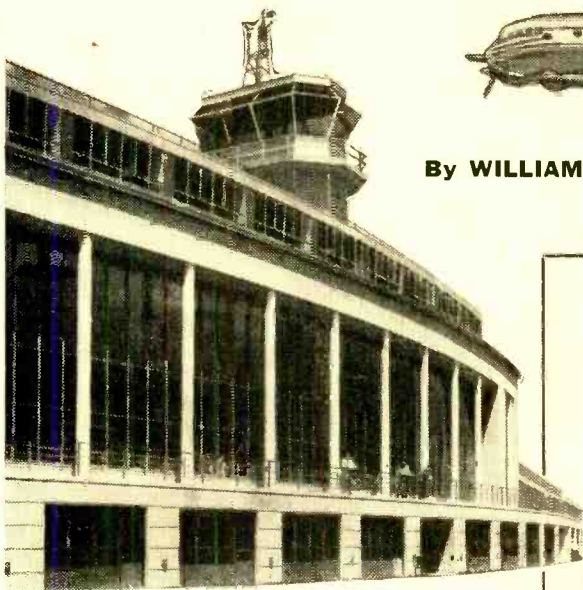

By WILLIAM I. ORR



Miniature v.h.f. receiver ("T-Ear")

doubles your fun while traveling via airlines

HAVE YOU EVER gotten something for nothing? It isn't easy these days. But here is something for *almost* nothing—a transistorized v.h.f. receiver that tunes from 90 mc. to 145 mc. and operates from one or two penlite cells.

If you are around an airport, you can use it to listen to the control tower talk to the aircraft. If you take a flight, you can listen to the aircraft talk to the ground control station. If you participate in a ham radio hidden-transmitter hunt, you can "track down" the quarry with bloodhound-like accuracy. And you can do all this with the receiver operating in your pocket!

The unit that performs all these stunts is shown in the photographs. It employs a 1N82 v.h.f. silicon crystal diode detector, and an inexpensive CK722 transistor as an audio amplifier. The transistor is powered by one or two 1½-volt penlite batteries.

Assembly. You can build the v.h.f. "T-Ear" in a plastic box measuring approximately 2" x 2⅞" x 1" (obtainable from a local five-and-ten-cent store). A banana jack atop the box holds a 16" length of wire used as an antenna. On the front of

Transistorized "T-Ear" is shown below compared in size with a cigarette. Knob tunes in various airlines channels.

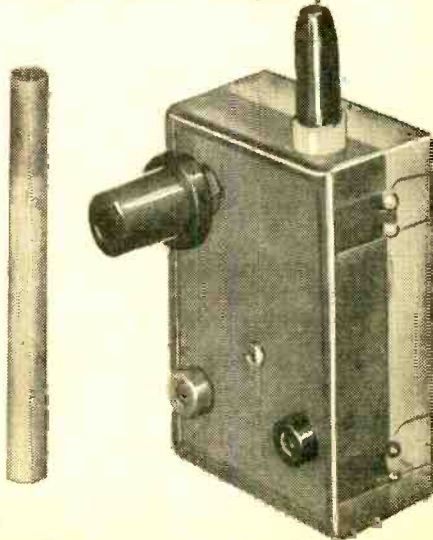

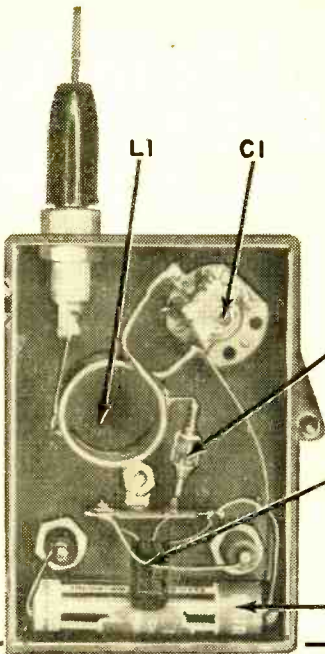

PARTS LIST

- B1—Penlite cell
- C1—9- μ fd. variable capacitor (Johnson 9M11)
- CR1—1N82 v.h.f. diode
- J1—Tip plug and jack
- J2, J3—Tip jack
- L1—4 turns of ± 16 tinned wire, $\frac{3}{4}$ " diameter, spaced to $\frac{1}{2}$ " long
- TR1—CK722 transistor (Raytheon)
- TR2—2N35 transistor (optional—see text)
- 1—2" x $2\frac{1}{8}$ " x 1" plastic case
- 1—Phenolic tie point (Cinch-Jones 53E)
- 1—Knob, $\frac{3}{16}$ " shaft
- 1—16" length of stiff copper wire for antenna

the box is a tuning capacitor, *C1*; this is an ordinary 9- μ fd. midget capacitor.

At the bottom of the plastic box, the penlite cell(s) is held in place by two short pieces of solid wire, soldered to the ends of the battery. Your negative (battery shell) lead goes directly to the earphone jack above the battery, while your positive lead goes to the transistor's emitter terminal. The collector of the transistor is distinguished by a red dot on the case. This terminal of the tie-point strip is connected to the other earphone pin-tip jack.

Wind a simple four-turn coil of #16 tinned wire and mount it across the terminals of *C1*. The coil is tapped one-half turn up from the end attached to the rotor of *C1*. Connect this tap to the antenna jack by a short length of wire. The rotor of *C1* is connected to the emitter of *TR1* by another length of short wire.

The last item to be placed in the circuit is the 1N82 v.h.f. diode. This connects between the base of the transistor and a tap on the tuning coil. Place the tap two turns

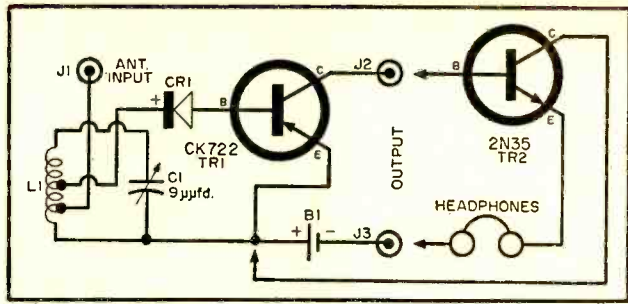

CR1 Simplicity of construction is shown in photo and schematic diagram of receiver. Headphones can be plugged directly into output of single transistor, but greater volume results if transistor *TR2* is added and *J2/J3* repositioned in circuit.

up from the end of the coil attached to the rotor of *C1*.

As in the case of the transistor, the 1N82 crystal may be damaged by excessive heat. As you solder each into the circuit, hold wire between part and point of soldering with long-nose pliers. When the 1N82 is connected, moisten your fingers and touch joint to draw as much heat out of it as possible. The crystal should be so oriented in the circuit that the terminal with the arrowhead is attached to the tie point.

As indicated in the caption above, the "T-Ear" can be made in two versions. Addition of the second transistor (the *n-p-n* 2N35, *TR2*) will increase the volume. This is particularly important if you want to use the "T-Ear" in a noisy area or with a very-high-impedance earphone. If your earphone has a d.c. resistance of between 1000 and 1500 ohms, the simple circuit with the single transistor will probably work very well. A 2000-ohm headset requires the additional transistor and an increased battery voltage (3 volts).

Testing. The v.h.f. "T-Ear" is now complete. It may be tested by bringing coil *L1* near a grid-dip oscillator tuned to the vicinity of 100 mc. If an antenna is attached to the GDO, and the GDO is modulated with a tone, it should be possible to receive the signal 10 or 15 feet away.

Don't expect the signals to blast your ears. The sensitivity of the "T-Ear" is very low. A good check for the sensitivity, and operation of your "T-Ear," is to listen in near a running automobile. If the sensitivity is up there where it belongs, you should hear the popping and snapping of the car's ignition.

Using the model at the local airport, the control transmitter could be heard several hundred feet from the tower, and the approaching planes could be heard as they were coming in for a landing.



By **RON ANDERSON**

Dig That Crazy Ribbon!

UP IN Greenwich, Conn., the night air was shattered by the 60-db roar of an African lion. Frantic phone calls to police headquarters brought a safari on the run, armed with ropes, nets and high-powered rifles. After carefully surrounding the wooded residential area where the beast had been reported, the police cautiously closed in.

But instead of a prowling predator, they bagged—of all things—a loudspeaker. It seems that there was a party in the neighborhood, and the host—a tape recording fan—had hidden a strong-muscled speaker in the bushes outside. As the party was slowing down, he played some tapes he had made at the zoo, “just to pep things up!” That’s what he told the judge—which goes to show that, while most uses for tape recorders in science and industry are pretty serious, tape has its zanier moments as well.

Animal Audio. In its off moments, the rusty ribbon—its magnetic coating of reddish-brown iron oxide gives it that color—has even been known to help little pigs become big pigs (by encouraging them to nurse from bottles given a maternal touch by taped sow sounds), to make hot dogs talk and plain dogs sing.

It has eavesdropped on earthquakes, frogs, fish, burglars, two-timing husbands, sounds from outer space and the heartbeat of a whale.

It has induced a temporary nervous breakdown in human beings by echoing their own speech and it has made others learn foreign languages in their sleep—and it found out all about Bridey Murphy.

An old rural saying—“It’s so hot you can hear the corn growing”—was proven by tape. A skeptical Wisconsin editor toted a tape recorder into a





To hear the corn grow is the exalted aim of these stalwarts of science. On a "field trip" with their recording gear, they stage what is probably the zaniest corn field scene since King Lear.



corn field on a still night and turned it on. The result? A tapeful of snap, crackle and pop—typical corn-growing sounds—hot off the cob.

Articulate Sausage. Talking hot dogs, barking in plain English, have tape vocal cords. Their electronic pedigree relates their breed to any number of inanimate objects, including talking refrigerators, elevators, gasoline pumps and Uncle Sam's mail boxes. As the unwary customer approaches the hot dog—or what have you—the gadget accosts him with pre-recorded jingles. It stimulates sales—so they say.

But talking dogs evidently are not enough to satisfy this wonderful age of science. A Dane named Carl Weismann chases dogs with a tape recorder to capture the haunting music of their howls. With his portable machine he toured the alleys and gutters of Copenhagen luring stray mongrels of all kinds to bark into his microphone. From this varied canine chorus he then snipped the taped barks into individual woofs, classified each on the musical scale from soprano to bass and put them all back together again in such sequence that they came out *Jingle Bells* when the patched-up tape was played.

And if you think this sounds completely silly, you are quite right. But consider that a record firm put it on a disc that sold half a million copies—"confounding man and beast" as *Life* magazine reported. Whatever it is, this proves *something*—possibly that the bark of a dog is worse than his bite.

Frog Courtship. Tape recordings also figured in a project reminiscent of the late Dr. Kinsey when a University of Texas biologist headed for the swamps to survey

the sexual behavior of toads and frogs. By taping the mating calls of various species, he discovered why some frogs lead a loveless life. That, incidentally, was not his purpose. The captured croaks are expected to contribute to knowledge of heredity factors in humans.

While we're on the subject of sex, there's the story about the ex-GI, allegedly from Newcastle, Pa., who corresponded via tape recordings with a Fraulein by name of Bertha Kohlz whom he had met on occupation duty in Germany. After two years of talking on tape, their hi-fi courtship warmed to the point where he married her and brought her to the United States. As far as is known, this is the only tape recorder to have a hand in carrying Kohlz to Newcastle.

Spell on Reels. The man who really started the tape reels rolling was a guy who wanted to be in two places at once—Bing Crosby. Back in 1948, with a yen for the easy life, Crosby took a dim view of spending his dinner hour in the studio so that the network's eastern listeners could hear his radio show "live" at a respectable hour.

Recordings were the only answer, but in those days producers paled at the mention of a canned show. They felt that the crooner's magic spell would defy confinement into grooves. Yet Crosby was insistent, so a few shows were disc-recorded in advance. As predicted, the shows lost their sparkle on wax. Editing and cutting—which could add snap to a slow show—was impossible on discs.

Then Crosby ran across the Ampex Corporation which had "liberated" the Magnetophon, the first tape recorder secretly



developed in wartime Germany. With this machine and the Scotch tape people's amazing new oxide-coated tape, "live" quality was a cinch. And to top it off, the rusty ribbon could be sliced and spliced like movie film. Editing became a snap—you might even say a "snip"—with nothing more than a pair of scissors and some sticky tape.

The result was that Crosby and his crew took a new lease on their Hooper rating and enjoyed dinner at home while a taped show "stood in" at the studio.

Tape Tax Tricks. Crosby's experience broke the sound barrier in radio. Soon "Duffy's Tavern" made history by taking shape on tape in the easygoing comfort of a Caribbean isle, where the cast basked contentedly in the sun. By taking their tape recorder abroad, they also managed to "erase" the income tax from their pay checks.

The famed sister team of Maro and Anahid Agemian, two outstanding musicians who appear in concert halls over the country, rehearse their piano and violin duets regularly, though they live thousands of miles apart. One sister, living on the west coast, tapes her piano part and sends the tape to the other sister, living on the east coast. She, in turn, plays the tape and practices right along on her violin.

While tape has given stars of both radio and television this super stand-in, it has also bequeathed dual personalities to lesser lights. Politicians discovered a legal way of stuffing extra votes into the ballot box—campaigning in several places simultaneously through recorded tape. While multiplying votes in this way, they complain that the tape won't shake hands, lead parades, and kiss babies.

Tape mementos from trip to Soviet Union remind Russel Lund and his family (above, left) that the Russian police are also tape recording fans. Senator Jackson of Washington (above) can be two or more places at once when campaigning by tape.

Pastorless churches now have tape services. Though many congregations seem willing to listen to sermons from a machine, some theologians object to tape-recorded prayers. Arguing that it is the sincerity of prayer that counts and not the mere sound of the words, they figure that hi-fi—though it speak with the tongue of angels—is but sounding brass.

Travelers carrying lightweight battery-powered tape recorders can now bring back audio panoramas from their journeys, livening up their photographs and movies with the music, street sounds, and speech of the countries they have visited. One Minneapolis family took a tape recorder to Russia to record the highlights of the trip. The police returned the compliment by "bugging" their hotel room with microphones to record *them*. This, evidently, was one of rare instances where the communists considered turn-about fair play.

In this random roundup of the odds and ends in tape recording, the accent is on the "odds." We therefore shan't go into the many sobersided uses of tape in science and communications. Tape today is the mirror and sounding board for the varied noises of the world. But like trick mirrors at a carnival, tape, too, reflects human folly. —30—



No Light in Your Eyes

A rear-view mirror that thinks for itself is the latest product available from Instrument Research Company. It is called "Mirrottron." A photoelectric cell mounted above the mirror (see photo at left) senses extra-bright headlights and automatically switches the mirror to protect the driver's eyes. Complete installations are being marketed for about \$25.00 each.



New Station Listing Out

The Communication Engineering Book Co., Monterey, Mass., has released its 1957 registry of stations licensed for industrial service. Included are taxi stations, railroad, citizens service, motor carrier, highway truck stations, etc. As an added attraction, the listing has been divided into two sections. The second part of this 76-page book contains calls listed by frequency. Price is \$4.00, postpaid.



Electronic Vacuum Pump

Shown at left is a unique vacuum pump to be used in betatrons. It removes air, yet has no outlet. Known as Consolidated Electrodynamics' "Evapor-Ion," it eats up air that normally would be pumped out.

Pure titanium wire, heated by electron bombardment, evaporates and condenses as a thin layer on the walls of the pump. Active gas molecules strike the titanium layer and are held as compounds. Inert gases are ionized and the electrical field violently drives them into the titanium layer. Here they are buried by subsequent titanium evaporation and a near-perfect vacuum is created.

Chasing Sferics

Spotted in strange-looking radio shacks from Palm Beach to the Azores and on to Newfoundland are USAF personnel chasing thunderstorm static. Lightning atmospherics (or "sferics," as the weathermen call them) are closely associated with weather upheavals. Tracking the sferics with special antennas and receivers, Air Force meteorologists are able to pinpoint disturbances and steer important airplane flights around dangerous storm centers. The men in the photo at right are shown plotting information obtained from several check points to be passed on to the various stations.



THERE IS a distinct need in many home workshops for a sensitive meter to serve as a "comparator." Rather than taking accurate readings of known values, it just compares a set of various meter readings.

A bare minimum of parts is required for this simple circuit. The combined diagrams and the photos show how a transistor amplifier and diode detector are quickly assembled. You can store away the finished unit without any feeling of precious workshop capital lying dormant. And the probe can do double duty if used with an insensitive volt-ohm-milliammeter.

The removable base is a piece of Micarta

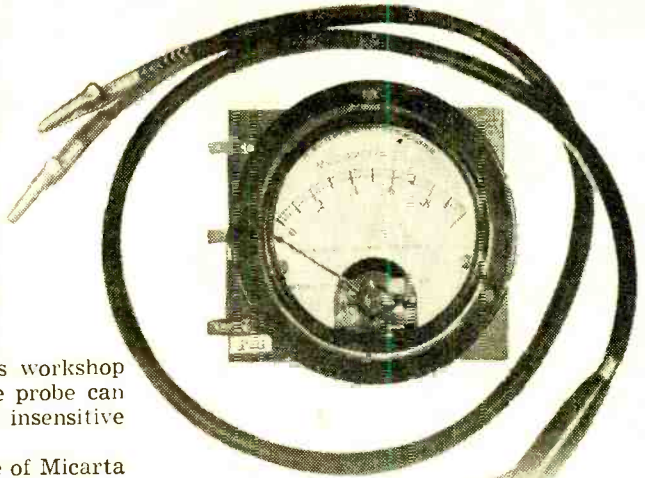

Building a Sensitive "Comparator"

on which all components are mounted; cut it square so that the meter will not roll around on the bench. Drill two large holes through the base for the meter studs. Mounting of the parts is not critical. The input terminals may, of course, be of any type that will connect to the probe or other types of connecting wires.

Assembly of the probe will vary according to the parts available. A ball point pen case, including the point, provides an ideal size handle to hold the diode, resistor and capacitor. The value of $0.01 \mu\text{fd}$. for $C1$ is a compromise between values for radio and audio frequencies. Since it does load a radio frequency circuit and does not pass very low audio frequencies, you might want to make two probes with different $C1$ values. A short length of shielded flexible cable with a stranded inner conductor connects the probe to the terminals of the meter amplifier.

—I. C. Chapel

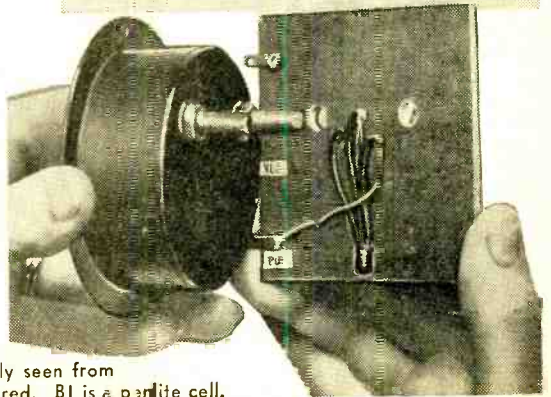
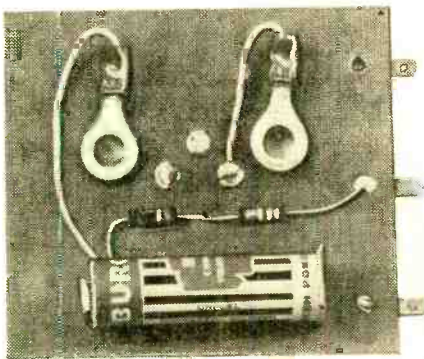
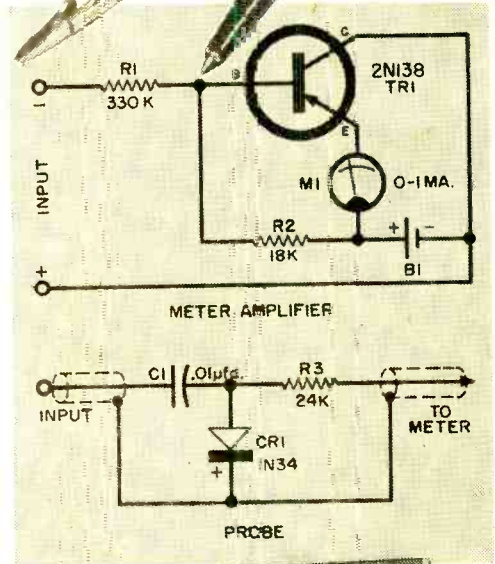

You can estimate low voltages with the simple meter amplifier and probe described and illustrated on this page. As may be clearly seen from the schematic diagrams, very few parts are required. B1 is a penlite cell.

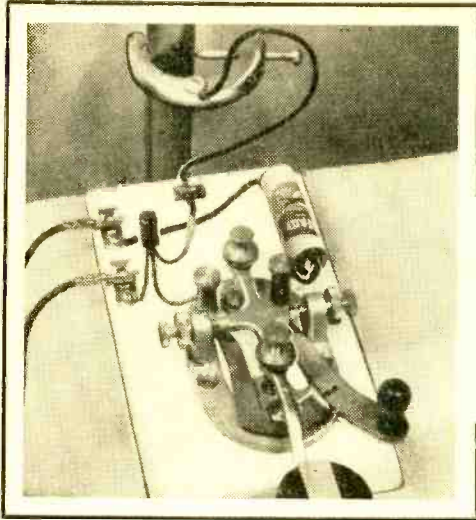

Simplest Code Practice Set

This unusual code practice set makes use of the "ground buzz" which can be taken off grounded water pipes in the average household. You can hear this buzz faintly by touching one tip of a pair of high-

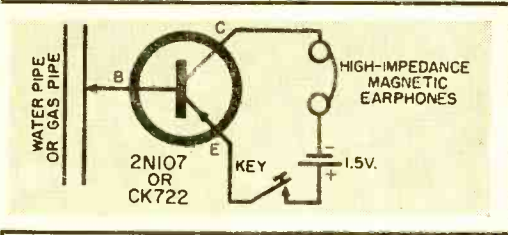

impedance magnetic phones to a grounded pipe and holding the other tip in your hand. The buzz can be amplified by simply wiring up a transistor in the fashion shown in the schematic.

While operating the key, you will notice that the buzz can be doubled in volume by touching the key lever. This explains why the aluminum band is fastened under the insulated knob and bent over the top of it. There is no danger of shock, but take care not to touch any "hot" high-voltage circuits such as a.c./d.c. radio chassis.

—Art Trauffer

Rejuvenating Old Decals

Panel decals sold by distributors under the trade names "Techni-Cals" and "Techni-Labels" do much to enhance the appearance of home-built equipment. These decals are available in several colors and in different sets to fit almost any electronic application. But excessive heat or moisture will disintegrate the plastic film that forms a base for the letters. When the label is soaked in water, the letters will not separate, and the user is left with a jumble of detached letters.

Rather than discard labels in such a condition, try this trick. Separate the sheets and spray them with a thin coat of plastic. This will form a thin film to which the in-



dividual letters will adhere. Follow the manufacturer's directions and apply the labels in the usual manner. After they have been positioned and allowed to dry, the plastic may be dissolved with a cotton swab dipped in acetone or nail polish remover. Use a gentle blotting action as you apply the swab.

—D. Derek Verner

Vector-Type Plug-In Unit

Every experimenter can enjoy the advantages of a vector-type plug-in assembly. You can make one from a socket, a 6-32 machine screw, and an old octal tube base. The diagram below shows how these various pieces are put together. Length of the screw will depend upon the type of components you mount around the particular tube socket—try 1½" as a start. Components are mounted between socket terminals and prongs; leads are soldered to prongs just like the center conductor of a coaxial cable to a phono plug.

—Jules O'Shea

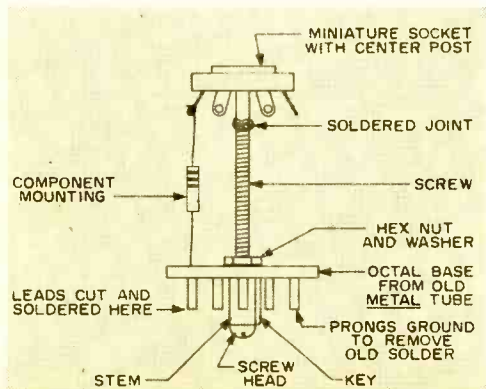

POPULAR ELECTRONICS



THE "VARISTROBE"

High Speed Stroboscope Freezes Motion

By HARVEY POLLACK

Uniformly moving machinery, speaker cones, electrical appliances, etc., can be studied while they are in operation.

WOULD YOU LIKE to examine the contortions of your high-speed circular saw, drill or bandsaw under conditions that seem to slow it down to a crawl? Any repetitive movement, whether rotary or reciprocating, can be viewed as though the moving body were at rest or in very lazy motion—under the flashing illumination of this wide-range "Varistrobe" (variable flash-rate stroboscope).

The "Varistrobe" consists essentially of a power supply, a time-base circuit or variable multivibrator, and a strobotron neon tube (631-P1, also called 1D21/SN4) which is triggered by the impulses from the multivibrator. On the *LOW* setting of the *RANGE* switch, the flash-rate may be varied from about 15 cps to a little above 60 cps; when set in the *HIGH* position, frequencies between 60 cps and 240 cps are easily covered. The intentional overlap of the two ranges permits the user to obtain any flash-rate from 15 cps (900 flashes per minute) to 240 cps (14,400 flashes per minute). The latter is the upper limit of the rating of the strobotron.

Each flash lasts between 1/2500 second and 1/5000 second. When the flash-rate is synchronized with the moving object, most of the motion occurs in darkness. The object is thus illuminated briefly in approximately the same spot each time it comes around, so that it appears stationary. If the flash-rate is a bit slower or faster than the number of rps, the rotation or reciprocation will be seen as a lazy, crawling motion.

Construction. Many of the chief structural details are shown in the photographs and illustrations. The power transformer,

filter capacitor, discharge capacitor, and frequency control potentiometer all appear above the chassis; the smaller components and the *RANGE* switch are mounted below the chassis.

The *RANGE* switch is a four-circuit, double-throw type. It was chosen for its availability in standard catalogs and for its small size. Only three of the contacts are employed in a single-throw arrangement. When you are wiring this switch into the circuit, be careful to arrange the contacts so that all three of the *LOW* setting capacitors (*C2a*, *C5*, and *C6*) are connected across their mates (*C2b*, *C4*, and *C7*) when switch is in *LOW* position.

You'll take real pride in the unit if you add panel decals, a high-quality knob and

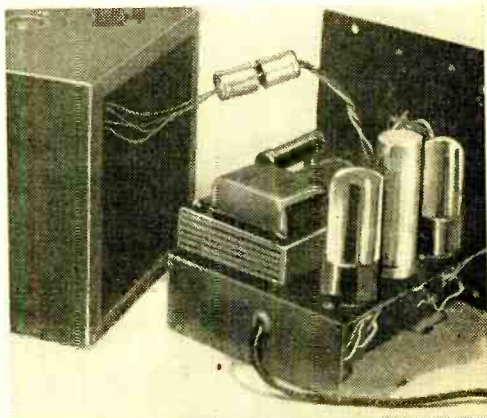

Components are mounted as shown here. Miniature cable connectors which join the four leads that go to strobotron socket on top of case make it simple to remove chassis for inspection or repairs.

Wire the unit as shown in schematic diagram. Parts used are listed below. Diagram at lower right, beneath the "How It Works," shows setup for calibrating the "Varistrobe."

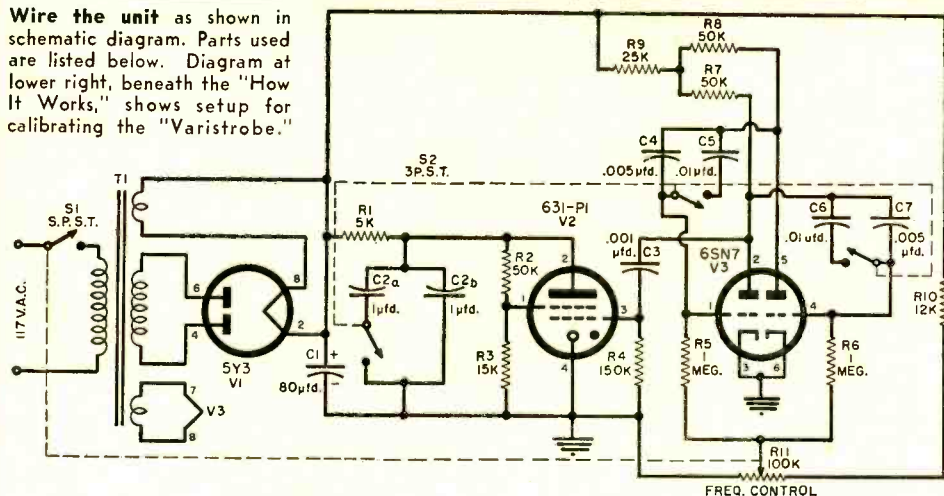

- C1—80- μ d., 450-volt capacitor (Sprague TVL-1735, twistlok type, can ground)
- C2—2 x 1.0 μ d., 600-volt capacitor (Cornell-Dubilier DYR 6110, can type, one lug common, can not part of capacitor)
- C3—0.001- μ d., 450-volt tubular paper capacitor (Sprague 68P1)
- C4, C7—0.005- μ d., 1-kv. capacitor (Centralab button type, Hi-cap 502)
- C5, C6—0.01- μ d., 600-volt capacitor (Centralab button type, Hi-cap 103)
- R1—5000-ohm, 10-watt wire-wound resistor (Sprague Type 10 KT or Type 10 NIT)
- R2—50,000-ohm, 1-watt, 10% resistor
- R3—15,000-ohm, 1-watt, 10% resistor
- R4—150,000-ohm, 1-watt, 10% resistor
- R5, R6—1-megohm, 1/2-watt, 10% resistor
- R7, R8—50,000-ohm, 1/2-watt, 10% resistor
- R9—25,000-ohm, 1-watt, 10% resistor
- R10—12,000-ohm, 1-watt, 10% resistor
- R11—100,000-ohm, linear taper potentiometer—frequency control (Mallory U-41)
- S1—S.p.s.t. On-off switch mounted on R11 (Mallory U-41 control to take US-46 switch)
- S2—3p.s.t. or 4p.2t. rotary type, non-shorting range switch (Mallory 3242)—see text
- T1—Power transformer, 235-0-235 sec. volts at 40 ma., 5 volts at 2 amp., 6.3 volts at 2 amp. (Stancor PM-8401)
- V1—5Y3 rectifier tube
- V2—631-P1 strobrotor (Sylvania)
- V3—6SN7GT multivibrator tube
- 1—6" x 6" x 6" cabinet, black wrinkle steel with built-in chassis (ICA Type 3823)
- 1—Case handle, 4 1/2" over-all length, chrome (ICA 3500)
- 1—5"-diameter parabolic reflector for strobrotor
- 1—4"-round dial, 325° rotation, chrome silver finish (ICA 2168)
- 1—Vernier dial marker for 4" dial (ICA 2191)

HOW IT WORKS

D.c. voltages applied to the anode, the shield grid, and the cathode of the 631-P1 strobrotor are such that the tube is ready to fire when the remaining grid is suddenly driven negative. Shield grid voltage is obtained through the voltage divider comprising R2 and R3. Each time the strobe grid is pulsed negative by the multivibrator, the strobrotor ionizes and instantly discharges C2b (or both C2b and C2a if S2 is closed). This sudden discharge which may amount to 100 amperes, or more, causes the emission of a bright orange-red flash.

The multivibrator produces approximately a square-wave output at a frequency which is determined by the time constant in the grid circuits of the two halves of the tube and by the grid bias which is governed by the setting of R11. Connecting C5 and C6 in parallel with C4 and C7 respectively when S2 is closed increases the time constant and causes slower firing. If the wiper of R11 is moved down to ground potential and S2 is closed, the lowest flash rate is obtained.

On the LOW setting, C2a is connected in parallel with C2b. This provides a greater discharge capacitance to keep the strobrotor glowing for a longer time. Thus, the light intensity on the low-frequency range is increased to yield about the same total of illumination as on the high-frequency range.

C3 and R4 make up a differentiating network which changes the square-wave output of the multivibrator to sharp voltage spikes suitable for triggering the strobrotor.

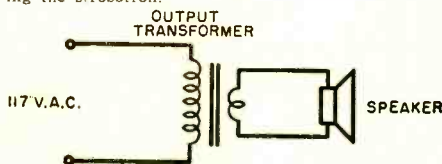

vernier indicator, and a carrying handle. Effectiveness of the strobrotor illumination is heavily dependent upon the quality of the reflector used behind it. The one shown in the pictures comes from an inexpensive Bower pocket flash.

Testing. Set the RANGE switch on LOW and rotate the potentiometer knob (R11) clockwise until the switch just clicks on. In about 30 seconds or less, the strob-

tron should start to flash at its slowest rate. At this point, it is very important to remove the 6SN7GT from its socket while the strobrotor is flashing. This should extinguish the glow in the strobrotor completely. If the flashing continues with the multivibrator tube removed, it indicates that the anode grid voltages on the strobrotor are incorrect—which may be caused by one or more of the following faults:

- (a) $R2$ and $R3$ may have been interchanged.
- (b) $C3$ may be leaky or shorted.
- (c) $R1$ or $R2$ or both may be shorted by some incorrect connection.
- (d) The voltage output of the transformer may be too high if any other but the specified type is used. The voltage

measured across the filter capacitor ($C1$) should be just about 300 volts.

If everything is working correctly, replace the 6SN7GT in its socket, and allow it to warm up once again. Slowly rotate the *FREQUENCY CONTROL* knob clockwise. The flash-rate should rise smoothly and evenly. As the frequency increases, the

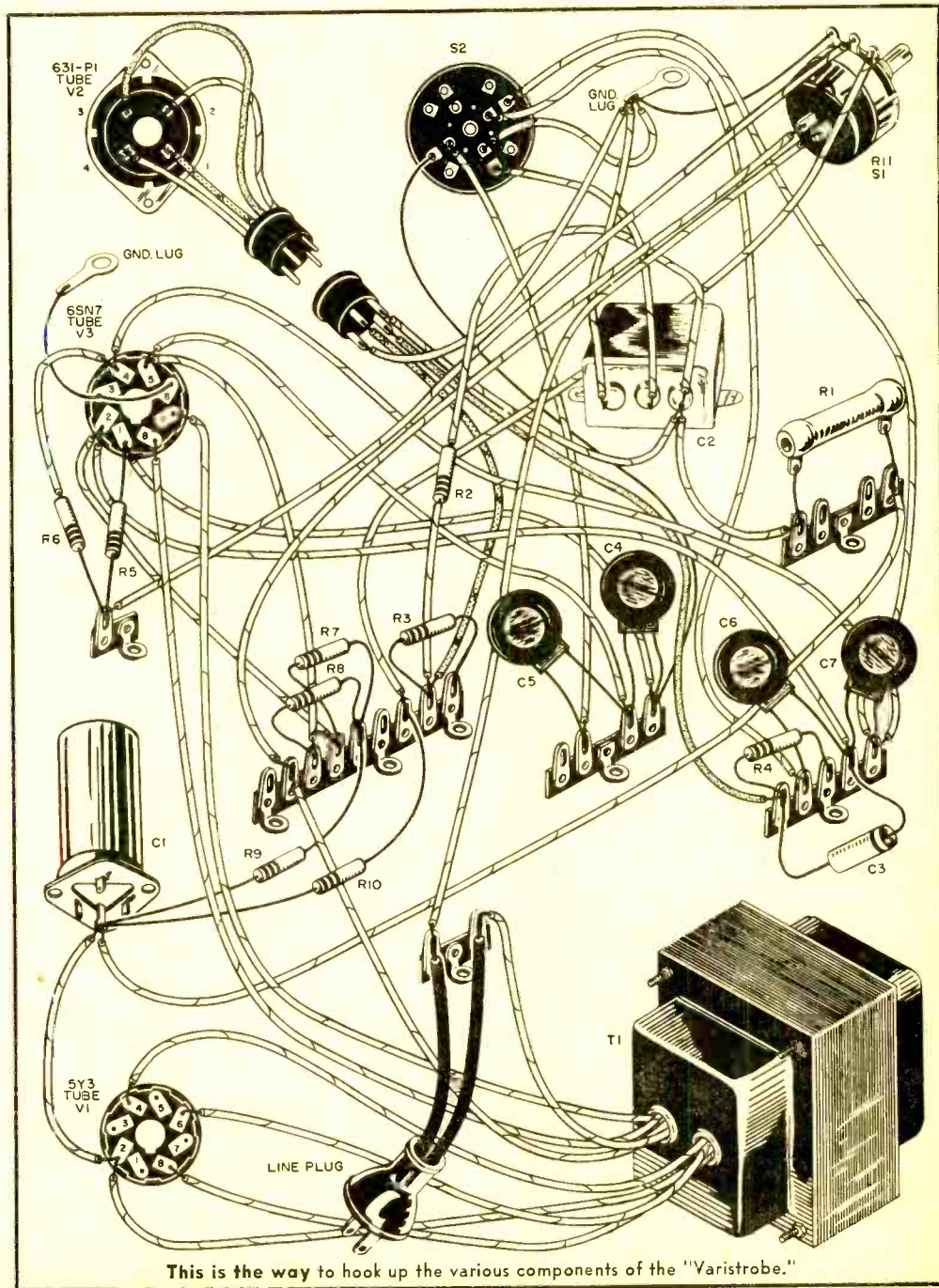

Model is attractively housed in black wrinkle steel cabinet with panel decals, a high-quality knob and vernier indicator, and a carrying handle. The 5"-diameter parabolic reflector, taken from a Bower pocket flash unit, slips easily over the strobotron.

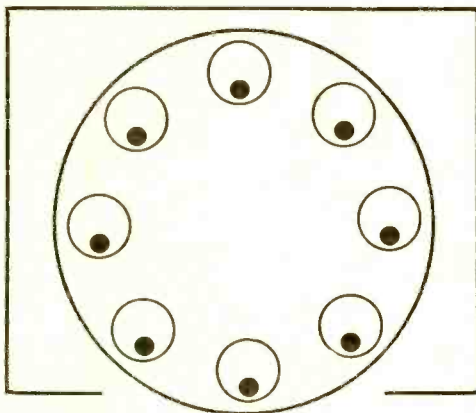
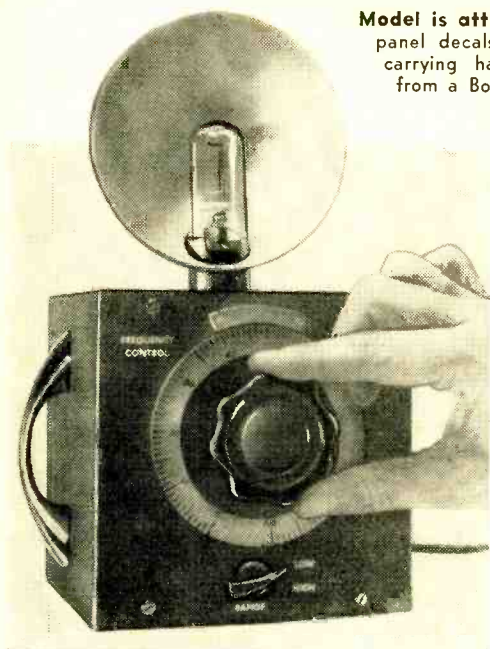

In strobe pattern above, black circles seem to rotate inside larger circles as disc is whirled under stroboscopic light of slightly higher or lower frequency than rpm of motor rotating the disc.

"song" of the strobotron rises in pitch and becomes a note of roughly 60 cps at the extreme clockwise position of the knob.

Return the control to its original counterclockwise position with the *ON-OFF* switch still *ON*, and turn the *RANGE* switch to its *HIGH* position. The flash-rate should advance appreciably and, as the knob is rotated clockwise again, should become much higher in pitch.

Calibration. The procedure is straightforward. First obtain some finely divided graph paper. Mark off the horizontal axis (see sample calibration chart) in terms of dial readings. The vertical axis carries two columns of figures: one for the *LOW* setting of the *RANGE* switch and one for

the *HIGH* position. For *LOW*, the numbers run from 0 to 70 cps, and for *HIGH* they range from 0 to 280 cps.

Set the "Varistrobe" in operation and let it run at its lowest frequency for a minimum of ten minutes to allow it to stabilize fully. While waiting, set up an old loudspeaker and output transformer and plug it into the 117-volt receptacle; the cone should hum loudly at 60 cps.

Keeping the *RANGE* switch on *LOW*, rotate the *FREQUENCY CONTROL* knob completely clockwise (frequency now being a bit higher than 60 cps), turn out the room lights, and illuminate the speaker cone with the strobe light. Slowly reduce the "Varistrobe" frequency until the cone appears to be absolutely stationary. Do it carefully so that you don't miss the first point where this occurs. The "Varistrobe" frequency is now exactly 60 cps, and a point may be placed on the graph with a hard, sharp-pointed pencil.

Again reduce the frequency slowly until the cone appears to "freeze" at the next setting; this is 30 cps, the cone being illuminated on every *alternate* vibration. Mark a point opposite the 30-cps scale level and above the new dial reading for this frequency. Repeat the procedure for 20 cps (cone illuminated every third vibration) and for 15 cps (cone illuminated every fourth vibration). This gives four coordinate points which may now be joined together by a straight line.

Using the same process on the *HIGH*

(Continued on page 116)

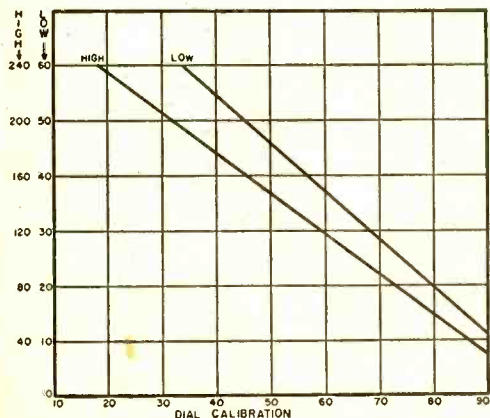

Sample calibration chart. See text for details.

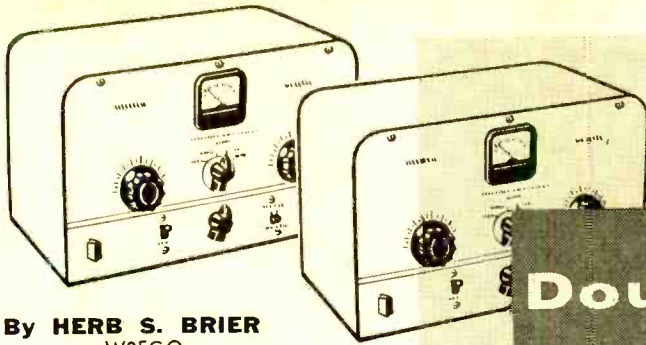

By **HERB S. BRIER**
W9EGQ

Double Your Heathkit AT1 Output

PROBABLY the most popular low-power transmitter available to radio amateurs in recent years has been the Heathkit AT1. Thousands of them are in daily use. Covering the amateur bands from 80 to 10 meters, the AT1 uses a 6AG7 crystal oscillator to drive a 6L6-G amplifier/frequency doubler to about 30 watts input. To insure stability, the 6L6 is operated as a frequency doubler on the bands above 80 meters and power output is no more than 10 watts on the 40-, 20-, 15-, and 10-meter bands.

This article tells how to substitute a 2E26 tube for the 6L6 in the AT1 transmitter and thus double its power output on the 40-, 20-, and 15-meter bands. The entire job can easily be completed in one evening at a cost of approximately \$6.00.

Amplifier Stage. If the Heathkit instruction manual is handy, it will help in making the following changes. Start at the output tube socket (socket *B* in *picture 1* in the manual). First remove the 100- μ fd. capacitor and the 1.1- μ h. r.f. choke connected to pin 3 of the socket from the circuit. Put the capacitor and choke aside temporarily. Then transfer the 22,000-ohm resistor and the 0.001- μ fd. fixed capacitor from pin 4 to pin 3 of the socket. Transfer the connections of pin 8 to pin 1 and connect pin 8 to the nearest ground lug.

Remove the leads from the 0.5- μ fd. capacitor and the 100-ohm resistor from pin 6 of the socket. Solder these two leads together, but clear of the socket pins. Replace the 47,000-ohm resistor connected to pin 5 of the socket with an 18,000-ohm, 2-watt resistor.

In revised circuit, the 2E26 (shown in foreground of photo) is substituted for the 6L6-G in the AT1 transmitter. Note the connections to its plate cap.

This completes the rewiring of the socket. Note that pin 2 remains grounded and that pin 7 remains the "hot" filament terminal on the tube socket.

Now make a "parasitic suppressor" by winding six turns of No. 16 or No. 14 wire around a pencil, spacing the turns, so that the coil is about $\frac{3}{4}$ " long. Slip the winding off the pencil and insert a 100-ohm, 2-watt resistor through it. Solder the ends of the coil to the leads of the resistor close to the resistor body.

Cut one lead of the suppressor to a length of about $\frac{3}{8}$ " and solder it to one lead of the 100- μ fd. capacitor previously

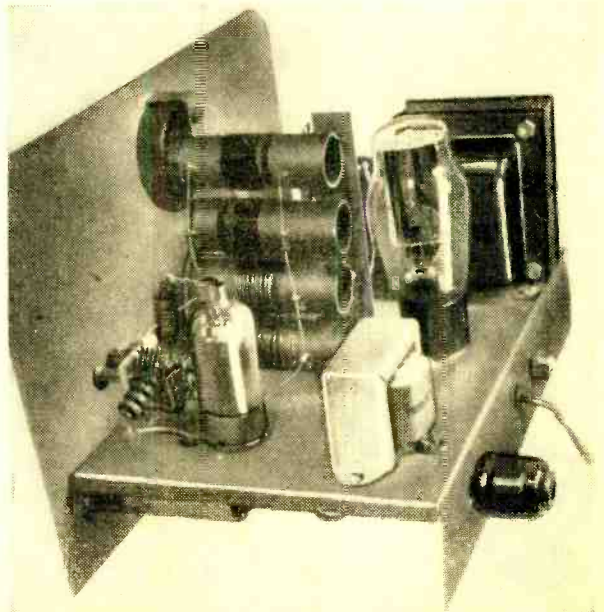

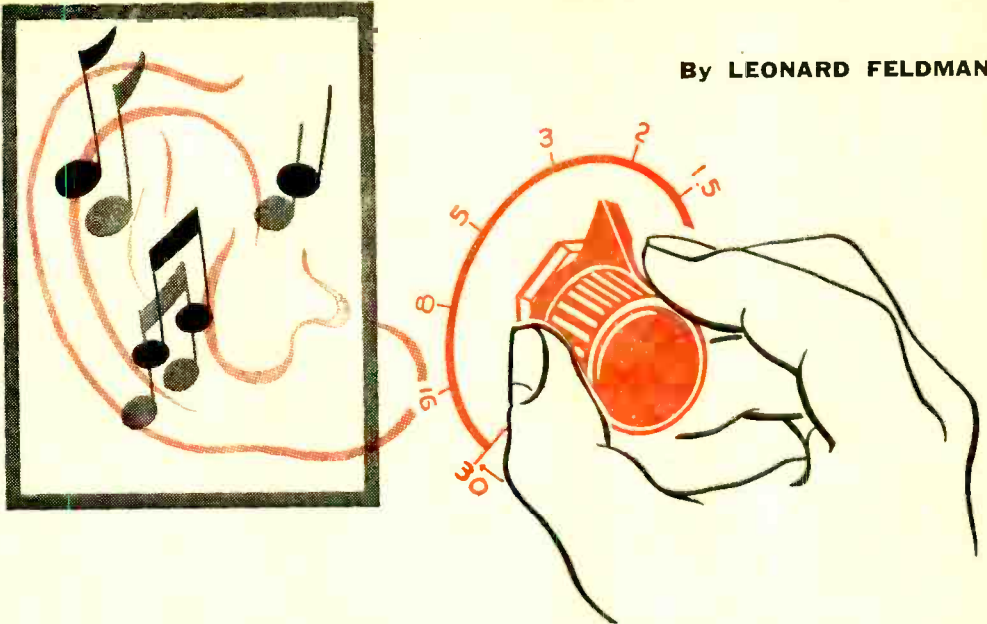

Damp Before Your Ears

Sound may be soggy or crisp—damping can make it so

AS AN AUDIO FAN, you may still be damp behind the ears unless the music you play is damped BEFORE it reaches your ears. "Damping" is the term used to describe the method by which audio components are made to follow the signal without "taking off" on their own.

The trick is to prevent the loudspeaker cone from overshooting its mark or continuing to jiggle back and forth after a sudden burst of sound. Good damping keeps the speaker motion strictly equivalent to the signal waveform. It keeps the speaker from distorting the signal by random and unrelated movements of its own. In a way, damping does for your speaker what shock absorbers do for your car: in either case, the tendency to fly off at the bumps must be counteracted.

Without damping, loudspeakers "run wild" and do strange things to music. By continuing to shuttle back and forth after a sharp drum beat, an undamped speaker changes the crisp impact of the stick on the tight drum skin into a hollow, gong-like sound. The same thing happens to the plucking sound of string instruments, the strumming of a guitar, the tonguing of brass and woodwinds—until the instruments lose their character in reproduction and run together into a soggy mess. Proper damping keeps the sounds separate and

distinct. You can then listen to details without having to strain to hear them.

Speaker "Brakes." A certain amount of damping is engineered right into loudspeakers, particularly the better ones. It acts as brakes on a "runaway" speaker cone. Additional damping is accomplished by mounting a speaker in a properly designed enclosure; this, incidentally, is a good reason why speakers and enclosures should never be considered separately, but always in terms of what each will do for the other. Usually, these two methods of correction do not provide adequate damping, and the free-swinging loudspeaker still needs help from the amplifier "to get control of itself."

Fortunately, the misbehaving loudspeaker itself contributes the reins by which the amplifier can hold it in check. When it keeps jiggling beyond the duration of the actual signal, it acts as an electric generator. A "back" voltage is induced in its voice coil moving within the field of the surrounding magnet (see page 58), which sends a current back into the amplifier.

As in the case of any generator, the more power drawn from it, the harder it is to turn the generator. If the load resistance (in our case the impedance "looking into the amplifier") were low enough, this voice-coil "generator" would be constrained

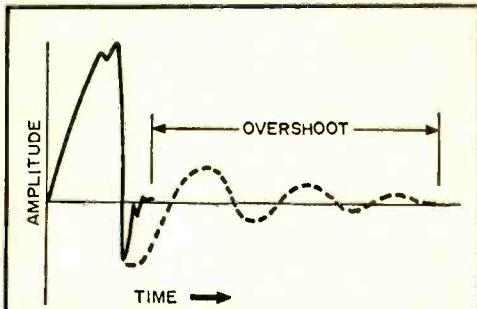

Showing damping problem graphically, the solid line represents the signal of a sharp sound burst (for instance, a drum beat). Improperly damped speaker keeps jiggling (dotted line) after actual sound stops. Extra undulations, called "overshoot," muddy the tone.

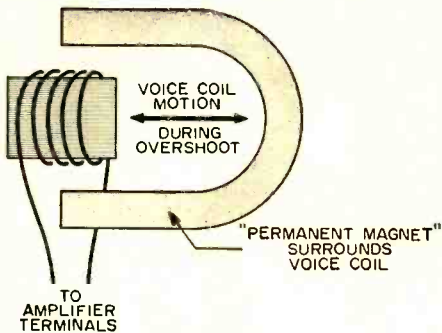

Loudspeaker coil moving against stationary magnet during "overshoot" acts as electric generator, causing current to flow back to amplifier. With proper damping, this current itself helps to check the overshoot.

in its movement because of the current in the coil due to the "back" voltage. Hence, the overshoot would be reduced and, ultimately, eliminated.

Tap Test. One of the most startling experiments confirming this fact requires only a loudspeaker (preferably 12" or larger in cone diameter) and a small piece of wire. Hold the loudspeaker in one hand, grasping it by its rear housing. Have nothing connected to the two speaker terminals. Then gently tap the surface of the paper cone with your finger. Note the hollow quality of the dull thud that echoes from the cone.

Next, with no electronic equipment of any kind connected to the speaker, simply connect a short piece of wire between the two terminals of the unit, thereby shorting out the voice coil. Repeat the finger tapping and notice what happens to the sound. Now the sound has become sharp and crisp. The reason, of course, is that you have placed a short circuit (i.e., almost no resistance at all) on the voice coil "gen-

erator" and it cannot move freely under these conditions. Since the cone is now stiffly "damped," the thudding echo previously heard has disappeared.

In actual operation, the speaker terminals are connected to the amplifier output terminals. The lower the resistance that the speaker coil "sees" at the amplifier terminals, the more highly damped it will be. In fact, if the amplifier could be made to "look" like a short circuit to the speaker, we would have almost maximum damping. If we could make the amplifier look like a *negative* resistance, we could come up with maximum damping. All these things are possible, electronically. The question is, how much damping is necessary?

Damping Factor. Loudspeaker manufacturers have recently begun to specify the optimum electrical damping that an amplifier should have to match a particular speaker properly. This "damping factor" is expressed as a number, obtained by dividing the rated loudspeaker voice-coil impedance (usually 4, 8 or 16 ohms) by the "internal resistance" of the amplifier in question.

Thus, if an 8-ohm loudspeaker is to be connected across the 8-ohm taps of an amplifier output strip and the internal resistance measured across these taps is $\frac{1}{2}$ ohm, the amplifier is said to have a damping factor of $8\frac{1}{2}$, or 16.

The so-called "output impedance" of an amplifier, as marked on the output terminal strip, actually refers to the impedance that a loudspeaker should have when connected to those terminals to assure maxi-

(Continued on page 113)

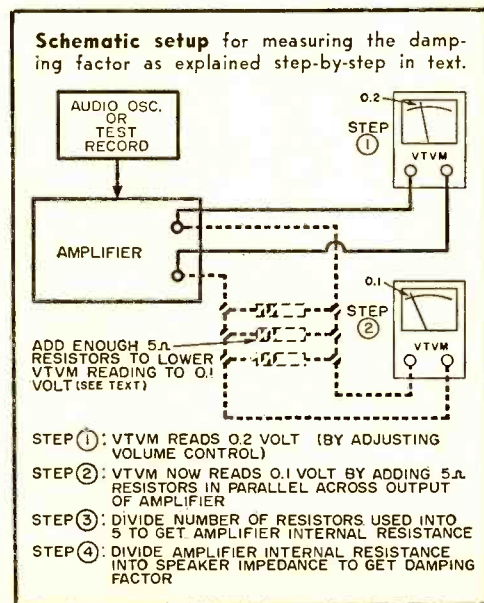

By RICHARD GRAHAM

The "Economy" Transistor Checker



IT DOESN'T TAKE LONG to accumulate a small but varied stock of transistors once you start experimenting with these little gems. Fortunately, to determine whether a transistor is good or bad requires a tester of extreme simplicity. The "Economy" Transistor Checker performs two sensitive tests which will quickly tell you if a transistor has been damaged due to overload or contamination of the germanium, whether the transistor is shorted or open-circuited, or if it is just excessively leaky.*

Construction of the transistor checker should take about one evening. It is housed in a 3" x 2" x 5 1/4" Minibox. Layout is not critical.

The transistor socket requires a 5/32" x 1 1/32" rectangular hole. Lay out the hole size carefully on the front panel with a scribe, then drill two 1/8" holes within the rectangle. The remaining aluminum can be readily removed in a few minutes with a variety of small "Swiss Files."

Mount the 6-volt battery on the rear cover of the checker. Bend strap of scrap aluminum so that it fits around the battery and clamp it firmly into place.

A worthwhile accessory is a test cable which will plug into the transistor socket and which has alligator clips on the other end. This provides a means of testing transistors that may have had their leads cut or badly bent and will no longer fit a socket. See the drawing on page 117.

Wiring the unit should present no problem if the wiring diagram is carefully followed. If you've worked with transistors

Set switch to proper position, plug transistor into socket, and observe the reading on the meter.

HOW IT WORKS

The transistor checker performs two basic tests for both the *n-p-n* and *p-n-p* junction transistors. The first test measures the leakage through a transistor from emitter to collector with the base circuit open. Some small amount of current flow can be observed on the meter. This is due to the internal back resistance of the collector-base junction which effectively biases the base-emitter junction in the forward direction, resulting in conduction through the transistor.

The second test determines the approximate common emitter current gain or beta. This is done by placing a 560,000-ohm resistor (*R1*) from the battery to the base of the transistor. The resulting current flow biases the base-emitter junction in the forward direction, which results in a marked increase in the collector current. The ratio of the change in collector current to the base input current is the common emitter current gain. Input base current is E/R or 10.7 microamperes. This ignores the voltage drop across the base-emitter junction. We can safely round off the input base current and, when multiplied by 100, the meter will read directly the value of beta or current gain.

Switch *S1* performs the function of reversing the battery polarity according to whether the switch is set in the *n-p-n* or *p-n-p* position.

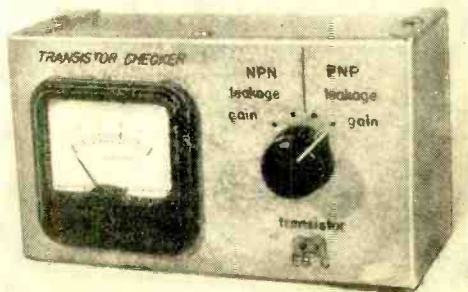

* The transistor checker will also give the approximate value of common emitter current gain—often referred to as *beta* in the transistor literature. This value can be checked against the manufacturers' literature or against other similar transistors for gain comparison.

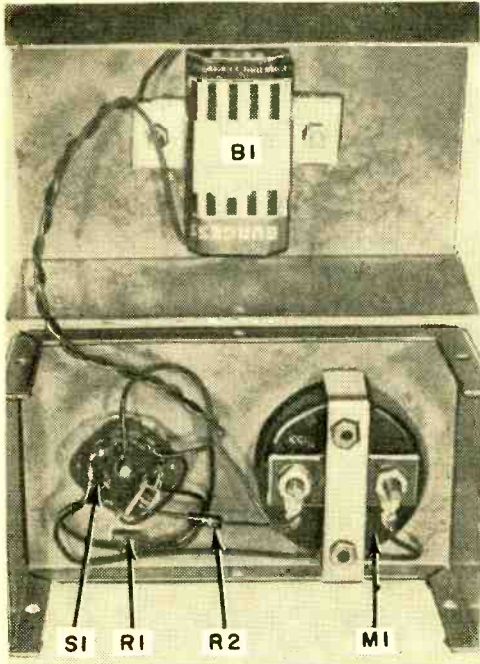

Looking into the transistor checker from the back, you can clearly see the layout of the parts. This unit will check any junction-type transistor.

at all, you've probably realized that particular care must be exercised regarding battery polarities and short circuits, etc. Usually you get one chance with transistors—unless you're fortunate and fast.

Battery drain is small and intermittent, so I have simply soldered the wire from the checker directly to the battery terminals. The battery should last for its shelf life.

To test a transistor in the checker, it is first necessary to know which basic type of transistor you have, i.e., whether it is a *p-n-p* or an *n-p-n* type. You can determine this from the manufacturer's description or from the polarity of the battery connections to the transistor if it is in a piece of equipment. A *p-n-p* transistor always has the collector supplied from the negative pole of the battery and the emitter supplied from the positive pole. The *n-p-n* type is reversed completely, i.e., the collector is supplied from the positive pole and the emitter from the negative pole of the battery.

Once this fact is established, it is only necessary to set the switch on the checker front panel to the leakage position for the type of transistor under test. Plug the transistor in the socket provided and observe the reading on the meter. The data in Table 1 give representative readings for several transistor types (see page 117).

In general, the lower the leakage, the better the transistor. It can then be noted that the inexpensive low-frequency types usually exhibit higher leakage than the more expensive low-frequency types.

To check the common-emitter current gain, merely set the switch to the gain position. An upward swing indicates a cur-
(Continued on page 117)

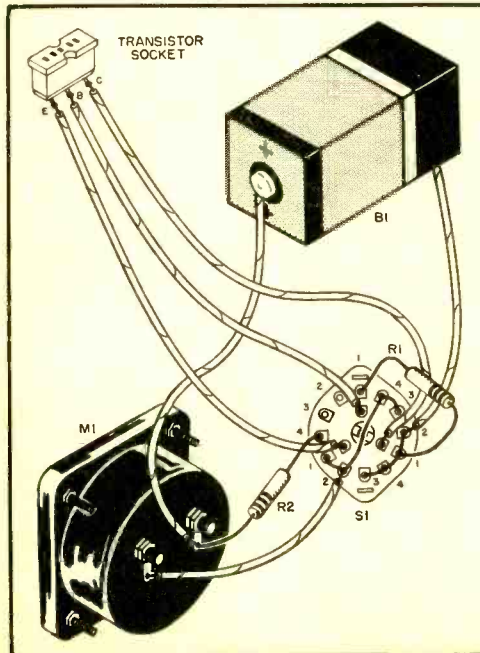

Pictorial and schematic diagrams show how parts are interconnected. See parts list below.

- B1—6-volt battery (Burgess Z4 or equivalent)
- M1—0.1 ma. meter (Shurite, Electro Mech, or equivalent)
- R1, R2—560,000-ohm 1/2-watt resistor
- S1—3-circuit, 4-position switch (Erie #612-08 or equivalent)

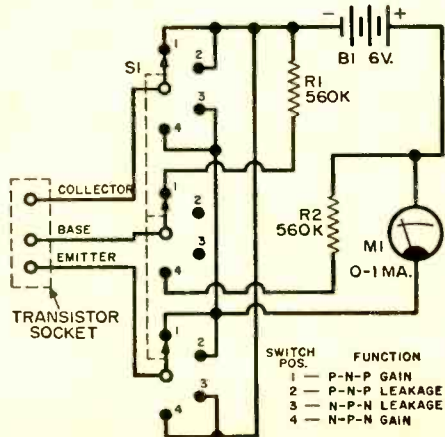

Easily Made Adapters for Experimental Work

MUCH TIME AND TROUBLE can be saved when you are trying various ear-phones or doing other experimental work if you have appropriate adapters. The four adapters shown below are easy to make. With them, you can quickly connect: (1) an earphone or other equipment using a "tiny plug" to a radio or other apparatus

using a miniature jack; (2) a miniature phone plug to a "tiny jack"; (3) a pair of phones or other equipment with a standard phone plug to a miniature jack or a "tiny jack"; and (4) any cord having a standard phone plug on the end to any piece of equipment having a standard phono type jack. A plastic pill container is used

for the first three adapters and a tin container with the fourth unit, each having a friction lid. All cutting should be done with a fine-tooth, narrow-blade hacksaw. Although Lafayette Radio catalog numbers are specified in most cases, a Telex Type 9231 plug may be substituted in the first adapter, and a Type 9240 miniature jack and mating plug could be employed with the second adapter.

—Art Trauffer

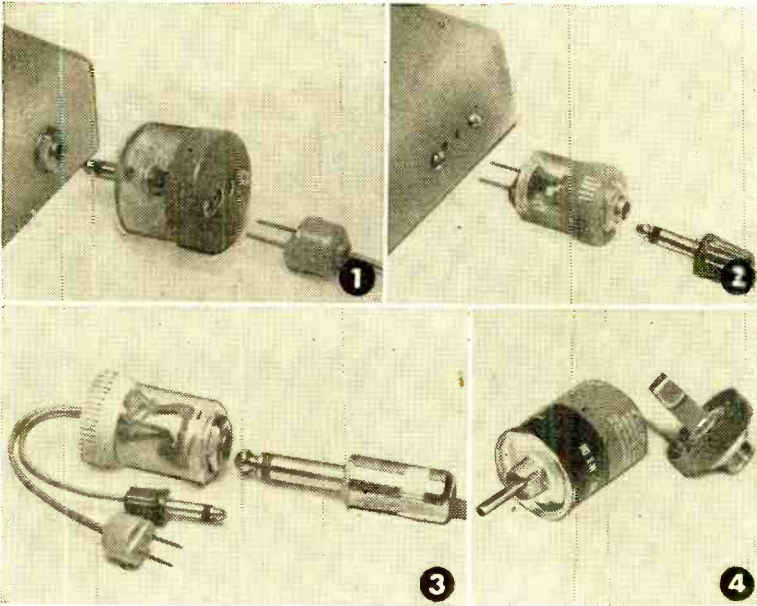

1 This plastic container has a $\frac{7}{8}$ " inside diameter. Saw off the container so that you have a bottom length of about $\frac{3}{4}$ ". Then drill a $\frac{7}{32}$ " hole in the center of the bottom for a miniature phone plug (MS-281) with its cap removed. Solder a 1" length of small plastic-covered flexible wire to each lug on the miniature plug, and cement the plug into the hole in the bottom of the container with Duco cement, allowing the two leads to extend into the tube. Drill four holes in the friction lid and mount the "tiny jack" (MS-284), using two $\frac{1}{16}$ "-diameter round-head machine screws about $\frac{1}{4}$ " long with hexagon nuts to fit. Solder the free ends of the two wires to the lugs on the "tiny jack," and put lid on container. In the model, a metal lid is used with plastic container to make adapter more rugged.

2 Saw off the container ("Eagle" styptic pencil case having a $\frac{1}{2}$ " inside diameter) so that you have a bottom length of about $\frac{3}{4}$ ". Drill a $\frac{3}{8}$ "-diameter hole in center of bottom for a "tiny plug" (MS-283) with cap removed. Solder two $\frac{3}{4}$ " lengths of wire to the lugs on the "tiny plug" and then cement plug into bottom of container with Duco, allowing the leads to extend into the tube. Solder the free ends of the two leads to the lugs on the miniature jack (MS-282), punch a $\frac{7}{32}$ " hole in center of lid, and mount lid on jack. Then place lid on container.

3 Inside diameter of container is about $\frac{6}{8}$ ". Bottom length should be about $\frac{1}{4}$ ". Drill a $\frac{3}{8}$ "-diameter hole in bottom center for a small-size standard phone jack (ICA Type 325). Cut two 4" lengths of plastic-covered twin-conductor wire (such as is used for hearing aids, etc.), and solder the wires to the two prongs on the standard jack; then mount the jack into the container. Punch a small hole through the center of the friction lid to pass the wires, and put the lid on the container. As shown in the photo, a miniature plug (MS-281) is soldered to the free end of one of the wires, and a "tiny plug" (MS-283) to the other wire.

4 This tin container is about 1" in diameter, and the bottom section should be about $1\frac{1}{4}$ " long. Smooth off the rough-cut edge. Punch a hole in the exact center of the bottom and enlarge it to $\frac{5}{16}$ " using a rat-tail file. Solder a standard phone plug into the hole. Then punch a hole in the exact center of the friction lid and enlarge it to $\frac{3}{8}$ ". Mount a small-size, standard, single-circuit phone jack in the lid. Take a short length of flexible insulated wire, solder one end into the pin of the phono plug, and solder the other end to the contact spring lug on the phone jack. Press the friction lid onto the body of the can, which can be painted or covered with colored Mystik tape to hide lettering.

By D. C. MARSHALL

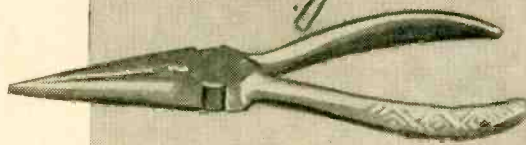
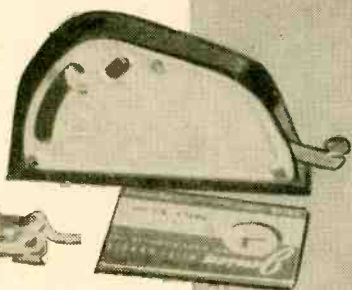

First Steps

in Record Player Maintenance

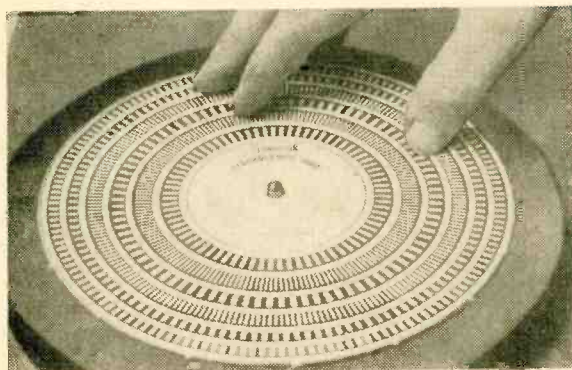

A

A Speed of the turntable should be checked at regular intervals, depending on how often it is used. A simple and inexpensive device for doing this is the "strobe" card. As shown at left, the "strobe" card fits onto the turntable. The card is marked in concentric bands for different phono speeds. If speed is correct, bands for that speed will appear to stand still when the turntable is running.

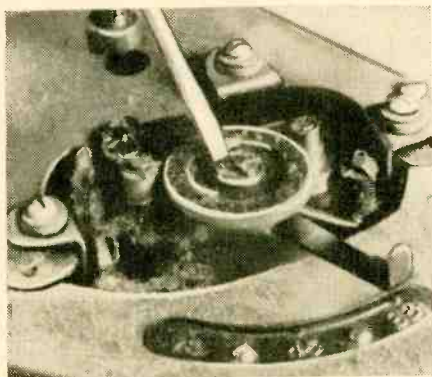

B

C To clean the driving mechanism, wipe the parts with a cloth soaked in carbon tetrachloride. If the rollers are glazed, causing slippage during operation, rub them gently with a fine grade of sandpaper or emery cloth. Idlers with "flats" or other obvious defects must then be replaced.

C

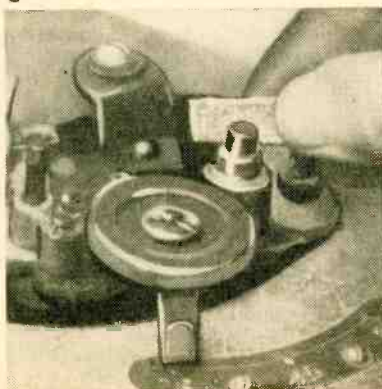

POPULAR ELECTRONICS

Keep your phono player in top form by following these steps

KEEPING your record player in top running form takes little time and effort and helps your records sound better and last longer. Described on these two pages are maintenance steps that require only the tools shown at left. These are (left to right): pocket microscope for inspecting stylus wear, replacement cartridge, stylus pressure gauge with package containing new stylus just below it; miniature screw-driver; and a pair of long-nose pliers.

The main causes of trouble in most phono players are incorrect speed, incorrect stylus pressure, defective stylus, or a defective cartridge. How to use these tools to correct such sore-spots is shown in the accompanying photos.

Generally speaking, the things to remember about maintaining a record player are: keep it clean, use proper pressure, make sure it's level. Don't lubricate *anything* except as specifically instructed by the manufacturer of the player you own! —30—

D Replacing a defective cartridge is a fairly simple chore, if you follow the recommended sequence of steps. Photos at right show how to handle the popular turnover type of cartridge. The first thing to do is to remove the holding and mounting screws, starting with the screw in the turnover handle of the cartridge.

E Next, remove the screw further up along the cartridge. This releases the cartridge from the "shell" portion of the tone arm. During this operation, remember to avoid putting undue strain on the tone arm itself as well as its movable mounting on the phono player.

F Final steps are unsoldering the pick-up leads from the old cartridge, and re-soldering them to the new one. Use a hot iron and work quickly to avoid overheating the cartridge. A good dodge here is to hold the cartridge connecting lugs with a pair of long-nose pliers which helps absorb excessive iron heat.

G Correct stylus pressure is a must for proper tracking, compliance, and minimum record wear. In the bottom photo at right, a stylus pressure gauge is in use. The gauge is placed on a turntable and the stylus set in the pan. A reading is shown on a dial calibrated in grams. Be sure to adjust the tone arm for the pressure recommended by the manufacturer of the cartridge that you're using.

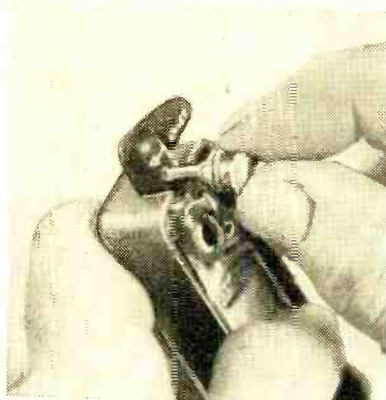

D



E



F

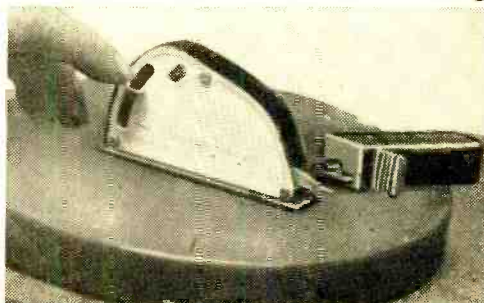

G

Kiss and Tell

Kissing and comparing notes has always been a blissful method of private testing. In its electronic form, it may prove an equal boon to industry. The quick osculation and subsequent recoil which bounces a stream of electrons against the surface of various materials is expected to reveal such secrets as "why did the paint peel off?" or "why did the pipe rust through?" This, in turn, may solve problems of metal-plating and corrosion research. Our picture (right) shows a test sample being inserted into the G.E. device, called an "Electron Diffraction Instrument."



Far Cry from the "Cuckoo" Clock

Germany's Black Forest was once famed for its cuckoo clocks. Bringing its technology up to date, the Saba-Works of the Black Forest has come out with a handsome large-screen projection TV set (left) that can be remotely controlled. An image of high optical density is formed on a small-faced cathode-ray tube in back of the set and projected on the screen through a lens system.



"Kid-Tested" Kit For Easy Audio

What good is even the best hi-fi kit if a guy with two left hands muffs the assembly? To avoid such pitfalls, Madison Electronics Co., of Madison, N. J., devised a new test method. They had their new "Audio Control Center" (shown below) and amplifier kits "kid-tested" by a couple of 14-year-olds, who assembled them without a hitch. If the kids can do it, presumably everybody can. Thanks to new modular construction, these kits have been made exceptionally easy to assemble without cutting corners on quality.

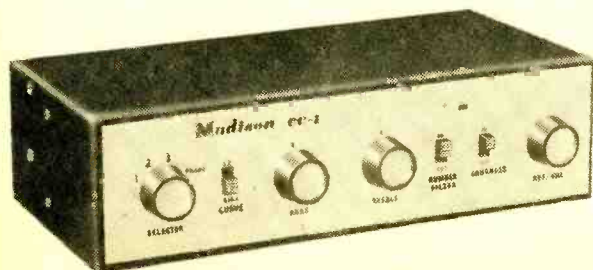

Stereophonic Chair

Grandfather's chair, "ears" and all, has been hauled down from the attic, dusted off, and given a new lease on life by Stereo Products Co., Severna Park, Md. By sticking loudspeakers into each of its side-"ears" and hooking them up to a stereo tape player, this company has come up with a new model of the old wing chair that provides an effect akin to listening with binaural earphones. Low volume assures semi-private listening.

EVERYONE, prospector or not, should have a Geiger counter. Many wise householders are assembling survival kits of food, bandages, and water. By adding this handy, inexpensive radiation detector, you can provide your family with a means of detection of contaminated material in the event of atomic warfare. Simple as the counter may be, it will detect radiation as feeble as that given off by a watch dial—or it could make you rich by locating a uranium ore vein.

Construction of the "Geiger Gun" is neither expensive nor difficult. The case shown is made of 1/16" brass. This is easily obtainable and readily formed to any shape. Actual dimensions of the case are determined by the size of the components you obtain. Location of the parts is not critical; however, it is suggested that you follow the layout illustrated.

Capacitor clips are used to hold the batteries. Scrape away the wrapper on *B1* so that the bare case is grounded to the chassis through the metal clip. Do not do this on *B2*, however; care should be used here so that the wrapper will not tear and short out the amplifier stage. Other battery connections are soldered directly to the poles.

Use another large clip to hold capacitor *C1* to the case. Holes are drilled in the case and the various switches and phone jacks are added where convenient. One-half of a fuse clip holds the tiny model airplane spark plug in place.

Mount the Geiger tube on the front of the case. A miniature tube shield should be drilled with about eight small holes to allow gamma rays to strike the tube surface directly. Drill a hole to accept a small

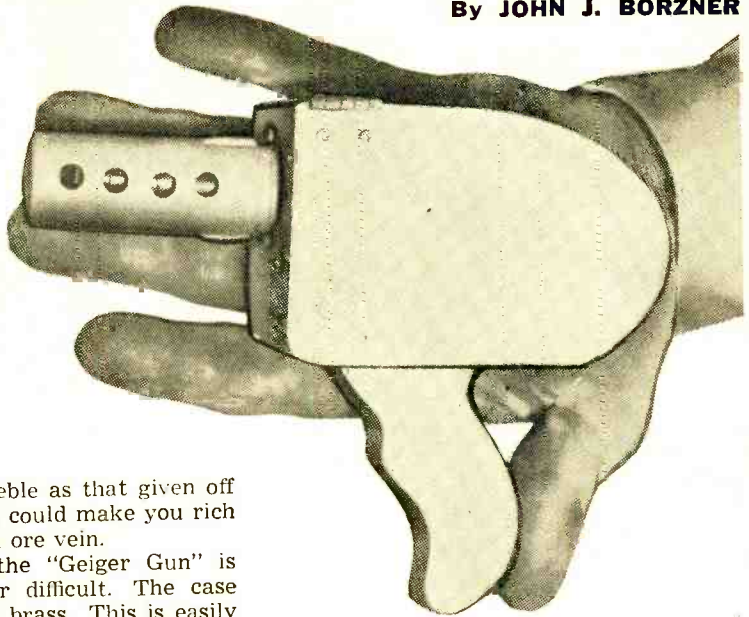

Geiger Gun

Ultra-simple counter useful

on camping trips or in

CD survival kit

rubber grommet on the front of the case, in the center of the tube shield socket. The anode wire of the Geiger tube enters the case through this insulated hole. Solder or clip a lead from the spark cap to this anode wire. Ground the glass shell of the tube by wrapping it with soft bell wire which is grounded to the chassis.

Shape a pistol grip handle from wood, and attach it to the bottom of the case with wood screws. A hinge can be added to the cover for easy access to the circuit. The lid is secured by a small sheet metal or wood screw at the bottom corner.

When wiring, follow the schematic closely. Be careful when the capacitor is charged. Although not deadly, the full charge is about 950 volts and can produce an uncomfortable shock.

After wiring is complete, test the unit by plugging in the headphones and pushing switch *S1* sharply and rapidly about 10 to 12 times. If no spark appears at the plug, minor gap adjustment should be made. Turn on the switch on the amplifier. (This switch is not necessary if the headphones are removed when the counter is not in

HOW IT WORKS

Operation of this pocket-size counter is simple. The inexpensive Geiger tube (*V1*) is charged to its 1000-volt operating voltage by applying a small current to the secondary of an audio output transformer (*T1*). A high voltage induced in the primary jumps the gap on the model airplane spark plug and is stored in the capacitor (*C1*).

After about ten such operations, the capacitor is charged to a point that will operate the Geiger tube. Normal background radiation of varying intensity (depending on geographical location) will be present at once and is noted in the form of clicks. These faint clicks are amplified by the transistor (*TR1*) and heard through the headphones.

Components of the "Geiger Gun" are identified in view at right with cover open. Follow schematic diagram (below, right) in wiring the counter. Parts list appears below.

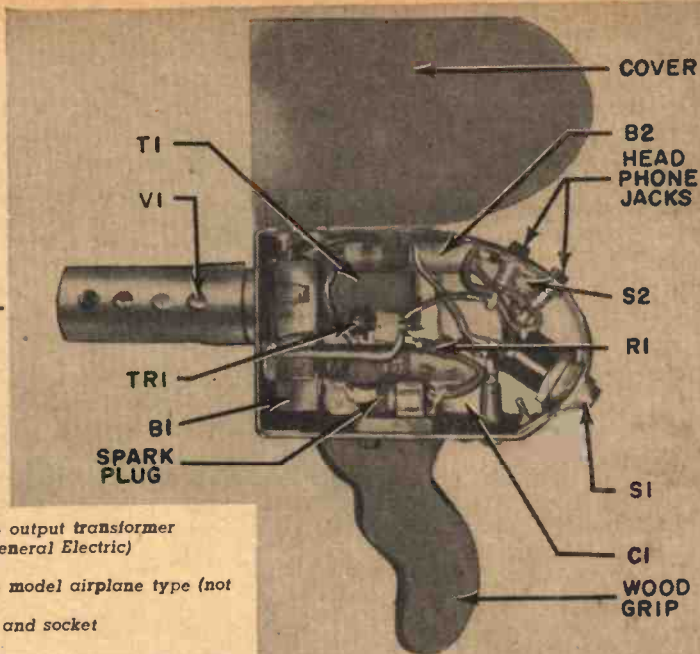

- B1—1½-volt battery (Eveready Pencil)
- B2—1½-volt battery (Eveready #912)
- C1—0.05- μ fd., 1600-w.v.d.c. capacitor
- R1—1-megohm resistor
- S1—Normally open push-button switch
- S2—S.p.s.t. slide switch
- T1—10,000-3.2 ohm audio output transformer
- TRI—2N107 transistor (General Electric)
- V1—CK1026 Geiger tube
- SPARK PLUG—Miniature model airplane type (not a "glow" type plug)
- 1—Miniature tube shield and socket
- 1—Transistor socket
- Misc. fuse clips, headphone jacks or plug, thin brass stock for case, capacitor clips, etc.

use.) When a radium watch dial is brought near the holes on the tube shield, a rash of clicks should be heard. When it is taken away, the normal background count will be resumed.

As a strong radiation force is brought close to the "Geiger Gun," clicks become more rapid. Any increase above normal cosmic ray background radiation should be investigated. Keep battery B1 fresh for best results.

When you go on that hunting or fishing trip, take this handy counter along. Remember, uranium is where you find it. —30—

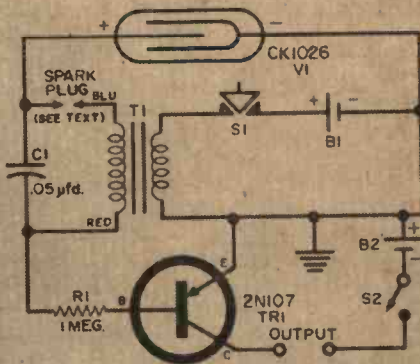

Mounting Flat Ferrite Antenna Coils

Flat ferrite transistor antenna coils, such as the Lafayette Radio MS-307, are not provided with any means for mounting. Where sufficient space is available, one of the very best ways to mount this coil is to

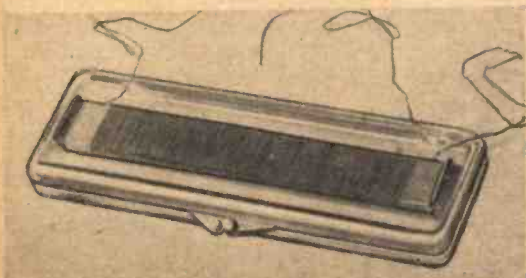

keep it in the plastic case in which it is shipped. Then cement the case to the cabinet of the receiver.

Drill three small holes through the underside of the case to pass out the coil leads. Also make holes on either side of the case about ¼" in from each end of the flat ferrite rod. Pass heavy thread through these holes a couple of times and over the end of the ferrite rod, pull the thread taut and knot it to hold the rod firmly against the inside of the case. A generous application of plastic cement over and around the knot will prevent it from becoming untied. Then close and seal case by running a fillet of cement around it. —Frank H. Tooker

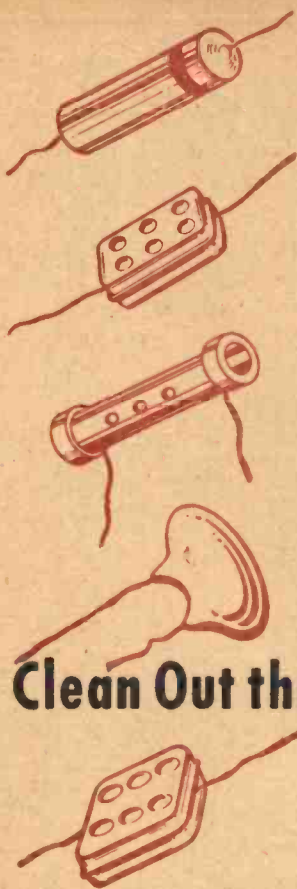

Clean Out the Junk Box with a Capaci-Meter

Stop wondering whether or not those capacitors are good or bad—this valuable test instrument will solve your problem

By R. L. WINKLEPLECK

PROBABLY every reader of POPULAR ELECTRONICS who builds his own projects has a VOM. It's one of the first test instruments an electronics fan buys, and it is used constantly. How else can one determine voltages, tell if a resistor is open, discover the value of an unmarked resistor or know whether a marked one has changed in value?

Similar questions arise every day concerning capacitors, but only a few of the most fortunate have the necessary test instrument to supply the answers. The pile of resistors in the junk box represents a definite use potential; the small capacitors, so often unmarked, continue to accumulate and are seldom used. Worse yet, small radio servicing jobs take forever when a bad capacitor is found only by replacement.

This easily built "Capaci-Meter" will accurately read values as small as 5 $\mu\mu\text{fd}$. It can be used to measure the values of small trimmers, the interelectrode capacitance of vacuum tubes, and the lengths of rolls of shielded cable. Its real worth, however, lies

in checking out the values of capacitors in ailing radios and TV sets, and putting on the "ready shelf" the unknowns from the junk box. You'll use it almost as frequently as your ohmmeter.

Construction Hints. The photographs show a suggested layout of components but modification—when using other parts either to reduce the size or change the shape of the Capaci-Meter—can be made without altering its accuracy. Changes can be made in the power supply to utilize components from the junk box in the best way possible; remember, however, that a regulated 150 volts at 60 to 70 ma. is needed. The cost of the meter can be reduced by selecting one of smaller size, or one may occasionally be found in war surplus sales.

Components can be arranged quite compactly to permit short, direct wiring. Insulating the chassis from the panel, as is done here with insulating shoulder washers, eliminates any danger of shock in using this particular type of power supply. It should be noted that the test posts are "hot" when a reading is being taken.

Be sure and grasp the crystal diode leads

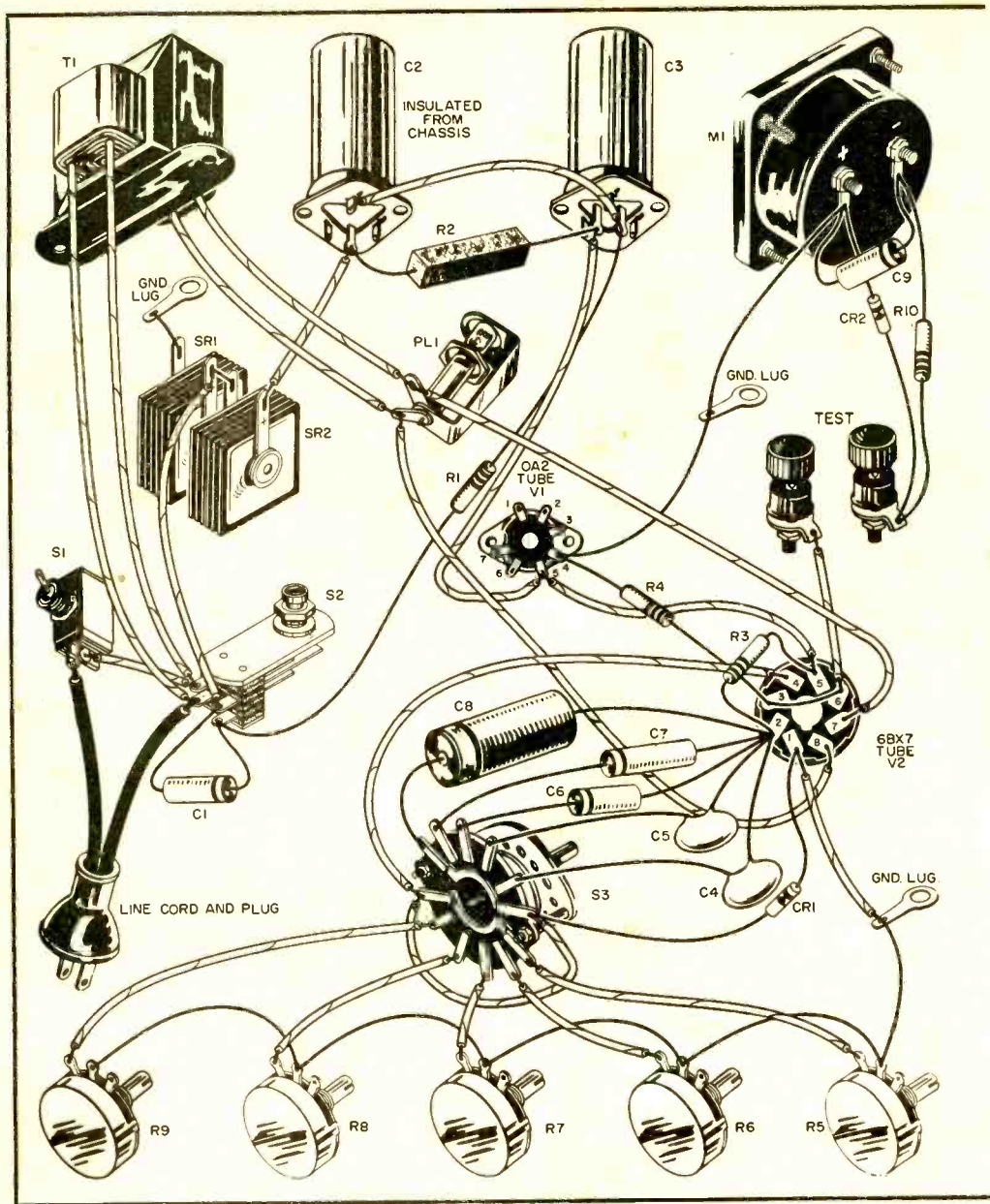

with a pair of pliers when soldering to prevent heat damage to the sensitive crystal. Check the wiring very carefully before turning the instrument on to avoid any possibilities of mistakes which might damage the meter. If all seems correct, turn the five potentiometers to the position which places maximum resistance in the circuit. Plug in the unit and turn it on.

Allow it to warm up for a few minutes. Then, with nothing connected to the test posts, depress the test switch; the regulator tube should glow on every range

switch position. If it fails to glow on one or more positions, the line voltage is probably low and the 2500-ohm, 10-watt resistor (R_2) should be replaced with one of 1500 ohms.

Calibrating the Unit. This is accomplished with the aid of five accurate capacitors, one for the maximum reading on each range. As the Capaci-Meter can be no more accurate than the calibrating capacitors, it is advisable to use only those with the best possible tolerance. Capacitors which are accurate to $\pm 1\%$ in values of

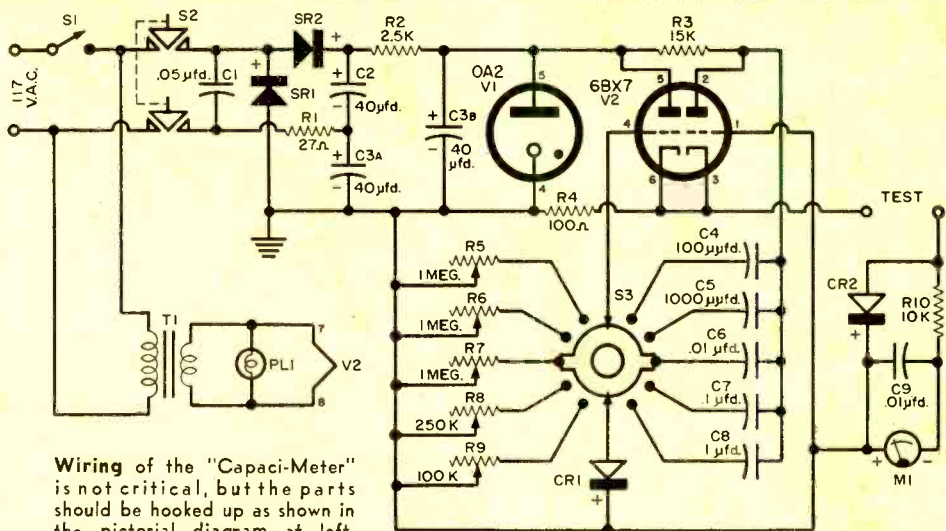

Wiring of the "Capaci-Meter" is not critical, but the parts should be hooked up as shown in the pictorial diagram at left. Schematic diagram appears above and parts list below. You'll find a detailed description of how the unit works at the right.

- C1—0.05- μ fd., 200-volt tubular capacitor
- C2—40- μ fd., 350-volt electrolytic capacitor
- C3a/C3b—40-40 μ fd., 350-volt electrolytic capacitor
- C4—100- μ fd. mica capacitor
- C5—1000- μ fd. mica capacitor
- C6, C9—0.01- μ fd. tubular capacitor
- C7—0.1- μ fd. tubular capacitor
- C8—1.0- μ fd. tubular capacitor
- CR1, CR2—1N34 crystal diode
- M1—0.50 microampere meter
- PL1—Pilot light assembly
- R1—27-ohm resistor
- R2—2500-ohm, 10-watt resistor
- R3—15,000-ohm, 2-watt resistor
- R4—100-ohm resistor
- R5, R6, R7—1-megohm linear potentiometer
- R8—250,000-ohm linear potentiometer
- R9—100,000-ohm linear potentiometer
- R10—10,000-ohm resistor
- S1—S.p.s.t. toggle switch
- S2—D.p.s.t. push-button switch
- S3—2-pole, 5-position wafer switch
- SR1, SR2—100-ma. selenium rectifier
- T1—6.3-volt, 1.2-ampere transformer
- V1—6A2 tube
- V2—6BX7 tube

HOW IT WORKS

The conventional bridge method of measurement (not used here) is accurate but inconvenient, and requires a signal generator for best results. The impedance method of measuring capacitance is a suitable alternative. Basically, an a.c. voltmeter or ammeter, in series with a resistor, is connected in series with the capacitor to be measured and then connected across a source of alternating current. The reading of the meter will be inversely proportional to the capacitor's impedance which, for non-electrolytics, we'll call its reactance at the measured frequency.

In other words, advantage is taken of the fact that the flow of current through a capacitor connected to an alternating voltage source is directly proportional to its capacitance. By calibrating the meter with a standard capacitor, the capacitance of the unknown can be read directly from the meter. This method cannot be used for capacitors with an appreciable resistance component or leakage, such as electrolytics.

The design of the Capaci-Meter utilizes a multi-vibrator circuit as a square-wave signal generator. In such a circuit, two triodes are connected as a two-stage, resistance-coupled amplifier with the plate of one section controlling the grid potential of the other. The fundamental frequency of the multi-vibrator is determined by the time constant of the grid resistor and capacitor. Provision is made for switching five different capacitor-resistor combinations into the circuit to produce five different fundamentals.

By bridging the 100-ohm resistor (R4), a portion of the square wave is diverted through the capacitor to be measured and the meter circuit. However, five capacitance ranges are possible since five fundamental frequencies are individually generated and impressed on the capacitor to be measured—and since as much current at high frequency will flow through a small capacitor as through a much larger capacitor when the frequency is lower.

Each of the five resistor-capacitor combinations is designed to produce full-scale meter deflection through each of five capacitor standards. Each resistor is variable to permit the slight adjustment necessary to deflect the meter exactly to full scale. The 0.1 μ fd. range requires a frequency of only about 8 cps, so the meter needle vibrates somewhat; the mid-point of the needle swing, however, provides a reasonably accurate reading. The other ranges require frequencies progressively higher to approximately 80 kc., and on these ranges the needle is quite stable.

100 μ fd., 1000 μ fd., and 0.01 μ fd. are available at quite reasonable prices. However, the two larger capacitors (0.1 μ fd. and 1.0 μ fd.) are both hard to find and very expensive when very close tolerance is desired. Usually it is sufficient to consider the purchase of only the three smaller precision capacitors.

First attach the 100- μ fd. standard capacitor to the test posts and turn the range switch to the position which places C4 and R9 in the circuit. Press the Read switch and adjust R9 until the meter needle is de-

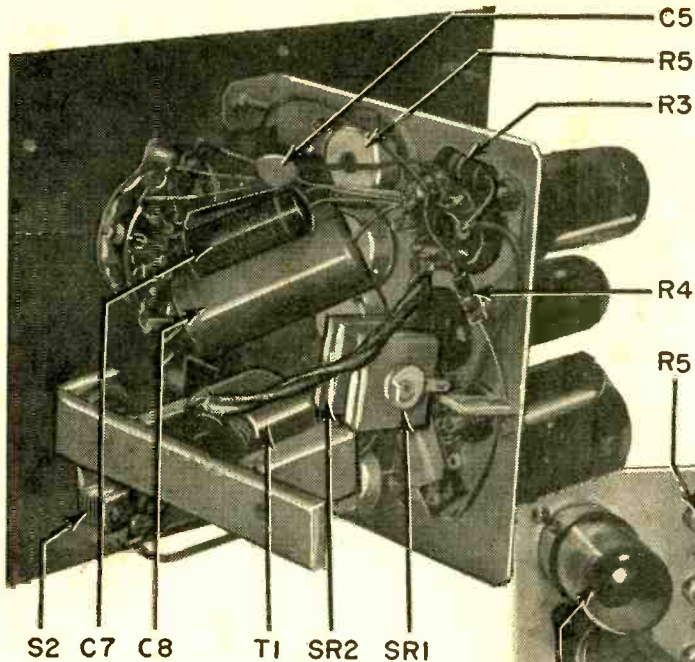

Suggested layout of the "Capaci-Meter" components is shown below and at left. Modification can be made without altering accuracy. The meter scale should be changed to show the five capacity ranges (below, left); the simplest way to do this is to cover the microampere values with an arc of white paper on which the capacitance values have been lettered.

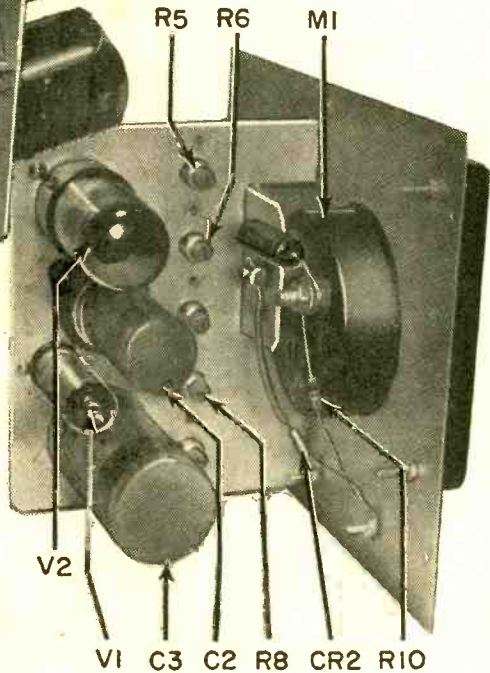
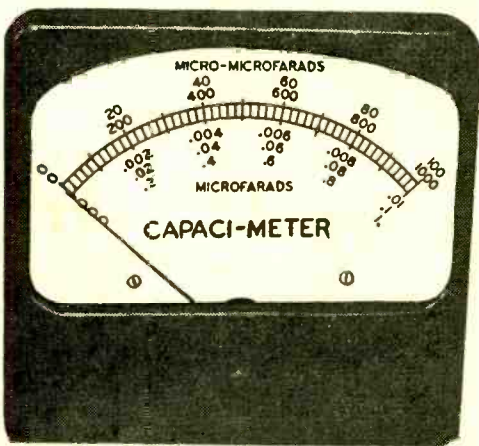

flected to full scale. Make this adjustment going toward full deflection rather than returning from beyond full scale. Follow this same procedure with each of the other standards (1000 $\mu\text{fd.}$ and 0.01 $\mu\text{fd.}$) for the respective range positions, and the calibration is complete.

After calibrating the 0-0.01 $\mu\text{fd.}$ range, a search of your junk box should turn up at least five 0.01- $\mu\text{fd.}$ capacitors whose values can be individually measured. Connect these capacitors in parallel to the test posts, and calibrate the meter on the 0-0.1 $\mu\text{fd.}$ range at a value representing the sum of the five capacitors. Follow this same procedure with a group of 0.1- $\mu\text{fd.}$ capacitors to calibrate the 0-1 $\mu\text{fd.}$ range.

During calibration, the capacitors should be fastened directly to the test posts. Two short test leads connected to the test posts and terminating in alligator clips will be very convenient for rapidly attaching and detaching capacitors after calibration has been completed. Such leads contribute a slight capacitance and may have significance on the lowest scale. This value can be determined by taking a reading before connecting a capacitor, and the amount then subtracted from the final reading.

Testing Capacitors. Attach the capacitor to be tested and start with the high range. If the needle goes off scale, the capacitor is larger than the meter can measure—or it is shorted. If the needle is only slightly deflected, drop down to a smaller capacity range until a point is reached which gives a significant needle deflection, and read the capacity directly from the meter.

Which End Is Up?

Unaccountably wearing her skates (and costume) in the Bomax Works of Birmingham, England, Kathy Reddington was evidently skating on thin ice when a huge new electromagnet latched onto the wrong end of her. Her subsequent position, while common in the antipodes, hereabouts is considered unusual. But traditional British calm can't be disturbed by such a minor matter as being upside down, and Kathy and her partner go on waltzing—after a fashion. It all goes to prove the exceptional strength of the magnet.



Telephoned "Spots"

Telephone lines can now be used to transmit messages at a rate of 1000 words per minute. Replacing slower methods using holes punched in tapes, Bell Telephone Laboratories records a simple "zero" or "one" code on magnetic tape (see photo at right). This elementary binary code appears as a number of "spots" of different magnetic polarities. Telephone users call over normal lines and can switch on high-speed equipment at will. It is claimed that one telephone line will handle in 16 hours the typed output of 30 stenographers working 8 hours. All equipment has been miniaturized with transistors, ferroelectric crystals and semiconductors.



Sunspots Aid Reception

So says John Nelson, of RCA Communications. In fact, the greater the number of sunspots, the more likely are short-wave receiving conditions to improve. Nelson has also worked out a theory involving the arrangement of the planets to predict sunspot disturbances. His long-range forecast for the fall of 1957 indicates that no really severe "blackouts" of radio communications are to be expected and that short-wave broadcasts will be heard as they have never been heard before.

Monitor System Saves \$\$\$

Customers paying their bills at the Tabagie Cartier Restaurant, Quebec City, are surprised by a panel of flickering lights on a box attached to the cash register (right). Hams immediately recognize the call of J. W. G. Laroche, VE2AGS, who has installed a surveillance system to monitor almost everything in his restaurant. From the panel, light, refrigeration, heating, kitchen ranges, etc., are all checked for operation. Laroche estimates that it saves \$2500 a year in maintenance fees.

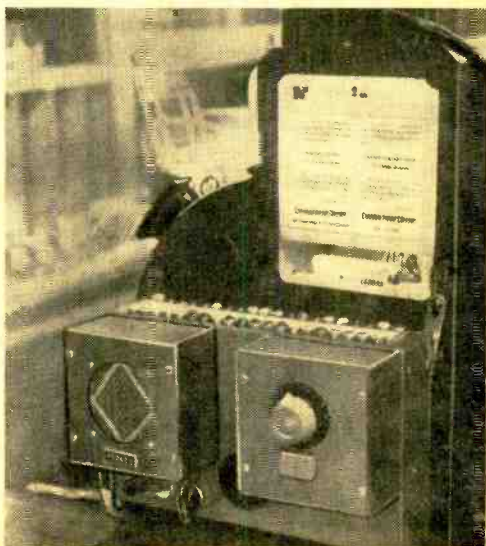

Air Cell Replaces Battery

The idea of getting something for nothing is entering the transistor field. It has been suggested that a separate tuned circuit, such as the one in diagram at right, be used to power transistorized receivers instead of batteries. Tuning to 1300 kc.—the

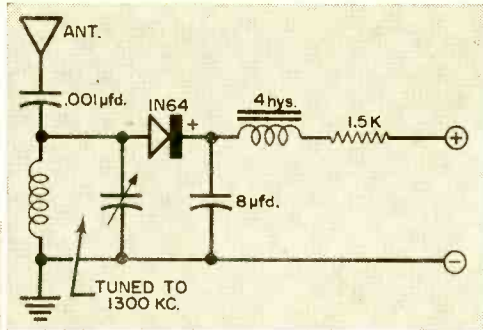
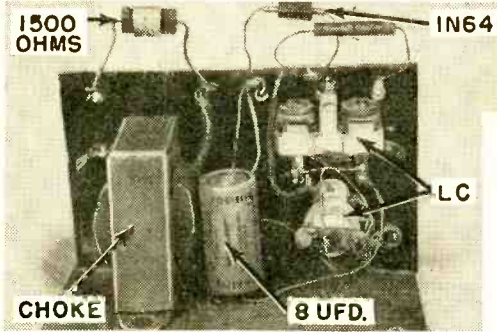

frequency of a local high-power AM broadcaster—I detected the signal through a 1N64 crystal diode and filtered it out via a 4-henry choke and a 8.0-μfd. capacitor. This provided me with a power supply of 300 microamperes at 3 volts, or 1000 μa. at 0.8 volt—enough for rough experimental work.
—I. C. Chapel

Transistor Identification

If you use a perforated Bakelite circuit board, a good way of identifying the collector contact of a transistor is to put a drop of paint in the little hole on the board nearest the collector side of the mounted transistor socket. It will run through the hole and enable the collector connection to be identified from either side of the circuit board. I also suggest using a different color paint for *p-n-p* and *n-p-n* transistors.

—Frank H. Tooker

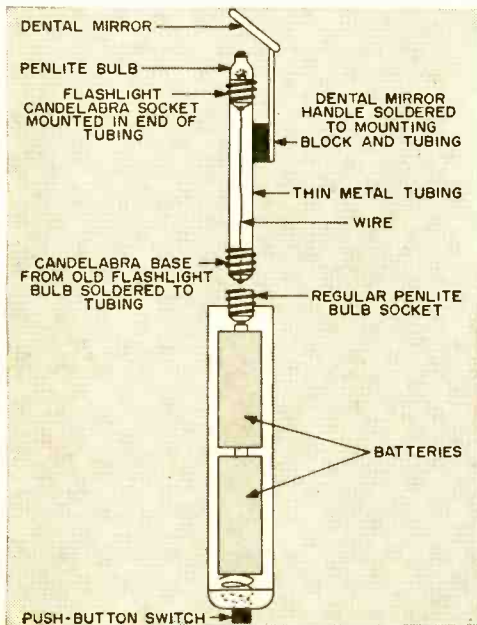
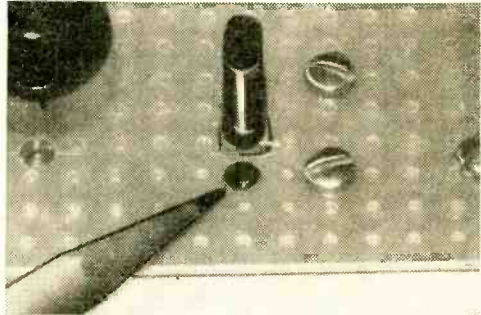

Mirror Sees Around Corner

I have developed a tool which overcomes the difficulty of seeing around corners. The barrel of a fountain pen is used as a holder for a rod on which a dental mirror is mounted, and the light bulb activated by batteries in the pen barrel. This small instrument permits minute examination through the reflection of the part in the illuminated mirror.

—Bob Curry

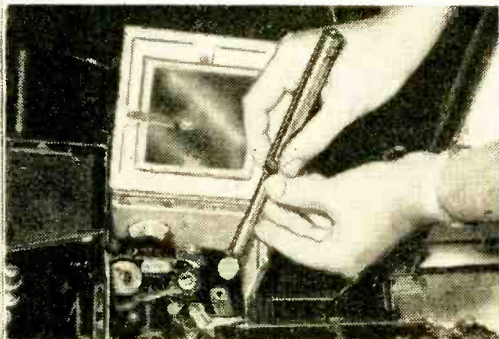

By LOUIS E. GARNER, JR.

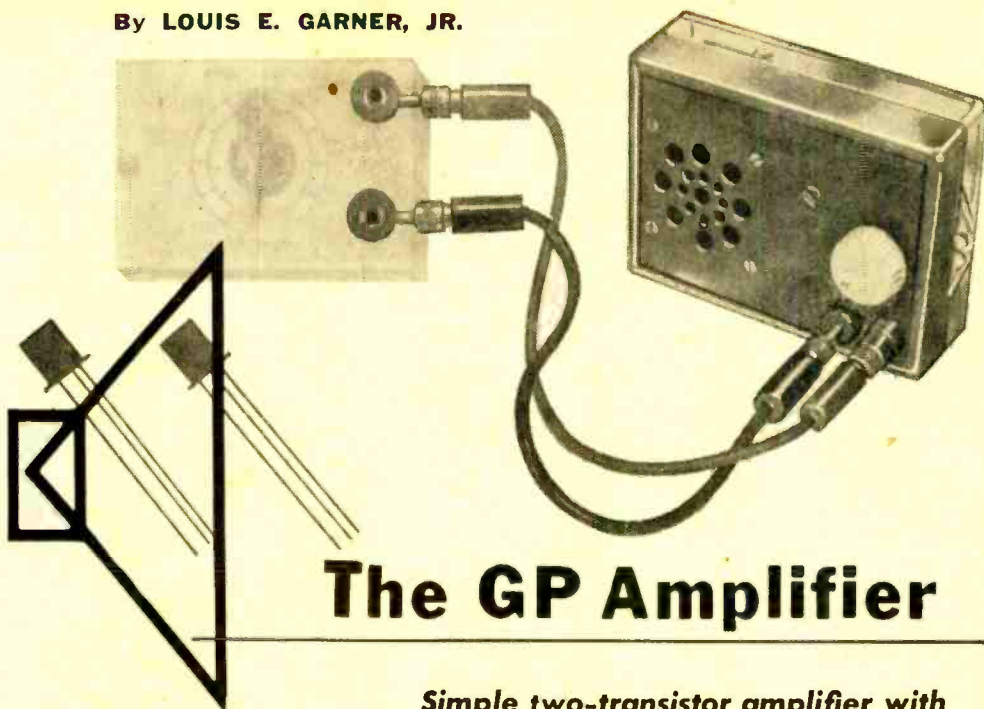

The GP Amplifier

Simple two-transistor amplifier with built-in power supply has variety of uses

ASIDE from standard test equipment, one of the most valuable home electronics workshop gadgets is the general-purpose audio amplifier with a built-in loudspeaker. You can use it as an audio signal tracer to track down hum in hi-fi systems or defects in p.a. or phonograph amplifiers. Combine it with a simple r.f. detector probe and it becomes an r.f. signal tracer. Entertainment-wise, it may be connected in place of headphones to a small receiver to provide loudspeaker operation.

The transistorized amplifier described in this article can do all of these things, and more. Employing two transistors, and designed around a subminiature loudspeaker, it has sufficient gain for many applications. Long battery life is insured by limiting the audio power output to a low—but usable—level.

Assembly. This amplifier is not too difficult for a novice to construct if the circuit is wired according to the schematic diagram. Neither layout nor lead dress will be especially critical. Just keep the "input" and "output" circuits well separated and make short, direct, point-to-point connections.

Either a plastic or a metal case may be used for housing the amplifier. A plastic case offers the advantages of attractive appearance and light weight, a metal case

greater ruggedness and better shielding. You can increase the attractiveness of a plastic case by coloring its front panel; just spray the inside of the cover with the Krylon color of your choice.

Regardless of the housing used, you'll want to provide a protective screen for the loudspeaker opening. The most economical scheme is to drill an ornamental pattern of holes in the case itself. But you may prefer to cut out a large speaker opening and use a separate protective grill, such as

HOW IT WORKS

The GP amplifier is a two-stage, resistance-coupled amplifier, using *p-n-p* junction transistors. The second stage is transformer-coupled to the loudspeaker. Operating power for the entire circuit is furnished by a single battery.

In operation, a portion of the audio signal connected to the *input* terminals, depending on the setting of control *R1*, is coupled through capacitor *C1* to the base-emitter circuit of the first stage. Bias for this stage is supplied through resistor *R2*. The audio signal appearing across collector load resistor *R3* is coupled through interstage capacitor *C2* to the base electrode of the second—or output—stage.

Bias for the second stage is supplied through *R4*. An unbypassed emitter resistor, *R5*, helps to stabilize this stage and to reduce harmonic distortion. Capacitor *C3*, from collector to circuit ground, bypasses the higher frequencies and further reduces the effects of harmonic distortion. Finally, the amplified signal is coupled through matching transformer *T1* to the loudspeaker's voice coil.

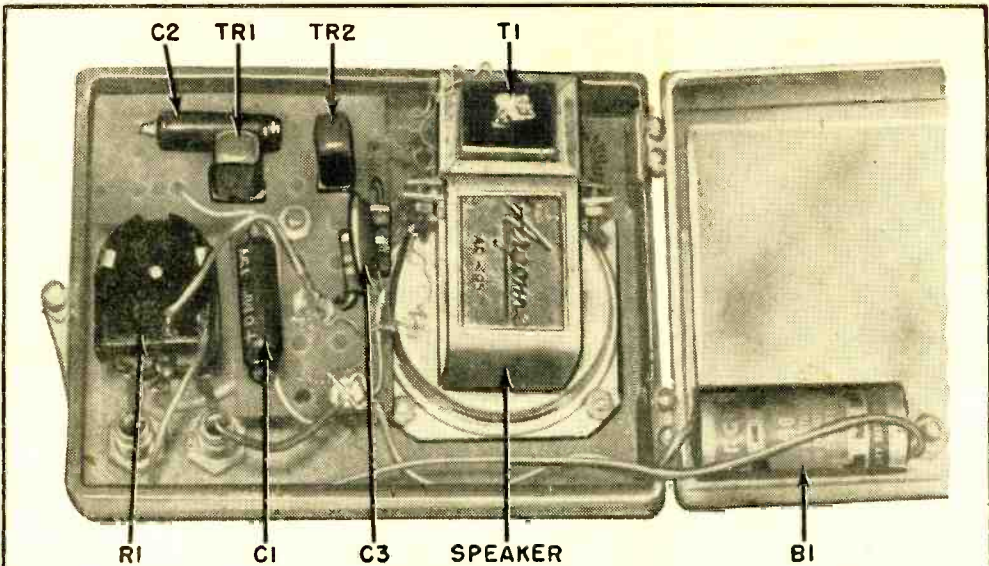

The "chassis" is a piece of perforated Bakelite board. Transistor sockets and small electrical components (see parts list) are wired on the chassis as a separate subassembly. After wiring, according to the schematic diagram, mount chassis in case with a single machine screw.

B1—15-volt miniature battery
 C1, C2—6- μ fd., 15-volt electrolytic capacitor
 C3—0.005- μ fd. disc ceramic capacitor
 R1—5000-ohm potentiometer
 R2—270,000-ohm, $\frac{1}{2}$ -watt carbon resistor
 R3—10,000-ohm, $\frac{1}{2}$ -watt carbon resistor
 R4—47,000-ohm, $\frac{1}{2}$ -watt carbon resistor
 R5—47-ohm, $\frac{1}{2}$ -watt carbon resistor
 S1—S.p.s.t. switch (on R1)

T1—Transistor output transformer, 2000 to 10 ohms (Argonne No. AR-96)
 TR1, TR2—Type CK722 transistor (Raytheon)
 SPKR—10-ohm v.c. subminiature PM loud-speaker (Argonne No. AR-95)
 2—Transistor sockets
 1—Small plastic case
 1—Perforated Bakelite mounting board
 Misc. hardware, phone tip jacks, small knob

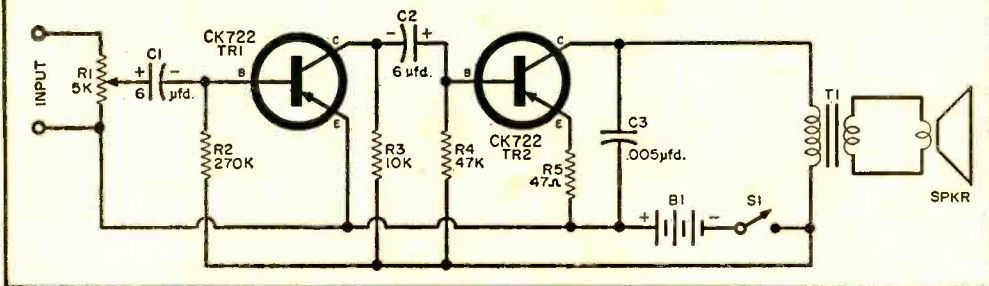

perforated aluminum. And you'll find that ordinary wire screen, either plain or flocked, will give good protection.

Any of several techniques may be employed in mounting the 15-volt miniature battery. In the model, a ground lug was soldered to the negative terminal of the unit, with the lug, in turn, attached to the plastic case with a machine screw and hex nut. Flexible wire leads were soldered to both positive and negative terminals to provide final connections.

Application. To use the amplifier, connect a pair of test leads or a shielded test cable to the *input* terminals. Then connect the free end of the test cable to the equipment to be checked. Rotate control *R1* until you obtain a usable volume level. To

conserve battery life, try to get in the habit of turning the amplifier "off" except when it is in actual use. With no filaments to heat up, the instrument is "on" and ready for business the instant *S1* is closed. When checking high-level signals, don't turn *R1* too high, or you may overload the amplifier—with resulting distortion.

Note that there is no d.c. blocking capacitor between the *input* terminal and *R1*. If you use the amplifier for checking audio signals in equipment where d.c. is likely to be present, an external blocking capacitor should be connected in series with the "hot" test lead. Or, if you prefer, you can install a permanent coupling capacitor in the input circuit. Use an 0.5 to 1.0 μ fd. capacitor with a 400-volt rating. —30—

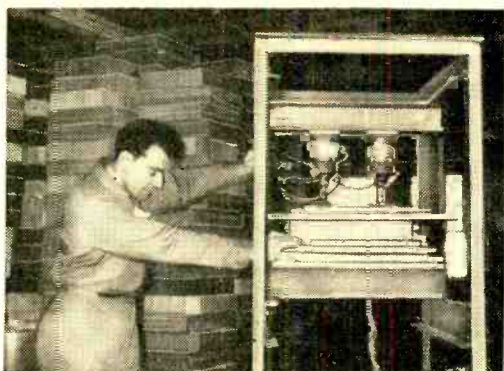

Electronic gluing speeds production of hi-fi cabinets and accessories. Machine above aligns pre-cut panels for turntable base, forges stronger bond in minutes than hand methods accomplished in days.

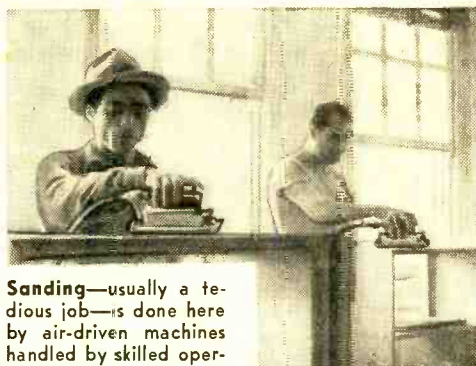

Sanding—usually a tedious job—is done here by air-driven machines handled by skilled operators. Proper sanding is essential to providing wood with a truly professional, finished appearance. Results attained by this machine method are said to rival those of hand sanding. After sanding, cabinets are sprayed (below, left).

Hi-Fi Cabinets = Beauty + Utility

Cabinart photos by Mildred Stagg



Spraying is done in separate booth. Operator handles spray gun almost like artist with brush, applying an even coat of lacquer. Variations in wood grain and coloration are compensated for during polishing.



Acoustical lining, requisite in bass reflex enclosures, is fastened by air-pressure stapling gun.



Complete speaker system, in which drivers and enclosure are integral units, requires extra care. Here, a technician checks out a Cabinart Klipsch three-way "Orthophonic" system after it has been installed in its corner horn enclosure. Crossover network, visible at left, is secured to inside bottom panel.

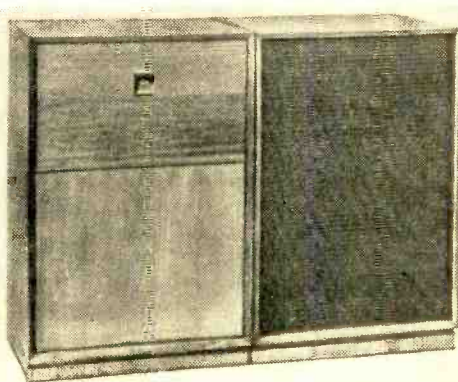

Finished product represents combined skills of professional team. The processes illustrated in the above photos—as well as such refinements as electrical planing and high-speed cutting—result in attractive, sturdy units styled and priced for home hi-fi installation.

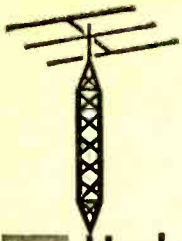

THE TRANSMITTING TOWER

Herb S. Brier, W9EGQ

AS SOON AS I saw the data on the new WRL Model 680 transmitter, I knew that the readers of the *Transmitting Tower* would like to have a report. So I immediately contacted World Radio Laboratories, in Council Bluffs, Iowa, about obtaining one for test.

The word from WRL was that the "680" was not quite ready for distribution (it is now) pending the arrival of a stock of coils from the coil winder and the instruction manual from the printer; fortunately, however, a few sample coils were on hand, and the lab technicians would be glad to assemble a unit and rush it to me. A few days later, the assembled transmitter arrived, complete with hand-drawn diagram and typewritten operating instructions.

The pictures give a good idea of its appearance. It is contained in an 8" x 14" x 8" grey cabinet with a two-tone grey panel and weighs 26 pounds.

WRL 680 Specifications. Electrically, the "680" is a complete phone/c.w. transmitter covering all amateur bands between 3.5 and 54 mc. It utilizes a 6V6 crystal oscillator-frequency multiplier driving a 6146 in the output stage to 65 watts input on c.w. and 50 watts on phone. The band of operation is selected by means of a six-position rotary switch.

Eighty-meter crystals are used for 3.5- and 7-mc. operation, 7-mc. crystals between 7 and 29.7 mc., and 8.334 to 9 mc. ones for 50 to 54 mc. output. Provision is also made for using an external VFO (not permitted for Novices) if desired.

The audio system of the "680" employs a 6U8 as a two-stage speech amplifier—driven by a crystal or other high-impedance microphone—to drive a 6L6G modulator. The 6L6G modulates the d.c. plate and screen input of the 6146 through a husky modulation choke.

Power to operate the transmitter is furnished by a husky power transformer, a 5U4GB rectifier, and a brute-force filter system.

Performance Tests. Up to and including the 21-mc. band, loading the 6146 to the

rated 65-watt c.w. input of the transmitter produced an r.f. output of 45 watts. On phone, its rated input of 55 watts produced an output of just under 40 watts. On 10 meters, where the 6146 operates as a frequency doubler, output was down somewhat, but still over 20 watts.

So far so good. This performance is nor-

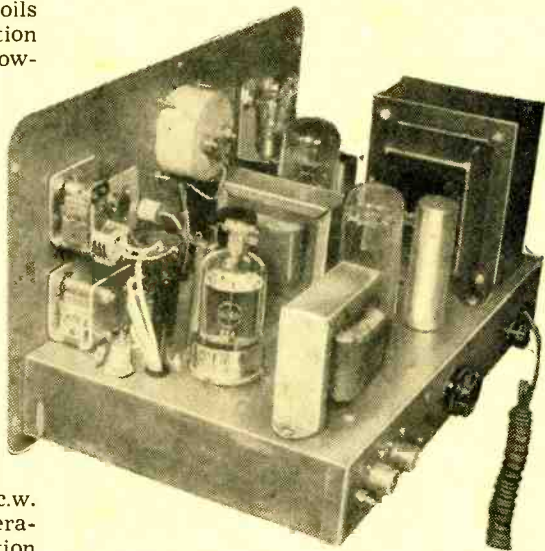

mal for the circuits and the power. But what about six meters? As I plugged in the crystal for six meters and connected the dummy antenna to the 6-meter coaxial output connector, I was prepared for an output of a couple of watts. Instead, it was the same as on 10 meters!

Up to 29.7 mc., in on-the-air tests, the output tank circuit of the transmitter is of the *pi*-network type, aided by an additional L section which is switched into the circuit on the 3.5- and 7-mc. bands. With this arrangement, it's no problem to feed power into any reasonable antenna.

On the 50-mc. band, however, the low-frequency coils are shorted out entirely, leaving only the 50-mc. coils in the circuit. A two-turn link coil at the "cold" end of the output coil couples the 50-mc. r.f. power

from it to the 50-mc. output connector. Such a coupling system works best when feeding a low-impedance load. This creates no special problems because most present-day 50-mc. antennas are fed through 50 to 75 ohm feed lines.

To put a signal on 50 mc., I hung a 50-mc. doublet* across the radio room between two screws in the picture molding. It was about 10 feet above the ground. With this antenna, I worked W9PLW between 9:00 and 10:00 p.m. while making various tests. Of course, for regular 50-mc. work, a higher outside antenna—preferably a rotary beam—would be desirable.

Television Interference? During these tests, the eight-year-old TV set in the radio room, which is rather susceptible to all forms of interference, was tuned to Channel 2. Turning on the transmitter put a light "veil" across the picture, and talking into the microphone put fairly heavy "sound bars" across it. On the 1957 RCA, 20 feet away in another room, there was no trace of interference. Also, for what it is worth, none of my neighbors has mentioned hearing the tests.

From these results, it would appear that TVI from 50-mc. operation of the transmitter should not be an insurmountable problem. Some nearby TV receivers might require the installation of a good high-pass

SEE NEXT PAGE FOR
*list of those who request help
in obtaining their ham licenses*

nals up to about 52 mc.—on the transmitter as a further precaution against TVI.

Conclusions. Operation of the "680" on the lower frequency bands is completely normal. My first CQ's on both phone and c.w. were answered and good reports received. C.w. keying and voice quality on phone were good. I obtained modulation by talking at a normal level a few inches from the crystal microphone with the audio gain control set about three-quarters open.

In common with other transmitters, the "680" is capable of emitting signals outside the amateur bands if incorrectly tuned. Therefore, it is necessary to follow the tuning instructions in the instruction manual carefully to avoid hearing from the FCC officially.

This transmitter is worth consideration by any new or prospective amateur who does not intend to stop with a Novice license, and by any amateur wishing a versatile, low-power, phone/c.w. transmitter. For Novice use, its first cost is somewhat higher than a "c.w.-only" transmitter, but its added features will be waiting to be used

◀ Inside view of the new WRL 680. A complete phone/c.w. transmitter covering all amateur bands between 3.5 and 54 mc., it utilizes a 6V6 crystal oscillator-frequency multiplier driving a 6146 in the output stage to 65 watts input on c.w. and 50 watts on phone.

Contained in 8" x 14" x 8" grey cabinet with two-tone grey panel, the transmitter weighs 26 pounds. Its performance on the various bands is discussed in the text. Band operation is selected by means of six-position rotary switch. ▶



filter at the tuner antenna terminals to overcome a lack of built-in selectivity (a receiver fault). In areas where Channel 2 is assigned, operating below 51 mc. will help; this will also permit using one of the newer type low-pass filters—which pass sig-

upon the receipt of a higher grade license.

The WRL 680 is available from World Radio Laboratories, 3415 West Broadway, Council Bluffs, Iowa, for \$84.95 in kit form and for \$99.95 in wired form. Also available in wired form only is the Model 66, covering 1.8 to 29.7 mc. Tubes are included at these prices, but key, microphone, and crystals are extra.

(Continued on page 120)

*This was a 9/4" length of #12 wire separated in the center by a small insulator and fed across the insulator through 75-ohm "twin lead." It was supported at the ends with pieces of cord, which also served as insulators.

HELP US OBTAIN OUR HAM LICENSES

In this section of the Transmitting Tower, the names of prospective amateurs requesting help and encouragement in obtaining their licenses are listed. To have your name listed, write to Herb S. Brier, W9EGQ, c/o POPULAR ELECTRONICS, 366 Madison Ave., New York 17, N. Y. Please print your name and address clearly. Names are grouped geographically by amateur call areas.

K1/W1 CALL AREA

Robert Di Padua (15), 1369 Mineral Spring Ave., N. Providence 4, R. I. Phone: EL 3-2512. (Needs help in selecting equipment)

Paul Zimmerman (18), 422 Brightwood Ave., Torrington, Conn.

Ralph L. Garrett, Jr., 235 Mt. Vernon St., W. Newton, Mass. Phone: DEcatur 2-1124. (Code)

Robert L. Skulley, 133 Forest Ave., Brockton, Mass. (Code and theory)

Bill McGurk, 86 W. Glen St., Holyoke, Mass. (Code)

David C. Hamilton, 47 School St., Old Orchard Beach, Me. Phone: 6-4021.

Douglas Koop, 2 Beauford Rd., So. Norwalk, Conn. (Code and theory)

K2/W2 CALL AREA

Thomas Casullo, 61-20 Grand Ave., Maspeth 78, N. Y. Phone: TW 4-9219. (Code and theory)

Robert Miglorino, Paul Markowitz, Don Borowski, Frank W. Gaff Jr., Robert C. Lieberman, 932 E. 22nd St., Paterson, N. J. (Code, theory, and repairing equipment)

Glenn Taylor, 1112 Ferngate Dr., Franklin Square, Long Island, N. Y.

H. Kuell, 18½ Thomas St., Newark, N. J.

Martin A. Barry, 27 Wellington Pl., Westwood, N. J. Phone: WEStwood 5-2817. (Code and theory)

Peter Cherry, 1554 Ocean Ave., Brooklyn 30, N. Y.

Jim Slattery (14), 3 Bohling Rd., New Hartford, N. Y. (Theory)

Albert R. Javarone (15), 5 E. 12th Ave., Gloversville, N. Y. (Code and theory)

Bruce Robinson, 108 Elm St., Waverly, N. Y. (Code and theory)

William Anthony (15), 280 Outwater Lane, Garfield, N. J. (Code and theory)

K3/W3 CALL AREA

Joseph C. Cessaro, 922 R.R. N. Church St., Hazelton, Pa. (Code and theory)

Edward Steedle (15), 200 Elizabeth Ave., E. Pittsburgh, Pa. (Code and theory)

Byron Whartnaby, 6 East Ave., Swanwyck, New Castle, Del.

William Martino, Jr., 2123 Watkins St., Philadelphia 45, Pa. (Code)

Ray Haines, 4069 Ford Rd., Philadelphia 31, Pa. Phone: GR 7-3719. (Code and theory)

Malcolm Heimer, R. F. D. #1, Beech Creek, Pa.

K4/W4 CALL AREA

Phil Poole, Box 240, McLean, Va. Phone: EL 6-3883.

John F. Limbach, R. F. D. #2, Box 56, McLean, Va. Phone: JE 3-7666.

Greely M. Wells, 1002 Coliseum Blvd., Montgomery, Ala. (Code and theory)

Glenn Cuthrell (11), Box 248, Maxton, N. C. (Code and theory)

Richard Stern, 9100 Emerson Ave., Miami Beach, Fla. Phone: UN 5-5339. (Code)

Henry G. Wilhelm, 2723 No. Harrison St., Arlington 7, Va.

Paul Robey Eanes, 1650 Goodwin St., Jacksonville 4, Fla. (Code and theory)

K5/W5 CALL AREA

Glynn Lorange (14), 10003 Buxton, Houston 17, Tex. (Code and theory)

C. R. Littlepage, Jr., 1308 W. 12th St., Austin 3, Tex.

Steve Campbell, 315 So. Waverly, Dallas 8, Tex.

Ronald Hebensperger, Rt. #2, Roosevelt, Okla. Phone: 1436W1 out of Hobart, Okla. (Code and theory)

Harold Icke, 439 Avant Ave., San Antonio, Tex. Phone: LE 4-4586. (Code)

Austin Neely, Charleston, Miss. (Code and theory)

K6/W6 CALL AREA

Mike Kaufman, 11615 Canton Pl., Studio City, Calif.

L. P. Kromer, QM2, USS Orange County LST-1068, FPO San Francisco, Calif. (General theory)

Lee Blakley (14), 715 Colorado Ave., Chulavista, Calif. (Code)

Reid Blake, 6 Morningside Dr., San Anselmo, Calif. (General code and theory)

Gregory McAllister, 6 Inman Ave., Kentfield, Calif. (General code and theory)

Kurt Pinkerton (13), 5637 Nauman Rd., Oxnard, Calif. (Code and theory)

K7/W7 CALL AREA

Ervin Neilson, P. O. Box 15, Steamboat, Nev.

K8/W8 CALL AREA

Vincent Bartolone, Box 36, Riverside, Mich. Josef Belohlavek, Jr., 3720 W. Sprague Rd., Parma 29, Ohio. (Code and theory)

Gary Rose, R. D. #1, Williamsfield, Ohio. (Code)

Richard Silverman, 16157 Indiana, Detroit 21, Mich. Phone: UN 1-8427. (Code and theory)

Terry Graf, 2135 Warren Rd., Lakewood 7, Ohio.

Wally Swerchowsky (15), 1591 Grace Ave., Lakewood 7, Ohio. Phone: LA 1-0964. (Code, theory and selection of equipment)

Chester Grabowski, 4364 E. 144th St., Cleveland 28, Ohio. (Code and theory)

Larry Mortimer (15), 3420 Bobendick, Saginaw, Mich. (Code and theory)

K9/W9 CALL AREA

Jerry Whalen, Rt. #1, Bonfield, Ill. (General code and theory)

John Turnquist, 548 Elm St., Glen Ellyn, Ill. (Code and theory)

Victor Belanger (14), 551 Sheffer Rd., Aurora, Ill. (Code and theory)

Leo Hoy, Sr., 1237 W. Cleveland Ave., Hobart, Ind. Phone: 1001R. (Code and theory)

Bill Whittaker (15), R. R. #1, Wolflake, Ill.

Robert Hughes (15), Grand Tower, Ill.

Ed Wiegand (16), R. R. #2, Edwardsville, Ill. (Code and theory)

K0/W0 CALL AREA

Jerry Pullins, 615 Simcock, Council Grove, Kans. Phone: 110-B. (General theory and regulations)

Paul E. Bueltmann, Jr., 3714 Lee Ave., St. Louis 7, Mo. (Code and theory)

Patrick Wintheiser, 619 W. Nassau St., St. Peter, Minn.

Cris Borger, 421 N. Emporia, Eldorado, Kans. (Code and theory)

John Sullivan, 527 N. Houser Dr., Eldorado, Kans. (Theory)

John Myers, 109-S-16th St., Parsons, Kans. (Code)

John Reed, 6220 Fontenelle Blvd., Omaha 11, Nebr.

VE AND OTHERS

Joe Turner, Royal Oak P. O., B. C., Canada. (Code and theory)

Doug Tribe, Royal Oak P. O., B. C., Canada. (Code and theory)

Morgan Aukongak, Golovin, Alaska.

To help prospective amateurs obtain their Novice licenses, the Radio-Electronics-Television Manufacturers Association offers a set of code records (recorded at a speed of 33½ rpm) and a Novice Theory Course for \$10.00, postpaid. The complete course or more information on it is available from RETMA, 1721 DeSales St., N. W., Washington 6, D. C.

Using the completed cutter to make right angles on 1/16" Lucite.

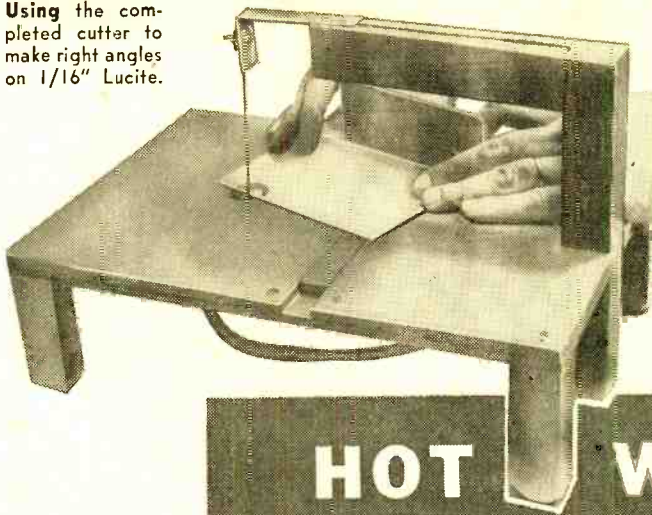

Slice thin sheet plastic with this easily constructed precision cutter

HOT WIRE PLASTIC CUTTER

By Harvey Pollack

THIN SHEET polystyrene plastic is one of the most useful electronic constructional materials. It is suitable for the fabrication of long pointer knobs, small sub-chassis for high-voltage parts, terminal panels, tie-lug mounting strips, panel call-outs and control labels, and has a host of other uses.

Most experimenters who attempt to work with plastic sheets experience difficulty in cutting the plastic to shape. This is particularly true of thicknesses of $\frac{1}{16}$ " or less. Using a hot-wire cutter is the easiest way to form thin plastic sheets. The one to be described here is built from scrap wood, scrap aluminum, and very inexpensive electrical parts. It produces a fully finished edge that requires no further sanding or filing, and will cut at any angle with the precision of a jigsaw.

Construction. The base of the cutter is formed from three pieces of $\frac{1}{4}$ " pine or birch plywood. The largest piece forms the lower section of the base; the two upper pieces are carefully spaced to take the slide rod of a miter guide in a tight but smooth sliding fit. For small miter guides, the spacing between the two upper sections is $\frac{3}{4}$ ". These sections are screwed to the lower plywood layer.

Place the three base pieces in the exact position they will occupy in the finished product and mark them for the wire feedthrough holes. These holes are centered on

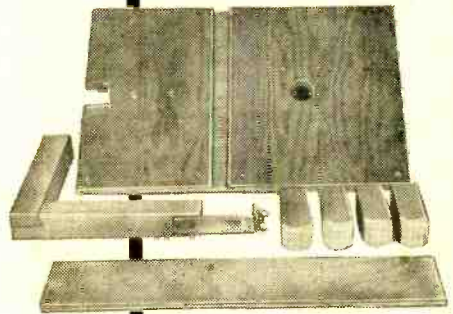

Disassembled view. Note position of feedthrough holes with respect to miter guide groove.

BILL OF MATERIALS

- 1—10" x 15" x $\frac{1}{4}$ " piece of plywood (lower base)
- 1—6 $\frac{1}{8}$ " x 10" x $\frac{1}{4}$ " piece of plywood (upper base)
- 1—8 $\frac{1}{8}$ " x 10" x $\frac{1}{4}$ " piece of plywood (upper base)
- 1—6 $\frac{3}{8}$ " x 1 $\frac{1}{4}$ " x 1 $\frac{1}{4}$ " piece of plywood (upright)
- 1—7 $\frac{3}{4}$ " x 1 $\frac{1}{4}$ " x 1 $\frac{1}{4}$ " piece of plywood (cross-arm)
- 4—3 $\frac{1}{2}$ " x 1 $\frac{1}{4}$ " x 1 $\frac{1}{4}$ " piece of plywood (legs)

the base with respect to the long edges and are located about 4 $\frac{3}{4}$ " from one short edge. Drill the upper base layer with a 1 $\frac{1}{8}$ " wood bit or expansion bit; this opening permits a 1"-diameter disc of thin aluminum (with needle-thick hole in the exact center) to fit below the surface of the top plywood board and rest on the bottom layer. Immediately below the 1 $\frac{1}{8}$ " hole, drill a $\frac{1}{4}$ " hole

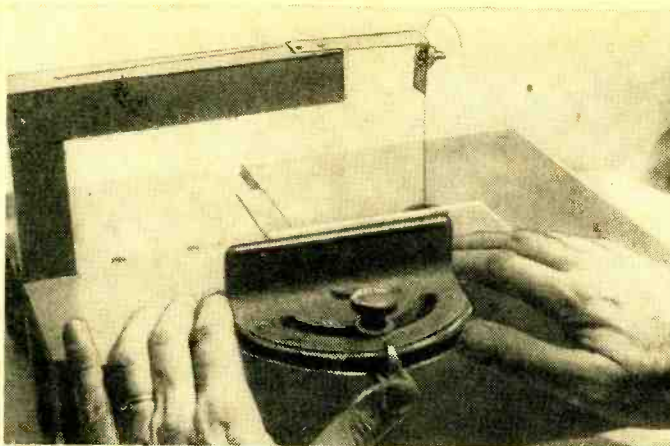
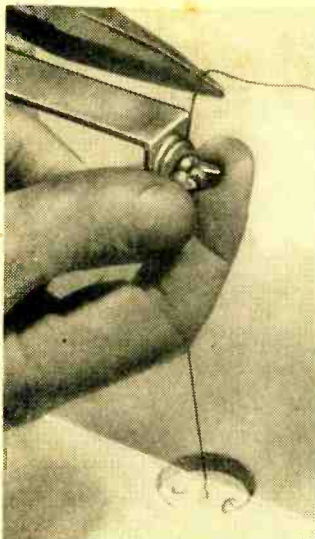

Tensioning and securing cutting wire (left); hole in aluminum disc should be so tiny that #28 Nichrome wire will barely clear it. Above, miter guide is used in angle-cutting a sheet of $\frac{1}{8}$ " polystyrene.

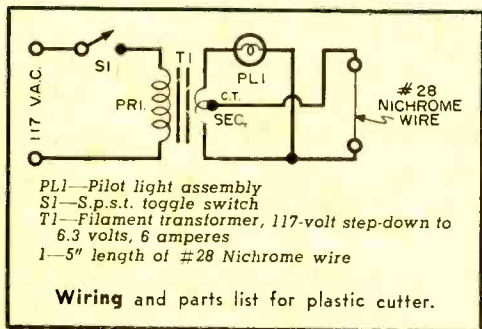

in the lower portion of the base concentrically with the one above.

After the base has been assembled, cut a square indentation in the center of the edge opposite the feedthrough holes. This will accept a $1\frac{1}{4}$ " x $1\frac{1}{4}$ " upright which forms the rising member of the support arm.

A mortised and glued joint between the crossarm and upright will repay the user in sturdiness. Before assembling the crossarm, cut a piece of 18-gauge aluminum $\frac{3}{4}$ " wide and $4\frac{3}{4}$ " long. Bend $1\frac{1}{4}$ " of the aluminum bar down at right angles, hold the crossbar in place with the aluminum strip on top of it, and sight straight down along the bent flat. The object is to position the aluminum strip so that its short flat is directly above the wire feedthrough hole. Drill the center of the short flat to clear an 8-32 machine screw before you screw the aluminum support to the crossarm.

Next, cut and glue the legs to the underside of the base at the corners, and secure the crossarm upright to the bottom of the base by means of a 3" steel angle.

As a last step in the mechanical construction, mount a front apron for the cut-

ter. Drill two $\frac{1}{2}$ " holes to take the switch and the pilot light assembly; then screw the apron to the front legs.

Wiring. Connect a 6.3-volt, 6-ampere filament transformer according to the diagram. Note that the pilot lamp is connected across the entire 6.3-volt secondary while only half of this winding supplies the current for heating the cutting wire.

The author found that a 4" length of #28 Nichrome wire provided the best cutting of thin polystyrene. This wire has a nominal resistance of a little over 4 ohms per foot, so that a 4" length draws about 4.5 amperes at 6 volts—well within the rating of the transformer. However, cut a 5" length of the wire, knot one end, and pass the other end upward through the feedthrough hole in the aluminum disc. Grasp the upper end of the wire with the tip of a pair of long-nose pliers, pass the wire around the bolt on the aluminum strip, and then tighten while holding the wire taut and the strip pulled down slightly. The strip will exert spring tension on the cutting wire and keep it from slackening.

Plug the line cord into a 117-volt a.c. outlet and turn the switch on. The Nichrome wire should become hot to the touch. The correct operating temperature is obtained when the wire is too hot to permit sustained finger contact but *not hot enough to show even a dull red glow*. If the temperature of the wire is too low, the cutting process will consume too much time; if it is too high, the cut sections will have an unsightly bead along the edges. Improper heating indicates incorrect wire size or dimensioning.

Using the Cutter. Plastic sheeting to be cut should always be scribed lightly

(Continued on page 115)

K I T

BUILDER'S KORNER

TIME WAS when the purchase of even a simple intercom represented a major investment. Today, anyone can enjoy its convenience for no more than the cost of a table model radio receiver. If you're willing to put in a few hours of pleasant work assembling your own system, it will be still less expensive.

The Knight Model Y-295 2-way home intercom kit represents a "real buy." Distributed exclusively by Allied Radio Corp., 100 N. Western Ave., Chicago 80, Ill., it

Actual assembly of the kit is handled as two independent projects. The master station is assembled first. Then the remote station is assembled as a separate operation. You'll find that the wiring has been simplified considerably. All hookup wires are supplied pre-cut to length and pre-stripped at both ends.

How much time you'll need to complete the kit will depend upon your skill and experience. If you've assembled kits before, (Continued on page 118)

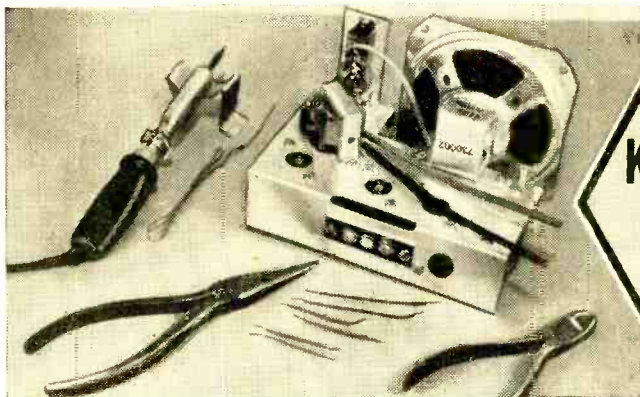

Knight Y-295 Kit Intercom

comes complete with all the electronic components needed to assemble a two-station system, including 50 feet of three-wire interconnecting cable—more than ample for most installations.

It assembles into two attractive metal cabinets measuring approximately 6½" x 5" x 4½" over-all. These two units serve as the "master" and the "remote" stations of the complete system. Both stations are equipped with "listen-talk" slide switches and a combination loudspeaker-microphone. The master unit also includes a combination "on-off" switch and volume control, and a small neon-type pilot lamp.

Putting It Together. The Model Y-295 kit is supplied with three separate items of instruction material: (1) a detailed instruction manual; (2) a large fold-out sheet of the major pictorial wiring diagrams; and (3) a letter-size sheet entitled "How to Read Color Code on Resistors and Condensers."

Pre-cut and pre-stripped hookup wire supplied with this kit speeds the wiring job. You'll find a Spin-tite socket wrench handy for mounting parts. Below, the "master" station is ready for operation.



AFTER CLASS

Special Information on Radio, TV,



Radar and Nucleonics

INTRODUCING THE FERRISTOR

THE GROWING "—istor" family, cornerstone of today's electronics, now boasts another tiny but sturdy member—the *ferristor*. Entirely different from the transistor in concept and construction, this virtually indestructible cube measures little more than one-half inch on a side and can replace the fragile, short-lived vacuum tube in many important and interesting applications.

As ferristors do not deteriorate with age or use, cannot be damaged by shock, vibration, or moisture, and do not generate much heat, they may be expected to perform reliably over a period well beyond the

normal life of other circuit components. Using ferristors and associated small parts, you can build "immortal" amplifiers, oscillators, free-running or one-shot multivibrators, current discriminators, and a whole variety of counter circuits.

Basically, a ferristor resembles a tiny transformer consisting of two windings of very fine wire on a common core, all encased in epoxy resin. The design of the transformer permits the core to saturate when the current in either winding (or both windings) becomes large enough. Thus, the ferristor is essentially a two-winding *saturable reactor*.

Saturable Reactance. Suppose we have a coil across which a radio-frequency voltage is applied (Fig. 1, right). The current that flows in resistor $R1$ is determined primarily by the size of the r.f. voltage, the resistance of $R1$, and the inductive reactance of coil $L1$. If the voltage is small and the core of the inductance unsaturated, the inductive reactance will be quite high and hence the current will be limited to a small but constant value.

Now assume that another separate current is gradually built up in a second coil wound on the same core as the first. This could be accomplished by slowly reducing the resistance of potentiometer $R2$, as shown in Fig. 1. For small values of current in $L2$, no noticeable effect will be observed on the other side of the transformer. As the current in $L2$ rises, the core will begin to saturate and the inductive reactance of $L1$ will diminish, causing the current from the r.f. voltage source through $R1$ to increase. Thus, this circuit makes it possible for a d.c. control current in $L2$ to influence the magnitude of the r.f. current in the secondary circuit.

Suppose we now substitute an audio (a.c.) current for the d.c. control current. As the amplitude of the audio wave goes through its variations, the core of the ferristor passes through various states of near-saturation, causing the inductive reactance of the secondary winding to vary in accordance with it. The variation of inductive reactance modulates the r.f. current in the secondary with the same wave-

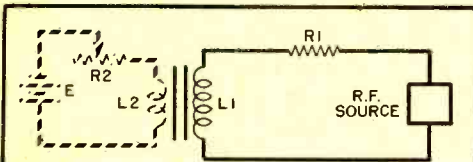

Fig. 1. How a control current governs the secondary current in a saturable reactor.

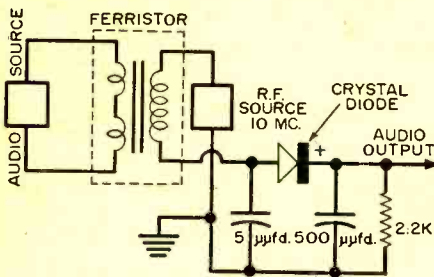

Fig. 2. A magnetic amplifier built around a ferristor. Amplification is achieved without use of either vacuum tubes or transistors.

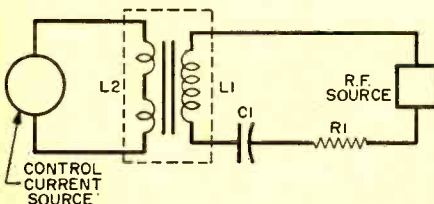
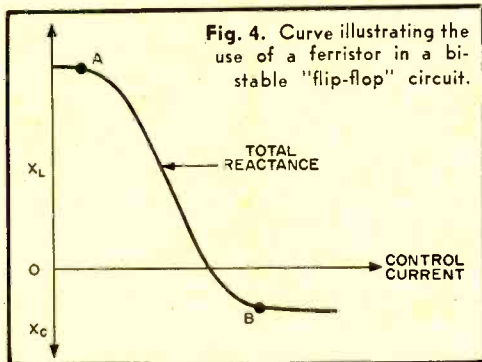

Fig. 3. Ferristor connected in circuit in such a way as to make use of ferro-resonance.

form except that the amplitude of the secondary modulation is much greater than the audio in the primary winding. This magnified effect results from the fact that the excursions of the fluctuating inductive reactance are more far-flung than the current variations in the primary coil.

When the modulated r.f. current in the secondary circuit is demodulated by a simple diode crystal and a pair of filter capacitors, the result is an amplified replica of the input signal or control current (Fig. 2). Amplification has thus been achieved without vacuum tubes or transistors.

Compare this circuit with that of a vacuum tube; they are roughly analogous. The audio current corresponds to the grid input voltage, the r.f. current to vacuum tube plate current, and the load resistance to the plate load of a tube. The r.f. supply



voltage replaces the normal B+ power supply voltage. Major differences are that the control factor is a current rather than a voltage and that the power supply voltage is r.f. rather than d.c.

Ferro-resonance. Ferristors may be put to use in another highly practical way by taking advantage of series resonance possibilities. When the inductive reactance of the r.f. winding equals the capacitive reactance of the circuit in which it is connected, the whole secondary system resonates. Under such circumstances, the resonant circuit passes so much current that the ferristor saturates and *latches-in* in this condition. This phenomenon is called *ferro-resonance*.

A ferro-resonant circuit has two stable states, i.e., two states in which it will remain indefinitely unless a suitable input signal is applied to cause a transition from one state to the other. In Fig. 3, *C1* has a value such that its capacitive reactance equals the inductive reactance of r.f. winding *L1* when the current flowing in this coil has brought the core nearly to the saturation point. You will recall that the

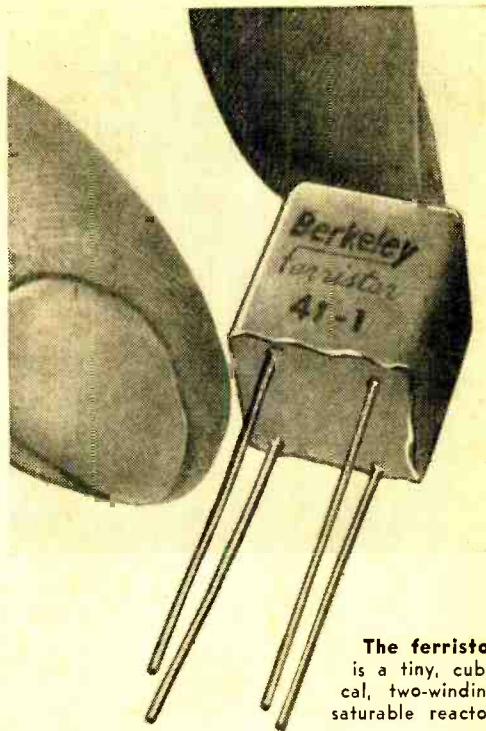

The ferristor is a tiny, cubical, two-winding saturable reactor.

inductive reactance of *any* coil diminishes as saturation is approached. At this point, the r.f. winding circuit becomes series resonant, and its total impedance drops so low that enough r.f. current flows to saturate the ferristor even in the absence of control current in *L2*. This is a stable state in which the ferristor persists as long as nothing is done to change it; the name "full-on" is often applied to such a condition.

The second stable state is obtained under conditions of *non-saturation*. Reference to Fig. 4 will help you to see how the ferristor may be triggered from one stable state to the other. When the r.f. voltage is first applied, the reactance of the circuit stabilizes at point A. We are assuming no current in the primary winding; also, the current in the r.f. winding has not yet driven the reactance down to the point where it will resonate with capacitor *C1* of Fig. 3. This is the "off" condition and is quite stable.

Now suppose that a surge of d.c. is sent through control winding *L2*. This current drives the core toward saturation, causing the reactance of the secondary winding to decrease. As the reactance approaches that of *C1*, series resonant conditions begin to prevail and the secondary impedance drops sharply to point B. Thus, the r.f. current rises to a peak value and stays there even

(Continued on page 118)

Sound



Impressions

THE TERM "talent scout" used to evoke the image of suave emissaries from Hollywood striking up conversations with pretty girls behind drug counters. Hi-fi has brought a new "talent scout" into the picture: the man with the tape recorder who travels about the world searching for new and exciting kinds of music to fill the insatiable ears of growing hordes of audio fans.

Latin Lass. On a jaunt to Brazil, Westminster's roving recordist spotted Clara Petraglia, a young math teacher who sings native folk songs as a hobby. Her voice and musical personality were so captivating that Westminster decided to feature her on a record called *Songs from Brazil* (WP 6030).

Whether your musical brow is high or low, you won't be able to resist these pleasantly exotic melodies with their subtle yet exciting rhythms. Most of all, you won't be able to resist Clara, who sounds as charming as she looks—simple and un-

affected, but with something in her voice that betrays a twinkle in her eye.

Yodel & Twang. At the other end of the world, Capitol's talent scouts were lugging their recorders up the Austrian Alps to bring back some fancy yodeling and zither playing. If you like zither playing and yodeling, this disc is your dish. *Music of the Austrian Alps* (Capitol T-10016) also features an odd, clanky, twangy, homemade instrument called a "hackbrett" (hacking board). It comes to you in flawless hi-fi, along with the clapping, stomping and shouting of the mountaineers, who apparently felt singularly inspired by their own efforts. Good fun for folk-music collectors.

A Touch of U.S.A. Here at home, an unusual event in folk music also became a matter of record. The Weavers held a songfest in Carnegie Hall. Any folk-singing group that can invade this long hair stronghold, fill it to the rafters and bring down the house, is bound to have something spe-

PICK OF THE RECORD RACK

RECORD	PERFORMERS	COMMENT
Richard Strauss: Don Juan, Till Eulenspiegel's Merry Pranks, "Rosenkavalier" Waltzes, "Feuersnot" Love Scene Columbia ML 5177	Philadelphia Orchestra Eugene Ormandy, conductor	What a collection! Eulenspiegel's rollicking ribaldry and mock drama paired with the passions of Don Juan and Rosenkavalier's bittersweet waltzes! Ormandy and his orchestra are just right for this lush music. Their rich cascades of sound are well gathered in Columbia's grooves. Fine for show-off—or for just listening.
Piston: The Incredible Flutist Ibert: Divertissement Rossini-Respighi: La Boutique Fantasque RCA Victor LM-2084	Boston Pops Orchestra Arthur Fiedler, conductor	There is a rampant notion that good music must be properly solemn. No wonder that composers, who also like a good laugh occasionally, get very bored with such pretentious nonsense. The three items on this disc all prove that spoof can be fine music, too. Particularly, Piston's <i>Incredible Flutist</i> has the contagious good humor of slapstick comedy. There are even barking dogs in the score. Victor engineers, apparently feeling a family relationship to their famed "Nipper," gave their own kind of top fidelity to man's best friend.
Music for Brass Columbia CL-941	Brass Group of the Jazz and Classical Music Society, Mitropoulos, conductor	With Benny Goodman sneaking over to the longhairs and Maestro Mitropoulos presiding over a jam session, the barriers between jazz and "classical" music are fast wiped out. Fascinating experimentation in sheer sound in <i>Music for Brass</i> points new ways to the use of these instruments. The recording does full justice to every snarl and sonority in these pioneering works. And to hear Benny Goodman play Mozart with the same technical mastery and innate sense of style that made him "King of Swing" is a pleasure indeed.
Mozart: Concerto for Clarinet Clarinet Quintet RCA Victor LM-2073	Benny Goodman, clarinet Boston Symphony Orchestra C. Munch, conductor	
Bartok: Concerto for Orchestra London LL-1632	L'Orchestre de la Suisse Romande E. Ansermet, conductor	True to its title, this work was expressly designed to show off the many facets of modern orchestral sound. The massed group of players is constantly broken up into all sorts of solo work—vying and contrasting with each other. Hi-fi evidently profits by their gambols, for this is an exceptionally colorful, clean-sounding disc. Far beyond being a mere showpiece, it is an enduring work, written in America by one of the great masters of modern music.

cial. Whatever this "something special" is, it has been neatly wrapped up in an on-the-spot recording by Vanguard (VRS 9010) entitled *The Weavers at Carnegie Hall*.

This disc simply bristles with rollicking high spirits, spontaneous laughter, hi-fi banjo picking, and some of the liveliest singing we've ever heard. Most of the songs are American—with just a few exotic items thrown in for contrast. Old Weaver favorites like *Darlin' Corey*, *Wimoweh*, *Good Night*, *Irene*, and the lilting *Kisses Are Sweeter Than Wine* make a welcome re-appearance after being unavailable for so long.

Recorded at the actual performance, this disc catches the excitement of the occasion—audience and artists responding to each other in cheerful give-and-take.

Orchestral Splendor. Folk music also has served as a stimulus to Bela Bartok, one of the truly daring pioneers of modern music. In his *Hungarian Sketches* and *Roumanian Folk Dances*, he has clothed the tunes of his native region with brilliant and colorful orchestral raiment. No matter what your musical taste, these catchy little dances, alternating with hauntingly lyrical pieces, will delight you at first hearing—and stay favorites for years. The other side of the disc offers Kodaly's *Hary Janos Suite*, the braggart tales of a boastful but likable old soldier, merrily told in tuneful melody with tantalizing orchestration.

There isn't a dull moment in these scores—nor in their performance. Antal Dorati, conducting the Minneapolis Orchestra, evidently feels the music deep in his bones and knows how to get it under your skin, too. The stunning rendition evidently inspired Mercury's engineers to do their very best. So run—do not walk—to your record store and get yourself this triple treat of music, performance and engineering matched to perfection on Mercury MG 50132.

Three Ways with Waltzes. *Hi-Fi Hi-Jinks with Strauss*, a new Vanguard demonstration disc (SRV-104), keeps up the cheerful mood of this month's record batch with a spate of polkas and waltzes by Strauss, played in lilting Viennese style by the Vienna State Opera Orchestra under Anton Paulik. Aside from a lot of fine, easy-listening music, hard-bitten hi-fi'ers will literally get a "bang" from an anvil-and-hammer clanking along with the *Feuerfest* polka for rhythmic accent. And speaking of percussion, you just can't beat the special \$1.98 price of this first-rate disc.

Favorite Strauss standbys (*Blue Danube*,



Clara Petraglia, a Brazilian schoolteacher, was discovered by talent scouts of Westminster Records to be an extraordinary folk singer.

Tales from the Vienna Woods, and the popular overtures to *Fledermaus* and *Gypsy Baron*, etc.) also come to us in a Mercury package (MG 50124) called *Viennese Night at the Proms*.

The Halle Orchestra of Manchester conducted by Sir John Barbirolli makes up in freshness, zest, and neatly turned detail what it lacks in easy-going *gemütlichkeit*. But "putting the English" on Strauss is not necessarily a fault. Anyone who likes the music might try it with this new twist—especially since the "fi" is fabulous. But if you want your Strauss more mellow—with a touch of nostalgia woven into the bright

(Continued on page 110)

LEXICON OF THE HI-FI BUILDER

By *rodrigues*



"Input Impedance"

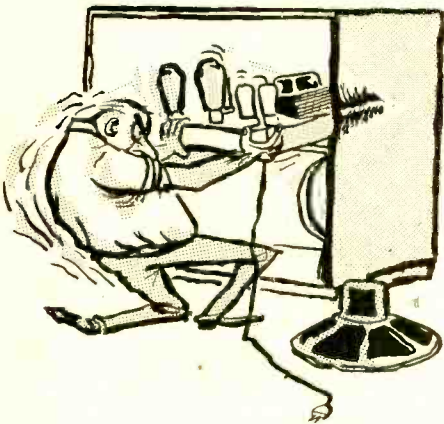

"Push-Pull Circuit"



"Stylus Pressure"

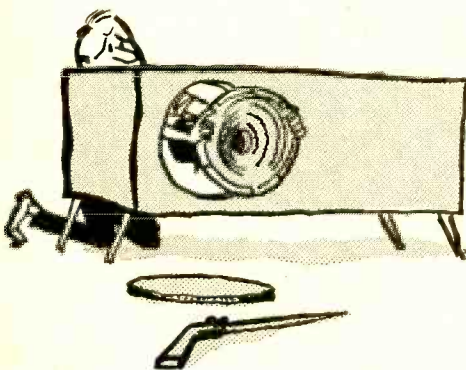

"High-Compliance System"



"Wow"

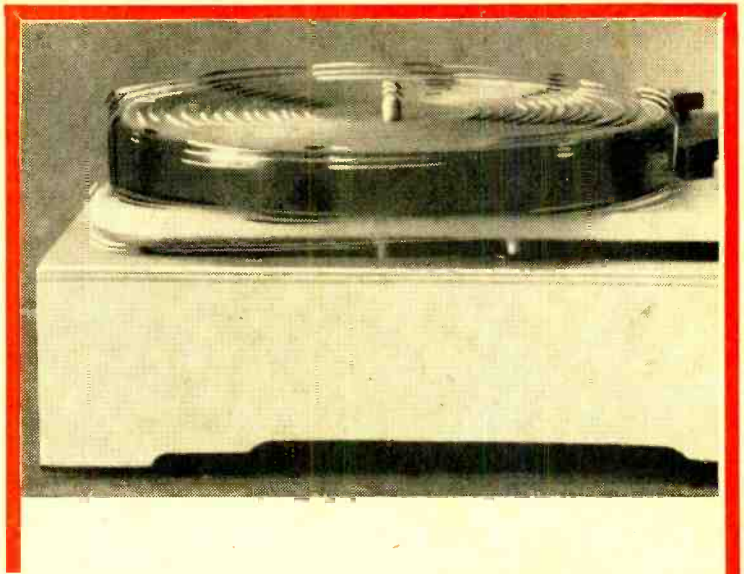

SHAKEPROOF

Your Hi-Fi Turntable

By ROBERT SAMPSON

Miniature earthquakes can wreck your music—here's how to calm them down

DO YOU have to tiptoe across the room when your phonograph is going to keep from bouncing the pickup? Does your rig spit out the music in broken bits, like a fast and furious

stutter, every time you move a muscle? Does the bouncing pickup dig bomb craters into your discs while emitting grim noises of battle?

Such things can happen on even the finest equipment unless your turntable is properly mounted. Here's how you can fix those shivers in two shakes.

To understand why control of vibration is so important in a turntable, think of your whole sound system simply as a vibration detector. If the surface of the turntable shakes with the stylus in the groove, the tip of the stylus shakes with it. Whenever the stylus tip moves at a frequency within the passband of the system, whether the motion comes from outside vibration or from the music in the record groove, an electrical pulse is sent into the amplifier that finally emerges from the speaker as sound.

"Earthquake" Spotter. A tiny shake can produce a mighty big noise. The tip of

your stylus has to be a fantastically sensitive vibration detector—like the instruments used for detecting distant earthquakes. After all, the system must produce the whole range from *pianissimo* to *fortissimo* from twists in the groove that measure only thousandths—even millionths—of an inch. This is fine as long as all the vibration comes from the groove of the record. Yet if the turntable itself shakes back and forth as little as a hundred-thousandth of an inch, you may get a noise out of your speaker that completely bedevils the music and frazzles your temper.

In most cheap phonographs, vibration of larger dimensions than this is common, as a result of haphazardly made rotating parts. The rough running

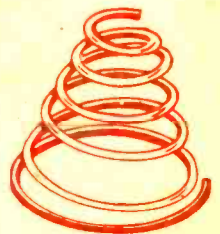

principally accounts for the well-known "rumble" where the music is always accompanied by what sounds like a passing truck or subway train. The only remedy other than a makeshift "rumble filter" is to trade your jerry-built turntable for a precision-made job.

In the finer turntable motors built for high fidelity, this internally produced vibration has been brought down to the extremely low levels required for high-quality disc reproduction. But even the best turntable assembly is vulnerable to vibration reaching it from "outside," from the floor of your room and through the cabinet, if it is not properly installed. This article tells how to avoid such room-size "earthquakes" from jiggling your pickup.

Trouble Below Bottom. Besides audible noise, there are several other ways that the

mangled by the inaudible overload. The amplifier just can't handle the music, being too busy with the sub-audible noise.

The best test for such "sub-bassment" ruckus is to touch the speaker cone very lightly with the tips of your fingers while a record is playing. If the cone keeps fluttering heavily like a flag in a high breeze, even when there are pauses in the music, you have a case of low-frequency shakes.

Another vibration difficulty is the one mentioned before: the pickup bouncing out of the groove. The latest pickups, with stylus pressures as low as 1 to 3 grams, rest on the record as lightly as a feather. This is dandy for low record wear and high fidelity, but it does mean that the pickup is easily jarred out of the groove by a heavy foot on the floor, a bus on the street outside, or dancing in the room. Shakeproof

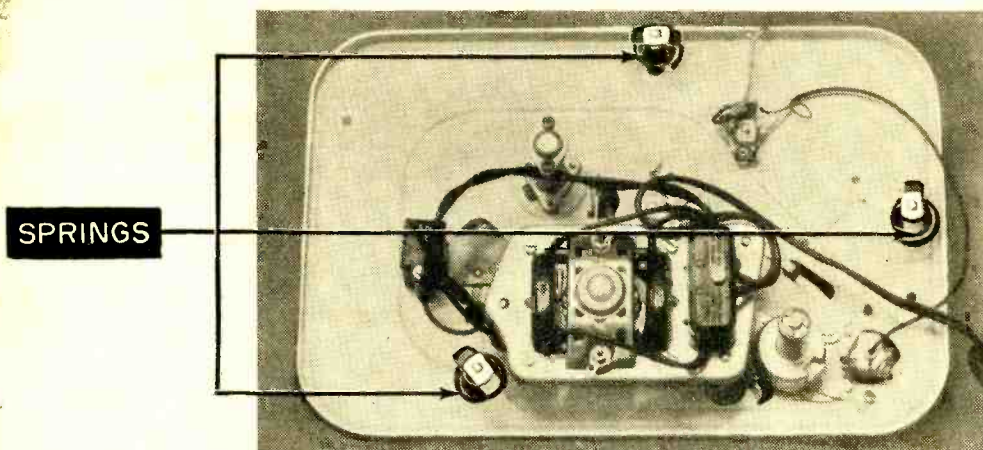

external shakes can knock the spots out of fidelity. Suppose the vibration of the turntable surface is at a frequency so low that you can't even hear it, say a bit below 20 cycles per second. Modern pickups and amplifiers, reaching further and further downward, are sensitive to such sub-bass frequencies as far down as 10 cycles per second—far below the hearing range of the human ear.

Now it happens that when a turntable shakes at a very low frequency, nine times out of ten it is a very hefty shake. Hence we get a tremendous electrical current pouring out of the pickup. By the time this surge reaches the output stage of the amplifier, it has been blown up into a sort of electric avalanche shoving the output tubes right into the distortion region. Then it tries to tear the speaker apart.

But you still can't hear it! The sound is below the frequency range of the ear. Yet the music playing at the same time will be

installation will also remedy this trouble.

Built-In Banshee. The last vibration difficulty we want to talk about is a real horror, if you happen to have it—acoustic feedback. Sound from the speaker, traveling through the air or through the floor of the room, shakes the turntable. This sends a new signal through the amplifier, which emerges from the speaker, shakes the table some more, goes through the amplifier, the speaker, back to table shaking, et cetera ad infinitum, like a dog chasing its tail.

With plenty of power being supplied by the amplifier, this high-gain audio tail-chasing can build up into a steady roar or scream that may well damage your amplifier or speaker. Or the feedback may occur only on loud notes of a certain frequency, which means that those notes will turn into banshee howls.

Acoustic feedback is most likely to occur when the speaker and turntable are mounted close together in the same cabi-



Many turntables come with springs already attached. The new Garrard Model T Mark II shown in these photos has three mounting springs (see view on facing page) which are forced through holes in the wooden base. A leaf spring prevents turntable from falling away from base after this is done. Correct spring position appears below; incorrect placing of spring is pictured at left.

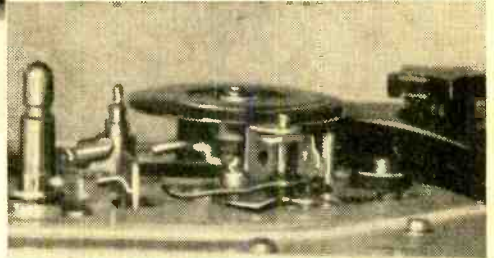

net, so the wood panels of the cabinet can transmit strong vibration directly from speaker to table.

One way to eliminate acoustic feedback is to set the turntable far apart from the loudspeaker. However, shakeproof mounting makes it possible to bring speaker and turntable closer together without drastic mishaps.

Routing the Rumble. Shakeproofing forestalls all the various troubles recounted here. Just follow three main principles.

(1) The first principle of proper installation is a very rigid connection between pickup and turntable. What we are trying to avoid is relative motion between pickup and table surface. So use a heavy motorboard, at least $\frac{3}{4}$ " plywood or the equivalent, with both pickup arm and turntable assembly tightly fastened to it. We are not talking here, of course, about the motor, but about the table itself. In the better assemblies, the motor is isolated by separate springs.

This principle has already been observed in some of the top-quality turntable assemblies now on the market. The turntable and pickup are on one rigid unit.

(2) The second principle is the isolation of the whole motorboard from the cabinet, and thus from the room. Put the whole assembly on spring supports, preferably rather soft steel springs. Rubber can be used, but it is usually hard to get a rubber mounting that does not collapse too far under the weight and at the same time is "soft" enough.

(3) This brings us to the third and most important principle of all. When you put a motorboard on springs, you have a system that can vibrate on its own. It has mass (the weight of the whole assembly) and compliance (the "give" of the springs).

Thus it has a resonant frequency, at which the whole motorboard will tend to bounce up and down on the springs with only a small push from outside vibration.

Slow Bounce Okay. The real trick for success in the installation is to get this resonant frequency, or "period," below 8 cycles per second, and the lower the better. This makes the whole unit highly resistant to external vibration at other frequencies. The bottom ends of the springs may shake, but the vibration doesn't reach the top. The motorboard just "sits there."

How do we determine the period of the motorboard and springs? Push down on one corner, depressing one of the springs, and then let go suddenly. If you can easily count the ups and downs as the board bounces, the period is very low, no more than a few times per second. If the board takes off in a fast vibration, you are in trouble.

To lower the period, you can add weight to the motorboard, or make the springs "softer," or both. The quickest way, if the springs will carry the additional weight, is simply to fasten a chunk of lead to the underside of the board. Remember that you will need a weight not too much smaller

(Continued on page 112)

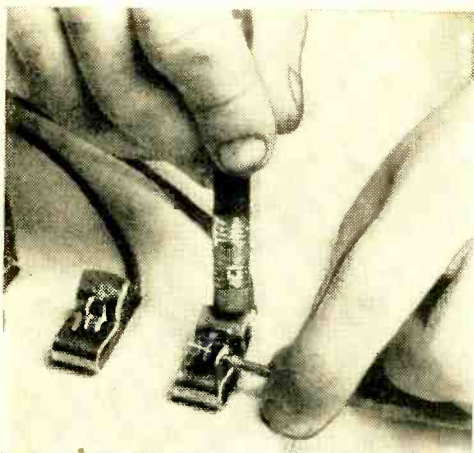

Keep a Pencil Eraser Handy

Our children and wives rightly complain that the tips of their fingers get sore from pressing on Fahnestock clips. In such cases, I always recommend that the clips be pressed with a pencil eraser as shown in photo above.

—Art Trauffer

Eye Brush/Needle Brush

You can salvage an eye make-up brush from milady's toilet accessories and cut it down to make a hi-fi needle brush. I cemented mine to a 45-rpm spindle adapter ring, then cemented the ring to the turntable. Carefully position brush so that it sweeps the needle but doesn't interfere with its travel.

—Andrew D. Setlow

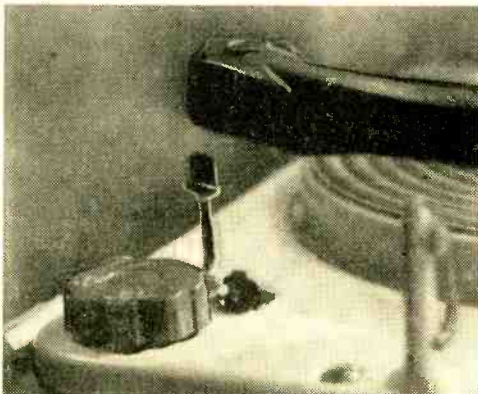

Shielded Radio Lead-In Reduces Noise

Radio receivers in apartment houses work better with outdoor antennas. Signal strength available inside an apartment is reduced by the shielding effect of the steel building frame. The noise level is frequently high, due to the unshielded lead-in picking up interference from fluorescent lights, household appliances, elevators, etc. This noise can be reduced by shielding the lead-in within the room.

Microphone cable or television coaxial lead-in cable makes a good shielded radio

lead-in. It is very important that the shield not touch any grounded objects such as steel window frames, radiators, water pipes, etc. If this happens with an a.c./d.c. set, the result may be burnt-out fuses, volume control switch, or even tubes. The reason is that one side of the power line is grounded by the utility company, and one side of the power cord is grounded to the chassis by the manufacturer. If the plug is inserted in the wall socket the "wrong" way, an accidentally grounded chassis forms a direct short across the power line, as shown in the diagram below.

For maximum effect, the shield must be connected to earth ground. In an a.c. set, this can be done by grounding the chassis to either a water pipe or a radiator. With an a.c./d.c. set, it is evident from the above that the only permissible ground for the chassis is that provided by the power line. The power cord plug must therefore always be inserted in the wall socket the right way.

—Eugene F. Coriell

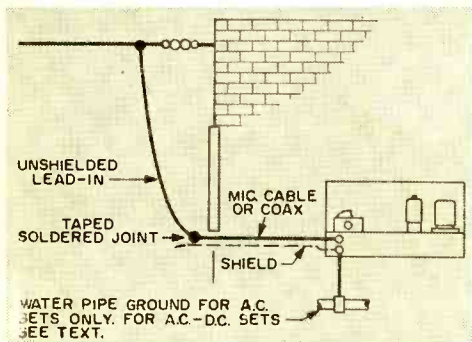

lead-in. The inner conductor is soldered to the outdoor lead-in at one end and connected to the receiver antenna post at the other end. The shield should be connected to the chassis and the outer end taped up to prevent contact with the building. (See drawing above for details.)

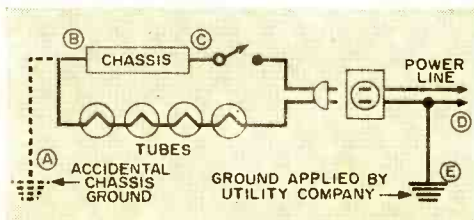

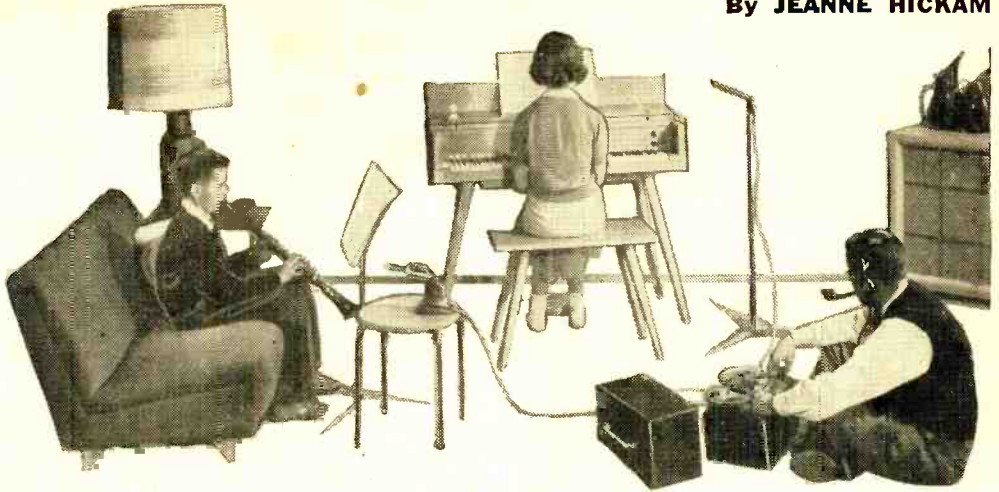

Photo courtesy Electro-Voice, Inc.

How to make GOOD Tape Recordings

RECORDING ON TAPE is more than a matter of pushing buttons if you want to have tapes that are as "high-fidelity" as your equipment can make them. Tapes should be a source of pride and enjoyment. It is sheer waste to spend hundreds of dollars on equipment, then mis-use it and get "dime-store" results.

Well, what's to be done? We assume that you have gone through the instruction manual which came with the recorder, and have acquainted yourself thoroughly with all of the controls. Does this sound too elementary? You'd be surprised at the number of people who just don't bother to do it. Take the time to orientate yourself fully in the workings of your recorder. It will be worth your while.

The best way to defeat the gremlins that

**The professionals have
no hidden secrets—your
tapes can be just as good**

bedevil recordists—and have fun doing so—is to make a *sample recording*, as outlined below. This recording will not only serve as a training session for you, but will show up many of your machine's defects which can be eliminated by adjustment.

What Tape To Use. Buy first-quality plastic-backed tape even for your very first recordings. You can always erase and re-use the tape, so why take chances? Using old paper-backed tape "until you get the hang of things" is a waste; you won't know what to blame if the recording turns out poorly.

Setting Up To Record. Always place your tape recorder on a level, firm surface to prevent mechanical vibrations from influencing the quality of the recording. Leave air space around the recorder's ventilation port (generally on the bottom of the recorder) so that it will not overheat. As thick rugs, blankets, foam rubber sofas, etc., will frequently block this port, be prepared to place "props" of some sort under the legs or feet of the recorder. This will lift it an inch or so to enable air to enter the port.

The microphone should be supported

RECORDING HINTS

Re-wind tape before using to "limber up" a new reel and prevent sticking.

Never re-wind past the tape heads.

Check tape feed reel to see that it is tightly packed.

Check program source to be recorded to determine whether it needs "tone correction."

Use a microphone stand, either floor or desk type, for added stability.

Make sure tape heads are clean, and properly oriented with respect to the tape.

"Ride the gain" as needed to maintain desired level during recording.

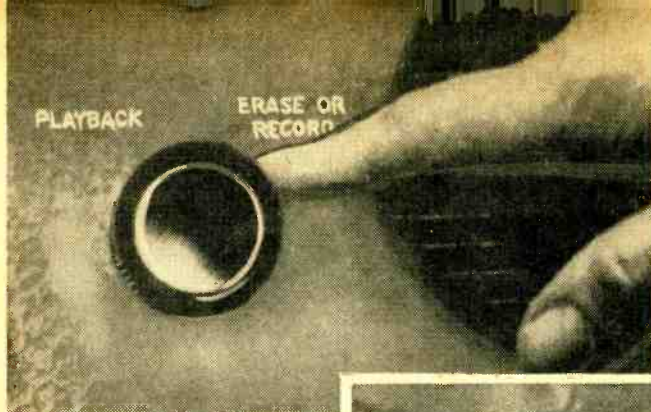

Proper setting of all operating controls is of prime importance. In addition to the "Playback-Record" switch, many recorders have controls for adjusting speed, as well as equalization for a particular speed. These items may seem obvious, but can ruin your recording if neglected.

Part of the head cover has been removed at right to show how the pressure pads hold the tape in contact with the recording head during operation. Worn pads, or springs on which they are mounted, will not hold tape in correct contact with head, resulting in low, or spotty volume.

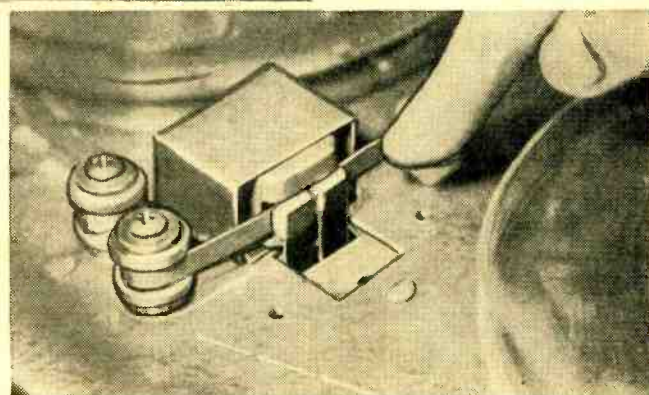

firmly. A mike stand is best. If one is not available, set the mike on a table. Hold it in your hand *only as a last resort*.

When recording from your radio, tuner, TV, or phonograph, pick up your sound from the volume control of this other source, or use a jack at the output of your hi-fi amplifier.* Less desirable, but workable, is to connect the recorder input to the speaker terminals of the other set. The poorest method is to record from the air with a mike placed in front of the loudspeaker; do *not* expect good results from this method.

Make sure of your connections and turn on the recorder. Allow sufficient time for warm-up. Check the tape threading. Almost all recorders use tape which is wound by the manufacturer with the oxide *in* (toward the hub of the reel). Most tape reels are already wound that way. In any case, the coated (dull) side of the tape must face the recording head. If necessary, rewind the tape.

Choose Right Tape Speed. Generally, the greater the tape speed, the better the fidelity. The highest speed on most home recorders is 7½ ips (inches per second), and—unless yours offers one higher—this is the logical choice for taping music. If the selection you wish to record is more than 30 minutes long (the playing time of a standard 7" reel of tape at 7½ ips), use

one of the extended-play tapes (such as "Irish" long play, "Scotch" extra-play, etc.) rather than resorting to a lower speed and less fidelity to "make it fit on the reel."

A speed of 3¼ ips will give satisfactory results with most spoken material you wish to preserve. And 1⅞ ips may be used for office dictation, records of business meetings, and the like; it will preserve the *words*, but will not faithfully reproduce individual *voices* because of its narrow frequency range.

Trial Run. Make a sample recording of the type of material to be taped. If "live," have your subject practice using the microphone. If off the air or from a phonograph, set the volume control on the program source to the level to be used at recording time. Perhaps your recorder has an equalizer control which must be set manually when the tape speed is changed—be sure that this adjustment has been made.

During the trial run, set the volume control on the recorder so that the volume indicator, in conformance with the instruction book, shows that the machine is neither overloaded nor under-amplified. Try to record your program material "flat." You can adjust the treble-bass balance to your taste during playback.

Sometimes, you might want to "gimmick" frequency response during recording, as, for instance, in certain popular music with heavy bass underlining, which might benefit by the addition of a bit of accent on the treble side. Experiment with both

* Detailed instructions on these hookups were published in *POPULAR ELECTRONICS*, March, April, and May, 1956, and are reprinted in the 1957 edition of the *Hi-Fi Guide and Yearbook*.



Arrows show path of tape from feed to take-up reels during recording. Note that on this particular machine an alternate path is required for rewind of tape. Each roller and its pad, around which tape passes, must be in good working condition for best results.

flat and adjusted settings in a test before doing this on a recording you want to preserve.

During the Test. If either the take-up or supply reel squeaks or rumbles, check to be sure it is firmly mounted on its spindle. Look also for warping, which will cause the reel to brush against the recorder. If the tape feeds unevenly, check the threading of the recorder again; improper splices in used or second-grade tape can also cause this trouble.

Some electrical appliances may cause fluctuations in the 117-volt a.c. line when they automatically turn on or off. If you can't disconnect the appliance, note where the deviation occurred in the recorded material, and remember that there will be a slight wow at that point during playback.

Irregularities in the winding of tape on the supply reel may cause variations. If this seems to be your trouble, try running the tape through your recorder at the fast forward or rewind speed (not past the recording head, please!) and then see how it behaves. Many recordists make this standard practice, maintaining that the tape feeds better when it is "limbered up."

If one reel fails to turn evenly, check your instruction book again. On many recorders, definite manual controls must be positively engaged. New recorders should be returned to the company from which they were obtained for adjustment if still under guarantee. If not, and if your recorder has a neoprene drive belt, look for slippage in this area. Do-it-yourself'ers can

replace such belts in most instances, but don't try to hurry the job. And *don't oil a recorder* unless you are sure you're doing exactly what the manufacturer recommends. One drop of oil in the wrong place can easily cause a drive belt to slip.

Checking Results. Stop recording and rewind your tape (not past the recording head, as this serves no useful purpose and merely dirties the head). Now, play it back.

Listen carefully for wow or flutter not caused by visible variation in the tape transport. Be sure that this is in the recording and not in the playback, where splices or voltage variations can produce the same ill effects. Play the test tape over a couple of times if in doubt.

Next, play the test back again at both lower and higher volumes than you anticipate using normally. Listen carefully for distortion caused by overloading the tape (recording with too much volume) or by over-amplification of the bass. Occasionally a volume indicator is not completely accurate; often a novice, or someone unaccustomed to a different type of indicator, will set the volume control incorrectly. If the over-all volume is too loud or too soft, try another test with an altered setting.

If your trouble is still lack of volume, look for the following causes: (1) defective idlers and springs that hold them; (2) weak tube or tubes—have them tested; (3) incorrect threading—the oxide (dull) side of the tape must contact the recording head(s); (4) dirty recording head(s)—clean with a Q-tip or pipe cleaner, moist-

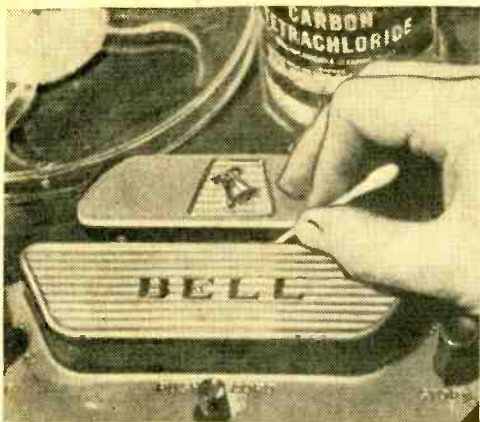

Clean heads regularly with cotton "Q-tip" or pipe cleaner dipped in carbon tetrachloride. Note that better grade tapes deposit less dirt on heads.

ened very slightly in *carbon tet* if absolutely necessary. Dry the head after using carbon tet, and allow another few minutes' time for further drying before rethreading. Run a second test, if necessary (or if you want to experiment with a different speed, volume, or treble-bass adjustment).

Now, Record. Trial run over, you are ready to make your first semi-professional recording. A little advance planning at this point will pay off in better results. Here are a few suggestions.

1. A series of spoken selections deserves an introduction on the tape itself, as does a taped version of a favorite radio program. Why not put this on the tape be-

fore making the recording, rather than splicing it on later?

2. When recording a series of musical selections (other than classics or opera), you will find that the finished results make more pleasant listening if you use the volume control during actual recording to "bring up" the music at the start of each selection and "fade out" at the end of it; this prevents a jar to the listener's nerves when the music starts suddenly after an interval of silence.

3. Some recorders leave an audible click on the tape when turned off. In recording a series of selections, you can eliminate this annoyance by pulling about an inch of tape back to the supply side manually each time you must stop the recorder. When you start recording again, the click will be erased.

4. Remember that the ear and brain are selective; we hear only what we wish among a number of simultaneous sounds. The microphone has no such ability—if an automobile horn sounds outside your open window, or if you strike a match or pour a glass of water during a recording, you will hear the sound reproduced during playback. Use your mike where it is as quiet as possible, and do all you can to prevent extraneous noise.

All this may seem like a lot of bother, but after you do it a few times, it will become as simple and automatic as the preparation you go through to take good photographs. And the results—in terms of GOOD home tapes—are well worth the effort.

—50—

BIZMAC at Bat—"Brain" Predicts 1957 Averages

Early in March, when the Army Ordnance Command's BIZMAC computer was demonstrated publicly for the first time, the operators used it to predict batting av-

erages for the 1957 season. Twelve of the leading major league baseball players were "analyzed" by the computer, which based its predictions on the players' averages for the past five years.

Leading the field was Mickey Mantle (.342); followed by Richie Ashburn (.328), Ted Williams (.322), Harvey Kuehn (.319), Minnie Minoso (.317), Carl Furillo (.314), Ray Boone (.313), Nellie Fox (.309), Stan Musial (.305), Ted Kluszewski (.304), Duke Snider (.302) and Yogi Berra (.297). This is a reminder—just to show that computers can be wrong.

In the photo at left is a portion of the BIZMAC control. The "real" use of the computer is to keep track of U. S. Army truck and tank supplies scattered over the world.



Reel Tricks for Tape Recordists

SOME OF THE FUN of tape recording lies in the little things which are by-products of your main hobby and which can add to the enjoyment of recording at home. One of these is making your own album to store recorded tapes. Another is to devise an "endless" tape recording—useful for repeating messages at regular intervals. The photos and captions on this page and the next tell you how to do both quickly and inexpensively.

—Ron Anderson

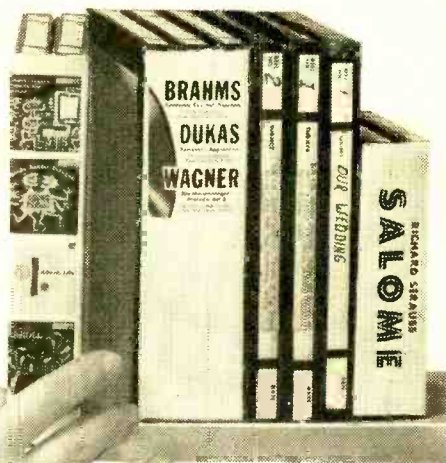

Homemade Tape Album

The first step in making a tape album is to glue two tape cartons front-to-back. Recommended method is to spread rubber cement on both surfaces to be bonded. Wait until they are almost dry, or "tacky"; then place them together firmly and hold tightly for about 30 seconds. Any number of empty tape cartons can be attached to each other in this manner.



Next, add a binding hinge. This piece helps keep the cartons together, and permits them to be turned so that they lie flat, exactly like sections of a record album. Suggested material for hinge is colored plastic, available in rolled strips. This material has high adhesion, is strong, and looks very "professional." (See page 96 for final step.)

Final step in making tape album is to add an appropriate label (right). This may be hand-lettered, cut from a magazine advertisement, etc. A similar label across the binding hinge will help identify selection when album is placed on shelf next to its mates. You can color-code albums, according to type of program material, by using different colors of plastic tape for binding and labels.

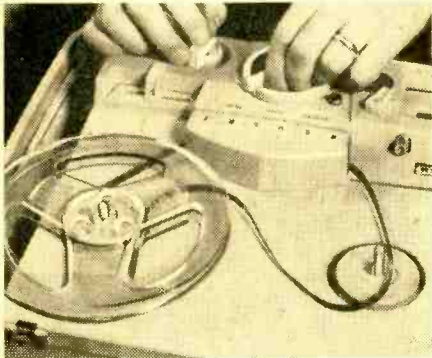

Messages of moderately long duration are put on continuous tape as shown below. Run tape over edge of table and hang empty reel on it. This provides enough weight to keep tape running smoothly. Be sure that tape does not pull away from recording head during the process or you'll lose some signal strength.

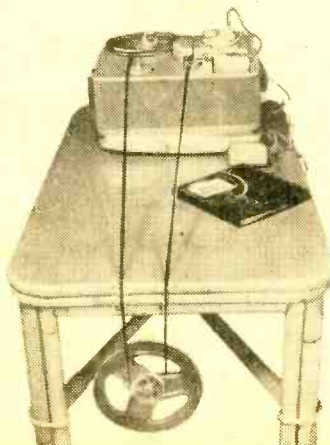

Endless Tape Recording

A continuous loop of recorded tape can be made in many sizes to suit different purposes. If the message you want to repeat is to be short, you can run the tape around one of the reels, or possibly around both, as shown in the photo at left. All you need do in this case is to splice the ends of a segment of tape of the desired length. A method for making a longer continuous tape is illustrated below, left. Still another method—and one that provides much longer messages because more tape can be used—is to let the tape spin off into a plastic bag fastened to your recorder. Just let the tape pile up hodgepodge in the bag and it won't snarl or tangle. This method is a bit tricky, but works well if you are careful. The tape must drop freely into the bag by force of gravity only. For best results, the bag should be located near the take-up reel position.

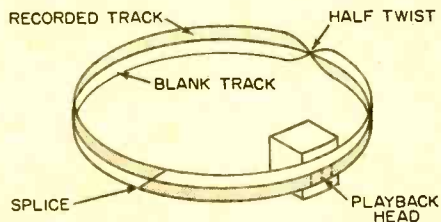

To repeat message, with silent period interspersed, use method shown above. Before splicing the two ends of your tape segment, put a half twist in it. When the tape plays, the message will be heard the first time around. When the splice passes the head, the tape will be turned around and the blank area will pass the head. Incidentally, this type of loop is known as a "Mobius strip" and is a mathematical oddity because it has, effectively, two surfaces bounded by a single curve.

Transistor Topics

By LOU GARNER

DID YOU KNOW that *you*—the transistor experimenter and gadgeteer—represent a sizable market for transistors? You do, and many transistor manufacturers, recognizing the importance of this market, have published practical “circuit manuals” which feature projects using their transistors. Here’s a quick run-down.

CBS-Hytron (Semiconductor Operations, Lowell, Mass.) has a four-page booklet available featuring circuits for its low-cost power transistors. “Bulletin PA-16” is free on request.

General Electric Company (Electronics Park, Syracuse 1, N. Y.) has published a 64-page manual featuring circuits, theory, outlines, and a chart of RETMA types. This “Transistor Manual” sells for 50 cents.

Radio Corp. of America (Semiconductor Div., Somerville, N. J.) has a new booklet on transistors and diodes (24 pages). Including 20 practical circuits, sections on

characteristics and theory, and interchangeability directory, it sells for 25 cents.

Raytheon Manufacturing Company (Newton 58, Mass.) has two booklets available. Both sell for 50 cents each. “Transistor Applications” is one of the first booklets issued by a transistor manufacturer and covers more than 50 circuits, many of which are article reprints. “Transistor Applications, Volume II,” is a brand-new booklet containing practical circuits plus valuable information on circuit design, installation and wiring hints, with data on related subjects—including a section on printed circuitry.

Sylvania Electric Products Inc. (100 Sylvan Rd., Woburn, Mass.) has published two small booklets selling for 25 cents each. Their titles are “28 Uses for Junction

Transistors” and “How to Make a Transistorized Portable Radio and 20 Other Applications for R-F Transistors.”

Readers’ Circuits. This month we are featuring two more of those ever-popular, simple broadcast-band receiver circuits. Each requires but a single transistor, plus relatively few additional parts. Both of them are intended primarily for the reception of local stations.

Featuring a unique *variable selectivity control*, the circuit shown in Fig. 1(A) was submitted by Richard Taylor, of 308 Stratford Rd., Brooklyn 18, N. Y. *C1* is a standard 365- μ fd. variable capacitor and *L1* a

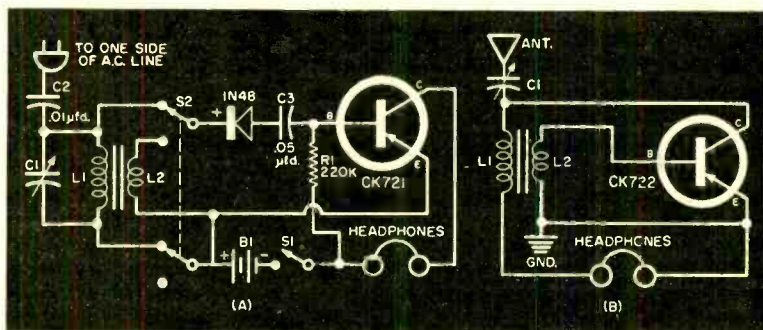

Fig. 1. Two simple receiver circuits submitted by our readers: (A) Richard Taylor’s variable selectivity receiver and (B) Mike Swink’s self-powered radio.

broadcast-band Feri-Loopstick. Step-down coil *L2* may be added to *L1* by scramble-winding about 15-20 turns of #28 enameled wire on top of this coil. *C2* and *C3* are disc ceramic or tubular paper capacitors. Selectivity switch *S2* is a d.p.d.t. slide switch (note that one terminal is left free), and *S1* is a s.p.s.t. switch used as a power switch. Power is supplied by a three-volt battery, *B1*; this may be made up by connecting two penlite cells in series.

Wiring is simple, straightforward and non-critical. You should have no trouble duplicating the project in a single evening. Note that *no ground is used with this receiver*. Instead, the a.c. power line serves as an antenna and is connected to the receiver through capacitor *C2*.

In operation, r.f. signals picked up by

the power line antenna are coupled through $C2$ to tuned circuit $L1-C1$, where the desired station is selected. With $S2$ in the position shown, this signal is transferred to the 1N48 diode detector and through $C3$ to the CK721 transistor, which amplifies the detected audio signal.

When the selectivity switch is thrown, $L1$ and $L2$ serve as a step-down r.f. transformer, matching the high impedance of the $L1-C1$ tuned circuit to the low input impedance of the detector-amplifier and thus minimizing loading on the tuned circuit. This reduces the over-all signal

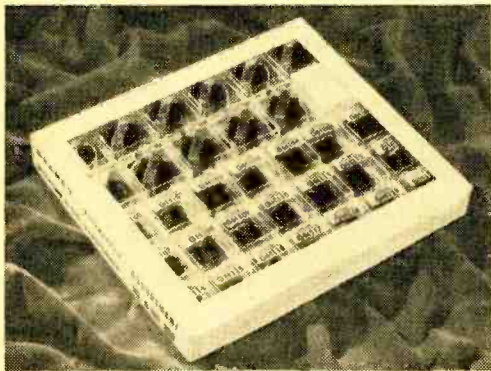

Gramer Hallderson's new transistor audio transformer "kit." Details appear in the text.

strength, but provides a real improvement in circuit selectivity.

In general, when using this receiver to pick up weaker stations, the selectivity switch ($S2$) should be left "up," as shown in the schematic. When tuning to stronger local stations, throw the selectivity switch "down."

An interesting "self-powered" radio circuit is shown in Fig. 1(B). Submitted by Mike Swink, of 4627 Cedar Springs, Dallas 19, Texas, this receiver requires neither dry cell nor sun battery for operation. Tuning capacitor $C1$ is a 380- μ fd. variable capacitor (365 μ fd. will work also). $L1$ is a standard broadcast-band Feri-Loopstick with six turns of #22 wire wound right on top of its coil ($L2$).

You should be able to assemble a similar receiver in a couple of hours. A good antenna and ground are required for best pickup, and high-impedance magnetic headphones should be used with the set. Once the circuit is wired and you have tuned in a local station, experiment with the connections to $L2$. In some cases, you can improve the set's sensitivity by reversing these connections.

In operation, r.f. signals picked up by the antenna-ground system are selected by series tuned circuit $C1-L1$. Step-down wind-

ing $L2$ serves to match the Feri-Loopstick to the low input impedance of the transistor. This transistor has the dual job of detecting and amplifying the selected signal. A small amount of regeneration may take place; hence the need for experimenting with $L2$'s connections. The transistor's d.c. operating power comes from the detected signal.

Transistor Identification. Our friend, Bob Middleton, chief field engineer of the Simpson Electric Co., and one of the nation's top authors on radio servicing, has sent us an outline of a simple technique for identifying transistor terminals by means of quick ohmmeter tests. Here's how it works:

The tests are made with a standard volt-ohm-milliammeter, using one of the *upper* ohmmeter ranges. To avoid possible transistor damage due to excessive current, *do not use the Ral range.*

Connect your ohmmeter leads across any two of the transistor's terminals. Make a mental note of the resistance value, and reverse the test leads. You'll obtain a different reading. The lower of the two readings is the forward resistance, and the higher is the backward or reverse resistance.

By measuring between each pair of the transistor's terminals, we can obtain three forward resistance readings. As the highest forward resistance occurs between the *emitter* and *collector* terminals, the remaining terminal is the *base* electrode.

At this stage, we have identified the *base* electrode, and we know which pair of electrodes are the *emitter* and *collector* . . . but we don't know which electrode is which. Before we can make a final identification, we'll have to determine whether the transistor is an *n-p-n* or a *p-n-p* unit.

To do this, connect the negative ohmmeter lead to the *base* electrode (previously identified), and apply the positive ohmmeter lead to the other two terminals in turn. A forward resistance reading in these tests shows that the transistor is a *p-n-p* type; a higher backward resistance reading identifies it as an *n-p-n* unit.

(Continued on page 112)



The Simpson Model 260 volt-ohm-milliammeter is useful for ohmmeter transistor tests.

TOOLS and GADGETS

SPOTLIGHT CONTINUITY TESTER

Incorporating an industrial flashlight with built-in jack, the Spotlight Electrical Circuit Continuity Tester, No. 1618CT, works through a three-volt battery supply. The test leads use plug and clips for

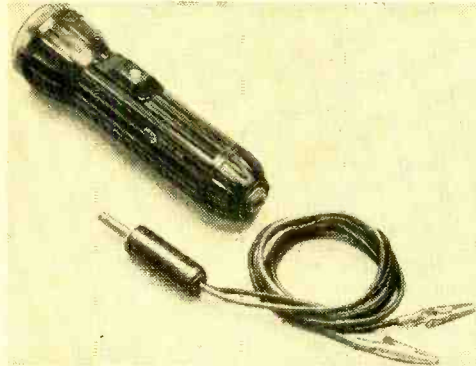

instant attachment. With this tester, you can check controls, fuses, grounds, short and open circuits, broken wire, switches, relays and burglar alarm systems. It is not intended for use on live wiring or as a voltage tester. (*Bright Star Industries, Inc.*, 600 Getty Ave., Clifton, N. J.)

SOLDERING IRON TRANSFORMER

The Model 54203 filament transformer is designed for use with all six-volt Oryx soldering irons. It is rated at 6 volts, 18 watts, and 3 amperes in continuous operation, and is being manufactured exclusively for Oryx by Triad Transformer Corp. The unit features screw-type terminals and clip holder for the iron, and comes with a.c. cord

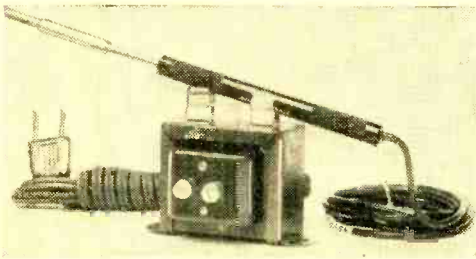

and holes for bench mounting. Net price, \$4.95. (*Oryx Company*, 9015 Wilshire Blvd., Beverly Hills, Calif.)

GROOVE JOINT PLIERS

Forged from high-strength beryllium copper, this multi-use pair of pliers is non-

magnetic, spark-resistant, and corrosion-resistant to most acids. It can double as an adjustable wrench, as a pipe wrench, or as a series of open-end wrenches, replacing several sizes of ordinary slip joint pliers.

This versatile tool is available in a 6½" size which provides parallel jaw openings

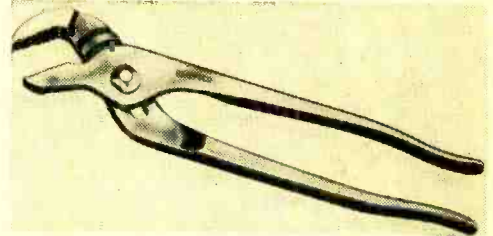

from 0 to 1" and in a 9½" size for 0 to 1½" openings. The five grooves provide non-slip gripping protection. (*The Safety Tool Division, The Beryllium Corporation*, Reading, Pa.)

ELECTRIC HAND SAW

Hours of sawing in hard-to-get-at places are said to be reduced to seconds with the Lesto GEB 4 portable a.c.-d.c. electric saw. With 20 different blades for you to choose from, it serves as a rip, crosscut, coping, keyhole, band, scroll or jig saw. It can cut through thick or thin wood at 3000 strokes per minute, leaving edges finer than "sandpaper-smooth," and can handle wood thicknesses up to 1½ inches.

Light (4½ pounds), yet rugged and accurate, the GEB 4 will cut curves and intri-

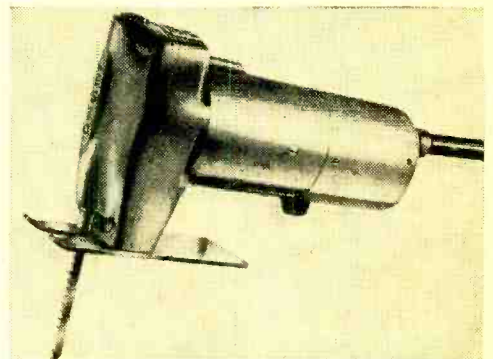

cate designs in a wide variety of materials—it cuts metal, hard rubber, plastic, asbestos, etc., as well as wood. Made of high-quality steel, and practically vibrationless, it is priced at \$62.50. (*Victor J. Krieg, Inc.*, 611 Broadway, New York 12, N. Y.)

MAGNETIC GUITAR MICROPHONE

Featuring separate volume and tone controls, this Alnico V magnetic pickup may be used with any F-hole guitar. When used in concert with a public address or phono-

graph amplifier, it will make any guitar an electric guitar. Tonal variations can be accomplished by sliding the pickup unit on

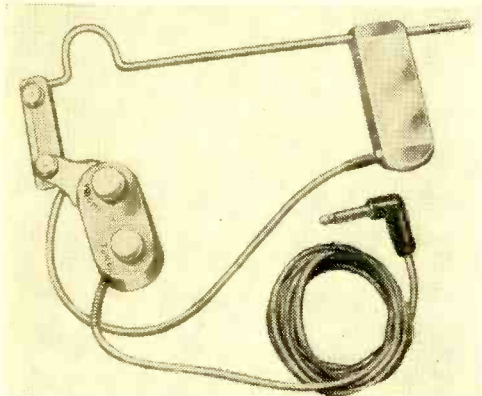

its supporting rod and by means of the electronic tone control. No. AR-35 includes eight feet of cable and a standard phone plug. List price, \$16.60. (Argonne Electronics Mfg. Corp., 27 Thompson St., New York 13, N. Y.)

VIBRATOR POWER SUPPLY KITS

Models VP-1-6 and VP-1-12 are appropriate for use in boats, automobiles, light aircraft, or any field application away from power lines. They will supply high-voltage B+ for most communications receivers, small p.a. systems, or even a miniature transmitter.

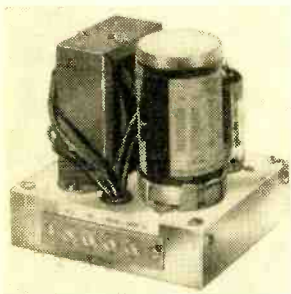

Each model provides 260 volts d.c. output at up to 60 milliamperes.

Everything is included in each kit: vibrator transformer, vibrator, 6X4 or 12X4 rectifier, and the necessary buffer capacitor, hash filter, and output filter capacitor. Model VP-1-6 operates from a 6-volt storage battery or battery eliminator and Model VP-1-12 from a 12-volt unit. (Heath Company, Benton Harbor, Mich.)

VOLTAGE-DROPPING RESISTORS

Wire-wound voltage-dropping resistors available from G-C Electronics Mfg. Co. are suitable for every application requiring a resistance drop from 12 to 6 volts. No. 5225, designed specifically for car radio ignition systems, is listed at \$2.50. A second model, No. 5226, intended for wider voltage-dropping requirements, may also be used for air conditioners, turning lights,

portable dictating machines, baby bottle warmers, and other auto accessories using 2½ to 9 amperes in 12-volt systems. No. 5226 is listed at \$3.00. (G-C Electronics Mfg. Co., 400 South Wyman Street, Rockford, Ill.)

VIBRATOR TEST ADAPTER

Easy to use with any standard tube tester, the PECO adapter will tell you whether the vibrator in your auto radio is working properly. If it is, both of the lights on the adapter will be illuminated with approximately equal brilliance. If your vibrator is defective, one or both

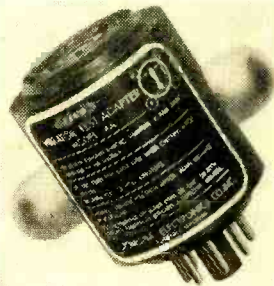

lights will be out. Model 4A (shown in photo) checks any standard 4-prong vibrator, 6- or 12-volt A-Base shunt-driven coil; Model 3D checks any standard 3-prong vibrator, 12-volt D-Base shunt-driven coil. (Pomona Electronics Co., Inc., 1126 W. Fifth Ave., Pomona, Calif.)

ONE-PIECE MASONRY ANCHOR

Pin-Grip one-piece anchors will secure clamps, electric cable straps, utility and junction boxes, fuse boxes, etc., to any kind of masonry. You simply insert the Pin-Grip into a hole drilled in the masonry, then

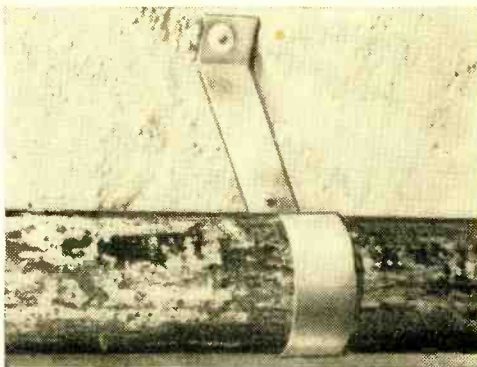

drive the pin flush with the anchor head using an ordinary hammer. The stainless steel pin, nested in the bored aluminum body of the Pin-Grip, forces out four expanding prongs which grip the wall within the masonry hole, resulting in a permanent, tight fastening job. A wide range of sizes is available to meet various requirements. (Star Expansion Central, Inc., 142 Liberty St., New York, N. Y.)

-50-

Tuning the Short-Wave Bands

—with Hank Bennett

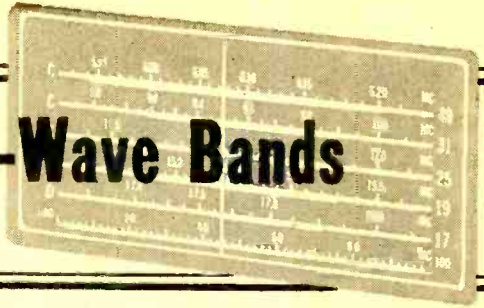

WITH THE THOUGHT that you may be interested in knowing more about some of the stations that are listed in this column, we plan to discuss one each month. Let's begin with *Radio Sarawak*. Although this is not an easy station to pick up on your receiver, it has been mentioned by quite a few of our reporters. Before going into details, we'll take a quick look at the country in which the station is located.

Sarawak is a British Crown Colony on the northwest coast of the Island of Borneo, roughly halfway between Indonesia

at some points halfway around the globe.

This is not to say that you can hear *Radio Sarawak* the very first time you tune to 5052 kc. In fact, you may learn the hard way that patience—and lots of it—is needed in order to log rarely heard stations like this one. Watch conditions closely, and when you notice a band opening, make the most of it.

Using "Radio Sarawak" as its call-sign and identification (no call letters), the station has a high-frequency, high-gain sky beam array antenna consisting of 12 dipoles. Interval signal is a simple descending melody played on a guitar.

Radio Sarawak operates on Saturdays at 2300-0030, Sundays at 0600-0900, and weekdays at 0000-0015 (from 2300 on Wednesdays and Fridays), with English news being broadcast at 0000 (*Radio Australia* news) and again at 0800 (relay from the BBC). Other transmissions are in Chinese, Iban, and Malay.

Verification is by QSL card or letter, and return postage is not required. Send your reports to: Mr.

J. R. Sandison, Chief Engineer, *Radio Sarawak*, Broadcasting House, Kuching, Sarawak. Postage from the USA is 4 cents (card), 8 cents (surface mail), and 25 cents (air mail).

Future plans call for enlarging the present studios and installing a new 7500-watt short-wave transmitter. The latter is expected to be in operation in September of this year, and reports on its quality and signal strength will be appreciated.

So much for *Radio Sarawak*. Tentatively scheduled for next month's column are some interesting facts about *Radio Japan*, an international broadcasting service conducted by the only public service broadcasting organization in Japan.

(Continued on page 122)

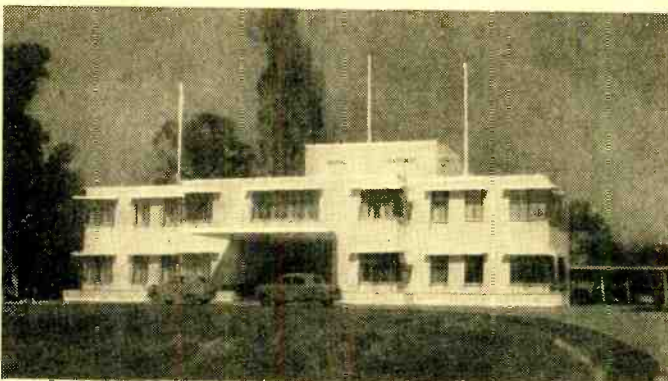

Radio Sarawak's Broadcasting House in Kuching. Facilities are expected to be enlarged in the near future and a new transmitter installed.

and the Philippines. Covering an area of 50,000 square miles (about the size of England and Wales), it has a population estimated at a half million. The capital of the country is Kuching, and it is here that we find *Radio Sarawak*.

This station, which is a fairly new one, was opened on June 7, 1954. It operates on a short-wave frequency of 5052 kc. and on the medium waves at 353 meters (850 kc.), using 5-kw. Marconi transmitters for both channels. *Radio Sarawak* claims to have a satisfactory regular coverage radius of 20 to 30 miles on the medium waves, and all of Sarawak on short waves. Since the short-wave outlet has been heard and verified in several of the eastern states, it is a fact that it can be heard, upon occasion,

July, 1957

TIPS and TECHNIQUES

"ALONG-THE-LINE" PHONE JACK

An empty 35-mm. film cartridge case—and its two ends—can be adapted to form the body of an "along-the-line" phone jack. Using a panel jack, insert its threaded part through one of the empty cartridge's end-caps, so that the cartridge body joins the cap and protects the connections and part of the attached cord. Screw on the threaded

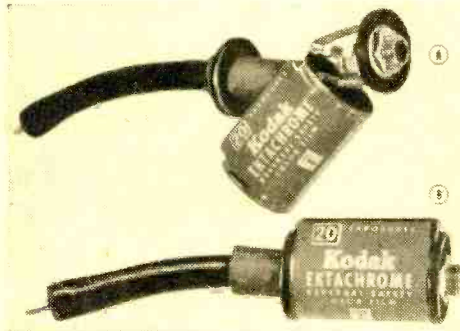

nut that comes with the phone jack, and tighten it on the end-cap.

Before wiring the jack, slip the other end-cap on the line. Make sure that the jack terminals will not interfere with the cartridge wall when finished. The terminals may be bent in slightly, so that they do not touch the cartridge wall. When wiring is done, slip the cartridge over the wiring, and into place by clamping it together with the end-caps. Using black masking tape, wrap the cartridge to insure an even stronger job. This method allows you to make inexpensive interconnections, particularly for audio components. —J.H.

DOOR-BELL TRANSFORMER FOR OUTPUT

A door-bell transformer makes quite a passable output transformer on some radios. One reason is that the output transformer is essentially a voltage step-down device—and so is the bell transformer. The output transformer is also an impedance-transforming gadget, matching the relatively high impedance of the plate circuit to the very low impedance of the speaker voice coil. While we are not accustomed to thinking of a bell transformer in these terms, it can perform this function. A

typical bell transformer has a d.c. resistance of about 400 ohms on the 115-volt side and about 4 ohms on the 6-volt side. This gives remarkably clean results when working out of a 1C5 in older battery portables. It works with varying degrees of success in other sets, depending upon how much distortion is acceptable. The distortion results from the inexact impedance match provided and from the design of the bell transformer, which of course was never meant for audio applications. However, the substitution does work and while the results are certainly not high-fidelity, neither are most small radios. —E.F.C.

PROTECT YOUR LOUDSPEAKER CONE

Do slipping screwdrivers sometimes poke holes into your speaker cones? This kind of mishap can be avoided by attaching a sheet of stiff cardboard in front of the cone during a construction or repair project. First cut the cardboard to fit the front of the speaker frame, as shown in the photograph. Then punch holes in the corners to match

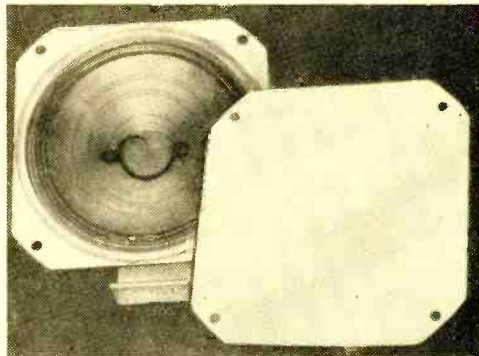

the speaker mounting holes and fasten with 6-32 x 1/4" machine screws. When the project is completed, remove the cardboard sheet and install the loudspeaker in its enclosure. —J.E.P.

SO WHO NEEDS TRANSISTOR SOCKETS?

Practically every experimenter has a coil of stranded hookup wire around his shop. How many of them have realized that they

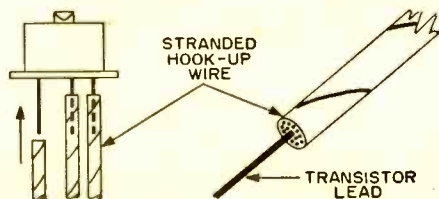

can, temporarily at least, use such wire to dispense with transistor sockets? Cut off

(Continued on page 108)

HEATHKITS . . . are fun to build, and you save by dealing directly with the manufacturer!

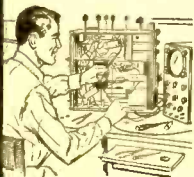

It's easy to follow simple step-by-step directions with large pictorial diagrams as your guide. You save labor costs and get more real quality for less money. Your greatest dollar value in fine kit-form equipment.

BUDGET YOUR PURCHASE . . .

We invite you to take advantage of the **HEATH TIME PAYMENT PLAN** on any order amounting to \$90 or more. Just 10% down, and the balance in twelve easy monthly payments. Write for complete details.



*Largest selling VTVM
in the world!
. . . etched circuit board*

HEATHKIT VACUUM TUBE VOLTMETER KIT

Sensitivity and reliability are combined in the V-7A. It features 1% precision resistors, large 4½" panel meter, and etched circuit boards. AC (RMS) and DC voltage ranges are 0-1.5, 5, 15, 50, 150, 500 and 1500. Peak-to-peak AC ranges are 0-4, 14, 40, 140, 400, 1400 and 4000 volts. Ohmmeter ranges provide multiplying factors of X1, X10, X100, X1000, X10K, X100K and X1 megohm.

MODEL V-7A

\$24.50

Shpg. Wt. 7 lbs.

\$2.45 DWN.,
\$2.06 MO.

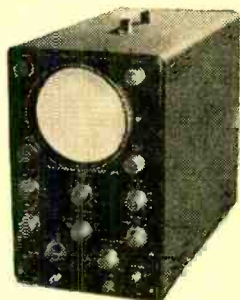

*New
improved . . .
full 5" size
. . . etched
circuit
for only*

\$42.50

Shpg. Wt. 21 lbs.

\$4.25 DWN.,
\$3.97 MO.

MODEL OM-2

HEATHKIT 5" PUSH-PULL OSCILLOSCOPE KIT

This new and improved oscilloscope sells for less than the previous model. You can have a full 5" oscilloscope at the remarkably low price of only \$42.50. The OM-2 provides wider vertical frequency response, extended sweep generator coverage, and increased stability. Vertical channel is essentially flat to over 1 MC, and down only 6 DB at 1.5 MC. The sweep generator functions from 20 CPS to over 150 KC. Amplifiers are push pull, and modern etched circuits are employed in critical parts of the circuit. A 5BP1 cathode ray tube is used. The scope features external or internal sweep and sync, one volt peak-to-peak reference voltage, three-position step attenuated input, adjustable spot shape control, and many other "extras."



*Compact, portable . . .
a favorite in the home
and in the service shop*

HEATHKIT HANDITESTER KIT

Measures AC or DC voltage at 0-10, 30, 300, 1000, and 5000 volts. Direct current ranges are 0-10MA and 0-100MA. Ohmmeter ranges are 0-3000 and 0-300,000 ohms. Sensitivity is 1000 ohms/volt. Features small size and rugged construction in sleek black bakelite case.

MODEL H-1

\$14.50

Shpg. Wt. 3 lbs.

\$1.45 DWN.,
\$1.22 MO.

HEATH COMPANY • BENTON HARBOR 10, MICH.
A Subsidiary of Daystrom, Incorporated



BRAND NEW MODEL

HEATHKIT

CW TRANSMITTER KIT



\$3.60 DWN.,
\$3.02 MO.

MODEL DX-20

\$35⁹⁵

Shpg. Wt. 18 lbs.

Here is a straight-CW transmitter that is one of the most efficient rigs available today. It is ideal for the novice, and even for the advanced-class CW operator. This 50 watt transmitter employs a 6DQ6A final amplifier, a 6CL6 oscillator, and a 5U4GB rectifier. It features one-knob band switching to cover 80, 40, 20, 15, 11 and 10 meters. It is designed for crystal excitation, but may be excited by an external VFO. A pi network output circuit is employed to match antenna impedances between 50 and 1000 ohms. If you appreciate a good signal on the CW bands, this is the transmitter for you!



MODEL SG-8

\$19⁵⁰

\$1.95 DWN.,
\$1.64 MO.

Shpg. Wt. 8 lbs.

POPULAR WITH SERVICEMEN
HEATHKIT

RF SIGNAL GENERATOR KIT

Produces RF signals from 160 KC to 110 MC on fundamentals on 5 bands, and covers 110 MC to 220 MC on-calibrated harmonics. Output may be pure RF, RF modulated at 400 CPS, or audio at 400 CPS. Preamplified coils eliminate the need for calibration after completion.



MODEL AR-3

\$29⁹⁵

**HAM BANDS
CLEARLY MARKED**

incl. Fed. Excise Tax
(less cabinet)
Shpg. Wt. 12 lbs.

\$3.00 DWN.,
\$2.52 MO.

HEATHKIT COMMUNICATIONS-TYPE

ALL BAND RECEIVER KIT

This receiver covers 550 KC to 30 MC in 4 bands, and is ideal for the short wave listener or beginning amateur. It provides good sensitivity and selectivity, combined with good image rejection. Amateur bands clearly marked on illuminated dial scale. Employs transformer-type power supply — electrical bandspread — antenna trimmer — separate RF and AF gain controls — noise limiter — headphone jack — and automatic gain control. Built in BFO for CW reception.

CABINET: Fabric-covered cabinet with aluminum panel as shown. Part 91-15A. Shipping wt. 5 lbs., \$4.95 incl. Fed. Ex. Tax, \$.50 dn., \$.42 mo.

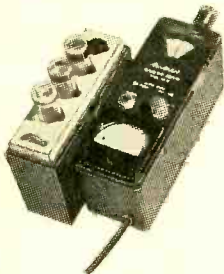

**FULL SET OF COILS
INCLUDED WITH KIT
HEATHKIT GRID DIP
METER KIT**

An instrument of many uses for the ham, experimenter, or serviceman. Useful in locating parasitics, neutralizing, determining resonant frequencies, etc. Covers 2 MC to 250 MC with prewound coils. Use to beat against unknown frequency, or as absorption-type wave-meter.

MODEL GD-1B

\$19⁹⁵

\$2.00 DWN.,
\$1.68 MO.

Shpg. Wt. 4 lbs.

HEATH COMPANY • BENTON HARBOR 10, MICH.
A Subsidiary of Daystrom, Incorporated

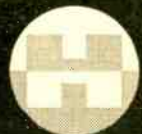

EASY TO BUILD
... A "LEARN-BY-DOING" EXPERIENCE

HEATHKIT BROADCAST BAND RECEIVER KIT

You need no previous experience to build this table-model radio. It covers 550 KC to 1620 KC and features good sensitivity and selectivity. A 5½" speaker is employed, along with high-gain miniature tubes and a new rod-type antenna. The power supply is transformer-operated. The kind of a set you will want to show off to your family and friends. Construction is simple. You "learn by doing" as the project moves along.

CABINET: Fabric-covered plywood cabinet as shown. Shipping Wt. 5 lbs., .50 dwn., .42 mo., part No. 91-9A. \$4.95 incl. Fed. Excise Tax.

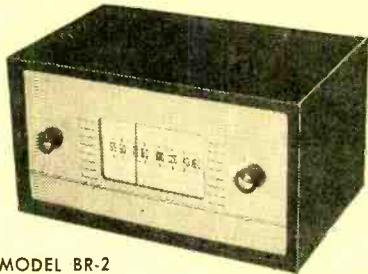

MODEL BR-2

\$18⁹⁵

incl. Fed.
Excise Tax
(less cabinet)

\$1.90 DWN.,
\$1.59 MO.

Shpg. Wt. 10 lbs.

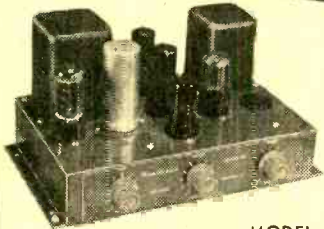

incl. Fed.
Excise Tax
\$1.80 DWN.,
\$1.51 MO.

MODEL A-7D

\$17⁹⁵

Shpg. Wt. 10 lbs.

REAL HI-FI PERFORMANCE
AT MINIMUM COST

HEATHKIT 7-WATT AMPLIFIER KIT

This 7-watt amplifier is more limited in power than other Heathkit models, but still qualifies for high fidelity, and its capabilities exceed those of many so called "high fidelity" phonograph amplifiers. Using a tapped-screen output transformer, the model A-7D provides a frequency response of ± 1½ DB from 20 to 20,000 CPS. Total distortion is held to surprisingly low level. The output stage is push-pull, and separate bass and treble tone controls are provided.

Model A-7E: Similar to the A-7D except that a 12SL7 tube has been added for preamplification. Features two inputs, RIAA compensation, and extra gain. \$20.35, incl. Fed. Excise Tax, \$2.04 dwn., \$1.71 mo.

MODEL CR-1

\$7⁹⁵

incl. Fed.
Excise Tax
Shpg. Wt. 3 lbs.

\$5.80 DWN.,
\$6.67 MO.



... INTERESTING PROJECT FOR ALL AGES

HEATHKIT CRYSTAL RECEIVER KIT

The crystal radio of dad's day is back again, but with big improvements! Sealed diode eliminates "cats whisker." Uses two high-Q tank circuits to tune 540 to 1600 KC. No external power required. Easy to build.

FOR AMATEUR OR PROFESSIONAL
PHOTOGRAPHERS

HEATHKIT ENLARGER TIMER KIT

This is an easy-to-build device for use by photographers in controlling their enlarger. It covers the range of 0 to 1 minute with a continuously variable control. Handles up to 350 watts. Timing cycle controlled electronically for maximum accuracy.



MODEL ET-1

\$11⁵⁰

Shpg. Wt. 3 lbs.

\$1.15 DWN.,
\$.97 MO.

HEATH COMPANY • BENTON HARBOR 10, MICH.
A Subsidiary of Daystrom, Incorporated

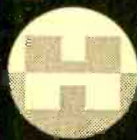

**NEW EDGE-LIGHTED
TUNING DIAL FOR
IMPROVED READABILITY**

HEATHKIT HIGH FIDELITY FM TUNER KIT

This FM tuner can provide real hi-fi performance at an unbelievably low price level. Covering 88 to 108 MC, the modern circuit features a stabilized, temperature compensated oscillator, AGC, broad-banded IF circuits, and better than 10 UV sensitivity for 20 DB of quieting. A ratio detector is employed for high efficiency, and all transformers are prealigned, as is the front end tuning unit. A new feature is the edge-lighted dial for improved readability, and a new dial cord arrangement for easier tuning. Matches the models WA-P2 and BC-1. Easy to build.



MODEL FM-3A

\$25⁹⁵

*incl. Fed.
Excise Tax
(with cabinet)
Shpg. Wt. 7 lbs.*

\$2.60 DWN.,
\$2.18 MO.



MODEL BC-1

\$25⁹⁵

*incl. Fed. Excise
Tax (with cabinet)
Shpg. Wt. 8 lbs.*

\$2.60 DWN.,
\$2.18 MO.

**NEW EDGE-LIGHTED TUNING
DIAL. MATCHES MODEL FM-3A**

HEATHKIT BROADBAND AM TUNER KIT

The BC-1 was designed especially for high fidelity applications. It features a low-distortion detector, broad band IF's, and other characteristics essential to usefulness in hi-fi. Sensitivity and selectivity are excellent, and audio response is within ± 1 DB from 20 CPS to 2 KC, with 5 DB of pre-emphasis at 10 KC to compensate for station rolloff. 6 DB signal to noise ratio at 2.5 UV. Covers 550 to 1600 KC. RF and IF coils are prealigned, and the power supply is built in. Features AVC, 2 outputs, and 2 antenna inputs. Tuning dial is edge-lighted for high readability.

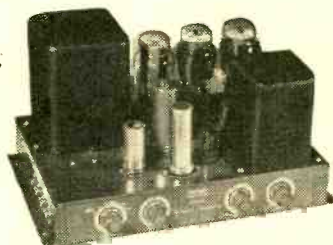

MODEL A-9B

\$35⁵⁰

*Shpg. Wt.
23 lbs.*

\$3.55 DWN.,
\$2.98 MO.

**FULL 20 WATTS FOR PA
OR HOME APPLICATIONS**

HEATHKIT 20-WATT AMPLIFIER KIT

This high-fidelity amplifier features full 20-watt output using push pull 6L6 tubes. Built-in preamplifier provides 4 separate inputs, selected by a panel-mounted switch. It has separate bass and treble tone controls, each offering 15 DB boost and cut. Output transformer is tapped at 4, 8, 16, and 500 ohms. Designed primarily for home installation, but used extensively for public address applications. True high-fidelity performance with frequency response of ± 1 DB from 20 CPS to 20,000 CPS. Total harmonic distortion only 1% (at 3 DB below rated output).

HEATH COMPANY • BENTON HARBOR 10, MICH.
A Subsidiary of Daystrom, Incorporated

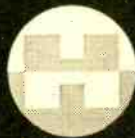

FEATURES GOOD LOOKS

AND HIGH PERFORMANCE

**HEATHKIT HIGH FIDELITY
SPEAKER SYSTEM KIT**

The model SS-1 covers 50 to 12,000 CPS within ± 5 DB, and can fulfill your present needs, and still provide for the future. It uses two Jensen speakers and has a cross-over frequency of 1600 CPS. The speaker system is rated at 25 watts, and the impedance is 16 ohms. The enclosure is a ducted-port bass reflex type and is most attractively styled. It is easy to build and can be finished in light or dark stain to suit your taste.

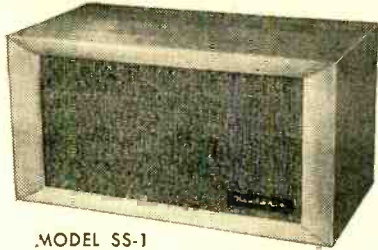

MODEL SS-1

\$39⁹⁵

\$4.00 DWN.,
\$3.36 MO.

Shpg. Wt. 30 lbs.

**ATTRACTIVE STYLING
MATCHES MODEL SS-1
HEATHKIT HIGH FIDELITY
RANGE EXTENDING
SPEAKER SYSTEM KIT**



MODEL SS-1B

\$99⁹⁵

\$10.00 DW.,
\$8.40 MO.

Shpg. Wt. 80 lbs.

The SS-1B is designed especially for use with the model SS-1. It consists of a 15" woofer and a compression-type super tweeter to add additional frequency coverage at both ends of the spectrum. Cross-over frequencies are 600, 1600, and 4,000 CPS. Together, the two speaker systems provide output from 35 to 16,000 CPS within ± 5 DB. The kit is easy to assemble with pre-cut and pre-drilled wood parts. Power rating is 35 watts, and impedance is 16 ohms.

Free 1957 CATALOG

Our new 56-page 1957 catalog describes more than 75 different kit models for experimenters, hams, students, engineers, industrial laboratories, etc. Send for your free copy now!



HOW TO ORDER

It's simple — just identify the kit you desire by its model number and send your order to the address listed below. Or, if you would rather budget your purchase, send for details of the Heath Time Payment Plan!

**ORDER
BLANK**

HEATH COMPANY • BENTON HARBOR 10, MICH.
A Subsidiary of Daystrom, Incorporated

Name _____

Address _____

City _____ Zone _____ State _____

- SHIP VIA**
- Parcel Post
 - Express
 - Freight
 - Best Way

Quantity	Item	Model No.	Price

Enclosed find check money order for \$_____. Please ship C.O.D. postage enclosed for _____ lbs. On express orders do not include transportation charges — they will be collected by the express

agency at time of delivery. On parcel post orders include postage for weight shown. Orders from Canada and APC's must include full remittance. NOTE: All prices subject to change without notice.

POSTAGE

TOTAL

Tips

(Continued from page 102)

the transistor leads to about $\frac{3}{4}$ " in length and force them into the end of the stranded hookup wire—complete with insulation as shown in diagram. —J.T.

TEST SPEAKER FOR VOICE-COIL RUB

To test a speaker for free movement of the voice coil and cone, first grasp the speaker securely with one hand. Then, with the center of the cone close to the ear, strike the back of the speaker frame sharply with the heel of the other hand, as shown in the photo.



This sharp blow will set the cone vibrating at its natural resonant frequency, and the voice coil will vibrate in the air-gap at the same time. If the voice coil has free movement in the air-gap, you will hear a clear *boing* with no muffling and rattles. If the voice coil and cone sound free but you hear some rattling anyway, chances are that it is coming from some other spot.

One common method of testing for voice-coil rub is to press on the cone with the fingers to see if a rub can be heard or felt, but this method probably doesn't do the more expensive speakers any good. —A.T.

CLEANING FINE FILES

Fine smoothing files, "Swiss Needle" files, and similar files having small, closely spaced teeth are rather difficult to clean—especially after use on aluminum, plastic, copper, or other soft materials which tend

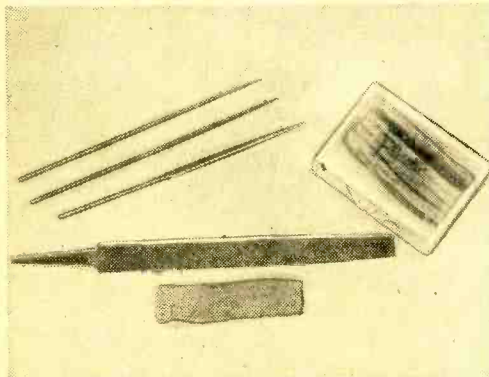

to clog. Here's a cleaning trick borrowed from typists!

Pick up some "Plastic Type Cleaner" at

your local stationery, office supply or five-and-dime store. After brushing the file to remove large particles, press the plastic cleaner firmly against the file's surface. Use plenty of pressure to insure that the cleaner penetrates into the teeth crevices. When you "peel" the plastic away, you'll find that most of the smaller particles will adhere to it. For stubborn cases, repeat this operation two or more times. —G.R.

USE SPIRAL COPING SAW

New experimenters with pinched pocket-books should invest in a "Tyler Spyrall Coping Saw Blade." With teeth cut around

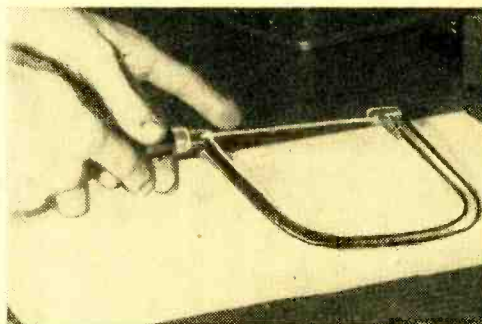

all sides of the blade rather than along one face, it simplifies cutting wood, plastic, and particularly aluminum. —C.C.

NEAT SOLDERLESS CONNECTORS

Connectors for the ends of small wires used in radio and other electrical applications can be attached in a hurry with one or two taps of a hammer. They are plated brass rivets of the kind that are hollow at both ends. Just give the wire end one turn around the rivet, forming it into a neat, firm fit with a rivet set. This kind of con-



connector requires less space than the usual soldered connector and improves the appearance of any job. Also, it comes in handy when connectors must be installed at locations away from the workbench, where soldering would be inconvenient. —K.M.

TRANSISTORIZED AM-SW RECEIVER



Compact EKERADIO features the world's smallest AM radio with short-wave band. Weighing only 8 ounces, this battery, transistorized radio operates on a powerful subminiature tube and transistor. Special features: switch for short wave, ball-bearing tuning condenser, metal calibrated dial, and comes complete with the latest type ear piece, same as used in the best hearing aids. Radio case comes in wrinkled gold finish. Plays instantly at

any time anywhere. Wired and air-tested . . . batteries, button receiver, and 8-foot receiving wire antenna. Ready to play, \$29.95 postpaid.

BEGINNER'S KIT

12,000-mile transistorized radio in kit form. Transistor, resistor, bolts, plastic plate, wire for short-wave coils, special tuning coil, 2 printed circuit units, battery clips, oscillator coil, phone clips, subminiature tube, hook-up wire, antenna lead and solder. Complete with easy-to-follow instructions. AM as well as short wave. Kit complete, \$5.95. Trim, double head set \$2.00 extra.

2-STAGE TRANSISTOR AMPLIFIER

Output nearly 1/8 of a watt . . . can be used as a pre-amp. Complete kit with transistors only \$5.95 postpaid. Add 4% Sales Tax in California.

EKERADIO ELECTRONIC DEVELOPMENTS

646 N. Fair Oaks Avenue
PASADENA, CALIFORNIA

your present speaker in a KARLSON TRANSDUCER

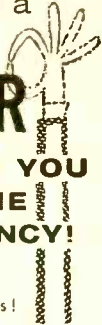

CAN GIVE YOU
10x THE
EFFICIENCY!

- ✓ 2x the dispersion!
- ✓ 2 more octaves bass!
- ✓ Flatter response - Less distortion!
- ✓ Unexcelled transient response!



IN EASY-TO-ASSEMBLE

KITS from \$18.60
to \$57 net.

Also assembled models from \$26.70 to \$174.

KARLSON ASSOCIATES INC.

Dept. PE, 1610 Neck Rd. Bklyn, 29, N.Y.

NEW THIS YEAR!

in the **PHOTOGRAPHY
DIRECTORY**

Special 16-page section on
**WHERE TO SELL
YOUR PICTURES**

You'll profit from this money-making guide to the photo market — newspapers, calendar and greeting card firms, trade journals and magazines interested in buying your photographs.

Just one of the big, extra features in the 1957 PHOTOGRAPHY DIRECTORY. Buy your copy today — only \$1.00. On sale now at all newsstands.



1957 PHOTOGRAPHY DIRECTORY

& BUYING GUIDE

Most Complete Handbook of Photographic products

Details on exciting
new products from
all over the world

SPECIAL SECTION:
**WHERE TO SELL
YOUR PICTURES**
**A MONEY-MAKING
GUIDE TO
PHOTO MARKETS**



Compiled by the editors of POPULAR PHOTOGRAPHY Price \$1.00 (Not in Canada and elsewhere)

OVER 5,000 LISTINGS 1,000 ILLUSTRATED

ILLUSTRATED LISTINGS

Cameras . . . Lenses . . . Lighting Equipment . . .
Enlargers . . . Meters . . . Equipment . . . Projectors . . .
Flash & Speeding Units . . . Exposure Meters . . .
Films & Papers . . . Stereo Equipment . . . Filters . . .
Tape Recorders, etc., etc.

LATEST MODELS

LATEST PRICES

PLUS: DIRECTORY OF PHOTO SCHOOLS

WE DON'T NEED ENGINEERS

... but they write to us daily to order our
GENIAC Electric Brain Construction Kits

So do TEACHERS, SCIENTIFIC AMATEURS, INDUSTRIAL FIRMS
and schools. (See list below.)

**THOUSANDS OF SATISFIED CUSTOMERS have
bought GENIACS on a 7 DAY REFUND guarantee**

We are proud to offer our 1957 Model GENIAC, with up to the minute im-
provements for the thousands of new customers who can use them.

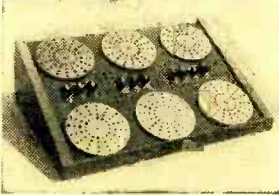

WHAT IS A GENIAC?

Here is a picture of the 1957 Model GENIAC in the display rack
(\$3.00 separately) which comes with every kit.

GENIAC stands for *Genius Semi-Automatic Computer*. A kit of
specially designed switch decks and racks which permit the user to
construct more than thirty different machines (following directions
and wiring diagrams) and as many more as he is able to design him-
self. These machines demonstrate the applications of electric circuitry.

APPLICATIONS OF GENIAC

SIMPLE COMPUTER CIRCUITS of binary, decimal adding, subtracting,
dividing, multiplying machines, **PROBLEMS** in symbolic logic, rea-
soning, comparing, **PSYCHOLOGICAL TESTING** and **EXPERIMENT**
GAME PLAYING CIRCUITS for tit-tat-toe and nim. **ACTUARIAL**
ANALYSIS.

SOME OF OUR CUSTOMERS

Allis-Chalmers • Remington-Rand • International Business Machines
• Manuel Missionary College • Barnard College • Westinghouse Elec-
tric • Philips Laboratories • General Insurance Co. of America •
Lafayette Radio • Rohr Aircraft Co. • Albert Einstein Medical Col-
lege • Naval Research Laboratories • Board of Education, Tecumseh,
Nebraska • Los Angeles Public Schools • Jefferson Union High School
• Oklahoma A & M • Courtland Jr. High School • Bell Telephone
Laboratories.

WHAT COMES WITH THE KIT?

BOOKS—1. **SIMPLE ELECTRIC BRAINS, AND HOW TO MAKE THEM**
... 64 page experiment manual.—NEW! 2. **MINDS AND MACHINES**
... 200 page text on computers, automation and cybernetics.—NEW!
3. **WIRING DIAGRAMS** for basic GENIAC circuits.—NEW! 4. **Begin-
ners Manual** for the person who has little or no familiarity with
electric circuits.—NEW! 5. **GENIAC study guide** ... the equivalent
of a full course in computer fundamentals, lists additional readings.
PARTS—PANELS, DISCS, RACK (for easy assembly and display),
Hardware, wire, tools, battery, holder, etc. for more than thirty
machines.

SEND for your GENIAC now. At only \$19.95, a bargain, comes com-
plete with over 400 parts and components, 7 books and manuals.
We guarantee that if you do not want to keep GENIAC after one
week you can return it for full refund.

Add 80¢ west of Miss. \$2 outside U.S. Mail Name & Address with
check or Money Order to

OLIVER GARFIELD CO., DEPT. PE-77C

126 LEXINGTON AVE.

NEW YORK 16, N. Y.

Sound Impressions

(Continued from page 85)

fabric—listen to the records made for Lon-
don by the late Clemens Krauss (LL-484,
LL-683, and LL-970), or Bruno Walter's
waltz-time essays on Columbia ML-5113.

Mixed Piano. "Light, lacy, summer mu-
sic" is one way to describe the humorous
and subtle *Concertino for Piano and Or-
chestra* by Jean Francaix. Though all the
instruments often seem furiously busy, the
tonal texture of this elegant little piece al-
ways stays wispy and transparent. It's fine
for hi-fi. Try it if you have a taste for
whimsy and the unusual.

On the same disc (Decca DL 9900) are
two other out-of-the-way compositions for
piano and orchestra: Richard Strauss' *Bur-
leske*, a full-throated and flamboyant show-
piece of ready appeal, and Honegger's tart,
terse *Concertino*. Fine performances by
Margit Weber, piano, and the Radio Berlin
Orchestra under F. Fricsay are very clean-
ly recorded.

Harem Saga. The same conductor and
orchestra bring us a new version of Rim-
ski-Korsakov's *Scheherazade* on Decca DL
9908. This lush tone poem is based on the
story of "1001 Nights." The Sultan of Tur-
key, convinced of the falseness and faith-
lessness of women, is in the habit of put-
ting his various wives to death after the
first night. Scheherazade saves her neck
by telling tales that keep the Sultan in
suspense from one night to the next so that
the Sultan can't kill her if he wants to
hear the end of the story. After 1001
nights he has gotten so used to her that he
forgets about the head-chopping—and they
live happily ever after.

This Oriental prescription for happy mar-
riage is set to magnificently melodious, rich-
ly rolling music. None can cavil at the fine
performance presented here, except to note
that Fricsay's tasteful restraint sometimes
makes the sultry harem temptress sound a
bit prim. (If you want Scheherazade to
get you hot under the collar, try Orman-
dy's supercharged version on Columbia
CL-850.) But Decca's disc is beautifully
played, well recorded, and won't cloy in
repetition.

Smooth & Mellow. If you like your
temptresses less tempestuous than Sche-
herazade, try Dorothy Carless' *Mixed Emo-
tions* on High Fidelity Recording R-402.
Dorothy is to British radio what Dinah
Shore is to NBC. Her silky voice weaves
in softly with the accompanying trio in a
group of easy-listening songs that can make
you feel very cuddly in a cocktail lounge or
(if you have an extension speaker) in a
garden hammock.

—50—

**help
science
unlock
the
mystery of
cripping MS**



**GIVE TO
MULTIPLE SCLEROSIS
c/o LOCAL POSTMASTER**

SPECTACULAR SALE CONTINUED BY DEMAND! DOUBLE BONUS OFFER!

**FREE
GIANT
SUMMER
FLYER**
WRITE TO DAY!

**MONEY BACK
GUARANTEE OF
SATISFACTION**



10 "POLY" BOXES. asstd. sizes. Clear plastic, hinged w/snap locks. Reg. \$2.50. **\$1**

15 ROTARY SWITCHES, ceramic & bakelite; 1, 2, 3 gangs. Std. shafts. Wt. 3 lbs. Reg. \$1. **\$10.**

15 VOLUME CONTROLS, singles & duals. 70 meg. Wt. **\$1**
1 lb. Reg. \$10.

10 IF TRANSFORMERS. Metal can, asstd. freqs. for radio, TV, hobby use. Wt. 3 lbs. Reg. **\$1**
\$15.

30 POWER RESISTORS. WW, candolin, sand-coated vitreous. 15 values: 5 to 50 W, 35 to 11000 ohms. Wt. 2 lbs. **\$1**
Reg. \$8.

EMERSON TUNER. HI-Q, permeability-tuned ANT. & osc. coils, w/padders on 2 x 4" plate, variable tuning mech. 500 to 1800 kc. Reg. \$5. **\$1**

40 POP. BULBS. 1.1 to 0 V, screw & bayonet types, miniature. Wt. 1/2 lb. Reg. **\$1**
\$3.20.

SUB-MINI SOLENOID. 1 x 5/8 x 3/4". Change elec. energy to mechanical. 12 VDC @ 300 ma, actuates plunger. Wt. 1 oz. **\$1**
Reg. \$2.50.

3 AC-DC CHOKES, 800 ohms, 3H-50ma. Open frame mtg. for power supplies. Wt. 2 lbs. **\$1**
Reg. \$1 ea.

100 CERAMIC CONDENSERS, asstd. types; top mfg. 30 values, color-coded. Discs, too. **\$1**
Reg. \$15.

100 COIL FORMS. Wide variety sizes, insulation. Wt. 1 lb. **\$1**
Reg. \$10.

000-999 COUNTER. Veeder-Root reset type, for all counting jobs. Reg. \$6. **\$1**

15 PANEL SWITCHES. Push, momentary, power, thermal. Wide variety. Wt. 2 lbs. **\$1**
Reg. \$18.

3 OUTPUT XFMRs. Single & p/p tubes; 35L6, 50B5, 50L6 & 6V6 to 1-4 ohm v.c. Wt. **\$1**
2 lbs. Reg. \$5.

8-PC. NUTDRIVER SET. Plastic handle; 3/16, 7/32, 1/2, 5/16, 11/32, 3/8, 7/16" steel socket wrenches in plastic case. **\$1**
Wt. 1 lb. \$3 value.

40 TUBE SOCKETS, 4 to 14 prong. Transistor & printed circuit, 7's & 9's octals; ceramic & mica, too. Wt. 1 lb. **\$1**
Reg. \$8.

R/C CONTROL SCOOP! Chassis incl. 3000-ohm mini control relay, 1.5 to 6.3-1.5A fl. xfmr., resistors, cond., pot. sockets. **\$1**
Wt. 2 lbs.

15-PC. TWIST DRILL SET, 1/16 thru 1/4" by 3/4ths in graduated plastic holders. Reg. \$4. **\$1**

60 XFMRs, COILS, IF, RF, ant., slug-tuned coils, chokes, 25 types. Wt. 3 lbs. Reg. **\$15.**

MINI-METER BUY! 1 1/2" round, chromed, 0-6 amps, AC. For model railroads, power supplies, mobile. Reg. \$2. **\$1**

Your choice of
1. ANY \$1 KIT FREE!



\$15 assortment of RADIO PARTS FREE!

DOUBLE BONUS = Sixteen Dollars worth of parts free with \$10.00 order!

DOLLARBUYS!

WORLD'S SMALLEST RADIO KIT. 2 1/2 x 1 1/4 x 3/4" w/permeability tuner, diode, all parts, instructions. Reg. \$1 **\$3.50.**

20 PRINTED CIRCUITS, asstd. top makes for transistor, radio, hobby circuitry. Reg. **\$1**
\$10.

6 PILOT LITE ASSEMBLIES. Std. mtg., mini bayonet, amber jewel. Reg. 75c ea. **\$1**

40 DISC CONDENSERS—transistor & printed circuit types. **\$1**
Reg. \$8.

100 RADIO PARTS, resistors, condensers, forms, plugs, sockets. Wt. 2 lbs. Reg. **\$15.**

40 MOLDED CONDENSERS. .0001 to 0.1 mf up to 1000V. Brown, black ceramic cased. **\$1**
Wt. 1 lb. Reg. \$3.

2 MIKE TRANSFORMERS, carbon. Encased, 200 ohms to hi-imp. grid, w/leads. Wt. 1 **\$1**
lb. Reg. \$4.

40 HI-Q CONDENSERS. Finest made! Ceramic tubular cased, asstd. popular values. Reg. **\$1**
\$8.

70 MICA CONDENSERS, 30 values. .00001 to .01 mf to 1000V. Silver, 5%, incl. Wt. 1 **\$1**
lb. Reg. \$5.

60 STANDARD KNOBS. Asstd. colors, bakelite & plastic. Set-screw types, too. Wt. 2 **\$1**
lbs. Reg. \$9.

60 TERMINAL STRIPS & BOARDS. 15 types. 1 to 20 screw & solder pts. Wt. 1 **\$1**
lb. Reg. \$5.

70 RESISTORS. Insulated IRC, A-B, etc. 5 ohms to 10 megs; 1/2, 1 & 2W. 1% & 5%, **\$1**
too. Wt. 1/2 lb. Reg. \$10.95.

60 TUBULAR CONDENSERS. Wide asst. values, voltages. **\$1**
mfrs. Wt. 2 lbs. Reg. \$12.

6 AC/DC LINE CORD SETS. Asstd. rubber, plastic; 6-ft. long. Molded plugs, tinned ends. **\$1**
Wt. 1 lb.

15 PRECISION KNOBS. "Daka-Ware." Finest made! Knurled, skirted types. Black bakelite; brass inserts, set screw. **\$1**
Reg. \$6.

5 SYLVANIA DIODES. Silicon, 1N21, two 1N22's, 1N23, **\$1**
1N105. Reg. \$12.

175-FT. HOOKUP WIRE in 25-ft. rolls. Asstd. colors, stranding, insulation. #18 to 24. **\$1**
Wt. 2 lbs. Reg. \$3.75.

3 LBS. HARDWARE. Approx. 2000 pcs. asstd. screws, brackets, etc. Reg. \$8. **\$1**

125 RESISTORS, 1/2, 1 W. 40 values: 5 ohms to 10 megs. 5%, too. Reg. **\$15.**

10 ELECTROLYTICS, asstd. can, tubular types to 500 mf. **\$1**
Wt. 3 lbs. Reg. \$14.

50 PLUGS & RECEPTACLES. Audio, power, chassis, panel & spkr. types. Wt. 2 lbs. **\$1**

40 PRECISION RESISTORS. Carbonfilm, Wilkors, etc. 1%; wide variety values, 1/2 & 1W. **\$1**
Wt. 1/2 lb. Reg. \$18.

JULY SPECIAL Transistor & Subminiature PARTS

SALE!

SUB-MINI SPEAKER Only 1 1/2" sq., heavy \$1.99 magnet, 3.2 ohm v.c.	SUB-MINI P-N-P TRANSISTOR 1/2 pencil eraser size! Used in "Name" portables. W/factory "spec" sheet. \$1.00
WORLD'S SMALLEST TRANSISTOR Choice of three, all fine steel, color coded leads; 20K to 1K; 10c to 2KCT, 500CT to 3.2 ohms...ea. \$1.49	"POSTAGE STAMP" MIKE Crystal, hi-imp. 3/4" sq. w/poly case. Crisp, clear to 8,000 cps... \$1.00
SUPERHET OSCILLATOR COIL 5/8 x 9/32". Matches "Poly-Cased Variable." \$1.00 59c ea. 2 for	40 SUB-MINI RESISTORS 1/4" long, 20 values: 15 ohms-10 megs. 1/5 W. \$1.00 Reg. \$6.
SUPERHET VARIABLE Poly-Cased, 5/8 x 1-1/16". 2-gang; ant. sect: 10 to 208 mf; osc. sect: 10 to 100 mmf. \$1.95	8 TRANSISTOR SOCKETS For sub-mini tubes, too. Mica-filled. Reg. \$3. \$1.00
CRYSTAL PHONE Hearing aid type, w/cord. Use as mike, \$1.39 tool	2 TRANSISTOR "OUNCER" TRANSFORMERS UTC Interstage, 1 x 3/4 x 3/4". Imp. ratios unknown. Color-coded leads. Reg. \$10. \$1.00
2,000 OHM PHONE Hearing aid type, with cord \$1.69	4 FERRI-LOOSTICK CORES Hi-Q, asstd. flat & tubular. 5 to 7" long. Wt. 1 1/2 lbs. \$1.00
SUPER SOLAR BATTERY Plug-in type, for all SUN projects. 2 1/2 x 1 3/4 x 1/2" plastic case. Outperforms \$2.98 Infamed B2M.	TRANSISTOR ADD-A-STAGE Makes any crystal set (like our own) into transistor radio. Instructions, transistor, case, parts \$1.99
8,000 OHM DYNAMIC PHONE Finest of hearing aid-types. Makes weak sigs loud. W/cord & plug. \$3.88	SUPER SENSITIVE RELAY 100 to 500 microamps; 0.5 VDC excites 4,000 ohm coil. SPDT adj. cont. \$2.98 Molded case.

HOW TO ORDER

ORDER BY "BLACK TYPE" HEADLINES, i.e. "One R/C CONTROL SCOOP, \$1.00!"
Send check or M.O. including sufficient postage; excess returned. C.O.D. orders, 25% down. Rated, net 30 days. (Canada—postage 45¢ 1st lb.; 28¢ each add'l. lb.)

LEKTRON

SPECIALTIES

131-133 Everett Ave. Chelsea 50, Mass.

LEARN basic electricity electronics

THE EASY "PICTURE BOOK" WAY!



Just Released: The fabulous ILLUSTRATED Training Course now used by the U. S. Navy!

You Learn By Pictures

Over 25,000 Navy trainees have already learned Basic Electricity and Basic Electronics this easy, "Picture Book" way! Now, for the first time, YOU can master the basics of Electricity and Electronics with this same "Learn-by-Pictures" training course! Over 1,700 simple, easy-to-understand drawings explain every section—these "teaching" pictures actually make up more than half the entire course! No other Basic Electricity or Basic Electronics course in America uses this revolutionary illustrative technique! You learn faster and easier than you'd dream possible!

A Complete Idea on Every Page

Here's how this easy, illustrated course works: every page covers one complete idea! There's at least one big illustration on that same page to explain it! What's more, an imaginary instructor stands figuratively at your elbow, doing "demonstrations" that make it even easier for you to understand. Then, at the end of every section, you'll find review pages that highlight the important topics you've just covered. You build a thorough, step-by-step knowledge at your own pace—as fast as you yourself want to go!

Everyday English--A Course Anyone Can Understand

Sponsored by the Navy to turn our trained technicians in record time, this modern course presents Basic Electricity and Basic Electronics in a simple way that everyone can grasp—regardless of previous education! Every phase is made instantly clear—explained in plain, down to earth English—with hundreds of easy-to-understand illustrations to help you!

10 Complete Volumes

Volumes 1 and 2 of "Basic Electricity" cover DC components and circuits; Volumes 3 and 4 cover AC components and circuits; Volume 5 covers AC and DC motors and machinery. Volume 1 of "Basic Electronics" covers Diodes and Power Supplies; Vols. 2 and 3 cover Amplifiers and Oscillators; Vols. 4 and 5 cover Transmitters and Receivers.

Home Study Without Correspondence

This course is so different, so complete—there's no need for the usual letter writing, question and answer correspondence! Learn at home—at your own pace!

10 Day Examination--Money Back Guarantee

Send today for these exciting new training courses—you risk nothing! When you receive the volumes, examine them in your own home for 10 full days. If, at the end of that time, you're not completely satisfied, simply return the books to us and we'll gladly refund your full purchase price! Total cost for either 5-volume course is only \$9.00! In Canada, prices approximately 5% higher.

ORDER TODAY!

These books are sold by electronics parts jobbers and book stores. If YOUR dealer doesn't have these books, mail this coupon to us!

JOHN F. RIDER PUBLISHER, INC.
116 West 14th St., N.Y.C.

I have enclosed \$ _____ Please send me
 5-vol. Basic Electricity set @ \$9 set
 5-vol. Basic Electronics set @ \$9 set
 Both sets. I understand I may return the books in 10 days, and receive a complete refund of the full purchase price if I am not satisfied.
 Add state or city sales tax where applicable.

Name.....
 Address.....
 City & State..... PE-7

Shakeproof Your Turntable

(Continued from page 89)

than that already resting on the springs to lower the period substantially.

In addition to the low period, it is helpful to have "snubbers" in the springs, which act very much like the snubbers on the wheels of a car. If you use coil springs, you can stuff the insides of the springs tightly with cloth so that even if the assembly does start to bounce, it will be slowed to a stop after one or two motions.

Jump for Joy. Now—you have your unit on proper springs, it has a low period, it has good snubbers. Start a record and put a pickup in the groove. Jump up and down as hard as you can in the middle of the floor. It's nice, isn't it, to see that pickup go right on about its business, as though you weren't there hopping around like a jerk! —30—



Transistor Topics

(Continued from page 98)

To identify the two remaining electrodes, connect the ohmmeter leads to these two terminals, reversing the connections if necessary, and determine the forward resistance. With the leads connected to indicate forward resistance (the lower value), the positive ohmmeter lead will be connected to the collector of an *n-p-n* transistor; if the unit is a *p-n-p* transistor, the positive ohmmeter lead will be connected to the emitter electrode.

Things to Come. The C. Carrier Co., 734 15th St., N. W., Washington, D. C., is advertising a partially transistorized projection color television receiver. Watch future issues of POP'tronics for further information on this new development!

A market survey made for the Philco Corporation by Stanford Research Institute predicts that transistor production will reach 125,000,000 units annually by 1959, as compared to an anticipated production of 26,000,000 units this year . . . an increase of about 500% in only three years. If transistorized fuel injection systems continue to grow in popularity, this market alone may require as many as 30,000,000 units annually!

Product News. Lafayette Radio (165-08 Liberty Ave., Jamaica 33, N. Y.) is introducing several new transistorized radio receiver kits. One model is a broadcast-band superhet featuring *n-p-n* transistors. Another model features two-band operation. There is some possibility that a three-band model will be introduced in the future by this company.

We've heard a rumor that The Heath

Company (Benton Harbor, Mich.) will bring out a transistorized portable receiver kit before too long.

A heat-powered transistorized receiver has been developed by N. V. Philips Gloeilampenfabrieken, Eindhoven, Holland. A thermopile, or "battery" of thermocouples, serves as the power supply. This may be heated by candles, by gas, or even by a kerosene lamp.

The Gramer Halldorson Transformer Corporation (2734 N. Pulaski Rd., Chicago 39, Ill.) has introduced a series of 150- and 300-milliwatt transistor audio transformers. A total of 32 are represented in the series—21 lower power units and 11 300-mw. units. To assist the engineer and advanced experimenter, these transformers are available in a complete assortment as a packaged "kit." (See the photograph on page 98.)

That's it for now, fellows. Keep cool, and don't get sunburned. . . .

Low



Damp Before Your Ears

(Continued from page 58)

imum power transfer between amplifier and speaker.

Damping Measurement. You can readily measure the damping factor of your present amplifier, to determine how closely it meets the recommendations given for the particular loudspeaker you plan to purchase. All you need is a dozen or more 5-ohm, 1/2-watt resistors and an audio oscillator. If you have no oscillator, use instead a test record having a sustained tone of 1000 cycles or 400 cycles. An a.c. voltmeter having 0-1 volt as its lowest range completes the necessary equipment.

Disconnect the loudspeaker from the amplifier output. Hook up the voltmeter to the correct output terminals of the amplifier (depending on the impedance of the proposed speaker). Then apply a signal to the amplifier either from the audio generator or the test record. Adjust the vol-

WHAT DAMPING DOES FOR YOUR SPEAKER		
	Good Damping	Poor Damping
Distortion	If present, greatly decreased	If present, it goes unchecked
Bass	Flattens false peaks	Boomy due to uncontrolled resonance
Treble	Tends to be flat	Tends to shrill peaks
Transients	Sharp sounds clean and crisp	Sharp sounds blurred

LEARN BASIC TELEVISION

The whole world of black and white television is before you for only \$10.00.



New 5-volume Rider "picture book" course by Dr. Alexander Schure teaches the complete basic principles and practices of black and white television easily, quickly and understandably. You can master the basics of television easily, rapidly and thoroughly with this "learn by pictures" training course.

It's so easy to learn

Here's how this easy, illustrated course works. Every page covers one complete idea! There's at least one big illustration on that same page to explain it! What's more, an imaginary instructor stands figuratively at your elbow, doing "demonstrations" that make the theory easy for you to follow and understand. Then, at the end of every section, you'll find a review that highlights the important topics you've just covered. You build a thorough, step-by-step knowledge at your own pace—as fast as you yourself want to go.

No experience, education needed

BASIC TELEVISION uses the same methods that have proven so successful in the famous Rider "picture books" on electricity and electronics. This comprehensive course presents Basic Television in simple, down-to-earth language that everyone can understand—regardless of previous education. All that is assumed is that you have a knowledge of radio. Every phase of television is made instantly clear—explained in plain English supported by carefully prepared, large and exciting drawings that make every idea crystal-clear.

5 complete volumes

It starts with the transmitter and discusses in detail the following subjects: Volume 1 deals with the transmitter; the handling and the operation of the camera; formation of the picture signal and the general content of the transmitter. Volume 2 covers the organization of the entire TV receiver treating each section individually from antenna to picture tube. Volumes 3, 4 and 5 contain the TV receiver circuit explanations. Each volume covers a specific number of sections in the receiver. In effect, the presentation is like a spiral—first an overall view of the whole, and then the detailed explanation of each part. The most perfect modern teaching technique. The result—maximum understanding.

Learn at home—no correspondence

This course is so complete, so different—there's no need for the usual letter writing, question and correspondence. You learn in the comfort of your home, in your spare time . . . at your own pace.

10-day examination—Money Back Guarantee

Send today for these exciting new training courses—you risk nothing! When you receive the volumes, examine them in your own home for 10 full days. If, at the end of that time, you're not completely satisfied, we will simply return your full purchase price! Total cost for this 5-volume course is only \$10.00! In Canada, prices approximately 6% higher.

ORDER TODAY

These books are sold by electronics parts jobbers and book stores. If YOUR dealer doesn't have these books, mail this coupon to us.

JOHN F. RIDER PUBLISHER, INC. Dept. PE-7
116 West 14th St., N.Y.C.

I have enclosed \$ _____ Please send me

5-vol. BASIC TELEVISION set (soft cover) at \$10.00 per set

Deluxe cloth bound edition all 5 vols. in a single binding \$11.50

I understand I may return the books in 10 days, and receive a complete refund of the full purchase price if I am not satisfied.

NAME _____

ADDRESS _____

CITY & STATE _____

ume until the meter reads about 0.2 volt. Now place across the output terminals as many of the 5-ohm resistors as are necessary to reduce the meter reading to 0.1 volt. In adding resistors in parallel, make certain to solder each one across the other, because even a fraction of an ohm of contact resistance will throw off this measurement.

After obtaining a reading of 0.1 volt, count the number of resistors used and divide this number into 5 to obtain the internal resistance of the amplifier. Next, divide the internal resistance into the impedance of the speaker to obtain the damping factor. The schematic on page 58 illustrates the procedure.

Optimum Matching. Having determined the damping factor of your amplifier, what can you do about it? If you should find that the damping factor is just about right for the speaker of your choice, let it go at that. On the other hand, if the damping factor exceeds the amount required for your loudspeaker, it is very simple to lower the damping factor externally.

Suppose an 8-ohm loudspeaker has a recommended damping factor of 4. That means that the loudspeaker, "looking back towards the amplifier," should see 2 ohms of resistance. Suppose then that the internal amplifier resistance, as measured by

the procedure given above, is only 1 ohm. Simply add an external 1-ohm resistor (having at least a 2-watt rating if you play your music very loud) in series with one of the speaker leads, and you have met the requirements of the speaker manufacturer. The result will be a distinct—if subtle—difference in the sound you hear.

The situation is less simple if you find that your amplifier does not provide sufficient internal damping for the loudspeaker you want to use. There is very little you can do about it without making elaborate circuit changes. Your best bet is to find a more compatible speaker—or amplifier.

A good many amplifiers are now equipped with a variable damping factor control. This lets you match the damping factor of the amplifier to a wide variety of speakers. More important, such controls enable the user to set the damping factor at a point most pleasing in terms of over-all sound, taking into account the vagaries of speaker enclosures, listening rooms, furnishings, etc. While some of these controls are labeled by various trade names, they all amount to pretty much the same thing, differing only in the provided range of control. With such a control, you can "crisp" music to your taste—dry, soggy, or in-between—just like bacon. —50—

ENTHUSIASTIC PRAISE GREETED THE WORLD'S FIRST COLOR ANNUAL



"A Noteworthy . . . Satisfying Achievement"

—THE NEW YORK TIMES

"Big, bold, beautiful"

—CLEVELAND PRESS

"Expertly presented . . . excellent"

—IRVING DESFOR
ASSOCIATED PRESS
CAMERA EDITOR

NOW—the big, second edition of the POPULAR PHOTOGRAPHY COLOR ANNUAL is on sale. It features completely new portfolios and pictures by such master photographers as: Briggs, de Evia, Groebli, Haas, Halsman, Karsh, Penn, Stern, Winquist and others.

- PLUS**
- a strikingly illustrated, provocative debate on the NUDE IN PHOTOGRAPHY—Is It Art?
 - a symposium by 15 famous photographers, critics and authors on IS COLOR CREATIVE?
 - a complete handbook for the color photographer—with charts on filters for color, color temperature meters, instructions on color processing and printing!
 - AND page after page of exquisite color reproductions—the largest collection of color photographs ever published in any single volume!

**LOOK FOR THE 1957 POPULAR PHOTOGRAPHY COLOR ANNUAL!
NOW ON SALE AT ALL NEWSSTANDS—ONLY \$1.00!**



"ONE DOLLAR buys"

As much as \$15 worth—Everything Brand New and sold to you with a money back guarantee.

- | | |
|--|---|
| 100 ASSORTED 1/2 WATT RESISTORS. \$1 | 15 ASSORTED ROTARY SWITCHES \$1.50 worth. \$1 |
| 70 ASSORTED 1 WATT RESISTORS. \$1 | 10 6 FT. ELECTRIC LINE CORDS with plugs. \$1 |
| 35 ASSORTED 2 WATT RESISTORS. \$1 | 20 10KV CARTWHEEL COND. total list \$35. \$1 |
| 100 FUSES 1 AMP standard size 1 1/4" x 1/4". \$1 | 50 100Ω 1/2 WATT RESISTORS 5%. \$1 |
| 100' FINEST NYLON DIAL CORD best size. \$1 | 50 470KΩ 1 WATT RESISTORS 10%. \$1 |
| 50 ASST. TUBULAR CONDENSERS 85°. \$1 | 25 100KΩ 2 WATT RESISTORS 10%. \$1 |
| 10 ELECTROLYTIC COND. 100/50 - 50/25V. \$1 | 10 ASST. WIREWOUND RES. 5, 10, 20 watts. \$1 |
| 35 ASST. RADIO KNOBS screw and push-on. \$1 | 3 AUDIO OUTPUT TRANSFORMERS 50L6 type. \$1 |
| 400 ASST. HARDWARE, screws, nuts, rivets, etc. \$1 | 3 AUDIO OUTPUT TRANS. 6K6 or 6V6 type. \$1 |
| 200 SELF TAPPING SCREWS #8 x 1/2". \$1 | 3 I.F. COIL TRANSFORMERS 456kc. \$1 |
| 50 ASST. SOCKETS octal and miniature. \$1 | 2 I.F. COIL TRANSFORMERS 10.7 mc FM. \$1 |
| 50 ASST. MICA CONDENSERS some in 5%. \$1 | 4 OVAL LOOP ANTENNAS asst. hi-gain types. \$1 |
| 50 ASST. CERAMIC CONDENSERS. \$1 | 3 LOOPSTICK ANT. new ferrite, adjustable. \$1 |
| 10 ASST. VOLUME CONTROLS less switch. \$1 | 12 RADIO OSCILLATOR COILS 456kc. \$1 |
| 5 ASST. VOLUME CONTROLS with switch. \$1 | 3 1/2 MEG VOLUME CONTROLS with switch. \$1 |
| 20 ASST. PILOT LIGHTS #44, 46, 47, 51. \$1 | 1 6" PM SPEAKER alnico #5 magnet. \$1 |
| 10 PILOT LIGHT SKTS. bayonet type, wired. \$1 | 2 \$2.50 SAPPHIRE NEEDLES 4000 playings. \$1 |
| 50 ASST. TERMINAL STRIPS 1, 2, 3, 4 lug. \$1 | 2 SELENIUM RECTIFIERS 1-65ma. 1-100ma. \$1 |
| 10 ASST. RADIO ELECTRO. CONDENSERS. \$1 | 5 DIODE CRYSTALS 2-IN21 2-IN23 1-IN64. \$1 |
| 5 ASST. TV ELECTROLYTIC CONDENSERS. \$1 | 50 TUBULAR CONDENSERS .02-400V. \$1 |
| 15 ASST. TV COILS sync. peaking, width, etc. \$1 | 50 TUBULAR CONDENSERS .001-600V. \$1 |
| 200' HOOK-UP WIRE & SOLDER KIT. \$1 | 25 TUBULAR CONDENSERS .01-600V. \$1 |
| 100' TWIN LEAD-IN WIRE 200Ω heavy duty. \$1 | 20 TUBULAR CONDENSERS .25-600V. \$1 |
| 1 57 INDOOR TV ANTENNA hi-gain 3 section. \$1 | 20 TUBULAR CONDENSERS .047-600V. \$1 |
| 25 ASST. MICA TRIMMER CONDENSERS. \$1 | 3 ELECTROLYTIC COND. 50/30 - 150V. \$1 |
| 1 TV SYNCHROGUIDE TRANSFORMER #205R1. \$1 | 3 ELECTROLYTIC COND. 40/10/10 - 450V. \$1 |
| 1 TV SYNCHROLOC TRANSFORMER #208T8. \$1 | 3 ELECTROLYTIC COND. 40/40 - 450V. \$1 |
| 1 TV RATIO DETECTOR TRANS. 4.5mc. \$1 | 3 TV ALIGNMENT TOOLS 7", 12", 18". \$1 |
| 6 SPIN TIGHT SOCKET SET 3/16" to 7/16". \$1 | |

HANDY WAY TO ORDER—Simply tear out advertisement and pencil mark items wanted, enclose with money order or check. No letter needed, envelope address is sufficient. You will receive a new copy of this ad for re-orders.

ON SMALL ORDERS—Include stamps for postage, excess will be refunded. Larger orders shipped express collect.

Resistor & condenser code charts FREE with each order

BROOKS RADIO & TV CORP.

84 Vesey St., Dept. E, New York 7, N. Y.

trodes will still be at ground potential and the patient will not be in danger of possible electrocution!

After placing the patient between two suitable electrodes, the machine is tuned until a milliammeter in the plate circuit swings to maximum. This shows that the entire load circuit, including the patient himself, is in resonance with the oscillator. In effect, the patient acts as a dielectric between the electrodes.

Although the FCC has approved several different models of self-excited oscillator diathermies, some manufacturers claim that such equipment can never be relied upon to remain on the legal frequency. These manufacturers swear by crystal-controlled units which provide pin-point frequency stability and remove all the guesswork during the life of the machine regardless of tube changes or dislocation of wiring or components. As for output power, about 400 watts is considered by the medical profession as just about right to produce deep-seated heating in bone and cartilage tissue.

The erstwhile "miracle of medicine" that sprang directly from radio experimentation is now shorn of false claims and unreasonable expectation. Yet its very real merits have earned for it a firm and respected place in the doctor's office for specific, limited application. In the home, diathermy equipment should be used only on a doctor's advice. In either case, increasing public dependence on radio-operated devices demands that every diathermy user know the necessary precautions to safeguard radio service from interference. —30—



The "Varistrobe"

(Continued from page 54)

setting of the RANGE switch yields the calibration line from 60 cps to 240 cps. This may be drawn on the same sheet of paper as shown in the sample. In this case, start from 60 cps and work your way up in frequency. Cessation of motion can be observed for 60 cps, 120 cps, 180 cps, and 240 cps, giving four points for the second calibration line. Now your tachometer graph is ready for use.

To find the speed of any rotating or reciprocating body, scratch or chalk it in one spot that will be clearly visible while it is in motion. Next, determine the highest frequency which freezes the reference mark so that it is visible in only one place. The dial may now be read and translated in cps from the graph. To convert cps into revolutions or reciprocations per minute, multiply the cps by 60. —30—

LEARN

RADAR MICROWAVES TRANSMITTERS

CODE TV RADIO

Phila. Wireless Technical Institute

1533 Pine St. Philadelphia 2, Penna.

A Non-Profit Corp. Founded in 1908

Write for free catalog "P"

"Economy" Transistor Checker

(Continued from page 60)

rent gain. If the leakage reading was very low, the meter reading, multiplied by 100, can be called the approximate beta (β) for the transistor. At any rate, the meter reading can be checked against Table 1.*

If the transistor has an appreciable amount of leakage, the current gain (β) can be obtained by observing the change in meter reading when switching from the

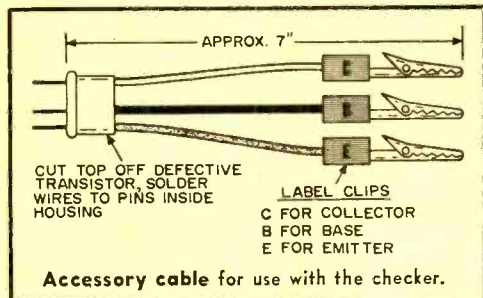

leakage to gain positions. The difference between these two readings divided by the change in base input current which occurs when switching between leakage and gain positions will give the common emitter current gain. For example, in the transistor checker, the base input current is 10.7 microamperes. Thus, if the meter reads a change of 0.5 milliamperes in going

Transistor Type No.	Leakage Reading	Gain Reading
CK722	0.1	0.3
2N107	0.1	0.5
2N45	0.2	0.4
2N78	0.05	0.55
2N94	0.0	0.3
2N137	0.1	0.7

Table 1. Typical leakage and gain readings obtained for several different types of transistors.

from leakage to gain positions, the approximate current gain would be 0.0005 divided by 0.000107, or 46.7.

Many manufacturers rate transistor gain as alpha (α) which is the common-base current gain. This is a number always less than "1" for junction transistors and is generally of the order of 0.98.

* The purists will note that this statement was qualified by using the word "approximate" in reference to current gain. Strictly speaking, the current gain depends on the d.c. operating point of the transistor, just as μ does in vacuum tubes. It is measured in the laboratory by a.c. methods at the desired fixed d.c. operating point. However, the simplicity and the fact that transistors themselves are not as closely controlled justify the method used in the checker.

IN ONLY 2 YEARS

he'll have an
ASSOCIATE of SCIENCE
DEGREE in...

ELECTRONICS ENGINEERING DESIGN

The increasingly acute shortage of engineering talent assures unlimited opportunities in electronic and aviation fields. A 2-year intensive course at Embry-Riddle—an approved technical institute—leads to a Degree and specialization in rewarding careers such as servo and instrumentation engineer, electro-mechanical engineer, electronic design engineer, and materials and process engineer.

Embry-Riddle's constant supervision, concentration on essentials, and minimum required instruction of 25 hours per week assures you the education your future requires. You'll enjoy Miami's perfect year-round climate for study and training.

Take your big step now. Think BIG—think Aviation! Mail coupon for pictorial brochure and complete outline of curricula.



TRAINING
AUTHORIZED
UNDER
G. I. BILLS

MAIL THIS COUPON TODAY

DEAN OF ADMISSIONS, Dept. 47
Embry-Riddle Aeronautical Institute
Miami 30, Florida

Without obligation, please send FREE and post-paid full particulars.

- ELECTRONICS ENGINEERING DESIGN
 AERONAUTICAL ENGINEERING DESIGN
 A. & P. TECHNICIAN FLIGHT

Name..... Age.....

Address.....

City..... State.....

I am a (check one) Veteran Non-Veteran

Can you think faster than this Machine?

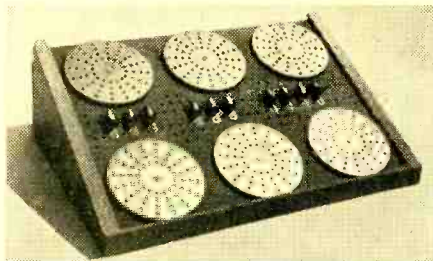

GENIAC set up to do a problem in check valve research
Be careful before you answer. GENIAC the first electrical brain construction kit is equipped to play tic-tac-toe, cipher and encipher codes, convert from binary to decimal, reason (in syllogisms) as well as add, subtract, multiply and divide. Specific problems in a variety of fields—actuarial, policy claim settlement, physics, etc.—can be set up and solved with the components. Connections are solderless and are completely explained with templates in the manual. This covers 33 circuits and shows how new ones can be designed.

You will find building and using GENIACS a wonderful experience; one kit user wrote us: "this kit has opened up a new world of thinking to me." You actually see how computing, problem solving, and game play (Tic-tac-toe, nim, etc.) can be analyzed with Boolean Algebra and the algebraic solutions transformed directly into circuit diagrams. You benefit from over 400 specially designed and manufactured components a machine that solves problems faster than you can express them.

---MAIL THIS COUPON---

SCIENCE KITS, Dept. PE-77B, Oliver Garfield Company
126 Lexington Avenue, New York 16, N. Y.

Please send me:

1 GENIAC Electric Brain Construction Kit and Manual.

\$19.95 (East of Mississippi)

\$20.95 (Elsewhere in United States)

\$21.95 (Outside the United States)

Returnable in seven days for full refund if not satisfied.

I enclose \$..... in full payment.

My name and address are attached.



college graduates get ahead faster!

You see it in your own city. They have higher incomes . . . advance more rapidly. Grasp your chance for a better life. Industrial growth . . . automation . . . technical advances create career opportunities for engineers, accountants, management experts. Share rewards awaiting college-trained men. Important firms visit campus regularly to employ Tri-State College graduates. Start any quarter in this world-famed college. *Approved for veterans.*

Bach. of Science degree in 27 months

In Mechanical, Civil, Electrical, Chemical, Aeronautical, Radio (TV-Electronics) Engineering. *In 36 months a B.S. in Business Administration (General Business, Accounting, Motor Transport, Management majors).* Superior students may accelerate. 36-week course in Drafting. *Intensive programs:* technical fundamentals stressed; comprehensive courses with more professional class hours. *Small classes:* personalized instruction. Enrollment limited to 1550. Preparatory courses. *Beautiful campus.* Well-equipped, new and modernized buildings and laboratories. Enter Sept., Jan., March, June. Earnest, capable students (whose time and budget require accelerated courses and modest costs) are invited to write Jean McCarthy, Director of Admissions, for catalog and book "Your Career in Engineering and Commerce."



TRI-STATE COLLEGE

3677 College Avenue

Angola, Indiana

AMAZING NEW "LIFETIME" RADIO

GUARANTEED TO WORK FOR YOUR LIFETIME! USES NO TUBES, BATTERIES OR ELECTRICAL PLUG-INS. Never runs down! SMALLER THAN A PACK OF CIGARETTES! RECEIVES LOCAL RADIO STATIONS MOST ANYTIME, ANYWHERE WITHOUT EXTRA ANTENNA. Uses crystal diode Hi-Q Tuner. Beautiful black gold speaker-phone grill—plastic cabinet.



SEND ONLY \$2.00

(bill, ck, mo) and pay post-man \$4.99

COD on arrival or send \$6.99 for postpaid delivery. SENT COMPLETE READY TO LISTEN—NOTHING EXTRA TO BUY EVER! Aerial kit included free for distant stations. Available only from:

MIDWAY COMPANY, Dept. GPL-7, Kearney, Nebraska

After Class

(Continued from page 83)

after the d.c. surge has long since passed away. We have now arrived at the "full-on" stable state.

To bring the ferristor back to the non-saturated stable state, or the "off" condition, all that we need do is drop the r.f. voltage temporarily to some smaller value. Such a drop permits the r.f. current to decrease, which in turn restores the core to its non-saturated, non-resonant state so that the circuit once again stabilizes at point A. This useful bi-stable action may be utilized in pulse counters such as are found in computers and in ring counters like those found in rugged industrial decimal counting units.

A small permanent magnet is mounted on some types of ferristors. The magnet can be rotated to increase or decrease the initial degree of saturation, achieving a biasing effect corresponding to grid bias in vacuum-tube circuits. This arrangement is used in oscillators and multivibrators to establish correct biasing conditions for free-running operation.

—30—

Kit Builder's Korner

(Continued from page 81)

are a moderately fast worker, and don't mind staying up a little late, you can assemble and install the complete system in a single evening.

Special Features. The heart of the Knight intercom system is a three-tube audio amplifier contained in the master station. Designed for 117-volt a.c./d.c. operation, the amplifier uses a 12AV6 tube as the first amplifier stage, a 50C5 as a power amplifier, and a 35W4 as the rectifier. The danger of accidental shock is minimized by "floating" the amplifier's power supply circuit above chassis ground.

Because only the master station needs to be connected to a power outlet, the remote station may be located at almost any point. If the #22-gauge three-wire cable supplied

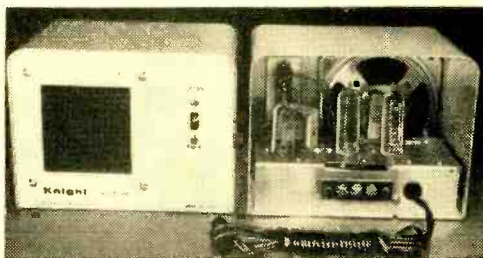

The completed intercom—front view of the "remote" unit (left) and rear view of the "master."

Always say you saw it in—POPULAR ELECTRONICS

with the kit is used to connect the two stations, they may be placed up to 50 feet apart. If #18-gauge wire is used, they may be as much as 200 feet apart.

It is evident that the kit and instructions were planned with the needs of the beginner as well as the more advanced worker in mind. Special efforts have been made to simplify the identification of component parts. For example, the resistors are taped to a small cardboard sheet, with each resistor value identified according to component number.

From a constructional viewpoint, the use of pre-cut and pre-stripped hookup wire certainly is a desirable feature. It eliminates a rather tedious part of the wiring job. From an operational viewpoint, the provision for a pilot light and a front panel volume control are features which are highly desirable but often omitted in low-cost intercom systems.

Comment. In general, this is an excellent low-cost intercom system and a kit which assembles with a minimum of effort. There are only two items which your columnist feels should be modified.

First, as now designed, the three-wire interconnecting cable is soldered permanently to connection points in the remote station, although a screw-type terminal

strip is provided for these connections in the master station. Screw-type terminal strips would be preferable in both stations.

Secondly, the back of the remote station is left open. With children about, inquisitive fingers could get into trouble. A back made out of fiberboard or metal would solve this problem.

-30-

Double Your AT1 Output

(Continued from page 56)

meter operation. The *Output* dial turns at approximately the same position as it did before the transmitter was modified.

Maximum power output from the modified transmitter is obtained with a maximum grid current of approximately 2.0 ma. to the 2E26. On 80 and 40 meters, over 5.0 ma. of grid current can be obtained. It is controlled by detuning the *Driver* control on these bands.

The power output from the modified AT1 is approximately double its former value on the 40-, 20-, and 15-meter bands. Substituting a 6146 tube for the 2E26, without additional circuit changes, will give slightly more output (and input), but the 6146 costs somewhat more than the 2E26.

-30-

Abraham Marcus, co-author of famous best-seller "Elements of Radio" makes amazing offer!



TRY MY TV and RADIO REPAIR COURSE FREE FOR 1 MONTH

"If you haven't earned at least \$100 in spare time during that period you pay not a cent."

Here it is! The most amazing guarantee ever offered on any radio-TV course anywhere! We'll send you Abraham Marcus' course to use FREE for one full month! If in that time you haven't actually made \$100 fixing radios and TV sets, just return the books to us and pay not a penny!

Why do we make this sensational offer? First, because these books are so easy to use. They are written in the same clear, easy-to-understand language that made the author's "Elements of Radio" a 1,000,000-copy best-seller. Second, because these books get right to the point—tell you what to do in 1-2-3 fashion. For example, once you master the first few chapters of the TV book you are ready for business—ready to do service jobs in the field—jobs that account for over 80% of all service calls.

DON'T WAIT! You risk nothing when you send the coupon at right. You don't have to keep the books and pay for them unless you actually make extra money fixing radios and TV sets. Even when you decide to keep them, you pay on easy terms. Mail the coupon now.

WHAT YOU GET IN THESE 3 GIANT VOLUMES
ELEMENTS OF TELEVISION SERVICING. Analyzes and illustrates more TV defects than any other book, and provides complete, step-by-step procedure for correcting each. You can actually SEE what to do by looking at the pictures. Reveals for the first time all details, theory and servicing procedures for the RCA 28-tube color television receiver, the CBS-Columbia Model 205 color set, and the Motorola 19-inch color receiver.
RADIO PROJECTS. Build your own receivers! Gives you 10 easy-to-follow projects, including crystal detector receiver—diode detector receiver—regenerative receiver—audio-frequency amplifier—tuned-radio-frequency tuner—AC-DC superheterodyne receiver—etc.

RADIO SERVICING Theory and Practice. Here is everything you need to know about radio repair, replacement, and readjustment. Easy-to-understand, step-by-step self-training handbook shows you how to locate and remedy defects quickly. Covers TRF receivers; superheterodyne receivers; short-wave, portable, automobile receivers, etc. Explains how to use testing instruments such as meter, vacuum-tube voltmeters, tube checkers, etc., etc.



MAIL THIS COUPON

Prentice-Hall, Inc., Dept. 5702-J2
 Englewood Cliffs, New Jersey

Please send me Abraham Marcus' TV & RADIO REPAIR COURSE (3 volumes) for 10 days FREE examination. Within 10 days I will either return it and owe nothing, or send my first payment of \$5.60. Then, after I have used the course for a FULL MONTH, if I am not satisfied I may return it and you will refund my first payment. Or I will keep the course and send you two more payments of \$5.60 a month for two months.

Name
 Address
 City Zone State

The Transmitting Tower

(Continued from page 77)

Gary, KN4MKE, (13), has been on the air about two months with his Hammarlund HQ-129X receiver and WRL Globe Chief transmitter. He has worked 24 states and England, Scotland, Canada, and Peru. Gary is working on plans for a 9002-6J6 "bike mobile" for two meters and would appreciate suggestions.

... **Ben, KN5IRO**, uses a Johnson Viking Adventurer transmitter and a National NC-98 receiver helped along by a BC-453, a Q-Multiplier, and a preselector built from plans in POPULAR ELECTRONICS, October, 1956. In three months on the air, he has confirmed 40 states and also worked Alaska, Canada, and Hawaii. He uses W6SAI's 15-meter beam described in POPULAR ELECTRONICS, November, 1956, and finds that it works very well.

Want to work England on 40 meters? **J. E. Alban, G3JEA**, who has been the first European contact for many "Generals" on 40 meters, has called many Novices but has managed to work only one of them. G3JEA offers to make skeds with Novices on weekdays between 2200 and 0100 GMT (4:00 to 7:00 p.m., EST) and 2200 to 0700 GMT (4:00 p.m. to 1:00 a.m., EST) on weekends. He will listen between 7150 and 7200 kc., and will transmit below 7150 kc. ... **Dan, KN9HJK**, runs 75 watts into a 45' antenna and uses a Hallicrafters S-40B receiver. In 10 days on 40 meters, he has made 13 contacts in five states. Dan's pet gripe is hams who try to send

faster than they know how. He offers to help prospective hams obtain their licenses. ... **Ernie, VE3GG**, now has a Heath DX-35 transmitter feeding a 20-meter doublet and a "surplus" RCAF receiver. He has worked 41 states and nine countries. Ernie reports hearing many Novice signals mixed in with the DX on 20 meters. They are most likely from Novices who have hit a wrong "peak" in tuning their transmitters to 15 meters. This is easy to do, so watch out for it.

Bob, KNØIHF, thinks that 17 contacts in six states in three months on 40 meters indicates that he is not getting out too well. He wonders why he cannot make more contacts. Bob uses an Adventurer transmitter into a 30' vertical antenna and a Hallicrafters S-38D receiver. ... But if Bob thinks he has troubles, let him listen to the troubles of **Sheldon, KNZZAB**. In three weeks of trying with a Globe Chief, feeding a folded dipole antenna 40' high and well in the clear, he has not gotten an answer from a single one of all the stations he has heard on his Hallicrafters SX-43 receiver. Repeated checks indicate that everything is working perfectly—but no contacts! I'll bet, though, that he will have worked 20 states by this time.

Bill, KN9DGF, (37), started his ham career with the one-tube transmitter and one-tube receiver described in the booklet "How To Become A Radio Amateur," with which equipment he made many contacts. He then got a Heath AT1 transmitter and an NC-98 receiver. Operating on 3716 kc., he has made

GIGANTIC SAVE-TO-70% MAIL SALE

WAR SURPLUS EXCESS INVENTORY BANKRUPT STOCK

DC MILLIAMMETER

• Brand new genuine Weston 0-1 MA basic meter, 18.6 MV full scale with external precision multiplier. In square metal case with test lead. 3/8" x 2 1/2".
Cost Govt. \$50. SALE \$4.49 Ppd.

FM TRANSMITTER

• New army surplus. Model BC-604. Freq. range 20-27.9 MC. Input 12 or 24-v DC. 1 1/2" x 1 1/2" x 10 1/2". Wt. 56 lbs. Less dynamotor, crystals. Cost Govt. \$504.00. SALE \$17.95 FOB
• DM-37 dynamotor for above \$5.95 FOB.
Set 80 crystals 20 to 27.9 mc. \$19.95 FOB.

SIGNAL GENERATOR

• Army surplus, Model I-198-B. Contains 957 acorn tube. Frequency range, 150 to 225 MC. Battery operated. Wonderful exper. unit. 8" x 8" x 13 1/2". Wt. 7 1/2 lbs.
SALE \$2.99 FOB

99¢ KITS 99¢

Your Choice—Prepaid in U.S.A.

- 11 Potentiometers. Good value. 99¢
- 26 Resistors. To 10-W. 99¢
- 5 Vacuum Tubes. A real buy. 99¢
- 14 Capacitors. Tubulars, bathtubs. 99¢
- 16 Tube Sockets. 4, 7, octals, etc. 99¢
- 1 Surprise Package. Min. value \$8. 99¢

POWER SUPPLY

• Navy model CIG211078. Uses dynamotor 4188. Voltage regulated input, 12 to 13-v at 27 amps. Output 250-v at 60 MA and 300-v at 225 MA. Contains midiget 13-v, 10 rpm motor. Dim. 11" x 7 1/2" x 8". Net wt. 34 lbs. Govt. cost over \$100.00.
SALE \$9.95 FOB

RAL-8 RECEIVER

• Brand new Navy surplus precision monitor receiver. Complete with separate power supply. Range 0.3 to 23 MC. Input 115-v, 60-c, AC. Wt. 300 lbs. Govt. cost \$100.00.
SALE \$49.95 FOB

SPECIAL OF THE MONTH!

MIDGET ALNICO GENERATOR

• Hand operated AC generator signal unit. Voltages up to 110. Ideal for signal bells, fish worm getter, experiments, many other uses. Cost over \$18.00.
SALE \$3.49 Ppd.

ELECTRONIC SPECIALS

Last Minute Items—New Surplus

- Dynamotor, DM-37 25-v/625-v or 12-v/280-v. SALE \$5.95 FOB
- Acorn Tubes, 955 or 954, Govt. cost \$3.60. SALE .39 Ppd.
- Chrome 3" Bell, 15 to 25-v AC or DC. SALE .99 Ppd.
- ARC-5 Transmitter, 3 to 4 MC, less dynamotor. SALE 7.95 FOB
- Army Geiger Tube. Precision radiation detection tube. Full instructions. Make ultra sensitive uranium Geiger counter unit. Worth \$100.00. Cost \$9.50. SALE \$1.95 Ppd.

ORDER FROM AD or write for big new FREE CATALOG 1000s items at tremendous savings. We pay frt. except where FOB.

SURPLUS CENTER

843 "O" St., LINCOLN, NEBRASKA

NEW! 4-Transistor Pocket Radio!



Size of cigarette package. No external antenna needed. Brings in stations 800 miles away at night. Loud volume. Uses 12 1/2-cent flashlight battery that lasts 1500 hours. Printed circuit. Free literature.

Complete kit, \$23.50. Fully wired, \$29.50.
Send for yours today!

Order now from
GARDINER ELECTRONICS CO., Dept. 13
2545 EAST INDIAN SCHOOL ROAD • PHOENIX, ARIZONA

LOWEST PRICES ANYWHERE
Picture Tubes—Transmitter Tubes—Radio & TV Parts

WRITE FOR STANLEY'S NEW FREE CATALOG

DUMONT AND RCA INC.

BRAND NEW TV PICTURE TUBES

UNCONDITIONALLY GUARANTEED FOR ONE YEAR
No dud required

10" Tube \$10.95	17" Tube \$17.95
12" Tube \$12.95	19" Tube \$20.95
14" Tube \$14.95	20" Tube \$20.95
16" Tube \$16.95	21" Tube \$22.95

Add \$4.00 to above prices for aluminumized tubes

TERMS: 25% deposit on all
COD's. Picture tubes F.O.B. Parsippany, N. J., via Rail-
way Express.

STANLEY

ELECTRONICS CORP.

840 MAIN ST.
PATERSON, N. J.

over 500 contacts in 25 states. Bill has passed his Technician examination and is waiting for word on the General test. He offers to help prospective amateurs get their licenses. . .

Ken, KN2VZE, powers his home-built, 10-watt transmitter from the power supply in his National NC-57 receiver. With this combination, he has made 70 contacts in 20 states—best DX Oregon—in two months on 40 meters.

Paul, KN8AYZ, runs a "full pint" to his Globe Chief, into a center-fed doublet. He receives with an S-38D receiver. His states-worked total is 20, and his latest project is a 15-meter, "beer can" vertical antenna. . .

Avery, KNØHLA, would like a sked with a station in the Denver area. He runs 65 watts to a DX-35 which feeds a 40-meter long-wire antenna through an AC1 antenna coupler. His receiver is an S-40B, with a Q-Multiplier. Avery has 11 states confirmed out of his 163 contacts in 19 states. . . **Henry, KN9GUW**, has worked one lonely Canadian, a VE5, in making 120 contacts in 26 states in seven weeks of 40-meter operation. His tools were a Johnson Adventurer transmitter, a 40-meter dipole 18' high, and a Hallicrafters S-85. His best DX is the west coast a couple of times.

Tony, KN6VAW, receives with a Hallicrafters S-38C and transmits through a Globe Chief running 75 watts to excite a 50' antenna, 23' high. The combination has been potent enough to work 29 states and Norway, Australia, Japan, Ecuador, and Alaska in 3½ months on the air. QSL percentages are 100% out, 80% in. . . **Alan, W1DVY**, would like to "go mobile" with his S-38C and DX-35 if he could find a power device to convert the 6 or 12 volts, d. c., from the car storage battery to 115 volts, a.c. Actually, d.c.-to-a.c. converters are listed in all radio supply house catalogs. A "junior" model of 30-watts rating, which would handle the receiver, is available for about \$10.00, but one heavy enough to handle a DX-35 would cost over \$50.00 and would draw around 30 amperes from a 6-volt battery.

Kay, KL7BVV, and husband, KL7BPY, comprise the population of the 100% ham town of Narrow Point, Alaska. The OM is an electronics technician for the CAA. Before he was sent to Alaska, Kay paid little attention to his hamming; but being 40 miles from her nearest neighbors on the other side of the



Kay, KL7BVV, operates at Narrow Point, Alaska. Her equipment includes an NC-300 receiver, HT-9 transmitter, a two-element beam and an "all-band" doublet. Kay's first W9 contact was with W9EGQ.

July, 1957

NEW WRL *Globe Scout 680* Now for the **6-80M Bands!***



Only
10%
Down

Only
\$729
per mo.

Cash Price, Kit . . \$84.95
Cash Price, Wired \$99.95

- ★ Completely bandswitching, 6-80 M; may be used by the advanced ham as well as the technician on fone and the novice on CW.
- ★ 65 watts on CW; 50 watts on fone.
- ★ Built-in power supply.
- ★ High level modulation; full modulation of Final.
- ★ TVI-shielded cabinet.
- ★ New-type, shielded, full-range plastic meter (D'Arsonval movement) for better readability.
- ★ Pi-net output on 10-80M; link-coupled output on 6M, matching into low impedance beams.
- ★ Adaptable for mobile operation.
- ★ Complete detailed manual and assembly instructions accompany kit form.

*Also available as shown except for frequency range; Globe Scout 66 for 10-160 meters, wired only, \$10.00 down, \$8.10 per mo. Cash Price, \$99.95

TUBE LINE-UP

6146 Final, 6V6 Oscillator, 6L6 Modulator, 6U8 Speech Amplifier and Driver, 5U4 Rectifier.

Send for Detailed Brochure Today!
GET THE STORY

on these hy-gain products:

Globe Spanners • 5-Band Wonder Doublet
Triple Globe Spanners • RotoBrake
Globe Topper Vertical Antennas

WORLD RADIO LABORATORIES

3415 W. Broadway Council Bluffs, Iowa

Please rush me complete information on the new Globe Scout 680, and details about the Globe Spanner Beams.

Name: _____

Address: _____

City & State: _____

with ID and anmts in English; Portuguese follows with music. (4)

Bulgaria—Radio Sofia, 9700 kc., is heard very well with two daily xmsns to N.A. in English at 2000-2030 and at 2300-2330. News is given at 2000 and 2300; native and classical music and commentaries make up the balance of the xmsn. (GS, PV, 206)

Cape Verde Islands—CR4AA, Radio Clube de Cabo Verde, Praia, is noted on 7135 kc. at 1600-1645 with music and Portuguese language. This 3-kw. station may be difficult to receive due to c.w.-QRM. (BL)

Ceylon—Colombo is heard on 15,265 kc. at 2030-2330 with English, replacing the 15,120-kc. outlet now being used at the same time for a xmsn in Hindi. (100)

China—Radio Peking has dictation-speed English news at 1030 on 15,060 kc. (JY)

Another xmsn in English news is heard at 2200-2210, commentary to 2218A, music to 2223, another talk to 2230 s/off. (226)

Cuba—COBL, Radio Aeropuerto en Havana, Havana, 9833 kc., is being heard in the west as early as 1800 with excellent music and all-Spanish anmts and ID. This xmsn is heard until 1925 when Budapest signs on. It has also been noted at 0000-0135. (61)

Dominican Republic—La Voz Dominicana, Ciudad Trujillo, is heard well at 1430 with local news and at 1445 with English lessons over HI2T, 9735 kc., HI4T, 5970 kc., and HI7T, 3285 kc. (OS)

HI3C, La Voz de Papagayo, La Romano,

continues channel-hopping and was recently logged on 2440 kc. after having been on 2420 and 2380 kc. (91)

Ecuador—A new station—location as yet undetermined—is HCFC1, heard Sundays at 1900-2200 when Radio Commerce is off. The frequency is 5982 kc. (100)

HCJB, Quito, continues to be heard well on 15,115, 11,915, 9745, and 6050 kc. with many religious programs. HCJB claims to have the first 50,000-watt missionary station in the world (9745 kc.). (176)

El Salvador—YSS, Radio Nacional de El Salvador, San Salvador, is noted on 9552 kc. at 1600 with American music. The signal is good and free of QRM. (OS)

England—The BBC states that its frequencies have calls assigned to them and not calls assigned to transmitters, so there is no way now for the listener to determine separate stations. (27)

Ethiopia—ETHA, Radio Addis Ababa, has been noted a number of times on 15,010V kc. from 1315 to 1415 fade-out, with English news at 1315. Another English newscast is slated for 1100-1115. Has anyone heard it? (61)

France—Radiodiffusion Francaise, Paris, carries an English religious period on 7240 and 9550 kc. at 0244-0400, presumably Sunday only. Here is a good chance to log and verify this country. (11)

French Equatorial Africa—Brazzaville has moved from 17,885 kc. to 17,880 kc. and is noted at 0830-1030 to the far east. The 11,970-

BUILD YOUR OWN AMATEUR TRANSMITTER!

... FROM ONE OF THESE 3 FEATURE-PACKED KITS!



NOW THAT YOU'VE GOT YOUR NOVICE TICKET, WHICH TRANSMITTER ARE YOU GOING TO BUY?

THAT'S A GOOD CHOICE! IT'S TVI SUPPRESSED--WORKS ALL BANDS 80 THRU 10--AND LOADS MOST ANY ANTENNA, TOO!



I'M SOLD ON VIKING GEAR--BUT WHAT TRANSMITTER ARE YOU GOING TO BUY?



I WANT THE 50 WATT VIKING "ADVENTURER" KIT--THE SAME TYPE TRANSMITTER USED TO EARN THE FIRST NOVICE WAC!

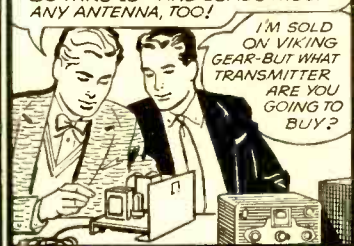

I WANT EITHER THE "RANGER" OR "VALIANT." BOTH ARE BAND-SWITCHING 160 THRU 10--AND OPERATE BY BUILT-IN VFO OR CRYSTAL CONTROL! BOTH ARE EFFECTIVELY TVI SUPPRESSED AND HAVE HIGH EFFICIENCY PI-NETWORK OUTPUTS!

WHAT'S THE DIFFERENCE?

THE "RANGER" RATES AT 75 WATTS CW INPUT... 65 PHONE.. THE "VALIANT" IS RATED AT 275 WATTS CW AND 55B... 200 PHONE. BOTH FEATURE TIMED SEQUENCE KEYING, AND THE "VALIANT" HAS SPEECH CLIPPING, MODULATION LIMITING, AND "PUSH-TO-TALK."

HERE'S ANOTHER FEATURE, BOYS. BOTH THE "RANGER" AND THE "VALIANT" MAY BE USED TO DRIVE ANY OF THE POPULAR KILOWATT TUBES--NO CHANGES REQUIRED TO SWITCH FROM TRANSMITTER TO EXCITER OPERATION.

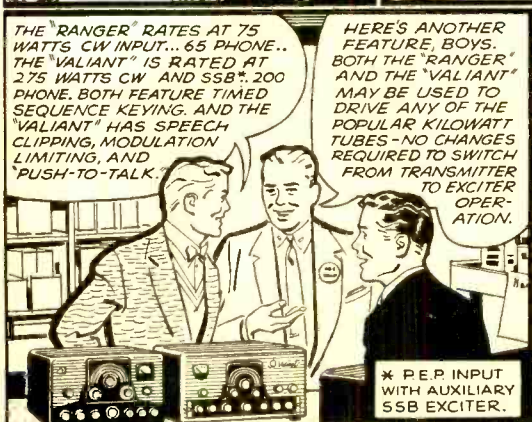

* PEP INPUT WITH AUXILIARY 55B EXCITER.



"ADVENTURER"
Kit... \$54.95 Net



"RANGER"
Kit... \$214.50 Net
Wired... \$293.00 Net



"VALIANT"
Kit... \$349.50 Net
Wired... \$439.50 Net

● GET THE FULL STORY ON THESE 3 GREAT TRANSMITTERS--

WRITE TODAY

E. F. JOHNSON COMPANY
3006 Second Ave., S. W., Waseca, Minnesota

Please send me a copy of your most recent amateur catalog.

Name _____

Address _____

City _____ State _____

Shrinks Hemorrhoids New Way Without Surgery

Science Finds Healing Substance That
Relieves Pain — Shrinks Hemorrhoids

For the first time science has found a new healing substance with the astonishing ability to shrink hemorrhoids and to relieve pain—without surgery.

In case after case, while gently relieving pain, actual reduction (shrinkage) took place.

Most amazing of all—results were so thorough that sufferers made astonishing statements like "Piles have ceased to be a problem!"

The secret is a new healing substance (Bio-Dyne*)—discovery of a world-famous research institute.

This substance is now available in *suppository or ointment form* under the name *Preparation H.** Ask for it at all drug counters—money back guarantee.
*Reg. U.S. Pat. Off.

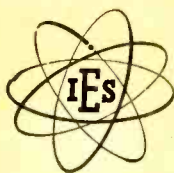

ELECTRONIC TECHNICIANS ARE IN DEMAND

TRAINED MEN ARE NEEDED NOW!

In just 18 months you can complete Electronic Technicians training to enter this ever-growing industry.

Day or evening classes. Opportunity for employment in local industry. Approved for Korean Veterans.

Terms beginning July, September, January, April
Write for Catalog 224 TODAY

INDIANAPOLIS ELECTRONIC SCHOOL

312 E. Washington St. Indianapolis 4, Indiana

2 WAY PORTABLE RADIO SET

SENDS—RECEIVES UP TO 10 MILES AS SHOWN

with built-in antenna or hundreds of miles with outside antenna! Works on 80 and 40 meter (Novice) amateur radio bands—also Aircraft and overseas broadcast (3 to 8 mc). PORTABLE SELF-CONTAINED POWERED WITH STANDARD PORTABLE RADIO BATTERIES. NO AC PLUG-INS NEEDED! Take it with you everywhere you go—on trips, vacations, camping—keep in contact with home, friends. Has 5 watt crystal controlled transmitter—Sensitive Regenerative Receiver. Semi-Receive switch.



WESTERN RADIO DEPT. BNE-7 KEARNEY, NEBR.

WT. only 3 lbs. Size, only 6" x 4" x 4". TESTED
—PROVEN—SIMPLIFIED—PRACTICAL—Full information given on quick easy to get license.
SEND ONLY \$3.00 (bill, ck, nol and pay postage on arrival or send \$14.95 for postpaid delivery. Complete kit includes all parts, tube, coils, plastic cabinet, easy instructions. (Set of batteries \$2.95; crystal \$1.25) COMPLETELY WIRED AND TESTED POSTPAID \$19.95.2 a regular \$49.95 value—Order now before price goes up GUARANTEED—AVAILABLE ONLY FROM:



SAVE \$9.00

NORELCO Men's Electric Shaver. Latest model, brand new and fully guaranteed. Complete with case, cord and cleaning brush. Regularly retails at \$24.95. Our price \$15.95 postage paid. All orders filled within 24 hours. Your money back if you are not fully satisfied. Send check or money order to:

JOHN BROOKS, Dept. 590, Box 212, St. Louis 3, Mo.

EASY TO LEARN CODE

Learn or increase speed with an Instructograph—the Radio-Teletype Code Teacher that takes the place of an operator-instructor and enables anyone to master code without further assistance. Available Tapes from beginners alphabet to typical messages on all subjects. Speed range 5 to 40 WPM. Always ready—no QRM. Thousands have "acquired the code" with the Instructograph System. Write today for convenient rental and purchase plans.
4713-F Sheridan Road, Chicago 40, Illinois
INSTRUCTOGRAPH COMPANY



kc. xmtr has moved to 11,975 kc. and is heard well in the east at 1900-2200 and 0000-0200. This latter outlet comes through poorly in the midwest with its 1730 newscast; s/off at 1755. (DD, 51, 100)

Germany—*Deutsche Welle*, Cologne, is now on 21,490 kc. (replacing 21,650 kc.) at 0930-1230 to the near east. English news is heard at 1030-1040. This period is in parallel with 17,815 kc. (MM, 59, 92, 100)

Ghana—Accra, on 4915 kc., has been tuned at 1715 with commentaries and on 3366 kc. at 0100 with news. The latter xmtn is heard well in the midwest with the 4915-kc. outlet weaker and the 9615-kc. outlet not audible. The address is: P. O. Box 1633, Accra. (27, 253)

Haiti—4VB, *Radio Commerce*, Port-au-Prince, has moved from 6091 kc. to 5980 kc.

SHORT-WAVE ABBREVIATIONS

A—Approximate frequency
A.B.C.—Australian Broadcasting Corporation
annt—Announcement
BBC—British Broadcasting Corporation
c.w.—Morse code
ID—Identity: identification
kc.—Kilocycles
kw.—Kilowatts
N.A.—North America
QRM—Interference
s/off—Sign-off
s/on—Sign-on
V—Frequency varies
VOA—Voice of America
xmtn—Transmission from station
xmtr—Transmitter used by station

and is heard well at 1900-2230 except Sunday. (59, 100)

4VEH, Cape Haitien, has been testing on 9600 kc. due to jamming on the 9656-kc. channel. English is noted at 2000-2230, dual to 17,820 and 6105 kc. (4, 26, 59)

4VWI, Cape Haitien, has moved from 21,525 kc. to 15,390 kc. at 0500-0930 (Saturdays to 1030) due to jamming. The "Listener's Post" is noted at 0930 on Saturdays. (4)

Hong Kong—*Radio Hong Kong* carries English lessons at 2300-2315 on 3940 kc.; Chinese music is heard at 2315-2330, Chinese news until 0000. (169) (Editor's Note: This station may be heard on the lower frequency bands when conditions are excellent and if there is little QRM from the 75-meter stations.)

India—*All-India Radio*, Delhi, is often heard in the south on 17,830 kc. at 2130-2145 with news and from 2145 to 2200 s/off with music, and on 17,720 kc. with English news at 0830-0840. (226)

Israel—*Voice of Zion*, TelAviv, has been noted on 11,845 and 11,760 kc. with English news at 1500-1515 and another English period from 1645 to 1714/close. Both outlets announce as 9008 kc. These two new outlets are not as yet confirmed. (59)

Japan—Two lesser heard stations are JO22, 6065 kc., and JOZ, 3925 kc. The 6065-kc. channel is heard in the western states at 0900-1015 with an English period of news, stock and market reports, Japanese melodies. (225, 233)

Lebanon—FXE, 8035 V kc., Beirut, is being noted with an English program at 1000-1030. The signal is good at first but rapidly weakens. (61)

Liberia—ELWA, Monrovia, carries English

to N.A. on Tuesdays only at 1945-2145 on 9653 kc. (announced 9645 kc.) with news at 2130. Programs are mostly religious. A new outlet on 17,852 kc. is noted to East Africa at 0000 s/on. (*JM, SC, 4, 8, 25, 26, 133*)

Malaya—*Radio Malaya*, Singapore, has moved from 7250 to 7280 kc. (*169*)

Nepal—*Radio Nepal*, Kathmandu (via India), is reported to have English news at 0800-0805 and at 2335-2340 on 7100 kc. Has anyone heard it as yet?

Netherlands—*Radio Nederland*, Hilversum, operates to N.A. at 1615-1655 on 15,425 and 15,445 kc., and at 2130-2210 on 9590 kc. (*JL*)

Norway—*Norea Radio* (Nordic Radio Evangelistic Ass'n) is currently testing over WT-AN, Tangier, 9784 kc., and will probably be on the air during the summer at 1630-1700 on this frequency. They may also test on other channels. Reports go to: Grensen, 19, Oslo, Norway. (*WRH*)

Novaya Zemlya—A station announcing as *The Voice of Novaya Zemlya* was noted on 6195 kc. at 0201 and again at 0224 with English news. The signal is weak but clear. The station indicated that it has only 235 watts. (*MA*) (Editor's Note: Novaya Zemlya is a large island, some 1400 miles northeast of Moscow. Further details on this station are requested.)

Pakistan—*Radio Pakistan*, Karachi, can be noted on 15,335 kc. at 1930-2015 s/off to East Asia, and on 15,245 kc. at 1415-1500 with news at 1430, both xmsns in English. (*JC, 153, 226*)

Philippines—DZI6, Manila, 11,805 kc., has increased power to 10 kw. and is scheduled at 1600-1030. A new 1500-watt xmtr may be in operation on 21,515 kc. shortly. (*WRH, 4*)

South Korea—HLKA, Seoul, 11,925 and 15,410 kc., carries English from the VOA at

Miscellaneous Reports

Aero—Weather reports for the local areas may be heard at 0000 from Paris Overseas Radio on 8820A kc., at 0005 from New York Overseas Radio on 8850A kc., and at 0010 from San Francisco on 8880A kc. (*152*)

Telephone—A Greek telephone station has been noted on 13,075A kc. about 1755, giving test announcements in Greek. Location may be Athens. Information on this station would be appreciated.

Unidentified—A station is being noted on 15,370V kc. at 1900-2100 with old American recordings and some Chinese (?) language. It is also noted mornings about 0700. This may or may not be the new Burma station. (*JH*)

1630-1700, and from the United Nations at 0800-0900. Reports go to: Bureau of Radio Broadcasts, Public Information Office, Seoul, South Korea. (*184*)

Spanish Guinea—Bata, 8800 kc., is tuned very weakly in Spanish at 1630. (*BL*)

Spanish Morocco—A rare catch is Tetuan, on 6067 kc. This 5-kw. station is heard in the south at 1830 with Arabic chanting and a fair-to-good signal. (*BL*)

Sweden—*Radio Sweden*, Stockholm, operates to N.A. daily at 0900-0930 on 17,840 kc.,

July, 1957

FOR THE HI-FI FAN:

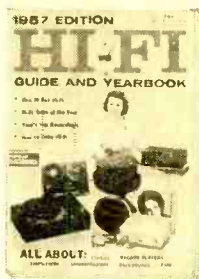

THE WORLD'S
MOST
COMPLETE
HI-FI GUIDE!

164 PAGES!

(Compiled by the editors of)
POPULAR ELECTRONICS

NINE BIG CHAPTERS ON:

- Why and How Hi-Fi
- Tuners
- Tape and Tape Recorders
- Record Players and Changers
- Tone Arms, Cartridges and Needles
- Preamplifiers and Amplifiers
- Loudspeakers
- Speaker Enclosures
- Saving Money in Hi-Fi
- PLUS a helpful Yearbook Section which discusses the latest trends in high fidelity . . . lists the nation's outstanding Hi-Fi records, artists, all FM stations, contains a complete calendar of 1957 Hi-Fi shows, and includes a directory of free Hi-Fi literature.

NOW ON SALE AT ALL NEWSSTANDS
AND RADIO PARTS DEALERS—



ONLY 75¢

Ziff-Davis Publishing Company
366 Madison Avenue, New York 17, N. Y.

PORT ARTHUR COLLEGE ELECTRONICS COMMUNICATIONS

AM FM Television Broadcast Engineering
Marine Radio Radar

CHECK THESE FEATURES: tuition \$34 per mo., room & board \$50 per mo. in dorm on campus. College operates 5 KW broadcast station. Students get on-the-job training at studios on campus. FCC license training with all courses. Well equipped classrooms & lab., am fm transmitters, radar & marine eqmt., television camera chain, experiment lab test eqmt. & other training aids. Our graduates in demand at good salaries. Free placement service. Have trained men from all 48 states. Approved for GI. Write for details.

PORT ARTHUR COLLEGE Port Arthur
Texas
Established in 1909



ROAD TO RICHES

You can be the next uranium millionaire! Government guarantees huge bonus! PRI Instruments from \$29.95. See your local dealer today! FREE CATALOG!

Write PRI, 4223PT W. Jefferson
Los Angeles 16, California

DEALERS WANTED



GET INTO ELECTRONICS

Train for best technical positions in a top-flight school. Specialize in missiles, computers, radar, communications, industrial electronics, color TV, automation. Excellent program in theory, laboratory, mathematics. Major firms select our graduates as tech. reps., field engineers, specialists. Associate degree granted. 21 months' program. High school or equivalent required. Catalog.

VALPARAISO TECHNICAL INSTITUTE
DEPT. PE VALPARAISO, INDIANA

TRANSISTORS 2 for \$1.00

- Save dollars on experimenting by using quality surplus p-n-p audio transistors.
- Receive our regular customer bargain flyer by mailing your get-acquainted order today.

THE RESEARCHER

P. O. BOX 175
DEPT. P

N. DAYTON STATION
DAYTON 4, OHIO

MOVING?

BE SURE POPULAR ELECTRONICS FOLLOWS YOU. PLEASE SEND YOUR CHANGE OF ADDRESS TO

POPULAR ELECTRONICS

CIRCULATION DEPARTMENT

64 E. Lake St.

Chicago 1, Ill.

ENGINEERING
DEGREE IN
27 MONTHS

B.S. Degree, Aero., Chem., Civil, Elec., Mech. & Electronic Eng. (inc. Radio, TV), 36 mo. B.S. degree in Math., Chem., Physics. Prep courses. Demand for grads. Spacious campus. 29 bldgs; dorms, auditorium, gym. Low rate. Earn board. G.I. appr. Enter Dec., March, June, Sept. Catalog, 237 E. Washington Boulevard Fort Wayne 2, Indiana

Keeping pace with progress

INDIANA TECHNICAL COLLEGE

and at 2030-2100 on 11,810 kc. The "DX Bulletin" is on Mondays at 0925. (4, 11, 153, 226, JL)

Switzerland—The regular DX program from Berne is broadcast on the first Thursday of each month at 2100 on HER3, 6165 kc., HER4, 9535 kc., and HER5, 11,865 kc. (DH)

Tahiti—Radio Tahiti, Papeete, is still being heard well in English at 0230-0245 on 6135 kc. The s/off is at 0300. (MA, WM, 210, 231)

Tangier—IBRA Radio, Tangier, has moved to 9900 kc. and is being used in English, dual to 15,020 and 11,342 kc. (4, 59, 76)

Radio Tangier, 9325 kc., has been noted at 1530 with music and test programs. The ad-

SHORT-WAVE CONTRIBUTORS

Maurice Ashby (MA), Wichita, Kans.
John Crane (JC), Riverside, Conn.
S. J. Cerami (SC), Bunkie, La.
Donald Davenport (DD), Monroe, Wis.
Dave Haley, Jr. (DH), Roxbury, Mass.
James Hart (JH), Irvington, N. J.
Ronald Kenyon (RK), Ashland, Ky.
Ben Locke (BL), Marthaville, La.
Johnnie Leber (JL), Winter Haven, Fla.
D. M. Patterson, Jr. (DM), Las Piedras, Venez.
John Mehigan (JM), Chicago, Ill.
Mark Murphy (MM), McDonald, Pa.
Walter Maychrovicz (WM), Ashtabula, Ohio
Julien Pincket (JP), Montreal, Quebec
Gary Sikorski (GS), Chicopee, Mass.
Omar Sanchez (OS), Cienfuegos, Cuba
Paul Valentino (PV), Columbia, S. C.
John Young, Jr. (JY), Lawndale, Calif.
Stewart West (4), Union, N. J.
Bill Berger (8), Fairfax, Okla.
Chuck Maxant (11), Baldwin, N. Y.
Francis Welch, Jr. (25), Worcester, Mass.
Floyd Backus (26), Richmond, Va.
Gerry Dexter (27), Waterloo, Iowa
Bill Schultz (51), North Arlington, N. J.
Grady Ferguson (59), Charlotte, N. C.
John Beaver (61), Pueblo, Colo.
Bill Hutchinson (76), Baltimore, Md.
C. M. Stanbury, II (91), Crystal Beach, Ont.
Del Green (92), Salt Lake City, Utah
Roger Legee (100), McLean, Va.
Fred Kent (133), Winterset, Iowa
Roy Bugden (152), Fort Lauderdale, Fla.
Arthur Teal (153), Chester, Conn.
Ha Chung-kwan (169), Kowloon, Hong Kong
Silas Dunn (173), Little Rock, Ark.
Eugene Simpson (176), Arlington, Mass.
Steven Beeferman (184), Bayside, N. Y.
Anthony Gargano (206), Philadelphia, Pa.
Chris Bennion (208), Riverside, Conn.
Andre Myron (210), Valleyford, Wash.
John Caldwell (213), Tours, France
Stewart MacKenzie (225), Long Beach, Calif.
William Bing (226), New Orleans, La.
Tom Conner (231), Ashland, Oregon
Richard Albright (233), South Gate, Calif.
Jim Pickering (233), Hightstown, N. J.
World Radio Handbook (WRH)

dress is: Radio Tangier, Aleko Lilius, Grand Hotel, Saltsjobaden, Sweden. (26, 208, 213)

Vatican City—The Vatican State Radio can be heard on 9550 kc. Sundays at 0300 only with a religious program and on 15,120 kc. in English at 1315. (25, 61)

Venezuela—YVMK, Radio Cabimas, Cabimas, verified by prepared card after a year. This one is probably operating very close to 2500 kc. (91)

"The Supper Club," formerly heard on YVLK, 4970 kc., is now broadcast from YVKT, Radio Liberator, Caracas, on 3245 kc. at 1800-1900. (DM)

Yugoslavia—Radio Belgrade has returned to 6100 kc. from 6150 and 6130 kc., and carries English news at 1715-1730. Signals are strong in east, fair to good in west. (4, 61) —50—

**POPULAR
ELECTRONICS**

BARGAIN BASEMENT

SAVE ON THESE SPECIAL BUYS OF THE MONTH

RADIO CONTROL Headquarters

For model airplanes, boats, cars, etc. FREE CATALOG "P."
No operator's license required. FREE—SEND FOR FCC FORM 505
Garage Door Radio Control Transmitting & Receiver Kits Available.
R/C TRANSMITTER & RECEIVER KIT: 27 1/4 mc. 5 watt 2-Tube
Simple Transm. & 2-Tube Rec. incl. Drilled Bases, **\$9.95**
Wound Coil, Res., Cond., SIGMA Relay, Instruc.
R/C Xmitter, Hi-Power HAND HELD, Compl. \$17.95; KIT 11.95
SIGMA 4F RELAY: 8,000 ohm, \$3.85; 6 Reed Relay 14.95
2-6V Battery Charger Kit \$4.95; wired 6.95
R/C BOOKS: Model Control \$1; Radio Control \$1; Handbook 2.25
CRYSTALS: 27,255 Mc. Peterson 29A, \$3.95; HOLDER 15
2" METERS, 150 MicroA, \$3.95; 500 MicroA, \$3.95; 3 Ma 2.95
RELAY CONTROL UNIT incl. Sensitive 10,000 ohm Sig-
ma Relay (15 1/2 Ma) Thermal Bi-
metal Strip, Heating Element, Hi Z Audio Choke, Mini Al-
nico V Magnet, Neon Lamp, Resistors, Capacitors 99
TUBES: XFG1, RK61, 3A4, 3A5, 1A6G4, 6K4—Transistors 99
Storage Cells: Mini 2A/hr Silver Cell \$5.75; 27A/hr NiCd 2.75
RELAYS, 10K ohm 2 Ma DC or 110V AC SPDT 95¢; SPST .85
GYRO ELECTRONICS 325-P CANAL ST.
NEW YORK 13, N. Y.

19.95 LAFAYETTE SPECIAL

RADIO CONTROL TRANSMITTER



Completely assembled — tested — and guaranteed R/O transmitter. Includes tube and 27,255 MC crystal, 6 sect. telescoping antenna. Size: 4" x 4" x 12". Approx. 1 mile range. Shpg. wt., 3 lbs. Less batteries.

F-249 Net 19.95

Lafayette Radio DEPT PE-G
165-08 LIBERTY AVE., JAMAICA 33,
Include postage with order



**LITTLE "JEWEL"
R/C RELAY**

The Mighty Mite of the R/C field. Weighs less than 1/2 oz. Only 3/4" H x 17/32" W x 1-1/16" L. Highly sensitive—extremely rugged. Pulls at 1.4 Ma—drops out 1.2 Ma D.C. S.P.D.T. 5000 ohm coil.

F-260 Net 2.75

Lafayette Radio DEPT PEG
100 SIXTH AVE., BOSTON 10, MASS., 110 Federal St.
NEWARK 2, N. J., 24 Central Ave.
NEW YORK, N. Y., PLAINFIELD, N. J., 139 W. Second St.
BRONX 5B, N. Y., 542 E. Fordham Rd.
Include postage with order

MAGNETIC GUITAR MICROPHONE

Complete with Individual Tone and Volume Controls



High impedance contact mike specially designed for use with guitar. Easily mounted under strings without special attachments. While in mounted position, mike can be raised or lowered easily on rod to create varying tonal effects. With 8 ft. cable and standard phone plug. Shpg. wt. 2 1/2 lbs.

PA-38 Net 9.95

Lafayette Radio DEPT PEG
165-08 LIBERTY AVE.,
JAMAICA 33, N. Y.

METAL LOCATOR ENTHUSIASTS

This is for you . . . BC-1141-C amplifier, the electronic heart of the famous SCR-625 mine detector. This unit is brand new with 2-1N5 and 1-1G6 vacuum tubes, in steel carrying case with handle; net weight with batteries is only 10 pounds. It operates from internal batteries (not included) and is complete with schematic diagram of the whole SCR-625 detector set. Case measures 14" by 6" by 5" including hinged cover. Operating panel hinges out for easy access to interior shock mounted chassis. This is a 1000 cycle fixed frequency amplifier, brand spanking new, and a once-in-a-lifetime bargain at \$5.95. Set of 3 spare vacuum tubes \$1.00. Shipping weight 12 pounds.

Write for free government surplus bargain bulletin

JOE PALMER, 1440 Las Salinas Way, Sacramento, California

7.95 LAFAYETTE SPECIAL

R/C RECEIVER



Completely wired and assembled, with tube, ready to operate on exam free 27,255 MC remote control band. Size: 1 3/4" x 1-15/16" x 3". Weight 3.3 oz. Uses one 1.5 volt and one 45 volt battery. Less batteries. Shpg. wt., 6 oz.

F-208 Net 7.95

Lafayette Radio DEPT PE-G
100 SIXTH AVE., BOSTON 10, MASS., 110 Federal St.
NEWARK 2, N. J., 24 Central Ave.
NEW YORK, N. Y., PLAINFIELD, N. J., 139 W. Second St.
BRONX 5B, N. Y., 542 E. Fordham Rd.
Include postage with order

Classified

RATE: 50¢ per word. Minimum 10 words prepaid. September issue closes July 3rd. Send order and remittance to: POPULAR ELECTRONICS, 366 Madison Avenue, N. Y. C. 17.

FOR SALE

WALKIE-TALKIE chassis \$6.98. See our display ad in this issue. Springfield Enterprises.

CITIZEN'S band radio plans for building your own receiver and information on transmitter design, FCC requirements, etc. plus special discount on type approved transceivers. All for \$1.00. Springfield Enterprises, Box 54-E7, Springfield Gardens 13, N. Y.

DIAGRAMS for repairing radio \$1.00. Television \$2.00. Give make, model. Diagram Service, Box 672-PE, Hartford 1, Conn.

WALKIE-TALKIE. Build wireless portable radio-phone for less than \$10.00. Plans for variable frequency and crystal control types, only 50¢ for both, including assembly photographs. Springfield Enterprises, Box 54-E7, Springfield Gardens 13, N. Y.

TRANSISTOR Wireless Broadcaster Kit. \$9.95. Literature. Amerlabs, 471 Clifton Ave., Newark 4, N. J.

BUY Direct, all German Hi-F1 equipment, recorders, cameras, tremendous savings. Specify needs, receive return airmail reply. Polber, Augustenstr. 71, Munich, Germany.

PRINTED Circuits: Design and construct your own. Wonderful for transistor units. Copper boards, etching compound, and all instructions \$2.00. Dawntronics, PEM, 2051 Lansing, Denver 8, Colorado.

WHOLESALE Catalog! Discounts to 80%! Clothing, Appliances, Tools, Housewares, Jewelry, etc! Midwest, EP-156, Pontiac, Illinois.

PLANS for 50 Electrical experiments, toys and novelties—\$1.00. S. Rajkowski, 11 1/2 Jones St., Pittsburgh 23, Pa.

NEW! Pocket radio transmitter uses transistor. Plans 25¢. Complete kit only \$7.98. Free literature on all our products available at factory prices. Springfield Enterprises, Box 54-E7, Springfield Gardens 13, N. Y.

TUBES-TV, Radio, Transmitting And Industrial Types At Sensibly Low Prices. New, Guaranteed 1st Quality Top Name Brands Only. Write For Free Catalog or Call Walker 5-7000, Barry Electronics Corp., 512 Broadway, New York 12N, N. Y.

DIAGRAMS! Repair Information! Radios—Amplifiers—Recorders \$1.00. Televisions \$1.50. Give Make, Model, Chassis. TV Miltie, Box 101-PE, Hicksville, New York.

COMPLETE Television sets \$11.95. Jones TV, 1115 Rambler Avenue, Pottstown, Pa.

HAMS! Work-the-world Alcoa all-band vertical antenna for 80, 40, 20, 15, 10, 6 meters, \$16.95 shipped collect. Guaranteed, needs little space, no guy wires. Literature. Gotham, 1805A Purdy Ave., Miami Beach, Fla.

TRANSISTOR Workshop. Write for details! Transit, Box 15-C8, Alden Manor, New York.

"20 CRYSTAL Set Plans" Handbook \$0.60. Laboratories, 328-L Fuller, Redwood City, California.

MINIATURE Six Transistor Speaker-Radio, Completely Wired \$42.95 Postpaid. Electronic Outlet, Wolcott Ave., Lawrence, Mass.

ELECTRONIC Hypnotiser. Simplifies the art of Hypnosis. Diagrams & Operating Instructions \$1.25. Kit \$16.50. Wired & tested \$29.50. C. Carrier Co., 734 15th St., N.W., Washington 5, D. C.

POLICE Radar Detector. Stop before those radar speed traps. Fool proof, legal system. Complete diagrams & instructions. \$2.75. C. Carrier Co., 734 15th St., N.W., Washington, D. C.

EAVESDROP with a pack of cigarettes. Miniature transistorized radio transmitter. Complete diagrams & instructions. \$1.25. C. Carrier Co., 734 15th St., N.W., Washington 5, D. C.

2 WAY Wrist Radio with auxiliary long distance booster. Complete diagrams and instructions. \$1.25. C. Carrier Co., 734 15th St., N.W., Washington 5, D. C.

CAR Television. Television in your car. Easy to build and install. Complete Diagrams & Instructions. \$1.25. C. Carrier Co., 734 15th St., N.W., Washington 5, D. C.

COLOR TV, Portable, Projection, Transistorized. Complete diagrams & instructions. \$2.75. C. Carrier Co., 734 15th St., N.W., Washington 5, D. C.

TELEPHONE Extension in your car. Answer your home telephone by radio from your car. Complete diagrams and instructions. \$1.25. C. Carrier Co., 734 15th St., N.W., Washington 5, D. C.

STEREOPHONIC Pocket AM-FM-Shortwave. Ekeradio, 646 North Fair Oaks, Pasadena, California.

WANTED

CASH Paid! Sell your surplus electronic tubes. Want unused, clean transmitting, special purpose, receiving, TV types, magnetrons, klystrons, broadcast, etc. Also want military & commercial lab test and communications gear. We swap too, for tubes or choice equipment. Send specific details in first letter. For a fair deal write, wire or telephone: Barry, 512 Broadway, New York 12, N. Y. Walker 5-7000.

CYLINDER and old disc phonographs. Edison, Conqueror, Idella, and Oratorio models. Berliner Gramophones and Zono-o-phones, Columbia cylinder Graphophones, and Coin-operated cylinder Phonos. What old catalogues and literature on early phonos prior to 1919. Will pay cash or trade late hi-fi components. **POPULAR ELECTRONICS, Box 50.**

BUSINESS OPPORTUNITIES

VENDING Machines—No Selling. Operate a route of coin machines and earn amazing profits. 32-page catalog free. Parkway Machine Corporation, Dept. 12, 715 Ensor St., Baltimore 2, Md.

MAKE \$25-\$50 Week, clipping newspaper items for publishers. Some clippings worth \$5.00. Particulars free. National, 81-PE, Knickerbocker Station, New York City.

MONEY-money-money! Yours for installing Rickay wavetraps part time to stop interference from nearby powerful broadcast stations. High Profits, protected territories. Get the facts: Rickay Enterprises, 97 Joyce Street, Bloomfield, Connecticut.

INVENTIONS WANTED

INVENTIONS wanted. Patented; unpatented. Global Marketing Service, 2420—77th, Oakland 5, Calif.

HELP WANTED

ELECTRONICS—Phoenix, Arizona—"The Electronics Center Of The World" "The Home Of Solar Energy Research." Long Range Educational Programs In Development. Make Your Place With General Electric, Sperry Rand, Goodyear, Motorola, AResearch, Reynolds Aluminum, Etc. From Trainee To Engineer This Is Your Future! These Publications Now Available: 1. "Arizona Jobs." A Complete Analysis, \$1.00; 2. "Western Livin'." A Cost Survey, \$1.00; 3. "Inside Facts." Our Prospectus, \$0.75. Act Now For Limited Offer—All Three Reports, \$2.00. Arizona Employment Consultants, Box 10245, Phoenix, Ariz.

EMPLOYMENT INFORMATION

HIGH Paying Jobs: Foreign, U.S.A. All trades. Travel paid. Information. Application forms. Write Dept. 21M National, 1020 Broad, Newark, N. J.

INSTRUCTION

LEARN While Asleep! Complete instructions \$2.00. Guaranteed. Research Association, Box 610-PE, Omaha, Nebraska.

LEARN Electronics. Earn degree at recognized college. Catalog free. Electronics Dept., Trinidad College, Trinidad, Colorado.

CODE your trouble? With your tape recorder you can cure it completely. We guarantee results. Novice tape—basic instruction plus practice material to 8 WPM, \$5.95. Advanced tape—practice material 9 to 18WPM, \$4.95. Both tapes, \$9.95. 7" dual track, 3¾ IPS. Tapedcode, Box 31-B, Langhorne, Penna.

METHODS Of Inventing is a home study course designed to teach you how to develop and apply your imagination. Everyone can create useful ideas. Let us show you how. Send \$10. to A. English, 18 Midwood Rd., Tenafly, N. J. (If, after you have completed the course, you are not satisfied, your money will be refunded.)

ENGINEERING Degrees, EE Option Electronics earned through home study. Residence classes also available. Pacific International University (American College of Engineering), 5719-D Santa Monica Boulevard, Hollywood 38, Calif.

LEARN Morse Code quickly, easily! Beginner's new, sensational manual, only 50¢. American Electronics, 1203E Bryant Avenue, New York 59, N. Y.

HIGH FIDELITY

DISGUSTED of "Hi" Hi-Fi Prices? Unusual discounts on all high fidelity requirements. Write now. Key Electronics Co., 120 Liberty, New York 6, N. Y.

TAPE RECORDERS

RECORDERS, Hi Fi, Tapes. Free wholesale catalogue Carston, 215-P E. 88 St., N. Y. C. 28.

TAPE Recorders, Tape. Unusual Values. Free Catalog. Dressner, 69-02 F, 174 St., Flushing 65, N. Y.

MISCELLANEOUS

SONGPOEMS and Lyrics Wanted! Mail to: Tin Pan Alley, Inc., 1650 Broadway, New York 19, N. Y.

When you order by mail . . .
please print your name and address clearly, be specific in your order, enclose proper amount, allow ample time for delivery.

ADVERTISER'S INDEX

ADVERTISER	PAGE NO.
Allied Radio Corp.	8, 9
Atomic Laboratories	18
Audak Company	12
Bailey Technical Schools	32
Brooks, John	124
Brooks Radio & TV Corp.	116
Cabinart	24
Capitol Radio Engineering Institute	27
Carloma Corporation	18
Central Technical Institute	21
Centralab	26
Cleveland Institute of Radio Electronics	17
Coyne Electrical School	5
DeVry Technical Institute	11
Ekeradio Electronic Developments	109
Electronic Experimenter's Handbook	25
Electronic Instrument Co., Inc. (EICO)	34
Electronic Measurements Corp.	22
Embry-Riddle Aeronautical Institute	117
Gardiner Electronics Co.	120
Garfield Co., Oliver	7, 110, 118
Grantham Schools	115
Greenlee Tool Co.	14
Gyro Electronics	127
Heath Company	103, 104, 105, 106, 107
Hershel Radio Co.	28
Hi-Fi Guide and Yearbook	125
Indiana Technical College	126
Indianapolis Electronic School	124
Instructograph Company	124
International Correspondence Schools	13
Johnson Company, E. F.	123
Karlson Associates Inc.	109
Lafayette Radio	30, 31, 127
Lektron Specialties	111
Midway Company	118
Miller, Gustave	122
Moss Electronics Distributing Co., Inc.	130, 3rd & 4th Covers
National Company	Second Cover
National Radio Institute	3
National Schools	19
North American Philips Co., Inc.	6
Pacific States University	122
Palley's	122
Palmer, Joe	127
Philadelphia Wireless Technical Institute	116
Photography Directory & Buying Guide	109
Popular Photography Color Annual	114
Port Arthur College	126
Precision Radiation Instruments, Inc.	126
Prentice-Hall, Inc.	119
Progressive "Edu-Kits" Inc.	29
Quality Electronics	122
RCA Institutes, Inc.	23
Raytheon Manufacturing Company	15
Rek-O-Kut Company, Inc.	16
Researcher, The	126
Rider, Publisher, Inc., John F.	112, 113
Springfield Enterprises	14
Standard Line Electric Company	33
Stanley Electronics Corp.	120
Surplus Center	120
Sylvania Electronic Products, Inc.	24
"TAB"	129
Tri-State College	118
Valparaiso Technical Institute	126
Video Electric Company	20
Western Radio	122, 124
Whitehall Pharmaceutical Co.	124
World Radio Laboratories	10, 121

KITS! KITS! KITS!

Each "TAB" Kit Contains The Finest Selection

35 Precision Resistors	40 Inductors
10 Switches	35 Power Resistors
75 Resistors IAC etc 1/2 1/2W	75 Mica Condensers
15 Carbon Resistors	5 Crystal Diodes
45 Panel Lamps	250 Ft. Hook Up Wire, Ass't'd
12 Electrolytic Cond's	100 Fuses, ass't'd all types
15 Volume Controls	100 Ceramic Condensers
36 Tube Sockets	150 Coil Forms
65 Tubular Condensers	6 Crystals & Holders
500 Lugs & Eyelets	65 Inductors & Coils
10 Bathtub Oil Cond's	5 Microswitches
5 lbs. Surprise Package	10 Wheat Lamps
10 Transmit Mica Cond's	3 Transistor Xfms

Order Ten Kits

We Ship Eleven!!!

Every Kit Sold On "TAB" Money Back Guarantee!

EACH KIT ONLY **99c**



"TAB" FINEST HI-FI RECORDING TAPE
7" Reel—1200 Ft. Per Reel **\$1.45** Lots

Sold on Money Back Guarantee

Highest quality Hi-Fi Precision Coated & Silt-FERRO-SHEEN processed, quality controlled, constant output, Noise FREE, Splice FREE Plastic Tape. Freq. 7 1/2 IPS, 40-15KC Oxide-Wnd In. "TAB" @ \$1.59 ea.; 3/\$1.50 ea.

New 1st Quality "MYLAR" 2400 Ft. Reel

Ferro-Sheen processed RECORDING TAPE @ \$4.49

"TAB" SPECIAL @ 3/\$12; 12/\$45

Guaranteed Replacement Needles—All Cartridges

Single Diamond \$8.98; Dual Dia \$16.98; Dia-Sapphire \$10.98

Please Send Cartridge Name & Number

NEW IMPROVED "TAB" HI-FI SPEAKERS!

13" TRIAX, 25 WATT/20-20000 CYCS. #F15H3X	\$37.50
12" TRIAX, 20 WATT/40-20000 CYCS. #F1243X	28.50
12" COAX, 20 WATT/35-18000 CYCS. #F1242X	22.00
SONOTONE CA12/COAX/12 WATT/40-14000 CYCS.	19.11

BAUBUY C "TAB" FOR ALL HI-FI!!!
ALL MAKES & TYPES AT THE RIGHT PRICE!
WE BUY! & SELL & TRADE AS WELL!!!

NEW PREAMP & AMP 60 WATT HI-FI

U-Build-It Preamp & Amplifier Model T60, 20 to 100000 cycles at 60 watts with minimum distortion. Bass & Treble Tone Controls, 5 point Record Selector, Phono-Pickup Selector, Signal Selector, Tape Recorder input, 25lb HI-FI Output Transformer feeds 4, 8 or 16 Ohm speakers & electrostatic units also 2 power outlets. The Newest, Latest & Finest design easily built KIT

MODEL T60 Pro-Wired Ready to Play \$93

DYNA MARK II 50 Watt New Kit \$69.75

DYNA MARK II Demonstrators Pro-Wired \$69

SNOOPERSCOPE "See-In-Dark" Tube & Data \$5 @ 2 for \$9

MATCHED INPUT & OUTPUT TRANSISTOR AUDIO TRANSFORMERS \$2

MINIATURE AC/6 or 12V FAN \$6 value \$1.89, 3 for \$5

FREE! WRITE TODAY FOR OUR NEW CATALOGS

\$59 ELECTRONIC FLASH! 400 II SHAWLITE \$5520

Assembled & ready to work! Not a Kit! Latest features: SUPER CIRCUIT—Low cost flash less than 3/4¢. Inbuilt AC & Batteries* all in one case, powerful, compact. Guide # Color 60+ & B&W 200+. Recycle 2 seeds includes 80W \$24/525mf/450WV Flash condenser. Special \$20 *Batteries not included. Two (2)/240V \$10 New Photoflash Condensers Low Leakage \$25 mfd/450WV/55Wsec. Gld Famous Mfr \$6 @ 2/\$11, 6/\$30



PHOTOFASH SLAVE "PE" APRIL 57

PF59B COMPLETELY BUILT READY TO FLASH \$20

"TAB" PHOTO ELECTRONIC FLASH BOOK \$50

ILLINOIS PHOTOFASH HANDBOOK \$50

TUBES "TAB" TESTED GUARANTEED

OUR 12th Year in BUSINESS

0A2 .80	9LP7 2.00	68G6 2.00	7Q7 .79
0B2 .72	2C22 20/\$1	68Q7 .99	12AT6 .59
0B3 .82	7193 20/\$1	6C4 .49	12AT7 .79
0C3 .84	434A 1.98	6C56 .69	12AU7 .69
0D3 .80	1N34A 2/\$1	6C6 1.49	12AV6 .69
0Z4 .50	CK722 .99	6H6 .59	12A6 .59
1AX2 .98	5U4 .59	6J5 .59	12AX4 .79
1B3 .78	5Y4 .89	6L5 1.19	12X7 .79
1L4 .82	5Y3 .59	6K6 .59	12BH7 .89
1R4 .88	6AR4 .59	6K7 .79	12BY7 .89
1R5 .78	6AC7 .97	6L6 1.19	12C6 .79
1S4 .78	6AG7 .97	6L5 1.19	12BK7 .69
1S5 .68	6AH4 .89	6SA7 .79	12SN7 .69
1T4 .69	6AH6 .95	6S7 .69	12SQ7 .69
1U5 .59	6AK5 .69	6S17 .69	1A47 .69
1X2 .66	6AL5 .59	6SK7 .69	198G6 1.69
2D21 .68	6AQ5 .66	6SL7 .69	25BQ6 1.29
2X2 .48	6A55 .59	6SN7 .69	25Z6 .79
2V3 .48	6AT6 .49	6SQ7 .59	35C5 .59
3A5 .69	6AU4 .89	6T4 1.19	35L6 .59
954 10/\$1	6AV6 .59	6T8 .99	35W4 .59
955 .33	6AX4 .79	6U8 .98	35Z5 .69
957 .30	6BA6 .59	6V6 .59	50A5 .59
1619 4/\$1	6BC5 .59	6W6 .79	50B5 .79
1625 .29	6BK5 .89	7F7 .79	50C5 .59
1626 5/\$1	6BF5 .79	7A8 .79	50L6 .69
1629 4/\$1	6BG6 1.49	7C5 .79	75 1.00
807 1.15	6BK5 .89	7F7 .79	75 5/\$1
808 .89	6BL7 .99	7F8 .79	77 5/\$1
5BP1 1.49	6BN6 .89	7N7 .79	117L7 1.75

"TAB" TERMS: Money Back Gtd. (cost of Mds. only), \$2 min. order F.O.B. N.Y.C. Add shpg. charges or for C.O.D. 25% Dep. Tubes Gtd. via R-Exp. only. Prices shown are subject to change.

111P Liberty St., N.Y. 6J, N.Y., Rector 2-6245

Superior's New Model 670-A

SUPER-METER



A Combination VOLT-OHM MILLIAMMETER PLUS
CAPACITY, REACTANCE, INDUCTANCE AND DECIBEL MEASUREMENTS.
SPECIFICATIONS:

D.C. VOLTS: 0 to 7.5/15/75/150/750/1,500/7,500 Volts
A.C. VOLTS: 0 to 15/30/150/300/1,500/3,000 Volts
OUTPUT VOLTS: 0 to 15/30/150/300/1,500/3,000 Volts
D.C. CURRENT: 0 to 1.5/15, Ma. 0 to 1.5/15 Amperes
RESISTANCE: 0 to 1,000/100,000 Ohms 0 to 10 Megohms
CAPACITY: .001 to 1 Mfd. 1 to 50 Mfd. (Good-Bad scale for checking quality of electrolytic condensers)

ADDED FEATURE:
Built-in ISOLATION TRANSFORMER reduces possibility of burning out meter through misuse.

The Model 670-A comes housed in a rugged crackle-finished steel cabinet complete with test leads and operating instructions.

REACTANCE: 50 to 2,500 Ohms. **INDUCTANCE:** .15 to 7 Henries
2,500 Ohms to 2.5 Megohms 7 to 7,000 Henries
DECIBELS: -6 to +18, +14 to +38, +34 to +58

28⁴⁰

Superior's New Model 770-A

The FIRST POCKET-SIZED

VOLT-OHM MILLIAMMETER



USING THE NEW "FULL-VIEW" METER.

71% MORE SCALE AREA!!

Yes, although our new FULL-VIEW D'Arsonval type meter occupies exactly the same space used by the older standard 2 1/2" Meters, it provides 71% more scale area. As a result all calibrations are printed in large easy-to-read type and for the first time it is now possible to obtain measurements instead of approximations on a popular priced pocket-sized V.O.M.

FEATURES

Compact — measures 3 1/4" x 5 1/4" x 2 1/4"
Uses "Full View" 2% accurate 850 Micro-ampere D'Arsonval type meter. Housed in round-cornered, molded case. Beautiful black etched panel. Depressed letters filled with permanent white, insures long-life even with constant use.

6 A.C. VOLTAGE RANGES: 0-15/30/150/300/1500/3000 Volts. 6 D.C. VOLTAGE RANGES: 0-7.5/15/75/150/750/1500 Volts. 2 RESISTANCE RANGES: 0-10,000 Ohms 0-1 Megohm. 3 D.C. CURRENT RANGES: 0-15/150 Ma., 0-1.5 Amps. 3 DECIBEL RANGES: -6 db to +18 db, +14 db to +38 db, +34 db, to +58 db.

Model 770A comes complete with self-contained batteries, test leads and operating instructions.

15⁸⁵

Superior's New Model TV-50

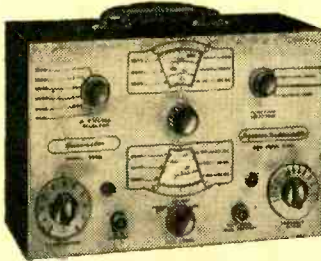

MODEL TV-50 comes absolutely complete with shielded leads and operating instructions. Only

47⁵⁰

GENOMETER

7 SIGNAL GENERATORS IN ONE! R. F. Signal Generator for A.M. • R. F. Signal Generator for F.M. • Audio Frequency Generator • Bar Generator • Cross Hatch Generator • Color Dot Pattern Generator • Marker Generator

B. F. SIGNAL GENERATOR: Provides complete coverage for A.M. and P.M. alignment. Generates Radio Frequencies from 100 Kilocycles to 60 Megacycles on fundamentals and from 60 Megacycles to 180 Megacycles on powerful harmonics. • **VARIABLE AUDIO FREQUENCY GENERATOR:** In addition to a fixed 400 cycle sine-wave audio, the Genometer provides a variable 300 cycle to 20,000 cycle peaked wave audio signal. • **BAR GENERATOR:** Projects an actual Bar Pattern on any TV Receiver Screen. Pattern will consist of 4 to 16 horizontal bars or 7 to 20 vertical bars. • **CROSS HATCH GENERATOR:** Genometer will project a cross-hatch pattern on any TV picture tube. The pattern will consist of non-shifting horizontal and vertical lines interlaced to provide a stable cross-hatch effect. • **DOT PATTERN GENERATOR (FOR COLOR TV):** The Dot Pattern projected on any color TV Receiver tube by the Model TV-50 will enable you to adjust for proper color convergence. • **MARKER GENERATOR:** The following markers are provided: 189 Kc., 262.5 Kc., 456 Kc., 600 Kc., 1000 Kc., 1400 Kc., 1600 Kc., 2000 Kc., 2500 Kc., 3579 Kc., 4.5 Mc., 5 Mc., 10.7 Mc., (3579 Kc. is the color burst frequency.)

SHIPPED ON APPROVAL NO MONEY WITH ORDER — NO C. O. D.

SEE FOLLOWING PAGE FOR COMPLETE DETAILS

MOSS ELECTRONIC DISTRIBUTING CO., INC. DEPT. D-355, 3849 TENTH AVENUE, NEW YORK 34, N. Y.

For the first time ever: **ONE TESTER** **PROVIDES ALL THE SERVICES LISTED BELOW!**

Superior's

New Model

76



Specifications

✓CAPACITY BRIDGE SECTION

4 Ranges: .0001 Microfarad to .005 Microfarad; .001 Microfarad to .5 Microfarad; .1 Microfarad to 50 Microfarads; 20 Microfarads to 1000 Microfarads. This section will also locate shorts, and leakages up to 20 megohms. And finally, this section will measure the power factor of all condensers from .1 to 1000 Microfarads. (Power factor is the ability of a condenser to retain a charge and thereby filter efficiently.)

✓RESISTANCE BRIDGE SECTION

2 Ranges: 100 ohms to 50,000 ohms; 10,000 ohms to 5 meg-ohms. Resistance can be measured without disconnecting capacitor connected across it. (Except, of course, when the R C combination is part of an R C bank.)

As Design Engineers, we the undersigned would like to say that the Model 76 is in our opinion the best combination unit of its kind we have been privileged to design. Although it is comparatively a low-priced tester, it will, after you become acquainted with its multiple services, be your most frequently used instrument.

S. LITT
 L. MELENKEVITZ

IT'S A

CONDENSER BRIDGE

with a range of .0001 Microfarad to 1000 Microfarads (Measures power factor and leakage too.)

IT'S A

RESISTANCE BRIDGE

with a range of 100 ohms to 5 megohms.

IT'S A

SIGNAL TRACER

which will enable you to trace the signal from antenna to speaker of all receivers and to finally pinpoint the exact cause of trouble whether it be a part or circuit defect.

IT'S A

TV ANTENNA TESTER

The TV Antenna Tester section is used first to determine if a "break" exists in the TV antenna and if a break does exist the specific point (in feet from set) where it is.

✓SIGNAL TRACER SECTION

A built-in high gain pentode voltage amplifier, plus a diode rectifier, plus a direct coupled triode amplifier are combined to provide this highly sensitive signal tracing service. With the use of the R.F. and A.F. Probes included with the Model 76, you can make stage gain measurements, locate signal loss in R.F. and Audio stages, localize faulty stages, locate distortion and hum, etc. Provision has been made for use of phones and meter if desired.

✓TV ANTENNA TESTER SECTION

Loss of sync., snow and instability are only a few of the faults which may be due to a break in the antenna, so why not check the TV antenna first? The Model 76 will enable you to locate a break in any TV antenna and if a break does exist, the Model 76 will measure the location of the break in feet from the set terminals. 2 Ranges: 2' to 200' for 72 ohm coax and 2' to 250' for 300 ohm ribbon.

Model 76 comes complete with all accessories including R.F. and A.F. Probes; Test Leads and operating instructions. Nothing else to buy Only

\$26⁹⁵

SHIPPED ON APPROVAL NO MONEY WITH ORDER — NO C. O. D.

We invite you to try before you buy any of the models described on this page, the preceding page and the following page. If after a 10 day trial you are completely satisfied and decide to keep the Tester, you need send us only the down payment and agree to pay the balance due at the monthly indicated rate.

**NO INTEREST
 OR FINANCE
 CHARGES ADDED!**

If not completely satisfied, you are privileged to return the Tester to us, cancelling any further obligation.

MOSS ELECTRONIC DISTRIBUTING CO., INC.
 DEPT. D-355 3849 TENTH AVENUE, NEW YORK 34, N. Y.

Please send me the units checked. I agree to pay down payment within 10 days and to pay the monthly balance as shown. It is understood there will be no finance or interest charges added. It is further understood that should I fail to make payments when due, the full unpaid balance shall become immediately due and payable.

- | | |
|---|---|
| <input type="checkbox"/> Model TW-11... Total Price \$47.50
\$11.50 within 10 days. Balance \$6.00 monthly for 6 months. | <input type="checkbox"/> Model TV-50... Total Price \$47.50
\$11.50 within 10 days. Balance \$6.00 monthly for 6 months. |
| <input type="checkbox"/> Model TD-55... Total Price \$26.95
\$6.95 within 10 days. Balance \$5.00 monthly for 4 months. | <input type="checkbox"/> Model 76... Total Price \$26.95
\$6.95 within 10 days. Balance \$5.00 monthly for 4 months. |
| <input type="checkbox"/> Model 670-A... Total Price \$28.40
\$7.40 within 10 days. Balance \$3.50 monthly for 6 months. | <input type="checkbox"/> Model 770-A... Total Price \$15.85
\$3.85 within 10 days. Balance \$4.00 monthly for 3 months. |

Name _____

Address _____

City _____ State _____

All prices net, F.O.B., N.Y.C.

www.americanradiohistory.com

SEE OTHER SIDE

CUT OUT AND MAIL TODAY! ➔

Superior's New Model TD-55

Streamlined

TUBE TESTER



FOR

The Experimenter or Part-time Serviceman, who has delayed purchasing a higher priced Tube Tester. The Professional Serviceman, who needs an extra Tube Tester for outside calls. The busy TV Service Organization, which needs extra Tube Testers for its field men.

- You can't insert a tube in wrong socket. Separate sockets are used, one for each type of tube base. • "Free-point" element switching system Any pin may be used as a filament pin and the voltage applied between that pin and any other pin, or even the "top-cap". • Checks for shorts and leakages between all elements. Provides a super sensitive method of checking for shorts and leakages up to 5 Megohms between any and all of the terminals. Continuity between various sections is individually indicated. • Elemental switches are numbered in strict accordance with R.M.A. specification. The 4 position fast-action snap switches are all numbered in exact accordance with the standard R.M.A. numbering system.

Speedy, yet efficient operation is accomplished by: Elimination of old style sockets used for testing obsolete tubes (26, 27, 57, 59, etc.) and providing sockets and circuits for efficiently testing the new Noval and Sub-Minar types.

Model TD-55 comes complete with operating instructions and charts and streamlined carrying case.

\$26⁹⁵

Superior's new Model TW-11, STANDARD PROFESSIONAL

TUBE TESTER

- Tests all tubes, including 4, 5, 6, 7, Octal, Lock-in, Hearing Aid, Thyatron, Miniatures, Sub-miniatures, Novals, Sub-minars. Proximity fuse types, etc.
- Uses the new self-cleaning Lever Action Switches for individual element testing. Because all elements are numbered according to pin-number in the RMA base numbering system, the user can instantly identify which element is under test. Tubes having tapped filaments and tubes with filaments terminating in more than one pin are truly tested with the Model TW-11 as any of the pins may be placed in the neutral position when necessary.
- The Model TW-11 does not use any combination type sockets. Instead individual sockets are used for each type of tube. Thus it is impossible to damage a tube by inserting it in the wrong socket.
- Free-moving built-in roll chart provides complete data for all tubes. All tube listings printed in large easy-to-read type.

- NOISE TEST: Phono-jack on front panel for plugging in either phones or external amplifier will detect microphonic tubes or noise due to faulty elements and loose internal connections.

EXTRAORDINARY FEATURE

- SEPARATE SCALE FOR LOW-CURRENT TUBES - Previously, on emission type tube testers, it has been standard practice to use one scale for all tubes. As a result, the calibration for low-current types has been restricted to a small portion of the scale. The extra scale used here greatly simplifies testing of low-current types.

The Model TW-11 operates on 105-130 Volt 60 Cycles A.C. Comes housed in a beautiful hand-rubbed oak cabinet complete with portable cover.

\$47⁵⁰



**SHIPPED ON APPROVAL
NO MONEY WITH ORDER - NO C.O.D.**

FIRST CLASS

Permit No. 61430

New York, N. Y.

BUSINESS REPLY CARD

No Postage Stamp Necessary if Mailed in the U. S.

POSTAGE WILL BE PAID BY -

MOSS ELECTRONIC DIST. CO., INC.

3849 TENTH AVENUE

NEW YORK 34, N. Y.

We invite you to try before you buy any of the models described on this and the preceding pages. If after a 10 day trial you are completely satisfied and decide to keep the Tester, you need send us only the down payment and agree to pay the balance due at the monthly indicated rate. (See other side for time-payment schedule details.)

**NO INTEREST
OR FINANCE
CHARGES ADDED!**

If not completely satisfied, you are privileged to return the Tester to us, cancelling any further obligation.

**SEE OTHER
SIDE**

CUT OUT AND MAIL TODAY!