

YOU Can Build This Pocket Radio

(see page 53)

POPULAR ELECTRONICS

JANUARY
1957

35
CENTS



This Issue:

Becoming a Ham (p. 47)

Sandwich Baffle (p. 63)

S. W. Converter (p. 67)

Hi-Fi Crossovers (p. 70)

HIGH POWER **LOW POWER** **AC POWER** **DC POWER**

POWER-LAB

BY **precise**

OPERATES YOUR WHOLE BENCH & SHOP

**KIT
or
WIRED**

YOU'LL START AND END EACH WORKING DAY WITH THE POWER-LAB

For the first time in the industry, one instrument takes the place of more than 11 pieces of equipment and makes you wonder why no one ever did this before . . . the most useful, often used, test device in your shop.

Here's the story . . . now, you can get all this COMPLETE IN ONE KIT (kit or wired):

- ★ A BATTERY ELIMINATOR
- ★ A BATTERY CHARGER
- ★ A HIGH CURRENT LINE VOLTAGE VARIAC
- ★ AN AC LINE VOLTAGE METER
- ★ AN AC LINE AMMETER
- ★ AN AC LINE WATTMETER
- ★ AN AC LINE ISOLATION TRANSFORMER
- ★ A LOW VOLTAGE, HIGH CURRENT AC SUPPLY
- ★ A DC LINE VOLTAGE VARIABLE SUPPLY
- ★ A DC HIGH CURRENT AMMETER
- ★ AN AGC BIAS BOX



MODEL 711
(100 Watts of Isolation) . . . 711K — \$49.95 kit
711W — \$64.95 wired

MODEL 713
(300 Watts of Isolation) . . . 713K — \$62.95 kit
713W — \$79.95 wired

When you buy POWER-LAB by Precise, you get all the advantages of owning a battery eliminator for servicing auto radios (even signal seekers), an AC-DC Converter, a supply for transistor sets, AND OF MAINTAINING A CONSTANT 115 volts in checking on TV set variations. You can even run the set down to 105 volts for testing for horizontal jitter and back up to 125 volts for high voltage breakdown, thereby eliminating the cause of many call-backs due to arcing . . . PLUS

. . . PLUS . . . PLUS . . . the 101 uses you'll find each day for POWER-LAB versatility.

Just look at these specs . . . the switches used are more than ample to carry related loads required and the quality of every component is EXCELLENT. You could easily pay three to four times the price of the POWER-LAB for the equipment to perform only a few of the functions of the POWER-LAB!

There's NO OTHER INSTRUMENT LIKE THE POWER-LAB ON THE MARKET. Here again, Precise engineering is proud to be the first to supply a need that has too long existed in the service trade.

Your Distributor will be proud to show you THE POWER-LAB

Prices slightly higher in the West. Prices and specifications subject to change without notice.

ALL SPECS BELOW ARE FOR MOD. 711 AND 713 UNLESS OTHERWISE SPECIFIED

	VOLTS		MAXIMUM	CONTINUOUS
Low Voltage DC	2 ranges 0-15v	Full Wave	20 amps*	10 amps*
	0-30v	Full Wave Bridge	20 amps*	10 amps*
Low Voltage AC	0-24v			20 amps
High Voltage AC	No Isolation 90-140 volts		20 amps	1000 watts
			2000 watts	
High Voltage AC	Model 713 with Isolation 90-140 volts			3 amps
				300 watts
High Voltage AC	Model 711 with Isolation 90-140 volts			1 amp
				100 watts
High Voltage DC	110-180 volts		.1 amp**	.075 amp**

*Depending on voltage.

**May be increased up to 10 amperes at additional cost.

WRITE FOR CATALOG PE 1-7

SEE THE MANY MORE PRECISE INSTRUMENTS AND PROBES AT YOUR DISTRIBUTOR TODAY!

precise DEVELOPMENT CORP. OCEANSIDE, NEW YORK, U.S.A.

Free!

WITH THIS OFFER

60% to 75% of all TV failures are caused by faulty tubes. This amazing new giant-sized "Detect-O-Scope" tells you, at a glance, exactly how to spot bad tubes in any TV set. Saves time, money — makes you an "expert" TV trouble-shooter! Gives

Amazing New TV "DETECT-O-SCOPE"

Spots Bad TV Tubes in a jiffy!

identification numbers of tubes that may be causing trouble; shows you how to locate, check and replace them safely. 16 x 21 inches; copy-righted. Sells for \$1.00 but yours absolutely FREE on this offer!

YOURS FREE WITH THE FAMOUS MANUAL DESCRIBED BELOW

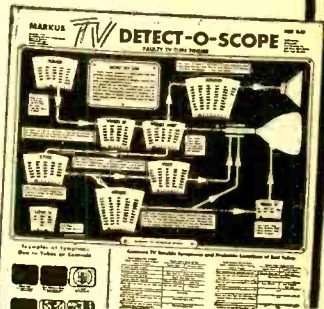

FIX TV AND RADIO SETS RIGHT AWAY

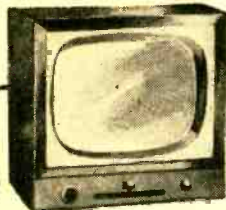

—even if you never fixed a lamp or doorbell before!

McGraw-Hill's Amazing New Low-Cost Instruction Manual Skips Hard-to-Understand "Theories" and Formulas — Tells HOW-TO-DO-IT in PLAIN ENGLISH



TELEVISION AND RADIO REPAIRING

TRY IT FREE ON YOUR OWN SET FOR 10 DAYS

AT LAST—a well-known EXPERT tells you in PLAIN ENGLISH how to fix TV or radio sets! Right from the very first chapters you can start doing simple repairs... and before you're HALF way through the manual, you can fix HALF the television and radio sets that you encounter. In just a few weeks you can start fixing your own and friends' sets... even start your own money-making business at home. NO complicated formulas! NOT a study book! Deals only with parts that go wrong in sets—tells HOW to find the trouble — and the EASY way to FIX IT!



Save Money on Your Own Set

Save \$50 to \$100 a year installing and servicing your own set. Book tells what to do if picture is blurred—split—distorted—titled—wiggles—too pale or black — jitters — "snow"—drifts—etc.

for the most "unhandy" beginner. A-B-C directions and 700 clear photos, diagrams, and drawings show exactly WHAT and HOW to fix, step-by-step. Includes everything you need to know: where and how to buy tubes and parts; where and how to get an official circuit diagram of any set; how to choose and use basic tools; how to test tubes WITHOUT a tube tester; how to use 58 common TV controls; simple "cures" for common TV and radio troubles; how to fix loudspeakers, phono pick-ups, install and check antennas—and much more.

Why It's So EASY
John Markus, Associate Editor of Electronics Magazine, spent FOUR years making this one-volume manual practical and easy-to-follow — even

SEND NO MONEY

Mail coupon below — without money! When book arrives try it out on your own or neighbors' sets. See how simple and easy it makes nearly every repair job. Make it pay for itself in 10 days or don't keep it. Mail coupon NOW to: McGraw-Hill Book Co., Dept. PEL-1, 327 West 41st St., New York 36, N. Y.

... Also Yours for 10 DAYS' FREE TRIAL:

PRACTICAL RADIO SERVICING

By Marcus and Levy
100 MILLION radio sets still in use! Learn to fix them. Make good money in full or spare time. New guide shows you how to handle any type set—how to trouble-shoot, test, repair, replace parts. Hundreds of clear pictures, diagrams make it easy. Includes servicing radio-phonograph combinations. Check proper box in coupon for FREE TRIAL.

PARTIAL CONTENTS
How to Remove and Replace Tubes • Testing Tubes without a Tester • Using a Table Tester • Power Supply Troubles • How to Test and Replace Resistors, Controls, Switches, Condensers, Coils, Transformers • Speakers • Phono Pickups • Antennas and MUCH MORE.

McGraw-Hill Book Co., Dept. PEL-1
327 West 41st St., New York 36, N. Y.

Send TV "DETECT-O-SCOPE" FREE with Markus' Television and Radio Repairing for 10 DAYS' TRIAL. If not delighted, I may return book, pay nothing. Otherwise, I will send only \$1.95 plus few cents shipping; then 3 monthly payments of \$2. ("Detect-O-Scope" is FREE in any case.)

Send Practical Radio Servicing for 10 DAYS' TRIAL. If I keep it, I will send only \$2.50 plus few cents shipping; then 3 monthly payments of only \$2 each.

Name
Address PEL-1

City Zone State

SAVE MONEY. Check here if enclosing payment WITH coupon (\$7.95 for TV and Radio Repairing; \$8.50 for Practical Radio Servicing). Then WE pay all shipping costs. Same 10-day return privilege. (Offer good in U.S.A. only.)

POPULAR ELECTRONICS is published monthly by Ziff-Davis Publishing Company, William B. Ziff, Chairman of the Board (1946-1953), at 64 E. Lake St., Chicago 1, Ill. Entered as second class matter August 27, 1954 at the Post Office, Chicago, Illinois. SUBSCRIPTION RATES: One year U.S. and possessions, and Canada \$4.00; Pan-American Union countries \$4.50, all other foreign countries \$5.00.

POPULAR ELECTRONICS

CONTENTS

FEATURE Articles and Electronic Developments

TV—Over the Hill and Into the Dale.....	Dave Scher	39
London—New York TV in '57?.....		41
Making Noise Is Their Job.....	Melvin Mandell	42
Foil Those Tube Forgers.....		44
WIAW Will Help YOU Become a Ham.....	Perry F. Williams, W1UED	47
Electronics Will Locate Those Car Rattles.....	R. Wayne Crawford	57

ELECTRONIC Build-It-Yourself Projects

How to Build a Reflex Transistor Superhet.....	Louis E. Garner, Jr.	53
More Solar Battery Experiments.....	E. G. Louis	59
Dynamic Pillow Speaker.....	Art Trauffer	66
Proximity Detector Is a TV Commercial Killer.....	R. Wayne Crawford	66
The 5:15—Simplicity in a Short-Wave Converter.....	Richard Graham	67
Build an "Economy" Tube Tester.....	Richard Graham	73
Make Your Own Dynamic Mike.....	Luis Vicens	82
Transtopic Experiment No. 14—"All-Frequency" Signal Generator.....	Louis E. Garner, Jr.	85
Useful Battery Power Pack.....	E. G. Louis	86
Mount Your Speaker for Convenience.....	R. L. Winklepleck	90

AUDIO and Hi-Fi Features

The Why's and Whereof's of Watts.....	Leonard Feldman	49
Building a Sandwich Baffle.....	David B. Weems	63
Crossovers Are The Answer.....	A. Stewart Hegeman	70
Make Your Own Crossover.....	John J. Dougherty	72
What's New in Hi-Fi.....		87

Miscellaneous Electronic News

Lab Aloft Chases Cosmic Rays.....		46
Sky-High Radar.....		46
This "Brain" Squirts.....		46
Trial/Error Machine.....		46
Keeping Tabs on the Competition.....		52
Pen-Size Meter Warns Against Fall-Out.....		52
Private Paging System.....		52
Test Lab on Wheels.....		52
Electronic Footwork.....		62
How Wet Is It?.....		62
Improved SSB-AM Reception.....		62
Super-Fast Data Recorder.....		62
Oversize Meter on New VTVM.....		86

(Also see page 6 for DEPARTMENTS)

Cover photo by Maynard Frank Wolfe

© 1956 by Ziff-Davis Publishing Company. All rights reserved.

Average Net Paid Circulation 240,151

JANUARY 1957

VOL. 6—NUMBER 1

Publisher
OLIVER READ, W1ETI

Managing Editor
OLIVER P. FERRELL

Technical Editor
CHARLES S. TEPFER

Feature Editor
NORMAN EISENBERG

Associate Editors
HANS H. FANTEL
MARGARET MAGNA

Contributing Editors
H. BENNETT L. E. GARNER, JR.
H. S. BRIER H. POLLACK
J. T. FRYE R. P. TURNER

Art Editor
ALFONS J. REICH

Art and Drafting Dept.
FRANK SAYLES
J. A. GOLANEK M. WHELPLEY
W. K. VAHLSING J. A. ROTH

Advertising Director
L. L. OSTEN

Advertising Manager
WILLIAM G. McROY

Midwest Adv. Manager
JIM WEAKLEY

Western Adv. Manager
JOHN E. PAYNE



Member
Audit Bureau of
Circulations



ZIFF-DAVIS PUBLISHING COMPANY
W. B. ZIFF (1898-1953) FOUNDER

Also Publishers of
RADIO & TELEVISION NEWS
Editorial and Executive Offices
366 Madison Ave., New York 17, N.Y.
MU 7-8080

President
B. G. DAVIS

Vice-President
H. J. MORGANROTH

Vice-President
M. FROELICH

Vice-Pres. & Circ. Dir.
M. MICHAELSON

Secretary-Treasurer
G. E. CARNEY

Art Director
AL GRUEN

BRANCH OFFICES
CHICAGO (11)
64 E. Lake St., AN 3-5200
LOS ANGELES (14)
215 W. 7th St. (Room 412)
Trinity 8043

SUBSCRIPTION SERVICE:
All communications concerning subscriptions should be addressed to Circulation Dept., 64 E. Lake St., Chicago 1, Ill. Include your old address as well as new—enclosing if possible an address label from a recent issue of this magazine. Allow at least 4 weeks for change of address.

CONTRIBUTORS:
Contributors are advised to retain a copy of their manuscripts and illustrations. Contributions should be mailed to the New York Editorial Office and must be accompanied by return postage. Contributions will be handled with reasonable care, but this magazine assumes no responsibility for their safety. Any copy accepted is subject to whatever adaptations and revisions are necessary to meet the requirements of this publication. Payment covers all author's, contributor's and contestant's rights, title, and interest in and to the material accepted and will be made at our current rates upon acceptance. All photos and drawings will be considered as part of material purchased.

POPULAR ELECTRONICS



Train in Great Shops of COYNE for better jobs in

ELECTRICITY - TELEVISION

ELECTRONICS

RADIO - COLOR TV

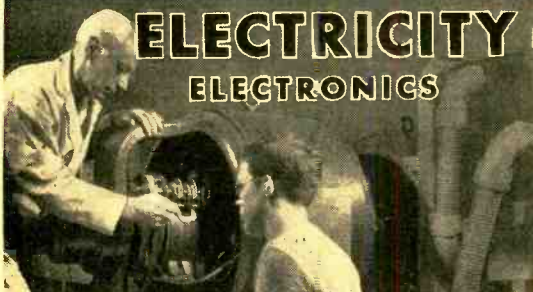

TWO TOP OPPORTUNITY FIELDS

Whether 17 or up to 45 years of age, train the Coyne way for a better job and a real future in **ELECTRICITY-ELECTRONICS** or **TELEVISION-RADIO**, fields that offer a world of opportunities. Train on real, full-size equipment at COYNE where thousands of successful men have trained for nearly 60 years—largest, oldest, best equipped school of its kind—established 1899. No advanced education or previous experience needed. Employment service to graduates. **START NOW—PAY LATER**—Liberal Finance Plans and Easy Payment Plans. Also part-time employment help for students. Training in Refrigeration and Electric Appliances can be included.

B. W. COOKE Jr., President

COYNE ELECTRICAL SCHOOL

FOUNDED 1899

A Technical Trade Institute Operated Not For Profit
500 S. Paulina Street, Chicago, Dept. 17-71H

ELECTRICITY • RADIO • TELEVISION • REFRIGERATION • ELECTRONICS

MAIL COUPON FOR FREE BOOK

Send coupon for 48-page illustrated book "Guide to Careers in Electricity-Electronics and Television-Radio." No cost; no obligation; no salesman will call. Vets and Non-Vets get vital facts now!



B. W. COOKE Jr., President
COYNE ELECTRICAL SCHOOL
500 S. Paulina St., Chicago 12, Ill., Dept. 17-71H

Send **BIG FREE** book and details of your training offer. This does not obligate me and no salesman will call. I am interested in:

() Electricity-Electronics () Television-Radio

Name _____

Address _____

City _____ State _____

COYNE QUALITY

TELEVISION RADIO - COLOR TV

Home Training

at Unbelievably Low Cost



The future is **YOURS** in **TELEVISION!**

A fabulous field—good pay—fascinating work—a prosperous future in a good job, or independence in your own business!

Coyne brings you **MODERN-QUALITY** Television Home Training; training designed to meet Coyne standards at truly lowest cost—you pay for training only—no costly "put together kits." Not an old Radio Course with Television "tacked on." Here is **MODERN TELEVISION TRAINING** including **Radio, UHF and Color TV**. No Radio background or previous experience needed. Personal guidance by Coyne Staff. **Practical Job Guides** to show you how to do actual servicing jobs—**make money early in course**. Free Lifetime Employment Service to Graduates.

B. W. COOKE, Jr.,
President



COYNE ELECTRICAL SCHOOL

A TECHNICAL TRADE INSTITUTE OPERATED
NOT FOR PROFIT

500 S. Paulina Street, Chicago 12, Dept. 17-HT7

Coyne—the Institution behind this training... the largest, oldest, best equipped residential school of its kind. Founded 1899.

Send Coupon for Free Book

and full details, including easy Payment Plan. No obligation, no salesman will call.



COYNE Television Home Training Division

500 S. Paulina St., Chicago 12, Ill.
Dept. 17-HT7

Send Free Book and details on how I can get Coyne Quality Television Home Training at low cost and easy terms.

Name _____

Address _____

City _____ State _____

For High Fidelity That Grows
One Economical Step at a Time

Electro-Voice SPEAKER BUILDING BLOCK PLAN

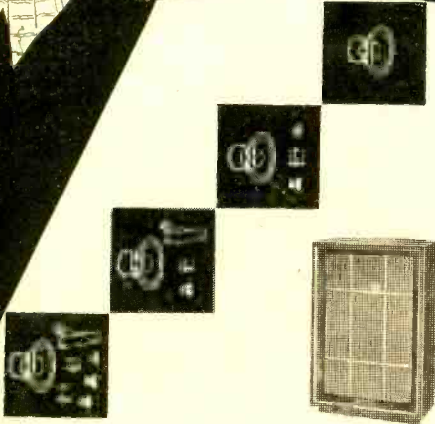

Before you spend a dime for high-fidelity speakers, Electro-Voice lets you hear the improvement as you build from a single speaker to a multi-speaker system. Unique E-V Systems Selector lets you dial your own system—you hear *in advance* how each new speaker component enhances the illusion of musical reality!

Follow the E-V Building Block Plan, start with a single speaker, add compatible components as budget permits. Here's how:

START with E-V Aristocrat corner folded-horn speaker enclosure and E-V Model SP12B full-range coaxial loudspeaker. Speaker and enclosure just \$102 Net! Or buy only the ready-to-assemble Aristocrat KD6 enclosure kit..... \$39.00 net.

STEP UP your enjoyment by adding E-V Model T35B VHF driver (for those silky highs), Model AT37 level control and Model X36 crossover. Complete system and enclosure just..... \$136.50 Net!

OR STEP UP by adding Model T10A HF driver with Model 8HD horn, Model AT37 level control and Model X825 crossover for more mid-range response. Complete system and enclosure just..... \$185.50 Net!

COMPLETE your integrated Electro-Voice reproducing system by adding ALL the components listed to your basic Model SP12B speaker. Separate controls for the Brilliance and Presence ranges compensate for room acoustics and individual tastes. Your total for all components and enclosure just..... \$220.00 Net!

From start to finish, every step of the way, you'll thrill to music reproduced as only Electro-Voice 'Listeneered' components can reproduce it!

Electro-Voice, manufacturer of the most complete high-fidelity product range—speakers, speaker enclosures, systems, amplifiers, preamps, tuners, phono cartridges, Do-It-Yourself enclosure kits and microphones. Available everywhere.

SEE YOUR ELECTRO-VOICE DEALER TODAY!

Electro-Voice®

ELECTRO-VOICE, INC. • BUCHANAN, MICHIGAN

Canada: E-V of Canada Ltd., 1908 Avenue Road, Toronto, Ontario.
Export: 13 East 40th Street, New York 16, U.S.A. Cables: ARLAB

DEPARTMENTS

Carl & Jerry.....	John T. Frye	10
Letters from Our Readers.....		24
POP'tronics Bookshelf.....		28
McWatts.....	Carl Kohler	32
Tips and Techniques.....		34
Tools and Gadgets.....		36
After Class.....		77
Tuning the Short-Wave Bands.....	Hank Bennett	79
The Transmitting Tower.....	Herb S. Brier	80
Transistor Topics.....	Lou Garner	83

COMING NEXT MONTH (FEBRUARY)

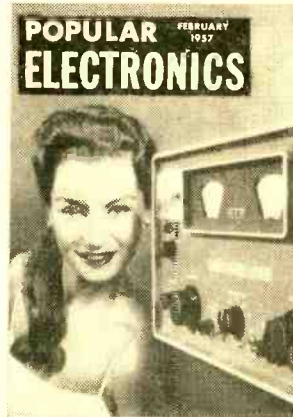

(ON SALE JANUARY 22)

There's a wealth of construction material scheduled for February—"how-to-build" articles on a powerful xenon-filled timing light, an FM commercial killer, the "Economy" transistor tester, a DX booster, a police call receiver, a thermistorized anemometer, and a three-transistor hearing aid.

Look for: the "electronic" crossover; how to improve the low-frequency output of your AM set; what hi-fi amplifier presence controls do and how to build one. You'll also discover how radio signals literally ride piggyback on meteor trails, the part that two-way radio plays in Civil Air Patrol operations, and exactly what can be heard in the short-wave broadcast bands.

IN THIS MONTH'S RADIO & TELEVISION NEWS

(JANUARY)

- Behind the Giant Brains
(History of Computers)
- Crystal Photocell Circuits
- A New Master Control Preamp
- Power Requirements for Hi-Fi
- Buying a Tone Arm

Always say you saw it in—POPULAR ELECTRONICS

LOOKING FOR JOB SECURITY AND SUCCESS?

LET MY STUDENTS AND GRADUATES TELL YOU

ABOUT MY TRAINING —

NEW! NEW! NEW!
COLOR TELEVISION TECHNICIAN COURSE

Learn the latest. Be prepared for your share of those profits! RTTA's Color TV Servicing Course brings you the most complete, up-to-the-minute data and procedures for the servicing and maintenance of all Color TV receivers and equipment. The 14 lesson course guides you through the development and transmission of the composite color TV signal, and includes troubleshooting and servicing methods. The same step-by-step, easy-to-follow approach used so successfully in our other courses. Previous radio or TV training or experience required.

Sylvania Now Sponsoring RTTA's Color TV Technician Course

One of the nation's largest electronics manufacturers and marketers Sylvania Electric Products Inc. in its continuing effort to cooperate with independent service dealers is now sponsoring the RTTA Color Television Technician Course.

The Color Television Technician Course is being made available to authorized Sylvania Dealers throughout the 48 states who are interested in expanding their knowledge and experience in Color TV servicing.

HAS OWN BUSINESS



I have a shop at home and have been working on radio and TV after working hours of my regular job. I average \$50 a week for this part time work. RTTA training helped me in making extra money and giving me experience in the electronic field.

Richard Hennis, Little Rock, Ark. 6/30/54

SERVICE MANAGER



I manage two radio and television shops, one here and one in Pompano Beach. RTTA training increased my knowledge of TV circuits and showed me new, quicker methods of repairing. Lessons as presented are very concise and clear.

William Phillips, Fort Lauderdale, Fla.

REPAIRED EVERY SET



RTTA training helped me to understand TV more thoroughly. I have repaired every set that I was called on to repair. 6/21/54

Andrew Busi, Jr., Iselin, Pa.

L. C. Lane, B.S., M.A. President, Radio-Television Training Association. Executive Director, Pierce School of Radio & Television.



— ABOUT MY EQUIPMENT

YOU GET ALL THIS EQUIPMENT

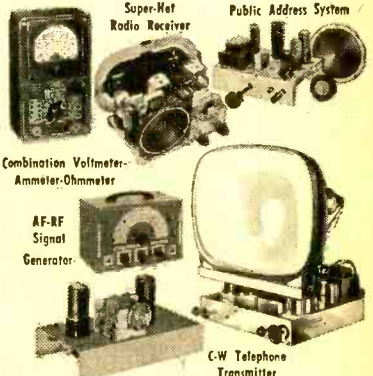

"... a money making little gem."

I have completed kit #26 and was amazed at how it works. I showed it to a friend of mine and he asked me to set it up for one of the picnics his social club was having. That sure is a money making little gem.

John Fernandez, Fresno, Calif. 6/7/54

"We get excellent pictures..."
 I would like to compliment you on an excellent and complete course. We get excellent pictures on my TV set from WSYR (Syracuse, N.Y.), approximately 110 air miles away. The set is working good and I have had to replace only three tubes since I assembled it two years ago.

Larry H. Stafford, Kingston, Ont., Canada 7/8/54

"... very good reception..."

I have really enjoyed the course and have come a long way in TV servicing. I am getting very good reception on my TV station considering that the nearest VHF station is 120 miles.

J. W. Manlon, Jr., Henderson, Texas 7/13/54

YOU, TOO, CAN GET A BETTER-PAYING JOB IN THE EVER-EXPANDING RADIO-TELEVISION-ELECTRONICS FIELD

Why limit yourself and your earnings because of your lack of training. Learn AT HOME in your SPARE TIME to be an electronic technician, television repairman, or studio technician. You don't need any experience whatsoever. Many students earn enough in their spare time to pay for the entire course.

After you finish my Radio-FM Television Course or FM-Television Course you can have, if you want it, two weeks of laboratory training at my associate resident school in New York City—AT NO EXTRA COST.

If you have had previous radio and television experience you can take my practical TV Studio Technician Course to qualify for a good-paying job in a TV studio.

Write to me today and let me show you how you can begin now to put yourself on the road to a better future.

VETERANS!

My school fully approved to train veterans under new Korean G.I. Bill. Don't lose your school benefits by waiting too long. Write discharge date on coupon.

Radio-Television Training Association

52 EAST 19th STREET • NEW YORK 3, N. Y.

Licensed by the State of New York • Approved for Veteran Training

January, 1957

YOU GET THESE FREE



MAIL THIS COUPON TODAY!

Mr. Leonard C. Lane, President
 RADIO-TELEVISION TRAINING ASSOCIATION
 Dept. PE-1D, 52 East 19th Street,
 New York 3, N. Y.

Dear Mr. Lane: Send me your NEW FREE BOOK, FREE SAMPLE LESSON that will show me how I can make TOP MONEY IN TELEVISION. I understand I am under no obligation.

(PLEASE PRINT PLAINLY)

Name _____ Age _____

Address _____

City _____ Zone _____ State _____

- Color TV Course
- Radio-FM-TV Technician Course
- FM-TV Technician Course
- TV Studio Technician Course

VETERANS!
 Write discharge date

**BUILD THE
BEST
AND SAVE!**

**you get the most for your money when you build
ALLIED'S own knight-kits**

- ★ You get maximum value for your kit dollar
 - ★ You get premium quality parts
 - ★ You get advanced design and top performance
 - ★ You get exclusive new features
 - ★ You get easiest-to-follow instructions for assured success in the finished equipment
- BUY WITH CONFIDENCE FROM THE PIONEERS IN ELECTRONIC KITS**

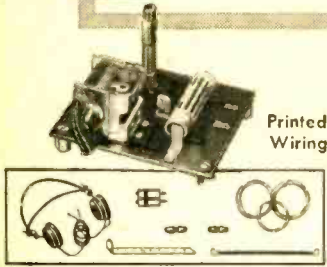

Printed Wiring

**Fascinating knight-kit
TRANSISTOR RADIO KIT**

Model S-765 Experiment with the marvel of transistors! Printed circuit mounting board simplifies assembling. Just mount components, solder a few connections and enjoy excellent AM broadcast reception. Compact; fits in palm of your hand; operates from single penlight cell that lasts for months. Complete with all parts, transistor and penlight cell. Easy to assemble. Shpg. wt., 2 lbs.

Model S-765. Net only **\$4.35**
S-266. Accessory kit; 4000 ohm double headphones and all parts for outdoor antenna. Net. **\$3.15**



**knight-kit TWO-WAY
INTERCOM SYSTEM KIT**

Model S-295 Easy to build—ideal for home or office. Consists of Master and Remote unit, each with press-to-talk switch. Remote can be left "open" for distant answering or baby-sitting. In "closed" position, Remote remains private, but can be called and can originate calls. High-gain 2-stage amplifier and 4" PM speakers. With tubes and 50-ft. cable. (Up to 200-ft. may be added.) Each unit 4 3/4 x 6 1/2 x 4 3/4"; antique white finish. For AC or DC. Easy to assemble. 7 lbs.

S-295. Net only..... **\$14.75**



**knight-kit "SPACE-SPANNER"
BANDSWITCHING RECEIVER KIT**

Model S-243 All-new 2-band receiver, easy to build—a great value. Band-switch selects thrilling short wave, including amateur, aircraft, police and marine radio (6 to 18 mc), and standard broadcast. Highly sensitive regenerative circuit. Has 4" PM speaker and beam-power output for strong volume. Kit includes calibrated panel, punched chassis, all parts and tubes (less cabinet). Easy to build. 7 x 10 1/2 x 6"; for 110-120 v. 50-60 cycle AC or DC. Shpg. wt., 4 1/2 lbs.

Model S-243. Net only **\$15.95**
S-247. Matching cabinet for above **\$2.90**

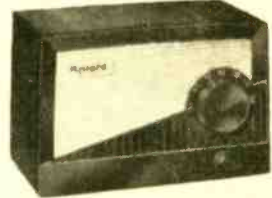

**knight-kit "RANGER II"
AC-DC SUPERHET RADIO KIT**

Model S-735 Build this top quality table model radio at low cost! Tunes full AM broadcast, 540 to 1680 kc (includes police calls). Features Alnico PM dynamic speaker; automatic volume control; sensitive Superhet circuit; handsome plastic cabinet. Easy, step-by-step assembly. Complete with punched chassis, all parts and tubes, speaker and smartly styled bakelite cabinet (6 x 9 x 5"). For AC or DC. Shpg. wt., 8 lbs.

Model S-735. Net only **\$17.25**

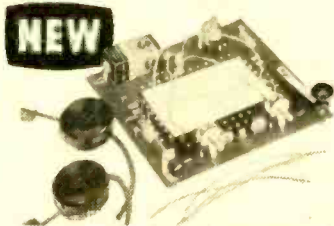

**knight-kit TRANSISTORIZED
ELECTRONIC 10-IN-1 LAB KIT**

Model Y-299 Sensational—work with transistors! Assemble the basic parts once, then complete project after project (10 in all), just by plugging leads into proper jacks on printed-circuit board—no wiring changes needed. Make the following: AM radio; amplifier; wireless broadcaster; code practice oscillator; electronic timer, switch, flasher; voice-operated, capacity-operated and photoelectric relays. Includes all parts, 2 transistors, battery, headphone, instructions for projects. 3 lbs.

Model Y-299. Net only ... **\$15.45**

IDEAL KIT FOR THE HAM



Model S-255
only

\$38.95

**knight-kit 50-WATT
CW TRANSMITTER KIT**

Compact, value-packed, low-power rig. 50 watts input to 807; 6AG7 oscillator takes crystal or VFO; bandswitching covers 80, 40, 20, 15, 11-10 meters; pi matching network eliminates separate antenna tuner; clean cathode keying of oscillator and final; excellent TVI suppression; meter reads plate or grid of final. With all parts, tubes, wire, solder and instructions (less key and crystal). 8 1/4 x 11 1/4 x 8 3/4". 18 lbs.

Model S-255. Net only. **\$38.95**

order from **ALLIED RADIO** 100 N. WESTERN AVE., CHICAGO 80, ILL.

YOU BUILD THE BEST AND SAVE MORE WITH **knight-kits**



knight-kit
VTVM KIT
with printed
circuit board
Model F-125
only **\$24.95**

Easy to build. Reads peak-to-peak. 1% resistors. Balanced-bridge push-pull circuit; 4 1/2" meter, 200 microamp. Ranges: AC peak-to-peak volts, 0-4-14-46-140-400-1400-4000; AC rms v. and DC v., 0-1.5-5-15-50-150-500-1500; ohms, 0-1000-10K-100K, 1-10-100-1000 meg; db scale, -10 to +5. Zero-center scale; direct-reading db scale; polarity reversing switch. Ready to build. 7 1/4 x 5 1/4 x 4 3/8". 6 lbs.

Model F-125. Net only **\$24.95**
F-126. High Voltage Probe. **\$4.75**
F-127. High Frequency Probe. ... **\$3.45**



knight-kit
20,000 OHM/VOLT
VOM KIT
Model F-140
only **\$29.50**

Low cost 32-range VOM. Features 4 1/2" 50-microampere meter; 1% precision multipliers; 2% accuracy full-scale deflection. Ranges: AC, DC and output volts, 0-2.5-10-50-250-1000-5000; Resistance, 0-2000-200,000 ohms and 0-20 meg; DC ma, 0.1-10-100; DC amps, 0-1-10; Decibels, -30 to +63 (6 ranges). Black bakelite case, 6 1/4 x 5 1/4 x 3 3/4". Ready to build. 5 lbs.

Model F-140. Net only **\$29.50**



knight-kit
"IN CIRCUIT"
CAPACITY
CHECKER KIT
Model **\$12.50**
F-119 only

Remarkable unit checks capacitors while they're still wired in the circuit! All you do is press a button—and the "magic eye" shows opens and shorts. Tests opens and shorts on capacitors of 20 mmf or greater, even if in parallel with a resistance as low as 50 ohms. Complete; ready to build. 5 lbs.

Model F-119. Net only **\$12.50**



FREE 356-PAGE
1957 CATALOG

It's your money-saving guide to everything in Electronics, featuring more than 25 other **KNIGHT-KITS**, including Test Instruments, Hobbyist Kits and Amateur Kits. Send for it!

ORDER NOW

BUILD YOUR OWN QUALITY **HI-FI** AND SAVE!

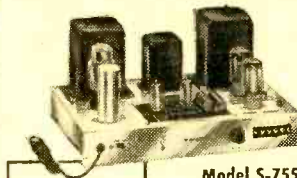

knight-kit LINEAR-DELUXE
BASIC 25-WATT HI-FI
AMPLIFIER KIT

Custom quality at very low cost. For use with any tuner or preamp with full set of controls. Deluxe features: Chrome-plated chassis; potted transformers and chokes; printed circuit wiring board; balance and damping controls. *Output:* 25 watts. *Response:* +0.5 db, 10 to 120,000 cps at 20 watts. *Speaker Outputs:* 4, 8 and 16 ohms. 6 1/4 x 14 x 9". With all parts, tubes, instructions; ready to build. Shpg. wt., 27 lbs.

Model S-755
only **\$44.50**

Model S-755. Net only **\$44.50**
S-759. Metal enclosure for above; black finish. **\$4.25**

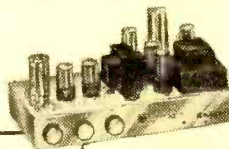

knight-kit 10-WATT
ECONOMY HI-FI AMPLIFIER KIT

True Hi-Fi at lowest cost. Only 0.5 volt drives amplifier to full 10 watts output! *Response:* +1 db, 30 to 20,000 cps at 10 watts. *Distortion:* less than 0.5% at 10 watts. Chrome-plated chassis is punched for preamp kit listed below. Matches 8-ohm speakers. With tubes, all parts, easy instructions. 7 x 13 x 6" Shpg. wt., 14 lbs.

Model S-753
only **\$23.50**

Model S-753. Net only **\$23.50**
S-235. Preamp kit (for magnetic cartridges) **\$3.10**
S-757. Metal enclosure for above; black finish. **\$3.95**

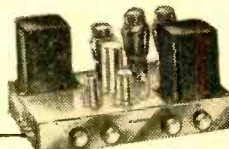

knight-kit 20-WATT
LOW COST HI-FI AMPLIFIER KIT

Delivers deluxe Hi-Fi sound. Includes built-in preamp; inputs for magnetic cartridges, etc.; record compensator; bass and treble controls, etc. *Response:* +1 db, 20-20,000 cps at 20 watts. *Speaker Outputs:* 4, 8, 16 and 500 ohms. Chrome-plated chassis, 7 1/2 x 13 x 8 3/4". With all parts, tubes and easy instructions. 23 lbs.

Model S-750
only **\$35.75**

Model S-750. Net only **\$35.75**
S-758. Metal enclosure for above; black finish. **\$4.15**



ALL PRICES NET F. O. B. CHICAGO • EASY TERMS AVAILABLE

ALLIED RADIO

ALLIED RADIO CORP., Dept. 079-A-7
100 N. Western Ave., Chicago 80, Ill.

OUR
36th
YEAR

Ship me the following KNIGHT-KITS:

Quantity	Description	Model	Price

\$ _____ enclosed. For parcel post, include postage (express is shipped collect).

Send me your FREE 1957 ALLIED 356-Page Catalog.

Name _____

Address _____

City _____ Zone _____ State _____

FULL FIDELITY MUSIC ENJOYMENT

TWIN-CONES IN A SINGLE

F.R.S. SPEAKER

COVER THE AUDIBLE RANGE

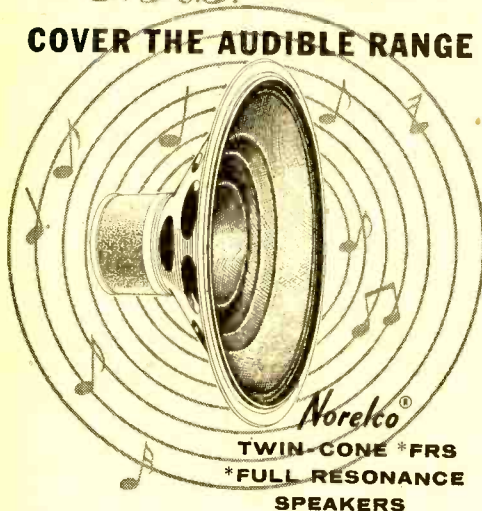

In a single speaker, Norelco has created an unusually efficient sound radiator. These twin-cone speakers incorporate a small cone for reproducing high frequencies and a large cone for lower frequencies. Both cones operate in conjunction from a single voice coil—producing balanced sensitivity and uniform sound for all ranges. Arrangement of both cones reflect and diffuse the sound while moving in phase to provide even sound distribution.

A deep air gap within a homogeneous magnetic field provides unusually large movement of the voice coil resulting in distortion-free reproduction over the entire frequency range. Impedance does not diminish with higher frequencies and volume is practically constant throughout the whole audible range.

Send today for your catalog on Norelco *FRS Twin-Cone Speakers. It contains specification data, sound distribution curves, frequency characteristics on these speakers as well as the new Norelco Speaker Enclosures.



Send to Dept. NT for more details

North American Philips Co., Inc.
100 E. 42nd Street
New York 17, N. Y.

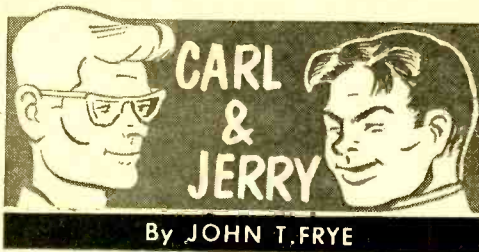

The "Meller Smeller"

OUR HEROES were caught up in the mid-winter doldrums. Holidays had come and gone, leaving only denuded Christmas trees forlornly awaiting the trash trucks in the alleys amid piles of soggy ashes and a litter of crumpled New Year's Eve hats. Carl and Jerry were both suffering from a let-down feeling after the excitement of the year's end; and summer vacation seemed a long, long way off as a cold rain beat against the windows of their basement laboratory.

Jerry was sprawled on his favorite old leather couch, but Carl paced restlessly about the room, wiping dust from the instruments above the bench, leafing listlessly through parts catalogs, and straightening the files of electronics books and magazines on the shelves.

"Doggone it, Jerry, let's do something!" he finally blurted out. "I'm getting the willies."

"Well, look through some of the late issues of the electronics magazines and see if you can find anything in them to build," Jerry said with a yawn, stretching his arms lazily.

"I don't want to copy something another guy has worked out already—not this time," Carl said impatiently. "We've done a lot of that and will do a lot more . . . because it's the best way in the world to learn how to follow plans and directions, how to mount electronic parts correctly, and how to connect them together. But once in a while, it seems to me, we ought to try to work out something electronic all by ourselves, just for the heck of it."

"You know, I believe you've got something there," Jerry exclaimed as he sat up on the couch. "It's pretty easy for us to fall into the habit of letting someone else do all our thinking and planning and quit trying to dream up something new ourselves. You got anything in mind for us to start on?"

"Nope," Carl admitted; "I can't think of anything . . . wait a minute!" he interrupted himself as he sniffed the air. A strong odor of boiling cabbage from the kitchen upstairs was being wafted into the

Always say you saw it in—POPULAR ELECTRONICS

LOOK THEM OVER!

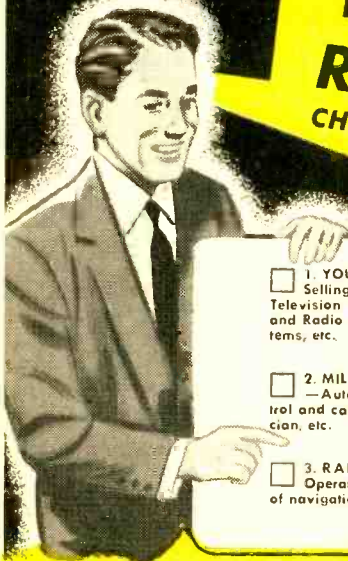

A wide variety of opportunities awaits the Trained Man in the Fast Growing Fields of

TELEVISION

RADIO • ELECTRONICS

CHECK THESE OUTSTANDING OPPORTUNITIES!

- 1. YOUR OWN BUSINESS—Selling, installing, servicing Television (including Color TV) and Radio receivers, sound systems, etc.
- 2. MILITARY ELECTRONICS—Automatic weapons control and communications technician, etc.
- 3. RADAR TECHNICIAN—Operation and maintenance of navigation devices, etc.
- 4. TV-RADIO BROADCASTING—Studio technician, control room operator, TV cameraman. FCC licensed operator.
- 5. INDUSTRIAL TELEVISION—Installation, operation servicing of closed circuit TV systems.
- 6. AIRCRAFT RADIO—Flight tester, control tower operator, radio operator.
- 7. AUTOMATION ELECTRONICS—Specialist on electronic instruments and automatic controls.
- 8. TWO-WAY RADIO—Operation and maintenance of police, taxi, bus, truck communications systems.
- 9. REMOTE CONTROLS—Laboratory specialist on servo-mechanisms, guided missiles, radio-controlled devices.
- 10. COMPUTERS—Install and maintain Electronic "Brain" devices for office and industry.

... PLUS MANY OTHERS

Scores of jobs like those above in the technical end of Television-Radio-Electronics are open to men with proper training. Hundreds of DeVry graduates hold jobs like those. Many prepared at home and then we helped them get started. Hundreds had no previous technical training, no high school diploma, and while training never left home nor quit their jobs. Many were married men. Some paid for their training by repairing TV and Radio sets in their spare time.

DTI's program helps you do this because it is different. You get on-the-job type experience, clear explanations. You build and keep your own test equipment, as you perform over 300 practical projects. You use visual training HOME MOVIES and the remarkable Electro-Lab. You may even build a fine quality 21-inch Television set, if you wish.

TRAIN IN OUR WELL-EQUIPPED LABORATORIES

If you prefer, you can get all of your training in our great Chicago Laboratories. Friendly, capable instructors work closely with you, as you learn about the commercial equipment you encounter later in the field. Students use this fine equipment, including the broadcast-type cameras, monitors, microphones, etc. in our TV-Radio studios... the color TV sets... the test instruments, etc. Send coupon for details.

EMPLOYMENT SERVICE

Placement is the "payoff" in any training program. We have close contact with many employers in our field. We are proud of our graduates—for they have done us proud! That's why we believe we can help you get started. And if you are thinking of going into business for yourself, we help you there too.

IMPORTANT FACTS ABOUT MILITARY SERVICE

We have valuable information showing how to make the most of your service in the Armed Forces. Mail the coupon.

HOME MOVIES

We loan you a projector and many reels of instructive film. Run them off yourself. How clear the basic principles of Electronics can be with this helpful training aid — DTI exclusive!

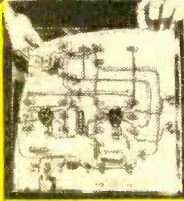

EXCLUSIVE ELECTRO-LAB

Wiring diagrams show up through the transparent base. You follow each diagram, making scores of circuits. Parts are mounted quickly easily with spring clip connectors. Over 300 projects include the building of a 5-inch Oscilloscope and a Vacuum Tube Voltmeter... both valuable test instruments.

VACUUM TUBE VOLTMETER

HERE'S ALL YOU DO

If you are 17 to 55 and want to prepare to get into a field with good pay and promising future, just fill in the coupon and send it to us. We will tell you how you may get ready for a wonderful future for yourself and your loved ones.

Accredited Member of National Home Study Council

SEND COUPON! GET FREE BOOKLET!

DEVRY TECHNICAL INSTITUTE
4141 Belmont Ave., Chicago 41, Ill., Dept. PE-1-N

I would like a copy of "Electronics and YOU" showing many opportunities in Television-Radio-Electronics, and how DTI may prepare me for a start in this billion dollar field.

Of the opportunities listed above, I am interested in No. _____

Name _____ Age _____

Street _____ Apt. _____

City _____ Zone _____ State _____
1038 DTI's training is also available in Canada



One of America's Foremost Electronics Training Centers

DEVRY TECHNICAL INSTITUTE

Formerly DeForest's Training, Inc.

4141 BELMONT AVENUE, CHICAGO 41, ILLINOIS

Perfect Pair...



CK722 and CK768

TRANSISTORS

You won't find a better performing, easier to use, less expensive combination than these two, top-quality Raytheon Transistors.

The CK768 is specially designed for RF application with the Raytheon CK722 for audio circuits. They pair up perfectly. Yet the CK722 costs but 99¢, the CK768 only \$1.50 — \$2.49 for the best transistor combination that money can buy. Available from stock through your Raytheon Tube Supplier.

**Get the Raytheon
TRANSISTOR APPLICATIONS BOOK**
116 pages — over 50 practical circuits — using low cost Raytheon Transistors. For your copy send 50¢ to Raytheon, Dept. P7.



Excellence in Electronics

RAYTHEON MFG. CO.

Receiving and Cathode Ray Tube Operations
Newton 58, Massachusetts

Carl & Jerry (Continued from page 10)

basement by the circulating blower of the hot air heating system. "How about our inventing an electronic gadget to kill odors, sort of a portable affair to be worn by people who have to work in smelly places, such as slaughter houses, glue factories, and so on?"

"We-l-l-l, I dunno," Jerry said dubiously. "You got in mind some sort of helmet with a breathing porthole through which all incoming air has to pass so that we can put our electronic odor strainer in that porthole?"

"Sure," Carl said quickly, although the helmet idea had not popped into his head until the instant Jerry mentioned it. "In our experimental models we can use cardboard boxes for the helmets, with heavy cloth over the bottom and a hole ringed with elastic to make the cloth fit closely about the wearer's neck and shut off all intake of air by that route."

"Better go easy on the elastic or it will shut off all air—period!" Jerry suggested; "but I think I'm getting an idea."

"Let's have it, then," demanded Carl.

JERRY took a deep breath. "Do you remember the experiments we carried out in physics class with the electroscope when we were studying electrostatic electricity?"

"I think so," Carl cautiously admitted.

"Well, concentrate on the one where we were studying an induced charge. Remember the instructor held a negatively charged rod near the ball on top of the electroscope. This shoved the negative electrons on the ball away from the charging rod, making the side of the ball opposite the rod negative and the side nearest the rod positive."

"I'm with you; drive on," Carl said as Jerry paused.

"Okay; then you'll remember that the teacher touched the negatively charged side of the ball with his finger, letting some of the electrons escape to ground. Next he removed his finger, and finally he removed the charging rod. This, as we found by experiment, left the ball with an over-all, positive charge resulting from its loss of negative electrons."

"Check," Carl said, "but what's that got to do with our invention?"

"I'm coming to that. Suppose we cut out the fronts of our cardboard helmets and replace them, in each case, with three layers of screen wire, placed one in front of the other and carefully insulated from each other. Now all air, bearing the tiny particles of the material causing the offen-

PICK YOUR FUTURE HERE

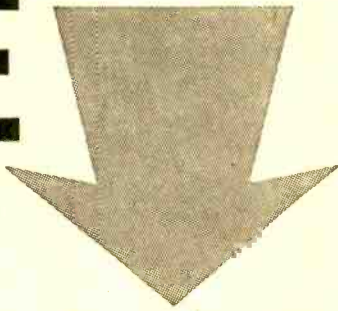
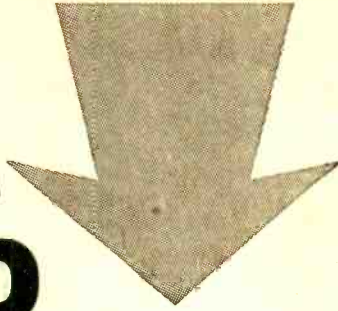

Look over this list of career opportunities. Find the field where you'll spend your future. Will you be successful in it? Or will you barely make a living? *Here's a chance to find out!* I. C. S. will send you *absolutely free* an up-to-date brochure on the field that interests you—including job information and 1957 opportunity outlook. Mark and mail the coupon *today!*



SPECIAL FREE OFFER
36-page book,
"How to Succeed."
Authoritative career
guide filled with
helpful tips. Sent free
with brochure
to those who mail
coupon without delay.

For Real Job Security—Get an I. C. S. Diploma! I. C. S., Scranton 9, Penna. Member, National Home Study Council

INTERNATIONAL CORRESPONDENCE SCHOOLS

65TH YEAR

BOX 76622M, SCRANTON 9, PENNA.

Without cost or obligation, send me "HOW TO SUCCEED" and the opportunity booklet about the field BEFORE which I have marked X (plus sample lesson):

ARCHITECTURE and BUILDING CONSTRUCTION

- Architecture
- Architectural Interiors
- Building Contractor
- Building Estimator
- Building Maintenance
- Carpentry and Mill Work
- Heating
- Painting Contractor
- Plumbing
- Reading Arch. Blueprints

ART

- Cartooning
- Commercial Art
- Fashion Illustrating
- Magazine Illustrating
- Show Card and Sign Lettering
- Sketching and Painting

AUTOMOTIVE

- Auto Body Rebuilding
- Auto Elec. Technician
- Auto-Engine Tune Up
- Automobile Mechanic

AVIATION

- Aeronautical Engineering Jr.
- Aircraft & Engine Mechanic

BUSINESS

- Advertising
- Bookkeeping and Accounting
- Business Administration
- Business Correspondence
- Public Accounting
- Creative Salesmanship
- Federal Tax
- Letter-writing Improvement
- Office Management
- Professional Secretary
- Retail Business Management
- Sales Management
- Stenographic-Secretarial
- Traffic Management

CHEMISTRY

- Analytical Chemistry
- Chemical Engineering
- Chem. Lab. Technician
- General Chemistry
- Natural Gas Prod. & Trans.
- Petroleum Engineering
- Plastics
- Pulp and Paper Making

CIVIL, STRUCTURAL ENGINEERING

- Civil Engineering
- Construction Engineering
- Highway Engineering
- Reading Struct. Blueprints
- Sanitary Engineering
- Structural Engineering
- Surveying and Mapping

DRAFTING

- Aircraft Drafting
- Architectural Drafting
- Electrical Drafting
- Mechanical Drafting
- Mine Surveying and Mapping
- Plumbing Drawings and Estimating
- Structural Drafting

ELECTRICAL

- Electrical Engineering
- Electrical Maintenance
- Electrician Contracting
- Lineman

HIGH SCHOOL

- Commercial Good English
- High School Subjects
- Mathematics

(Partial list of 256 courses)

LEADERSHIP

- Foremanship
- Industrial Supervision
- Leadership and Organization
- Personnel-Labor Relations

MECHANICAL AND SHOP

- Gas—Electric Welding
- Heat Treatment Metallurgy
- Industrial Engineering
- Industrial Instrumentation
- Industrial Supervision
- Internal Combustion Engines
- Machine Design-Drafting
- Machine Shop Inspection
- Machine Shop Practice
- Mechanical Engineering
- Quality Control
- Reading Shop Blueprints
- Refrigeration
- Sheet Metal Worker
- Tool Design Toolmaking

RADIO, TELEVISION

- Industrial Electronics
- Practical Radio TV Eng'ring
- Radio and TV Servicing
- Radio Operating

- Television Technician

RAILROAD

- Air Brake Equipment
- Car Inspector
- Diesel Engineer & Fireman
- Station Foreman

STEAM AND DIESEL POWER

- Combustion Engineering
- Diesel—Elec. Diesel Eng's
- Electric Light and Power
- Stationary Fireman
- Stationary Steam Engineering

TEXTILE

- Carding and Spinning
- Cotton, Rayon, Woolen Mfg.
- Finishing and Dyeing
- Loom Fixing Textile Des'g
- Textile Eng'g Throwing
- Warping and Weaving

MISCELLANEOUS

- Domestic Refrigeration
- Marine Engineering
- Ocean Navigation
- Professional Engineering
- Short Story Writing
- Telephony

Name _____ Age _____ Home Address _____

City _____ Zone _____ State _____ Working Hours _____ A.M. to P.M. _____

Occupation _____

Canadian residents send coupon to International Correspondence Schools, Canadian, Ltd., Montreal, Canada. . . . Special tuition rates to members of the U. S. Armed Forces.

for the first time ...
 a five-volt phono cartridge
 with response to 10,000 cps
 for improvement-replacement
 applications!

the new

SHURE
W9

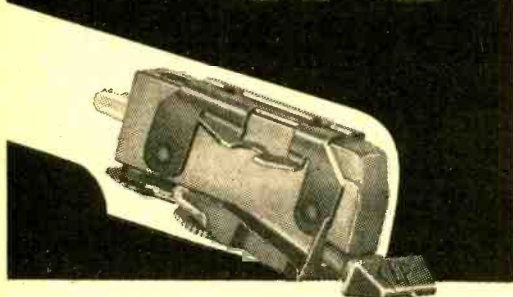

This three-speed, dual-needle, dual-voltage crystal cartridge creates a whole new market for you! With the Shure W9, you can dramatically improve the sound of low-cost, low gain phonographs. The W9 replaces sixty-nine frequently used, high output cartridges of twelve manufacturers.

You can replace the needle of the W9 in a matter of seconds, without tools and without removing the cartridge from the tone arm.

SPECIFICATIONS

- Output: 5.0V for 78 rpm, 3.5V for microgroove*
- Needle Force: 9 grams
- Response: 40-10,000 cps
- Net Weight: 7 grams
- List Price: \$9.50 with two synthesized sapphire needles

*Model W9 has capacitor furnished as an accessory. With capacitor, output is 1.7V for microgroove, 2.5V for 78 rpm.

SHURE *The Mark of Quality*
SHURE BROTHERS, INC.
 Microphones ~ Electronic Components
 214 HARTREY AVENUE • EVANSTON, ILLINOIS
 "In Electronics since 1925"

Carl & Jerry (Continued from page 12)

sive odors, must pass through all three layers of screen to reach the nostrils of the wearer."

"You're still getting through to me."

"Good. Now suppose we place a strong positive charge on the screen nearest the front of the helmet, ground the middle screen, and place a strong negative charge on the screen nearest the wearer's face. Keep these potentials in mind as I use this baseball to represent a tiny particle of the smelly substance on its way through the three screens.

"As the particle passes through the first screen and continues on beyond it, the positive charge of the screen forces the mobile negative electrons on the particle to the rear of it, next to the grounded screen. When the particle touches this grounded screen—and we'll make it a finer mesh to be sure most of the particles do touch it—the pushed-around electrons will escape to ground, leaving the particle with a net positive charge as it continues on through the grounded screen."

"**I GET IT!**" cried Carl. "The negatively charged rear screen will exert a comethither on those positively charged particles, and they will plaster themselves right to it. Not a bit of the odor will be able to get through."

"Well, now, I wouldn't go that far," Jerry said cautiously. "Some of the particles will probably still be able to penetrate our electronic trap; but at least it ought to whittle down and mellow an offensive smell until it will be enduring."

"Mellow a smell," Carl quoted. "There's a name for our gadget. Let's call it our *Meller Smeller*."

"Okay," Jerry agreed with a laugh, "but maybe we ought to wait until it's built before we worry about the name. How are we going to produce the charging potentials we'll need on the front and rear screens?"

"How about using a heavy-duty transistor as a blocking oscillator? If we set the frequency to about 16,000 cycles, we should be able to use a TV horizontal output transformer, designed for operation at 15,750 cycles, to raise the output of the oscillator to quite a respectable voltage. Then a miniature TV high-voltage rectifier will change this stepped-up alternating current to direct current for application to the screens."

"You're in the groove, man!" Jerry applauded. "We can use a very-high-resistance tapped bleeder across the output. The tap

(Continued on page 18)

Get into

TELEVISION RADIO-ELECTRONICS

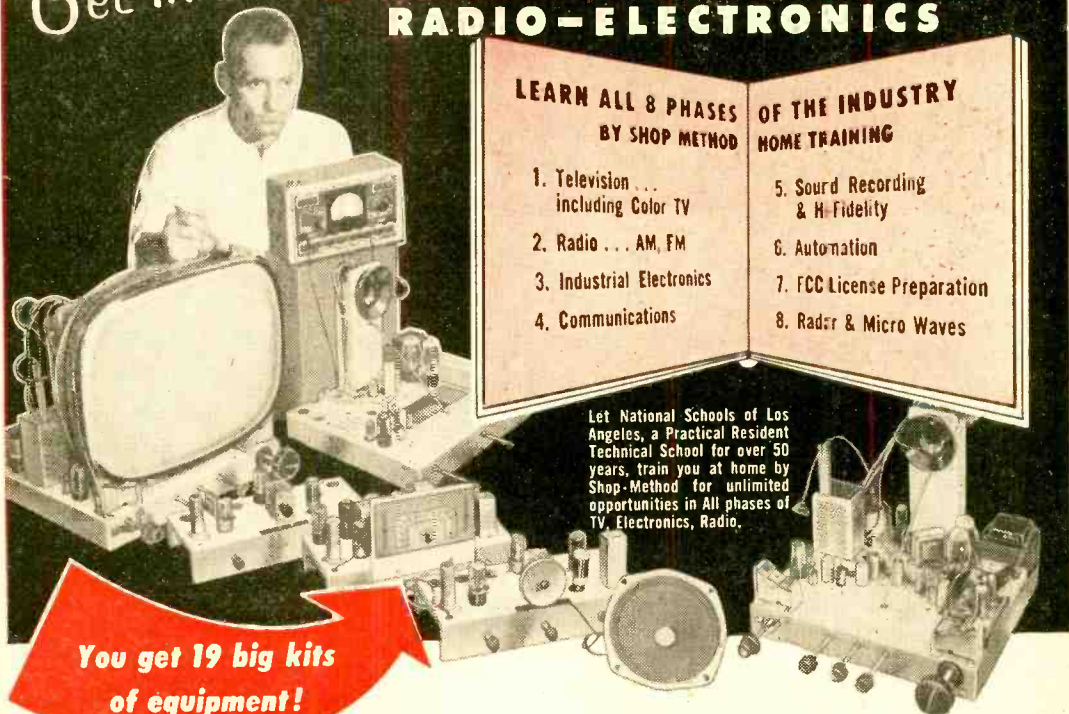

LEARN ALL 8 PHASES
BY SHOP METHOD

OF THE INDUSTRY
HOME TRAINING

1. Television . . . including Color TV
2. Radio . . . AM, FM
3. Industrial Electronics
4. Communications
5. Sound Recording & H-Fidelity
6. Automation
7. FCC License Preparation
8. Radar & Micro Waves

Let National Schools of Los Angeles, a Practical Resident Technical School for over 50 years, train you at home by Shop-Method for unlimited opportunities in All phases of TV, Electronics, Radio.

**You get 19 big kits
of equipment!**

**GOOD JOBS . . . MORE MONEY
SECURITY . . . ALL CAN BE YOURS**

YOU are needed in the great modern Television-Electronics industry. Trained technicians are in growing demand, at excellent pay, in sales and service, manufacturing, broadcasting, telecasting, communications, research, and many other important branches of the field. National Schools Master Shop-Method Training, with newly added lessons and equipment prepares you in your spare time right in your own home for these fascinating opportunities. **OUR OUTSTANDING METHOD IS PROVED BY THE SUCCESS OF GRADUATES ALL OVER THE WORLD!**

YOUR TRAINING IS ALL INCLUSIVE

We prepare you for a long list of job opportunities. Thousands of TV and Radio receivers are being sold every day—more than ever before. And, now, Color TV is here! Applications of Electronics in industry—**AUTOMATION**—are growing in tremendous strides. The whole field is alive—opening up new, important jobs rapidly. National Schools complete training program qualifies you in all phases of the industry.

YOU EARN WHILE YOU LEARN

Many students pay for their entire training—and more—with spare time earning. We'll show you how you can, too! Early in your course you receive material that shows you how to earn extra money servicing TV and Radio receivers, appliances, etc., for friends and acquaintances.

YOU GET EVERYTHING YOU NEED

Clear, profusely illustrated lessons, shop-tested manuals, modern circuit diagrams, practical job projects—all the valuable equipment shown above—many other materials and services—consultation privilege with our qualified staff, and Graduate Employment Service. **EVERYTHING YOU NEED** for outstanding success in Electronics.

**INDUSTRY NEEDS YOU. NATIONAL SCHOOLS
WILL TRAIN YOU. SEND FOR FACTS TODAY
NO OBLIGATION.**

YOU LEARN BY SHOP METHOD . . . you do servicing, circuit analysis, and do over 100 down-to-earth experiments. You build a Superhet Receiver and a modern TV Receiver, from the ground up, including a new, big screen picture tube. You also receive a professional, factory-made **MULTI-TESTER**. All of this standard equipment is yours to keep . . . at just one low tuition.

RESIDENT TRAINING AT LOS ANGELES

If you wish to take your training in our Resident School at Los Angeles, the world's TV capital, start **NOW** in our big, modern Shops, Labs and Radio-TV Studios. Here you work with latest Electronic equipment—professionally installed—finest, most complete facilities offered by any school. Expert, friendly instructors. Personal attention. Graduate Employment Service. Help in finding home near school—part time job while you learn. Check box in coupon for full information.

Approved for
GI Training



NATIONAL SCHOOLS

LOS ANGELES 37, CALIF

In Canada: 811 W. Hastings St., Vancouver, B. C.

**FREE!
VALUABLE BOOK
& SAMPLE LESSON
—Just Send
Coupon!**



NATIONAL SCHOOLS

TECHNICAL TRADE TRAINING SINCE 1905
LOS ANGELES 37, CALIFORNIA

GET FAST SERVICE—MAIL NOW TO OFFICE NEAREST YOU!

NATIONAL SCHOOLS, DEPT. R2G-17
4000 S. FIGUEROA ST. OR 187 N. LA SALLE ST
LOS ANGELES 37, CALIF OR CHICAGO 3, ILL
Rush free TV-Radio "Opportunity" Book and sample
lesson. No salesman will call.

NAME _____ AGE _____
ADDRESS _____
CITY _____ ZONE _____ STATE _____

Check if interested ONLY in Resident School training at Los Angeles.
VETERANS: Give date of Discharge _____

Lafayette's

4 AND 6 TRANSISTOR SUPERHET KITS POCKET AND HOME RADIOS FOR SPEAKER AND EARPHONE OPERATION

FIRST
BUILD
THIS

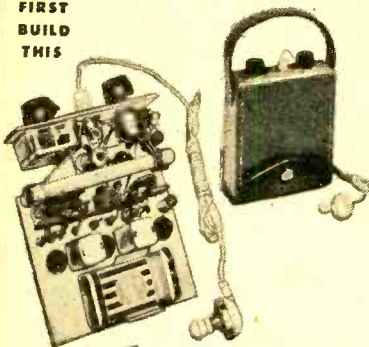

POCKET SIZE: 4" L x 3-5/16" W x 1" D BUILT-IN ANTENNA! REQUIRES NO EXTERNAL ANTENNA OR GROUND!

Lafayette engineers have designed this fascinating 4-transistor superhet receiver kit in a unique and interesting form. It is, by itself, a completely self-contained, pocket sized personal portable set which operates a miniature earpiece so only you can hear; by plugging into the KT-96 kit listed below, it is instantly converted to a full 6-transistor home radio, complete with speaker for the entire family to enjoy. The set is completely subminiaturized and utilizes the new, radically different Argonne "Poly-Vari-Con" ultra miniature 2-gang variable condenser. You will be delighted with the truly subminiature parts, from the variable which measures only 1-1/16" square x 3/8" deep, to the tiny I.F.'s and electrolytics. The chassis measures only 4" L x 3-5/16" W x 1" D. You'll be amazed at its performance. Circuit features use of 4 transistors (2 high frequency and 2 audio type) plus a germanium diode, 2 I.F. stages and built-in high gain ferrite core and antenna. The result is a sensitive, stable and selective set covering the entire broadcast band. Requires no outside antenna or ground connection. The kit is furnished complete with transistors and all parts, including battery and chassis already drilled and punched. The earpiece and carrying case are accessory items, not supplied. All necessary pictorial and circuit diagrams are furnished with simple, easy-to-follow instructions. Shpg. wt., 2 lbs.

THEM
BUILD
THIS

19.95

KT-94 Kit	Net 19.95
MS-311 LEATHER CARRYING CASE	Net 1.95
MS-260 Super power dynamic earpiece	Net 3.95
MS-278 Economy earpiece	Net 1.95

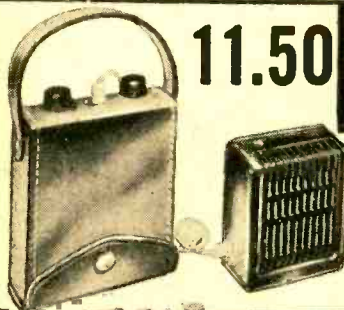

11.50

2-TRANSISTOR CLASS B PUSH PULL OUTPUT STAGE KIT WITH SPEAKER SELF-CONTAINED IN BEAUTIFUL PLASTIC CASE.

• CONVERTS 4-TRANSISTOR KIT INTO A 6-TRANSISTOR HOME RADIO WITH SPEAKER

Add a completely transistorized push-pull audio stage to your 4 transistor receiver. Complete stage including speaker and case measures only 3 1/2" L x 2 3/4" W x 1 3/4" D. Plugs right into 4 transistor kit above. Converts your 4 transistor set to a 6 transistor plus diodes superhet receiver. Performance equal or superior to commercially wired sets selling at more than twice the price. Kit includes 2 transistors, 2 transformers, 2 1/2" PM speaker, pre-punched chassis, speaker case to hold entire stage, battery, hardware, instructions and diagrams. Shpg. wt., 1 lb.

KT-96

Net 11.50



FM-AM TUNER KIT

Basic FM-AM Tuner having outstanding specifications and delivering astonishing performance — all at a budget price in easily assembled kit form.

34.95

- AFC DEFEAT CIRCUIT WITH FRONT PANEL CONTROL
- FOSTER-SEELEY DISCRIMINATOR CIRCUIT
- GROUNDED GRID TRIODE AMPLIFIER
- 20-20,000 CPS RESPONSE

Choose this 7 tube compact high-fidelity FM-AM tuner whose characteristic features are found in units costing many times as much, and whose performance is unheard of at this low price. There are two front panel controls, a function control for AM, FM, PHONO, TV and a tuning/AFC defeat control. Features Armstrong FM circuit with limiter and Foster-Seeley discriminator. Simplified tuning with slide-rule dial and flywheel counter-weighted mechanism, high impedance phono input and high impedance audio output.

SPECIFICATIONS

FREQUENCY RANGE: FM 88-108MC, AM, 530-1650 KC. **ANTENNA INPUT:** FM, 300 ohms, AM Ferrite loopstick and high impedance external antenna. **DISTORTION:** Less than 1% at rated output. **FREQUENCY RESPONSE:** FM, +5 db 20 to 20,000 cps, AM ±3 db 20 to 5000 cps. **SENSITIVITY:** FM, 5 UV for 30 db quieting, AM, Loop sensitivity 80 UV/meter. **SELECTIVITY:** FM, 200 KC bandwidth, 6 db down; 375 KC FM discriminator peak to peak separation, AM, 2 KC bandwidth, 6 db down. **IMAGE REJECTION:** 30 db minimum. **MUM LEVEL:** 60 db below 100% modulation. **TUBE COMPONENTS:** 2-12AT7, 1-6BE6, 1-BA6, 2-6AU6, 1-6AL5 plus selenium rectifier. **SIZE:** 5 1/4" high x 9 3/4" wide x 9 1/2" deep (excluding knobs). **CONSUMPTION:** 30 watts. For 110-120V 60 cycles AC. Attractive etched copper-plated and lacquered finish. Less metal case. Shpg. wt., 9 lbs.

KT-100

NET 34.95

ML-100.....Metal cage for above, Shpg. wt., 3 lbs. 5.00

LAFAYETTE SIGNAL GENERATOR



COMPLETELY
WIRED
AND TESTED!
ACCURACY AND
QUALITY
GUARANTEED!

22.50

• FREQUENCY 120KC to 260MCI

- 120KC to 120MC ON FUNDAMENTALS!
- 30 DAY TRIAL PERIOD! FULL REFUND IF YOU ARE NOT SATISFIED FOR ANY REASON

Completely wired and tested instrument. Do not confuse with kits sold in the same price range. Has the quality and accuracy of instruments selling for 3 to 4 times as much. Six overlapping ranges — 120KC to 320KC, 320KC to 1000KC, 1MC to 3.2MC, 3.2MC to 11MC, 11MC to 38MC, 37MC to 130MC — all on fundamentals — calibrated harmonics from 120MC to 260MC. Switch between internal modulation at 400 cps or any external source at other frequencies. 400 cps signal can be used separately. Outputs are unmodulated RF, modulated RF and 400 cps audio. RF output is in excess of 100,000 micro volts. Jacks are provided for high or low RF output.

Highly stable special circuit design. Fine adjust RF control. AF output 2-3 volts, input 4 volts, across 1 megohm. 5 inch etched dial plate — protected by clear plastic bezel. Common AF terminals for EXT-MOD input and INT-AF output eliminates need for special connectors. Gray metal case — carrying handle — complete with leads, line cord and plug. For 105-125V. 50-60 cycle A.C. Shpg. wt., 8 lbs.

LSG-10 — Signal Generator

22.50

100 SIXTH AVE. NEW YORK, N.Y.
PLAINFIELD, N. J., 139 W. Second St. BOSTON 10, MASS., 110 Federal St.
BRONX 58, N. Y., 542 E. Fordham Rd. NEWARK 2, N. J., 24 Central Ave.
Include postage with order.

Lafayette Radio 165-08 Liberty Ave.
JAMAICA 33; N. Y.

FREE!

LAFAYETTE CATALOG



ELECTRONIC CATALOG PACKED WITH MONEY SAVERS

Packed with the largest selection of Electronic, Radio and T.V. Parts, and equipment, PA, Hi-Fi systems, tubes, antennas, Transistor Kits, parts and components, Test Equipment, new build your own kits, tools, books, Microscope, drafting equipment, Binoculars, Telescopes, All Radio, TV and Ham supplies—ALL AT GREAT SAVINGS—For the economy minded servicemen, dealer, engineer and technician. **CHUCK FULL OF BUYS! SEND FOR YOUR FREE COPY TO-DAY.**

3 TRANSISTOR HI-FI PREAMPLIFIER KIT



New Lafayette HI-FI Pream Kit using new GE 2N190 quality audio transistors. Separate Volume, Bass and Treble controls. Frequency response 20-20,000 cps. Three phono and microphone. Provides low-noise, stable preamplification without hum and microphonics. Complete with all parts, transistors, pre-punched chassis, battery and detailed step-by-step instructions. Size 4 1/2" x 3 3/4" x 1 1/8". Shpg. wt., 2 lbs.

KT-117—Complete Kit.....Net **18.45**

5 TRANSISTOR PUSH PULL AMPLIFIER KIT

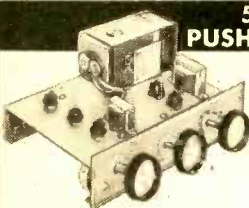

- 1/2 WATT, CLASS B, PUSH-PULL OUTPUT
- CRYSTAL AND MAGNETIC INPUT
- SEPARATE BASS AND TREBLE CONTROLS

New 5 transistor audio amplifier for phono—microphones—tuners—etc. Excellent for the experimenter—student—or any one desiring a good transistorized amplifier. Uses new G.E. 2N189 and 2N186A transistor. Inverse feed back for reduction of distortion. Transformer coupled driver and output stages. Complete with punched chassis, knobs, transistors, all parts and detailed instructions and diagrams.

KT-104—3.2 ohm output.....Net **22.95**
KT-105—8 ohm output.....Net **22.95**

TRANSISTOR CODE PRACTICE OSCILLATOR KIT

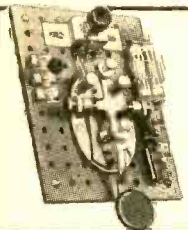

For those interested in mastering the international code, an audio tone oscillator is essential. The circuit of this transistorized feedback oscillator has the simplicity of the neon glow, the signal strength of the vacuum tube, and requires only two penlite cells for weeks of service. It may be used for solo practice, or two may send and receive with the same unit. Kit comes complete with Transistor, Telegraph Key, Resistors, Condensers, Masonite Board, etc., and Schematic Diagram.

KT-72.....Net **2.99**
Cannon ECI—Single Headset.....Net **1.13**

2 TRANSISTOR POCKET RADIO KIT



Packed into a 2 1/2" x 3 1/2" x 1 1/4" plastic case. This Two Transistor plus crystal diode radio kit offers many surprises, utilizing a regenerative detector circuit with transformer coupled audio stage, gives you high gain and excellent selectivity. Pulls in distant stations with ease with more than ample earphone volume. Kit comes complete with two transistors, crystal diode, loopstick, Arzooze transistor audio transformer, resistors, condensers, plastic case, etc. Including schematic and instructions.

KT-68A Complete Kit less earphones.....Net **10.95**
MS-260 New Super Power Dynamic Earphone, Idea Transistor Circuit Imp. 8000 ohm, D.C. 2000 ohm.....**3.95**

NEW POCKET AC-DC VOM MULTITESTER 2,000 ohm per Volt on AC & DC



• Completely wired — Not a kit
Accurate VOM with a sensitivity of 2000 ohms per volt on both AC and DC. Single selector switch. 3" 160 amp. meter. Scales: DC Volts: 0-10-50-500-1000; AC Volts: 0-10-50-500-1000; Ohms: 0-10K, 0-1 Meg; DC Current: 500 ua and 500 ma; Decibel: -20 to +22, +20 to 36; Capacity: 250 mmi to 2 mfd and .005 to 1 mfd. Heavy plastic panel, metal bottom. 4 1/4" x 3 1/2" x 1 1/8". With batteries and test leads. Shpg. wt. 4 lbs.
RW-27A.....**8.95**

3 TRANSISTOR SUPERHET POCKET RADIO KIT



- A TRUE POCKET SUPERHET RECEIVER—NO EXTERNAL ANTENNA!
- NO EXTERNAL GROUND!

A remarkable sensitive, super-selective pocket superhet receiver with astonishing performance over the complete broadcast band. Uses 2 high-frequency and one audio transistor plus efficient diode detector and features 2 specially matched IF transformers for maximum power transfer. The components are housed in a professional looking beige plastic case.

The receiver's appearance enhanced by attractive maroon and silver station dial. Sensitive built-in ferrite antenna eliminates need for external antenna. A designer's dream in a true pocket superhet receiver! Complete with all parts, transistors battery, case, dial and easy to follow step-by-step instructions. 4 1/2" x 2 5/8" x 1-1/16". Shpg. wt., 1 lb.

KT-116—Complete Kit, less earphone.....Net **16.95**
MS-260—Super Power Dynamic Earphone.....Net **3.95**

1 AND 2 TRANSISTOR POCKET RADIO KITS

ONE TRANSISTOR POCKET RADIO KIT—KT-97

- IDEAL FOR STUDENTS, HOBBYISTS AND EXPERIMENTERS

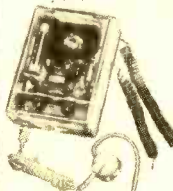

• PRE-PUNCHED CHASSIS FOR ADVANCEMENT TO 2 TRANSISTOR KIT
Ideal, low-cost transistor pocket radio kit. Super-selective ferrite loop antenna permits good reception up to 50 mile radius with approx. 50 ft. antenna and good ground. Provisions for advancement to 2 transistor receiver. Complete Kit, with simple detailed instructions. 3 3/4" x 2 5/8" x 1". Shpg. wt., 1 lb.

KT-97—Complete, less earphones.....Net **4.50**

TWO TRANSISTOR POCKET RADIO KIT—KT-98

Contains all KT-97 components plus additional R-C coupled transistor stage for increased sensitivity and output. Complete with instructions. Shpg. wt., 1 lb.

KT-98—Complete 2 Transistor Kit, less earphone.....Net **5.95**
MS-111—Crystal earphone for KT-97 and KT-98.....Net **1.49**
MS-260—Super power dynamic earphone.....Net **3.95**

20,000 OHM PER VOLT MULTITESTER SEMI KIT



A new kind of kit—the difficult work is already done—you wire in only a few multipliers and mount the battery holder to complete the unit. A fine high sensitivity (20,000 ohms per volt DC —5000 ohms per volt AC) instrument employing a 3" 40 microamp movement. Has 4 DC voltage, 4 AC voltage, 2 DC current, 3 resistance and 2 db ranges. Complete with test leads and detailed instructions. Size 3 3/4" x 1 3/8" x 1 1/8". Shpg. wt., 3 lbs.

KT-20—Kit.....Net **11.95**

Lafayette Radio 165-08 Liberty Ave.
DEPT 1A JAMAICA 33; N. Y.

SEND FREE CATALOG!

NAME _____
ADDRESS _____
CITY _____
ZONE _____ STATE _____

CUT OUT AND MAIL TODAY!



NEW! Mail Order Center ----->

Your choice of school is highly important to your career in



**INDUSTRIAL
ELECTRONICS**



**RADIO-
TELEVISION**



**ELECTRONICS
COMMUNICATIONS**

Become an
ELECTRICAL ENGINEER
or an
ENGINEERING TECHNICIAN
at

MSOE in Milwaukee

Choose from courses in:
ELECTRICAL ENGINEERING
Bachelor of Science degree in 36 months.
Communications option (radio-tv)
Power option.

ENGINEERING TECHNICIAN
Assoc. in Applied Science degree — 18
months.
Electronics Communications
Electrical Power.

MSOE — located in Milwaukee, one of America's largest industrial centers — is a national leader in electronics instruction — with complete facilities, including the latest laboratory equipment, visual aid theater, amateur radio transmitter — offers 93 subjects in electrical engineering, electronics, radio, television, electrical power, and electricity.

Advisory committee of leading industrialists. Courses approved for veterans. Over 50,000 former students. Excellent placement record.



QUARTERS STARTING OCTOBER, JANUARY, APRIL, JULY

Choose wisely — your future depends on it. Write for more information today!

**MILWAUKEE
SCHOOL OF ENGINEERING**

Dept. PE 157, 1025 N. Milwaukee St.
Milwaukee 1, Wisconsin

Send FREE career booklets. (Please print)

I am interested in _____ (Name of course)

Name _____ Age _____

Address _____

City _____ Zone _____ State _____

If veteran, give discharge date. MS-57A

Carl & Jerry (Continued from page 14)

will go to the grounded screen, leaving one end of the bleeder positive for attachment to the front screen and the other end negative for connection to the rear screen."

"You get out a couple of those horizontal output transformers we salvaged from the junk TV sets the man gave us, and I'll hop over home and get a couple of cardboard boxes and some pieces of card wire," said Carl, throwing his slicker over his head as he prepared to dash through the rain; "and you'd better review some of those POPULAR ELECTRONICS articles on transistor oscillators while I'm gone. Then we can get to work."

THE DOLDRUMS had evaporated. Like everyone else, all the boys needed to be happy was something to be enthusiastic about; and their new project had provided this. For the next several hours, they were extremely busy constructing the helmets and building and adjusting the power supplies. They were able to get a total of about 1500 volts from the supplies, and they adjusted the taps so that the front screen was 500 volts positive with respect to the grounded center screen while the rear screen was 1000 volts negative. These voltages were fed through one-megohm resistors to limit the current and avoid dangerous shock if the screens were accidentally touched.

When all was ready, each donned a helmet and grinned foolishly at the other through the screens. At the moment, Jerry's mother was preparing liver smothered with onions in the kitchen; so they had an odor to work with.

"Well, how's your meller smeller working?" Jerry asked.

"I can't be sure," Carl answered in a muffled voice. "All I can smell is the soap that used to be packed in this box, but maybe its smell is so strong that it overrides that of the onions."

"You're lucky," Jerry growled. "This box had fresh halibut in it. I think I ought to be sniffing on the other side of the screen! I'm afraid we'll have to submit our inventions to a stronger test. We'll have to find a real hair-raising smell—one with which we can be SURE, as the TV commercial goes. Where can we find it?"

"The soap factory!" both boys chorused together after a moment's thought.

"That's it," Jerry said, as he slipped off his helmet. "That place puts out a 20-db-over-9 smell all the time. Right after supper let's ride out there on our bikes. It will be dark then, and no one will see us wearing these things; with our growing



NOW...there's a
GARRARD
Auto-Manual
Record Changer
for every
hi-fi system



World's Finest
RECORD PLAYING EQUIPMENT
from Manual Players to
Professional Transcription
Turntables

New
RC 88
Deluxe Changer
\$54.50
net

Full manual and automatic positions. True-turret drive...uses no belts. 4-pole "Induction Surge" motor. Fool-proof Garrard Pusher Platform.



New
RC 121
Mixer Changer
\$42.50
net

Garrard's most compact, economical changer - fits any cabinet. Simpli-Mix Operation permits stacking all record sizes together. 4-pole motor. Manual position.



New
RC 98
Superior Changer
\$67.50
net

All RC 88 features, including full manual position and true-turret drive, PLUS continuous + or - variable speed control on all 3 speeds.



301
Turntable
\$89.00
net

Supreme in its class. Individual card gives performance measurements for each unit. Dynamically balanced cast aluminum turntable. Heavy-duty 4-pole shaded motor.



Model T
Manual Player
\$32.50
net

This is the answer for a quality budget system. Incorporates all record playing features of the famed RC 80 record changer. 4-pole motor; automatic stop.

MAIL THIS COUPON TODAY

All Garrard and other B.I.C. components are illustrated and described fully in the B.I.C. High Fidelity Plan Book, a useful guide in planning any hi-fi system.
A quality-endorsed product of the B.I.C. Group



To: British Industries Corporation Dept. GA-357
Port Washington, N. Y.
Please send B.I.C. High Fidelity Plan Book.

Name _____
Address _____
City _____ Zone _____ State _____



**20
YEARS
OLD!**

He's already an
**ELECTRONICS
ENGINEERING
DESIGNER**

Out of high school just 2 years ago, this young man has already started a fascinating, highly rewarding career in electronics engineering. No matter whether you are now 18 years old—or 28—a 26-month Embry-Riddle education will prepare you for a quick start in this lucrative professional field.

Electronics Engineering Design course concentrates on essential technical studies and practical projects. With the aid of top flight Embry-Riddle instructors you'll master many absorbing fundamentals—Microwaves and Radar, Servomechanisms, Industrial Electronics and Television, to mention a few of the subjects.

The demand for trained engineers is greater than the supply—and will be for years! So take the first step now—mail this coupon. And remember, study and play in Miami's perfect year-round climate is stimulating and exciting.

FOUNDED 1926



SCHOOL OF AVIATION
MAIL THIS COUPON TODAY

Training Authorized under G.I. Bills

DEAN OF ADMISSIONS Dept. 47
Embry-Riddle School of Aviation, Miami 30, Florida

Without obligation, please send FREE and postpaid full particulars.

- ELECTRONICS ENGINEERING DESIGN**
- AERONAUTICAL ENGINEERING DESIGN**

Name _____ Age _____

Address _____

City _____ State _____

I am a (check one) Veteran Non-Veteran

Carl & Jerry (Continued from page 18)

reputation for being a little on the balmy side, that will be just as well."

Fortunately the rain had stopped right after supper, and the night was clear and unseasonably warm for January. The boys pedaled side by side along the little used river road going out to the soap factory. Their bicycle lamps sliced through the dark tunnel produced by the overhanging trees.

"Hold it!" Carl said suddenly as he hit the brake and his rear wheel skidded sideways. Squarely in the circle of light cast by his headlamp was a small sleek black creature with a white stripe extending down his back and along his bushy arched tail.

"Well, what do you know, a skunk!" Jerry exclaimed. "The thaw must have brought him out early tonight."

The little animal showed absolutely no fear or inclination to leave the center of the road.

"Hey, Jer," Carl said slowly, "do you know what I'm thinking?"

"I'm afraid to ask," Jerry admitted.

"If we REALLY want to try out the meller smellers, we'll never have a better chance," Carl said hoarsely, as though the suggestion were being squeezed out of him.

"Okay," Jerry replied, starting to pull on his helmet, "but let's not overdo things. Let's just circle around him to the downwind side and see if he comes in like Cha-



... Simultaneous cries of anguish issued from two boyish throats, and they tore off the helmets as they coughed, spluttered, and gassed for air ...

Always say you saw it in—POPULAR ELECTRONICS

POPULAR BOATING

JANUARY BOAT SHOW ISSUE

THE
WORLD'S
FIRST
COMPLETE
MARINE
DIRECTORY

PRICE \$1.00

ILLUSTRATED LISTINGS
LATEST MODELS
LATEST PRICES



ON SALE JAN. 3—
EVERYWHERE!

LEARN basic electricity electronics
THE EASY "PICTURE BOOK" WAY!



Just Released: The fabulous ILLUSTRATED Training Course now used by the U. S. Navy!

You Learn by Pictures

Over 25,000 Navy trainees have already learned Basic Electricity and Basic Electronics this easy, "Picture Book" way! Now, for the first time, YOU can master the basics of Electricity and Electronics with this *same* "Learn-by-Pictures" training course! Over 1,700 simple, easy-to-understand drawings explain every section—these "teaching" pictures actually make up more than half the *entire* course! No other Basic Electricity or Basic Electronics course in America uses this revolutionary illustrative technique! You learn faster and easier than you'd dream possible!

A Complete Idea on Every Page

Here's how this easy, illustrated course works: *every page* covers one complete idea! There's at least one big illustration on that *same* page to explain it! What's more, an imaginary instructor stands figuratively at your elbow, doing "demonstrations" that make it even *easier* for you to understand. Then, at the end of every section, you'll find *review pages* that highlight the important topics you've just covered. You build a thorough, step-by-step knowledge at your own pace—as fast as you *yourself* want to go!

Everyday English--A Course Anyone Can Understand

Sponsored by the Navy to turn out trained technicians in record time, this modern course presents Basic Electricity and Basic Electronics in a simple way that *everyone* can grasp—*regardless of previous education!* Every phase is made *instantly* clear—explained in plain, down to earth English—with *hundreds* of easy-to-understand illustrations to help you!

10 Complete Volumes

Volumes 1 and 2 of "Basic Electricity" cover DC components and circuits; Volumes 3 and 4 cover AC components and circuits; Volume 5 covers AC and DC motors and machinery. Volume 1 of "Basic Electronics" covers Diodes and Power Supplies; Vols. 2 and 3 cover Amplifiers and Oscillators; Vols. 4 and 5 cover Transmitters and Receivers.

Home Study Without Correspondence

This course is so *different*, so *complete*—there's *no need* for the usual letter writing, question and answer correspondence! Learn at home—at your own pace!

10 Day Examination--Money Back Guarantee

Send today for these exciting new training courses—*you risk nothing!* When you receive the volumes, examine them in your own home for 10 full days. If, at the end of that time, you're not completely satisfied, simply return the books to us and we'll gladly *refund your full purchase price!* Total cost for either 5-volume course is only \$9.00! In Canada, prices approximately 5% higher.

ORDER TODAY!

These books are sold by electronics parts jobbers and book stores. If YOUR dealer doesn't have these books, mail this coupon to us!

JOHN F. RIDER PUBLISHER, INC.
116 West 14th St., N.Y.C.

- I have enclosed \$..... Please send me
 5-vol. Basic Electricity set @ \$9 set
 5-vol. Basic Electronics set @ \$9 set
 Both sets. I understand I may return the books in 10 days, and receive a complete refund of the full purchase price if I am not satisfied.
 Add state or city sales tax where applicable.

Name.....
 Address.....
 City & State..... P-10A

Carl & Jerry (Continued from page 20)

nel Number Five. Try not to make him angry."

Leaving their bicycles on the kick-stands with the headlamps centered on the little animal, the boys began a careful circuit about him. The skunk turned also, so that he faced them, and began an irritated little patting of the ground with his front paws. Had the boys known more about skunks, they would have recognized this danger signal for what it was and have beat an immediate retreat; but instead they proceeded cautiously to circle the little beast. Suddenly he turned his back on them, as though in contempt, and almost immediately there issued from two boyish throats simultaneous cries of anguish.

They tore off the helmets as they coughed, spluttered, and gasped for air, for the skunk had really let them have it at close range.

"Whew!" Carl said, when he finally could talk. "That meller smeller of mine must be working in reverse. It seemed to concentrate the odor. I actually couldn't get my breath until I got it off. Now I can breathe, but I'm not sure I want to—at least not *in!*"

"I know what you mean," Jerry said soulfully. "Well, let's sneak home, get some other clothes, bury these, and see how much of this odor will come off in a shower. And let's hurry. I can't stand myself; and you're not exactly attar of roses either, old buddy."

THEY carried out this suggestion without further delay. A bath and fresh clothing left only the pungent memory of their experience. But then they had to pick up the discarded clothing they had hurled out of a basement window and carry it to the back of Jerry's lot for interment.

"Jer," Carl grunted as he plied the shovel, "what do you suppose went wrong with the meller smellers? Do you think Mr. Skunk was just too much for them and that nothing could have stopped his odor?"

"I don't know," Jerry admitted, as he cut the wires loose from the reeking meller smeller helmets and dropped the latter gingerly into the hole Carl had dug. "Several things could have been wrong: maybe the spacing between the screens wasn't right; maybe we didn't have the proper potentials on the screens; or maybe the whole idea was a dud to start with. All I know is that at this moment the entire subject is extremely distasteful to me."

"Yeah," Carl agreed, patting down the earth with the back of the shovel; "you might say it stinks."



CARL E. SMITH, E. E.
President



Accredited by National
Home Study Council

How to Pass

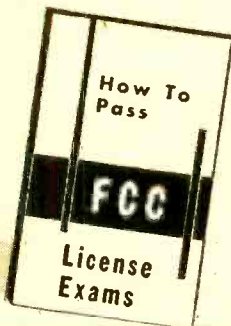

FCC

COMMERCIAL

License Exams

Get your FCC License
Quickly!

We Guarantee to train you until you receive Your FCC License

Get all 3 FREE

CLEVELAND INSTITUTE Training results in success with commercial FCC examinations—easily—and quickly. Here's Proof:

Name and Address	License	Time
Walter Eggers, Pacific Grove	1st	12 weeks
Paul Reichert, West Salem, Ohio	2nd	10 weeks
Harold Phipps, LaPorte, Indiana	1st	28 weeks
John H. Johnson, Boise City, Okla.	2nd	12 weeks
James Faint, Johnstown, Pa.	1st	26 weeks

(Names and addresses of trainees in your area sent on request)

Cleveland Institute training results in job offers like these:

Radio Operators & Technicians

American Airlines has openings for radio operators and radio mechanics. Operators start at \$334.53 per month. Radio mechanic's salary up to \$1.99 per hour. Periodic increases with opportunity for advancement. Many company benefits.

Electronic Technicians

Convair Electronics Department: Radio and Radar Mechanics, Electronics Technicians, and Junior Engineers are wanted for a special program on fire control development and installation. Beginning rate: \$365 and up.

And our trainees get good jobs

Electronics Technician

"I am now employed by the Collins Radio Company as a Lab Technician. (This job was listed in your bulletin.) I have used the information gathered from your course in so many ways and I know that my training with Cleveland Institute helped me a great deal to obtain the job."

Charles D. Sindelar, Cedar Rapids, Iowa

CLEVELAND INSTITUTE OF RADIO ELECTRONICS

4900 Euclid Bldg.

Desk PE-20

Cleveland 3, Ohio

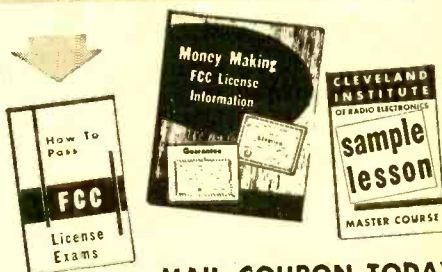

MAIL COUPON TODAY

Cleveland Institute of Radio Electronics

Desk PE-20, 4900 Euclid Ave., Cleveland 3, O.

Please send Free Booklets prepared to help me get ahead in Electronics. I have had training or experience in Electronics as indicated below:

- | | |
|---|---|
| <input type="checkbox"/> Military | <input type="checkbox"/> Broadcasting |
| <input type="checkbox"/> Radio-TV Servicing | <input type="checkbox"/> Home Experimenting |
| <input type="checkbox"/> Manufacturing | <input type="checkbox"/> Telephone Company |
| <input type="checkbox"/> Amateur Radio | <input type="checkbox"/> Other _____ |

In what kind of work are you now engaged?

In what branch of Electronics are you interested?

Name _____ Age _____

Address _____

City _____ Zone _____ State _____

Special Tuition Rates to Members of Armed Forces

POPULAR **SAMS BOOKS** FOR THE
EXPERIMENTER • AMATEUR • TECHNICIAN



USE THIS HANDY ORDER FORM

- Hi-Fi Handbook.** The new book for everyone interested in Hi-Fi design, selection and installation. Covers sound theory, distortion, loudspeakers, baffles, enclosures, amplifiers, pre-amplifiers, controls, etc. Invaluable hints on equipment selection, program sources, speaker location, etc. 240 pages, 5½ x 8½. **\$3.00**
- Transistors.** The first complete, practical book on Transistors and their application in TV-Radio-Electronics. Explains theory, circuitry, installation, testing techniques and servicing. 100 pages; 5½ x 8½; illustrated. **\$1.50**
- So You Want to Be a Ham.** Shows you how to get your license and acquire equipment. Covers: Conquering the Code, Getting Your Ticket, Going on the Air, etc. 196 pages; 5½ x 8½; illustrated. **\$2.50**
- Basic Radio Manual.** Complete course covers theory, definitions, components. Includes section on actual projects that translate theory into practice. 248 pages; 8½ x 11"; illustrated. **\$5.00**
- Basic TV Manual.** Covers all phases of TV set operation and design from picture tube to antenna. Includes project section demonstrating theory in action. 312 pages; 8½ x 11"; illustrated. **\$5.00**
- Atomic Radiation, Detection and Measurement.** Helps you understand nuclear science and its applications. Covers circuitry and operation of all types of detection devices. 200 pages; 5½ x 8½. **\$3.00**
- Electronic Metal Locators.** Explains how Metal Locators operate, describes commercial types, shows how to build locators. Describes uses in industry, for prospecting and for mine detection. Complete coverage of the subject. 124 pages; 5½ x 8½; fully illustrated. **\$2.50**
- Radio Receiver Servicing.** Covers all basic receiver types—gives time-saving hints for solving common troubles, such as dead set, weak set, noisy set, etc. 192 pages; 5½ x 8½; illustrated. **\$2.50**
- Tape Recorders.** Explains recorder theory, tape characteristics, how recorders work; covers motorboard mechanism, drive motors, volume indicators, bias oscillators, amplifiers, magnetic heads, equalization circuits. 176 pages; 5½ x 8½; illustrated. **\$2.75**

HOWARD W. SAMS & CO., INC.

Order from any Radio & TV Supplier-Wholesaler, or mail to Howard W. Sams & Co., Inc., Dept. 14-A7, 2201 E. 46th St., Indianapolis 5, Ind.

Send books checked above. My (check) (money order) for \$..... is enclosed.

Name.....

Address.....

City..... Zone..... State.....

(outside U.S.A. priced slightly higher)

LETTERS
FROM OUR READERS

Wrist-Watch Radio

■ In your January, 1955, issue, there is a statement about the possibilities of transistorized wrist-watch radios. Can you give me the names of manufacturers who are offering such products to the public?

(name withheld)

This inquiry is one of the most common received at the POP'tronics editorial offices. As far as we know, there are no wrist-watch receivers or transmitters available to the public. Several attempts have been made by manufacturers to miniaturize transistor receivers so that they may be worn on the wrist. The most notable example is the LEL model mentioned in the July, 1956, issue. Otherwise, wrist-watch radios are still just around the corner.

Kind Words

■ Congratulations to your hi-fi editors and writers. They keep the features unpretentious and never make it hard on the stomach.

W. BOORMAN
San Bruno, Calif.

■ Art Trauffer neglected the most practical application of his "Amplifierless Record Player" (November, 1956, p. 80). I built one for my four-year-old who now listens to nursery songs to his heart's content while we grownups sit in blissful silence.

F. A. CARTIER
Montgomery, Ala.

Who Speaks for Tape?

■ I've been following your hi-fi contents with particular interest in the tape recording articles. I think the mixing article in the November, 1956, issue is the answer I've been seeking for a long time. But satisfy my curiosity—who is the author, Richard Dubbe?

WAYNE JEFFREY
New York, N. Y.

Thanks, Wayne, for your kind remarks about the hi-fi material. Mr. Dubbe is a technical service engineer at Minnesota Mining & Manufacturing, one of the world's largest producers of magnetic tape. Dick has done a lot of writing on tape and related subjects. By the way, if enough readers would like it, we could run a biography of the authors in each issue.

Who Will Tackle These?

■ I use my Hallicrafters SX-62 for utility communications. It needs a simple squelch circuit to silence the receiver between transmissions.

GARY A. SHAPIRO
Bridgeport, Conn.

■ Why not more articles on u.h.f. and v.h.f. gear. There are plenty of high-quality, easy-to-get parts available to enable the design of modulators, power amplifiers, etc. I think your ham readers

Always say you saw it in—POPULAR ELECTRONICS

FREE

1957 EICO® CATALOG

SAVES YOU 50% on your TEST INSTRUMENT & HI-FI COSTS 50 KITS & WIRED MODELS to choose from!

EICO® 84 Withers St., Bklyn. 11, N. Y.

Show me HOW TO SAVE 50% on Laboratory Precision test instruments & Hi-Fi. Send FREE catalog & name of neighborhood EICO Distributor. **P-1**

Name

Address

City Zone State

Occupation Prices 5% higher on West Coast



Home, car, TV, appliance repairs:
#540 NEW!
REDI-TESTER
KIT \$12.95
WIRED \$15.95



VACUUM TUBE VOLTMETER
#221
KIT \$25.95
WIRED \$39.95



NEW! PEAK-to-PEAK VTVM
#232 & UNI-PROBE (pat. pend.)
KIT \$29.95
WIRED \$49.95

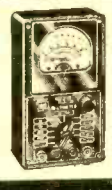

1000 Ohms/Volt MULTIMETER
#536
KIT \$12.90
WIRED \$14.90

PERFORMANCE-PROVED by TV manufacturers, electronic schools and over 100,000 Servicemen. OVER 1 MILLION in use today!



5" PUSH-PULL SCOPE #425
KIT \$44.95
WIRED \$79.95
Lowest-priced professional Scope



NEW! COLOR & BLACK-& WHITE 5-MC TV SCOPE #460
KIT \$79.95
WIRED \$129.50

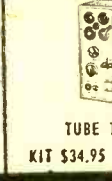

TUBE TESTER #625
KIT \$34.95
WIRED \$49.95

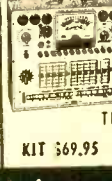

#666
NEW! DYNAMIC CONDUCTANCE TUBE & TRANSISTOR TESTER
KIT \$69.95
WIRED \$109.95

YOU BUILD EICO KITS in ONE evening, but — they LAST a LIFETIME!



NEW! 20-WATT Ultra-Linear HIGH FIDELITY AMPLIFIER #HF20
KIT \$49.95
WIRED \$79.95



NEW! HIGH FIDELITY PREAMPLIFIER #HF61
KIT \$24.95
WIRED \$37.95
with Power Supply:
KIT \$29.95
WIRED \$44.95

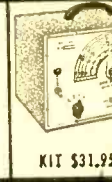

Sine & Square Wave AUDIO GENERATOR #377
KIT \$31.95
WIRED \$49.95



RF-AF SIGNAL GENERATOR #320
KIT \$19.95
WIRED \$29.95

LATEST engineering • FINEST components • EASY instructions



NEW! RF-AF SIGNAL GENERATOR #324 (150 kc to 435 mc)
KIT \$26.95
WIRED \$39.95



TV-FM SWEEP GENERATOR #360
KIT \$34.95
WIRED \$49.95



MULTI-SIGNAL TRACER #145
KIT \$19.95
WIRED \$28.95



1000 Ohms/Volt MULTIMETER #556 (4 1/2" METER)
KIT \$16.90
WIRED \$23.50

EXCLUSIVE 5-WAY GUARANTEE on components, instructions, performance — and LIFETIME service and calibration!



6V & 12V BATTERY ELIMINATOR & CHARGER
KIT \$29.95
WIRED \$38.95



R-C BRIDGE & R-C-L COMPARATOR #950B
KIT \$19.95
WIRED \$29.95



Test radio, hearing aid, flashlight, photo-flash, electronic equipment batteries.
BATTERY TESTER #584
KIT \$9.95
WIRED \$12.95



RETMA Res. Sub. Box #1100
KIT \$5.95
WIRED \$9.95
RETMA Cap. Sub. Box #1120
KIT \$5.95
WIRED \$9.95

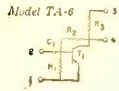

A PRIZE TROPHY

for miniaturized audio amplification

No closed season... no limit... to its applications

New Centralab Single-Stage Transistor Amplifier

- High-gain, low-power transistor amplifier can be used by itself in microphones and other miniature circuit designs. Or, you can combine several units, to get a multiple-stage unit for other audio applications.
- This is a complete amplifier housing capacitance, resistance, transistor, and wiring. Gain, 24 db. Noise level, less than 1/2 millivolts. Supply voltage, 1.35v.
- As small as an eraser on an ordinary lead pencil.
- Ask your Centralab distributor for Model TA-6 — or TA-7. Send coupon for Bulletin EP-75 containing complete information, schematics, and curves.

Centralab

A DIVISION OF GLOBE-UNION INC.
994A East Keefe Avenue, Milwaukee 1, Wisconsin
Send me free Bulletin EP-75.

Name _____
 Company _____
 Address _____
 City _____ Zone _____ State _____ Y-5625

Letters (Continued from page 24)

would be interested in seeing some of these put to good use.

WAYNE MANNETT
Olympia, Wash.

■ Why not supplement your article on the camera synchronization tester (August, 1956, p. 100) with a design of an electronic gadget to check shutter speeds?

S. G. CULVER
Orinda, Calif

■ The construction projects using transistors have been very good as far as I am concerned. I would like to see more on control circuits (both remote and photoelectric) using these components.

NORMAN MILLER
Minneapolis, Minn.

■ I'm sure your readers would appreciate an adapter that would attach to an FM tuner and would pick up TV sound transmissions.

PAUL DAMAI
Calumet City, Ill.

Information Requested

■ I recently acquired an addition to my collection of gadgets. It is a Meissner Model 9-1065 phone recorder and public address system. No instructions were included and none are available from the manufacturer. Can anyone lend me a copy, or tell me where I could obtain a duplicate set?

M. RALPH BERKE
133 Acacia Ave.
Ottawa, Ont., Canada

■ What was the value of the capacitor in the old Model "T" spark coil? I have several coils and I think the capacitors are shot. What do I replace them with?

JACK K. WILLIAMS
Webb School
Claremont, Calif.

More on Those "Dishes"

■ I am given to understand that parabolic dishes are available from C. W. Torngren Co., Inc., 236 Pearl St., Somerville 45, Mass. They manufacture these dishes in sizes ranging from four inches to six feet. The material is aluminum, and prices vary according to the physical size of the dish.

RICHARD ENEBAK
St. Paul 6, Minn.

Thanks, Dick, for the information on parabolic dishes. We're scheduling a big feature on spectacular uses of parabolas in the near future.

World Tape Pals Grows

■ We have been busy answering the deluge of letters that came in after publication of your feature article in the August, 1956, issue (p. 39). We have received about 800 inquiries from places as far away as Guam and the Dominican Republic.

HARRY MATTHEWS
Dallas, Texas

Gosh Harry, we're sure pleased to hear that World Tape Pals is growing. Any readers that missed the above article on tape correspondence can write to Harry at Box 9211, Dallas, Texas for information.

IF JOBS

Like These are
"on your mind"

... but you can't qualify
because you lack advanced
technical knowledge ...

**SEND NOW FOR CREI'S
FREE NEW BOOKLET!**

It's crammed with facts, data and a tested plan to prepare you for big jobs and high-salaried careers being offered in "Want ads" like those here, which appear daily all over the U.S. They show how desperately the electronics industry needs *trained* men. They show what opportunities await you—if you get advanced technical training. Look what's happening:

40,000,000 TV sets in use. 430 TV stations on the air, more coming. Color TV coming ahead fast. Over 125,000,000 radios in use. Over 97,000 radio-equipped police cars. At least 87,000 radio-equipped American ships. By 1960, the industry should do \$15 billion of business per year.

THOUSANDS ARE NEEDED!

... for development, research, design, production, testing, inspection, manufacture, broadcasting, telecasting, servicing. You can qualify *only* if you advance your knowledge. Take 2 minutes right now to write for the free new CREI booklet. No obligation.

RADIO! TV! ELECTRONICS!

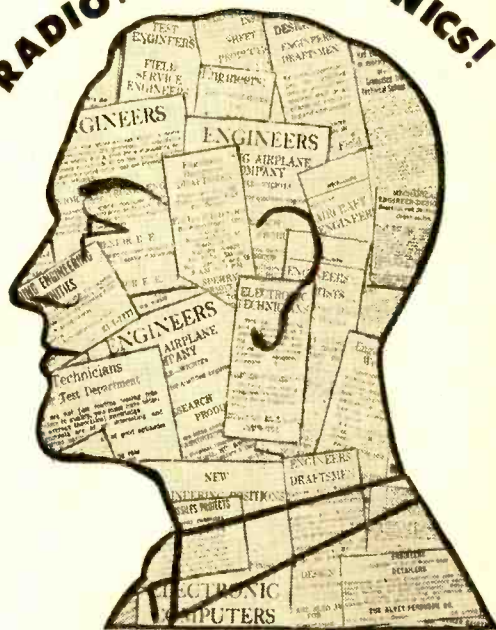

JUST WHAT INDUSTRY ORDERED!

CREI is equipped to teach you what industry needs. Many leading companies choose CREI to train their own technical staffs. Among them: United Air Lines, Canadian Broadcasting Corporation, Columbia Broadcasting System, Glenn L. Martin Co., All-American Cable and Radio, Inc.

NO COLLEGE DEGREE NECESSARY

If you have the equivalent of a high school education, are good at mathematics, and have some electronic experience—you can qualify for CREI. CREI also offers residence training at same high technical level. Classes start at regular intervals. Qualified residence school graduates earn degree: "Associate in Applied Science." Check coupon for residence study literature.

DON'T WASTE ONE MINUTE INVEST TWO!

Fill out the coupon. Mail right away. Get your free booklet and CREI plan by return mail. No obligation.

To help us answer your request intelligently, please give the following information:

EMPLOYED BY

TYPE OF PRESENT WORK

SCHOOL BACKGROUND

ELECTRONICS EXPERIENCE

IN WHAT BRANCH OF ELECTRONICS ARE YOU MOST INTERESTED

MAIL THIS COUPON . . . TODAY!

CAPITOL RADIO ENGINEERING INSTITUTE

ECPD Accredited Technical Institute Curricula—Founded in 1927
3224 16th St., N.W., Dept. 1210 WASHINGTON 10, D. C.
Send booklet "Your Future in the New World of Electronics" and course outline.

CHECK FIELD OF GREATEST INTEREST

- Practical Radio Electronics Engineering
- Broadcast Radio Engineering (AM, FM, TV)
- Practical Television Engineering
- Practical Aeronautical Electronics Engineering

Name Age

Street

City Zone State

Check: Home Study Residence School Korean Veteran



POP'tronics



BOOKSHELF

"ELEMENTS OF RADIO" by Charles I. Hellman. Published by D. Van Nostrand Co., Inc., 120 Alexander St., Princeton, N. J. 354 pages. Hard cover. \$4.95.

Clearly written and amply illustrated, this new book on fundamentals covers electrical theory, a.c., inductance, capacitance, resonance, tube theory and operation, oscillators, basic transmitters and antennas, receivers, power supplies, cathode ray oscilloscopes, transistors, television essentials—and some special applications such as printed circuits, photoelectricity, etc. The salient points of each topic are explained in straightforward fashion, with mathematical references held to a minimum.

From point of view of its contents and treatment, this book should have wide use as a beginner's text, as a general review for the more advanced, or as an approach to electronics for the technically minded

layman. Its value as a training aid is enhanced by the questions provided at the end of each chapter.

Recommended: for anyone who needs a book on radio fundamentals.

"PROFITABLE RADIO TROUBLESHOOTING" by William Marcus and Alex Levy. Published by McGraw-Hill Book Co., Inc., 330 W. 42 St., New York 36, N. Y. 350 pages. Hard cover. \$5.95.

Practical short cuts in servicing and troubleshooting home radio and TV receivers are presented in this book. The use of professional test equipment is explained, as well as the most likely procedures for tracking down the various defects that might plague the average set. Much theory is included which may help the technician do a faster, more accurate, and more profitable job.

Recommended: to all engaged in servicing.

"RADIO ELECTRONICS MADE SIMPLE" by Martin Schwartz. Published by American Electronics Co., 1203 Bryant Ave., New York 59, N. Y. 191 pages. Soft cover. \$1.95.

Assuming no previous technical training on the part of the reader, this book covers radio theory from direct current and mag-

NEW! *compass-pivoted* **Audax TONE-ARM**
now in KIT form—at HALF price!
accommodates ANY cartridge

AUDAX KT-12: KIT, \$14.55 NET

Factory-assembled, \$24.00 NET

AUDAX KT-16: KIT, \$17.55 NET

Factory-assembled, \$30.00 NET

All above prices include cartridge-housing.

You do-it-yourself with no tools other than a nail-file or small screwdriver.



The new KT models exactly duplicate the Audax "Compass-Pivoted" transcription arm long recognized as top "blue chip." These new arms are the crowning achievement of a quarter-century of constant refinement and re-engineering of the very first commercial electronic pickup arm (Audax 1928) . . . to the fewest possible parts. It is this very *nth degree* engineered simplicity that makes the new KT arms possible.

Anyone can assemble a KT arm in about 10 minutes — and save 50%! The "Selector-Index" permits instant adjustment for any stylus-pressure. The newly-designed cartridge-housing enables checking of the all-important stylus-to-groove alignment at a glance.

No tone arm equals the new Audax KT — regardless of price! Read October 1956 "Popular Electronics," page 57. See the new KT arms at your dealer. (If shipped from New York City, add 40¢ for postage.) Fill out the coupon.

Fine audio-electronic apparatus for 35 years

Audax

AUDAX COMPANY
 500 Fifth Avenue, New York 36, N. Y.

AUDAX COMPANY, 500 FIFTH AVENUE, NEW YORK 36
 Attn.: Mr. P.

Send me FREE latest Audax catalog and name of nearest dealer.

Name.....

Address.....

City..... Zone..... State.....

MEN 17-55!
HERE'S A NEW
OPPORTUNITY
FOR YOU!

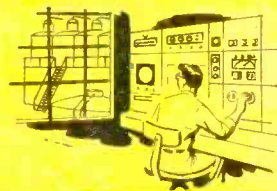

Industrial Processing

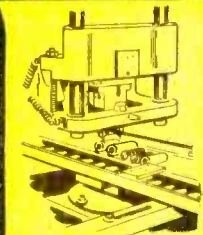

Making Electronic Devices

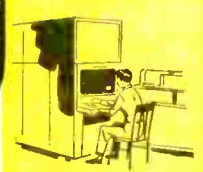

Recording and Billing



Anti-aircraft gun control

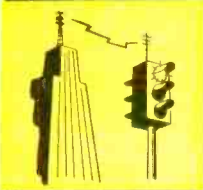

Traffic control signals



PREPARE AT HOME FOR A
PROFITABLE CAREER IN
AUTOMATION
ELECTRONICS*

Get in on the Ground Floor of this
Fast-Moving Field

Want a better job? . . . more money? . . . better working conditions? These are the things that can come to a man when he has a skill to offer . . . especially when that skill is in a newer field where ground floor opportunities often lead to well-paying positions. Such a field is the Electronic applications to AUTOMATION — and what a field!

Many plants, large and small, in various parts of the country are looking for ways of using automatic electronic control equipment to help turn out a better product and at lower cost. This equipment must be designed, installed and maintained — calling for well trained men. That's where YOU may come in!

You need no special technical experience . . . no previous knowledge of Automation Electronics . . . to prepare for a future that can be bright and more secure. For now there is a proved way to get this important know-how. Mail coupon for complete details. Men 17 to 55 preferred.

***WHAT IS AUTOMATION ELECTRONICS?**

Simply stated, this refers to the marvelous electronic controls that will help regulate the much talked about "automatic factory" — as well as other amazing automatic equipment in plants, offices and elsewhere. It is a gateway to some of the most desirable opportunities in the amazing, newer field of Automation.

ONE OF AMERICA'S
FOREMOST ELECTRONICS
TRAINING CENTERS



DEVRY TECHNICAL INSTITUTE
 CHICAGO 41, ILLINOIS
 FORMERLY
DEFOREST'S TRAINING, INC.



A New Training Program!

As one of the leading organizations of its kind, the DeVry Technical Institute has years of experience in teaching Electronics, Television and Radio. So it is only natural for this training institute to develop a new program to prepare men for good jobs in instrumentation — as well as in the design, installation and maintenance of Electronic controls — as applied to Automation.

EMPLOYMENT SERVICE

Following the same proved method used to train thousands of other men, you get valuable practical experience from actual electronic equipment. You also receive well-illustrated texts and effective moving pictures to show important basic principles—a wonderful home training advantage! To top that off, D.T.I. provides actual employment help when you have completed the training—all of which can open the way to many new and exciting opportunities.

Accredited Member of
 National Home Study Council

MAIL THIS COUPON TODAY!

DEVRY TECHNICAL INSTITUTE, Dept. PE-1A-N
 4141 Belmont Avenue, Chicago 41, Ill.

I would like a FREE copy of your booklet, "Automation and YOU." Also further information about the newer Electronic opportunities in AUTOMATION, and facts on how you may help me to prepare.

Name _____ Age _____
 Please Print

Street _____ Apt. _____

City _____ Zone _____ State _____

1012 **DeVry's Canadian Training Center is at**
 580 Roselawn Avenue, Toronto 12, Ontario

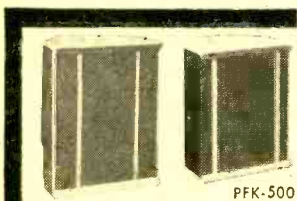

PFK-120/150

PFK-500

pfk
pre-finished
Kits



PFK-300

designed by Paul Klipsch

Now you need only a screwdriver to put together a furniture-finished Klipsch speaker enclosure, indistinguishable from factory-assembled Rebel 3, 4 or 5. Also available as conventional, unfinished kits.

Write for
**COMPLETE
CATALOG!**

- 36 pages
- 16 other hi-fi kits
- 29 equipment cabinets
- 4 matched speaker systems
- 20 hi-fi accessories



cabinart

'57

Cabinart

99 North 11th Street
Brooklyn 11, N. Y.

largest manufacturer of cabinets and kits for hi-fi
a division of G&H Wood Products Co., Inc.



**save on
hi-fi**

**SEND FOR THE 1957
ALLIED CATALOG**

Features the world's largest selection of systems and components.

free Shows you how to choose a custom Hi-Fi music system for your home at no more than the cost of an ordinary phonograph. Tells you what to look for and how to save money. Offers dozens of complete systems and hundreds of individual units, including the famous money-saving Hi-Fi Knight-Kits. For everything in Hi-Fi and Electronics, get the **FREE 1957 Allied Catalog.**

ALLIED RADIO
America's Hi-Fi Center

ALLIED RADIO CORP., Dept. JJ-17
100 N. Western Ave., Chicago 80, Ill.

Send **FREE** 1957 **ALLIED** Catalog.

Name _____

Address _____

City _____

Zone _____

State _____

netism up through tubes, oscillators, amplifiers, transmitters, receivers, and antennas. The schematics presented illustrate basic types of the various devices discussed. Written in everyday language by a former radio instructor, this volume should put the reader on "speaking terms" with things electronic.

Recommended: for the beginner and non-professional hobbyist.



"HIGH FIDELITY: A PRACTICAL GUIDE" by Charles Fowler. Published by McGraw-Hill Book Co., Inc., 330 W. 42 St., New York 19, N. Y. 311 pages. Hard cover. \$4.95.

As an introduction to—and survey of—hi-fi, this book scores very "hi" itself. It covers components and systems, and even dares tread into such controversial areas as the selection, matching, and budgeting of equipment. Chapters are subdivided into topical sections, each dealing with an aspect of hi-fi that has become a typical problem or question for the listener, such as "one or several loudspeakers," "impedance matching," "record wear," etc. A wealth of information is presented in an engaging style; the book should be easy reading, even for non-technical people.

The discussion of components starts with "the room in which we listen" and then goes to speakers, working "backward" through amplifiers, control units, and program sources. This is a worthy approach, because the average listener's first perception of a hi-fi system would logically be the loudspeaker and the sounds it produces. What's more, the subject of room acoustics is too often neglected, and many have learned from costly experience that an expensive system may sound horrible in a room that is too "live" or too "dead."

Recommended: to all interested in hi-fi.

Free Literature Roundup

A circular, titled "How to Use Supreme Publications for Faster Television and Radio Repairs," will be sent on request from Supreme Publications, 1760 Balsam Rd., Highland Park, Ill.

Nearly 1000 coils, transformers, chokes, etc., are listed in Miller's new "General Catalog No. 57-A." For your copy, write to the J. W. Miller Co., 5917 South Main St., Los Angeles 3, Calif.

Lafayette Radio's new "Catalog No. 300" contains 162 pages of listings of components and parts. Write to their new mail order headquarters at 165-08 Liberty Ave., Jamaica 33, N. Y., and ask for one. —30—

BUILD 16 RADIO CIRCUITS AT HOME

only \$19.95

with the New Improved 1957 PROGRESSIVE RADIO "EDU-KIT"

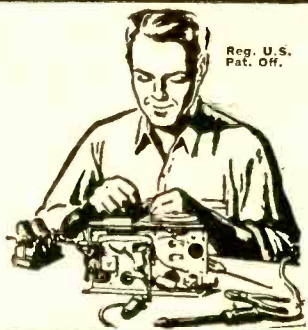

Reg. U.S. Pat. Off.

A Practical Home Radio Course

Now Includes
TESTER, SOLDERING IRON, HIGH FIDELITY SIGNAL TRACER, CODE OSCILLATOR, PRINTED CIRCUIT SIGNAL INJECTOR

- No Knowledge of Radio Necessary
- No Additional Parts or Tools Needed
- Excellent Background for TV

NOW! FREE TOOLS WITH "EDU-KIT"

WHAT THE "EDU-KIT" OFFERS YOU

The "Edu-Kit" offers you an outstanding PRACTICAL HOME RADIO COURSE at a rock-bottom price. Our Kit is designed to train Radio & Electronics Technicians, making use of the most modern methods of home training. You will learn radio theory, construction practice and servicing.

You will learn how to build radios, using regular schematics; how to wire and solder in a professional manner; how to service and trouble-shoot radios. You will work with the standard type of punched metal chassis as well as the latest development of Printed Circuit chassis.

You will learn the basic principles of radio. You will construct, study and work with RF and AF amplifiers and oscillators, detectors, rectifiers, test equipment. You will learn and practice the Progressive Code Oscillator. You will learn and practice trouble-shooting, using the Progressive Signal Tracer, the Progressive Signal Injector, the Progressive Dynamic Radio & Electronics Tester and the accompanying instructional material.

You will receive training for the Novice, Technician and General Classes of F.C.C. Radio Amateur Licenses. You will build 16 Receiver, Transmitter, Code Oscillator, Signal Tracer and Signal Injector circuits, and learn how to operate them. You will receive an excellent background for Television.

Absolutely no previous knowledge of radio or science is required. The "Edu-Kit" is the product of many years of teaching and engineering experience. The "Edu-Kit" will provide you with a basic education in Electronics and Radio, worth many times the complete price of \$19.95. The Signal Tracer alone is worth more than the price of the entire Kit.

THE KIT FOR EVERYONE

You do not need the slightest background in radio or science. Whether you are interested in Radio & Electronics because you want an interesting hobby, a well paying business or a job with a future, you will find the "Edu-Kit" a worth-while investment.

Here is an excerpt from a letter that we received from Loren DePriest, 1496 4th St., Mansfield, Ohio: "I have spent many pleasant hours in constructing the radios from the schematics in your book, and have learned a great deal from them. Being as I am interested in Radio, I consider the money spent for your course as a wise investment. I have learned more from your course by actually doing than I did from an expensive course."

Many thousands of individuals of all ages and backgrounds have successfully used the "Edu-Kit" in more than 79 countries of the world. The "Edu-Kit" has been carefully designed, step by step, so that

you cannot make a mistake. The "Edu-Kit" allows you to teach yourself at your own rate.

The "Edu-Kit" is also used for courses of study, extra-curricular activities, industrial personnel training and rehabilitation. The "Edu-Kit" is used by Jr. High Schools, High Schools, Technical Schools, Jr. Colleges, Colleges, Universities, Industrial firms, Rehabilitation Hospitals, Boards of Education, U. S. Govt. agencies, United Nations Educational, Scientific and Cultural Organizations (UNESCO), Veterans Administration, and numerous adult, radio and young peoples' groups and clubs. The "Edu-Kit" is also popular with servicemen throughout this country and abroad.

Designed for universal use, the "Edu-Kit" operates on any voltage, from 105 to 125 volts, AC and DC. For use in countries employing higher line voltages, a 210-250 Volt AC/DC model is available.

PROGRESSIVE TEACHING METHOD

The Progressive Radio "Edu-Kit" is the foremost educational radio kit in the world, and is universally accepted as the standard in the field of electronics training. The "Edu-Kit" uses the modern educational principle of "Learn by Doing." Therefore you construct, learn schematics, study theory, practice trouble-shooting—all in a closely integrated program designed to be an easily learned, thorough and interesting background in radio. You begin by examining the various radio parts of the "Edu-Kit." You then learn the function, theory and wiring of these parts. Then you build a simple radio. With this first set you will enjoy listening to regular broadcast stations, learn theory, practice testing and trouble-shooting. Then you build a more advanced radio, learn more advanced theory and techniques. Gradually, in a progressive manner, and at your own rate, you will find yourself constructing more advanced multi-tube radio circuits, and doing work like a professional Radio Technician.

THE "EDU-KIT" IS COMPLETE

You will receive all parts and instructions necessary to build 16 different radio and electronics circuits, each guaranteed to operate. Our Kits contain tubes, tube sockets, variable, electrolytic and paper dielectric condensers, resistors, tie strips, coils, hardware, tubing, punched metal chassis, Instruction Manuals, etc.

In addition, you receive Printed Circuit materials, including Printed Circuit chassis, special tube sockets, hardware and instructions. You also receive a useful set of

tools, a professional electric soldering iron, and a self-powered Dynamic Radio & Electronics Tester. The "Edu-Kit" also includes Code Instructions and the Progressive Code Oscillator, in addition to F.C.C.-type Questions and Answers for Radio Amateur License training. You will also receive lessons for servicing with the Progressive Signal Tracer and the Progressive Signal Injector, a High Fidelity Guide and a Quiz Book. You receive all parts, tools, instructions, etc. Everything is yours to keep.

FREE
 Hi-Fi, Radio & TV Servicing Manuals on request (see coupon below)

SERVICING LESSONS

You will learn trouble-shooting and servicing in a progressive manner. You will practice repairs on the sets that you construct. You will learn symptoms and causes of troubles in home, portable and car radios. You will learn how to use the professional Signal Tracer, the unique Signal Injector and the dynamic Radio & Electronics Tester. While you are learning in this practical way you will be able to do many a repair job for your friends and neighbors, and charge fees which will far exceed the price of the "Edu-Kit." Our Consultation Service will help you with any technical problems you may have.

J. Statatis, of 25 Poplar Pl., Waterbury, Conn., writes: "I have repaired several sets for my friends, and made money. The "Edu-Kit" paid for itself. I was ready to spend \$240 for a Course, but I found your ad and sent for your Kit."

FROM OUR MAIL BAG

Ben Valerio, P. O. Box 21, Magna, Utah: "The Edu-Kits are wonderful. Here I am sending you the questions and also the answers for them. I have been in Radio for the last seven years, but like to work with Radio Kits, and like to build Radio Testing Equipment. I enjoyed every minute I worked with the different kits; the Signal Tracer works fine. Also like to let you know that I feel proud of becoming a member of your Radio Club."

Robert L. Shuff, 1534 Monroe Ave., Huntington, W. Va.: "Thought I would drop you a few lines to say that I received my Edu-Kit, and was really amazed that such a bargain can be had at such a low price. I have already started repairing radios and phonographs. My friends were really surprised to see me get into the swing of it so quickly. The Troubleshooting Tester that comes with the Kit is really swell, and finds the trouble if there is any to be found."

PRINTED CIRCUITRY

At no increase in price, the "Edu-Kit" now includes Printed Circuitry. You build a Printed Circuit Signal Injector, a unique servicing instrument that can detect many Radio and TV troubles. This revolutionary new technique of radio construction is now becoming popular in commercial radio and TV sets.

A Printed Circuit is a special insulated chassis on which has been deposited a conducting material, which takes the place of wiring. The various parts are merely plugged in and soldered to terminals.

UNCONDITIONAL MONEY-BACK GUARANTEE

ORDER DIRECT FROM AD
 RECEIVE FREE BONUS RESISTOR KIT WORTH \$5

- Send "Edu-Kit" Postpaid. I enclose full payment of \$19.95.
- Send "Edu-Kit" C.O.D. I will pay \$19.95 plus postage.
- Send me FREE additional information describing "Edu-Kit." Include FREE valuable Hi-Fi, Radio and TV Servicing Literature. (Outside U.S.A.—No C.O.D.'s. Send check on U.S. bank or Intern'l M.O. "Edu-Kit" for 105-125 V. AC/DC \$20.95; 210-250 V. AC/DC \$23.45.)

Name
 Address

PROGRESSIVE "EDU-KITS" INC.

497 Union Ave., Room 528D, Brooklyn 11, N. Y.

FREE EXTRAS

- SET OF TOOLS • RADIO & ELECTRONICS TESTER • ELECTRIC SOLDERING IRON • TESTER INSTRUCTION MANUAL • HIGH FIDELITY GUIDE • QUIZZES • TELEVISION BOOK • RADIO TROUBLE-SHOOTING BOOK • MEMBERSHIP IN RADIO-TV CLUB: CONSULTATION SERVICE • FCC AMATEUR LICENSE TRAINING • PRINTED CIRCUITRY

Complete Training

FOR BETTER RADIO-TV SERVICE JOBS



Let these two great new Ghirardi training books teach you to handle all types of AM, FM and TV service jobs by approved professional methods—and watch your efficiency and earnings soar!

Each book is up-to-date. Each contains the latest data on the latest methods and equipment—NOT a re-hash of old, out-of-date material. Each is co-authored by A. A. Ghirardi whose famous RADIO PHYSICS COURSE and MODERN RADIO SERVICING were, for 20 years, more widely used for military, school and home study training than any other books of their type!

THE NEW Ghirardi RADIO-TV SERVICE LIBRARY

Almost 1500 pages and over 800 clear illustrations show step-by-step how to handle every phase of troubleshooting and servicing.

1—Radio and Television Receiver TROUBLESHOOTING AND REPAIR

A complete guide to profitable professional methods. For the beginner, it is a comprehensive training course. For the experienced serviceman, it is a quick way to "brush up" on specific jobs, to develop improved techniques or to find fast answers to puzzling service problems. Includes invaluable "step-by-step" service charts, 620 pages, 417 illus., price \$7.50 separately.

2—Radio and Television Receiver CIRCUITRY AND OPERATION

This 669-page volume is the ideal guide for servicemen who realize it pays to know what really makes modern radio-TV receivers "tick" and why. Gives a complete understanding of basic circuits and circuit variations; how to recognize them at a glance; how to eliminate guesswork and useless testing in servicing them. 417 illus. Price separately \$6.75.

New low price . . . you save \$1.25

If broken into lesson form and sent to you as a "course," you'd regard these two great books as a bargain at \$5.00 or more!

Under this new offer, you save \$1.25 on the price of the two books—and have the privilege of paying in easy installments while you use them! No lessons to wait for. You learn fast—and right!

STUDY 10 DAYS FREE!

Dept. PE-17, RINEHART & CO., Inc.
232 Madison Ave., New York 16, N. Y.

Send books below for 10-day FREE EXAMINATION. In 10 days, I will either remit price indicated or return books post-paid and owe you nothing.

Radio & TV Receiver TROUBLESHOOTING & REPAIR (Price \$7.50 separately)

Radio & TV CIRCUITRY & OPERATION (Price \$6.75)

Check here for MONEY-SAVING COMBINATION OFFER . . . Save \$1.25. Send both of above big books at special price of only \$13.00 for the two. (Regular price \$14.25 . . . you save \$1.25). Payable at rate of \$4 after 10 days if you decide to keep books and \$3 a month for 3 months until the total of \$13.00 has been paid.

Name

Address

City, Zone, State

Outside U.S.A.—\$8.00 for TROUBLESHOOTING & REPAIR; \$7.25 for CIRCUITRY & OPERATION; \$14.00 for both books. Cash with order, but money refunded if you return books in 10 days.

McWatts

By CARL KOHLER

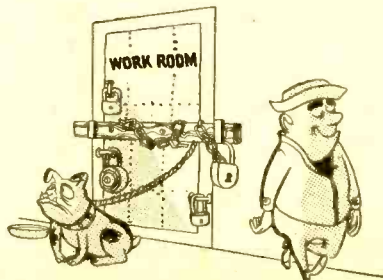
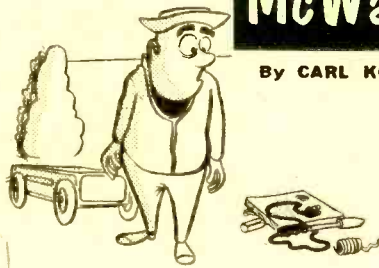

Join the Thousands of Central-Trained Technicians
Now Enjoying **HIGH-PAY CAREERS** in...

GUIDED MISSILES—AUTOMATION

**ELECTRONICS
TELEVISION
RADIO**

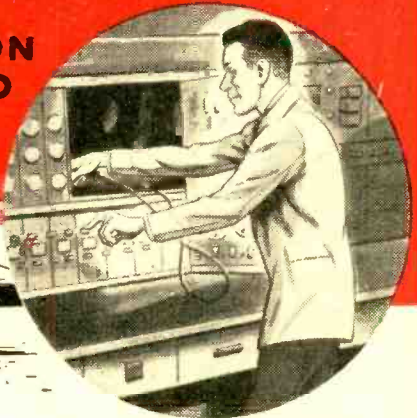
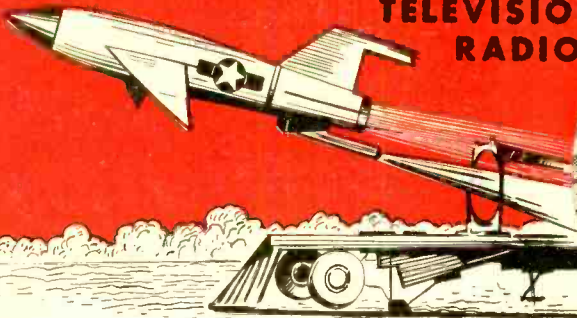

**Outstanding Employment
Opportunities Open to
Central Graduates!**

No matter what you're doing now . . . whether you've ever had previous technical experience or not, you can begin right now to prepare for a great career in these fascinating, rewarding fields!

Capitalize on the fact that Central's nationally recognized, proven training methods, top instructors and long record of educational achievement have put Central-trained men in high demand throughout America! . . . that Central's graduates are periodically interviewed and employed by many of the Country's foremost industrial giants and leading employers of electronics specialists. Hundreds of radio and TV stations look to Central as a reliable source for competent, thoroughly trained technicians . . . and the nation's major airlines and aircraft manufacturers have hired hundreds of Central-trained technicians for important communications and electronics positions.

3 Proven Training Plans

1. HOME STUDY COURSE (with 9 kits of equipment)—Qualifies you for diploma, FCC license exam, and a variety of electronics jobs (or transfer into advanced resident training).

2. HOME STUDY—RESIDENT COURSE (with 9 kits of equipment)—Home study, followed by short period of resident training. Qualifies you for diploma, FCC license exam, and a wide variety of positions (or continue with advanced resident training). An ECPD-accredited engineering technician program.

3. FULL RESIDENT COURSE—Qualifies you for Associate of Science (A.S.) degree and top-pay employment opportunities as Electronics Engineering Technician. An ECPD-accredited engineering technician program. Part-time employment opportunities available for students while training.

How Central's "Progressive Plan" Will Pay Off for YOU!

Central's complete, accredited training is designed to get you the technical job you want . . . in the shortest possible time! Through Central's "Progressive Plan" of study, as you complete each phase of training your earning capacity goes higher! How far "up the ladder" you want to go is entirely up to you. A few short weeks of training prepares you for certain basic jobs. Then, with every additional phase of training you complete, you qualify for more advanced types of positions that command higher salaries. You can settle for any of a wide variety of well-paid, worthwhile jobs along the line . . . or you can use Central's complete training to advance right up to the top-level, top-pay positions! *Don't limit yourself!* Get the facts on Central's complete training. Mail the coupon today!

VETERANS Central offers courses approved under G. I. Bill

**Mail Coupon for
FREE BOOK**

**YOUR FUTURE
IN
ELECTRONICS**

CENTRAL TECHNICAL INSTITUTE

Dept. A-17 1644 Wyandotte St.
Kansas City 8, Missouri

Tell me more about how you can qualify me for a high-pay Electronics career.

Name.....Age.....

Address.....Phone.....

City, State.....County.....

If Korean vet., give approx. discharge date.....

KNOW YOUR P's AND Q's ABOUT GOOD TEST EQUIPMENT

only EMC
instruments
give you ...

Precision
components
and assembly
techniques
insuring
unexcelled

Performance
and accuracy
never before
at such a low

Price
with the
famous EMC
standards of

Quality
all of which means
you get a greater

Quantity
of modern equipment
for better,
faster servicing.



NEW RF Signal
Generator

EMC Model 501
with leads
\$37.90 (Wired &
Tested)
\$24.90 (Kit Form)

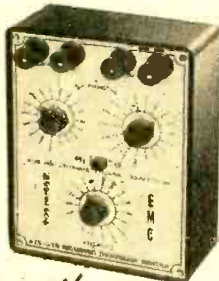

NEW Resistance-Capacity
Substitution Box

EMC Model 900
\$19.90 (Wired &
Tested)
\$10.25 (Kit Form)

Free

Yes, tell me more, send me — FREE — a
detailed catalog of the complete EMC line.

Name
Street
City State

PE-1

EMC

ELECTRONIC MEASUREMENTS CORP.
625 BROADWAY, NEW YORK 12,
NEW YORK

EXPORT DEPT. . . . 370 BROADWAY, NEW YORK 13, N. Y.

TIPS and TECHNIQUES

CABLE CLAMPS HAVE MANY USES

Keep an assortment of cable clamps handy, even if you don't build much equipment using heavy cables. Here are a few uses for them:

- (1) Use them for mounting line cords, cables, or small tubing.
- (2) Clamp large resistors (1 and 2 watt-ers) against a chassis with them. This increases the heat dissipation, using the chassis as a "heat sink," and will permit

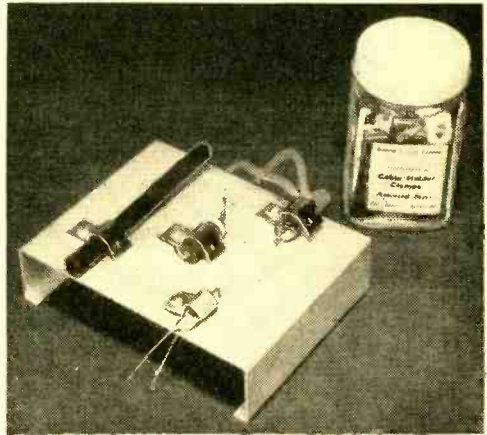

you to employ resistors up to—or slightly in excess of—their rated wattage. But perform this trick with *insulated* resistors only!

- (3) Flatten them to make small "L" brackets or shield supports.
- (4) For inexpensive pilot lamps, use them to clamp a neon lamp or regular pilot bulb against a small hole in the chassis or front panel.
- (5) Mount odd-shaped components with them—such as mercury switches. —L. E. G.

TRUST YOUR TUBE TESTER—SOMETIMES

Tube testers are ingenious devices, and more often than not they will detect defective tubes. However, two points should be remembered in evaluating the results of tube tester checks. The first is that the ordinary tester cannot check a given type tube under all the possible conditions of its

(Continued on page 96)

It Won't Come Off!



All recording tape is coated with magnetic oxide. This coating rubs off ordinary tapes in use, and forms a harmful deposit of abrasive dust on the recording head. Unless the head is constantly cleaned, the collection of abrasive eventually wears it out. After a few playings, the tape loses enough coating to alter its original frequency response characteristic.

WITH TAPE MADE BY THE EXCLUSIVE



irish

BRAND

FERRO-SHEEN PROCESS

The Oxide Will NOT Rub Off!

The irish FERRO-SHEEN process of tape manufacture anchors the oxide coating to the base inseparably and much more smoothly. The entire vicious cycle of shedding and abrasion of recording head and tape is eliminated, resulting in longer life for both tape and head and improved frequency response.

THERE'S AN **irish**
FERRO-SHEEN TAPE
FOR EVERY
RECORDING REQUIREMENT:

irish GREEN BAND
On 1.5-mil acetate base.

irish SHAMROCK
On 1.5-mil pre-selected
premium-quality acetate base.

irish LONG PLAY
On 1-mil Mylar base.

irish DOUBLE PLAY
On 0.5-mil Mylar base.

irish SOUND PLATE
On super-tough 1.5-mil Mylar base.



If not available at your local dealer's, write direct to:
ORRADIO INDUSTRIES, INC., Opelika 1, Ala.
Export Division: Morhan Exporting Corp., N. Y. C.
In Canada: Atlas Radio Corp., Ltd., Toronto

KITS! KITS!

HERSHEL'S KITS ACCLAIMED BEST!

ALL KITS CONTAIN THE FINEST
ASSORTMENTS. OVER 10,000 SOLD!

**YOUR CHOICE
ANY KIT
LISTED IN
THIS AD 97c**

- 30 TUBE SOCKETS
- 2 1/2-lbs of HARDWARE
- 15 ROTARY SWITCHES
- 10 Electrolytic Condensers
- 40 Radio & TV KNOBS
- 40 BY-PASS Condensers
- 60 CARBON RESISTORS
- 60 MICA CONDENSERS
- 100 SET SCREWS
- 8 1N22 XTAL DIODES
- 50 Ceramic Condensers
- 15 Variable Condensers (Air and Mica)
- 50 RF CHOKES.
- 20 POWER RESISTORS
- 1 Phono Motor 115 Vac.
- 50 TERMINAL STRIPS
- 200 ft. HOOK-UP WIRE
- 1 TRANS. 6.3V-110 Vac.
- 5 Meissner Plug-In COILS
- 5 PILOT PANEL LITES
- 50 FUSES 3AG UP
- 1 Meter Rectifier O-1MA.
- 1 IGN. COIL 3V-15,000 VSEC.
- 25-Ft. Phono-Mike Cable
- 3 SELENIUM RECTIFIERS (65 MA. 110V.)
- 1 PHOTO Electric CELL
- 10 STRAIN INSULATORS
- 1 TELEGRAPH KEY
- 5 MICRO SWITCHES
- 75-Ft. 300 OHM TV LEAD-IN
- 25 TV STAND OFFS
- 24 SHOCK MOUNTS
- 1 PHONO XTAL with NEEDLE
- 1 PIX TUBE BRIGHTENER
- 3 CONDENSERS (500 MMFD 20,000 Volt)
- 100 Ft. of SPAGHETTI
- 1 RCA Flyback Trans.
- 10 BATHTUB CONDENSERS
- 10 GRAIN WHEAT LAMPS
- 5 RADIO-PHONO CHASSIS
- 4 LOOP ANTENNAS (RADIO)
- 1 PHANTOM ANTENNA A-62
- 100 SPRINGS (RADIO-PHONO)
- 5 RADIO NOISE FILTERS
- 25-Ft. RG-58/U COAXIAL CABLE with PLUGS
- 2 Powerful ALNICO 5 Magnets

All New **MYSTERY PACKAGE**
of ELECTRONIC PARTS



Worth \$40.00
Our Price
\$3.95
Shr. Wt. 20-lbs

It's the surprise of your life! 20 pounds of BRAND NEW usable GOVT. surplus. The ideal gift for ham's, etc.

OIL CONDENSER



\$1.65

2 MFD. 3000 pyranel VDC. w/ Mounting Brackets. 1-1 Mfd. removed from New equip. 4 1/4" x 4 1/4" x 2 1/2"

ARC-5 COMMAND TRANSMITTER



\$8.95

7 to 9.1 Mc. B. A. R. d. Now in Cartons. w/ 1 1/2" tubes. Hottest Buy in the Country

TERMS: Cash with order or 25% DOWN—BALANCE C.O.D.
ALL PRICES NET F.O.B. DETROIT MINIMUM ORDER \$2.00

HERSHEL RADIO CO.

5249 GRAND RIVER Detroit 8, Michigan

TYler 8-9400

BEST BUY IN HI-FI
Grommes **KITS**

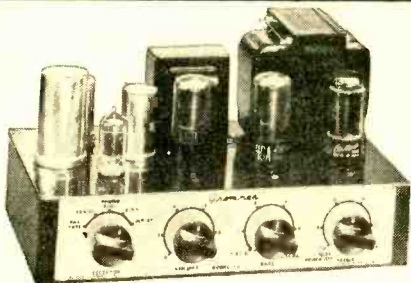

THE Little Jewel
MUSIC LOVERS AMPLIFIER

Featured by Life Magazine as the best buy in the field . . . now available in Kit Form. It's easy and fun to assemble. Power Output: 10 Watts. Freq. Response: ± 1 DB, 20 to 20,000 CPS. With 3 inputs: Radio, Magnetic and Crystal Phono and Microphone. Charcoal and Gold Finish. Including 5 tubes and complete instructions. Shipping Weight: 9 lbs.
 LJK KIT. Net **\$24⁹⁵**



61-PGK 20 Watt HI-FI AMPLIFIER

Single unit amplifier with built-in pre-amplifier and all the controls. This exceptional Kit provides separate turnover and roll off record compensators and loudness, volume, feedback bass and treble tone controls. Freq. Response: ± 0.5 DB, 15 to 30,000 CPS. Charcoal and Gold Finish. Shipping Wt. 20 lbs. Complete with easy-to-follow instructions.
 61-PGK. Net **\$59⁵⁰**

See your Hi-Fi Dealer.
 If he cannot help you, write . . .

Grommes—A Division of Precision Electronics, Inc.
 Dept. P-1, 9101 King Ave., Franklin Park, Illinois

- Send complete Kit details. Send Kit.
- COD (\$5 enclosed). Postpaid. (Full payment enclosed. Enclose name of Dealer. (If any.)

Name

Address

City Zone State

10-day money back guarantee on all Kits

TOOLS
 and
GADGETS



MIDGET SOLDERING IRON

Delicate precision work on printed circuits—as well as regular radio and TV circuits—and intricate electrical work can be performed with the new Wall “Pencil” soldering iron. Built to withstand “production line punishment,” it weighs only an ounce, has an $\frac{1}{8}$ ” tip, and is just $7\frac{1}{2}$ ” long.

The “Pencil” iron is said to reach production heat four times faster than any

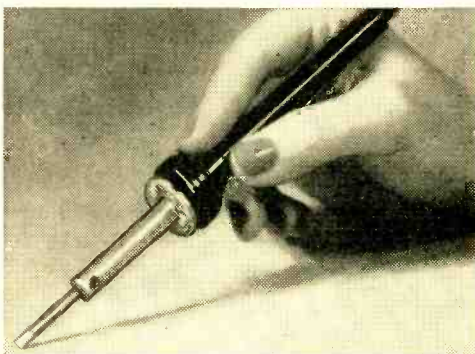

soldering iron of equal tip size. Excessive fusing and tip-burning are eliminated through thermostatic action guaranteed for the life of the iron. (Wall Manufacturing Co., Grove City, Pa.)

“TV ROLL-AROUND”

Installing casters under a large television set is a quick and easy job if you have a Telco “TV Roll-Around.” You set just one wing nut, and the device will fit

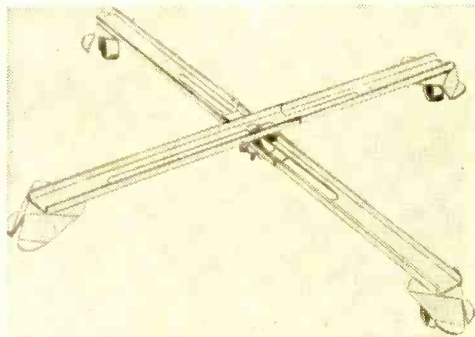

beneath nearly any console receiver now on the market. Heavy steel channel construction provides the frame ruggedness
 (Continued on page 98)

RCA offers you the
 finest training
 at home in
Radio-TV
 electronics,
 TV servicing,
 Color TV

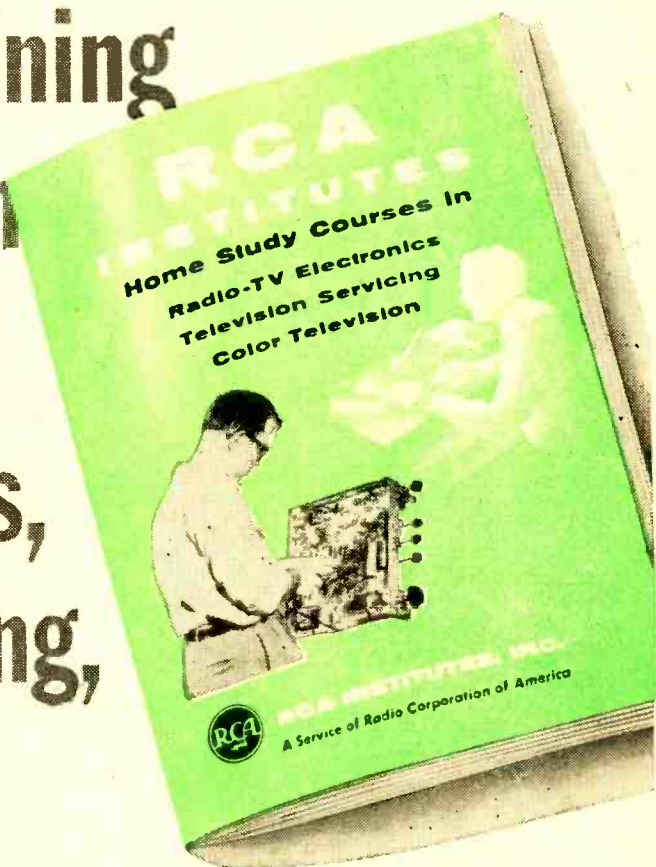

**SEND FOR THIS FREE
 BOOK NOW!**

The instruction you receive and equipment you get (and keep) will start you on your way. Pay-as-you-learn. You pay for only one study group at a time. This 52 page book contains complete information on Home Study Courses for the beginner and the advanced student.



RCA INSTITUTES, INC.
 A SERVICE OF RADIO CORPORATION of AMERICA
 350 WEST FOURTH STREET, NEW YORK 14, N.Y.

RCA Institutes, Inc., Home Study PE-17
 350 West Fourth Street New York 14, N. Y.
 Without obligation, send me FREE CATALOG
 on Home Study Courses in Radio, Television
 and Color TV. No salesman will call.

Name
 Please Print
 Address
 City Zone ... State

VETERANS
 KOREAN G.I.
 P.L. 550
 CHECK HERE

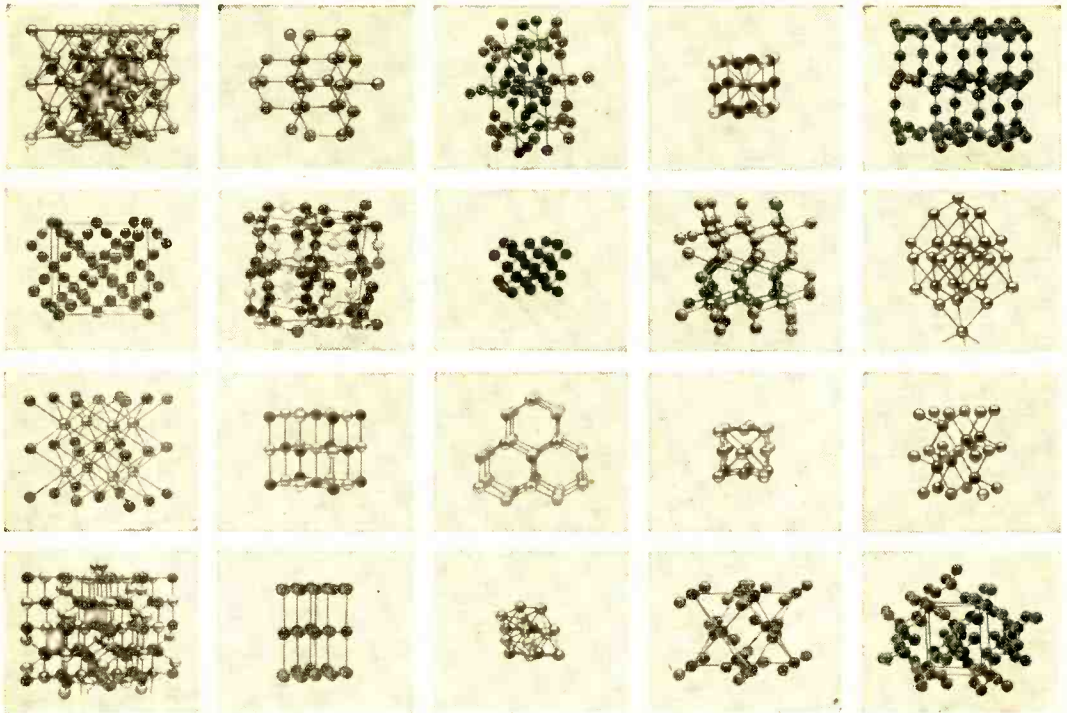

Crystal structure models. Top row, left to right: cuprite, zincblende, rutile, perovskite, tridymite. Second row: cristobalite, potassium dihydrogen phosphate, diamond, pyrites, arsenic. Third row: caesium chloride, sodium chloride, wurtzite, copper, niccolite. Fourth row: spinel, graphite, beryllium, carbon dioxide, alpha-quartz.

FROM ATOMS TO STARS

Research at Bell Telephone Laboratories ranges from the ultimate structure of solids to the radio signals from outer space. Radio interference research created the new science of radio astronomy; research in solids produced the transistor and the Bell Solar Battery.

Between atoms and stars lie great areas of effort and achievement in physics, electronics, metallurgy, chemistry and biology. Mechanical engineers visualize and design new devices. Mathematicians fore-

shadow new communications techniques.

Despite the diversity of their talents, Bell Laboratories scientists and engineers have much in common. A habit of teamwork channels these talents into great advances.

These men have developed the world's finest telephone system. In doing so, many have become leaders in their fields. Opportunities for achievement await qualified scientists and engineers at Bell Telephone Laboratories.

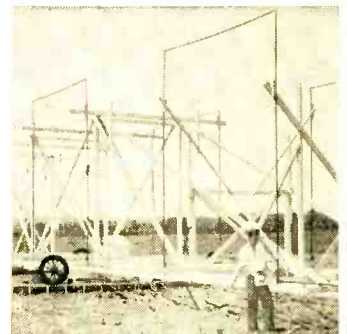

Directional antenna used by Karl G. Jansky in discovery of stellar radio signals at Bell Telephone Laboratories in 1932.

BELL TELEPHONE LABORATORIES

World center of communications research. Largest industrial laboratory in the United States.



TV

Over the Hill and Into the Dale

By DAVE SCHER

**"Translators" open new vistas
for mountain-locked communities**

NIGHT HAS FALLEN over the valley. The day's labors ended, a family relaxes in its sitting room. A tired man puffs on a pipe; his wife darns socks; the kids play checkers; a dog curls up lazily before the fire. Peaceful and restful—but isn't something missing?

Of course, you've guessed it: no television! Literally thousands of Americans have been deprived of TV, not because they can't afford to buy receivers, but because reception is poor or impossible in their communities!

Most of us take for granted our nightly sessions before the magic silver screen, but there are many regions that are literally land-locked, and TV signals have not yet learned to climb mountains.

"Translating" TV. Dwellers in these fringe and "shadow" areas can take hope, however, with the development of an ingenious new system for bringing big-city TV to any remote area. Known as a "TV Translator," this device picks up standard v.h.f. telecasts, converts them to u.h.f. (channels 70 through 83) and retransmits them for the benefit of viewers in a given area. Sound and picture quality of "translated TV" is said to be as good as in big city areas.

Developed by Adler Electronics, New Rochelle, N. Y., the low-power (10-watt) Translator solves the video problems that have been plaguing outlying communities. Early last year, the FCC ordered all unlicensed "boosters" to shut down because such devices were held to be in violation of existing FCC broadcast regulations. The "boosters" represented an attempt to give TV broadcasts a much-needed lift over mountains into land-locked areas. Working with passive reflector antennas (also unauthorized), the boosters provided some help, but the FCC ordered them "off the air."

The Adler Translator system sidesteps possible interference by converting the TV signal to a different frequency and then

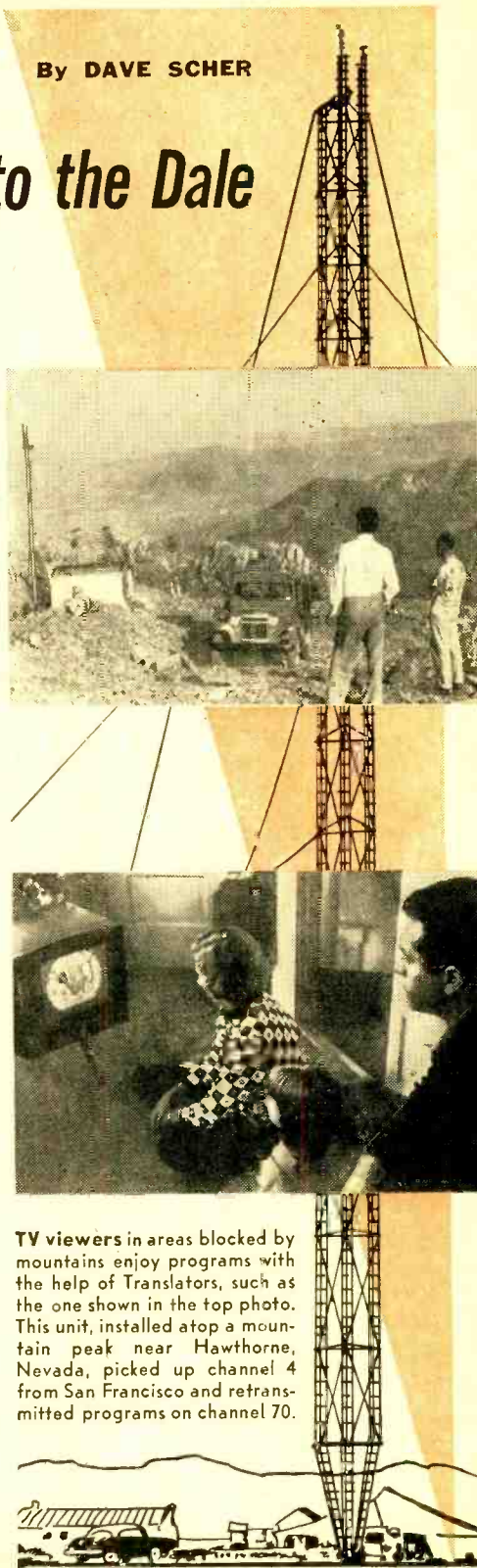

TV viewers in areas blocked by mountains enjoy programs with the help of Translators, such as the one shown in the top photo. This unit, installed atop a mountain peak near Hawthorne, Nevada, picked up channel 4 from San Francisco and retransmitted programs on channel 70.

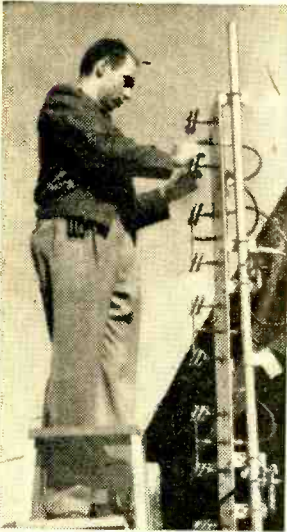

Translator is housed in small weatherproof shack (below). Note antenna at right. Programs are beamed out on one of the u.h.f. channels. Programs that originate on a u.h.f. channel may also be "translated" with a frequency converter and then retransmitted.

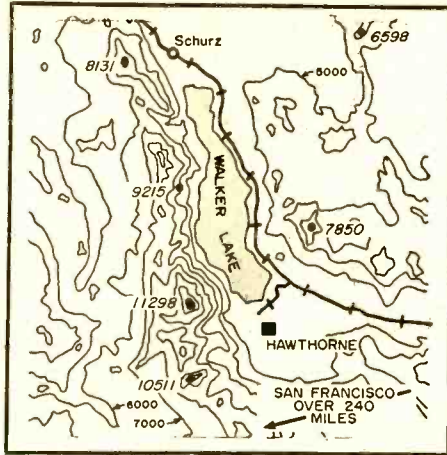

High mountain peaks surround town of Hawthorne, as shown by contour map at left. Note distance to San Francisco. TV programs from that city were received satisfactorily in Hawthorne with the aid of a Translator. Far left, a technician adjusts the elements of a four-unit antenna used at the Translator site.

transmitting it on a "clear channel." The Translator includes a v.h.f. antenna, v.h.f. tuner, v.h.f. to u.h.f. converter, u.h.f. amplifiers, u.h.f. antenna, and an automatic code identifier. A single cabinet houses all this gear. Antenna combinations handle various powers and special radiation patterns. Because the Translator's output is confined to the less-congested upper end of the u.h.f. band, the FCC has granted approval for the system.

Adler recently conducted a demonstration at Quincy, Washington, in the heart of a land-locked area. Picking up Spokane's channel 4 (KXLY-TV), 150 miles distant, the Translator retransmitted on u.h.f. channel 78 to receivers in Quincy. The nearest receiver was 6½ miles from the Translator site. Excellent reception was reported as far away as 18 miles.

Typical Installation. In service, a typical Translator installation is sheltered within a weatherproof shack, with a power line
(Continued on page 102)



QUESTIONS AND ANSWERS ON THE TV TRANSLATOR

What does the Translator do? The Translator picks up a TV signal, converts it to an unused u.h.f. channel, and retransmits it so that TV sets in land-locked regions can receive programs with picture and sound quality as good as on sets in metropolitan areas.

Who can own and operate a Translator? The equipment may be owned and used as a community utility, financed by a fund that could be set up by individuals or by local governments.

How large an area will a Translator serve? This depends on the height of the transmitting antenna. An area up to 10 miles can be adequately serviced by one Translator.

Are specially trained personnel needed? Anyone holding a commercial radio operator's license of any grade may be put in charge of the Translator, supervising it by remote control.

May local "commercials" be fed into the Translator? No. The Translator is used strictly to repeat programs of existing TV stations and may not originate its own program material. The only signal it may originate is its own station identification, which is transmitted at regular intervals by an automatic device.

What are the advantages of a Translator? The Translator does not interfere with existing TV signals on authorized channels. The transmitted signals are free of snow, "hot" or "blind" spots, and image blemishes.

Which channels can a Translator handle? The Translator receives any v.h.f. channel (2 to 13). Where it is needed to receive a u.h.f. station, an additional converter may be added to the equipment. Programs are then beamed out on u.h.f. channels 70 through 83.

SOUND - 71.75 MC.
VIDEO - 67.25 MC.
525 LINES
30 FRAMES

SOUND - 41.5 MC.
VIDEO - 45.0 MC.
405 LINES
25 FRAMES

RIVERHEAD
N.Y.

LONDON
ENG.

London-New York TV in 57?

TELEVIEWERS of NBC's "Wide Wide World" may have the unusual experience of looking in on a live show direct from London. According to the book, TV signals are supposed to fade out just beyond the horizon, wandering off into the sky, never to return. But when TV signals from overseas popped into NBC's monitor screens at Riverhead, Long Island, it became evident that the v.h.f. waves don't know the rules they are supposed to follow.

Searching for an explanation of ocean-hopping TV signals, scientists related this unusual case of v.h.f. reception to periodic explosions on the surface of the sun, commonly known as "sunspots." Occurring at fairly regular intervals of 11 years, these "spots" are often more than 100,000 miles wide. They cause strong variations in the magnetic field of the earth and also increase the ionization of the upper atmosphere through their ultraviolet rays. As a result, the outer fringe of the atmosphere, from 175 to 350 miles above the earth, becomes sufficiently reflective to bounce back v.h.f. signals which at other times would have passed through them into space. At the peak of the 11-year sunspot cycle, high-frequency signals can be received over thousands of miles.

To keep the TV reflections from being

drowned in "noise," NBC picks up these signals on the quiet Long Island shore, far from elevators, trucks, buses, and other interference sources. The signals must be received with English-type equipment. From Long Island, a microwave link flashes the signal to New York City, where the image is converted to American TV standards. This conversion is accomplished by simply letting an RCA Vidicon camera look at a British TV set screen. The high persistence of the Vidicon tube provides a sort of memory-storage effect between one frame and the next, so that the speed difference between British and American standards is smoothed out. The camera then yields a signal that can be fed into American TV transmitters.

Images were blurred at this writing. But as the sunspot season approaches its 11-year peak, the signal level—and hence the picture quality—will improve. The resulting observations will prove highly interesting, not only to people yearning for an instantaneous look at Piccadilly, but also to scientists concerned with the possibilities of ionospheric long-range transmission. Furthermore, important scientific data about the ionospheric layers in upper atmosphere can be deduced from these v.h.f. radiation patterns.

-50-

Vidicon camera, operated by Robert Fraser of NBC's engineering staff, points at the monitor screen displaying TV signals arriving from England by ionospheric reflection. This unusual mode of transmission results from periodic sunspots. The high image persistence of the Vidicon camera converts the British frame sequence to the faster American transmission rate.

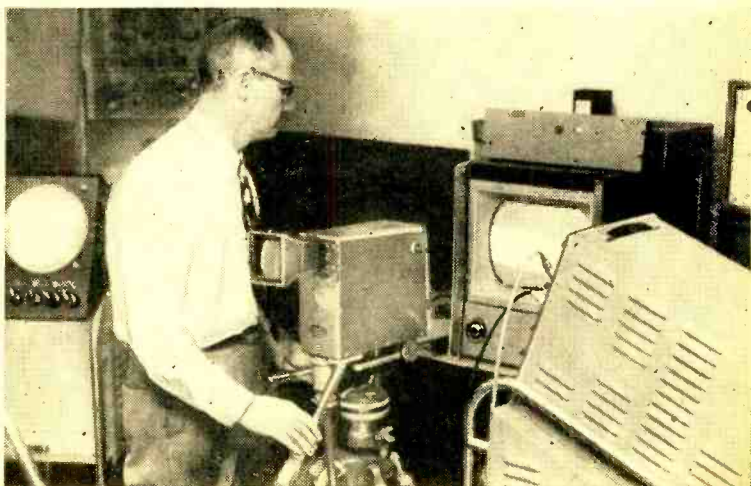

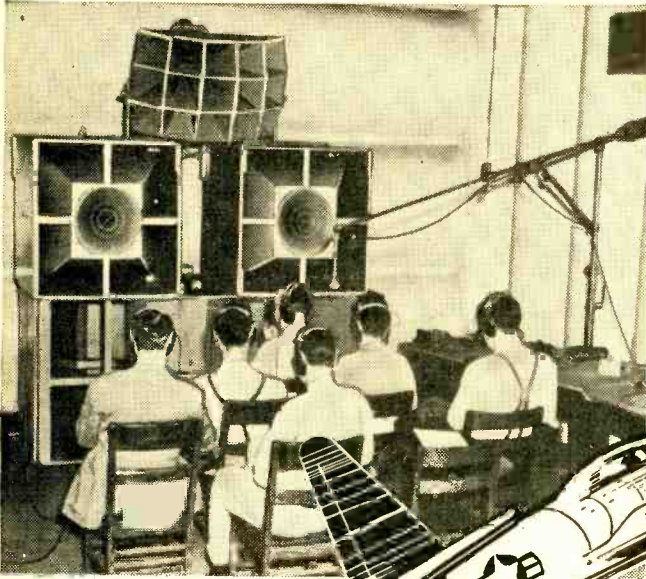

Noise room at left is part of RCA's Camden, N. J., plant. These men, representing the crew of a bomber, are testing new intercom equipment for intelligibility against a background of simulated jet engine roar at 120 db. Many plane makers, such as Boeing, Douglas, Convair and Bell, have sound chambers for testing noise effects.

Making Noise is Their Job

EVER-NOISIER jet and rocket engines in military aircraft have created a new occupation for electronic technicians—building, assembling, maintaining and operating sound chambers where engine noise is duplicated for test purposes.

A few such "noise rooms" were built during World War II to study the effect of plane noise on crew members. But due to the recent discovery that engine noise can actually destroy parts of the plane itself and make its delicate electronic equipment go haywire, sonic chambers are being constructed throughout the aircraft and aviation industries at break-neck pace.

At the moment, these chambers are being used to test experimental structures and equipment, but when enough is known about the destructive effects of "acoustic vibration," the U. S. Air Force will undoubtedly require that much air-

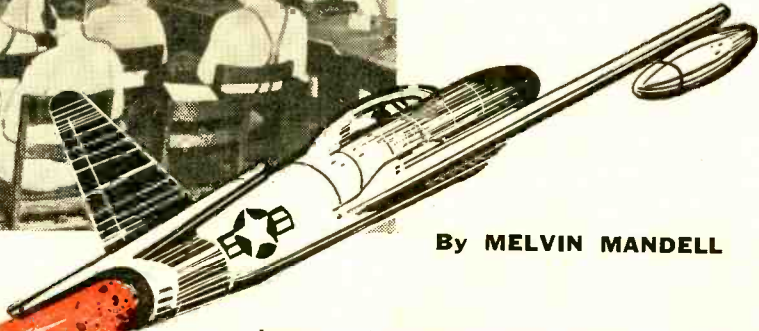

By **MELVIN MANDELL**

borne equipment be subjected to high noise tests as it comes off the production line. Then the building and maintaining of high noise chambers will become a "boom" industry. And the men who know how to run them will draw premium pay.

Catching the Gremlin. That noise can wreck physical objects was first clearly realized in 1952. The XB-52, prototype of the famous eight-jet bomber, was pulled out on the runway at the Boeing Aircraft Company plant in Seattle. Her engines were revved up to full power. In only 15 minutes, cracks were seen on the wings and tail surfaces near the engines: noise alone was the culprit. Those surfaces had to be replaced by much heavier and stiffer metal before the XB-52 could be taken off the ground.

Mysterious failures of delicate electronic and electromechanical equipment in planes began to worry engineers shortly afterwards. Nobody could catch the gremlin until Marvin Levine and Fred Mintz of Chi-

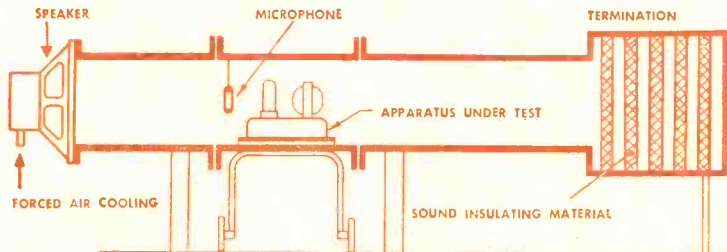

Apparatus to be tested by sonic technicians is rolled into position on a cart in the Convair "Pipe." Sewer pipe is used here as the chamber wall.

ago's renowned Armour Research Foundation conclusively demonstrated in 1954 that noise from jet engines could upset electron tubes, relays and accelerometers. Using a small noise box, they subjected rugged military-type tubes to an intensity of 130 db of noise from recordings of jet engines. Although the tubes had safely passed military tests for *mechanical* vibration, they failed or operated erratically under *acoustic* vibration. Yet they still passed the shake-table tests afterwards. Noise was the gremlin!

Noise Apparatus. After Boeing engineers discovered the harmful effect of noise on metal structures, they and a number of other aircraft manufacturers began to study metal samples subjected to acoustic vibration. At first, Boeing tested plane parts in the exhaust of an actual jet engine; but this method was an expensive



Panel of metal above was destroyed by 170-db noise in Boeing sound chamber.

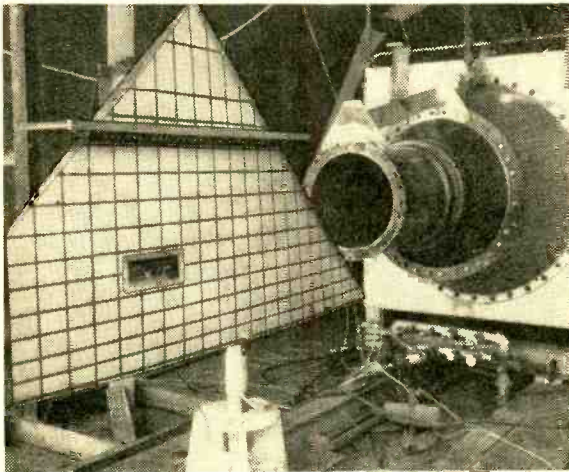

Aircraft parts like stabilizer above at first were tested in actual jet engine exhausts by Boeing engineers for ability to withstand high noise. Now they use a sound chamber.

Oscilloscope photo taken at Armour Research Foundation shows the effect of acoustic vibration on a sensitive relay. Sharp peaks indicate wide-open contacts.

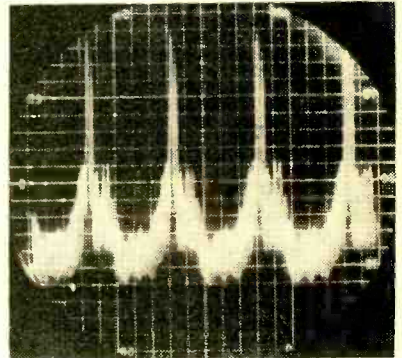

and an impractical way of doing the job.

The engineers then set to work designing equipment to make noises as loud as those of existing jet engines. The resulting apparatus uses compressed air running through a special motor-controlled valve to produce a single-frequency sound up to 170 db in intensity. Electronic instruments measure the effect of the noise on metal panels and airborne equipment.

But now that the latest jet engines make noises up to 190 db, the Boeing facility is obsolete. So they are building a new one—expected to cost a quarter of a million dollars—that will howl away at 190 db.

In addition to Boeing, planemakers like Douglas, Convair and Bell have sound chambers. At the National Advisory Com-

mittee on Aeronautics laboratory at Langley Field, Va., the effect of noise on metal panels is studied using sirens and air jets as the sound sources.

Many electronic design laboratories duplicated the original one-loudspeaker noise box used by Levine and Mintz at Armour Research. But it was too small to test a complete radio or radar receiver. So Dr. John K. Hilliard of Altec Lansing designed a hexagon-shaped box mounting seven big speakers. That's about as many speakers as can be used because only 3 db is gained each time you double the number of loudspeakers.

Hilliard wants someone to develop more powerful and efficient loudspeakers for this

(Continued on page 104)

Foil Those Tube Forgers

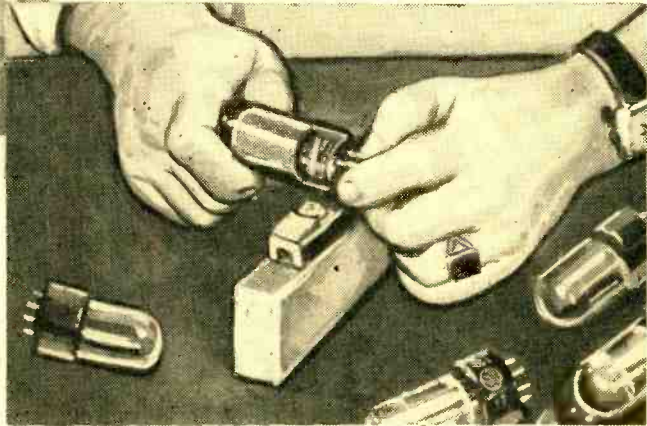

Rebranding tubes, the forger (at right) rolls the base over a rubber stamp with counterfeit lettering. Above, a legitimate tube is shown next to an almost identical forgery.

You can help stamp out crime in the electronic tube trade

THE OLD WARNING about taking wooden nickels has returned in electronic guise: beware of counterfeit radio tubes! Every trade has its own kind of crooks. Electronics' contribution to the criminal roster is the fly-by-night dealer who buys up old, defective tubes for next to nothing, forges a new brand on them, and sells them at "bargain prices."

Dressed-Up Duds. Forgers sometimes get hold of discarded tubes by pretending that they are to be used as targets in a shooting gallery. The tubes are then cleaned and polished to a fresh-looking gloss, and rebranded with the name of a prominent manufacturer.

Most important, the rebrander removes the old warranty number and replaces it with a current code. Some forgers, equipped equally with gall and skill, actually have the nerve to turn their newly "guaranteed" tubes back to the manufacturer, complaining indignantly that the tube does not work and "please send a new one, pronto."

Of course, the crook and his customer will be the first to yell when the manufacturer's loss shows up in a price increase to be borne by the entire public. Large manufacturers, like Sylvania and G.E., estimate

a million dollar loss annually through this kind of fraud.

It's Up To You! The tube industry recently started an all-out campaign to stop this racket. Each tube returned to the manufacturer is now closely examined to make sure that it is legitimate. Furthermore, the factory destroys all defective reject tubes to keep them from falling into the hands of the forgers. Only first-rate tubes are put on the market.

Nearly 500 million receiving and allied type tubes were manufactured during 1955, with a considerable percentage destined for the replacement tube market. For each new replacement tube sold, a dud of that type usually was discarded. The above figure highlights the importance of halting

REAL TUBE BARGAINS

Rebranded tubes should not be confused with legitimate "surplus tubes." Surplus tubes are available at low prices from honest discount dealers. As a rule, they are new tubes obtained from equipment manufacturers who may have gone bankrupt or out of business, or may have changed the design of their products so that they no longer need their tube stock. Since such manufacturers usually buy tubes at wholesale prices, their remaining stock may be legitimately sold to surplus dealers at low rates. These legitimate discount tube distributors offer the radio experimenter good values at low prices.

the flow of duds into illicit channels. But public cooperation is also needed to dry up the black market.

The industry is urging all electronics amateurs, experimenters, repair shops and the general public to cooperate in driving the rebrand racketeers out of business. Smash every one of your used-up tubes. Don't sell them and don't give them away.

The tube manufacturers themselves are

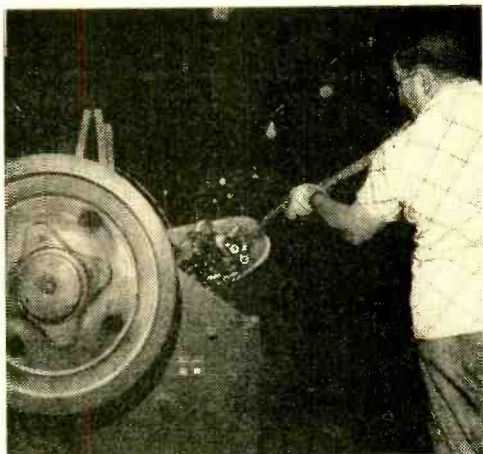

Huge tube crushers are stoked with reject tubes at the General Electric Tube Dept. (top) and at Sylvania's tube plant at Emporium, Pa. (left). Such a procedure keeps substandard tubes off the market. These companies feel that all burned-out or defective tubes should be smashed to keep them out of the reach of criminal rebranders. After crushing, a flotation process separates glass splinters from the heavier metals, which are then recovered.

aiding local law enforcement in bringing these forgers to trial. Some companies have assigned detectives to obtain legal evidence against the rebranders. A recently convicted rebrander was sentenced to two years in prison. He boasted that counterfeiting could have brought him an income of \$25,000 annually if he hadn't been too lazy to work steadily!

Sylvania Electric Co. has offered a \$1000 reward for "information leading to the arrest and conviction" of individual or company fraudulently branding tubes with the Sylvania name. The Philco Corporation buys up all old tubes for five cents each. These and other measures are designed to pull the rug out from under the rebranding racket.

Junk-Selling Methods. The tube counterfeiter usually is a pretty slick operator. He tells a good story. The pitch might be that he bought unused quality tubes at an auction, when a service shop went out of business, and is passing on the saving to you. He might claim that an equipment manufacturer discontinued certain tube types in his equipment and sold these unused quality tubes at a loss.

To sidestep suspicion, the forger often mixes a number of good tubes into a pile of duds to be palmed off to gullible customers.

One sure way to know if the tubes you buy are unused factory-tested quality products is to insist on a carton with the warranty information printed thereon. You are



Quality control programs supplement regular production testing to make sure that all tubes sold under brand name meet specifications. Scientific sampling techniques validate spot testing.

not likely to go wrong if each and every tube comes in a new brand-name carton.

There are no legitimate tube "seconds." Tubes that fail to meet specifications are not marketed by responsible manufacturers. Instead, they are smashed at the plant in large machines to make sure that no defective tubes reach the market; for a dud is never a bargain.

Sky-High Radar

A sailor in the "crow's nest" atop the tall forward mast was once the Navy's method for seeing ahead. Later, the rotating search radar helped to keep a lookout in night and fog. Now Sikorsky's new radar helicopter, shown at left, hovers as a high vanguard above the fleet, expanding the early-warning range. The bulging radome in the nose houses the antenna for high-powered radar, capable of spotting planes at double the usual distance.



Trial/Error Machine

A new electronic brain, called "Automex," which differentiates between right and wrong decisions and profits from its own mistakes, is operated by Dr. R. Hooke of Westinghouse. In the photo at right, the machine is solving the problem of a man trying to climb a mountain in total darkness and reach the top with the fewest steps, knowing only whether he has moved up or down. This logic solves many different problems.



This "Brain" Squirts

Say goodbye to carburetor trouble. In fact, say goodbye to the whole carburetor — which may soon be replaced by Bendix' new "Electrojector" fuel injection system. The engine displayed at left is fed by the little electronic "brain box" in front, which senses operating conditions and adjusts fuel spray accordingly. Humidity, temperature, and richness of fuel mixture are all taken into account for best engine performance.

Lab Aloft Chases Cosmic Rays

Outwardly, the globe-girdling KC-97 shown here looks like just another big Air Force tanker. Yet it houses a unique flying lab now being taken on a 90,000-mile research mission to chart the incidence of cosmic rays around the world. Detectable only at great height, these rays affect the outer magnetic field of our planet. Whether they influence radio reception is not known.



By PERRY F. WILLIAMS,
W1UED

W1AW Will Help YOU Become a Ham



**Practice receiving
the code necessary to
obtain a ham license
by listening to W1AW**

EVERY EVENING, from a short-wave radio station in Newington, Conn., the letters "QST QST QST de W1AW W1AW W1AW" ring out crisply in International Morse Code, calling to order a unique classroom of the air. Responding to the call are doctors and housewives, truck drivers and bankers, teachers and machinists, engineers and school children in cities and towns throughout the country. Each sits in front of a short-wave receiver, pencil in hand, translating the dits and dahs of radio code into English letters and words. Their common objective is to acquire sufficient skill in code reception to pass the Federal Communications Commission examination for an amateur radio operator license.

The "teacher" of this code class is a machine which uses a punched tape to trigger the seven short-wave transmitters. "Final exams" are given once a month, when station W1AW conducts its code proficiency certificate session. One minute of perfect copy is required for "graduation" at any particular speed, in 5-wpm steps from 10 to 35 wpm. Anyone is welcome to make use of the code practice, and to receive a certificate of proficiency, without charge, upon sending qualifying copy to the American Radio Relay League in West Hartford, Conn. The League conducts the program as one of its services not only for amateurs, but for those wishing to join the ranks of the nation's 150,000 "hams."

Becoming a "Ham." W1AW's code practice program is a key to the door of the fascinating hobby of amateur radio. Hams claim the distinction of having the only hobby which is provided for in international law, and for which a license is necessary.

In the United States, the FCC is in charge of issuing amateur licenses after an examination in code, radio theory and regulations. One of the tests is simple enough to have been passed by children of seven, while another is so tough that professional operators have been known to fail it.

Most newcomers—more than 25,000 last year—start with the Novice license, requiring a code speed of five words per minute, and a simple written exam. Though it is valid for only a year, and grants limited privileges, the Novice license provides the thrills of two-way communication using one's own private radio station in the cellar, attic or living room. Quite a few Novices have "worked" (ham lingo for contacted or communicated with) all 48 states; several have reached all six continents and as many as 50 countries during their license period.

You don't have to travel a long way to try either of these exams. The papers are obtained from the nearest office of the FCC, and any amateur holding a General (or higher) Class license may serve as the examiner. Government and commercial radio telegraphers can conduct the tests, too.

The next step, and one which most hams regard as their goal, is the General Class license. The written exam is a little tougher and a speed of 13 wpm is necessary. With this license, an amateur may operate on any amateur band, using phone (voice), c.w. (code), radioteletype, or other forms of communications authorized on some bands.

Choice of Activities. Not only does the amateur have a choice as to the bands and types of signals he uses, but there also is a variety of activities available to him. The



At WIAW, the operator adjusts the tape transport mechanism for the daily code lessons. These lessons are transmitted in the radio amateur bands.



The operating position at WIAW includes a variety of standard-brand radio amateur receivers and transmitters. Both phone and c.w. are employed.



largest group is the "rag-chewers," congenial fellows who like to strike up conversations over the air with almost anyone, be he in the next town or halfway across the globe. Then there are the "DX hounds." These fellows aren't too interested in chatting with the ham in the next state; what they want is contacts with amateurs in exotic places like Tibet, or Gambia, or Qatar, or Niue. There's a special award highly regarded by the DX'ers, the DX (distance) Century Club, issued by the ARRL for submitting proof of communications with 100 or more different countries or territories. Amateurs regularly exchange colorful postcards confirming radio contacts, and these are submitted for the DXCC and for other awards.

"Traffic men" are hams who meet at regular times on a certain frequency to relay messages for each other and for the general public. A typical message might be from a Yale student to his folks in Ohio wondering what happened to his laundry; another from a "boot" at Great Lakes Naval Training Center telling his girl in Miami that he'll be home Friday; and a third from W6XXX in Los Angeles to W7XXX in Phoenix asking him to listen on 50 mc. at 9 p.m. Wednesday. Many of the message relayers are members of the National Traffic System, set up by the League; all take part merely for the pleasure of snappy, purposeful operating. The FCC forbids amateurs to accept any sort of pay for services performed as hams.

Still another group is interested in emergency operation. These hams hold regular drills once a week or oftener, to keep themselves in trim for the real emergency, be it fire, flood, hurricane, blizzard, tornado, explosion or enemy attack which may some

(Continued on page 110)



Being a radio amateur attracts all ages. C. N. Crapo, of Milwaukee, Wis., has held the same license since 1920; his call letters are W9VD. The young lady at the left received her license when she was seven years old; she is Sharon Pakinas, of Bothell, Wash., and her call letters are WN7UOH.

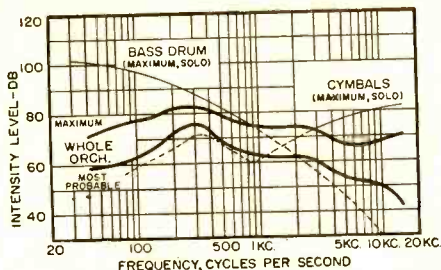

Graph shows sound levels of live orchestra at a distance of 20 feet.

The Why's and Wherefore's of WATTS

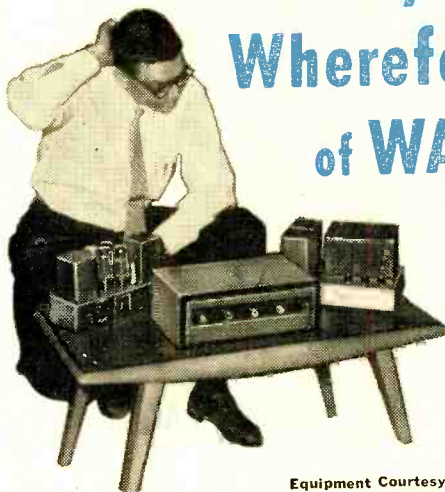

Equipment Courtesy Hudson Radio

By LEONARD FELDMAN

Stop scratching your head over which amplifier to get; here's the answer to your power output requirements

"Leading authorities maintain that the minimum acceptable power-handling capacity of a hi-fi amplifier shall be at least 25 watts."

"Our research shows that the purchase of an amplifier having a power rating of over 10 watts is a waste of money."

"A leading speaker manufacturer has recommended that power amplifiers for use with his speaker should be rated at 30 watts or better."

"Five watts of audio fed to an 'efficient' loudspeaker is more than the human ear can stand."

IF YOU'RE TRYING to decide which high-fidelity amplifier to buy, you've probably run across conflicting comments like those above. But before you can hope to find the amplifier that best suits your needs, you should know what this "power" and "watts" talk is all about.

All the sound we hear, whether natural or reproduced, is caused by a movement of air. High-pitched sounds mean that the air is vibrating at a fast rate. Low-pitched sounds are caused by air moving at a slower rate. It takes power to move this air, just as surely as it takes power to move an automobile. The more power you apply to the drive-shaft of a car, the faster it will accelerate. Similarly, the harder you push the air in making sound, the louder will be the sensation to the listener.

DB's and Power. The decibel or "db" is used as a measure of sound and power because it indicates the way our ears behave

when subjected to sound vibrations, or moving air. When you double the power applied to move the air in making a given sound, the sound doesn't seem twice as loud, but only *slightly* louder. We call this a change of 3 db. On the other hand, 10 db represents a power change of 10 to 1. In other words, actual power change, measured in watts, (just like the light-giving power of an electric lamp), is much greater than the equivalent change in decibels. The decibel method of measurement more nearly approximates the way our hearing system responds to changes in sound intensity.

It's obvious that the more power an amplifier can feed to a loudspeaker, the louder is the sound that can be produced by the loudspeaker. However, because of the way we hear sound, doubling the power of an amplifier will not make its maximum sound output seem twice as loud, but only *slightly* louder. To choose an amplifier suitable to the needs of the listening room, we need to consider several factors:

1. How much power is there behind real live music?
2. How loudly would you like music played in your living room?
3. How loudly will *other* members of your family *let* you play music? (The second and third questions are usually separated by about 10 db!)
4. What speaker are you planning to use with the system?
5. Will you ever want to add additional

speakers in other rooms? (Don't answer this one too hastily!)

6. How large is your listening area and how is it furnished?

Listening Power. Before we even tackle the first question, there's an important point that needs clearing up. The top rating of an amplifier does not necessarily indicate how it will sound at lower levels. Take a good-quality 20-watt amplifier and place it alongside a 10-watt amplifier. Send in just enough signal to develop, say, 1/2 watt—and it is unlikely that you will hear any difference between the two. The difference only shows when a very loud sound of 15-watts power must be fed to the

speaker. That's when the first amplifier will handle it, but the second one will overload and cause annoying distortion.

A good analogy is that of a 100- and a 200-horsepower automobile creeping along in metropolitan traffic. Since neither car can be "opened up" to its full power, both travel neck and neck, performing equally well.

How Loud Is Music? The "quietest" sound anyone can hear is measured at "0 db." The loudest sound anyone can hear before it actually becomes harmful is about 120 db louder than the softest sound. Anything we call "sound"—including music—falls somewhere in between those two extremes.

To get a good idea of where a symphony orchestra playing about 20 feet from you fits into this picture, refer to the sound level graph on page 49. At first glance, it would appear that a level of about 80 db is the loudest sound you can expect to hear. However, bear in mind that these are *average* levels, and that instantaneous peaks or bursts of music may actually exceed this particular level by as much as 20 db. (Notice the curve for the bass drum solo, for example.)

Now, if we had a simple way of relating watts of amplifier power to decibels, we would know how much power would be needed for the amplifier. But—we have to consider the second and third factors.

Home vs. Concert Hall. Since the purpose of an amplifier and speaker system is to "push some air around," the question naturally arises, "How much air?" Even traveling at the same speed, a motor scooter could never haul the load of a two-ton truck. Similarly, a little one-watt amplifier might make a lot of noise come out of a loudspeaker (if both you and the speaker are in a coat closet), but you'd hardly even hear such a system if it were installed in Carnegie Hall. The truth is, when playing records, you're *not* in Carnegie Hall but in your living room. So we've got to determine just how much air has to be pushed around in *that room* and how hard it must be pushed to satisfy your musical tastes.

All of this is not meant to imply that

HOW TO ESTIMATE YOUR POWER AMPLIFIER REQUIREMENTS

1. Decide on the loudest average listening level you will ever require.
2. Add 20 db to the above, for peaks in program material.
3. "Size up" your listening room by multiplying the length by width by height of the room. Work to the nearest foot. That will be accurate enough.
4. Determine the acoustic power in watts from the chart below.
5. Find out the efficiency of the loudspeaker you plan to use.
6. Divide the acoustic wattage requirements by the speaker efficiency.
7. Double this figure to allow for overly absorptive draperies, rugs, etc.
8. Allow for any additional boosting you plan to do by means of tone controls, bearing in mind that 3 db of bass boost represents a 2-to-1 increase in power—6 db, a 4-to-1 increase—and 10 db, a full 10-to-1 increase in power.
9. If, after making the above estimations, you find that the amplifier turns out to be too costly, revise your top listening level **DOWNWARDS** and purchase the best possible loudspeaker you can afford—for, at comfortable room volume, with all other things being equal and the amplifier not "pushed" beyond its capabilities, it's the quality of the loudspeaker that most determines what your home music system will sound like.

Table at right shows acoustic wattage required for various listening levels in different-sized rooms. This table, used in conjunction with instructions listed above, will help you choose correct amplifier for your hi-fi.

AVERAGE INTENSITY LEVEL (db)	ACOUSTICAL POWER FOR DIFFERENT ROOM VOLUMES (watts)			
	1000 cu. ft.	2000 cu. ft.	3000 cu. ft.	4000 cu. ft.
55	.0000051	.0000098	.000014	.000019
60	.000016	.000031	.000045	.000059
65	.000051	.000098	.00014	.00019
70	.00016	.00031	.00045	.00059
75	.00051	.00098	.0014	.0019
80	.0016	.0031	.0045	.0059
90	.016	.031	.045	.059
100	.16	.31	.45	.59
110	1.6	3.1	4.5	5.9

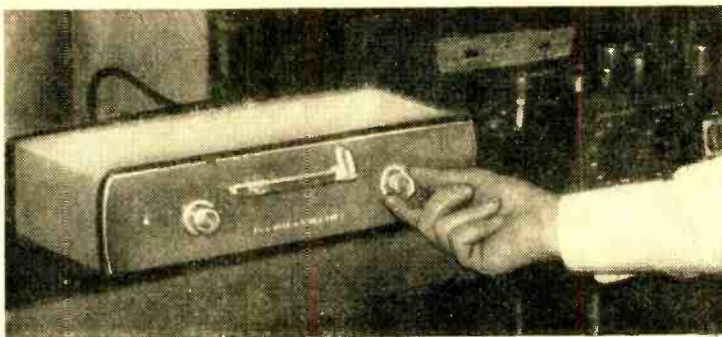

Boosting bass, even slightly, may require double the power-handling capacity of the amplifier. This little known—but important—fact should be considered when you choose an amplifier for a hi-fi system.

you *can't* duplicate the concert hall level of 80 db or even 100 db in your living room. All we're saying is that you will most likely settle for a comfortable 60 db with the possibility of occasional 80-db peaks. In any case, that's something you must decide for yourself. Having made up your mind whether to go for full concert hall volume or not, and knowing the size of your listening area, you can determine from the table on page 50 just how many *acoustic watts* of power you'll need to fill the room with that much sound.

Let's work out a sample based on an average living room which measures 12' x 20' and has an 8'2" ceiling. The volume of such a room is just under 2000 cubic feet (width x height x depth). Suppose, despite our warnings, you decide that at some time you will want to "crank the system wide open" and really duplicate concert hall volume, or go for a glorious 80 db on average music, with possible 100-db peaks on the cymbal crashes. Consulting the chart, you find that you need a mere .31 acoustic watt (less than $\frac{1}{3}$ watt) to do the job. Seems hardly necessary to invest in a power amplifier at all, does it? Actually, we've been neglecting the biggest unknown of all, the *loudspeaker*.

Loudspeaker Efficiency. All along we've been talking about acoustic power needed to do the job of making music for our ears. That means actual power caused by the "back and forth" motion of the loudspeaker cone itself. There isn't a speaker manufacturer we know of who will deny that by far the most inefficient of all the components in a hi-fi setup is the loudspeaker itself. That doesn't mean it's the most inferior part of the system but it does mean that the speaker puts out far fewer acoustic or *usable* watts than are put into it by the power amplifier. Actually, most of the power an amplifier feeds to a loudspeaker "goes up in heat." (In much the same way, an electric light bulb only converts a small fraction of the electrical "watts" fed to it from the socket into usable light. The rest is wasted in the

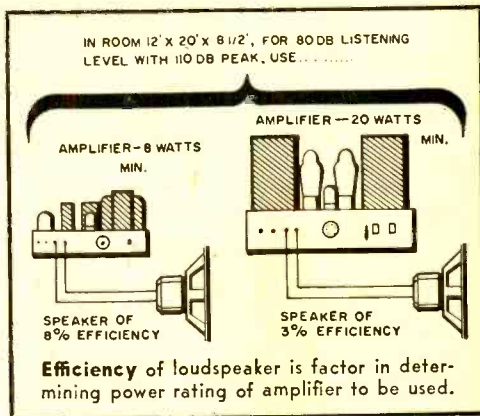

form of heat—a fact easily checked by touching a bulb that has been lit for several hours!)

Furthermore, not all loudspeakers have the same efficiency. They vary from "highly efficient" units of 10% to 20% to all-time lows of considerably less than 1%. If you've been following the latest advertisements put out by loudspeaker manufacturers, you probably realize that there's something of a "factional war" going on between the proponents of the "high" efficiency units and the relatively "low" efficiency units. Far be it from us to get into the squabble. All we want to do is point out the fact that a speaker having an efficiency of 1% will require 100 times as much amplifier power for a given acoustic power—or that, in our example, to get .31 acoustic watt means hooking up such a speaker to an amplifier able to supply 31 watts to the speaker. A speaker having an efficiency of 10% will need 10 times as many amplifier watts for a given number of acoustic watts or, again using our example, 3.2 watts supplied by the amplifier are all that will be needed to meet the same acoustic requirements.

It should now be apparent that unless you have a fairly good idea of the efficiency of the loudspeaker you propose to buy, you

(Continued on page 112)



Keeping Tabs on the Competition

Electronics has moved into the front lines of merchandising with the installation of an automatic price indicator in Fearson's liquor store in Washington, D. C.

The device shows price changes and compares competitors' prices with those offered by Pearson. Retail prices of 80 different brands of potables appear on a board which is controlled remotely by a telephone dial operated from the store's office. This device was designed, built, and installed by Amperon Electronics, New York, N. Y., with the cooperation of National Union Electric Co., Orange, N. J. It cost Pearson about \$20,000.

Private Paging System

Members of the staff of Strong Memorial Hospital, Rochester, N. Y., are being paged quietly and privately through a new "Page-master" selective paging system manufactured by Stromberg-Carlson, a division of General Dynamics Corp., Rochester, N. Y. With this system, a doctor or other hospital worker carries in his pocket a small radio receiver. Paging signals are broadcast from a transmitter whose control panel is located at the hospital's telephone switchboard, shown in the photo at right.



Pen-Size Meter Warns Against Fall-Out

About the size of a fountain pen, Bendix's dosimeter provides detection and measurement of gamma radiation from "fall-out" caused by nuclear explosions. Dosimeter readings are also helpful to medical personnel in treatment of radiological casualties. More than a million dollars' worth of these devices has been purchased by the government. Originally produced exclusively for the U. S. Armed Forces and Federal Civil Defense Administration, the dosimeter has recently been made available to the public. It is produced by the Cincinnati Division of Bendix Aviation Corp. Retail price is \$9.90.

Test Lab on Wheels

To assist field installations in maintaining accuracy of electronic test equipment, the U. S. Signal Corps is using a mobile Equipment Calibration Test Van which operates from signal depots to service field sites. A view of the van's interior is shown at right. In addition to its provisions for adjusting field equipment, the van stocks some parts, such as precision resistors, capacitors, and basic meters for on-the-spot repair jobs of defective gear. A total of six such vans is expected to be in use early this year. Overseas units are also contemplated.

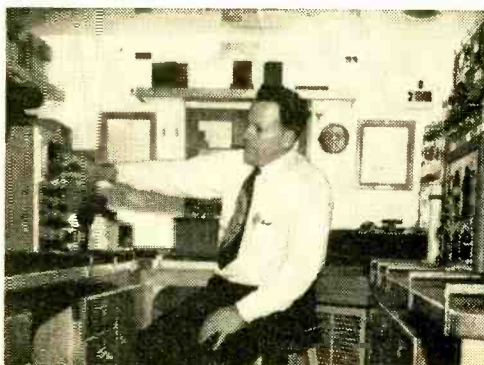

By **LOUIS E. GARNER, JR.**

Housed in a small plastic case, colored to suit your taste, the receiver is not much larger than a pack of cigarettes.

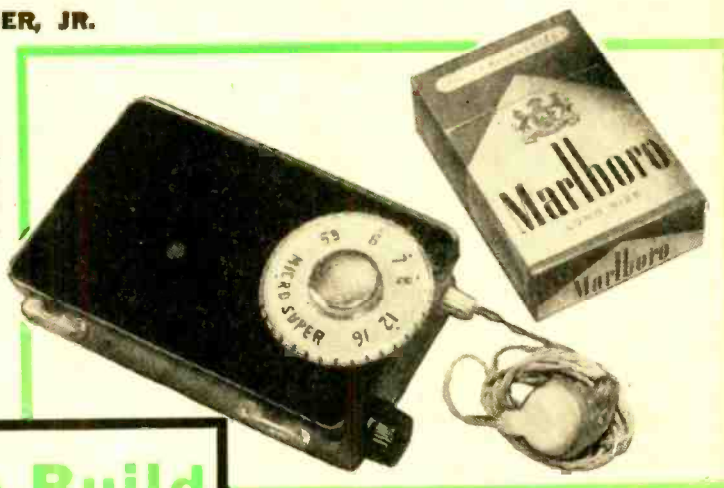

How to Build a Reflex Transistor Superhet

This "shirt pocket" receiver uses only three transistors and needs no outside antenna

BOTH experimenters and builders will agree that a pocket radio receiver would win almost any construction popularity poll. Here is a transistorized pocket superhet with a circuit that uses only three transistors. It features a reflex arrangement and direct coupling.

A small, clear plastic box makes an excellent cabinet for the receiver. You can color the cabinet by spraying the box on the inside with Acrylic plastic of whatever color you prefer.

Assembly. Cut a piece of thin Bakelite board to fit the plastic box and use this as a chassis, following the general layout shown in the photographs, and wiring according to the schematic and pictorial diagrams. Neither layout nor lead dress is especially critical.

The volume control ($R9$) and output jack ($J1$) are mounted on small brackets. Coils ($L1$ and $L2$), i.e. transformers ($T1$, $T2$), the battery holder, diode ($CR1$), transistors, the tuning capacitor ($C1a/C1b$, $C2a/C2b$), and ceramic and electrolytic capacitors are mounted above the Bakelite chassis. Resistors are below the chassis.

Use two small fuse clips to mount coil $L1$, placing one clip at each end of the ferrite core. Coil $L2$ is simply cemented in

position with one terminal inserted through the chassis. Transformer ($T1$, $T2$) and coil ($L2$) connections are identified on page 54; the coil leads to $L1$ are color-coded.

Although the self-contained antenna coil, $L1$, should have adequate pickup for strong local stations, you'll find that the receiver's sensitivity can be increased if you add a short (2' to 3') antenna lead to the "white" terminal of $L1$.

Alignment. Like all superhet receivers, this set will have to be aligned before use. It is a fairly simple operation and consists



To align the superhet, you'll need a signal generator and an insulated alignment tool.

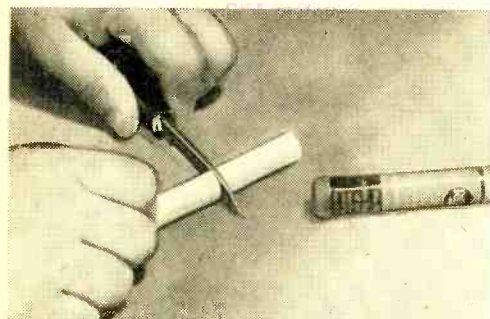
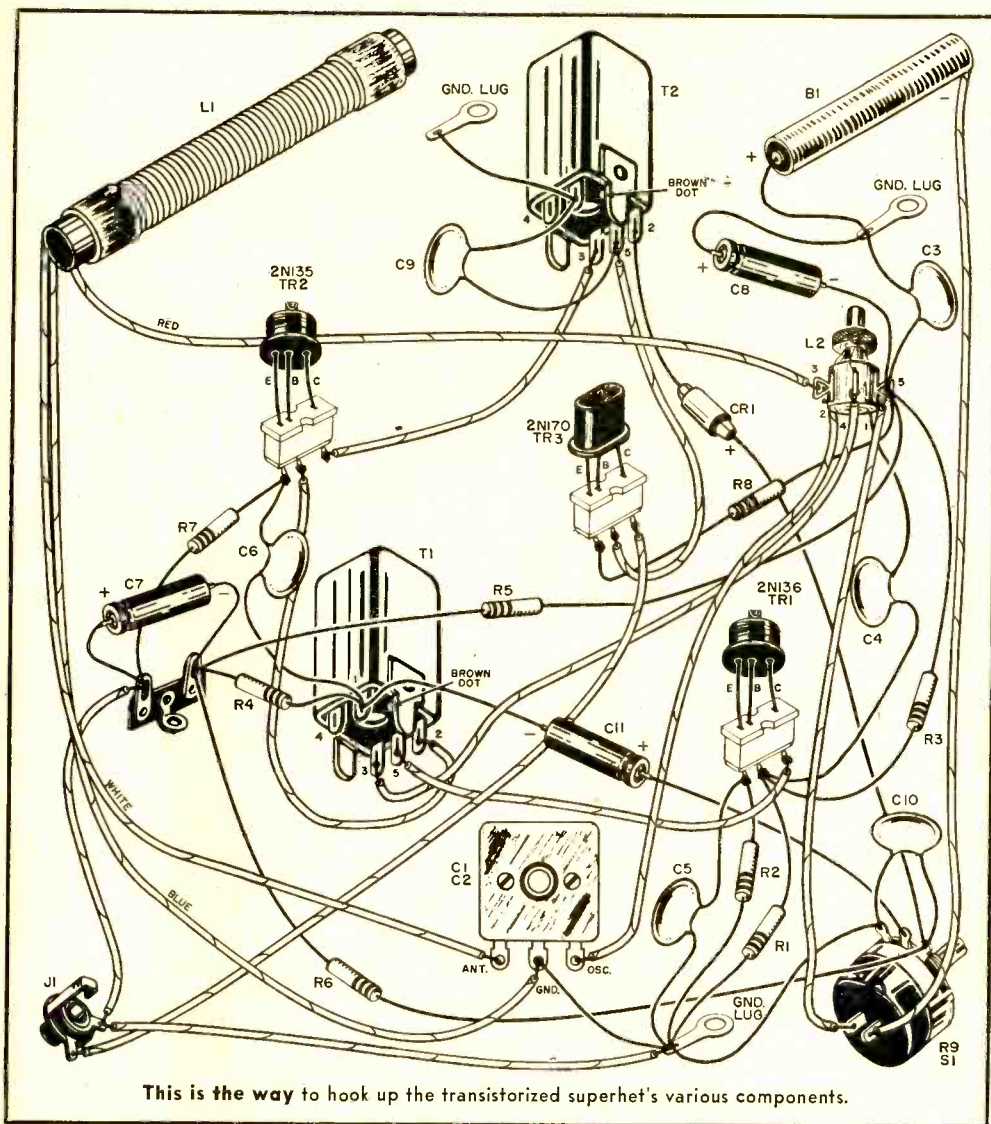

Operating power for the simple receiver is supplied by an 11.2-volt battery, made up by cutting an eight-cell section from an RCA Type VSO87 "separable cell" battery. You can easily cut out the desired section with an ordinary pocket knife.

of adjusting all fixed tuned circuits for maximum performance. You'll need a standard r.f. signal generator and an insulated alignment tool.

Connect the signal generator's "ground" lead to circuit "ground" (positive side of B1). Connect the "hot" lead through a small (10 to 25 $\mu\text{fd.}$) capacitor to the "white" terminal of L1. Make sure the tuning capacitor plates are fully meshed. Then adjust the signal generator to deliver a *modulated* r.f. signal at 455 kc.

Advance the volume control to maximum output, listening to the earphone for an audio tone. Adjust the "output" control of the signal generator until the tone can just be heard. Using the insulated alignment tool, adjust the iron core slugs of the i.f.

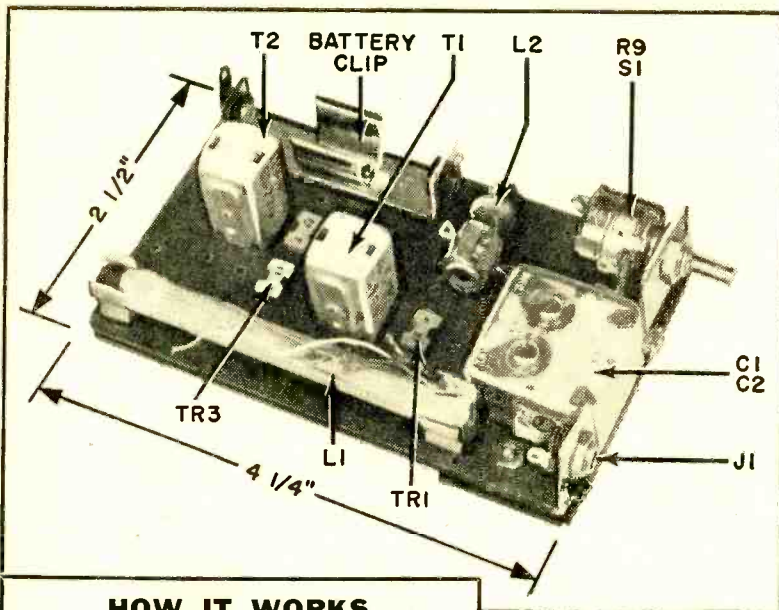

Top view of the receiver chassis shows location of all major components. The transistors are not in their respective sockets. Screw adjustments of C1b and C2b are visible on the top of C1/C2. Antenna coil L1 is held in place with a pair of fuse clips.

HOW IT WORKS

In operation, r.f. signals are picked up and selected by tuned circuit C1a/C1b-L1. The first transistor, TR1, is connected as *oscillator-converter*, with L2 serving as the oscillator coil. The incoming r.f. signal and the locally generated signal are combined in this stage to produce the 455-kc. i.f. signal which, in turn, is selected by a tuned circuit (T1) serving as the collector load for the stage.

The second transistor stage, TR2, serves as both the i.f. amplifier and the first audio amplifier stage. Capacitors C6 and C9 serve as r.f. bypass units. A fixed bias is applied through R5, bypassed by C7, and isolation resistor R4, acting in conjunction with emitter resistor R7. In addition to the fixed bias, a variable bias is supplied from the detector's load resistor R9 through isolation resistor R6.

After amplification, the i.f. signal is coupled through transformer T2 to the second detector, a type 1N64 crystal diode. Detection (demodulation) occurs in this stage, and appears across diode load resistor R9, the volume control. The a.f. portion of the detected signal is coupled through C11 to the base of TR2. This signal is then amplified with the base-emitter circuit of TR3 serving as the collector load for TR2 as far as the a.f. signal is concerned. TR3 serves as the second a.f. stage and the earphone serves as the collector load for TR3.

The general type of circuit arrangement used here is known as a *reflex* circuit.

transformers for maximum output, as heard in the earphone. These cores are reached through holes in the bottom of the transformers. Always use the *minimum* signal that will give you an easily heard tone.

After peaking the i.f. transformers, remove the coupling capacitor (attached to the "white" terminal), replacing it with a much smaller unit (about 5 μ d.). Shift the signal generator to 1600 kc. and open the tuning capacitor's plates. Adjust the trimmer, C2b, on the back of the oscillator capacitor for a peak in output. Then turn the receiver's tuning dial to 1500 kc. (plates partially meshed), and shift the

signal generator to this frequency. Adjust the r.f. trimmer, C1b, for a peak in output.

Finally, shift the signal generator to 600 kc. and turn the receiver's dial to the low-frequency end of the band—the tuning capacitor's plates should be almost fully meshed. Now, "rocking" the tuning capacitor back and forth slightly, adjust the slug of L2 for a peak in output. Recheck all three adjustments (C2b, C1b, and L2).

With the alignment completed, remove the signal generator lead and the small input coupling capacitor. Complete the assembly by installing the receiver in its plastic case.

-30-



Electronics Will Locate Those Car Rattles



By R. WAYNE CRAWFORD

*Find that rattle and shake
the kinks out of the family
car with this novel gadget*

MOST OF US have noticed annoying rattles in our automobiles. At the first opportunity we drive into a garage, get out the screwdriver, pair of pliers and wrench, and start tightening every screw and bolt in the general vicinity of the rattle. Then, all too often, we find the rattle still present the next time we are out driving.

A rattle is caused by the vibration of a loose screw or bolt that has a "natural frequency" at which it will vibrate or oscillate. This vibration will also occur at any integral multiple of the "natural frequency"—which is the reason that some of the rattles in your automobile are noticeable only at particular speeds. As you drive at different speeds, you may hear entirely different rattles.

It's easy to locate rattles! By utilizing the "natural frequency" phenomena and introducing a vibration, the loose object can be made to rattle when the car is not in use. Once the object has started rattling, you can locate the rattle and eliminate it. An audio oscillator and a speaker may be used to introduce the vibration.

The frequency of an audio oscillator can be adjusted to the "natural frequency" of the object that is causing the offending rattle. The speaker serves as a transducer or means of transmitting the vibrations to the body of the automobile. These vibra-

tions are of much lower magnitude than the vibrations of a moving automobile, but they are great enough to cause a loose object to rattle.

The audio oscillator should have sufficient power to drive the speaker. If it does not, a simple stage of amplification may be added. (The writer found that the audio stage of a discarded a.c./d.c. receiver worked very well.) Another consideration is the amount of noise you can create without upsetting your neighbors. If you have neighbors that object to the howling of a large speaker, use a directional speaker to

Mounting your speaker inside a 1-lb. coffee can (below) makes it directional enough to set up vibrations in the body of the automobile without using excessive volume, which might otherwise prove annoying to your neighbors.

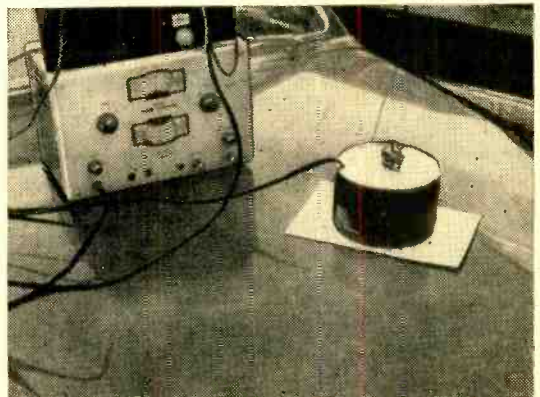
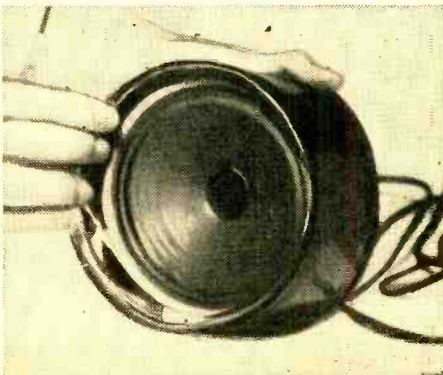

To locate a rattle on the outside of your car, place the speaker in the general vicinity of the rattle. A sheet of paper under the can (above) prevents speaker itself from rattling and protects the finish.

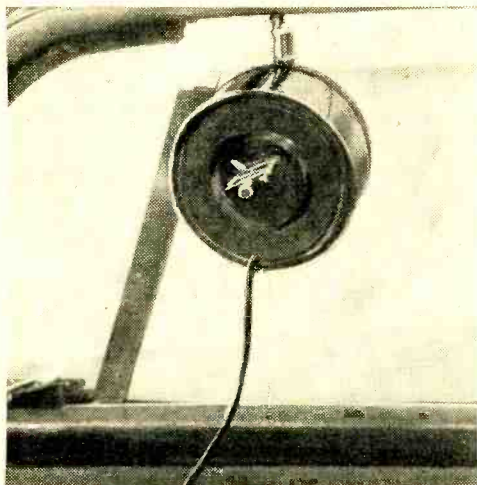

Clamping speaker over edge of car window will enable you to locate rattles in the door. When the window is rolled up, the speaker is firmly mounted. The clamp in the bottom of the can holds speaker securely inside.

transfer the vibration to the automobile body at a moderate volume level.

A standard 1-lb. coffee can may be used to make a 4" speaker directional. Mount the speaker inside the can by drilling a hole in the bottom of the can and slipping a small clamp through the bracket that holds the magnet. Be sure to crimp the sealing rim around the lip of the can to prevent it from rattling. The cable to the speaker may be brought out through a hole in the bottom of the can. This cable should be about 12' long to enable you to move the speaker to different sections of the automobile.

The greatest number of rattles in an automobile occur in the area around the dashboard. The simplest way to locate a rattle in this region is to open the glove compartment door and set the speaker, open end down, on the door. Place a piece of paper under the speaker to prevent a rattle due to the vibration of the speaker

against the glove compartment door. Start the audio oscillator at the low-frequency end and slowly increase the frequency. (It must be increased *slowly*, for the "natural frequency" of some of the loose objects may be quite critical.) At some point in the frequency spectrum, the loose screw or bolt will start to rattle. When a rattle occurs, adjust the frequency of the audio oscillator until the rattle is loudest. It will be simple then to locate the source of the rattle.

In the event the design of your automobile is such that the speaker cannot be mounted on the glove compartment door, attach an "L" bracket to the side of the speaker can and clamp the can under the dashboard with a "C" clamp.

To find a rattle in a door, use a clamp that will clip over your window; when the window is rolled up, the speaker is firmly mounted. If a piece of the chrome trim on the hood is loose, you may isolate the rattle by placing the speaker face down on the hood. Rattles in the trunk of your automobile can be located by placing the speaker on the floor of the trunk. Avoid holding the speaker with your hand, so that your body will not absorb much of the vibration and lessen the effectiveness of the system.

This method of locating rattles is not confined to automobiles but works equally well in the home. It is especially valuable for locating rattles in appliances where it is dangerous or impossible to check for loose objects when the appliances are in operation.

-30-

Setting the speaker on the open glove compartment door is the ideal way to locate rattles that frequently occur in and around the dashboard. Here, again, the piece of paper under the speaker prevents rattles caused by vibration of the speaker against the compartment door.

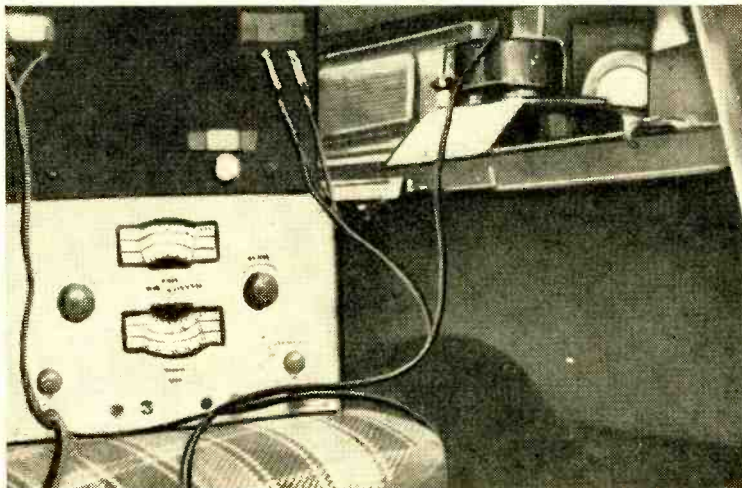



By
E. G. Louis

MORE

Solar Battery Experiments

POWER FROM THE SUN! In recent years these exciting words, along with the equally magical phrase, "power from the atom," have fired man's imagination. Oddly enough, these two expressions mean much the same thing, for the sun is simply a gigantic atomic engine, generating heat and light by atomic *fusion*, a process similar to that used in the H-bomb.

The day of inefficient, indirect and extremely lengthy methods of employing sun power is rapidly drawing to a close. With semiconductors—materials similar to those used in the fabulous transistor—science has at last unlocked the secret of changing sunlight directly into electrical power. Today, the light falling on a few square inches of sensitive material will operate a radio receiver, an audio oscillator—or even a practical radio transmitter.

SOLAR CELLS AND SUN BATTERIES

The word *Sol* is the name of the ancient Roman god of the sun. Hence, *solar*, derived from *Sol* and meaning "of the sun," is often used interchangeably with *sun*. Devices for changing sunlight into electrical power may be called either *solar cells* or *sun cells*, while a bank of such devices may be termed a *sun battery*, or, if preferred, a *solar battery*.

Modern solar cells are made from either of two elements—*selenium* or *silicon*. *Selenium* units have been available longer*, having been used in photographer's exposure meters, simple light controls, etc. Selenium, one of the family of semiconductor

*An article appearing in the November, 1955, issue of POPULAR ELECTRONICS discussed some interesting experiments performed with selenium cells.

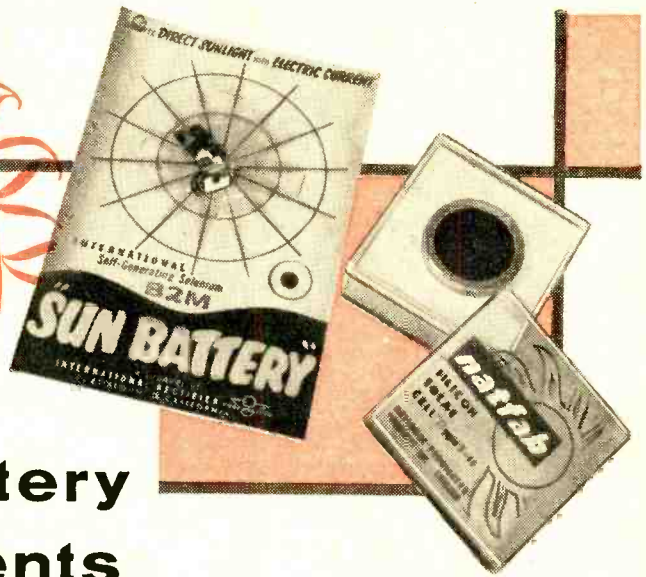

The difference between silicon and selenium cells, and how they are used in three simple circuits

elements which includes germanium—the principal ingredient of most commercially available transistors, is also used in power rectifiers. Selenium Sun Batteries for the experimenter are available from International Rectifier Corporation, 1521 East Grand Ave., El Segundo, Calif.

Silicon, the principal ingredient of common sand, has been used in practical solar cells for a comparatively short period of time. Developed by Bell Telephone Laboratories, the silicon cell is much more efficient than the older selenium cell. Silicon, like selenium, is widely used in high-power rectifiers and, like germanium, is also em-

Multi-cell battery, as shown below, will provide greater voltages than a single cell, and can be easily assembled. See Fig. 1 on following page.

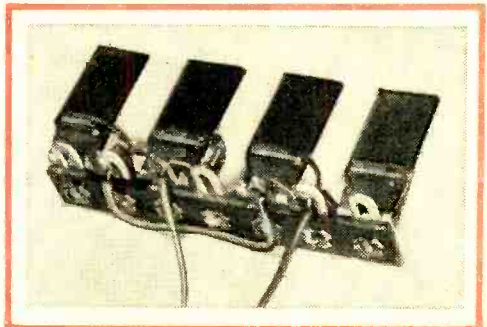

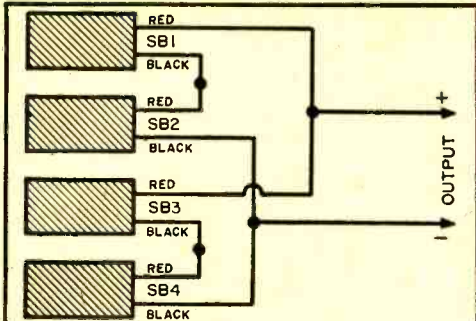
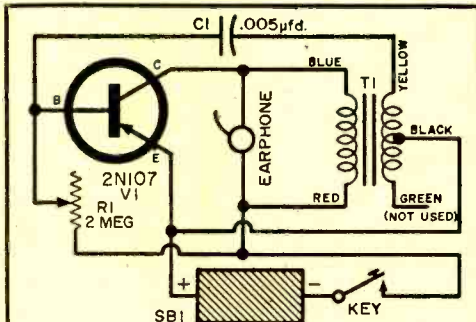

Fig. 1. Four-cell battery with series-parallel connection. The two upper cells are connected in series to form one string, and the two lower cells form a second string. The two strings are connected in parallel. Lead color-coding shown applies to B2M selenium cells.

ployed in the production of transistors. A manufacturer of silicon Solar Cells is National Fabricated Products, Inc., 2650 West Belden Ave., Chicago 47, Ill.

The voltage developed by a single solar battery or cell depends both on the materials used in its construction and on the amount of light striking its sensitive surface. The current it can deliver depends on the amount of light striking its surface, on its internal resistance, on the resistance of the load, and *on its area*—the larger the cell, the greater the current it can deliver, and hence the greater its power output.

In full noon sunlight, a selenium cell will



- C1—0.005- μ fd. disc ceramic capacitor
- R1—2-megohm carbon potentiometer
- SB1—Solar battery (see text)
- T1—Transistor transformer (Argonne No. AR-109)
- V1—2N107 p-n-p transistor (General Electric)
- Earphone—High-impedance magnetic earphone (crystal will work also)
- Key—Standard hand key
- 1—Breadboard chassis (perforated Masonite, about 6" x 8")
- 1—Transistor socket
- Misc. rubber feet, volume control bracket, knob, solder lugs, Fahnestock clips, machine screws, nuts, wire, solder, etc.

Fig. 2. Schematic diagram and parts list for sun-powered code practice oscillator.

develop about 0.5 volt under typical "no-load" conditions. Under ideal conditions, it may develop close to 0.6 volt. A silicon cell develops between 0.3 and 0.5 volt under similar conditions.

Where a greater voltage or current is needed than can be obtained from a single cell, whether silicon or selenium, a "bank" or battery of many cells may be used. To obtain greater voltages, the individual cells are connected in series. To obtain greater currents, a larger cell may be used, or many cells may be connected in parallel.

For experimental applications, a series-parallel connection of the cells is preferred. A typical four-cell battery, employing a series-parallel connection, is shown schematically in Fig. 1.

EXPERIMENTAL APPLICATIONS

With Solar Cells and Sun Batteries now available on an "across-the-counter" basis from leading electronic parts distributors, any interested experimenter can investigate and work in this exciting field. Here are three easy-to-build projects you can start with—a "Code Practice Oscillator," a simple "Broadcast Band Receiver," and a "C.W. Radio Transmitter." All three of these projects use transistors, whose minute power requirements make them ideally suited for operation in sunlight-powered circuits.

For your experiments, use either a NAT-FAB S-1 Solar Cell (silicon cell) or an International Rectifier B2M Sun Battery (selenium cell). For optimum results, you'll do best with a multi-cell "battery" similar to the arrangement shown in Fig. 1. Either silicon or selenium cells may be used for making up the battery. If you choose the silicon cell, the outer case is the *positive* terminal, while the center terminal, on the rear of the unit, is the *negative* terminal. Color-coded leads are attached to the B2M selenium cell—red for positive, black for negative.

Code Practice Oscillator. Wire this project following the circuit in Fig. 2. The earphone may be either a high-impedance magnetic or a crystal unit. Close the *key* and adjust *R1* for proper operation, with the battery (*SB1*) exposed to full sunlight. If you can't get oscillation, try reversing either the primary or secondary leads of *T1*—but not both. Tone quality can be changed by varying size of capacitor *C1*.

The transistor is used in a "tickler feedback" audio oscillator arrangement, with transformer *T1* furnishing the feedback necessary to start and sustain oscillation. Capacitor *C1* serves to couple the feedback signal to the base electrode of the transistor, with base bias current supplied

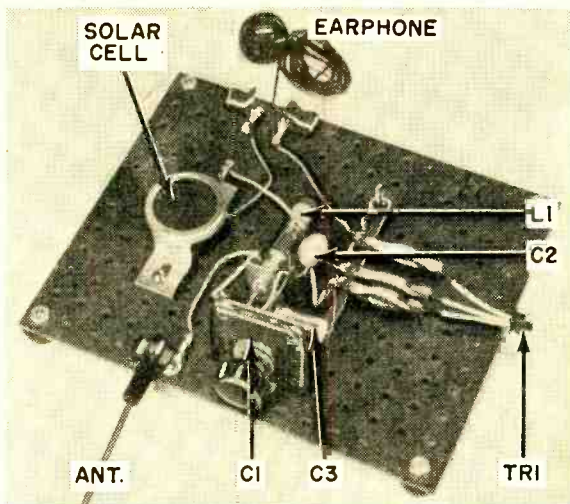

The broadcast receiver is shown above, made up in breadboard fashion to simplify construction and experimental changes in parts value or circuit arrangement. Perforated Masonite makes an excellent breadboard chassis, and you don't have to worry about layout and machine work as you would on metal.

The radio transmitter and its key are at right. See page 114 for schematic diagram and parts list. If the transistor socket is also constructed on perforated board, it will simplify trying different transistors and eliminate need for cutting transistor leads short.

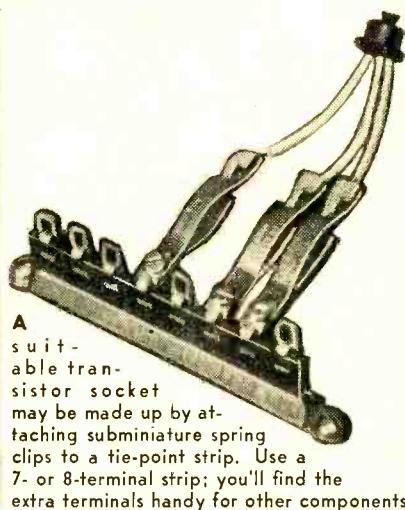

A suitable transistor socket may be made up by attaching subminiature spring clips to a tie-point strip. Use a 7- or 8-terminal strip; you'll find the extra terminals handy for other components.

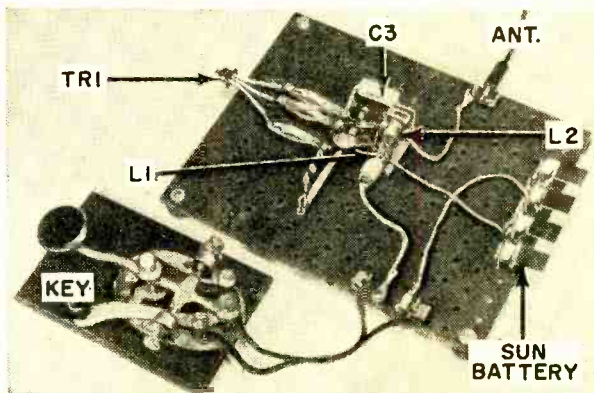

through $R1$. The "load" is connected in parallel with the primary winding of $T1$; because of its relatively high impedance, the earphone has a negligible effect on circuit operation. The common-emitter circuit configuration is used.

Broadcast Band Receiver. A receiver wired according to the circuit diagram given in Fig. 3 will have considerably more gain than the average crystal receiver, but will still require a good antenna and ground for best results. No special precautions need be followed in wiring the circuit, but a magnetic earphone must be employed. In some cases, depending on local conditions, better results are obtained if a crystal diode (such as a 1N34A) is substituted for coupling capacitor $C2$. Connect the anode terminal to the base of the transistor. Individual stations are tuned in by adjusting variable capacitor $C1$. You will obtain best operation in full noon sunlight.

Radio signals picked up by the antenna-ground system are selected by tuned circuit $C1-L1$. A tap on $L1$ permits matching the low input impedance of the transistor,

(Continued on page 113)

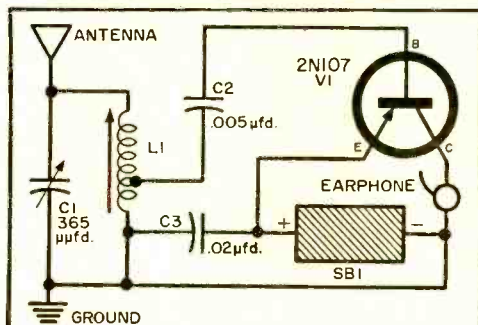

- $C1$ —365- $\mu\text{fd.}$ variable capacitor (Lafayette No. MS-215)
- $C2$ —0.005- $\mu\text{fd.}$ disc ceramic capacitor
- $C3$ —0.02- $\mu\text{fd.}$ tubular capacitor
- $L1$ —Tapped Loopstick
- $SB1$ —Solar battery (see text)
- $V1$ —2N107 p-n-p transistor (General Electric)
- Earphone—High-impedance magnetic earphone
- l —Breadboard chassis (perforated Masonite, about 6" x 8")
- l —Transistor socket
- Misc. rubber feet, tuning capacitor bracket, coil bracket, solder lugs, Fahnestock clips, machine screws, nuts, wire, solder, etc.

Fig. 3. Schematic diagram and parts list for the simple AM broadcast band receiver.



Electronic Footwork

The girl in the photo at left is not walking off with a valuable piece of electronic equipment; she is taking part in one of a series of experiments being conducted by the Commonwealth Scientific and Industrial Research Organization of Australia. Fastened to the girl's ankle is a transmitter which sends data to the receiver in the corner. The information thus collected forms part of a study of the comfort factors in floor surfaces. This investigation is part of a long-range research program Australians are conducting to improve the efficiency of their industries. Laboratories such as this one have been set up in various sections to make first-hand studies of local conditions. (Photo by Authenticated News.)

Improved SSB-AM Reception

Better long-range radio communication, utilizing a SSB (single-sideband) AM technique, is provided by the receiver shown below. Built for the U. S. Air Force by General Electric Co., Electronics Park, Syracuse, N. Y., the set uses a new "synchronous detection" system. Shown with the receiver is engineer Dr. John P. Costas, who says that the new system offers increased resistance to interference and jamming. Dr. Costas also asserts that the SSB technique is the "logical replacement" for conventional short-wave AM radio communications.



How Wet Is It?

Shown below testing the amount of moisture in a dehydrated food is the "Moisturometer," a new device that provides



Super-Fast Data Recorder



Capable of recording data from electronic computers faster than any previously used method is the "Characteron" Computer Readout shown at left. This device can record data equal in amount to that in a 300-page book in just 30 seconds. Its results are reproduced in permanent, readable form. The device was developed by Stromberg-Carlson, a division of General Dynamics Corp., at its San Diego, Calif., plant for use at Johns Hopkins University.

a direct reading of the moisture percentage in any granular material, such as food, plastic powders, soils, etc. The unit weighs less than 1½ pounds, uses transistors, and is battery-powered. Readings are shown on a microammeter. Calibration permits an accuracy of $\pm 5\%$ at 70° F. For more details, write to the manufacturer, Henry Francis Parks Laboratory, Portland 15, Oregon. Price is \$75.00 f.o.b. Portland.

POPULAR ELECTRONICS

Building a Sandwich Baffle

By DAVID B. WEEMS

Easily built hi-fi enclosure provides a "full course" of clean sound when used with a low-cost 12" speaker

THIS HI-FI SANDWICH is not for eating, but audio enthusiasts will certainly want to sink their teeth into it. For about eight dollars and a few hours of your time, you can duplicate a really fine speaker baffle that has proven quite the thing for hi-fi'ers in Italy and France. And you'd have to go a longer way than Europe to beat its performance at such low cost.

Designed for corner placement, the "Sandwich Baffle" uses the bass reflex principle, with the cutouts for the port also serving as clearance for any wall-molding or woodwork that otherwise might prevent a nice, tight, flush fit against the room walls. Its dimensions, as you can see from the photo, provide ample baffling for a 12" speaker and yet are proportioned attractively to form a good-looking item on anyone's hi-fi menu.

Best of all, this simple, inexpensive baffle really helps a speaker sound good, because of its extremely rigid construction. Add to this the obvious advantage of corner placement for improved bass radiation and wide-angle dispersion of sound—and you really have quite a baffle!

Inside the Sandwich. The "sandwich" in this case consists of a sheet of Celotex fitted between two plywood panels. Glue is the "dressing" and wood screws are the "toothpicks" to complete this tempting acoustical dish. The result is a speaker mounting board which is no less than 1 1/4" thick. Fitted flush to the walls forming a corner of the room, such a board makes a

neat enclosure. The walls become the sides of the enclosure; the floor serves as the bottom; and an additional triangular panel tops off the whole thing.

The items you'll need, listed on page 65, shouldn't cost more than \$8.00. However, you might want to make a change or two. For example, a 4' x 6' sheet of plywood is big enough, but the grain of the wood will run diagonally on the top piece. If you want to match the top grain with that on the front panel, you'd better get a 4' x 8' sheet of plywood. Also, you may want to substitute a "decorator grade" of 1/4" veneer-faced plywood for the front panel. Such changes would up the cost of the project, naturally. If you do get the better grade of plywood, use 1" screws instead of the 1 1/4" specified.

The "Bread." Construction details are shown in the drawing on page 64. Mark out A and C end to end on

the plywood so that a 20" strip will be left for the top pieces (D and E). The three pieces that go together to make the front panel (A, B, and C) should be identical. An easy way to make them is to use the piece cut first as a pattern for the other two.

Decide which piece of plywood is going to be the face (A). Then, in piece C, drill about 24 holes. The holes should be about 3/16" in diameter and well distributed over the surface of the sheet, but no closer than about 2" from the side edges. You may be tempted to substitute smaller holes for the No. 8 screws, but the holes in C must be



large enough for the screws to pass through freely without threading the plywood. Small holes would impede the action of the screws in drawing the sandwich tight.

Filling and Spread. Place the three pieces in position and either lightly nail or clamp them while you drill small guide holes through the Celotex (B) and into the back of the front plywood (A). A No. 2 drill is adequate for these guide holes. Don't forget to mark the drill about 1 1/4" from the end to warn you to stop before it plunges through the face of the baffle. Take the pieces apart and smear their inside

surfaces with glue. Apply glue to both sides of the Celotex and also to the inside surfaces of the plywood. The Celotex will absorb some glue, but it is not necessary to "size" it first.

As soon as the glue is spread, place the pieces together again and begin putting in screws immediately. Use a washer under each screw to prevent the screw from piercing the face of the baffle. One washer per screw should be enough.

You may note in the photos that some countersunk flathead screws were used in the construction of the model shown. They

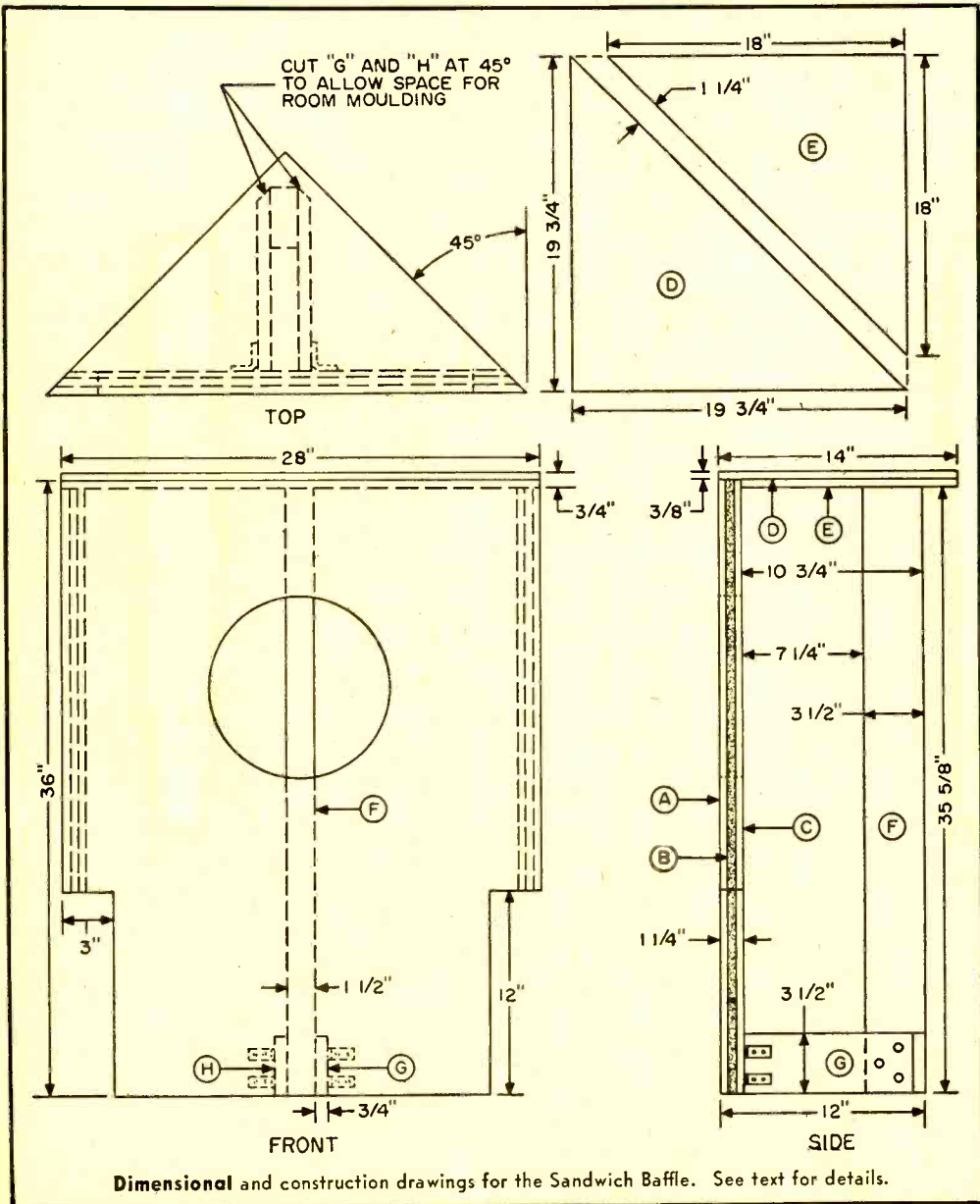

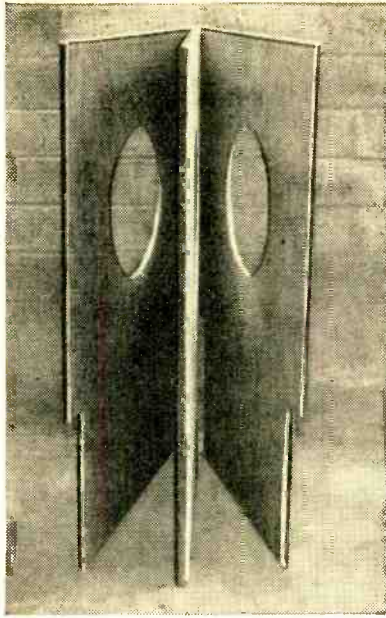

"Sandwich" (far left) is formed by bonding sheet of Celotex between two plywood panels. Photo directly at left shows how top piece, back brace, and speaker are fitted to complete the baffle.

Felt strips stretched from rear of baffle panel to vertical bracing piece, as shown below, help reduce unwanted acoustical effects such as standing waves, panel vibration, and boom.

were 1" in length and countersunk far enough to allow them to grip into the front plywood. That method may be used, but the depth of the countersinking is rather critical. Either way, you should tighten each screw at least twice. When you are sure that each one is snug, put the panel aside to allow the glue to set before you continue working with it.

Final Cuts. The other pieces may be cut while the glue is setting, but unless you are sure of your work, the top assembly should be delayed until the final step with the front panel is completed. That last operation, sawing a 45° bevel on each side edge of the baffle, can be done with a handsaw, but it's well worth getting someone with a power saw to do it for you. (And for the sake of his saw blade, we hope you will have followed directions and kept the screws about 2" from the edges!)

After the bevel is sawed, stand the panel in a corner to guide you in the final marking of the top pieces for exact size. Then panels D and E can be glued and screwed



together to make the top. A 1/8" drill may be used for the screw holes through panel E. It is important to place some of the holes near the periphery to draw the edges tight, particularly at each corner. Again, use clamps or light nailing to hold the pieces in position while you make smaller guide holes in piece D.

Next, cut parts F, G, and H to size. The brackets should be attached to G and H and those parts glued and screwed to F, using the extra No. 8 screws. Then set the front panel upright on floor or worktable. The assembled structure of F, G, and H may now be fastened into position

(Continued on page 106)

BILL OF MATERIALS

- 1—4' x 6' x 3/8" piece of fir plywood
 - 1—28" x 36" x 1/2" piece of Celotex
 - 1—2" x 4" x 35/8" piece of lumber*
 - 2—1" x 4" x 10 3/4" pieces of lumber*
 - 3 doz.—1 1/4" No. 8 round head screws
 - 2 doz.—Washers for round head screws
 - 1 doz.—5/8" No. 6 screws
 - 1 set—1 1/2" brackets (4) with 3/4" No. 6 screws
- Wood glue
Packing crate material (see text)
Finishing materials

*Actual dimensions of 2" x 4" lumber are 1 1/2" x 3 1/2"; actual dimensions of 1" x 4" lumber are 3/4" x 3 1/2".

Dynamic Pillow Speaker

THIS easily assembled pillow speaker will allow you to listen to your bedside radio as late as you please without disturbing the sleep of others. It consists of a 2½" speaker in a tough plastic case.

A lightweight 2-conductor plastic-covered cord, with a plug on each end, permits the



speaker to be plugged into a closed-circuit jack installed on the radio. (Mount the jack on the radio cabinet or back panel, making sure that it is insulated from the radio's chassis.) The jack is wired into the voice-coil circuit in a manner that mutes the radio's speaker when you plug in the pillow speaker.

The writer used a "Sound Box" maroon-colored speaker case (Lafayette Radio MS-315) which has a removable back and a factory-installed socket on one side. A 2½" speaker is simply placed in the case and wired to the socket. When the back is screw-fastened to the case, the speaker is held firmly without rattling. A length of lightweight connecting cord, with a miniature plug soldered to one end and a standard



The speaker is shown at left installed in case with back cover removed. Above, it is plugged into jack on back panel of radio.

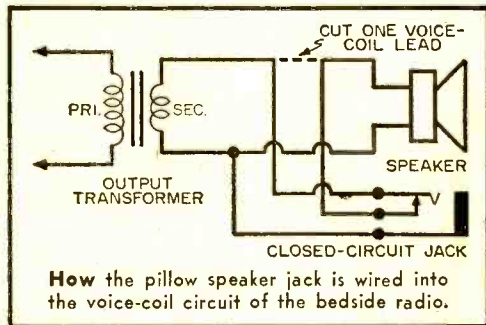

phone plug connected to the other end, completes the pillow speaker and connecting cord assembly.

NOTE: This hookup is not recommended in cases where one side of the output transformer secondary goes to one side of the speaker voice coil via the metal chassis, unless you re-wire the voice-coil circuit to isolate the coil from a possible hot chassis.

—Art Trauffer

Proximity Detector Is a TV Commercial Killer

THE "PROXIMITY DETECTOR" described in the April, 1956, issue of POPULAR ELECTRONICS can be utilized in many interesting ways. One application provides a method of reducing the volume of a televi-

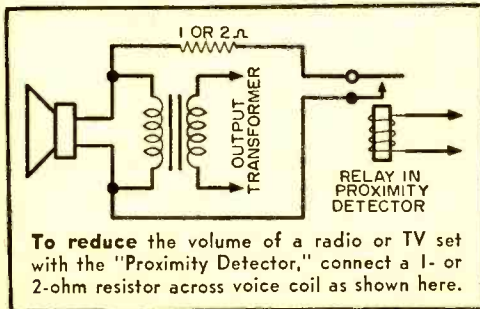

sion set or of a radio from remote points.

Connecting a 1- or 2-ohm resistor across the voice coil of the speaker, in the manner shown in the diagram, will reduce the volume to a low level. The exact value of the resistance will vary with the TV set or radio with which the unit is to be used and the volume level desired.

An especially valuable spot for a sensing lead is one within easy reach of your telephone—it will prevent a frantic dash for the volume control when the telephone rings. By reducing the sensitivity of the detector and using several sensing leads placed in various spots around the room, the volume of your television set can be reduced or eliminated from any location.

—R. Wayne Crawford

POPULAR ELECTRONICS

By RICHARD GRAHAM

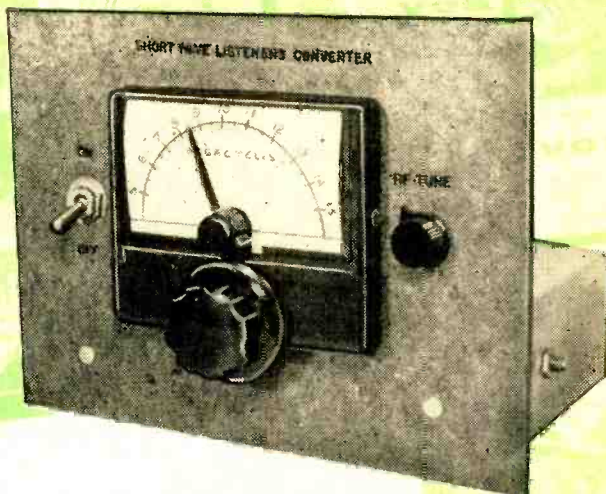

The 5:15 } Simplicity in a Short-Wave Converter

ALTHOUGH great strides have been made in the field of radio and electronics, one thrill which has consistently held the interest of all generations is that of short-wave listening. This thrill can be yours if you construct a simple converter which, when it is attached to any standard broadcast receiver, will enable you to receive short-wave signals from all over the world.

This converter covers all the major short-wave broadcast bands in the 5 to 15 mc. range. Its construction is only slightly more involved than that of a typical one-tube receiver.

Construction. The "5:15" is assembled on an aluminum chassis measuring 7" x 5" x 2". It is recommended that the general layout in the photographs be followed to insure adequate isolation between the coils L_1/L_2 and L_4/L_5 . Coil L_2 and oscillator coil L_3 are placed on opposite sides of the chassis. The output coil, L_4 , is also located under the chassis but is placed on the opposite corner. This coil arrangement is essential.

As an economy measure, the coils can be wound on a $\frac{3}{4}$ "-diameter dowel. After winding, apply a coating of either polystyrene cement or colorless nail polish. A third alternative is to let the coils soak in melted paraffin. They are held to the chassis by small wood screws.

There is no power transformer in the "5:15" converter. To eliminate the possibility of dangerous electrical shocks, the a.c. line is not grounded to the chassis. The

0.005- μ f.d. capacitor, C_4 , grounds the chassis for r.f. only.

Only one fixed adjustment needs to be made when you initially put the "5:15" into operation. Hook up the converter to the broadcast receiver as shown in the diagram below. Adjust the main tuning dial to any signal on the air that can be found, simultaneously adjusting the "RF Tune" control for maximum strength. Now merely adjust trimmer capacitor C_5 for maximum signal volume from the receiver.

Calibration. This can present a problem if no signal generator or communications receiver is available. However, the converter dial can always be calibrated by actual on-the-air signals from stations of known frequency. While it may take a little longer to accumulate enough calibration points that way, such a method is just as

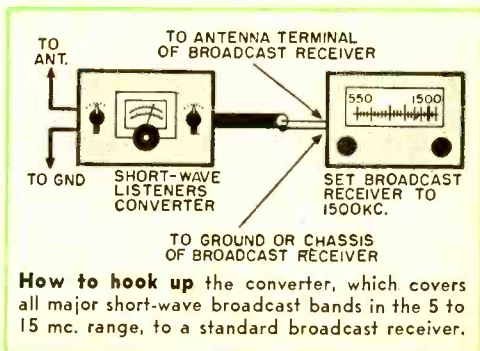

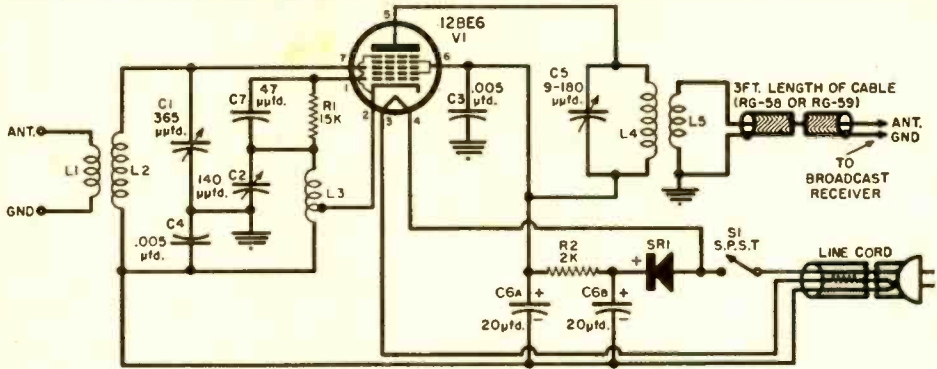

Schematic and pictorial diagrams of the short-wave converter, with parts list at right.

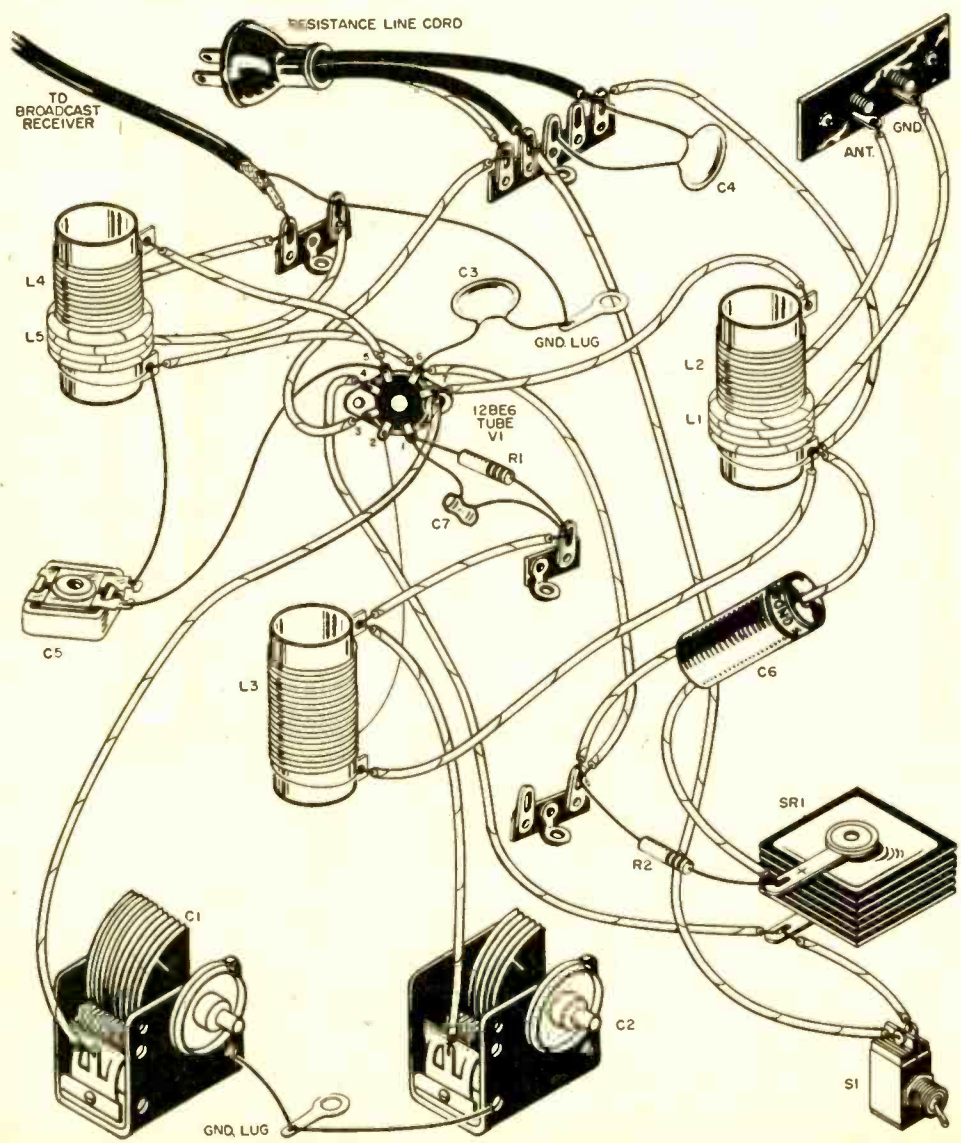

- C1—365- μ fd. variable capacitor
- C2—140- μ fd. variable capacitor
- C3, C4—0.005- μ fd., 600-volt fixed ceramic capacitor
- C5—9.180 μ fd. variable trimmer capacitor
- C6a/C6b—20/20 μ fd., 150-volt d.c. dual electrolytic capacitor
- C7—47- μ fd., 600-volt fixed ceramic capacitor
- L1—4 turns of hookup wire wound over bottom end of L2
- L2—12 turns of No. 30 DSC wire, close-wound on $\frac{3}{4}$ "-diameter form
- L3—11 turns of No. 30 DSC wire, close-wound with tap at 3 turns from bottom (r.f. ground end) on $\frac{3}{4}$ "-diameter form
- L4—76 turns of No. 30 DSC wire, close-wound on $\frac{3}{4}$ "-diameter form
- L5—4 turns of hookup wire over bottom of L4
- R1—15,000-ohm, $\frac{1}{2}$ -watt resistor
- R2—2000-ohm, 1-watt resistor
- S1—S.p.s.t. toggle switch
- SR1—65-ma. selenium rectifier
- V1—12BE6 tube
- 1—560-ohm resistance line cord
- 1—3' length of cable (RG-58 or RG-59)

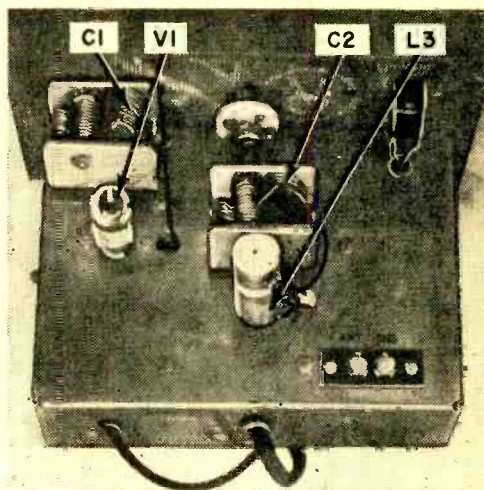

Top view of the "5:15" (above), assembled on a 7"x5"x2" aluminum chassis. Variable capacitors C1 and C2, coil L3 and the 12BE6 tube are identified. Frequency changing is accomplished by adjusting the oscillator frequency by means of capacitor C2, which is driven by the main dial of the converter.

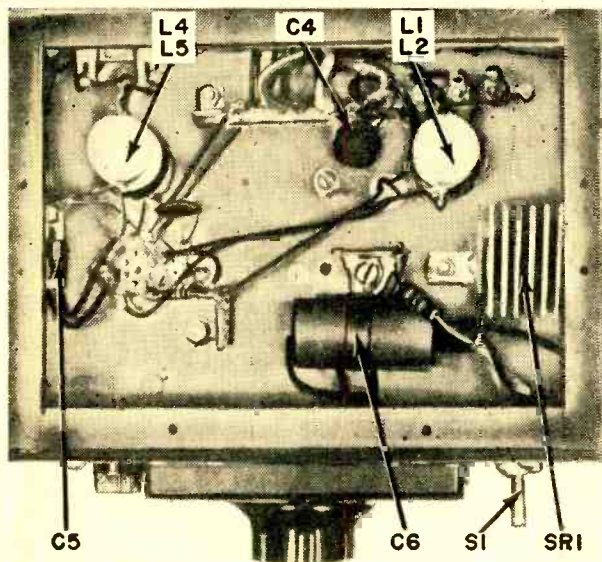

Below-chassis view of unit (at left) shows placement of coils on opposite sides of chassis. Adequate isolation must be maintained between coils L1/L2 and L4/L5. The "RF Tune" control is located at the left of the main tuning dial; when you adjust the dial, this control must be adjusted simultaneously.

valid as either of the two following methods.

To use a signal generator for calibration, it is only necessary to hook the generator up to the input antenna and ground terminals of the converter and set the generator at various known frequencies from 5 to 15 mc., meanwhile tuning in each signal on the converter as if it were an actual on-the-air signal.

A third method of calibrating the converter is to use a communications receiver which covers the frequencies from 6 to 17 mc. Place the communications receiver antenna lead near the oscillator coil L3. Set variable capacitor C2 to maximum capacity. Now tune the communications receiver around 6.5 mc. Somewhere in the vicinity of this frequency, a strong steady signal will be heard. This is the oscillator signal in the

(Continued on page 129)

HOW IT WORKS

You will notice that the converter is actually a receiver "front end," i.e., it comprises the r.f. mixer and oscillator circuits. It serves as a means of converting any frequency between 5.0 and 15 mc. to 1500 kc. The 1500-kc. signal can then be fed into any broadcast receiver tuned to that frequency.

When a 5.0-mc. signal is applied to grid No. 3 of the 12BE6 and the oscillator portion of the converter is applying a 6.5-mc. signal to grid No. 1 of the 12BE6 (pin No. 1), the output signal at the plate of the 12BE6 will be the original two input signals of 5.0 and 6.5 mc., and two new frequencies—11.5 mc. and 1.5 mc. This last resultant frequency is the one which we can use in our broadcast receiver.

We have just converted a signal from 5.0 mc. to 1.5 mc. This same reasoning would apply if we chose any other signal frequency besides 5.0 mc. All that would have to change would be the oscillator frequency. In the converter, frequency changing is accomplished by adjusting the oscillator frequency by means of the variable capacitor C2. This is the capacitor that is driven by the main dial of the converter.

Crossovers

Are The Answer

By A. STEWART HEGEMAN

Get the most out of your speakers
with these simple network circuits

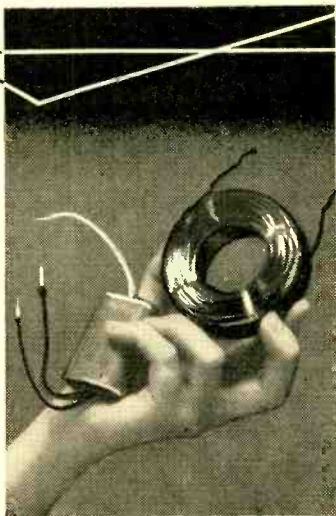

IF YOU HAVE a single loudspeaker in your hi-fi system, you can safely bet that it clogs up the frequency response. No single-unit speaker can efficiently cover the whole spectrum of musical sound. It suffers from having to stretch its range both high and low, like a tenor trying to sing soprano, bass, and everything in between all at once. The result is a brave compromise—some treble and some bass must be sacrificed.

Yet it is just those shimmering highs and throbbing lows, flashing like highlights on a clear stream of music, that put the thrill into real hi-fi. To catch these elusive extremes of the frequency range, serious hi-fi fans rely on separate woofers for bass and tweeters for treble. Such speakers don't need to compromise. They are built especially for the particular range they cover. They don't need to stretch beyond it.

Sometimes even a separate mid-range unit is added to make a three-way system, in which each speaker specializes even further, each covering only a fairly narrow frequency band, with greater clarity and efficiency. But before any multiple speaker system can be hooked up to the amplifier, one more component is needed: *the crossover network*.

Sound Splitting. Without a crossover network, part of the music would go to the wrong address. Heavy bass would run right into the delicate tweeter and tear it apart, or at least make it howl with anguish. At the other end, the rapid treble oscillations would feed into the heavy woofer, which,

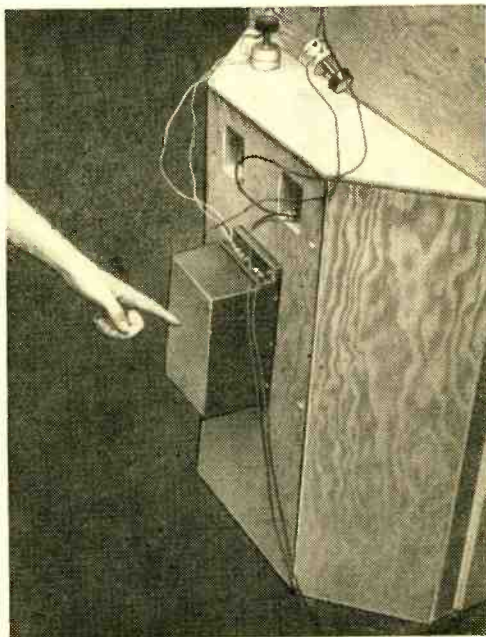

The Sherwood SFX35 shown here is being used experimentally with a Heathkit 3-way speaker system. The crossover frequencies are 300 and 5000 cycles, separating the three speakers in the system.

unable to swing fast enough, would simply convert them into heat. The tonal leftovers from such a mismatch would be a definitely low-fi hash.

To prevent such a log jam of frequencies, the crossover network acts somewhat like a traffic cop directing heavy trucks into one lane and light vehicles into another. It takes the output of the amplifier and splits it into separate channels for bass and treble, leading each to its proper speaker. For this reason, the crossover network is also known as a "frequency dividing net-

work" or sometimes simply as a "frequency divider."

Under the Lid. To many hi-fi fans, the crossover network is just a mysterious box connected between the amplifier and the speaker system. But once the lid is lifted from this box, the simple logic of its design is readily apparent even to the novice.

All we need to remember is that a certain size of coil passes low frequencies while it inhibits highs, and that with a certain value of capacitor, it's the other way around. Thus, by combining a coil and a capacitor into an electronic filter network, you can make the bass go one way and the treble another. Four factors affect the performance of a crossover network: (1) crossover frequency; (2) operating impedance; (3)

there is a certain amount of freedom in the choice of crossover frequency. Where a separate mid-range unit is added to form a three-way system, we need two crossover frequencies to separate the three speakers

Frequencies below 300 cps are fed into the woofer in the corner enclosure below. The frequencies between 300 and 5000 cps go into the mid-range unit at right, which is located atop the woofer. The internal crossover network originally furnished with the Heathkit system has been disabled for these experiments.

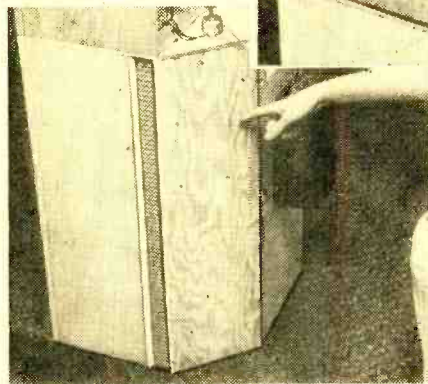

attenuation slope; (4) insertion loss. A definition of each term will clear up any possible confusion caused by such hi-fi shop-talk.

Crossover frequency. This is the frequency where the woofer leaves off and the tweeter takes over. The network must be designed to split the whole tonal range into an upper and lower channel at precisely that point. Choice of the crossover frequency therefore depends on the response range of the loudspeakers used in the system.

If woofer and tweeter ranges overlap,

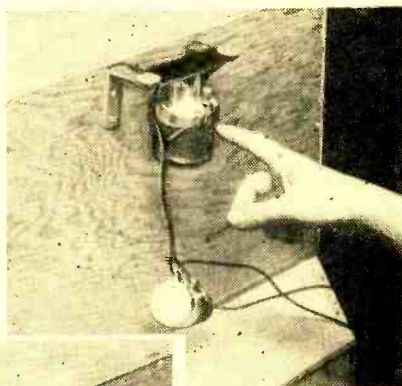

Electro-Voice tweeter above is pointed towards ceiling to obtain nondirectional effect on highs. Note that both mid-range and treble speakers have level controls wired into this temporary hookup. These level controls adjust proper balance between the three speaker units.

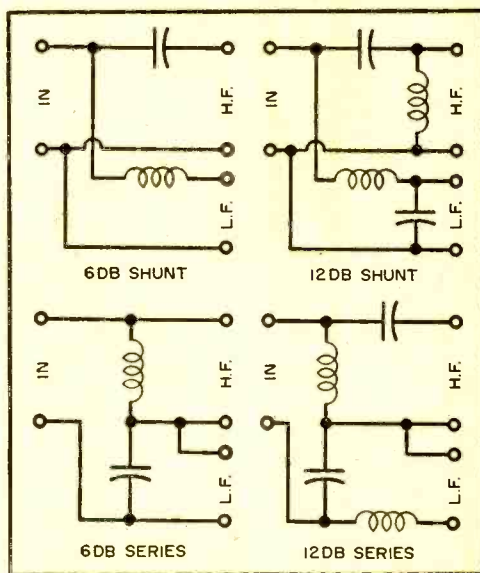

Crossovers consist simply of a coil and a capacitor wired in shunt or series as shown. By using two coils and two capacitors, the attenuation rate is increased from 6 to 12 db, four times less power.

in the system. Choice of a frequency affects the over-all sound. Some designers feel that naturalness in the reproduction of string instruments and the human voice is best achieved when both the fundamental tone and the first two harmonics are generated by a single loudspeaker. These designers prefer their crossover frequencies very low (e.g., around 200 cps for mid-range crossover) or very high (e.g., 5000 cps for

the tweeter) and avoid crossing over in the middle range. However, this is not a hard-and-fast rule. Well-balanced systems have been designed with crossover frequencies anywhere in the spectrum. Other factors being equal, a low crossover frequency for the woofer usually produces cleaner sound since it keeps higher frequencies away from the woofer and thus prevents their inter-modulation with the bass.

Operating Impedance. For most efficient circuit operation, the crossover network must match the impedance of the signal source (i.e., the amplifier) to the impedance of its load (i.e., the speakers). In other words, a 16-ohm network should be driven from the 16-ohm terminals of the amplifier and should feed into 16-ohm loudspeakers. If the operating impedance of the network is not matched by the amplifier and speakers connected to it, the crossover frequency will shift from its proper value.

Impedance mismatch between crossover network and speakers can be corrected by adding shunt or series resistors. If this is done, however, part of the energy going to the speaker will be silently burned up in the corrective resistors. That makes uphill work for the amplifier, taxing its power reserve and possibly driving it to distortion. Picking matched components in the first place avoids such wasteful makeshifts.

Attenuation Slope. Actually, the crossover frequency is not a sharp cutoff. The woofer signal doesn't simply "stop short" to avoid entering the tweeter range. Neither does the tweeter "slam on the brakes" to keep from sliding over into the woofer's "territory." Instead, both high and low range taper off gradually in the middle with plenty of overlap. The rate of this taper and hence the area of overlap define the sharpness of separation between treble and bass.

With a single coil and capacitor in each speaker line, treble and bass response fall off at the rate of 6 db per octave, counted from the crossover point. Networks with two coils and two capacitors squelch "out of bounds" frequencies at the rate of 12 db per octave.

Sharp separation is not necessarily an advantage. Where woofer and tweeter themselves overlap in their frequency response, the lower attenuation rate of 6 db per octave seems preferable to many listeners. It makes the sound source seem more unified, avoiding the feeling that the sound is split, with treble and bass coming from different locations. However, the most important consideration in choosing between a 6-db or 12-db network is the frequency limits of the loudspeakers to be fed by the network. No speaker should receive large amounts of

(Continued on page 111)

MAKE YOUR OWN CROSSOVER

The simple circuit shown here makes a satisfactory crossover network for a two-way speaker system with separate tweeter and woofer, and takes only a few minutes to assemble. Capacitor *C* passes

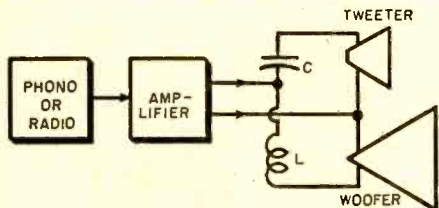

the treble to the tweeter but blocks the bass, while coil *L* admits bass to the woofer but excludes treble.

To choose the right values of *C* and *L* for your particular installation, simply follow this procedure:

(a) Check the impedances of woofer and tweeter. They are usually marked on the speaker or appear in the manufacturer's specifications. If not, you can approximate each impedance by simply measuring the d.c. resistance of the voice coil with an ohmmeter.

(b) Pick a crossover frequency somewhere between

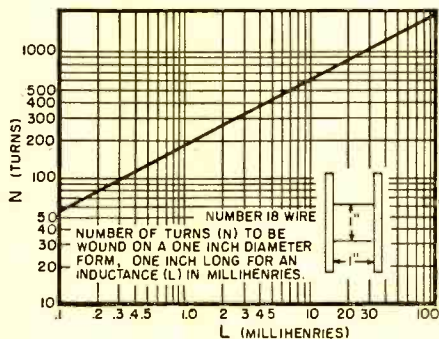

600 and 2000 cps, depending on the response range of your woofer and tweeter.

(c) To determine *C*, multiply the tweeter impedance by the crossover frequency and divide the product into 159,000.

(d) To determine *L*, multiply the woofer impedance by 159 and divide the product by the crossover frequency.

(e) To wind the coil yourself, you must know how many turns to wind on a 1"-long, 1"-diameter form. You find the number of turns by multiplying the square root of *L* by 180, or by consulting the chart above. (Use No. 18 copper wire.)

(f) To obtain *C*, either buy a paper capacitor of the proper size, or buy two electrolytic capacitors



(such as those used in a.c.-d.c. radios as filter capacitors) of twice the needed capacitance and connect them back to back as shown. —John J. Dougherty

Build

an "Economy" Tube Tester

IF YOU'RE ANYTHING like the typical electronics experimenter, you undoubtedly have quite a collection of vacuum tubes. Junked radios have a habit of gravitating toward the experimenter like a duck to water. The trouble is, however, that a goodly portion of old radio tubes are worn out. How can you tell which tubes are good and which are bad? The solution to this dilemma is very simple and quite economical. Build a tube tester.

A glance at the front view of the tube tester described in this article reveals that it's unlike any you've seen before. Designed for a flat wallet, it equals the performance of many commercial units. It measures tube emission and gain, and will detect noisy or microphonic tubes as well as shorted elements within a tube.

Results do not come out in terms of *GOOD*, *FAIR* or *BAD* as in commercial tube testers. The quality of a tube is read in terms of milliamperes of plate, screen and/or cathode current. These values are then compared to those stated for a good tube in the tube manual.*

You can duplicate this tester for approximately 15 dollars—assuming you have a VOM capable of reading a.c. and d.c. volts and d.c. milliamperes. The use of jacks and jumper leads in the construction of the tube tester is a big step towards real economy and makes the tester extremely versatile. Admittedly, it is not as convenient to operate as a commercial tester; but while this may be important to some in the TV and radio service business, where time is money, it is seldom a real inconvenience to the home experimenter.

Construct the tester in a sloping panel box. The panel should be removable for wiring and servicing, and can be made of Masonite. Dimensions of the box are shown in the drawing on the following page.

The panel layout is uncrowded although

* Similarly, the value of transconductance comes out in micromhos directly. This value can be compared to that found in the tube manual.

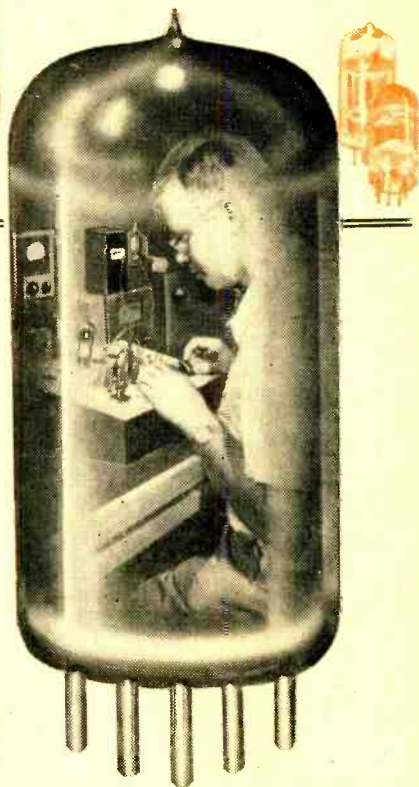

By **RICHARD GRAHAM**

**If tube data and pin connections
are available, you'll be able to
test any tube with this device**

it incorporates a total of eight tube sockets: 4-pin, 5-pin, 6-pin, a combination 7-pin large and small, an octal, a loctal, a 7-pin miniature, and a 9-pin miniature tube socket.

Jacks can be either of the banana type or the phone tip variety. The model shown uses the banana type only because this type was available. The two rows of nine jacks are connected to the tube socket pins. These two rows of jacks are paralleled, i.e., both jacks No. 1 are connected together, both jacks No. 2 are connected together, etc. The numbered jacks are then wired to the corresponding socket pins. Thus, for example, jack No. 3 connects to pin No. 3 of all the tube sockets; jack No. 8 would be connected only to the octal, loctal and 9-pin miniature sockets, since these are the only sockets with a No. 8 socket pin.

Panel wiring is quite routine, and it is



Front view of unit shows sloping panel, with tube being tested. VOM is at left. The author calls his model a "Free Point" tester because all of the socket pins are brought out to corresponding jacks on the front panel which can then be connected to variable plate, grid and filament supplies.

difficult to make an error. To lighten the tedium of the wiring, try cutting 54 pieces of wire four inches long, and stripping and thinning the ends. Such a length is adequate for all wiring between sockets. Next, cut, strip and tin nine leads that are long enough to reach from the sockets to the jacks. The same general procedure can be used for the 20 leads between the filament transformer and filament switch.

The plate and grid voltage supply is constructed on a separate chassis. Layout of the parts is not critical, as can be seen in the photographs. The two selenium rectifiers (*SR1*, *SR2*) for the B+ portion of the power supply are of the type intended for voltage doubler service, having three terminals. For this power supply, the middle terminal is not used, since the plus side of each rectifier is tied together. This enables a higher voltage rating. The only other point of caution in wiring the power

supply is to observe the rectifier and capacitor polarities shown on the diagram on page 75 (bottom).

Complete the tester by preparing the accessory jumper leads. The quantities and lead lengths of the jumpers and test leads recommended for use with this tester are shown in the drawing on page 76.

Check out your wiring by connecting a VOM on d.c. volts across the B+ and B- jacks. The voltage should be made to vary from 150 to 290 volts with no load other than the meter by varying the "plate supply" control (*R5*) on the front panel. Repeat this procedure with the meter connected across the C+ and C- jacks. Adjustment of the "grid supply" control (*R4*) on the front panel should vary the voltage from zero to 50 volts.

It might also be advisable to check the jacks to the tube pin wiring with the ohmmeter set on low-ohms scale. Likewise,

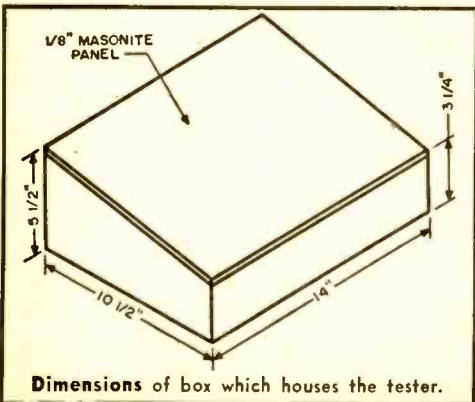

Wiring for the tube tester. The diagram at the top of the next page shows the socket wiring; the two duplicate rows of jacks connecting to the tube sockets make for convenience in setting up and operating the tester. Directly at right is the complete power supply; be sure to observe the rectifier and capacitor polarities shown. Parts list appears below.

- C1—50- μ d., 50-volt electrolytic capacitor
- C2a/C2b/C2c—16- μ d., 450-volt triple electrolytic capacitor
- CH1—8-henry, 75-ma. choke (Stancor C1355)
- R1—4700-ohm, 2-watt resistor
- R2—33,000-ohm, 2-watt resistor
- R3—25-ohm, 2-watt potentiometer
- R4—50,000-ohm potentiometer
- R5—5000-ohm, 25-watt potentiometer

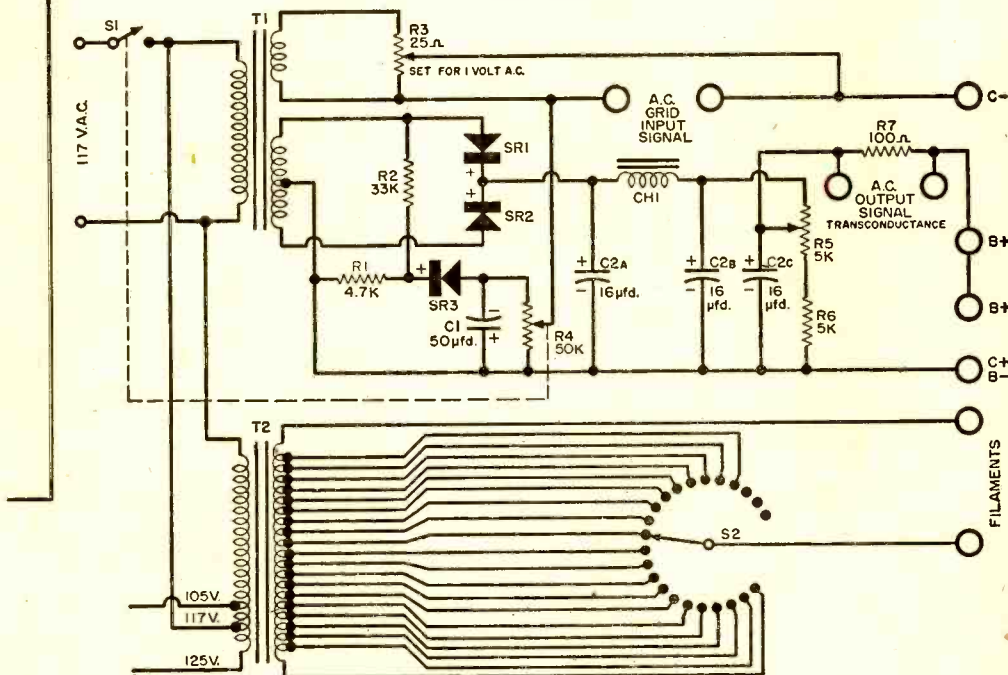
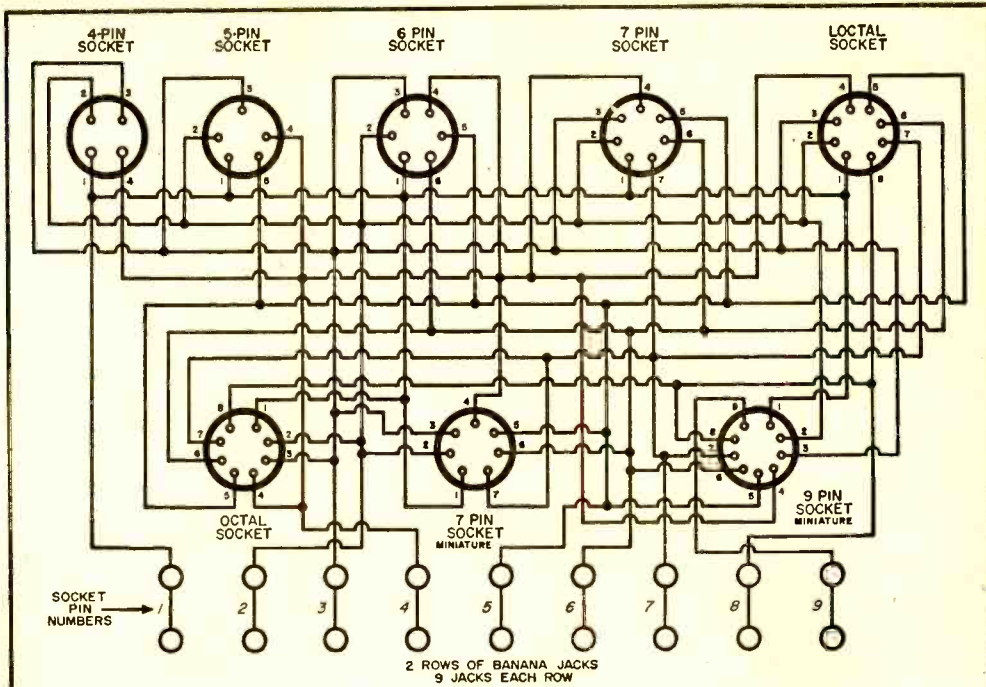

R6—5000-ohm, 10-watt resistor
 R7—100-ohm, 2-watt resistor
 S1—S.p.s.t. switch on R4
 S2—23-position, single-pole rotary switch (Centralab No. 1443)
 SR1, SR2—75-ma. selenium rectifier, voltage doubler type (Sarkes Tarzian Model 78D)
 SR3—65-ma. half-wave selenium rectifier
 T1—Power transformer, 240-0-240 volt @ 70 ma;

6.3-volt @ 3 amperes (Stancor PC8419)
 T2—Tube checker multi-tapped filament transformer; 1.1-, 1.4-, 1.5-, 2.0-, 2.5-, 3.0-, 3.3-, 5.0-, 6.3-, 7.0-, 7.5-, 12-, 30-, 35-, 50-, 70-, 85-, 110-, 117-volt secondary (Stancor P1834-3)
 8—Tube sockets; 4-pin 5-pin, 6-pin, combination large and small 7-pin, loctal, octal, 7-pin miniature, 9-pin miniature
 28—Banana jacks (or equivalent) and 25 plugs

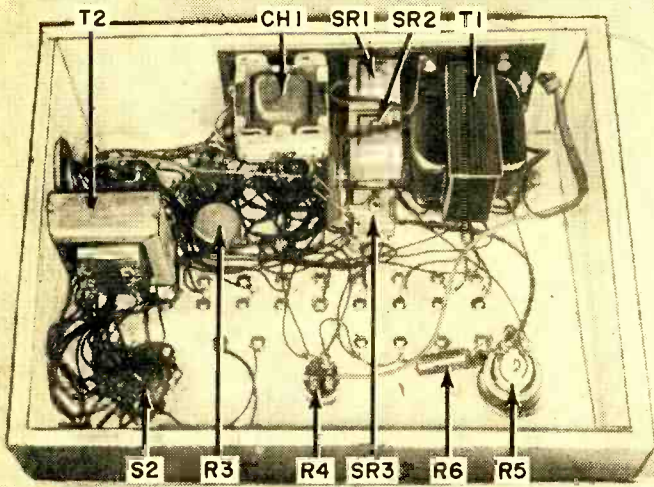

Bottom view of the tube tester (at left) indicates placement of major parts. Filament supply is at far left. The plate and grid voltage supply, shown at the top of the photo, is constructed on a separate chassis—in this case a piece of 8" x 3 1/2" scrap aluminum.

Top view of the plate and grid supply subchassis (below). Layout of components is not critical. Leads connecting to this part of the power supply should be made about 5" longer than necessary so that it can be removed for servicing.

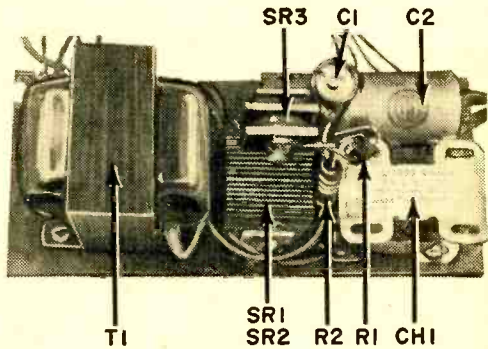
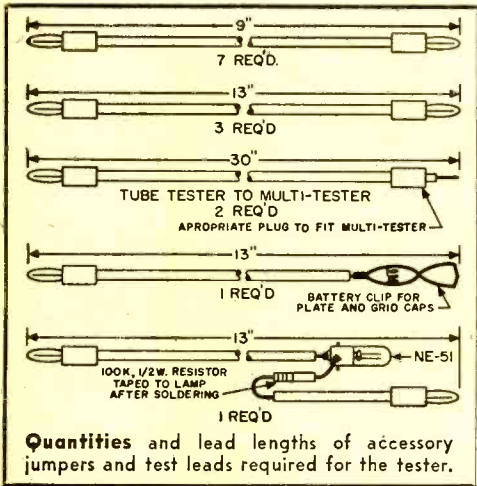

check the a.c. filament voltages vs. filament switch positions.

To test a tube, plug it into the tester for a quality check. Let's take a type 6C4 tube to illustrate the simple procedure. The first step is to look up the tube in the manual and note the pin connections. Pins No. 3 and No. 4 comprise the filament. Thus, jacks No. 3 and No. 4 are wired to the two "filament" voltage jacks by means of the jumper cord.

Set the "filament" switch (S2) to the 6.3-volt position. Pin No. 6 is the tube grid, so jack No. 6 is wired to the jack labeled C—. The plate connection for the 6C4 is made to either pin No. 1 or No. 5. Thus, jack No. 1 or No. 5 is wired to the jack marked B+. Set the "plate supply" control to maximum counterclockwise position and R3 to minimum resistance.

Now turn the tester on and plug the VOM across the C+ and C— jacks. Set

the "grid supply" control to make the VOM read —8.5 volts. This is the value stated in the tube manual under class A amplifier operation. Then place the VOM across the B— and B+ jacks and set the "plate supply" control to 250 volts.

Remove the VOM, set it on milliamperes, and insert it in the lead between the B+ jack and the plate jack of the tube (either jack No. 1 or No. 5 for the 6C4 tube, as above). Now the current passed by the tube can be read. The tube manual states that this should be 10.5 ma. The reading should be fairly close, although the values may easily vary 20 to 30%.

To test the transconductance, set the VOM to a.c. volts. Place the meter across the test jack to meter the a.c. voltage in series with the grid supply. Adjust R3 so that the voltage across the test jack is 1 volt. Now have the VOM read the voltage across the 100-ohm resistor (R7) in series with the plate. The meter should read 0.22 volt. This voltage multiplied by 10,000 will give the transconductance directly in micromhos. In the case of the

(Continued on page 108)

AFTER CLASS

Special Information on Radio, TV,



Radar and Nucleonics

SOME FACTS ON QUARTZ CRYSTALS

IN THE U. S. Naval Observatory at Arlington, Va., is the master of all master-clocks. The primary standard for all the timepieces of the nation, this clock is never fast or slow by more than a few seconds in *one-hundred million*. If you were to measure the distance between New York and Miami, Florida, with this kind of accuracy, the results would not be in error by more than the length of one standard cigarette!

Such fabulous micro-precision, matched only by the earth itself as it spins on its axis, is keyed to a tiny slab of crystalline quartz held under rigid temperature control in a special oven. Although it may soon be supplanted by an even more precise time standard (resonance of caesium atoms), the quartz crystal still remains the most important frequency-controlling device in existence today.

How They Are Cut. Oscillating crystals are cut from so-called *mother stones* by high-speed carborundum wheels. Although

tions during synthesis are held under rigid laboratory control.

A crystal exhibits *piezoelectric* activity. This means that it develops electric charges on its faces when compressed or otherwise distorted in shape. When connected in the grid circuit of a vacuum tube, sustained oscillations of one particular frequency are produced. Since the thickness of the crystal plate is an important factor



Bell Telephone Labs.

Synthetic quartz mother stone shown at the right was grown in a laboratory.

James Knights Co.

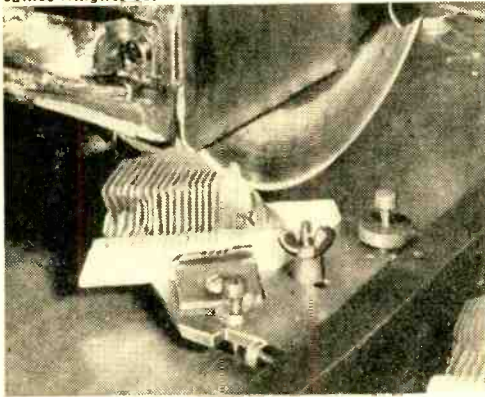

Thin wafers are cut from large mother stones by multiple saw at left. Wafers must then be ground and polished. Below, crystal blanks are being loaded into a planetary type of lapping machine prior to final polishing.



most finished plates come from natural quartz prisms, modern techniques for growing mother stones in the laboratory have been perfected to the degree where our dependence upon nature soon will be unnecessary. Synthetic crystals are often superior to natural ones since the condi-

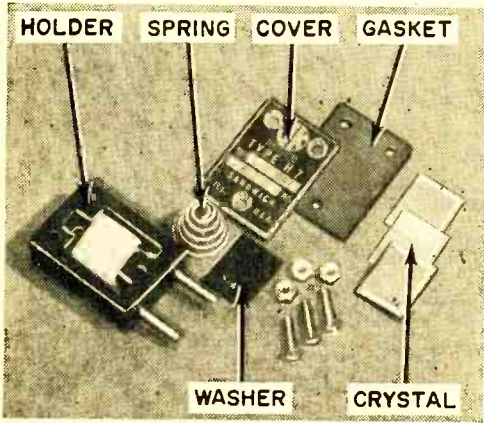

Disassembled military type FT-243 (7620-kc.) pressure-sandwich type of crystal holder used extensively in communications equipment.

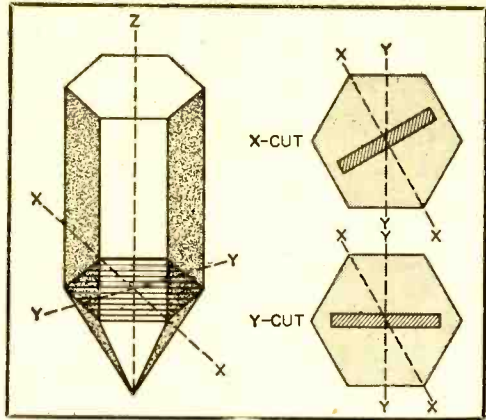

Fig. 1. Axes of mother stone and orientation planes of X-cut and Y-cut crystal blanks. A hexagonal prism has six X and six Y axes.

in determining the frequency of oscillation, the cut blank is ground and polished until its mechanical resonant frequency arrives at the desired value; the thinner the crystal, the higher its resonant frequency.

At one time, only X-cut and Y-cut crystals were available. These terms indicate that the crystal slices are taken from the mother stone at right angles to the X and Y axes. The X-axis is a line joining two opposite corners of the hexagonal prism and the Y-axis is a line joining the midpoints of the two opposite faces. (See Fig. 1.) Both of these cuts are subject to tem-

perature effects, changing frequency over relatively wide ranges as the temperature varies.

Between 1934 and 1949, vastly improved cuts were discovered by scientists connected with Bell Telephone Laboratories and RCA. Labeled AT, BT, V, CT, and DT, these crystals were ground from blanks oriented at complex angles with the axes of the mother stone. Finally, in 1940, the most stable quartz crystal ever devised was announced by W. P. Mason. Known as the GT-cut, this crystal shows no ap-

(Continued on page 116)

Four types of mountings. At left is a 110-kc. X-cut crystal in a military type HC-13/U holder which produces very little damping and some mechanical resonance in wires supporting the crystal. Next is a GT-cut in a special holder; the crystal is first plated with gold, then placed in evacuated glass holder, and is supported by eight wires soldered to plating. In cutaway view, a circular, silver-plated AT-cut in a glass holder is mounted inside temperature-controlled oven for greater stability. At right is a close-up view of an NT-cut in a miniature glass holder supported by four wires.

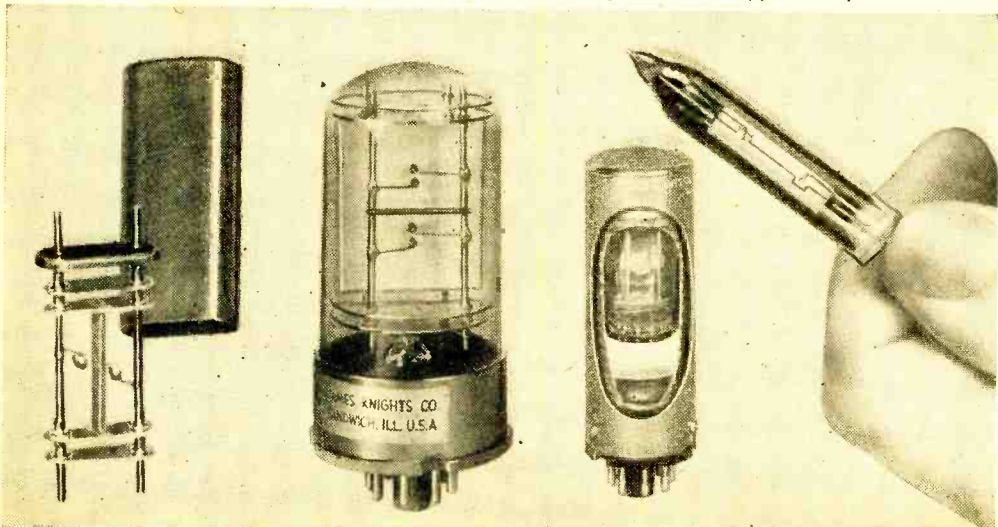

Tuning the Short-Wave Bands

with Hank Bennett



EVERY DAY we receive mail from our readers inquiring about radio clubs—their membership requirements, publications and addresses. Other questions which you ask most frequently concern reference books, sending reports to s.w. stations, antenna-ground systems, etc. Should the following paragraphs not give you enough in-



Michael Dorgan, Jordan, N. Y., tunes in stations from 550 to 18,000 kc. with 1941 Zenith receiver.

formation on these subjects, or if you have any other questions relating to short-wave radio which are not covered, please feel free to write to your S.W. Editor.

Clubs and Books. First, here is a brief description of four of the larger radio clubs. *The Newark News Radio Club* issues a monthly bulletin covering the broadcast, ham, short-wave broadcast, s.w. commercial, FM and TV bands. Its dues are \$4.00 a year. Write to the NNRC at 215 Market St., Newark 1, N. J. *The Universal Radio DX Club* issues 19 bulletins yearly covering the short-wave broadcast and ham bands. Its \$3.00 annual membership fee may be sent to the URDXC, 21446 Birch St., Hayward, Calif. *The International Shortwave Club* issues a monthly bulletin covering the short-wave broadcast and ham bands. For dues information and membership requirements, write to the ISWC, 100, Adams Gardens Estates, London, SE 16, England. *The National Radio Club* is mainly for broadcast-band enthusiasts; complete details on this club may be obtained from Ray B.

January, 1957

Edge, whose address is 325 Shirley Ave., Buffalo 15, N. Y.

One of the best sources of information pertaining to s.w. stations, their frequencies, call signs, locations, schedules, interval signals, identifications and addresses is the *World Radio Handbook*, published in Denmark, and distributed in the USA by Gilfer Associates, Box 239, Grand Central Station, New York 17, N. Y.; it sells for about \$2.00, and the 1957 edition should be available by January 15. The URDXC issues a yearly log book available to members. The NNRC is currently publishing a band survey, available to members, that covers a different s.w. band each month; in a yearly period, all of the s.w. bands are covered by this survey. The Foreign Broadcast Information Service in Washington, D. C., issues a set of four books that list stations by frequency, location, and name or call; the fourth lists foreign FM and TV stations. The price for the set is \$4.10 and orders should be sent to the Superintendent of Documents, U. S. Government Printing Office, Washington, 25, D. C.

How to Send Reports. Reports to s.w. stations should preferably be in letter form, although SWL cards, while not always containing sufficient technical information, will suffice. Briefly, you should include the name of the station (call or slogan), location, frequency, and power. (Continued on page 123)



Listening post of David Quarterson, Farrell, Pa.

79

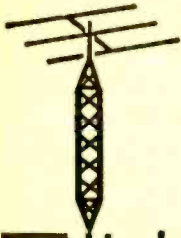

THE TRANSMITTING TOWER

Herb S. Brier, W9EGQ

WHENEVER amateur antennas are being discussed, someone is almost sure to say that many Novices do not realize the importance of having a good antenna. But this is not really true. Certainly some of us have less efficient antennas than we would like to have, but this is usually a matter of necessity, not of choice.

There is not much mystery about what constitutes an efficient amateur antenna. In its simplest form, it consists of a length of wire a half-wave long (length in feet = $468/\text{frequency in mc.}$) at the desired frequency, 30' to 50' high, and well separated from utility wires, buildings and other power-absorbing objects. It is connected to the transmitter through a low-loss transmission line.

The impedance of a half-wave antenna varies from about 2500 ohms at each end to about 50 to 75 ohms in the center. By inserting an insulator in the center of the antenna and connecting a 72-75 ohm transmission line at this point, a "matched-impedance center-fed doublet" is formed. The other end of the transmission line, which may be of any reasonable length, is connected to the output terminals of the transmitter.

The main disadvantage of such half-wave doublets is that they are generally one-band antennas. When a half-wave antenna is operated at certain multiples of its fundamental frequency, it performs as several half-wave antennas connected in series. On 40 meters, for example, an 80-

meter antenna is two half-wavelengths long; and on 20 meters, it is four half-wavelengths long. Consequently, on all even multiples of its fundamental frequency, the center impedance of a half-wave antenna becomes very high, resulting in a 30:1 to 50:1 mismatch. A mismatch of this magnitude will multiply the power lost in the transmission line many times.

On odd harmonics of its fundamental frequency, however, the center impedance of the antenna is again low. Thus, a 40-meter center-fed antenna usually works quite well on 15 meters.

All-Band Antennas. The "multimatch" antenna, developed by Chester Buchanan, W3DZZ, resembles a slightly shortened 80-meter doublet fed with 72-75 ohm transmission line. However, 32' on each side of the center insulator, a parallel-connected, coil-and-capacitor "trap" is inserted in the antenna. Between each trap and the end insulator is an additional 22' length of wire.

The inductance of the coil in each trap is 8.2 $\mu\text{h.}$, and the value of the capacitor is 60 $\mu\text{fd.}$ They resonate each trap in the middle of the 40-meter band and, as a result, both traps effectively isolate the 64' center section of the antenna from the 22' end sections, and the antenna operates as a half-wave, 40-meter doublet.

On 80 meters, the traps act as loading coils to resonate the entire 108' length of the antenna to the center of this band. On

(Continued on page 120)

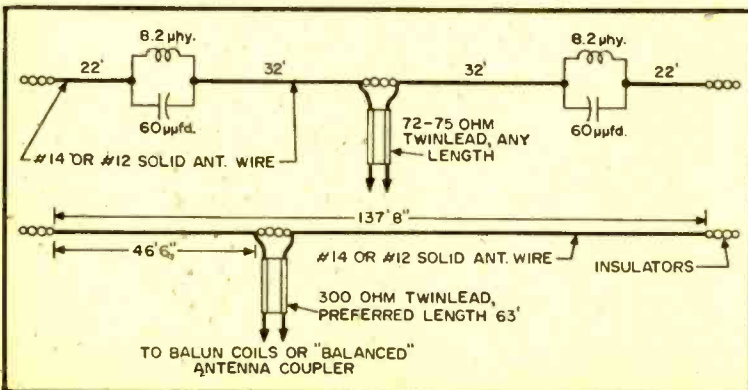

Two popular types of "all-band" amateur antennas for the 80- to 10-meter bands which are discussed in the text. At top is a "multimatch" antenna, while below it is one version of the Windom antenna.

HELP US OBTAIN OUR HAM LICENSES

In this section of the Transmitting Tower, the names of prospective amateurs requesting help and encouragement in obtaining their licenses are listed. To have your name listed, write to Herb S. Brier, W9EGQ, % POPULAR ELECTRONICS, 366 Madison Ave., New York 17, N. Y. Please print your name and address clearly. Names are grouped geographically by amateur call areas.

K1/W1 CALL AREA

William Fullin, Alvin Drive, Norwalk, Conn. (Code)

Arthur Simmons, 146 Cottage St., New Bedford, Mass.

Bruce E. N. Whitley, 14 French St., Providence 5, R. I. Phone: ST 1-8047. (Code)

Charles I. Leavitt, 2046-2048 Washington St., Boston 19, Mass. Phone: HI 5-7300. (Code)

Henry J. Maresi TD3, FAETU Det. #3, NAS, Quonset Point, R. I. (Code and theory)

K2/W2 CALL AREA

Robert Mark, 225 W. 232 St., New York 63, N. Y.

Daniel Gardner, 831 Gerard Ave., Bronx 51, N. Y. (Code and theory)

Barry Schaeffer, 50 Navajo Ave., Lake Hiawatha, N. J. (Code and theory)

David Ostrom, Woodcrest, Rifton, N. Y.

Darwin Muir, Toms River, N. J. (Code and theory)

Joseph Tofieddo, 79 Bregman Ave., New Hyde Park, N. Y.

Thomas McDonough (16), 628 61st St., Brooklyn 20, N. Y. Phone: HY 2-6728. (Code and theory)

Noah Goldenberg, 1132 55th St., Brooklyn 19, N. Y. (Code and theory)

K3/W3 CALL AREA

Thomas Quay (14), 405 So. Franklin St., Allentown, Pa. (Code and theory)

Jared Wolf (14), Box 127, Concordville, Pa. Phone: Valley Brook 2560. (Code and theory)

Jones L. Jordan, Jr., R.D. #1, Glen Mills, Delaware Co., Pa. Phone: Valley Brook 2782. (Code and theory)

Redmond Stevens, 100 Jefferson St. N.W., Washington 11, D. C.

Don Beighley (16), 318 Home St., New Kensington, Pa. (Code)

John Yokoff, 117 Parade St., Erie, Pa. (Would like to trade SWL cards; will answer all letters)

Paul Elko, 209 Sarah St., McKees Rocks, Pa. (Code and theory)

Richard Moriarity, Box 141, Winburne, Pa. Phone: 3682

K5/W5 CALL AREA

Jack Staggs, 3417 McLean, Ft. Worth, Texas. (Needs help in code and advice on constructing Novice station)

Robert Brown (14), 134 Bobby Lou Dr., San Antonio 9, Texas.

David Andrews, 4324 Westway, Dallas 5, Texas.

John Storie (13), 2427 North Boston Ave., Tulsa, Okla. (Code and theory)

K6/W6 CALL AREA

Robert Hayden Stormer, 1109 Mound, Alameda, Calif. (Code)

Larry Benfield, 13101 7th St., Chino, Calif. (Code and theory)

Bing Kaye, 5880 Los Molinos, Buena Park, Calif.

K7/W7 CALL AREA

Clair Button (17), 2951 East 8th Ct., Casper, Wyo. Phone: 2-2275. (Code and theory)

Ned Stevens, 953 Third Ave., Salt Lake City 3, Utah. Phone: EL 9-8825. (Code and theory)

K8/W8 CALL AREA

Dale Pavlicek, 344 E. 266 St., Euclid 32, Ohio. (Code and theory)

Robert T. Day, Den Bar Rd., Bloomfield Hills, Mich. (Code and theory)

Robert Meehan, 1146 S. James Rd., Columbus, Ohio. (Code)

Tom Covert, 1338 Taggart N.E., Massillon, Ohio. Phone: TE 3-9773. (Code and theory for General Class)

Walter Luehr, % Longview Hosp. (Wd 62), Cincinnati 16, Ohio.

John Bartlett, 202 McGraw Ave., Grafton, W. Va. (Antenna information and General Class)

Wesley Rishel (11), 2100 Revely, Lakewood, Ohio. (Code and theory)

Don Bigelow (14), 113 Elm St., Bay City, Mich. (Needs help in theory; wants to hear from someone with a Hallicrafters S-20R.)

K9/W9 CALL AREA

Edward S. McKim, 641 Aldine St., Chicago 13, Ill. Phone: GR 2-0193. (Code and theory)

John A. Hagen, 18745 Henry St., Lansing, Ill. (Code and theory)

B. Juanita Harris (Mrs.), 2300 Louisiana St., Gary, Ind. Phone: Turner 2-8976. (Code and theory)

William Elderti, 1409 S. 10th St., Pekin, Ill. (Theory)

Robert D. Nelson, 260 So. Channing St., Elgin, Ill. (Code)

K0/W0 CALL AREA

Eugene Chapman, Papillion, Neb. (Code and theory)

Glenn Runyan, 117 Cutler, Waterloo, Iowa. (Code and theory)

Thomas E. Storm, 529 N. Hillside, Apt. 3, Wichita 6, Kansas. Phone: MU 4-6027. (Code and theory)

Dennis Greischar, 114 7th Ave. So., St. James, Minn. (Code, theory and regulations)

James Olseth, 400 4th Ave. No., St. James, Minn. (Code, theory and regulations)

Allen J. Strand, 515 W. J St., Forest City, Iowa. (Code, theory and regulations)

Val Angell III, 9901 Girard Ave. So., Minneapolis 20, Minn. (Code; will answer all letters)

Allan Charles Mueller, Box 216, Arlington, Minn. (Code and theory)

Louis F. Endsley, 333 E. 27th St., North Kansas City 16, Mo. (Will answer all letters and cards)

VE AND OTHERS

Fred Hicks, Box 340, Picton, Ont., Canada.
Chong Man Lee, #333-97 Sindang-dong, Songdong-Ku, Seoul, Korea. (Theory)

To help prospective amateurs obtain their Novice licenses, the Radio-Electronics-Television Manufacturers Association offers a set of code records (recorded at a speed of 33 $\frac{1}{3}$ rpm) and a Novice Theory Course for \$10.00, post-paid. The complete course or more information on it is available from RETMA, Suite 800, Wyatt Bldg., 777 Fourteenth St., N. W., Washington 5, D. C.

Make Your Own Dynamic Mike

MICROPHONES are used extensively in almost every branch of electronics—in paging systems, by hams, in p.a. installations, with recorders, and in broadcast studios. Electronics hobbyists are major “mike” users. Of the various types of microphones available, an electromagnetic—unit offers several advan-

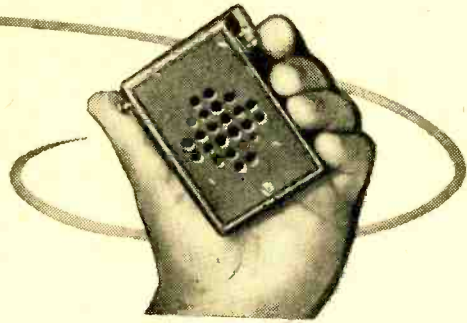

a satisfactory housing for most applications, but if the mike is to be used where the hum and electrical noise level is likely to be high, a small metal case is preferable because of its shielding qualities.

Some type of protective opening is needed for the subminiature loudspeaker. This may be a decorative pattern of drilled holes, or a piece of plain or flocked metal screening mounted behind a circular cut-out in the case.

The chassis is a small piece of perforated Bakelite. The transistor socket and small electrical components are mounted on it. Although a transistor socket was used in the model, this component may be eliminated and the transistor wired permanently in place if desired. A single 15-volt battery is used; a small lug is soldered to one of its end terminals, and is attached to the case with a machine screw and nut.

(Continued on page 102)

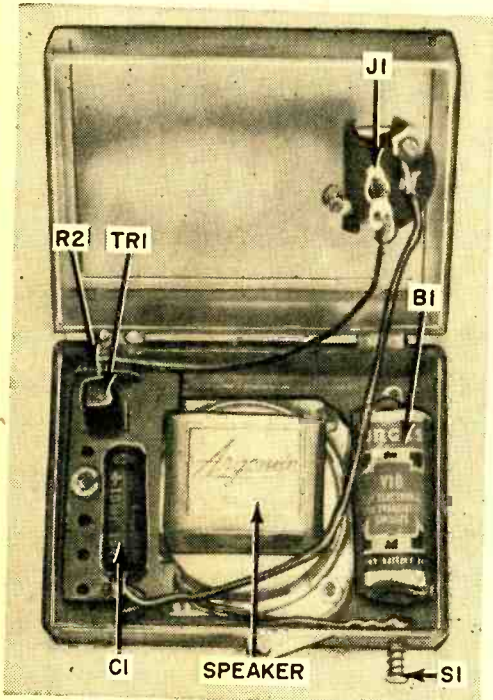

Assembled transistORIZED microphone in small plastic box. Note how parts fit around loudspeaker.

tages over other types for experimental use. Less noisy than a carbon microphone, and with better resistance to moisture and shock than crystal units, the dynamic mike has only two drawbacks—it is generally more costly than other types, and its output is far lower than that of a carbon mike.

Except for its low output impedance, a PM loudspeaker makes an excellent dynamic microphone. But by teaming up a PM speaker with a transistor, we can assemble a truly dynamic mike which has the high output impedance needed by most audio amplifiers, coupled with a high output level . . . comparable to that obtained from carbon microphones.

Construction. The author's model of the dynamic microphone was assembled in a small plastic box. A plastic case makes

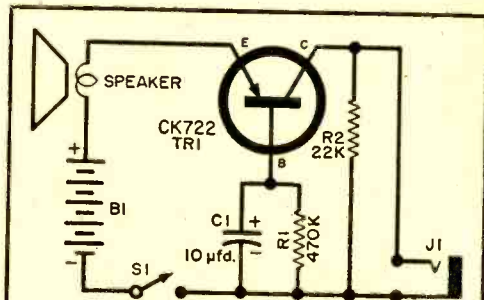

- B1—15-volt miniature battery (Burgess No. Y10)
- C1—10- μ d., 15- or 25-volt electrolytic capacitor
- J1—Phono jack
- R1—470,000-ohm, $\frac{1}{2}$ -watt carbon resistor
- R2—22,000-ohm, $\frac{1}{2}$ -watt carbon resistor
- S1—S.p.s.t. switch (see text)
- TRI—CK722 transistor (Raytheon)
- Speaker—Subminiature PM loudspeaker, 10-ohm voice coil (Argonne No. 95)
- 1—Transistor socket
- 1—Small plastic box
- 1—Perforated Bakelite mounting board
- Misc. machine screws, nuts, wire, solder, etc.

Schematic and parts list for the microphone.

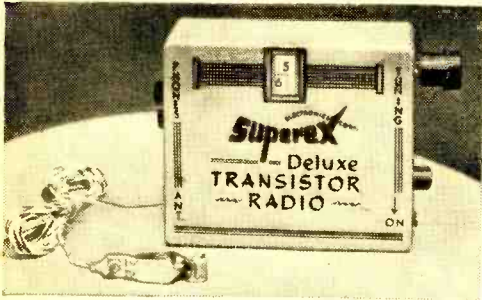

SupereX's new two-transistor-and-diode radio, available in kit form, features a printed circuit and operates on two penlite batteries.

sharp drop in the price of all transistorized receivers transistors should appear in TV receivers (portables) before the end of the year.

There should be a number of transistorized toys available before next Christmas and watch for a rapid swing to "all transistor" computers and aircraft electronics gear.

Reader's Circuit. Take a transistor receiver circuit, add a POP'tronics reader, an assortment of suitable parts, a dash of imagination, shake well and . . . presto . . . you can come up with almost anything. One result might be a penlite-sized radio receiver you can wear in your shirt pocket. At least, that's what Elton V. Stolberg (W7OUV) built with these ingredients.

You shouldn't have too much trouble assembling a duplicate of Elton's receiver if you work carefully. Start with a penlite flashlight case having a push-in, off-center-lock type of switch. These are available

at most five and dime and at many drug stores.

Elton suggests that you begin actual construction by modifying tuning coil *L1*. This is a General Cement Adjust-A-Loop coil. Unsolder and loosen the antenna and coil leads, removing them from the soldering lugs; then break the fiber mounting ring for the soldering lugs and remove it. Modify the mounting clip by bending the two large spring "ears" so that the coil is supported when the clip is pressed into the flashlight bulb socket assembly . . . the bulb is removed, of course.

Other parts, including a Raytheon 1N66 diode (*CR1*) and two CK722 transistors (*TR1* and *TR2*) are wired in a straight line after the coil. Care must be taken to keep the assembly compact, so that it will fit within its case. Over-all length is critical also. The completed assembly, including a plastic "spacer" disc and the two Mallory Type 400 mercury cells, should approximate the length of two penlite cells, to insure proper operation of the push-button switch. The two mercury cells, in series, supply slightly under three volts, and their life—in normal operation—should be well in excess of 50 hours.

Use the smallest parts you can obtain to avoid overcrowding. *C1* and *C2* are Aero-vox P83Z microminiature capacitors; *C3* is a Barco Type P6-8 electrolytic.

With all components soldered permanently in position, take special care when installing the diode (*CR1*) and the transistors. Using a pair of pliers, grasp the lead being soldered at a point between the soldered joint and the body of the component.
(Continued on page 115)

This transistor chart, made up from a "Reference Sheet" distributed by General Transistor Corp., will serve as a general guide for comparable types of p-n-p transistors.

Use*	G.T.	Raytheon	G.E.	Sylvania	RCA	CBS	T.I.	Philco
A	GT-14	CK-723, 2N63					301	
A, R	GT-20	CK-721, CK-727 2N64, 2N106	2N44, 2N81		2N104		301	
A	GT-34	CK-722					300	
A, R	GT-81	CK-725, 2N65	2N43	2N34	2N77, 2N105 2N175		302, 310	2N223
A, C	GT-83		2N76, 2N190					
A, C, S	GT-345	CK-870, CK-871						
A, O, R	GT-109	2N138	2N186, 2N187 2N188			2N180	2N185	2N224, 2N226
A, O, R	GT-81HS	CK-751				2N180		
A, C, R	GT-759	2N11A, 2N111						
A, C, R	GT-760	2N112, 2N112A CK-760	2N135		2N139			
A, C, R	GT-761	CK-761, 2N113 CK-766, CK-766A	2N123, 2N136 2N137, 2N167		2N140			
A, C, R	GT-762	2N114, CK-762						
A	GT-222		2N107					

*A—audio, C—computer, O—output, R—radio, S—symmetrical

Transtopic

Experiment No. 14

"All-Frequency" Signal Generator

THIS is another experiment in the series that started in the March, 1956, issue. The last experiment, No. 13, appeared on page 65 of the December issue.

By removing some parts from the light beam receiver (Experiment No. 13), you can convert it into a "full-time" oscillator supplying both audio signals and r.f. signals through the entire AM broadcast band—simultaneously! Thus, it may be used to "inject" a signal at any stage in a receiver, checking the operation of that and succeeding stages. A shielded cable, with alligator clips, is employed to connect the output to a receiver.

To use the "all-frequency" signal generator in servicing a "dead" radio, connect the shield of the cable to receiver ground (or chassis).

Adjust $R1$ to about the middle of its range and turn $R6$ full up. With the receiver warmed up, touch the other clip of the output cable to the grid of the receiver's audio output tube. If the receiver's power supply and output stage are functioning, you should hear a tone from the loudspeaker. Tone pitch depends on the setting of $R1$, volume on the setting of $R6$.

Next, transfer the "hot clip" to the grid of the first audio amplifier, then to the i.f. stage, and to the converter and r.f. stages. At each point, you should hear a signal from the loudspeaker. When you fail to get a tone, as you inject a signal into a particular stage, you've isolated the "dead" stage! Final checks with a multimeter should enable you to locate the defective part in that stage.

Operation of this signal generator is similar to that of the light beam receiver—but you may wonder why both audio and radio frequency signals are obtained. The reason is a simple one: the signal waveform generated by the oscillator is essentially a sharp pulse (see inset drawing) which is extremely rich in harmonics—even multiples of the basic frequency. If the basic frequency is 1500 cycles, the second harmonic is 3000 cycles, the third harmonic 4500 cycles, the fourth harmonic 6000 cycles, etc. These harmonic signals extend up through—and beyond—the AM broadcast band.

Thus, the signal produced by the instrument essentially "blankets" the entire AM band, and may be picked up at almost any setting of the receiver's dial. Because of this, the instrument makes a good "radio jammer" . . . so don't attach an antenna and ground!

—Louis E. Garner, Jr.

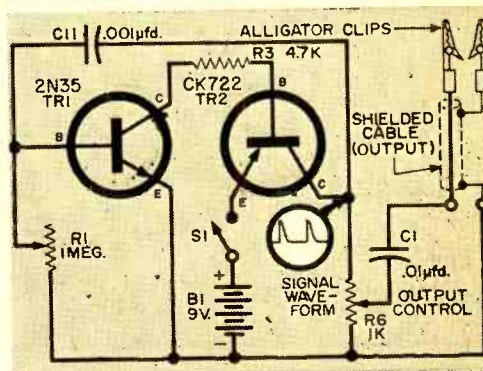
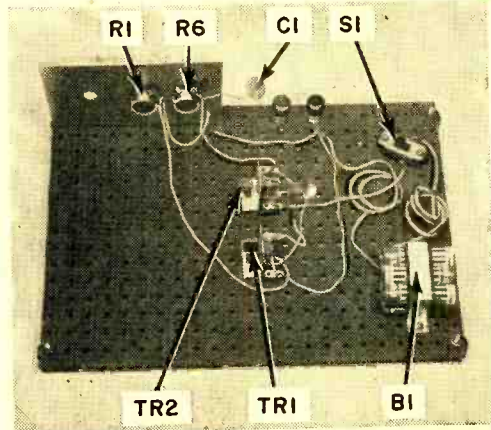

Useful Battery Power Pack

AN ADJUSTABLE-VOLTAGE d.c. power source is a real necessity for bread-board tests of transistor circuits and for working with portable radios, test gear, or on experiments with miniature motors. If you've priced the necessary components, you'll know that building an a.c.-operated low-voltage power supply can be an expensive proposition. Here's an inexpensive, easy-to-assemble power pack that should be ample for most of your bench work.

This power pack supplies pure d.c. at voltages ranging from about 1.5 to 9 volts, and at currents up to 500 milliamperes (0.5 amp.) for short periods; and it can be used as a multiple power source. To assemble it, all you will need is a mounting base, a few battery "boxes," batteries, a handful of Fahnestock clips, and some small hardware. A piece of perforated Masonite can serve as a base.

Rubber feet were mounted in each corner of the model built by the author. Three Austincraft No. 144 battery "boxes" were used, connected to supply nine volts from six Burgess No. 1 dry cells. The output leads of each battery box were brought to a separate pair of Fahnestock clips. The frames of all three boxes were bonded together and connected to another clip

which is used for grounding.

With this arrangement, you have three independent 3-volt sources. Two sections may be connected in series to furnish six volts or all three sections can be connected in series to supply nine volts. For heavy current drains, over an ampere, for example, the three sections may be connected in parallel. Finally, where you need smaller voltage increments, you can use a clip

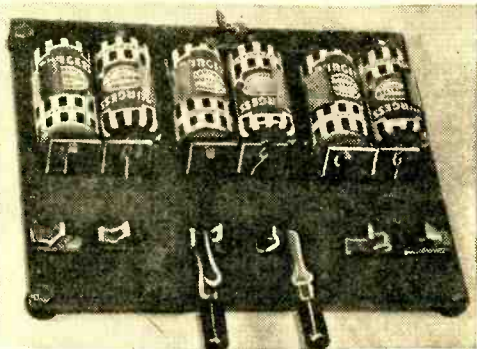

lead to "tap" into the individual battery boxes, obtaining nominal output voltages covering the range of 1.5, 3, 4.5, 6, 7.5 and 9 volts.
—E. G. Louis

Oversize Meter on New VTVM

IF YOU HAVE ROOM around the house for a workshop or laboratory, the new Hickok Model 225K VTVM kit should find a place there. Unlike the vast majority of

scales and makes each subdivision readable without a lot of guesswork. The longer meter needle means greater damping, which in turn means that the meter does not "overshoot."

A 225K kit can be assembled in just under six working hours. This includes complete wiring and assembly. A lot of credit is due the very thorough 60-page instruction book with its logical point-by-point method of assembly.

The VTVM will measure all of the useful a.c. and d.c. voltages from 1.5 to 1200 volts. Input impedance on both direct and alternating current is over 10 megohms. Seven ohmmeter ranges are included, covering the span of 0.2 ohm to 1000 megohms. An added feature of the 225K is a "Continuity Test Buzzer" which provides an audible indication where continuity of circuits having less than 10 ohms need to be checked.

This is Hickok's first venture into the kit field, although they have been active for 45 years in developing test equipment. If the Model 225K is an indication, we may expect more creative thinking in kit designs. Write to Hickok Electrical Instrument Co., 10500 Dupont Ave., Cleveland 8, Ohio, for additional information.

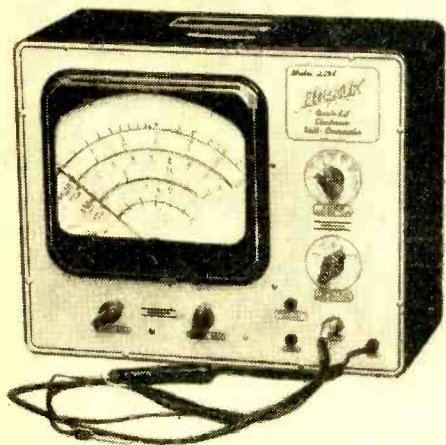

VTVM kits, this one has a meter that can really be seen. In fact, the meter is over 9" wide and can be read from any part of the workbench. A meter of this size also has other advantages. It stretches out the

what's new in hi-fi

STEREOPHONIC SOUND—once a movie theatre novelty—is now a hi-fi marvel you can enjoy at home. This latest iron in the hi-fi fire is sparked by a number of units offered by leading manufacturers.

A most impressive unit is a new console by Ampex which houses a complete hi-fi system, including stereotape. The price, a little better than \$1400, will deter many who can't see spending as much on sound as they might on a car; yet Ampex has launched this instrument with avowed high hopes. Included in the console is a Garrard record changer and G.E. pickup, a Fisher tuner, the Ampex recorder with provision for stereo playback, and two separate 10-watt amplifiers, each driving its own neatly baffled 8" speaker. Visitors at the Hi-Fi Show in New York City last October had a chance to hear this console; all others are urged to visit their local hi-fi shop for a real sonic thrill.

The same thrill at somewhat less cost is also available from a number of other stereotape machines. The Ampex A121 "table-top" system (shown at the top of this page) is such an instrument, while the Model A122 is a portable, and lower-priced, stereotape system. For further information, write to Ampex Corp., 934 Charter St., Redwood City, Calif.

Similar tape equipment is found in a new line by Berlant-Concertone. Extremely versatile, these units will record full-track tapes for professional masters, or half-track tapes for the home library. They

**For all hi-fi'ers:
a conscientious report
on components, kits,
systems, trends, and events
in the world of audio**

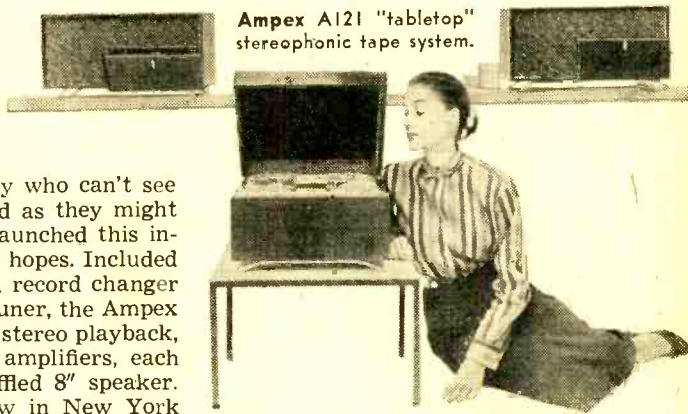

Ampex A121 "tabletop"
stereophonic tape system.

play back full- or half-track tapes, or stereotapes. Specially designed preamplifiers may be incorporated with the basic tape decks for the various functions. Details are available from American Electronics, Inc., 655 W. Washington Blvd., Los Angeles 15, Calif.

Sharing the spotlight on the new stereotape stage is Magnecord's Model M-90. This tape machine, the "leader" in the Magnecord line, was used for demonstrating hi-fi recording and playback in conjunction with a concert given by the Connecticut Symphony Orchestra last October in Hartford, Conn. Information on the M-90, as well as on more modestly priced Magnecord units,

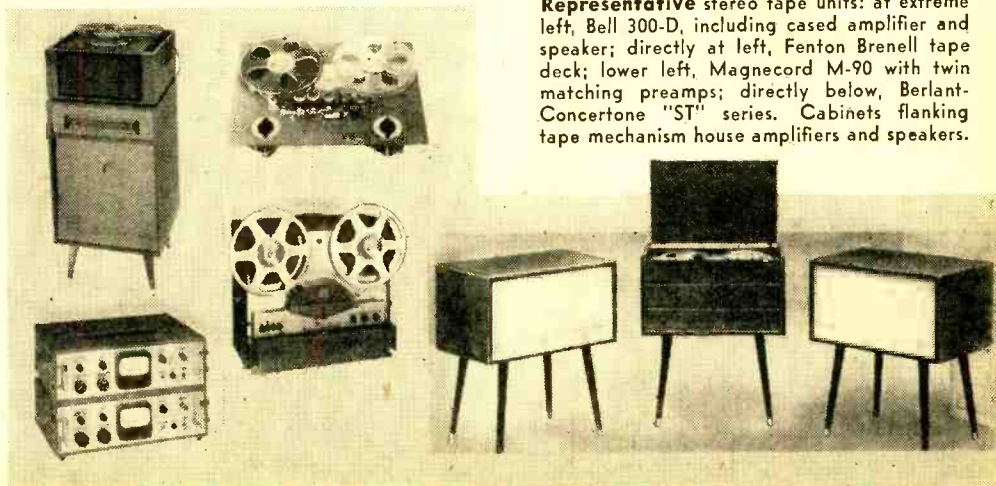

Representative stereo tape units: at extreme left, Bell 300-D, including cased amplifier and speaker; directly at left, Fenton Brenell tape deck; lower left, Magnecord M-90 with twin matching preamps; directly below, Berlant-Concertone "ST" series. Cabinets flanking tape mechanism house amplifiers and speakers.



Bogen stereo amplifier unit.



Norco head.



Above, Bib tape splicer. Left, Irish "No-Spill" tape reels.

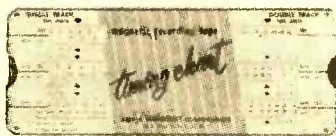

Reeves timing chart.

the 10-watt amplifier in the ST-10; the other drives any external amplifier. In other words, the ST-10 is a neat and compact means of bridging the gap between a stereophonic tape deck and a conventional single-channel sound system. Details on this less-than-\$60 unit may be obtained from David Bogen Co., Inc., P. O. Box 500, Paramus, N. J.

Another neatly designed unit for helping tape enthusiasts make the changeover from monaural to stereophonic tape is a magnetic record/playback head offered by Nortronic. The "Norco" head may be used in new equipment as well as for replacement and conversion of existing recorders. It can be compensated for flat response from 30 to 10,000 cps at tape speed of 7.5 ips. Details are available from the Nortronic Co., 1015 So. Sixth St., Minneapolis 4, Minn.

New Irish brand tape reels—made by ORadio Industries, Inc., Opelika, Ala.—promise to eliminate the spill-and-tangle bug that has plagued recordists. The new "No-Spill" reel utilizes two notches on opposite ends of the reel. A rubber band, slipped over the notches, holds the tape securely in place. Easier access to the threading eye is also afforded. An additional feature is 28 square inches of indexing space on the four large flange areas.

From Britain comes a new tape splicer, simple to use and applicable for both mending broken tapes and editing taped

may be obtained by writing to Magnecord, Inc., 1101 S. Kilbourn Ave., Chicago 24, Illinois.

Lower Priced Units. Coming down on the price scale, tape enthusiasts might consider any of the very attractive units offered by several leading companies. Many are portable but can be used for hi-fi. For details contact the manufacturers: Bell Sound Systems, Inc., 555 Marion Rd., Columbus 7, Ohio; EMC Recordings Corp., 806 E. 7th St., St. Paul 6, Minn.; Fenton Co., 15 Moore St., New York 4, N. Y.; Pentron Corp., 777 So. Tripp Ave., Chicago 24, Ill.; RCA Victor Div., Camden 2, N. J.; Viking of Minneapolis, 6900 Aldrich Ave. So., Minneapolis 20, Minn.; and V-M Corp., Benton Harbor, Mich.

Accessories, Too. Designed to make life easier for tape enthusiasts are several new recording accessories, of which the most striking is Bogen's Model ST-10 playback amplifier. This simple, moderately priced unit incorporates dual preamplifiers and a single 10-watt amplifier. When used with a tape playback deck, the output of the stereophonic tape heads is fed to both preamps of the ST-10. One of these drives



Corner baffle (left) built with Allied kit.



Cabinart kit (above) for Jensen speaker system.

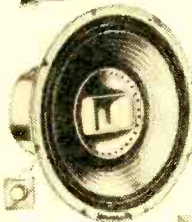

Above, University "Dif-faxial" 3-way speaker. At right, cabinets built from River Edge kits.

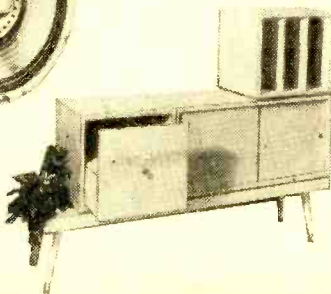

New! A MACHINE THAT COMPOSES MUSIC

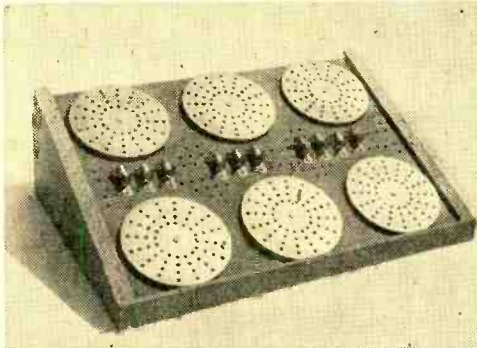

Actual tune composed on GENIAC

**COMPUTES, "REASONS"
PLAYS GAMES**

**GENIAC
ELECTRIC BRAIN**

BUILD IT YOURSELF in a few hours!

Yes, you build any one of 33 exciting electric brain machines in just a few hours by following the clear-cut, step-by-step directions given in a thrilling booklet! No soldering required . . . no wiring beyond your skill! GENIAC is a genuine brain machine—not a toy. The **only** logic machine kit that not only adds, subtracts, etc., but presents the basic ideas of cybernetics, Boolean algebra, symbolic logic, automatation, etc. So simple to construct that even a twelve-year-old can make a machine that will fascinate people with advanced scientific training! With the special circuitry of GENIAC, the Electric Brain Construction kit, you can compose tunes automatically. These new circuits were never available before!

OVER 400 COMPONENTS AND PARTS. Circuits operate on one flashlight battery, and the use of ingeniously designed parts makes building circuits one of the most fascinating things you've ever done! You set up problems in a variety of fields—and get your answers almost quicker than you can set them up! Play games with the machine—nim, tic-tac-toe, etc.—and pit your brain against its logic! Solve puzzles in a few seconds that would take you hours without the aid of the machine. You actually see how computing and problem-solving is analyzed with algebraic solutions transferred directly into circuit diagrams.

YOUR COST FOR GENIAC KIT: only \$19.95 postpaid. The 1956 Model GENIAC KIT contains: (1) a complete 200-page text, "Minds and Machines"—a basic introduction to computers. (2) "How to Construct Electrical Brains At Home"—a fully illustrated text book on basic computer design theory and circuits with specific instructions for building circuits. (3) Wiring Diagram Manual. A special booklet with full scale diagrams that you can tear out and place on your work bench for easy assembly. (4) Beginners' Manual. Starting from scratch, the manual adds fifteen extra experiments, thoroughly tested using GENIAC components to teach the basic symbols of electric circuits. (5) Over 400 components and parts.

So—mail the coupon for your GENIAC today! Your money back if not delighted!

Some Firms and Institutions that have ordered GENIAC:

Allis-Chalmers
Remington-Rand
International
Business
Machines
Wheeldex Mfg. Co.
Manuel Missionary
College

Walter V. Clarke
Associates
Barnard College
Westinghouse
Electric
Phillips
Laboratories

General Insurance
Co. of America
Lafayette Radio
Rohr Aircraft Co.
Albert Einstein
Medical College
Naval Research
Laboratories

Los Angeles
Public Schools
Kansas State
University
Duke University
Coral Gables
Bell Telephone
Laboratories

K1—Only

\$19⁹⁵

Postpaid

DIGITAL COMPUTER COURSE

Have you ever wanted to build a small digital computing device? One that reproduces in miniature what computers like ENIAC, SEAC, BIZMAC, etc., do on a large scale? Our DIGITAL COMPUTER course shows how to set up and build computers and experiment with pulses, storage, gates, flip flops, adding, subtracting, multiplying and applications of Boolean Algebra to circuit design. You get an introduction to programming. More important, you learn how and where to buy computer parts to build your own computers. Manuals, wiring diagrams and texts provide a complete introduction to theory and practice of DIGITAL COMPUTERS clearly explained. We have a complete question answering service. This is the finest and only DIGITAL COMPUTER course **\$28.00** on the market, postpaid. . . . C2-

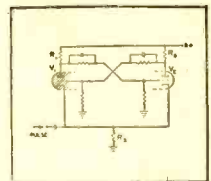

A modulo 2 counter. More commonly a flip-flop arrangement of 2 triodes. This is the main elementary component from which counters and accumulators are assembled.

We have 38 other courses in computer technology, physics, electronics, television, radio, radar, acoustics, construction of robots, mathematics: including trigonometry, algebra, calculus, statistics, chemistry, biology and psychology. Write now for free descriptive literature and enrollment forms.

OLIVER GARFIELD CO., Dept. PE-17, 31 Broadway, New Haven, Conn.

Name..... Age..... Occupation.....
City..... Zone..... State.....

programs. The "Bib" features vertical, diagonal, and horizontal mitres and a razor-type cutter. Retail price is \$3.95. Details are available from Ercona Corp., 551 Fifth Ave., New York 17, N. Y.

If timing is your pet problem, better get hold of the new Soundcraft Timing Chart. Issued by Reeves Soundcraft Corp., 10 E. 52nd St., New York 22, N. Y., this handy "slide-rule" type data card retails for only \$1.00.

And for helping your recorder keep a "clear head," try EMC's head-maintenance kit. Priced at \$1.50, the kit includes a supply of cleaner and lubricant, brush applicators, and an instruction manual. It is made by EMC Recordings Corp., 806 E. 7th St., St. Paul 6, Minnesota.

Speakers, Etc. University Loudspeakers has introduced the term "diffaxial." A two-way "diffaxial" uses the "diffusicone" method of mechanical crossover, while the three-way "diffaxial" adds a separate tweeter horn to the diffusicone system. For details, write to University Loudspeakers, Inc., 80 Kensico Ave., White Plains, N. Y.

Two new do-it-yourself kits are available from the Heath Co., Benton Harbor, Mich. One of these kits builds a small general-purpose speaker system and matching enclosure. An expanded system built from the second kit may be added.

The Jensen line of speaker system kits, ranging in size and price from the modest

"Duette" to the large "Imperial," is now available with matching cabinet kits made and sold by Cabinart. Seven basic enclosure kits are offered in the new line, each designed to house a specific Jensen speaker system. Details are available from either Jensen Mfg. Co., 6601 So. Laramie Ave., Chicago 38, Ill., or from Cabinart Div., G & H Wood Products Co., Inc., 99 N. 11th St., Brooklyn 11, N. Y.

Electro-Voice's speaker systems and enclosures in kit form continue as popular items for hi-fi'ers who favor folded horn designs. This company's new "Catalog-Guide 117-118" describes the line in detail. Send 25 cents to Electro-Voice, Inc., Buchanan, Mich., for a copy.

New lines have been announced by River Edge and Jay-Vee. The former includes modular units for housing components with a matching bass reflex enclosure, and Jay-Vee is offering a variety of speaker enclosures in sizes from shelf models to floor models. For information on River Edge, write to British Industries Corp., 80 Shore Rd., Pt. Washington, N. Y. The Jay-Vee Wood Products Co. is located at 66 Church Rd., Lansdale, Pa.

Newest kit line is the series of speaker enclosures announced by Allied Radio Corp., 100 N. Western Ave., Chicago 80, Ill. Corner horns and bass reflex cabinets for 12" and 15" speakers are featured at prices from \$24.00 to \$69.00.

-30-

Mount Your Meter for Convenience

ANYONE who has had occasion to use a VOM or VTVM knows the inconvenience of craning and twisting to get a head-on look at the meter. It always seems to be too high or too low, or it's not facing the experimenter squarely. Under such conditions, an accurate reading is often impossible.

After years of such nonsense, the writer finally took the logical step, long postponed, of building a mounting for his VTVM which makes it a simple matter to adjust the tilt of the meter to face him squarely. This mount or support can be simply constructed in less than an hour from some scraps of wood around the workshop.

Dimensions aren't given in this article. They'll vary with the size and shape of your test instrument. Just be sure that the mounting you build provides adjustment for tilt and swing, has a large and heavy base for stability, and is designed to permit easy removal of the instrument for use away from the shop.

Mine has a heavy oak base for weight and stability. The frame around the meter is a neat sliding fit. A narrow strip across

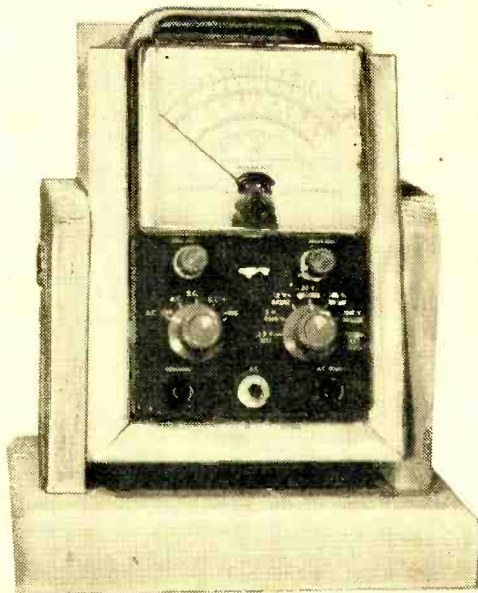

the top-back of the handle holds the meter in place and still permits it to be removed with ease.

—R. L. Winklepleck

POPULAR ELECTRONICS

HEATHKITS . . . are fun to build, and you save by dealing directly with the manufacturer!



It's easy to follow simple step-by-step directions with large pictorial diagrams as your guide. You save labor costs and get more real quality for less money. Your greatest dollar value in fine kit-form equipment.

BUDGET YOUR PURCHASE . . .

We invite you to take advantage of the HEATH TIME PAYMENT PLAN on any order amounting to \$90 or more. Just 10% down, and the balance in twelve easy monthly payments. Write for complete details.

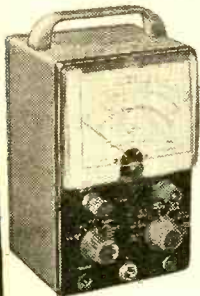

MODEL V-7A

\$24.50

Shpg. Wt. 7 lbs.

\$2.45 DWN.,
\$2.06 MO.

*Largest selling VTVM
in the world!*

. . . etched circuit board

HEATHKIT VACUUM TUBE VOLTMETER KIT

Sensitivity and reliability are combined in the V-7A. It features 1% precision resistors, large 4½" panel meter, and etched circuit boards. AC (RMS) and DC voltage ranges are 0-1.5, 5, 15, 50, 150, 500 and 1500. Peak-to-peak AC ranges are 0-4, 14, 40, 140, 400, 1400 and 4000 volts. Ohm-meter ranges provide multiplying factors of X1, X10, X100, X1000, X10K, X100K and X1 megohm.



*New
improved . . .
full 5" size
. . . etched
circuit
for only*

\$42.50

Shpg. Wt. 21 lbs.

\$4.25 DWN.,
\$3.97 MO.

MODEL OM-2

HEATHKIT 5" PUSH-PULL OSCILLOSCOPE KIT

This new and improved oscilloscope sells for less than the previous model. You can have a full 5" oscilloscope at the remarkably low price of only \$42.50. The OM-2 provides wider vertical frequency response, extended sweep generator coverage, and increased stability. Vertical channel is essentially flat to over 1 MC, and down only 6 DB at 1.5 MC. The sweep generator functions from 20 CPS to over 150 KC. Amplifiers are push pull, and modern etched circuits are employed in critical parts of the circuit. A 5BP1 cathode ray tube is used. The scope features external or internal sweep and sync, one volt peak-to-peak reference voltage, three-position step attenuated input, adjustable spot shape control, and many other "extras."



MODEL M-1

\$14.50

Shpg. Wt. 3 lbs.

\$1.45 DWN.,
\$1.25 MO.

*Compact, portable . . .
a favorite in the home
and in the service shop*

HEATHKIT HANDITESTER KIT

Measures AC or DC voltage at 0-10, 30, 300, 1000, and 5000 volts. Direct current ranges are 0-10MA and 0-100MA. Ohm-meter ranges are 0-3000 and 0-300,000 ohms. Sensitivity is 1000 ohms/volt. Features small size and rugged construction in sleek black bakelite case.

HEATH COMPANY • BENTON HARBOR 10, MICH.
A Subsidiary of Daystrom, Incorporated





\$3.60 DWN.,
\$3.02 MO.

MODEL DX-20

\$35⁹⁵

Shpg. Wt. 18 lbs.

BRAND NEW MODEL

HEATHKIT

CW TRANSMITTER KIT

Here is a straight-CW transmitter that is one of the most efficient rigs available today. It is ideal for the novice, and even for the advanced-class CW operator. This 50 watt transmitter employs a 6DQ6A final amplifier, a 6CL6 oscillator, and a 5U4GB rectifier. It features one-knob band switching to cover 80, 40, 20, 15, 11 and 10 meters. It is designed for crystal excitation, but may be excited by an external VFO. A pi network output circuit is employed to match antenna impedances between 50 and 1000 ohms. If you appreciate a good signal on the CW bands, this is the transmitter for you!



MODEL SG-8

\$19⁵⁰

\$1.95 DWN.,
\$1.64 MO.

Shpg. Wt. 8 lbs.

POPULAR WITH SERVICEMEN

HEATHKIT

RF SIGNAL GENERATOR KIT

Produces RF signals from 160 KC to 110 MC on fundamentals on 5 bands, and covers 110 MC to 220 MC on calibrated harmonics. Output may be pure RF, RF modulated at 400 CPS, or audio at 400 CPS. Prealigned coils eliminate the need for calibration after completion.

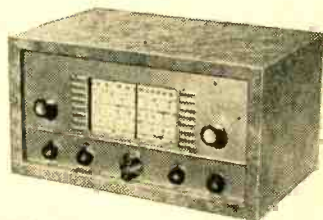

MODEL AR-3

\$30⁷⁵

HAM BANDS
CLEARLY MARKED

incl. Fed. Excise Tax
(less cabinet)
Shpg. Wt. 12 lbs.

\$3.08 DWN.,
\$2.58 MO.

HEATHKIT COMMUNICATIONS-TYPE

ALL BAND RECEIVER KIT

This receiver covers 550 KC to 30 MC in 4 bands, and is ideal for the short wave listener or beginning amateur. It provides good sensitivity and selectivity, combined with good image rejection. Amateur bands clearly marked on illuminated dial scale. Employs transformer-type power supply — electrical bandspread — antenna trimmer — separate RF and AF gain controls — noise limiter — headphone jack — and automatic gain control. Built in BFO for CW reception.

CABINET: Fabric-covered cabinet with aluminum panel as shown. Part 91-15A. Shipping wt. 5 lbs., \$4.95 incl. Fed. Ex. Tax, \$.50 dn., \$.42 mo.



MODEL GD-1B

\$19⁹⁵

\$2.00 DWN.,
\$1.68 MO.

Shpg. Wt. 4 lbs.

FULL SET OF COILS
INCLUDED WITH KIT
**HEATHKIT GRID DIP
METER KIT**

An instrument of many uses for the ham, experimenter, or serviceman. Useful in locating parasites, neutralizing, determining resonant frequencies, etc. Covers 2 MC to 250 MC with prewound coils. Use to beat against unknown frequency, or as absorption-type wavemeter.

HEATH COMPANY • BENTON HARBOR 10, MICH.

A Subsidiary of Daystrom, Incorporated

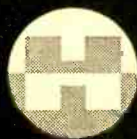

EASY TO BUILD
 ... A "LEARN-BY-DOING" EXPERIENCE
**HEATHKIT BROADCAST BAND
 RECEIVER KIT**

You need no previous experience to build this table-model radio. It covers 550 KC to 1620 KC and features good sensitivity and selectivity. A 5½" speaker is employed, along with high-gain miniature tubes and a new rod-type antenna. The power supply is transformer-operated. The kind of a set you will want to show off to your family and friends. Construction is simple. You "learn by doing" as the project moves along.

CABINET: Fabric-covered plywood cabinet as shown. Shipping Wt. 5 lbs., .50 dwn., .42 mo., part No. 91-9A. \$4.95 incl. Fed. Excise Tax.

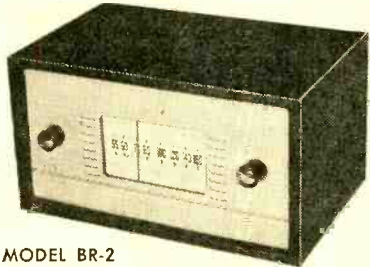

MODEL BR-2

\$1925

incl. Fed.
Excise Tax
(less cabinet)

\$1.55 DWN.,
\$1.62 MO.

Shpg. Wt. 10 lbs.

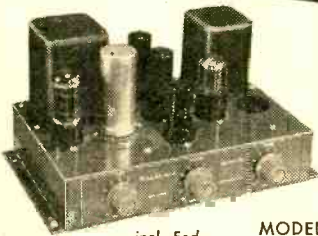

incl. Fed.
Excise Tax
\$1.87 DWN.,
\$1.57 MO.

MODEL A-7D

\$1865

Shpg. Wt. 10 lbs.

**REAL HI-FI PERFORMANCE
 AT MINIMUM COST**

**HEATHKIT 7-WATT
 AMPLIFIER KIT**

This 7-watt amplifier is more limited in power than other Heathkit models, but still qualifies for high fidelity, and its capabilities exceed those of many so called "high fidelity" phonograph amplifiers. Using a tapped-screen output transformer, the model A-7D provides a frequency response of ± 1½ DB from 20 to 20,000 CPS. Total distortion is held to surprisingly low level. The output stage is push-pull, and separate bass and treble tone controls are provided.

Model A-7E: Similar to the A-7D except that a 12SL7 tube has been added for preamplification. Features two inputs, RIAA compensation, and extra gain. \$20.35, incl. Fed. Excise Tax, \$2.04 dwn., \$1.71 mo.

MODEL CR-1

\$875

incl. Fed.
Excise Tax
Shpg. Wt. 3 lbs.

\$.88 DWN.,
\$.73 MO.



... INTERESTING PROJECT FOR ALL AGES

**HEATHKIT
 CRYSTAL RECEIVER KIT**

The crystal radio of dad's day is back again, but with big improvements! Sealed diode eliminates "cats whisker." Uses two high-Q tank circuits to tune 540 to 1600 KC. No external power required. Easy to build.

**FOR AMATEUR OR PROFESSIONAL
 PHOTOGRAPHERS**

**HEATHKIT
 ENLARGER
 TIMER KIT**

This is an easy-to-build device for use by photographers in controlling their enlarger. It covers the range of 0 to 1 minute with a continuously variable control. Handles up to 350 watts. Timing cycle controlled electronically for maximum accuracy.



MODEL ET-1

\$1150

Shpg. Wt. 3 lbs.

\$1.15 DWN.,
\$.97 MO.

HEATH COMPANY • BENTON HARBOR 10, MICH.
 A Subsidiary of Daystrom, Incorporated

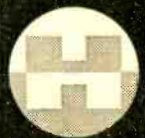

**NEW EDGE-LIGHTED
TUNING DIAL FOR
IMPROVED READABILITY**

**HEATHKIT HIGH FIDELITY
FM TUNER KIT**

This FM tuner can provide real hi-fi performance at an unbelievably low price level. Covering 88 to 108 MC, the modern circuit features a stabilized, temperature compensated oscillator, AGC, broad-banded IF circuits, and better than 10 UV sensitivity for 20 DB of quieting. A ratio detector is employed for high efficiency, and all transformers are prealigned, as is the front end tuning unit. A new feature is the edge-lighted dial for improved readability, and a new dial cord arrangement for easier tuning. Matches the models WA-P2 and BC-1. Easy to build.



MODEL FM-3A

\$26⁹⁵

*incl. Fed. Excise Tax (with cabinet)
Shpg. Wt. 7 lbs.*

**\$2.70 DWN.,
\$2.26 MO.**

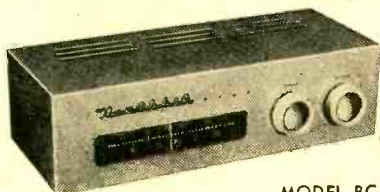

MODEL BC-1

\$26⁹⁵

*incl. Fed. Excise Tax (with cabinet)
Shpg. Wt. 8 lbs.*

**\$2.70 DWN.,
\$2.26 MO.**

**NEW EDGE-LIGHTED TUNING
DIAL. MATCHES MODEL FM-3A**

**HEATHKIT BROADBAND
AM TUNER KIT**

The BC-1 was designed especially for high fidelity applications. It features a low-distortion detector, broad band IF's, and other characteristics essential to usefulness in hi-fi. Sensitivity and selectivity are excellent, and audio response is within ± 1 DB from 20 CPS to 2 KC, with 5 DB of pre-emphasis at 10 KC to compensate for station rolloff. 6 DB signal to noise ratio at 2.5 UV. Covers 550 to 1600 KC. RF and IF coils are prealigned, and the power supply is built in. Features AVC, 2 outputs, and 2 antenna inputs. Tuning dial is edge-lighted for high readability.

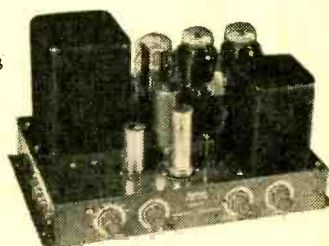

MODEL A-9B

\$35⁵⁰

Shpg. Wt. 23 lbs.

**\$3.55 DWN.,
\$2.98 MO.**

**FULL 20 WATTS FOR PA
OR HOME APPLICATIONS**

**HEATHKIT 20-WATT
AMPLIFIER KIT**

This high-fidelity amplifier features full 20-watt output using push pull 6L6 tubes. Built-in preamplifier provides 4 separate inputs, selected by a panel-mounted switch. It has separate bass and treble tone controls, each offering 15 DB boost and cut. Output transformer is tapped at 4, 8, 16, and 500 ohms. Designed primarily for home installation, but used extensively for public address applications. True high-fidelity performance with frequency response of ± 1 DB from 20 CPS to 20,000 CPS. Total harmonic distortion only 1% (at 3 DB below rated output).

HEATH COMPANY • BENTON HARBOR 10, MICH.
A Subsidiary of Daystrom, Incorporated

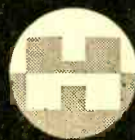

FEATURES GOOD LOOKS

AND HIGH PERFORMANCE

**HEATHKIT HIGH FIDELITY
SPEAKER SYSTEM KIT**

The model SS-1 covers 50 to 12,000 CPS within ± 5 DB, and can fulfill your present needs, and still provide for the future. It uses two Jensen speakers and has a cross-over frequency of 1600 CPS. The speaker system is rated at 25 watts, and the impedance is 16 ohms. The enclosure is a ducted-port bass reflex type and is most attractively styled. It is easy to build and can be finished in light or dark stain to suit your taste.



MODEL SS-1

\$39⁹⁵

\$4.00 DWN.,
\$3.36 MO.

Shpg. Wt. 30 lbs.

**ATTRACTIVE STYLING
MATCHES MODEL SS-1**

**HEATHKIT HIGH FIDELITY
RANGE EXTENDING
SPEAKER SYSTEM KIT**



MODEL SS-1B

\$99⁹⁵

\$10.00 DWN.,
\$8.40 MO.

Shpg. Wt. 80 lbs.

The SS-1B is designed especially for use with the model SS-1. It consists of a 15" woofer and a compression-type super tweeter to add additional frequency coverage at both ends of the spectrum. Cross-over frequencies are 600, 1600, and 4,000 CPS. Together, the two speaker systems provide output from 35 to 16,000 CPS within ± 5 DB. The kit is easy to assemble with pre-cut and pre-drilled wood parts. Power rating is 35 watts, and impedance is 16 ohms.

Free 1957 CATALOG

Our new 56-page 1957 catalog describes more than 75 different kit models for experimenters, hams, students, engineers, industrial laboratories, etc. Send for your free copy now!

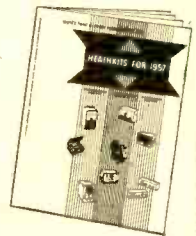

HOW TO ORDER

It's simple — just identify the kit you desire by its model number and send your order to the address listed below. Or, if you would rather budget your purchase, send for details of the Heath Time Payment Plan!

**ORDER
BLANK**

HEATH COMPANY • BENTON HARBOR 10, MICH.
A Subsidiary of Daystrom, Incorporated

Name _____
Address _____
City _____ Zone _____ State _____

SHIP VIA

- Parcel Post
- Express
- Freight
- Best Way

Quantity	Item	Model No.	Price

Enclosed find check money order for \$_____. Please ship C.O.D. postage enclosed for _____ lbs. On express orders do not include transportation charges — they will be collected by the express

agency at time of delivery. On parcel post orders include postage for weight shown. Orders from Canada and APO's must include full remittance. NOTE: All prices subject to change without notice.

POSTAGE

TOTAL

Tips

(Continued from page 34)

use. The second is that some circuits are more sensitive to tube deficiencies than others using the same tube type. Therefore, a tube which tests "bad" might be unusable in some applications but work well in others. The best test is to substitute a tube known to be good and observe results.

Assuming that a doubtful tube is not burned out and has no internal shorts between elements, it's a good idea to save it for possible use in other equipment. For example, a tube which is useless in a pre-amplifier stage due to noise might very well be usable in a later stage using the same type, since the louder signal level of the later stage may literally drown out the tube noise. Just be sure to keep doubtful tubes separate from the good ones. —E. F. C.

QUICK WIRING TO PHONE JACKS

Experimental and test work often requires quick wire connections to phone jacks. Such connections can be made easily

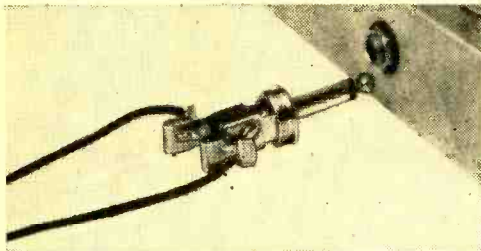

with the simple adapter shown in the photo.

Remove the outer shell of a standard phone plug, and screw-fasten or solder a medium-size Fahnestock clip to each terminal on the plug, as shown. This trick is fine for all circuits where no high degree of shielding is required, or where no high voltages are used. —A. T.

MAKING GROOVED COIL FORMS

Forms for winding coils can be made from polystyrene rod in $\frac{3}{8}$ " and $\frac{1}{2}$ " diameters. These rods may be grooved quickly and easily using ordinary dies available at reasonable prices from any hardware store. Dies of $\frac{3}{8}$ "-diameter are available in 16 and 24 threads per inch, and $\frac{1}{2}$ " dies in 13 and 20 threads per inch. Originally intended for threading steel and other metals, even the cheapest dies should last indefinitely if they are used to cut nothing harder than polystyrene. —F. H. T.

PROTECTING PHONE PLUGS

To protect phone cords—and other connecting cords—from wear due to friction and bending at the place where they enter the plugs, it's a good idea to cover the cords with sleeves made from soft rubber

or soft plastic tubing. Of course, if the cord you want to cover uses phone tips, be sure the tubing is large enough to pass the tips. If necessary, the opening in the back

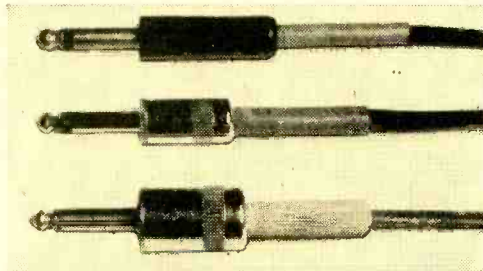

end of the plug can be enlarged a little to pass the tubing. The tubing can be anchored to the cord inside the plug by wrapping it with tape. —A. T.

IMPROVING SURPLUS SPEAKERS

Surplus speakers are sometimes supplied *without* the familiar heavy cardboard ring for their rims. This cardboard ring, while not essential for speaker operation, is desirable for proper installation, for it serves both as a spacer and as a cushion.

If you have a speaker minus its cardboard rim, here's an easily installed substitute. Pick up some narrow felt *weatherstripping* at your local hardware store. Using a good general-purpose cement, such as Pliobond, coat one side of the stripping. You'll find that the felt will soak up a certain amount of the cement. Allow the felt to dry, then apply a thin second coat of

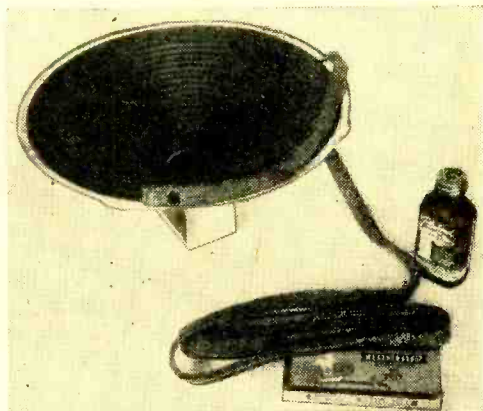

cement to the felt, and a coat to the rim of the loudspeaker. Press the felt firmly in place around the rim, using a single-ended razor blade or sharp knife to cut and fit the ends.

Finally, invert the speaker on your bench, so that its weight acts to "clamp" the felt in place. Allow the speaker to remain undisturbed for about 24 hours, permitting the cement to set firmly. —E. G. L.

Send for MusiCraft's **FREE** high fidelity catalog



Just off the press!
Jam-packed
with latest
hi-fi values!

Here's a *special* high fidelity catalog that you'll find particularly useful, because we have included *only* equipment which we at MusiCraft consider the *best*—from the standpoint of *compatibility* and stable operating efficiency—in every price range.

Page after page pictures the newest high fidelity equipment with detailed information about characteristics and specifications.

Whatever you want—whatever you need—speakers, tuners, amplifiers, turntables, “do-it-yourself” kits, etc.—MusiCraft's new catalog features all the top quality components from leading manufacturers.

Send now for your free copy of the new **MUSICRAFT HIGH FIDELITY CATALOG:**

MusiCraft

48-B East Oak Street
Chicago 11, Illinois
Delaware 7-4150

name _____

address _____

city _____ zone _____ state _____

Tools

(Continued from page 36)

desired, while ball bearing casters give it finger-tip mobility. The "TV Roll-Around" comes completely assembled; "legs" are extended to the proper distance and secured in place with the center wing nut. List price, \$7.95. (Television Hardware Mfg. Co., div. of General Cement-Textron American, 919 Taylor Ave., Rockford, Ill.)

CAPACITOR/RECTIFIER TESTER

With an applied voltage of 150 volts, approximating the working voltage of components in your set, the Capacitester, Series II, will show up open, intermittent, shorted or leaky capacitors. It will check all types of capacitors, and will also quickly indicate a faulty selenium rectifier.



Measuring 4" x 4" x 2", the unit fits easily into a tool kit. Price, \$9.95, postpaid, complete with two test leads and full instructions. (The Barjay Co., 145 West 40th St., New York, N. Y.)

DIAL COMES WITH ILLUMINATOR KIT

A new version of the MCN dial, smallest of National's dials for individual calibration, includes a dial illuminator kit as optional equipment. The illuminator is bracket-mounted to the output coupling so that the 6.3-volt #51 panel light rotates behind the scale with the pointer over the dial face.

Scaled down for use in mobile installations, small converters and tuners, the MCN dial has three blank calibrating scales and a 0-100 logging scale. Over-all measurements, with illuminator, are 3 $\frac{3}{8}$ " wide, 2 $\frac{3}{4}$ " high, and 1 $\frac{1}{4}$ " behind the dial

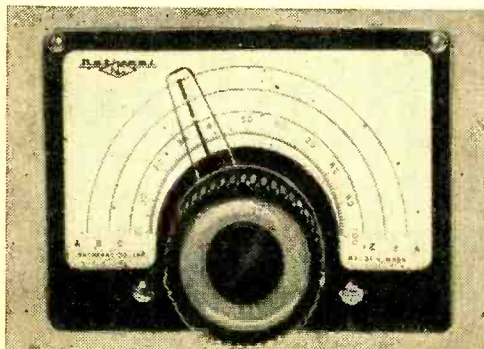

panel. (National Company, 61 Sherman St., Malden 48, Mass.)

LINE-LOAD SURVEY METER

The Model AC-12 line-load survey meter will precheck the ability of 110-volt a.c.

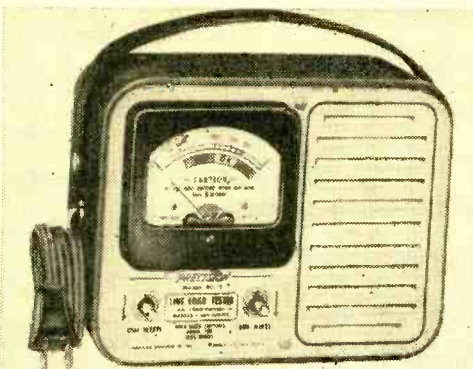

power lines to handle loads imposed by a wide range of electrical appliances, such as air conditioners, broilers, etc. It has a wide-vision meter with a scaleplate in three colors. Line-load conditions are indicated directly as "LOW," "OK," or "HIGH."

Supplied in a lightweight, ventilated blue-grey case with aluminum panel, Model AC-12 measures 5 $\frac{7}{8}$ " x 7 $\frac{3}{4}$ " x 3 $\frac{1}{2}$ " and weighs five pounds. It also reads actual line voltage. Net price, \$29.50. (Precision Apparatus Company, Inc., 70-31 84th St., Glendale 27, L. I., N. Y.)

MINIATURE DESK RACKS

The Modu-Rak line of miniature desk racks for use in modular construction of test equipment makes any part of a complex electronic system easily accessible for assembly or repair. Technicians can simply pull out and service the particular circuit they are interested in without disturbing the rest of the equipment.

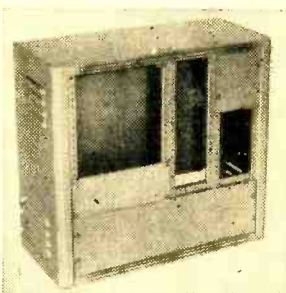

Designed for standard 19", 9 $\frac{1}{2}$ ", and 4 $\frac{3}{4}$ " rack panels, Modu-Raks are available 21 $\frac{3}{4}$ " wide by 12" deep and 12 $\frac{1}{4}$ " wide by 12" deep, in a variety of heights, with removable rear panels or doors. Panel mounting holes are tapped for 10-32 machine screws on universal spacings, and panels fit into a recess so that the edges are not exposed. (Premier Metal Products Co., 337 Manida St., New York 59, N. Y.)

-50-

You Can Train at Home for Good Pay Jobs in RADIO-TELEVISION

Fast Growing Industry Offers Good Pay, Security, Bright Future

**LESSON AND
CATALOG FREE
MAIL CARD**

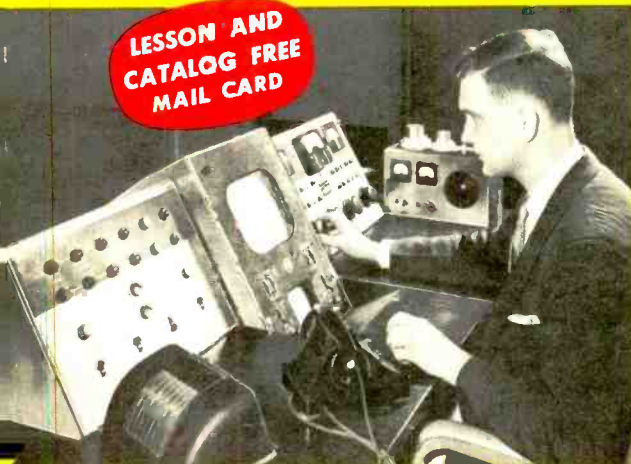

Training PLUS OPPORTUNITY is the ideal combination for success. Today's OPPORTUNITY field is Radio-Television. Over 125 million home Radios plus 30 million sets in cars and 40,000,000 Television sets mean big money, opportunity for trained Radio-Television Technicians. More than 4,000 Radio and TV Broadcasting stations offer interesting and important positions for technicians, operators. Color Television, portable TV sets, Hi-Fi, other developments assure future growth.



**J. E. SMITH
Founder**

Since 1914—for more than 40 years—N.R.I. has been training ambitious men at home in spare time for Radio-TV. Thousands of successful graduates say N.R.I.'s 50-50 training method is a fast, easy, effective way to higher earnings, desirable jobs. Planned experiments and practice bring basic principles, techniques to life right in your own home. Find out what dependable training can do for you.

Add to Your Income Starting Soon

You Learn by Doing—Get Practical Experience with Kits N.R.I. Sends



Make \$10-\$15 a Week Extra Fixing Sets in Your Spare Time

Soon after enrolling, many N.R.I. students start earning extra money fixing neighbors' radio sets. Many earn enough extra to pay entire cost of course and provide capital to start their own full time Radio-TV business after getting N.R.I. Diploma. Mail Postage Free postcard for Sample Lesson. See how practical it is to learn at home. Get 64-Page Catalog, too. See equipment you get, opportunities in this growing field. Prices of N.R.I. Courses are low, terms easy.

Nothing takes the place of practical experience. As part of N.R.I. Servicing Course you build AC-DC Radio Receiver and Vacuum Tube Voltmeter shown below. Use them to make tests, conduct experiments, get practical experience. All equipment yours to keep.

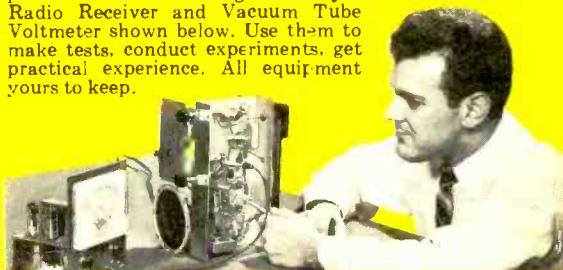

Find Out What Oldest and Largest Home Study Radio-Television School Offers You

See Other Side

CUT OUT AND MAIL CARD NOW

N.R.I. TRAINED THESE MEN



Thanks N.R.I. for Good Start
"Right now I am doing spare-time repairs on Radios and Television. Intend to go into full time servicing." C. HIGGINS, Waltham, Mass.



Engineer with Station WHPE
"I operated a successful Radio repair shop. Then I got a job with WPAQ and now I am an engineer for WHPE." VAN W. WORKMAN, High Point, N. C.



Quit Job to Start own Business
"I decided to quit my job and do TV work full time. I love my work and am doing all right financially." W. F. KLINE, Cincinnati, Ohio.



N.R.I. Course Started His Way up
"I was a cab driver earning \$35 a week. Then I enrolled with N.R.I. Now I am a tester with TV maker." J. H. SHEPHERD, Bloomington, Indiana.

**SAMPLE LESSON
AND CATALOG
BOTH FREE**

**NO STAMP NEEDED!
WE PAY POSTAGE**

This card entitles you to Actual Lesson on Servicing, shows how you learn Radio-Television at home. You'll also receive 64-Page Catalog.

**NATIONAL RADIO INSTITUTE, Dept. D4
Washington 9, D. C.**

Please mail me the FREE sample lesson and 64-Page Catalog. (No Salesman will call.)

Name _____ Age _____

Address _____

City _____ Zone _____ State _____

Approved Member, National Home Study Council

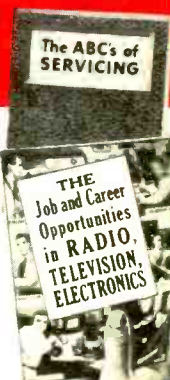

Practice Servicing-Communications with Kits of Parts N.R.I. Sends



YOU BUILD AC-DC Superhet Receiver

N.R.I. Servicing Course includes all needed parts. Get actual servicing experience practicing with this modern receiver.

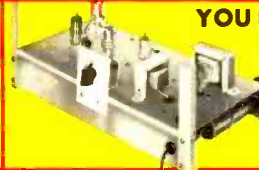

YOU BUILD Signal Generator

You build this Signal Generator. Learn how to compensate high frequency amplifiers, practice aligning typical I. F. amplifiers in receiver circuits.

YOU BUILD Broadcasting Transmitter

As part of N.R.I. Communications Course you build this low power Transmitter, learn commercial broadcasting operators' methods, procedures.

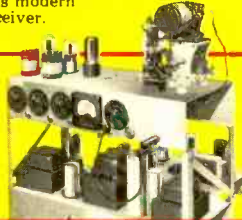

YOU BUILD Vacuum Tube Voltmeter

Use it to conduct experiments; earn extra cash fixing neighbors' sets; bring to life theory you learn from N.R.I.'s easy-to-understand texts.

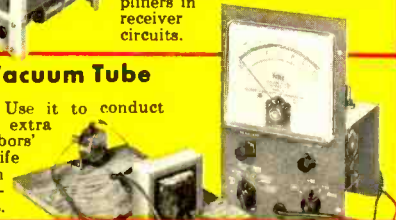

Radio-Television Can Give You a Good Job with a Future

N.R.I. Graduates do Important Work — Get Important Pay



Chief Engineer with Station

"I am Chief Engineer of Station KGCU. I have my own spare time business servicing two-way communications systems." R. BARNETT, Bismarck, N. D.



Paid for Instruments

"I am doing very well in spare time TV and Radio. Sometimes have three TV jobs waiting. Paid for instruments out of earnings." G. F. SEAMAN, New York, N. Y.



Has Own Radio-TV Business

"We have an appliance store with our Radio and TV servicing. During my Army service, N.R.I. training helped me." W. M. WEIDNER, Fairfax, S. D.

Here is a line of work that people respect—a vocation where you can advance, win a place for yourself, earn good pay and gain much personal satisfaction. And you can learn at home in your spare time. Smart fellows everywhere are using their spare time to develop new knowledge, new skills. They know it is the trained man who gets ahead, gets the better job, drives the better car. is respected for what he knows and can do.

Be a Skilled Technician

The technical man is looked up to. He should be. He does important work, gets good pay for it. Radio-Television offers that kind of work. There are more than 40 million Televisions, 150 million home and auto Radios. Millions more are sold each year. There are splendid opportunities for the man well trained in Radio-Television Servicing or Broadcasting. Micro-Wave Relay, Aviation and Police Radio, Two-Way Communications for buses, taxis, trucks, etc. are expanding—making more jobs, greater opportunity.

Tested Way To Better Pay

N.R.I. Training is practical, thorough. You get the benefit of N.R.I.'s 40 years experience training men for success in Radio-Television. N.R.I. training is backed by the record and reputation of the OLDEST and LARGEST home study Radio-TV school. Most

successful N.R.I. men start without any knowledge of Radio, many without a high school education. Find out what Radio-Television training can mean to you. Make a decisive move today toward becoming one of that select group—a Radio-TV Technician. Send for Actual Lesson and 64-Page Catalog, both FREE. NATIONAL RADIO INSTITUTE, Dept. D4, Washington, D.C.

See Other Side

FIRST CLASS

Permit No. 20-R
(Sec. 34.9, P. L. & R.)
Washington, D. C.

BUSINESS REPLY CARD

No Postage Stamp Necessary If Mailed In The United States

POSTAGE WILL BE PAID BY

NATIONAL RADIO INSTITUTE

16th and U Sts., N. W.

Washington 9, D. C.

**SAMPLE LESSON
and CATALOG
Both FREE**

**Cut out and mail
Postage Free Card**

40¢ FOR ANY TUBE

we will not
BE UNDERSOLD!
\$37⁰⁰ PER HUNDRED

DON'T PAY MORE FOR SET TESTED LONG LIFE DEPENDABLE RADIO & TV TUBES • BUY VIDEO • INDIVIDUALLY BOXED—ALL GUARANTEED FOR ONE YEAR OR YOUR MONEY BACK WITHIN 5 DAYS—37.00 Per Hundred



We Have OVER 1000 USED TV SETS

At All Times in Our Huge Warehouse. Buy one or more of these WORKING TV's to sell or use as your own second set! All sets in GOOD WORKING condition! Your Choice—Console or Table Model.

10"	\$23.00	19"	\$58.00
12"	\$28.00	20"	\$64.00
14"	\$33.00	21"	\$72.00
16"	\$40.00	24"	\$99.00
17"	\$46.00		

When ordering TV's, state whether table model or console is desired. Also preference on make of set. All TV's sent railway express F.O.B. Newark. On any quantity WIRE or CALL today!

Some Standard Brand—Others With Famous VIDEO Brand

0A2	3BC5	6AQ7GT	6H6GT	6Y6G	12SJ7GT
0A3	3CB6	6AS5	6J4	7A5	12SK7
0A4	3Q4	6A57G	6J5GT	7A7	12SN7GT
0B2	3Q5GT	6AT6	6J6	7B5	12SQ7
0C3	3S4	6AU4GT	6K6GT	7B7	12V6GT
0Z4	3V4	6AUSGT	6L6	7C5	12X4
1A7GT	4B27	6AU6	6N7GT	7C6	14A7
1B3GT	4B97	6BV5GT	6S4	7C7	14B6
1C7G	5AM8	6AV6	6S7G	7F7	14Q7
1F4	5AN8	6AX4GT	6SA7	7F8	19BG6G
1H4	5AQ5	6BA6	6SB7Y	7N7	19T8
1H5GT	5AT8	6AX5GT	6SC7	7Q7	24A
1J6GT	5AW4	6BC5	6SF5	7Y4	25AV5GT
1L4	5AZ4	6BC7	6SF7	7Z4	25BQ6GT
1L6	5J6	6BE6	6SG7	12A6	25CD6G
1LA6	5T4	6BF5	6SH7	12AH7GT	25CU6
1LC5	5T8	6BG6G	6SJ7GT	12AT6	25L6GT
1LH4	5U4G	6BH6	6SK7GT	12AT7	25W4GT
1LNS	5U8	6BJ6	6SL7GT	12AU6	25Z6GT
1NSGT	5V4G	6BK5	6SN7GT	12AU7	35L6GT
1S4	5V6GT	6BK7	6SQ7	12AV6	35W4
1S5	5Y3	6BN6	6SS7	12AV7	35Y4
1T4	5Y4G	6BL7GT	6SV7	12AX4GT	35Z3
1U4	6AB4	6BQ6GT	6T8	12AX7	35Z5GT
1U5	6AC7	6BQ7	6U4GT	12AZ7	50A5
1V2	6AG5	6BY5G	6U7G	12B4	50B5
1X2	6AF4	6BZ7	6U8	12BA6	50CS
2A7	6AH4GT	6C4	6V3	12BE6	50L6GT
2D21	6AK5	6CB6	6V6GT	12BH7	80
2X2	6AL5	6CD6G	6W4GT	12BY7	117N7GT
3A4	6AM8	6CF6	6W6GT	12CU6	117P7GT
3A5	6AN4	6CS6	6X4	12SA7	117Z3
3AL5	6N8	6CU6GT	6X5GT	12SG7	
3AU6	6AQ5	6E5	6X8	12SH7	

FREE BONUS ANTENNA GIVEN WITH ANY TV SET ORDER!

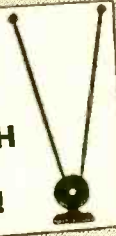

FREE RCA "CHEATER" CORD GIVEN WITH ANY TUBE ORDER OF \$7.00 OR MORE!

SEND for our FREE complete TUBE & PARTS LIST and order blank.

SAME DAY SHIPMENT OF ALL ORDERS!

FREE POSTAGE in U.S.A. and Territories on orders over \$5.00. 25¢ handling charge on orders under \$5.00. 25% deposit required on C.O.D.'s. Please send approximate postage or freight on Canadian and foreign orders. Subject to prior sale.

VIDEO ELECTRIC COMPANY

79 CLINTON PL. NEWARK, N. J. Phone Humboldt 4.9848

TV—Over Hill and Into Dale

(Continued from page 40)

(117 volts a.c., 420 watts) brought in from the nearest source. For each channel desired, a separate Translator unit and individual pairs of receiving and transmitting antennas are needed; however, they may be housed in the same shelter and their antennas mounted on the same supporting structure with no interference problems. Units may also be cascaded, one station relaying to another in sequence to cover distance and terrain problems beyond single-installation capacity.

Anyone holding a commercial radio operator's license of any grade may be in charge of a Translator station, supervising it from a remote control point. Although most of its operation is performed automatically by impulses from the primary transmitter, the operator exercises emergency control whenever necessary. Permits for station operation are obtained through standard FCC application procedure.

The Translator may not be used to originate "commercials" or any program material. Its own identification is transmitted at regular intervals by automatic keyer equipment. Primary TV station owners

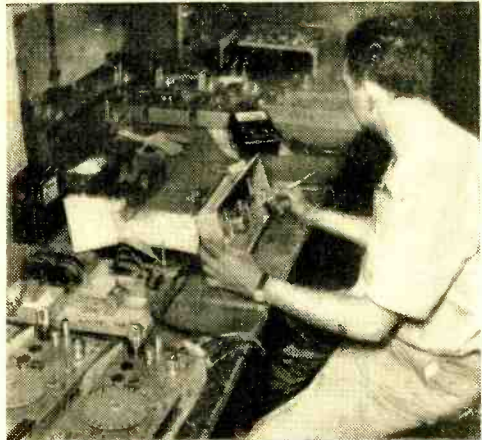

Coded identification signals are sent automatically at regular intervals by the chassis shown above. Translator originates no other signals.

may acquire Translator stations for supplementary service to fill voids in field patterns and thus reach previously inaccessible TV viewing audiences.

It is these new audiences, "fringe" and "shadow," for whom the Translator was developed. These people are now able to enjoy their TV receivers with programs that boast enough power, consistent clarity, and the government's "O.K." —30—

Make Your Own Dynamic Mike

(Continued from page 82)

The simple "on-off" push-button switch *S1* is made up from a short machine screw, a small compression spring, a hex nut, and a piece of flexible hookup wire, arranged so that the nut presses against one battery

terminal when the screw is depressed. A permanent connection may be made by turning the screw in until it presses tightly against the battery.

Installation and Use. The dynamic microphone is used just like any other microphone equipped with a "push-to-talk" switch. Connect a shielded cable from *J1* to the input jack of the amplifier, recorder or transmitter with which the instrument is to be used. To use the mike, simply depress *S1* and speak in a normal voice, holding the instrument a few inches from your mouth.

There is no d.c. isolation in the output circuit of the dynamic microphone—note that the transistor's collector electrode connects directly to the "hot" terminal of jack *J1*. Isolation is not needed in the microphone if it is used with equipment having a "blocking" capacitor in the input circuit.* —LUIS VICENS

HOW IT WORKS

The *p-n-p* junction transistor does two important jobs. It acts as an impedance matching device, matching the low output impedance of the loudspeaker to the high input impedance of the equipment with which the mike is used. It also serves as a preamplifier, increasing the level of the audio signal until it approaches the output level of a carbon microphone.

The transistor is connected in the common-base circuit configuration. A common-base amplifier has a low input impedance and a moderately high output impedance. Since the loudspeaker has a 10-ohm impedance, a good match to the amplifier is obtained. Base bias for the stage is supplied through resistor *R1*, bypassed by electrolytic capacitor *C1*. Resistor *R2* serves as the output load impedance. Power is supplied by a single battery, *B1*.

In operation, the loudspeaker converts sound into electrical signals. This audio signal is applied to the emitter-base circuit of the transistor. The transistor stage amplifies the signal and provides a step-up in impedances, with the amplified signal appearing across collector load resistor *R2*. A shielded single-conductor lead, connected to *J1*, conducts the output signal to the equipment with which the microphone is used.

*If there is a chance that the mike will be used with equipment having no d.c. isolation, a blocking capacitor should be added to the microphone's output circuit. Simply connect a moderate-sized capacitor (0.1 to 1.0 μ fd.) between the transistor's collector and the "hot" terminal of *J1*. The capacitor's voltage rating is not too important—a 50 to 100 volt (or higher) unit will be ample.

50 BIGGEST \$1 BUYS IN U.S.!

FREE! ANY \$1 ITEM IN THIS AD FREE WITH ANY \$10 ORDER! **SPECTACULAR VALUES IN THIS MOVING SALE GOOD ONLY 'TIL FEB. 1!**

WORLD FAMOUS **KIT KING** DOLLAR BUYS!

- 13 40 SUBMINIATURE RESISTORS in poly box 1/2" long! 20 values, 15 ohms to 10 megs; 1 1/2 W. Reg. \$1
- 14 2 TRANSISTOR LOG-ON STICKS, tapped. Match transistors. HI-Q ferrite aid, core, superior selectivity, broadcast band. Reg. \$1.25 ea.
- 15 25 PORCELAIN CONDENSERS, tubular, 10 values: .001 to .03mf to 1000WV. Reg. 1/2 lb. Reg. 25¢ each
- 16 10 PANEL SWITCHES. 11.5 VAC. micro, push, power types, w/ON-OFF switch. plates. Wt. 2 lbs. Reg. \$8.50
- 17 3 OUTPUT XFMRs. (Choose any three) 500VA, 351.6, 501.6, 6V6; to 3-4 ohms. Reg. \$1.50 each
- 18 R/C SCOOP! Chassis w/hl. xfmr., 115VAC to 6.3 @ 1.5A; 3000 ohm relay; resistors, condensers, sockets. Wt. 2 lbs. Reg. \$8
- 19 150 COIL FORMS, 15 types, asstd. sizes, insulation. Reg. \$13
- 20 40 OIL CONDENSERS. Bath-tub, tubular, rect. .005 to 1mf up to 600V. Wt. 3 lbs. Reg. \$15
- 21 15-PC. TWIST DRILL SET. 1/16 thru 1/4" by 64ths; in graduated plastic holders. Reg. \$4
- 22 SUN BATTERY & photo-cell. 1 1/2" dia. Better than \$1 famed B2M1. Reg. \$2.95
- 23 10 "POLY" BOXES. Asstd. sizes, clear plastic hinged boxes w/snap locks. Reg. \$1
- 24 70 TERMINAL STRIPS and boards, 15 types; 1 to 20 screw & solder pts. Wt. 1 lb. Reg. \$5
- 25 15 VOLUME CONTROLS. Asstd. values to 1 meg. Duals w/switch, too. Wt. 1 lb. Reg. \$0
- 26 60 TUBULAR CONDENSERS. 30 types, .0005 to 0.5mf to 1500V. Wt. 2 lbs. Reg. \$1
- 27 30 POWER RESISTORS. WW, condom, sandcoated, vitreous. 15 values: 5 to 50W; 35 to 11000 ohms. Wt. 2 lbs. Reg. \$8
- 28 3 HEAVY DUTY CHOKES. 200 mhs, 3H. Strap \$1 ntd. Reg. \$2.50 ea.
- 29 15 ROTARY SWITCHES. A.W. et. ceramic, bakelite units incl. multiple gangs. Wt. 3 lbs. Reg. \$14
- 30 40 MOLDED CONDENSERS, V. Brown, black ceramic cased. Wt. 1 lb. Reg. \$8
- 31 8-PC NUTDRIVER KIT. Plastic handle, 3/16, 7/32, 1/4, 5/16, 11/32, 3/8, 7/16" steel socket wrenches in plastic case. Wt. 1 lb. \$3
- 32 10 ELECTROLYTICS, FP & twist, tubular, rect. Asstd. sizes, 8 to 500mf to 450V. Wt. 3 lbs. Reg. \$15
- 33 3 LBS. HARDWARE, 2000 pcs. asstd. screws, springs, washers, etc. Reg. \$8
- 34 70 RESISTORS, insulated IRC, A-B, etc. 5 ohms to 10 megs, 1/2, 1 & 2 W; 1% & 5% tol. Wt. 1/2 lb. Reg. \$10.95
- 35 G-E PREAMP KIT for magnetic cartridges. Chassis, parts, diagram. Less \$507 (88¢ extra). Wt. 1 lb. Reg. \$4.50
- 36 15 ERIE TRIMMERS, 8-50mmf. Reg. 85¢ each
- 37 70 STANDARD KNOBS. Asstd. colors, bakelite & steel. Wt. 2 lbs. Reg. \$9
- 38 30 PRECISION RESISTORS. Wax & carbon; 30 values, 56 ohms to 1 meg; 1/4, 1 & 2W. 1% to 1. Wt. 1/2 lb. Reg. \$21
- 39 175-ft. HOOKUP WIRE in 25-ft. rolls. Asstd. colors, strapping, insulation. #18 to 24. Wt. 2 lbs. Reg. \$3.75
- 40 70 MICA CONDENSERS, 30 values: 0.001 to .01mf to 1000V. Silver, 5% tol. Wt. 1 lb. Reg. \$5
- 41 SUBMINIATURE MIKE, crystal 1/2" sq. Crisp, clear response to 8,000 cps. Plastic case. Reg. \$3
- 42 BENCH VISE, heavy steel w/ clamp type base. 1 1/2" jaws. Reg. \$2.50
- 43 40 PLUGS & RECEPTACLES. Wide variety, including fuse posts. Wt. 3 lbs. Reg. \$7.50
- 44 FOUR G-E IN69 DIODES. Germanium, superior to commercial. In poly bag. Reg. \$3
- 45 5 SILICON DIODES. IN21, two IN22, IN23, IN-105. Reg. \$15
- 46 125 RESISTOR SCOOP! Carbon, 1/2 to 2W, 40 values; 5 Ohms to 10 megs. 5% tol. Reg. \$15
- 47 25 SUBMINIATURE PARTS. Asst. printed circuits, condensers. Reg. \$18
- 48 FIVE ROLLS TAPE—electrical, plastic, friction, rubber; for home, shop, lab. Reg. \$2.50
- 49 30 POPULAR BULBS, 1.1 to 6V, screw & bayonet types, miniature. Wt. 1/2 lb. Reg. \$2.40
- 50 100 RADIO PARTS! Wide variety resistors, condensers, pots, plugs, strips, plugs, forms & more! Reg. \$10
- 51 THREE TRANSISTORS—Scoop! 3 CBS printed circuit transistors, plug-in type. Reg. \$5
- 52 30 DISCS, standoff, button ceramic condensers. Wide variety: 5mmf to .01mf. Reg. \$7
- 53 5-PC. JEWELER'S SCREW-DRIVER SET for miniature work. All different in plastic case. Reg. \$2.50
- 54 25 TUBE SOCKETS, 4 to 11-prong, miniature, sub-miniature, octals, zip-ins. Tube shield, tool. Wt. 2 lbs. Reg. \$8.50
- 55 100 CERAMIC CONDENSERS! U.S.A. first! Asstd. types, tool Reg. \$1
- 56 Eliminate transf. & r/c coupled amp. stages. 100K typ., 5000 DC ohms; ctr. tapped. 3/8" x 1/8". Reg. \$3
- 57 2 SUB-MINI I.F. XFMRs. World's smallest—1/2" x 7/16". Double-ended hi-Q ferrite lined core. 5 terms, enclosed. Reg. \$1.50 ea.
- 58 15 AC/DC LINE CORDS for clocks, motors, etc. 2 cond. w/molded plugs. Wt. 1 lb. Reg. \$3.75
- 59 7 PILOT LITES. Std. mtr. Amber jewel, enclosed. Miniature bayonet. Reg. \$1
- 60 8-PC. MAGNETIZED screw-driver set. Ideal for working in inaccessible places. Drivers hold screws in position. \$3.50 value.
- 61 4 CRYSTAL DIODES. Most used IN34, IN56, IN58, IN69 in poly bag. Reg. \$5
- 62 10 TRANSISTOR SOCKETS, for sub-mini tubes, too. Mica filled. Reg. \$3.

KIT KING TRANSISTOR HOBBY-CRAFT EXCLUSIVES

<p>88 CRYSTAL HEARING AID PHONE Phone tipped, w/3 ft. plastic cord. . . . Only \$1.49</p>	<p>90 MINIATURE VARIABLE Only 1 1/2" sq. x 1 1/2" w/1" long shaft. 10-385 mmf. Ideal for transistor radios. 69c</p>	<p>92 FULLY WIRED TRANSISTOR POCKET OSCILLATOR Smallest self-powered unit in the world. Only 2 3/8" x 1 1/2" x 1". Loud clear tone for signal tracing, code practice. Less phones. \$2.88</p>	<p>94 TRANSISTOR RADIO SPEAKER Smallest in the world. 1 1/2" sq. Heavy pm magnet. 3.2 VC. Sturdy construction. ONLY \$1.99</p>
<p>89 SUPER-POWER DYNAMIC HEARD-AID PHONE 8,000 ohms Imp. Makes weak signals loud. HI-FI quality for every transistor radio. \$3.99</p>	<p>91 TRANSISTOR "ADD-A-STAGE" Transistorize crystal sets easily. . . . add an amp. stage. Pre drilled case, parts, instructions. ONLY \$2.50</p>	<p>93 TRANSISTOR XFMR. SCOOP! LOWEST PRICE IN U.S.A. Silicon Pk. 20,000 ohms; sec.; 1000 ohms. Only 23/32 x 1/2". Reg. \$4.50! \$1.77</p>	<p>95 TRANSISTOR SCOOP! ONLY \$1 EACH</p>

FOUR SUB-MINI RECTIFIERS
96 Designed for printed & transistor circuits. 1/2-wave. 1 x 3/4", w/ leads. Reg. \$8. 4 for \$1

AMAZING TRANSISTOR BUY!
97 Hermetically sealed PNP. (Unable to name mfr.) Satisfaction guaranteed! Only \$1

MINI-METER BUY!
98 Only 1 3/4" round. Amps. AC. For model railroads, power supplies, mobile. Reg. \$3. Only \$1

3-TUBE POCKET SUPERHET RADIO (NOT A KIT)
1 Completely wired—Ready to play! Loud, sensitive, selective signals. Built-in hi-Q ferrite antenna. NO EXTERNAL ANTENNA OR GROUND NEEDED! Volume and tuning dials, with hearing-aid phone. Priced \$20 elsewhere! Rugged, w/ big set performance. Ship, wt. 1 lb.
2 Batteries, \$2.00 extra.

ONLY \$12.99

Write Today FOR FREE NEW GIANT '57 FLYER!

NOTE OUR NEW ADDRESS WHEN ORDERING ELECTRONICS PARTS KITS

LEKTRON SPECIALTIES

131-133 EVERETT AVENUE CHELSEA 50, MASS.

HOW TO ORDER

Order by circled numbers. Send check or MO, including sufficient postage—excess returned. C.O.D. orders 25% down. Rated, net 30 days. PE-1

Making Noise Is Their Job

(Continued from page 43)

purpose. Present conventional speakers are only about 2% efficient in converting electric power to sound energy (electrostatic speakers are even less efficient). Loudspeakers are preferred for testing electronic gear because the exact noise spectrum of the engine can be duplicated by means of tape recordings.

Testing Effects. Metal parts are usually tested by single-frequency noise. The frequency of the source is varied within the frequency spectrum of the jet engine until the resonant point of the wing or tail surface is found. Then the sound source is turned on full blast until weakening or damage is noted. Damage is observed visually through a glass window or by a closed-circuit TV system.

Loudspeaker sources are also used to test the effects of noise on pilots and intercom equipment. The Navy has been operating a noise chamber at Pensacola, Fla., for some years in an attempt to uncover the psychological effect of noise on crew members.

At Wright Field, in Ohio, a new two-and-one-half-million dollar noise lab is under construction for the Air Force's Aeromedical Laboratory. Although primarily for

tests on humans, it will be used for testing equipment and components as well. Indiana University is also carrying on a program of testing humans in noise environments.

At RCA's new guided missile factory in Moorestown, N. J., a big noise room is used to test new microphones and other intercom equipment against a background of simulated plane noise. A group of men use the microphones and earphones to see if they can understand one another against a deafening racket of 120 db. Newly developed microphones operate nearly as well in this noise as your home telephone does in a quiet bedroom. There is a similar room at RCA's Camden plant.

The Way They Work. Technicians operating sound chambers will generally work under one engineer but with a number of different design engineers as each brings his latest brainchild for testing. The noise measuring gear must be in a nearby sound-proofed instrumentation room because you can't stay in the same room with the sound source running at full power—it can instantly deafen and possibly kill the operator.

None of the schools train men to operate sound chambers because it is still such a new field. But a good audio background is a real help. Big amplifiers are needed to

**GIGANTIC
SAVE-TO-70%**

MAIL SALE

**WAR SURPLUS
EXCESS INVENTORY
BANKRUPT STOCK**

GEAR-HEAD MOTOR

• Brand new. Will operate air dampers, valves, remote boat steering, window and door locks, garage doors. Remote tuning, rotate antenna arrays, etc.
• 9000 rpm all ball-bearing motor driving a worm gear, rotary double shaft. Very powerful due to high (1000 to 1) reduction ratio. Output speed is 6-10 rpm. Will operate on 6 to 24 volts DC or 8 to 12 volts AC. Fully reversible.
• Has limit switches to control travel limit. Splined double shaft 3/4" dia. Overall dimensions 9"x5"x4". Marvellous equipment buy. Govt. cost over \$100.
SALE \$8.72 Ppd.



INVALID CHAIR—BOYS AUTO MOTOR

• Marvellous ball bearing battery (6 or 12 v) electric rear reduction motor. Makes wonderful amazing electric drive for boys auto, invalids chair, etc. Also useful for factory electric lifts-trucks, etc.
• Gear ratio 40 to 1. Hi-torque. Finest precision gears. Fully reversible. Buy of the year. Est. Govt. Cost over \$150 Sale, \$14.99 F.O.B.



BOAT & TRUCK ELECTRIC WINCH

Operates from 6 or 12-v battery over 1000-lb. capacity
• Powerful expensive fully reversible Govt. ball bearing motor with built-in 100-to-1 ratio precision reduction gear. Gives smooth powerful pull on winch cable.
• Hundreds of applications. Mount on boat trailers, boat docks, raising anchors, etc.
• Ideal for trucks, farm equipment trailers, industrial uses. Cuts labor loading boats 90%.
Wt. 54 lbs. 17"x12"x8". Drum holds 40' 1/4" or 75' 3/16" cable. Orig. Govt. Cost over \$200.
F.O.B. Lincoln \$46.71



SURPLUS CENTER BUYS (Prepaid)

- 6-Volt Electric Winch (\$250) \$48.71
- Power Plants (110-v 60-c 1000-w) 149.50
- Weston 0-100 Amp DC Meter 5.71
- G.E. 0-300 Amp DC Meter 6.89
- Triplett 0-15 Amp DC meter 3.91
- Triplett 0-50 Volt DC Meter 3.96
- Simpson 0-120 M.A. RP Meter 6.91
- Westinghouse 0-35 M.A. DC Meter 3.91
- Edwards AC-DC Bell (\$3.75)79
- Laboratory Sensitive Relay (\$11.50) 2.37
- Relay Spring Adjusters (\$2.50)97
- Relay Gram Gauge (\$7.50) 2.91
- Machinists Calipers 2.94
- 110-v to 20-c Telering (\$7.0) 9.91
- Federal Dual Amplifier-Repeater 19.76

PERSONNEL CARRIER MOTOR



• Amazing buy! Use for golf cars, factory personnel carriers, boys auto, and 100s other uses.
• Powerful expensive ball-bearing gear reduction motor runs on any 6-v or 12-v storage battery. Powerful high torque. Shaft speed 150-300 rpm. Full instr. Easily reversible. Wt. 34 lbs. Gov't. cost over \$200 Sale \$19.46 F.O.B.

DIAL TELEPHONE

• Genuine standard make dial telephone. Will work on any modern system as extension phone. Similar to picture.
• Completely self-contained transmission circuit, harmonic bell. Easy to connect. Complete with cord. List \$30.50 SALE, \$13.21 Ppd.



AIR CORPS DYNAMOTOR

• Delivers 500 and 1000 volts at 200 m.a. from 12-volt battery. Ideal ham power mobile supply. Govt. cost \$100. SALE \$12.95 Ppd.

SPECIAL OF THE MONTH GEAR REDUCTION AC-DC MOTOR

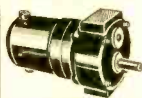

• Expensive geared down ball bearing motor. Gear ratio 54 to 1. Output speed 200 rpm but can be reduced by rheostat to any speed down to 10 rpm. Very hi-torque. Fully reversible. Will run on DC 6 to 24 volts, or on 115-v AC. Dozens uses industry, experimental, window displays, etc. Marvellous unit. Est. Cost \$35 Special \$4.97 Ppd.

Automatic Remote Control Switch



• Amazing dial telephone switch. Complete with dial. Dial up any number from 1 to 99.
• Fine for remote control, private phone system, amazing demonstration, experimental, etc. Used but good. Instructions furnished. Cost over \$100. Sale \$13.71 Ppd.

LARGE AC SELSYNS



• Finest large 110-v 60-c powerful Selsyns. Marvellous for experimental use. Make wonderful wind direction weather units. Transmit mechanical motion electrically. Run on small AC generators, etc. Many uses. Size 4"x8". Wt. 8 lbs. each. Runs directly off 110-v 60-c Govt. cost \$79.50 each SALE, \$15.41 per pair Ppd. or \$8.00 each

ORDER FROM AD or write for big new WINTER CATALOG 1000s of items! Motors, sporting goods, hand-electric tools, watches, etc. We pay freight except where stated "F.O.B."

"Nationally known—World famous"

SURPLUS CENTER

843 "O" St., LINCOLN, NEBRASKA

STANLEY ELECTRONICS

joins the
tube crushing program

In line with its policy of providing service and quality to its customers, Stanley Electronics of Passaic, N. J. has entered into an agreement with a crusher to crush and destroy any and all old or obsolete tubes to take them off the market.

For the first time: You can send all your old tubes to one location, Metallic Enterprises, Inc., 113 Mill St., Paterson, N. J. and receive credit dollars for them.

Our crusher will take them all and allow you a 5¢ credit toward each tube you buy.

Broken Tubes — Smashed Tubes —
Tubes of any condition
are worth

5¢
ea.

Pull them out of your attic. Dig them out of your garden. Crush them before shipping if you want to. Regardless of the shape its in, any tube is worth money. Any quantity — 1 to a million.

HERE'S HOW IT WORKS . . .

Suppose you send in 100 old, broken or smashed tubes. You will receive 5¢ credit for each tube to be applied toward the purchase of 100 new tubes of any type you want. If your order is for less than the number you have shipped to the crusher, you will receive a credit for the balance to be used against any future purchases. Pack and ship your tubes as scrap material post or freight prepaid to Metallic Enterprises, Inc., 113 Mill St., Paterson, N. J. with a packing slip listing the quantity of tubes shipped for credit. Send Stanley a duplicate of that slip with your order so that proper credit can be given. — **DO NOT SEND ANY TUBES TO STANLEY.**

STANLEY 935 MAIN AVE.
PASSAIC, N. J.
ELECTRONICS CORP Gregory 1-2498

Your order will include one or more of these famous brands

UNCONDITIONALLY GUARANTEED FOR ONE YEAR

Individually boxed—R.F.T.M.A. SPECS.

WRITE FOR NEW FREE-TUBE and PARTS LIST!

OZ4	.43	6AV6	.39	784	.44
1A7GT	.43	6AX4	.67	785	.41
1AX2	.79	6AX5GT	.57	786	.42
1B3GT	.68	6BA6	.47	787	.43
1B4P	.35	6BA7	.49	788	.47
1C5GT	.41	6BC5	.50	7C4	.39
1D5GP	.43	6BD5GT	.53	7C5	.42
1E7GT	.41	6BE6	.46	7C6	.43
1G6GT	.41	6BF5	.40	7C7	.45
1M5GT	.47	6BG6G	1.18	7E5	.23
1LA4	.57	6BH6	.51	7E6	.30
1LA6	.47	6BJ6	.47	7E7	.49
1LB4	.59	6BK5	.68	7F7	.59
1LC5	.49	6BK7A	.76	7F8	.70
1LN5	.47	6BL7GT	.75	7G7	.75
1N5GT	.50	6BN6	.58	7H7	.50
1R4	.66	6BQ6GT	.80	7H7	.50
1R5	.51	6BQ7A	.80	7K7	.75
1S4	.59	6BY5G	.58	7L7	.58
1S5	.51	6BZ7	.37	7Q7	.59
1T4	.51	6C4	.64	7T7	.50
1T5GT	.58	6C5GT	.35	7Y4	.35
1U4	.47	6CF6	.80	7Z4	.40
1U5	.50	6C6	.39	12A7G	.41
1U6	.53	6C8B	.51	12A7T	.66
1X2A	.68	6CL6	.71	12A7U	.41
2A3	.50	6CD6G	1.18	12A7V	.59
2A4	.51	6C56	.51	12A7W	.42
3AL5	.57	6D6	.48	12A7X	.67
3AU6	.57	6E5	.44	12A7Y	.63
3AV6	.57	6F3GT	.37	12A7Z	.90
3BA6	.60	6H6GT	.38	12BA6	.46
3BE6	.67	6J5	.49	12BA7	.60
3C5GT	.57	6J7	.43	12B8A	.68
3J4	.47	6J7	.43	12B8B	.46
3V4	.58	6J7GT	.45	12B8T	.60
5A05	.60	6J8G	.43	12B9T	.64
5AT8	.80	6K5GT	.47	12J5GT	.40
5JG	.60	6G6GT	.39	12K8	.49
5T4	.69	6K7	.39	12S47	.47
5UR	.80	6K7GT	.39	12S47GT	.48
5U4G	.49	6K9G	.65	12S7GT	.45
5V4G	.58	6K9GT	.65	12S7T	.47
5X4G	.44	6L6G	.68	12S7GT	.45
5Y3C	.39	6S4	.43	12S7K7	.48
5Y3GT	.39	6S4T	.48	12S7GT	.50
5Y4G	.43	6S7	.48	12S7GT	.60
5Z3	.45	6SD7GT	.57	12S7GT	.57
5Z4	.54	6S7	.41	12S7GT	.40
6A7	.57	6S7GT	.43	14A7	.45
6A8A	.45	6S7	.43	18B6G	1.18
6A8B	.80	6S7	.50	19T8	.70
6AC5GT	.59	6S7GT	.57	23R0GT	.85
6AC7	.67	6S7GT	.57	25L6GT	.47
6AF4	.79	6S7	.41	25L6GT	.37
6AG5	.50	6S7	.42	35A5	.46
6AG7	.69	6S7	.41	35B3	.48
6AH4	.80	6T7G	.63	35C5	.48
6AH6	.70	6T8	.68	35L6GT	.47
6AK5	.54	6U8	.80	35W4	.37
6AL6	.42	6V6GT	.46	35Y4	.40
6AL7GT	.70	6W4GT	.40	35Z3	.41
6AQ5	.46	6W6GT	.53	35Z5GT	.40
6AQ6	.42	6X4	.39	45L5GT	.40
6AQ7GT	.70	6X5GT	.39	50A5	.48
6AW8	.80	6X8	.75	50D5	.48
6AN8	.80	6Y6G	.60	50E5	.48
6AS5	.48	7A4-XXL	.47	50LGT	.45
6AT6	.39	7A5	.53	70L3GT	.45
6AU4	.85	7A6	.45	70L7GT	.60
6AU5GT	.60	7A7	.45	11Z3	.37
6AU6	.43	7A8	.45	11Z8GT	.62

Brand New DUMONT AND RCA lic.

TV PICTURE TUBES

One year Guarantee—in factory sealed carton—

No dud required

10 inch	\$10.95	17 inch	\$17.95
12 inch	\$12.95	19 inch	\$20.95
14 inch	\$14.95	20 inch	\$20.95
16 inch	\$16.95	21 inch	\$22.95

Add \$4.00 to above prices for aluminized tubes

TERMS: FREE POSTAGE on all prepaid continental U.S.A. orders on receiving tubes only. 50¢ handling charge on all orders under \$5. 2 1/2% deposit on all COD's. Picture tubes F.O.B. Passaic, N. J. via Railway Express.

10¢

BRINGS YOU "BUYERS' GUIDE TO THE LIGHT CARS"

Originally published in **SPORTS CARS ILLUSTRATED**, this exhaustive 14-page special survey covers everything from the Italian Alfa to the Swedish Volvo.

In preparing this report, SCI's experts personally inspected and drove just about every light car on the market.

It's yours for only 10¢. Send for your copy of the **BUYERS' GUIDE TO THE LIGHT CARS** today.

SPORTS CARS ILLUSTRATED,
Dept. 1016, PE-17
366 Madison Ave., New York 17, N.Y.

Here's my 10¢. Please send me a copy of "BUYERS' GUIDE TO THE LIGHT CARS."

Name _____

Address _____

City _____ Zone _____ State _____

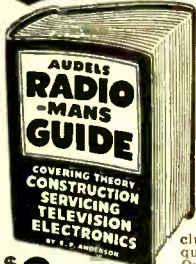

TV TELLS HOW TO ANSWER RADIO RADIO T.V. QUESTIONS SERVICE LIBRARY

HERE IS LATE INFORMATION IN A HANDY FORM FOR RADIO AND TELEVISION REPAIRMEN, SERVICEMEN AND STUDENTS
AUDELS T.V. RADIO SERVICE LIBRARY—Over 1500 Pages—1085 Illustrations & Diagrams, 1001 Important Facts & Figures on Modern T.V., Radio, Electronic Devices at your fingers ends. Highly Endorsed.

INCLUDES TRANSISTORS & Transistor Circuits, Rectifiers, Record Changers, P.A. Systems, Tape Recorders, Phonograph Pick-ups, F.M., Auto Radio, Radio Compass, Short Wave, Radar, etc.

**ASK TO SEE IT!
IT WILL PAY TO KNOW—**

The Basic Principles—Construction—Installation—Operation—Repairs—Trouble Shooting, Shows How to get Sharp, Clear, T.V. Pictures. Install Aerials—How to Test. Explains Color Systems, Methods of Conversion, Terms, etc. Includes Ultra High Frequency—Valuable for Quick Ready Reference and Home Study.

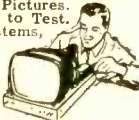

Get this Information for Yourself
7 DAY TEST—PAY ONLY \$1 MO.

**\$6 COMPLETE
2 VOLUMES**

MAIL ORDER

AUDEL, Publishers, 49 W. 23 St., New York 10, N.Y.
Mail AUDELS T.V. RADIO SERVICE LIBRARY (2 Volumes) \$6 or 7 days free trial. If O. K. I will remit \$1 in 7 days and \$1 monthly until \$6 is paid. Otherwise I will return them.

Name _____

Address _____

Occupation _____

Employed by _____ PE

drive the loudspeaker-type sound sources, and special high-intensity microphones are necessary in all types of chambers to measure the noise level. Knowing how to operate and maintain instruments like scopes, db meters, frequency meters, voltmeters and strain gauges is essential.

As planes become faster, their engines must be more powerful—and therefore produce even more destructive noise. That means more and louder sound chambers. High noise as a problem is just one sample of the many challenging opportunities that will continue to open up to the electronics industry as all branches of our technology expand. And every opportunity for the electronics industry means more and better jobs for electronic technicians.

-30-

Building a Sandwich Baffle

(Continued from page 65)

by screwing the brackets to the rear of the front panel. The top can be fastened down with glue and finishing nails.

Add the Dressing. For a final finishing touch, a grille cloth can be inserted over a wooden hoop cut to fit inside the speaker opening. The hoop is made by soaking a strip of thin packing crate material (about 1" wide by 35" long) in hot water for a few hours. The family bathtub is a convenient place to do the soaking.

After an hour of soaking, bend the strip into a semicircle and then put it back to soak longer. When it will finally make a complete circle, clamp it into a hoop and let it dry for a few hours, but not completely, before you cut it to the exact circumference and use it. After the grille cloth is pulled tight over the hoop, use small nails to fasten the hoop permanently in position.

Now install a speaker and you're ready to listen. You'll find that the "Sandwich" puts out very clean sound, due to its rigid construction. It will probably be worthwhile to add some acoustical treatment in the form of felt strips or cotton batting stretched from piece F to the rear of the front panel (see photo on page 65).

For Special Servings. If your speaker is deeper than 7 1/4", you may have to notch the 2" x 4" upright or else reposition it. As planned, it will clear a 3/4" molding. The edges of the port cutouts shown were left unbeveled; however, if you plan to use the cabinet with one 12" speaker, the port area may be increased by cutting a bevel there too. For a 12" speaker with very low resonance (35-50 cycles), you should increase the height of the front panel to 40", bevel the port edges, and locate the speaker midway between the top



THE FINEST AND MOST COMPLETE LINE OF Transistor Coils & I.F. Transformers

All loops described below have a secondary which is overcoupled for maximum gain stability with a variation in output load. Designed to match an input impedance of approximately 600 ohms. These loops also make excellent antenna coils for conventional vacuum tube receivers. They offer better signal pickup and increased selectivity over ordinary air loops.

SUBMINIATURE ANTENNA LOOPS



An adjustable antenna coil with a high Q ferrite core. May be used with any variable condenser having a maximum capacity between 250 & 450 mmf.

Dimensions: $\frac{1}{2}$ " x $2\frac{1}{2}$ "

Cat. No.	Q @ 790 KC	Freq. Range	Tuning Cond. Max. Capacity	List Price
2002	250	540-1650 KC	250-450 mmf.	\$1.50

I. F. TRANSFORMERS



Catalog Nos. 2041 and 2042 are miniature I.F. transformers having a tuned primary and untuned secondary. The primary is tapped for use in circuits which require a tap. Proper impedance match between primary and secondary insures optimum performance. Dimensions: $\frac{1}{2}$ " sq. x $\frac{3}{8}$ " high.

Manufactured under K-TRAN patents of and by Automatic Manufacturing Corp.

Cat. No.	Freq.	Impedance	Use	List Price
2041	455 KC	25K—600 Ohms	Input	\$2.85
2042	455 KC	25K—1000 Ohms	Output	2.85

SUBMINIATURE



To our knowledge the 9-C1 and 9-C2 are the smallest I.F. transformers in existence. All technical specifications for the 2041 and 2042 apply respectively to the 9-C1 and 9-C2. Dimensions: $\frac{3}{8}$ " sq. x $\frac{5}{8}$ " high

Manufactured under K-TRAN patents of and by Automatic Manufacturing Corp.

Cat. No.	Freq.	Impedance	Use	List Price
9-C1	455 KC	25K—600 Ohms	Input	\$3.50
9-C2	455 KC	25K—1000 Ohms	Output	3.50

UNSHIELDED MINIATURE OSC.



These coils are designed for use in a converter circuit using only one transistor for both the oscillator and mixer. Dimensions: $\frac{3}{8}$ " x 1" high

Cat. No.	Tuning Cond. Max. Capacity	I.F. Freq.	Use	List Price
2020	365 mmf.	455 KC	Osc.	\$2.00
2022	78-100 mmf.	455 KC	Osc.	2.00

SHIELDED SUB-MINIATURE OSC.



The 2021 oscillator coil is a sub-miniature shielded version of the #2022 described above. Identical in size to our 9-C1 and 9-C2 I.F. transformers. Designed for use with a condenser having a maximum capacity of approximately 100 mmf. (Miller #2110). $\frac{3}{8}$ " sq. x $\frac{5}{8}$ " high

Manufactured under K-TRAN patents of and by Automatic Manufacturing Corp.

Cat. No.	Max. Capacity	Freq.	Use	List Price
2021	100	455 KC	Osc.	\$2.50

STANDARD ANTENNA LOOPS



Due to its large pickup area the #2000 is one of our most popular loops. Dimensions: $\frac{3}{4}$ " x 9"

Cat. No.	Q @ 790 KC	Freq. Range	Tuning Cond. Max. Capacity	List Price
2000	450	540-1650 KC	365 mmf.	\$2.75

MINIATURE ANTENNA LOOPS

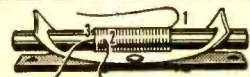

Similar to the #2000 described above but smaller in size for miniature sets. Slightly less signal pickup than the #2000, but extremely high Q. Dimensions: $\frac{3}{4}$ " x $3\frac{3}{4}$ "

Cat. No.	Q @ 790 KC	Freq. Range	Tuning Cond. Max. Capacity	List Price
2001	550	540-1650 KC	365 mmf.	\$2.50
2003	500	540-1650 KC	125 mmf.	2.50

FLAT FERRITE LOOPS



These coils are wound on flat ferrite strips rather than the normal ferrite rods. Due to this unique physical configuration they are remarkably sensitive for their small size.

Dimensions: $\frac{1}{4}$ " x $\frac{3}{4}$ " x $3\frac{3}{4}$ "

Cat. No.	Q @ 790 KC	Freq. Range	Tuning Cond. Max. Capacity	List Price
2004	500	540-1650 KC	365 mmf.	\$2.50
2005	450	540-1650 KC	125 mmf.	2.50

VARIABLE CONDENSERS



Catalog #2110 is a miniature 2-gang variable condenser. The antenna section has a range of 10-130 mmf. Catalog #2112 is a standard size 2-gang condenser having a range of 10-365 mmf. for both sections. Shaft is $\frac{1}{4}$ " dia. x $1\frac{1}{8}$ " long.

Cat. No.	Sections	Dimensions	List Price
2110	2	$\frac{3}{4}$ " x $1\frac{3}{8}$ " x $1\frac{1}{4}$ "	\$2.50
2112	2	$2\frac{3}{8}$ " x $1\frac{1}{4}$ " x $1\frac{1}{8}$ "	3.50

SOLO BY ALL LEADING RADIO AND TELEVISION PARTS DISTRIBUTORS
Write for General Catalog 57A

J. W. MILLER COMPANY

5917 South Main Street • Los Angeles 3, Calif.

Canadian Representative Atlas Radio Corp. Ltd. 50 Wingold Ave. Toronto 10, Ont. Canada

TAKE MUSIC, NEWS, EVERYWHERE

PERSONAL POCKET RADIO



Here's the radio sensation of a decade — pocket radio the size of two cigarette packs. Take it everywhere — Perfect for hunting, fishing, walking, picnics, spectator sports. 3-tube, battery powered, built-in super-sensitive ferrite antenna. Tunes broadcast band 530 to 1650 kc. with Conrad frequencies marked. Comes equipped with B battery and hearing-aid type earphone. Case $1\frac{1}{4}$ " x $3\frac{1}{2}$ " x $5\frac{1}{2}$ ". Weighs less than pound. Reception to 75 miles daytime, 1,000 miles at night.

Back view—cover removed.

send only \$5.00

(ck. or M.O.): pay postman \$14.95 plus small charge for C.O.D. and postage or send \$19.95 for postpaid delivery. If not completely satisfied, return radio within 10 days for full refund. This imported radio carries a full 90 day guarantee on tubes and parts.

MINI-TRONICS CO. 5030 LINDEN LINCOLN, NEBR.

Top Pay Jobs in TV-ELECTRONICS-RADIO



High pay, opportunity, prestige, security ... all yours, as a qualified Electronics Technician! Get your training NOW in the big, recognized shops, Labs. and TV-Radio Studios at National Schools in Los Angeles, foremost since 1905. Here you work with latest Electronics equipment — professionally installed — finest, most complete facilities offered by any school. Expert, friendly instructors. Personal attention. Graduate Employment Service. Help in finding home near school. Part time job while you learn. Mail coupon NOW, TODAY... for full information.

NATIONAL SCHOOLS

National Schools Dept. RX2G-17
4000 So. Figueroa Los Angeles 37, Calif.
Send Free Electronics Opportunity Book Today

Name _____ Age _____
Address _____
City _____ State _____

MATHEMATICS

ADVANCED

INDUSTRY TODAY DEMANDS. MORE THAN EVER, THE MAN WITH A GOOD MATHEMATICAL FOUNDATION.

In any branch of engineering, too, mathematics (up to and including calculus) is essential if you want to get ahead in this modern age of technical development. Our reasonably priced home study courses can train you by easy stages to advanced standards—even from an elementary beginning. Examination successes have been won by our students throughout the world. Write today for our handbook listing mathematics and over ninety other courses in all branches of engineering.

Civil	Radio	A.M.I.Mech.E.
Structural	Electronics	A.M.Brit.I.R.E.
Mechanical	Aeronautical	A.F.R.Ae.S.
Electrical	A.M.I.C.E.	B.Sc. (Pure Science)



105 PAGE HANDBOOK FREE

Canadian Institute of Science and Technology Limited
639 Century Bldg., 412, 5th St. N.W. Washington, D.C.
Please forward free of cost or obligation your handbook, "ENGINEERING OPPORTUNITIES".

Name

Address

..... Course

Interested in

..... Age

Canadian Address: Canadian Institute of Science
Garden Building, 263 Adelaide St. W., Toronto, Ont.

NOW The Short Cut to Learning You've Been Waiting for



Learn Anything
FASTER...more easily
with amazing
Dormiphone Memory Trainer

The Scientific Discovery That Works for You... Awake or Asleep

- Keep ahead in your work
- Memorize more quickly
- Make school subjects easier
- Help break bad habits
- Help induce sleep
- Learn a language
- Correct your speech

Now, at last, science shows you how to learn "by ear." With Dormiphonic Memory Trainer, you start learning when awake... continue while asleep... save time, effort... learn 20% to 35% faster. So simple a child can operate it—so easy and practical it is used by educators, psychologists, people of all ages and occupations all over the world.

Break Down Barriers to Learning.
Find out HOW the Dormiphonic Memory Trainer works FOR YOU—

how it can help you learn anything in less time, without intensive self-application. Write for FREE Book, "A New Dimension in Learning," or call for FREE DEMONSTRATION—Get the Scientific Evidence Today.

MODERNOPHONE, INC.
292-017 Radio City, New York 20, N. Y.

Gentlemen: Please send me your FREE Booklet. I am interested in learning more about the DORMIPHONIC Memory Trainer and what it can do for me. No obligation—no salesman will call.
 If under 18, check here for Special Booklet A

NAME

ADDRESS

CITY ZONE STATE

My main interest in Dormiphonics is for:

<input type="checkbox"/> Learning a Language	<input type="checkbox"/> Speech Improvement
<input type="checkbox"/> Memorization	<input type="checkbox"/> Sleep Inducement
<input type="checkbox"/> Habit Correction	<input type="checkbox"/> School or College Work

of the baffle and the tops of the ports. For a 15" speaker, increase the size of the front panel to about 36" wide by 40" high.

For an 8" or 10" speaker, it would be wise to cut the same 11"-diameter opening as for the 12" unit, and then mount the speaker in the front of an adapter piece so that the cavity depth in the front of the speaker is reduced for the smaller diameter units.

A separate tweeter may be mounted above the woofer and can be isolated from the woofer by a Celotex partition, which, except for a cutout to fit around F, could be the same size as E. When using a tweeter in this way, increase the height of the baffle by 3" or 4" to make room for the tweeter and its partition.

-30-

"Economy" Tube Tester

(Continued from page 76)

type 6C4, it would be 2200 micromhos.

Don't be too surprised when some tubes exceed the value stated in the manual. A corresponding amount, however, will fall below the value in the manual. The value of transconductance gives a direct measure of the tube's worth as an amplifier.

Many cheaper meters will still read d.c. even when switched to the a.c. position. Since the 100-ohm resistor has a direct current flowing through it, the meter may read this as well as the a.c. voltage present. If such is the case, place a 1.0- μ f. capacitor in series with the meter. Some VOM's have an "output" position which can be used instead.

To test for a noisy or microphonic tube, simply plug in a set of headphones in the jacks across the 100-ohm resistor, R7. Tapping the tube will reveal if it is noisy.

To test for shorts, remove all jumpers except the filament connections. To test for a short between elements, place the B— lead on one element, and place the jumper lead with the neon lamp between the B+ jack and the other element under test. This procedure is repeated for suspected shorts between any or all of the tube elements. If a short is present, the neon lamp will light. When testing for a short between the cathode and grid or plate, connect the cathode to the B+ terminal, thus making the other elements negative. Otherwise the neon lamp will give a false indication of a short.

When setting up the tester for a screen grid tube, always use the tube manual data giving equal plate and screen voltages. If this is not possible, a screen dropping resistor may be needed to drop the plate voltage to that required by the screen.

-30-

TU-7, TU-26, and TU-10-B Tuning Units—\$1.95 ea.

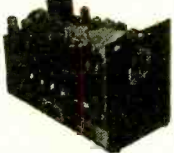

Used in the BC-375 transmitter, but the most favorable and acceptable piece of surplus gear for obtaining good cheap usable parts. The TU-10-B contains three double spaced transmitting type variable condensers of 16, 27, and 7 plate varieties, 3 mica transmitting type micas, 2 isolantite shaft couplings, antenna coupling switch, two precision vernier dials, chokes, inductances and other useful parts. Better order plenty before supply is exhausted again. TU-7 and TU-26 also in stock, same price. Ship. wt. 13 lbs. Size 7 1/2" x 10 1/2" x 7 1/2". **PRICE, Used, ea. \$1.95 New, ea. \$2.50**

Freq. Crystals... Less Than 5c Ea.

Imagine crystals costing Govt. \$3.50 to \$12.00 ea. in this assortment. 100 brand new; various freqs.; plenty in ham bands. Practically all types of holders; all mounted; guaranteed to oscillate. Assortment of 100. Ship. wt. 4 lbs. **\$4.95**



OAV-1 TEST SIGNAL GENERATOR \$19.95

This signal generator was used to provide a test signal of constant frequency for operation and alignment of 1F amplifier stages in the CG-46ACQ type receivers. The generator covers the range between 150-250 megacycles. Amplitude modulated square wave output is obtained at frequencies of .1, 1, 10, and 100 Kc. depending on the position of the Freq. mod. Pulse switch. A 15 Mc. signal is also provided by a second osc. stage. Power is supplied by internal 115 V., 60 cycle AC supply connected to source by cord provided. Wt. of unit 62 lbs. Brand new with instruction book. Price \$19.95



GOLF CAR MOTOR \$4.50

New 1 1/2 HP. battery operated motor for building up your golf car or other use. Operates from 12 to 24 V. with speed to 6000 RPM. Measures 4 1/2" dia. x 9" long, 5/8" shaft. Wt. 11 1/2 lbs. Ship. wt. 13 lbs.



SYNCHRO Motor and Generator Only

\$4.95 Per Pair

Simply connect like stator wires of each unit (marked with S on unit) and rotor wires (marked with R on unit) in series with 110 V. 60 cycle current, you have an electrical equivalent of a flex. shaft without usual limit to length, backlash error, and friction. Ideal for your beam direction indicators, wind direction indicators, antenna rotation, etc. Popular size 5 (6 1/2" long 3 1/2" dia.). Units orig. made for 400 cycle but operate intermittently on 60 cycle when connected in series as above. Ship. wt. 12 lbs. per pair. Price **\$4.95** per pair, used units. Regular 60 cycle units, per pair. **\$9.95**



10 SUB STATION INTERCOM

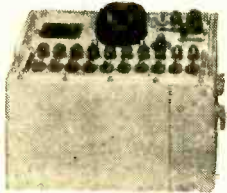

Navy I-A surplus interphone master for up to 10 sub stations. 110 V. 60 cycle internal transformer type power supply. Has heavy slug PM combination speaker and microphone unit. Controllable volume and indicator for each station. Mfgd. by various factories and some have a different appearance than pictured but all for same application. Units are complete with tubes and speaker; but may need some repairs—sold by Navy as repairable condition. Orig. Navy packing. Ship. wt. 60 lbs. Size of unit 14" x 8 3/4" x 10". **Price—each \$19.50**

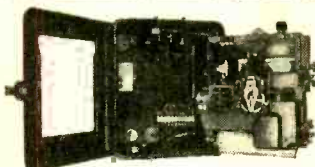

Leeds & Northrup Micromax Recorders

Strip type recorder used for controlling and recording wide variety of processes. Used originally for temp. range of 350-550° C. but may be changed for other applications. Operates on Wheatstone bridge principle using AC galvanometer movement. Original cost several times our low price. Removed from demilitarized equipment which in many cases was new. Sold as used but guaranteed, or money back if not satisfied. Ship. wt. approx. **\$179.50** 165 lbs. Ea.

APN-4 Radar Scope



As pictured less tubes and crystal. CRO tube included. Ship. wt. approx. 45 lbs. Removed from surplus aircraft. **\$9.95** Price at



New Lauson Gas Generator

Brand New Lauson engine driven generator for 12.6 V. 2 A. DC and 500 V. 85 Ma. outputs. Ideal field unit. Comes with cord and spare parts. Size 21 1/2" x 16" x 10 1/2". Wt. 64 lbs. Ship. wt. **\$29.50** approx. 100 lbs. Price

Kerosene or Gasoline Heater Reduced to \$4.95

Brand new. Evans blue flame heater. Output approx. 50,000 BTU. Ideal for garage or shack where not confined. Size: 10" dia x 12" high. Cost Govt. many times our low price. Shipped in orig. packing; **\$4.95** wt. 47 lbs.



TEST SET EE-1 NEW—\$19.50

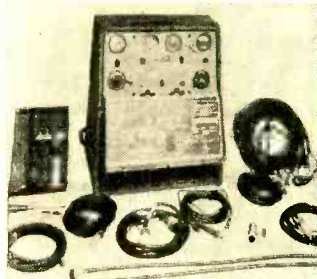

A test set for aircraft containing AC & DC volt, ohms, meter, tachometer, pressure gauge & test gauge cords & tools. In aluminum suitcase type case that opens forming sloping 2 sec. panel. Ideal for your test bench applications. Cost hundreds of dollars but yours in original evacuated shipping container for only. **\$19.50** Ship. wt. 270 lbs.

14 Amp. Battery Charger While Supply Lasts

Cost Govt. \$300 ea. Our purchase of large quantity allows this bargain. Charges 6, 12, or 24 V. batteries at 14 amp. rate max. Operates from 110 V. DC. Mfg. by Waid-Leonard. Size 12" w x 20" h x 10" d. Brand new in orig. packing; wt. approx. 80 lbs. They'll go fast at this low price, so order **\$7.50** now

R-1/Arr-1 RECEIVER Brand New \$1.95



The ever popular 220 mc. one with conversion data. Tunes 238-256 mc. Brand new demilitarized (input coil base broken). Ship. wt. 6 lbs. Ea. **\$1.95** Brand new. Not demilitarized. Ship. wt. 6 lbs. Ea. **\$2.95**

APS-3 Radar Complete—\$275.00

Brand new APS-3 radar. Ideal for use on boats. Complete except interconnecting cables and power source. Ship. wt. **\$275.00** approx. 600 lbs. Sale Price

T-39/APQ-9

As described in Feb. '50 CQ for citizens and amateur 420-450 Mc. converter. Ship. wt. 43 lbs. each **\$4.95**

TYPE CAEN 21887 Motor Generator Set \$35.00

115 v-60 cycle, 3100 rpm, GE enclosed motor of 1/2 hp. Drives a DC generator with output of 400 v, 155 ma, 400 v, 20 ma & 15 va-3.5 amp. Makes an ideal power supply for amateur. Supplying both HV & filament. Unit weight is 61 lbs. and measures 22 1/2" long x 8" h x 10" deep overall. Brand new motor and generator **\$35.00**



ESSE

REMIT SHIPPING CHARGE AND INSTRUCTIONS WITH ALL ORDERS. OTHERWISE ORDER WILL BE SHIPPED EXPRESS COLLECT. ALL ITEMS GUARANTEED TO YOUR SATISFACTION OR MONEY REFUNDED IF RETURNED PREPAID WITHIN 10 DAYS OF RECEIPT.

RADIO CO. • 42 WEST SOUTH ST. • INDIANAPOLIS 25, INDIANA



Half the Fun Is Building It... with a TECH-MASTER Kit!

NEW HI-FI FM TUNER

Self-contained power supply • Tuning range 87-109 Mc • 200Kc IF bandwidth • Grounded-grid RF stage • AFC with front control cutoff • Microvernier tuning • No-drift ratio detector • 4 uv sensitivity for 20 db quieting • Standard deemphasis network • .8 volt RMS cathode-follower output • 3.2 volt RMS high-impedance output • 300 ohm input impedance • Switch-controlled AC receptacle for auxiliary equipment.



Model FM-18, complete with punched chassis, tubes, and hardware (less wire and solder)..... **\$29.50**

NEW WILLIAMSON TYPE 20-WATT AMPLIFIER

Frequency response flat and smooth thru entire audible range • Less than .0025 distortion at normal listening levels • Excellent transient characteristics.



Model TM-15A, complete with tubes; sockets, terminal strips, and connectors mounted..... **\$49.95**

NEW DELUXE SELF-POWERED PREAMP-EQUALIZER

Cathode-follower output • Loudness compensating control • Input selector • 4 input channels • Independent bass and treble boost and attenuation • 5-position equalization control • AC receptacle for auxiliary equipment • Self-contained power supply.

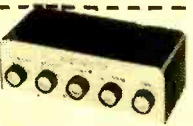

Model TM-16 SP, complete with matching gold escutcheon..... **\$24.50**

Write for latest catalog of
complete Tech-Master line
TECH-MASTER CORPORATION
75 Front Street, Brooklyn 1, N. Y.



**TELEVISION
RADIO
AUDIO**

LEARN RADAR MICROWAVES TRANSMITTERS CODE TV RADIO

Phila. Wireless Technical Institute
1533 Pine St. Philadelphia 2, Penna.

A Non-Profit Corp. Founded in 1908

Write for free catalog "P"

LMB BOX CHASSIS OFFERS FREE Inside LMB boxes

10 tested kit diagram projectors for the builder. Each one of these kit diagrams built by a recognized expert. Kit projects are complete in every detail. Circuit diagram, photo of project both front and rear photo. Rear photo shows wiring and parts. Detailed instructions for building, complete parts list and approximate cost. Complete to build except parts and your distributor can supply the parts. Ask your distributor for the list of LMB kit Diagram Projects. If he does not have them, write to

LMB 1011 Venice Blvd.
Los Angeles 15, Calif.

W1AW Will Help YOU

(Continued from page 48)

day hit their communities, tearing up normal communications facilities in the process. With their equipment powered by gasoline generators or batteries, they are ready to fill in whenever called upon. Their organization, the Amateur Radio Emergency Corps, sponsored by the League, is the backbone of the official civil defense communications system, The Radio Amateur Civil Emergency Service.

What ARRL Is. Most hams, of course, have two or more of these interests, and split their operating time among them. They all have in common the American Radio Relay League, a non-profit, non-stock membership corporation with headquarters at 38 LaSalle Road, West Hartford 7, Conn. Anyone interested in amateur radio may become a member, but voting membership is restricted to U. S. and Canadian amateurs.

The headquarters is a beehive of activity. About 65 paid employees, including 27 hams, are engaged full time in coordinating the work of volunteer amateur appointees, conducting contests and other activities, designing new equipment to be described in the League's monthly magazine *QST* and in the "bible" of hamdom, *The Radio Amateurs' Handbook*, and in producing and distributing other inexpensive booklets to help amateurs learn about and improve their hobby. Especially important for the beginner is the "Gateway to Amateur Radio" package, including *Learning the Radiotelegraph Code*, *How to Become a Radio Amateur*, *The Radio Amateurs' License Manual*, and *Operating an Amateur Station*. Headquarters also distributes free information on getting started in amateur radio.

Four miles away is the Hiram Percy Maxim Memorial Station—W1AW—which is owned by the membership, and was built to honor the famed inventor who was the co-founder of the League in 1914 and its president until his death in 1936. The call letters were his own, and were assigned to the League in commemoration by a special action of the FCC after "The Old Man" died.

Sparked by the ARRL, amateur radio has seen a tremendous growth through the years. Fifty thousand hams held licenses in 1941. Fifteen years later, in 1956, there are 150,000 hams—and more are coming.

They're bound to—for as any ham can tell you, no other hobby can match this one: the fun of the rag-chew, the excitement of a contest, the thrill of working a new country, the satisfaction of smooth-running "home-brew" equipment, and that wonderful useful feeling which comes from message-handling and emergency work. —30—

Crossovers Are The Answer

(Continued from page 72)

energy beyond its response limit. A sharp cutoff is therefore recommended with certain units. For instance, if a tweeter is not supposed to receive much energy below its cutoff point (say 2000 cps), the crossover network should cut the response sharply at that point rather than let it gradually slope off with plenty of overlap.

Insertion Loss. Since there are no perfect conductors, any coil or capacitor offers some resistance to the flow of current. Because the crossover network operates at low voltage and high current, there is bound to be some energy loss due to the resistance in the coils. By winding the coil with heavier gauge wire (No. 16 or larger), the power loss resulting from insertion of the network into the hi-fi system can usually be kept down to 10% of the total amplifier output (= 1 db). Since most hi-fi installations can get along very well on the remaining 90% of their power, this loss is not critical. Only air-core coils should be used in crossover networks; iron cores produce hysteresis and magnetic losses which upset the power and frequency response of the network.

Level Controls. The crossover network itself splits the available energy equally be-

tween treble and bass channels. Yet the woofer and tweeter may not be equally efficient in converting this electrical energy to actual sound. The resulting difference will cause the tweeter to "out-shout" the woofer or vice versa. For this reason, a level control should be provided with the crossover network to balance the sound between the high and low end. Such a control also lets you compensate for the acoustics of the listening room, which may either reflect a lot of treble or swallow it up.

The level control on fancier networks is a so-called "T-pad" or "H-pad," with constant impedance at all settings. Yet in lower priced crossover networks, ordinary potentiometers are used without ill effect.

Damping Problems. Speaker impedance variations at different frequencies reflect back into the network, causing slight tonal changes.

Most of us have come to accept these little inconsistencies of tone color without even noticing them. Yet those whose keen ears remember what music *really* sounds like won't stop short of perfection. Several pioneer designs have come up with an answer to this impedance and damping problem: a crossover before rather than after the amplifier and dual-channel amplification. Our next issue will discuss these de luxe systems.

-30-

BECOME A HAM

WITH THE GATEWAY TO

amateur radio

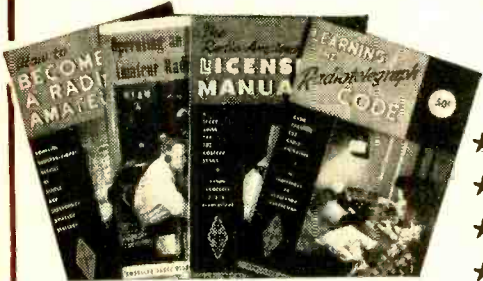

- ★ HOW TO BECOME A RADIO AMATEUR
- ★ THE RADIO AMATEUR'S LICENSE MANUAL
- ★ LEARNING THE RADIOTELEGRAPH CODE
- ★ OPERATING AN AMATEUR RADIO STATION

Starting out in amateur radio you will find these publications a necessary part of your reading and studying for the coveted amateur radio operator's ticket. Written in clear, concise language, they help point the way for the beginner. Tried and proven by thousands upon thousands of amateurs, these ARRL publications are truly the "Gateway to Amateur Radio."

Only \$1.50

Postpaid Booklets

AMERICAN RADIO RELAY LEAGUE, Inc.

West Hartford 7, Connecticut

Name.....

Street.....

City.....State.....

Cash.....Check.....Money Order.....

**NOW! Custom Install
your own Hi-Fi Recorder**
Low Cost! Plugs into any amplifier & speaker



**Staff OK Tested by
Tape Recording Magazine**

Tape mechanism has sensational UniMagic control, 2-speed record and playback, instant, automatic braking, special record-playback and erase heads. **Matching preamplifier**—Response: 50-12000 cps \pm 3db, signal-noise ratio 47 db. Professional controls include illuminated VU recording meter. Finished in brushed copper and jet black. Carries famous Pentron warranty. TM-56 tape mechanism \$89.95 list. P-4 preamplifier \$79.95 list.

Write for **FREE Bulletin . . . Name of Nearest Dealer!**

PENTRON
The Pentron Corporation
767 S. Tripp Ave.
Chicago 24, Ill.
Canada: Atlas Radio, Ltd., Toronto

NEW MAGIC RADIO WALKIE TALKIE!
YOUR OWN POCKET SIZE RADIO STATION!
BROADCASTS TO ANY HOME OR CAR RADIO WITHOUT WIRES OR HOOKUPS! Wt. only 5 oz. Size (1 1/2 x 4 1/2"). Built-in telescoping antenna. Powerful transistor-sensitive microphone. Frequency setter, break-in switch! Runs for weeks on self-contained flashlight batteries. Durable plastic case. With this Radio Talkie you CAN TALK TO YOUR FRIENDS UP TO A BLOCK OR MORE AWAY! Talk up to 1 mile or more between two automobiles. INSTANT OPERATION! Just push button to talk! No license needed. Uses inductive field magnetic radiation. Useful and real fun in a million ways! **GUARANTEED TO WORK. 1 YEAR SERVICE GUARANTEE.**
SEND ONLY \$2.00. (cash, ck, mo) and pay postman \$9.99 COD postage or send \$11.99 for prepaid delivery. COMPLETE READY TO OPERATE with instructions and hundreds of ways and tricks for broadcasts thru any radio you desire. Price may go up soon so get your **NEW POWERFUL RADIO WALKIE TALKIE NOW.** Available only from: **WESTERN RADIO, Dept. REL-1, KEARNEY, NEBR.**

PEE WEE BATTERYLESS "LIFETIME" RADIO
REALLY WORKS—FOR LIFE!
Works WITHOUT TUBES, BATTERIES OR ELECTRICAL PLUGS. Will never run down or burn out! World's smallest. SMALLER THAN A PACK OF CIGARETTES! GUARANTEED TO RECEIVE LOCAL RADIO STATIONS ANYTIME—ANYWHERE YOU GO! Sensational new Ferite Selective Tuning Perma-Crystal diode. Super SPEAKER-PHONE, durable black and gold plastic case.
SEND ONLY \$2.00 (bill, ck, mo) and pay postman \$4.99 COD postage on arrival or send \$6.99 for postpaid delivery. SENT COMPLETE READY TO LISTEN WITH LIFETIME GUARANTEE. Nothing extra to buy—ever. Available only from: **MIDWAY COMPANY Dept. WPL-1 KEARNEY, NEBRASKA**

MULTIPLE FM-TV COUPLER . . .
Designed to permit simultaneous operation of an unlimited number of FM and TV sets from one common antenna. Coupler can be used on any open line or twin lead regardless of spacing or impedance. Simple to install! It will deliver the signal to the set without causing loss or distortion in other sets on the same antenna. Coupler is Dependable . . . Service free . . . Permanent . . . Satisfaction guaranteed or money refunded . . . \$3.00 Postpaid . . . Check or Money Order . . . No C.O.D.'s.
NANTAIS ANTENNA SYSTEMS
15718 Paramount Boulevard, Paramount, California

Why's and Wherefore's of Watts

(Continued from page 51)

cannot even attempt to estimate your amplifier requirements with any reasonable degree of accuracy. This is the single factor that we can't put a number on. Only the speaker manufacturer involved can do that for you—and more and more of them, realizing the misunderstanding that exists on this one point, are becoming less and less reluctant to publish this information as a regular part of their sales specifications. It's really nothing to be ashamed of! Most of us have known for years that an automobile engine only converts about 6% of the energy contained in a gallon of gas into usable power, but we still buy millions of cars each year!

Multiple Speaker Systems. If you feel that eventually a second or even a third loudspeaker installation in another room or two is good future planning, the formula is simple as can be. If the second room is about like the first and you ever plan to have both speakers going at the same time, you'll need double the power of your first calculations.

Important point: many loudspeaker installations are equipped with so-called level controls, or pads, with which it is possible to turn off the sound coming from a given speaker. Just because the sound is turned off in this manner doesn't mean you're using less power. The same amount of power is being absorbed at the speaker terminals. It's simply all used up as heat in the wire-wound resistor which makes up the speaker-control. The only way an amplifier can be used for two speakers and still require the power calculated for only one is if you actually switch the appropriate speaker in and out, effectively disconnecting one terminal of each speaker not in use.

Tone Controls Use Power. If your listening room, your personal tastes, or any of countless other factors make you want to add a little bass boost by means of the tone controls on your amplifier, you'd better take that fact into account before you go shopping for watts. Remember, a bass boost of only 3 db requires *double* the power-handling capacity at certain frequencies than would be the case if all your tone controls were set for flat response!

Power and Frequency Response. As long as we're talking about specifications, there's one the amplifier people could be a little more detailed about. Amplifiers, as a rule, perform best for "middle" tones. The extremely low-pitched and high-pitched tones are generally much harder to reproduce at high power levels. An orchestra,

however, has instruments at both extremes as well as in the "middle", and you'll notice from our graph that all the frequencies need pretty much the same power for a given volume of sound. Therefore, it's important to know not just that a given amplifier produces a maximum undistorted power of "5 watts" or "10 watts" or even "50 watts," but that it can produce that much power at *all* the frequencies involved in musical reproduction, or at least from 30 cps to 15,000 cps. If this were not the case, certain instruments would be clear and undistorted at maximum volume while others, such as the bass drum or cymbals, might be annoyingly distorted at the same listening level.

The important thing to remember when choosing an amplifier is that a high-fidelity system has to work properly *as a whole*, and that the loudspeaker, listening room, and personal listening preferences must be carefully considered before you can pin a number on the amount of watts required. The right amount of watts, however, can really "make" a hi-fi system.

-30-

More Solar Battery Experiments

(Continued from page 61)

avoiding excessive loading on the tuned circuit, and thus insuring good selectivity and gain. The selected r.f. signal is coupled through capacitor *C2* to the base-emitter circuit of the transistor, connected as an unbiased common-emitter detector-amplifier. Demodulation (detection) occurs in the base-emitter circuit of the transistor, with the resulting audio-signal amplified by the transistor and used to drive the ear-phone. Capacitor *C3* serves as a simple r.f. bypass across the power source.

C.W. Radio Transmitter. With a good antenna and earth ground connected, and with battery *SB1* exposed to full sunlight, you should be able to send c.w. (code) signals to a standard communications receiver from distances up to 40 or 50 feet using a radio transmitter wired according to the circuit in Fig. 4. To get this range, you'll need a multicell battery, however.

There are no special "tricks" in wiring and layout is non-critical. Feedback coil *L2* consists of around 10-15 turns of enameled wire, tightly wound on top of *L1*—you may have to reverse the connections of this winding to get oscillation. You will need an r.f. type transistor for best results—a G.E. Type 2N170 *n-p-n* unit is specified, but you can substitute a Raytheon Type CK768 *p-n-p* unit if you reverse the battery leads.

With the wiring completed and double-

1957 ALLIED ELECTRONIC SUPPLY CATALOG

free!

356
value-packed
PAGES



WORLD'S
LARGEST
STOCKS

SAVE ON EVERYTHING
IN ELECTRONICS



Our
36th
year

Everything for Experimenters, Builders,
Amateurs, Servicemen, Engineers
and Hi-Fi Hobbyists

Save on *everything* in Electronics:
Hi-Fi systems and components;
latest builders' kits (see the famous KNIGHT-KIT line); recorders
and phono equipment; TV tubes,
antennas, accessories; Amateur
station equipment; P.A. systems;
test instruments; industrial elec-
tronic supplies—plus *everything*
in parts, tubes, transistors, tools
and books. Get more for your
money—send today for your
FREE 1957 ALLIED Catalog!

Everything in Electronics
From One Reliable Source

Send
for FREE
Catalog

ALLIED RADIO

ALLIED RADIO CORP., Dept. 79-A-7
100 N. Western Ave., Chicago 80, Ill.

Rush FREE 1957 ALLIED 356-Page Catalog

Name _____

Address _____

City _____ Zone _____ State _____

LEARN A FOREIGN LANGUAGE QUICKLY!

Start to speak
SPANISH
FRENCH
GERMAN
ITALIAN

in only 7 days



It's a fact, the new Language Phone Method will have you speaking words, phrases, even entire sentences within one short week! With this *proven* method you learn a foreign language just as you would a popular song. This way, you listen to the voice of your language professor electrically transcribed on high-fidelity unbreakable records. At the same time you see the words he is speaking in a printed supplementary manual. What's more, you learn to speak *correctly*, with exactly the right inflections—true Parisian French, true Heidelberg German, etc.

Send for Free Booklet

Mail coupon below for the free booklet that tells you all about the new Language Phone Method.

MAIL THIS COUPON

Funk & Wagnalls Company, Dept. PE-2
153 East 24th St., New York 10, N. Y.

Please send me free booklet about the quick, easy way to learn () Spanish, () French, () German, () Italian, and tell me how I may obtain a complete Language Phone Kit for seven days' free trial.

Name

Address

City Zone State

LEARN COLOR TV— ELECTRONICS—TV—RADIO



MIDWEST'S OLDEST TV-ELECTRONICS SCHOOL. 10 months resident short course with shop & theory training. Broad Scope —Embraces communications & all phases electronics. Prepares for FCC license exam. Approved by Missouri State Dept. of Education & Veterans' Adm. 1000's grads coast to coast. NOT THE BIGGEST—JUST BEST. Our 26th year. Vets. & non-vets eligible. Free information. Give age & date discharged.

UNIVERSAL TELEVISION SYSTEM INC.

1222E Admiral Blvd. Kansas City 5, Mo.



QUAL-KITS ARE EASIEST!

Hi-Fi Amplifier Kit \$28.50

Hi-Fi AM-FM Tuner Kit \$28.95*

And they have the finest features and specs. Fully illustrated step-by-step 28-page manual makes assembly a snap! WRITE FOR FREE CATALOG!

319 Church Street QUALITY ELECTRONICS Dept. P-1 New York 13, N. Y.

EASY TO LEARN CODE

Learn or increase speed with an Instructograph—the Radio-Telegraph Code Teacher that takes the place of an operator-instructor and enables anyone to master code without further assistance. Available tapes from beginners alphabet to typical messages on all subjects. Speed range 5 to 40 WPM. Always ready—no GRM. Thousands have "acquired the code" with the Instructograph System. Write today for convenient rental and purchase plans.



INSTRUCTOGRAPH COMPANY

4713-F Sheridan Road, Chicago 40, Illinois

checked for errors, install the transistor, attach a good antenna and ground, and place the unit within eight or ten feet of a communications receiver. The receiver should be tuned to a "dead" spot near the middle of the broadcast band (about 900 to 1200 kc.) and its BFO should be "on"—since this is a c.w. transmitter, a BFO must be used with the receiver to hear the code signals. Close the *key* and expose the battery to full sunlight. With an insulated alignment tool, gradually adjust *L1*'s iron "slug," listening for a signal from the receiver. If you can't pick up a signal after adjusting the "slug" over its entire range, try reversing the connections to *L2*.

Once you are sure the transmitter is operating, you can move it away from the receiver, experimenting to determine the maximum range possible with your particular circuit.

In operation, the transistor is connected as a "tickler feedback" r.f. oscillator, with *L2* serving as the feedback winding. Frequency of operation is determined by tuned circuit *L1-C1*, plus various distributed wiring capacities. A tap on *L1* prevents excessive loading on the tuned circuit and insures reasonably stable operation. R.f. energy from *L2* is coupled through capacitor *C2* to the base of the transistor, with

- C1—50-300 μ fd. tubular ceramic capacitor
- C2—0.005- μ fd. disc ceramic capacitor
- C3—0.02- μ fd. tubular capacitor
- L1—Tapped Loopstick
- L2—Feedback winding (see text)
- R1—100,000-ohm, 1/2-watt carbon resistor
- SB1—Solar battery (see text)
- V1—2N170 n-p-n r.f. transistor (General Electric)
- Key—Standard hand key
- 1—Breadboard chassis (perforated Masonite, about 6" x 8")
- 1—Transistor socket
- Misc. rubber feet, coil bracket, Fahnestock clips, solder lugs, machine screws, nuts, wire, solder, etc.

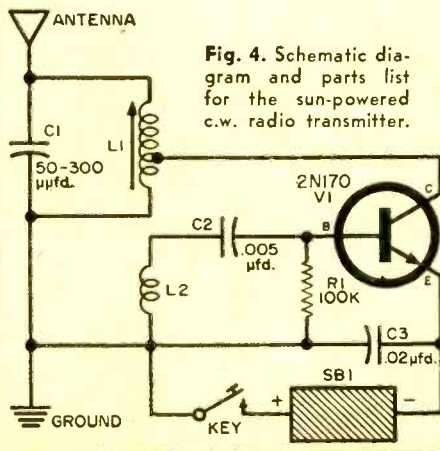
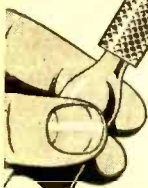

Fig. 4. Schematic diagram and parts list for the sun-powered c.w. radio transmitter.

Jet King
POCKET-SIZE

**BUTANE
BLOW
TORCH**

**SOLDERS!
BRAZES!
FIXES LEAKS!**



ONLY
\$1.95
WITH CHARGER

Every do-it-yourself and hobby fan needs this Kidde JET KING butane Blow Torch. Just the tool you've been looking for to do dozens of jobs in home or hobby...TV, appliance, lamp, radio or plumbing repairs...precision soldering, brazing or metal craft. Useful, too, for starting charcoal fires. A tiny, clean, safe charger does the job.

Each charger gives 30 minutes of intense 3500° pinpoint flame; turns on and off. Extra chargers, 39¢ per box of 2. **MONEY BACK GUARANTEE.** Send check, cash or money order. We pay postage.

BURTONS Dept. E-12, 1727 Glendale Blvd.
Los Angeles 26, Calif.

Please send me _____ JET KING BLOW TORCHES plus:
_____ boxes extra chargers (limit 2 boxes per torch).
My check , money order for \$ _____ is enclosed.

Name _____
Street _____
City _____ State _____

In Calif., add 4% sales tax.

**F.C.C. LICENSE
QUICKLY!**

**Home Study or Resident Classes
—FREE DETAILS—**

Grantham School, Desk 73-A

1505 N. Western Ave. OR 821—19th Street N. W.
Hollywood 27, Calif. Washington 6, D. C.

Please send me your free booklet, telling how I can get my commercial FCC license quickly. I understand there is no obligation and no salesman will call.

NAME

ADDRESS

CITY STATE

AMAZING NEW PERSONAL POCKET RADIO



LISTEN IN PRIVATE WHILE YOU WALK! SMALLER AND LIGHTER THAN ANY TRANSISTOR "POCKET RADIO" We only 1/2 lb. Size 1 1/2" x 2 1/4" x 3/4" complete. Black Gold breakproof plastic case. POSITIVELY NO HOOKUPS OR WIRES NEEDED! BUILT IN 1000 MILE ANTENNA! Snap in flashlight batteries lasts for months. "Glow in the Dark!" Easy to use top controls (while walking, riding, etc.) Has almost invisible earpiece—LETS YOU ALONE LISTEN ANYTIME, ANYWHERE without anyone else knowing you are hearing radio music, sports, news, weather, etc. **GUARANTEED TO WORK ANYWHERE. ONE YEAR SERVICE GUARANTEE.**

SEND ONLY \$5.00 (ok. mo) and pay postman \$14.95 plus postage on delivery or send \$19.95 for postpaid delivery. A REAL \$39.95 VALUE! AVAILABLE NOW ONLY FROM US AT HALF PRICE. American model NOT AN UNWORKABLE INCOMPLETE KIT OF PARTS OR PLAYTHING. A REAL MIDGET PERSONAL POCKET SIZE RADIO. Price will go up soon so order now. Available only from:

WESTERN RADIO Dept. APL-1 KEARNEY, NEBR.

tion. R1 serves as the collector load for the first stage, C3 as the interstage coupling capacitor, and a pair of magnetic headphones as the output load of the second (TR2) stage. Base bias current for the first stage (TR1) is supplied by the d.c. component of the detected signal; bias for the second stage is supplied through R2.

Product News. Correction! Last month we announced that, for the first time, *high-fidelity* transistor audio transformers were available *only* from Lafayette Radio (165-08 Liberty Ave., Jamaica 33, N. Y.). Actually, in addition to Lafayette, these units (AR-500 and AR-501) are available from *all* regular Argonne distributors.

Superex Electronics Corporation (4-6 Radford Place, Yonkers, N. Y.) has announced an addition to its line of radio kits... a two-transistor-and-diode receiver which features a printed circuit and operates on two penlite batteries.

From Centralab (Milwaukee, Wis.) comes news of a whole line of subminiature pre-packaged transistor audio amplifiers. Included in the line are one-, three- and four-stage units. The *largest* unit in the line, a four-stage amplifier, measures only one inch by a half-inch by one-quarter inch thick, yet it contains 21 parts... four transistors, five capacitors, and 12 resistors. The smallest unit is no larger than the eraser on a wooden pencil!

Typical specifications for the four-stage amplifier show a gain of 75 db at 1 kc., an input impedance of 1000 ohms, and a power output of 1 milliwatt at 15% distortion or 0.36 mw. at 2% distortion, with a signal-to-noise ratio of 38 db. Frequency response is 250 to 20,000 cps within 5 db, and power requirements are 4 ma. at 1.3 volts.

That's all for now, fellows... and a Happy New Year to you!

Lou

After Class

(Continued from page 78)

preciable change in frequency from -25° C to +75° C; the cut remains virtually "on-frequency" over a range of 180° F!

The kind of cut you might use depends upon the depth of your purse and its contents. X- and Y-cuts are quite inexpensive, while a GT-cut for a specific frequency is still prohibitive in cost to experimenters of average means.

Characteristics. The most important single crystal parameter is its *temperature coefficient*. Since the frequency of a Y-cut crystal rises with temperature, it is said to have a positive coefficient; conversely, the coefficient of an X-cut crystal is negative

because frequency drops with rising temperature.

For example, the temperature coefficient of a certain Y-cut crystal is given as +75 p/m/C°. This is read as "plus 75 parts per million per °C." It means that for every degree rise in temperature, the crystal frequency rises 75 cps for each megacycle of its basic frequency. Thus, if you assume that the temperature of this Y-cut crystal ground for 3 mc. at 0° C goes up 10° C, the change in frequency will be: 75 cps X 3 mc. X 10° = 2250 cps = .00225 mc. Adding this to the basic frequency gives 3.00225 mc. On the surface, this does not appear to be a serious deviation, but it is a change of 750 parts per million for only 10° of temperature variation. The GT-cut, on the other hand, varies only one part per million over a 100° C range (180° F).

For any given cut at a specified temperature, the frequency of oscillation is determined by the thickness of the blank. As a crystal is ground thinner and thinner, its natural frequency rises. In the early days of crystal control, it was virtually impossible to grind the quartz slabs thin enough to exceed 20 mc. without having them fracture during operation. Since some cuts are worse than others in this respect, the thickness-frequency specification for each is given in terms of the *frequency factor*. This parameter is defined by the simple equation: $k = F \times t$; where F is the fundamental frequency of the crystal in mc., t is the thickness in thousandths of an inch, and k is the frequency factor of the particular cut.

For example, the X-cut has a frequency factor of approximately 112 while the Y-cut is rated at 77. Suppose that one of each of these were to be ground to oscil-

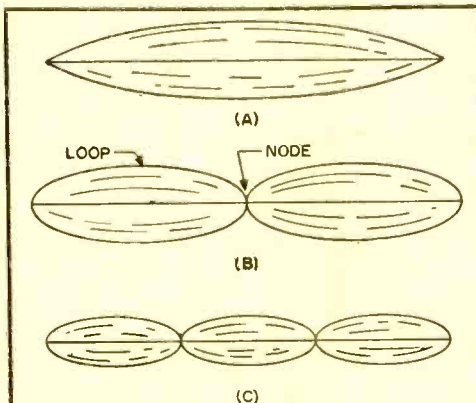

Fig. 2. Analogy showing relation of overtones to fundamental: (A) a string producing its fundamental tone by vibrating in one part; (B) first overtone or second harmonic of the string; (C) second overtone or third harmonic.

the WINNING PAIR

FROM
"the World's Most Personalized Radio Supply House!"

**THE WRL 90 WATT
Globe Chief Kit**

Only **\$500**
PER MO.
~~\$49.95~~
Cash
WIRED FORM
\$64.95

POWER SUPPLY INCLUDED
(75 Watts for Novice Use)

Completely bandswitching, 160-10M. Provisions for Antenna Changeover Relay, speech modulator input, VFO input and operation; Combination Pi-Net. Modified Grid Block Keying. Kit wiring pre-cut and pre-tinned; contains all parts and simplified assembly instructions. Complete with well-filtered power supply. 100% trade-in value allowed toward a Globe King 500B or Globe Champion 300, if made within one year of purchase date.

**WRL's NEW
Screen
Modulator**

(with printed circuit)

Designed specifically for use with the WRL Globe Chief, but may be used with any other Xmtr. such as Heath AT-1, Johnson Adventurer, Knight 50 Watt Xmtr., etc. Permits radio-telephone operation of CW Xmtr. at minimum cost. Self contained in 5 1/4 x 2 1/2 x 2 1/8" chassis. All connections from modulator to Xmtr. are included. Printed circuit board and complete instruction manual make assembly of this kit a dream.

Only **\$13.95**

**SEND FOR COMPLETE INFO
ON THE GLOBE CHIEF KIT
TODAY**

FREE 1957 CATALOG!

WORLD RADIO LABORATORIES
3415 West Broadway
Council Bluffs, Iowa

Please rush to me:

Free 1957 Catalog
 Globe Chief Brochure

NAME: _____

ADDRESS: _____

CITY & STATE: _____

late at 4 mc. Their respective thicknesses would be:

$$\text{X-cut: } t = k/F = 112/4 = .0028''$$

$$\text{Y-cut: } t = k/F = 77/4 = .0019''$$

From this it is evident that the larger the frequency factor of a crystal, the thicker it may be for a given frequency. The AT-cut, with a frequency factor of about 66, is just about the thinnest of all plates.

Overtone Crystals. An overtone or harmonic quartz crystal is one that has been specially ground or otherwise treated by the manufacturer so that it vibrates in two or more parts rather than as a whole. Essentially, this process is very similar to overtone production in musical instruments where the sounding body vibrates in parts showing nodes and loops along its length (Fig. 2). If a crystal were to vibrate in two equal parts, the output would be exactly double the fundamental or "one-part" frequency. In practice, this is seldom the case, because overtone crystals do not "break up" into equal sections as they oscillate.

If, for example, an AT-cut crystal is treated to produce third harmonic output at 21 mc., it might be marked "7-mc. fundamental." This means that its harmonic frequency is *approximately* three times its fundamental; its output may differ from

the true third harmonic by several megacycles. When such crystals are purchased for transmitter control, the buyer should know the harmonic output rather than the fundamental frequency.

Overtone crystals are almost always used in special oscillator circuits in which the crystal responds at its *series resonant frequency*. Standard oscillators operate at their parallel resonant frequencies.

Mounting. The development of better crystal holders has kept pace with improvements in the fabrication of finished quartz plates. These holders are designed to avoid interference with the piezoelectric vibrations of the crystal and to provide protection against mechanical shock. In the pressure-sandwich type of holder, the crystal is supported between two electrodes which are in intimate contact with a pair of flat metal plates to insure good electrical connection. Spring loading and the use of fiber and neoprene make for firm support, excellent protection, and hermetic sealing. This type of holder typifies medium-frequency mounting techniques; at the higher frequencies, particularly when overtone crystals are employed, other kinds of holders are favored.

For extra-precise control of frequency, crystal holders are often enclosed in ther-



FIRST COMPLETE MARINE

DIRECTORY IN JANUARY

POPULAR BOATING!

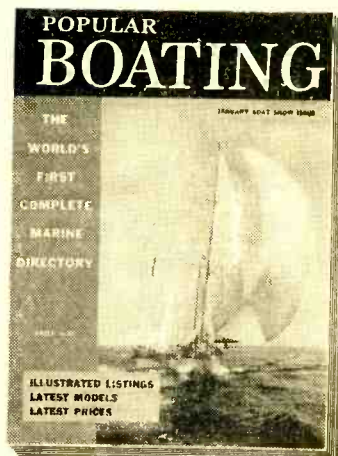

The world's first complete Marine Directory is yours as a big extra bonus in the January Boat Show Issue of POPULAR BOATING, on sale December 27!

If you now own a pleasure boat . . . or plan to buy one soon . . . here's your guide to all craft, equipment and accessories on the market. It contains over 1000 illustrations . . . lists models and specifications accurately . . . reports manufacturers' names and prices in full.

Be sure to buy your copy of the Giant 300-page January issue of POPULAR BOATING. On sale December 27 at your favorite newsstand—only \$1.00.

CUT CHASSIS HOLES FAST!



Smooth, accurate openings made in 1½ minutes or less with Greenlee Radio Chassis Punch

Quickly make smooth, accurate holes in metal, bakelite, or hard rubber with a GREENLEE Chassis Punch. Easy to operate . . . simply turn with an ordinary wrench. Round, square, key, and "D" types . . . wide range of sizes to make openings for sockets, plugs, controls, meters, terminal strips, transformers, panel lights, etc. Assure perfect fit of parts and professional finish to every job. Write for descriptive literature. Greenlee Tool Co., 2381 Columbia Ave., Rockford, Ill.

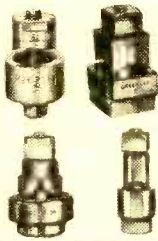

SHOOT TV TROUBLE FAST

With H. G. Cisin's Copyright RAPID "TV TROUBLE SHOOTING METHOD"

Without experience or knowledge, this guaranteed new method of servicing TV sets enables you to DIAGNOSE TV troubles as rapidly as an expert. NO THEORY—NO MATH—you can locate all faults in record-breaking time regardless of make or model. "TV TROUBLE SHOOTING METHOD" is the most valuable aid to TV servicing ever written. Be a TV Trouble Diagnostician. Increase your present earnings. Open your own Profitable Business or get a high-paying skilled job.

It's all in this book . . . Nothing more to Pay—Nothing else to Buy

85 picture troubles, over 58 raster and 17 sound troubles. By this unique copyrighted method you know EXACTLY WHERE the trouble is; plus step-by-step instructions, including 69 RAPID CHECKS, enabling you to find the faulty part.

13 IMPORTANT PRELIMINARY CHECKS NEED NO INSTRUMENTS! Of the 69 Rapid Checks, OVER 65 ALSO REQUIRE NO INSTRUMENTS! Rapid checks include emergency checks for distorted pictures, defective tubes including PIX tube, plus 57 others. ALL EXPLAINED IN SIMPLE LANGUAGE. PERFORMED WITHOUT INSTRUMENTS. MANY CHECKS USE THE PICTURE TUBE AS A GUIDE.

H. G. Cisin, the author, is the inventor of the AC/DC midjet radio. He licenses RCA, AT&T, etc. He has also trained thousands of technicians now owning their own prosperous TV service organizations or holding highly paid TV positions. His years of experience are embodied in this remarkable new book. Guaranteed Money Back in 5 Days If Not Satisfied!

ABSOLUTELY FREE with each order: H. G. Cisin's newest book "TV & RADIO TUBE SUBSTITUTION GUIDE." Gives direct replacements of set and picture tubes. Most valuable servicing aid! ACT NOW—get both books postpaid at cost of only one!

\$1 Post-paid

RUSH COUPON NOW!

H. G. CISIN, CONSULTING ENGINEER,
Amagansett, N. Y.

Dept. P-22

Enclosed find \$1. Rush both books.

Name

Address

City Zone State

ALL TUBES UNCONDITIONALLY GUARANTEED FOR 1 YEAR

On orders of less than 100 tubes — 41¢ each

BRAND NEW TV PICTURE TUBES

RCA and DUMONT Licensed

Partial Listing No dud required

Type	T.M. Price
10BP4	\$10.95
12LP4	12.95
12QP4	10.00
14CP4	15.25
15DP4	16.95
16DP4	18.50
16GP4	19.25
16KP4	17.00
16RP4	\$17.00
17BP4	19.00
17GP4	21.00
17LP4	18.00
19AP4	23.00
20CP4	24.00
21ALP4A	24.00
21EP4	24.00

Picture tubes
F.O.B. PASSAIC, N. J.
via Railway Express

PRETESTED TUBES—INDIVIDUALLY BOXED

0Z4	6AUG	6SH7	12BA6
1B3GT	6AUG5GT	6S17GT	12BE6
1H5GT	6AV5	6SK7GT	12AZ7
1LC5	6AV6	6SL7GT	12BH7
1LN5	6AX4GT	6SN7GT	12BY7
1NSGT	6AT6	6SQ7	12SA7
1Q5GT	6AH4GT	6SR7	12SG7
1R5	6BA6	6TB	12S17GT
1S4	6BC5	6UB	12SK7
1S5	6BE6	6V3	12S17GT
1T4	6BG6G	6V6GT	12SN7GT
1T5GT	6BJ6	6W4GT	12SQ7
1U4	6BK5	6W6GT	12SR7
1U5	6BK7	6X4	19T8
1X2	6BL7GT	6X5GT	19BG6G
3Q4	6B5GT	6Y6G	25B06GT
3S4	6BQ7	7C5	25L6GT
3V4	6BY5G	7C6	25Z5
5U4G	6BZ7	7E7	25Z6GT
5V4G	6C4	7F7	35B5
5Y3	6CB6	7F8	35C5
6AB4	6CD6G	7N7	35L6GT
6AC7	6F6	12AL5	35W4
6AG5	6H6GT	12AT7	35Y4
6AG7	6J5GT	12AU6	35Z5GT
6AF4	6J6	12AU7	50A5
6AK5	6K6GT	12AV6	50B5
6AL5	6L6	12AV7	50C5
6AQ6	6M4	12AX7	50L6GT
6AS5	6S8GT	12AX4GT	117Z3
6AT6	6SA7	12BY7	

Free Postage on all prepaid continental U.S.A. orders. 50¢ handling charge on all orders under \$5.00. 25% deposit on all C.O.D. Subject to prior sale.

take your pick any assortment

100

receiving

tubes

\$38

FREE! 3in-1

PRECISION SCREWDRIVER SET

WITHEVERY ORDER

regardless of size!

TUBE MART

DISCOUNT HOUSE

PRescott 3-0330

The Lakpet Bldg.

Passaic, N. J.

PORT ARTHUR COLLEGE ELECTRONICS COMMUNICATIONS

AM FM Television Broadcast Engineering
Marine Radio Radar

CHECK THESE FEATURES: tuition \$34 per mo., room & board \$50 per mo. in dorm on campus. College operates 5 KW broadcast station. Students get on-the-job training with all courses. Well equipped classrooms & lab., am fm transmitters, radar & marine eqmt., television camera chain, experiment lab test eqmt. & other training aids. Our graduates in demand at good salaries. Free placement service. Have trained men from all 48 states. Approved for GI. Write for details.

PORT ARTHUR COLLEGE Port Arthur
Established in 1909 Texas

RADIO COURSES

- FCC LICENSE PREPARATION
- COMMERCIAL
- AMATEUR
- CODE BRUSH-UP
- THEORY
- TELEVISION AND RADIO SERVICING
- Residence Courses Only
- Personal Counseling Approved for Veterans

YMCA TRADE & TECHNICAL SCHOOL of N. Y.
15 West 63 St. New York 23, N. Y.
EN 2-8117 Catalog P. E.  53rd Year

WANT A BETTER JOB? BECOME AN ELECTRONIC ENGINEER

ONLY 32 MONTHS TO EARN A BACHELOR OF SCIENCE DEGREE IN ELECTRONICS ENGINEERING
Class enrollment limited to allow for individual instructions. Chartered by state of California. Nonprofit-nonsectarian, co-educational—established 26 years.

APPROVED FOR VETS—ENROLL NOW!
SEND FOR FREE CATALOG

PACIFIC STATES UNIVERSITY
1516 S. WESTERN AVE., Dept. M., LOS ANGELES, CALIF.

BIG MONEY FOR YOU THROUGH V.S.I. ELECTRONICS & TV SCHOOL

AGE—NO BARRIER—FUTURE UNLIMITED—EQUIPMENT—ALL THE LATEST—TECHNIQUES—THE BEST APPROVED FOR VETS—CORRESPONDENCE OR RESIDENCE

WRITE FOR YOUR CATALOG—NOW
V.S.I. TELEVISION SCHOOL

4570 Firestone Blvd. Dept. P.E. South Gate, Calif.

YOUR F. C. C. LICENSE

GUARANTEED REPARATION

Get Your License by the Easy Emig Method—Paced at Your Speed—Study Time at Your Convenience.
Write Now For Free Information

EMIG SCHOOL OF ELECTRONICS
4902 SUNSET BLVD. HOLLYWOOD 27, CALIF.

GARAGE DOOR OPENER

Actuator Mechanism \$24.50

EASY TO INSTALL, SAFE, RELIABLE

WRITE for interesting free information . . . TODAY

P. E. HAWKINS CO.

631 Prospect Dept. PE Kansas City 24, Mo.

mostatically controlled ovens which maintain the frequency constant over extremely wide variations in ambient temperature. Such holders are very compact and weigh only a few ounces.

-30-

The Transmitting Tower

(Continued from page 80)

20 meters, the traps act as capacitances and shorten the electrical length of the antenna slightly, so that it acts as a doublet three half-wavelengths long. On 15 meters and 10 meters, the traps have little effect on the antenna, which now operates as five half-waves and seven half-waves, respectively, on these bands.

Several companies manufacture antenna traps for use in "multimatch" antennas with slightly different dimensions from those given above, which are recommended for use with the W3DZZ traps. The traps are available from most amateur supply houses.

There are several versions of the Windom antenna in existence. The most popular version is 137' 8" long. It is fed 46' 6" from one end through a 63' length of 300-ohm, TV twin-lead. This point is chosen because it gives the best average impedance match between the antenna and the 300-ohm twin-lead.

A set of balun coils (B & W or Airdux) or an antenna coupler is usually required between the transmitter and the transmission line of a Windom antenna. Balun coils are especially convenient for use with transmitters with *pi*-network output tank circuits. Once installed, the baluns need no further adjustment when the operating frequency is changed.

Easier to install than the antennas just described is the *end-fed antenna*, one end of which is brought right into the radio shack and is connected directly to the transmitter. Unfortunately, this brings part of the antenna close to buildings, rain gutters and other objects which may absorb power as well as distort the antenna radiation pattern. Nevertheless, such an antenna usually works quite well on 80 and 40 meters.

For best efficiency, an end-fed antenna should be a half-wave long at the lowest operating frequency (130' at 80 meters). Unfortunately, most *pi*-networks have difficulty coping with the high impedance of such a length, without the aid of an external antenna coupler. Consequently, a compromise length is frequently used. An 85' length has been found to load well and to radiate with reasonably high efficiency on the bands from 80 through 10 meters.

Incidentally, the importance of a good

transmitter ground when a single-wire antenna is used must be stressed.

Your Best Bet. A directly fed antenna is probably the best bet for hams living where lack of space or a landlord's edict prevents putting up a better one. One strung inside of a wooden building will usually radiate fairly well. By starting at the front corner of the house and stringing it to the opposite rear corner, with a few zigzags in between, a surprising amount of wire can be gotten up in even a small apartment.

Unfortunately, an antenna inside of a metal frame building is usually too well shielded to be at all effective. But even then, all is not lost. Go to a lumber yard and buy a couple of 1/4" or 3/8" dowel rods, 3' to 5' long. Fasten them to the sills of two windows as far apart as possible on the same wall of your apartment, so that the rods extend straight out from the wall, and hang your antenna between them. If you varnish the rods or spray them with clear plastic before installing them, they will not absorb moisture and you can dispense with insulators.

By using very small wire for the antenna, it becomes invisible from more than a few feet away. In fact, many amateurs have put up full-length antennas, using

fine wire and buttons or pieces of plastic knitting needles for insulators, without attracting any undesired attention.

A quarter-pound spool of No. 36 to No. 40 wire provides the raw material for a lot of antenna experiments. Of course, this fine wire is fragile and easily broken but, once up, it will stay up for a long time.

To reduce breakage, terminate the "invisible" antenna outside the shack window and solder a heavier, flexible wire to it for a lead-in. Fasten the lead-in firmly near the antenna, so that it cannot move and break free.

News and Views

In three months on the air, **Bill, KN4KIR**, has worked 24 states on 40 and 15 meters. He uses an NC-98 receiver and Johnson Adventurer transmitter. . . . **Nick, KN6THN**, could only put up a 22' antenna about 10' high when he first got on the air two months ago, but he managed to work six states with it. Now he has a 3-element, 15-meter beam and "things are really popping." He pops with a Globe Scout transmitter and an NC-240D receiver.

. . . **Jim, K4HMS**, worked 46 states and 12 countries on four continents as a Novice. In three weeks as a General, he has worked the two missing states and eight more countries. He uses a Globe Scout and an S-53A with a Q5'er.

Steve, KN6TAY, sticks to 40 meters with his

WHICH TRANSMITTER KIT TO BUY?

I JUST GOT MY NOVICE TICKET, BUT WHICH KIT SHOULD I BUY?

SAY, THIS VIKING "ADVENTURER" LOOKS LIKE THE ONE FOR ME!

YOU MEAN YOUR RIG WAS MADE FROM A KIT?

SURE, IT'S TVI SUPPRESSED--WORKS ALL BANDS--80 THRU 10--LOADS ALMOST ANY ANTENNA--AND IT'S PUNCHED AND DRILLED FOR YOU, TOO!

THAT'S EASY! CHOOSE THE KIT THAT GIVES YOU THE MOST FOR YOUR MONEY!

LATER SAY! STEP BY STEP INSTRUCTIONS! I'LL BE FINISHED TONIGHT!

EVERYTHING IS SUPPLIED. ALL YOU NEED IS YOUR OWN KEY AND CRYSTAL.

JOHNSON MAKES A COMPLETE LINE OF TELEGRAPH KEYS, TOO. WRITE FOR FULL INFORMATION.

VIKING "ADVENTURER" CW KIT
Compact, completely self-contained 50 watt transmitter kit. Single knob bandswitching—effectively TVI suppressed. Easy assembly by novice or experienced amateur. 80, 40, 20, 15, and 11-10 meters. Cat. No. 240-181-1 complete with tubes. **\$54.95**

MAIL TODAY

E. F. JOHNSON COMPANY
3002 Second Ave., S.W., Waseca, Minnesota

Please send me a copy of Bulletin 727, which describes the Viking "Adventurer" in detail.

NAME _____

ADDRESS _____

CITY _____ STATE _____

TALK · LISTEN · AROUND THE WORLD!



WITH THIS RADIO AMATEUR TRANSMITTER-RECEIVER SENDS AND RECEIVES THOUSANDS OF MILES on Amateur 80 and 40 meter bands—also, Aircraft and foreign bands (3 to 8 mc). PORTABLE SELF-CONTAINED BATTERY POWERED! NO AC PLUG-INS, NO DANGEROUS HI-VOLTAGES. Low cost battery lasts for MONTHS. Crystal controlled transmitter—Power input up to 5 watts—ENOUGH TO TALK 1 MILE OR 1000. REGENERATIVE RECEIVER pulls in weakest stations. Front Panel Send-receive switch—no complicated hookups. Uses any standard antenna. Size only 6" x 4" x 4". Wt. 3 lbs. TESTED—PROVEN—SIMPLIFIED—PRACTICAL—SAFE for radio beginners (NOVICE). Easy to get license. Full information included.

SEND ONLY \$5.00 (bill, check, mo) and pay postman \$9.95 C.O.D. postage on arrival or send \$14.95 and we will send postpaid. Complete kit includes all parts, tube, full instruction, less batteries and crystal—or COMPLETELY WIRED AND TESTED FOR \$19.95! WESTERN RADIO DEPT BNE-1 KEARNEY, NEBRASKA

CABINET MAKING



LOW COST HOME TRAINING COURSE FOR BEGINNERS & ADVANCED CRAFTSMEN

Make money. Learn skills and secrets of fine woodworking and tool use. Professionally prepared shop method training tells and shows how. Covers everything. Easy to master.

Write for **INTERSTATE TRAINING SERVICE**
Free Booklet DEPT F-95 PORTLAND 13, OREGON

CODE SENDING SPEED



Be a "key" man. Learn how to send and receive messages in code by telegraph and radio. Good pay, adventure, interesting work. Learn at home quickly through famous Candler System. Quality for Amateur or Commercial License. Write for FREE BOOK. CANDLER SYSTEM CO. Dept. 5-O, Box 928, Denver 1, Colo., U.S.A.

INVENTORS

Send for **REGISTERED PATENT ATTORNEY**
PATENT INFORMATION Book and INVENTOR'S RECORD without obligation
ASSOCIATE EXAMINER U.S. PAT. OFF. 1922-1929
GUSTAVE MILLER Patent Attorney & Advisor U. S. NAVY DEPT. 1930-1947
17-PE WARNER BUILDING WASHINGTON 4, D.C. **PATENT LAWYER**

GET INTO ELECTRONICS

Train for best technical positions in a Top-flight school. Specialize in missiles, computers, radar, communications, industrial electronics, color TV, automation. Excellent program in theory, laboratory, mathematics. Major firms select our graduates as Tech. reps., field engineers, specialists. Associate degree granted. 21 months' program. High school or equivalent required. Catalog.

VALPARAISO TECHNICAL INSTITUTE
DEPT. PE VALPARAISO, INDIANA

Shrinks Hemorrhoids New Way Without Surgery

Science Finds Healing Substance That Relieves Pain—Shrinks Hemorrhoids

For the first time science has found a new healing substance with the astonishing ability to shrink hemorrhoids and to relieve pain—without surgery.

In case after case, while gently relieving pain, actual reduction (shrinkage) took place.

Most amazing of all—results were so thorough that sufferers made astonishing statements like "Piles have ceased to be a problem!"

The secret is a new healing substance (Bio-Dyne*)—discovery of a world-famous research institute.

This substance is now available in *suppository or ointment form* under the name *Preparation H**. Ask for it at all drug counters—money back guarantee.

*Reg. U.S. Pat. Off.

AT-1 transmitter feeding a quarter-wave antenna with an input of 30 watts, and he has an S-85 receiver. In four months on the air, he has made 64 contacts; his best DX has been 600 miles. If all goes well, he will have passed his General exam about the time you read this. . . . **Gerald, KNØGUJ**, is another 40-meter man. In three months as a Novice, his home-built 6146 transmitter has worked 20 states and VE3 and VE4 (Canada). For receiving, he uses an NC-98 with a Q-Multiplier, and his antenna is a 40-meter doublet.

In Canada, **Ken, VE3EHW**, runs 13 watts to a 6L6 in a home-built transmitter, which feeds a 140' end-fed "zepp" antenna. This equipment, plus an Echophone receiver, has worked 11 states in one month. . . . **Bob, KN5DZE**, uses a DX-35 at 65/70 watts and twirls a three-element rotary beam on 15 meters. Thirty-seven states, and England, Puerto Rico, Hawaii, Ireland, New Zealand, Australia, Germany and Canada have answered his calls so far. He hears them come back on an NC-98 receiver. Bob hopes to WAS (work all states) as a Novice and then get his General class license. . . . **Clayton, KN5ESV**, does his radiating through a 44' vertical antenna, constructed of triangular TV tower sections. It is supported on a husky base insulator mounted on top of a 1½-kva. pole transformer case, which houses the antenna tuning network. Although licensed since April, Clayton did not get his DX-35 transmitter and S-85 receiver until fall. After getting on the air, he made 45 contacts in nine states in a month.

Hans, DJ2NN, (Germany) reports that about every other Novice he works on the 21-mc. band mentions reading about him in the September *Transmitting Tower* and seeing the picture of his station in the October issue, which is more than Hans has done, as it takes six months or more for American magazines to get to Germany. DJ2NN has worked 43 states and is depending upon Novices on 21 mc. for the rest. As he worked 45 of them in a recent two-week period, the job should not take too long. . . . **Ed, WN7FHE**, uses an AT-1 transmitter and an AC-1 antenna coupler to feed a 135' antenna on 3735 kc. His receiver is an S-38D. He had made only two contacts when he wrote us, but had been on the air only three days. He has undoubtedly mailed out a lot of QSL cards since then.

Ed, W8BME, got his Novice license in May, 1955, at the age of 46, and his General Class license in April, 1956. He recommends amateur radio as a fascinating hobby for anyone, be he six or sixty. With his AT-1 transmitter and AC-1 antenna coupler feeding a "dog-leg" antenna 135' long, Ed has made 103 contacts in 17 states and Canada. He is a member of the Rag Chewer's Club, and he QSL's 100%. . . . **Jerry, KN2TNI**, thought for a long time that he was never going to have any use out of his Novice license. He just couldn't seem to get his home-built thirty-watter to work well enough to make any contacts. But perseverance finally won out, and he raised W3FBU. Since then, he has been doing fine. His antenna is 120' long and 20' high, and his receiver is an S-38D.

"Rock," K6QHA, uses a converted ARC-5 transmitter at 90 watts to feed an off-centered antenna and a "Novice Q5'er" on 40 meters. His score for a month of operation is 22 states and Canada. He offers to help anyone get his license.

Contributors to "News and Views": KN4KIR, 4605 7th Ct. So., Birmingham 6, Ala.; KN6THN, 326 N. Kings Rd., Los Angeles 48, Calif.; K4HMS, 200 S. Atlanta St., Smyrna, Ga.; KN6TAY, 11172 Welby Way, North Hollywood, Calif.; KNØGUJ, P. O. Box 113, Parkers Prairie, Minn.; VE3EHW, 30 Frank St., Brantford 6, Ontario, Canada; KN5DZE, 316 South 11th St., Columbus, Miss.; KN5ESV, RFD #1, Shattuck, Okla.; DJ2NN, 5 Joh. v. Weerthstrasse, Freiburg I. BR., Western Germany; WN7FHE, Rte. 2, Box 129-A, Grandview, Wash.; W8BME, 549 Clark St., Toledo 5, Ohio; KN2TNI, 4 East Underhill Pl., White Plains, N. Y.; K6QHA, 2544 Marvin Ave., Los Angeles, Calif. Practically all of these contributors promise that they will answer all letters received—if you should want to get in touch with them.

That uses up our space this month. Remember, this is your column; so write your views. 73,

Herb, W9EGQ

Tuning the Short-Wave Bands

(Continued from page 79)

quency, exact times of reception, reception conditions, signal strength and readability, and program details. Be sure to enclose return postage.

Antennas and Receivers. Many of the larger communications-type receivers do not need an elaborate antenna system for pulling in DX. Often a short piece of wire will suffice. For older models or non-communication type receivers, longer wires are usually needed. A good tight ground wire running from your radio to an iron pipe driven into moist earth makes an excellent ground and will often greatly reduce line and atmospheric noises.

If your receiver reads in megacycles (mc.), you can easily convert it to kilocycles (kc.) by adding three zeros after the megacycle figure. For instance, 4 mc. would be 4000 kc. and 17 mc. would be 17,000 kc.

Station Reports

Here is the resume of current reports. All times shown are EST, 24-hour system. This month we are featuring reports of stations that are not often heard or reported, as well as frequency changes.

Angola—Emissora Oficial, Angola, is heard at 1530 fade-in with a variety of music and native language, and dual to 11,862 kc. This station, on 4955 kc., closes at 1730 (Saturday at 1830A). The 6355-kc. and 9051-kc. outlets are apparently inactive. (GC)

Argentina—LRS1, Radio Splendid, 9742 kc., Buenos Aires, is now operating on this frequency, replacing 9315 kc. It is audible at

January, 1957

FIX BLACK & WHITE TV COLOR

Repair more sets in less time!

Examine this NEW handbook FREE!

HERE IT IS! . . . the newest, most complete, easy-to-follow television servicing guide ever published! Following the same clear approach that made the author's "Elements of Radio" a 1,000,000-copy best-seller, this brand-new book gives you everything you need to know to make extra money fixing both black-and-white and color TV sets. Just master the first few chapters of this book and you are ready for business—



Elements of TV SERVICING

by Abraham Marcus (co-author of famous best-seller, "Elements of Radio") and Samuel Gendler

- Reveals for the first time all details, theory and servicing procedures for the RCA 28-tube color Television receiver, the CBS-Columbia Model 205 color set, and the Motorola 19-inch color receiver.
- Analyzes and Illustrates—so you can actually see what to do—more TV defects than any other book, and provides complete, step-by-step procedure for correcting each one.
- Gives you tested money-making tips and time-saving methods for profitable TV repair and servicing.

PARTIAL CONTENTS: Field servicing—how to install and adjust a new receiver—how to choose the proper antenna and how to erect it—100 common defects (with actual photos of defects) and how to correct them. Bench servicing—set-up for bench servicing—the heater circuit and low-voltage power supply—the horizontal sweep and high-voltage sections—vertical sweep section—synchronization section—alignment—etc., etc. Color television—practical color television receivers—color tube adjustment—trouble-shooting the color television receiver—etc., etc.

USE IT FREE FOR 10 DAYS! Get this great new how-to-do-it TV Servicing book today. Just mail coupon below for 10-day Free-Examination Copy of "Elements of Television Servicing."

MAIL COUPON NOW!

PRENTICE-HALL, INC., Dept. 5702-A1
Englewood Cliffs, N. J.

Send me, for 10 DAYS' FREE TRIAL, "Elements of Television Servicing." Within 10 days, I will either send \$6.95 plus postage, or return the book and owe nothing.

Name

Address

City..... Zone..... State.....

SAVE! Send \$6.95 with this coupon and we will pay postage. Same return privilege: refund guaranteed.

LOOK FOR THESE ZIFF-DAVIS MAGAZINES AT YOUR FAVORITE NEWSSTAND!

ON SALE NOW



Will electronics replace the skilled pilot in the aircraft of tomorrow? Is a human "obsolete" at rocket speeds? A world-famous test pilot gives his candid opinion about the future of high speed flight in the January issue of FLYING.

ON SALE DECEMBER 27



Electronic computers have made many of today's scientific and engineering miracles possible. Scientists look to these electronic brains to help solve even more complex problems of the future. You'll want to read the complete two-part story beginning in January RADIO & TELEVISION NEWS, the world's leading electronics magazine.

ON SALE NOW



Strange things have been going on under the hoods of experimental automobiles. Here's your chance to learn about unusual "odd-ball" engines—developed to increase efficiency, but not yet in mass production. Be sure to read about them in January AUTO MECHANICS.

ON SALE NOW



The first air-cooled engine to be made in America in 22 years is in production. You won't want to miss reading about it in January SPORTS CARS ILLUSTRATED. In addition, you'll enjoy the complete technical breakdown and cut-away of the MG that recently set a new speed record at Bonneville.



ZIFF-DAVIS PUBLISHING CO.,
366 Madison Avenue,
New York 17, N.Y.

Publishers of:

Popular Photography * Radio & Television News * Popular Electronics * Flying * Popular Boating * Sports Cars Illustrated * Auto Mechanics * Modern Bride * Fashion * Photography Annual * Color Photography Annual * Photography Directory & Buying Guide * Hi-Fi Annual & Audio Handbook * Color Television Annual * Pen Pals * Amazing Stories * Fantastic * Dream World * G.I. Joe * Willie The Clown

times around 1900 but usually covered by HCJB, 9744 kc. (100)

Belgium—Brussels is now operating on a new frequency of 11,860 kc., replacing 11,850 kc., and is heard well broadcasting to N.A. at 1815-2000. (100)

Brazil—Radio *Excelsior*, Sao Paulo, a new station on 9585 kc., can be heard at 1800-2200 in Portuguese. PRL8, Rio de Janeiro, a new xmtr for *Radio Nacional*, is noted at 1700-2315 in parallel with 6147 and 9720 kc. (100)

Radio Catholica, Florianapolis, is heard with Portuguese talks and music at 1945-2000. (TG)

Canary Islands—EA8AB, Tenerife, 7295 kc., is weak from 1745 with a program in Spanish. After a Spanish ID and anthem, the station closes at 1757. (GC)

China—Chungking, 9736 kc., can be heard at times around 0632 in Chinese. This is a hard one to hear due to heavy QRM from HI2T, Dominican Republic, on 9735 kc. (GC)

Costa Rica—TIHBG, *Radio Cristal*, San Jose, can be noted on 6006 kc. at 1800 with sports news in Spanish. Reports to this station should be sent to Box 341, San Jose. (CC)

Ecuador—HC1NE, *Radio Nacional Espejo*, Quito, 4680 kc., is heard at 1900-0000 on this new channel, using a new 5-kw. xmtr. HC5GE, *Radio Mundial*, Riobamba, is being noted on 6300 kc. at 1800-2300 s/off. (100)

HCJB, Quito, is now operating with its new 50-kw. xmtr. on 9745 and 15,115 kc. It is easily heard at 0745 with religious music and at 1900-2300 with religious programs, mostly in English. HCJB can also be tuned on 11,915 and 6050 kc. (8, RC, GK, NH, MF)

Finland—The Finnish Broadcasting Co., Helsinki, now operates to N.A. at 0700-0900 weekdays with English news at 0700-0715 (the same schedule is in effect Sunday but no English is presented); to Europe and South America at 0550-0650 daily with English news at 0550. Frequencies are OIX2, 9550 kc., OIX4, 15,190 kc., and OIX5, 17,800 kc. (Direct from the station).

France—*Radiodiffusion Francaise*, Paris, can be heard in English to Great Britain at 1500-1600 on 15,400 kc. They send a nice QSL card. (11)

French Equatorial Africa—The English session from *Radio Brazzaville*, 11,970 kc., has been cancelled. The English news bulletin directed to N.A. will be heard at 2015 on 11,970

Report Cards Available

Your S. W. Editor has Reporting Cards and letter-size Report Sheets available at no charge to anyone who wishes to use them for sending reports in to this column. If you haven't received any, drop us a line and we'll be glad to forward some to you.

and 9620 kc. English news session at 0015-0030 on 11,970 and 9730 kc. is unchanged. (61)

French Somaliland—*Ici Radio Djibouti*, 4975 kc., is believed to be the station noted here testing from 1540 fade-in with Afrikaans-type music to 1600 s/off with French ID and no anthem. (GC)

Germany—The *Deutsche Welle*, Cologne, has its second 100-kw. xmtr and has dropped

the third channel on each xmsn. The Far East xmsn has been moved to an earlier time. Revised schedule is as follows: at 0200-0500 to Far East on 11,795 and 21,650 kc. (new frequency); at 0930-1230 to Near East on 15,275 and 17,815 kc.; at 1300-1600 to Africa on 11,795 and 15,275 kc.; at 1700-2000 to South America on 11,795 and 15,375 kc.; at 2030-2330 to N.A. on 9640 and 11,795 kc. Use of 5980, 9630, 11,945, and 17,875 kc. frequencies has been dropped. (100)

Gold Coast—Accra is being heard on 4915 kc. at 1715 s/off, dual with 3366 kc. The 3366-kc. outlet is noted at 1655 with jazz music; variety music after 1700. The s/off follows

ABBREVIATIONS

A—Approximate frequency
 BBC—British Broadcasting Corporation
 c.w.—Continuous wave
 ID—Identification, identity
 IS—Interval signal
 kw.—Kilowatt
 N.A.—North America(n)
 QRM—Interference
 s/on—Sign-on
 s/off—Sign-off
 xmsn—Transmission from station
 xmtr—Transmitter used by station

"God Save The Queen." Also heard around 0100. (GC, 100)

Greece—Radio Athens has been noted on 17,745 kc. with English news at 1230-1245. This frequency has been replaced now by 11,927 kc. (dual to 15,345 kc.) at 1700-1730 and at 1800-1830 in Greek. (25, 100)

Guatemala—Radio Quetzal, TGAR, Guatemala City, is listed on 5960 kc. but is heard closer to 5890 kc. at 2200-2320 with language and music programs. Reports go to 12 Avenida 26-27. (49)

Honduras—HROW, Radio Montserrat, Tegucigalpa, has moved from 6020 kc. to 5880 kc. and is heard at 1800-2300. (100)

HRA, La Voz de Lempira, 5890A kc., is heard with world news in Spanish at 2335-2342, music to 2358, s/off at 0000. Reports go to HRA, La Voz de Lempira, Comayaguela, D. C., Honduras. (31)

India—Delhi is being heard on 15,245 kc. in English, dual with 12,020 and 15,105 kc. (100)

Delhi is noted on 17,800 kc. at 0845-0900 with Oriental music and an English ID at 0900. News in English can be heard on 17,830 kc. at 2130-2145 s/off. (31, 61)

Indonesia—YDF, Djakarta, 6045 kc., was noted in Home Service xmsn at 0915-1030. Oriental music and Indonesian language made up the programs. (61)

Israel—The latest schedule for 4XB31, Tel-Aviv, reads: 1430-1515 in Yiddish, 1515-1545 in Hebrew, 1545-1630 in French, 1630-1715 (Sunday to 1730) in English. In addition, they operate at 1745-1830 to South America and at 1230-1315 to Africa in the English language. (SK, 37, 83, 104)

Lebanon—Beirut, 8036 kc., is scheduled as follows: in French at 0015-0030 (Sunday at 0015-0115), 0630-0700, 1400-1515; in English at 1000-1100. On Thursday and Sunday, they have a "Request Program" in French at 0500-0630. (95)

Luxembourg—Radio Luxembourg, Junglin-

January, 1957

IT'S THE BIGGEST AND BEST EVER

FREE THE GIANT ALL NEW 1957 BA CATALOG

A COMPLETE BUYING GUIDE FOR EVERYTHING IN...
**RADIO • TV
 ELECTRONICS**
1957
BA
 SINCE 1927

172 KING-SIZED PAGES

EVERYTHING IN RADIO TV AND ELECTRONICS

100'S OF NEW ITEMS LISTED HERE FOR 1st TIME

21 PAGES OF BARGAINS NOT IN ANY OTHER CATALOG

BURSTEIN-APPLEBEE CO.
 Dept. PE, 1012 McGee St., Kansas City 6, Mo.
 Send Free BA Catalog No. 571

Name.....
 Address.....
 City..... State.....

SEND FOR IT TODAY

LINGUAPHONE

MAKES IT EASY TO LISTEN and LEARN to

Speak

**SPANISH [American or European] • FRENCH
 JAPANESE • GERMAN • ITALIAN
 MODERN GREEK—any of 34 languages available**

for FREE TRIAL AT HOME

With LINGUAPHONE—The World's Standard Conversational Method—You Start to SPEAK another language TOMORROW—or IT COSTS YOU NOTHING!
 For just 20 Minutes a Day you listen to Linguaphone's lifelike, conversational recordings. It is easy—AND FUN—to learn another language AT HOME with LINGUAPHONE—the same natural way you learned to speak before you went to school.
 Only LINGUAPHONE brings 8 to 12 of the world's best native language teachers into your home. You hear both men and women speak about everyday matters in their native tongue. YOU understand—YOU SPEAK correctly as they do. It's like living in another country.
 That's why Linguaphone is used "round the world" by educators, governments and business firms. More than a million home-study students of all ages have learned another language this ideal way.
 Send today for Free booklet fully describing the conversational method; also details on how you may obtain a COMPLETE Course-unit in the language you choose on FREE TRIAL. Linguaphone Institute, T-89-017 Radio City, N. Y. 20.

Linguaphone Institute, T-89-017 Radio City, New York 20, N. Y.

Please send me:
 FREE Book Details on FREE Trial.
 No obligation, of course.

My language interest is.....
 Name.....
 Address.....
 City..... Zone..... State.....
 The World's Standard Conversational Method for Over Half a Century



college graduates get ahead faster!

You see it in your own city. They have higher incomes . . . advance more rapidly. Grasp your chance for a better life. Industrial growth . . . automation . . . technical advances create career opportunities for engineers, accountants, management experts. Share rewards awaiting college-trained men. Important firms visit campus regularly to employ Tri-State College graduates. Start any quarter in this world-famed college. Approved for veterans.

Bach. of Science degree in 27 months

in Mechanical, Civil, Electrical, Chemical, Aeronautical, Radio (TV-Electronics) Engineering. In 36 months a B.S. in Business Administration (General Business, Accounting, Motor Transport Management majors). Superior students may accelerate. 36-week course in Drafting. Intensive programs: technical fundamentals stressed; comprehensive courses with more professional class hours. Small classes: personalized instruction. Enrollment limited to 1550. Preparatory courses. Beautiful campus. Well-equipped, new and modernized buildings and laboratories. Enter March, June, Sept., Jan. Earnest, capable students (whose time and budget require accelerated courses and modest costs) are invited to write Jean McCarthy, Director of Admissions, for catalog and book "Your Career in Engineering and Commerce."



TRI-STATE COLLEGE

3617 College Avenue Angola, Indiana

PALM SIZE RADIO 1000 MILE RANGE

There is no substitute for an ELECTRON TUBE when long range reception is desired. Complete kit covers STANDARD Broadcast Band. All parts including wiring board and battery adapter fit inside of palm size plastic case. Set uses hearing aid batteries for low voltage supply. We can supply at \$1.50 including extra "A" battery. Assembly time about a half hour with simple easy do it yourself circuit diagram. Use with any high imp. ear-phone or we can supply radio type at \$1.25 or a super quality hearing aid earset at \$4.55. Everything you purchase is American made FULLY GUARANTEED to outperform inferior parts of Japanese origin. C.O.D. orders accepted with \$1.00 deposit. **PRECISION PRODUCTS CO., Placerville, Calif.**

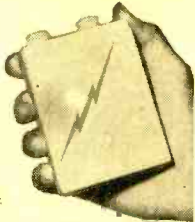

MOVING?

BE SURE POPULAR ELECTRONICS FOLLOWS YOU. PLEASE SEND YOUR CHANGE OF ADDRESS TO

POPULAR ELECTRONICS

CIRCULATION DEPARTMENT

64 E. Lake St.

Chicago 1, Ill.

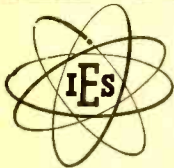

ELECTRONIC TECHNICIANS

ARE IN DEMAND

TRAINED MEN ARE NEEDED NOW!

In just 18 months you can complete Electronic Technicians training to enter this ever-growing industry. Day or evening classes.

Opportunity for employment in local industry. Approved for Korean Veterans.

Terms beginning January, April, July, September

Write for Catalog 224 TODAY

INDIANAPOLIS ELECTRONIC SCHOOL

312 E. Washington St.

Indianapolis 4, Indiana

ster, has been noted on 6090 kc. around 0130 in German with very heavy QRM. (DC)

Malaya—Radio Malaya, ZHP3, Singapore, 7199 kc., can be tuned around 0625 with pop records. It is heard at poor to fair level and there is some ham QRM. (GC)

Radio Malaya, ZH18, Singapore, is heard on 4820 kc. at 0830-0900 with a jazz program; news at 0900-0915 which is followed by more music. (31)

Mozambique—Radio Clube de Mozambique has been testing a new xmtr of 100-kw. power to Europe on 17,795 kc. at 0900-1030 and on 15,085 kc. at 1100-1515. Reports go to P. O. Box 594, Lourenco Marques. (26, 95, 44)

The outlet on 9772 kc. has been moved to 9640 kc. and can be heard well at 0900-1010 s/off with English programs of music and

SHORT-WAVE CONTRIBUTORS

Camilo A. Castillo (CC), Panama City, Panama
David W. Crockett (DC), Winston-Salem, N. C.
Roy Conley (RC), Andrews, N. C.
Tom Conner (TC), Ashland, Oregon
Milton Faivre (MF), Tampa, Fla.
Tibor Gasparik (TG), Cleveland, Ohio
Nick Hardesty (NH), Clearwater, Fla.
Gary Kaplan (GK), Philadelphia, Pa.
Sheldon Klapholz (SK), Cleveland, Ohio
Glen Kippel (KP), Denver, Colo.
Bill Berger (8), Fairfax, Okla.
Chuck Maxant (11), Baldwin, N. Y.
Francis Welch, Jr. (25), Worcester, Mass.
Floyd Backus (26), Richmond, Va.
Gordon Nelson (31), Inglewood, Calif.
David Bergdahl (32), Valley Stream, N. Y.
Stuart Fidler (37), Jordan, N. Y.
Anson Boice (44), New Britain, Conn.
Enmet Riggie (48), Massillon, Ohio
Paul Mathieu (49), Southbridge, Mass.
Jim Cumbie (54), Sherman, Texas
John Beaver (61), Pueblo, Colo.
Lee Kunkel (68), Redlands, Calif.
John Mann (82), Montreal, P. Q.
Rob Hatter (83), Syracuse, N. Y.
Frank Gilmore (85), Springfield, Mo.
Port Baughman (95), Rockport, Texas
Roger Legge (100), McLean, Va.
Ed Kowalski (104), Philadelphia, Pa.

(Full addresses available on request)

Special thanks go to George Cox (GC) New Castle, Pa., for his efforts in logging many of the lesser known stations listed this month.

commercials. The ID and IS are given hourly. (GC, KP, 68)

Nigeria—The East Regional Service at Egunu, 3967 kc., is noted almost daily around 1700 (Saturday to 1800A). Kaduna, 3326 kc., was noted at 1650 with instrumentals and a weak signal and QRM from a Mexican c.w. station on 3325 kc. They close at 1700A. (GC)

North Korea—The North Korean station on 6250 kc. has been identified as Radio Korani, Pyongyang. It is noted at 0626 with Korean music and native language. This one usually fades out rapidly by 0700. (GC)

Pakistan—Karachi, 15,245 kc., can be heard with English programs at 1315-1400 and 1415-1500, replacing 21,580 kc. (100)

Karachi can also be heard on 17,715 kc. at 0845-0915 with Oriental music and news, and on 17,750 kc. at 1930-2000 to the Southeast Asia Area with Oriental music. English ID at

2000, press review and music follow. (25, 82)

Portuguese India—CR8AB, Goa, 9610 kc., is another hard one to hear but watch for it around 0200-0300 and 0710-0725 with some pop records and announcements in Hindi. (48)

Saudi Arabia—Djaddah, 17,787 kc., has been tuned at 1000 s/on with Arabic music and ID. They cause considerable QRM to Switzerland on 17,784 kc. (GC)

Sierra Leone—Sierra Leone B/C Co., Freetown, 3316 kc., is heard from 1653 fade-in to 1705A s/off with ID as given above. They close with "God Save The Queen." Reports go to Sierra Leone Broadcasting Service, Public Relations Office, 26a, Westmoreland Street, Freetown, Sierra Leone. (GC)

South Africa—South African B/C Co., Roberts Heights, operates Monday-Friday at 0730-0845. ID is given in Afrikaans and English. Classical music follows. Johannesburg, 9523 kc., is noted at 0115 with music; news at 0130 in native language. Paradys, 4800 kc., has moved from 4809 kc. and causes QRM to Nigeria at 0900. They have setting-up exercises at 2345-0000, chimes, and then news. (GC, 31, 100)

South Vietnam—Radio Saigon, the Voice of the Republic of Vietnam, has for some time been broadcasting an English session at 1100-1130 on 9745A kc. French follows. (TC)

Sweden—Stockholm is operating on a new frequency of 17,840 kc. at 0600-0645 to Latin America (replacing 17,800 kc.) and 0815-0915 to Eastern N.A. (replacing 15,155 kc.). Other N.A. xmsns are heard at 1900-2130 (9620 kc.) to the eastern portion, at 1100-1145 (15,155

kc.) and at 0000-0100 (9620 kc.) to the western states. Radio Sweden relays the Home Service at 0000-0400 on 6065 kc., 0400-1100 on 11,880 kc., 1100-1800 on 6065 kc., and 0000-1800 on 7270 kc. (100)

Switzerland—A new station in Geneva, HEU2, 9520 kc., is being used to relay the 1215-1407 United Nations broadcast to Europe that originates on WBOU, 15,230 kc., and WDSI, 21,570 kc. (54)

HER9, Berne, is using 25,640 kc. at 0215-0730. (100)

Syria—Damascus is being heard at good level at 0800-0900 in Arabic for Morocco. QRM from Rome after 0815. (GC, 100)

Damascus is also being tuned on 17,865 kc. in an English period at 1545-1630 with news, Oriental music, and announcements. ID is Syrian Broadcasting Service in Damascus, Syria. (31, 61)

Tahiti—Radio Tahiti, FZP9, Papeete, on 6135 kc., is heard at 0200-0245/close with English news and feature program at 0230-0244. This is a new closing time. (49)

USA—The Voice of America on 21,650, 17,830, and 15,270 kc. has a DX forecast daily at 1305A for the day and week which is highly accurate. On Saturday they present a 15-minute program devoted to amateur radio in which they give a DX forecast. This latter program is heard at 1345. (85)

Venezuela—YVME, Ondas Del Lago, 4800 kc., Maracaibo, has returned to the air after several months' absence, using a new xmtr with the best YV signal in the 4-megacycle band. (100)

-50-

bigger BETTER BARGAINS at VIDEO

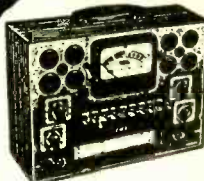

**EICO
TUBE
Tester**
Model
625K

- Illuminated gear-driven "Speed Rollchart"
- New lever-action switches for individual testing of every element
- Tests all conventional and TV tubes

\$49.95 wired Kit, **\$34⁹⁵**



**Brand New
PICTURE TUBES**

- RCA Licensed • One Year Unconditional Guarantee

Type	Price	Type	Price
10BP4	\$11.90	17BP4	\$20.63
12LP4	\$14.38	19AP4	\$24.81
14BP4	\$16.86	21AP4	\$28.79
16RP4	\$19.38	21EP4	\$28.79
16LP4	\$19.38	24AP4	\$42.50

Picture tubes shipped F.O.B. Harrison, N. J. Above types are most popular. However, you may order any equivalent size at the same price!

NEW INDOOR ANTENNA

Both UHF and VHF. Brings better reception than most outdoor antennas. Use on top of TV. List price \$9.95.

YOUR PRICE \$3²⁹
Lots of 3
\$3.99 each

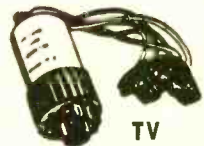

TV TUBE BRIGHTENER

Fits all makes of picture tubes. AC parallel circuits. Completely automatic. Easy to install.

each
Lots of 3
89^c 99^c each, single

FREE POSTAGE in U.S.A. and Territories on orders over \$5.00. 25¢ handling charge on orders under \$5.00. 25% deposit required on C.O.D.'s. Please send approximate postage or freight on Canadian and foreign orders. Subject to prior sale.

ELECTRIC COMPANY
79 CLINTON PL. NEWARK, N. J.
Phone HUmboldt 4-9848

POPULAR ELECTRONICS

BARGAIN BASEMENT

SAVE ON THESE SPECIAL BUYS OF THE MONTH

19.95 LAFAYETTE SPECIAL
RADIO CONTROL TRANSMITTER

Completely assembled — tested — and guaranteed R/C transmitter. Includes tube and 27.255 MC crystal, 6 set, telescoping antenna. Size: 4" x 4" x 12". Approx. 1 mile range. Shpg. wt., 3 lbs. Less batteries.
F-249 Net 19.95

Lafayette Radio DEPT PE-1
165-08 LIBERTY AVE., JAMAICA 33,
 Include postage with order.

New Midget POCKET SIZE Radio
\$2.98

Listen at work, play, in bed. Fits shirt pocket. No tubes. No batteries. No electric plug-ins. No expense. Plays day & night forever. New self-powered diode rectifier replaces tubes. **NO BUILDING.** Tuner covers complete broadcast band. Short aerial brings in local stations. Red plastic case only 3x3 1/4 x 1 1/2 inches. Lifetime guarantee. Radio (without phone) **\$2.98.** Hearing Aid Phone (plugs in ear, flesh-colored (almost invisible)) **\$1.98.** Regular phone **\$1.25.**

JOHNSON SMITH CO., Dept. 528, Detroit 7, Mich.
New Catalog 3200 Novelties
 Novelties, jokes, tricks, magic, fun-makers, hobbies, jewelry, radios, home-craft, photo items, etc. Cat. 10c. Johnson Smith & Company, Dept. 528, Detroit 7, Mich.

RADIO CONTROL Headquarters
 For model airplanes, boats, cars, etc. FREE CATALOG "P."
 No operator's license required. FREE SEND FOR FCC FORM 505 Garage Door Radio Control Transmitters & Receivers Kit Available.

R/C TRANSMITTER & RECEIVER KIT
 27 3/4 Mc. 5 Watt 2-Tube Simple Transmitter & Super-sens. 2 Tube Simple Receiver—Parts incl. Drilled Bases Wound Coil, Res., Cond., SIGMA Relay, Instruct. **\$9.95**

SIGMA 4F RELAY: 8,000 ohm, \$3.85; 6 Reed Relay 14.95
 2-6V Battery Charger Kit \$4.95; wired 6.95
 R/C BOOKS: Model Control \$1; Radio Control \$1; Handbook 2.25
 CRYSTALS: 27.255 Mc. Petersen Z9A. \$3.98; HOLDER 15
 2" METERS, 150 MicroA, \$3.95. 0-1 Ma. 3.65

RELAY CONTROL UNIT incl. Sensitive 10,000 ohm Sigma Relay (1 1/2" Ma) Thermal Si-metal Strip, Heating Element, Hi Z Audio Choke, Mini Alnico V Magnet, Neon Lamp, Resistors, Capacitors only .99
 TUBES: XFG1, RK61, 3A4, 3A5, 6K4, 6K6 99
 Storage Batteries: Mini, 6V, NT6, \$2.45; 2V 27A/Hour. 2.75
 Flash STROBOSCOPE 110 V. AC Range, 30-2000 P/M. 29.85

GYRO ELECTRONICS 325-P CANAL, N. Y. 13, N. Y.

HARMONICA CONTACT MICROPHONE
Makes a one man band out of every harmonica player.

A fine quality, sensitive, crystal microphone with a high output especially designed to fit harmonicas. May be connected to any P. A. system, or the audio section of a phonograph or radio. Installation is simple. Sturdily built and measures only 1 1/8" L x 3/8" W x 3/4" D. Complete with 7 ft. shielded cable. Dept. PE-L. Net 2.95

Lafayette Radio **165-08 LIBERTY AVE. JAMAICA 33, N. Y.**

SUPER SPECIALS AT GROVE'S TRANSISTOR HEADQUARTERS

RAYTHEON TRANSISTOR RADIO CABINETS \$.98
 TRANSISTOR LOOPSTIKS (7-INCH) 1.49
 CRYSTAL EARPHONES (1000 OHM) 1.49
 MIDGET RELAYS (SPDT-5000 OHM) 2.75
 CK722 EQUIVALENT TRANSISTORS 7.95
 VOKAR TRANSISTOR I.F. KIT (3-IF'S-1 OSC COIL) 5.39
 1 1/2" MIN. SPEAKER WITH OUTPUT TRANSFORMER 2.95
 3" PM SPEAKERS OR 4" PM SPEAKERS 9.99
 CLEAR PLASTIC CASES W/ COVER (SX2X1) 10
 SUB-MIN. PHONE PLUG AND JACK 49
 TRANSISTOR TESTER KIT (WITH METER) 7.95
 5-PRONG TRANSISTOR SOCKETS 1.99
 CRYSTAL LAPEL MICROPHONES 2.49
 PRINTED CKT. TRANSISTOR RADIO KIT 6.95
 SUPER TRANSISTOR RADIO KIT (\$19.95 VALUE) 19.95
 (INCLUDES MIN. SPEAKER-2 TRANSISTORS-DIODE)

GROVE ELECTRONIC SUPPLY CO.
 4103 W. BELMONT AVE. CHICAGO 41, ILLINOIS

New PRINTED CIRCUIT NOVICE TRANSMITTER KIT
2 BANDS 40 & 80 meters

The PCK-100 is a complete 20 watt Novice transmitter kit for 80 and 40 meters. The circuit utilizes a Pierce type 6C4 oscillator and a 5703 tuned amplifier. It required no meters for tuning and works into any simple antenna system.

The PCK-100 is also useful as an exciter for higher powered transmitters and can also be used as a radio controlled equipment.

20 Watts only \$995

MODEL PCK-100
 mitter and by simple rearrangement can also be used as a transmitter for radio controlled equipment.

EBY SALES CO. OF N. Y. Power Supply PS-100
 180 Lafayette St., N.Y.C. 13, N.Y. | Less Tube **\$11.95** Net

LITTLE "JEWEL" R/C RELAY

The Mighty Mite of the R/C field. Weighs less than 1/2 oz. Only 3/8" H x 17/32" W x 1-1/16" L. Highly sensitive—extremely rugged. Pulls at 1.4 Ma—drops out 1.2 Ma D.C. S.P.D.T. 5000 ohm coil.
F-260 Net 2.75

Lafayette Radio **100 SIXTH AVE., BOSTON 10, MASS., 110 Federal St. NEWARK 2, N. J., 24 Central Ave. PLAINFIELD, N. J., 139 W. Second St. BROWX 58, N. Y., 542 E. Fordham Rd**
 DEPT PE2 Include postage with order

ATOMIC ENERGY AN CONNECTORS

ONLY ONE OF ITS SIZE & TYPE CAPABLE OF CARRYING UP TO 10,000 VOLTS. ONLY 20 amp. — gold alloy contacts. **\$237** POST PAID IN U.S.A.
 Tiny—size of your index finger.

SANFORD ESTES & COMPANY
 ELECTRICAL DIV.
 4548 COTTAGE GROVE CHICAGO 15, ILL.

Brand New RL-42—Bargain Antenna Reel and Motor

1/4 H.P. 24 V. DC motor (will also operate on AC) with gear reducer & reversing. This is the one used to build the coil winders. SHIP. wt. 11 lbs. **\$1.95** in original packing. Ea.
10 for \$17.50
 Include Postage
MONEY BACK GUARANTEED if Returned Prepaid within 10 Days

ESSE RADIO CO. 42 West South St. Indianapolis 25, Indiana

7.95 LAFAYETTE SPECIAL R/C RECEIVER

Completely wired and assembled, with tube, ready to operate on exam free 27.255 MC remote control band. Size: 1 3/8" x 1-15/16" x 3". Weight 3.3 oz. Uses one 1.5 volt and one 45 volt battery. Less batteries. Shpg. wt., 6 oz.
F-208 Net 7.95

Lafayette Radio **100 SIXTH AVE., BOSTON 10, MASS., 110 Federal St. NEWARK 2, N. J., 24 Central Ave. PLAINFIELD, N. J., 139 W. Second St. BROWX 58, N. Y., 542 E. Fordham Rd**
 DEPT PE2 Include postage with order

The 5:15—Short-Wave Converter

(Continued from page 69)

converter. Note the frequency on the dial of the communications receiver, then subtract 1.5 mc. from this reading. The resulting number will be the frequency to which the converter main tuning dial is set. This frequency can be marked on the dial. The main tuning dial may then be set at various spots throughout its range and the procedure repeated to calibrate the dial completely.

In using the converter, always keep adjusting the "RF Tune" control as the main tuning dial is adjusted. If you are searching for a signal, adjust the "RF Tune" control for maximum background noise. The position of this control will always roughly correspond to the position of the pointer of the main tuning dial.

—50—

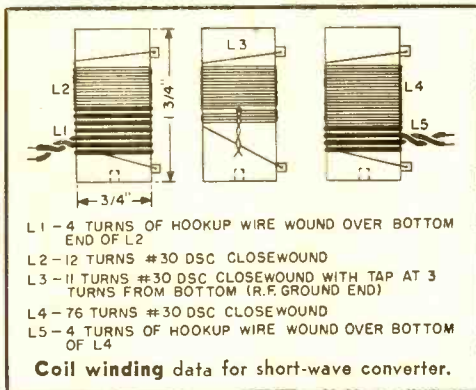

ASSEMBLE YOUR OWN

WALKIE-TALKIE

RADIOPHONE



for as little as

\$6.98

plus accessories

Specifications: 1 to 5 mile range with 18-inch antenna and much more with directional beam antenna. Tunes from 144 to 148 mcs. High level amplitude modulation. Silver plated tank circuit and many other exclusive features assure maximum efficiency and long battery life. Fully portable—no external connections ever needed. Meets FCC requirements for general class amateur license. No minimum age requirement.

The following components are all you need to assemble a complete walkie-talkie as illustrated. Factory wired and tested transceiver chassis complete with special dual tube \$6.98
 High output carbon mike \$1.49
 Miniature mike transformer \$.98
 Powerful alnico magnet headphone \$1.25
 Strong 16 gauge aluminum case [8"x5"x2"] with all holes punched, battery compartment, battery switch plus all hardware and fittings including 18" antenna \$3.98

Uses standard batteries available at your local radio store. All components except tubes guaranteed for one year. Include 5% for postage. COD's require \$2.00 deposit

SPECIAL: Limited quantity, brand new Western Electric telephone handsets \$6.98
 Receiver impedance matching transformer for using handset with walkie-talkie \$.98

All orders immediately acknowledged

SPRINGFIELD ENTERPRISES

Box 54-E Springfield Gardens 13, N. Y.

ENGINEERING
DEGREE IN
27 MONTHS

INDIANA TECHNICAL COLLEGE

B.S. Degree, Aeronautical, Chemical, Civil, Electrical, Mechanical, & Electronic Eng. (inc. Radio & TV). B.S. degree in 36 mo. in Math., Chem., Physics, Prep. courses. Low rates. Earn board. Large industrial center. Students from 48 states, 21 countries. Demand for grads. G.I. appr. Enter Mar., June, Sept., Dec. Catalog 2317 E. Washington Boulevard Fort Wayne 2, Indiana

Classified

RATE: 50¢ per word. Minimum 10 words prepaid. March issue closes January 3rd. Send order and remittance to: POPULAR ELECTRONICS, 366 Madison Avenue, N. Y. C. 17.

FOR SALE

24 PAGE Handbook "Crystal Set Construction" including Experimenter's catalog—30¢. Laboratories, 328-L Fuller, Redwood City, California.

WALKIE-Talkie chassis \$6.98. Illustrated in this issue. See index on last page. Springfield Enterprises.

CITIZENS band radio plans for building your own receiver and information on transmitter design. FCC requirements, etc. plus special discount on type approved transceivers. All for \$1.00. Springfield Enterprises, Box 54-E1, Springfield Gardens 13, N. Y.

DIAGRAMS for repairing radios \$1.00. Television \$2.00. Give make, model. Diagram Service, Box 672-PE, Hartford 1, Conn.

WALKIE-TALKIE. Build wireless portable radiophone for less than \$10.00. Plans for variable frequency and crystal control types, only 50¢ for both, including assembly photographs. Springfield Enterprises, Box 54-E1, Springfield Gardens 13, N. Y.

TRANSISTOR devices, walkie-talkies, VHF AM-FM portable radios, wireless mikes, etc. at wholesale prices direct from our factory. Free literature. Springfield Enterprises, Box 54-E1, Springfield Gardens 13, N. Y.

TUBES-TV, Radio, Transmitting And Industrial Types At Sensibly Low Prices. New. Guaranteed 1st Quality Top Name Brands Only. Write For Free Catalog or Call Walker 5-7000, Barry Electronics Corp., 512 Broadway, New York 12N, N. Y.

DIAGRAMS! Repair Information! Radios—Amplifiers—Recorders \$1.00. Television \$1.50. Give Make, Model, Chassis. TV Mittie, Box 101-PE, Hicksville, New York.

TELEPHONE Transmitter. Hand set type. Suitable for inter-house phones, speakers or any communication purpose. Delivered two for \$1.00. No C.O.D.'s. Telephones. Dept. C-729, 1760 Lunt, Chicago 26.

COMPLETE Television sets \$11.95. Jones TV, 1115 Rambler Avenue, Pottstown, Pa.

BUILD powerful 3 transistor radio. Plans, 50¢. Cook, 4003-E Roosevelt, Midland, Texas.

INSTANT Soldering of electronic connections. No waiting for tips to heat. Only light weight pencil to hold. Free literature. Meyer Engineering, Ferrysburg, Michigan.

NEW for all Hams and SWL'ers. UR Call Letters in Plastic. Attaches to smooth surfaces, windshield, xmitter, receiver etc. Only \$1.00 Postpaid. Frad Co., Dept. B-1, Box 234, Coshocton, Ohio.

BUY Government Surplus—Walkie-Talkies; Radio-TV Electronics; Transceivers; Test Equipment; Oscilloscopes; Radar; Voltmeters—Direct from U.S. Government Depots—Fraction of Army Costs—List & Procedure \$1.00—Brody, Box 8-PE, Sunnyside 4, New York.

REMAINING Instruction "Sheets" regarding "Different" 3' Square, 4-CK722 Radio (Speaker! No Transformers! Stations Remote! No Outside Antenna!) "Plus" Companion "Battery-Eliminator" Data \$1.00 until exhausted! "Booklet" form "then" \$3.00! Details: D. W. Bush, 2345-A South El-Camino-Real, San-Clemente, California.

TELEPHONE Extension in your car. Answer your home telephone by radio from your car. Complete diagrams and instructions. \$1.25. C. Carrier Co., 734 15th St., N.W., Washington 5, D. C.

EAVESDROP with a pack of cigarettes. Miniature transistorized radio transmitter. Complete diagrams & instructions. \$1.25. C. Carrier Co., 734 15th St., N.W., Washington 5, D. C.

CARTONED Radio Tubes Name Brands. 60% Discount. C.O.D. Free Radio Parts List. Anderson's Radio Service, 44 B Limestone St., Caribou 6, Maine.

ELECTRIC Guitars, amplifiers, parts, wholesale. Free catalog. Carvin PE 287 Covina, Calif.

WANTED

CYLINDER and old disc phonographs. Edison, Conqueror, Idella, and Oratorio models. Berliner Gramophones and Zono-o-phones, Columbia cylinder Graphophones, and Coin-operated cylinder Phonos. Want old catalogues and literature on early phonos prior to 1919. Will pay cash or trade late hi-fi components. **POPULAR ELECTRONICS**, Box 50.

TUBES and equipment bought, sold and exchanged. For action and a fair deal write B. F. Gensler, W2LN1 56 Crosby St., N. Y., 12N, N. Y.

REPAIRS AND SERVICING

KITWIRING specialist reasonable. Gerard Herman, 927-30th Ave., Seattle, Washington.

INVENTIONS WANTED

INVENTIONS wanted. Patented; unpatented. Global Marketing Service, 2420 77th, Oakland 5, Calif.

BUSINESS OPPORTUNITIES

\$60 WEEKLY, spare time—easy! Home Venetian Blind Laundry. Free book. Burt, 2434BY, Wichita 13, Kansas.

VENDING Machines—No Selling. Operate a route of coin machines and earn amazing profits. 32-page catalog free. Parkway Machine Corporation, Dept. 12, 715 Ensor St., Baltimore 2, Md.

PLATE Baby Shoes, jewelry, gifts, bronze and colored pearl. Free booklet. Thompson, 11029 South Vermont, Los Angeles 44, Calif.

TO \$100.00 Weekly. Sparetime, Home Operated Mail-order Business. Successful "Beginner's" Plan. Everything Supplied. Lynn, 10420-E National, Los Angeles 34.

EMPLOYMENT INFORMATION

JOBS—High Pay. South America, the Islands, USA, foreign countries. All trades. Clerical, labor, engineers, drivers, others. Women also. Fare paid. Application forms. For information. Write Section 92B, National Employment Information, 1020 Broad, Newark, N. J.

TAPE RECORDERS

RECORDERS, Tape, Hi-Fi. Wholesale Prices. Catalogue. Kerstin, 215 E. 88 St., N. Y. C. 28.

TAPE RECORDERS, Tape. Unusual Values. Free Catalog. Dressner, 69-02F, 174 St., Flushing 65, N. Y.

WHOLESALE! Recorders. Tapes. Phonographs. Radios. Catalogue 10¢. Towers—155, Philadelphia 5.

PRE-RECORDED Tapes, Recorders, Accessories, Unusual Values, Catalog. Efsco Sales, 270-A Concord Avenue, West Hempstead, N. Y.

CODE made easy with your Tape Recorder. Most modern method known. Novice course \$11; General \$10. Pass that General test with a breeze. Dual track 3¼ IPS. Tapedcode, Box 31-B, Langhorne, Pa.

HIGH FIDELITY

FREE Monthly Hi-Fi Bulletin. Write for quotation on any components. Sound Reproduction Inc., 34 New St., Newark, N. J. Mitchell 2-6816.

INSTRUCTION

ENGINEERING Degrees earned by home study. (Residential Courses also available.) Pacific Internation University, Box 27724-D, Hollywood 27, California.

BECOME Tax Consultant. Graduates earn \$3,000 every tax season preparing returns evenings. State approved. Union Institute, 68 Hudson, Hoboken 3S, N. J.

LEARN While Asleep! Details free. Research Association, Box 610, Omaha.

PIANO Tuning course. Complete self-instruction lessons. Also teaches you piano regulating, repairing and other servicing operations. Wonderful illustrations. Full price only \$4.95 postpaid, or C. O. D. plus postage. Satisfaction guaranteed or refund. Nelson Company, 210 South Clinton, Dept. AT-43, Chicago 6.

KNOW Morse Code in minutes. Revolutionary Code Teacher proved 10 years. 50¢ and self-addressed stamped-envelope to "Philkoda-E", 7120 Lanser, Birmingham, Mich.

STAMP COLLECTING

300 DIFFERENT Given Free With Approvals. Particulars. Windsor Stamps, 8834B Cornell Ave., Chicago 17.

MISCELLANEOUS

SONGPOEMS and Lyrics Wanted! Mail to: Tin Pan Alley, Inc., 1650 Broadway, New York 19, N. Y.

KITS Wired—Any brand, type; Quotations—Ullman, 195 Foxmeadow, Scarsdale, N. Y.

CLEANING House. Selling instruments, parts, hi-fi components, books. Write for free list. Frank Malley, 210 E. 17 St., New York 3, N. Y.

When you order by mail . . .

please print your name and address clearly, be specific in your order, enclose proper amount, allow ample time for delivery.

ADVERTISER'S INDEX

ADVERTISER	PAGE NO.
Allied Radio Corp.	8, 9, 30, 113
American Radio Relay League	111
Audak Company	35
Audel Publishers	106
Bell Telephone Laboratories	38
British Industries Corp.	19
Burstein-Appelbee Co.	125
Burton's	30
Cabinart	118
Canadian Institute of Science and Technology Limited	108
Candler System Co.	122
Capitol Radio Engineering Institute	27
Centralab	26
Central Technical Institute	33
Cisin Consulting Engineer, H. G.	119
Cleveland Institute of Electronics	23
Coyne Electrical School	5, 113
DeVry Technical Institute	11, 29
Eby Sales	128
Electronic Instrument Co., Inc. (EICO)	25
Electronic Measurements Corp.	34
Electro-Voice	6
Embry-Riddle School of Aviation	20
Emig School of Electronics	120
Esse Radio Co.	109, 128
Funk & Wagnalls Company	114
Garfield Co., Oliver	89
Grantham School	116
Greenlee Tool Co.	119
Grommes	36
Grove Electronics	128
Gyro Electronics	120
Hawkins Co., P. E.	93, 94, 95
Heath Company	28
Hershel Radio Co.	129
Indiana Technical College	126
Indianapolis Electronic School	114
Instructograph Company	13
International Correspondence Schools	122
Interstate Training Service	121
Johnson Co., E. F.	16, 17, 128
Lafayette Radio	103
Lektron Specialties	110
LMB Box Chassis	125
Linguaphone Institute	3
McGraw-Hill Book Co., Inc.	112
Midway Company	107
Miller, Gustave	18
Miller Company, J. W.	107
Milwaukee School of Engineering	108
Mini-Tronics Co.	132, 3rd & 4th Covers
Modernophone, Inc.	97
Moss Electric Distributing Co., Inc.	99, 100
Muscraft	15, 107
National Radio Institute	10
National Schools	35
North American Phillips Co., Inc.	110
Orradio Industries Inc.	20
Ortho-Sonic Instruments Inc.	110
Pacific States University	118
Pentron Corporation	120
Phila. Wireless Technical Institute	36
Popular Boating	110
Port Arthur College	120
Precision Development Co.	2nd Cover
Precision Electronics	36
Prentice-Hall	127
Progressive "Edu-Kits," Inc.	31
Quality Electronics	114
Radio-Television Training Association	12
Raytheon Mfg. Co.	37
RCA Institute	22
Rider Publishing Co., Inc., John F.	32
Rinehart & Co., Inc.	24
Sams & Co., Inc., Howard W.	14
Shure Brothers	128
Smith & Company, Johnson	105
Springfield Enterprises	104
Stanley Electronics Corp.	131
Surplus Center	106
"TAB"	122
Tech-Master Products Co.	113
Tri-State College	114
Tube Mart	120
U. S. School of Music	127
Universal Collision Schools	101, 112, 122
V. S. I. Television School	117
Valparaiso Technical Institute	120
Video Electric Company	122
Western Radio	122
Whitehall Pharmaceutical Co.	117
World Radio Labs	120
YMCA Trade Schools	120

PLAY RIGHT AWAY!

Even if You Don't Know a Note of Music Now

Now it's EASY to learn any instrument. No boring exercises. Start playing real pieces by notes right away. Amazing progress at home, in spare time. No teacher. Few cents per lesson. 800,000 students! Write for FREE BOOK. U. S. School of Music, Studio A3961, Fort Washington, N. Y. No salesman will call. (Our 59th successful year!)



WRITE FOR NEW BONUS CATALOG

TUBES *Guaranteed* TESTED OUR 12TH YEAR IN BUSINESS

0A2 .70	6AQ5 .45	654 .45	12AX4 .70
0Z4 .42	6AS5 .75	65A7 .45	12AX7 .55
1B3 .65	6AT6 .35	6BH7 .40	12BH7 .65
1L4 .40	6AU4 .75	6SJ7 .45	
1R5 .49	6AU6 .40	6SK7 .45	CK1028 3.25
1S5 .40	6AX4 .50	6SL7 .55	
1S5 .40	6BA6 .45	6SN7 .55	12BY7 .70
1T4 .49	6BC5 .45	6SQ7 .39	12SA7 .65
1U4 .45	6BE6 .45	6T4 1.00	12SK7 .43
1U5 .40	6BF5 .50		12SN7 .55
1X2A .60	6BG6 1.12		12SQ7 .45
2V3 .75	6BK5 .75	1N21 .25	14A7 .55
3A4 .48	6BL7 .80		19BQ5 1.25
3A5 .75	6BN6 .65	6T8 .75	25BQ6 .90
3Q4 .45	6BQ6 .90	6U6 .45	25Z6 .45
3V4 .55	6BQ7 .85	6V6 .55	35C5 .50
5U4G .42	6C4 .35	6W6 .55	35C5 .50
5Y3G .65		6X4 .30	35L6 .50
6AB4 .40	2D21 .75	7A8 .50	35WA .45
6AC7 .64		7C5 .55	35Z5 .45
6AQ5 .45	6CB6 .48	7F7 .75	50A5 .45
6AH4 .75	6CD6 1.12	7F8 .68	50B5 .55
	6H6 .45	7N7 .55	50C5 .45
5BP1 1.75	6J6 .45	7Q7 .75	50L6 .40
6AH6 .85	6K6 .39	12AT6 .40	75 .45
6AK5 .50	6L6 .65	12A7 .65	76 .45
6AL5 .88		12AU7 .50	77 .40
		12AV6 .35	117L7/N7 1.75
		12AV7 .75	



INFRARED SNOOPSCOPE
See in Dark Tube

SELECTED, GTD & TESTED for resolution, 1st class image converter viewing tube, Hi-sensitivity simplified design 2" dia. Willemite screen—Hi-Resolution, Tube & Data, "TAB" SPECIAL @ \$4.75; 2 for \$9

MODEL PS2003, Snooperscope Doubler Power Supply, Less Chassis \$13.95

NEW "TABLITE" ELECTRONIC FLASH KITS
AC & Battery Operation Inbuilt
All in One Camera Case

MODEL 400B, 60 Watt Sec'd. color 75+ B&W 225+ Recycles 2 Sec'd. @ \$25.95
Two (2) 240 VOLT BATTERIES @ \$10



Write for Details & Specifications

KITS! KITS!

Each "TAB" Kit Contains the Finest Selection of Top Quality Components in the Most Popular Values & Sizes

EXTRA! Free Kit with Each \$10 Kit Order

- | | |
|-------------------------|-------------------------------|
| 25 Precision Resistors | 25 Power Resistors |
| 10 Switches | 65 Mica Condensers |
| 25 Knobs | 3 Crystal Diodes |
| 75 Carbon Resistors* | 250 ft. Hook Up Wire, Ass't'd |
| 36 Panel Lamps | 100 Fuses |
| 10 Electrolytic Cond's | 35 Ceramic Condensers |
| 13 Volume Controls | 10 Rotary Switches |
| 25 Tube Sockets | 6 Crystals |
| 50 Tubular Condensers | 60 Inductors & Coils |
| 500 Lugs & Eyelets* | 5 Microswitches |
| 10 Bathub Oil Cond's | 10 Wheat Lamps |
| 5 lbs. Surprise Package | * In Plastic Box |
| 10 Transmit Mica Cond's | |
| 40 Insulators | |

1,000's OF SATISFIED CUSTOMERS
EACH KIT ONLY **99c**
Every Kit Sold on "TAB" Money Back Guarantee

NEW "TABTRON" SELENIUM RECTIFIERS
FULL WAVE BRIDGE
Dated—One Year Guarantee

18VAC 14VDC—1 Amp. \$1.40; 2A \$2.00; 3A \$2.90;
4A \$3.50; 6A \$3.95; 10A \$5.85; 12A \$7.20
16VAC 28VDC—1 Amp. \$2.80; 2A \$3.40; 3A \$4.10;
4A \$6.40; 6A \$7.70; 10A \$11.35; 12A \$14.25
RECTIFIER 18 to 24V/BA (5 lb) TRANS. 115 VAC INPUT,
220 Value. Delivers 14 to 20 VDC, Ideal R.R. SPECIAL \$11

NEW VARIABLE 0 to 6 & 12 VOLT/12 AMP DC Filtered Power Supply

Battery Eliminator, Charger, Model RR, Plater, Aircraft, Marine or any DC requirement. Extra Hvy. duty Selenium Rectified, 2 meters V & A. Designed for cont. service & up to 20 amps intermittent overload, Input 115 VAC, 60 Cy. MODEL T612V12AC \$33.00



"TAB" FINEST HI-FI RECORDING TAPE
7" Reel—1200 Ft. Per Reel **\$1.45** Lols dl 12

Sold on Money Back Guarantee Highest quality Hi-Fi Precision Coated & Slit. Famous maker's quality tape. Constant output. Noise FREE. Splice FREE. Freq. 7 1/2 IPS. 40-15KC Oxide Wnd In. "TAB" @ \$1.59 ea; 3/\$1.50 ea.

"TAB"

TERMS: Money Back Gtd. (cost of mds. only), 5% min. order. F.O.B. N.Y.C. Add ship. charges or for C.O.D. 25% Dep. Tubes Gtd. via R-Exp. only. Prices shown are subject to change.

Dept. 1PE7, 111 Liberty St., N.Y. 6, N.Y., Rector 2-6245

Superior's New Model 670-A

SUPER-METER



A Combination VOLT-OHM MILLIAMMETER PLUS CAPACITY, REACTANCE, INDUCTANCE AND DECIBEL MEASUREMENTS.

SPECIFICATIONS:

- D.C. VOLTS:** 0 to 7.5/15/75/150/750/1,500/7,500 Volts
- A.C. VOLTS:** 0 to 15/30/150/300/1,500/3,000 Volts
- OUTPUT VOLTS:** 0 to 15/30/150/300/1,500/3,000 Volts
- D.C. CURRENT:** 0 to 1.5/15/150 Ma. 0 to 1.5/15 Amperes
- RESISTANCE:** 0 to 1,000/100,000 Ohms 0 to 10 Megohms
- CAPACITY:** .001 to 1 Mfd. 1 to 50 Mfd. (Good-Bad scale for checking quality of electrolytic condensers)
- REACTANCE:** 50 to 2,500 Ohms, 2,500 Ohms to 2.5 Megohms
- INDUCTANCE:** 15 to 7 Henries 7 to 7,000 Henries
- DECIBELS:** -6 to +18, +14 to +38, +34 to +58

ADDED FEATURE: Built-in ISOLATION TRANSFORMER reduces possibility of burning out meter through misuse.

The Model 670-A comes housed in a rugged crackle-finished steel cabinet complete with test leads and operating instructions.

28⁴⁰

Superior's New Model TV-60



20,000 OHMS PER VOLT

ALLMETER

Includes services never before provided by an instrument of this type. Read and compare features and specifications below!

- FEATURES**
- * Giant recessed 6½ inch 40 Microampere meter with mirrored scale.
 - * Built-in Isolation Transformer.
 - * Use of the latest type printed circuit and 1% multipliers assure unchanging accurate readings.

- 8 D.C. VOLTAGE RANGES: (At a sensitivity of 20,000 Ohms per Volt) 0 to 15/75/150/300/750/1500/7500/30,000 Volts.
- 7 A.C. VOLTAGE RANGES: (At a sensitivity of 5,000 Ohms per Volt) 0 to 15/75/150/300/750/1500/7500 Volts.
- 3 RESISTANCE RANGES: 0 to 2,000/200,000 Ohms, 0-20 Megohms.
- 2 CAPACITY RANGES: .00025 Mfd. to 30 Mfd.
- 5 D.C. CURRENT RANGES: 0-75 Microamperes, 0 to 7.5/75/750/Milliamperes, 0 to 15 Amperes.
- 3 DECIBEL RANGES: -6 db to +58 db.
- R.F. SIGNAL TRACER SERVICE: Enables following the R.F. signal from the antenna to speaker of any radio or TV receiver and using that signal as a basis of measurement to first isolate the faulty stage and finally the component or circuit condition causing the trouble.
- AUDIO SIGNAL TRACER SERVICE: Functions in the same manner as the R.F. Signal Tracing service specified above except that it is used for the location of cause of trouble in all audio and amplifier systems.

Model TV-60 comes complete with book of instructions; pair of standard test leads; high-voltage probe; detachable line cord; R.F. Signal Tracer Probe and Audio Signal Tracer Probe. Plofilm bag for all above accessories is also included. Price complete. Nothing else to buy. ONLY

52⁵⁰

Superior's New Model TV-50

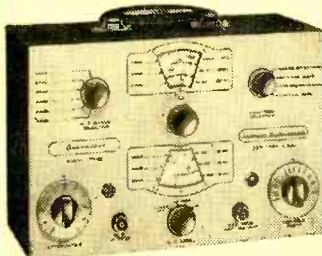

MODEL TV-50 comes absolutely complete with shielded leads and operating instructions. Only

GENOMETER

- 7 SIGNAL GENERATORS IN ONE! R. F. Signal Generator for A.M. • R. F. Signal Generator for F.M. • Audio Frequency Generator • Bar Generator • Cross Hatch Generator • Color Dot Pattern Generator • Marker Generator
- R. F. SIGNAL GENERATOR: Provides complete coverage for A.M. and F.M. alignment. Generates Radio Frequencies from 100 Kilocycles to 60 Megacycles on fundamentals and from 60 Megacycles to 180 Megacycles on powerful harmonics.
- VARIABLE AUDIO FREQUENCY GENERATOR: In addition to a fixed 400 cycle sine-wave audio, the Genometer provides a variable 300 cycle to 20,000 cycle peaked wave audio signal.
- BAR GENERATOR: Projects an actual Bar Pattern on any TV Receiver Screen. Pattern will consist of 4 to 16 horizontal bars or 7 to 20 vertical bars.
- CROSS HATCH GENERATOR: Genometer will project a cross-hatch pattern on any TV picture tube. The pattern will consist of non-shifting horizontal and vertical lines interlaced to provide a stable cross-hatch effect.
- DOT PATTERN GENERATOR (FOR COLOR TV): The Dot Pattern projected on any color TV Receiver tube by the Model TV-50 will enable you to adjust for proper color convergence.
- MARKER GENERATOR: The following markers are provided: 189 Kc., 262.5 Kc., 456 Kc., 600 Kc., 1000 Kc., 1400 Kc., 1600 Kc., 2000 Kc., 2500 Kc., 379 Kc., 4.5 Mc., 5 Mc., 10.7 Mc., (3579 Kc. is the color burst frequency.)

47⁵⁰

**SHIPPED ON APPROVAL
NO MONEY WITH ORDER - NO C.O.D.**

MOSS ELECTRONIC DISTRIBUTING COMPANY, INC.
3849 Tenth Ave. New York 39, N.Y.



For the first time ever: ONE TESTER PROVIDES ALL THE SERVICES LISTED BELOW!

Superior's

New Model

76



IT'S A

CONDENSER BRIDGE

with a range of .00001 Microfarad to 1000 Microfarads (Measures power factor and leakage too.)

IT'S A

RESISTANCE BRIDGE

with a range of 100 ohms to 5 megohms.

IT'S A

SIGNAL TRACER

which will enable you to trace the signal from antenna to speaker of all receivers and to finally pinpoint the exact cause of trouble whether it be a part or circuit defect.

IT'S A

TV ANTENNA TESTER

The TV Antenna Tester section is used first to determine if a "break" exists in the TV antenna and if a break does exist the specific point (in feet from set) where it is.

Specifications

✓CAPACITY BRIDGE SECTION

4 Ranges: .00001 Microfarad to .005 Microfarad; .001 Microfarad to .5 Microfarad; 1 Microfarad to 50 Microfarads; 20 Microfarads to 1000 Microfarads. This section will also locate shorts, and leakages up to 20 megohms. And finally, this section will measure the power factor of all condensers from .1 to 1000 Microfarads. (Power factor is the ability of a condenser to retain a charge and thereby filter efficiently.)

✓RESISTANCE BRIDGE SECTION

2 Ranges: 100 ohms to 50,000 ohms; 10,000 ohms to 5 megohms. Resistance can be measured without disconnecting capacitor connected across it. (Except, of course, when the R C combination is part of an R C bank.)

✓SIGNAL TRACER SECTION

A built-in high gain pentode voltage amplifier, plus a diode rectifier, plus a direct coupled triode amplifier are combined to provide this highly sensitive signal tracing service. With the use of the R.F. and A.F. Probes included with the Model 76, you can make stage gain measurements, locate signal loss in R.F. and Audio stages, localize faulty stages, locate distortion and hum, etc. Provision has been made for use of phones and meter if desired.

✓TV ANTENNA TESTER SECTION

Loss of sync., snow and instability are only a few of the faults which may be due to a break in the antenna, so why not check the TV antenna first? The Model 76 will enable you to locate a break in any TV antenna and if a break does exist, the Model 76 will measure the location of the break in feet from the set terminals. 2 Ranges: 2' to 200' for 72 ohm coax and 2' to 250' for 300 ohm ribbon.

As Design Engineers, we the undersigned would like to say that the Model 76 is in our opinion the best combination unit of its kind we have been privileged to design. Although it is comparatively a low-priced tester, it will, after you become acquainted with its multiple services, be your most frequently used instrument.

S. LITT
L. MELENKEVITZ

Model 76 comes complete with all accessories including R.F. and A.F. Probes; Test Leads and operating instructions. Nothing else to buy Only

\$26⁹⁵

SHIPPED ON APPROVAL NO MONEY WITH ORDER — NO C. O. D.

We invite you to try before you buy any of the models described on this page, the preceding page and the following page. If after a 10 day trial you are completely satisfied and decide to keep the Tester, you need send us only the down payment and agree to pay the balance due at the monthly indicated rate.

**NO INTEREST
OR FINANCE
CHARGES ADDED!**

If not completely satisfied, you are privileged to return the Tester to us, cancelling any further obligation.

MOSS ELECTRONIC DISTRIBUTING CO., INC.

Dept. D-307 3849 Tenth Avenue, New York 34, N.Y.

Please send me the units checked. I agree to pay down payment within 10 days and to pay the monthly balance as shown. It is understood there will be no finance or interest charges added. It is further understood that should I fail to make payments when due, the full unpaid balance shall become immediately due and payable.

- | | |
|--|--|
| <input type="checkbox"/> Model TV-11 . . . Total Price \$47.50
\$11.50 within 10 days. Balance \$6.00 monthly for 6 months. | <input type="checkbox"/> Model 670-A . . . Total Price \$28.40
\$7.40 within 10 days. Balance \$3.50 monthly for 6 months. |
| <input type="checkbox"/> Model TD-55 . . . Total Price \$26.95
\$6.95 within 10 days. Balance \$5.00 monthly for 4 months. | <input type="checkbox"/> Model TV-50 . . . Total Price \$47.50
\$11.50 within 10 days. Balance \$6.00 monthly for 6 months. |
| <input type="checkbox"/> Model 76 . . . Total Price \$26.95
\$6.95 within 10 days. Balance \$5.00 monthly for 4 months. | <input type="checkbox"/> Model TV-60 . . . Total Price \$52.50
\$12.50 within 10 days. Balance \$8.00 monthly for 5 months. |

Name _____

Address _____

City _____ Zone _____ State _____

**SEE OTHER
SIDE**

CUT OUT AND MAIL TODAY! ▶

All prices net, F.O.B., N.Y.C.

Superior's New Model TD-55

Streamlined

TUBE TESTER



FOR

The Experimenter or Part-time Serviceman, who has delayed purchasing a higher priced Tube Tester. The Professional Serviceman, who needs an extra Tube Tester for outside calls. The busy TV Service Organization, which needs extra Tube Testers for its field men.

• You can't insert a tube in wrong socket. Separate sockets are used, one for each type of tube base. • "Free-point" element switching system Any pin may be used as a filament pin and the voltage applied between that pin and any other pin, or even the "top-cap". • Checks for shorts and leakages between all elements. Provides a super sensitive method of checking for shorts and leakages up to 5 Megohms between any and all of the terminals. Continuity between various sections is individually indicated. • Elemental switches are numbered in strict accordance with R.M.A. specification. The 4 position fast-action snap switches are all numbered in exact accordance with the standard R.M.A. numbering system.

Speedy, yet efficient operation is accomplished by: Elimination of old style sockets used for testing obsolete tubes (26, 27, 57, 59, etc.) and providing sockets and circuits for efficiently testing the new Noval and Sub-Minar types.

Model TD-55 comes complete with operating instructions and charts and streamlined carrying case.

\$26⁹⁵

Superior's New Model TV-11

Standard Professional

TUBE TESTER



★ Tests all tubes including 4, 5, 6, 7, Octal, Lock-in, Peanut, Bantam, Hearing Aid, Thyatron Miniatures, Sub-miniatures, Novals, Sub-minars, Proximity fuse types, etc.

★ Uses the new self-cleaning Lever Action Switches for individual element testing. Because all elements are numbered according to pin-number in the RMA base numbering system, the user can instantly identify which element is under test. Tubes having tapped filaments and tubes with filaments terminating in more than one pin are truly tested with the Model TV-11 as any of the pins may be placed in the neutral position when necessary.

★ The Model TV-11 does not use any combination type sockets. Instead individual sockets are used for each type of tube. Thus it is impossible to damage a tube by inserting it in the wrong socket.

★ Free-moving built-in roll chart provides complete data for all tubes.

★ Newly designed Line Voltage Control compensates for variation of any Line Voltage between 105 Volts and 130 Volts.

★ NOISE TEST: Phono-jack on front panel for plugging in either phones or external amplifier will detect microphonic tubes or noise due to faulty elements and loose internal connections.

The model TV-11 operates on 105-130 Volt 60 Cycles A.C. Comes housed in a beautiful hand-rubbed oak cabinet complete with portable cover.

EXTRA SERVICE — The Model TV-11 may be used as an extremely sensitive Condenser Leakage Checker. A relaxa-

tion type oscillator incorporated in this model will detect leakages even when the frequency is one per minute.

\$47⁵⁰

SHIPPED ON APPROVAL NO MONEY WITH ORDER — NO C.O.D.

FIRST CLASS

Permit No. 61430

New York, N. Y.

BUSINESS REPLY CARD

No Postage Stamp Necessary if Mailed in the U. S.

POSTAGE WILL BE PAID BY —

MOSS ELECTRONIC DIST. CO., INC.

3849 TENTH AVENUE

NEW YORK 34, N.Y.

We invite you to try before you buy any of the models described on this and the preceding pages. If after a 10 day trial you are completely satisfied and decide to keep the Tester, you need send us only the down payment and agree to pay the balance due at the monthly indicated rate. (See other side for time-payment schedule details.)

**NO INTEREST
OR FINANCE
CHARGES ADDED!**

If not completely satisfied, you are privileged to return the Tester to us, cancelling any further obligation.

SEE OTHER SIDE

◀ CUT OUT AND MAIL TODAY!