

# POPULAR ELECTRONICS

SEPTEMBER  
1956

25  
CENTS

in U. S. and Canada

## First Transistor Short-Wave Converter

(see page 37)

• Radio Waves From Venus

• How To Be a  
Tech Writer

• Electrostatic  
Speakers

• Build 1-Tube  
Superhet

*W*



# TEST 5 TUBES in 4 SECONDS each... ACCURATELY!

WITH THE NEW ADVANCED ENGINEERED

## precise

MODEL 116

### Gm. & Em. ULTRAFAST TUBE & TRANSISTOR TESTER



Completely  
NEW!

PRECISE MODEL 116K in kit form **\$69.95**  
 PRECISE MODEL 116W factory wired **\$119.95**  
 Incl. Carrying Case & Cover

Servicemen know the Precise Model 111 (the winner in an independent survey) easily rates "the finest tube tester in the field" at any price, BUT FOR AN ON THE JOB QUICK-TEST... the fastest, most accurate is the PRECISE Model 116. What's more you test tubes the foolproof method inherent in the famous Precise Model 111.

Did you ever wish you could plug in 5 of the same type tubes at once and check each one individually by rotating a switch? YOU CAN WITH THE PRECISE MODEL 116—Plug in 5 IF tubes and let them heat up at once and then check each one separately by rotating the TUBE BANK switch. ACTUALLY CHECK 5 TUBES IN 20 SECONDS, 4 SECONDS PER TUBE.

The Precise Model 111 taught the lesson that IF amplifier tubes (like the 6BC5 or 6AU6) should be tested for Gm (mutual transconductance) while the power amplifiers (like the 6L6) should be tested for Em (emission)—that's ULTRAFAST Model 116 test! It checks each section of each tube separately... by rotating the FUNCTION SWITCH... each triode of a dual triode is checked individually... each diode and the triode of a duo-diode-triode is separately tested and not lumped as in other testers... and a pentode is tested as a pentode—not a diode. TRANSISTORS, SHORTS, GAS, LIFE, Em, Gm etcetera can be tested with the PRECISE Model 116.

You can inexpensively extend the Precise Model 116 to test filament current, etc. The Model 116 gives an accurate, ultra-fast (3 basic knobs for testing) check of television tubes!

No Surplus—An etched panel—beautiful Molexkin covered wood carrying case and specially simplified instructions makes the PRECISE MODEL 116 THE FINEST FAST-CHECK TUBE TESTER AND DOLLAR EARNING TRAVELING COMPANION A TV SERVICEMAN EVER HAD.

Not yet at your distributor. Order NOW to insure early delivery.  
 SEE YOUR LOCAL DISTRIBUTOR FOR PROOF OF WHAT WE OFFER—OR WRITE US FOR DOCUMENTARY RESULTS OF AN INDEPENDENT SCIENTIFIC SURVEY.



THE FAMOUS MODEL 111  
 111K ..... \$79.95  
 111W ..... \$139.95  
 incl. Carrying Case & Cover

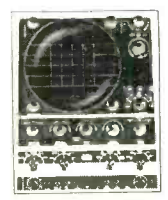

THE FIRST LOW PRICED  
 7" COLOR SCOPE  
 306K ..... \$99.95  
 300W ..... \$199.50



LOW PRICED 5" SCOPE  
 315K ..... \$49.95  
 315W ..... \$84.95

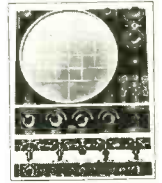

THE FIRST AND ONLY  
 9 1/2" COLOR SCOPE  
 308K ..... \$129.50  
 308W ..... \$229.50



LOWEST PRICED  
 WIRED 4 1/2" VTVM  
 909K ..... \$25.98  
 909W ..... \$37.50



RF-AF-BAR GENERATOR  
 with pre-assembled\* head  
 630K ..... \$39.95  
 630KA\* ..... \$38.95  
 630W ..... \$53.95

Prices slightly higher in the West. Prices and specifications subject to change without notice. PTAK \$2.95 PTAW \$4.25



THE FINEST VOLT, REG.  
 7" VTVM KIT  
 9071K ..... \$35.95  
 9071W ..... \$49.95  
 K = KIT  
 W = WIRED

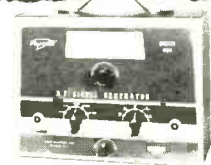

LOW PRICED RF SIGNAL GENERATOR  
 "BEST BUY" IN GEN. FIELD  
 610K ..... \$23.95  
 610KA pre-assembled head ..... \$28.95  
 610W ..... \$39.95



UNIV. AF, SINE, SQ. & PULSE GEN  
 635K ..... \$33.50  
 635W ..... \$52.50

SEE THE MANY MORE PRECISE INSTRUMENTS AND PROBES AT YOUR DISTRIBUTOR TODAY!

**precise** DEVELOPMENT CORP. OCEANSIDE, NEW YORK, U.S.A.

WRITE FOR CATALOG PE 6-6





**Want better pay,  
steady work and  
a way to make  
extra money?**

# Learn at Home IN YOUR SPARE TIME to Fix Electrical Appliances

To build a better future, get into a field where there's much important work and the security that comes from knowing a good trade. Servicing electrical appliances offers that OPPORTUNITY. Every wired home has an average of 8 electrical appliances. Up to 10 million new appliances are sold every year and owners pay well to keep them in repair. That's making a fast-growing need for trained men.

and do actual electrical appliance repair jobs. If you want better pay learn this good trade. No need to give up your present job. You can train at home in your spare time for only \$2.50 down and \$5.00 a month. A small price to pay for increased earnings, a more secure future. Paste coupon below on a 2c postal or mail in envelope for "How to Learn Servicing Electrical Appliances" and a free sample lesson.

**Start Soon to Earn \$3, \$4, \$5,  
an Hour Extra in Your Spare Time**

Start soon to fix electric toasters, clocks, fans, vacuum cleaners and other appliances for neighbors and friends. Work in your basement, garage or spare room. Pick up \$3 to \$5 an Hour *extra that way*. It's easy to increase your earning power—to pay for this training many times over with your spare time earnings.

**Learn and Earn with Multi-Use  
Tester Built with Parts We Send**

This course includes the parts to build a portable, sturdy Appliance Tester that helps you locate electrical defects quickly and easily. You use it to learn

**2c TO MAIL THIS  
COUPON MAY START  
YOU TO SUCCESS  
LESSON AND BOOK  
FREE**

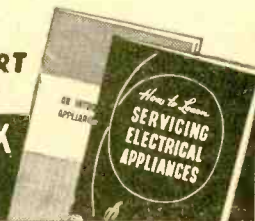

**NATIONAL RADIO INSTITUTE  
Dept. D4J6, Washington 9, D. C.**

Please send me Electric Appliance Training lesson and book free. (No salesman will call.)

Name: ..... Age: .....

Address: .....

City: ..... Zone: ..... State: .....

POPULAR ELECTRONICS is published monthly by Ziff-Davis Publishing Company, William B. Ziff, Chairman of the Board (1946-1953), at 64 E. Lake St., Chicago 1, Ill. Entered as second class matter August 27, 1954 at the Post Office, Chicago, Illinois. SUBSCRIPTION RATES: One year U.S. and possessions, and Canada \$3.00; Pan-American Union countries \$3.50; all other foreign countries \$4.00.

# POPULAR ELECTRONICS

## CONTENTS

### FEATURE Articles

Radio Waves Heard from Jupiter and Venus.....	O. P. Ferrell	35
First Transistorized Short-Wave Converter.....		37
Army Studies Radio Wave Curvature.....		43
Government by Automation.....		48
What About TECH WRITING?.....	John A. Norman	73

### ELECTRONIC Build-It-Yourself Projects

The "Soft Touch"—An Electronic Touch-o-Matic Control	Harvey Pollack	39
How to Use a Grid Dipper.....	B. van Sutphin	49
"Printing Wiring" Techniques for the Experimenter (Part 2)	Louis E. Garner, Jr.	53
Fool Your Friends with an Electronic Lock.....	John P. Shields	60
Simple Dual Proportional R/C System.....	R. L. McIntyre	63
Oil Bath Increases Rectifier Rating.....	H. J. Carter	67
Custom-Design Your Time Switches.....	Wm. B. Rasmussen	69
Build a "Minidyne"—The Miniature Superheterodyne	Frank H. Tooker	75
D.C.-Operated Fire Alarm.....	I. C. Chapel	85
Relaxation Oscillator Makes Perpetual Flasher	Forrest H. Frantz, Sr.	85
Identifying Salvaged Transformers.....	Frank H. Tooker	88

### AUDIO and HI-FI Features

Hi-Fi Revives Kings of Swing.....	Robert M. Hawthorne	45
What's New in Hi-Fi.....		58
Do You Really Have Hi-Fi?.....	Norman Eisenberg	82
The Plate That Talks.....	R. S. Lanier	89

### DEPARTMENTS

Carl & Jerry.....	John T. Frye	10
POP'tronics Bookshelf.....		22
Letters from Our Readers.....		26
Tuning the Short-Wave Bands.....	Hank Bennett	59
The Transmitting Tower.....	Herb S. Brier	71
After Class.....		79
Transistor Topics.....	Lou Garner	86
Tools and Gadgets.....		98
Tips and Techniques.....		101

(Also see page 6 for NEWS of Electronic Developments)

© 1956 by Ziff-Davis Publishing Company. All rights reserved.

Average Net Paid Circulation 205,193

SEPTEMBER 1956

VOL. 5—NUMBER 3

Publisher  
OLIVER READ, W1ET1

Managing Editor  
OLIVER P. FERRELL

Technical Editor  
MILTON S. SNITZER

Feature Editor  
NORMAN EISENBERG

Associate Editors  
HANS H. FANTEL  
MARGARET MAGNA

Contributing Editors  
H. BENNETT L. E. GARNER, JR.  
H. S. BRIER H. POLLACK  
J. T. FRYE R. P. TURNER

Art Editor  
ALFONS J. REICH

Art and Drafting Dept.  
FRANK SAYLES

J. A. GOLANEK M. WHELPLEY  
W. K. VAHLISING J. A. ROTH

Advertising Director  
L. L. OSTEN

Advertising Manager  
WILLIAM G. MCROY

Midwest Adv. Manager  
JIM WEAKLEY

Western Adv. Manager  
JOHN E. PAYNE



Member  
Audit Bureau of  
Circulations



ZIFF-DAVIS  
PUBLISHING COMPANY  
W. B. ZIFF (1898-1953) FOUNDER

Also Publishers of  
RADIO & TELEVISION NEWS  
Editorial and Executive Offices  
366 Madison Ave., New York 17, N. Y.  
MU 7-8080

President  
B. G. DAVIS

Vice-President  
H. J. MORGANROTH

Vice-President  
M. FROELICH

Vice-Pres. & Circ. Dir  
M. MICHAELSON

Secretary-Treasurer  
G. E. CARNEY

Art Director  
AL GRUEN

BRANCH OFFICES  
CHICAGO (1)  
64 E. Lake St., AN 3-5200  
LOS ANGELES (14)  
215 W. 7th St. (Room 412)  
Trinity 8043

#### SUBSCRIPTION SERVICE:

All communications concerning subscriptions should be addressed to Circulation Dept., 64 E. Lake St., Chicago 17, Ill. Include your old address as well as new—enclosing if possible an address label from a recent issue of this magazine. Allow at least 4 weeks for change of address.

#### CONTRIBUTORS:

Contributors are advised to retain a copy of their manuscripts and illustrations. Contributions should be mailed to the New York Editorial Office and must be accompanied by return postage. Contributions will be handled with reasonable care, but this magazine assumes no responsibility for their safety. Any copy accepted is subject to whatever adaptations and revisions are necessary to meet the requirements of this publication. Payment covers all author's, contributor's and contestant's rights, title, and interest in and to the material accepted and will be made at our current rates upon acceptance. All photos and drawings will be considered as part of material purchased.

POPULAR ELECTRONICS





Train in Great Shops of COYNE for better jobs in

# ELECTRICITY or TELEVISION

ELECTRONICS RADIO-COLOR TV



## TWO TOP OPPORTUNITY FIELDS

Whether 17 or up to 45 years of age, train the Coyne way for a better job and a real future in **ELECTRICITY-ELECTRONICS** or **TELEVISION-RADIO**, fields that offer a world of opportunities. Train on real, full-size equipment at COYNE where thousands of successful men have trained for over 57 years—**largest, oldest, best equipped school of its kind**—established 1899. No advanced education or previous experience needed. Employment service to graduates. **START NOW—PAY LATER**—Finance Plan and Easy Monthly Payment Plan. Also part-time employment help for students. Training in Refrigeration and Electric Appliances can be included.

B. W. COOKE, President

**COYNE**  
ELECTRICAL SCHOOL

FOUNDED 1899

A Technical Trade Institute Operated Not For Profit  
500 S. Paulina Street, Chicago, Dept. 66-71H

ELECTRICITY • RADIO • TELEVISION • REFRIGERATION • ELECTRONICS

## MAIL COUPON FOR FREE BOOK

Send coupon for 48-page illustrated book "Guide to Careers in Electricity-Electronics and Television-Radio." No cost; no obligation; no salesman will call. Vets and Non-Vets get vital facts now!



B. W. COOKE, President  
COYNE ELECTRICAL SCHOOL  
500 S. Paulina St., Chicago 12, Ill., Dept. 66-71H

Send **BIG FREE** book and details of your training offer. This does not obligate me and no salesman will call. I am interested in:

( ) Electricity-Electronics ( ) Television-Radio

Name \_\_\_\_\_

Address \_\_\_\_\_

City \_\_\_\_\_ State \_\_\_\_\_

# COYNE QUALITY TELEVISION RADIO-COLOR TV

Home Training  
at Unbelievably Low Cost



The future is **YOURS** in **TELEVISION!**  
A fabulous field—good pay—fascinating work—a prosperous future in a good job, or independence in your own business!

Coyne brings you **MODERN-QUALITY** Television Home Training; training designed to meet Coyne standards at truly lowest cost—you pay for training only—no costly "put together kits." Not an old Radio Course with Television "tacked on." Here is **MODERN TELEVISION TRAINING** including **Radio, UHF and Color TV**. No Radio background or previous experience needed. Personal guidance by Coyne Staff. **Practical Job Guides** to show you how to do actual servicing jobs—**make money early in course**. Free Lifetime Employment Service to Graduates.

**COYNE**  
ELECTRICAL SCHOOL  
A TECHNICAL TRADE INSTITUTE OPERATED NOT FOR PROFIT  
500 S. Paulina Street, Chicago 12, Dept. 66-HT7

B. W. COOKE, President



Coyne—The Institution behind this training... the largest, oldest, best equipped residential school of its kind. Founded 1899.

## Send Coupon for Free Book

and full details, including easy Payment Plan. No obligation, no salesman will call.

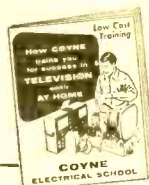

### COYNE Television Home Training Division

500 S. Paulina St., Chicago 12, Ill.  
Dept. 66-HT7

Send Free Book and details on how I can get Coyne Quality Television Home Training at low cost and easy terms.

Name \_\_\_\_\_

Address \_\_\_\_\_

City \_\_\_\_\_ State \_\_\_\_\_

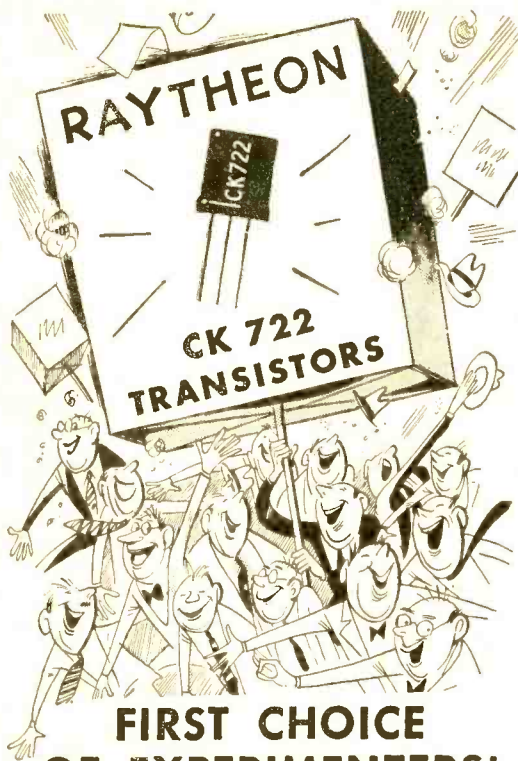

## FIRST CHOICE OF EXPERIMENTERS!

Nine out of every ten transistorized circuits—for oscillators, timers, receivers, geiger counters, etc.—are designed to use the Raytheon CK722 Transistor. This tremendous popularity means that the Raytheon CK722 is the top quality transistor providing outstanding performance in a wide range of applications. It means that you can use it with complete confidence that it will give you top notch performance. What's more, you'll find low cost Raytheon CK722 Transistors on the shelves of leading electronic distributors everywhere. You can get them when you want them.

only 99¢

### RAYTHEON TRANSISTOR APPLICATIONS BOOK

116 pages — over 50 practical circuits — all using the CK722. For your copy send 50¢ to Raytheon, Dept. P7.



*Excellence in Electronics*

**RAYTHEON MFG. CO.**

Receiving and Cathode Ray Tube Operations  
Newton 58, Massachusetts

## NEWS of Electronic Developments

Electronic Scales Weigh Trucks on the Run.....	38
Storm Tracking in Your Living Room.....	38
Electronics "Feels Out" Toy Train Track.....	44
Radomes Tested to Assure Radar Accuracy.....	44
Super Magnet Gets Gas Chamber.....	52
Telephone Cords Are Better, Too.....	52
Yarn Without Yawn.....	52
Junior Ham Wins Jackpot.....	57
Tinkertoy Design Simplifies Chassis.....	57

See also page 58 (What's New in Hi-Fi)

### COMING NEXT MONTH (OCTOBER)



(ON SALE SEPTEMBER 20)

Our second anniversary issue will contain more pages and will be specially devoted to hi-fi with features on tone controls, AM/FM tuners, hi-fi maintenance techniques and compressed speaker enclosures.

There will also be stories on long-wave DX'ing, R/C equipment, home-built test equipment, 21-mc. preselectors and an all-electronic device for measuring relative humidity.

Also look for our regular departments written by Hank Bennett (on SWL'ing), Herb Brier (on Novice ham radio), John Frye (Carl & Jerry), and Lou Garner (Transistor Topics).

### IN THIS MONTH'S RADIO & TELEVISION NEWS

(SEPTEMBER)

- Preview of New TV and Radio Sets
- Hi-Fi Equipment Cabinets
- Experiments with a Series Multivibrator
- How to Match Hi-Fi Components
- Giant Computer—"Brain" of the SAGE System
- An All-Transistor Superhet Tuner



# PUT YOURSELF IN THE Top-Paying TELEVISION PICTURE...



L. C. Lane, B.S., M.A.  
President, Radio-Television  
Training Association  
Executive Director, Pierce  
School of Radio & Television.

Today, when demand for trained men is higher than ever before, pay is higher than ever before, you can train AT HOME in your SPARE TIME to become a Television Technician.



**NO EXPERIENCE NEEDED...** Many of my successful graduates had no more than a grammar school education.

## VETERANS!

My school fully approved to train Veterans under new Korean G.I. Bill. Don't lose your school benefits by waiting too long. Write discharge date on coupon.



Almost from the very start you can earn extra money while learning by repairing radio-TV sets for friends and neighbors. Many of my students earn up to \$25 a week... pay for their entire training from spare time earnings... start their own profitable service business.



You get two weeks, 50 hours, of intensive laboratory work on modern electronic equipment at our associate school in New York City — Pierce School of Radio and Television. And I give you this AT NO EXTRA COST whatsoever, after you finish your home study training in the Radio-FM-TV Technician Course or FM-TV Technician Course. However, your home study course is complete even without this two-week laboratory session. It is only one of the many Extras available to you from RTTA if you want it.

**CHOOSE FROM THREE COMPLETE COURSES** covering all phases of Radio, FM and TV

1. Radio, FM and Television Technician Course — no previous experience needed.
2. FM-TV Technician Course — previous training or experience in radio required.
3. TV Cameraman and Studio Technician Course — advanced training for men with Radio or TV training or experience.

## Radio-Television Training Association

52 EAST 19th STREET • NEW YORK 3, N. Y.

Licensed by the State of New York • Approved for Veteran Training



C-W Telephone Transmitter



Combination Voltmeter-Ammeter-Ohmmeter



Public Address System



AF-RF Sign-F Generator



Super-Het Radio Receiver

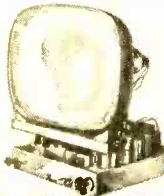

## ENOUGH EQUIPMENT TO SET UP YOUR OWN HOME LABORATORY

As part of your training I give you the equipment you need to set up your own home laboratory and prepare for a BETTER-PAY TV JOB. You build and keep an Electromagnetic TV RECEIVER designed and engineered to take any size picture tube up to 21-inch, (10-inch tube furnished. Slight extra cost for larger sizes.)... also a Super-Het Radio Receiver, AF-RF Signal Generator, Combination Voltmeter-Ammeter-Ohmmeter, C-W Telephone Transmitter, Public Address System, AC-DC Power supply. Everything supplied, including all tubes.

## FCC COACHING COURSE

Qualifies you for Higher Pay! Given to all my students AT NO EXTRA COST after TV Theory and Practice is completed. Helps you qualify for the TOP JOBS in Radio-TV that demand an FCC License! Full training and preparation at home for your FCC License.

## MY FREE AIDS SHOW YOU HOW AND WHERE TO GET A BETTER PAY JOB IN TELEVISION

See for yourself how my simple, practical methods can make success as easy for you as they have for my hundreds of graduates.

## MAIL THIS COUPON TODAY

Mr. Leonard C. Lane, President  
RADIO-TELEVISION TRAINING ASSOCIATION  
Dept. E-9 C, 52 East 19th Street, New York 3, N. Y.

Dear Mr. Lane: Send me your NEW FREE BOOK, FREE SAMPLE LESSON, and FREE aids that will show me how I can make TOP MONEY IN TELEVISION. I understand I am under no obligation.

(PLEASE PRINT PLAINLY)

Name \_\_\_\_\_ Age \_\_\_\_\_

Address \_\_\_\_\_

City \_\_\_\_\_ Zone \_\_\_\_\_ State \_\_\_\_\_

I AM INTERESTED IN:

- Radio-FM-TV Technician Course
- FM-TV Technician Course
- TV Cameraman & Studio Technician Course

## VETERANS!

Write discharge date

**NO OBLIGATION!**

**BUILD THE  
BEST  
AND SAVE!**

## you get the most for your money when you build **ALLIED'S** own **knight-kits**

- ★ You get maximum value for your kit dollar
  - ★ You get advanced design and top performance
  - ★ You get premium quality parts
  - ★ You get exclusive new features
  - ★ You get easiest-to-follow instructions for assured success in the finished equipment
- BUY WITH CONFIDENCE FROM THE PIONEERS IN ELECTRONIC KITS**

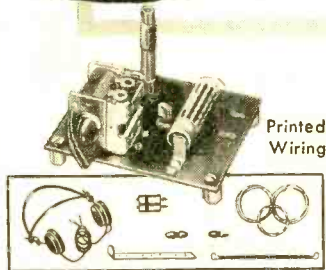

Printed Wiring

### Fascinating knight-kit TRANSISTOR RADIO KIT

Model S-765  
only  
**\$4.35**

Experiment with the marvel of transistors! Printed circuit mounting board simplifies assembling. Just mount components, solder a few connections and enjoy excellent AM broadcast reception. Compact; fits in palm of your hand; operates from single penlight cell that lasts for months. Complete with all parts, transistor and penlight cell. Easy to assemble. Shpg. wt., 2 lbs.

Model S-765. Net only ..... **\$4.35**  
S-266. Accessory kit; 4000 ohm double headphones and all parts for outdoor antenna. Net. .... **\$3.15**

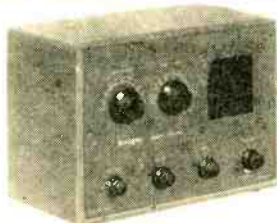

### knight-kit "SPACE-SPANNER" BANDSWITCHING RECEIVER KIT

Model S-243  
only  
**\$15.95**

All-new 2-band receiver, easy to build—a great value. Band-switch selects thrilling short wave, including amateur, aircraft, police and marine radio (6 to 18 mc), and standard broadcast. Highly sensitive regenerative circuit. Has 4" PM speaker and beam-power output for strong volume. Kit includes calibrated panel, punched chassis, all parts and tubes (less cabinet). Easy to build. 7 x 10½ x 6"; for 110-120 v. 50-60 cycle AC or DC. Shpg. wt., 4½ lbs.

Model S-243. Net only ..... **\$15.95**  
S-247. Matching cabinet for above \$2.90



### knight-kit "RANGER II" AC-DC SUPERHET RADIO KIT

Model S-735  
only  
**\$17.25**

Build this top quality table model radio at low cost! Tunes full AM broadcast, 540 to 1680 kc (includes police calls). Features Alnico PM dynamic speaker; automatic volume control; sensitive Superhet circuit; handsome plastic cabinet. Easy, step-by-step assembly. Complete with punched chassis, all parts and tubes, speaker and smartly styled bakelite cabinet (6 x 9 x 5"). For AC or DC. Shpg. wt., 8 lbs.

Model S-735. Net only ..... **\$17.25**



### knight-kit TWO-WAY INTERCOM SYSTEM KIT

Model S-295  
only  
**\$14.75**

Easy to build—ideal for home or office. Consists of Master and Remote unit, each with press-to-talk switch. Remote can be left "open" for distant answering or baby-sitting. In "closed" position, Remote remains private, but can be called and can originate calls. High-gain 2-stage amplifier and 4" PM speakers. With tubes and 50-ft. cable. (Up to 200-ft. may be added.) Each unit 4¼ x 6½ x 4¾"; antique white finish. For AC or DC. Easy to assemble. 7 lbs.

S-295. Net only ..... **\$14.75**

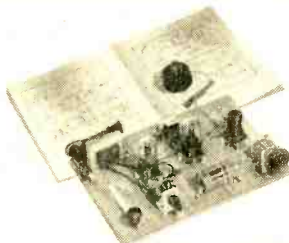

### knight-kit 10-IN-1 LAB KIT

Model S-265  
only  
**\$12.65**

Instructive, fascinating! Enables you to build any one of 10 circuits: Broadcast receiver for headphone reception; Phono Oscillator to play records through any radio; Phono Amplifier; Code Practice Oscillator; Signal Tracer; Electronic Timer; Relay, etc. Includes tubes, all parts, instructions (less photo-tube and socket, and headphone). Ready to build. For 110-120 v., 50-60 cy. AC. 10 lbs.

Model S-265. Net only ..... **\$12.65**  
J-112. Headphone for above ..... **\$1.05**  
C-100. Antenna Kit for above ..... **\$1.05**



Model S-255  
only  
**\$43.75**

### knight-kit 50-WATT CW TRANSMITTER KIT

Compact, value-packed, low-power rig. 50 watts input to 807; 6AG7 oscillator takes crystal or VFO; bandswitching covers 80, 40, 20, 15, 11-10 meters; pi matching network eliminates separate antenna tuner; clean cathode keying of oscillator and final; excellent TVI suppression; meter reads plate or grid of final. With all parts, tubes, wire, solder and instructions (less key and crystal). 8¼ x 11¼ x 8¾". 18 lbs.

Model S-255. Net only. **\$43.75**

order from **ALLIED RADIO** 100 N. WESTERN AVE., CHICAGO 80, ILL.



# YOU BUILD THE BEST AND SAVE MORE WITH knight-kits



**knight-kit**  
**VTVM KIT**  
 with printed  
 circuit board  
 Model F-125  
**\$24.95**  
 only

Easy to build. Reads peak-to-peak. 1% resistors. Balanced-bridge push-pull circuit; 4 1/2" meter, 200 microamp. Ranges: AC peak-to-peak volts, 0-4-14-40-140-100-1400-4000; AC rms v. and DC v., 0-1.5-5-15-50-150-500-1500; ohms, 0-100-10K-100K, 1-10-100-1000 meg; db scale, -10 to +5. Zero-center scale; direct-reading db scale; polarity reversing switch. Ready to build. 7 3/4 x 5 3/4 x 4 3/4". 6 lbs.

Model F-125. Net only ..... \$24.95

F-126. High Voltage Probe..... \$4.75

F-127. High Frequency Probe... \$3.45



**knight-kit**  
**20,000 OHM/VOLT**  
**VOM KIT**  
 Model F-140  
**\$29.50**  
 only

Low cost 32-range VOM. Features 4 1/2" 50-microampere meter; 1% precision multipliers; 2% accuracy full-scale deflection. Ranges: AC, DC and output volts, 0-2.5-10-50-250-1000-5000; Resistance, 0-2000-200,000 ohms and 0-20 meg; DC ma, 0.1-10-100; DC amps, 0-1-10; Decibels, -30 to +63 (6 ranges). Black bakelite case, 6 3/4 x 5 3/4 x 3 3/4". Ready to build. 5 lbs.

Model F-140. Net only..... \$29.50



**knight-kit**  
**"IN CIRCUIT"**  
**CAPACITY**  
**CHECKER KIT**  
 Model  
 F-119 only **\$12.50**

Remarkable unit checks capacitors while they're still wired in the circuit! All you do is press a button—and the "magic eye" shows opens and shorts. Tests opens and shorts on capacitors of 20 mmf or greater, even if in parallel with a resistance as low as 50 ohms. Complete; ready to build. 5 lbs.

Model F-119. Net only..... \$12.50



**FREE 356-PAGE**  
**1957 CATALOG**

It's your money-saving guide to everything in Electronics, featuring more than 25 other KNIGHT-KITS, including Test Instruments, Hobbyist Kits and Amateur Kits. Send for it!

**ORDER NOW**

## BUILD YOUR OWN QUALITY HI-FI AND SAVE!

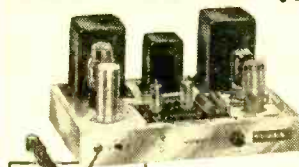

**knight-kit LINEAR-DELUXE**  
**BASIC 25-WATT HI-FI**  
**AMPLIFIER KIT**

Custom quality at very low cost. For use with any tuner or preamp with full set of controls. Deluxe features: Chrome-plated chassis; potted transformers and chokes; printed circuit wiring board; balance and damping controls. Output: 25 watts. Response: +0.5 db, 10 to 120,000 cps at 20 watts.

Model S-755  
 only **\$44.50**

Distortion: 0.15% at 25 watts. Speaker Outputs: 4, 8 and 16 ohms. 6 1/4 x 14 x 9". With all parts, tubes, instructions; ready to build. Shpg. wt., 27 lbs.

Model S-755. Net only..... \$44.50

S-759. Metal enclosure for above; black finish. .... \$4.25



**knight-kit 10-WATT**  
**ECONOMY HI-FI AMPLIFIER KIT**

True Hi-Fi at lowest cost. Only 0.5 volt drives amplifier to full 10 watts output! Response: +1 db, 30 to 20,000 cps at 10 watts. Distortion: less than 0.5% at 10 watts. Chrome-plated chassis is punched for preamp kit listed below. Matches 8-ohm speakers. With tubes, all parts, easy instructions. 7 x 13 x 6". Shpg. wt., 14 lbs.

Model S-753  
 only **\$23.50**

Model S-753. Net only..... \$23.50

S-235. Preamp kit (for magnetic cartridges)..... \$3.10

S-757. Metal enclosure for above; black finish.... \$3.95



**knight-kit 20-WATT**  
**LOW COST HI-FI AMPLIFIER KIT**

Delivers deluxe Hi-Fi sound. Includes built-in preamp; inputs for magnetic cartridges, etc.; record compensator; bass and treble controls, etc. Response: +1 db, 20-20,000 cps at 20 watts. Speaker Outputs: 4, 8, 16 and 500 ohms. Chrome-plated chassis, 7 1/2 x 13 x 8 3/4". With all parts, tubes and easy instructions. 23 lbs.

Model S-750  
 only **\$35.75**

Model S-750. Net only..... \$35.75

S-758. Metal enclosure for above; black finish.... \$4.15



ALL PRICES NET F. O. B. CHICAGO • EASY TERMS AVAILABLE

# ALLIED RADIO

ALLIED RADIO CORP., Dept. 79-J-6,  
 100 N. Western Ave., Chicago 80, Ill.

**OUR**  
**36th**  
**YEAR**

Ship me the following KNIGHT-KITS:

Quantity	Description	Model	Price

\$\_\_\_\_\_ enclosed. For parcel post, include postage (express is shipped collect).

Send me your FREE 1957 ALLIED 356-Page Catalog.

Name \_\_\_\_\_

Address \_\_\_\_\_

City \_\_\_\_\_ Zone \_\_\_\_\_ State \_\_\_\_\_

# NEW R. L. DRAKE TVI FILTER

## Cuts out

# 6 Meter Interference

### Improved High Pass Filter protects TV receivers from most amateur TVI

Now Drake offers a new improved High Pass Filter that really attenuates 6-Meter interference. The new Drake TV-300-HP, when properly installed on TV receiver, effectively protects against both I.F. interference and interference from amateur bands—6 meters to 160 meters—even from the next door neighbor's transmitter.

#### R. L. DRAKE TV-300-HP



**\$3.57**  
amateur net

#### FEATURES

- Better protection than previous model, plus addition of 6-Meter protection.
- Attenuation, 55 mc. and higher, less than 1 db.
- Attenuation, 52 mc. and lower, more than 40 db.
- Iron-core, bifilar coils for maximum reduction of parallel current interference.
- More parts, but no increase in price.
- 300 ohms optimum impedance.
- High attenuation with low insertion loss.
- For use with all TV receivers.

**R. L. DRAKE CO.**  
MIAMISBURG, OHIO

AVAILABLE FROM LEADING ELECTRONIC PARTS DISTRIBUTORS.

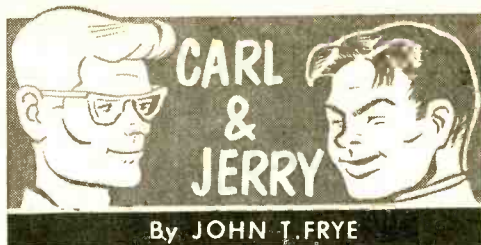

### Electronic Beach Buggy

**I**T WAS A BLISTERING-HOT last-of-August day, and Carl and Jerry were at the beach, but they were not swimming. Instead, they lolled in the scanty shade of spindly growth on the side of a sand dune and looked disconsolately across the absolutely empty beach at the close-spaced row of large signs sticking in the sand along the edge of the water. The signs read: "DANGER! Water Polluted with Acid. Stay Out!"

A Great Lakes tanker loaded with acid had been in a collision just off shore and lost most of its cargo. This highly concentrated acid, blown in to shore by the wind, had collected on the sand and rocks of the beach. While it was slowly diluting, there was still enough left to cause serious burns to the skin and even more damage to the eyes if it came in contact with them.

"A fine kettle of fish this is," Carl growled. "Here is as hot a day as we've had all summer; there is all of Lake Michigan ready to cool us off; and for all the good it's doing us, we might as well be out in the middle of the Sahara Desert."

"While you're wallowing in self-pity, don't forget that school is coming up like thunder," Jerry added. "In about a week the beach will be O.K. again, but we'll be sweating it out in the brain factory."

**B**OTH BOYS contemplated this gloomy prospect in silence for a little while, and then Carl said: "Jer, have you dreamed up any ideas yet about how we can raise some money to buy the transistors, special transformers, tiny capacitors, and other parts we'll need for our transistor experiments this winter?"

"Nope. I've not come up with a thing. How about you?"

"Me, neither," Carl replied as he looked across the empty beach, "unless—"

"Unless what?" Jerry demanded, raising himself on an elbow to follow Carl's glance.

"Unless we could do a little beachcombing. You know how packed this place normally is, especially on weekends. There's hardly room to set down a bottle of suntan lotion. Think of all the coins that

Always say you saw it in—POPULAR ELECTRONICS





Maybe It's Easier Than You Think...

...To prepare for a profitable future in the big opportunity fields of

# TELEVISION RADIO • ELECTRONICS

### "DO-IT-YOURSELF" TRAINING

You get many shipments of high-quality parts. You perform over 300 PRACTICAL projects, including building your own test equipment: A Vacuum Tube Voltmeter and a 5 inch Oscilloscope. You KEEP these high-quality, commercial-type instruments to help you earn money during your training and you can use them later on your job. No need to buy such costly equipment when you start out in this field.



VACUUM TUBE  
VOLTMETER

### YOU GET CLEAR INSTRUCTIONS

You just ought to read the text of DTI lessons! The words are easy to understand. The directions make everything clear. There are lots of pictures and diagrams, many placed on handy "fold-out" sheets that stay alongside the explanations. You read it, you see diagrams without a lot of flipping back and forth.



OSCILLOSCOPE

### NOTHING LIKE DTI—HERE'S WHY

Only DTI provides you with training movies and the "ELECTRO-LAB." You run off the movies yourself, and check your reading and "doing" by seeing many basic principles in action on a screen. You can repeat any film several times until you are sure you "get it."

With the "ELECTRO-LAB" you copy a hookup like tracing a picture on issue paper! The diagrams you follow show through a sheet of clear plastic. You mount the parts, using spring clip connectors to save soldering time as you go from one circuit to another. This cuts mechanical work to a minimum!

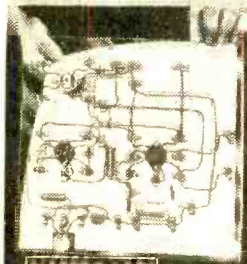

ELECTRO-LAB

\*Trademark

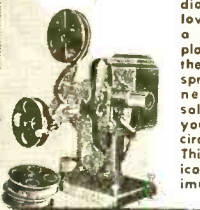

MOVIE PROJECTOR



One of America's Foremost Electronics Training Centers

Member National Home Study Council



**DEVRY TECHNICAL INSTITUTE**

CHICAGO 41, ILLINOIS

FORMERLY

DEFOREST'S TRAINING, INC.

### Read these simple ABC's on how you can get started

Maybe you have been envying the man with a good future in Television-Radio-Electronics—and thinking that's not for you. But, if you are 17 to 55, maybe it is! You don't need previous technical training nor advanced education. You don't have to quit your job and leave home. A lot of men are taking our program, getting ready for good jobs or to start their own business. Many are married. Quite a few are over 40. Many of them never finished high school. What is holding you back? All you have to do is fill out the coupon, send it in to us and we will tell you how we have trained many men like yourself and helped them get started toward real jobs with good money and a fine future.

### 25 YEARS PROOF

For 25 years we have trained men for better jobs right in their own homes. This first-hand experience in helping thousands of men brings a great advantage to men like you—training KNOW-HOW designed for REAL RESULTS!

### TRAIN IN WELL-EQUIPPED LABORATORIES

If you can come to Chicago, you can get all your training in our big, modern training laboratories where friendly instructors work closely with you as you use much valuable equipment similar to that found in the industry—even including our Television and Radio studio cameras, monitors, microphones, etc. Send the coupon for details.

### WE HELP YOU GET STARTED IN THE FIELD

DeVry Tech training in Television-Radio-Electronics turns out a man that knows his business! Many employers all over the United States and Canada are aware of that. Our EMPLOYMENT SERVICE is in close contact with many men who do the hiring. The help we give you in getting started in a new job is one of the most valuable features of DeVry Tech. What's more, if you're interested in STARTING YOUR OWN BUSINESS we'll be able to give you help there too.

### IS MILITARY SERVICE AHEAD OF YOU?

If you're soon to enter the ARMED FORCES, we have special information that will be of real value to you. Don't delay. Your future in Television-Radio-Electronics may be nearer than you think. Send that coupon now.

## GET THIS BOOKLET FREE!

DEVRY TECHNICAL INSTITUTE  
4141 Belmont Ave., Chicago 41, Ill., Dept. PE-9-M

I would like a copy of "Electronics and YOU" showing many opportunities in Television-Radio-Electronics, and how DTI may prepare me for a start in this billion dollar field.

Name \_\_\_\_\_ Age \_\_\_\_\_

PLEASE PRINT

Street \_\_\_\_\_ Apt. \_\_\_\_\_

City \_\_\_\_\_ Zone \_\_\_\_\_ State \_\_\_\_\_

1041

DTI's training is also available in Canada

# POPULAR SAMS BOOKS FOR THE EXPERIMENTER • AMATEUR • TECHNICIAN



## USE THIS HANDY ORDER FORM

- Attenuators, Equalizers and Filters.** Describes the design, application and theory of operation of every type of Attenuator, Equalizer and Wave-Filter used in audio, recording and reproducing systems, both professional and home-type. 176 pages; 5½ x 8½". \$2.75 Library-bound deluxe edition ..... \$4.00
- Transistors.** The first complete, practical book on Transistors and their application in TV-Radio-Electronics. Explains theory, circuitry, installation, testing techniques and servicing. 100 pages; 5½ x 8½"; illustrated ..... \$1.50
- So You Want to Be a Ham.** Shows you how to get your license and acquire equipment. Covers: Conquering the Code, Getting Your Ticket, Going on the Air, etc. 196 pages; 5½ x 8½"; illustrated ..... \$2.50
- Basic Radio Manual.** Complete course covers theory, definitions, components. Includes section on actual projects that translate theory into practice. 248 pages; 8½ x 11"; illustrated ..... \$5.00
- Basic TV Manual.** Covers all phases of TV set operation and design from picture tube to antenna. Includes project section demonstrating theory in action. 312 pages; 8½ x 11"; illustrated ..... \$5.00
- Atomic Radiation, Detection and Measurement.** Helps you understand nuclear science and its applications. Covers circuitry and operation of all types of detection devices. 200 pages; 5½ x 8½" ..... \$3.00
- Recording & Reproduction of Sound.** Oliver Read's best-seller on all phases of Audio. Full analysis of recorders and recording techniques. Complete data on amplifiers, speakers, mikes, phono equipment, P.A., etc. 810 pages; 6" x 9"; profusely illustrated ..... \$7.95
- Radio Receiver Servicing.** Covers all basic receiver types—gives time-saving hints for solving common troubles, such as dead set, weak set, noisy set, etc. 192 pages; 5½ x 8½"; illustrated ..... \$2.50
- Tape Recorders.** Explains recorder theory, tape characteristics, how recorders work; covers motorboard mechanism, drive motors, volume indicators, bias oscillators, amplifiers, magnetic heads, equalization circuits. 176 pages; 5½ x 8½"; illustrated ..... \$2.75

### HOWARD W. SAMS & CO., INC.

Order from any Radio & TV Supplier-Wholesaler, or mail to Howard W. Sams & Co., Inc., Dept. 14-J6, 2201 E. 46th St., Indianapolis 5, Ind.

Send books checked above. My (check) (money order) for \$..... is enclosed.

Name.....

Address.....

City..... Zone..... State.....

(outside U.S.A. priced slightly higher)

## Carl & Jerry (Continued from page 10)

must have slipped from upside-down pockets into the sand, of all the rings and watches that have been removed to take a plunge and lost, of all the cigarette lighters, bracelets—"

"Okay, okay!" Jerry interrupted. "So what do we do? Sift the sand?"

"A good electronics man like you ought to be ashamed to think of anything so crude and mechanical as that," Carl chided. "We can use our handy-dandy metal locator that we built from the article in the June, 1955, POPULAR ELECTRONICS. You know how we found Farmer Sloan's gold watch out in the cornfield with it; well, most of the valuables here will only be covered with an inch or so of sand, and the metal locator should be able to sniff them out easily. Only one thing's wrong: that treasure-finder is a little heavy to use over a long period of time, and I just know who will be elected to carry it. Lugging that thing around out there in the hot sun does not appeal—"

"**H**OLD IT! I've got an idea," Jerry broke in. "Suppose we mount that little gasoline washing machine motor of yours on the back of my wagon with the big rubber tires. The motor can drive one of the rear wheels through a couple of jackshafts and combination of speed-reducing V-pulleys so it will make the wagon just creep along. You'll also remember that I've taken all the remote control equipment out of the model tugboat while I'm refinishing the hull; so we can put this into the wagon and remote-control it. A solenoid operating a belt-tightener can serve as a clutch, and we can use one of those fractional-horsepower, reversible electric motors with a speed-reducing, power-amplifying gear train to steer the wagon. We can sit right here in the shade and send that wagon wherever we want to... up and down the whole beach."

"Well good, good, goody for us!" Carl said sarcastically; "but what's all that got to do with our locating the loot?"

"I'm coming to that. We'll mount the treasure-locator on the wagon with the search coil out in front, just clearing the surface of the sand. The audio beat-note signal that we hear in the earphones when something metallic appears near the search coil will be amplified, rectified, and the resulting current can be used to operate a sensitive relay which, in turn, will operate the clutch solenoid."

"You're getting through to me!" Carl said, with the enthusiasm boys invariably feel for a really complicated Rube Goldberg device. "When the search coil passes



# I saw my job failure in my family's eyes

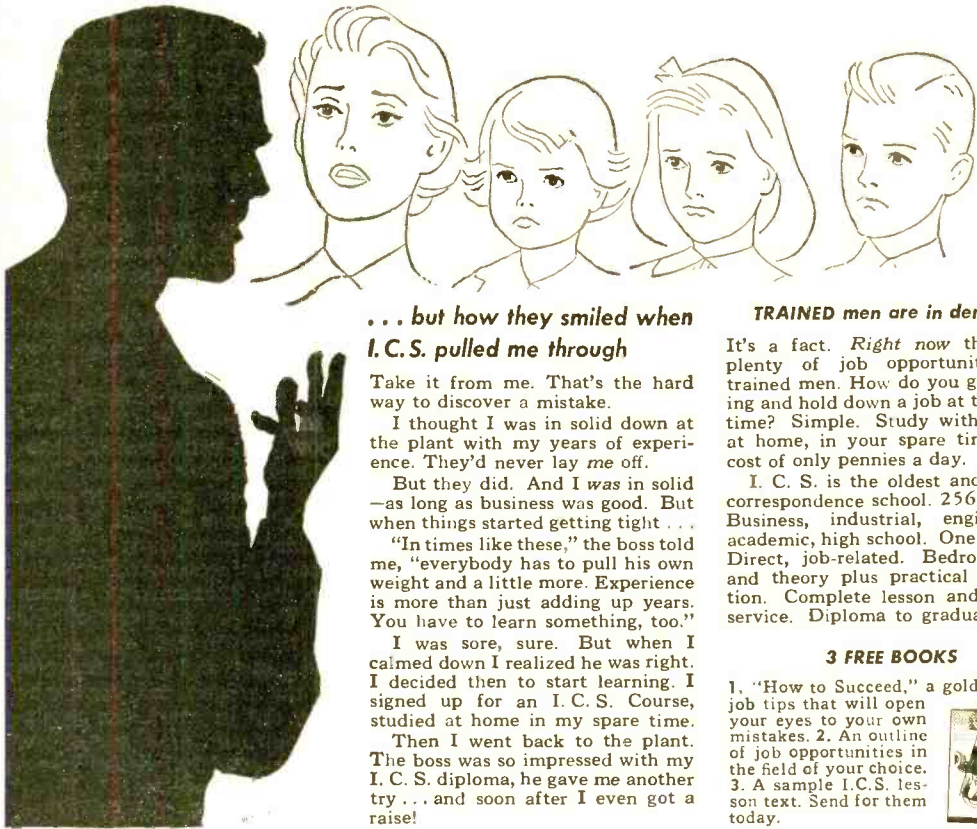

... but how they smiled when I. C. S. pulled me through

Take it from me. That's the hard way to discover a mistake.

I thought I was in solid down at the plant with my years of experience. They'd never lay me off.

But they did. And I was in solid—as long as business was good. But when things started getting tight...

"In times like these," the boss told me, "everybody has to pull his own weight and a little more. Experience is more than just adding up years. You have to learn something, too."

I was sore, sure. But when I calmed down I realized he was right. I decided then to start learning. I signed up for an I. C. S. Course, studied at home in my spare time.

Then I went back to the plant. The boss was so impressed with my I. C. S. diploma, he gave me another try... and soon after I even got a raise!

## TRAINED men are in demand

It's a fact. *Right now* there are plenty of job opportunities for trained men. How do you get training and hold down a job at the same time? Simple. Study with I. C. S. at home, in your spare time, at a cost of only pennies a day.

I. C. S. is the oldest and largest correspondence school. 256 courses. Business, industrial, engineering, academic, high school. One for you. Direct, job-related. Bedrock facts and theory plus practical application. Complete lesson and answer service. Diploma to graduates.

## 3 FREE BOOKS

1. "How to Succeed," a gold mine of job tips that will open your eyes to your own mistakes. 2. An outline of job opportunities in the field of your choice. 3. A sample I. C. S. lesson text. Send for them today.



For Real Job Security—Get an I. C. S. Diploma!

I. C. S., Scranton 9, Penna.

Member, National Home Study Council

## INTERNATIONAL CORRESPONDENCE SCHOOLS

65<sup>TH</sup> YEAR

BOX 22522H, SCRANTON 9, PENNA.

(Partial list of 256 courses)

Without cost or obligation, send me "HOW TO SUCCEED" and the opportunity booklet about the field BEFORE which I have marked X (plus sample lesson):

- |  |   |  |  |   |
|--|---|--|--|---|
| <p><b>ARCHITECTURE and BUILDING CONSTRUCTION</b></p> <ul style="list-style-type: none"> <li><input type="checkbox"/> Air Conditioning—Refrig.</li> <li><input type="checkbox"/> Architecture</li> <li><input type="checkbox"/> Architectural Interiors</li> <li><input type="checkbox"/> Building Contractor</li> <li><input type="checkbox"/> Building Estimator</li> <li><input type="checkbox"/> Building Maintenance</li> <li><input type="checkbox"/> Carpentry and Mill Work</li> <li><input type="checkbox"/> Heating</li> <li><input type="checkbox"/> Painting Contractor</li> <li><input type="checkbox"/> Plumbing</li> <li><input type="checkbox"/> Reading Arch. Blueprints</li> </ul> <p><b>ART</b></p> <ul style="list-style-type: none"> <li><input type="checkbox"/> Cartooning</li> <li><input type="checkbox"/> Commercial Art</li> <li><input type="checkbox"/> Fashion Illustrating</li> <li><input type="checkbox"/> Magazine Illustrating</li> <li><input type="checkbox"/> Show Card and Sign Lettering</li> <li><input type="checkbox"/> Sketching and Painting</li> </ul> <p><b>AUTOMOTIVE</b></p> <ul style="list-style-type: none"> <li><input type="checkbox"/> Auto Body Rebuilding</li> <li><input type="checkbox"/> Auto Elec. Technician</li> <li><input type="checkbox"/> Auto-Engine Tune Up</li> <li><input type="checkbox"/> Automobile Mechanic</li> </ul> | <p><b>AVIATION</b></p> <ul style="list-style-type: none"> <li><input type="checkbox"/> Aeronautical Engineering Jr.</li> <li><input type="checkbox"/> Aircraft &amp; Engine Mechanic</li> </ul> <p><b>BUSINESS</b></p> <ul style="list-style-type: none"> <li><input type="checkbox"/> Advertising</li> <li><input type="checkbox"/> Bookkeeping and Accounting</li> <li><input type="checkbox"/> Business Administration</li> <li><input type="checkbox"/> Business Correspondence</li> <li><input type="checkbox"/> Public Accounting</li> <li><input type="checkbox"/> Creative Salesmanship</li> <li><input type="checkbox"/> Federal Tax</li> <li><input type="checkbox"/> Letter-writing Improvement</li> <li><input type="checkbox"/> Office Management</li> <li><input type="checkbox"/> Professional Secretary</li> <li><input type="checkbox"/> Retail Business Management</li> <li><input type="checkbox"/> Sales Management</li> <li><input type="checkbox"/> Stenographic-Secretarial</li> <li><input type="checkbox"/> Traffic Management</li> </ul> <p><b>CHEMISTRY</b></p> <ul style="list-style-type: none"> <li><input type="checkbox"/> Analytical Chemistry</li> <li><input type="checkbox"/> Chemical Engineering</li> <li><input type="checkbox"/> Chem. Lab. Technician</li> <li><input type="checkbox"/> General Chemistry</li> <li><input type="checkbox"/> Natural Gas Prod. &amp; Trans.</li> <li><input type="checkbox"/> Petroleum Engineering</li> <li><input type="checkbox"/> Plastics</li> <li><input type="checkbox"/> Pulp and Paper Making</li> </ul> | <p><b>CIVIL, STRUCTURAL ENGINEERING</b></p> <ul style="list-style-type: none"> <li><input type="checkbox"/> Civil Engineering</li> <li><input type="checkbox"/> Construction Engineering</li> <li><input type="checkbox"/> Highway Engineering</li> <li><input type="checkbox"/> Reading Struct. Blueprints</li> <li><input type="checkbox"/> Sanitary Engineering</li> <li><input type="checkbox"/> Structural Engineering</li> <li><input type="checkbox"/> Surveying and Mapping</li> </ul> <p><b>DRAFTING</b></p> <ul style="list-style-type: none"> <li><input type="checkbox"/> Aircraft Drafting</li> <li><input type="checkbox"/> Architectural Drafting</li> <li><input type="checkbox"/> Electrical Drafting</li> <li><input type="checkbox"/> Mechanical Drafting</li> <li><input type="checkbox"/> Mine Surveying and Mapping</li> <li><input type="checkbox"/> Plumbing Drawing and Estimating</li> <li><input type="checkbox"/> Structural Drafting</li> </ul> <p><b>ELECTRICAL</b></p> <ul style="list-style-type: none"> <li><input type="checkbox"/> Electrical Engineering</li> <li><input type="checkbox"/> Electrical Maintenance</li> <li><input type="checkbox"/> Electrician <input type="checkbox"/> Contracting</li> <li><input type="checkbox"/> Lineman</li> </ul> <p><b>HIGH SCHOOL</b></p> <ul style="list-style-type: none"> <li><input type="checkbox"/> Commercial <input type="checkbox"/> Good English</li> <li><input type="checkbox"/> High School Subjects</li> <li><input type="checkbox"/> Mathematics</li> </ul> | <p><b>LEADERSHIP</b></p> <ul style="list-style-type: none"> <li><input type="checkbox"/> Foremanship</li> <li><input type="checkbox"/> Industrial Supervision</li> <li><input type="checkbox"/> Leadership and Organization</li> <li><input type="checkbox"/> Personnel-Labor Relations</li> </ul> <p><b>MECHANICAL AND SHOP</b></p> <ul style="list-style-type: none"> <li><input type="checkbox"/> Gas—Electric Welding</li> <li><input type="checkbox"/> Heat Treatment <input type="checkbox"/> Metallurgy</li> <li><input type="checkbox"/> Industrial Engineering</li> <li><input type="checkbox"/> Industrial Instrumentation</li> <li><input type="checkbox"/> Industrial Supervision</li> <li><input type="checkbox"/> Internal Combustion Engines</li> <li><input type="checkbox"/> Machine Design-Drafting</li> <li><input type="checkbox"/> Machine Shop Inspection</li> <li><input type="checkbox"/> Machine Shop Practice</li> <li><input type="checkbox"/> Mechanical Engineering</li> <li><input type="checkbox"/> Quality Control</li> <li><input type="checkbox"/> Reading Shop Blueprints</li> <li><input type="checkbox"/> Refrigeration</li> <li><input type="checkbox"/> Sheet Metal Worker</li> <li><input type="checkbox"/> Tool Design</li> </ul> <p><b>RADIO, TELEVISION</b></p> <ul style="list-style-type: none"> <li><input type="checkbox"/> Industrial Electronics</li> <li><input type="checkbox"/> Practical Radio TV Eng'ing</li> <li><input type="checkbox"/> High School Subjects</li> <li><input type="checkbox"/> Radio Operating</li> </ul> | <ul style="list-style-type: none"> <li><input type="checkbox"/> Television Technician</li> <li><b>RAILROAD</b></li> <li><input type="checkbox"/> Air Brake Equipment</li> <li><input type="checkbox"/> Car Inspector</li> <li><input type="checkbox"/> Diesel Engineer &amp; Fireman</li> <li><input type="checkbox"/> Section Foreman</li> <li><b>STEAM AND DIESEL POWER</b></li> <li><input type="checkbox"/> Combustion Engineering</li> <li><input type="checkbox"/> Diesel—Elec. <input type="checkbox"/> Diesel Eng'g's</li> <li><input type="checkbox"/> Electric Light and Power</li> <li><input type="checkbox"/> Stationary Fireman</li> <li><input type="checkbox"/> Stationary Steam Engineering</li> <li><b>TEXTILE</b></li> <li><input type="checkbox"/> Carding and Spinning</li> <li><input type="checkbox"/> Cotton, Rayon, Woolen Mfg.</li> <li><input type="checkbox"/> Finishing and Dyeing</li> <li><input type="checkbox"/> Loom Fixing <input type="checkbox"/> Textile Des'ing</li> <li><input type="checkbox"/> Textile Eng'g's <input type="checkbox"/> Throwing</li> <li><input type="checkbox"/> Warping and Weaving</li> <li><b>MISCELLANEOUS</b></li> <li><input type="checkbox"/> Domestic Refrigeration</li> <li><input type="checkbox"/> Marine Engineering</li> <li><input type="checkbox"/> Ocean Navigation</li> <li><input type="checkbox"/> Professional Engineering</li> <li><input type="checkbox"/> Short Story Writing</li> <li><input type="checkbox"/> Telephony</li> </ul> |
|--|---|--|--|---|

Name \_\_\_\_\_ Age \_\_\_\_\_ Home Address \_\_\_\_\_

City \_\_\_\_\_ Zone \_\_\_\_\_ State \_\_\_\_\_ Working Hours \_\_\_\_\_ A.M. to P.M. \_\_\_\_\_

Occupation \_\_\_\_\_

Canadian residents send coupon to International Correspondence Schools, Canadian, Ltd., Montreal, Canada. . . . Special tuition rates to members of the U. S. Armed Forces.

# RADIO SHACK EXCLUSIVES!

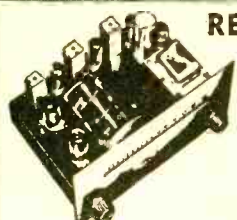

**REALISTIC hi-fi FM TUNER**  
not a kit!  
**\$39<sup>95</sup>**

Features hi-fi Armstrong FM with Foster-Seeley discriminator and AFC, 5- $\mu$ v sensitivity for 30 db quieting, tuned RF stage, built-in AC supply, 20—20,000 cps,  $\pm$ 0.5 db, pilot light, slide-rule dial, switch for FM or phono feed-thru, tape output jack, compact 4 $\frac{1}{4}$ " x 9 $\frac{1}{2}$ " x 6 $\frac{3}{8}$ " deep. Ship wt. 6 $\frac{1}{4}$  lbs. Order No. 36-888-PE.

## NEW REALISTIC SPEAKER

List \$41.50  
**EXCLUSIVE \$19<sup>95</sup>**



Suspension-cone hi-fi speaker installed in solid, tuned, vented, duct-type, furniture-finished walnut cabinet! Lab-verified 50—12,000 cps; 4 ohms, 15 watts. REAL lows — clean highs — ultra-compact. 14 $\frac{1}{2}$ " x 11" x 10 $\frac{1}{2}$ ". Ship wt. 12 lbs. Order No. R-9036-PE.

**EXCLUSIVE \$10<sup>95</sup>**



**SLIM dynamic MICROPHONE**  
Reg. \$40.00 ARCHER

Tuned-cavity construction, high impedance, output 56 db, 50—11,000 cps, built-in ON-OFF switch, 12' cable, black metal. Swiveling cradle included FREE. 8 ounces net, only 7 $\frac{1}{2}$ " long, 1 $\frac{1}{4}$ " dia. Ship wt. 2 lbs. Order No. R-9084-PE.



## HANDEL'S MESSIAH

A DELUXE ALBUM of three 12" LP records, factory-fresh, factory-sealed. Orig. \$19.95. Scherchen, London Symphony, London Phil. choir. Ship wt. 4 lbs. Order No. WAL-308-PE.

## NEW CATALOG

All the LATEST in hi-fi, transistors, components, ham gear and instruments. Send coupon for YOUR free copy of this big, new 224-page guide to the best buys in radio and electronics.

### RADIO SHACK CORPORATION

167 Washington St., Boston 8, Mass.  
230 Crown St., New Haven 10, Conn.

Please send me FREE Catalog #57PE.

Name .....  
St. ....  
City ..... Zone .....  
State .....

## Carl & Jerry (Continued from page 12)

over something metallic like, say, a five-hundred-dollar diamond-studded gold watch, the audio signal produced will trip the relay that will operate the solenoid that will stop the wagon. The gadget will just sit there like a faithful little old bird dog on 'point' until we leisurely stroll down to it, brush away the sand, pick up the watch, and toss it into the pillowcase full of other valuables we have already found."

"Well, let's go!" Jerry said, getting to his feet and brushing the loose sand from his knees and the seat of his trousers.

AND GO they did, just as fast as they could pedal their bicycles home. The heat that had seemed so oppressive when they had nothing to do was entirely forgotten now as they worked out details of mounting the powerful little gasoline motor on the fat-tired coaster wagon. They connected up the remote control receiver and its reed-type actuator so that it could operate the steering mechanism and the simple clutch. Then they arranged the metal locator so that its hoop-shaped search coil was carried well out in front of the wagon two or three inches above the ground. With the motor and the jackshafts mounted behind the wagon and the probe coil sticking away out in front, the resulting ungainly appearance was something like that of an elongated king-sized insect . . . but the contraption worked!

Proof of this was had when Jerry fished a nickel from his pocket and recklessly tossed it out onto the middle of the lawn. They started up the self-powered remote-controlled treasure finder and sent it into action quartering back and forth across the yard. After having first turned up three rusty nails and an old belt buckle, it finally stopped with the search coil directly over the nickel. That was all the "testing" the boys needed. They immediately began coaxing Jerry's mother to drive them and their invention down to the beach in the station wagon, and did not let up until she agreed. Just as they were starting out the drive, Carl suddenly exclaimed: "Wups! Wait a minute. We're forgetting something."

He vaulted over the low fence between the two houses and disappeared into his own house. Almost immediately he came dashing back out waving an empty pillowcase in which to dump their findings.

ONCE at the beach, the boys lost no time in putting their electronic beach buggy into action. The large tires kept the wheels of the wagon from cutting down



# FREE-ANY 3

OF THESE HIGH-FIDELITY

## 12" COLUMBIA (LP) RECORDS

If you join the Columbia (LP) Record Club now—and agree to accept as few as 4 selections during the coming 12 months.

### 1 Ports of Call

Philadelphia Orchestra, Ormandy, conductor. 6 works—*Bolero, Espana, Escapes, Pavane, etc.*

### 2 The Voice

Frank Sinatra sings 12 numbers that first brought him fame . . . like *Fools Rush In, I Don't Know Why, Lover, Laura, Paradise, etc.*

### 3 King of Swing: Vol. 1

Benny Goodman and his Original Orchestra, Trio, Quartet. *Ridin' High, Peckin'*—9 more.

### 4 My Fair Lady

Percy Faith and his Orchestra play selections from this hit show — *I Could Have Danced All Night, etc.*

### 5 Mendelssohn: Tchaikovsky: Violin Concerto

Francescatti, violin; New York Philharmonic, Mitropoulos, conductor.

### 6 I Love Paris

Michel Legrand and his Orch. play *La Vie En Rose, Paris*—12 more.

### 7 Jazz: Red Hot & Cool

Dave Brubeck Quartet in *Sometimes I'm Happy, Lover, Little Girl Blue, Indiana*—3 more.

### 8 Levant Plays Gershwin

Gershwin's three greatest orchestral works — *Concerto in F; Rhapsody in Blue; An American in Paris.*

### 9 Saturday Night Mood

Dance music played by 12 bands — Jimmy Dorsey, Sammy Kaye, etc.

### 10 Beethoven: Symphony No. 5 Mozart: Symphony No. 40

Philadelphia Orchestra, Ormandy, conductor.

### 11 Music of Jerome Kern

Andre Kostelanetz and his Orch. play 20 Kern favorites—*The Song Is You, You Are Love, etc.*

### 12 Ambassador Satch

European Concert Recordings by Louis Armstrong and All-Stars. 10 numbers in all.

**YES!** You may have, FREE, ANY 3 of these best-selling 12" Columbia (LP) records. We make this offer to introduce you to the money-saving program of the Columbia (LP) Record Club . . . a program that selects for you each month the greatest works in every field of music—performed by the world's finest artists and brilliantly reproduced on Columbia (LP) records.

#### HOW THE CLUB OPERATES

To enjoy the benefits of this program—mail the coupon, indicating which of the four Club divisions best suits your musical taste: Classical; Jazz; Listening and Dancing; Broadway, Movies, Television and Musical Comedies.

Each month you will receive free the Club Magazine which describes the current selections in all four divisions. You may accept or reject the monthly selection for your division . . . or take records from the other divisions—thereby assuring you of the widest possible choice of recorded entertainment. Or you may tell us to send you NO record in any month. Your only obligation is to accept as few as 4 selections from the almost 100 to be offered during the next 12 months, and you may cancel membership any time thereafter. The records you want are mailed and billed to you for the low price of only \$3.98, plus a small mailing charge.

#### FREE BONUS RECORDS GIVEN REGULARLY

The 3 records sent to you now represent an "advance" of the Club's bonus system—given to you at once. After fulfilling your membership obligation by purchasing 4 records, you will receive an additional free Bonus record of your choice for every two additional Club selections you accept. Bonus records are superb 12" Columbia (LP) records—like those shown here.

Indicate on the coupon which 3 records you want free, and the division you prefer . . . then mail it at once. You must be delighted with membership or you may cancel without obligation by returning the free records within 10 days.

### COLUMBIA (LP) RECORD CLUB

165 West 46th St., New York 36, N. Y.

#### MAIL THIS COUPON NOW!

COLUMBIA (LP) RECORD CLUB, Dept. 510  
165 West 46th St., New York 36, N. Y.

Please send me as my FREE gift the 3 records indicated here: (Select the 3 records you want from the list on this page, and circle the corresponding numbers here)

1 2 3 4 5 6 7 8 9 10 11 12

and enroll me in the following division of the Club.  
(check one box only)

Classical  Listening and Dancing  Jazz  
 Broadway, Movies, Television and Musical Comedies

Each month you will send me the Columbia (LP) Record Club Magazine which describes the records offered in all four Club divisions. I have the privilege of accepting the monthly selection in the division checked above, or any other selection described, or none at all. My only obligation is to accept a minimum of four records in the next 12 months at the regular list price plus a small mailing charge. After accepting 4 records, I will receive a free Bonus record for every two additional records I purchase. If not delighted with membership, I may cancel within 10 days by returning all records.

Name.....  
(Please Print)

Address.....

City.....Zone.....State.....

CANADA: Prices slightly higher. Address 11-13 Soho St., Toronto 2B.

If you wish to have this membership credited to an established Columbia Records dealer, authorized to accept subscriptions, please fill in the following information:

Dealer's Name.....

Dealer's Address.....23

© "Columbia", (LP), Marcas Rea.

# HERSHEL'S SPECTACULARS!

**OIL CONDENSER**  
**\$165**  
  
 2 MFD. 3000 VDC. Pyranol Oil W Mounting Brackets.  
 1-1 Mfd. 3000 VDC. removed from equip. 4 3/4" x 4 1/4" x 2 1/2"

**ARC-3 COMMAND TRANSMITTER**  
 YOUR CHOICE  
**\$8.95**  
  
 2.1 to 3 MC. 7 to 9.1 MC. B and B in New in Cartons. with tubes.  
 Hottest Buy in the Country

**PHOTO ELECTRIC CELL**  
**95¢**  
  
 CE Vacuum Cell used in A M P R O Sound Projector. Also useful for opening garage doors and Alarm Systems.

**25-Ft. RG58/U COAXIAL CABLE**  
 With Male & Female Plugs  
**97¢**

**GE Pyranol Oil CONDENSER**  
 12 MFD. 330 VAC. 60 Cy. Removed from NEW equip.  
**95¢**

**YOUR CHOICE ANY KIT LISTED IN THIS AD**  
**97¢**

**30 TUBE SOCKETS.**  
 A Subminiatures, 7 & 9 pin miniatures, 1 to 8 pins. Mica-filled & ceramic shield base type, too!

**60 MICA CONDENSERS.**  
 L Rare offer! Postage stamp types. 25 values. .0001 to .01 to 1200 WVDC. Many silver. 5¢/2¢/1¢

**2000 PCS. HARDWARE.**  
 B Radio, TV, shop, wood-working screws, springs, grommets, etc.

**100 SET SCREWS**  
 W ASST. Slotted and Allen Wrench Type. from 6/32 up.

**40 MOULDED CONDENSERS.**  
 C Best known makes! .0005 to 0.1 mf to 1000V. Oils, too.

**30 POPULAR BULBS.**  
 N Special! Wide variety standard, miniature, screw and bayonet types. 1.1 thru 6V.

**15 ROTARY SWITCHES.**  
 T Experimenters, note! Varied asst. single & dual gangs.

**8 CRYSTAL DIODES.**  
 W 1N22 Brand New

**8 TUBULAR ELECTROLYTICS.**  
 E Popular values to 450V. Top makes. axial leads.

**50 CERAMIC CONDENSERS.**  
 P Tubular, disc, button & standoffs! 5 to .01 mfd to 1000V.

**60 KNOBS.**  
 F Instrument, radio, TV types. Push-on & set screw types. Some 35¢ ea.

**12 VOLUME CONTROLS.**  
 Q Handy shop, asst. of radio, TV lab units. Some V-W.

**20 ASSORTED BULBS.**  
 U Asst. standard screw & bayonet. 2 thru 24 VDC

**50 RF COILS & CHOKES**  
 R Tubular, disc, button & standoffs! 20 types.

**60 TUBULAR CONDENSERS.**  
 H 25 values! .0005 to 1 mf. up to 6000V. Oils, too.

**20 POWER RESISTORS.**  
 S Wirewound, 20 values. 5 ohms to 12,000. 5 to 50 watts. Candohm & tubular types.

**10 FP & TWIST ELECTROLYTICS.**  
 I Asst. to 1000 mfd. to 450V. Some multiples.

**100 COIL FORMS.**  
 J Experimenters, note! Wide variety of shapes & sizes. Ceramic and bakelite.

**60 CARBON RESISTORS.**  
 K Insulated, 35 values. 15 ohms to 10 megs. 1/2, 1 & 2W. 5¢/1¢/1¢/1¢. Incl. famous Allen Bradley!

**All New MYSTERY PACKAGE of ELECTRONIC PARTS**  
 Worth \$40.00  
 Our Price **\$3.95**  
 Ship Wt. 20 lbs.  

**PICTURE TUBE BRIGHTENER 94¢**

TERMS: Cash with order or 25% DOWN—BALANCE C.O.D.  
 ALL PRICES NET F.O.B. DETROIT MINIMUM ORDER \$2.00

**HERSHEL RADIO CO.**  
 TYler 8-9400  
 5249 GRAND RIVER Detroit 8, Michigan

## Carl & Jerry (Continued from page 14)

into the sand, and the gasoline motor—thanks to the down-gearing—had an easy task propelling the vehicle along. At first the boys could not resist the temptation to send the treasure locator hither and thither along the beach to test out the operation of the remote control; but when it was found that this functioned perfectly, they settled down to directing the movement of the wagon in a regular pattern that eventually would cover the whole area of the beach in sight of what they dubbed their "command post."

The wagon had hardly gone a hundred yards when it came to a halt, and there was nothing leisurely about the way the boys dashed down to where it was sitting quietly put-put-putting away. As Carl eagerly brushed away the sand from beneath the search coil, he uncovered a little slip of tin foil from a stick of chewing gum, and instantly the wagon started chugging ahead, indicating that the bit of tin foil was what it had in mind.

A little disappointed, the boys started back to their command post, but before they reached it, the wagon stopped again. It had found another scrap of tin foil. To cut a long and painful story short, the metal locator found exactly twenty-three bits of tin foil in two hours—and it found nothing else! Actually, the boys were expending more energy running back and forth between their command post and the wagon than they would have used if they had simply carried the metal locator in the first place; but to them, of course, this fact was entirely irrelevant and beside the point.

Finally, Carl knelt in front of the search coil with the twenty-third scrap of tin foil in his hand and addressed it with an impassioned speech: "Now look, Tin-Foil Terry, you don't seem to get the idea. We're not looking for this kind of stuff. We can get all the tin foil we need. We want something like *this!*" He placed some coins in the palm of his hand and held them directly in front of the search coil. "Now will you please, please get off this tin-foil binge you're on and go out there and find some of these pretty little engraved silver discs? Will you please?"

**A** GAIN the boys trudged back to their command post, and the wagon chugged on down the beach. It did not hesitate until it reached the turn-around point, nor did it stop on the way back until it was almost directly in front of the boys. Then the motor speeded up a little as the sole-noid clutch operated to stop the wagon.

"More tin foil," Carl grunted, heaving



# This book is a Gold Mine Send for it immediately!



**REVEALS HOW YOU CAN GAIN QUICKER SUCCESS  
OR TURN YOUR HOBBY INTO A WELL-PAID CAREER  
IN RADIO . . . TELEVISION . . . ELECTRONICS**

## Whether you're an amateur . . . a hobbyist . . . or already in electronics . . . Let us show you how to have a bright career in **RADIO! TELEVISION! ELECTRONICS!**

### TURN YOUR HOBBY INTO A HIGH-PAY CAREER!

Today thousands of electronics hobbyists have an opportunity to turn their hobbies into profits. It's the "Age of Electronics"! Trained men are in crucial demand! You may be "outside" the electronics industries now, working on a job you enjoy far less than experimenting, building, transmitting, receiving; working for less money than is being paid to electronics engineering technicians. But your "true love" is electronics. Why not awaken to your opportunities—now?

### ELECTRONICS HAS GOOD PAYING JOBS FOR TRAINED MEN LIKE YOU!

And only trained men can fill them. You can get your share, if you take time now to gain that indispensable knowledge.

Here are just two of the high-level opportunities available to CREI-trained men:

"Just about four months have passed since I made my first recruiting trip to CREI. As a result of that visit Messrs. Kols, Plante and Wenger are now members of the Laboratories and Mr. Kresge soon will be . . . we have some openings now and will have others . . ."—Bell Telephone Laboratories, Murray Hill, N. J.

"Two openings in our Field Service . . . aircraft electronics . . . starting salary is \$380 and up . . ."—North American Aviation, Inc., Columbus, Ohio.

### YOU NEED ADVANCED TRAINING

Sure you have some experience. But the fellows with only partial technical knowledge move slowly, or stand still while you—the man with advanced technical training—plunge ahead in the golden world of electronics opportunities.

### ACQUIRE NECESSARY TRAINING AT HOME

Use spare-time hobby hours for CREI Home Study as thousands of successful technicians have done since 1927. Get concentrated training in minimum time, then step into a good job and enjoy good pay in the mushrooming electronics industry.

### SEND FOR FREE BOOKLET. IT TELLS YOU HOW

How to gain career success in the tremendous electronics industries. It pinpoints opportunities which exist. By 1960, the electronics industries will do no less than \$15 billion worth of business per year, not counting military orders. Take TV for example; there are about 36,000,000 TV sets and over 425 TV stations on the air. Color TV is pushing ahead furiously. Electronics is the ONE field of maximum opportunity in this electronic age.

### CREI TRAINS YOU IN MINIMUM TIME AT HOME

Thousands of men before you have benefited quickly from CREI Home Study training. Thousands of CREI graduates are now employed in industry here and abroad. Here is what they say:

"In this time of less than two years, I have almost doubled my salary and have gone from wireman, to engineering assistant and now to junior engineer. I have CREI to thank."—Frank A. Eckert, 22 Clover Lane, Levittown, Pa.

### VETERAN?

If discharged after June 27, 1950, let new Korean Bill of Rights help you get resident instruction. Check coupon for full data.

### LIKE TO STUDY IN WASHINGTON?

CREI also offers resident instruction at same high level day or night. Classes start often. Check coupon for Residence School catalog. Qualified residence graduates earn degree: "Associate in Applied Science."

**FAMOUS FOR 29 YEARS**  
CREI is known and respected throughout the Electronic world. Since 1927 we have trained thousands in the military, industry and government. **ASK ANY ENGINEER.**

To help us answer your request intelligently, please give the following information:

EMPLOYED BY .....

TYPE OF PRESENT WORK .....

SCHOOL BACKGROUND .....

ELECTRONICS EXPERIENCE .....

IN WHAT BRANCH OF ELECTRONICS ARE YOU MOST INTERESTED? .....

## MAIL THIS COUPON . . . TODAY!

### CAPITOL RADIO ENGINEERING INSTITUTE

Accredited Technical Institute Curricula—Founded in 1927  
3224 16th St., N. W., Dept. 129-C, Washington 10, D. C.  
Send booklet "Your Future in the New World of Electronics" and course outline.

- CHECK FIELD OF GREATEST INTEREST
- Practical Radio Electronic Engineering
  - Broadcast Radio Engineering (AM, FM, TV)
  - Practical Television Engineering
  - Practical Aeronautical Electronic Engineering

Name .....

Street .....

City .....

Zone .....

State .....

Check:  Home Study  Residence School  Korean Veteran



# LOOK

what \$35<sup>90</sup> buys...

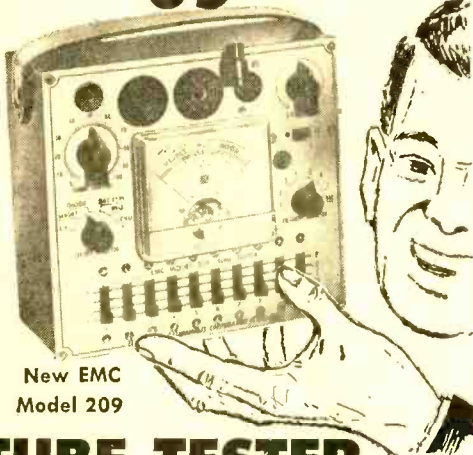

New EMC Model 209

## TUBE TESTER AND REJUVENATOR\*

"YOU CAN HOLD THIS MINIATURIZED INSTRUMENT IN ONE HAND... a revolutionary new development, it gives fast, absolutely accurate checks for tube quality, shorts, leakages, continuity, and opens on all modern and future tubes... uses standard emission test for quick readings on modern, 3 1/2" plastic meter... flexible switching system prevents obsolescence. This professional instrument also rejuvenates picture tubes with the Model CRA (Picture Tube Test Adaptor)\*... specially designed by advanced engineering techniques, its handy size (6 3/4" x 7 1/2" x 4") makes it ideal for home calls."

EMC Model 209 (as illustrated in Hammertone metal case) \$35.90

FREE



In oak carrying case 38.50  
Kit form 25.90

Complete with plastic-covered, detailed instruction book and tube listings.

\*EMC Model CRA (Picture Tube Adaptor) 4.50

Yes, send me full technical information about Model 209 and a complete catalog of other EMC Instruments. PE-9

NAME \_\_\_\_\_

STREET \_\_\_\_\_

CITY \_\_\_\_\_ STATE \_\_\_\_\_

# EMC

ELECTRONIC MEASUREMENTS CORP.  
280 LAFAYETTE STREET  
NEW YORK 12, NEW YORK

EXPORT DEPT. 370 BROADWAY, N. Y. 13, N. Y.

### Carl & Jerry (Continued from page 16)

himself to his feet and starting across the hot sand toward the wagon.

"You can't be sure," Jerry said, optimistically, as he followed along. "We can hope, anyway."

And when Carl started brushing away the sand, it began to look as though his pep talk to Tin-Foil Terry had done some good, for no scrap of tin foil appeared, and the wagon stayed put, showing that whatever it was pointing to was still there.

"Dig deeper," Jerry suggested, as he knelt beside his pal.

Carl scooped away the sand to a depth of eight or ten inches, and suddenly his fingers touched a parcel wrapped in moldy, rotting, brown paper. He lifted it out of the hole and discovered that it was a heavy package some four inches wide by seven inches long by an inch thick. The wagon started up when the parcel was removed from beneath the coil, but Jerry stopped it by shorting out the spark plug of the motor.

"What the heck is it?" Jerry asked, with much curiosity.

"You got me, but I guess there's only one way to find out," Carl said, as he started unwrapping the decaying paper. Inside were two rectangular metal plates carefully wrapped separately in soft flannel. He handed one to Jerry to examine while he scrutinized the other.

"It's got a kind of design engraved on one of the flat surfaces," he said slowly, turning it so that the light made the design stand out. "There's a kind of cameo in the middle with a man's head on it, and



... The dark man's beady black eyes glistened coldly out of his pasty white face as he held out a demanding hand for the rectangular metal plates...



**NOW!**  
 world's first and only  
**TRANSISTORIZED**  
 Amateur Band Converter

**Regency**  
**ATC-1**

a tiny self-powered  
 converter that connects  
**INSTANTLY**  
 to any receiver

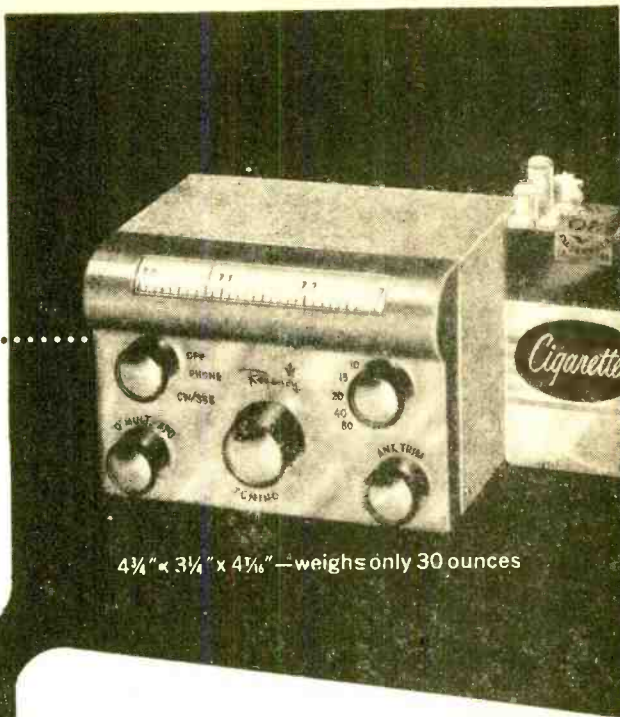
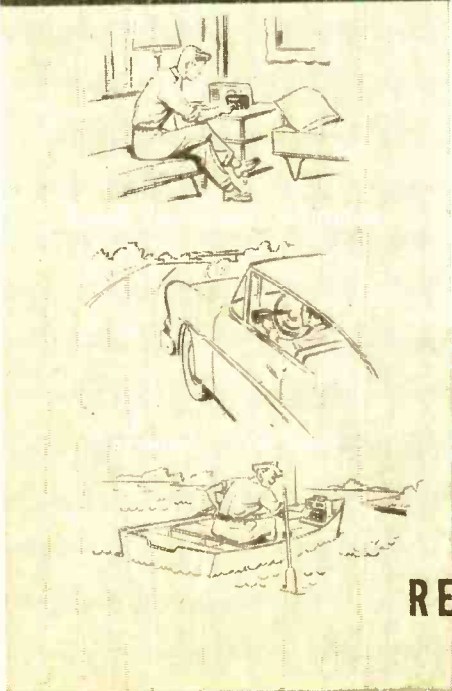

4 1/4" x 3 1/4" x 4 1/8" — weighs only 30 ounces

● No other converter like it! REGENCY's new ATC-1 is truly portable. Hooks up in seconds to *any* receiver (including car radios)—only connections are to an antenna and to receiver's antenna input.

The ATC-1 takes no power from the receiver. It is self-powered by three tiny Penlight cells which have a current drain of only 450 to 600 micro-amperes.

**World's Smallest Converter.** Use of transistors instead of bulky vacuum tubes makes this remarkable unit as easy to carry as a candid camera—it's actually less than half the size of this page!

The ATC-1 provides AM, CW and SSB reception on the 80, 40, 20, 15 and 10 meter amateur bands. Sensitivity is 5 to 10 mv for 6 db signal-noise ratio. A modified "Q" multiplier circuit improves sensitivity and selectivity for phone operation. Smartly styled aluminum cabinet is covered in dark grey tweed with satin finished aluminum front.

With features that can't be duplicated at any price, the transistorized REGENCY ATC-1 is available now at just . . . \$79.50  
amateur net

See and hear this miniature marvel at your local distributor.

Bulletin giving complete details and specifications yours on request.

**REGENCY** Division • I. D. E. A., Incorporated

Dept. D, 7900 Pendleton Pike, Indianapolis 26, Indiana

# EZ2 Build

Introducing the Brand New, Low-Cost,  
Top-Performing

## 90 Watt Globe Chief Kit

(75 WATTS FOR NOVICE USE)



Just \$5.00 Down  
Cash: \$49.95

Only  
**\$500**  
per mo.

Wired Form:  
\$64.95

All the power a  
Novice can use plus  
20% safety factor in  
case of local line  
voltage drop.

Complete instruction  
manual; all parts; chassis  
pre-punched; wires  
pre-cut and pre-tinned.  
No experience necessary.

- ✓ Completely bandswitching, 160-10M  
Built-in power supply!
- ✓ Pi-Net matches antennas, 52-600 ohms
- ✓ Sturdy, compact; handsomely styled
- ✓ Modified Grid-Block keying for  
maximum safety
- ✓ Provisions for Speech Modulator\* and  
VFO input
- ✓ 100% trade-in value on Globe King  
or new Champion, within 1 year

\* The new WRL Plug-In Screen Modulator Kit (com-  
plete) has been designed for use with the Globe  
Chief; may also be used with the Johnson Adventurer,  
Heath Kit AT-1, or similar CW Xmtrs. . . . \$13.95

SEND FOR DETAILED BROCHURE TODAY!

### FREE 1957 CATALOG!

WORLD RADIO LABORATORIES  
3415 West Broadway  
Council Bluffs, Iowa

Please rush to me:

- Free 1957 Catalog  
 Globe Chief Brochure



NAME: \_\_\_\_\_

ADDRESS: \_\_\_\_\_

CITY & STATE: \_\_\_\_\_

## Carl & Jerry (Continued from page 18)

there's some printing, too, but it's hard to make out because it's printed backwards."

"Mine's got a picture of some kind of big public building in the middle, and it has both letters and numbers printed on it. Let me see. Say, these must be printing plates for making mo—"

"Never mind what they are," a gruff voice commanded. "Just give them to me. They're mine."

The boys had been so intent on examining their find they had not heard the short dark man approaching in the soft sand. His beady black eyes glinted coldly out of his pasty white face as he held out a demanding hand for the plates.

"**H**OLD IT, Jake!" still another strange voice interrupted, and three men came running from behind one of the nearby dunes. At first the man they addressed as Jake looked as though he might run for it; but when he saw the guns in the hands of the approaching trio, he stood still.

"Couldn't wait any longer, huh, Jake?" one of the men inquired as he frisked the short dark man for a possible weapon.

"I'm clean," Jake grunted; "and I could have waited until you guys layin' out there in the dunes took root if these brats hadn't forced my hand."

"Hey, can anybody tell us what's going on?" Jerry piped up.

"This is Jake, The Penman," the leader of the trio explained. "He's a well-known counterfeiter just out of prison after doing a stretch. But when the counterfeiting ring was broken up, the plates were never found. We put a tail on Jake as soon as he left prison, hoping he would lead us to where the plates were hidden; and, thanks to you boys and your—your—gadget there, he did. I'm not sure, but I rather think there will be a reward of some sort coming to you for helping to find the plates. But just as a matter of curiosity, would you mind telling us what that thing is? We've been lying out there watching you all afternoon, and none of us can figure it out."

Carl and Jerry, both talking at once, began an explanation of how the electronic beach buggy worked. When they finished, the leader of the three Federal agents shook his head as though to clear it of a bad dream.

"I still don't get it," he confessed; "but right here in my hand is the evidence that it works. Don't be surprised if some of the Treasury people want to examine it after I make my report. We might be able to use it in our business!"

—50—



# RCA offers you the finest training at home in Radio-TV electronics, TV servicing, Color TV

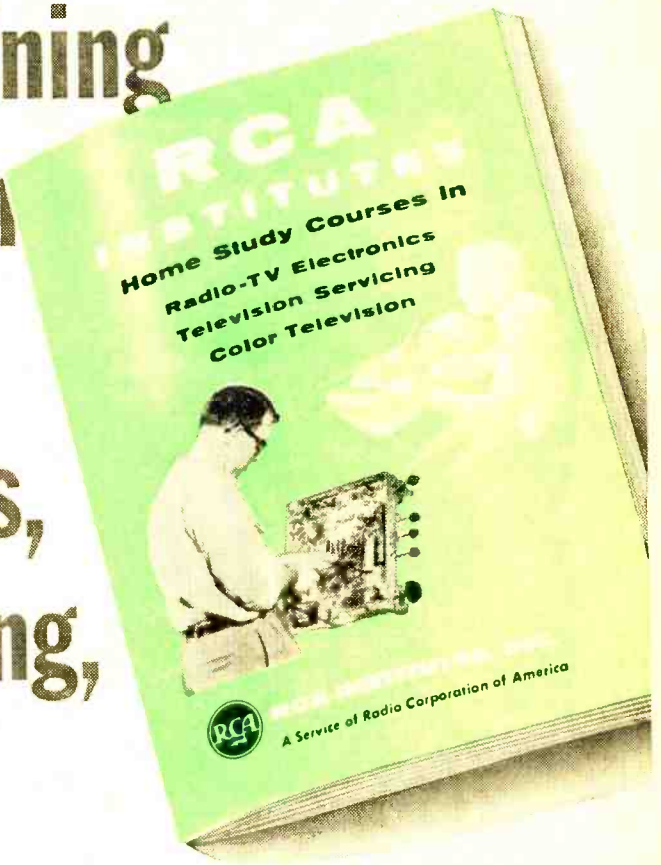

## SEND FOR THIS FREE BOOK NOW!



**RCA INSTITUTES, INC.**  
*A SERVICE OF RADIO CORPORATION OF AMERICA*  
 350 WEST FOURTH STREET, NEW YORK 14, N.Y.

The instruction you receive and equipment you get (and keep) will start you on your way. Pay-as-you-learn. You pay for only one study group at a time. This 52 page book contains complete information on Home Study Courses for the beginner and the advanced student.

RCA Institutes, Inc., Home Study PE-96  
 350 West Fourth Street New York 14, N. Y.  
 Without obligation, send me FREE CATALOG  
 on Home Study Courses in Radio, Television  
 and Color TV. No salesman will call.

Name .....  
 Please Print

Address .....

City ..... Zone ..... State .....



# FREE

1956  
**EICO**<sup>®</sup>  
CATALOG

tells you how to **SAVE 50%**  
on your test equipment costs!

46 EICO KITS & INSTRUMENTS to choose from!



5" PUSH-PULL  
OSCILLOSCOPE  
#425  
KIT \$44.95  
Wired \$79.95

VACUUM TUBE  
VOLTMETER



#221  
KIT \$25.95  
Wired \$39.95

For Laboratory Precision at Lowest Cost—  
buy EICO!



1000 Ohms/Volt  
MULTIMETER  
#536  
KIT \$12.90  
Wired \$14.90

TUBE TESTER #625

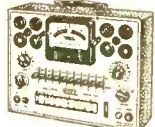

KIT \$34.95    Wired \$49.95

You build EICO KITS in 1 evening, but—  
they last a lifetime!



NEW! UTILITY  
TESTER #540.  
KIT \$12.95  
WIRED \$15.95

6V & 12V BATTERY ELIMINATOR  
& CHARGER #1050



KIT \$29.95    Wired \$38.95

EICO—performance-proved by TV manufac-  
turers, electronic schools and over 100,000  
servicemen! OVER 1/2 MILLION in use today!



NEW! COLOR &  
BLACK-&WHITE  
5-MC TV SCOPE  
#460  
KIT \$79.95  
Wired \$129.50

NEW! 20-Watt Ultra-Linear  
HIGH FIDELITY AMPLIFIER



#HF 20  
KIT \$49.95    Wired \$79.95

MAIL COUPON NOW. Prices 5% higher on  
West Coast. Electronic Instrument Co., Inc.,  
84 Withers St., Brooklyn 11, N. Y.

**EICO** 84 Withers St., Brooklyn 11, N. Y.

Send FREE 1956 Catalog and name of  
neighborhood EICO distributor. PE-9

Name .....

Address .....

City..... Zone..... State.....

Occupation .....

# POP'tronics



## BOOKSHELF

"INDUSTRIAL ELECTRONICS" by Ed-  
ward J. Bukstein. Published by Frederick  
Ungar Publishing Co., 105 E. 24th St., New  
York 10, N. Y. 197 pages. Cloth bound.  
Price, \$3.95.

A well-known and widely read author  
("The Magic of Electronics," numerous ar-  
ticles in RADIO & TELEVISION NEWS, etc.)  
has assembled here hundreds of questions  
and answers that cover the basic funda-  
mentals of industrial electronics. The first  
six chapters of the book deal with stand-  
ard types of equipment that are unique to  
industrial applications. Resistance weld-  
ing, photo-electricity, x-rays, thyratrons,  
counters and scalars, and time delay cir-  
cuits are included. Chapters 7 and 8 dis-  
cuss special circuits and applications, such  
as multivibrators, special power supplies,  
squaring circuits, integrators, r.f. heating,  
Geiger counters, etc. Test instruments are  
taken up in Chapter 9.

Questions and answers that comprise the  
text are exhaustive, and cover the field as  
thoroughly as conventional textbook treat-  
ment might. A topical index and numerous  
drawings help clarify the material.

*Recommended:* as an excellent reference  
work, as well as an introduction to the  
subject, for the technician or experimenter  
who has mastered the fundamentals of  
basic electronics.



"THE LONG PLAYING RECORD GUIDE"  
by Warren De Motte. Published by Dell  
Publishing Co., Inc., 261 Fifth Ave., New  
York 16, N. Y. 448 pages. Paper bound.  
Price, 50 cents.

This volume contains a listing of a num-  
ber of LP records made from 1948 to early  
1955. Not every composer, and not every  
composition is included, but there are  
enough selections among the 7000 record  
sides discussed to afford many music lovers  
and hi-fi enthusiasts plenty to choose from.  
The over-all plan of the book resembles  
that of a record catalog such as is avail-  
able at the counter of any record dealer.

The unique feature of this guide is that it  
offers brief critical evaluations of the sev-  
eral recordings listed for each composition.  
As such, it could prove quite helpful. The





# INTERESTED IN Electronics-TV-Radio

CARL E. SMITH,  
E.E., President

then you will want to know

## WHAT IS THE FCC?

It's amazing what the future holds for you in this modern world of electronics. Let me send you the entire story—FREE!

- How to pass the FCC Exam
- A Sample FCC lesson
- Money-making FCC License Information

I can train you to pass the Valuable FCC exam in a minimum of time if you have any practical experience and a fair knowledge of mathematics.

CARL E. SMITH, E.E., President

## How Can I Get a Valuable FCC COMMERCIAL LICENSE?

MY PASSPORT TO FUTURE SECURITY  
GET THESE FREE



### These Three Booklets Tell You

- 1 Where to apply to take FCC Examinations.
  - 2 Scope of knowledge required.
  - 3 Necessary FCC exam preparation.
  - 4 Positive knowledge check.
- And additional data of great value.

### JOIN the LIST of SUCCESSFUL ELECTRONIC TECHNICIANS

	License	Time
Walter Eggers, Pacific Grove	1st Class	12 Weeks
Paul Reichert, West Salem, Ohio	2nd Class	10 Weeks
Harold Phipps, LaPorte, Indiana	1st Class	28 Weeks
John J. Johnson, Boise City, Okla.	2nd Class	12 Weeks
James Faint, Johnstown, Pa.	1st Class	26 Weeks

AND THOUSANDS MORE!

### YOUR GUARANTEE—

If you fail to pass your Commercial License exam after completing our course, we guarantee to continue your training without additional cost of any kind until you successfully obtain your Commercial License.

## START BUILDING FOR A LIFETIME PROFESSION

- Employers make job offers every month!
- Your FCC ticket is recognized by most employers in the Electronics field as proof of your technical ability.
- Pave the way for Your Share of the better things in life.

### Cleveland Institute of Radio Electronics

Member National  
Home Study Council

Desk PE-16, 4900 Euclid Ave., Cleveland 3, Ohio

Please send Free Booklets prepared to help me get ahead in Electronics.  
I have had training or experience in Electronics as indicated below:

- |   |   |  |
|---|---|--|
| <input type="checkbox"/> Military           | <input type="checkbox"/> Amateur Radio      | <input type="checkbox"/> Telephone Company |
| <input type="checkbox"/> Radio-TV Servicing | <input type="checkbox"/> Broadcasting       | <input type="checkbox"/> Other             |
| <input type="checkbox"/> Manufacturing      | <input type="checkbox"/> Home Experimenting |  |

In what kind of work are you now engaged? .....

In what branch of Electronics are you interested? .....

Name ..... Age ..... Address .....

City ..... Zone ..... State .....

Special Tuition Rates to Members of Armed Forces

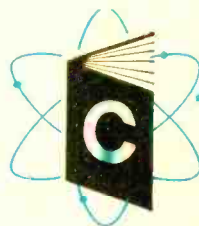

# 3+3=410

when  
you use  
the *new*

## SHURE RK-56

### REPLACEMENT CARTRIDGE KIT

as a companion to the RK-54

The 3 CARTRIDGES in the RK-56 Kit provide dependable, quickly-installed replacements for 218 cartridges of seven manufacturers.

When used with the RK-54 kit (where 3 cartridges replace 192) you will have profitable replacements for 410 of the most frequently used phono cartridges!

LIST PRICE **\$22.95** With technical data, repl. chart and plastic box.

Here is broadest coverage for the lowest investment. The RK-56 Kit contains:

Cartridge	Application	OUTPUT LEVEL		Response To
		MG	78	
WC10 Ceramic	Extended range, Improvement- Replacement cartridge for 132 3-speed, plastic-case cartridges, crystal or ceramic, single needle or turnover.	.78v	1.0v	12,000 cps
W70 Crystal	All-Purpose Single-Needle Unit. For Webster C and CX series.	3.0v	3.8v	5,000 cps
W72 Crystal	Dual-Voltage 3-speed Turnover for Webster FX and Astatic LQD series.	3v or 4v*		5,000 cps

\*Model W72 has a slip-on capacitor furnished as an accessory. With the capacitor, output is 2v for 78 RPM, 1.5v for 33 $\frac{1}{3}$ , 45 RPM. Without the capacitor, output is 4v for 78 RPM, 3v for 33 $\frac{1}{3}$ , 45 RPM.

Available at your Shure Distributor... or write to Shure for complete information on this new profitable replacement kit.

## SHURE BROTHERS, INC.

214 Hartrey Avenue • Evanston, Illinois

book is, of course, limited in its coverage; pressings made in the last year and a half are not discussed.

*Recommended:* as a possible "quickie" guide to LP discs.



"BLOCKING OSCILLATORS" by Alexander Schure. Published by John F. Rider Publisher, Inc., 480 Canal St., New York 13, N. Y. 72 pages. Paper bound. Price, \$1.25.

Blocking oscillators, widely used as starting or triggering circuits in many special applications, are explained and illustrated in this compact volume. Mathematics has been held to a minimum; the text here is for technicians, students, and experimenters whose work demands an understanding of basic concepts. Emphasis, in the explanations, is placed on the role of the transformer used in such circuits.

*Recommended:* as an introduction to the subject for the beginner, and as a review for the advanced technician.



"TV TROUBLE TRACER" (Vol. 5) by H. G. Cisin. Published by Harry G. Cisin, Amagansett, N. Y. 45 pages. Paper bound. Price, 50 cents.

Forty common picture defects that may develop in a number of 1955-56 television receivers are described in this guide. The cause is explained, and the remedy is suggested. In addition to pictures of the TV screen, with the objectionable characteristics plainly outlined, there are a number of chassis layout diagrams that help locate tubes and other components.

*Recommended:* as a "short-cut" servicing guide to late model TV sets.

### Free Literature Roundup

A brochure on a new 400-kw. generator series is available from Kato Engineering Co., Dept. R-C, Mankato, Minn.

The Berkshire "Labstroke," Model 18A, is described on "Catalog Sheet No. 18A-1." The instrument is an inexpensive 60-cycle stroboscope, useful for determining motor speeds. Write to Berkshire Laboratories, 898 Bank Village, Greenville, N. C.

Available from Radio Craftsmen, Inc., 4223 W. Jefferson Blvd., Los Angeles 16, Calif., is an attractively printed brochure covering its line of hi-fi components.

A 16-page illustrated brochure describing Philco's microwave communications equipment has been issued by the Philco Corp., Govt. & Industrial Div., 4700 Wissachickon Ave., Philadelphia 44, Pa. -30-



# NATIONAL SCHOOLS

*proudly presents*

FOR MEN  
WHO WANT  
TO EARN  
MORE MONEY

## TELEVISION • ALL 8 BRANCHES OF TELEVISION • ELECTRONICS • RADIO IN ONE DYNAMIC, MODERN SHOP METHOD, HOME TRAINING COURSE

\*Registration applied for

Another great advance in **HOME STUDY TRAINING**. Let National Schools, of Los Angeles, a practical Technical Resident Trade School for over 50 years, train you at home by Shop-Method, for today's unlimited opportunities in **ALL 8 BRANCHES** of the Television, Electronics, Radio Industry.

Check all you receive in *One Master Course* at One Low Tuition

1. Television — Including Color TV
2. Radio — FM and AM
3. Industrial Electronics
4. Sound Recording and Hi-Fidelity
5. Preparation for FCC License
6. Automation
7. Radar and Sonar
8. Communications

ALL OF THIS MODERN NEWEST PRACTICAL EQUIPMENT IS YOURS TO KEEP!

- Parts to Build a modern TV set, including large screen Picture Tube
- Parts to build a powerful Super-Hot Receiver, standard broadcast and short wave.
- Parts to conduct many experiments and build Continuity Checker, HF Oscillator, TV Circuits, Audio Oscillator, THF Receiver, Signal Generator
- Professional Multimeter
- These are a MUST for all technicians

### YOU DO MANY PRACTICAL JOBS

You do servicing, circuit analysis and many other down-to-earth experiments. You build a modern TV set from the ground up — with equipment kits we give you, including a new large screen picture tube and professional Multimeter, at no additional charge.

**EARN AS YOU LEARN!** Many of our students earn their entire tuition and more in Spare Time jobs we show them how to do while learning. **YOU GET GRADUATE ADVISORY SERVICE, TOO**

ALL YOURS  
TO KEEP

### L. J. ROSENKRANZ President of NATIONAL SCHOOLS



This Master Shop-Method course is completely up-to-date. Here in Los Angeles, the TV and Electronics center of the world, we are able to keep in constant touch with the industries latest developments. As a student, you will quickly master all phases at home — in your spare time. Your earning power will grow with every lesson. Just as thousands of National Schools graduates do every day, you can handle servicing, manufacturing, repairing, hundreds of other jobs, or make good money in your own business. **SECURE YOUR FUTURE—NOW SEND COUPON BELOW**



IN THESE MODERN TV STUDIOS, SHOPS AND LABORATORIES, your Shop Method Home Study Course was developed by experienced instructors and engineers. What an advantage that is to you at home — each lesson is tested, proved, easy to understand. You can master the most up-to-date projects, such as color TV set repair, printed circuits — even prepare for F.C.C. License and industrial electronics without taking a special course. **TAKE YOUR FIRST STEP NOW TO A TOP-PAY JOB IN TV, ELECTRONICS, RADIO. SEND COUPON BELOW TODAY**

APPROVED FOR  
VETERANS  
AND  
NON-VETERANS

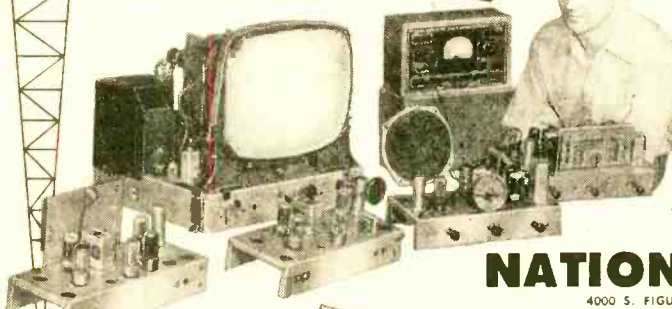

MEMBER



### FREE!

Fully Illustrated "CAREER" BOOK in TV, Radio, Electronics, AND actual Sample Lesson—yours at no cost, no obligation. **SEND COUPON NOW—TODAY!**



## NATIONAL SCHOOLS

4000 S. FIGUEROA ST., LOS ANGELES 37, CALIF.

187 N. LA SALLE ST., CHICAGO 1, ILL.

IN CANADA: 811 W. Hastings St., Vancouver, B. C.

### NATIONAL SCHOOLS TECHNICAL TRADE TRAINING SINCE 1905 Los Angeles, California

GET FAST SERVICE—MAIL NOW TO OFFICE NEAREST YOU!

NATIONAL SCHOOLS, DEPT. R2Q-96

4000 S. FIGUEROA ST. OR 187 N. LA SALLE ST.

LOS ANGELES 37, CALIF. CHICAGO 1, ILL.

Rush free TV-Radio "Opportunity" Book and sample lesson. No salesman will call.

NAME \_\_\_\_\_ BIRTHDAY \_\_\_\_\_ 19\_\_

ADDRESS \_\_\_\_\_

CITY \_\_\_\_\_ ZONE \_\_\_\_\_ STATE \_\_\_\_\_

VETERANS: Give Date of Discharge \_\_\_\_\_

# LEARN **basic** electricity electronics

THE EASY "PICTURE-BOOK" WAY!



**Just Released: The fabulous  
ILLUSTRATED Training Course  
now used by the U. S. Navy!**

**You Learn by Pictures:**

Over 25,000 Navy trainees have already learned Basic Electricity and Basic Electronics this easy, "Picture Book" way! Now, for the first time, YOU can master the basics of Electricity and Electronics with this *same* "Learn-by-Pictures" training course! Over 1,700 simple, easy-to-understand drawings explain every section—these "teaching" pictures actually make up more than half the *entire* course! No other Basic Electricity or Basic Electronics course in America uses this revolutionary illustrative technique! You learn faster and easier than you'd dream possible!

**A Complete Idea on Every Page:**

Here's how this easy, illustrated course works: *every page* covers one complete idea! There's *at least one* big illustration on that *same page* to explain it! What's more, an imaginary instructor stands figuratively at your elbow, doing "demonstrations" that make it even *easier* for you to understand. Then, at the end of every section, you'll find *review pages* that highlight the important topics you've just covered. You build a thorough, step-by-step knowledge at your own pace—as fast as *you yourself want to go!*

**Everyday English—A Course Anyone Can Understand:**

Sponsored by the Navy to turn out trained technicians in record time, this modern course presents Basic Electricity and Basic Electronics in a simple way that *everyone* can grasp—regardless of previous education! Every phase is made *instantly clear*—explained in plain, down to earth English—with *hundreds* of easy-to-understand illustrations to help you!

**10 Complete Volumes:**

Volumes 1 and 2 of "Basic Electricity" cover DC components and circuits; Volumes 3 and 4 cover AC components and circuits; Volume 5 covers AC and DC motors and machinery. Volume 1 of "Basic Electronics" covers Diodes and Power Supplies; Vols. 2 and 3 cover Amplifiers and Oscillators; Vols. 4 and 5 cover Transmitters and Receivers.

**Home Study Without Correspondence:**

This course is so *different*, so *complete*—there's no need for the usual letter writing, question and answer correspondence! Learn at home—at your own pace!

**10 Day Examination—Money Back Guarantee:**

Send today for these exciting new training courses—you *risk nothing!* When you receive the volumes, examine them in your own home for 10 full days. If, at the end of that time, you're not completely satisfied, simply return the books to us and we'll gladly *refund your full purchase price!* Total cost for either 5-volume course is only \$9.00! In Canada, prices approximately 5% higher.

**ORDER TODAY!**

**These books are sold by electronics parts jobbers and book stores. If YOUR dealer doesn't have these books, mail this coupon to us!**

JOHN F. RIDER PUBLISHER, INC.  
480 Canal Street, N. Y. C.

I have enclosed \$ \_\_\_\_\_ Please send me  
 5-vol. Basic Electricity set @ \$9 set  
 5-vol. Basic Electronics set @ \$9 set  
 Both sets. I understand I may return the books in 10 days, and receive a complete refund of the full purchase price if I am not satisfied.  
 Add state or city sales tax where applicable.

Name \_\_\_\_\_  
 Address \_\_\_\_\_  
 City & State \_\_\_\_\_ P-9A

# LETTERS

## FROM OUR READERS

### Electronics/Rocket Experimenters

■ Would appreciate your printing the address of the Rocket Experimental Society of Canada in POPtronics. I believe other readers with a mutual interest in rockets and electronics might want to contact us.

R. W. SCHNEIDER  
 Rocket Experimental Society of Canada  
 Amherst, N. S.  
 Canada

### More on TV DX

■ I read your article on TV DX in the June issue with very great interest. Let's have lots more about TV.

RONNIE HINES  
 Opalocka, Fla.

■ Sure enjoyed that article on TV DX, but believe you should have included more data on antennas, boosters, etc.

BOB P. WARD  
 Riverdale, Mich.

*Numerous letters were received commenting favorably on the TV DX story. More information is scheduled to appear within the near future.*

### Appreciation of Kohler

■ Just finished reading Carl Kohler's "Operation Chaos" in the June issue. It was nothing short of terrific.

By the way, here's a challenge for you to publish a circuit similar to the one Carl described.

JOE CROWTHER  
 Lincolnwood, Ill.

*As in the past, the Editors are not responsible for the brain storms of humorist and UPA animator ("Magoo" cartoons) Kohler. However, Carl's fans should look in POPtronics next month for "Hi Tide in the Tweeter"—a satire on some particular hi-fi records.*

### Boost for Our Baffles

■ I varied the "Octahedral" (April, 1956, issue, p. 74) to fit a 10" speaker and am very happy with the results.

I used Celotex lining for the three non-parallel sides, attached the speaker to an old radio receiver, and find that the highs and lows are better now than when the set was new.

IRVING LANG  
 Bronx, N. Y.

### New Twist on the Mark II

■ Just finished the Mark II \$3 speaker baffle described in the May issue. I don't think that any enclosure costing more than ten times as much gives better sound reproduction.

I managed to make the Mark II out of a 4' x 6'

Always say you saw it in—POPULAR ELECTRONICS



# ATTENTION: MEN 17 to 55

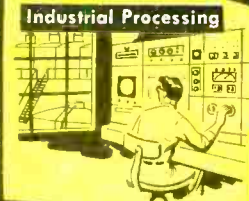

*Does your present job offer advancement?*

**PREPARE NOW AT HOME FOR A PROFITABLE CAREER IN**

# AUTOMATION ELECTRONICS!

**PRACTICAL NEW TRAINING METHOD IS THOROUGH, DOWN-TO-EARTH!**

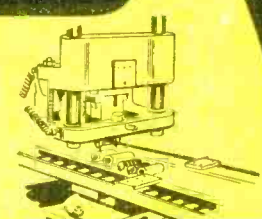

In plant after plant, many machines are being designed to run themselves. This is called "Automation." The jobs of some men who used to run these machines are gradually disappearing. Every year sees more changes; more unskilled jobs being replaced. But it's moving many new jobs too—good pay, solid future jobs in plants, offices and elsewhere—for men who are trained in Automation Electronics.

**NOW IS THE TIME TO GET YOUR TRAINING**  
The design, operation and maintenance of controls that regulate the new "automatic equipment," is a promising field of the future. It's still uncrowded. There's time to get in on the ground floor if you act now.

**NO PREVIOUS TECHNICAL TRAINING NEEDED**  
Many men 17 to 55, regardless of present job, even men without previous technical training or advanced education, can train for good jobs in Automation Electronics. DeVry Technical Institute offers effective training in your own home with movies, plenty of practical equipment and easy-to-read texts. Or get all of your training in DeVry's large well-equipped training laboratories in Chicago... one of the finest of its kind!

**WE HELP YOU GET STARTED IN THE FIELD**  
When you've completed the DTI training, you'll have the know-how—the practical training you need to hold down a good job in Automation. Our effective Employment Service will help you get

started toward many wonderful and exciting opportunities. You have nothing to lose—and much to gain. Send that coupon now so we can tell you about it.

**MANY SUCCESSFUL GRADUATES**  
For 25 years, DTI has been building men for better jobs. Our files contain many letters from men who have won success in electronics and who give much credit to their DTI training.

**GET INTERESTING NEW BOOKLET**  
The interesting story of "Automation and YOU" is yours for the asking. Simply fill in... mail the coupon. See how DeVry's training programs may prepare YOU for a start in this coming new field.



**GET THIS BOOKLET FREE**

One of America's Foremost Electronics Training Centers



Member of National Home Study Council

**DEVRY TECHNICAL INSTITUTE**  
CHICAGO 41, ILLINOIS  
FORMERLY  
DEFOREST'S TRAINING, INC.

**DEVRY TECHNICAL INSTITUTE, Dept. PE-9A-M**  
4141 Belmont Avenue, Chicago 41, Ill.

I would like further information about the newer Electronic opportunities in AUTOMATION, also facts on how you may help me to prepare.

Name \_\_\_\_\_ Age \_\_\_\_\_  
Please Print  
Street \_\_\_\_\_ Apt. \_\_\_\_\_  
City \_\_\_\_\_ Zone \_\_\_\_\_ State \_\_\_\_\_  
1040 DTI's training is available in Canada

sheet of Celotex, so really the Mark II is a \$2 baffle for a 12" speaker. Your other readers can do this by cutting the 4' x 6' sheet right across at the 39" line. This half is used for front panel A and back E. The other half is 33" long; cut sides C and D out of it and glue and nail a 1" strip on one end of C and D so they are 34" long. Then there will be enough material left for pieces B, F, G, and H.

MICHAEL SALUSO  
Toronto, Ont.

### More on OAB—OAB—

■ I'm just another fellow curious about that so-called "OABT OABT" radio signal on 538 kc.

F. E. HULSMAN, VE1YQ  
Yarmouth, N. S.

*As mentioned on page 28 of our last issue, the signal OAB— was determined to be an aircraft beacon operated by the USAF at Otis Air Force Base. This information did not prove to be 100% accurate since the transmitter is actually located at North Truro, Mass., near the tip of Cape Cod.*

### Good L.F. Converter

■ Please mention to your readers that the popular Command receiver known as the BC-453 makes a good low-frequency converter. I have used this receiver as a tunable i.f. and l.f. converter with excellent results. It is still available as a war surplus item for about \$10.

WES HAYWARD, W7ZOI  
Richland, Wash.

### Another Low-Frequency Mystery

■ In the lowest section of the broadcast band, I can hear a continuous transmission of twelve A's and IY T (sent twice). Apparently it is only audible in this territory. What is it?

PAUL ALEXANDER  
Conroe, Texas

### Anyone for Colombia?

■ I enjoyed my first issue of POP'tronics and think you will have a regular reader in Bogota in the future.

I am interested in exchanging letters with any readers who wish to learn or practice Spanish. It would be fine if correspondents were interested in ham radio or servicing.

GUSTAVO BERNAL, SZA  
Radio Clinica  
Calle 13-A #17-36  
Bogota, Colombia

### Yagi Works FB on FM

■ I sure like that FM Yagi antenna on page 58 of the July, 1956, issue. I'm getting some DX on this band and was wondering about possibilities of scatter reception.

GEORGE PETERMAN  
Washington, D. C.

*We're glad to report, George, that a feature article on scatter reception of FM and TV signals is scheduled later in the fall. The likelihood of scatter FM signals is not too good. As will be pointed*

## DO YOU WANT A BETTER AMPLIFIER?

### Build a 50 watt DYNAKIT

MARK II



\$69.95  
net

A premium kit for the audio perfectionist, the Dynakit sounds better because it is designed for outstanding transient response and stability, for higher power at low distortion, and for complete and accurate reproducibility. The improvement over conventional circuits is immediately apparent to the discriminating listener.

The Dynakit combines unequalled quality with economy and simplicity. It features the finest of parts, like the superb Dynaco A-430 output transformer. At the same time construction is greatly simplified by the Dynaco pre-assembled printed circuit unit which includes the major portion of the wiring.

The Dynakit is sold complete with all parts and the pre-wired printed circuit assembly. Complete specifications are available on request.

AVAILABLE FROM ELECTRONIC PARTS  
AND AUDIO DISTRIBUTORS

DYNA COMPANY, Dept. PE, 5142 Master St., Phila. 31, Pa.

### USE A DYNACO TRANSFORMER TO MODERNIZE YOUR PRESENT AMPLIFIER

Dynaco super-fidelity transformers are a new design which permits lower distortion and wider frequency response in high fidelity amplifiers. Models are available from 10 to 100 watts including the 50 watt A-430 transformer which can be used to increase the power of Williamson Amplifiers to 50 watts.

#### MODELS

A-410	10 watts 6V6, EL-84	\$14.95
A-420	25 watts KT-66, 5881, EL-34	19.95
A-430	50 watts 6550, EL-34 (6CA7)	29.95
A-440	100 watts 6550	39.95
A-450	100 watts PP par 6550, EL-34	39.95

(all with tapped primaries except A-440 which has tertiary for screen or cathode feedback)

Full data and details of Williamson Amplifier conversion available on request



MEN WITH MECHANICAL SKILLS:



# CAN YOU MEET THIS CHALLENGE?



## Mechanics Creed

Upon my honor I swear that I shall hold in sacred trust the rights and privileges conferred upon me as a certified mechanic. Knowing full well that the safety and lives of others are dependent upon my skill and judgment, I shall never knowingly subject others to risks which I would not be willing to assume for myself, or for those dear to me.

In discharging this trust, I pledge myself never to undertake work or approve work which I believe to be beyond the limits of my knowledge; nor shall I allow any superior to persuade me to approve aircraft or equipment as airworthy against my better judgment; nor shall I permit my judgment to be influenced by money or other personal gain; nor shall I pass as airworthy aircraft or equipment about which I am in doubt, either as a result of direct inspection or uncertainty regarding the ability of others who have worked on it to accomplish their work satisfactorily.

I realize the grave responsibility which is mine as a certified mechanic to exercise my judgment on the airworthiness of aircraft and equipment. I, therefore, pledge unyielding adherence to these precepts for the advancement of aviation and for the dignity of my vocation.

If you are a man who takes real pride in a job well done, the Air Force offers you a challenging and rewarding career. The safety of our country, and the lives of its defenders, depend on your accuracy and devotion to duty. Act today and put your skills to work tomorrow—in the U. S. Air Force.

GO PLACES FASTER ON  
THE ALL VOLUNTEER  
TEAM

**THE U.S. AIR FORCE**

PASTE COUPON ON POSTCARD

NI-40-PE3

*And Mail To*

Airman Recruiting Information Branch  
Box 2202  
Wright-Patterson AFB, Ohio

Please send more information on my opportunities for enlisting in the U. S. Air Force. I am between the ages of 17-34 and reside in U.S.A. or possessions.

Name \_\_\_\_\_

Address \_\_\_\_\_ Age \_\_\_\_\_

City \_\_\_\_\_ Zone \_\_\_\_\_ State \_\_\_\_\_

out in our forthcoming article, the scattering effect from the ionosphere stops around 70 mc. The tropospheric scattering effect does not pick up until the frequency is around 500 mc.

### OOPS!

■ Did you know that the photo on page 98 of your July, 1956, issue showing the "wire jungle" was upside down?

THE FRAMEMEN  
Beacon Office  
Richmond, Cal.

*Oh well, another reason why most of our editors have snow-white hair. Associate Editor Fantel, Art Editor Reich and the printer will alternate penitence by standing on their heads for one hour each day.*

### Another OOPS!

■ In your July issue, the four stamps in the upper right-hand corner of page 63 are not German. They are from Switzerland and are war souvenirs.

LOUIS SAMUEL  
Shelton, Conn.

■ Those German stamps are really of Swiss origin. The name "Aktivdienst" was the common and official designation for Army Service in Switzerland.

DR. F. KREUZER  
Hanover, N. H.

*Many thanks to eagle-eyed readers Samuel and Kreuzer. Absolute identification of these stamps was appreciated by all concerned. The stamps were used to solicit money for members of the*

Funker Kompanie as a sort of PX or company recreation fund.

### Miniaturized W/W Control

■ You may be interested to know that I was able to miniaturize the wired-wireless control receiver. This was originally described in your June, 1956, issue on page 63.

I substituted a miniature 7-pin thyratron (known as the 5823) for the OA4-G and a Clarostat "humdinger" potentiometer, combined with a miniature ratchet relay. Then I was able to mount it all in a 1" x 7/8" x 2" plastic case.

The ratchet relay also gives me the advantage of the lock-in feature; the first pulse turns the receptacle "on" and the next pulse turns it "off" again.

E. H. KLINE  
Philadelphia, Pa.

### Availability of Utah Transformer

■ I would appreciate your bringing to the attention of your readers that the Utah 1755 transistor transformer is available from Lafayette Radio, 100 Sixth Ave., New York 13, N. Y. I have checked with this company and they report a good stock.

This transformer was required in my article on the miniature tone generator, page 71 of the May, 1956, issue.

FRANK H. TOOKER  
Lakehurst, N. J.

*Thanks for the information, Frank. We hope that it will be helpful to our readers.* —30—

\* jam-proof

**ROCKBAR CORPORATION**

Another reason why today's fastest selling high fidelity record changer is

# Collaro

\* Jam-Proof —

safety clutch feature prevents damage even if tone arm is moved or held during change cycle.



For other features and new popular price, see your hi-fi dealer or write Dept. 10-18

650 Halstead Avenue, Mamaroneck, N. Y.



# SPACE MAN...

with a  
Brief Case

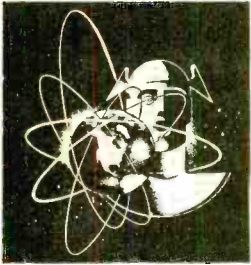

Science has a new kind of space man these days. He carries a brief case.

His mission is as new, as exciting and as challenging as a trip to the moon. In many cases you'll find him on the team at Remington Rand Univac®, one of the engineers or technicians who have given UNIVAC the title,

**"First in Electronic Computing Systems"**

Futures at UNIVAC are as unlimited as the space above. In fact, new facilities and fresh working conditions are being born each day at Remington Rand Univac which means that new members are needed for the Univac team. This is your chance to establish the career every man wants. Write today.

**IMMEDIATE OPENINGS FOR:**

At South Norwalk we have immediate openings for Mechanical and Electro-Mechanical Engineers with a bachelor's degree in *Engineering*. Extensive mechanical design background may substitute for some college. Men selected will do basic preliminary design and layout of small mechanisms. Work will require the development of original ideas and the ability to apply logical analysis to design problems.



Send Complete Resume to —

***Remington Rand Univac***

DIVISION OF SPERRY RAND CORPORATION

Attention Mr. A. L. Croble

Wilson Avenue • South Norwalk, Connecticut





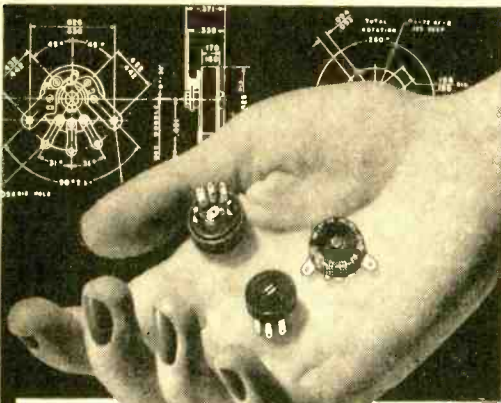

© Registered in U.S. Patent Office





## Model B16 Miniature Radiohm®

*A control that fits the tight spots*

-  Design this compact, versatile control into your next receiver, pocket radio or any application where you want the most for your money in a miniature control.
-  Originally designed for hearing aids, so you know they're compact.
-  Comes complete with removable knobs.  $\frac{3}{32}$ " diameter with knobs,  $\frac{5}{8}$ " diameter with knobs removed.
-  Rated at  $\frac{1}{10}$  watt. Resistance range, 500 ohms to 5 megohms.
-  Can be furnished with or without built-in switch. Rated at — 6.5 amps at 1.5 V.D.C. or .2 amps at 45 V.D.C.
-  Not a laboratory curiosity. Over 6,000,000 now in use where space and weight are problems, and where only the best will do.

See your Centralab distributor for these B16 Radiohms and many other fine controls. Send coupon below for free catalog showing Centralab's complete line of electronic components.

# Centralab

A DIVISION OF GLOBE-UNION INC.  
9941 E. Keefe Ave., Milwaukee 1, Wisconsin

Send me free Catalog.

Name   
Address   
City  Zone  State

## Now — KEPRO KITS let you make PRINTED CIRCUITS

*as easy as  
writing your name*

**Your Circuit Design by Photographic  
Process Without Photo Equipment**

Simple, fast... allows beginners, hams and engineers, complete material for all phases of etched circuits from individual design to production prototypes.

KEPRO PROFESSIONAL KIT contains 2-18 sq. inch sheets of presensitized copper-clad phenolic, processing chemicals, developing and etching trays, printing frame, negative material... #P-101, \$5.40.

KEPRO PRINTED CIRCUIT LAB—Ideal for industrial and extensive experimental work. P.C. sockets, hardware, presensitized single and double copper-clad phenolic, photo layout kit, negative material, glass processing trays, printing frame, photo flood lamp, safe light, processing chemicals... #L-505, \$31.50.

NOTE: Keil specializes in complete printed circuits for industries... from original design to finished assemblies.



Bulk material prices on request.  
At better Electronic dealers... If he cannot supply, write today to:

## DOUBLE THE PLEASURE OF YOUR HI-FI WITH A *Linthrop* TWIN EXTENSION SPEAKER



Here it is... a compact twin-speaker unit that connects in seconds to any hi-fi, phonograph, TV or radio, and brings the full tone of your set to any remote part of the house. Or use it in the same room for rich, all 'round sound. Made by one of America's outstanding hi-fi speaker manufacturers. Beautiful light or dark wood cabinet containing an 8" woofer and 3 1/2" tweeter, frequency range 40-15000, 4 ohm impedance. Measures 20 1/2" wide x 10" deep x 9 1/4" high. Faced with attractive grille cloth.

ORDER DIRECT FROM MANUFACTURER AND SAVE... send just \$23.95 for complete unit postpaid and tax paid, with money back guarantee. Specify light or dark finish. Send check or money order, or order C.O.D. and pay postage.

*Linthrop* MFG. CO.

433 FULTON, N.W.  
GRAND RAPIDS, MICH.

BRING GLORIOUS  
SOUND TO YOUR

- KITCHEN
- BEDROOM
- BASEMENT
- DINING ROOM
- PATIO
- REC. ROOM

MUSIC, SPORTS,  
DRAMATIC SHOWS  
ANYWHERE IN  
YOUR HOME OR  
COTTAGE AT  
LOW, LOW COST!

ONLY  
**\$23.95**  
COMPLETE!

Always say you saw it in—POPULAR ELECTRONICS



Join the Thousands of Central-Trained Technicians  
Now Enjoying **HIGH-PAY CAREERS** in...

**GUIDED MISSILES—AUTOMATION**

**ELECTRONICS  
TELEVISION  
RADIO**



**Outstanding Employment  
Opportunities Open to  
Central Graduates!**

No matter what you're doing now . . . whether you've ever had previous technical experience or not, you can begin right now to prepare for a great career in these fascinating, rewarding fields!

Capitalize on the fact that Central's nationally recognized, proven training methods, top instructors and long record of educational achievement have put Central-trained men in high demand throughout America! . . . that Central's graduates are periodically interviewed and employed by many of the Country's foremost industrial giants and leading employers of electronics specialists. Hundreds of radio and TV stations look to Central as a reliable source for competent, thoroughly trained technicians . . . and the nation's major airlines and aircraft manufacturers have hired hundreds of Central-trained technicians for important communications and electronics positions.

**3 Proven Training Plans**

**1. HOME STUDY COURSE** (with 9 kits of equipment)—Qualifies you for diploma, FCC license exam, and a variety of electronics jobs (or transfer into advanced resident training).

**2. HOME STUDY—RESIDENT COURSE** (with 9 kits of equipment)—Home study, followed by short period of resident training. Qualifies you for diploma, FCC license exam, and a wide variety of positions (or continue with advanced resident training). An ECPD-accredited engineering technician program.

**3. FULL RESIDENT COURSE**—Qualifies you for Associate of Science (A.S.) degree and top-pay employment opportunities as Electronics Engineering Technician. An ECPD-accredited engineering technician program. Part-time employment opportunities available for students while training.

**How Central's "Progressive Plan"  
Will Pay Off for YOU!**

Central's complete, accredited training is designed to get you the technical job you want . . . in the shortest possible time! Through Central's "Progressive Plan" of study, as you complete each phase of training your earning capacity goes higher! How far "up the ladder" you want to go is entirely up to you. A few short weeks of training prepares you for certain basic jobs. Then, with every additional phase of training you complete, you qualify for more advanced types of positions that command higher salaries. You can settle for any of a wide variety of well-paid, worthwhile jobs along the line . . . or you can use Central's complete training to advance right up to the *top-level, top-pay* positions! *Don't limit yourself!* Get the facts on Central's complete training. Mail the coupon today!

**VETERANS** Central offers courses approved under G. I. Bill

**Mail Coupon for  
FREE BOOK**

**YOUR FUTURE  
IN  
ELECTRONICS**

**CENTRAL TECHNICAL INSTITUTE**

Dept. A-96 1644 Wyandotte St.  
Kansas City 8, Missouri

Tell me more about how you can qualify me for a high-pay Electronics career.

Name.....Age.....

Address.....Phone.....

City, State.....County.....

If Korean vet., give approx. discharge date .....



**MODEL S-38D**  
\$49.95

**COVERAGE:** Standard Broadcast from 540-1650 kc plus international reception on 3 Short-Wave Bands covering 1650 kc—32 Mc.

The radioman's idea of radio . . . This famous Hallicrafters' radio, now with smart new styling, amazes even the experts with its superior performance. Featuring the same skillful engineering found in much higher priced communications sets make the S-38D ideal for the Short-Wave listener or new radio amateur.



**MODEL S-94 or S-95**  
\$59.95

**COVERAGE:** S-94: 30-50 Mc—S-95: 152-173 Mc

For the thrill of emergency radio—Police, Fire . . . Two new high performance receivers replacing the popular Hallicrafters S-81 and S-82. Compact, easy-to-operate and covers police, fire, taxicab, bus, railroad, private telephone mobile, forestry and other industrial and emergency-service communications operating within models' frequencies. Newly engineered FM chassis provides low frequency drift and high signal-to-noise ratio.

## for hams • novices • short wave listeners...



**MODEL S-53A**  
\$89.95

**COVERAGE:** Standard Broadcast from 540-1630 kc plus four Short-Wave bands over 2.5—31 and 48—54.5 Mc.

**FEATURES:** Large easy-to-read overseas dial with international stations clearly marked. Electrical bandspread and logging scale. Five inch built-in PM speaker, jacks for headphones plus phonograph jack. Temperature compensated to reduce fading due to frequency shift. Two stages of i.f.



**MODEL S-85 or S-86**  
\$119.95

**COVERAGE:** Broadcast band 540-1680 kc plus three S/W bands 1680 kc—34 Mc.

This newly engineered Hallicrafters receiver has the 10, 11, 15, 20, 40 and 80 meter amateur bands calibrated on large easy-to-read dial. Over 1000° of calibrated bandspread for better selectivity on ham bands. Husky, full sized unit features separate bandspread tuning condenser and built-in PM 5" speaker.

## world wide enjoyment

# is yours with hallicrafters

...at everybody's price!



**MODEL SX-96**  
\$249.95  
Matching R-46B  
Speaker \$17.95

**COVERAGE:** Standard Broadcast; 538-1580 kc; Three S/W Bands, 1720 kc-34 Mc. Band 1: 538 kc-1580 kc—Band 2: 1720 kc-4.9 Mc—Band 3: 4.6 Mc-13 Mc—Band 4: 12 Mc-34 Mc.

**TYPE OF SIGNALS:** AM-CW-SSB

**FEATURES:** Precision gear drives are used on both main tuning and band spread dials.

Most talked about receiver on the air . . . This Hallicrafters double conversion selectable side band receiver offers major improvements in stability by the addition of temperature compensation in the high frequency oscillator circuits and the use of crystal controlled second conversion oscillators. Hallicrafters highly selectable 50 kc i-f system is used in this new precision-built receiver.



**MODEL SX-99**  
\$149.95  
Matching R-46B  
Speaker \$17.95

**COVERAGE:** Broadcast Band 540-1680 kc plus three Short-Wave Bands covers 1680 kc-34 Mc. Packed with all the features most in demand by the DX enthusiast, this model is a real stand-out in its price range. The large, very easy to read dial features over 1000 degrees of calibrated bandspread through the 10, 11, 15, 20, 40 and 80 meter amateur bands. Incorporated in the advanced design are such much-wanted components as an "S" meter, a separate bandspread tuning condenser, a crystal filter and an antenna trimmer. Grey-black steel and brushed chrome cabinet is perfectly styled for appearance and function.



# Radio Waves Heard from Jupiter and Venus

By O. P. FERRELL



**R**ADIO WAVES spanning interplanetary space are now a certainty. The dreams of science fiction writers and the predictions of Nikola Tesla are closer to reality. Positive identification of radio waves generated by means unknown on both Jupiter and Venus has been established. Work is progressing rapidly in this field by teams of sci-

entists in Europe, Australia and the United States, where giant radio telescopes are now in use.

Radio signals from beyond the earth have been known for about twenty years. But these came mostly from turbulent areas of outer space, where intense electrical activity accompanies the formation of new stars and the gigantic eruptions of distant suns beyond the reach of even the largest telescopes. Only lately have radio star-gazers been hearing odd noises from our relatively quiet and astronomically "dead" next-door neighbors, the planets.

**Thundering Jupiter.** Electromagnetic waves picked up from Jupiter lack a clearly defined frequency, yet are best heard around 22 megacycles. With their

**Giant antenna atop Naval Research Laboratory** measures 50 feet across. Signals received from Venus are recorded below by astronomer T. P. McCullough.

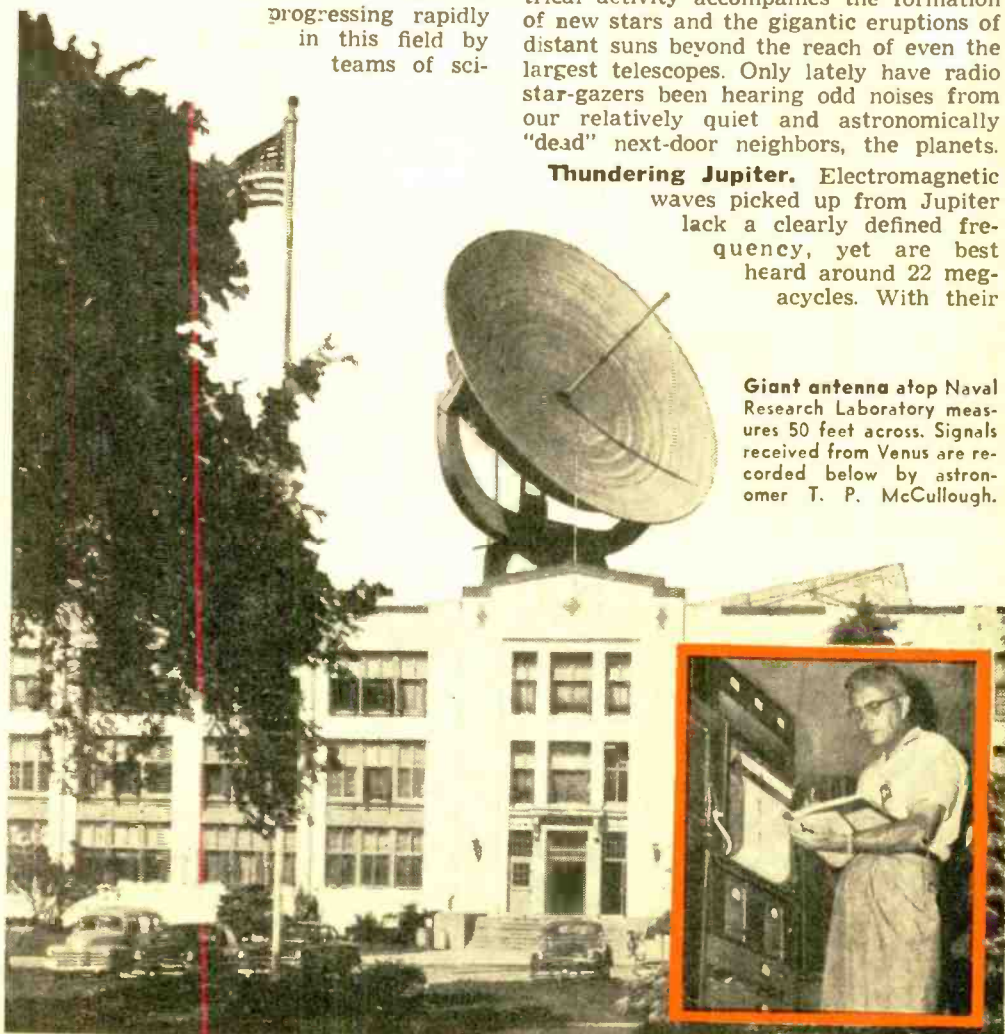

frequency distribution being random throughout a wide band, the signals sound just like static caused by storms. Since Jupiter, like Earth, is surrounded by a gaseous atmosphere, it is quite possible that the radiation it sends out is a sign of turbulent weather.

Lending probability to this theory is the electrical behavior of the weather-bearing layers in our own terrestrial atmosphere. About 50,000 thunderstorms per day pass over the face of the earth. About 2000 are going strong at any one moment, giving off about 100 lightning flashes every second. Each lightning flash is a 3-millisecond burst of 2000-3000 amperes, reaching peaks around 10,000 amperes. That's a lot of electrical popping for our small planet. To radios on Jupiter, it would probably sound the same way that the waves from Jupiter sound to us.

**Hot Venus.** Until a few months ago, it seemed that Jupiter was the only planet to radiate electromagnetic waves. Yet earlier this year, Dr. John Kraus of Ohio State University also caught signals from Venus, the planet which is prominent in the sky as the Evening and Morning Star. The Naval Research Laboratory in Washington independently made the same discovery.

Signals from Venus reported by the Navy differ from those of Jupiter. They are not generated by electric disturbances of the atmosphere, but by the molecular activity of heat. The wavelength of the Venus signals stays fairly constant at 3 cm., which corresponds to a temperature of more than 212° F—the boiling point of water. Any water existing on Venus would therefore be in the form of steam. This makes it unlikely that living organisms as

we know them could exist on that planet.

**Giant Antennas.** No ordinary antenna will catch these faint signals from the stars. Instead, radio astronomers employ huge parabolas or dipole arrays to concentrate the dim stellar mutterings at the receiver input.

For instance, the giant parabola atop the Naval Research Laboratory Building in Washington acts like the mirror in an ordinary optical reflector telescope. All the energy is focused in a single point at the tip of the central pole, from whence it is funneled to the receiver. The antenna is automatically rotated so as to keep pointing at the same target in space, regardless of the motion of the earth. Signal gain attainable with this antenna is over one million.

The optical refracting telescope, exemplified by ordinary field glasses, also has its electronic equivalent. Helical antennas, looking like vast coil-spring mattresses, bend the incoming radio waves as a deflection coil bends the beam in a TV tube. In this manner, they concentrate the incident energy at the pickup point. By stringing a large number of coil-shaped structures in an array, the gain is multiplied in proportion to the total antenna size. On this principle, Ohio State University built the 96-coil unit, which successfully eavesdropped on Venus.

Whether similar waves will be heard from Mars is still an open question. As Mars draws closer to Earth this year than it has at any time within the past 20 years, the chances of intercepting its radio waves, if any, are greatly increased. Experiments continue as the massive antennas seek out our brother and sister planets in the solar system. —30—

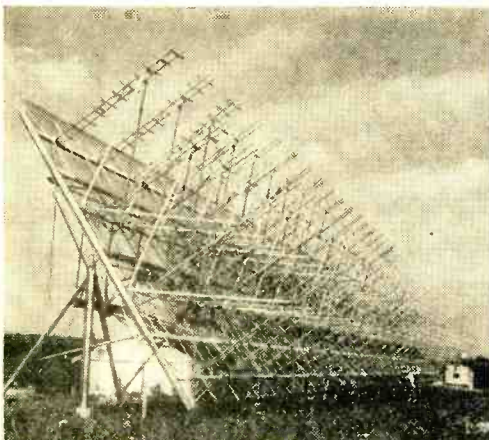

**Helical antenna array** for the radio telescope at the Ohio State University consists of 96 spiral coil elements to refract the incoming signals.

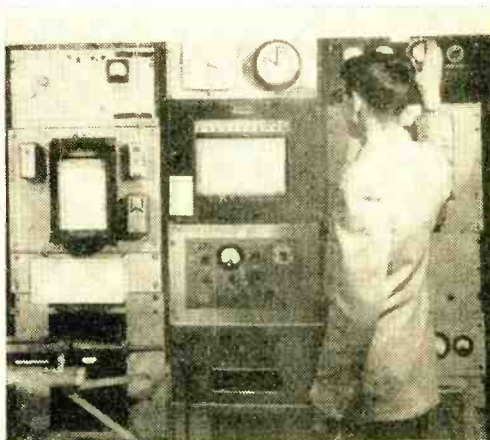

**Ultra-sensitive superhet** receivers are checked by technician to assure low internal noise for clearer recognition of marginal signal patterns.





## First Transistorized Short-Wave Converter

Our POP'tronics model this month is Diane Pappou. Photographer and secretary, Diane was a "find" of your editors working in another Z-D publication, Popular Photography.

Cover Photo by Maynard Frank Wolfe

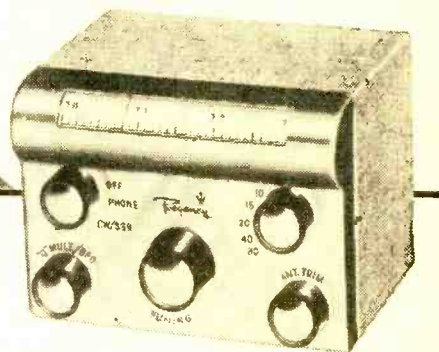

**T**HE BOTTLENECK preventing the evolution of transistorized equipment into the short-wave bands has been broken. Appropriately, the first step was taken by Regency—who several years ago introduced the first truly miniature all-transistor radio receiver. Their revolutionary new transistor converter covers all of the short-wave ham bands up to 30 megacycles!

Heart of the converter is the recently announced surface barrier SB-100 transistor.\* It is utilized in a special circuit to serve as a high-frequency first detector stage. Credit for the design is due J. F. Towler, V9MNY, ex-W5BYV and W5CEG. Bandspread coverage of the 80, 40, 20, 15 and 10-meter bands results from very careful permeability-tuned coil design. Sensitivity is roughly comparable to mobile ham converters with two or three vacuum tubes.

An additional transistorized circuit (using a 2N172) has been wired into the Regency amateur band converter. This circuit can be made to oscillate, thus enabling reception of either regular c.w. or single-sideband (SSB) signals. When the converter is switched to the phone reception position, the 2N172 circuit becomes a special "Q-multiplier." As pointed out on page 91 of our May, 1956, issue, "Q" multiplication permits increased selectivity or station separation ability. A front panel

\* Practically all transistors in use on the market today are fused junction or alloy types. This is also the first commonly available application of the new surface barrier transistor.

control is attached to the circuit so that the ham or SWL operator can adjust the degree of selectivity or the amount of c.w. injection voltage.

Called the ATC-1, the Regency converter weighs just about 30 ounces. In size, it measures 4 $\frac{3}{4}$ " wide, 3 $\frac{1}{4}$ " high, and 4" deep. Although the converter can be used anywhere with any type of broadcast-band receiver, the manufacturer is making special provisions to bracket-mount it on an automobile steering column.

As in all transistor circuits, the power requirements are almost unbelievably small. Three penlite cells, securely mounted in clips on the back panel of the converter, provide enough power to operate it for at least six months. Batteries are readily accessible without removing the case.

In order to assure maximum protection of the SB-100 surface barrier transistor, a crystal diode (CK706) is employed as a high-intensity signal bypass. Thus, if the converter is used in an automobile, the CK706 will prevent damage to the transistors should another mobile transmitter pull up alongside in another car. Hams will also be interested in knowing that a connection is provided on the rear panel which permits the converter to be disabled during transmissions.

Since the ATC-1 is self-powered and only requires a connection to a broadcast receiver (1200 to 1300 kc.) and an antenna, it will find many uses in homes, cars and field trips of hams and SWL's. —30—

## Storm Tracking in Your Living Room

A RADAR DEVICE linked to WLW's regular TV transmitter is the very newest wrinkle in weather reporting. With a specially adapted antenna installed atop the WLW transmitter building overlooking Cincinnati, and a radarscope at the downtown WLW Weather Station in Crosley Square, this new unit can "track" approaching storms within a 125-mile radius of Cincinnati, Ohio.

The only such permanent installation in the world to be operated by a TV station, this radar will provide viewers with the unique opportunity of actually watching the weather on the radarscope as it moves across Cincinnati's television territory.

Costing \$25,000, the device was manufactured by Decca in England. It will be able to forecast with pinpoint accuracy the direction, speed and time of arrival in the WLW television area of any given thunderstorm, tornado, or unusual weather.

Radar-gathered weather news supple-



ments reports from the widely scattered official weather stations to fill in purely local conditions. Radar spots threatening cloud masses that cause sudden freak storms or showers, which otherwise would go unpredicted. According to Jim Fidler, who heads WLW's weather service, the new device will allow as much as six to eight hours speedup in weather forecasting, thus lengthening the forecast span.

## Electronic Scales Weigh Trucks on the Run

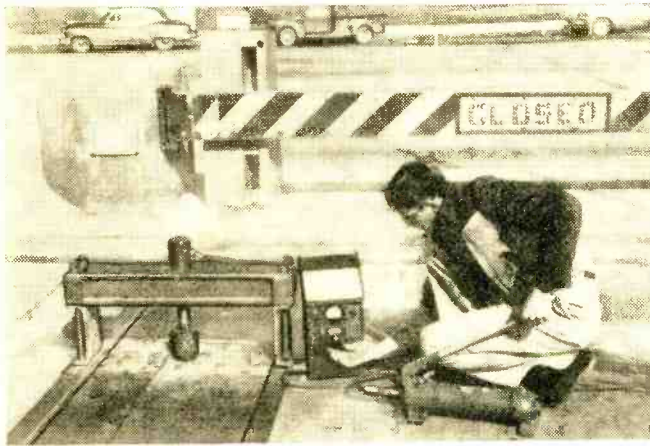

Dynamic weighing on highway scales is expected to solve many traffic problems. Accuracy of weight measurements is checked at regular intervals by means of a calibration kit (as shown at left). Test loads are applied through the calibrating cell to the scale platform, and weights as recorded in the toll booth are compared with readings on the indicator.

WITH MORE GOODS and more people than ever on the move, America's transportation seems to be heading for some kind of general traffic jam. Until new highways are completed, the main job is to get maximum traffic flow on already existing roads.

On the Pennsylvania and Ohio Turnpikes, trucks no longer need to stop for the scales, thereby holding up traffic and blocking a lane. They are now weighed "on the run" by a new electronic scale. A strain transducer imbedded in the road converts weight to voltage. An indicator in the toll

booths adds up the weight for the total number of axles on the truck and identifies overloaded axles. Photoelectric cells provide an automatic count of the number of axles on any given truck.

Besides keeping traffic rolling at a faster rate, the electronic scale, made by Baldwin-Lima-Hamilton Corp. of Philadelphia, offers other advantages. It has no moving parts, responds instantly to load, is hermetically sealed against dust and moisture, stays accurate in any weather, and deflects less than 1/100th of an inch under the heaviest load.



No more fumbling for light switches with the "Touch-o-Matic!" Designed as a lamp base, it can be modified to control on-and-off switching of any electrical device in the home.



## The "Soft Touch"

### An Electronic Touch-o-Matic Control

**A** TOUCH of the fingertips and the lights flash on! Another touch—and off they go! Now, modern electronics brings you a luxurious new type of light and appliance control that ends all fumbling for switches and pull-chains in the dark. Best of all, you can build it easily and inexpensively in a couple of evenings. Once it is put into operation, watch the mystification on the faces of your friends. Note, too, how many orders you get from them for duplicate "Touch-o-Matic" controls.

The unit to be described here was designed as a lamp base, but it may be modified easily to control on-and-off switching of any electrical device in the home. Since it operates when any part of the body bridges the space between two adjacent conductors, it has a multitude of possible applications.

For those suffering from the effects of paralysis, two touch plates may be mounted within one-quarter of an inch of each other on the wall so that the forehead or cheek can conveniently bridge the gap. Immobilization of the fingers due to arthritis or accident presents no problems to the "Touch-o-Matic" control. The back of the

By HARVEY POLLACK

***The last word in convenience  
and safety, this easy-to-build  
light and appliance control  
turns on or off at a mere touch***

hand, the elbow, or the forearm may be used to operate lights or electrical appliances, to make nurse calls, or do any other switching job.

Any electrical device used around the home, particularly within the reach of children, must feature the last word in safety. Here's how the "Touch-o-Matic" control stacks up.

*No shock hazard.* The touch plates are isolated from each other by an extremely large resistance. The same is true of the a.c. lines and either touch plate. Even on

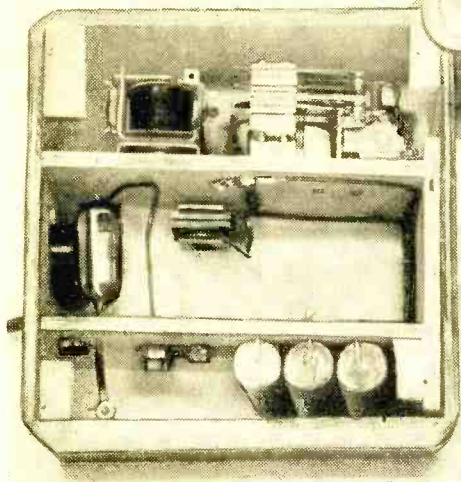

Double-shelf construction of the wooden chassis makes for easy wiring. Upper side of top shelf holds the 7-pin socket and relays RL1 and RL2; under side, the selenium rectifier SR1 and resistor R1. Upper side of bottom shelf holds resistor R2; under side of bottom shelf, resistors R3 and R4 and capacitors C1 and C2.

a direct short circuit to ground, the maximum current that can flow is of the order of 1/10,000 of an ampere.

**No polarized plugs.** A standard a.c. plug is used. It may be inserted in the receptacle in any position without affecting the positive action of the "Touch-o-Matic" control.

**Negligible idling current.** The standby power consumed is so low that the total cost of operation over a period of a year of normal usage is less than 15 cents.

**Wide tolerance for line voltage varia-**

## HOW IT WORKS

The 5823 is a cold-cathode thyatron. Although its anode and cathode are directly across the pulsating d.c. supply from the selenium rectifier, the tube does not fire as long as the grid or firing electrode is floating. When the contact plates are bridged by even a very high resistance, the positive line voltage peaks are applied to the grid, causing the tube to fire. The anode potential is applied as a voltage which appears across the 1- $\mu$ fd. capacitor C2, which charges to approximately line voltage through R2.

As the 5823 triggers, relay RL1 in its cathode circuit is pulled in; but as soon as the charge on C2 drops below the critical voltage, the tube is restored to its non-conducting condition except for a small residual discharge—which keeps C2 from again taking on sufficient potential to initiate a second large discharge. Hence, the fingers may be held on the contact plates indefinitely without causing repetitive relay action.

As soon as the bridge is removed, however, the grid again floats and even the small residual discharge disappears, permitting C2 to charge to line voltage once again, readying the control for the next impulse. The 22-ohm resistor, R1, serves as a surge protection for the selenium rectifier and also as a fuse if C1 should become short-circuited.

Relay RL2 is a locking relay which alternately opens and closes the external circuit with each advance of the cam.

tions. This model has been tested over a range of 95 to 130 volts without once missing fire!

**No heat generated.** Since there are no heater or filament type tubes, nor any other heat contributing elements in the entire circuit, the system will run cold at all times.

**Construction.** A unique approach was adopted in the construction of the model. The notion to use a metal box was immediately discarded for two reasons: relays switching inside metal produce objectionable noise, and there is always danger of short circuits and exposure to the line voltage where so much metal is present. Thus, wood was used throughout.

With an eye to easy wiring and the elimination of "tight" spots, a double-shelf construction design was selected as illustrated in the photographs. The small shelves are first cut to size and drilled for the mounting screws. The components are then mounted as follows:

**Top shelf, upper side:** the 7-pin miniature socket (bottom up), the 2500-ohm relay (RL1), and the 120-volt a.c. locking relay (RL2).

**Top shelf, under side:** the selenium rectifier and the 22-ohm series resistor (R1).

**Lower shelf, upper side:** resistor R2.

**Lower shelf, under side:** resistors R3 and R4 and capacitors C1 and C2.

One  $\frac{1}{4}$ " hole is drilled through the upper shelf near the locking relay for the passage of all intershelf wiring. The shelves carry the required solder lugs for the pig-tails of the small parts; small holes through which the leads of the capacitors pass support these components adequately. The shelves are glued to the supporting plywood side before wiring by grooving the latter slightly and cementing with a good wood glue such as "Elmer's Glue-All."

Except for the four wires that go to the output socket SO1 and the contact electrodes, all wiring should be completed and tested before the shelf assembly is slipped into its case. Note that only two of the locking relay contacts are used: one of the moving-blade contacts, and its associated lower contact. This relay is a stock item



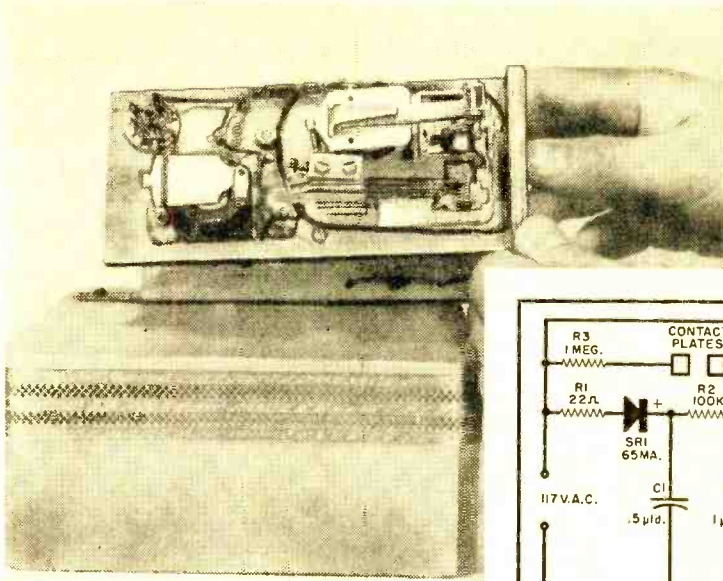

Looking down at the top shelf of the chassis; note position of socket and relays. Brass strapping around the upper rim of the base serves as one contact electrode. A short piece of strapping across the top-rear of the box, on which metallic base of lamp will rest, acts as the other contact electrode.

which, in its least expensive form, comes equipped with double-pole, double-throw contact configuration.

The case is a matter of individual preference. The author's model was constructed entirely of glued three-ply fir with deeply chamfered corners. A strip of ornamental lamp base brass strapping encircles the upper rim of the base to serve as one contact electrode. A short piece of the same material across the top-rear of the box acts as the other electrode. The lamp has a metallic base which rests upon the short length of strapping; hence, bridging the gap between the lamp base and the rim strip operates the relay from almost any position. A chassis type of a.c. receptacle on the side completes the case assembly.

**Testing.** Before applying a.c. power, use your ohmmeter to make sure you have

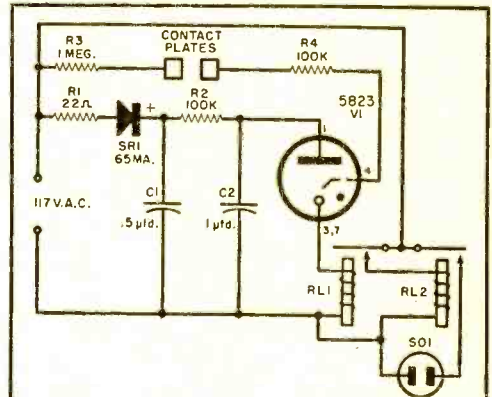

- C1—0.5  $\mu$ d., 400-volt capacitor
- C2—1.0  $\mu$ d., 400-volt capacitor (two 0.5- $\mu$ d. units used in model to fit space)
- R1—22-ohm,  $\frac{1}{2}$ -watt resistor
- R2, R4—100,000-ohm,  $\frac{1}{2}$ -watt resistor
- R3—1-megohm,  $\frac{1}{2}$ -watt resistor
- RL1—2500-ohm, s.p.d.t. relay, upper contact not used (Potter & Brumfield LB-5 or equal)
- RL2—110-volt a.c. locking relay (Guardian 1R-RC-100-115 AR)
- SO1—A.c. receptacle, chassis-mounting type
- SR1—65-ma. selenium rectifier (Sarkes-Tarzian Model 65)
- V1—5823 tube
- 1—Line cord and plug
- 1—7-pin miniature tube socket
- 1—Strip of brass strapping for case

Wiring diagram and parts list for the control.

Glue the shelves to the supporting plywood side before wiring by grooving the latter slightly and cementing with a good wood glue. All wiring should be done before shelves are inserted in case. A chassis type of a.c. receptacle on the side completes the case assembly.

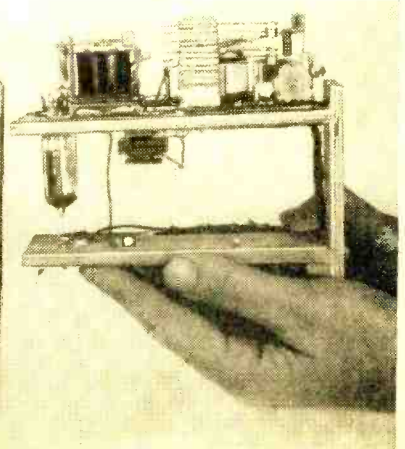
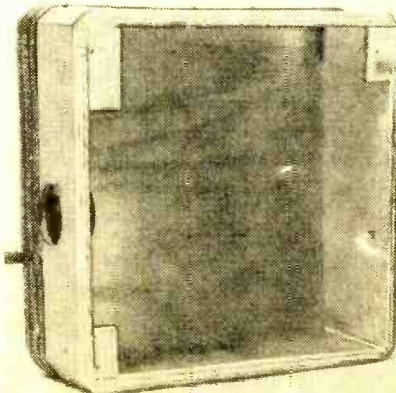

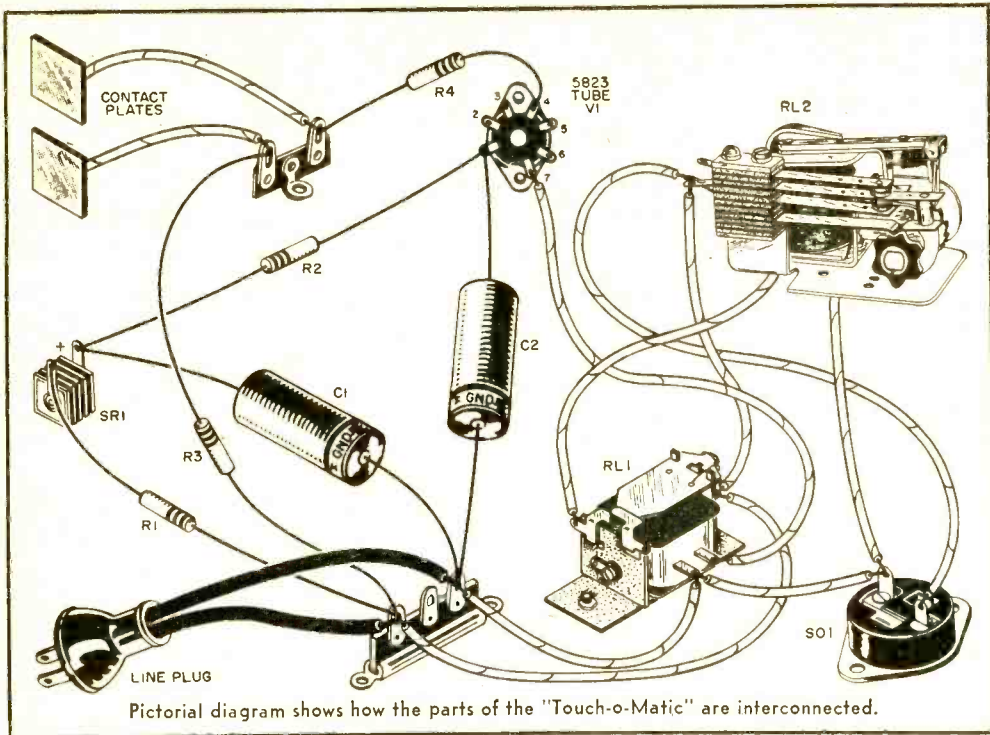

not inadvertently wired in any short circuits. Also check to see that  $R_3$  and  $R_4$  isolate the contact plate terminals from the rest of the system. Note the position of the contacts of relay  $RL_2$  (the locking relay) and plug the line cord into the a.c. receptacle.

Using your fingers, touch both of the contact terminals. The 2500-ohm relay ( $RL_1$ ) should pull in and drop out immediately, causing  $RL_2$  to advance to a new position. If the contacts were open, they should now be closed and vice-versa. Remove the fingers and repeat the procedure, allowing about a half-second or so between bridgings. The cam of  $RL_2$  should rotate to an alternate position each time the control is triggered.

If everything operates according to these specifications, the double shelf assembly may now be slipped into the case and the four remaining wires connected: two leads to  $SO_1$  and two leads to the case contact strips.

**Trouble-Shooting.** Assuming that all wiring is correct, one or more defective parts may occasionally cause troubles to show up. Here is a list of possible troubles that could occur, together with suggestions for cures that will probably prove helpful to you.

*Overheating and smoking of  $R_1$ .* This is an indication that  $C_1$  is short-circuited. Test this part with your ohmmeter. It

should show several megohms of resistance after taking a charge.

*Overheating of the selenium rectifier.*  $C_1$  may be very leaky. Replace it with a better grade of capacitor.

*Relay  $RL_1$  does not pull in.* Quite a few things may cause this: (a) an open relay coil on relay  $RL_1$ —check with ohmmeter for continuity; (b) defective 5823 tube—test by replacing with another tube of the same type (this tube cannot be checked on a tube tester); (c) leaky or open capacitor  $C_1$  or  $C_2$ —check with capacitor checker or by substitution; (d) either  $R_3$  or  $R_4$  may be open—check with ohmmeter; (e) selenium rectifier could be defective—measure voltage across  $C_2$  with v.t.v.m. (voltage should be 100 volts or over).

*Relay  $RL_1$  pulls in but does not release upon removal of bridge.* The 5823 may be defective—make a replacement check.  $C_2$  may be labeled incorrectly. Too much capacitance here may cause this to happen. Check by replacement.

*Relay  $RL_1$  chatters or hums with bridge in place.*  $R_2$  may be short-circuited or too small in value—test with ohmmeter.

*Relay  $RL_1$  works correctly but relay  $RL_2$  does not advance.* Assuming that the coil of relay  $RL_2$  has been checked previously by tapping it right across the a.c. line, the most likely cause of this trouble is apt to be dirty or oxidized contacts on relay  $RL_1$ .



# Army Studies Radio Wave Curvature

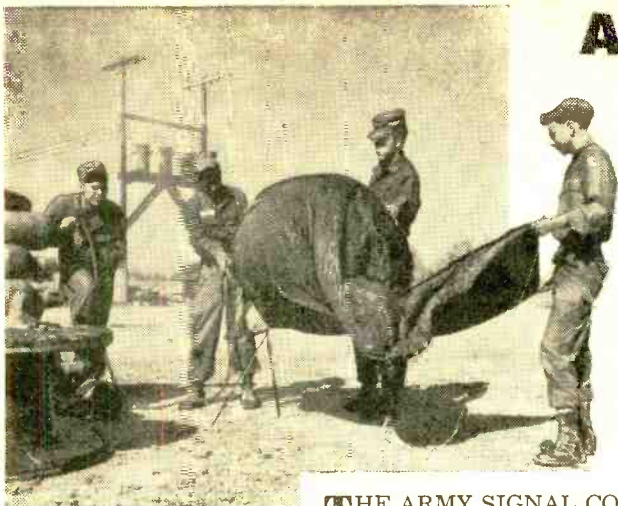

Weather tests are being conducted by Army to analyze effects of temperature and humidity changes on microwave transmissions. At left, members of meteorological team prepare "KYTOON"—a helium-filled nylon-covered balloon—for ascent.

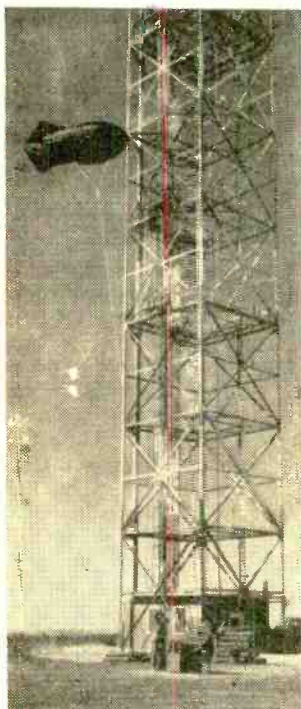

U. S. Army Photos

The "KYTOON," carrying a "Wiresonde" which records temperature and humidity, rises in front of 200' tower containing electronic equipment used to measure air conditions (above). This weather balloon can go as high as 1500 feet.

Wind direction, velocity and humidity are checked on instruments located in base of tower (right). Testing takes place at Gila Bend, Arizona.

September, 1956

**T**HE ARMY SIGNAL CORPS is carefully watching weather effects on microwaves with an eye towards "seeing" beyond the horizon. Normally, microwaves—used by u.h.f. TV stations—can only travel from transmitting point to the horizon, or within line of sight. However, certain types of weather conditions trap these radio waves and curve them around the horizon.

Personnel of the Aviation and Meteorological Dept., Army Electronic Proving Ground, Fort Huachuca, Arizona, are interested in determining the exact constitution of these unusual conditions. Electronic measuring instruments have been developed that will detect minute changes in the temperature and humidity of surrounding air.

Scientists have discovered that a small change in the humidity of the air near the surface has the effect of trapping the radio wave. Microwaves caught by trapping are said to be "ducted"—or passed along as if they were inside of a metallic wave guide. A sudden temperature rise some 50 to 200 feet above the surface appears to have the strongest effect.

The Signal Corps needs to know the extent of these effects to judge whether or not microwave transmissions can be intercepted by an enemy. During World War II ducting was suspected when TV pictures from the Nazi-held transmitter in Paris could be seen across the English Channel—to the military advantage of the British.

—30—



## Electronics "Feels Out" Toy Train Track

**T**HIS MODEL RAILROAD is no toy. Its weight, as it presses against the track, its centrifugal force on curves, and all the other factors of its motion are picked up by strain-sensitive transducers, converted into voltages, and automatically recorded and displayed by the instruments arrayed in the back.

The purpose of this elaborate setup is not to increase safety on model railroads but to demonstrate to automation engineers the possibilities of electronic control of manufacturing processes.

Designed by Allen B. Du Mont Laboratories, Inc., the system includes oscilloscopes so sensitive that the minute signals generated by the strain and displacement gauges on the tracks can be displayed without need for preamplifiers.

The railroad is "watched" by the Du Mont "Tel-Eye" closed-circuit industrial

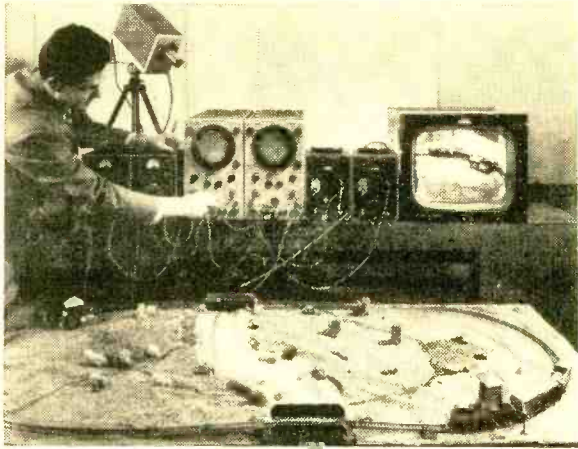

TV system. The small camera near the engineer's head "sees" the picture projected on the TV screen at the far right. Together, the visual and telemeter monitors provide complete supervision for almost any industrial process.

## Radomes Tested to Assure Radar Accuracy

**M**ILITARY AIRCRAFT carry hundreds of pounds of specialized electronic equipment. Largest and most cumbersome are the antennas for radars. To protect these antennas, they are often hidden behind plastic bubbles—commonly called radomes.

As flight speeds increase, radomes must become sturdier; and as they become sturdier, they are more likely to affect radar waves. To check on the effects of radomes upon radar signals, the U. S. Air Force has established a radome testing range. It

is part of the Air Research and Development Command's Wright Air Development Center, Dayton, Ohio, where an elaborate radiation research program has been under way for many years.

Specialized microwave antennas are mounted inside radomes and the amount of radar signal energy absorbed or reflected by the radome measured. In test installations, the radomes can be tilted and rocked around the radar antenna. Beam distortion, false reflections, and bore sight (directional) errors are being studied.

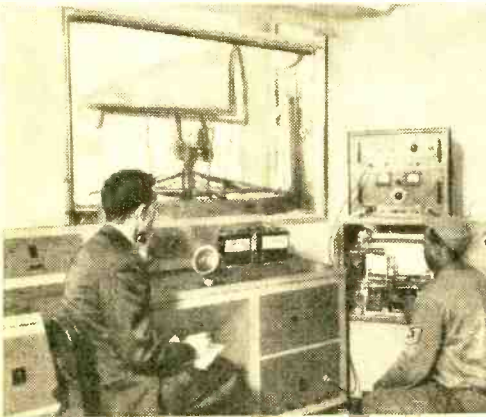

Transmission and reflection of microwaves by the radome seen through glass is recorded in this test monitor station by an Air Force research team at Wright Air Development Center.

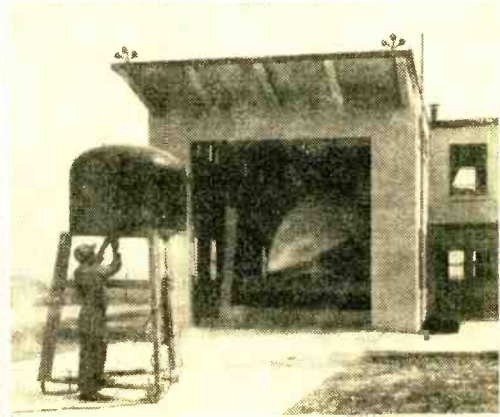

Microwaves are sent through radome inside the building to the receiving antenna being adjusted in foreground. The radome is rotated during the test to permit waves to penetrate all parts.



## Hi-Fi Revives

# Kings of Swing

By ROBERT M. HAWTHORNE

**Electronic wizardry brings back unfaded favorites of jazz**

Glenn Miller's trombone still casts magic from millions of phonographs with new tonal gloss gained by dubbing process shown below.

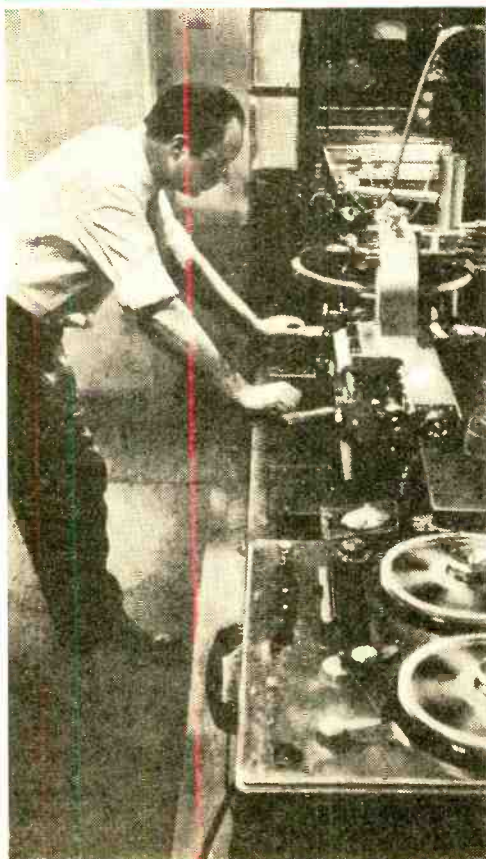

**E**VERY ONCE IN A WHILE, something happens to show up the old pessimist who said that we can't eat our cake *and* have it. Nine times out of ten, lately, that "something" comes out of an electronics laboratory.

This time, the breadboard boys have dared and done the impossible by coaxing the music but not the noise out of aging records to give us back our good old-fashioned cake with fresh hi-fi trimmings. The delicacy they serve up is the Golden Era of Swing—the late 30's; and it's good to savor the smooth blend of this fine old recipe once more.

Benny Goodman, Glenn Miller, Tommy Dorsey—these are names to conjure with. And the conjuring is done by audio engineers who delve into stacks of fuzzy old broadcast transcriptions, put them through the electronic mill and come up with clean, up-to-date sound. If there's magic in the music, some of it must have rubbed off to turn sober engineers into sorcerers. For yesteryear's Kings of Swing are transplanted into the hi-fi age, not dimmed by time but with their tonal luster actually brighter than on the distant day when they faced the microphone.

There was no tape then to offer linear response to the lambent shades of Artie Shaw's warm-molasses clarinet or the mellow swoops of Tommy Dorsey's trombone. Recordings were cut on wax and acetate



Louis Armstrong

Tommy Dorsey

discs whose small inner diameters crammed upper frequencies into a tightly packed tonal hash. Part and parcel of the method were the excessive surface noise, the narrow frequency range, and all the other defects we've almost forgotten since the advent of tape, vinylite, and hot-stylus feedback cutters.

Minor surface flaws might crop up in any of the several transfer steps between master and finished record—scratches, "ticks" and "pops" caused by dust particles on one of the many plating surfaces leading up to the final steel stamper. Even obscure causes like needle pinch in the grooves of the springy and therefore dimensionally unstable acetate master contributed their share to the general racket that went hand in hand with the recorded music of the 30's.

**The Clean-Up.** Just what kind of scalpel does the modern record surgeon use to cut away noise without skinning the music? Let's take a look in the "operating room" and watch the rejuvenation of a record, step by step. This is not a recording session in the usual sense. There are no musicians adjusting stands or squawking the first note of the day on dry reeds—no technicians setting up mikes, laying cables, and intoning their monotonous "Testing: one, two, three . . ." There is, in fact, only one recording engineer, one old record, a playback turntable and a tape machine.

The old record might be a "mother," i.e., an inverse copy produced by electroplating from the original master cut. Occasionally it is an unplayed shellac pressing from the company's stock. In more than a few cases, the only recording available is a commercial copy borrowed from a private collection. The only thing we're sure of is that this is not the master, for that was almost always destroyed in the initial transfer.



Artie Shaw

Before he can take even the first step in the re-recording process, the engineer must fit the record groove with the proper needles. He wants to get out all the sound in the old record, noise included. A needle that rides the walls of the groove or digs into the bottom might miss some of the wiggles. After trying needles of slightly varying radii, he finally gets a perfect fit. He sets the turntable spinning at 78 rpm and lowers the tone arm.

The opening phrases of an old swing classic come to life in the monitor speaker. The wide-range reproducing system grabs up everything—snaps, crackles, pops, surface noise, scratch marks, perhaps some rumble, and—oh, yes—the music. The whole sonic melange is spread out on a tape, racing past the recording head at 30 inches per second for optimum response and easy editing.

Now begins the long, tedious process of noise elimination, with "clicks" and "pops" heading the agenda. To remove these, the tape is played through until a click comes along. Then the tape is stopped and backed up slowly, by hand. At this speed the click sounds like a long growl. It is snipped out, and the cut ends are spliced together. The missing piece of tape, tiny in comparison with the two-and-a-half feet the machine gobbles up every second, does not alter the beat of the music enough for even a musician to notice.

The click-removing process completed,





**Benny Goodman**



**Count Basie**



**Lionel Hampton**

our engineer can now turn to the music itself. He blocks out the higher frequencies of surface noise, running the signal from the original tape through a set of filters onto a second tape. The playback of the second tape shows that he cut out too much: the music is dull and thumpy from the preponderance of lows. Adjusting the equalization to pass slightly higher frequencies, he tries again. This time the life has come back, but so has some of the noise. Nine times out of ten, he winds up "riding the controls" along with the music as the tape reels off.

To catch the shimmering brilliance of a trumpet, he opens the treble wide. He can safely do so, for the blast of the instrument easily overrides the noise admitted with it. But as soon as the player takes the trumpet from his lips, the frequency spectrum passed by the filter must be narrowed again. By suitable adjustment of the filter, he tries to do justice to the various instrumental and vocal solos and passages of ensemble playing while all the time striving for the optimum signal-to-noise ratio. In classical music, the engineer follows the score. But in jazz, where most of the music is improvised, he must often learn the music by heart.

Attempts have been made to design an automatic device to "read" the frequency content and loudness level of the music from the tape and automatically adjust the filter action to suit the program material from one moment to the next. But none of these could match the deft blend of technical skill and artistic judgment that marks a good recording engineer. He regards and handles his dials as musical instruments. In effect, he becomes part of the band. Like a musician, he practices a highly personal art; for in the end he has only his ear and his finely developed taste to tell him whether he has done a good job.

**Double Dubbing.** At times the engineer will even perform the seemingly impossible in his search for realism. He can, for example, separate out and re-emphasize one of two instruments of *the same range* from a duet. This is not so mysterious as it sounds. Each instrument obtains its characteristic tone, or timbre, not from the basic note it plays, but from its *over-tones*. These are a series of fainter tones at fixed, proportional frequencies above the frequency of the basic note, and they

(Continued on page 118)

## SWING ERA RE-RELEASES WITH IMPROVED SOUND

### COLUMBIA:

#### Benny Goodman

- The Great Benny Goodman  
(1937, 39) CL 820  
The Vintage Goodman (1931-35)  
Carnegie Hall Jazz Concert  
(1938) CL 814-16

### VICTOR:

#### Count Basie

LPM-1112

#### Tommy Dorsey

- That Sentimental Gentleman LPM-6003

#### Benny Goodman

- Golden Age of Swing LPT-6703  
Golden Age of Benny Goodman LPM-1099

#### Glenn Miller

- Air Force LPT-6702  
—Limited Edition LPT-6700, 01

#### Artie Shaw

- Artie Shaw LPT-6000  
Both Feet in the Groove LPM-1201

### DECCA:

#### Woody Herman

- Woodchopper's Ball (1938-42) DL 8133

## Government by Automation

**T**HE STATE OF CALIFORNIA is trying out "government by automation." This doesn't mean that California is relying on electronic brains to provide the judgment and the know-how it takes to run public affairs. After all, there aren't any machines that can put out wisdom or statecraft. But at California's State Capitol in Sacramento, more than four million dollars worth of electronic equipment is hard at work on a variety of state chores, from maintaining employment records of more than 5,400,000 Californians to identifying hit-and-run drivers.

One IBM computer does engineering calculation for highway construction. It figures cut-and-fill requirements at a cost of \$50 per mile. When the job was done by an engineer with a desk calculator, it cost \$300 per mile. "Even more important than the monetary saving is the saving in engineering manpower," says department director Frank Durkee. "This machine does the paper work and frees engineers for field work."

In the Department of Justice, an IBM computer helps to catch criminals by sorting crimes according to the offender's special methods. For example, a burglar who has a certain way of cutting through windows to enter a home and trusses his victim in a certain manner would be quickly picked out by this machine from a great number of other crime reports. It is precisely criminals with a "professional touch" who make themselves liable to "capture" by the computer. Viewers of "Dragnet" have already seen how the computer helps police work by quickly spotting the like-



**Highway engineer** above checks electronic "earth mover," which calculates the number of cubic yards of cut-and-fill required for road construction. Automatic accounting machine below issues 16,000 car ownership certificates daily.

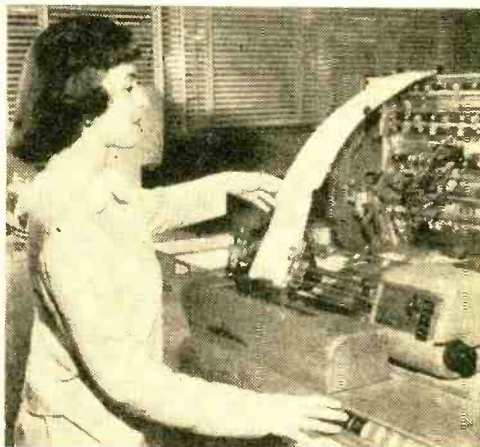

*Photos Courtesy of International Business Machines Corp.*



**Accident records** are totted up automatically at the rate of 150 lines per minute by this IBM accounting machine. The information is distributed to Highway Patrol Area Commanders to guide them in allocating officers to critical locations.

liest suspects in the whole criminal file for questioning about a specific offense. In addition, IBM electronic sorters keep complete records of every gun registered in the state, and every piece of pawned property. Stolen articles can thus be spotted by machines and returned to their owners.

California completes its "automated government" with electronic payroll and book-keeping departments. Still another IBM computer checks unemployment insurance claims in millionths of a second.

Thirty other states have already written to Sacramento for information concerning this type of push-button administration. As our population grows, maybe automation of this kind is the answer to the problem of the increasing cost and complexity of government.

-30-



# How to Use a Grid Dipper

By  
B. VAN SUTPHIN

*With a grid-dip  
oscillator, you can  
check circuits, frequency,  
and realign your receiver*



**W**ITHIN the past ten years, the grip-dip oscillator—or GDO, as it is sometimes called—has enjoyed a new surge of popularity. Numerous experimenters now consider the GDO as necessary in the modern ham shack or workshop as the VOM or VTVM. Grid-dip oscillators have been used in electronics laboratories for many years, but recently wide-range units in kit form became available at prices to fit the budget of the average ham or experimenter.

The grid-dip oscillator is really a calibrated, wide-range, low-power r.f. oscillator coupled to an indicating device. An example of a commonly available GDO unit is shown in the photo above. Note the use of plug-in coils so that the wide frequency range—generally from about 2.0 mc. to 250 mc.—can be obtained with minimum r.f. losses, and so that the GDO can be easily coupled to the circuit under test.

When the oscillator grid circuit is coupled to an external resonant circuit and the oscillator is tuned to the frequency of the external circuit, power will be absorbed from the oscillator and the grid current will decrease. The resonant frequency of the external circuit can then be read from the calibrated dial of the grid-dip oscillator. The "sensitivity" control is used to set the initial grid current reading

to approximately half-scale on the meter—so that the dip will be sharp and easily recognized, and to allow for differences in oscillator activity on the various ranges. When the instrument is used as an indicating wavemeter, this control limits the current through the meter.

**Testing Circuits.** There are many uses for a GDO. Suppose that you have just finished winding the coils for a receiver or converter described in POP'tronics and want to be sure they cover the desired frequency range. Merely couple the GDO to each of the coils in turn and look for the dips in the meter reading. By tuning each external circuit over its range and checking for resonance at each end, you can quickly determine whether the coils have the desired tuning range.

Almost any resonant circuit can be checked just as easily. One important point in connection with this type of testing is that it is not necessary to apply power to the circuit under test. The only power required is for operating the GDO.

Here is another example of the kind of tests you can make with the GDO. In a ham transmitter having frequency multiplier stages, you must be sure that the individual stages are tuned to the proper frequencies. Consider the four-stage 2-me-

Photo at right illustrates method of coupling the GDO to a coil when making tests. This type of coupling is best both when the instrument is used as a grid-dip oscillator and when it is used as indicating wavemeter.

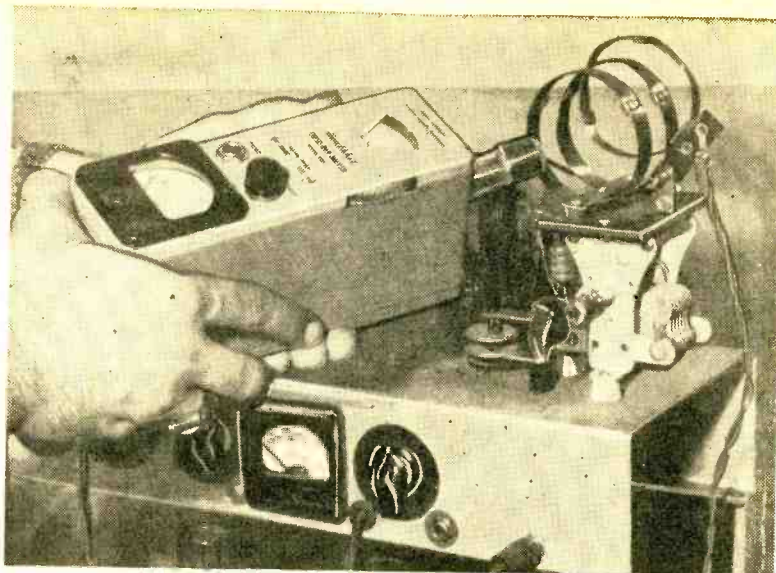

Method of coupling the GDO to an AM receiver loop during alignment is shown at the left. The individual r.f. and i.f. trimmers should be adjusted for maximum reading. On the opposite page is an alignment table for a typical a.c.-d.c. receiver, adapted for using GDO as a signal generator.



ter transmitter shown in Fig. 1. The plate circuit of the oscillator must be tuned to 16 mc., the plate circuit of the first tripler to 48 mc., the plate circuit of the second tripler to 144 mc., and the plate circuit of the final stage to 144 mc. By setting the GDO to each of these frequencies in turn and trying to tune the particular transmitter circuit so that a dip is obtained, you can tell whether the circuits can be tuned to resonance at the proper frequencies. This type of testing is particularly useful in preventing damage to expensive transmitting tubes in case one of the plate circuits cannot be adjusted to resonance.

This basic testing method can be used in any receiver or transmitter containing a

tuned circuit. The ability to reach resonance of the tuning range of the circuit can be checked very quickly. Everyone who displays any interest in radio has had a neighbor or friend come by, at one time or another, dragging his little table-model radio and explaining: "It just stopped suddenly. I took the back off to reach the tubes and saw some loose screws, so I tightened them. One tube was bad and I replaced it—but the set doesn't play now."

Obviously, alignment is in order. Many experimenters hesitate to undertake such a job because they do not have a commercial signal generator. With a GDO, however, they have a signal generator and quickly can realign the receiver, although it is still generally best to obtain complete alignment data beforehand. This is included with the service information which can be purchased from many radio parts jobbers.

**Aligning Receivers.** An alignment table for typical a.c.-d.c. receivers appears on page 51. This table will be used as an ex-



ample in the following discussion. Incidentally, this alignment procedure is standard for sets of this type and can be used if it is inconvenient or impossible to buy the service information for a particular brand of receiver.

Since grid dip oscillators do not have a provision for modulating the output signal, some indicating device must be connected to the receiver during alignment. A sensitive d.c. voltmeter (20,000 ohms per volt, on VTVM) connected across the receiver volume control is the method commonly used.

Connect the indicating device to the receiver circuit. Tune the set to the low-frequency end of the dial. Plug the proper coil in the GDO and set the dial to the desired i.f. The preferred method of coupling the GDO to the receiver during alignment is shown on the preceding page.

Adjust the i.f. trimmers for maximum reading of the indicator. Then set the receiver dial to the 1500-kc. point and adjust the oscillator trimmer in the receiver so that a 1500-kc. signal from the GDO gives maximum indication. Finally, adjust the r.f.—or mixer trimmer—on the receiver for maximum indication. (If there is a strong local station operating between 1300 kc. and 1600 kc., you can use the signal from the station in adjusting the oscillator and r.f. trimmers in the receiver. Simply adjust the oscillator trimmer so that the signal comes in at the proper point on the dial and adjust the r.f. trimmer for maximum output from the receiver.)

Aligning home-made receivers and converters is just as easy. Connect an indi-

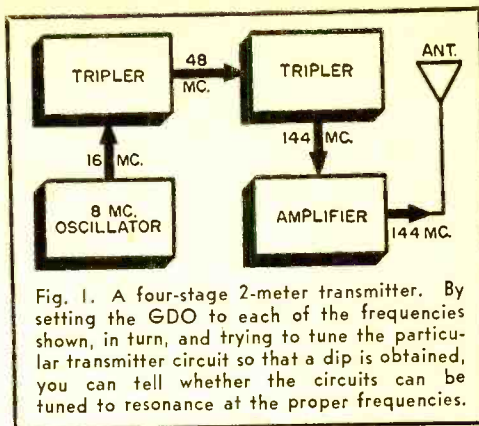

Fig. 1. A four-stage 2-meter transmitter. By setting the GDO to each of the frequencies shown, in turn, and trying to tune the particular transmitter circuit so that a dip is obtained, you can tell whether the circuits can be tuned to resonance at the proper frequencies.

cating device to the equipment and loosely couple the GDO to the input circuit. Set the GDO to the proper frequency and go on to adjust the various stages. Most grid-dip oscillators have a switch which will convert the instrument to a wide-range indicating wavemeter or simple diode phone monitor with the addition of a pair of headphones.

**Checking Frequencies.** Novice hams are aware that FCC regulations require all ham stations to have some means of checking their frequency other than the calibration of the crystal or VFO used in the transmitter. With the GDO set for use as an indicating wavemeter, it is ideal for frequency checking or "band spotting."

Of course, the calibration of the GDO dial is not accurate enough for use in calibrating a VFO, but it will indicate whether a transmitter is operating in the band. If greater accuracy is desired, the GDO calibration can be checked against a frequency standard of known accuracy and a specially drawn calibration scale can be substituted.

When the GDO is set for use as an indicating wavemeter, it can also be employed as a phone monitor to check the modulation quality of the output signal. Simply plug headphones in the jack on the panel, lightly couple the GDO coil to the transmitter output, and listen while someone else uses the mike. This should provide an accurate check of your ham station phone signal.

Only a few of the many uses for the valuable grid-dip oscillator have been discussed here. You will find others described in the instruction manual accompanying this versatile instrument.

### ALIGNMENT INSTRUCTIONS

For output indication, connect a sensitive d.c. voltmeter across the second detector load resistor or receiver volume control, the positive meter lead going to the B— side of the control.

Signal Generator Frequency	Receiver Dial Setting	Trimmers to be Adjusted	Remarks
455 kc.	Low-frequency end of dial	All i.f.	If necessary to prevent interference, change setting of receiver dial slightly
1500 kc.	1500 kc.	Oscillator trimmer on smaller section of gang capacitor	See note below
1500 kc.	1500 kc.	Mixer trimmer on larger section of gang capacitor	See note below

Note: A signal from a station operating between 1300 kc. and 1600 kc. can be used in adjusting the oscillator trimmer and the mixer trimmer.

## Super Magnet Gets Gas Chamber

**L**ITERALLY TOO HOT to handle, a new material for making what may become the world's strongest magnets must be

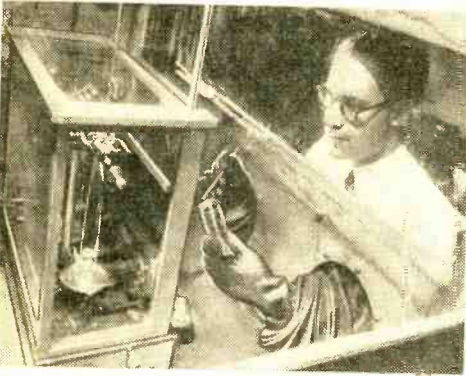

the special chamber shown in the photo. The inert atmosphere of helium gas within the chamber prevents the powder from burning itself out of existence before it can be used.

Under advanced study by the Air Research and Development Command of the United States Air Force, the new material can be shaped into a variety of forms. Once processed and sealed into a plastic binder, the powder is orientated in a powerful magnetic field and molded to shape. The result is a magnet material ten times stronger than present-day types. What's more, the material can be shaped readily into a variety of novel forms that suggest a wide number of important uses and applications. Conventional permanent magnets can be made in relatively few different basic shapes.

Prior to the ARDC's work with the material, major research on it was carried out by the Westinghouse Electric Corp. under the direction of Dr. Clarence Zener.

processed by "remote control." The substance is a highly purified manganese-bismuth powder which catches fire spontaneously on exposure to air. Consequently, it must be prepared and processed in

## Telephone Cords Are Better, Too

**E**ACH of the telephone handset cords shown in the photograph at right is under one pound of tension and is being bent back and forth repeatedly through a 180° arc. Periodically, throughout this test, the cords are checked electrically to determine their conductance.

The result of this transmission line torture is, essentially, better phone equipment. Cords, like other telephone components, must keep pace with communications progress. To make sure they do so, engineers and technicians at Bell Telephone Laboratories conduct continuous research and testing. While the concentration is on handset cords, the "Cord Develop-

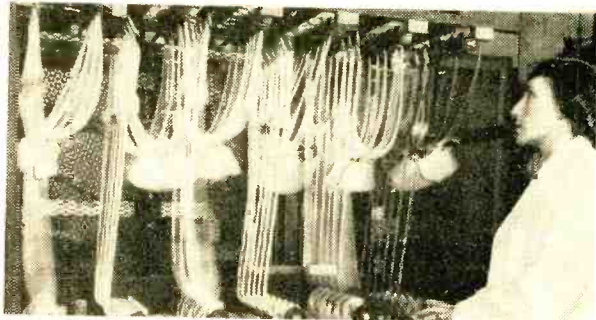

ment Group" is also concerned with patch cords, power cords, test cords, and many others. The testing devices used subject the cords to more abuse than they would ever take in the home.

## Yarn Without Yawn

**A**N INSTRUMENT called the "Speedotex," developed in England, measures the speed of yarn as it is fed into a knitting machine. The gadget, demonstrated in the photo by an operator in a textile mill, has been on trial for a year in many British factories. Although designed to measure yarn speed, it also levels up any number of feeds to a large knitting machine, saving over two hours in work preparations, and providing great accuracy of spindle speeds. "Speedotex" is manufactured by Dukes and Briggs Engineering Co., Ltd., Manchester, England.

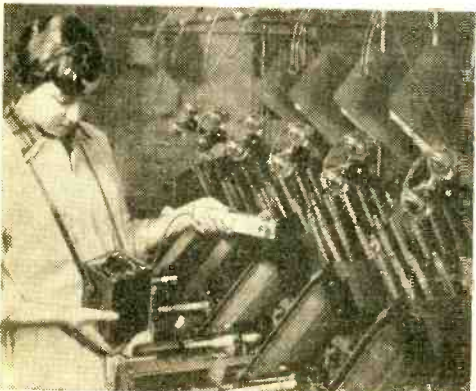



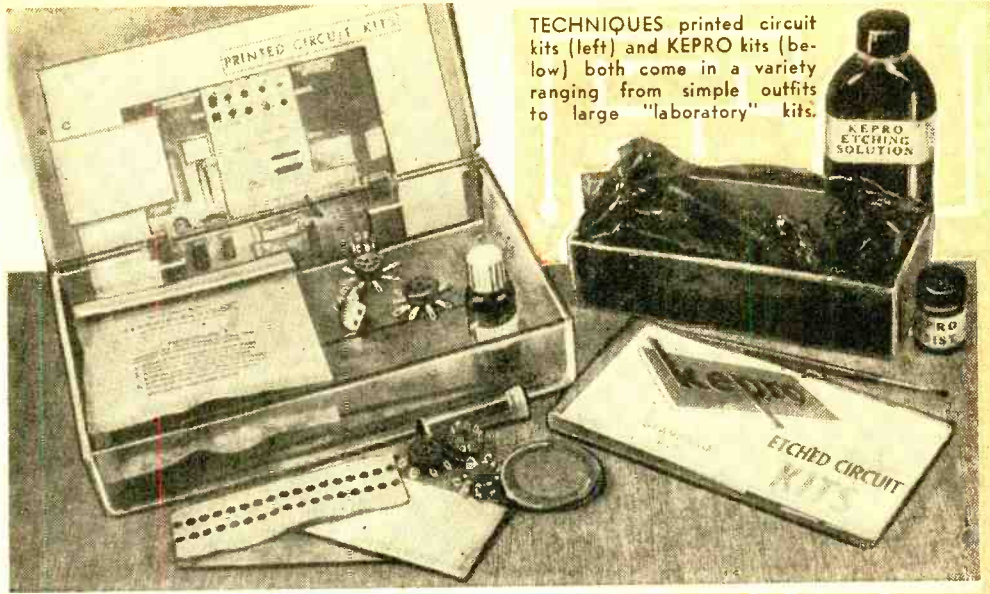

TECHNIQUES printed circuit kits (left) and KEPRO kits (below) both come in a variety ranging from simple outfits to large "laboratory" kits.

## "Printed Wiring" Techniques

By LOUIS E. GARNER, Jr. for the Experimenter

**Part 2 of two-part series presents final steps in making your own etched circuit boards, plus other techniques**

LAST MONTH we talked about the methods and advantages of substituting printed wiring methods for conventional hand wiring. We also discussed in detail the first four basic steps to follow in making an etched wiring board and assembling a complete circuit: (1) making a layout, (2) preparing the board, (3) transferring layout to board, and (4) applying resist.

**Step 5—Etching the Board.** A ferric chloride solution ( $\text{FeCl}_3$ ) is used for etching the board. This is furnished in either liquid or powdered form in kits. It also may be purchased at engraving supply houses in liquid form, and from some drug stores and chemical supply houses in powdered or lump form. If you use the etchant from a kit, follow the instructions furnished with it.

If you obtain a ferric chloride solution from a photo-engraving supply house, you'll generally find it furnished as "42% Ferric Chloride." This solution is rather

thick and may be diluted before use. Add plain water at the ratio of one quart of water to one gallon of solution.

If you obtain the ferric chloride in powdered form, dissolve it in a Pyrex glass or an enameled container. Proper ratio is approximately three ounces of ferric chloride to six ounces of water. The dissolving action is *exothermic* . . . that is, heat is evolved as the ferric chloride goes into solution, so don't worry if the solution heats up slightly.

*Caution:* Use care when working with the etchant. It will stain clothing. While not especially dangerous, the ferric chloride solution is "bitey" and may irritate sensitive skin. If possible, wear rubber gloves when working with it.

The actual etching is carried out in a small flat tray, similar to those used by photographers. A shallow Pyrex cooking dish makes an excellent tray. Either "hot" or "cold" etching may be employed. The "hot" etching technique is somewhat faster than "cold" etching. With the "hot" etching method, you'll need a small "hot plate" and either a Pyrex dish or tray or an enameled metal tray. If you use the "cold" etching method, a shallow plastic box or tray can serve as the etching container.

To etch the circuit board by means of the "hot" method, pour a sufficient amount



"Hot" method of etching printed circuit board.



With the "cold" method, etching time is longer.

of the etchant into the tray to cover the circuit board to a depth of about  $\frac{1}{4}$  to  $\frac{3}{8}$  of an inch. The actual amount of etchant used is not critical as long as the board is completely covered. If in doubt, always take a larger quantity. Place the tray on the hot plate and turn on the heat. Drop the circuit board *gently* into the etchant, taking care not to splash the solution. Copper side should be up. Move the board around from time to time during the etching process, using a plastic or glass rod or a pair of plastic tongs.

In general, as the temperature of the etchant is raised, up to the boiling point, the faster the etching action. If it is too hot, however, excessive water evaporation will take place, concentrating the solution and slowing the etching process. An "ideal" etching temperature is between 90° and 130° F. After considerable etching using the "hot" method, a little water may be added to the solution to replace the water lost through evaporation.

To etch the circuit board by means of the "cold" method, pour about a half-inch of etchant into the tray. A plastic tray may be used. Again, drop the board *gently* into the tray, copper side up. Rock the tray slightly during the etching process so that the etchant moves back and forth across the surface of the board.

An average circuit board may be etched with the "hot" method in about two to five minutes, depending on the condition of the etchant, the amount of exposed copper, and the actual etching temperature. With the "cold" method, etching time is around ten to twenty minutes. Regardless of the method used, continue the etching process

until all *exposed* copper is removed, leaving only the copper foil protected by the resist.

When the etching is completed, the etchant may be returned to a tightly sealed storage jar or bottle and the circuit board thoroughly rinsed under clear running water. Allow the board to dry.

**Step 6—Cleaning the Board.** After thorough rinsing and drying, the resist should be removed from the board, leaving the copper foil "printed" circuit.

Ink resist may be removed by rubbing with steel wool, and a final cleaning made using a soft cloth dampened slightly with general-purpose solvent (such as General Cement No. 31-16). Tape resist is simply peeled off.

**Step 7—Final Machining.** Component mounting and eyelet mounting holes are drilled in the etched board at the points located during Step 3. Normally a size #52 drill is used, but a slightly smaller or larger drill may be employed in some cases. Use a solid backing for the board during drilling to avoid cracking the phenolic. With the drilling completed, mount eyelets (brass or copper) in appropriate holes. Generally, eyelets are mounted wherever connections are likely to be removed and replaced frequently. Where permanent connections are to be made, eyelets are not necessary.

**Step 8—Mounting and Soldering.** Resistors, capacitors, coils, and similar components are mounted by passing their leads through appropriate holes in the etched circuit board. The customary practice is to mount these components on the "back" (non-etched) side of the board;



when mounted in this position, lead tension tends to hold the foil in place instead of pulling it away from the base. Leave the component leads full length. After passing the leads through the holes and pressing the component tightly against the board, the leads are bent slightly to one side, holding the components in position through natural tension. Circuit cross-overs, where necessary, may be made with short lengths of ordinary hookup wire, stripped at both ends.

Either a soldering gun or a pencil-type soldering iron with a small ( $\frac{1}{8}$ " tip should be used for soldering the connections. Best results can be obtained with a low-melting-point solder such as General Cement #9131 solder and a special printed-circuit soldering flux such as General Cement #12-2 "Print-Kote Soldering Flux." Do *not* use paste rosin flux nor, under any circumstances, acid-core solder in wiring circuits.

The proper soldering technique is to apply a drop of special flux (if used) to the copper foil where the connection is to be made. Then hold the tip of the soldering iron against the lead slightly above—but *not touching*—the copper foil. Solder is applied to the lead, and allowed to flow down and onto the copper. *Remove the iron as soon as the solder flows onto the copper foil.* A slightly different technique is to accumulate a drop of solder on the tip of the iron and to hold this against the lead, allowing it to flow down and over the copper foil.

Special pains must be taken to complete all soldering as quickly as possible. Excessive heat will result in a separation of the copper foil and phenolic backing.

When all leads have been soldered in place, projecting wires may be cut off close to the circuit board, using a pair of diagonal cutters. As a final "touch," the completed circuit may be given one or two coats of silicone resin, either sprayed on from a pressure-type can or applied with a small brush. This insulates and protects the completed circuit and reduces the chances of arcing between adjacent conductors under conditions of high humidity. Either type of silicone resin is available from General Cement as Type 14-6 (spray can) or Type 14-2 (liquid).

**Short Cuts.** The technique of making up etched circuit boards, as described, appears long and tedious. Actually, the work moves much more rapidly, for many of the steps take, at the most, a few minutes. In addition, as skill is gained in making up printed wiring layouts, you'll find you can combine several of the steps. For example, the author seldom makes a circuit layout in advance. Instead, he combines Steps 1,

Remove ink resist by rubbing with steel wool, and cleaning with damp soft cloth. Tape resist is simply peeled off.



Machining the etched board. When you drill component and eyelet mounting holes in the board, use a solid backing to avoid cracking the phenolic. A drill of the #52 size is generally used, although a slightly larger or smaller drill may be employed sometimes.

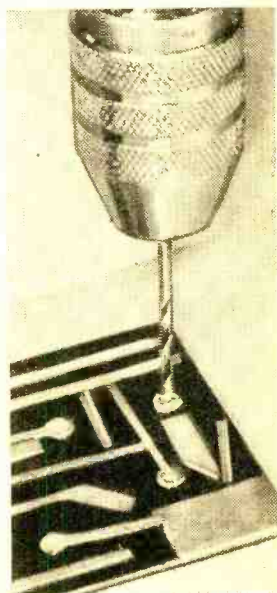

In the correct soldering technique, the solder is allowed to flow down to the copper foil. Excessive heat when soldering causes copper foil to separate from phenolic base.

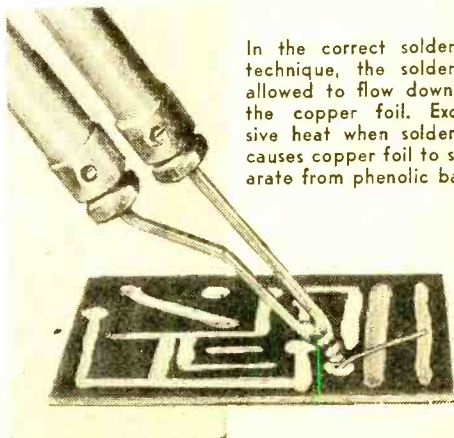

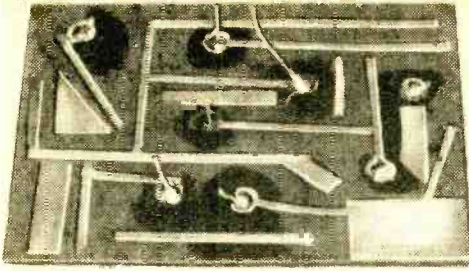

"Front" view of completed circuit board, with component leads not yet clipped. Dark stains are caused by liquid flux in soldering the connections.

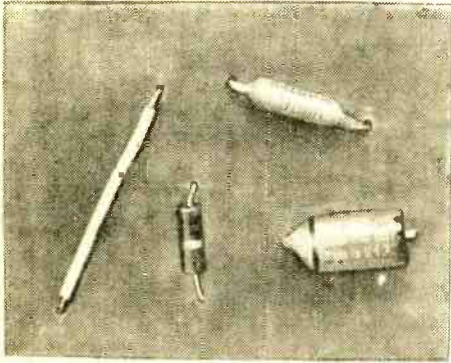

"Back" (non-etched) view of completed board shows parts in position. A piece of hookup wire, stripped at both ends, serves as circuit crossover.

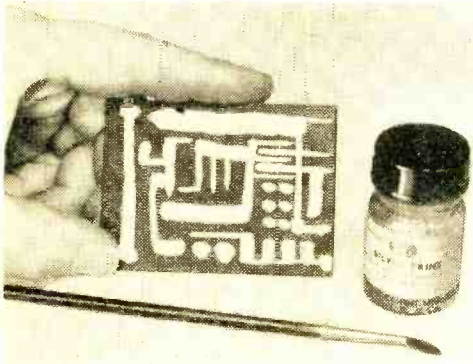

"Painted" circuit board made up by applying metallic "Silver Print" on Bakelite base. Eyelets must be used for all connections in painted circuits.

3 and 4, and, using a tape resist, makes up the layout directly on the copper-clad board. Results obtained by working in this manner are quite satisfactory.

More time may be saved by avoiding components requiring large or odd-shaped holes, and by choosing a layout to fit on

standard sizes of phenolic board as furnished by the kit manufacturers.

**MAKING PAINTED CIRCUITS.** A less popular—but still practical—method of making up a printed wiring board is to "paint" the circuit in place, using a metallic conducting ink on an insulated base. Almost any heat-resistant insulating material will serve as a base as long as it has high insulation resistance and does not tend to absorb moisture. Suitable materials are Bakelite and natural phenolic boards. A suitable metallic paint is General Cement's No. 21-1 "Silver Print."

As in the case of the etched circuit board, you make a scale layout first. Then transfer it to the insulating base material. Here the similarity in the two techniques changes. Instead of applying a "resist," the circuit is now "painted" on the board, using a small brush or pen. Since the conductor is a relatively thin layer of metallic deposit, "minimum" width of an individual conductor should be about  $\frac{1}{8}$ " instead of  $\frac{1}{32}$ " . . . and, in some cases, it even may be necessary to apply two coats of metallic ink.

Drill holes in the board for mounting components, as in the first technique; but since the thin metal deposit will not support a soldered joint, *eyelets* must be used for all connections. In addition, after you mount the components and solder them in position, it may be necessary to "retouch" around each eyelet to insure a good electrical connection.

Of the two techniques for making "printed" wiring boards, the etched circuit board method is preferred for the average home experimenter. It is by far the least critical of the two methods and, although it requires a few more steps, can be carried out with less practice.

**ADVANCED TECHNIQUES.** There are two additional techniques for making up etched circuit boards which have not been discussed. Both of these are simple enough to be practical for use in a home workshop or laboratory, but are better suited for the production of several identical circuit boards than for a "single-shot" circuit.

One of these techniques is the "silk-screen" method, in which a silk-screen stencil is first made up and used in applying an ink or paint resist to the copper-clad phenolic. The second technique is the "photographic" process, which involves a light-sensitive copper-clad board. The photographic technique is the one most often used in large-scale commercial work.

If there is sufficient interest on the part of POP'tronics readers in these more advanced techniques, they may be discussed in a future issue . . . let us know if you'd like to see such an article.



## Tinkertoy Design Simplifies Chassis

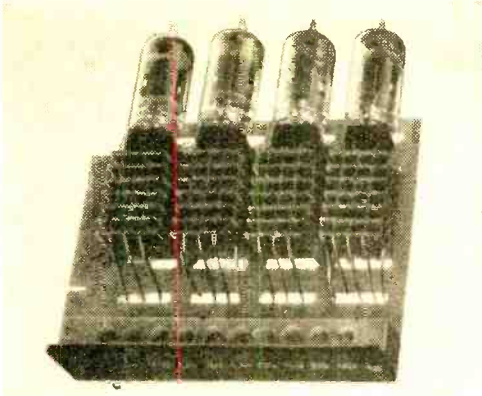

**T**HE DAY is surely gone when a piece of electronic equipment was a mess of wires with capacitors and resistors sticking out at odd angles. The flat printed circuit eliminated the traditional wire maze, and the "resistor board" with its neatly arrayed components has given a "new look" to electronic design.

Stacking up layers of printed circuits atop one another is the latest trend. Each circuit forms a thin wafer, and a small stack of such wafers—looking like a miniature skyscraper—makes up a complete equipment stage. The tube or transistor operating the stage usually sits on top of the stack.

Each wafer in the stack is called a module and the entire method of construction is therefore called *modular design*. It was first developed by the National Bureau of Standards for the purpose of cramming the greatest possible number of components into the smallest possible space. Because of the way the modules are con-

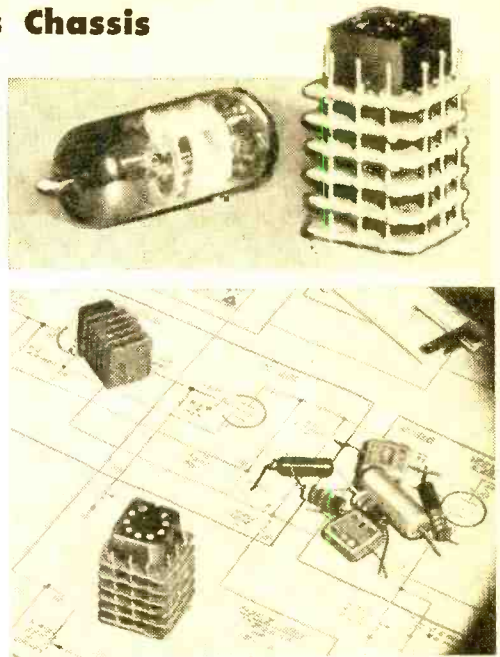

**Stacked modules** perform all passive circuit functions, replacing conventional components shown on schematic above. Hardly bigger than a miniature tube (top), modules are arrayed in miniature chassis like the counter unit shown at top, left.

nected, this development was nicknamed "Project Tinkertoy."

Commercial development of the Tinkertoy idea has been taken over by ACF Electronics, a division of ACF Industries at Alexandria, Virginia. Their aim has been to make the Tinkertoy modules electronically stable and sufficiently resistant to heat and mechanical shock for use in rocket-propelled missiles. Small size and light weight fit modules for such use.



## Junior Ham Wins Jackpot

**T**O HAUL IN \$100,000 in a TV quiz based on solid information rather than trick questions would be quite a feather in anyone's cap. Golden eggs this size are rarely laid by a goose. In this case, the winner was 10-year old Leonard Ross, who stumped NBC's "The Big Surprise" show by his expert knowledge of stock market operations.

Lenny's precocious intelligence also helped him get his ham Novice license at the age of seven and his Technician and General licenses at the age of eight. This makes him probably the youngest ham ever licensed by the FCC. Lenny's brother, Daniel, 17, got Lenny interested in radio and also steered quite a few other boys in his neighborhood onto the subject.

Our picture shows Lenny, W6SJR, Tujunga, Calif., answering questions on the stock market presented to him by Quizmaster Mike Wallace.

FAIRCHILD RECORDING  
EQUIPMENT CO.  
154th St. & Powells Cove  
Blvd.  
Whitestone, N. Y.



**Turntable** features flexible, endless-belt drive and stepped idler coupling. Designated as Model 411 "Turromatic," this 3-speed unit is sound-proofed and uses double-shock-mounts for the motor. It is recommended as a professional quality component for custom installations. Net price, with induction motor, \$99.50; with hysteresis motor, \$144.50.

HARMAN-KARDON, INC.  
520 Main St.  
Westbury, Long Island,  
N. Y.

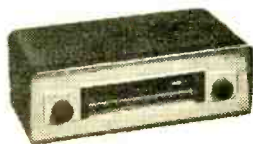

**FM-AM tuner** incorporates full Armstrong FM circuitry, tuned r.f. stage on FM, automatic frequency control. The "Overture" Model T-10 features compact "pancake" design, may be used with any external amplifier having audio controls. Retail price of \$79.50 includes mounting cage.

## what's new in hi-fi

AUDIOGERSH CORP.  
23 Park Place  
New York 7, N. Y.



**"Miratwin" cartridge** consists of 2 variable reluctance phono pickups assembled back-to-back. Unit is a turnover type with separate styli for standard and micro-groove records. Response within 2 db at 33 $\frac{1}{3}$  rpm is rated at 30 to 18,500 cps. Cartridge may be mounted in most standard tone arms. Model MST-2D (sapphire stylus for 78 rpm and diamond for LP's), \$45.00 net; Model MST-2A (two sapphire styli), \$22.50. Replacement styli available.

EICO  
84 Withers St.  
Brooklyn 11, N. Y.



**Preamplifier** has full control and equalization facilities, accepts all types of program input signals. Output may be fed to power amplifier and tape recorder. Response is rated within 1 db from 8 to 100,000 cps. Model HF61 (with power supply) sells for \$29.95 as kit; factory-wired, \$44.95. Model HF61A (without power supply) is \$24.95 as kit; factory-wired, \$37.95.

UNITED AUDIO PRODUCTS  
202-4 East 19th St.  
New York 3, N. Y.



**Loudspeaker** (Wigo, Model ERD 12) is 12" single-cone unit with rated frequency response from 25 to 15,000 cycles. Cone is molded with concentric rings to improve compliance for bass; impregnated cloth suspension is said to aid mid-range; rubberized apex of voice coil support helps dispersion of highs. Magnet weight is 3 $\frac{3}{4}$  pounds; power rating, 30 watts. For added high-frequency response, the manufacturer recommends using Wigo tweeter TW500 and crossover at 4000 cycles.

HEATH COMPANY  
Benton Harbor 5, Mich.



**Enclosure** is part of multiple speaker system available in kit form. Model SS-1 (not shown here) is miniature resonator with two drivers, covering range from 50 to 12,000 cycles. Model SS-1B (shown) includes larger cabinet, 15" woofer, and additional tweeter for extending range down to 35 and up to 16,000 cycles. Crossover network, with high-frequency level control, is furnished with SS-1B. Power rating is 35 watts; nominal impedance, 16 ohms.



# Tuning the Short-Wave Bands

—with Hank Bennett—

**T**HE FEATURED DX'er for this issue is Alfred Ewer, of 28 Lakefront Rd., Apartment 9, Dartmouth, Nova Scotia. He is married, 25 years old (he'll be 26 on August 30th), and has one daughter. Alfred is with the Canadian Navy.

Our September DX'er uses a Hall receiver, a Hallicrafters S-38D, and an RCA Victor "Transworld Portable" to pull in his DX stations. Before he moved recently, Alfred used an outdoor antenna, 40' long

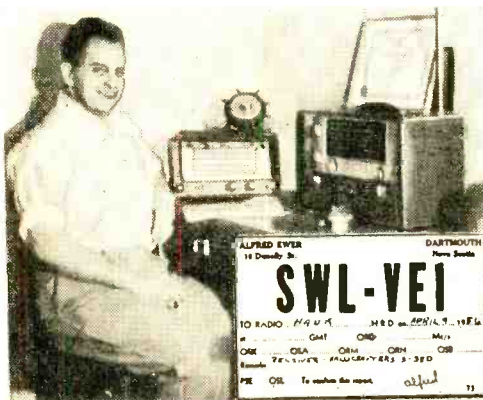

Meet Alfred Ewer, of Dartmouth, Nova Scotia, accompanied by two receivers and his SWL card.

and 15' high. When last we heard, he was using a 10' piece of wire "laying on the deck," and reported that *Radio Japan* was coming through very well.

There is no equipment in the Ewer listening post besides the three receivers. Judging from his impressive array of verifications from 34 countries in less than two years, it is evident that Alfred is having a good bit of success with these receivers. He started his DX'ing in 1954 and

## PROGRAM SCHEDULES

A monthly program schedule can be obtained from Radio Canada by writing to the CBC International Service, P. O. Box 6000, Montreal, Quebec. Radio Pakistan is issuing copies of "Pakistan Calling"; write to Nazir Press, McLeod Road, Karachi, Pakistan, for your copy.

sent his first station report out in 1955. Since that time, he has been quite active and has reported to this s.w. section with regularity.

Alfred told your Editor that he prizes his QSL from Delhi, India, above all others. When we asked him about his favorites, he mentioned that *Radio Australia* was the s.w. station he liked most, 25 meters his choice of the DX bands. His best DX came about when he logged *Radio Thailand*.

In addition to being one of POP'tronics' top reporters, Alfred belongs to the Newark News Radio Club, the American Radio Relay League, and the Dartmouth Amateur Radio Club. He likes to write to foreign SWL's and his great ambition is to receive verifications from 100 countries.

**Club Notes.** The World Shortwave Club is now located at 740 Dana St., Redlands,

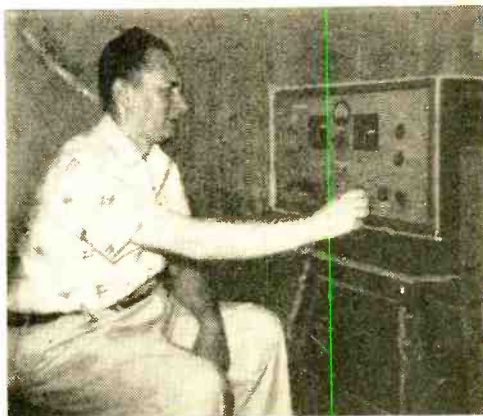

Listening post of Ralph Kuhnert, Springfield, Mass.

Calif. Anyone interested in joining should write to this address, in care of Mr. Rolan Riker.

The Newark News Radio Club will hold its Annual Convention on Saturday, September 8, at the Shady Rest Picnic Grounds, Route 33, just east of Freehold, N. J. Although it is mainly for the members of the club, anyone interested in the NNRC or in SWL'ing is invited to attend.

(Continued on page 110)

# Fool Your Friends with an

By JOHN P. SHIELDS

**No knobs to turn, no buttons to push—when you have the “key,” you can open it in an instant**

**I**N RECENT YEARS a number of electronic locks have been devised. Such locks generally contain an electromagnetically controlled latch. When a simple switch is used to control the current through the solenoid, the lock is little more than a holding device—because it is virtually impossible to conceal the switch well enough to foil an intruder and at the same time keep it accessible to authorized users.

The versatile electronic lock described in this article eliminates the faults of switched locks. It is mounted entirely inside the device it locks, with no knobs to turn or buttons to push. Yet, it can be instantly opened by the possessor of its “key.” Without the “key,” it would probably take an individual several hours to open it, even someone who knew the secret of its operation.

Parts requirements of the electronic lock and its “key” are shown in the diagrams. In laying out parts for the lock, only the position of coil *L2* is at all critical. Mount it on a

2-terminal insulated tie strip, so that it is parallel to one side of the chassis box and about  $\frac{1}{8}$ " from its edge. Then, cut a 2" hole in the cover opposite the coil so that the metal will not shield *L2* from the “key.” The hole may be round or square, whichever is the more convenient to cut, and it may be covered with a thin piece of Bakelite, plastic, or other insulating material.

The oscillating frequency is determined by *L2* and *C2* and may be almost any frequency. The values shown produce a frequency of approximately 3000 kc.

As can be seen in the photos, *L2* is self-supporting, but it is advisable to wind the “key” coil on a form for permanence under handling. Choose a form about 2½" long, wind *L1* close to one end of the form, and mount *C1* inside the form. The extra

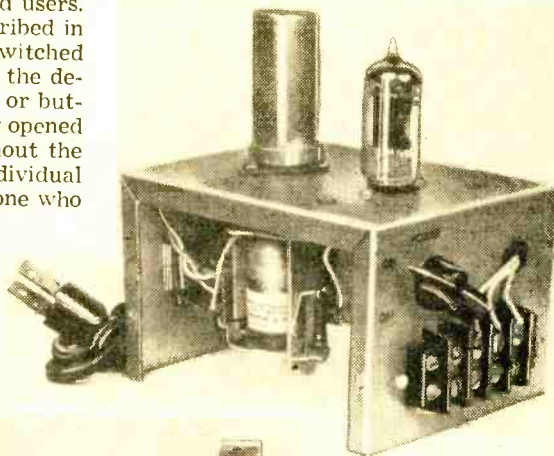

Completed electronic lock (above) is neat and attractive in appearance. Concealed on the opposite side of the unit is the cutout in the box which makes *L2* accessible to the operating “key.”

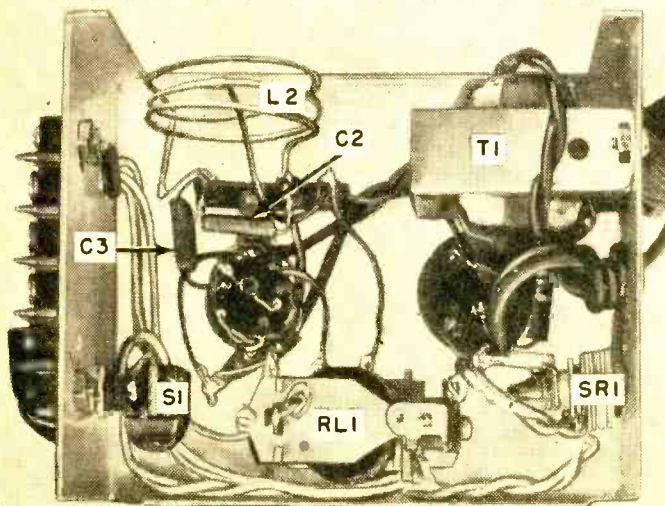

In underchassis view, mounting positions of all components in the lock control unit may be clearly seen. The position of coil *L2* is the only one which is at all critical.

POPULAR ELECTRONICS



# Electronic Lock

length of the form will serve as a handle—holding the “key” in your fingers might detune it. Give *L1* a coating of coil dope after it is wound to hold the turns in place.

**Adjustment.** If available, a v.t.v.m. or a 20,000-ohm-per-volt voltmeter is convenient for tuning the lock. Connect one terminal to the chassis and the other one to the oscillator grid (pin 2 of the socket). The meter should show a negative voltage of 10 to 15 volts.

Bring the “key” within  $\frac{1}{2}$ " of *L2* and parallel to it. Hold the “key” in this position and carefully adjust *C1* while watching the meter pointer. At one setting of the capacitor, the pointer should dip sharply. Move the “key” away from *L2* until there is only a slight dip in the meter reading as *C1* is tuned. Adjust *C1* to the position that



## PARTS LIST

- C1*—70-350- $\mu$ fd. variable mica capacitor
- C2*—200- $\mu$ fd. silver-mica capacitor, 5% accuracy
- C3*—200- $\mu$ fd. mica capacitor
- C4*—.005- $\mu$ fd. disc ceramic capacitor (not used in model but may improve stability of operation)
- C5, C6*—Dual 10- $\mu$ fd., 150-volt electrolytic capacitor
- L1*—4 turns of No. 16 wire,  $1\frac{1}{2}$ " dia., wound on a coil form
- L2*—Wire having the same dimensions as *L1*, spaced about double the wire diameter between turns, with center tap.
- R1*—100,000-ohm,  $\frac{1}{2}$ -watt resistor
- R2*—47-ohm, 1-watt resistor
- R3*—1000-ohm, 1-watt resistor
- RL1*—S.p.d.t. relay, 5000-ohm coil (Potter & Brumfield LM5-5000 or equivalent)
- S1*—S.p.s.t. switch
- SR1*—65-ma. selenium rectifier
- T1*—Power transformer, 125 volts @ 15 ma., and 6.3 volts @ 0.6 amp. (Stancor PS-8415, or equivalent)
- V1, V2*—12AU7 tube
- 1—3" x 4" x 5" aluminum box

causes the sharpest and deepest dip in the meter reading. Put the “key” aside and adjust the relay spring tension so that the relay armature just remains open when power is applied to the unit. Bringing the “key” near *L2* should then cause the relay armature to pull in, and removing the “key” should permit the armature to drop out.

If a high-resistance voltmeter is not available, proceed in the following manner. First, adjust relay spring tension so that the armature just *does not* pull in with power applied to the unit. Then, short pin 2 of the 12AU7 socket to the chassis momentarily with a screwdriver. The relay should close and open again when short is removed. Adjust relay until it performs

Schematic wiring diagram and parts list solve the “mystery” of the electronic lock.

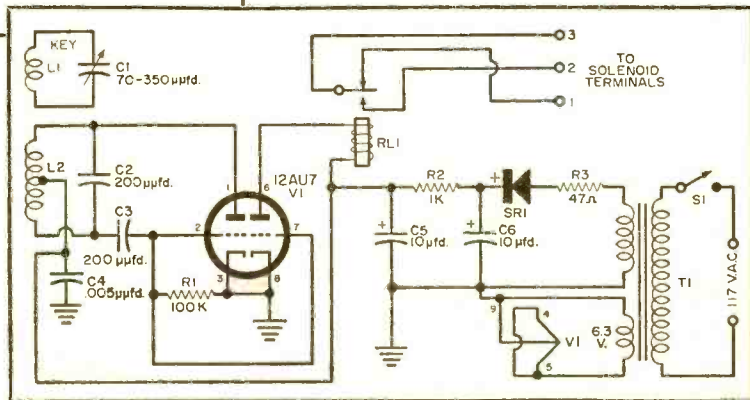

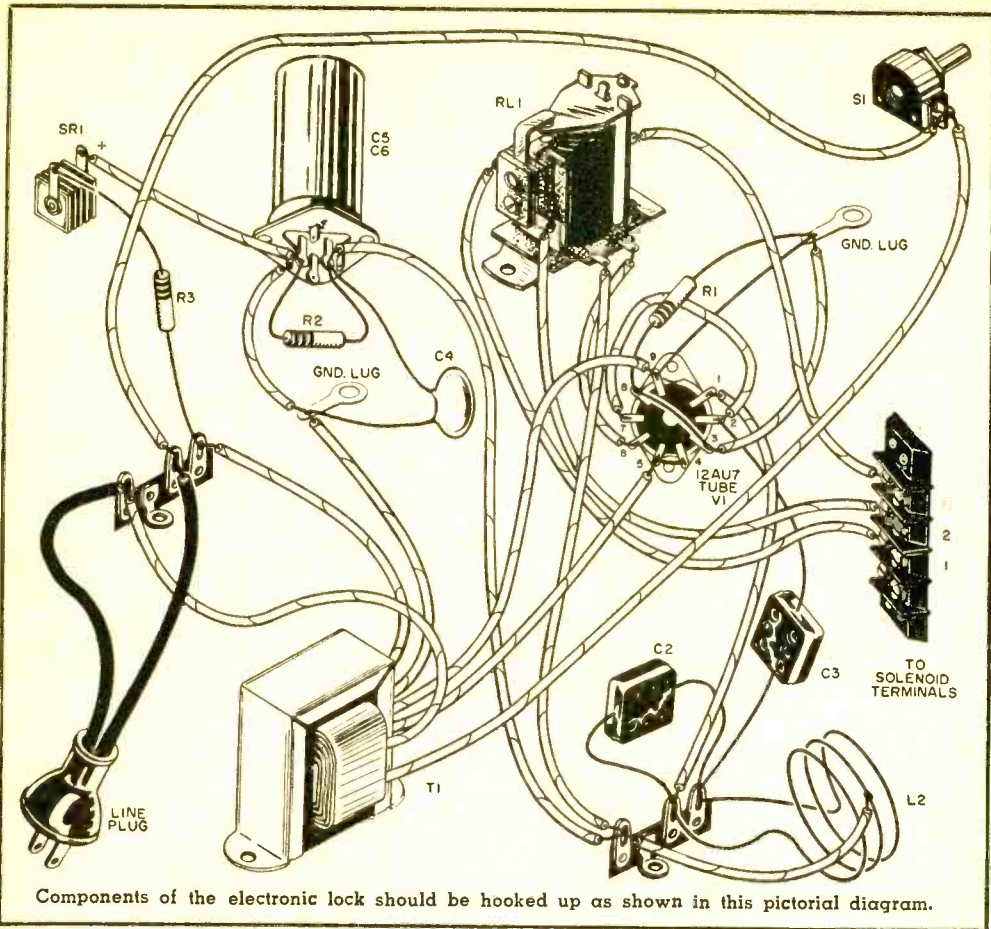

in this manner. The "key" is tuned by holding it close to  $L2$  and adjusting  $C1$  until the relay closes. When properly adjusted, bringing the "key" within  $\frac{1}{2}$ " or  $\frac{3}{4}$ " of  $L2$  should suffice to operate the relay.

After these adjustments have been completed, put the cover on the box with the cutout opposite  $L2$ . The unit is ready to be installed in its permanent position. It may be mounted with the cutout against a wall or door and controlled by the "key" right through the mounting surface—assuming, of course, that the separation between the key and  $L2$  is not too great. The "key" will work through wood, plaster, or other insulating materials as well as through air. However, even a thin layer of metal over  $L2$  will prevent it from functioning.

A suitable electromagnetic latch to be used in conjunction with this control unit can be constructed from a solenoid, such as the Guardian Type 4C 117-volt a.c. solenoid, which has a plunger movement of  $1\frac{1}{8}$ " and is designed for continuous duty. The lock mechanism to be controlled by the solenoid can easily be constructed from a standard

door lock, available at any hardware counter. Use a brass or other non-magnetic material to join the solenoid plunger to the movable lock "tongue."

### HOW IT WORKS

One-half of the 12AU7 oscillates at a frequency determined by the constants of  $C2$  and  $L2$ . This energy circulates back and forth between  $C2$  and  $L2$ , generating a r.f. field around the coil. Grid current flows through resistor  $R1$  on the positive halves of the excitation cycles, developing a voltage drop across the resistor, with negative polarity at the grid end. This negative bias voltage, being also applied to the grid of the second half of the tube, reduces the plate current through the relay coil to a low value.

When the "key," which is a simple tuned circuit resonating at the oscillating frequency, is brought near  $L2$ , it extracts power from the field around it. This reduces the energy fed back to the grid of the tube and decreases the negative bias voltage. Consequently, increased current flows through the relay coil causing its armature to pull in, closing the relay contacts, and thereby applying power to the external circuit. The oscillator is powered from the a.c. line through a selenium rectifier ( $SRI$ ) and a resistance-capacitance filter.

NOTE: Failure of the power source will not unlock the door or the device to which this is attached.



By R. L. McINTYRE

You can fly high, wide and handsome if you add elevator control to your R/C model

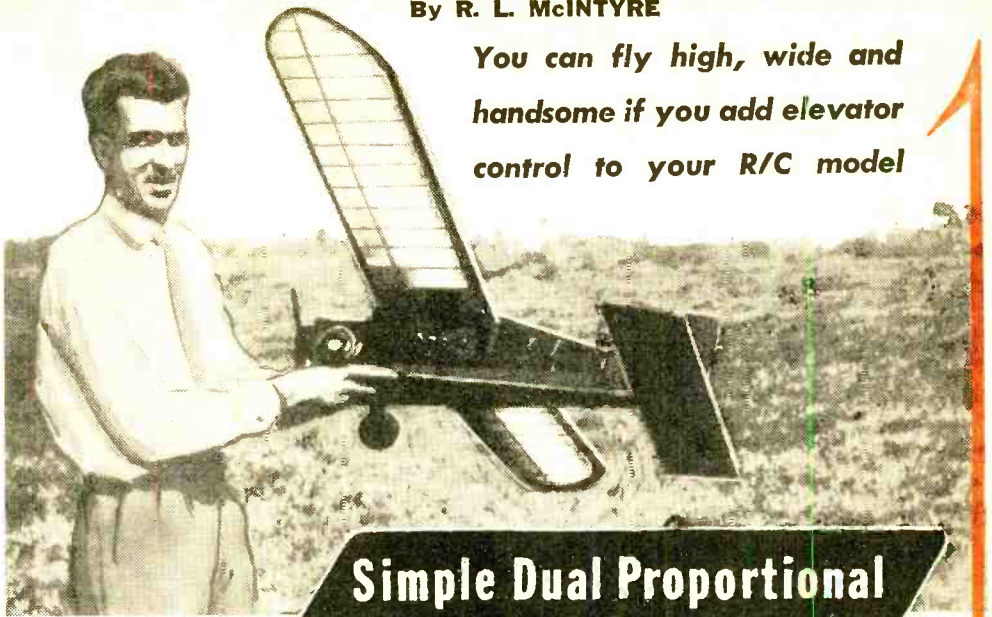

## Simple Dual Proportional R/C System

**I**F YOU HAVE WANTED to enjoy the added thrill of elevator control along with rudder control on that favorite R/C model, but can't afford the cost or weight of a tone control system, this article is for you. The system described here offers two proportional controls on one channel, and it uses a standard transmitter and receiver as building blocks.

When flying with this dual proportional system, the flyer has two controls: the rudder control which varies the pulse width, and the elevator control which varies the pulse repetition rate. Continuous control is always available by merely regulating the resistance of potentiometers *R8* and *R10*. Thus, it is easy to develop the feel of flying with this system.

The heart of the system is the pulser. This is the unit which does the actual controlling of the model; so it is necessary to observe a few precautions during its construction.

**Pulser Construction.** Layout of the pulser is not critical, but I prefer to keep the control box as a separate unit as it allows greater freedom of movement. You can build the pulser as a complete unit if you wish. If you follow my design, be sure that the control box is small enough to be held in your hand comfortably, and yet large enough to contain the two potentiometers. The cable used to connect the control box to the pulser should be of the shielded two-conductor type. Ground the shield to

the arm of *R8* (rudder) and to the pulser chassis to avoid hand capacity changes.

Any plate-type relay may be substituted for the Sigma 4F (*RL3*) as long as you change the value of *R5* so that its resistance—plus that of the relay you substitute—adds up to 12,000 ohms. A common connection between A-plus and B-minus is necessary to stabilize the neutral rudder at all elevator positions. As the 3A5 tube (*V3*) has a high-filament drain, the A battery should be fairly large.

*One word of warning!* If you are now flying proportional rudder and the pulse stops at full rudder positions, the elevator will be in the full-up position. If your pulser does stop in this manner, increase values of resistors *R6* and *R7* in the grid circuits. If you wish to reset the pulse rates—the lowest rate is set by increasing the values of *C5* and *C6*, and the highest rate is set by reducing the value of resistor *R9* in series with *R10*.

For those who have proportional rudder control installed and want to add the elevator section to a receiver, I have included a diagram of the base I used as shown in the photographs of the elevator control. The receiver should have a plate current drop of approximately 1 ma. on receipt of signal. If it meets this requirement, then mount the 3V4 tube, relay and other components on the base as shown, keeping the lead from the original receiver to *C4* as short as possible. Refer to the complete

At right is a front view of the transmitter with its 24" antenna and the dual control box; this transmitter can be used with simple push-button control for escapement by plugging another cord in unused plug on front panel. Directly below is a close-up of the pulser and transmitter; pilot lamp shown just under transmitter is in series with the crystal to protect it from excess current. In the remaining photo—an internal view of the pulser control box—the control at the end is the elevator control and the one at the top is the rudder control.

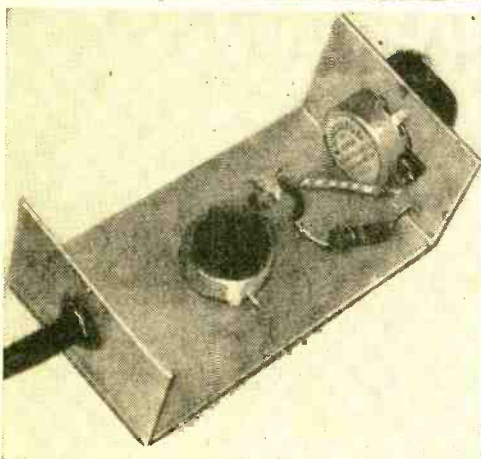
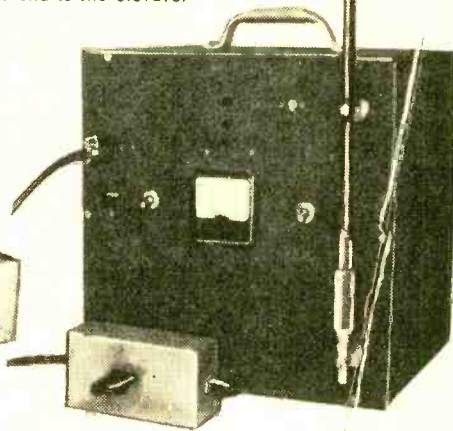
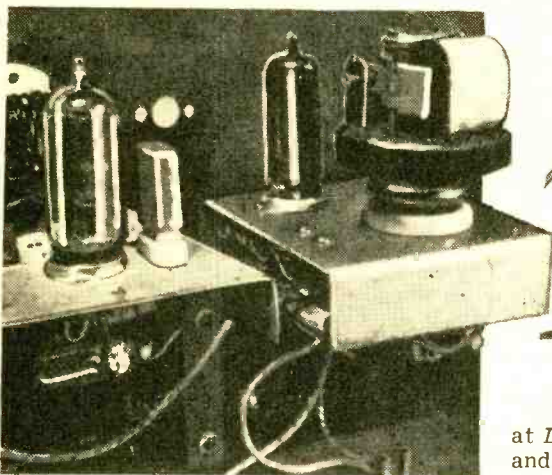

at  $L2$ , then connect  $R1$  from pin 3 to pin 5 and solder at pin 3.

Take another piece of wire and connect it from pin 2 to pin 4 of  $V1$  and then to the outside terminal of  $L1$ . You can now solder all three points. Connect the other terminal of  $L1$  (see schematic) to the front terminal of  $C1$  and up to  $L2$ . Solder these points.

Attach  $C3$  from  $L2$  to pin 5, with the marked end of  $C3$  closest to the pin.  $RFC3$  is connected from pin 5 of  $V1$  to pin 5 of  $V2$ . Solder at  $V2$ . Connect  $RFC2$  from pin 1 of  $V1$  to pin 1 of  $V2$ , and  $C4$  from pin 6 of  $V2$  to  $L2$ —leaving the lead on  $C4$  long enough to reach the relay. Solder at  $L2$ .

Connect  $R2$  and  $CR1$  from pin 6 to pin 4 of  $V2$ . Solder pin 6, then solder in  $R3$  from pin 4 to 5 of  $V2$ . Using solid wire, solder leads from pin 2 and pin 3 of  $V2$  long enough to reach relay. Connect A and B battery leads to pin 5 of  $V1$ , then solder.

You can now mount both relays. Connect the leads from  $L2$ , and pins 2 and 3 of  $V2$  to the elevator relay and solder. Connect the B-plus lead to the unused end of each relay, the A-plus lead to pin 1 of  $V1$ , and solder all connections.

Carefully check the finished unit against the schematic, then connect the batteries and check the voltages on the tube sockets. You should have 45 volts from pin 5 to pin 2 and 1.5 volts from pin 5 to pin 1 on both tube sockets.

**Tuning.** The procedure for tuning the receiver should be followed closely. Insert the 3S4 only, and connect the filament batteries. Then connect a 25,000-ohm potentiometer in series with the 45-volt B-plus lead through a milliammeter to the set as shown in the schematic.

Adjust the external series potentiometer

receiver construction for details on building and tuning the elevator control.

**Receiver Construction.** First lay out the base and drill all holes in a piece of 1/16 linen base Bakelite. The tube sockets are mounted about 1/2" below the base on eyelets or spacers. With the sockets in place, mount  $L1$ ,  $C1$  and  $L2$  permanently in place, in the positions shown. Check to see if the relays fit, but do not keep them on the base as they may be damaged by solder.

Work one lead of  $RFC1$  between the socket for  $V1$  and  $L2$  so that it reaches its terminal on  $L2$ . Shape the other lead to reach the front terminal of the padder  $C1$ , but do not solder. Connect a piece of solid tinned wire from the back terminal of  $C1$  to  $L2$  and solder at  $C1$  only.

Connect  $C2$  from  $L2$  to pin 3 of  $V1$ . Solder



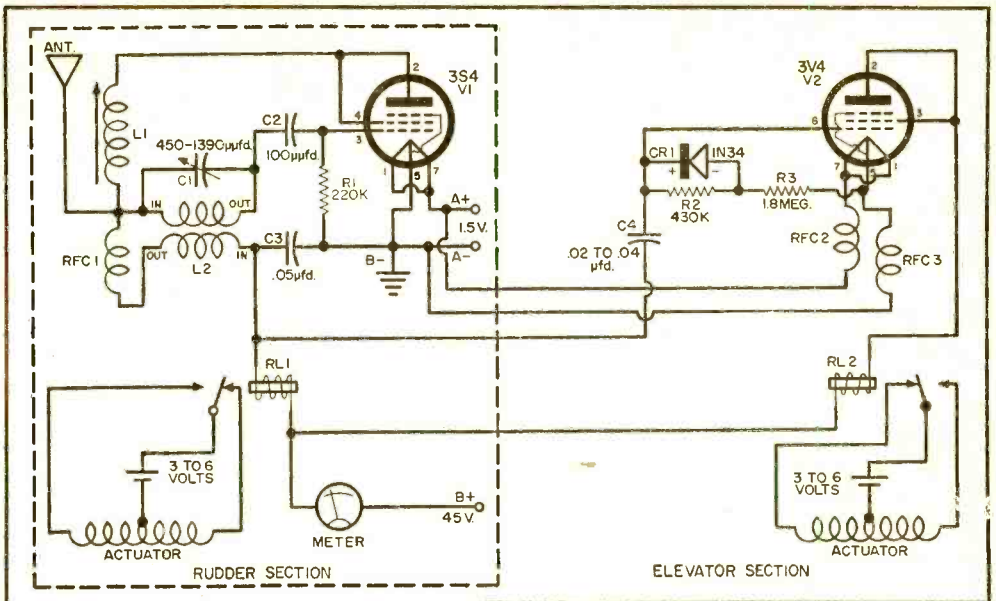

Schematic diagram and parts list for receiver.

- C1—450-1390  $\mu$ fd. capacitor (Arco Padder #308m)
- C2—100- $\mu$ fd. ceramic capacitor
- C3—0.05- $\mu$ fd., 200-volt capacitor
- C4—0.02-0.04  $\mu$ fd., 200-volt capacitor (see text)
- CR1—1N34 crystal diode
- L1—18 turns of wire on  $\frac{1}{4}$ " iron core slug form
- L2—National OSR or Miller 313 coil
- R1—220,000-ohm,  $\frac{1}{2}$ -watt resistor
- R2—430,000-ohm,  $\frac{1}{2}$ -watt resistor
- R3—1.8-megohm,  $\frac{1}{2}$ -watt resistor
- RFC1, RFC2, RFC3—69 turns of #34 wire on  $\frac{1}{4}$ " form
- RL1—2000-ohm Sigma 4F or 5000-ohm Neomatic relay
- RL2—2000-ohm Sigma 4F or 7250-ohm Neomatic relay
- V1—3S4 tube
- V2—3V4 tube

Top view of the elevator unit showing the relay and tube. Note that although a 3S4 tube appears in this photo, the correct tube to use is a 3V4 as shown on the circuit diagram (above, right).

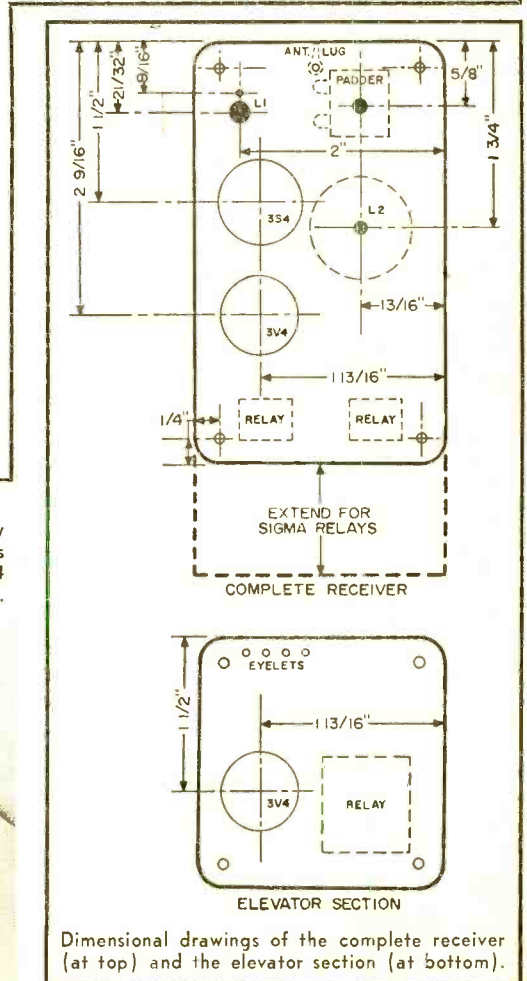
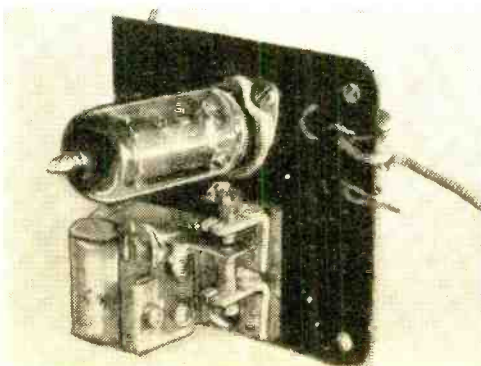

Dimensional drawings of the complete receiver (at top) and the elevator section (at bottom).

Schematic diagram of the pulser unit appears at right; parts list for pulser is given below.

- C5—0.25- $\mu$ fd., 200-volt paper capacitor
- C6—0.25- $\mu$ fd., 200-volt paper capacitor
- R4—12,000-ohm resistor
- R5—10,000-ohm resistor
- R6, R7—50,000-ohm resistor
- R8—1-megohm linear taper potentiometer
- R9—2-megohm,  $\frac{1}{2}$ -watt resistor
- R10—10-megohm linear taper potentiometer
- RL3—2000-ohm Sigma 4F relay
- V3—3A5 tube

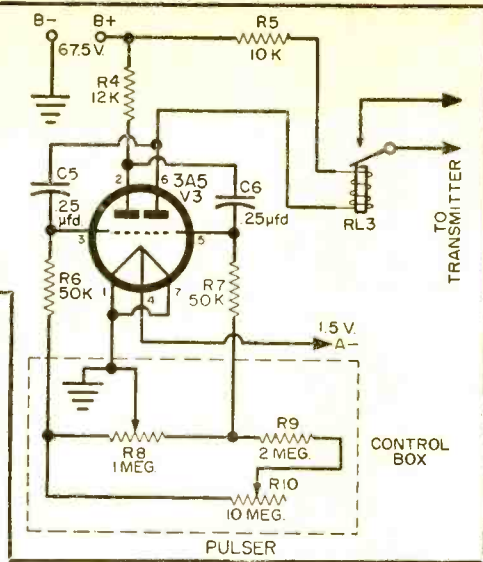

to allow 1.7 ma. of current to flow, then set the rudder relay to pull in. Readjust to give 1.5 ma. and set the relay to drop out.

To adjust the elevator relay, insert the 3V4 and set the series potentiometer. The current is now the total of rudder current and elevator current, so subtract the rudder current to get the correct reading.

Remove the 3V4 and tune the receiver to 27,255 mc. by watching for a dip in receiver plate current as you key the transmitter. This dip should be 1 ma. It can be adjusted by turning the paddler capacitor to the left until the current drops off and then giving it one-half turn to the right.

Replace the 3V4 and key the transmitter.

The rudder relay should drop out and stay out as long as the key is closed. The elevator relay should drop out momentarily and close again almost immediately. Should the elevator relay stay open, check the wiring.

If the wiring is correct, reduce  $C_4$  from 0.04  $\mu$ fd. to 0.03  $\mu$ fd. and try again. This capacitor should be as large as possible and not cause the elevator to follow the rudder.

The unit is now ready to install with any activator. I used the one put out by Southwestern Electronics, Houston, Texas, although another unit could have been employed.

All of the parts may be obtained at most radio supply houses. The Miller #313 coil can be used in place of the National OSR with about 1 ma. more plate current being the only difference in operation. Any slug-tuned coil that will tune to 27,255 mc. may be used for  $L_1$ , and the 1N34 can be replaced by nearly any germanium diode.

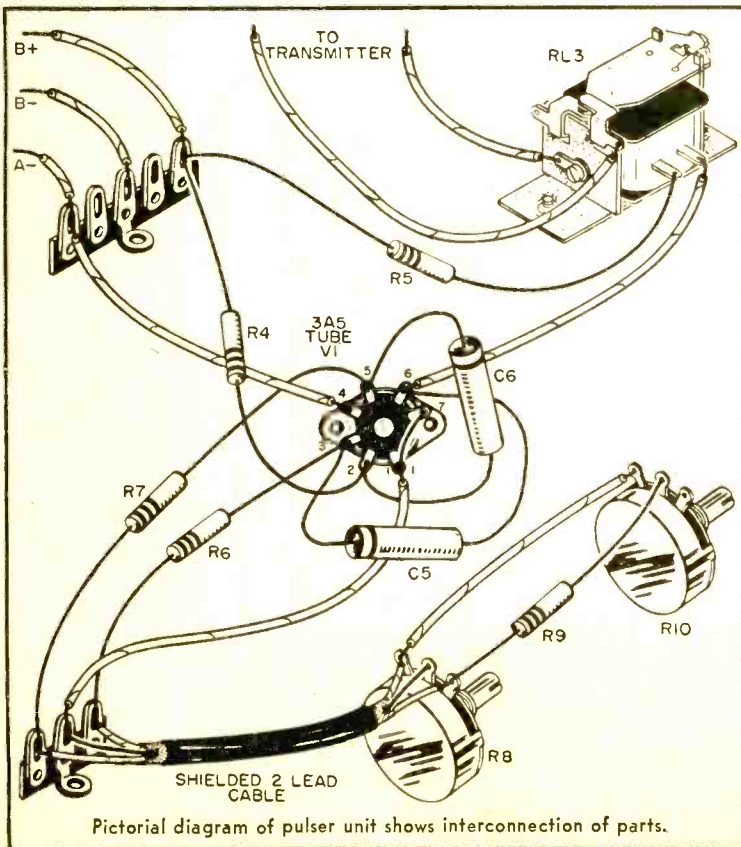

Pictorial diagram of pulser unit shows interconnection of parts.



# Oil Bath Increases Rectifier Rating

By  
**H. J. CARTER**

**D**ON'T DISCARD a burned-out selenium rectifier; it probably has some good plates that you can re-assemble into an inexpensive, high-current, low-voltage rectifier for battery charging, electroplating, or for supplying d.c. filament power.

Since filament rectifiers and battery chargers usually supply amperes, you may wonder how a radio-type rectifier rated in milliamperes could be used in these applications. The answer is simply to cool it! By immersing the rebuilt rectifier in a bath of light oil, you can safely increase its current rating to nine or ten times normal values.

**Choose a rectifier** suitable for rebuilding by first estimating the current required in your application. If you want to charge a 2-volt wet cell battery of the type used in portable radios, your rectifier should handle 1 ampere; if your application is trickle-charging a 6-volt automobile battery, the rectifier must handle about 3 amperes.

Divide the current estimated for your application by 10. The quotient is the rating (in amperes) of the rectifier you select for rebuilding. Of course, you can use any rectifier rated at a higher current if it is available. *Caution:* do not parallel two rebuilt rectifiers to increase the current-handling capacity.

Like most selenium rectifiers available to the experimenter, the Federal No. 1016 is

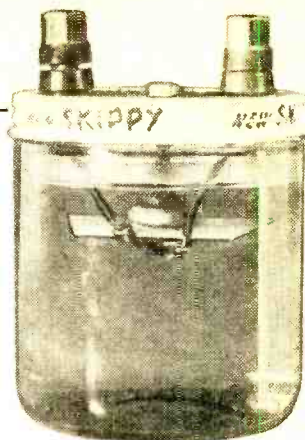

Rebuilt rectifier is mounted in a jar of cooling oil, with rectifier at least one inch below surface. Use a jar or can with a tight lid, and pierce a tiny hole in top so jar can breathe. Cooling the rectifier in any light oil will increase its normal current rating up to 9 or 10 times.

assembled with a brass eyelet. To disassemble the selenium stack, hold the rectifier against a solid surface and file off the end of the eyelet. Be careful not to injure the rectifier plates.

When the stack feels loose, carefully pull the plates apart. If any discs stick to the plates, apply a little paint remover before pulling them apart. Wipe off the paint remover with a damp rag. Do not try to force the plates apart with a knife or screwdriver. Save all the small parts except the

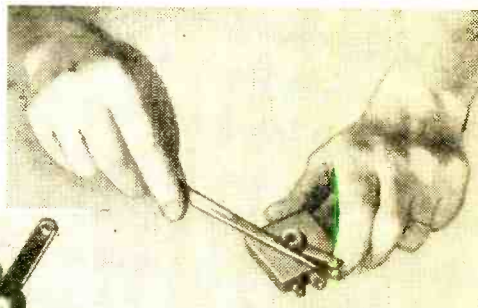

To disassemble the selenium stack of a burned-out rectifier, hold rectifier against solid surface and gently file off end of eyelet. When the stack feels loose, carefully pull the plates apart.

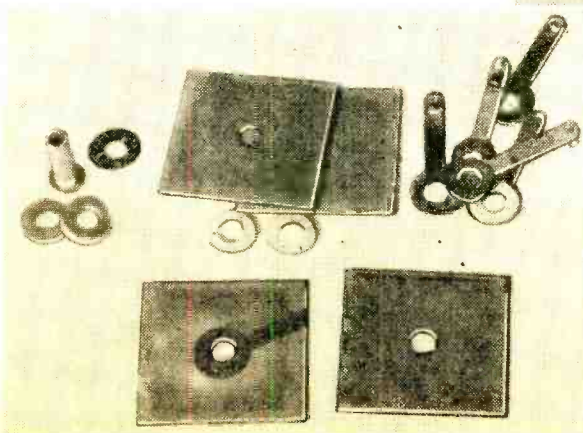

Parts from bridge stack are shown at left. In reassembling rectifier, be sure to choose a plate which shows no signs of damage or discoloration. Save all small parts except eyelet for re-use.

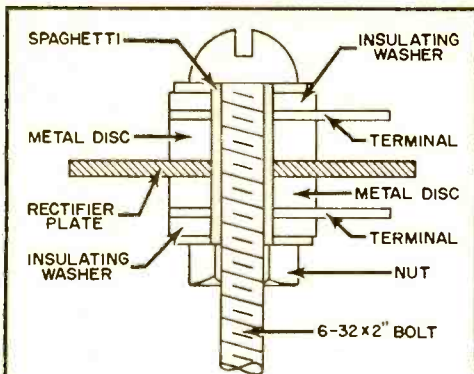

Fig. 1. Mechanical assembly of rectifier built around plate taken from burned-out unit. Center bolt should be at least 2" long, and plastic spaghetti is best for insulating plate from bolt. Washers are placed under screw head and nut.

eyelet so that you can use them again in the rebuilt rectifier.

Examine the plates for evidence of burning or shorting, and select a plate that has no dark spots or discoloration. Assemble the selected plate with the parts shown in Fig. 1, using a center bolt at least two inches long. Plastic spaghetti which slips over the bolt easily is preferred for insulating the plate from the bolt. Sandpaper the contacting surfaces of the metal discs and terminal lugs to remove any minute projections which might injure the selenium barrier layer. Wipe all contacting surfaces carefully to remove dust and grit before assembling the parts.

Tighten the assembly by holding the nut in a wrench and using a screwdriver. Do not tighten excessively, and do not clamp the plate in a vise while tightening.

The coolant oil may be held in any container with a capacity of at least eight fluid-ounces. Since oil can be messy if spilled, a jar or can with a tight lid is best. Pierce a tiny hole with an icpick so that the container can "breathe."

You can use almost any light oil, even cooking oils, but a mineral oil such as "Nujol" is preferred since it will not smoke or deteriorate at the temperatures encountered under full load (up to 180° F).

Test the rectifier polarity and mark the terminals before using it. A simple way to test the polarity is to connect the rectifier in series with a flashlight cell and a 2-volt lamp. If the lamp glows, the rectifier terminal connected to the positive battery terminal is the *anode*; if the lamp does not glow, it is the *cathode*. (The plus sign marked on selenium rectifiers denotes the cathode.)

Sample circuits are shown in Fig. 2. The battery-charging circuit requires a

transformer rated at approximately twice the battery voltage. If you use this circuit for charging a 2-volt wet cell battery, the transformer should be rated at 5 volts.

In the electroplating circuit, a primary resistor, *R1*, is used to vary the plating current. The transformer delivers current at a voltage sufficient to overcome the rectifier drop in most applications.

The filament supply is controlled by choosing the capacitance of *C1* to give the desired filament voltage when loaded. You should not operate this circuit unloaded since the voltage rating of *C1* would probably be exceeded.

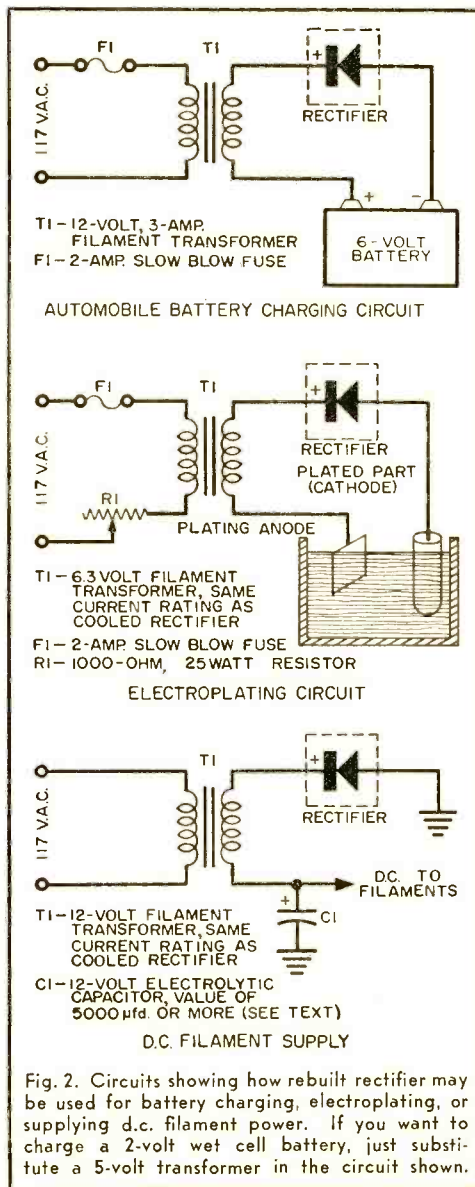

Fig. 2. Circuits showing how rebuilt rectifier may be used for battery charging, electroplating, or supplying d.c. filament power. If you want to charge a 2-volt wet cell battery, just substitute a 5-volt transformer in the circuit shown.



# Custom-Design Your Time Switches

By  
WM. B. RASMUSSEN

**There's no limit to what you can do with timing motor and cam-Microswitch combinations**

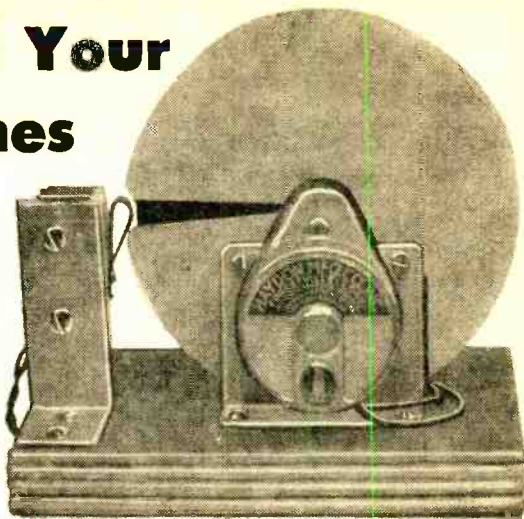

A FASCINATING ARRAY of timing mechanisms (or, if you please, *gadgets*) for controlling electrical circuits at predetermined intervals can easily be constructed from inexpensive timing motors and Microswitches. You can make controls which will automatically defrost the refrigerator, or turn yard and out-building lights on and off. Radios, ventilating fans, kitchen appliances and, in fact, anything electrical can be turned on or off at will by a timing motor and cam-Microswitch combination.

There is nothing very complicated about timing mechanisms. The mechanics and wiring are simple. An electrical circuit is turned "on" or "off" by the Microswitch, which is actuated by a cam, which is turned by the timing motor. The design of the cam determines how many switching operations take place during one revolution of the cam. Naturally, the speed of the timing motor determines the number of revolutions made by the cam during a given time interval. Of the timing motors currently available to the experimenter, two types are most practical: those operating at one revolution per minute and those operating at one revolution per day, both 117 volts a.c.

Microswitches, or snap-action switches, are so called because of the small amount of plunger travel needed to actuate the contacts. Switches with leaf actuators are most suitable for cam operation. Electrically, there are three basic types of Microswitches:

(A) Single-pole, single-throw, normally open (s.p.s.t., NO). Actuating the switch closes one circuit.

(B) Single-pole, single-throw, normally closed (s.p.s.t., NC). Actuating the switch opens one circuit.

(C) Single-pole, double-throw (s.p.d.t.).

This type has one input and two output terminals. In the normal or "at rest" position, one of the output terminals is "off." Actuating the switch reverses this condition. Thus, although only one circuit is controlled, the output can be switched into either of two channels as desired. Consequently, a s.p.d.t. switch can also be utilized as either "s.p.s.t., NO" or "s.p.s.t., NC."

Composition of the cams is a matter of personal preference. For convenience in fabricating, the material should be easy to work (aluminum, plastic, Masonite). Some provision should be made for turning the cam on the motor shaft to facilitate synchronization. This is most easily done by making the cam fit quite snugly on the

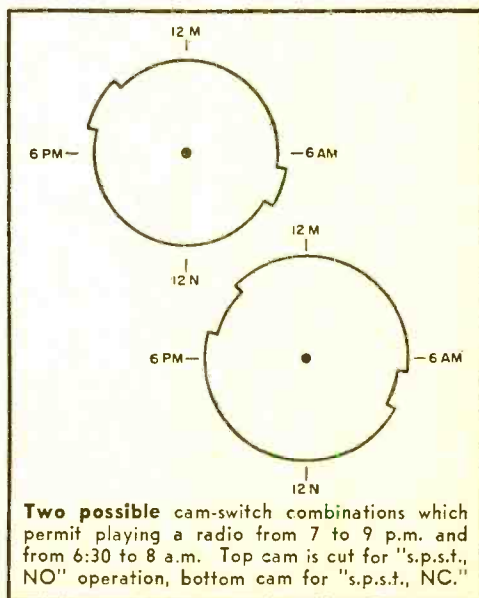

**Multiple cam** control with "s.p.s.t., NO" switch turns on a household ventilating fan for ten minutes every two hours. These cams consist of pointed machine screws threaded into a plastic disc; by turning them in or out, the duration of each interval can be shortened or lengthened as desired.

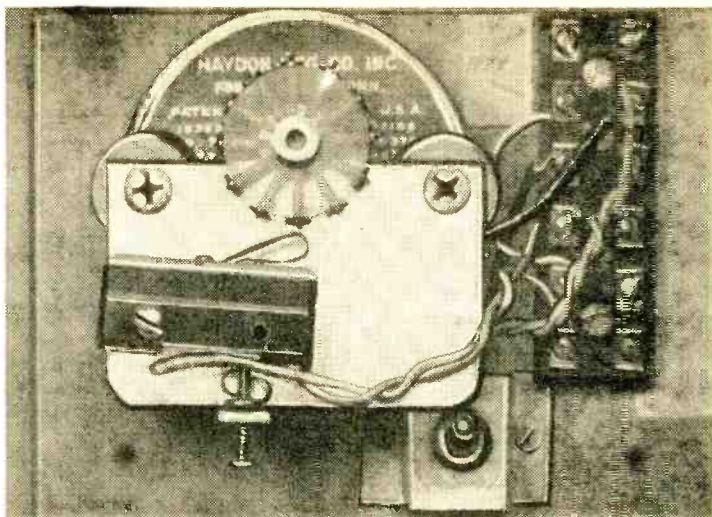

shaft. As the load offered by the Micro-switch is negligible, there is no danger of the cam slipping during operation.

**The simplest timing combination** is that of a single cam driven by a 1-rpd motor and switch. A "s.p.s.t., NO" switch has the most potential uses. On page 69 (top) is the application for defrosting a refrigerator. The black control segment of the cam represents a 30-minute interval ( $7\frac{1}{2}^\circ$  of the circle). During the time ( $23\frac{1}{2}$  hours) that the white area of the cam is in contact with the leaf actuator of the switch, the circuit is closed. When the black area reaches the actuator, the load is removed and the switch opens, turning off the refrigerator which then defrosts for half an hour. If a "s.p.s.t.,

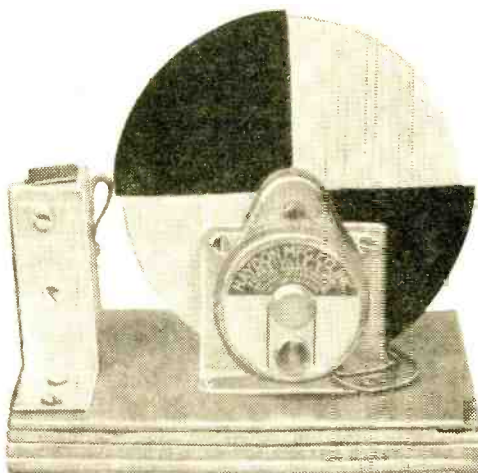

**"On" and "off"** interval is 15 seconds in this simple traffic signal system. When the s.p.d.t. switch is actuated, the lower light is illuminated, the North-South ports show red and the East-West ones green. During the following 15 seconds, after the switch returns to its normal position, the upper lamp is "on" and the colors are reversed.

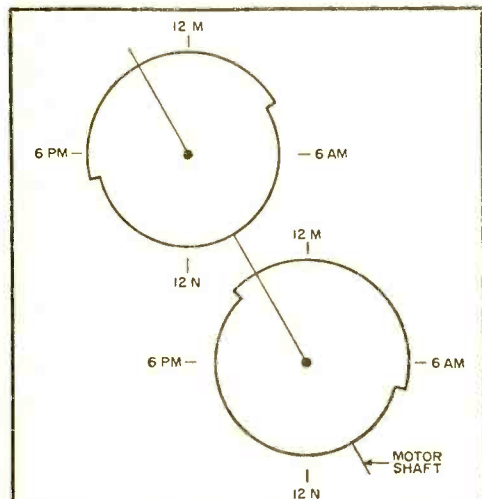

**Exploded view** of a variable cam set to turn on a yard light from 5 p.m. to 7 a.m. Variable cams, composed of two or more cams clamped together, permit control periods to be adjusted.

NC" switch were used for this same application, the black area would have to extend beyond the periphery of the disc instead of below. Then, when contacted by the cam, the switch would be actuated and the circuit opened.

Heart of these control systems is the cam. By using a protractor and keeping in mind that 1 hour equals  $15^\circ$ , accurate intervals of any desired duration can be laid out. The amount of material which has to be cut away from the periphery of the disc is really much less than the illustrations indicate. In the example above, controlling the "off"

*(Continued on page 121)*



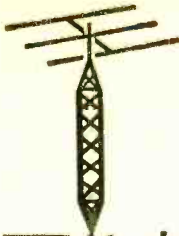

# THE TRANSMITTING TOWER

Herb S. Brier, W9EGQ

**N**EW AMATEURS, probably without exception, and most old-timers, too, do not believe that a first contact with another station is complete until QSL cards have been exchanged. QSL cards get their name from the international Q signal: QSL—"I acknowledge receipt of—." They confirm the fact that a successful two-way radio contact has actually taken place.

It is almost like making the contact over again when a QSL card arrives in the mail. This is especially true when a long-awaited card from a rare country or a new state arrives. Later, after time has dimmed the memory of the original contacts, browsing through a stack of old QSL cards enables you to recall interesting and amusing details which had been almost forgotten. In addition, there is probably not a single piece of equipment in a ham shack that interests a visitor as much as its collection of QSL cards.

**Sending QSL Cards.** Besides the personal satisfaction they bring, QSL cards are also required to obtain the various certificates for achievements, such as WAS

(Worked All States), WAC (Worked All Continents), and DXCC (DX Century Club—for working 100 different countries) issued by the American Radio Relay League, and similar certificates issued by other amateur organizations throughout the world. All of them have one requirement in common. Written proof of all claimed contacts must be presented before a certificate will be issued.

A good QSL card should contain the following information:

1. The call sign and location of the sending station
2. Name and address of the operator
3. Call sign of the station worked
4. Signal report—readability, strength, tone (quality on phone)
5. Date and time of the contact
6. Frequency band used
7. Mode of emission used (code, voice, etc.)

In addition to this indispensable information, most QSL cards also contain a brief description of the station equipment and a line or two for remarks about conditions, signals, and similar subjects. It is also ap-



Station call letters are prominently displayed on the typical batch of QSL cards shown above.

propriate to include information on the awards earned by your station or yourself, such as WAS, Code Proficiency Certificate, A-1 Operator, and the like.

A simple postal card or a letter containing the information listed above will serve the fundamental purpose of a QSL card. Nevertheless, most amateurs prefer something a bit fancier. The illustration on page 71 indicates some of the forms their fancies take.

Typically, a QSL card is the size of a standard postal card (3¼" x 5½"), with the station call letters prominently displayed across its face. The operator's name and



Gerhard Sam Plessinger, KN5DNQ, Lindale, Texas.

address are also usually on the face of the card in smaller type. Depending upon individual preference, the remaining information may appear on the face of the card, or it may appear upon the back.

In general, a card with all writing on the back looks a bit neater than one with writing on its face. On the other hand, when a QSL card is mounted in an album or on a wall for display, information written on the back cannot be seen. Also, cards printed on one side only are somewhat less expensive than cards printed on both sides.

Commercially printed QSL cards cost from about \$2.00 per hundred for a simple card printed in a single color on a fair grade of card stock to several times this amount for a fancy, multi-colored card on high-grade card stock. The number of cards ordered at a time also affects their cost; the cost per card goes down as larger quantities are ordered.

Sample cards can be obtained from QSL printers upon request. (See classified columns of *QST* or *CQ* for addresses.) Some of them charge a small fee for samples, but not all of them do.

Some amateurs prefer to make their own cards, either for economy's sake or to express their own ideas. Usually, the more attractive of these are the cards that stress

simplicity of design. Avoid odd sizes. They are hard to display and file along with standard-sized cards. Oversized ones get battered in the mails, and non-standard size cards cost a cent more to mail.

Suitable cards can be printed directly on stamped postal cards by cutting an appropriate stencil for use on a duplicating machine or by having a rubber stamp made to your design. Hams who are photographers can also make extremely attractive QSL cards.

**Getting Maximum Returns.** Many amateurs complain that they QSL 100% themselves, but they get only a small percentage of cards in return. To be honest about it, the only way to get 100% return from cards sent is to wait for the other fellow to QSL first. In fact, some amateurs have developed this idea to the point where they get ten cards for every one they send.

Two disadvantages of this idea are that it makes you look cheap and it reduces the number of cards you receive. There are quite a few members of the You-QSL-First club. It is better to resign yourself to the fact that you are not going to get an answer to every card you send. The average return is about 65%. However, by sending out your cards with careful attention to detail, you can improve this percentage quite a bit.

The important things are to make your card so valuable and attractive to the other fellow that he will want to answer it with one of his own. To do this, send your card as promptly as possible, so that the contact is still fresh in the recipient's memory, and fill it in accurately and completely.

Start by being sure that you write his call correctly. It does not help your case to write a "W" for a "K" or vice versa in a

#### Free Radio Course

The Queens Evening Trade School, 47th Ave. and 37th St., Long Island City 1, N. Y., will offer free courses in radio and television service this fall, according to Mr. Milton Wendroff, of the school's Radio-Television Department. Registration for all classes will be held at the school on September 10 and 11, from 7:00 to 9:00 p.m.

call or to put your own call letters in the space where the other call letters are supposed to go.

Always show on what band a contact was made and whether the contact was on phone or code. To you, this information may be of little importance, but to an operator who is striving for a special record,

(Continued on page 123)





By JOHN A. NORMAN

# What About TECH WRITING?

Photo Courtesy of Bell Telephone Laboratories

**TECH** writer true (electronic) expd  
Radar/electronics; EE or evng studt.  
\$80-120. Lawrence Agcy. 120 W 42.

---

**TECHNICAL WRITERS, SR & JR**  
Federal Electric Corp, Rte 17, Lodi, N.J

---

**TECHL EDITOR**  
Military handbks; must know military  
spcs, bk layout. Gotham Agcy, 55 W 42

**A**RE YOU QUALIFIED to fill any of these jobs? They are samples of recent openings in "technical writing"—a new, promising, and not too widely understood field.

Although much of industry leans heavily on tech writers, it is safe to say that the greatest number are employed in electronics. The first ad, for instance, and the "JR" part of the second ad call for men who have some electronic training but no definite experience in tech writing. The third ad, on the other hand, requires a man with perhaps limited electronic training but a fairly specific kind of tech manual background.

**What Is a Tech Writer?** In the broadest sense, the technical writer translates the work or products of a specialized group into language that can be understood by the non-specialized group. A man preparing an instruction folder telling housewives how to use a new electric mixer is doing a job of technical writing. Similarly, a team of men preparing volumes on the use and maintenance of a radar system is engaged in technical writing. An assistant to a top scientist, writing a report on recent experiments to be presented to a Board of Directors, or a POP'tronics reader sending in an item for the "Tips and

Techniques" department is, in effect, doing tech writing.

In each example, it is presumed that the writer possesses two important qualities. He must understand the subject he is writing about. And he must be able to express this understanding in the language, style, vocabulary, and diagrammatic symbols common to his field and which he knows will be grasped readily by his readers.

Often, this part of the job is quite knotty. A sonar engineer may talk to the tech writer about a sweep circuit—but how does the writer explain this to others who may never have heard of sweep circuits?

Similarly, a product engineer may explain to the writer the correct use of a wafer switch and a potentiometer with linear taper. But how does the tech writer translate these operating instructions to a lay consumer who thinks of a "wafer" as something you dip into a cup of tea, and to whom "linear taper" is a meaningless cryptogram?

Part of his work, then, involves a constant search for verbal expressions and graphic symbols that can be grasped by his readers and still provide enough correct instruction for them to do the right thing at the right time with the equipment in question.

What is a tech writer? Ask one in the business. He'll tell you he's a combination of many things, including analyzer of equipment and processes, student of human nature, teacher, and—of course—fast and prolific writer of clear, concise prose.

**Engineers as Writers.** Often the demands of a particular technical post require that a man—engaged primarily in

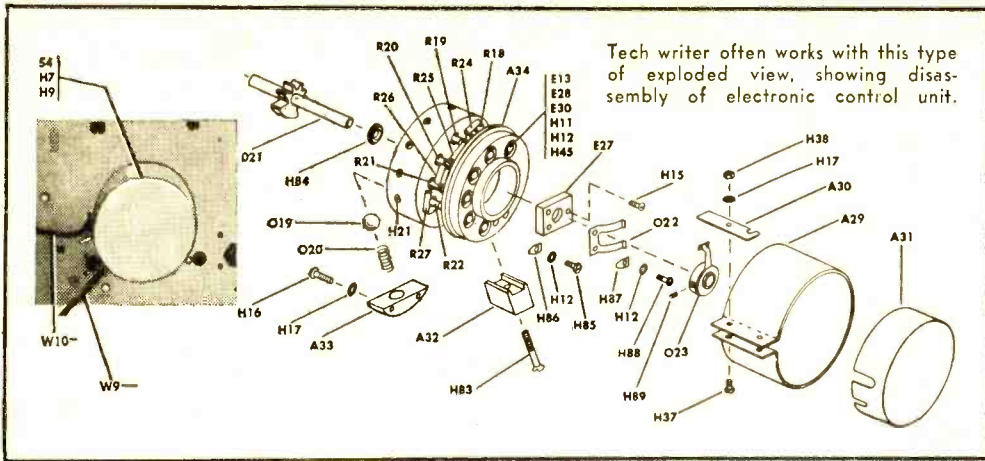

research or production—submit a report or other form of verbal communication regarding his work. A project engineer may have to explain how a new product works so that the advertising department can understand enough about it to write intelligent sales copy. Or a government agency—buying 5000 units—may require a handbook of instructions to accompany the product. In this case, a professional technical writer would probably be assigned to do the book, but his basic information would have to come from the project engineer.

Consequently, the engineer or scientist responsible for a product or new development becomes a primary source of information about it. Communication at this level is critical to the further development of the product, its manufacture, use, and eventual maintenance in the field. One wrong—or misunderstood—phrase at this

stage can produce a "snafu" at some point within the plant as well as for users of the equipment miles away and years later.

In many situations, the requirements of good, clear communication are so great that a professional writer may be hired whose chief task is to prevent misunderstandings between engineers and executives. Diagrams, specifications, and instructions to personnel must be prepared so that their meaning is unmistakable.

Whether or not the professional tech writer is used in such situations, most firms in recent years have demanded that the men they hire as engineers and technicians have at least the ability to express themselves clearly regarding their work. The need has become so great that universities have instituted special writing courses for students working toward science and engineering degrees. As Profes-

*(Continued on page 108)*

## ADMIN ASST TO CHIEF ENGR

\$8-10,000  
FEE REPAID IN 6 MONTHS  
SMALL PRODUCT LINES

This firmly established leader in the field of testing offers a fine opportunity for the man capable of absorbing the entire non-technical load of the chief engineer.

The successful applicant will be between 30-42. He will have at least 5 years of administrative background with not less than 3 years of supervisory experience.

A degree in engineering or business administration is preferred. Ability to organize projects, budgets and reports is a prime qualification.

Experience in office management, correspondence and liaison is desirable.

This ad is from a recent listing made by Suburban Employment, a New York agency specializing in electronics and engineering. Many would consider it a "dream job" in terms of salary and promise of interesting, stimulating work. It is a type of job not too far afield from the main area of interest of a technical writer.

Agency director David L. Golan indicates that the title of "Administrative Assistant" could readily apply to an experienced tech writer who has managed, in the course of his job experience, to pick up various related skills in administration and budgeting. In this particular case, Golan points out: "All the non-engineering load of the chief engineer would be established by one applicant hired. Evaluating reports, preparing technical summaries, and handling correspondence would comprise about 60% of the job load." And, adds Golan, there are "many higher priced opportunities in the technical field open to tech writers with appropriate additional background."

Naturally, jobs like this are not for beginners—but they represent the kind of openings that often develop for experienced men.



By  
FRANK H. TOOKER

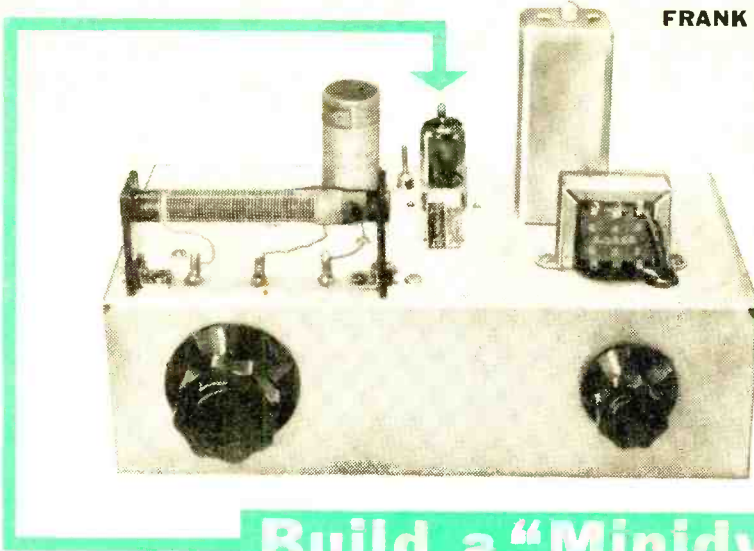

## Build a "Minidyne"

# The Miniature Superheterodyne

**S**INGLE-TUBE radio receivers are always in the novelty class. Still, with a careful selection of parts and attention to detail in the layout and construction, such a receiver can be made to perform amazingly well. The little one-tuber described in this article uses a type 6U8 combination pentode-triode tube, and takes advantage of the superheterodyne principle to obtain high gain, excellent selectivity, adequate sensitivity, and enough audio power to enable many stations to be heard through a loudspeaker.

Thanks to an unusual circuit, this little reflex receiver is perfectly stable without neutralization—and without the use of any device which seeks to obtain stability at the price of gain, selectivity, or sensitivity. The author has dubbed it the "Minidyne," because it is undoubtedly the *minimum* superheterodyne.

**Construction.** Tuning capacitor *C2-C3* is a two-section superhet type having a 365- $\mu$ fd. mixer section and a cut-plate oscillator section. A capacitor with the oscillator section at the back and the mixer section in front is preferred since this arrangement provides for the best layout and shortest leads.

If you have to use the more conventional-type tuning capacitor, a somewhat different layout of the parts will be in order, and longer leads may be necessary. In this case, use an arrangement which pro-

vides the shortest, most direct leads in the i.f. amplifier. Above all, avoid crossing "hot" grid and plate leads. If these leads are too long, or if they are laid out in close proximity to each other, uncontrollable instability is almost certain to result.

The transistor-type antenna coil, *L1*, can be seen in front-view photo above. As purchased, this coil is supplied with a waxed fiber mounting bracket. The author preferred a more substantial mount, so he removed the fiber bracket and replaced it with two Bakelite end plates secured to the chassis with small metal L-brackets. Insulated connections (from *L1*) through the chassis are made with solder lugs, 6-32 screws, and flat and extruded fiber washers. Capacitor *C1*, a small mica compression-type trimmer, is mounted below deck as close as possible to the appropriate feed-thru connection to *L1*.

Coil *L2* is a conventional Grayburne "Vari-Loopstick." The range of adjustment of its inductance is sufficient to en-

This receiver requires an external power supply capable of delivering about 250 volts d.c. and 6.3 volts a.c. The supply shown on page 74 of the July, 1956, issue would be satisfactory. Also, an r.f. signal generator with built-in 400-cycle modulation is required to align the receiver properly.

The Editors

able it to be used as an oscillator coil when it is connected across  $C3$ . It is mounted near the tube, so the connections can be made as short as possible.

Coil  $L4$  is the feedback winding. It is wound on the "Loopstick" right below  $L2$ , and consists of eight turns of No. 28 enameled wire. The turns are close-spaced and are wound on the form in the same direction as the turns of  $L2$ . When this method of winding is used, the lead of  $L4$  that is nearest  $L2$  is the one connected to bypass capacitor  $C4$  and one end of re-

sistor  $R2$ . Both  $C4$  and  $R2$  should be located as close to the feedback winding as possible.

The coupling between the oscillator and the mixer diode,  $CR1$ , is important. In any oscillator of this type, the cleanest waveform is always developed across the grid coil. Thus, in the "Minidyne," inductive coupling between  $L2$  and  $CR1$  is employed. The coupling coil,  $L3$ , is wound directly upon the sleeve which the manufacturer has cemented over  $L2$ . It consists of 15 turns of No. 28 enameled wire, close-

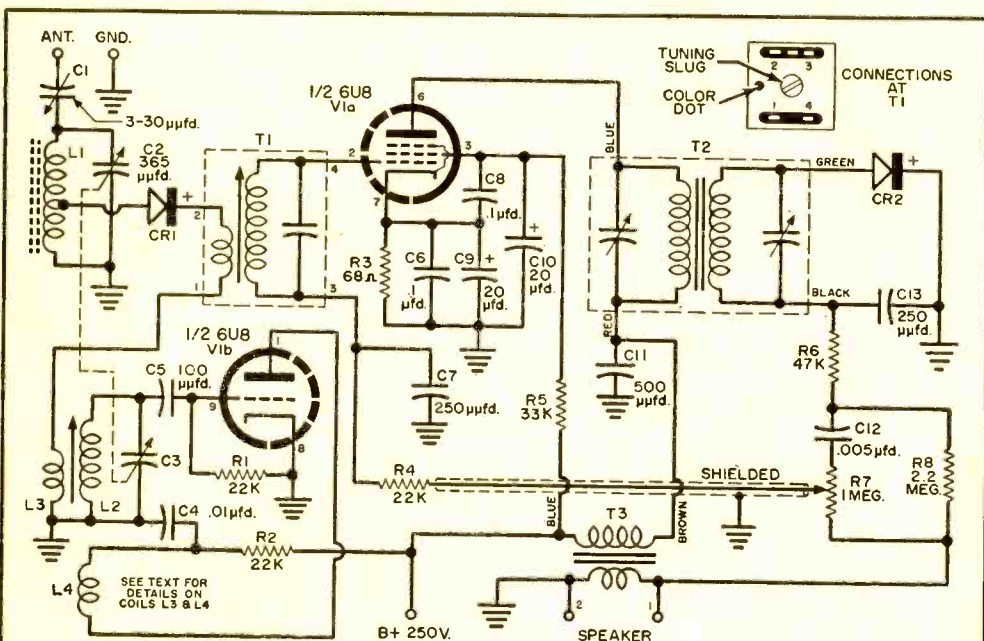

Schematic wiring diagram and parts list for the "Minidyne" one-tube reflex receiver.

- C1—3-30  $\mu$ fd. mica compression trimmer capacitor
- C2-C3—Dual superhet-type variable capacitor, 365- $\mu$ fd. mixer section, cut-plate oscillator section
- C4—0.01- $\mu$ fd. ceramic capacitor
- C5—100- $\mu$ fd. mica capacitor
- C6—0.1- $\mu$ fd., 200-volt paper bypass capacitor
- C7, C13—250- $\mu$ fd. mica capacitor
- C8—0.1- $\mu$ fd., 400-volt, 455-kc. series resonant capacitor (Sprague Type 72P52 or equal)
- C9, C10—20-20  $\mu$ d., 25/300 volt, dual electrolytic capacitor (Sprague Type TVL-2555 or equal)
- C11—500- $\mu$ fd. mica capacitor
- C12—0.005- $\mu$ fd. mica or ceramic capacitor
- CR1, CR2—Type 1N54A germanium crystal diode
- L1—Transistor loop antenna, fixed inductance, tunes 540-1650 kc. with 365- $\mu$ fd. variable capacitor, tapped to match 600-ohm input (similar to Latayette Radio MS-166)
- L2—Ferrite antenna coil (Grayburne "Vari-Loopstick" or equal)
- L3—Coupling coil, 15 turns No. 28 enameled wire (see text)
- L4—Feedback coil, 8 turns No. 28 enameled wire (see text)

- R1, R4—22,000-ohm, 1/2-watt composition resistor
- R2—22,000-ohm, 2-watt composition resistor
- R3—68-ohm, 1/2-watt composition resistor
- R5—33,000-ohm, 1-watt composition resistor
- R6—47,000-ohm, 1/2-watt composition resistor
- R7—1-megohm volume control potentiometer
- R8—2.2-megohm, 1/2-watt composition resistor
- T1—Transistor i.f. transformer with 600-ohm secondary used as primary (Miller Type 2041 or equal)—see text
- T2—Iron-core diode output i.f. transformer (Miller 612-C4 or equal)
- T3—Universal output transformer (Stancor A-3856 or equal)
- V1—Type 6U8 tube
- SPEAKER—Quam 52A21
- 1—10" x 5" x 3" chassis
- 1—9-pin miniature tube socket
- 4—2-terminal screw-type terminal strips
- 1—4-terminal screw-type terminal strip
- 1—Cabinet for speaker (ICA Type 3988 or equal)
- 2—Knobs
- Misc. hardware, shielded grid wire, grommets, solder lugs, extruded and flat fiber washers, etc.



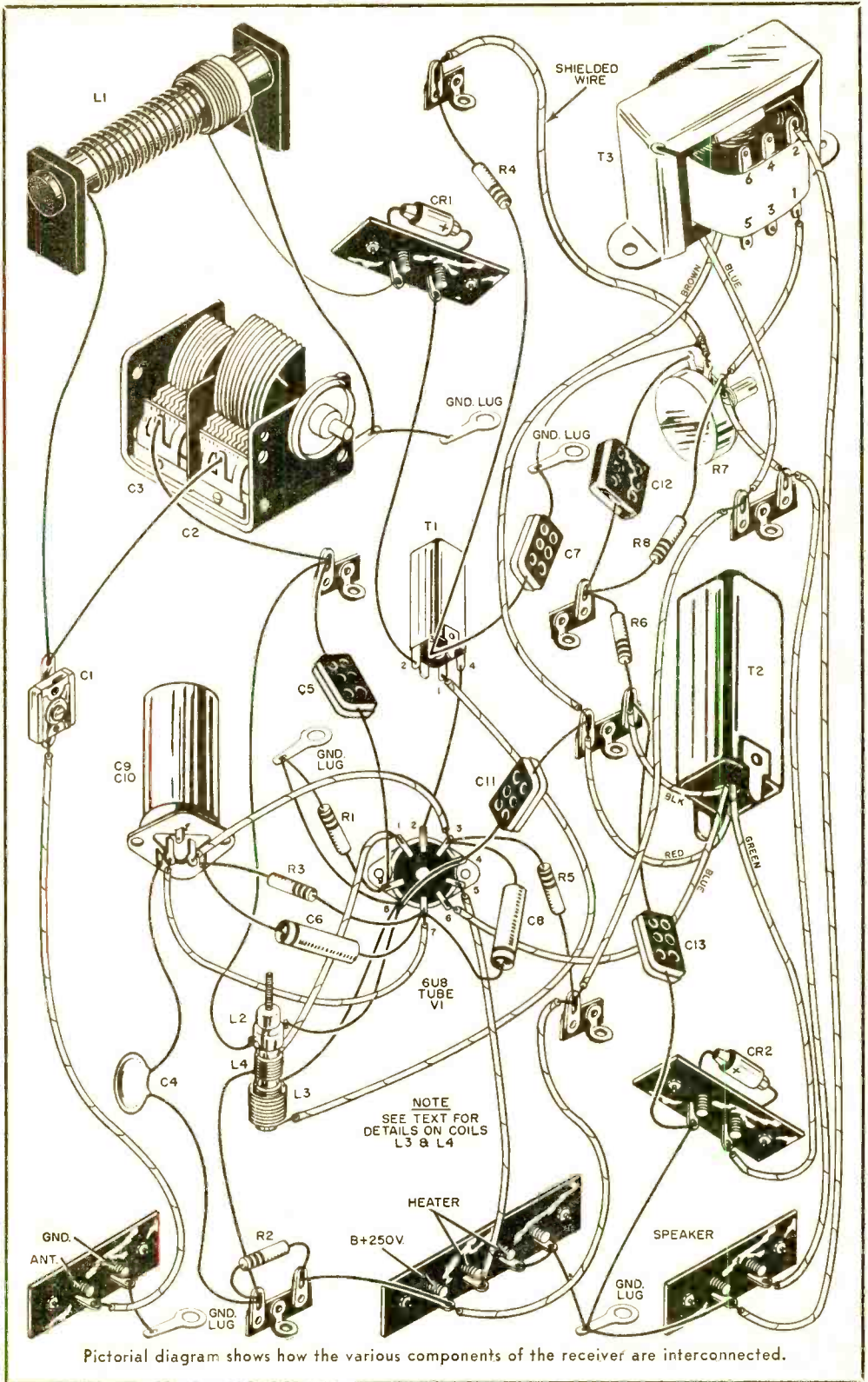

Pictorial diagram shows how the various components of the receiver are interconnected.

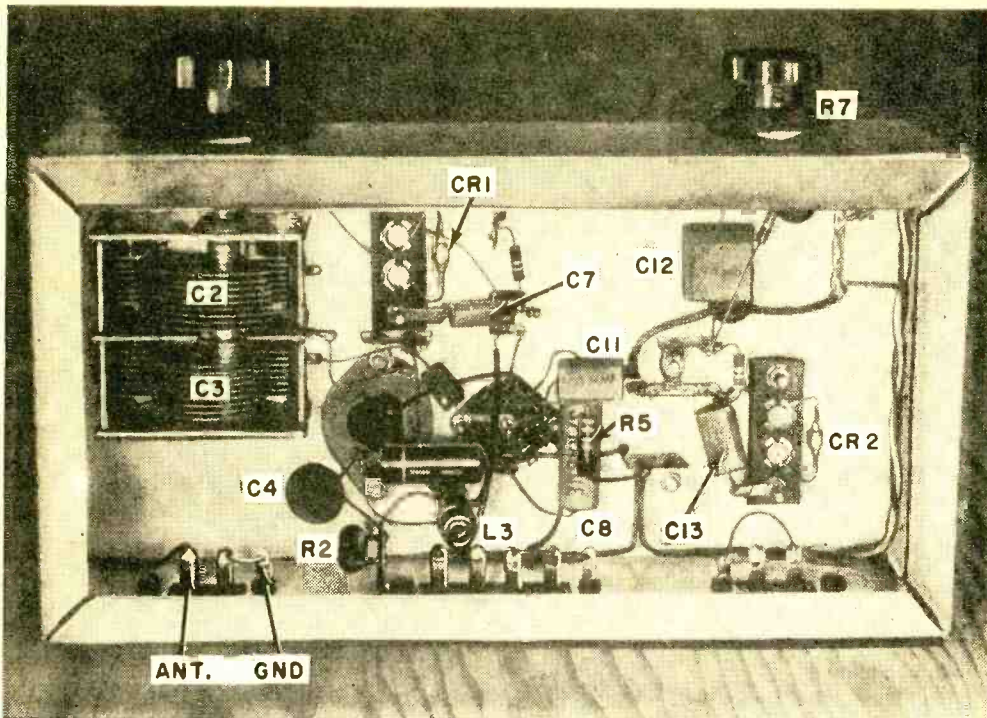

## HOW IT WORKS

All of the gain in the "Minidyne" is obtained in the pentode portion of the 6U8 (*V1a*) which operates in a reflex circuit to provide amplification at both intermediate radio and audio frequencies. The triode portion (*V1b*) is used as an r.f. oscillator. 1N54A germanium crystal diodes serve as mixer and second detector. The tuned mixer coil, *L1*, is a transistor "loop" antenna tapped at 600 ohms. The first i.f. transformer, *T1*, is a transistor i.f. transformer with the 600-ohm secondary winding used as the primary in this circuit.

The signal picked up by the antenna is delivered to the tuned circuit, *L1-C2*. A portion of the signal is taken off at the tap on *L1* and fed to the germanium crystal diode, *CR1*. At the same time, a steady r.f. signal having a frequency 455 kc. higher than the signal received in the antenna circuit is being generated in the tuned circuit composed of coil *L2* and variable capacitor *C3*. A portion of this signal is coupled through coil *L3* and fed to the primary of *T1*. The antenna signal and the local oscillator signal mix in *CR1* to produce the 455-kc. i.f. The secondary of *T1* is tuned to 455 kc. and steps up the voltage induced in it by the primary due to the resonant nature of the circuit.

Then, the i.f. signal is fed to the control grid of *V1a*, the 6U8 pentode. It is amplified by *V1a* as an r.f. voltage and applied to the primary of *T2*, a diode output transformer. This signal is detected by *CR2*. The resulting audio signal is developed across the diode load resistor, *R8*. Capacitor *C13* and resistor *R6* comprise an r.f. filter to help keep unwanted i.f. energy out of the audio circuit. Capacitor *C12* couples the audio signal to the volume control, *R7*, and—simultaneously—blocks out the d.c. component of detection, forcing it to flow to ground through *R8*.

The audio signal from volume control *R7* is fed through a second r.f. filter, *R4* and *C7*, and back through the secondary of *T1* to the control grid of *V1a*. After undergoing a.f. amplification in *V1a*, the audio signal passes through the primary of *T3* without effect and is impressed across the primary of *T3*, the audio output transformer. The secondary of *T3* feeds the loudspeaker. Capacitor *C11* shunts the i.f. signal to ground, thereby helping to keep this signal from entering the audio output transformer.

Many of the components of the "Minidyne" are identified in this under-chassis view.

wound, and is held in place by a small band of insulating tape.

Because of the many currents of many different frequencies which flow in close proximity in a receiver of this type, it is highly desirable that all exposed r.f. leads and all audio grid leads be kept as short as possible. Belden 8885 shielded grid lead is used between the volume control, *R7*, and the r.f. filter resistor, *R4*. Capacitor *C7* and resistor *R4* should be located as closely as possible to transformer *T1*. The same is true of *C13*, *R6* and *C11* in respect to *T2*.

Transformer *T3* is a universal audio output transformer designed to couple a single plate or push-pull plates to the voice coil of a speaker. The red center-tap lead will not be used. If a howl develops in the speaker when volume control *R7* is turned toward its minimum setting, reverse the primary connections to *T3*.

**Alignment.** When the "Minidyne" has been completely assembled and the wiring thoroughly rechecked, connect it to a speaker and a power supply. Temporarily short-circuit the plates of the oscillator tuning capacitor *C3*, and hook up an r.f. signal generator to the antenna and ground terminals of the receiver. Set the

(Continued on page 131)



# AFTER CLASS



## SUBATOMIC FOOTPRINTS

**A**T THIS VERY MOMENT—as you read this—you are being riddled by sub-microscopic bullets, sprayed and permeated by potential death rays, and assailed from every side by wild energies of which you are not even aware. Were it not for our sensitive scientific instruments, we should still be unconcernedly going through life, blithely unconscious of the invisible “energy-world” around us.

Cosmic rays, radio waves, high-energy electrons, and a host of other energy packages buzz into us and through us as if we didn't exist. Our radios, television, and radar receivers tell us about the variety of waves that surround us, but what of the dozen or so subatomic particles which do not advertise themselves quite as loudly?

The existence of these tiny elemental bits of matter had been suspected for many years before the first “viewing” device was even conceived. As a matter of fact, they announced their presence to Henri Becquerel in 1896 by leaving their “footprints” behind them as they flashed through the emulsion of a piece of photographic film inadvertently left in a drawer

near some uranium. Becquerel simply remarked in his notes that radioactive emanations from the uranium had fogged the film, not realizing that he had “invented” the first subatomic particle detector.

**Vapor Trails.** Although we cannot see these particles, we can at least see where they have been. One of the methods used to study them involves special photographic emulsions; another is the cloud chamber, invented by the English physicist C. T. R. Wilson in 1911.

In the cloud chamber, the space within a hollow chamber is super-saturated with water vapor. Electrically charged particles have the ability to serve as condensation nuclei, i.e., they encourage water vapor in their immediate vicinity to change to liquid water droplets. So—as a subatomic particle of the charged variety strays into the chamber, it causes condensation of vapor all along its path—leaving a trail behind it much like the vapor trails that appear behind a speeding jet plane. The trail is substantially thicker than the particle itself; hence it becomes visible and may be studied.

There are two basic types of cloud chambers. The Wilson cloud chamber is an expansion type in which saturated water vapor is brought to the super-saturated state by a sudden expansion of the volume of

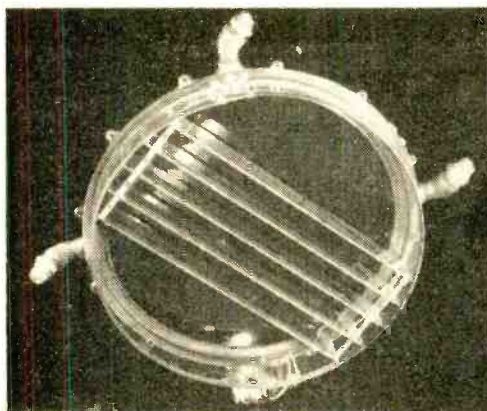

**Modern research** expansion-type cloud chamber (above), known as the “Pantograph,” has 22” diameter and is 3½” high.

**World's largest** cloud chamber (right), originally designed for study of cosmic ray air showers, is now in use at the “Bevatron” at U. C. Radiation Laboratory.

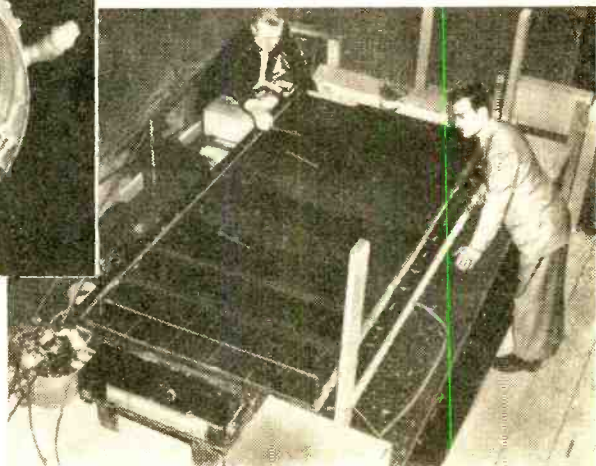

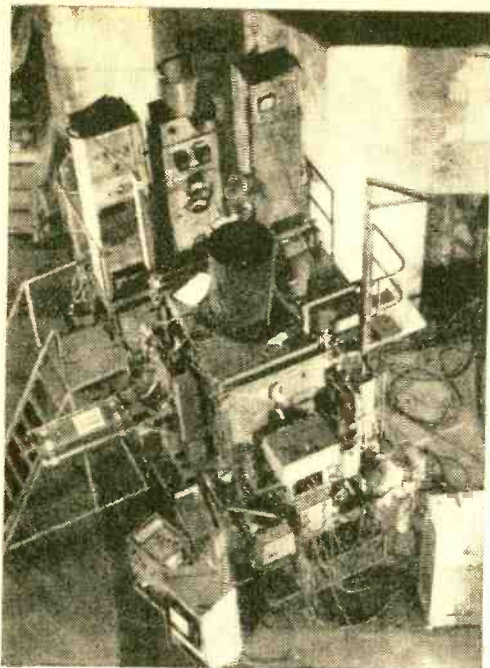

**Experimental setup** for use with cloud chamber. In the background, you can see the concrete shielding of the 184" cyclotron at the U. C. Radiation Laboratory.

almost all the tracks seen will be caused by those mysterious vagrants from outer space, the cosmic rays. Although cosmic rays in themselves are incapable of leaving tracks, their energy is so high, particularly in the upper atmosphere, that they smash into and disrupt atoms of any elements that happen to be present, releasing a shower of all kinds of charged (and uncharged) particles.

These particles include the now familiar electrons, protons, and neutrons as well as numerous other recently discovered atomic debris—such as nine different kinds of mesons, positrons, antiprotons, lambda particles, sigma particles, and cascade particles. Most of them, with the notable exception of the neutron, two types of mesons, and the neutrino, leave characteristic vapor trails which make it possible to identify the causative agents. For instance, electrons make much fainter and thinner tracks than the heavier positive bodies.

An alpha particle is a helium atom which has been stripped of its orbital electrons so that only the nucleus remains; the nucleus contains two protons and two neutrons, is quite massive, and is heavily ionizing. Alpha particles radiate from the gas radon which is always present in the air in small quantities. At first an alpha track is sharply defined, but then suddenly billows out as if it were exploding into a puff of smoke.

the chamber. The subatomic footprints which form in this instrument are very fleeting, lasting for about 1/30 second. Later, in 1939, Langsdorf at the University of California invented a cloud chamber in which the conditions required for track formation are maintained continuously; after many years of research, the Langsdorf chamber was perfected to the point where it could be used as a research instrument.

**Cosmic Rays.** When no source of radiation is placed in or near the cloud chamber,

**The signature of a high-energy electron as it travels through the cloud chamber under the influence of a magnetic field.**

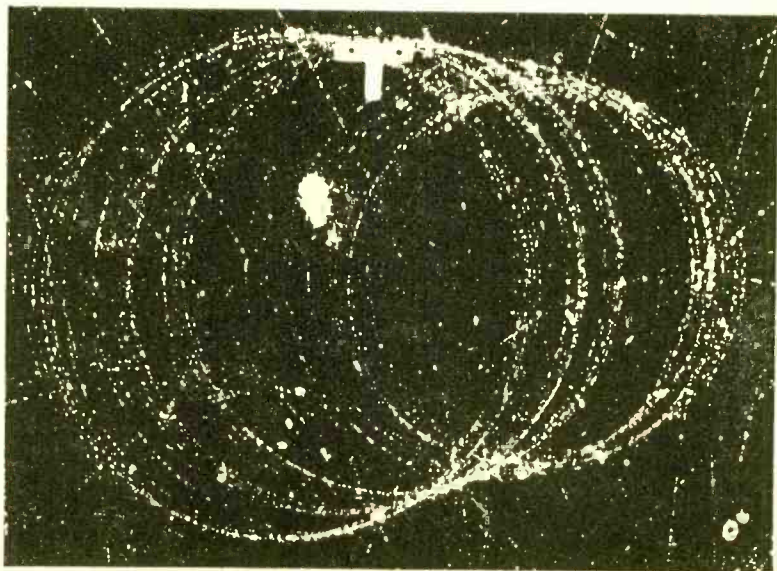

*All Photos Courtesy of University of California Radiation Laboratory*



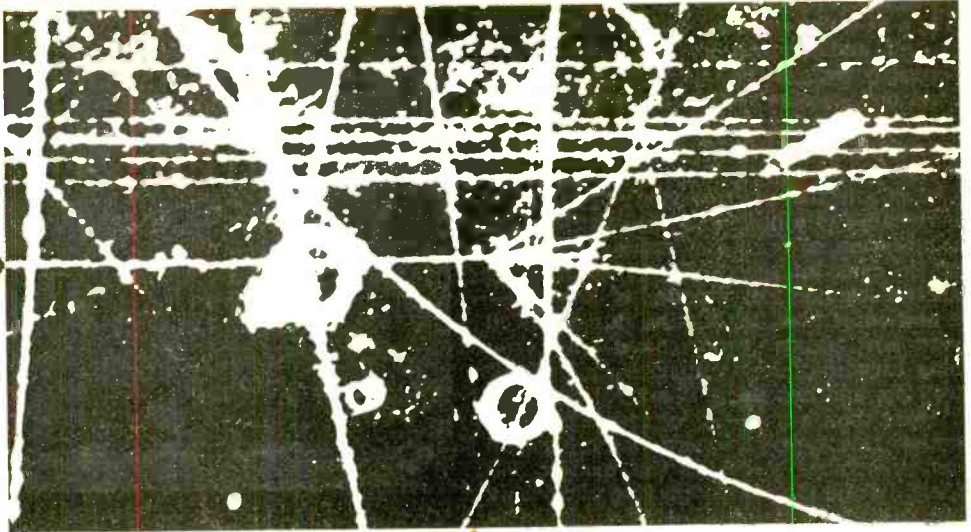

**A five-billion-volt meson** from the world-famous Bevatron is shown above striking a hydrogen atom in a diffusion cloud chamber, thus producing six charged particles. This is an outstanding example of the phenomenon known as multiple meson production. (The meson enters the picture from the left, as indicated by the arrow, and the collision occurs at the photo's exact center.)

Neutrons and other neutral particles do not leave their signatures behind them because they have no electric charge and cannot act as nuclei for condensation. There is, however, ample evidence of their very real existence. Neutrons smash into atoms and liberate other charged particles that can be identified in the cloud chamber; for instance, a fast neutron charging through the vapor may collide head-on with a hydrogen atom, tear away the latter's lone electron, and cause the proton in the hydrogen nucleus to make a track that tells the story of the atomic catastrophe.

**Cloud Chambers.** Of all the scientific devices used for research in the first half of the 20th century, the cloud chamber is probably responsible for the making of more Nobel prize winners in physics than any other.

C. T. R. Wilson was awarded the Nobel prize in 1927 for the invention of the chamber itself and some of the discoveries he made with it. The positron—a particle which is the counterpart of the familiar negative electron in all respects except for the fact that it carries a positive charge—was discovered by the American, C. D. Anderson, during an investigation of cosmic rays by the use of a cloud chamber.

It was also in a cloud chamber that the elusive dream of the ancient alchemists was first observed actually occurring: transmutation of one element into another. P. M. S. Blackett, Nobel prize winner in 1948, filled a cloud chamber with nitrogen

and bombarded this gas with high-energy alpha particles. The alpha particles smashed into nitrogen nuclei, set up a complex series of nuclear changes from which a proton and an oxygen atom then emerged; thus, nitrogen was transmuted to oxygen.

As recently as September, 1953, a new discovery of the first rank was made with a cloud chamber. At Brookhaven National Laboratory, research workers bombarded hydrogen gas in a cloud chamber with very high energy pi mesons coming from the now-famous Cosmotron accelerator. They observed the first artificially produced V-particles. Naturally occurring V-particles from cosmic rays had been studied previously with the aid of cloud chambers.

The life history of a cosmic particle from space that generates its track in a cloud chamber and then comes to rest is something to capture the imagination. It may be the nucleus of a helium, iron, or nickel atom torn from its electrons millions of years ago in the very heart of an immense star thousands of times more massive than our own sun. Blown out of the star by the unimaginable energy of billions of exploding atoms . . . accelerated through the vastness of interstellar space by ever-present magnetic and electric fields . . . escaping collision with cosmic dust for millions of years . . . it finally stumbles into our atmosphere and—in a single split second—loses all the energy stored in it since birth!

**R**ECORDS that "show off" or "show up" a hi-fi system have become best sellers among audiophiles. At least one record company reports that its "test and demonstration" release far outsells any other single disc, including all the topnotch performances of some of the world's greatest music.

Visit a hi-fi'er at home and you're apt to be treated to a broadside of drum thumps, a pulsation of frequency tones, a barrage of tin cans interspersed with the roar of ancient cannon, or—wonder of wonders—a session of absolute silence, during which your host stands proudly besides his spinning turntable, with volume turned all the way up, and breathes: "See? No rumble!"

More than a curiosity or mere sonic exercise, this type of record has a rightful and inevitable place on the modern LP shelf. While a constant playing of nothing but such discs may gain you complete isolation from the rest of the world, it is safe to say that no record collection is complete without at least two such records: one, the kind that tests the performance of a hi-fi system for response, distortion, tracking, etc., and the other, the kind that shows off a hi-fi system to best advantage, celebrating the pure joy of the sonic miracles achieved in recent years by recording engineers.

Often, there is no sharp difference between the two types of discs. A record that has a frequency tone run of, say, 40 to 15,000 cps, is not only a test of your system's response but—if your rig does reproduce the entire range—it becomes a means of showing off the system. Such a record is both a "show-off" and a "show-up" type. Pickups, amplifiers, and speakers which clear the sonic hurdles incorporated on such records can rightfully be called "hi-fi."

Similarly, records which are largely musical in content may be regarded as mainly the "show-off" kind . . . yet, if you know in advance what to listen for (it is usually stated in the printed literature accompanying the record), you are in a position to judge the kind of sound your system is—or should be—putting out.

**"Testing . . . 1, 2, 3, 4 . . ."** Hi-fi recording has given us more than lifelike sound. Thanks to the ingenuity of recording engineers, discs are available that provide home tests of phono systems previously considered possible only in the laboratory. Designed strictly for checking how well your hi-fi system is doing its job, this type of record has no program material—but what is recorded onto the grooves is something that should excite all audiophiles.

One such pressing, Dubbings' *The Meas-*

## Do You Really Have Hi-Fi?

**Hi-fi specialty records test  
a sound system, demonstrate  
its quality . . . first of series**

*ure of Your Phonograph's Performance* (D-100), tests—without the need for meters—stylus pressure, frequency response, crossover points of multiple speaker systems, turntable rumble, wow and flutter, and the tracking and compliance of your pickup. Using this record is simplicity itself. You simply follow the instructions on the record jacket.

Some of the tests are marvels of economy and cleverness. The tracking test, for instance, is a 400-cycle tone repeated with increasing intensity level. The fourth run of this frequency is intended literally to kick the stylus up over the record grooves—and this it will do, except to the most advanced professional equipment.

Beyond these performance characteristics, the record fancier is often concerned about proper equalization. To assist hi-fi'ers in this area, Dubbings issued its D-101, *The Measure of Your Phonograph's Equalization*. It contains four frequency tone runs, each from 30 cps to 12,000 cps, and is cut according to the AES, NARTB, LP, and new ORTHO (RIAA) curves.

This pressing has a two-fold use: first, it enables you to check the accuracy of your equalizing circuit and switch controls; second, you can use the disc to obtain approximate equalization settings (if you have no equalizer) by correct adjustment of bass and treble controls.

D-101 is best used with an a.c. voltmeter hooked across the speaker terminals. A



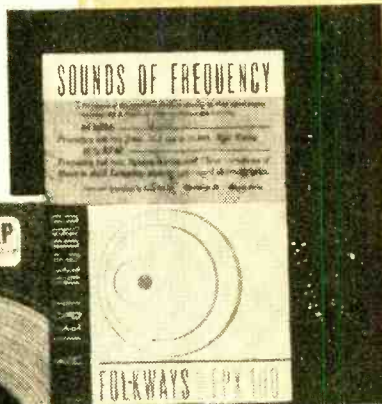
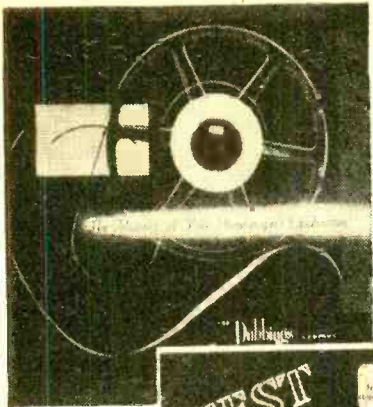

By **NORMAN EISENBERG**  
Feature Editor

typical reading, at the standard reference frequency of 1000 cycles, might be 0.4 volt. Without equalization, readings at frequencies above and below 1000 cycles will vary considerably. The idea is to adjust treble control (for tones above 1000 cps) and the bass control (for tones below 1000 cps) so that all a.c. voltage readings are as close to the 1000-cps reading as possible.

The tones are heard long enough to permit adjustment while you watch the a.c. voltmeter needle swing back and forth until you get it just where you want it—in this case, as near as possible to the original 0.4 reading. When you have finished taking readings for the tones in one curve, you can mark the approximate roll-off and turnover settings on your treble and bass controls respectively—and this will be an approximate equalization for records cut to that curve.

Anticipating that many record collectors will not be inclined to fuss with an a.c. voltmeter, Dubbings has developed a simple and cheap substitute for this application. Known as the *Test Level Indicator* (D-500), this gadget consists of three low-voltage bulbs sitting in a neat plastic box. The bulbs are so arranged as to light up at 3-decibel intervals when connected across the leads to the loudspeaker. The right-hand bulb indicates a 3-db rise; the left-hand bulb a 3-db cut.

In using the D-500, you adjust your amplifier controls for the correct amount of

glow in two out of three bulbs. When operated in accordance with the manufacturer's instructions, the D-500 can provide results fairly close to those obtained with an a.c. voltmeter.

**Beams and 'Scope Traces.** Also providing the nontechnical audiophile with something easy to do is the "N-A Beam" test for intermodulation distortion, recorded by Emery Cook as his *Series 50*. The theory behind this record is involved, but what it comes to for the listener is simply this: if you hear a "dot-dash" (coded "A"), your system is all right; if you hear a "dash-dot" (coded "N"), it isn't.

Wider ground is covered by Cook's *Series 10* test records. There are two versions of this pressing, one recorded at 33½ rpm for "greatest convenience," and the other at 78 rpm for "highest accuracy." The 78-rpm pressing is intended for playback using a microgroove stylus. The advantage claimed for the combination of 78-rpm speed and .001 groove is greater fidelity in the very high frequency regions. Both of these discs permit frequency and distortion measurements, determination of arm resonance, tracking error, etc. The *Series 10* is best used with at least an a.c. voltmeter and preferably additional measuring equipment such as a distortion analyzer. In this respect, it is more of a professional's test record, although the advanced home hi-fi'er can use it to advantage.

Somewhat similar to the Cook test releases is Folkway's *Sounds of Frequency* (FPX-100). Made by Peter Bartok, son of the late composer, Bela Bartok, this disc is intended for use with an oscilloscope

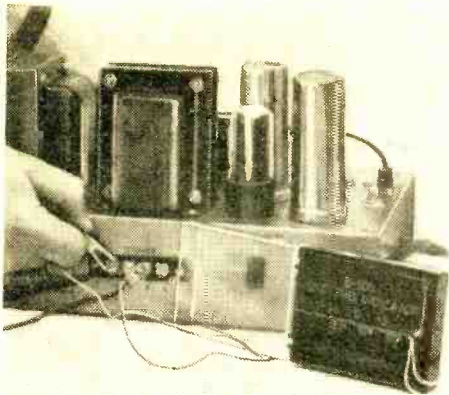

**Substitute** for a.c. voltmeter in signal voltage measurements is Dubbings "Test Level Indicator." Two leads connect across speaker output terminals on amplifier. Device is intended for use with Dubbings test record. Relative intensities of glow in bulbs are interpreted as signal measurements.

and volume indicator. Its range is somewhat awesome, containing tones from 15.6 cycles up to 22.5 kc. Included are square waves (ever hear one?), demonstrations of high-frequency loss and increased distortion on the inner grooves of a record, equalization characteristics, and a few other test runs of impressive quality.

Accompanying the latter release is a booklet containing an excellent series of photos of oscilloscope traces, showing how certain bands should look, regardless of how they sound. The philosophy behind this is, apparently, that although you may not hear a frequency of 22,000 cycles you might want to see what it looks like.

**The Sound and the Fury.** Back in the 1920's, there was a ferment in the art world which involved experimenting with lines, color, form, etc. The general idea was not to paint pictures that looked like anything or anybody, but rather to gen-

erate "interesting design patterns." If nobody knew what you were talking about when your canvas was finished, who cared? Scornful of such work, the more literal-minded members of the public and the critical press labeled this movement "art for art's sake."

Today, in the field of sound reproduction, we are going through pretty much the same kind of thing. It could be called the "sound for sound's sake" movement. A succession of earthquake rumbles, train whistles, clucking hens, buzzing flies, and shrieks from outer space has been recorded and launched with an intensity and ferocity and fidelity like nothing since the invention of the phonograph. The records containing these sounds are strictly non-musical—in fact, they're anti-musical—but there they are, and look at 'em sell!

Chief exponent of the trend toward tonal terror is, of course, Mr. Emory Cook, head of the recording laboratories in Stamford, Conn., which bear his name and which produce the test records discussed above. Something of a maverick, something of a leg-puller, and something of a genius, Mr. Cook has managed—in these records—to combine the sound enthusiast's interest in audiology with the thrill-seeker's bent for the unusual, the different, the outlandish.

Releases of this sort are not to be taken too literally as "test" records; often they

*(Continued on page 106)*

**All manner** of sound is recorded by Emory Cook, shown here "on location," as he tapes special outdoor sequence. Recording is later transferred to master disc for record manufacture. In addition to unusual sounds, Cook has recorded a series of excellent audio test records. Startling realism and high technical standards characterize his work, which has taken him to many far-off places, including—by means of sensitive microphones—the reaches of outer space. (Photo by Walter Bursten).





## D.C.-Operated Fire Alarm

**T**HIS FIRE ALARM is really an assembly job built around a simple sheet steel frame about  $\frac{1}{32}$ " thick and bent on a garage vise to a U-shape. The dimensions of the U-form rigidly hold an automobile thermostat measuring  $1\frac{1}{2}$ " in diameter and  $1\frac{1}{4}$ " thick (at 75° F ambient temperature).

The thermostat is inserted in the open end of the U after the Microswitch has been temporarily fastened in position. Clearance between the thermostat and the Microswitch is then adjusted so that the Microswitch is electrically "open" at 75° and definitely "closed" at 150°.

These adjustments are made by completing the wiring from the switch (using flexible wires) through alarm bell to a 6-volt battery, and then placing the unit in the kitchen oven. The oven is heated to 150° and the pressure adjusted between the Microswitch and the thermostat until the contacts close. The Microswitch will probably require a movement of  $\frac{1}{16}$ " before it closes the circuit, so a direct contact with the thermostat—not a clearance—is the proper setting.

Since I mounted the unit in an attic which can reach a temperature of 120° on

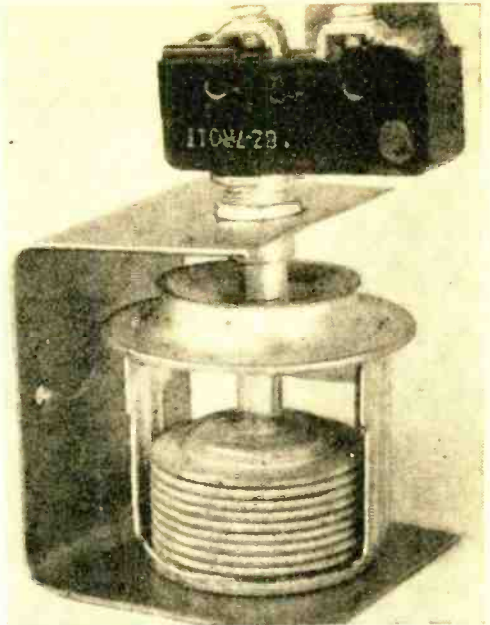

a hot day, the alarm was adjusted to operate at 150°. This setting has proven to be safe from false alarms and yet has been found to be dependable in case of excessive heat.  
—I. C. Chapel

## Relaxation Oscillator Makes Perpetual Flasher

**H**ERE IS SOMETHING you can build in a few minutes and that will catch the attention of everyone who sees it. Call it a "Perpetual Flasher." Although its source of power may be an old 90-volt battery, this small blinking light will keep on flashing for years.

Note that the circuit has only three parts and a battery. The principle of operation is very simple. The capacitor charges through the 10-megohm resistor. When it is sufficiently charged, the neon bulb "lights up," effectively shorting the capacitor and simultaneously extinguish-

ing the bulb. The waveform of the voltage across the capacitor is shown at the bottom of the schematic.

The flashing rate is a function of the

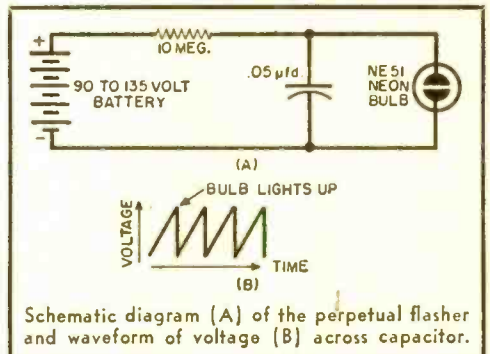

values of  $R$  and  $C$ . Decreasing either will increase the frequency (flashing rate), and increasing either will decrease the frequency. The frequency is also a function of voltage. An old 90-volt battery or two old  $67\frac{1}{2}$ -volt batteries in series will operate the "Perpetual Flasher." Since the power dissipation is a small decimal part of a watt, the device will generally operate throughout the shelf life of the battery.  
—Forrest H. Frantz, Sr.



# Transistor Topics

By LOU GARNER

AS THE EXPRESSION GOES, Summer has just about "had it." Sure, there'll be a few more warm—or even hot—days, but the nip of Fall will soon be in the air . . . and experimenters all over the world will start cleaning and tinning their soldering irons, checking their stock of components, ordering new parts, and lining up their pet projects. Summer usually brings a falling off of interest in indoor hobbies—in business, it's called the "Summer Slump." But in the autumn there is a general reawakening of interest—and hobbyists attack their projects with renewed vigor . . . rested after a summer of play and sparked by the cool autumn breezes.

Have you thought about a name for transistor experimenters? I'm still trying to find a good "handle" for them . . . something to compare with *ham* for amateur radio operators and *audiophile* for hi-fi enthusiasts.

**Reader's Circuit.** Regenerative receiver circuits continue to be popular with home builders and experimenters, so we're featuring another this month, suggested by Vincent E. Henley, Jr., of 806 Atlantic St., S.E., Washington 20, D.C. His circuit features two transistors, a diode, and operation on a 3-volt battery.

Referring to the schematic diagram below, *L1* is a broadcast-band "Vari-Loop-stick," *L2* consists of 16 turns of litz wire wound on top of *L1* (after removing the

cardboard cover), and *C1* is a miniature 365- $\mu$ fd. or 420- $\mu$ fd. variable capacitor. The s.p.s.t. "on-off" switch, *S1*, may be mounted on the regeneration control *R1*, or a separate slide or toggle switch used, as preferred by the individual builder. The 3-volt battery may be made up by connecting two penlite cells in series. Moderate-impedance (2000-ohm) magnetic head-



You'll find details on the new "Mascot" pocket radio, manufactured by Televex, Inc., on page 120.

phones are used. Transistors *TR1* and *TR2* are Raytheon's popular CK722.

Vincent indicates he obtains good reception with a 26" length of hookup wire as an external antenna (ANT.), and *without* using an external ground. His model is assembled in a small plastic box.

In operation, the first stage (*TR1*) serves as a regenerative detector, with the 1N64 diode assisting in the detection action. The feedback necessary to regeneration is obtained through coil *L2*, inductively coupled to the main tuning coil *L1*. The audio output signal is coupled through capacitor *C3* to the second stage, *TR2*, which serves as a simple audio amplifier. The *grounded-emitter* circuit configuration is used in both stages.

To use the receiver, advance the regeneration control (*R1*) until a hiss or similar sound is heard in the headphones. Adjust *C1* to tune in the desired station, readjusting *R1* if necessary for best reception. If no hiss—or other indication of regeneration

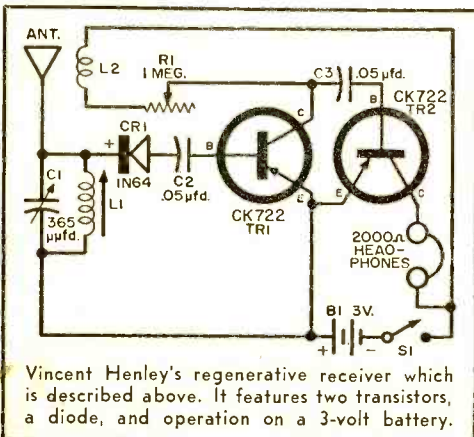

Vincent Henley's regenerative receiver which is described above. It features two transistors, a diode, and operation on a 3-volt battery.



—can be obtained, reverse the connections to *L2*.

A few tips, Vincent . . . you may find that replacing *TR1* with Raytheon's new r.f. transistor, Type CK768, will improve gain. And, in some cases, the gain of the second stage will be improved by applying a small bias . . . you can do this by connecting a small resistor from its *base* electrode to the negative side of the battery. Determine the best value experimentally . . . it will probably fall between 220,000 ohms and 1 megohm. A ½-watt resistor is okay.

**Tickler File.** As mentioned last month, we're devoting some space to "tickling" your memories about new items mentioned in previous columns. Here goes:

(1) G.E.'s new 2N170 is an *n-p-n* transistor with a 4-mc. cutoff frequency.

(2) Your columnist's new *Transistor Circuit Handbook* . . . with nearly 200 practical circuits . . . is available from your regular distributor.

(3) Raytheon's CK768, a *p-n-p* r.f. transistor, sells for only \$1.50.

**Tech Talk.** Although the majority of published transistor circuits feature either capacitive or transformer interstage coupling, transistors are well suited to *direct coupling*. Direct-coupled circuits are generally simpler than other types because, in such a circuit, there is a d.c. path from the "output" electrode of one stage to the "input" electrode of the second stage. This may be either a direct wire connection or

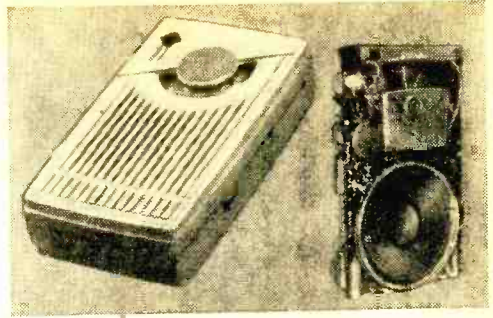

Exterior and interior views of Telefunken's new transistorized pocket receiver . . . the first all-transistor receiver manufactured in West Germany.

a series current limiting resistor, depending on the circuit and its intended application.

In addition to simpler circuitry, direct-coupled arrangements are less expensive to assemble than other types, since expensive coupling capacitors and interstage transformers are not used. And, from a technical viewpoint, they generally offer a much improved frequency response characteristic, particularly at the "low" end of the frequency spectrum. Properly designed circuits may be made "flat" to 0 cycles per second (d.c.).

Typical two-stage direct-coupled circuits are shown in the schematic diagram at left. Both of these are suitable for experimental work, and may be used in receivers, amplifiers, or control applications, depending on the nature of the input signal and the type of load used. In a receiver or audio amplifier, the load may be a pair of headphones; in an instrument, the load may be a resistor or a meter; and in a control circuit, the load may be an electromagnetic relay.

Circuit (A) features two transistors of the same type and is basically a common-collector amplifier direct-coupled to a common-emitter stage. Bias for the first stage is supplied through *R1*. This circuit is essentially the same as that used in Marvelco's new *Tandem Transistor*. It features a *high* input impedance and a gain which is approximately equal to that of the second stage . . . the first stage serves simply to match impedances and supplies relatively little gain. *N-p-n* transistors may be substituted for the *p-n-p* types shown simply by reversing the battery (*B1*) polarity.

Circuit (B) utilizes the opposite d.c. characteristics of *n-p-n* and *p-n-p* transistors to permit direct coupling from collector to base. Since both stages use the common-emitter configuration, this circuit has a low input impedance, but it provides

(Continued on page 120)

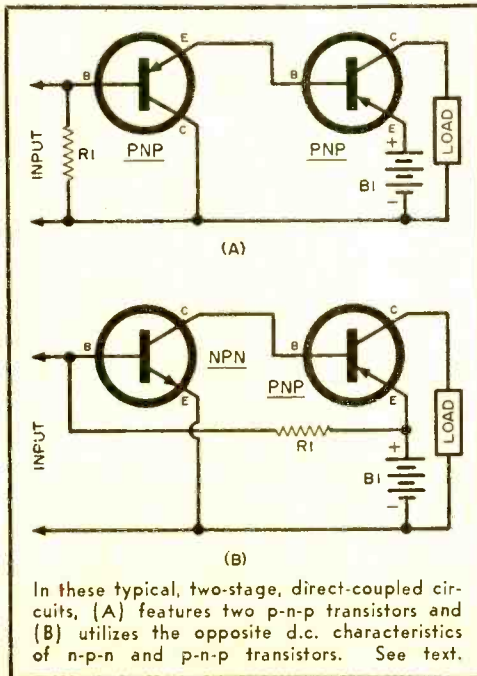

# Identifying Salvaged Transformers

EVERY EXPERIMENTER accumulates various and sundry audio output transformers—the type that's used to match a power tube, or tubes, to a loudspeaker. He salvages them from old radio receivers with the idea that one day they'll be useful. Sooner or later our hero finds that he has neglected to tag or otherwise identify the transformers he has stowed away.

The equipment needed to identify a transformer consists of: an a.c. vacuum-tube voltmeter, such as the Heathkit Model AV-2; a small 6.3-volt filament transformer, such as the Triad F-13X (any 1-ampere unit will do as well); a 10,000-ohm wire-wound potentiometer; and a power cord and plug.

Set up the circuit shown in the schematic diagram. If you are unable to tell by inspection which two of the four or five leads coming out of your transformer are

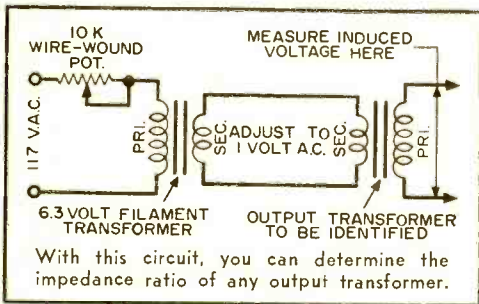

the secondary connections, measure the d.c. resistances between the various leads. The two leads (of a 4- or 5-lead output transformer) that have the *lowest* resistance are the secondary leads.

If you're checking a 4-lead transformer, the two remaining leads are the primary. If you're checking a 5-lead transformer, the two remaining leads that have the *highest* resistance are the two plate leads; the third lead is the center-tap connection. A 4-lead output transformer is made to match a *single tube* to a speaker voice coil. A 5-lead transformer matches *push-pull* tubes to the voice coil.

After you have made the few simple connections, set the potentiometer to where the full 10,000 ohms is in the circuit, and plug the line cord into the 117-volt a.c. socket. Connect your v.t.v.m. across the *secondary* of the output transformer. Then, adjust the potentiometer until your meter reads *exactly 1 volt*.

As soon as this adjustment has been made, set your meter to a higher range (the 100-volt range will usually be the

right one), and immediately switch the meter leads to the primary of the output transformer. Measure the voltage across the primary and write it down. Multiply this number by itself, and then multiply the product by the voice-coil impedance of the speaker you want to use. Your final figure is the load impedance into which the plate of your power tube will work when you're using this particular transformer and speaker.

**EXAMPLE I:** Suppose, after setting the voltage across the secondary of our output transformer very carefully to 1 volt, we read the voltage across the primary and find it to be exactly 39.5 volts. We write this down and multiply it by itself ( $39.5 \times 39.5$ ) and obtain the product: 1560.25. The voice-coil impedance of the speaker we want to use happens to be 3.2 ohms, so we multiply our 1560.25 by 3.2, and get 4992.8. This is close to 5000, so we'll call it 5000 ohms—the right impedance to match the plate of a 6V6 or a 6AQ5 power tube.

**EXAMPLE II:** Suppose we have a 5-lead output transformer and, after carefully setting its secondary to 1 volt, we measure the voltage across the two primary plate leads and find it to be 42 volts. We have an 8-ohm speaker, so we multiply  $42 \times 42 \times 8$  and get 14,112. Call it 14,000 ohms. This will match a pair of 6F6's, or 6K6GT's, or 6AR5's in push-pull to the voice coil of our 8-ohm speaker.

Proper plate loads at various grid bias and plate potentials for a number of power tubes can be found in the *RCA Receiving Tube Manual*, or the tube section of *The Radio Amateur's Handbook* published by the American Radio Relay League (A. R. L.).

—Frank H. Tooker

## HOW IT WORKS

It is easy to identify the impedance ratio of an output transformer by means of two useful iron-core transformer formulas:

$$(N_s/N_p)^2 = Z_s/Z_p \text{ and } N_s/N_p = E_s/E_p$$

in which  $N_s$  represents the number of turns on the secondary of our output transformer;  $N_p$ , the number of turns on the primary;  $Z_s$ , the impedance to be placed across the secondary;  $Z_p$ , the impedance reflected into the primary;  $E_s$ , a voltage impressed or induced across the secondary; and  $E_p$ , the voltage impressed or induced across the primary.

In this circuit, a filament transformer is used to drive the secondary of the unknown transformer. The voltage is carefully adjusted and measured by an a.c. vacuum-tube voltmeter. Once the secondary voltage is known, the v.t.v.m. is used to measure the voltage induced in the primary. Through the formula above, the nominal primary load impedance can be found.



# The Plate That Talks

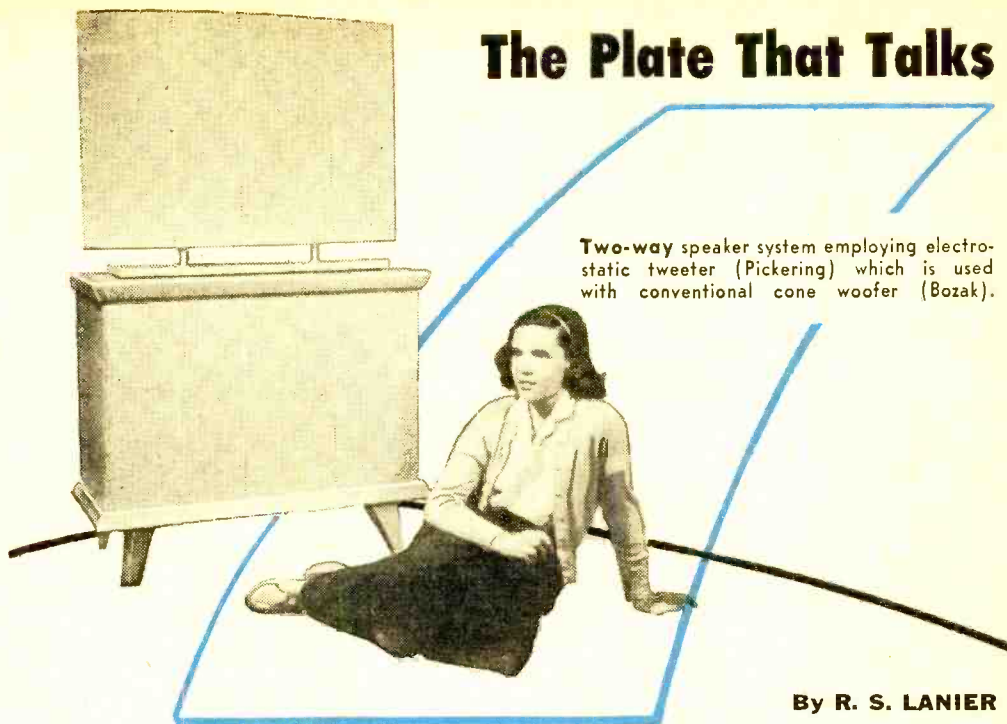

Two-way speaker system employing electrostatic tweeter (Pickering) which is used with conventional cone woofer (Bozak).

By R. S. LANIER

***Electrostatic speakers generate sound in a way that has thrilled many hi-fi fans; here's how they do it***

**L**ONG AWAITED and much discussed, electrostatic speakers are here—apparently to stay. Although available commercial models cover only the mid-range and high frequencies of the audio spectrum, we may expect that sooner or later full-range electrostatic reproducers will be on the market. Development work, here and abroad, is now under way on such devices.

Recent models are, of course, hi-fi news—although their operation is based on tried-and-true electronic principles. If you take apart an electrostatic speaker, you have what is, essentially, an overgrown capacitor. One plate of this capacitor is stationary and can't move; the other is suspended elastically so that it can move. Feed an a.c. signal across these two plates and the movable one will vibrate, creating sound waves. That, in a nutshell, is how the electrostatic speaker works.

But, as in all things electronic, there's more to this story than the insides of a nutshell. The basic principle of electrostatic speakers was known years ago, but audio engineers chose the electromagnetic principle as the big hook on which to hang their speaker designs. There were many good reasons for such a choice. Among

them were: cost of construction and operation; over-all smoothness of response; wide frequency band coverage; output level; efficiency.

Many experts still feel that these advantages have not been seriously challenged by the electrostatic speaker and never will be. Others point to the highly rated performance of electrostatics at the high frequencies, emphasizing the importance of good reproduction in this area for the ultimate perception of clean overtones that characterizes real hi-fi.

**The Moving Plate.** In preparation for hi-fi-dom's reception of electrostatic speakers, it's a good idea to understand just how these units operate. As stated above, the basic action is capacitive, depending on the build-up of an electrostatic field between two conductive plates.

When the charges on the two plates are of the same polarity (both plus or both negative), the static field (or tension, or force) between the two plates tends to push them apart. When the charges are of opposite polarity (one positive and the other negative), the two plates are "attracted" and the force pulls inward between them. Varying the charge—as an

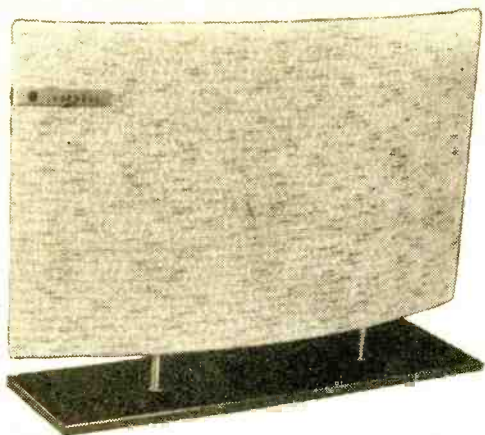

**Curved surface** of Pickering "Iso-phase" electrostatic tweeter disperses highs uniformly into room.

audio signal voltage can—varies the force and creates a "push-pull" effect across the two plates.

To make a loudspeaker of two such plates, or panels, three things must be done. First, fix one panel so that it can't move. Second, suspend the other in an elastic mounting so that it can move a very short distance with respect to the first plate. Finally, feed across the two panels a signal voltage that represents speech or music (see drawing at left).

The movable panel will be pushed and pulled with respect to the fixed panel with a force that is proportional to the signal voltage. The resultant vibrations will move the surrounding air to create sound.

This arrangement makes possible a re-producer diaphragm that moves as an integral unit. The force of any point on the surface equals that at every other point, thus eliminating "break-up"—long a bug-aboo of conventional speakers. Break-up occurs when some parts of the speaker diaphragm do not move in step with the voice coil.

At middle and high frequencies, for example, the flexible cone of a conventional speaker is pushed at one area only, near its attachment to the voice coil. Some distortion may result. In the better speakers, this difficulty has been controlled so that distortion is fairly low. Well-designed horn tweeters reduce it to a minimum. But, it appears that the electrostatic speaker has no such problem at all. This would indicate a high degree of purity in the propagation of high frequencies.

**Practical Problems.** There were two big obstacles that stood in the way of electrostatic speakers clearing the high-frequency hurdles. One was the spacing of the two plates.

The diaphragm, or moving plate, must be very close to the fixed plate for any usable electrostatic force to be developed. The closer together the two plates, the stronger the sound available. But the plates can't get close enough to touch each other during the movement of the diaphragm; this would, naturally, short out the audio signal and defeat the purpose of the whole setup.

In the past, experimenters attempted to solve this problem by stretching a thin metal foil tightly in front of a plate. Another method was to mount the foil on a layer of rubber. Neither method worked very well. The foil could not be made both lightweight and strong enough to do the job. Thus, the spacing problem be-

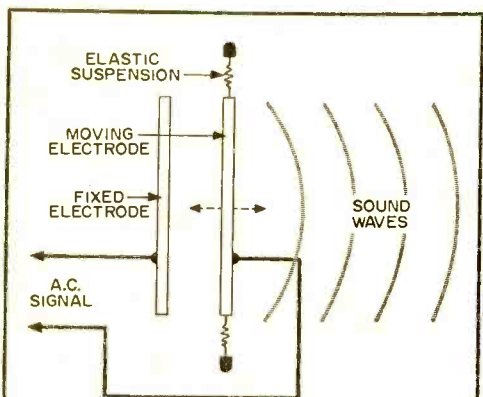

**Basic action** of electrostatic speaker is diagrammed above. Simplified version of push-pull electrostatic speaker is shown below: in (A), no signal is applied; in (B), the applied signal of 50 volts creates unbalance between plates and diaphragm vibrates, producing sound.

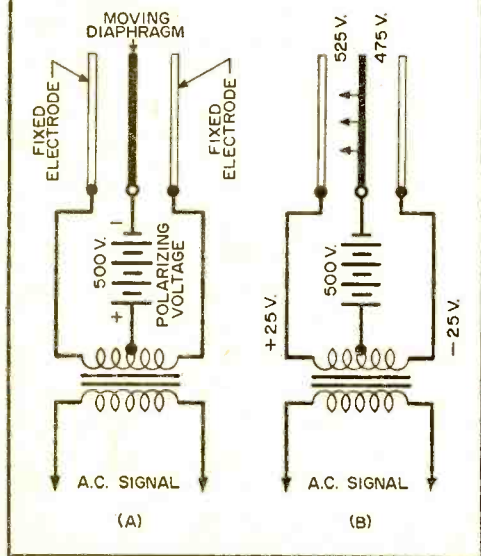





Four panels, at various angles for dispersal of highs, characterize the Janszen electrostatic tweeter, a push-pull unit handling 1000 cps and up.

came, effectively, a problem of finding and using the right material for the diaphragm.

The second problem involved a basic law of physics: the mechanical force between two charges varies inversely as the square of the distance between them. For example, if two charges attract each other with a certain force when they are one inch apart, the same two charges will attract each other with only one-fourth that force when they are two inches apart.

This square-law relationship between distance and force means that when the diaphragm moves well away from the fixed plate the resultant force will not be in strict proportion to the applied signal voltage. Harmonic and intermodulation distortion will result; the speaker will not be linear in response.

**The "Push-Pull" Speaker.** To solve the distance-force problem, both American manufacturers of electrostatic speakers (Pickering and Janszen) use a push-pull system which is said to be completely linear (see drawing on page 92). The force applied to the diaphragm is proportional to the applied signal voltage no matter where the diaphragm is at any time during its vibrations.

The push-pull system uses two fixed electrodes; the moving diaphragm is suspended between them. A fixed d.c. voltage (the "polarizing" or "bias" voltage) is applied to the speaker by means of the transformer center-tap, creating an initial electrostatic force between the diaphragm and each electrode. With no a.c. signal, the force is balanced; the diaphragm is pulled equally in both directions and so stays in the middle. No sound is generated.

When a signal is applied to the transformer, the voltage varies. In effect, the polarizing d.c. voltage is "modulated" by the a.c. signal. This action pulls the diaphragm first toward one electrode, then toward the other. Resultant vibrations generate the sound.

**Diaphragm and Suspension.** The problem of choosing a suitable material for the diaphragm is solved in both the Pickering

and Janszen units by the use of a very thin, lightweight, strong plastic which is made into an electrode by depositing on it a microscopic layer of metal. The suspension of the diaphragm, however, is quite different in each make.

In the Pickering speaker (see drawing on page 92), the diaphragm is not stretched and held at its edges. Instead, the "inert diaphragm" method is used, with the plastic supported by a number of small spring elements across its surface, between it and the two outer electrodes. This entire "sandwich" (consisting of the outer electrodes and the diaphragm) is curved in the horizontal plane, which helps in the even distribution of highs throughout the listening area. In addition, the outer electrodes have numerous openings to allow both the front and the back waves to emerge from the unit.

Two models of the Pickering speaker are currently sold: the larger (2' by 3') is designed to cover the frequency range from 400 cps up. The smaller (12" by 18") handles the range from 1000 cps up. Obviously, the lower the frequency range handled by the electrostatic method, the larger—and costlier—must be the unit.

Both units are free-standing and self-contained. They can be placed anywhere near the woofer and its enclosure. Each

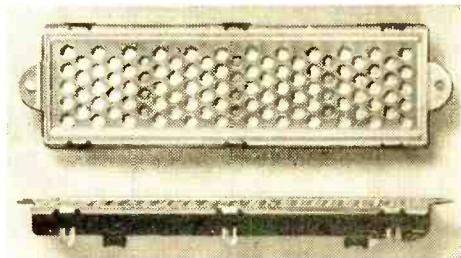

Examples of single-ended electrostatic tweeters are the Arnhold "Isophon" (above) and the Lorenz SKL-100. Both units are small, fairly inexpensive, and simple to connect. Isophon handles range from 7000 cycles and up; Lorenz, 5000 cycles and up.



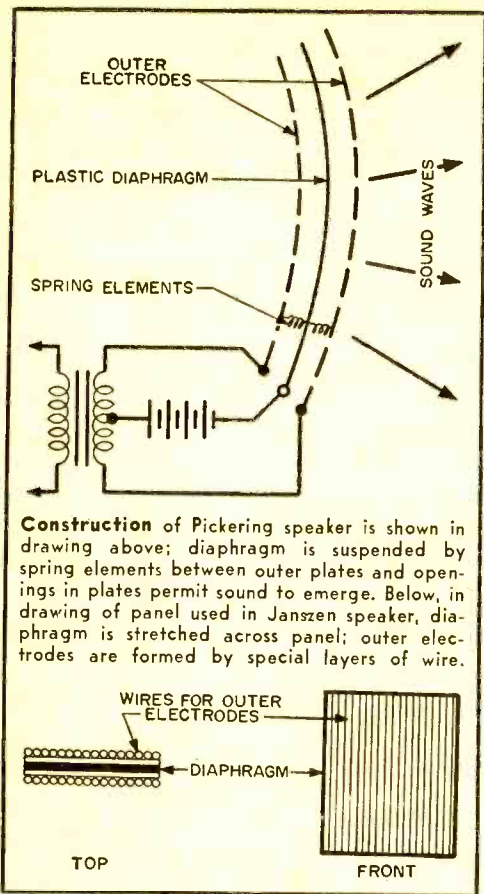

**Construction** of Pickering speaker is shown in drawing above; diaphragm is suspended by spring elements between outer plates and openings in plates permit sound to emerge. Below, in drawing of panel used in Janszen speaker, diaphragm is stretched across panel; outer electrodes are formed by special layers of wire.

speaker is used with an adapter unit which serves as a crossover network, supplies the polarizing voltage, and matches the speaker to the amplifier. The rig can be used with any standard hi-fi amplifier. A typical hookup is shown in the photo on page 89.

The Janszen speaker (see drawing above) consists of a series of four flat panels, each about six inches square. The plastic diaphragm is stretched across the frame of each panel. On each side of the diaphragm, in each panel, is a network of parallel wires which forms the outer electrodes of the push-pull circuit. This unit is intended to cover the frequency range from 1000 cps and up. It is furnished with a high-pass filter for crossover, and a polarizing voltage supply. Like the Pickering, it is free-standing and self-contained. (For further information on these units, contact Pickering and Co., Inc., Oceanside, N. Y., and Janszen Laboratory, Inc., 69 Harvey St., Cambridge, Mass.)

**Single-Ended Electrostatics.** In addition to the push-pull speakers, there are a few small, single-ended electrostatics such

as the Isophon (Arnold Ceramics, Inc., 1 East 57 St., New York, N. Y.), and the Lorenz (Kingdom Products, Ltd., 23 Park Place, New York 7, N. Y.).

Designed to handle only the very upper range (the Isophon takes off at 7000 cps, the Lorenz at 5000 cps), these tweeters serve as "top" reproducers in three-way systems or as high-frequency aids to wide-range cone speakers where relatively high crossover points can be used. The distortion inherent in their single-ended construction is minimized by permitting the diaphragm to move only thousandths of an inch, or less. At that, such microscopic motion is enough to produce sizable sound levels at high frequencies.

**How Do They Sound?** Most listeners agree that, properly connected and matched to suitable woofers, electrostatic speakers make excellent mid-range and tweeter units. Of course, in the last analysis every listener must decide for himself. Listen, if you can, to "A-B" tests in which the highs are played first through a horn or cone tweeter and then through an electrostatic unit.

Advocates of the electrostatic devices urge you to listen for two main things. First, the over-all response is said to be very smooth with no audible peaks and no "break-up." Transient response is claimed to be excellent. Intermodulation and harmonic distortion have been measured at less than 1% at full output.

Second, the point-source effect, or "sound coming from a hole in a box" is eliminated. The wide radiating surface spreads the sound over a large area so that it "just seems to be there." While the highs may not come at you with the impact of a pile-driver, they are all present and perhaps in a more natural-sounding way.

**What About Bass?** Practical use of electrostatic speakers, at least so far, involves a two-way speaker system in which the bass is handled by a cone woofer while the mid-range and highs are sounded by the electrostatic unit. The crossover point depends on the particular electrostatic speaker used; some take over at about 500 cps, others at 1000 cps. In any case, the electrostatic reproducer must be fairly well balanced with whatever woofer is used. Power ratings and relative efficiencies must be watched lest the sound output is unbalanced in favor of highs or lows.

One of the big problems faced in developing electrostatic speakers for the full audio range, including bass, is the spacing of the electrodes. As frequency is lowered, the diaphragm has to move farther to maintain balanced sound output. At 100

(Continued on page 122)



# NOW—BUILD IT YOURSELF in a few hours!

# Amazing *electric* Brain

## COMPUTES, PLAYS GAMES, "REASONS"!

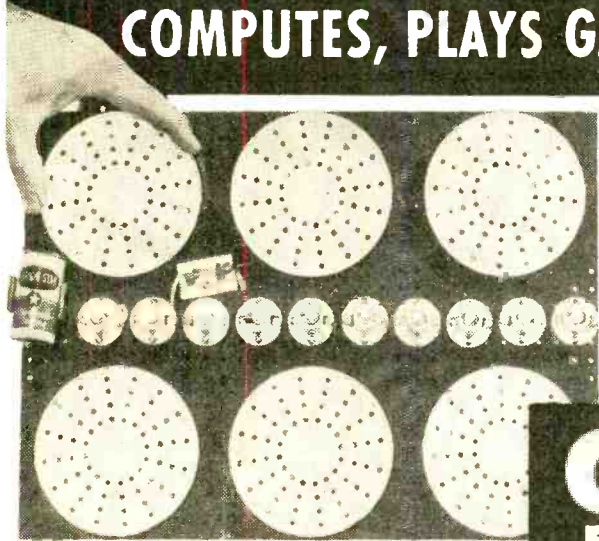

Here's a wonderful kit that gives you a fascinating introduction to the logic machines of our modern age! The devices you can build test intelligence, code and decode, count, play Tic-tac-toe, solve problems! Converts from binary to decimal — reasons in syllogisms — computes! Send for your kit today!

# GENIAC

## ELECTRIC BRAIN

### You can build 33 different machines, including

Binary Adding Machine	Automatic Oil Furnace Circuit
Secret Coder & Decoder	Machine for a Space Ship's Airlock
Machine for Arithmetical Carrying	Intelligence Tester
Comparing Machine	Burglar Alarm Adder,
Reasoning Machine	Subtractor, Multiplier, Divider
General Combination Locks	
Machines Requiring Logic	

### Some Firms and Institutions that have ordered GENIAC:

Allis-Chalmers Remington-Rand International Business Machines Wheelindex Mfg. Co. Manuel Missionary College Walter V. Clarke Associates	Albert Einstein Medical College Naval Research Laboratories Board of Education, Tecumseh, Nebraska Marshfield Public Schools Los Angeles Public Schools Jefferson Union High School Oklahoma A&M Kansas State University Duke University Coral Gables Senior High School Courthland Jr. High School Bell Telephone Laboratories
Barnard College Westinghouse Electric Phillips Laboratories General Insurance Co. of America Lafayette Radio Rohr Aircraft Co. Southwest Missouri State College	

**Y**ES, you build any one of 33 exciting electric brain machines in just a few hours by following the clear-cut, step-by-step directions given in a thrilling booklet! No soldering required... no wiring beyond your skill! GENIAC is a genuine brain machine — not a toy. The *only* logic machine kit that not only adds, subtracts, etc., but presents the basic ideas of cybernetics, Boolean algebra, symbolic logic, automatation, etc. So simple to construct that even a twelve-year-old can make a machine that will fascinate people with advanced scientific training!

**OVER 400 COMPONENTS AND PARTS.** Circuits operate on one flashlight battery, and the use of ingeniously designed parts makes building circuits one of the most fascinating things you've ever done! You set up problems in a variety of fields — and get your answers almost quicker than you can set them up! Play games with the machine — nlm, tic-tac-toe, etc. — and pit your brain against its logic! Solve puzzles in a few seconds that would take you hours without the aid of the machine.

You actually *see* how computing and problem — solving is analyzed with algebraic solutions transferred directly into circuit diagrams.

**YOUR COST FOR GENIAC KIT:** only \$19.95 postpaid. The 1956 Model GENIAC KIT contains: (1) a complete 200-page text, "Minds and Machines" — a basic introduction to computers. (2) "How to Construct Electrical Brains At Home" — a fully illustrated text book on basic computer design theory and circuits with specific instructions for building circuits. (3) Wiring Diagram Manual. A special booklet with full scale diagrams that you can tear out and place on your work bench for easy assembly. (4) Beginners' Manual. Starting from scratch, the manual adds fifteen extra experiments, thoroughly tested using GENIAC components to teach the basic symbols of electric circuits. (5) Over 400 components and parts.

So — mail the coupon for your GENIAC today! (Teachers: take advantage of 10% deduction if ordered for use in institutions). Your money back if not delighted!

**ORDER GENIAC ON OUR MONEY BACK Guarantee!**

SCIENCE KITS, Dept. 96  
Oliver Garfield Co., 126 Lexington Ave., New York 16, N. Y.

Please send me:

1 GENIAC Electric Brain Construction Kit and Manuals.

\$19.95 (East of Mississippi)

\$20.95 (Elsewhere in United States)

\$21.95 (Outside the United States)

Returnable in seven days for full refund if not satisfied. I enclose \$..... in full payment.

Name.....

Address.....

City..... Zone..... State.....

*build your own*

# HEATHKIT



*... and have fun doing it!*

Circuit boards cut assembly time in half

1% resistors insure instrument accuracy.

High impedance and high sensitivity.

Attractive styling—functional design.

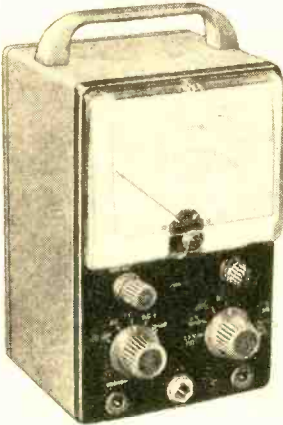

MODEL V-7A

**\$24<sup>50</sup>**

SHIPPING WT. 7 LBS.

Every Heathkit comes complete with detailed step-by-step instructions and large pictorial diagrams that insure successful construction—even for the beginner. Enjoy both the satisfaction and the economy of "building it yourself."

*etched circuit vacuum tube*

## voltmeter kit

In addition to measuring AC (rms), DC, and resistance, the modern-design V-7A incorporates facilities for peak-to-peak measurements. These are essential in FM and television servicing.

AC (rms) and DC voltage ranges are 1.5, 5, 15, 50, 150, 500, and 1500. Peak-to-peak AC voltage ranges are 4, 14, 40, 140, 400, 1400, at 4,000. Ohmmeter ranges are X1, X10, X100, X1000, X10K, X100K, and X 1 megohm. A db scale is also provided. Polarity reversing switch provided for DC measurements, and zero center operation is within range of the front panel

controls. Employs a 200 microampere meter for indication. Input impedance is 11 megohms.

Etched metal, pre-wired circuit boards insure fast, easy assembly and result in reliable operation. Circuit board is 50% thicker for more rugged physical construction. 1% precision resistors used for utmost accuracy.

*Heathkit*

### HANDITESTER KIT



MODEL M-1

**\$14<sup>50</sup>**

Shpg. Wt. 3 lbs.

The Model M-1 measures AC or DC voltage at 0-10, 30, 300, 1000, and 5000 volts. Measures direct current at 0-10 ma and 0-100 ma. Provides ohmmeter ranges of 0-3000 (30 ohm center scale) and 0-300,000 ohms (3000 ohms center scale). Features a 400 microampere meter for sensitivity of 1000 ohms per volt. Handy and portable. Will fit in your coat pocket, tool box, glove compartment, or desk drawer.

*Heathkit* VOM KIT

20,000 ohms/v. DC and 5,000 ohms/v. AC sensitivity. Ranges (AC and DC) are 0-1.5, 5, 50, 150, 500, 1500, and 5000 v. Direct current ranges are 0-150 ua, 15 ma, 150 ma, 500 ma, and 15 a. Resistance ranges provide center-scale readings of 15, 1500 and 150,000 ohms. DB ranges cover -10 db to  $\pm 65$  db.

Features 4 1/2" 50 ua meter and 1% precision resistors.



MODEL MM-1

**\$29<sup>50</sup>**

Shpg. Wt. 6 lbs.

**HEATH COMPANY** A Subsidiary of Daystrom, Inc.  
BENTON HARBOR 5, MICHIGAN



# Heathkit 3" oscilloscope kit

ETCHED CIRCUIT

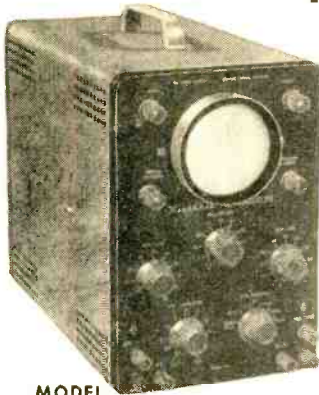

MODEL  
OL-1

**\$29<sup>50</sup>** Shpg. Wt.  
14 Lbs.

Push-pull vertical and horizontal amplifiers.

Light weight and small size for portability.

Good sensitivity and broad frequency response.

Etched metal circuit boards for simplified assembly.

Attractive panel and case styling.

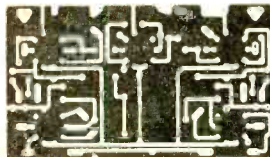

This compact little oscilloscope is just the ticket for use in the ham shack or home workshop. Measures only 9½" H. x 6½" W. x 11¼" D. Weighs only 11 pounds.

Employing etched metal circuit boards, the Model OL-1 features vertical response with in  $\pm 3$  db from 2 cps to 200 kc. Vertical sensitivity is 0.25 volts rms per inch, peak-to-peak, and sweep generator operates from 20 cps to 100,000 cps. Provision for direct RF connection to deflection plates. Incorporates many features not expected at this price level. The 8-tube circuit features a type 3GP1 cathode ray tube.

Cathode-follower output for isolation.

No oscillator calibration required.

Covers 160 kc to 220 mc (including harmonics).



# Heathkit signal generator kit

This signal generator covers 160 kc to 110 mc on fundamentals in 5 bands. Calibrated harmonics extend its usefulness up to 220 mc. The output signal is modulated at 400 cps, and the RF output is in excess of 100,000 microvolts. Output controlled by both a continuously variable and a fixed step attenuator. Audio output may be obtained for amplifier testing.

MODEL  
SG-8  
**\$19<sup>50</sup>**  
Shpg. Wt.  
8 Lbs.

This is one of the biggest signal generator bargains available today. The tried and proven Model SG-8 offers all of the outstanding features required for a basic service instrument or for use in experimenting in the home workshop. High quality components and outstanding performance. Easy to build, and no calibration required for ordinary use.

# Heathkit grid dip meter kit

This extremely valuable instrument is a convenient signal source for determining the frequency of other signals by the comparison method. Range is from 2 mc to 250 mc. Uses 500 ua meter for indication, and is provided with a sensitivity control and headphone jack. Includes prewound coils and rack. For hams, experimenters, and servicemen.

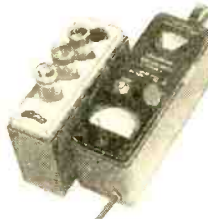

MODEL GD-1B  
**\$19<sup>50</sup>**  
Shpg. Wt. 4 Lbs.

# Heathkit ANTENNA impedance meter kit

Used in conjunction with a signal source, the Model AM-1 will enable you to measure RF impedance. Valuable in line matching, adjustment of beam and mobile antennas, etc. Will double as a phone monitor or relative field strength indicator. A 100 micro-ampere meter is employed. Covers the impedance range from 0 to 600 ohms. An instrument of many uses for the amateur. Easily pays for itself through the jobs it will perform.



MODEL  
AM-1  
**\$14<sup>50</sup>** Shpg. Wt.  
2 Lbs.

**HEATH COMPANY** A SUBSIDIARY OF  
DAYSTROM, INC.  
BENTON HARBOR 5, MICHIGAN



MODEL VF-1

**\$19.50**

Shpg. Wt. 7 Lbs.

a socket on the Heathkit Model AT-1 transmitter, or supplied with power from most transmitters.

Features illuminated and pre-calibrated dial scale. Cable and plug provided to fit crystal socket of any modern transmitter.

*Heathkit*  
**vfo**  
KIT

- ☆ 6AU6 electron-coupled oscillator.
- ☆ OA2 voltage regulator tube for stability.
- ☆ Smooth-acting illuminated dial.
- ☆ Easy to build and attractively styled.

This variable frequency oscillator covers 160-80-40-15-11 and 10 meters with three basic oscillator frequencies. RF output is better than 10 volts average on fundamentals. Enjoy the convenience and flexibility of VFO operation at no more than the price of crystals. May be powered from

Extra features include copper-plated chassis, ceramic coil forms, extensive shielding, etc. High quality parts!

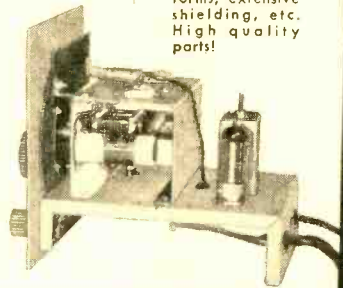

**SPECIFICATIONS:**

RF Amplifier Power Input... 25-30 watts  
Output Connection... 52 ohms  
Band Coverage... 80, 40, 20, 15, 11, 10 Meters

**Tube Complement:**

5U4G... Rectifier  
6AG7... Oscillator-Multiplier  
6L6... Amplifier-Doubler

*Heathkit* CW amateur transmitter kit

This CW transmitter is complete with its own power supply and covers 80, 40, 20, 15, 11, and 10 meters. Incorporates such outstanding features as key-click filter, line filter, copper plated chassis, pre-wound coils, and high quality components. Employs a 6AG7 oscillator, 6L6 final amplifier. Operates up to 30 watts plate power input.

MODEL AT-1

**\$29.50**

Shpg. Wt. 15 Lbs.

Single-knob band-switching for 80, 40, 20, 15, 11 and 10 meters.  
plate power input 25-30 watts.

Panel meter monitors final grid or plate current.  
Best dollar-per-watt buy on the market.

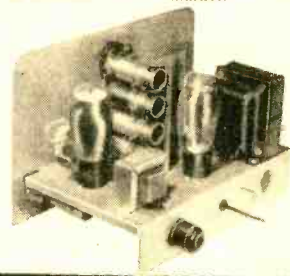

Slide-rule dial-electrical band-spread-ham bands marked.

Slug-tuned coils and efficient IF transformers for good sensitivity and selectivity.

Transformer-operated power supply for safety and high efficiency.

*Heathkit* COMMUNICATIONS TYPE all band receiver kit

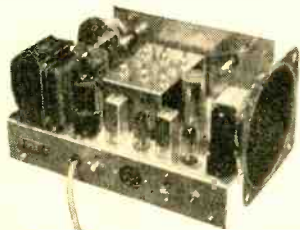

**\$27.95**

MODEL AR-3  
Shpg. Wt. 12 Lbs.

CABINET: Fabric-covered cabinet available. Includes aluminum panel, speaker grille, and protective rubber feet. Measures 12-1/4" W. x 6-3/4" H. x 7-3/4" D. No. 91-15. Shpg. Wt. 6 Lbs. \$4.99.

The Model AR-3 covers from 550 kc to 30 mc on 4 bands. Covers foreign broadcast, radio hams, and other interesting short wave signals.

Features good sensitivity and selectivity. Separate RF and AF gain controls—noise limiter—AGC—VFO, headphone jack—5 1/2" PM speaker and illuminated tuning dial.

**SPECIFICATIONS:**

Frequency Range... 550 kc to 30 mc on four bands

- Tube Complement... 1—12BE6 oscillator and mixer  
1—12BA6 IF amplifier  
1—12AV6 second detector, AVC, first audio amplifier and reflex BFO  
1—12A6 beam power output  
1—5Y3 full wave rectifier

**HEATH COMPANY** A SUBSIDIARY OF DAYSTROM, INC.  
BENTON HARBOR 5, MICHIGAN





# TOOLS and GADGETS

## REMOTE CONTROL FOR YOUR SET

You can turn your present TV, radio or hi-fi into a remote control set in a few seconds by connecting the "Remote LAZY-TROL" to it. This is said to be the only remote-controller with: (1) on-off switch, (2) volume controller, and (3) earphone plug-in. The "LAZY-TROL" can be used



with speaker only, earphones only, or both together.

Whenever the music is too loud or too soft, you can adjust it without moving out of your easy chair. Or if you want to listen to only part of the program, you can turn it on or off at will. It's all done with one knob. List price, \$9.95, with 20 feet of wiring. (Televeex, Inc., Kew Gardens 15, N. Y.)

## VERSATILE HACKSAW

Depth of cut is unlimited with the "Leytool" hacksaw, since the entire frame remains on the operator's side of the material, and inside cuts are also possible. Once the saw cut is blade deep, the nose of the spring-loaded blade support rests against the material being sawed, and only the blade moves back and forth through the

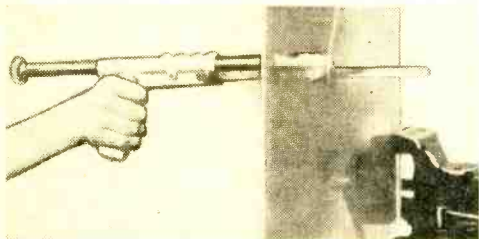

cut. The molded finger rest stays directly above the portion of the blade doing the cutting.

Made of die-cast aluminum and English steel, the "Leytool" saw will take either 10" or 12" standard hacksaw blades. It

weighs a little over 1½ pounds, and measures only 5" x 16" x 1½". A pistol grip handle gives the operator complete control. Price, \$7.95. (Hallbee Products Company, 142 Mill St., Parma, Mich.)

## HOME FIRE ALARM

Fires which break out in any part of the home—from basement to attic—can be detected and reported by the "Lert-A-Larm." This extended protection is made possible

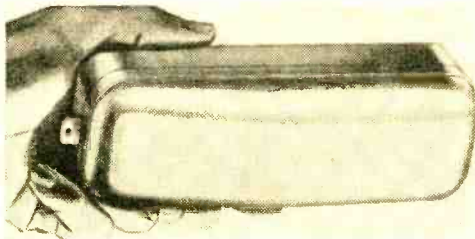

by running a thin wire (non-electrical), interspersed with fusible links, back and forth over the areas to be protected. A temperature of 158° anywhere along the wire will cause one of the links to melt, setting off the alarm in the living quarters.

Not dependent upon household current, "Lert-A-Larm" is powered by self-contained batteries. It can be installed by the home-owner using only simple tools. Model A, with 100 feet of wire and 12 fusible links, is \$12.95 postpaid. (Time Products Co., 1350 N. Jackson, Milwaukee 2, Wis.)

## NEW LIMBS FOR CRIPPLED TABLES

Metal folding legs make replacing wobbly "fixed" table-legs, or assembling new tables, an inexpensive and simple task. Any table top may be used which is made of plywood, pressed wood or other suitable

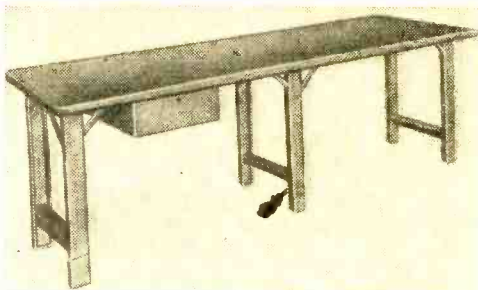

material. The only tool necessary to do the job is a screwdriver. Constructed of 1" heavy-gauge steel tubing and equipped with double-action safety locks, these legs can support 1500 pounds.

There are also heavy-duty "fixed" legs for tables which will safely support 5000 pounds (shown in photo). A 2" adjustment in height is possible, enabling you to level the table easily if floor is uneven. (ABC Metal Products Company, 115 West 30th St., Dept. 25, New York 1, N. Y.)



# You Can Train at Home for Good Pay Jobs in RADIO-TELEVISION

**Fast Growing Industry Offers Good Pay, Security, Bright Future**

**LESSON AND CATALOG FREE MAIL CARD**

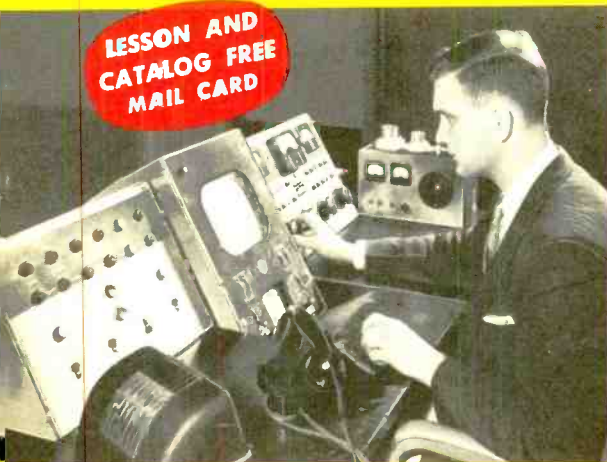

Training PLUS OPPORTUNITY is the ideal combination for success. Today's OPPORTUNITY field is Radio-Television. Over 125 million home Radios plus 30 million sets in cars and 40,000,000 Television sets mean big money, opportunity for trained Radio-Television Technicians. More than 4,000 Radio and TV Broadcasting stations offer interesting and important positions for technicians, operators. Color Television, portable TV sets, Hi-Fi, other developments assure future growth.



**J.E. SMITH  
Founder**

Since 1914—for more than 40 years—N.R.I. has been training ambitious men at home in spare time for Radio-TV. Thousands of successful graduates say N.R.I.'s 50-50 training method is a fast, easy, effective way to higher earnings, desirable jobs. Planned experiments and practice bring basic principles, techniques to life right in your own home. Find out what dependable training can do for you.

**You Learn by Doing—Get Practical Experience with Kits N.R.I. Sends**

**Add to Your Income Starting Soon**

**Make \$10-\$15 a Week Extra Fixing Sets in Your Spare Time**

Soon after enrolling, many N.R.I. students start earning extra money fixing neighbors' radio sets. Many earn enough extra to pay entire cost of course and provide capital to start their own full time Radio-TV business after getting N.R.I. Diploma. Mail Postage Free postcard for Sample Lesson. See how practical it is to learn at home. Get 64-Page Catalog, too. See equipment you get, opportunities in this growing field. Prices of N.R.I. Courses are low, terms easy.



Nothing takes the place of practical experience. As part of N.R.I. Servicing Course you build AC-DC Radio Receiver and Vacuum Tube Voltmeter shown below. Use them to make tests, conduct experiments, get practical experience. All equipment yours to keep.



**Find Out What Oldest and Largest Home Study Radio-Television School Offers You**

**See Other Side**

**CUT OUT AND MAIL CARD NOW**

**N.R.I. TRAINED THESE MEN**



**"Thanks N.R.I. for Good Start"**  
"Right now I am doing spare-time repairs on Radios and Television. Intend to go into full time servicing." C. HIGGINS, Waltham, Mass.



**Engineer with Station WHPE**  
"I operated a successful Radio repairshop. Then I got a job with WPA and now I am an engineer for WHPE." VAN W. WORKMAN, High Point, N. C.



**Quit Job to Start own Business**  
"I decided to quit my job and do TV work full time. I love my work and am doing all right financially." W. F. KLINE, Cincinnati, Ohio.



**N.R.I. Course Started His Way up**  
"I was a cab driver earning \$35 a week. Then I enrolled with N.R.I. Now I am a tester with TV maker." J. H. SHEPHERD, Bloomington, Indiana.

**SAMPLE LESSON AND CATALOG BOTH FREE**

**NO STAMP NEEDED!  
WE PAY POSTAGE**

This card entitles you to Actual Lesson on Servicing, shows how you learn Radio-Television at home. You'll also receive 64-Page Catalog.

**NATIONAL RADIO INSTITUTE, Dept. D4  
Washington 9, D. C.**

Please mail me the FREE sample lesson and 64-Page Catalog. (No Salesman will call.)

Name \_\_\_\_\_ Age \_\_\_\_\_

Address \_\_\_\_\_

City \_\_\_\_\_ Zone \_\_\_\_\_ State \_\_\_\_\_

Approved Member, National Home Study Council

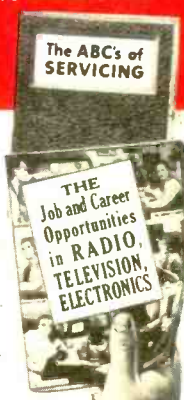

**Practice Servicing-Communications with Kits of Parts N.R.I. Sends**



**YOU BUILD AC-DC Superhet Receiver**

N.R.I. Servicing Course includes all needed parts. Get actual servicing experience practicing with this modern receiver.



**YOU BUILD Signal Generator**

You build this Signal Generator. Learn how to compensate high frequency amplifiers, practice aligning typical I. F. amplifiers in receiver circuits.

**YOU BUILD Broadcasting Transmitter**

As part of N.R.I. Communications Course you build this low power Transmitter, learn commercial broadcasting operators' methods, procedures.



**YOU BUILD Vacuum Tube Voltmeter**

Use it to conduct experiments; earn extra cash fixing neighbors' sets; bring to life theory you learn from N.R.I.'s easy-to-understand texts.



# Radio-Television Can Give You a Good Job with a Future

**N.R.I. Graduates do Important Work — Get Important Pay**



**Chief Engineer with Station**

"I am Chief Engineer of Station KGCU. I have my own spare time business servicing two-way communications systems." R. BARNETT, Bismarek, N. D.



**Paid for Instruments**

"I am doing very well in spare time TV and Radio. Sometimes have three TV jobs waiting. Paid for instruments out of earnings." G. F. SEAMAN, New York, N. Y.



**Has Own Radio-TV Business**

"We have an appliance store with our Radio and TV servicing. During my Army service, N.R.I. training helped me." W. M. WEIDNER, Fairfax, S. D.

Here is a line of work that people respect—a vocation where you can advance, win a place for yourself, earn good pay and gain much personal satisfaction. And you can learn at home in your spare time. Smart fellows everywhere are using their spare time to develop new knowledge, new skills. They know it is the trained man who gets ahead, gets the better job, drives the better car, is respected for what he knows and can do.

**Be a Skilled Technician**

The technical man is looked up to. He should be. He does important work, gets good pay for it. Radio-Television offers that kind of work. There are more than 40 million Televisions, 150 million home and auto Radios. Millions more are sold each year. There are splendid opportunities for the man well trained in Radio-Television Servicing or Broadcasting. Micro-Wave Relay, Aviation and Police Radio, Two-Way Communications for buses, taxis, trucks, etc. are expanding—making more jobs, greater opportunity.

**Tested Way To Better Pay**

N.R.I. Training is practical, thorough. You get the benefit of N.R.I.'s 40 years experience training men for success in Radio-Television. N.R.I. training is backed by the record and reputation of the OLDEST and LARGEST home study Radio-TV school. Most

successful N.R.I. men start without any knowledge of Radio, many without a high school education. Find out what Radio-Television training can mean to you. Make a decisive move today toward becoming one of that select group—a Radio-TV Technician. Send for Actual Lesson and 64-Page Catalog, both FREE. NATIONAL RADIO INSTITUTE, Dept. D4, Washington, D. C.

**See Other Side**

FIRST CLASS  
Permit No. 20-R  
(Sec. 34.9, P. L. & R.)  
Washington, D. C.

**BUSINESS REPLY CARD**  
No Postage Stamp Necessary If Mailed In The United States

POSTAGE WILL BE PAID BY  
**NATIONAL RADIO INSTITUTE**  
16th and U Sts., N. W.  
Washington 9, D. C.

**SAMPLE LESSON and CATALOG Both FREE**  
**Cut out and mail Postage Free Card**



# TIPS and TECHNIQUES

## LINE CORD HOLDERS

The next time you visit your local hardware store, pick up a handful of clothes-line cleats. They are quite inexpensive, and you'll find that a pair, bolted together, makes an excellent and durable holder for extension cords, spare line cords, mike ca-

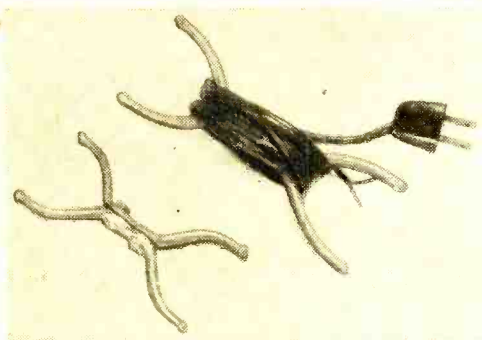

bles, speaker line, or any of the other types of cable or wire you're likely to have around your electronics workshop.

When you use the holder for an extension line cord, unwind only the amount of cord needed, and you'll have a neater—and safer—installation. Remember that a loose cord can trip someone! —L. E. G.

## JOINING FINE WIRE

Often the experimenter is faced with the problem of joining two ends of fine "hair" wire, such as may be found in a.c. meter coils, solenoids, etc. To solve this problem quickly and effortlessly, simply twist the two ends to be joined into a pigtail splice. Then dip the splice into a small quantity of lighter fluid, and apply a flame. The resulting heat will cause the ends of the fine wires to melt and fuse together into a small ball of copper. This forms, in effect, a permanently welded connection. —R. L. K.

## COVERING CABINET SCRATCHES

It is almost impossible to avoid scratches on radio, TV and hi-fi cabinets when the units are being repaired. A quick way to cover up such scratches is to rub in a little brown soldering paste and then rub off the excess. A more professional procedure is

to use a gadget such as the General Cement "Scratch Stik," which consists of a felt wick fed by a reservoir of stain. There are also penetrating dye stains available in small bottles at radio parts houses for the same purpose. —E. F. C.

## SIMPLE BURR REMOVER

A tool that will remove burrs in a jiffy from around small holes, drilled in a chassis or any other metal part, can be made quickly and easily from a screwdriver—as shown in the sketch. The two sides at the tip of the blade are ground away, as shown



by the dotted lines, to form a flat, pointed instrument.

The end of the screwdriver can then be inserted into the drilled hole and rotated once or twice to cut away the burr. An angle of about 90° for the point gives excellent results. Use a good quality, tool-steel screwdriver, and grind slowly and carefully to avoid heating the blade and drawing its temper. —F. H. T.

## COLORS IDENTIFY SOCKET DRIVERS

Different colors or shades of paint help in identifying various sizes of socket drivers quickly and easily. Simply dip or paint each of the handles of the different-size wrenches a different color. If a base is used, the same code may be applied to it as an aid in returning each

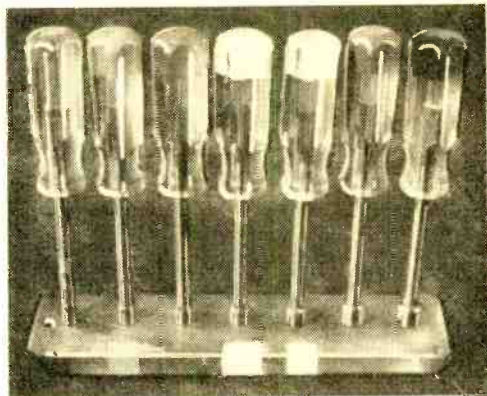

driver to its proper place. This system may be readily adapted to other types and sets of tools as a time saver. —C. A. P.

## KEEP FILTERS AT HAND

To aid in running down defective filter capacitors which cause hum in radios, amplifiers, tape recorders, etc., keep a test capacitor handy. The test unit may be an 8- or 10- $\mu$ f. electrolytic capacitor having a working voltage rating of 350 volts d.c. or better, with insulated alligator clips on



## WANTED

**Willing to pay cash for Early Phonographs with outside horns**

WANT Coronet (illustrated), Double Bell Wonder, Victor Types A, D, and O, Monarch Special, and Improved Monarch. Also Edison Idelia, Excelsior, and Treadle Phonographs. Want early Bell-Tainter, American Gramophones, Multiphone, Multinola, Scott Magazine Phonograph, Peerless, Sovereign, Wizard Phonograph, Regina Hexaphone, and Graphophones. Also catalogues or old literature on phonos made prior to 1906. Want unusual machines and coin-in-slot cylinder phonographs.

**A few duplicate Edisons and graphophones are now available for sale or trade.**

Send clear snapshot and full information to  
Box 50  
POPULAR ELECTRONICS  
366 Madison Ave., New York 17, N. Y.

its leads. Simply clip the test capacitor across those in the set, maintaining the same polarity, and note whether the hum decreases.

This procedure will not work with shorted or nearly shorted filter capacitors, in which case it is first necessary to disconnect one side of the suspected filter. Shorted or badly leaking units are generally indicated by overheated rectifier tubes or power transformers. Don't forget to short out any filter capacitor momentarily before wiring or unwiring it, as even a weak one may retain enough charge to cause a shock or damage to test equipment. And remember—this precaution also applies to your test capacitor. —E. F. C.

### IMPROVISED CONTINUITY CHECKER

An improvised continuity checker may be constructed from a flashlight bulb, a piece of fairly stiff bare wire, tape and a flashlight battery. Wrap the wire around the base of the bulb and, while holding the bottom contact of the bulb against the top contact of the battery, bend the wire and bring it down along the sides of the bat-

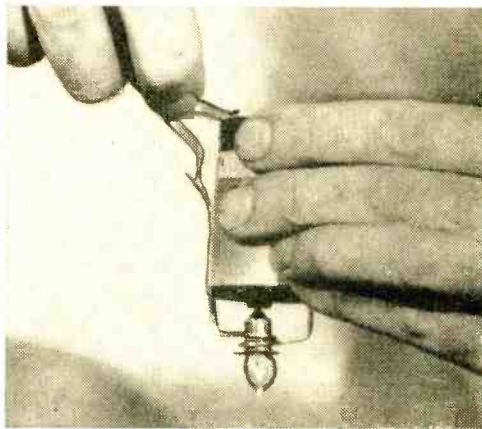

tery, taping it in place. Make sure the bulb is pressed tightly against the top battery contact.

To use this simple tester, touch the end of the wire and the base of the battery to the wires of the appliance to be tested. If the bulb lights, continuity is present; if it does not, there is no continuity. The tester is suitable only for dead circuits of low resistance. —C. A. P.

## RADIO CONTROL Headquarters

For model airplanes, boats, cars, etc. FREE CATALOG "P". No operator's license required. FREE—SEND FOR FCC FORM 505 Garage Door Radio Control Transmitters & Receivers Kits Available.

Most POWERFUL 5 Watt TRANSMITTER—LOWEST PRICE. Famous 2 Tube MAC 11 Circuit, with GYRO MAGIC TUNING INDICATOR. Completely Tested, includes: 9 1/2 ft. sect. Antenna. Remote "Clicker," Keying Switch Meter. Beautiful Cabinet 12x7x6. MODEL X3 . . . . . \$24.95  
MODEL X1 w. 2V Storage btry. charger, Vibr. pack. \$39.95  
2" METERS. 150 MicroA. \$3.95; 500 MicroA. \$3.95  
R/C TRANSMITTER & RECEIVER KIT: 27 1/4 Mc. 5 Watt 2-Tube Simple Transmitter & Supersens. 2-Tube Simple Receiver—Part incl. Drilled Bases Wound Coils, C Res., Cond., SIGMA Relay, instruc. . . . . Only \$9.95  
SIGMA 4F RELAY: 8,000 ohm, \$3.85; 6 Reed Relay 14.95  
2-6V Battery Charger Kit \$4.95; wired 6.95  
R/C BOOKS: Model Control \$1; Radio Control \$1; Handbook \$ 2.25  
CRYSTALS: 27.255 Mc. Petersen Z9A . . . . . \$3.95; HOLDER .15  
**STROBOSCOPE** "Freezes" or Slows Down Motion of Machinery w. High-Speed Electronic Flash 1D21 Tube Complete ready-to-operate, 110V AC. . . . . 18.95  
**RELAY CONTROL UNIT** incl. Sensitive 10,000 ohm Sigma Relay (1 1/2 in.) Thermal Bimetal Strip, Heating Element, Hi Z Audio Choke, Mini Alnico V Magnet, Neon Lamp, Resistors, Capacitors . . . . . .99  
TUBES: XFG1, RK61, 2A4, 3A5, 1AG4, 6K4—TRANSISTORS . . . . .99  
Storage BATTERIES: Mini, 6V, NT6 \$2.45; 2 Volts 27A Hour Diehl PM MIDGET MOTOR, 27 VDC 10,000 RPM, 2"x1"x1" . . . . . 1.95  
Sens. Sigma RELAYS 10K ohm 2 Ma DC or 110V AC . . . . . .85  
SPDT 95c; SPST . . . . . .85



**GYRO ELECTRONICS** 325-P CANAL ST., N. Y. 13, N. Y.

## GET INTO ELECTRONICS

You can enter this uncrowded, interesting field. Defense expansion, new developments demand trained specialists. Study all phases of radio & electronics theory and practice: TV, FM; broadcasting; servicing; aviation, marine, police radio. Prepare for good pay, 18-month course. Graduates in demand by major companies. H. S. or equivalent required. Begin January, March, June, September, Campus life. Write for Catalog.

**VALPARAISO TECHNICAL INSTITUTE**  
Dept. PE Valparaiso, Indiana



# LIFETIME GUARANTEED

# TUBES

**SAVE**

## BRAND NEW PICTURE TUBES

- RCA Licensed
- One Year Unconditional Guarantee.

Type	Price	Type	Price
10BP4	\$11.90	17BP4	\$20.63
12LP4	14.38	19AP4	24.61
14BP4	16.85	21AP4	28.79
16RP4	19.38	21EP4	28.79
16LP4	19.38	24AP4	42.50

Picture Tubes shipped F.O.B. Harrison, N. J.

## NEW INDOOR ANTENNA

Both UHF and VHF. Brings better reception than most outdoor antennas. Use on top of TV. **\$3.99 each**  
List price \$9.95

Lot's of 3 **YOUR PRICE \$3.29** each  
**FREE BONUS BOX**

With Every \$25 Order

- 1 RCA Cheater Cord
- 10 Assorted resistors
- 10 Assorted 2 Color "blank" tube
- 1 6B26GT tube
- 1 6AU6 tube
- 1 6CB6 tube

## FREE CLOCK RADIO

Within 30 Days With Every \$125 Purchase with famous Wakemaster clock radio wakes you up to music or alarm. movement purchased outright from MAJOR BRAND for \$17.95. In ivory or rust.

## FREE GIFT CERTIFICATE\*

Worth \$5 toward the purchase of any of our merchandise on future orders will be \*Free Gift Certificate cannot be used to obtain another certificate unless order is \$55 or more.

## USED TV SETS

Picture	Tube	Guaranteed to Work!	Price	GE
• Emerson	• RCA	• Zenith	• Caphart	• Others
• Motorola				
10" SET	Table Model	Console	\$16.95	\$19.95
12" SET	Table Model	Console	\$22.95	\$24.95
14" SET	Table Model	Console	\$27.95	\$31.00
16" SET	Table Model	Console	\$32.00	\$34.95
17" SET	Table Model	Console	\$37.00	\$39.00

All prices F.O.B. Harrison, N. J. Prices on request for 19", 20", 21" and 24" sets.

• We guarantee to replace tubes labeled MAJOR BRAND forever • Each tube Individually Boxed and Guaranteed For Life • Over A Half Million Tubes Always In Stock • Immediate Shipment • Free Postage On All Orders With Full Remittance

## HERE'S HOW LIFETIME GUARANTEED TUBES SAVE YOU MONEY

• There are fewer "call backs" • There are no "out of date" tubes • "Peak Performance" testing in our fully equipped Testing Department before shipment guarantees quality.

0Z4	.43	5BQ7	.89	6BK5	.68	6V6GT	.46	12BZ7	.61
1A4P	.33	5AW4	.75	6BK7	.76	6W4GT	.39	12CU6	.95
1A7GT	.43	5J6	.63	6BL7GT	.75	6W6GT	.53	12CU6	.45
1B3GT	.65	5T4	.69	6BN6	.59	6X4	.34	12SJ7	.45
1C5GT	.41	5U4G	.43	6BQ6GT	.78	6X5	.34	12SK7	.45
1D5GP	.43	5UB	.74	6BQ7	.78	6X8	.73	12SN7GT	.56
1E7GT	.41	5V4G	.59	6BYS6	.58	6Y6G	.55	12SQ7	.37
1G6GT	.41	5Y3	.31	6BZ7	.88	7A4	.45	12SR7	.45
1H4G	.43	5Y4G	.36	6C4	.37	7A5	.53	12X4	.37
1H5GT	.47	5Z3	.41	6C5	.35	7A6	.45	14A7	.42
1J6GT	.47	6A7	.57	6CB6	.49	7A7	.43	14B6	.38
1L4	.45	6A8	.45	6C6G	1.15	7A8	.45	14C7	.50
1L6	.55	6B84	.43	6C6	.48	7B5	.39	19B6GG	1.15
1L4A	.57	6AC7	.67	6E5	.44	7B6	.42	19T8	.65
1L6A	.47	6AF4	.79	6F5	.37	7B7	.41	24A	.39
1L8A	.57	6AG5	.50	6F6	.38	7B8	.45	25AV5GT	7.4
1LCS	.49	6AG7	.69	6G6	.40	7C4	.39	25BQ6GT	.78
1LC6	.47	6AH6	.69	6H6	.38	7C5	.42	25L6GT	.47
1LD5	.57	6AJ5	.70	6J4	1.79	7C6	.43	24W4GT	.43
1LE3	.57	6AK5	.54	6J5	.39	7C7	.45	25Z5	.37
1LG5	.57	6AL5	.39	6J6	.47	7E5	.45	27	.25
1LH4	.64	6AQ5	.46	6J7	.43	7E6	.55	35A5	.46
1LNS	.47	6AR5	.46	6J8G	.85	7E7	.70	35R5	.50
1NSGT	.50	6A55	.48	6K6GT	.37	7F7	.59	35CS	.50
1R5	.50	6A56	1.70	6K7	.39	7F8	.70	35L6GT	.47
1S5	.42	6A57G	2.19	6K8	.65	7G7	.75	35W4	.34
1T4	.50	6A76	.39	6L6	.68	7H7	.50	35Y4	.34
1U4	.47	6AU4GT	.65	6L7	.42	7J7	.75	35Z3	.39
1U5	.42	6AU5GT	.59	6N7	.60	7K7	.75	35Z5GT	.34
1V2	.65	6AU6	.42	6Q7	.40	7L7	.75	50A5	.46
1X2	.61	6AV5GT	.65	6S4	.40	7N7	.50	50B5	.50
2A3	.55	6AV6	.39	6S47	.45	12AT6	.37	50C5	.50
2A5	.55	6AX4GT	.60	6SC7	.48	12AT7	.66	50L6GT	.43
2A7	.55	6AX5GT	.57	6SG7	.41	12AZ7	.63	75	.42
3A4	.51	6B4G	.52	6SH7	.43	12AU6	.41	76	.42
3A5	.50	6B8	.69	6S17	.43	12AU7	.53	77	.38
3AL5	.45	6B8A	.47	6SK7	.45	12AV6	.35	78	.38
3AU6	.46	6BA7	.58	6SL7GT	.55	12AV7	.67	80	.34
3BC5	.54	6BC5	.47	6SN7GT	.55	12AX4GT	.65	84	6Z4
3BN6	.70	6BC7	.80	6SQ7	.39	12AX7	.58	117L7GT	1.09
3CB6	.52	6BEG	.42	12B4	.68			117N7GT	1.09
3Q4	.46	6BF5	.40	6SS7	.41	12B6A	.46	117P7GT	1.09
3Q5GT	.57	6BF6	.50	6T4	.95	12B6B	.48		
3S4	.47	6BG6G	1.15	6T8	.68	12B6E	.46		1.09
3V4	.47	6BH6	.50	6U8	.75	12BH7	.60		1.723
4BZ7	.95	6BJ6	.47	6V3	.80	12BY7	.65		117Z6GT

WE PAY ALL POSTAGE on orders shipped in USA, Territories and APO's. Send only purchase price of merchandise. Please include approximate postage on foreign shipments. All orders subject to prior sale. Add 25c handling on orders under \$5.00. Quantity users write for special discount.

Write For FREE Tube List—Order Blank—and FREE Sample Tube Carton. We want YOU On Our Mailing List!  
**SPECIAL SURPRISE**  
Mention where you saw our ad and we will send you FREE three 6SN7GT's with any order of \$10.00 or more.

# MAJOR BRAND TUBE CO.

Romano Bldg.

Harrison, N. J.

Write Dept. 9-PE

ESsex 4-1106

**KLIPSCH**  
**SHORTHORN**  
 corner horn  
 speaker system



Designed and manufactured by the originator of the KLIPSCHORN speaker system, the SHORTHORN is second only to the Klipschorn system in performance. Using coordinated acoustic elements, including filters, it offers exceptionally smooth response, free from distortion. Back loading horn extends bass range without resonance.

Available in kit form, with or without drive system. Prices from \$39 for the do-it-yourself horn kit to \$216 for assembled horn with KLIPSCH ORTHO 3-way drive system installed. Write for literature.

**KLIPSCH & ASSOCIATES**  
 HOPE, ARKANSAS

**F.C.C. LICENSE**

**QUICKLY!**

Correspondence or Residence Preparation for FCC Examinations. Results Guaranteed.

Our specialty is preparing you to pass FCC license examinations. Beginners get 2nd class license in 8 weeks, 1st class in 4 additional weeks. Students with background often finish more rapidly.

Write For Free Booklet

**GRANTHAM School of Electronics**

Desk 3A  
 1505 N. Western Ave.  
 Hollywood 27, Calif.

Desk 3A  
 821 19th St. N. W.  
 Washington, D. C.

**GARAGE DOOR  
 OPENER** Actuator Mechanism **\$24.50**

EASY TO INSTALL, SAFE, RELIABLE

WRITE for interesting free information ... TODAY

**P. E. HAWKINS CO.**

631 PROSPECT KANSAS CITY 24, MO.

**ENGINEERING  
 DEGREE IN  
 27 MONTHS**

**B. S. DEGREE**, Aeronautical, Chemical, Civil, Electrical, Mechanical and Electronic Engineering (inc. Radio and TV), Drafting, One-year, G.I. Government approved. Low rate. Earn bond. Large industrial center. Students from 48 states, 21 countries. Demand for graduates. Enter September, December, March, June. Write today for catalog. 2396 E. Washington Boulevard, Fort Wayne 2, Indiana.

**INDIANA TECHNICAL COLLEGE**

unfinished chassis, white on painted panels and other dark-colored objects.

Curved lettering may be made by cutting the words into individual letters and then putting them on in alignment with a length of small-diameter wire bent to the desired shape and held in place with a couple (or more) pieces of Scotch tape. Cut the wire longer than the length of the lettering and put the tape where no letters are to appear.

—F. H. T.

**SCREWDRIVER STARTS SMALL NUTS**

Small nuts in hard-to-reach places can be started quite readily by using a grip-per-type screwdriver. As shown in the pho-

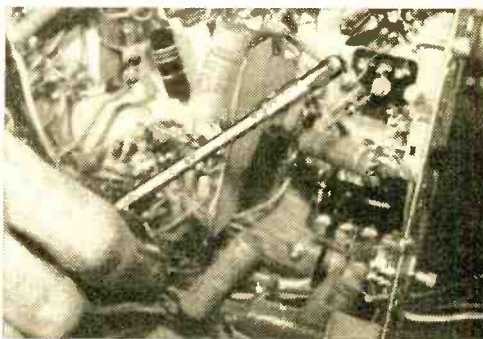

to, such a screwdriver is fitted with two small metal springs at the end of its blade. Although primarily designed for grabbing small screws, this tool works very nicely on nuts.

—C. A. P.

**METAL SPACERS**

When constructing electronic equipment, there is often a need for a metal spacer of the right size. To assure an adequate supply, buy an assortment of brass telescopic tubing at the nearest model and hobby shop, and make your own. This tubing is usually sold in one-foot lengths. The cost depends on the diameter and will range from 15 to 30 cents per length.

To make the spacer, simply select the correct-size tubing for the screw being used, cut to the proper length with a hacksaw, and dress the ends with a file. A thick-walled spacer can be made by adding the next two or three larger sizes before cutting.

The following table lists the size of tubing required for each of the most-often-used machine screws:

Screw Size	Tubing Size
2-56	1/8" OD x .014" wall
4-36 or 4-40	5/32" OD x .014" wall
6-32	3/16" OD x .014" wall
8-32	7/32" OD x .014" wall
10-24 or 10-32	7/32" OD x .014" wall
12-24	1/4" OD x .014" wall
1/4-20	9/32" OD x 0.14" wall

—J. E. P.



# Lafayette Brings You Super Values!

## 4 TRANSISTOR SUPERHET POCKET RADIO KIT WITH BUILT-IN ANTENNA POCKET SIZE 1 3/8" x 2 1/2" x 3 3/4" REQUIRES NO EXTERNAL ANTENNA OR GROUND

A POWER PACKED RECEIVER WITH 2 I.F. STAGES AND 2 RC COUPLED AUDIO STAGES

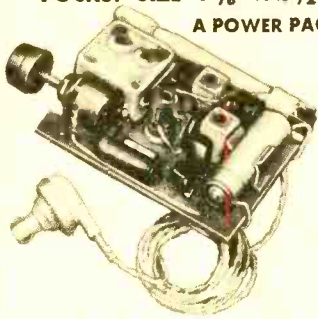

### COMPLETE PARTS INCLUDING TRANSISTORS

The exceptional sensitivity characterizing this receiver, making external antenna and ground unnecessary, stems from the use of the new Poly-Vari-Con miniature variable condenser and properly matched loop, oscillator coil and I.F.'s. This circuit performs amazingly over the entire broadcast band. The four transistors (2 high frequency and 2 audio types) plus a germanium diode provide a miniature carpiece with power to spare. Truly miniaturized, the entire set can be mounted on a bakelite board 2 1/2" x 3 3/4" as illustrated, and can be mounted in an inexpensive plastic box.

### COMPLETE LIST OF PARTS LESS EARPHONES AND CASE

We supply all the basic electronic components including 3" x 3 3/4" undrilled mounting board and leave cabinet size and layout to your ingenuity. Four G.E. transistors, (1-2N136, 1-2N135, 2-2N107) are included as well as the matched RF and IF components and crystal diode detector. All other parts such as resistors, condensers, brackets, hardware, etc. including miniaturized electrolytic condensers, volume control and battery are provided. Construction aids and schematic diagram included.

CI-101. Complete parts, less earphones and case... Net 19.10  
MS-260. Super powered dynamic earphone ..... Net 3.95



### FM-AM TUNER KIT

Basic FM-AM Tuner having outstanding specifications and delivering astonishing performance — all at a budget price in easily assembled kit form.

**32.50**

- AFC DEFEAT CIRCUIT WITH FRONT PANEL CONTROL
- FOSTER-SEELEY DISCRIMINATOR CIRCUIT
- GROUNDED GRID TRIODE AMPLIFIER
- 20-20,000 CPS RESPONSE

Choose this 7 tube compact high-fidelity FM-AM tuner whose characteristic features are found in units costing many times as much, and whose performance is unheard of at this low price. There are two front panel controls, a function control for AM, FM, PHONO, TV and a tuning/AFC defeat control. Features Armstrong FM circuit with limiter and Foster-Seeley discriminator. Simplified tuning with slide-rule dial and flywheel counterweighted mechanism, high impedance phono input and high impedance audio output.

### SPECIFICATIONS

FREQUENCY RANGE: FM 88-108MC, AM, 530-1650 KC. ANTENNA INPUT: FM, 300 ohms, AM Ferrite loopstick and high impedance external antenna. DISTORTION: Less than 1% at rated output. FREQUENCY RESPONSE: FM, +5 db 20 to 20,000 cps, AM ± 3 db 20 to 5000 cps. SENSITIVITY: FM, 5 UV for 30 db quieting, AM, Loop sensitivity 80 UV/meter. SELECTIVITY: FM, 200 KC bandwidth, 6 db down; 375 KC FM discriminator peak to peak separation, AM, 8 KC bandwidth, 6 db down. IMAGE REJECTION: 30 db minimum. HUM LEVEL: 60 db below 100% modulation. TUBE COMPLEMENT: 2-12AT7, 1-6BE6, 1-BA6, 2-6AU6, 1-6AL5 plus selenium rectifier. SIZE: 5 1/4" high x 3 3/8" wide x 9 1/2" deep (excluding knobs). CONSUMPTION: 30 watts, for 110-120V 60 cycle A.C. Attractive etched copper-plated and lacquered finish. Less metal case. Shpg. wt., 9 lbs.

KT-100 ..... NET 32.50  
ML-100 ..... Metal cage for above, Shpg. wt., 3 lbs. .... 5.00

### 2 TRANSISTOR POCKET RADIO KIT

Packed into a 2 1/2" x 3 1/2" x 1 1/4" plastic case. This Two Transistor plus crystal diode radio kit offers many surprises, utilizing a regenerative detector circuit with transformer coupled audio stage, gives you high gain and excellent selectivity. Pulls in distant stations with ease with more than ample earphone volume. Kit comes complete with two transistors, crystal diode, loopstick, Armstrong discriminator audio transformer, resistors, condensers, plastic case, etc. Including schematic and instructions.

KT-68A Complete Kit less earphones. Net 11.80  
MS-200 New Super Power Dynamic Earphone. Ideal for Transistor Circuit Imp. 8000 ohm, D.C. 2000 ohm ..... 3.95

### NEW POCKET AC-DC VOM MULTITESTER 2,000 ohm per Volt on AC & DC

• Completely wired — Not a kit  
Accurate VOM with a sensitivity of 2000 ohms per volt on both AC and DC. Single selector switch. 3" 160 amp. meter. Scales: DC Volts: 0-10-50-500-1000; AC Volts: 0-10-50-500-1000; Ohms: 0-10K, 0-1 Meg; DC Current: 500 ua and 500 ma; Decibel: -20 to +22, +20 to 36; Capacity: 250 mmf ± 2 mfd and .005 to .01 mfd. Heavy plastic panel, metal bottom. 4 1/4" x 3 1/2" x 1 3/8". With batteries and test leads. Shpg. wt. 4 lbs.

RW-27A ..... 7.95

### LAFAYETTE SIGNAL GENERATOR



COMPLETELY WIRED AND TESTED! ACCURACY AND QUALITY GUARANTEED!

**22.50**

- FREQUENCY 120KC to 260MC!
- 120KC to 120MC CN FUNDAMENTALS!
- 30 DAY TRIAL PERIOD! FULL REFUND IF YOU ARE NOT SATISFIED FOR ANY REASON

Completely wired and tested instrument. Do not confuse with kits sold in the same price range. Has the quality and accuracy of instruments selling for 3 to 4 times as much. Six overlapping ranges — 120KC to 320KC, 320KC to 1000KC, 1MC to 3.2MC, 3.2MC to 11MC, 11MC to 38MC, 37MC to 130MC — all on fundamentals — calibrated harmonics from 1205KC to 260MC. Switch between internal modulation at 400 cps or any external source at other frequencies. 400 cps signal can be used separately. Outputs are unmodulated RF, modulated RF and 400 cps audio. RF output is in excess of 100,000 micro volts. Jacks are provided for high or low RF output.

Highly stable special circuit design. Fine adjust RF control. AF output 2-3 volts, input 4 volts, across 1 megohm. 5 inch etched dial plate — protected by clear plastic bezel. Common AF terminals for EXT-MOD input and INT-AF output eliminates need for special connectors. Gray metal case — carrying handle — complete with leads, line cord and plug. For 105-125V, E0-60 cycle A.C. Shpg. wt., 8 lbs.

LSG-10 — Signal Generator ..... 22.50

**Lafayette Radio**  
100 SIXTH AVE.  
NEW YORK, N.Y.

DEPT. P-1

BOSTON 10, MASS., 110 Federal St.  
NEWARK 2, N. J., 74 Central Ave.  
ELMFIELD, N. J., 139 W. Second St.  
BRONX 58, N. Y., 542 E. Fordham Rd.

Include postage with order.

Send FREE 164-Page Lafayette Catalog



FREE

Name \_\_\_\_\_

Address \_\_\_\_\_

City \_\_\_\_\_ Zone \_\_\_\_\_ State \_\_\_\_\_

# LEARN A FOREIGN LANGUAGE QUICKLY!

Start to speak  
**SPANISH**  
**FRENCH**  
**GERMAN**  
**ITALIAN**

*in only 7 days*



It's a fact, the new Language Phone Method will have you speaking words, phrases, even entire sentences within one short week! With this *proven* method you learn a foreign language just as you would a popular song. This way, you listen to the voice of your language professor electrically transcribed on high-fidelity unbreakable records. At the same time you see the words he is speaking in a printed supplementary manual. What's more, you learn to speak *correctly*, with exactly the right inflections—true Parisian French, true Heidelberg German, etc.

### Send for Free Booklet

Mail coupon below for the free booklet that tells you all about the new Language Phone Method.

### MAIL THIS COUPON

Funk & Wagnalls Company, Dept. PE-1  
153 East 24th St., New York 10, N. Y.  
Please send me free booklet about the quick, easy way to learn  
( ) Spanish, ( ) French, ( ) German, ( ) Italian, and tell  
me how I may obtain a complete Language Phone Kit for seven  
days' free trial.

Name .....  
Address .....  
City ..... Zone ..... State .....

## UNUSUAL OPPORTUNITY TO BUY DIRECT

# PERSONALIZED POCKET RADIO



This is no ordinary pocket radio—it's equivalent in sensitivity to any household radio—ruggedly built for use—not a toy—beautiful case. Look at the 3 tube construction. Special ferrite antenna unaffected by hand capacity (no fade out) 530 to 1650 Kc—with CD freq. plainly marked. Case measures 5 5/8" x 2 1/4" x 1 1/4", designed for extra ear phone. Equipped with B battery & 40" ear cord and ear phone. You'll use this radio every day—at sporting events, while riding, walking, at work, at play, etc.—for all sorts of pleasure. Order yours NOW.



Back view—  
case removed

Sharp selectivity & sensitivity

send only \$5.00 (ck or M.O.) and pay postman \$14.95 plus small postage charge, or send \$19.95 for postpaid delivery. We positively guarantee this imported radio to please on arrival, and during operation; also a 90 day parts guarantee.

MINI-TRONICS CO. 5030 LINDEN LINCOLN, NEBR.

# ATTENTION

- Hobbyists
- Club Members
- Study Groups

Subscriptions to **POPULAR ELECTRONICS** at special bulk rates are available to club members, study groups, employee groups, schools, etc.

For information, write to:  
**POPULAR ELECTRONICS, Dept. 1016**  
366 Madison Ave. New York 17, N. Y.

## Do You Really Have Hi-Fi?

(Continued from page 84)

test little more than your credibility, patience, and tolerance to noise. On the other hand, the fully modulated grooves with the incredible amplitude peaks that Cook manages to squeeze into them do provide a fairly accurate test of any phono's ability to track, comply, and reproduce.

If, for example, your system can get through and survive some of the bands on *The Compleat In Fidelity* (Cook "Longe Plae" No. 1044), you can be sure it will handle almost any music with the greatest of ease. One side of this utterly unbelievable pressing contains such items as the sounds of jet aircraft, steam locomotives, crying babies, Mexican firecrackers, gas engines, and what is probably the most horrible organ recording in history complete with a high percentage of distortion and climaxed by the buzzing of a fly trapped in the organ—a buzzing which is so annoyingly realistic that you are ready to swat your speaker cabinet, perhaps with "Longe Plae" No. 1044 itself.

In a sense, *The Compleat In Fidelity* is the gruesome climax to a series of "pure sound" records which Cook has been releasing steadily in recent years. A typical one is *Out of This World* (Cook Long Play No. 5012). Side 1 of this release contains earthquakes and ground tremors. If your turntable rumbles, it may actually help the sound here. Often, the two can't be distinguished. In any case, for those who would rather hear their earthquakes than see them, this disc might prove engaging.

The flip side, containing sounds picked up from outer space, is labeled *Iono-spheric Swishes, Whistlers, Tweeks, The Dawn Chorus*. Here, the sounds are interspersed with a running interview in which a Dartmouth professor explains the unearthly sonic phenomena you are hearing. Somehow, we can't help but feel that too often this interview resembles one of Bob and Ray's satiric take-offs; we never quite know whether Mr. Cook is pulling our leg while presumably pulling these weird sounds from the rarefied regions above *terra firma*.

Be that as it may, Mr. Cook may have had his head in the clouds on this one, but the down-to-earth value of such a release is its challenge to the industry to record and press discs containing music that can boast such dynamic range and presence. The extent to which the recording industry is meeting this challenge and supplying the demand for top quality, wide-range recordings is best illustrated by a number of recent "show-off" releases to be discussed next month.



HE WON'T EAT ANYTHING BUT BURGESS BATTERIES!

LASTING POWER  
UNIFORM DEPENDABILITY  
STEEL CLAD GUARANTEE

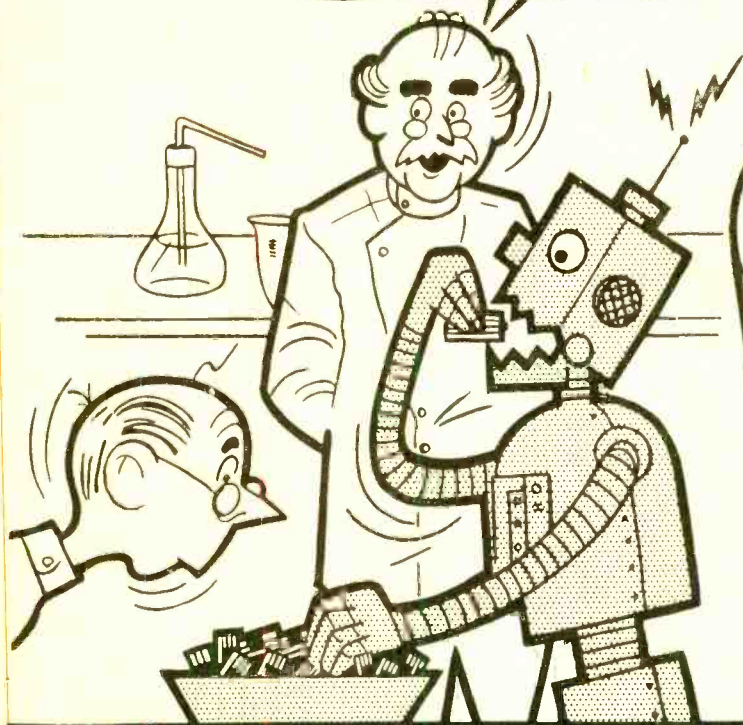

Powerful, fresh Burgess batteries are outstanding for dependable long life and uniform high quality. They're guaranteed! Ask for them!



MAKERS OF THE FAMOUS RADAR-LITE

**AMAZING NEW PERSONAL POCKET RADIO**



**LISTEN WHILE YOU WALK DOWN THE STREET!**  
Slips in any pocket—wt. only 7 ozs. Size 2 3/4 x 4 3/8 x 1 1/4". Beautiful Black Gold Plastic Case. NO HOOK-UPS—NO WIRES—NO PLUG-INS! Self-contained. 150-hour life flashlight batteries and BUILT-IN ANTENNA. POSITIVELY NO AERIAL. HOOK-UPS EVER! GUARANTEED RECEPTION OF RADIO STATIONS TO 50 MILES up to 1500 miles for powerful stations! New patented super-regenerative Duo-triode tube and transformer audio stage for sharp selectivity and sensitivity! Easy to use top tuner (while walking). Tiny plastic personal carrying LETS YOU ALONE LISTEN WHILE YOU WALK, VISIT, WORK, RIDE OR SLEEP ANYTIME—ANYWHERE. MONEY-BACK GUARANTEE AND ONE YEAR SERVICE GUARANTEE.  
**SEND ONLY \$5.00** (ck. mo) and pay postman \$14.95 plus postage on delivery or send \$19.95 for postpaid delivery. GET YOUR TINY-TONE REAL POCKET RADIO now and be ready to listen to Civil Defense Alarms, news, music, sports, etc. on a moment's notice without bothering those around you. NOT AN UNWORKABLE INCOMPLETE KIT OR PLAYING BUT A REAL POCKET RADIO! Shipped complete with batteries—Ready to listen! Available only from: WESTERN RADIO, DEPT. APL-9, Kearney, Nebr.

LEARN  
**RADAR MICROWAVES TRANSMITTERS**  
**CODE TV RADIO**

Phila. Wireless Technical Institute  
1533 Pine St. Philadelphia 2, Penna.  
A Non-Profit Corp. Founded in 1908  
Write for free catalog "P"

## What About Tech Writing?

(Continued from page 74)

sor B. B. Gamzue of New York University puts it: "These men are finding that writing is a professional tool as valuable to them as the slide rule. By instituting the technical writing course, the engineering college has fulfilled an obligation to its students and their future employers."

**The "How-to-Do-It" Need.** Beyond the lab report, the specialized magazine article, the formal specification, and miscellaneous intra-industry communications, is the large area of technical-instruction-writing that is more generally taken to be the domain of the full-time professional tech writer. Such a writer may be employed by the firm producing the items he writes about. Or, he may work for a large publishing house which has a technical writing division. Or, he may be on the staff of a "job-house," which specializes in technical manuals and related literature. Or, he may write courses for a technical school.

Regardless of where they are employed, such writers have one job in common: telling others how to use something or how to do something. To the extent that an understanding of theory is needed for intelligent operation, the writer must also include something of the "how" and "why"

behind a piece of equipment or process.

A tech writer's understanding of theory need not be as profound as that of the engineer's—but it must be enough to place the writer on "speaking terms" with his area of interest. A supply of such writers, plus industry's willingness to use them instead of forcing their engineers to "double in brass" is anticipated by many.

**Getting Started.** The ground rules for getting into tech writing are still flexible; this is a relatively young field. Many start as technicians or engineers with little previous interest in writing. But most beginners with a bent for writing, plus an interest and background or training in things technical, find their way into electronics or other fields of technical and business activity. Either way, the ability to explain—in writing—accompanied by a definite liking for this kind of work are "musts."

Within the area of tech writing itself, there are several specialized jobs known by different titles. A "parts lister," for example, catalogs a large piece of equipment down to its last resistor and solder lug. Painstaking and often tedious, such work has provided many with an avenue of approach to becoming full-fledged technical writers.

Writers themselves are often graded as "senior" and "junior," depending on per-

# 40¢ FOR ANY TUBE

WE WILL NOT BE UNDERSOLD



### We Have OVER 1000 USED TV SETS

At All Times In Our Huge Warehouse. Buy one or more of these WORKING TVs to sell or use as your own second set! All sets in GOOD WORKING condition! Your Choice—Console or Table Model.

10".....	\$23.00	19".....	\$58.00
12".....	\$28.00	20".....	\$64.00
14".....	\$33.00	21".....	\$72.00
16".....	\$40.00	24".....	\$99.00
17".....	\$46.00		

When ordering TVs, state whether table model or console is desired. Also preference on make of set. All TVs sent railway express F.O.B. Newark. On any quantity WIRE or CALL today.

#### SAME DAY SHIPMENT OF ALL ORDERS!

FREE BONUS ANTENNA GIVEN WITH ANY TV SET ORDER!

SEND for our FREE complete TUBE & PARTS LIST and order blank.

FREE POSTAGE in U.S.A. and Territories on orders over \$5.00. 2% handling charge on orders under \$5.00. 25% deposit required on C.O.D.s. Please send approximate postage or freight on Canadian and foreign orders. Subject to prior sale.

DON'T PAY MORE FOR TESTED LONG LIFE DEPENDABLE RADIO & TV TUBES • BUY VIDEO • INDIVIDUALLY BOXED—ALL GUARANTEED FOR ONE YEAR OR YOUR MONEY BACK WITHIN 5 DAYS—37.00 Per Hundred

Some Standard Brand—Others With Famous VIDEO Brand

0A2	2X2	6AC7	6BK5	6SG7	7FR	12V6GT
0A3	3A4	6AG5	6BK7	6SH7	7N7	12X4
0A4	3A5	6AF4	6BN6	6SJ7GT	7Q7	14A7
0B2	3AL5	6AH4GT	6BL7GT	6SK7GT	7Y4	14B6
0C3	3AU6	6AK5	6B06GT	6SL7GT	7Z4	14C7
0Z4	3BC5	6AL5	6B07	6SN7GT		14C8GG
1A7GT	3CB6	6AM8	6BY5G	6SQ7	12AH7GT	19T8
1B3GT	3Q4	6AN4	6BZ7	6SS7	12AT6	2A4
1C7G	3Q5GT	6NB	6C4	6SV7	12AT7	25A5SGT
1F4	354	6AQ5	6CB6	6T8	12AU6	25B0GGT
1H4	3V4	6AQ7GT	6CD6G	6U4GT	12AU7	25C0GG
1HSGT	4B27	6AS5	6CF6	6U7G	12AV6	25C06
1J6GT	4B97	6AS7G	6CS6	6U8	12AV7	25D0GGT
1L4	5AM8	6AT6	6CU6GT	6V3	12AX4GT	25W4GT
1L6	5AN8	6AU4GT	6ES	6V6GT	12AX7	25Z6GT
1LC5	5AQ5	6AU5GT	6HG7	6W4GT	12AZ7	35L6GT
1LH4	5ATR	6AU6	6J4	6WG6T	12B4	35W4
1LN5	5AW4	6BV5GT	6JS7	6X4	12BA6	35Y4
1NSGT	5AZ4	6AV6	6J6	6K5GT	12BE6	35Z3
1S4	5J6	6AX4GT	6KG6T	6K8	12B87	35Z5GT
1S5	5T4	6BA6	6L6	6V6G	12BY7	50A5
1T4	5TR	6AX5GT	6H7GT	7A5	12C06	50B5
1U4	5U4G	6BC5	6S4	7A7	12C47	50C5
1U5	5UR	6BC7	6S7G	7B5	12SQT	50L6GT
1V2	5V4G	6BE5	6SA7	7B7	12SH7	50T
1X2	5V6GT	6BF5	6SR7Y	7C5	12SJTGT	117N7GT
2A7	5Y3	6BG6G	6SC7	7C7	12SK7	117P7GT
2D21	5Y4G	6BH6	6SF5	7C7	12SN7GT	117Z3
	6AB4	6BJ6	6SF7	7E7	12SQ7	

FREE RCA "CHEATER" CORD GIVEN WITH ANY TUBE ORDER OF \$7.00 OR MORE!

# VIDEO ELECTRIC COMPANY

79 CLINTON PL. NEWARK, N. J. Phone Humboldt 4-9848



sonal experience and salary earned. The writer prepares the text of a handbook or manual, confers with product engineers, researches the equipment, may run tests on it under plant supervision, and orders art work for illustrating his book. Sometimes he acts as a "project director," supervising the work of a team of writers, parts listers, draftsmen and layout artists all engaged in a series of books.

When the term "editor" is employed in such a situation it can mean practically anything: the "editor" can be anyone from the general manager to a senior tech writer to a nontechnical person who scans every line for grammatical correctness and conformance to handbook requirements. This last item is of great importance, particularly in government-requisitioned manuals. There are government specifications for the manuals as well as for the equipment itself, and a handbook—regardless of how well it's written and how accurate it is technically—will be rejected if it does not present its information in the organized form demanded by the specification.

Many tech writers find these demands too restrictive; when the job is voluminous and complex, the services of an editor who is a specialist at interpreting government specifications may be required.

**Pay and Rating.** Because it's a fairly new field, salaries in tech writing vary. Generally, the beginner with no experience but some training and aptitude will start as a "trainee" and earn up to \$2.00 an hour. As his experience and technical understanding grow, so do job advancement and salary. A senior writer with four or more years on the job may earn from \$3.50 to \$4.50 an hour. The figures vary with the type of company, the nature of the work, and the demand for and supply of writers at the time.

Invariably, a man seeking a job in tech writing will be given some kind of test at his interview. He may be shown a number of standard circuits and asked to explain them. He may also be handed a poorly written paragraph and asked to rewrite it.

A unique test has been developed by Emil Filepp, a Project Manager in the Technical Writing Service at McGraw-Hill Book Company, New York City. Filepp asks an applicant to write instructions on "How to Fill an Inkwell." The result, according to Filepp, ". . . is graded for spelling, punctuation, use of words, sentence structure, economy of language. In addition, it shows how well the writer can organize written material, and whether the applicant has a good feeling for equipment and an appreciation of detail."

For a home test, Filepp suggests that

# Complete Training

## FOR BETTER RADIO-TV SERVICE JOBS

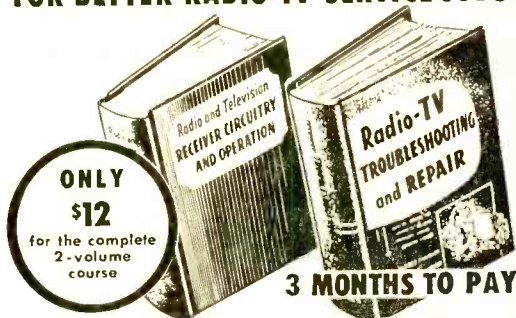

Let these two great new Ghirardi training books teach you to handle all types of AM, FM and TV service jobs by approved professional methods—and watch your efficiency and earnings soar!

Each book is brand new. Each contains the latest data on the latest methods and equipment—NOT a re-hash of old, out-of-date material. Each is co-authored by A. A. Ghirardi whose famous RADIO PHYSICS COURSE and MODERN RADIO SERVICING were, for 20 years, more widely used for military, school and home study training than any other books of their type!

## THE NEW Ghirardi RADIO-TV SERVICE LIBRARY

Almost 1500 pages and over 800 clear illustrations show step-by-step how to handle every phase of troubleshooting and servicing.

### 1—Radio and Television Receiver TROUBLESHOOTING AND REPAIR

A complete guide to profitable professional methods. For the beginner, it is a comprehensive training course. For the experienced serviceman, it is a quick way to "brush up" on specific jobs, to develop improved techniques or to find fast answers to puzzling service problems. Includes invaluable "step-by-step" service charts, 820 Pages, 417 illus., price \$6.75 separately. (Outside U.S.A. \$7.25)

### 2—Radio and Television Receiver CIRCUITRY AND OPERATION

This 600-page volume is the ideal guide for servicemen who realize it pays to know what really makes modern radio-TV receivers "tick" and why. Gives a complete understanding of basic circuits and circuit variations; how to recognize them at a glance; how to eliminate guesswork and useless testing in servicing them. 417 illus. Price separately \$6.50 (outside U.S.A. \$7.00).

### New low price . . . you save \$1.25

If broken into lesson form and sent to you as a "course," you'd regard these two great books as a bargain at \$50 or more!

Under this new offer, you save \$1.25 on the price of the two books—and have the privilege of paying in easy installments while you use them! No lessons to wait for. You learn fast—and right!

### STUDY 10 DAYS FREE!

Dept. PE-96, RINEHART & CO., Inc.  
232 Madison Ave., New York 16, N. Y.

Send books below for 10-day FREE EXAMINATION. In 10 days, I will either remit price indicated or return books post-paid and owe you nothing.

- Radio & TV CIRCUITRY & OPERATION (Price \$6.50)
- Radio & TV Receiver TROUBLESHOOTING & REPAIR (Price \$6.75 separately)

Check here for MONEY-SAVING COMBINATION OFFER . . . Save \$1.25. Send both of above big books at special price of only \$12.00 for the two. (Regular price \$13.25 . . . you save \$1.25). Payable at rate of \$3 after 10 days if you decide to keep books and \$3 a month for 3 months until the total of \$12 has been paid.

Name .....

Address .....

City, Zone, State .....

Outside U.S.A.—\$7.25 for TROUBLESHOOTING & REPAIR; \$7.00 for CIRCUITRY & OPERATION; \$13.00 for both books. Cash with order, but money refunded if you return books in 10 days.

Rinehart Books are sold by leading book stores.

**CUSTOM BUILT • HEAVY DUTY  
CUSTOM WORK TABLES • complete**



(drawer extra)

only **\$2750**

k.d. F.O.B. factory  
(easily assembled)

1/4" Tempered Masonite on 1/4" Solid Pine  
size: 30"W x 72"L x 35"H

Also available: All steel tables, steel shelving, folding tables and folding legs. Send for Catalogs and Prices.

**Build your own heavy duty  
WORK TABLES & BENCHES . .**

Simply attach a set of A B C steel adjustable bench legs to your table top. Made of Heavy Gauge STEEL CHANNEL, engineered to safely support 5000 pounds. With 2" adjustment in height.

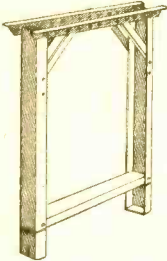

Mail check or money order. Save C.O.D. collection charges. N.Y.C. add 3% sales tax. . . ORDER TODAY. GUARANTEED

28" wide x 33" high  
**\$895** per set  
of two

**\$450** each  
f.o.b. factory

**A B C METAL PRODUCTS**  
Dept. 24, 115 W. 30 St., N. Y. 1, N. Y.

**NEW! PRINTED CIRCUIT  
Transistor Radio**

**Pocket size—works anywhere**

- Features P-N-P Junction Transistor
- Permeability tuning, Diode detection
- Printed circuit eliminates extra wires
- Batteries last for months
- Expensive hearing aid headset included
- Furnished complete, nothing else to buy



**\$9.95** Postpaid  
Only in kit form

Here is a powerful, completely portable radio, employing the latest type of transistor audio amplification and printed circuitry. Tiny size, only 2 3/8" x 3 1/2" x 3/4" fits in pocket or purse. Uses so little current, batteries last for months. Kit can be assembled by anyone with just a soldering iron. Guaranteed to work. Comes complete with plastic case, batteries, headset, all parts. Nothing else to buy. See your distributor. If he doesn't stock, write direct. Send no money. Just pay postman \$9.95 plus C.O.D. charges, or send check or money order for \$9.95 and we pay postage.

TRADYNE, INC., 11 W. MONUMENT AVE., DAYTON 2, OHIO. Dept. E-7

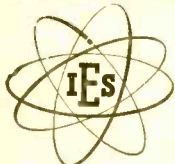

**ELECTRONIC TECHNICIANS  
ARE IN DEMAND  
TRAINED MEN ARE NEEDED NOW!**

In just 15 months you can complete Electronic Technicians training to enter this ever-growing industry. Day or evening classes. Opportunity for employment in local industry. Approved for Korean Veterans.

Terms beginning January, April, July, September

Write for Catalog 224 TODAY

**INDIANAPOLIS ELECTRONIC SCHOOL**

312 E. Washington St.

Indianapolis 4, Indiana

110

you try writing on "How to Tie a Necktie." If someone can do the job successfully, following your written instructions, you may make a successful tech writer.

Once you get your "foot in the door," you may proceed well past the threshold into a promising and lucrative career. Tech writing, itself interesting and well paying, often serves as a stepping stone to better things.

-30-

**Tuning the Short-Wave Bands**

(Continued from page 59)

Here we go into the list of reports for this month. All times shown are Eastern Standard, 24-hour system.

**Aden**—The Aden Broadcasting Station, operating on 6045 kc., is scheduled in Arabic from 1030 to 1230 except for English around 1210. (WSMC)

**Australia**—The *Radio Australia* broadcasts to Eastern North America at 0715-0845 and to Western North America at 1015-1115 are now on 11,740 kc., replacing 9615 kc. The DX tips broadcasts on Sundays remain at 0830 and 1100. (RL)

Other transmissions are: to the North Pacific and Northeast Asia at 0330-0845 on 15,210 kc., and at 1715-1930 to the same areas on 15,160 kc.; to South and Southeast Asia from 0900 to 1230 on 11,900, 9580, 7220 kc. and at 1715-1930 on 11,900 and 15,320 kc.; to Europe and the British Isles at 0100-0145 (French) and 0145-0230 (English) on 11,740 and 15,160 kc.; to the Mid-Pacific Areas at 1500-1700 on 17,840 kc. (English). (BV)

**Belgium**—The Brussels transmissions to North America are now at 1200-1245 and at 1615-1800 on 15,335 kc. and at 1815-2000 on 11,850 kc. OTC, Leopoldville, Belgian Congo, continues to relay the 1815-2000 broadcast on 9655 kc. (RL)

**Bolivia**—Try for CP38, La Paz, 9444 kc., around 0700 and 2130. This station is not on the air on Tuesdays. The slogan is *La Cruz del Sur (The Southern Cross)*. (BT)

**Brazil**—PSF, *Agencia Nacional*, 14,690 kc., can be logged at excellent level around 1730 but often is covered by c.w. QRM. PRL7, 9720 kc., Rio de Janeiro, can be heard at 1715 in Spanish. R. *Mayrinck Viega*, 9575 kc., Rio de Janeiro, is usually good at 1845 with English and Latin-American vocal music. R. *Gaucha*, PRC22, 9675 kc., Porto Alegre, is another that is often heard around 1830. (FW)

*Radio Globo*, Avenida Rio Branco 183, Rio de Janeiro, has begun daily transmissions with its new s.w. outlet on 6035 kc. and can be heard around 1830. (WRH)

**Chile**—*Radio Sociedad Nacional de Agricultura*, operating on 12,000 kc., has extended its German Hour by 30 minutes on Sundays. It is now scheduled from 1730 to 1800 with "Kleine Meisterwerke," and from 1800 to 1900 with national and popular music. The weekday schedule remains unchanged at 1940-2010 (except Monday). (WRH)

**Colombia**—*Radiodifusora Nacional*, 5010

Always say you saw it in—POPULAR ELECTRONICS



# HUGE EXPANSION SALE—UNTIL SEPT. 30<sup>TH</sup> ONLY! 53 BIGGEST DOLLARBUYS IN U.S.!

**FREE!**  
Any item In  
this ad Free  
with \$10  
order!

**ANY ITEM  
IN THIS AD  
ONLY ONE  
DOLLAR!**

**EARN FREE  
KITS IN OUR  
CREDIT-  
BONUS PLAN**  
Write for  
information  
Any order enrolls you

**FREE!  
NEW FALL  
FLYER!**  
Unmatched  
Bargains!

## World Famous **KIT KING** DOLLARBUYS—Exclusive with **LEKTRON!**

- 40 MINIATURE RESISTORS.** Subminiature, tool 1/2 & 1/5 W. Transistor hobbyists, note! 20 values: 56 ohms \$1 to 4.7 megs. Reg. \$7.
- 2-TUBE AMPLIFIER KIT.** Exc. tone & vol. Chassis, parts & diagram. Less output trans., 50L6, 35Z5 tubes. \$1 Wt. 2 lbs. Reg. \$3.50.
- 8-PC. NUTDRIVER KIT.** Plastic handle; 3/16, 7/32, 1/4, 5/16, 11/32, 3/8, 7/16" steel socket wrenches; plastic case. Wt. 1 lb. \$3.50 \$1 value.
- 20 HI-QUALITY KNOBS.** Hi-Fi, recorder, instrument types. Knurled, skirted, engraved. Brass insert w/set screws. Wt. 1/2 lb. Reg. \$7. \$1
- THREE LBS. HARDWARE.** 2,000 pcs. Ass'd. screws, springs, washers, brackets, etc. Hundreds of items! Reg. \$1 \$8.
- G-E PREAMP KIT** for magnetic cartridges. Complete w/chassis & parts. Diagram. Less 68C7 (88c extra). Wt. 1 lb. Reg. \$4.50.
- 30-TUBE SOCKETS.** 4, 5, 6, 7, 8, 9, 11-prong. Miniatures, octals, wafers, "zip-ins", moldings. Tube shields, tool \$1 Wt. 2 lbs. Reg. \$7.
- 70 STANDARD KNOBS.** Radio, TV, appliance, lab types. Ass'd. colors; bakelite & plastic. Wt. 2 lbs. Reg. \$1 \$9.
- 30 PRECISION RESISTORS.** WW & carb-51m. 30 values: 56 ohms to 1 meg. 1/2, 1 & 2 W. Some \$5, 1% tol. Wt. 1/2 lb. Reg. \$21.
- 20 AC/DC LINE CORDS** for clocks, motors, etc. Molded plugs; 2 cond. Wt. 1 lb. \$1 Reg. \$5.
- 70 MICA CONDENSERS.** Aerovox, Sangamo, C.D. 30 values: .00101 to .01 mf. to 1000V. Silver, 5% tol. Wt. 1 lb. Reg. \$15.
- 175-FT. HOOKUP WIRE.** 25-ft. rolls; ass'd. colors; insulation, stranding, #18 to 24. Wt. 2 lbs. Reg. \$1 \$3.75
- 150 COIL FORMS.** Ass'd. hermetically sealed types, miniature, bakelite & compressed forms. 20 styles. \$1 Wt. 2 lbs. Reg. \$9.
- 75 CERAMIC CONDENSERS!** Scoop! 35 ass'd. values; tubular and discs, 5 mmf to .01 mf. up to 3 KV. Wt. 1/2 lb. \$1 Reg. \$11.
- 40 POPULAR BULBS.** 1.1 to 6V. Screw & bay. types. Miniature. Wt. 1/2 lb. Reg. \$1 \$3.
- 70 RESISTORS.** Insulated, IRC, Allen-Bradley, etc. 5 ohms to 10 megs, 1/2, 1 & 2 Reg. \$11.
- 25 VARIABLES.** Air, mica and ceramic cased units. Singles & duals to 350mmf. Shaft types, tool 13 values. \$1 Wt. 1 lb. Reg. \$12.
- 10 ELECTROLYTICS.** FP & twist, tubular, rect. Ass'd. sizes; multiples tool \$ to 200 mf. to 450 V. Wt. 3 lbs. \$1 Reg. \$15.
- 4 SILICON DIODES.** Syl-vania 1N21, 1N22, 1N25, 1N105. Reg. \$8.50. \$1
- 12 SWITCHES.** Micro, push, AC, mobile, rotary. Wt. \$1 3 lbs. Reg. \$15.
- 30 POWER RESISTORS.** Wirewound, 5 to 50 W; 35 to 11,000 ohms. Cerdohm, sand-coated, vitreous, 15 values. \$1 Wt. 2 lbs. Reg. \$8.
- 70 TUBULAR CONDENSERS.** Popular makes; 30 types: .0005 to 0.5 mf to 1500 V. Wt. 2 lbs. Reg. \$12.
- 40 OIL CONDENSERS.** Long-lasting, tubular, rect. types. .005 to 1 mf up to 600 V. Wt. 3 lbs. Reg. \$1 \$15.
- 3 GERMANIUM DIODES.** Hughes subminiature, \$1 1N34, 1N51. Reg. \$3.50.
- 15 VOLUME CONTROLS.** 10 meg. values, to 0.5 \$1 meg. Wt. 1 lb. Reg. \$9.
- 70 TERMINAL STRIPS & boards.** 15 types: 1 to 20 screw & solder points. Wt. \$1 1 lb. Reg. \$5.
- 40 MOLDED CONDENSERS.** .001 to 0.1 mf up to 1000 V. Brown, black ceramic \$1 Wt. 1 lb. Reg. \$8.
- 10 AC/DC PANEL SWITCHES,** 115 V. Slide handle, SPDT. Lug terms. \$1 Wt. 6 lb. Reg. \$3.
- 115 VAC MOTOR** for fans, phono, hobby use. 1/250 HP; 3,000 rpm. W/line \$1 cord. Wt. 2 lbs. Reg. \$4.50.
- 30 POPULAR CERAMIC CONDENSERS:** disc, button, stand-off, cartoned types, 10 values: 5 mmf to .01 mf to 5000 V. Wt. 1/2 lb. Reg. \$8.
- THREE 200 MIL CHOKES,** 2 H, 60 ohms. Open frame, strap mtd. Power supply \$1 special. Wt. 2 lbs. Reg. \$6.
- 60 XFMRs & COILS.** IF, RF, ant., slug-tuned coils, chokes, 25 types! Wt. 9 \$1 lbs. Reg. \$15.
- 2 PRECISION POTS.** Dejur, 20,000 ohms; 6 watts, 1% linearity accuracy. For lab. \$1 shop. Wt. 1 lb. Reg. \$10.
- 25 MINIATURE SOCKETS.** 7-pin Amphelon, blue loss material. No mtg. plates needed. Just "ZIP-IN." \$1 Reg. \$6.
- 20 ±44 BULBS.** 6 V miniature bayonet. Reg. 10¢ \$1 ea.
- CRYSTAL RADIO KIT.** All parts mounted. Complete w/pre-drilled cabinet, germanium diode, loopstick tuner, instruc. Wt. 1 1/2 lb. Reg. \$3. \$1
- R/C SCOOP!** Chassis includes: fil. xfmr., 115VAC to 6.3 @ 1.5A; 3000 ohm relay, resistors, capacitors, etc. \$1 Wt. 2 lbs. Reg. \$8.
- 10 TRANSISTOR SOCKETS.** Hobbyists, note! For transistors, subminiature tubes. Mica filled. Reg. 24¢ ea. \$1
- 15 TWIST DRILLS,** for hand and electric drills. Tempered steel, 1/16 thru 1/4". \$1 sizes, w/plastic case. Reg. \$1 \$3.
- 15 ERIE TRIMMERS,** 8- \$1 50 mf. Reg. 85¢ ea.
- PHOTO TIMER.** 0 to 60 minutes. Panel type; rings bell alarm. Wt. 2 lbs. Reg. \$1 \$5.
- 15 VARIABLES.** 3-12 mmf, w/1" long shaft. Reg. \$1 50¢ ea.
- 6 HOBBY CHASSIS.** Pre-punched; miniature tube holes. Projects up to 5 tubes. 8" x 4" x 2". Wt. 5 lbs. \$1 Reg. \$5.
- POWER XFMR SCOOP!** Primary 115 VAC; Sec., 250 VAC (tapped @ 24) @ 25 ma.; 6V @ 6A. Wt. 4 lbs. Reg. \$1 \$9.
- 7 PILOT LITES.** Amber, enclosed. For miniature bay. bulbs. Std. panel mtg. Wt. \$1 1 lb. Reg. \$4.50.
- 4 SELENIUM RECTIFIERS.** 1N, 18VAC. Output 12VDC @ 0.25 A. Fullwave. Reg. \$1 \$2 ea.
- VEEDER-ROOT COUNTER.** Counts to 9,999. Spring return type. Reg. \$5 \$1
- SUN BATTERY & Photo electric cell.** 1 1/2" dia. Better than famed B2M for photo elec. relays. Hobbyists must. \$1 Reg. \$5
- 10,000 OHM RELAY.** Pot-ter-Brumfield type LM5. 3ma; SPDT. Reg. \$3. \$1
- 2 FERRI-LOOPSTICKS.** Lat-est types. Fast tuning, no knob needed. Sensitive covers standard broadcast band. \$1 Reg. \$2.
- 20 XMTG MICAS,** .00025 to .01 mf to 1200V. \$1 Reg. \$20.
- NAVY TELEGRAPH KEY.** Sturdy bakelite base; J-38. Reg. \$3.50. \$1
- 10 "POLY" BOXES.** Ass'd. sizes clear plastic boxes, hinged w/snaps lock. Hundreds of uses! Reg. \$2.50. \$1
- 150 RESISTORS!** Insulated & uninsulated. 30 values: 52 ohms to 1 meg. 1/2 to 2 w; 5% tol! Wt. 1 lb. Reg. \$1 \$19.

**HOW TO ORDER**

Check items wanted. Enclose check or MO. Include sufficient postage, excess returned. C.O.D. orders, 25% down. Rated, net 30 days. Print name, address and amount money enclosed in margin. PE-9

**LEKTRON SPECIALTIES**  
28 GARDINER ST. CHELSEA 50, MASS.  
Visit our salesroom at 131 Everett Ave., Chelsea

## INSTALLING YOUR OWN HI-FI?

**Don't overlook the advantages of a good separate Pre-amplifier!**



**MODEL M 100 \$39.95**  
(Self powered slightly higher)

**AT LAST!** A quality equalizer pre-amplifier at a price you can afford... Outperforms units costing twice as much. Low noise, low distortion, and high gain... Record noise and distortion filter... Exclusive TREBLE PRESET... Full equalization and tone compensation... Takes standard magnetic pickups, radio tuners, tape recorders, etc... Sturdy, well built, attractive... Specifically designed for complete Hi-Fi recording and playback control... Available at all leading dealers...

- COMPLETE CONTROL OF EQUALIZATION, TONE AND SIGNAL.
- INPUTS FOR ALL PHONO PICKUPS, TUNERS, TAPE, ETC.
- EXTREMELY LOW NOISE, HUM AND DISTORTION.
- VARIABLE RECORD NOISE AND RUMBLE FILTERS.
- SELF POWERED AND UNPOWERED MODELS.
- SPACE SAVING, SIMPLE TO OPERATE.
- RUGGEDLY BUILT.

SEE YOUR DEALER OR  
WRITE FOR SPECIFICATIONS

Audio  
**ARTISANS, Inc.** 394 MILL, HAWTHORNE, NEW YORK

**Miniature Pre-amplifier by**



# VHF receivers



High performance  
top quality  
low price

Ideal for novice... amateur...  
emergency or communications monitoring in police, fire, taxi, airport or aircraft, C-D, CAP etc.

### FOUR MODELS

- FM.....  
30 to 50 mcs.
- AM.....  
112 to 132 mcs.
- AM.....  
132 to 152 mcs.
- FM.....  
152 to 174 mcs.

Featuring high sensitivity... excellent selectivity... Includes famous Gonset noise limiter and wholly electronic adjustable squelch for silent standby. All receivers have 8 tubes, built-in speaker and power supplies for 115V, AC/DC. Full vision calibrated dials. Adjustable strip-type antenna. Complete! Ready to operate!

At your distributor

**GONSET CO.**

801 South Main St., Burbank, Calif.

any model **59.50**

## LMB BOX CHASSIS OFFERS FREE Inside LMB boxes

10 tested kit diagram projectors for the builder. Each one of these kit diagrams built by a recognized expert. All projects are complete in every detail. Circuit diagram, photo of project both front and rear photo. Rear photo shows wiring and parts. Detailed instructions for building, complete parts list and approximate cost. Complete to build except parts and your distributor can supply the parts. Ask your distributor for the list of LMB kit Diagram Projects. If he does not have them, write to

**LMB** 1011 Venice Blvd.  
Los Angeles 15, Calif.

## PEE WEE BATTERYLESS "LIFETIME" RADIO



**REALLY WORKS—FOR LIFE!**  
WORKS WITHOUT TUBES, BATTERIES OR ELECTRICAL PLUGS. Will never run down or burn out. World's smallest. SMALLER THAN A PACK OF CIGARETTES! GUARANTEED TO RECEIVE LOCAL RADIO STATIONS ANYTIME—ANYWHERE YOU GO! Sensational new Ferrite Selective Tuner—Perma-Crystal diode. Super SPEAKERPHONE, durable black and gold plastic case.

SEND ONLY \$2.00 (bill, ck. mol) and pay postman \$4.99 COD postage on arrival or send \$6.99 for postpaid delivery. SENT COMPLETE READY TO LISTEN WITH LIFETIME GUARANTEE. Nothing extra to buy—ever. Available only from: MIDWAY COMPANY Dept. WPL-9 KEARNEY, NEBRASKA

## WANT A BETTER JOB: BECOME AN ELECTRONIC ENGINEER

ONLY 32 MONTHS TO EARN A BACHELOR OF SCIENCE DEGREE IN ELECTRONICS ENGINEERING

Class enrollment limited to allow for individual instructions. Chartered by state of California. Nonprofit-nonsectarian, co-educational—established 26 years.

APPROVED FOR VETS—ENROLL NOW!

SEND FOR FREE CATALOG

**PACIFIC STATES UNIVERSITY**

1516 S. WESTERN AVE., Dept. M, LOS ANGELES, CALIF.

kc., can be tuned with classical music at 2340-0005 s/off, in dual with 6180 kc. They send an attractive monthly program bulletin. (DX)

**Ecuador**—HCJB, Quito, 15,115 kc., is heard at fair to good level at 1645 with "Musical Mailbag." They have a Russian program at 1730 in parallel with 17,890 and 11,915 kc. The "Musical Mailbag" is heard on Thursdays only. (FW)

**El Salvador**—Anyone needing this country should try around 1100-1300 on 11,947 kc., or evenings to 2300 close-down on 9555A kc. (BT)

**Finland**—Helsinki has moved its North America xmsn to 2200-0000. It is heard with fair strength on 15,190 kc. The 17,800-kc. outlet is heard occasionally with fair signals, but their 9555-kc. channel is completely inaudible. (RL, PR)

**Formosa**—The Broadcasting Corp. of China, Taipei, would like to have listeners write in—they confirm reports with a very pretty card. They are currently carrying English on BED3, 15,225 kc., and BED6, 11,815 kc., both 50 kw., at 2355-0200 to North America. This schedule will be in effect until November 30. (CM)

**France**—RTF, Paris, is noted on a new channel of 21,620 kc., replacing 15,400 kc. at 0800-1000 to the Far East. (RL)

NOTE: The widely reported program "Paris Star Time" is not broadcast from Paris, as reported by many, but actually from 4VC, *Radio Commerce*, Port-au-Prince, Haiti, on Sundays at 1830-1900. This all-English program, with French music, precedes the 4VC s/off at 1900.

**French Equatorial Africa**—R. Brazzaville is operating on a new channel of 15,420 kc. at 0500-0720 and 0900-1000, replacing the 15,595-kc. channel. (RL)

The outlets on 9625 and 11,970 kc. have English news at 1835-1850, sports to 1855, then a return to the musical program. (RN)

**Germany**—Best reception of the 2030-2330 xmsn to North America of the *Deutsche Welle*, Cologne, using new 100-kw. transmitter, is on 11,795 kc. This broadcast is also on 9640 kc. (replacing 9735 kc.) and 5980 kc. News in English is at 2130. Cologne is using a new frequency of 17,875 kc. at 0500-0800 to the Far East, replacing 17,815 kc., and also a new 15,375-kc. channel at 1700-2000 to Latin America, replacing 15,275 kc. (RL, CM, KM, RA)

**Gilbert & Ellice Islands**—Tarawa, 6050 kc., has English only at 2330 s/on and 0000 on Saturdays only. (WSWC)

**Gao (Portuguese India)**—CR8AB, 9610 kc., has English programs at 0200-0300 and 0400-0800 at fair level. (WSWC)

**Gold Coast**—Gold Coast Broadcasting Service, 6200 and 4915 kc., 5 kw., carries English daily at 0550-1330; Sundays it begins at 0255. A new 20-kw. xmtr is scheduled to go into operation shortly. (DQ)

**Greece**—The Athens broadcast in English is now at 1230-1245 on 15,345 and 17,745 kc., preceded by the French broadcast at 1215-1230. These frequencies can also be heard in Greek at 1400-1500, at 1700-1730 and at 1800-1830. (RL)

**Guatemala**—TGNC, R. Cultural, Guatemala City, 11,850 kc., is now heard on Saturday only from 0712 s/on in Spanish. They





# THE NEW ALTEC LANSING "Acoustic Gate" MICROPHONE



6A Stand Switch  
is an accessory  
and must be  
ordered separately

SPECIFICATIONS	
Type:	Dynamic
Frequency Response:	30-15,000 cps
Output Impedance:	Low, 30/50 ohms Medium, 150/250 ohms High, 20,000 ohms
Output Level:	-58 dbm/10 dynes/cm <sup>2</sup>
Dimensions:	Diameter, 1" body, 1-1/2" max. Length, 7" (without connector)
Weight:	8 oz. (without connector)
Finish:	Black and green anodized
Mounting:	"Slidein" holder with 5/8"-27 Swivel head.
Price:	\$96.00 net

**RUGGED! DEPENDABLE!** Years in development, the new Altec "Acoustic Gate" principle is available for the first time in the sensational Altec 680A microphone. This feature eliminates the high frequency peaks inherent in conventional dynamic microphones; and provides outstanding performance throughout an extended high frequency range. Here at last is a broadcast dynamic that can be used under any conditions. It is unaffected by wind, water, dirt or weather. The amazing Altec "Acoustic Gate" 680A is first for quality, ruggedness and serviceability.

**SOUND REPUTATION  
SECOND TO NONE**



Write Dept. 9-P  
9356 Santa Monica Blvd., Beverly Hills, Calif.  
161 Sixth Ave., New York 13, N.Y.



\* "Acoustic Gate" is a peripheral sound entrance channel of 2 mil width which provides an acoustical resistance loading to the front of the diaphragm thereby eliminating high frequency peaks and extending the frequency response over an exceptionally wide range. (Patent Pending)

## NOW ON SALE

### POPULAR PHOTOGRAPHY'S SPECIAL COLOR ISSUE!

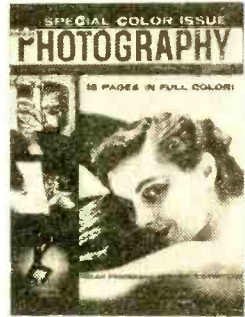

When you buy that next roll of color film, be sure to pick up a copy of September POPULAR PHOTOGRAPHY, too—a big, Special Issue on COLOR!

You'll find articles like these go hand in hand with good summer picture-making:

- COLOR ERRORS AND THEIR CURES
- GLAMOUR IN COLOR
- COLOR PROCESSING WITHOUT A DARKROOM
- PROFESSIONAL SECRETS OF COLOR CORRECTING
- HOW TO MAKE FLEXICHROME FULL-COLOR PRINTS

**BUY YOUR COPY OF SEPTEMBER  
POPULAR PHOTOGRAPHY TODAY!**

**On sale at all newsstands and camera stores.**

# SKYSWEEPER

Rugged 2-Meter BEAMS!

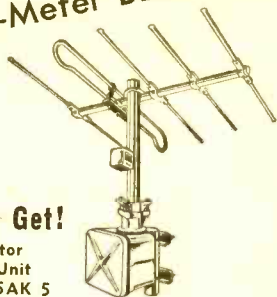
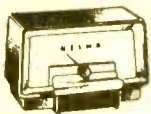

## Look what you Get!

- Finest Antenna Rotor
- Excellent Control Unit
- Skysweeper HM2-5AK 5 element beam
- 50' Rotor cable • 50' R8U
- 2 Mast sections

**\$3495** Complete

As above with 7 element beam, HM2-7AK... \$36.95  
 As above with 5 over 5 beam, HM2-10AK... \$37.95  
 As above with 7 over 7 beam, HM2-14AK... \$41.95

Satisfaction guaranteed—order today  
 All prices F.O.B. Chicago

IN CHICAGO VISIT PREMIER'S HAM SHACK

# PREMIER

3239 W. North Ave.

Chicago 47, Ill.

Phone: AR 6-5550

## Protect your BEAM...

- from: • Salt spray  
 • Weather • Chimney fumes

Easy-to-apply compound, keeps your Beam operating like Brand New—for years!

ALSO IDEAL FOR: ♦ Antenna Hardware ♦ Terminal Connections ♦ Rotor Housings ♦ All metal parts

See your nearest Ham Dealer!



No. E101 Antenna Coat  
 Enough to protect one full-size 20 meter beam or several TV antennas.  
 NET PRICE \$1.94  
 No. E46 Antenna Coat  
 Solvent ½ pint con. \$ .69

## TALK - LISTEN - AROUND THE WORLD!

RADIO AMATEUR TRANSMITTER-RECEIVER!



SENDS AND RECEIVES THOUSANDS OF MILES on Amateur 80 and 40 meter bands —also, Aircraft and foreign bands (3 to 8 mc). PORTABLE SELF-CONTAINED BATTERY POWERED! NO AC PLUG-INS. NO DANGEROUS HI-VOLTAGES. Low cost battery lasts for MONTHS. Crystal controlled transmitter—Power input up to 5 watts—ENOUGH TO TALK 1 MILE OR 1000. REGENERATIVE RECEIVER pulls in weakest stations. Front Panel Send/Receive switch—ENOUGH TO TALK 1 MILE OR 1000. REGENERATIVE RECEIVER pulls in weakest stations. Front Panel Send/Receive switch—

No troublesome relays or complicated hookup. Use any standard antenna. Size only 6"x4"x4". Wt. 3 lbs. TESTED—PROVEN—SIMPLIFIED—PRACTICAL—SAFE for radio beginners (NOVICE). Easy to get license. Full information included.  
 SEND ONLY \$5.00 (bill check, m.o. and pay postman \$9.95 C.O.D. postage on arrival or send \$14.95 and we will send postpaid. Complete kit includes all parts, tube, rolls, full instruction, less batteries and crystal—or COMPLETELY WIRED AND TESTED FOR \$19.95! Rush order today—NOW!  
 WESTERN RADIO DEPT. BNE-9 KEARNEY, NEBRASKA

have an English lesson for Spanish listeners at 0800. The signal is usually excellent. (SW)

**India**—The 1930 broadcast from *All-India Radio*, Delhi, is in English and beamed to Burma on 17,810 and 15,380 kc. Delhi is heard with excellent strength on 17,780 kc. at 1915-2015 with a broadcast in Tamil, dual to a new channel of 21,700 kc. (RL)

Delhi, on 15,210 kc., has English at 0830-0930. (NS)

Another English newscast is noted at 2130-2140 on 17,835A kc. (SW)

**Iran**—The Teheran broadcast in English at 1515-1530 is now receivable with fairly good strength on 15,100 kc. (RL, MI, FW)

The Sunday Poetry Hour at 1035 has been discontinued. (MI)

This station is also heard around 1350 with native music. (FB)

**Israel**—A new *Galei Zahal* outlet is 6175 kc., replacing 6725 kc. (WRH)

**Italy**—The Rome broadcasts to North America at 1730-2210 are heard with excellent signals on 11,905 and 15,325 kc. English programs are at 1915 and 2125. (RL)

**Japan**—*Radio Tokio* broadcasts to Eastern North America at 1800-1830 and 1930-2000 are now on 15,235 and 17,845 kc. Best reception is on 17,845 kc. during the 1930 program. The Western North America broadcast at 2230-2330 is transmitted on 15,235 and 17,825 kc. (RL, GF)

**Lebanon**—A Lebanese Forces station operating on 6500 kc. has been heard with Arabic programs at 0930-1025 close. Further details requested. (WRH)

**Malaya**—The British Far East Broadcasting Service at Singapore, 9690 kc., is heard very well at 0845-0945 with light music and "Radio Newsreel." (BV)

**Mexico**—XETW, Tampico, 100 watts, has English daily to Southern USA at 1930-0100 on 6130A kc. (DQ)

XEFT, Vera Cruz, 9545 kc., can be tuned at 2245-0020 with music and advertising. (WF)

XESC, *La Mas Espanole del Mundo*, Mexico City, 15,205 kc., is usually strong at 1730-1830 with music and talks. (DK)

**Monaco**—English can be heard from Monaco at 1705-1805 (Wednesday) and at 1705-1735 (Friday) on 6035 and 7349 kc. (DQ)

**Mozambique**—The best reception from Lourenco Marques at present is via CR7BD on 15,080 kc. at 1300-1515 s/off. All programs are in Portuguese. (RL)

**Netherlands**—*Radio Nederland*, Hilversum, is heard well on a new frequency of 15,365 kc. during the 2130-2210 English period to North America, replacing 11,730 kc. The 9590-kc. frequency remains on this transmission. Hilversum is also heard well on 17,775 kc. at 1800-2125 with Dutch and Spanish beamed to Latin America. (RL)

**New Zealand**—Wellington can be noted from ZL10, 15,220 kc., in a program beamed to Australia at 0015-0115 with m.w. relayed programs of light, popular, and classical music. The interval signal used before s/on is the chirping or call of the Bell Bird, a native bird of New Zealand. (BV)

ZL19, 11,830 kc., is often heard around 0130 with news reports. (DK)



**Nicaragua**—Two stations currently on the air are: YNRM, Matagalpa, 7590 kc., at 2045-2157 close, in Spanish, which often mentions Managua; and *Tropical Radio* (?) which is being noted in Spanish with the sign/off at 2205. (GF)

**Northern Rhodesia**—The Central African Broadcasting Station, Lusaka, is now broadcasting two programs. Program "A" is on 3914 and 7220 kc. at 0500 (Sunday at 0400) to 1400; there is English for Europeans on Thursday at 1300-1400 and Sunday at 0400-0600 and 1300-1400; broadcasts for Africans are on weekdays except Thursday at 1300-1400 and on Sunday at 0600-1300. Program "B" is broadcast on 4826 kc. daily at 1030-1230 in native languages only. After 1230, 4826 kc. carries the "A" program. (WRH)

**Norway**—Oslo is using 15,175 kc. on the 2000-2100 broadcast to North America, replacing 7210 kc. Other frequencies used are 9610 and 11,735 kc., with best reception on the latter since a Brazilian station usually covers the 9610-kc. transmission. (RL)

**Pakistan**—Radio Pakistan is heard on 15,335 kc. at 1945-2015 with English to Southeast Asia. This channel replaces 15,255 kc. (RL, GF)

**Panama**—HP5J, Panama City, 9607 kc., is noted at 1915 in Spanish, ending a musical program. This is usually well heard. (DX)

**Peru**—OBX4C, Radio El Sol, Lima, is again active, and is operating on 15,190 kc. Best reception usually is at 2100-2200 during the interval between Radio Canada and Helsinki use of 15,190 kc. (RL)

**Philippine Islands**—The Far East Broadcasting Co., P.O. Box 2041, Manila, has English periods at 1845-1900, 0300-0400, and 0900-1100 on DZH7, 9730 kc., DZH8, 11,855 kc., DZH9, 15,300 kc., and DZ16, 17,805 kc. (DD)

**Pitcairn Island**—A letter was recently received from T. C. Christian, Officer in Charge of Station ZBP. There is no broadcasting from the Island at present; ZBP operates on 12,110 kc. irregularly on c.w., m.c.w., and teletype with a power of 50 watts. He states further that residents of the Island depend on U.S. standard broadcast stations for their radio reception, as they are received perfectly there at night! (BF)

**Portugal**—Lisbon is operating on a new channel of 17,895 kc. at 0530-1945, with best reception after 1700. Their new 21 700-kc. frequency is used at 0530-0830 and at 1200-1515. Sundays at 0530-1515. The 2000-2230 North America xmsn is now on 11,840 kc. and 9775 kc., and the Western North America xmsn is on 9635 kc. at 2045-2230. (RL, GF)

**Saudi-Arabia**—Once in a while, listeners may be able to hear Arabic chants from Djeddah on 6175 kc. around 2300. At times they also use 5975 kc. and/or 11,850 kc. (BT)

**South Korea**—Western DX'ers may hear HLKB, 7235 kc., Seoul, around 0500-0700 in Korean and/or English. (BT)

**South Vietnam**—According to a letter from Mr. J. Varnoux, Saigon, a temporary agreement with the Vietnamese Government makes it possible to radiate a daily 2-hour program in French from Saigon over 9620 kc. (WRH)

Confirming this, the station has been heard

September, 1956

# 1957 ALLIED ELECTRONIC SUPPLY CATALOG

# free!

356  
value-packed  
PAGES



WORLD'S  
LARGEST  
STOCKS

SAVE ON EVERYTHING  
IN ELECTRONICS

Everything for Experimenters, Builders, Amateurs, Servicemen, Engineers and Hi-F Hobbyists

Save on *everything* in Electronics: Hi-Fi systems and components; latest builders' kits (see the famous K-NIGHT-KIT line); recorders and phono equipment; TV tubes, antennas, accessories; Amateur station equipment; P.A. systems; test instruments; industrial electronic supplies—plus *everything* in parts, tubes, transistors, tools and books. Get more for your money—send today for your FREE 1957 ALLIED Catalog!

Everything in Electronics  
From One Reliable Source

Our  
36th  
year

Send  
for FREE  
Catalog

ALLIED RADIO

ALLIED RADIO CORP., Dept. 79-J-6  
100 N. Western Ave., Chicago 80, Ill.

Rush FREE 1957 ALLIED 356-Page Catalog

Name \_\_\_\_\_

Address \_\_\_\_\_

City \_\_\_\_\_ Zone \_\_\_\_\_ State \_\_\_\_\_

on 9625A kc. with musical programs and a drama at 0820-0920. Interval signal was 11 notes and the usual slogans were in French. Schedule is presumed to be 0800-1000. (BF)

**Spain**—Madrid has shifted from 15,420 to 15,415 kc. It is heard at 0600-0730 to the Far East and at 0830-0900 in Arabic. (RL)

English periods to North America are at 2215-2300, 2315-0000, 0015-0100 on 9363 kc. and

#### ABBREVIATIONS

A—About this frequency  
 ABC—American Broadcasting Company  
 BBC—British Broadcasting Corp., London, England  
 BC—Broadcasting service or station  
 c.w. QRM—Interference from code station  
 kc.—Kilocycle  
 kw.—Kilowatt of power  
 mc.—Megacycle  
 m.c.w.—Modulated code transmissions  
 m.w.—Medium wave  
 QTH—Exact location  
 R.—Radio  
 s/off—Sign-off of station  
 s/on—Sign-on of station  
 V—Verified frequency  
 xmsn—Transmission from a radio station  
 xmt—Transmitter used by station

6130 kc. Another English period is at 1540 on 7100 and 6130 kc. (DD)

**Sweden**—The *Radio Sweden* broadcast to North America at 1900-2130 is now heard well on 11,880 kc. The morning broadcast at 0815-0915 is on 15,155 kc., but is usually covered by *Radio Moscow*. The xmsns for Western North America are at 1100-1145 on 15,155 kc. and at 0500-0600 on 11,705 kc. Stockholm is using a new frequency of 17,800 kc. at 0600-0645, 0930-1045, and 1200-1245, but interference from Rome is severe on this channel. (RL)

**Switzerland**—Berne has increased use of the higher frequencies. The summer and fall schedule, in effect until October 31, is as follows (italicized frequencies indicate new channels in use): to Australia—New Zealand—Far East at 0215-0445 on 11,865, 17,784 and 21,520 kc.; to Southeast Asia and Japan at 0745-0930 on 15,305, 17,784, 21,520 kc.; to India and Pakistan at 0945-1130 on 11,865 and 21,605 kc.; to the Middle East at 1145-1330 on 11,865 and 15,315 kc.; to Great Britain and Ireland at 1345-1530 on 9665 and 11,865 kc.; to Spain and Portugal at 1545-1730 on 9665 and 11,865 kc.; to Latin America at 1800-1945 on 9535, 11,865 and 15,305 kc.; to North America at 2030-2215 on 6165, 9535, 11,865 kc.; to Latin America at 2230-2300 on 9535 and 11,865 kc.; to Western North America at 2315-0000 on 6165, 9535, and 11,865 kc.; to Europe at 0015-0200, 0500-0830, 1030-1730 on 6165 and 9535 kc.; to Africa at 0015-0200 on 17,784 kc., 0500-0730 on 21,520 kc., 0945-1300 on 21,520 kc., and at 1315-1700 on 15,305 kc. (RL, FW, JM, AK)

**Syria**—The Damascus broadcast in English at 1530-1630 is now heard well on a new frequency of 17,865 kc., replacing 9555 kc. The 1900-2100 Arabic xmsn for Latin America is on new frequencies of 15,165 and 17,865 kc., replacing 9555 and 11,915 kc. (RL, GF, DQ)

**Turkey**—*Radio Ankara* is operating on 15,160 kc. at 1400-1645, replacing 7285 kc. The English program is at 1600-1645. The Ankara 17,825-kc. frequency can be heard at 0900-0915, after 0900 s/off of *Radio Norway*. (RL)

A station believed to be TAZ, Izmir, was tuned at 1530 with Turkish music to 1550 when light music followed. The s/off at 1600 was blotted out by c.w. signals. (BB)

The Istanbul Technical School is now operating on 7143 kc. with a radiated power of 100 watts. The call letters are TAO5. The Istanbul Technical University Radio is now on 7040 kc. (WRH)

**United States**—A report has just been received concerning *The Voice of Maritime Labor*, New York. This is reportedly operating over WFK39, 19,850 kc., WFL65, 15,850 kc., and WFK95, 15,700 kc. The latter frequency is best with news at 1250. This station is on the air on Sundays only. (HG)

**Venezuela**—Recent frequency shifts are: YVKX, Caracas, from 3390 to 3305 kc.; YVMU,

#### DX Programs

The following stations carry DX programs: Switzerland, over HER3, on 6165 kc., over HER4, 9535 kc., and HER5, 11,865 kc., on the first Thursday of each month at 2045-2115; Denmark, over OZF, Copenhagen, 9520 kc., each Tuesday at 2115-2130; Australia, over VLC9, Sundays at 0830 to Eastern North America; United States, over the *Voice of America* relay in Tangier, on Saturdays, at 1345-1400 on 9500 kc.; Hungary, over Budapest, 9833 kc., on Saturdays at 1620-1630. (NS)

Carora, from 2470 to 3340 kc.; and YVRA, Maturin, from 2360 to 3325 kc. (RL)

YVLK, Caracas, 4970 kc., has English at 1800-1900. The "Supper Club" is heard at 1800-1830 and 1850-1900 with American records and local commercials. (SF)

**Windward Islands**—The Windward Islands Broadcasting Service, Grenada, has shifted to new frequencies of 3390 and 17,800 kc., replacing 3395 and 17,745 kc. Their schedule is 1700-2115 daily except Saturday. (RL)

**Yugoslavia**—Try for English from Belgrade at 1645 on 6100 and 7200 kc. At times they may use 6150 kc. (BT)

-30-

#### SHORT-WAVE CONTRIBUTORS

Richard Albright (RA), South Gate, Calif.  
 Floyd Backus (FB), Richmond, Va.  
 John Beaver (BV), Pueblo, Colo.  
 Bernard Brown (BB), Derby, England  
 Grady Ferguson (GF), Charlotte, N. C.  
 Stuart Fidler (SF), Jordan, N. Y.  
 Warren Fisher (WF), Miami, Fla.  
 Bill Flynn (BF), Berkeley, Calif.  
 Harley Grimmer (HG), Chamcook, N. B., Canada  
 Mary Iwai (MI), Lombard, Ill.  
 Allen Kelly (AK), DeRidder, La.  
 David Kimpton (DK), Cobourg, Ontario  
 Roger Legge (RL), McLean, Va.  
 John Mann (JM), Montreal, P.Q.  
 Chuck Maxant (CM), Baldwin, N. Y.  
 Kurt Metzger, Jr. (KM), Ortonville, Mich.  
 Robert Nelson (RN), Newburgh, N. Y.  
 David Quarterston (DQ), Fairrell, Pa.  
 Peter Risse (PR), Atlanta, Ga.  
 Norman Styer (NS), Elverson, Pa.  
 Bruce Tuten (BT), Savannah, Ga.  
 Francis Welch (FW), Worcester, Mass.  
 Stewart West (SW), Union, N. J.  
*World Radio Handbook*, (WRH)  
 World Shortwave Club, (W-SWC)



**THE WONDER OF SOUND**  
 SOUND WILL DO YOUR WORK FOR YOU • IT COSTS ALMOST  
 NOTHING TO RUN THIS NEW GNOME VIBRATOR

**GUARANTEED  
 FOR  
 ONE YEAR**

**110 V  
 60 Cycles**



## SOUND-WAVE WASHER

Washes clothes and linen, also your daintiest underwear and silk or nylon stockings. It will wash it clean and snowy white. It will never damage them.

The wash is placed in a sink, tub or bucket and the sound waves go to work with no visible motion. Total washing and rinsing time approx. 30 min.

No space problem with this Sound Washer. You can keep it in a corner of a closet. You can take it with you on your vacation. *It is not much bigger than a child's top.*

ONLY \$49<sup>95</sup> PLUS \$1.55 POSTAGE AND INS. EXP. IS THE PRICE OF THIS LITTLE WONDER

**TO ORDER:** (C.O.D. PLUS C.O.D. CHARGES) OR SEND CHECK OR MONEY ORDER TO:  
 ELECTRONIC DEPT.

**B & P TRADING CORP., 16-18 Union St., Newark 5, New Jersey**

## Shrinks Hemorrhoids New Way Without Surgery

Science Finds Healing Substance That  
 Relieves Pain—Shrinks Hemorrhoids

For the first time science has found a new healing substance with the astonishing ability to shrink hemorrhoids and to relieve pain—without surgery.

In case after case, while gently relieving pain, actual reduction (shrinkage) took place.

Most amazing of all—results were so thorough that sufferers made astonishing statements like "Piles have ceased to be a problem!"

The secret is a new healing substance (Bio-Dyne\*)—discovery of a world-famous research institute.

This substance is now available in *suppository* or *ointment* form under the name *Preparation H\**. Ask for it at all drug counters—money back guarantee.

\*Reg. U.S. Pat. Off.

### SELF CHARGING TRANSISTORIZED GEIGER COUNTER

Includes • Holster • Radioactive Source • Uranium Official Yearbook (Reg. \$2.00) • Crystal Headphones

New! Revolutionary, reliable. Sensitive to gamma rays from all radioactive ores. Guaranteed. Free literature, or sent for Uranium Official Yearbook plus radioactive source...both for \$1.50

**WESTWOODRESEARCH & DEVELOPMENT LABORATORIES, INC.**  
 14945 Ventura Blvd., Dept. B, Sherman Oaks, California



only \$19.95 pdd.

Send check or m.o. (postage extra on C.O.D.'s)

## TRAINED MEN NEEDED!

**BIG PAY!—GOOD FUTURE!**

- DIESEL                       ELECTRONICS  
 AUTO                          AUTOMATION

**NEVER BEFORE** has the opportunity been so good for the properly trained mechanic and technician to step into **BIG PAY POSITIONS** with rapid advancement and future security virtually assured.

**YOUR SUCCESS** depends on the quality of training you receive, and the reputation of the school you attend.

**YOUR GUARANTEE** we are giving the best in mechanical and technical training is proved by the fact... we have a waiting list of good pay positions for our graduates, with leading companies throughout the United States.

**RESIDENT SHOP TRAINING** is easier and costs less than you may think! We provide you with housing and part-time jobs while in school, plus free nation-wide placement service for graduates.

Check subject above in which you are interested and mail for

FREE BOOKLET

Your Future  
 IN  
 ELECTRONICS  
 AND  
 AUTOMATION

**BAILEY**  
 Technical Schools

Veteran Approved  
 1626 S. Grand, St. Louis 4, Mo.

Your Future  
 IN  
 DIESEL and  
 AUTO  
 MECHANICS

Name \_\_\_\_\_ Age \_\_\_\_\_  
 Street \_\_\_\_\_  
 Town \_\_\_\_\_ Zone \_\_\_\_\_ State \_\_\_\_\_

**ALL NEW  
BIGGER THAN EVER!**



**NEWARK'S**  
Complete  
**ELECTRONICS**  
Catalog No. 65

Here's everything in Industrial  
Electronics, High Fidelity,  
Radio, TV and Amateur  
Equipment

Write  
today

**NEWARK**  
ELECTRIC COMPANY

Mail Order Division . . . Dept. P-9  
223 W. Madison St., Chicago 6, Illinois  
4736 W. Century Blvd., Inglewood, Calif.

## Hi-Fi Revives Kings of Swing

(Continued from page 47)

differ for every instrument. Hence the recording engineer can set his filters to pass one set of overtones and block another, bringing out one instrument while suppressing the other. Sometimes this requires "isolation" of one part of the total tonal spectrum on a separate tape, which is later blended by a sort of double-dubbing procedure into the main sound channel feeding the cutter.

As a final touch, the right amount of "liveness" is added to the rather dead-ish studio sound of these old records by the usual echo devices, and the tape is ready for transfer to the new microgroove master.

**Swing Back In Focus.** Proof of this particular pudding lies in the listening. The net result naturally falls short of present standards. But what has been accomplished is none the less remarkable. Gone is the hiss, the buzz, the scratch, and the muffled ventriloquist aura of yore. Instead, swing shifts into a new focus, crisp and clean with much better balance and articulation. Instruments are recognizable by their tone, rather than by the hopeful guesswork of the old days. There is even considerable expressiveness unearthed in some of the solo passages—fine touches lost before. Though lacking the hi-est of fi, these rejuvenated records are eminently listenable, even on wide-range equipment.

Best of all, these recordings bring back classic performances which epitomize a whole age: Benny Goodman's incomparable *Sing, Sing, Sing*, for example, recorded with a band whose roster reads like a Who's Who in Jazz—Harry James, Ziggy Elman, Gene Krupa, and an arm-long list of big-name *et ceteras*.

Benny's famous Carnegie Hall Concert is here, too. It's a fitting tribute to the King of Swing, who packed the Hall back in 1938, when a jazz concert was a daring innovation. The contents of the set are so numerous and so uniformly good that they can all be recommended with equal enthusiasm. The full-side (LP) free-for-all on Fats Waller's old standard, *Honey-suckle Rose*, is one of the finest anywhere.

If we add to Benny's hot numbers a few of Glenn Miller's smooth, dance-tempo arrangements from the Limited Edition album, the result is a nutshell picture of all that was best in the Swing Era. Although Miller's band almost always played from scores, the tempo favoring the less frantic type of dancing, still his work had a brightness and charm that's enjoyable today. The continuing popularity of some of his old favorites bears this out: *Little*

## INVENTORS

Send for  
**PATENT INFORMATION**  
Book and  
**INVENTOR'S RECORD**  
without obligation

**GUSTAVE MILLER**  
96-PE WARNER BUILDING  
WASHINGTON 4, D. C.

**REGISTERED PATENT  
ATTORNEY**

ASSOCIATE EXAMINER  
U. S. PAT. OFF. 1922-1929

Patent Attorney & Advisor  
U. S. NAVY DEPT. 1930-1947  
**PATENT LAWYER**

**SPEAK AND  
WRITE LIKE A**

**College Graduate**

If you lack complete college training in English you can now become an effective speaker, writer, and conversationalist—without going back to school. With the new CAREER INSTITUTE METHOD you can stop making mistakes in English, build up your vocabulary, speed up your reading, acquire real writing skill, learn the "secrets" of fluent conversation. Method successfully used by thousands. Takes only 15 minutes a day at home. Costs little. 32-page booklet mailed FREE upon request. Send card or letter NOW!

CAREER INSTITUTE, Dept. 1049, 25 E. Jackson, Chicago 4

## NORDIC

**CUSTOM RADIOS FOR  
1952 TO 56 FORDS**

SUPERHETERODYNE • BIG 6 x 9  
INCH SPEAKER • LOW BATTERY  
DRAIN • EASY INSTALLATION  
PERMEABILITY TUNER

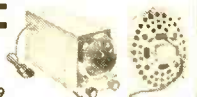

**\$38.90**

WRITE FOR LITERATURE

NORDIC RADIO COMPANY • BOX 582 • EVANSTON, ILL.

**Better Than Your Own Shoe Store at Home!**

Your own business — your own hours! Earn up to \$30 a day just showing magic Cushion Comfort! Styles for whole family! Shoe samples at no cost! Write NOW for FREE Catalog, all details!

TANNERS SHOE CO., 122 BROCKTON, MASS.



FREE CATALOG!



Brown Jug, for example; or *In the Mood*; or *Tuxedo Junction*.

Artie Shaw's liquid, effortless clarinet is restored to us. The restorations cover his big-band days, with both the phenomenally popular standards like *Frenesi* and *Begin the Beguine*, and a number of less well-known but no less excellent pieces. They show off such Shaw innovations as the full violin section in a swing band. The *Both Feet in the Groove* album contains forgotten gems like the slow-jump *Conin' On*, recorded on the same date (July 24, 1938) as the perennial *Beguine*, which pushed the Shaw organization to the top. For Artie in the slower, smooth-as-butter mood, the record contains a full, tricky arrangement of *What Is This Thing Called Love* that's guaranteed to wake a lot of twenty-year-old memories.

The names go on, too many for detail: Duke Ellington, one of the most original minds in the business; that old Sentimental Gentleman, Tommy Dorsey; Count Basie; Coleman Hawkins; Jess Stacy; and so on. There's enough available by now to whet the most jaded appetite.

"**In The Mood.**" For those of us who grew up under the reign of King Benny, and who spent our adolescence listening to "Music in the Miller Mood" on the "Chestersfield Hour," these records evoke nos-

## SHOOT TV TROUBLE FAST

### With H. G. Cisin's Copyrighted RAPID "TV TROUBLE SHOOTING METHOD"

Without experience or knowledge, this guaranteed new method of servicing TV sets enables you to DIAGNOSE TV troubles as rapidly as an expert. **NO THEORY—NO MATH**—you can locate all faults in record-breaking time regardless of make or model. "TV TROUBLE SHOOTING METHOD" is the most valuable aid to TV servicing ever written. Be a TV Trouble Diagnostician. Increase your present earnings. Open your own Profitable Business or get a high-paying skilled job.

**It's all in this book . . .  
Nothing more to Pay—Nothing else to Buy**

85 picture troubles, over 58 raster and 17 sound troubles. By this unique copyrighted method you know EXACTLY WHERE the trouble is; plus step-by-step instructions, including 69 RAPID CHECKS, enabling you to find the faulty part. 13 IMPORTANT PRELIMINARY CHECKS NEED NO INSTRUMENTS! Of the 69 Rapid Checks, OVER 65 ALSO REQUIRE NO INSTRUMENTS! Rapid checks include emergency checks for distorted pictures, defective tubes including 1"X tube, plus 57 others. ALL EXPLAINED IN SIMPLE LANGUAGE. PERFORMED WITHOUT INSTRUMENTS. MANY CHECKS USE THE PICTURE TUBE AS A GUIDE.

H. G. Cisin, the author, is the inventor of the AC/DC midjet radio. He licenses TV's, AT&T, etc. He has also trained thousands of technicians now owning their own prosperous TV service organizations or holding highly paid TV positions. His years of experience are embodied in this remarkable new book.

**Guaranteed Money Back in 5 Days If Not Satisfied!**

**ABSOLUTELY FREE** with each order: H. G. Cisin's new audio TV RADIO TUBE SUBSTITUTION GUIDE. Gives direct replacements of set and picture tubes. Most valuable servicing aid! **ACT NOW**—get both books postpaid at cost; of only one!

**\$1** Post paid

**RUSH COUPON NOW!**

R. G. CISIN, CONSULTING ENGINEER,  
Amagansett, N. Y. Dept. P-18

Enclosed find \$1. Rush both books.

Name .....  
Address .....  
City ..... Zone ..... State .....

**BIG TRADE-IN**

\*you pay shipping charges

Get up to \$5 for your old dud\*

Here's where you get

**THE RIGHT PRICES!**

**ALL TUBES UNCONDITIONALLY GUARANTEED FOR 1 YEAR**

- PRETESTED TUBES
- INDIVIDUALLY BOXED

024	6A06	6SH7	12BAG
1B3GT	6AU5GT	6S17GT	12BE6
1H5GT	6AV5	6SK7GT	12A27
1LC5	6AV6	6SL7GT	12B7
1LN5	6AX4GT	6SN7GT	12B7
1N5GT	6AT6	6SQ7	12SA7
1Q5GT	6AH4GT	6SR7	12S7
1R5	6BA6	6T8	12S17GT
1S4	6BC5	6U8	12SK7
1S5	6BE6	6V3	12SL7GT
1T4	6B06G	6V6GT	12SH7GT
1T5GT	6BJ6	6W4GT	12SQ7
1U4	6BK5	6W6GT	12SR7
1U5	6BK7	6X4	19T8
1X2	6BL7GT	6X5GT	19B6GG
3Q4	6B06GT	6Y6G	25B0GGT
3V4	6BQ7	7C5	25L6GT
3Y4	6BY5E	7C6	25Z5
5U4G	6BZ7	7E7	25Z6GT
5V4G	6C4	7F7	35B5
5Y3	6CB6	7F8	35C5
6AB4	6CD6E	7N7	35L6GT
6AC7	6F6	12A15	35W4
6AG5	6H6GT	12A17	35Y4
6AG7	6J5GT	12A18	3Z55GT
6AF4	6J6	12AU7	50A5
6AK5	6K6GT	12AV6	50B5
6AL5	6L6	12AV7	50C5
6AQE	6S4	12AX7	50L6GT
6A55	6S8GT	12AX4GT	117Z3
6AT6	6SA7	12BY7	

**ANY ASSORTMENT**

**RECEIVING TUBES**

**41c** ea.

**Quantity Buyers!**

**100 Tubes — \$38.00**

FREE POSTAGE on all pre-paid continental U. S. A. orders. 25c handling charge on all orders under \$5.00. 25% Deposit on all C.O.D.'s. Subject to prior sale.

PRescott 3-0330

**TRADE-IN ALLOWANCE**

for your old dud deductible from T. M. list price.

10"-14" \$2, 15" \$2.50, 16"-17" \$3.50, 19" \$4, 20" \$4.50, 21" \$5.

**BRAND NEW TV PICTURE TUBES**

RCA and DUMONT Licensed

Partial Listing

No dud required

Type	T.M. Price	Type	T.M. Price
10BP4	\$10.95	16RP4	\$17.00
12LP4	12.95	17BP4	19.00
12QP4	10.00	17GP4	21.00
14CP4	15.25	17LP4	18.00
15DP4	16.95	19AP4	23.00
16DP4	18.50	20CP4	24.00
16GP4	19.25	21ALP4A	24.00
16KP4	17.00	21EP4	24.00

Picture Tubes Shipped F.O.B.

Passaic, N. J. Via Railway Express

Dept. PE-9

**TUBE MART**

**DISCOUNT HOUSE**

The Lokpet Bldg. Passaic, N. J.

### 36" FLEXIBLE SHAFT

For Precision Working  
... Hard-To-Get-At-Places!

Req. \$9.95 . . .  
Now **\$5.95**

plus 35c p.p. and hdlg.

This handy flexible shaft with complete handle increases the utility of your electric drill, electric motor, grinder or drill press where 1/4" shank can be attached. Easily attached to do grinding, carving, drilling, sawing, polishing, buffing, slotting, engraving, etching, etc., on wood, metal, glass and plastics. The Flexible Shaft is tamper proof, sealed and designed for lifetime service. Can be operated at speeds up to 6000 RPM.

### 12 Pc. Needle & Warding FILE SET



ONLY  
**\$2.49** (plus 25c hdlg. & pstg.)

Made from the best quality tool steel, to fit the exacting requirements of mechanics, watch and jewelry craftsmen, hobbyists. Attractive kit contains the following 12pc. long needle and warding files with high test cutting qualities: round, flat, knife, square, triangular, in all textures: fine, medium fine, medium, medium coarse, coarse. Comes with polished wood handle and new type steel grip chuck.

Send Check or M.O. C.O.D. fee extra. **MONEY BACK GUARANTEE**

### 75c ea. for Finest Imported PRECISION PLIERS

- Flat Nose
- Combination
- Diagonal Cutter
- End Cutting Nippers
- Round Nose
- One Side Flat—One Side Round
- Snipe



FOR JEWELERS OPTICAL WORKERS HOBBYISTS CRAFTSMEN OF ALL KINDS! These superb German instruments are of die-forged, heat-treated high quality tool steel, fabricated to meet exacting specifications. All over ground and polished to smooth hard surfaces. Smooth working joints with just the right tension. Jaws meet perfectly to safely and securely hold even the most delicate objects in the hard-to-reach corners and angles. Each plier is 4" long and a veritable gem of precision and strength.

75c ea. . . . all 7 for **\$5.00** p.pd.

### SET OF 6 SWISS PRECISION SCREWDRIVERS



NEW LOW PRICE **\$1.25** p.pd.

Perfect for jewelers, watchmakers, hobbyists, etc. **SIX DIFFERENT SIZES:**

- |                 |                  |
|-----------------|------------------|
| No. 3 . . . . . | No. 6 . . . . .  |
| No. 4 . . . . . | No. 8 . . . . .  |
| No. 5 . . . . . | No. 10 . . . . . |

Knurled body grip assures easy handling. Finest steel and craftsmanship. A hard-to-beat value from Switzerland.

**SCOTT-MITCHELL HOUSE, INC.** DEPT. M-238, 611 BROADWAY, NEW YORK 12, N. Y.

talgia for what was perhaps a happier time. The intervening years of hot and cold war added, unfortunately, more to our wisdom than to our joy. Depression or no, the 30's saw us more relaxed than the atom age. These records captured the easy yet intense feeling of the times. That part of their content—the emotion transmuted into their grooves—can't be polished up by engineering, but it certainly takes on a poignant sheen in the perspective of memory.

### Transistor Topics

(Continued from page 87)

high gain. Bias for the first stage is supplied through resistor *R1*. The positions of the *n-p-n* and *p-n-p* transistors may be interchanged if the battery (*B1*) polarity is reversed. Known as a *complementary amplifier*, circuit (B) is suited to assembly using similar *n-p-n* and *p-n-p* transistors, such as G.E.'s 2N170 (*n-p-n*) and 2N107 (*p-n-p*) or Sylvania's 2N35 (*n-p-n*) and 2N34 (*p-n-p*).

### Product News. Lafayette Radio, 100

Sixth Ave., New York 13, N. Y., has just introduced a new "Hi-Q-Loopstick" antenna, designed specifically for transistor circuits but also suitable for use with vacuum tubes. The new antenna coil is intended for AM broadcast-band coverage, when used with a standard tuning capacitor, and is provided with a tap to match the comparatively low input impedances of transistor circuits . . . assuring maximum signal transfer and circuit efficiency. Type number is MS-299.

Good news for experimenters . . . more price cuts! G.E. has cut the net price of its new 2N170 *n-p-n* transistor to only \$1.45 . . . and the popular 2N107 *p-n-p* unit has been cut to 99 cents! These two transistors are ideal for experiments with *complementary* circuits (see above).

The General Transistor Corporation of Richmond Hill, N. Y., has announced a new *p-n-p* phototransistor, Type GT-66. A three-electrode unit, the GT-66 may be used as either a triode or diode light-sensitive cell. It is especially well suited for equipment employing a *modulated* (varying) light source.

A new "high power" transistor has been announced by CBS-Hytron. This unit, CBS Type 2N155, is designed specifically for use in auto radio receivers and is intended for operation on a 12-volt battery. It is a *p-n-p* transistor. Chances are you'll see some of these used in 1957 car radios.

The "Mascot," a new transistorized pocket radio manufactured by Televex, Inc., Kew Gardens, N. Y., features ex-

### TRAIN FOR CAREER IN ENGINEERING OR COMMERCE

BACH. SC. DEGREE IN 27 MONTHS in Mech., Civil, Elect., Chem., Aero., Radio (TV-Electronics) Engineering. IN 36 MONTHS in Bus. Adm. (Gen. Bus., Acctg., Motor Transport Mgt.) . . . capable students faster. Visit campus, see well-equipped labs. Heavy demand for graduates. Placement service. Prep courses. Approved for Vets. Enter Sept., Jan., March, June. Low cost. Write Jean McCarthy, Dir. Adm., for "Your Career in Eng. & Com."

at **TRI-STATE COLLEGE** 3696 College Ave., Angola, Indiana

### BE QUALITY WISE

Every kit complete with 28 page fully illustrated, instruction and assembly manual.

Write today for FREE catalogue

**HI-FI AMP. KIT \$28.50**

**HI-FI AM-FM TUNER KIT \$28.95**

COVER AND LEGS OPTIONAL. **QUALITY-ELECTRONICS, Dept. P-9** 319 Church St., New York 13, N. Y.

### earn as TAX EXPERT

**\$15 HOUR**

Our students earn as much as \$3,000 in 3 short months preparing income tax returns in spare time. Also operate lucrative year-round Business Tax Service. Dignified home-office business. Experience unnecessary. We train you; help you start. State approved home training program. Write today for free prospectus.

**UNION INSTITUTE, 68 Hoboken 30-M, N. J.**

### ELECTRONIC KITS

COMPLETE KITS FOR ARTICLES

DESCRIBED IN THIS AND OTHER MAGAZINES—WRITE FOR PRICES

**ALGERADIO ELECTRONICS CO.**

236 N. Franklin St. IV 9-0808 Hempstead, N. Y.



tremely long battery life (see photo on page 86). This two-transistor receiver, powered by a pair of small penlite cells . . . operated for more than 3000 hours with a single set of batteries . . . comes complete with a 20' antenna hank equipped with a miniature clip. Earphones are available as an optional accessory.

**Developments Overseas.** Although the United States is unquestionably the world leader in transistor development and in commercial applications, other nations are not idle. Your columnist has received word of transistor work in England, Holland, Japan, and in many other free nations. Latest news item is the announcement of a fully transistorized pocket receiver, developed by the world-famous Telefunken Company of Hanover, West Germany. The photo on page 87 shows exterior and interior views of this interesting five-transistor receiver.

Well, fellows, that's it for now . . . see you next month. . . .

—Lou

## Custom-Design Time Switches

(Continued from page 70)

interval was the prime consideration. A child with a bedside radio seldom turns it off before falling asleep. A timer set to control the duration of the "on" interval could save the parent quite a few steps. Cams cut for "s.p.s.t., NO" operation, and "s.p.s.t., NC" operation are shown on page 69 (bottom). Either cam permits playing the radio from 7 to 9 p.m. and from 6:30 to 8 in the morning. Note particularly that for controlling the "on" intervals the cam-switch combinations are reversed from what they were for "off" interval control. Since there are two possible cam-switch combinations, the constructor can select the type of cam easiest to fabricate for either "off" or "on" operation for each particular application.

The single cam and switch type of operation can also be used for controlling yard lights, chicken house lights, etc. Since the periods of daylight and darkness vary during the year, one fixed cam would unnecessarily waste electricity during the long summer days. However, variable cams, composed of two or more individual cams clamped together, permit the control periods to be adjusted whenever necessary. The drawing on page 70 shows an exploded view of a variable cam set to turn on a yard light from 5 p.m. to 7 a.m. By rotating one cam with respect to the other, this interval can be shortened or lengthened. If the load to be controlled exceeds the rating of the Microswitch, a relay with greater power-han-

# BUILD 16 RADIO CIRCUITS AT HOME

With the New Deluxe 1957 only \$19.95

## A PRACTICAL HOME RADIO COURSE

Now Includes  
**SOLDERING IRON AND TESTER, HIGH FIDELITY, SIGNAL TRACER, CODE OSCILLATOR, PRINTED CIRCUITRY**

Reg. U.S. Pat. Off.



### FREE TOOLS

- No Knowledge of Radio Needed
- No Other Parts, Tools Needed
- Excellent Background for TV

**FREE** Hi-Fi, Radio & TV Servicing Manuals on Request (See Coupon Below).

### WHAT THE "EDU-KIT" OFFERS YOU

The "Edu-Kit" offers you an outstanding PRACTICAL HOME RADIO COURSE at a rock-bottom price. You will learn radio theory, construction and servicing. You will learn how to build radios, using regular schematics; how to solder and wire in a professional manner; how to service and trouble-shoot radios. You will learn how to work with punched metal chassis as well as the new Printed Circuit chassis. You will learn the principles of RF and AF amplifiers and oscillators; detectors, rectifiers, test equipment, and more. You will learn and practice code, using the Progressive Code Oscillator. You will build 16 Receiver, Transmitter, Code Oscillator, Signal Tracer and Signal Injector circuits, and learn how to operate them. You will receive an excellent background for TV. In brief, you will receive a basic education in Electronics and Radio worth many times the small price you pay, only \$19.95 complete.

### PROGRESSIVE TEACHING METHOD

The Progressive Radio "Edu-Kit" is the foremost educational radio kit in the world, and is universally accepted as the standard in the field of electronics training. The "Edu-Kit" uses the modern educational principle of "Learn by Doing." You begin by building a simple radio. Gradually, in a progressive manner, and at your own rate, you construct more advanced multi-tube radio circuits, learn more advanced theory and techniques, and do work like a professional radio technician.

### THE KIT FOR EVERYONE

You do not need the slightest background in radio or science. The "Edu-Kit" is used by young and old, schools and clubs, by Armed Forces Personnel and Veterans Admin. for training and rehabilitation. The "Edu-Kit" is used in 79 countries throughout the world. Designed for universal use, the "Edu-Kit" operates on any voltage from 105 to 125 volts, AC and DC. For use in countries employing higher line voltages, a 210-250 Volt AC/DC model is available.

### THE "EDU-KIT" IS COMPLETE

You will receive all parts and instructions necessary to build 16 different radio and electronics circuits, each guaranteed to operate. Our kits contain all tubes, tube sockets, variable, electrolytic and paper dielectric condensers, resistors, tie strips, coils, hardware, tubing, punched metal chassis, instruction Manuals, etc. In addition, you receive Printed Circuit materials, including Printed Circuit chassis, special tube sockets, hardware and instructions. You also receive a useful set of tools, a professional electric soldering iron, and a self-powered, dynamic Radio and Electronics Tester. The "Edu-Kit" also includes Code Instructions and the Progressive Code Oscillator. "Edu-Kit" also receive lessons for servicing with the Progressive Signal Tracer and the Progressive Signal Injector, a High Fidelity Guide and Quiz Book. All parts, components, etc. of the "Edu-Kit" are 100% unconditionally guaranteed, brand new, carefully selected, tested and matched. Everything is yours to keep. The complete price of this practical home radio and electronics course is only \$19.95.

### TROUBLE-SHOOTING LESSONS

You will learn to troubleshoot and service radios, using the professional Signal Tracer, the unique Signal Injector, and the dynamic Radio and Electronics Tester. Our Consultation Service will help you with any technical problems.

J. Stasaltis, of 25 Poplar Pl., Waterbury, Conn., writes: "I have received several sets for my friends, and made money. The 'Edu-Kit' paid for itself. I was ready to spend \$240 for a course, but I found your ad and sent for your kit."

### FREE EXTRAS

- Radio and Electronics Tester • Electric Soldering Iron
- Set of Tools • Tester Instruction Book • Hi-Fi Book
- Radio Book • FCC Amateur License Training • TV Book • Quiz Book • Membership in Radio-TV Club; Consultation Service • Printed Circuitry

### UNCONDITIONAL MONEY-BACK GUARANTEE

ORDER FROM AD—RECEIVE FREE BONUS RESISTOR KIT WORTH \$5

- Send "Edu-Kit" Postpaid. I enclose full payment of \$19.95.
- Send "Edu-Kit" C.O.D. I will pay \$19.95 plus postage.
- Send me FREE additional information describing "Edu-Kit."
- Include FREE valuable Hi-Fi, Radio & TV Servicing Manuals. (Outside U.S.A.—No C.O.D.'s. "Edu-Kit" for 105-125 V. AC/DC \$20.95; 210-250 V. AC/DC \$23.45.)

Name \_\_\_\_\_  
Address \_\_\_\_\_

### PROGRESSIVE "EDU-KITS" INC.

497 Union Ave., Room 524-D, Brooklyn 11, N. Y.

# ELECTRICAL WIRING JOBS

Official  
CODE RULES  
made clear by  
PICTURES!

**2 GIANT Volumes** now made Easier!  
**3168** Surer! SAFER!  
**Pictures!** Newest idea in ages! Official National Electrical Code rules made crystal-clear by PICTURES! Books contain

thousands of pictures explaining every Code rule, parts of rules, exceptions, etc. Based on latest Code. Shows how to do a right job every time. Saves you time, money, inspection headaches. Pictures are big and clear . . . on 8½x11 page size . . . over 1600 pages. Covers things like wiring design and protection, wiring methods, hazardous locations, etc.

## ELECTRICAL CODE DIAGRAMS

A few minutes study a day makes you a real Code expert . . . helps you on the job every day.

- Speeds your electrical planning and installation
- Saves costly errors, expensive violations
- Numbered exactly like Code for quick reference



**FREE TRIAL! EASY TERMS!**

McGraw-Hill Book Co., Dept. PEL-9 (This offer applies to U. S. only)  
327 West 41st St., New York 36, N. Y.  
Send for 10 days' FREE trial McGraw-Hill's ELECTRICAL CODE DIAGRAMS, 2 vols. If not satisfied, I will return books. Otherwise I will send \$5.00, plus delivery charges, then \$5.00 a month until \$25.00 is paid. (We pay delivery if you remit with coupon; same return privilege.)

Name.....  
Address.....  
City & State.....  
Employed by..... PEL-9



**BATTERY HOLDERS**  
For All Type Dry Cells and Mercury Cells  
A complete range of voltages available through the use of ACME BATTERY HOLDERS wherever battery power is needed. Thousands are now being used in Geiger counters—Radies—Window displays—vending machines—radio control—battery powered toys and hundreds of other uses. Send for free price list.  
**ACME MODEL ENGINEERING CO.**  
8120-8 Seventh Ave., Brooklyn 9, N. Y.

## RADIO COURSES

- FCC LICENSE PREPARATION
- COMMERCIAL
  - AMATEUR
  - CODE BRUSH-UP
  - THEORY
- TELEVISION AND RADIO SERVICING  
Residence Courses Only  
Personal Counseling Approved for Veterans

**YMCA TRADE & TECHNICAL SCHOOL of N. Y.**  
15 West 63 St., New York 23, N. Y.  
EN 2-8117 Catalog P. E. 53rd Year

## FOR BIG MEN ONLY!

**SIZES 10 - 16 - WIDTHS AAA - EEE!**  
We SPECIALIZE in large sizes only . . . sizes 10 to 16; widths AAA to EEE. Golf Shoes; Wing Tips; Hand-Sewn Moccasins; Cordovans; Dress Oxfords; Light-weight, Flexible Casuals; Work Shoes; Sox; Slippers; Rubbers. Enjoy the finest in fit, comfort, style at amazingly low cost. Mail only. Write TODAY for FREE Style Book!  
**KING-SIZE, INC.** 890 Brockton, Mass.

SEND FOR FREE CATALOG

ding capacity can be operated by the Microswitch.

More than one cam can be driven by the same timing motor. Thus, with a switch actuated by each cam, several circuits can be controlled from one centrally located unit. It follows that for certain operations more than one switch could be operated by the same cam. The cams may be made in various ways. On page 70 (top) is a photo showing a control which turns on a household ventilating fan for ten minutes every two hours. The switch is "s.p.s.t., NO." For greater precision in adjusting the "on" intervals, the cams are pointed machine screws threaded into a plastic disc. By turning the screws in or out, the duration of each interval can be shortened or lengthened.

**One-rpm motor-cam systems** do not have the everyday practicability of the 1-rpd type, but many interesting gadgets can be devised which utilize them. For instance, a disc with a number of cams on the periphery could be used as a blinker, or a Christmas tree light flasher. By mounting several switches around this same cam, different lights—or strings of lights—could be synchronized so that when one is "on" the others are "off," etc. The cam could well take the form of a music box cylinder with pegs used to actuate the switches; with such an arrangement, a "light organ" could be constructed. There is no limit to what can be done with timing motors, cams and Microswitches.

## The Plate That Talks

(Continued from page 92)

cps, for example, the diaphragm must move four times as far as it does at 200 cps. But the two outer plates must remain very closely spaced for optimum operation. This spacing gives the suspended diaphragm very little room in which to vibrate. At the middle and high frequencies, where the motion is in thousandths of an inch, it is no problem. But the limits are reached when the diaphragm is forced into the low bass regions.

To an extent, this difficulty is overcome by increasing the size of the diaphragm. The bigger the diaphragm area, the better is its bass performance, and the less it has to move to put out the bass notes. Here, though, lies another problem involving ultimate size and cost and general practicability of a bass-reproducing electrostatic speaker. To date, this problem has been solved in theory only. Reports and rumors tell of experimental models both here and abroad. What will actually be produced remains to be seen.



## The Transmitting Tower

(Continued from page 72)

such as a single-band WAS, a QSL card which did not contain that information would be useless for his purpose.

Be careful to show the date and time of the contact clearly, so that the recipient will know where to check his log when he makes out your card. This is especially important in cards going to foreign amateurs. They almost always wait for a QSL from a USA station before sending one. Spell out the name of the month in such cards. To us, a date written 6-12-56 means June 12, 1956, but in most foreign countries it would mean 6, December, 1956.

Take enough time to make your card look neat. A carelessly penciled card gives the impression that the sender really did not care much what happened to his card, and the recipient may take the same attitude. A card on which all blanks are carefully filled in with pen or typewriter creates a much more favorable impression.

**Insuring Delivery.** At least as important as any of the above is to make sure that your card actually reaches its destination. Too many amateurs address their QSL cards "Operator Sam, KN9XXX, Chicago, Illinois," or in some other obviously inadequate manner. With very few excep-

tions, anyone sending a card with such an address would save money by leaving the stamp off and throwing the card away.

The best thing to do when a complete address is not available is to hold the card until it is obtained. However, if you wish to take a chance with a doubtful address, place the card in an envelope, write in the upper left-hand corner "If not delivered in 5 days, return to (Your Name, Your Address)," affix a 3-cent stamp, and mail. An undelivered card will come back, and you will at least know what happened to it.

The necessity for a complete address on a QSL card to insure its delivery imposes a handicap on newly licensed amateurs. It takes at least one issue of the *Call Book* after they get their licenses before their calls appear in it. Consequently, unless the stations they work happen to be in the *Call Book*, the only way they can get QSL cards at first is to send their addresses to every new station they work. The heavy interference in the amateur bands often makes it impossible to get an address through in either direction. Under these conditions, the wisest thing to do is to hold your card until the station is worked again or a new *Call Book* comes out.

If a QSL card does not arrive in return for yours within a reasonable time, send another one. The first one may have been

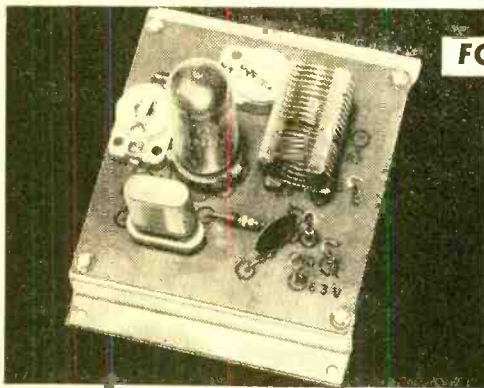

**FOR THE "DO-IT-YOURSELF" MAN!**

TRANSMITTER UNIT

*For Model Radio Control Use*

**MODEL RC-100 (BATTERY OPERATED)**

Measuring  $3\frac{1}{8}$ " x 4", the Model RC-100 Transmitter Unit is designed for coupling maximum power into the antenna to obtain LONGER RANGE of model control.

With Snap-On connections, the Unit has printed circuit; uses 3A5 tube in oscillator-multiplier circuit.

• **THE MOST ECONOMICAL QUALITY TRANSMITTER ON THE MARKET!**

Crystal controlled on 27.255 M.C. Available in low price kit form; easily assembled, with complete step-by-step instructions in each Unit.

Parts supplied as illustrated. In addition, requires batteries, any convenient carrying case, and simple whip antenna.

**Kit Form** (Includes tube and crystal Unit less batteries) **\$9.95**

**Wired and Tested** (includes tube and crystal but less batteries) **\$13.95**

**HOW TO ORDER:** For fastest possible service, RC-100 Transmitter Unit (or kit) are sold direct. When cash accompanies order, International prepays postage. Otherwise, shipment made C.O.D.

**International  
CRYSTAL MFG. CO. Inc.**

18 N. LEE PHONE FO 5-1165 OKLAHOMA CITY, OKLA

## HELP US OBTAIN OUR HAM LICENSES

In this section of the Transmitting Tower, the names of persons requesting help and encouragement in obtaining their amateur licenses are listed. To have your name listed, write to Herb S. Brier, W9EGQ, % POPULAR ELECTRONICS, 366 Madison Ave., New York 17, N. Y. Names are grouped geographically by amateur call areas.

### K1/W1 CALL AREA

David Duncan, 127 Blue Hill Ave., Milton 87, Mass.

Norman Piette, 91 Pulaski Blvd., Woonsocket, R. I. (Code and theory)

Ernest Godbout, 142 Garden St., Woonsocket, R. I. (Code and theory)

Francis Ascolillo, 119 Cornell St., Roslindale 31, Mass.

Rusty Bulis, 201 Birchwood Rd., Manchester, N. H. Phone: NA-2-8896. (Code)

Bob Gordon, 279 Upham St., Melrose, Mass. (Would like help in obtaining low-priced ham equipment)

George Howard, Jr., (15), Summer St., Franklin, Mass. Phone: 1131-W. (Code and theory)

### K2/W2 CALL AREA

Avrum Gittlet (17), 1424 43rd St., Brooklyn 19, N. Y. (Needs help with code; learned theory at Brooklyn Tech; will answer all mail)

Hugh Bruce (13), 2115 Troy Ave., Brooklyn 34, N. Y. (Code)

Harold Cohen (40), 2355 Ocean Ave., Brooklyn 29, N. Y. (Code and theory)

James McDonough (13), 686 East 28th St., Paterson 4, N. J. (Code)

Jay Cleary, 360 Woodward St., Jersey City 4, N. J.

### K3/W3 CALL AREA

James Glatt, 709 West Weber Ave., Dubois, Pa. (Would like SWL pen pals; will answer all letters)

Louis Lindenmayer, 3218 N. Fairhill St., Philadelphia 40, Pa. (Help with procedure in obtaining Novice license)

Anthony Glinskis, 9 W. Ogden St., Gerardsville, Pa. (Advice on equipment and aerial best suited for valley area)

Leonard Dietrich, Manatawny, Pa. (Code and theory)

James Reynolds, 755 Marietta Ave., Lancaster, Pa. (Needs help for code test and written examination)

### K4/W4 CALL AREA

Dwight Harman (13), Rt. #4, Kingston, Tenn. (Code)

Tommy Wright, Rt. 6, Box 167, (Ferry Pass) Pensacola, Fla. (Code)

Larry Benfield, Route #1, Mount Ulla, N. C.

Tommy Moultrie, 1487 Virginia Ave., Macon, Ga. Phone: 2-6858.

Earl W. King, M.O.Q. 2901, Camp Lejeune, N.C. (Theory)

### K5/W5 CALL AREA

Bob Wilkins, 906 West Commerce, Honey Grove, Texas. (Has been SWL'ing for three years, now wants to talk back; needs help with code)

Buddy Gilmore, Box 804, Aqua Dulce, Texas. (Code and theory; will answer all letters)

Leonard Clark, 146 Blossom Dr., San Antonio, Texas. (Theory and code)

Allen Kelly, K5-SWL, Rte. #3, DeRidder, La.

### K6/W6 CALL AREA

Ronald Malt, U.S.N. 352-72-92, YA-63, C/O F.P.O., San Francisco, Calif. (Home is Tulsa, Okla, but he is stationed in Alameda, Calif.)

Harry D. Jenkins, 2044 Sherman Drive, Concord, Calif. (Traded an oscilloscope for an s.w. receiver, became an avid SWL'er, now wants to become a ham)

Robert Hayden Stormer, 1109 Mound St., Alameda, Calif. (Theory and receiving code)

Earl H. Carder (34), 6148 Aura Ave., Reseda, Calif. (Radio theory)

James Lythans, 199 E. La Verne Ave., Pomona, Calif. (Code and theory)

### K7/W7 CALL AREA

Robert L. McMullen, 414 West 31st St., Cheyenne, Wyo. (Code and theory)

Thomas MacFarland, 807 W. 14th Ave., Spokane 4, Wash.

Rhio Hove, 219 So. 36th Ave., Yakima, Wash. (Code and theory, will answer all letters)

Lynn C. Ratcliffe, 1235 E. 92nd St., Seattle, Wash. Phone: KE-1496. (Advanced theory and code)

### K8/W8 CALL AREA

Ron Ruff, 2051 Division Rd., St. Clair, Mich. (Code and theory; would like to hear from hams with "Heathkit" OX35)

Richard J. Copits, 204 East Hamtramck, Mount Vernon, Ohio.

Frank V. Piekarski, 27 Morgantown St., Fairchance, Pa.

John W. Northrup, 39854 Ormsby, Mt. Clemens, Mich. (Code and theory) Phone: HO-8-4763.

Gregory Andracke, W8-SWL, 5940 Chatsworth, Detroit 24, Mich. Phone: TU-2-5323. (Code)

### K9/W9 CALL AREA

Thomas Ivas (16), 6844 S. Maplewood, Chicago 28, Ill.

William D. Dragoo, Jr., 305 S. McKinley St., Muncie, Ind. Phone: AT 2-3525. (Code and theory)

Robert Yolton (14), 2915 Colgate Rd., Madison, Wis.

Allen Butkus, KN9BET, 143 E. Walnut St., Oglesby, Ill. (Wants help on General Class theory, also pen pals)

Thomas Ivas (16), 6944 S. Maplewood, Chicago, Ill. (Code)

Roger Kimmel, 3808 N. 54 Blvd., Milwaukee 16, Wis. (Code)

### K0/W0 CALL AREA

Ronnie Ettinger, 1864 Hillcrest Ave., St. Paul 16, Minn.

Stanley Sides, Box 332, Malden, Mo. (Help in obtaining license and getting started afterward)

Carl Turnquist, 829 Mapleton, Boulder, Colo.

Duane Brady, P. O. Box 85, De Soto, Mo. (Code and theory, antenna tuning and matching)

Alfred Schott, Route 1, Milford, Iowa. (Theory)

Al Kennedy, KN0DFC, 2856 Texas Ave., St. Louis, Mo. Phone: PR-3-1113. (General Class theory)

### VE AND OTHERS

Bill Steinberg (15), 6701 Belard Rd., Cote St. Luc (Montreal), Quebec, Canada.

Graham A. Rife, 536 Frederick St., Preston, Ont., Canada. (Code, theory, Canadian regulations, equipment)

Noel Elliot (14), R.R. #1, Meadowvale, Ontario, Canada. (Code, theory, Canadian regulations; will answer all letters, will travel to Toronto for help)

Bob Wismer, 1676 W. 59 Ave., Vancouver 14, B. C.

To help prospective amateurs obtain their Novice licenses, the Radio-Electronics-Television Manufacturers Association offers a set of code records (recorded at a speed of 33 $\frac{1}{3}$  rpm) and a Novice Theory Course for \$10.00, postpaid. The complete course or more information on it is available from RETMA, Suite 800, Wyatt Bldg., 777 Fourteenth St., N. W., Washington 5, D. C.



ASSEMBLE YOUR OWN  
**WALKIE-TALKIE**  
RADIOPHONE



for as little as  
**\$6.50**  
plus accessories

Specifications: 1 to 5 mile range with 18-inch antenna and much more with directional beam antenna. Tunes from 144 to 148 mcs. High level amplitude modulation. Silver plated tank circuit and many other exclusive features assure maximum efficiency and long battery life. Fully portable—no external connections ever needed. Meets FCC requirements for general class amateur license. No minimum age requirement.

- The following components are all you need to assemble a complete walkie-talkie as illustrated. Factory wired and tested transmitter chassis complete with special dual tube \$6.50  
High output carbon mike \$1.49  
Miniature mike transformer \$ .98  
Powerful alnico magnet headphone \$1.25  
Strong 16 gauge aluminum case (8" x 5" x 2") with battery compartment, battery switch plus all hardware and fittings including 18 inch antenna \$3.98

Uses standard batteries available at your local radio store. All components except tubes guaranteed for one year. Please include 5% for postage. COD's require \$1.00 deposit. Thousands sold throughout the world. Foreign currency of equivalent exchange value plus sufficient amount for postage accepted.

All orders immediately acknowledged.

**SPRINGFIELD ENTERPRISES**

Box 54-E Springfield Gardens 13, N. Y.

# TECHNICIANS WANTED



**RADIO TELEVISION AND ELECTRONIC INDUSTRIES NEED WELL TRAINED MEN.**

The man who really has the "know-how" will win the best rank and position and the highest pay in the years ahead. Engineering Opportunities shows how you can be thoroughly trained by specialized home study courses. It lists details of over ninety courses in all branches of engineering and academic fields. Get your free copy of "Engineering Opportunities" to-day by mailing the coupon below.

Canadian Institute of Science & Technology Limited, 622 Century Bldg., 412, 5th St., N.W., Washington, D.C.

Please forward free of cost or obligation of any kind your 105-page handbook, "ENGINEERING OPPORTUNITIES".

Name \_\_\_\_\_  
Address \_\_\_\_\_  
Course interested in \_\_\_\_\_ Age \_\_\_\_\_

Canadian Enquiries: Canadian Institute of Science & Technology, 263 Adelaide St. W., Toronto, Ont.

## WHICH TRANSMITTER KIT TO BUY?



I JUST GOT MY NOVICE TICKET, BUT WHICH KIT SHOULD I BUY?



THAT'S EASY! CHOOSE THE KIT THAT GIVES YOU THE MOST FOR YOUR MONEY!



SAY, THIS VIKING "ADVENTURER" LOOKS LIKE THE ONE FOR ME!

NOW YOU'RE TALKING!! I'VE GOT ONE AND IT'S GOT 'EM ALL BEAT!

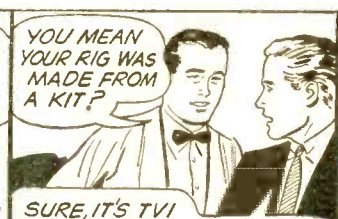

YOU MEAN YOUR RIG WAS MADE FROM A KIT?

SURE, IT'S TVI SUPPRESSED--WORKS ALL BANDS--80 THRU 10--LOADS ALMOST ANY ANTENNA--AND IT'S PUNCHED AND DRILLED FOR YOU, TOO!

**LATER** SAY! STEP BY STEP INSTRUCTIONS! I'LL BE FINISHED TONIGHT!

EVERYTHING IS SUPPLIED. ALL YOU NEED IS YOUR OWN KEY AND CRYSTAL.

JOHNSON MAKES A COMPLETE LINE OF TELEGRAPH KEYS, TOO. WRITE FOR FULL INFORMATION.

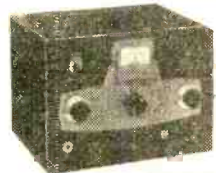

**VIKING "ADVENTURER" CW KIT**  
Compact, completely self-contained 50 watt transmitter kit. Single knob bandswitching—effectively TVI suppressed. Easy assembly by novice or experienced amateur. 80, 40, 20, 15, and 11-10 meters. Cat. No. 240-181-1 complete with tubes. **\$54.95**

**MAIL TODAY**

**E. F. JOHNSON COMPANY**  
3002 Second Ave., S.W., Waseca, Minnesota

Please send me a copy of Bulletin 727, which describes the Viking "Adventurer" in detail.

NAME \_\_\_\_\_  
ADDRESS \_\_\_\_\_  
CITY \_\_\_\_\_ STATE \_\_\_\_\_

lost or mislaid. Put the second one in an envelope, and enclose a courteous note, explaining why you need the addressee's card. Mention tactfully—if you actually want a confirmation of a contact, and not just wall paper—that a plain card containing the desired information will satisfy your needs. Use airmail for best results.

Incidentally, if you are one of those who have neglected to answer received-QSL cards because you do not have formal cards of your own, remember that most amateurs would far rather have a simple postal card than to be ignored entirely.

**SWL Cards.** Many short-wave listeners mail reports to amateur stations they hear and request QSL cards in return. Almost everything said above goes double for SWL cards. Few amateurs value a listener report nearly as much as they do a QSL card; consequently, it is harder to get a reply to one than to a QSL card. However, by following the above suggestions, you can expect about a 50% return from SWL cards. Including return postage improves the percentage somewhat, but the very thought makes some SWL's furious.

**Using QSL Bureaus.** At the head of each call area listing in the *Call Book* is the address of a DX QSL bureau. In addition, in the United States, an address of a Novice QSL bureau is also given. To re-

ceive cards through them, you must furnish a business-size stamped envelope addressed to yourself, with your call letters written in the upper left-hand corner, to your area QSL bureau. In addition, the Novice bureaus accept cards from both U.S. and foreign amateurs for distribution to Novices who have envelopes on file. Few Novices use the Novice QSL bureaus.

The DX QSL bureaus are designed strictly to distribute incoming foreign QSL cards. Most DX cards arrive via this route; therefore, if you work foreign DX, send an envelope or two to your area QSL manager; otherwise, your DX cards will remain in his files. Do not send your outgoing DX cards to him.

#### News and Views

**Dave F. Kovach, KN2RSM**, 161 La Grange St., Vestal, N. Y., writes: "I have been on the air two months and have made 75 QSO's (contacts) in 13 states and Canada. I have been using an AR-2 receiver and an AT-1 transmitter feeding a 120' end-fed antenna. I have just secured enough money to get an S-40A receiver. My biggest gripe is against stations that do not QSL. I QSL 100%, and I get a return of about 80%."

**Bill Skidmore, KN8AZQ**, 2513 Third St., Cuyahoga Falls, Ohio, says: "It is nice to read about the fellows you have worked in the *Transmitting Tower*. I tried changing the resistor in my AR-3 receiver, as Terry Meyers

## REBUILD YOUR CARBURETOR— IMPROVE ENGINE PERFORMANCE!

Eliminate sluggishness, cut down on gas consumption by rebuilding the carburetor in your car this weekend. A detailed article in September *AUTO MECHANICS* shows you how to use convenient carburetor kits to better your engine's performance.

*In the same issue:*

- HOW TO SOUNDPROOF YOUR CAR
- CAUSES AND CURES OF HARD STARTING
- IGNITION TIMING FOR PEAK PERFORMANCE
- REAR END REPAIRS
- TOOL UP FOR AN ENGINE JOB

BUY YOUR COPY OF SEPTEMBER *AUTO MECHANICS*

**On Sale Now at all Newsstands • Only 35¢**

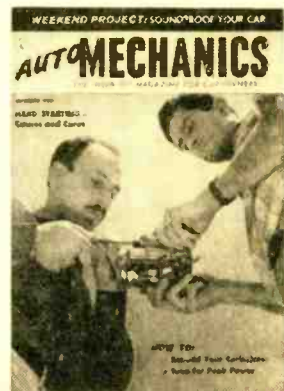



suggested on page 115 of the June P.E. It works swell. Also, the QF-1 Q-Multiplier you described in the May issue helps a lot."

**Jim Williams, W5BPA—W5ISX**, P.O. Box, Roswell, New Mexico, writes: "I am planning some antenna experiments at the 1500' height on the 1610' tower of KEWS-TV, where I am employed. This will probably be the world's highest amateur antenna. I'll appreciate suggestions as to what kind of antennas and what bands to try. Beams are out, because of their wind resistance. I plan to use 300-ohm ribbon to feed the antennas, because of its light weight and low wind resistance. The transmitter will be a Viking II."

**Walker C. Gallman, W4IHA**, 105 Woodland Ave., Great Falls, S. C., shows what can be done with low power. "I finally got on the air and with only 11 watts. My rig is the Sandwich Box Transmitter described in POPULAR ELECTRONICS for March. Frankly, I did not expect to get out of the state with it. Imagine my surprise when in five hours of operation I worked K2's, W3's, W4's, and W5's, with 589 'solid copy' reports. My antenna is a 40-meter dipole, 20' high, and my receiver is an AR-3. I am the first and only ham in my town. I'll be glad to help anyone who is interested."

**Jim Rogers, KNOEHG**, (17), Box 186, El Dorado, Kans., complains: "I like to rag-chew a little, but many of the stations I work just want to exchange reports, names, and addresses, and then sign off. So, if anyone else likes to rag-chew, look for me on 7184 kc. Even though I think rag-chewing is more fun than DX'ing, I have worked 34 states in nine call areas in about three months on the air. I use a TR-75 transmitter, running 60 watts, a 1/2-wave doublet antenna, and an S-85 receiver."

**Howard Schmidt, K2JYK**, 235 White St., Englewood, N. J., wastes no time in saying: "I have been a ham for two years now and have had a lot of fun at it. It seems to me that some of the newer hams are neglecting the privilege of sending messages or radio-grams. It may seem difficult, but it isn't, and I am sure that they would enjoy it."

**Robert Carraway, WN1HIR**, Chester, Mass., reports: "I have only worked eight states, because I stick to 80 meters in the afternoons, when I am lucky to get out of town with my AR-2, AT-1, and AC-1. I'll do better on the DX when I go on 40 meters. What I really want to talk about is the Northeastern Novice Net which Jay Worrell, WN1HUK, R.F.D. #2, Raymond, N. H., and I have organized. We meet on 80 meters, Saturday afternoons and weekday evenings, and invite everyone in the area to join us."

**Hugh Edmonds, Jr., KN4GBJ**, P.O. Box 277, Anderson, S. C., says: "I work 40 meters only for 24 states, with 21 confirmed. My transmitter is a Viking Adventurer, running 50 watts, and my receiver is a reconditioned SX-17. I would like a schedule with Okla., Mich., or any W1, 7, 9, or 0."

**Fred Beatty, KN8AJX**, 5301 Second Ave., Vienna, W. Va., reports: "I have tried about six different hobbies, but have not found any other as satisfying as amateur radio. I got my Novice license in February and hope to have my General by the end of the summer. My rig

*Your choice of school is highly important to your career in*



**INDUSTRIAL  
ELECTRONICS**



**RADIO**



**TELEVISION**

*Become an*  
**ELECTRICAL ENGINEER**  
*or an*  
**ENGINEERING TECHNICIAN**  
*at*  
**MSOE in Milwaukee**

*Choose from courses in:*

**ELECTRICAL ENGINEERING**

*Bachelor of Science degree in 36 to 42 months with a major in electronics or electrical power.*

**ELECTRICAL TECHNOLOGY**

*Engineering Technician certificate in 12 months in electronics, radio, or electrical power.*

*Associate in Applied Science degree in 18 months in radio and television.*

**TECHNICAL SERVICE**

*Service certificate in 6 months in electricity; in 12 months in radio and television.*

MSOE — located in Milwaukee, one of America's largest industrial centers — is a national leader in electronics instruction — with complete facilities, including the latest laboratory equipment, visual aid theater, amateur radio transmitter — offers 93 subjects in electrical engineering, electronics, radio, television, electrical power, and electricity.

Advisory committee of leading industrialists. Courses approved for veterans. Over 50,000 former students. Excellent placement record.

TERMS OPEN SEPTEMBER, JANUARY  
APRIL, JULY



*Choose wisely — your future depends on it. Write for more information today!*

**MILWAUKEE**  
**SCHOOL OF ENGINEERING**

Dept. PE-956, 1025 N. Milwaukee St.  
Milwaukee 1, Wisconsin

Send FREE career booklets on:

Electrical Engineering       Radio-Television

I am interested in .....  
(Name of course)

Name ..... Age .....

Address .....

City ..... Zone ... State .....

If veteran, give discharge date..... MS-31A

# LINGUAPHONE

MAKES IT EASY TO LISTEN and LEARN to

## Speak

**SPANISH** [ American or European ] • **FRENCH**  
**JAPANESE** • **GERMAN** • **ITALIAN**  
**MODERN GREEK**—any of 34 languages available  
**for FREE TRIAL AT HOME**

With LINGUAPHONE—The World's Standard Conversational Method—You Start to SPEAK another language TOMORROW—or IT COSTS YOU NOTHING!  
 For just 20 Minutes a Day you listen to Linguaphone's life-like recordings. It is easy—AND FUN—to learn another language AT HOME with LINGUAPHONE—the same natural way you learned to speak before you went to school.  
 ONLY LINGUAPHONE brings 8 to 12 of the world's best native language teachers into your home. You hear both men and women speak about everyday matters in their native tongue. YOU understand—YOU SPEAK correctly as they do. It's like living in another country. That's why Linguaphone is used 'round the world by educators, governments and business firms. More than a million home-study students of all ages have learned another language this ideal way.  
 Send today for Free booklet fully describing the conversational method; also details on how you may obtain a COMPLETE Course-unit in the language you choose on FREE TRIAL. Linguaphone Institute, T-89-096 Rock, Plaza, N. Y. 20.

Linguaphone Institute, Phone: Circle 7-0830  
 T-89-096 Rock, Plaza, New York 20, N. Y.

Please send me:  
 FREE Book  Information on FREE Trial. No obligation, of course.

My language interest is.....

Name.....

Address.....

City..... Zone..... State.....

The World's Standard Conversational Method for Over Half a Century

### LEARN TELEVISION

"AT THE MOST PRACTICAL SCHOOL IN THE WEST"  
 WORK ON LATE MODEL SETS—USING MODERN SERVICING EQUIPMENT AND TECHNIQUES; UNDER QUALIFIED TECHNICIAN INSTRUCTORS (SHORT RESIDENT) AND (CORRESPONDENCE COURSES)—NO UNNECESSARY MATH OR THEORY—ALSO UHF AND COLOR TV.  
 APPROVED FOR VETS—ENROLL NOW!  
 Day and Night Classes Write for Free Literature  
 Dept. 2A—Correspondence  
 Dept. 2R—Resident

V. S. I. TELEVISION SCHOOL 4570 Firestone Blvd.  
 South Gate, Calif.

### CABINET MAKING

**LOW COST HOME TRAINING COURSE FOR BEGINNERS & ADVANCED CRAFTSMEN**

Make money. Learn skills and secrets of fine woodworking and tool use. Professionally prepared shop method training tells and shows how. Covers everything. Easy to master.

**INTERSTATE TRAINING SERVICE**  
 Write for Free Booklet DEPT F-95 PORTLAND 13, OREGON

### "Persona-Tone" TV by DeRO EXTENSION SPEAKER

ONLY 9.95

Carry TV sound to any spot in the room. 3-way selector switch and sound volume control. 4x6 speaker. Veneer wood cabinet. Complete with cable. Fits any TV set for greater enjoyment. complete

AT LEADING JOBBERS, OR WRITE  
 DeRO ELECTRONICS, 134-A Nassau Rd., Roosevelt, L.I. N.Y.

Please Be Sure to Mention  
**POPULAR ELECTRONICS**  
 When Answering Advertisements

is an AT-1, and the receiver is an SX-25. I have worked 23 states, of which 17 are confirmed. I'd be happy for guys to write."

From Germany, **Hans Rohrbacher, DJ2NN**, Freiburg i. Br., J. v. Weerthstrasse 5, writes: "I was very lucky to get some old issues of POPULAR ELECTRONICS. Your articles and the letters from Novices in the USA are very helpful in completing the picture we have of the States. Perhaps you are interested in amateur radio here in Germany.

"On 15 meters, I have worked a lot of Novices with great fun. I was able to work 30 states in three months. My only frequency on 21 mc. is 21,120 kc., using a hand-rubbed crystal. I might say that some Novices make their calls too long, and QSB gets them before they finish. On 20-meter c.w., I have worked 250 W's in eight weeks; and on 40 meters, I have worked eight states. In the morning hours, W's are very strong on this band.

"My rig is all self-built, running 100-watts input. Unhappily, I must multiply frequency in the final amplifier for 20 and 15 meters, so my output is low on these bands, but I am planning a new 150-watt rig. At first, I used an indoor folded-dipole antenna. Now, I have an outdoor 40-meter Fuchs antenna, which does much better. My receiver is a 13-tube, two-conversion superheterodyne.

"About myself. I am 21 years old and a student of the Technical High School near Freiburg. There are 120,000 inhabitants here and only 12 hams, and only three of them are QRV for DX. I am alone on 21 mc. Besides amateur radio, I collect stamps, and am always happy to get a new stamp on a letter. Most German boys collect stamps, too; so don't forget this when QSL'ing directly. If you have any questions, I'll try to answer them the quickest way."

**John Rudolph**, 9 Myrtle Ave., Ridley Park, Pa., forwarded an interesting clipping from the "Stars And Stripes." It seems that W6BGJ, while driving near Rawlings, Wyo., came upon a bad automobile accident. He immediately called for help and an ambulance over his mobile transmitter, raising KH6QU in Hawaii, who relayed the information to W6RUQ in North Hollywood. He, with the aid of the American Legion Traffic Net, tried to raise any ham in Wyoming. This failing, he called the California police, who sent a message on teletype, via Dallas, Denver, and Laramie. Twenty-three minutes after W6BGJ's original call, an ambulance and a highway patrol reached the scene of the accident.

**Paul DeVivo, K2PGP**, 198-21 49th Ave., Flushing 65, N. Y., writes: "I want to congratulate W8VVD for his 'Hart-25' transmitter, described in the April, 1955, POPULAR ELECTRONICS. Since I got my General license and put a v.f.o. in front of it, it has really been working. With it, a dipole antenna, and an SX-25 receiver, I have worked Canada, Cuba, Puerto Rico, Virgin Islands, Guantanamo Bay, Guatemala, Brazil, Hawaii, England, Wales, Germany, Sweden, Switzerland, and Yugoslavia on 40 meters."

That's all our space for this month. Keep writing. 73,  
 Herb, W9EQQ



POPULAR  
ELECTRONICS

# BARGAIN BASEMENT

SAVE ON THESE SPECIAL BUYS OF THE MONTH

## R/C DUAL PROPORTIONAL KITS

Ace R/C Kits are available for the largest variety of Radio Control Transmitters and Receivers and related equipment. Transmitter and Receiver kits begin at \$7.95 for COMPLETE kits—only extras to buy are batteries. Write for Free catalog 56-2E.

Ace R/C East    Ace Radio Control    Ace R/C West  
Box 1661            Box 301            Box 18  
Burlington, N. C.    Higginsville, Mo.    Carmichael, Cal.

**19.95 LAFAYETTE SPECIAL**  
**RADIO CONTROL TRANSMITTER**



Completely assembled — tested — and guaranteed R/C transmitter. Includes tube and 27.255 MC crystal, 6 sect. telescoping antenna. Size: 4" x 4" x 12". Approx. 1 mile range. Shpg. wt., 3 lbs. Less batteries.  
**F-249** ..... Net **19.95**

*Lafayette Radio* 100 SIXTH AVE.  
NEW YORK, N. Y.  
BOSTON 10, MASS., 110 Federal St.  
NEWARK 2, N. J., 24 Central Ave.  
DEPT PE  
include postage with order.

**SELSYNS Only \$3.95 ea.**



Navy type 5 (ap-110 Volt  
prox. 6 1/2" L x 3 1/2" dia.). 60 Cycle  
Original cost. \$180.00  
Don't pass this value. Order motors, generators, transformers, and differentials all at this price. Ship. wt. 6 lbs.  
**\$3.95**  
ea. .... \$7.50  
Per pair .....

Include postage.  
MONEY BACK IF RETURNED  
PREPAID WITHIN TEN DAYS  
42 WEST SOUTH ST.  
INDIANAPOLIS 25, INDIANA

**ESSE RADIO CO.**

**THE BIGGEST 25¢ BARGAIN**  
**IN THE ELECTRONICS INDUSTRY**

Yes, just 25¢ will bring you the next 12 issues of our monthly bargain-packed bulletin, featuring: Motors, Meters, Relays, Timers, Blowers, Pumps, and thousands of outstanding electronic devices. Just a quarter starts you on the bandwagon of values.

**HERBACH & RADEMAN, INC.**  
1204 Arch Street            Philadelphia 7, Penna.

**TEST OSCILLOSCOPE**  
TS-100/AP

**\$34.50**

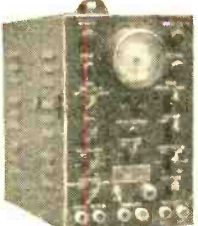

Used by U. S. Signal Corps for Viewing Video Pulses, Time Intervals, Etc. 110V—A.C. Send for Our Surplus Lists

SEMLER INDUSTRIES, INC.  
6853 LANKERSHIM BLVD., NORTH HOLLYWOOD, CALIF.

**7.95 LAFAYETTE SPECIAL**  
**RADIO CONTROL RECEIVER**

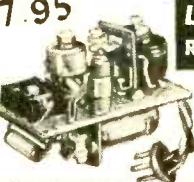

Completely wired and assembled, with tube, ready to operate on exam free 27.255 MC remote control band. Size: 1 3/4" x 1-15/16" x 3". Weight 3.3 oz. Uses one 1.5 volt and one 45 volt battery. Less batteries. Shpg. wt., 6 oz.  
**F-208** ..... Net **7.95**

*Lafayette Radio* 100 SIXTH AVE. BOSTON 10, MASS., 110 Federal St.  
NEW YORK, N. Y. NEWARK 2, N. J., 24 Central Ave.  
PLAINFIELD, N. J., 139 W. Second St.  
BRONX 58, N. Y., 547 E. Fordham Rd.  
DEPT PE  
include postage with order.

**"TAB" SPECIALS**



**Cutler Hammer Switch, Hvy Duty**  
#8744K6, 3PDT, will handle up to 10 amps., 1/2 H.P., 1 phase 115-575 VAC/3/4 H.P., 2-3 phase 115-575 Vac. Silver plated contacts. Reg. \$2.40; "TAB" @ 2 for \$1

**New Diehl Miniature PM Motor**  
Hi efficiency, ball bearing, type FD6-21, RPM 10,000/27.5 VDC. Excellent for models R.R. & experimenters. Size 1" H., 1" W., 2" D. \$20 Reg. "TAB" \$1.85

**"TAB"** 111 Liberty St., N. Y. 6, N. Y.  
Dept. 9B            Rector 2-6245

**BRAND NEW ELECTRONIC PHOTO FLASH**

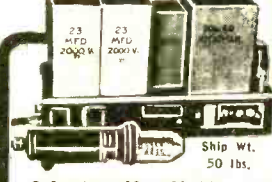

100 Watt Sec.  
**\$19.95**  
Ship wt. 50 lbs.

- Operate on 12 or 24 Volts
- Complete Strobe Housing
- SYLVANIA A-1073 Strobe
- Instruction Manual

**HERSHEL Radio Co.** 5249 Gr. River, Det. 8, Mich.

There's no better place for reaching so many electronics hobbyists and experimenters than on the pages of this magazine! Ask about **POPULAR ELECTRONICS'** "Bargain Basement" column rates and circulation figures by contacting **POPULAR ELECTRONICS**, 366 Madison Avenue, New York 17, N. Y.

The next (October) issue of **POPULAR ELECTRONICS** marks our second anniversary as America's foremost magazine for the electronics hobbyist and experimenter. It's the biggest issue in our history! Watch for it!

# Classified

RATE: 50¢ per word. Minimum 10 words prepaid. November Issue closes September 3rd. Send order and remittance to: POPULAR ELECTRONICS, 366 Madison Avenue, N. Y. C. 17.

## FOR SALE

**TUBES-TV, Radio, Transmitting And Industrial Types** At Sensibly Low Prices. New, Guaranteed 1st Quality Top Name Brands Only. Write For Free Catalog or call Walker 5-7000, Barry Electronics Corp., 512 Broadway, New York 12N, N. Y.

**DIAGRAMS** for repairing radios \$1.00, Television \$2.00. Give make, model. Diagram Service, Box 672-PE, Hartford 1, Conn.

**SECRET Beam Transmitter**, New, Five Mile Range, White & Infrared. Portable, Flashlight battery operation. Includes Signal Gun, Gunstock, Tripod, Infrared Goggles, Remote Control, Carrying Case, Manual. Government paid over \$50. Yours for only \$10 postpaid. Illustrated Signal Corps Manual 50c. Surplus, Box 118, Jersey City 4, N. J.

**TRANSISTOR Pre-Amp \$9.95, F-M Pocket Radio Kit \$3.95, Tube \$5.95, Earpiece \$5.95, Transistor Two Band Radio With Earpiece \$25.95, Three Electronic Questions Answered \$1.00 and Stamped Envelope, Ekeradio Electronic Developments, 646 No. Fair Oaks, Pasadena, Calif.**

**"AUTOMATIC Garage Door Control"** Book (POPtronics Bookshelf, March, 1956); standard parts; radio or post control. Complete assembly instructions, plans photos, exploded view: \$1.50. R-L Books, 13339-A Debby, Van Nuys, California. Guaranteed!

**AUTOMATIC Headlight Dimmer**. Transistorized. Kit or ready to install. Nagog, Littleton, Massachusetts.

**DIAGRAMS! Repair Information! Radios—Amplifiers—Recorders \$1.00, Televisions \$1.50.** Give Make, Model, Chassis. Norelco-Philips and Ampex tubes in stock! TV Millie, Box 101-PE, Hicksville, New York.

**"20 CRYSTAL Set Plans"** (SW record 5800 miles), Catalog and "Radiobuilder" magazine—25¢. Laboratories, 328-L Fuller, Redwood City, California.

**COMPLETE Television sets \$11.95.** Jones TV, 1115 Rambler Ave., Pottstown, Pa.

**WALKIE-talkie plans, constructional details.** Inexpensive, simple, compact. 50¢. Fabco Electronics, 7400 Jackson Pk., Birmingham, Mich.

**TUBES—Parts—80% off—Free List.** Federal, 986 18th Ave., Newark, N. J.

**PANEL Meters, Transformers, Tubes, Crystals.** Free List. Rajor Products Co., Box 81, Rego Park, N. Y.

**TRANSISTOR kits.** Pocket portable with earphone and battery \$7.95. Crystal diode receiver with transistor stage \$4.95, without \$3.95. Earphone \$1.95. Two transistor amplifier \$4.95. Microphone \$1.95. Wired kits \$2.00 extra. Altronics, 2815 Solway, St. Louis 21, Mo.

**SURPLUS Radar, transmitters, receivers, walkie-talkies.** Fantastic bargains. Picture catalog 5¢. Meshna, Malden, Mass.

## WANTED

**TUBES and equipment bought, sold and exchanged.** For action and a fair deal write B. F. Gensler, W2LNI, 56 Crosby St., N. Y. 12N, N. Y.

## INVENTIONS WANTED

**INVENTIONS** wanted. Patented; unpatented. Global Marketing Service, 2420 77th, Oakland 5, Calif.

## TAPE RECORDERS

**TAPE Recorders, Tape.** Unusual Values. Free Catalog. Dressner, 69-02F, 174 St., Flushing 65, N. Y.

**PRE-RECORDED Tapes.** Low price recording tape, Accessories. Catalog. Eisco Sales, 270-A Concord Avenue, West Hempstead, N. Y.

## BUSINESS OPPORTUNITIES

**PROFIT** through Growth Stocks. Special Report \$1 Shows You How. Brookmire, Inc., 52 Wall Street, New York City.

**TO \$100.00 Weekly.** Sparetime, Home Operated Mail-order Business. Successful "Beginner's" Plan. Everything Supplied. Lynn, 10420-E National, Los Angeles 34.

**VENDING Machines—No Selling.** Operate a route of coin machines and earn amazing profits. 32-page catalog free. Parkway Machine Corporation, Dept. 12, 715 Ensor St., Baltimore 2, Md.

**FREE Booklet "Money-Making Facts"** tells mechanically-inclined men how to start sparetime business at home. Lee Foley Company, Columbia Heights, Minnesota.

**\$70 WEEKLY—home, spare time.** Simplified mail bookkeeping. Immediate income—easy! Auditax, 34757Y, Los Angeles 34.

**\$150 WEEK—easy!** Start home Venetian Blind Laundry. Revealing book free. E. O. Co., 101 So. 44th, Philadelphia 4, Penna.

**AT Last! Something New and Sensational** in latest Tall Christmas Cards. Make Extra Money Fast! Show Satins, Velours, Metallics. Gets Easy Orders. Pays up to 100% Profit. 30 Free Samples. With Name 50 for \$1.50. Big Line. Amazing Convertible Pen-Pencil, Napkins, Gifts, Stationery. Several \$1.00 Boxes on Approval. Puro Greetings, 2801 Locust, Dept. 6185-L, St. Louis 12, Mo.

## EMPLOYMENT INFORMATION

**JOBS—High Pay.** South America, the Islands, USA, foreign countries. All trades. Clerical, labor, engineers, drivers, others. Women also. Fare paid. Application forms. For information. Write Section 92B, National Employment Information, 1020 Broad, Newark, N. J.

## INSTRUCTION

**FINISH High School** at home, spare time. No classes. Diploma awarded. Write for Free catalog. Wayne School, Catalog HET-13, 2527 Sheffield, Chicago 14.

**OPPORTUNITY!** Complete high school at home in spare time with 59-year-old school. Texts furnished. No classes. Diploma. Information booklet free. American School, Dept. X656, Drexel at 58th, Chicago 37, Illinois.

**ENGINEERING Degrees** earned by home study. Residential Courses Also Available. American College of Engineering, Box 27724-D, Hollywood 27, California.

## HIGH-FIDELITY

**FREE: Stroboscope Disc.** Gives accurate check of turntable speed and variations permitting adjustment to eliminate distortion, wrong pitch & "wow." Send 10¢ to cover postage & handling. Free catalog of TV repair books included. Harry G. Cisin, Amagansett, N. Y.

## RECORDS

**PHONOGRAPH Records Cheap.** Catalogue. Paramount, TD—313 East Market, Wilkes-Barre, Penna.

## STAMPS AND COINS

**INDIANHEAD Cent and 1st . . . 10¢.** Haas Coins, Desk PE-1, 2205 Northland, Lakewood 7, Ohio.

## MISCELLANEOUS

**FREE Kits List & Engineers' vocabulary.** Amacco, 252 Greenwich St., N. Y. C.

**GUARANTEED Finest Quality—100 Double Edge Razor Blades \$1.00.** United, Box 7, Corona 68, N. Y.

**PERSONAL Printer.** Self Contained Case, Automatic Inker \$1.00—500 Gummed Name & Address Labels Hundreds Uses \$1.00. United, Box 7, Corona 68, N. Y.

**SONGPOEMS and Lyrics Wanted!** Mail to: Tin Pan Alley, Inc., 1650 Broadway, New York 19, N. Y.

Always say you saw it in—POPULAR ELECTRONICS



## Build a "Minidyne"

(Continued from page 78)

signal generator to 455 kc. and switch on the 400-cycle modulator. Now, turn the receiver volume control to maximum.

Adjust the trimmers at the top of *T2* and the slug available through the underside of *T1* for maximum tone output from the speaker. Keep the volume control of the receiver at maximum, but back off the r.f. output from the signal generator as the i.f. circuits are brought into alignment. The most critical adjustment of the trimmers can be made when the tone from the speaker is just barely audible.

When the i.f. circuits are aligned, remove the temporary short circuit connected across the plates of *C3* and turn the plates of the tuning capacitor to where they are completely meshed. Set the r.f. signal generator at 550 kc., and adjust the slug in *L2* until the 400-cycle tone is again heard coming from the speaker. The length of the threaded brass adjusting screw on *L2* should be extending about  $\frac{1}{2}$ " when the adjustment is properly made.

Now, turn the plates of the tuning capacitor full out, and set the signal generator at 1700 kc. Adjust the trimmer on *C3* until the tone is heard coming from the speaker. Retune the receiver and the sig-

nal generator to 550 kc. and readjust the slug in *L2*. Then recheck the 1700 setting and, if necessary, retrim *C3*. This completes the alignment.

**Operation.** In the design of the "Minidyne," all stress has been laid on gain. Thus, it is not a high-fidelity receiver. With a 20' length of wire used as an antenna, it provides room volume when receiving stations are 50 miles away. However, the maximum audio output is limited. Severe distortion results from overloading the tube, so the length of the antenna should be limited to that which provides best over-all performance. Those constructors living in large cities which have strong broadcast transmitters will need a fairly short antenna. In some localities, enough signal may be picked up by *L1* alone, without any antenna.

Those of you who live at some distance from a powerful station, however, will need an antenna. For most efficient reception of a single station of your choice, back out the trimmer on *C2* until its capacitance is too low to be effective. Tune the "Minidyne" to the desired station and adjust *C1* for loudest and best performance. To receive several stations moderately well, juggle the adjustments of *C1* and the trimmer on *C2* until the reception is the best that can be obtained.

-50-

### Get This Valuable Book

# FREE

Just For Examining COYNE'S New Set

## "Applied Practical Radio-Television"

on 7 DAY FREE TRIAL!



**NOW!**  
**7 BIG BOOKS**  
IN ONE GREAT SET!

Yes, you get this big, brand new book, "150 Radio-Television Picture Patterns and Diagrams Explained," absolutely FREE! Just off the press. Gives complete 11" x 22" Schematic Diagrams on leading models Radio and TV Sets. Easy-to-read, large 8 1/2" x 11" pages, with full instructions on how to use the diagrams. A "must" in every repair kit. You get this book as a FREE Gift for asking to see Coyne's new 7-book set, "Applied Practical Radio-Television!"

**AT LAST! MONEY-MAKING "KNOW-HOW" ON TRANSISTORS, COLOR TV AND SERVICING**

Coyne's great 7-volume set gives you all the answers to servicing problems—quickly! For basic "know-how" that's easy to understand, you'll find everything you want in Volumes 1 to 5 on over 5000 practical facts and data. Every step from fundamentals to installing, servicing and troubleshooting all types of radio and TV sets. So up-to-date it covers COLOR TV, UHF and the latest on TRANSISTORS. All this plus Volume 6—NEW Coyne TECHNICAL DICTIONARY with over 4000 definitions of the latest terms, symbols and abbreviations in radio-TV, electronics and electricity.

**EXTRA! 900-PAGE TELEVISION CYCLOPEDIA INCLUDED**

And then, for speedy on-the-job use, you get volume 7—the famous Coyne TELEVISION CYCLOPEDIA. It answers today's television problems on servicing, alignment, installation, etc. In easy-to-find ABC order, cross-indexed. Use this 7-volume TV-RADIO LIBRARY FREE for 7 days; get the valuable Servicing Book ABSOLUTELY FREE!

SEND NO MONEY! Just mail coupon for 7-volume set on 7 days free trial. We'll include book of 150 TV-Radio Patterns and Diagrams. If you keep the set, pay \$2 in 7 days and \$2 per month until \$24.50 plus postage is paid. (Cash price, only \$22.95.) Or you can return the library at our expense in 7 days and owe nothing. **YOU BE THE JUDGE.** Either way, the book of TV-Radio Patterns is yours FREE to keep! Offer is limited. Act NOW!

### FREE BOOK—FREE TRIAL COUPON!

Educational Book Publishing Division  
COYNE ELECTRICAL SCHOOL, Dept. 96-PE  
500 S. Paulina St., Chicago 12, Ill.

YES! Send 7-Volume "Applied Practical Radio-Television" for 7 days FREE TRIAL per your offer. Include TV-Radio Patterns & Diagram Book FREE.

Name ..... Age .....

Address .....

City ..... Zone ..... State .....

Where Employed .....

Check here if you want library sent C.O.D. You pay Postman \$22.95 plus C.O.D. postage on delivery. 7-day money-back guarantee.

Educational Book Publishing Division  
**COYNE** ELECTRICAL SCHOOL  
500 S. Paulina St., Dept. 96-PE Chicago 12, Ill.

September, 1956

131

## WRITE FOR NEW BONUS CATALOG

### NEW "TABLITE" ELECTRONIC FLASH KITS AC & Battery Operation Inbuilt All in One Camera Case



Uses new to cost 10 voltage SUPER CIRCUIT constant bright light output; light duration 1/600 sec'd; color KGB80's; cost per flash less than 3c. 1000 to 2000 flashes per set of batteries. All kits with inbuilt AC pack. Kits less batteries. Easy to follow instructions.

MODEL 400B, 60 Watt Sec'd, color 75+; B&W 225+ @ \$29.95  
Recycles 2 sec'ds, less than 4 lbs.

MODEL 600B, 120 WATT Sec'd, color 100+; B&W 300+ @ \$44.95  
Recycles 5 sec'ds, less than 5 lbs.

TWO (2) 240 VOLT BATTERIES. @ \$10  
KITS ASSEMBLED. Additional. @ \$10

## KITS! KITS!

Each "TAB" Kit Contains the Finest Selection of Top Quality Components in the Most Popular Values & Sizes

**EXTRA:** Free Kit with Each \$10 Kit order

25 Precision Resistors	25 Power Resistors
10 Switches	65 Mica Condensers
25 Knobs	5 Crystal Diodes
75 Carbon Resistors*	250 ft. Hook Up Wire, Asst'd
36 Panel Lamps	100 Fuses
10 Electrolytic Cond's	35 Ceramic Condensers
15 Volume Controls	10 Rotary Switches
25 Tube Sockets	6 Crystals
50 Tubular Condensers	60 Inductors & Coils
500 Lugs & Eyes	5 Microswitches
10 Bathing Oil Cond's	5 Wheat Lamps
5 lbs. Surprise Package	* In Plastic Box
10 Transmit Mica Cond's	
40 Insulators	

1,000's OF SATISFIED CUSTOMERS

EACH KIT ONLY.....99c



"TAB" FINEST HI-FI RECORDING TAPE  
7" Reel—1200 Ft. Per Reel \$1.45 lots  
Sold on Money Back Guarantee.

Highest quality Hi-Fi Precision Coated & Sht. FERRO-SHEEN processed, quality controlled, constant output, Noise FREE, Splice FREE Plastic Tape. Freq. 7 1/2 IPS. 40-15KC Oxide Wind In. sets. "TAB" @ \$1.59 ea. 3/\$1.50 ea.

### They're Fun to Build, and You Save \$\$, too BUILD 'EM YOURSELF KITS

MULTITESTER, 1000 Ohms Per Volt. 31 ranges. AC/DC Volts: 0.1, 5, 10, 50, 100, 500, 5000V. Amps: 0.1, 10 ma; 0.1, 1A. Ohms: 0-5000, 100K, 1 meg. 6DB ranges. Model TE3. @ \$12.25

RF SIGNAL GENERATOR, for FM/AM alignment & TV marker. Freqs. 150KC to 34 mc. w/ calibrated harmonics to 102 mc. 400 cycle sine outputs. Precision made. Model TE4. @ \$18.95

VTVM, Precision built. 4 1/2" meter. AC/DC Volts: 0, 5, 10, 100, 500, 1000V. Ohms: 0.2 to 1000 meg. Steel case. Stable and accurate. Model TE2. @ \$24.25

TUBE TESTER, Professional type. tests all conventional, TV, series string & picture tubes. Model TE1. @ \$33

### INFRARED SNOOPSCOPE

Selected, GTD & Tested for resolution. 1st class image converter viewing tube. Hi-sensitivity simplified design 2" dia. Willemite screen—Hi-Resolution. Tube & Data. @ \$4.75; 2/\$9

### SNOOPSCOPE POWER SUPPLY

Model PS201—4500VDC/35MA Supply using dual doubler ckt. Housed in metal cabinet. @ \$21.95  
KIT. Same as above; parts only, less cabinet \$13.95



## TUBES

"TAB" Guaranteed  
TESTED  
OUR 12th YEAR IN BUSINESS

0A2	.70	6AQ5	.45	654	.45	12AX4	.70
0Z4	.42	6AS5	.75	654T	.55	12X7	.55
1B3	.60	6AT6	.65	65H7	.40	12BH7	.65
1L4	.40	6AU4	.75	65J7	.45		
1R5	.49	6AU6	.40	65K7	.45	CK1028	3.25
1S4	.60	6AX7	.60	65L7	.45		
1S5	.40	6BA6	.45	65N7	.55	12BY7	.70
1T4	.49	6BC5	.45	65Q7	.59	12CA7	.65
1U4	.40	6BE6	.45	6T4	1.00	12SK7	.43
1X5	.40	6BF5	.50			12SN7	.55
1X2A	.60	6BG6	1.12	1N21	.25	12SQ7	.45
2V3	.75	6E5	.75			14A7	.55
3A4	.48	6BL7	.80	6T8	.75	198G6	1.25
3A5	.75	6BN6	.65	6U8	.75	258Q6	.90
3Q4	.40	6AV6	.90	6V6	.45	25Z5	.45
3V4	.55	6BQ7	.85	6W6	.55	35C5	.50
5U4G	.42	6C4	.35	6X4	.30	35L6	.50
5Y3G	.65			7A8	.50	3WA	.45
6A4	.40	2D21	.75	7C5	.55	3Z5	.45
6AC7	.64	6H6	.45	7F7	.55	50A5	.45
6AQ5	.45	6CB6	.48	6V8	.68	50B5	.55
6AH4	.75	6CD6	1.12	7N7	.55	50C5	.45
		6H6	.45	7Q7	.75	50L6	.40
58P1	1.75	6J5	.38	6VAT6	.40	75	.45
		6J6	.45	12AT7	.65	76	.45
6AH6	.85	6K6	.39	12AU7	.50	77	.40
6AK5	.52	6K7	.35	12AV6	.35	117L7/N7	1.75
6AL5	.38	6L6	.65	12AV7	.75		

## "TAB"

TERMS: Money Back Gtd (cost of mfg. only). \$5 min. order F.O.B. N.Y.C. Add shpg. charges or for C.O.D. 25% Dep. Tubes Gtd, via R-Exp. only. Prices shown are subject to change.

Dept. 9PE6, 111 Liberty St., N.Y. 6, N.Y., Rector 2-6245

## ADVERTISER'S INDEX

ADVERTISER	PAGE NO.
ABC Metal Products	110
Ace Radio Company	129
Acme Model Engineering Co.	122
Algeradio Electronics	120
Allied Radio Corporation	8, 9, 115
Altec Lansing Corp.	113
Audio Artisans, Inc.	111
Auto Mechanic	126
B&P Trading Co.	117
Bailey Technical Schools	117
Burgess Battery Company	107
Canadian Institute of Science	125
Capitol Radio Engineering Institute	17
Career Institute	32
Centralab	118
Central Technical Institute	33
Cisin, Harry G.	119
Cleveland Institute of Radio Electronics	23
Columbia Records	15
Coyne Electrical School	5, 131
DeRo Electronics	128
DeVry Technical Institute.	11, 27
Drake, R. L.	18
Dyna Company	28
Electronic Measurements Corp.	10
Electronic Instrument Co., Inc. (EICO)	129
Esse Radio Co.	106
Funk & Wagnalls	106
Garfield Company, Oliver	93
Gonsel Company	112
Grantham School of Electronics	104
Gyro Electronics Co.	102
Hallcrafters	34
Hawkins, P. E.	94, 95, 96
Health Company	129
Herbach & Rademan	129
Hershel Radio Co.	16, 129
I.D.E.A., Inc.	19
Indiana Technical College	104
Indianapolis Electronic School	110
International Correspondence Schools	13
International Crystal Mfg. Co.	123
Interstate Training Service	128
Johnson Company, E. F.	125
Keil Engineering Products Co.	32
King-Size, Inc.	122
Klinsch & Associates	104
LMB	112
Lafayette Radio Corp.	105, 129, 129
Lektron Specialties	111
Linguaphone Institute	128
Linthrop Mfg. Co.	32
McGraw Hill Book Co., Inc.	122
Major Brand Tube Co.	103
Midway Company	112
Miller, Gustave	118
Milwaukee School of Engineering	127
Mini-Tronics Co.	106
Mosley Electronics Inc.	114
Moss Electronics Distributing Co., Inc.	3rd & 4th Covers
National Radio Institute	3, 99, 100
National Schools	25
Newark Electric Co.	118
Nordic Radio Co.	118
Pacific States University	112
Philadelphia Wireless Technical Institute	107
Presto Development Co.	2nd Cover
Premier Radio & TV Supply	114
Progressive "Edu-Kits," Inc.	121
Quality Electronics	120
RCA Institutes	21
Radio Shack Corporation	14
Radio TV Training Association	7
Raytheon Manufacturing Co.	31
Remington Rand Univac	26
Rider Publishing Co., Inc. John F.	109
Rinehart Books	109
Rockbar Corporation	30
Sams, Howard W.	12
Scott-Mitchell House, Inc.	120
Semler Industries, Inc.	129
Shure Brothers	24
Springfield Enterprises	125
"TAB"	129, 132
Tanner Shoes	118
TriDyne, Inc.	110
Tri-State College	119
Tue Mart, The	120
Union Institute	29
U. S. Air Force	128
V.S.I. Television School	102
Valparaiso Technical College	108
Video Electronics	107, 114
Western Radio	117
Westwood Research & Development Lab.	117
Whitehall Pharmaceutical Co.	117
World Radio Labs	20
YMCA Trade Schools	122



# SUPER-METER



A COMBINATION  
**VOLT-OHM MILLIAMMETER**  
 plus CAPACITY REACTANCE  
 INDUCTANCE AND DECIBEL  
 MEASUREMENTS

**ADDED FEATURE:**

Built in ISOLATION TRANSFORMER reduces possibility of burning out meter through misuse.

**SPECIFICATIONS:**

**D.C. VOLTS:** 0 to 7.5/15/30/150/750/1,500/7,500 Volts  
**A.C. VOLTS:** 0 to 15/30/150/300/1,500/3,000 Volts  
**OUTPUT VOLTS:** 0 to 15/30/150/300/1,500/3,000 Volts  
**D.C. CURRENT:** 0 to 1.5/15/150 Ma. to 0 to 1.5/15 Amperes  
**RESISTANCE:** 0 to 1 000/100,000 Ohms 0 to 10 Megohms  
**CAPACITY:** .00 to 1 Mfd. 1 to 50 Mfd. (Good-Bad scale for checking quality of electrolytic condensers.)  
**REACTANCE:** 50 to 2,500 Ohms 2,500 Ohms to 2.5 Megohms  
**INDUCTANCE:** .15 to 7 Henries 7 to 7,000 Henries  
**DECIBELS:** -6 to +18 +14 to +38 +34 to +58

The Model 670-A comes housed in a rugged rockle-finished steel cabinet complete with test leads, and operating instructions.

**28<sup>40</sup>**

# TUBE TESTER



QUICKLY AND EFFICIENTLY TESTS RADIO AND TV TUBES INCLUDING: SEVEN PIN MINIATURES; EIGHT PIN SUBMINARS, OCTALS AND LOCTALS; NINE PIN NOVALS

**YOU CAN'T INSERT A TUBE IN THE WRONG SOCKET.**

It is impossible to insert the tube in the wrong socket when using the new Model TC-55. Separate sockets are used, one for each type of tube base. If the tube fits in the socket it can be tested.

**"FREE-POINT" ELEMENT SWITCHING SYSTEM.**

The Model TC-55 incorporates a newly designed element selector switch system which reduces the possibility of obsolescence to an

absolute minimum. Any pin may be used as a filament pin and the voltage applied between that pin and any other pin, or even the "top-cap."

**CHECKS FOR SHORTS AND LEAKAGES BETWEEN ALL ELEMENTS.** The Model TC-55 provides a super sensitive method of checking for shorts and leakages up to 5 Megohms between any and all of the terminals.

**ELEMENTAL SWITCHES ARE NUMBERED IN STRICT ACCORDANCE WITH R.M.A. SPECIFICATION.**

One of the most important improvements, we believe, is the fact that the 4 position fast-action snap switches are all numbered in exact accordance with the standard R.M.A. numbering system. Thus, if the element terminating in pin No. 7 of a tube is under test, button No. 7 is used for that test.

The Model TC-55 comes complete with operating instructions and charts. Use it on the bench—use it for field calls. A streamlined carrying case, included at no extra charge, accommodates the tester and book of instructions.

**26<sup>95</sup>**

**ABOUT TESTING PICTURE TUBES...**

Of course you can buy an "adapter" which theoretically will convert your standard Tube Tester into a picture-tube tester. Sounds fine—but—it simply doesn't work out that way! We do not make nor do we recommend use of C.R.T. adapters because a Cathode Ray Tube is a very complex device and to properly test it, you need an instrument designed exclusively to test C.R. Tubes and nothing else. As compared to a make-shift adapter, which sells for about five dollars, our Model TV-40 C.R.T.

Superior's New  
 Model TV-40

# PICTURE TUBE TESTER

Tests ALL magnetically deflected tubes . . . in the set . . . out of the set . . . in the carton!!

- Tests all magnetically deflected picture tubes from 7 inch to 30 inch types.
- Tests for quality by the well established emission method. All readings on "Good-Bad" scale.
- Tests for inter-element shorts and leakages up to 5 megohms.
- Test for open elements.

**EASY TO USE:** Simply insert line cord into any 110 volt A.C. outlet, then attach tester socket to tube base (Ion trap need not be on tube). Throw switch up for quality test. . . read direct on Good-Bad scale, switch down for all leakage tests.

Model TV-40 Picture Tube Tester comes absolutely complete — nothing else to

buy. Housed in round cornered, molded bakelite case. Only

**15<sup>85</sup>**

# SHIPPED ON APPROVAL NO MONEY WITH ORDER — NO C.O.D.

We invite you to try before you buy any of the models described on this and the following page. If after a 10 day trial you are completely satisfied and decide to keep the Tester, you need send us only the down payment and agree to pay the balance due at the monthly indicated rate. (See other side for time-payment schedule details.)

**NO INTEREST  
 OR FINANCE  
 CHARGES ADDED!**

If not completely satisfied, you are privileged to return the Tester to us, cancelling any further obligation.

**SEE OTHER  
 SIDE**

**CUT OUT AND SEND POSTAGE-FREE AIR MAIL CARD TODAY!**

All prices net, F.O.B., N.Y.C.

**FIRST CLASS**

Permit No. 61430

New York, N. Y.

**BUSINESS REPLY CARD**

No Postage Stamp Necessary if Mailed in the U. S.

**VIA AIR MAIL**

POSTAGE WILL BE PAID BY —

**MOSS ELECTRONIC DIST. CO., INC.**

3849 TENTH AVENUE

NEW YORK 34, N. Y.

# TUBE TESTER



- ★ Tests all tubes including 4, 5, 6, 7, Octal, Lock-in, Peanut, Bantam, Hearing Aid, Thyatron Miniatures, Sub-miniatures, Novals, Sub-minars, Proximity fuse types, etc.
- ★ Uses the new self-cleaning Lever Action Switches for individual element testing. Because all elements are numbered according to pin-number in the RMA base numbering system, the user can instantly identify which element is under test. Tubes having tapped filaments and tubes with filaments terminating in more than one pin are truly tested with Model TV-11 as any of the pins may be placed in the neutral position when needed.

★ The Model TV-11 does not use any combination type sockets. Instead individual sockets are used for each type of tube. Thus it is impossible to damage a tube by inserting it in the wrong socket.

- ★ Free-moving built-in roll chart provides complete data for all tubes.
- ★ Newly designed Line Voltage Control compensates for variation of any Line Voltage between 105 Volts and 130 Volts.
- ★ NOISE TEST: Phono-Jack on front panel for plugging in either phones or external amplifier will detect microphonic tubes or noise due to faulty elements and loose internal connections.

**EXTRA SERVICE** — The Model TV-11 may be used as an extremely sensitive Condenser Leakage Checker. A relaxation type oscillator incorporated in this model will detect leakages even when the frequency is one per minute.

The model TV-11 operates on 105-130 Volt 60 Cycles A.C. Comes housed in a beautiful hand-rubbed oak cabinet complete with portable cover.

**47<sup>50</sup>**

# TRANS-CONDUCTANCE TUBE TESTER



## TESTING TUBES

• Employs improved TRANS-CONDUCTANCE circuit. An in-phase signal is impressed on the input section of a tube and the resultant plate current change is measured. This provides the most suitable method of simulating the manner in which tubes actually operate in Radio & TV receivers, amplifiers and other circuits. Amplification factor, plate resistance and cathode emission are all correlated in one meter reading. • **NEW LINE VOLTAGE ADJUSTING SYSTEM.** A tapcore transformer makes it possible to compensate for line voltage variations to a tolerance of better than 2%. • **SAFETY BUTTON**—protects both the tube under test and the instrument meter against damage due to overload or other form of improper switching. • **NEWLY DESIGNED FIVE POSITION LEVER SWITCH ASSEMBLY.** Permits application of separate voltages as required for both plate and grid of tube under test, resulting in improved Trans-Conductance circuit.

## ALSO TESTS TRANSISTORS!

A transistor can be safely and adequately tested only under dynamic conditions. The Model TV-12 will test all transistors in that approved manner, and quality is read directly on a special "transistor only" meter scale. The Model TV-12 will accommodate all transistors including NPN's, PNP's, Photo and Tetodes, whether made of Germanium or Silicon, either point contact or junction contact types.

## TESTING TRANSISTORS

The Model TV-12 housed in handsome rugged portable robinet sells for only

**72<sup>50</sup>**

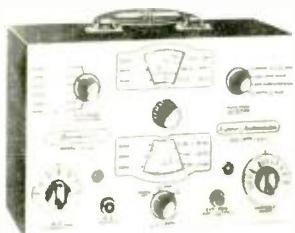

Superior's new Model TV-50

# GENOMETER

## 7 Signal Generators in One!

- ✓ R. F. Signal Generator for A.M.
- ✓ R. F. Signal Generator for F.M.
- ✓ Audio Frequency Generator
- ✓ Bar Generator
- ✓ Cross Hatch Generator
- ✓ Color Dot Pattern Generator
- ✓ Marker Generator

**R. F. SIGNAL GENERATOR:** The Model TV-50 Genometer provides complete coverage for A.M. and F.M. alignment. Generates Radio Frequencies from 100 Kilocycles to 60 Megacycles on fundamentals and from 60 Megacycles to 180 Megacycles on powerful harmonics.

**CROSS HATCH GENERATOR:** The Model TV-50 Genometer will project a cross hatch pattern on any TV picture tube. The pattern will consist of non-shifting, horizontal and vertical lines interlaced to provide a stable cross hatch effect.

**DOT PATTERN GENERATOR (FOR COLOR TV)** Although you will be able to use most of your regular standard equipment for servicing Color TV, the one addition which is a "must" is a Dot Pattern Generator. The Dot Pattern projected on any color TV Receiver tube by the Model TV-50 will enable you to adjust for proper color convergence.

**MARKER GENERATOR:** The Model TV-50 includes all the most frequently needed marker points. The following markers are provided: 189 Kc., 282.5 Kc., 456 Kc., 600 Kc., 1000 Kc., 1400 Kc., 1800 Kc., 2000 Kc., 2400 Kc., 3579 Kc., 4.5 Mc., 5 Mc., 10.7 Mc., 13579 Kc. is the color burst frequency.

**VARIABLE AUDIO FREQUENCY GENERATOR:** In addition to a fixed 400 cycle sine-wave audio, the Model TV-50 Genometer provides a variable 300 cycle to 20 000 cycle peaked wave audio signal.

**BAR GENERATOR:** The Model TV-50 projects an actual Bar Pattern on any TV Receiver Screen. Pattern will consist of 4 to 16 horizontal bars or 7 to 20 vertical bars.

**47<sup>50</sup>**

# SHIPPED ON APPROVAL NO MONEY WITH ORDER — NO C.O.D.

MOSS ELECTRONIC DISTRIBUTING CO., INC.  
Dept. D-257, 3849 Tenth Avenue, New York 34, N. Y.

Please send me the units checked. I agree to pay down payment within 10 days and to pay the monthly balance as shown. It is understood there will be no finance or interest charges added. It is further understood that should I fail to make payments when due, the full unpaid balance shall become immediately due and payable.

- Model TV-11 . . . Total Price \$47.50 \$11.50 within 10 days. Balance \$6.00 monthly for 6 months.
- Model TV-40 . . . Total Price \$15.85 \$3.85 within 10 days. Balance \$4.00 monthly for 3 months.
- Model TC-55 . . . Total Price \$26.95 \$6.95 within 10 days. Balance \$5.00 monthly for 4 months.
- Model 670-A . . . Total Price \$28.40 \$7.40 within 10 days. Balance \$3.50 monthly for 6 months.
- Model TV-50 . . . Total Price \$47.50 \$11.50 within 10 days. Balance \$6.00 monthly for 6 months.
- Model TV-12 . . . Total Price \$72.50 \$22.50 within 10 days. Balance \$10.00 monthly for 5 months.

Name \_\_\_\_\_  
Address \_\_\_\_\_  
City \_\_\_\_\_ Zone \_\_\_\_\_ State \_\_\_\_\_

All prices net, F.O.B., N.Y.C.

We invite you to try before you buy any of the models described on this and the preceding page. If after a 10 day trial you are completely satisfied and decide to keep the Tester, you need send us only the down payment and agree to pay the balance due at the monthly indicated rate.

**NO INTEREST  
OR FINANCE  
CHARGES ADDED!**

If not completely satisfied, you are privileged to return the Tester to us, cancelling any further obligation.

◀ **SEE OTHER SIDE**

◀ **CUT OUT AND SEND POSTAGE-FREE AIR MAIL CARD TODAY!**