

# POPULAR ELECTRONICS

AUGUST  
1956

25  
CENTS

in U. S. and Canada

## Home-Built "Ears" Detect Distant Aircraft

**How Electronic Minds Remember  
Printed Wiring Techniques  
Checking Old Radio Parts  
Build a Bass Reflex, Jr.  
Correspond with Tapes**



**NOW—BUILD IT YOURSELF in a few hours!**

# Amazing *electric* Brain

**COMPUTES, PLAYS GAMES, "REASONS"!**

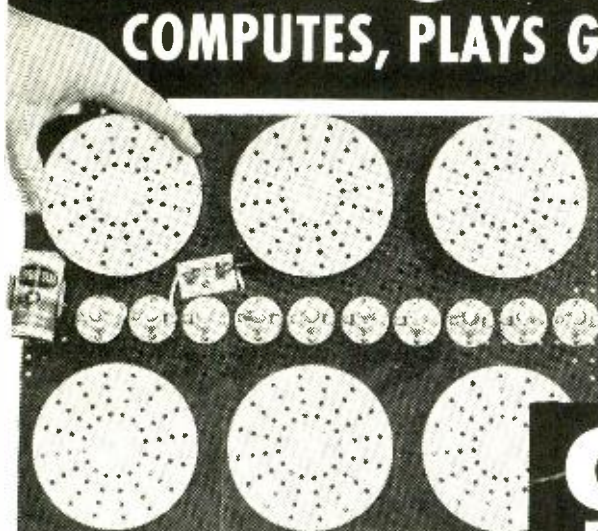

Here's a wonderful kit that gives you a fascinating introduction to the logic machines of our modern age! The devices you can build test intelligence, code and decode, count, play Tic-tac-toe, solve problems! Converts from binary to decimal — reasons in syllogisms — computes! Send for your kit today!

## GENIAC ELECTRIC BRAIN

**YES,** you build any one of 33 exciting electric brain machines in just a few hours by following the clear-cut, step-by-step directions given in a thrilling booklet! No soldering required... no wiring beyond your skill! GENIAC is a genuine brain machine—not a toy. The *only* logic machine kit that not only adds, subtracts, etc., but presents the basic ideas of cybernetics, Boolean algebra, symbolic logic, automatation, etc. So simple to construct that even a twelve-year-old can make a machine that will fascinate people with advanced scientific training!

**OVER 400 COMPONENTS AND PARTS.** Circuits operate on one flashlight battery, and the use of ingeniously designed parts makes building circuits one of the most fascinating things you've ever done! You set up problems in a variety of fields—and get your answers almost quicker than you can set them up! Play games with the machine—nim, tic-tac-toe, etc.—and pit your brain against its logic! Solve puzzles in a few seconds that would take you hours without the aid of the ma-

chine. You actually *see* how computing and problem—solving is analyzed with algebraic solutions transferred directly into circuit diagrams.

**YOUR COST FOR GENIAC KIT:** only \$19.95 postpaid. The 1956 Model GENIAC KIT contains: (1) a complete 200-page text, "Minds and Machines"—a basic introduction to computers. (2) "How to Construct Electrical Brains At Home"—a fully illustrated text book on basic computer design theory and circuits with specific instructions for building circuits. (3) Wiring Diagram Manual. A special booklet with full scale diagrams that you can tear out and place on your work bench for easy assembly. (4) Beginners' Manual. Starting from scratch, the manual adds fifteen extra experiments, thoroughly tested using GENIAC components to teach the basic symbols of electric circuits. (5) Over 400 components and parts.

So—mail the coupon for your GENIAC today! (Teachers: take advantage of 10% deduction if ordered for use in institutions). Your money back if not delighted!

### You can build 33 different machines, including

Binary Adding Machine	Automatic Oil Furnace Circuit
Secret Coder & Decoder	Machine for a Space Ship's Airlark
Machine for Arithmetical Carrying	Intelligence Tester
Comparing Machine	Burglar Alarm
Reasoning Machine	Puzzle Solvers
General Combination Locks	Adder, Subtractor, Multiplier, Divider
Games Requiring Logic	

### Some Firms and Institutions that have ordered GENIAC:

Allis-Chalmers Remington-Rand	Albert Einstein Medical College
International Business Machines Wheeldey Mfg. Co.	Naval Research Laboratories Board of Education, Tecumseh, Nebraska
Manuel Missionary College	Marshfield Public Schools
Walter V. Clarke Associates	Los Angeles Public Schools
Barnard College	Jefferson Union High School
Westinghouse Electric	Oklahoma A&M
Phillips Laboratories General	Kansas State University
Insurance Co. of America	Duke University
Lafayette	Coral Gables Senior High School
Radio	Courtland Jr. High School
Rohr Aircraft Co.	Bell Telephone Laboratories
Southwest Missouri State College	

**ORDER GENIAC ON OUR MONEY BACK Guarantee!**

SCIENCE KITS, Dept. PE-86  
Oliver Garfield Co., 126 Lexington Ave., New York 16, N. Y.

Please send me:  
1 GENIAC Electric Brain Construction Kit and Manuals.  
\$19.95 (East of Mississippi) .....  
\$20.95 (Elsewhere in United States) .....  
\$21.95 (Outside the United States) .....

Returnable in seven days for full refund if not satisfied. I enclose \$.....in full payment.

Name.....  
Address.....  
City.....Zone.....State.....





**J. E. SMITH**  
President, National Radio Institute. 40 years' experience training men at home for Radio-TV.

**I Will Send You A**  
**SAMPLE LESSON FREE**  
*to show you how easy, practical it is to*  
**Train at Home for Good**  
**Radio-Television Jobs**



**Make \$10, \$15 a Week Extra**  
Many men I train fix neighbors' Radios, make extra money, soon after they enroll. Actual equipment you build gives you practical experience.

**America's Fast Growing Industry Offers You Good Pay Plus a Bright Future**

TRAINING plus OPPORTUNITY is the PERFECT combination for ambitious men. Let me send you a sample lesson from my course to prove you can keep your job while TRAINING at home in your spare time for better pay and a brighter future. I will also send my 64-page book to show you that Radio-Television is today's field of OPPORTUNITY for properly trained men.



**Television's Growth is Making More Jobs, Prosperity**

Radio is bigger than ever and television is growing fast. Government, Aviation, Police, Ship, Microwave Relay, Two Way Communications for buses, taxis, railroads are other growing fields for Radio-Television trained men.

**I Trained These Men**

"I have a regular job as a police captain and also have a good spare time Radio and Television service business. Just opened my new showrooms and shop." — C. W. LEWIS, Pensacola, Florida.

"I decided to quit my job and do TV work full time. I love my work and am doing all right. If fellows knew what a wonderful investment NRI is, they would not hesitate." — W. F. KLINE, Cincinnati, Ohio.

"Thanks to NRI, I operated a successful Radio repair shop. Then I got a job with WPAQ, later WEOB and now am an engineer for WHPE." — VAN W. WORKMAN, High Point, N. Carolina.



**Mail Coupon—Find Out About This Tested Way to Better Pay**

Take NRI training for as little as \$5 a month. Many NRI graduates make more in two weeks than the total cost of my training. Mail coupon today for Actual Lesson and 64-page Book—Both FREE. J. E. SMITH, National Radio Institute, Dept. 6HD4, Washington 9, D. C. Our 40th Year.

**You Learn by Practicing with Equipment I Send**

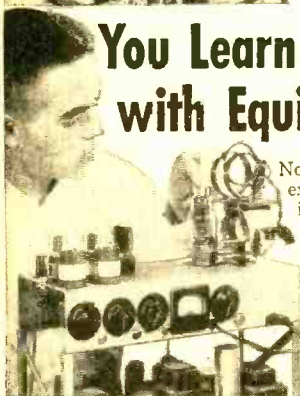

Nothing takes the place of practical experience. That's why NRI training is based on LEARNING BY DOING. My training includes kits of parts which you use to build equipment and get practical experience on circuits common to both Radio and Television. Shown at left is the low-power Broadcasting Transmitter you build as part of my Communications Course.



AVAILABLE TO **VETERANS** UNDER G. I. BILLS

**Good for Both—FREE**

Mr. J. E. Smith, President, Dept. 6HD4  
National Radio Institute, Washington 9, D. C.  
Mail me Sample Lesson and 64-page Book, FREE.  
(No salesman will call. Please write plainly.)

Name \_\_\_\_\_ Age \_\_\_\_\_  
Address \_\_\_\_\_  
City \_\_\_\_\_ Zone \_\_\_\_\_ State \_\_\_\_\_  
write in date of discharge  
**VETS** \_\_\_\_\_  
Approved Member, National Home Study Council

POPULAR ELECTRONICS is published monthly by Ziff-Davis Publishing Company, William B. Ziff, Chairman of the Board (1946-1953), at 61 E. Lake St., Chicago 1, Ill. Entered as second class matter August 27, 1954 at the Post Office, Chicago, Illinois. SUBSCRIPTION RATES: One year U.S. and possessions, and Canada \$3.00; Pan-American Union Countries \$3.50; all other foreign countries \$4.00.

# POPULAR ELECTRONICS

## CONTENTS

### FEATURE Articles

The Electronic Mind—How It Remembers.....	H. H. Fantel	31
Dodging the Weather—with Radar.....		37
SAGE—Whirlwind Defense Quarterback.....	E. D. Morgan	43
Automatic Pin Boy.....		54
Largest Radar Chain Tracks Missiles 1500 Miles.....		68
Tube Tester Plug-In Accessories Double Value and Quadruple Versatility.....		88
You CAN Phone from Your Boat.....	Elbert Robberson	91
Super-Safe Testing Assures Survival at Supersonic Speeds.....		95
Miniaturization Shrinks Hearing Aids.....		103

### ELECTRONIC Build-It-Yourself Projects

"Ears" for the CD Observer Post.....	Louis E. Garner, Jr.	47
The Batteries in Your Portable.....	Eugene F. Coriell, Lt. Col., USAF	51
90-Volt Neon Lamp Runs on 4½-Volt Battery.....	George P. Pearce	53
Magnetize for Fun and Utility.....	Rhys Samuels	57
"Printed Wiring" Techniques for the Experimenter (Part 1)	Louis E. Garner, Jr.	59
Microphone-to-Stand Adapter.....	Art Trauffer	63
Building a "See-Thru" Radio.....	Phil McCafferty	76
Junkbox Parts Checker.....	Richard Graham	83
Magnifying Sun Battery Power.....	Art Trauffer	90
It's a Cinch to Check Your Camera Synch.....	R. L. Winklepleck	100
Experimenters' R and C Stocks.....	B. W. Blachford	124

### AUDIO and HI-FI Features

Voices in the Mail.....	Celia Webster	39
AM Tuner for Low-Cost Hi-Fi.....	John A. Norman	52
Low-Down on Turntable Upkeep.....		56
Bass Reflex, Jr.....	Frank H. Tooker	71
Electronic Phono Speed Changer.....	H. J. Carter	89
Why We Equalize Our Hi-Fi.....	Leon Fields and R. M. Johnson	96
Enclosure Looks Good with Burlap Finish.....	Wm. B. Rasmussen	128

### DEPARTMENTS

Carl & Jerry.....	John T. Frye	8
POP'ronics Bookshelf.....		20
Letters from Our Readers.....		26
Transistor Topics.....	Lou Garner	65
Tuning the Short-Wave Bands.....	Hank Bennett	67
The Transmitting Tower.....	Herb S. Brier	78
Where Are You?.....		82
After Class.....		85
Tools and Gadgets.....		102
Tips and Techniques.....		105
Standardized Wiring Diagram Symbols.....		126
Resistor Color Code.....		127
Capacitor Color Code.....		127

(Also see page 6 for NEWS of Electronic Developments)

© 1956 by Ziff-Davis Publishing Company. All rights reserved.

Average Net Paid Circulation 205,193

AUGUST 1956

VOL. 5—NUMBER 2

**Publisher**  
OLIVER READ, WIETI

Managing Editor  
OLIVER P. FERRELL

Technical Editor  
MILTON S. SNITZER

Feature Editor  
NORMAN EISENBERG

Associate Editors  
HANS H. FANTEL  
MARGARET MAGNA

Contributing Editors  
H. BENNETT L. E. GARNER, JR.  
H. S. BRIER H. POLLACK  
J. T. FRYE R. P. TURNER

Art Editor  
ALFONS J. REICH

Art and Drafting Dept.  
FRANK SAYLES  
J. A. GOLANEK M. WHELPLEY  
W. K. VAHLING J. A. ROTH

Advertising Director  
L. L. OSTEN

Advertising Manager  
WILLIAM G. McROY

Midwest Adv. Manager  
JIM WEAKLEY

Western Adv. Manager  
JOHN E. PAYNE



Member  
Audit Bureau of  
Circulations



**ZIFF-DAVIS PUBLISHING COMPANY**  
W. B. ZIFF (1898-1953) FOUNDER

Also Publishers of  
RADIO & TELEVISION NEWS  
Editorial and Executive Offices  
366 Madison Ave., New York 17, N. Y.  
MU 7-8080

**President**  
B. G. DAVIS

Vice-President  
H. J. MORGANROTH

Vice-President  
M. FROELICH

Vice-Pres. & Circ. Dir.  
M. MICHAELSON

Secretary-Treasurer  
G. E. CARNEY

Art Director  
AL GRUEN

**BRANCH OFFICES**  
CHICAGO (1)  
64 E. Lake St., AN 3-5200  
LOS ANGELES (14)  
215 W. 7th St. (Room 412)  
Trinity 8043

**SUBSCRIPTION SERVICE:**  
All communications concerning subscriptions should be addressed to Circulation Dept., 64 E. Lake St., Chicago 1, Ill. Include your old address as well as new—enclosing if possible an address label from a recent issue of this magazine. Allow at least 4 weeks for change of address.

**CONTRIBUTORS:**  
Contributors are advised to retain a copy of their manuscripts and illustrations. Contributions should be mailed to the New York Editorial Office and must be accompanied by return postage. Contributions will be handled with reasonable care, but this magazine assumes no responsibility for their safety. Any copy accepted is subject to whatever adaptations and revisions are necessary to meet the requirements of this publication. Payment covers all authors' contributions and contentist's rights, title, and interest in and to the material accepted and will be made at our current rates upon acceptance. All photos and drawings will be considered as part of material purchased.

POPULAR ELECTRONICS





**COYNE QUALITY**

# TELEVISION RADIO-COLOR TV

Home Training  
*at Unbelievably Low Cost*



The future is **YOURS** in **TELEVISION!**  
A fabulous field—good pay—fascinating work—a prosperous future in a good job, or independence in your own business!

Coyne brings you **MODERN-QUALITY** Television Home Training; training designed to meet Coyne standards at truly lowest cost—you pay for training only—no costly "put together kits." Not an old Radio Course with Television "tacked on." Here is **MODERN TELEVISION TRAINING** including **Radio, UHF and Color TV.** No Radio background or previous experience needed. Personal guidance by Coyne Staff. **Practical Job Guides** to show you how to do actual servicing jobs—**make money early in course.** Free Life-time Employment Service to Graduates.

**COYNE**  
**ELECTRICAL SCHOOL**  
A TECHNICAL TRADE INSTITUTE OPERATED  
NOT FOR PROFIT  
500 S. Paulina Street, Chicago 12, Dept. C6-HT7

B. W. COOKE,  
President



*Coyne—the Institution behind this training... the largest, oldest, best equipped residential school of its kind. Founded 1899.*

## Send Coupon for Free Book

and full details, including easy Payment Plan. No obligation, no salesman will call.



### COYNE Television Home Training Division

500 S. Paulina St., Chicago 12, Ill.  
Dept. C6-HT7

Send Free Book and details on how I can get Coyne Quality Television Home Training at low cost and easy terms.

Name \_\_\_\_\_  
Address \_\_\_\_\_  
City \_\_\_\_\_ State \_\_\_\_\_

## Train in Great Shops of COYNE for better jobs in

# ELECTRICITY or TELEVISION

ELECTRONICS

RADIO-COLOR TV

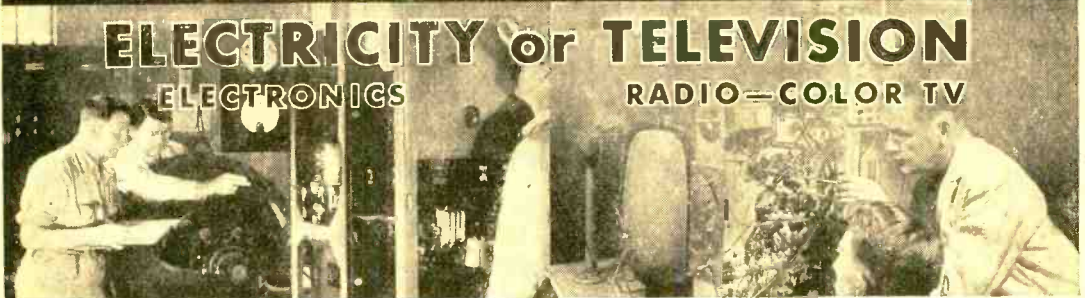

### TWO TOP OPPORTUNITY FIELDS

Whether 17 or up to 45 years of age, train the Coyne way for a better job and a real future in **ELECTRICITY-ELECTRONICS** or **TELEVISION-RADIO**, fields that offer a world of opportunities. Train on real, full-size equipment at COYNE where thousands of successful men have trained for over 57 years—**largest, oldest, best equipped school of its kind**—established 1899. No advanced education or previous experience needed. Employment service to graduates. **START NOW—PAY LATER**—Finance Plan and Easy Monthly Payment Plan. Also part-time employment help for students. Training in Refrigeration and Electric Appliances can be included.

B. W. COOKE, President

**COYNE**  
**ELECTRICAL SCHOOL**

FOUNDED 1899

A Technical Trade Institute Operated Not For Profit  
500 S. Paulina Street, Chicago, Dept. C6-71H  
ELECTRICITY • RADIO • TELEVISION • REFRIGERATION • ELECTRONICS

August, 1956

### MAIL COUPON FOR FREE BOOK

Send coupon for 48-page illustrated book "Guide to Careers in Electricity-Electronics and Television-Radio." No cost; no obligation; no salesman will call. Vets and Non-Vets get vital facts now!



B. W. COOKE, President  
COYNE ELECTRICAL SCHOOL  
500 S. Paulina St., Chicago 12, Ill., Dept. C6-71H

Send **BIG FREE** book and details of your training offer. This does not obligate me and no salesman will call. I am interested in:

( ) Electricity-Electronics ( ) Television-Radio

Name \_\_\_\_\_  
Address \_\_\_\_\_  
City \_\_\_\_\_ State \_\_\_\_\_

When You Want To Build  
Transistorized Equipment...



You Can't Beat This



The 116 page Raytheon Transistor Applications Book contains everything you need to know, including wiring diagrams, illustrations and parts lists, to build receivers, timers, oscillators, geiger-counters, metal locators, more than 50 practical, useful transistor applications. Available at your Raytheon Tube Supplier or send 50¢ to Department P7.

**ONLY  
50¢**

The RAYTHEON CK722 TRANSISTOR is used in most of the circuits in the book. You'll find it tops in quality and tops in performance yet the Raytheon CK722 is rock bottom in price. Available *only* through your Raytheon Tube Supplier.

**ONLY  
99¢**



*Excellence in Electronics*

**RAYTHEON MFG. CO.**

Receiving and Cathode Ray Tube Operations  
Newton 58, Massachusetts

NEWS of Electronic Developments

Dead Whale "Calls" Ship by Radio Buoy.....	35
"EVA" Paints Hot and Cold for Thermal Study....	35
No Sleeping at This Switch!.....	36
TV Checks Your Bounce.....	36
Soviets Use British TV Equipment.....	38
R/C Drone Is Television-Equipped.....	46
Ultrasonics Slices Quartz.....	46
Computer Goes Aloft.....	64
Vintage '39 Fortress Now Missile Target.....	64
Fish Need Sunlight to Find Way.....	70
Poly Bags Hold Valuable Parts.....	70
TV Guards the Gate.....	70
Myrtle—the (Electronic) Turtle—Knows Its Way Around.....	75
Print-Out Voltmeter Keeps Triple Record.....	75
Automation Idea Used in Tube Tester.....	82
Portable Detector Spots Deadly "Nerve" Gas.....	82
Accessories Clean, Store Records.....	99

COMING NEXT MONTH (SEPTEMBER)

**POPULAR ELECTRONICS**

(ON SALE AUGUST 21)

**Build a "Minidyne"**

A "minimum superheterodyne" can be constructed around a single 6U8 tube.

**Soft Touch Control System**

It will enable you to turn electrical devices on and off simply by touching them.

**McIntyre Dual Proportional Control**

How proportional control can be adapted to R/C transmitters and receivers.

**At Home with Your Hi-Fi Test Record**

What test records are all about, and how you can use them with your own hi-fi.

**Radar Tames Wild Blue Yonder**

Air traffic control is restoring order and safety to a threatening aerial chaos.

**Would You Like to Be a Tech Writer?**

Detailed analysis of qualifications necessary for technical writing.

IN THIS MONTH'S  
**RADIO & TELEVISION NEWS**

(AUGUST)

A New Approach to Hi-Fi Stereophonics

Transistorized Beach Phonograph

The Dual-Cone Loudspeaker

A Simple Preamplifier for the Home Builder

Always say you saw it in—POPULAR ELECTRONICS



**WANTED:  
200,000 TV  
SERVICE MEN!**

**VETERANS  
NON-VETERANS**

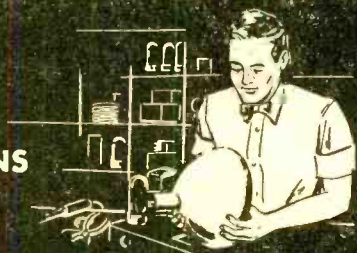

**GET IN ON THIS  
2 BILLION DOLLAR PLUM!**

200,000 — That's how many service men will be needed to handle television-radio-electronics industry requirements in the next few years. That's the figure given by the director of product service for CBS-Columbia — a man in a position to know. 2.7 billion dollars to be spent just for service and installation of TV sets in American homes by 1957! That's the figure given by one of the top men in the entire industry — the president of Radio Corporation of America.



L. C. Lane, B.S., M.A.  
President, Radio-Television  
Training Association  
Executive Director, Pierce  
School of Radio & Television.

**Think What This Means For YOU!**

Here is a field still in its infancy — New jobs with top pay and a secure future are being created every day — Here is a chance for you to get into a growing field with unlimited opportunity for advancement — Here is your chance to set up your own business and be your own boss — Here is your opportunity to get in on a 2 billion dollar plum by becoming a Television Technician.

**LEARN TELEVISION AT HOME  
IN YOUR SPARE TIME**

Trained men get the top jobs. You can qualify for one without giving up your present job or social life. My lessons are especially prepared for you to study at home — even if you have absolutely no experience in this field.

**CHOOSE FROM THREE COMPLETE COURSES**  
covering all phases of Radio, FM and TV

1. Radio, FM and Television Technician Course — no previous experience necessary.
2. FM-TV Technician Course — previous training or experience in radio required.
3. TV Cameraman and Studio Technician Course — advanced training for men with Radio or TV training or experience.

**VETERANS**

My School fully approved to train Veterans under new Korean G I Bill Don't lose your school benefits by waiting too long. Write discharge date on coupon.

**LEARN BY DOING**

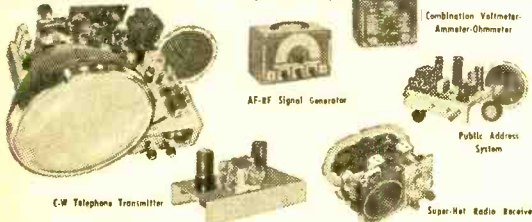

AF-RF Signal Generator

Combination Voltmeter-Ammeter-Ohmmeter

Public Address System

C-W Telephone Transmitter

Super-Het Radio Receiver

As part of your training, I give you the equipment you need to set up your own home laboratory and prepare for a BETTER PAY TV JOB. You build and keep an Electromagnetic TV RECEIVER designed and engineered to take any size picture tube up to 21-inch. (10-inch tube furnished. Slight extra cost for larger sizes.) . . . also a Super-Het Radio Receiver, AF-RF Signal Generator, Combination Voltmeter-Ammeter-Ohmmeter, C-W Telephone Transmitter, Public Address System, AC-DC Power Supply. Everything supplied, including all tubes.

**EARN WHILE YOU LEARN**

Almost from the very start of your course you can earn extra money by repairing sets for friends and neighbors. Many of my students earn up to \$25 a week . . . pay for their entire training with spare time earnings . . . start their own profitable service business.

**EXTRA TRAINING IN NEW-YORK CITY AT NO EXTRA COST!**

After you finish your home study training in Course 1 or 2 you can have two weeks, 50 hours, of intensive Lab work on modern electronic equipment at our associate resident school, Pierce School of Radio & Television. THIS EXTRA TRAINING IS YOURS AT NO EXTRA COST WHATSOEVER!

**FCC COACHING COURSE** — Important for BETTER-PAY JOBS requiring FCC license! You get this training AT NO EXTRA COST! Top TV jobs go to FCC-licensed technicians.

Mr. Leonard C. Lane, President  
**R T T A**

Dept. E-8C, 52 East 19th Street, New York 3, N. Y.

Dear Mr. Lane: Send me your NEW FREE BOOK, FREE SAMPLE LESSON, and FREE aids that will show me how I can make TOP MONEY IN TELEVISION. I understand I am under no obligation.

(PLEASE PRINT PLAINLY)

Name \_\_\_\_\_ Age \_\_\_\_\_

Address \_\_\_\_\_

City \_\_\_\_\_ Zone \_\_\_\_\_ State \_\_\_\_\_

**I AM INTERESTED IN:**

Radio-FM-TV Technician Course **Write discharge date**

FM-TV Technician Course

TV Cameraman & Studio Technician Course

**FREE!**

I'll send you my new 40-page book, "How to Make Money in Television, Radio-Electronics," a Free sample lesson, and other literature showing how and where you can get a top-pay job in Television.

**FREE HOW TO MAKE MONEY IN TV**

**FREE SAMPLE LESSON**

**Radio-Television Training Association**

52 EAST 19th STREET • NEW YORK 3, N. Y.

Licensed by the State of New York • Approved for Veteran Training

August, 1956

**NO OBLIGATION!**

for All  
**RECORD  
 SPEEDS**

The  
**Collaro**  
 High Fidelity



**4-Speed  
 Record Changer**

Model RC-456  
 for  
 78, 45, 33 $\frac{1}{3}$  and 16 $\frac{2}{3}$  rpm

**ROCKBAR CORPORATION**

650 Halstead Avenue, Mamaroneck, N.Y.

Tell me all about-the COLLARO RC-456

Name .....

Address .....

City..... Zone..... State.....

NA-18



**Bosco Has His Day**

**I**T WAS EVENING, and the boys were sitting on the back steps of Jerry's house. Carl had Bosco, his dog, firmly clamped between his knees and was wooling the dog's ears affectionately while Bosco growled in mock protest at this treatment that he actually loved.

"You stupid, no-account, dumb mutt," Carl muttered softly, as he looked morosely out at the long shadows creeping across the back lawn.

"What's Bosco done now?" Jerry wanted to know.

"It's what he hasn't done—or won't do," Carl replied. "A couple of days ago, as I was riding home on my bike after swimming, I ran across a fellow about our age working with a bird dog in a field out at the edge of town. He would hide a little cloth-covered ball that he called a 'bird' and send the dog in search of it. In nothing flat that dog would sniff out the bird and come trotting back to the guy with it in his mouth. This was interesting, and I was enjoying talking with the joker, but all at once he sort of looked down his nose at Bosco and wanted to know what kind of a dog *that* was.

"I said Bosco was just a plain dog, which seemed to strike him as real hilarious. Anyway, he gave out with a nasty laugh, and started a lot of who-shot-John about how he had papers for *his* dog, called Golden Arrow III, and that unless a dog had breeding you couldn't expect him to amount to much.

"Well, I got my back up at this, and remarked that it took more than a few sheets of paper to make a dog smart. I should have stopped there, but I got carried away and went on to say that if I couldn't teach Bosco to do everything Golden Arrow III was doing within a couple of weeks I'd eat my beanie. This character, whose name is Merrill, promptly took me up on it and said that if Bosco could equal Golden Arrow's performance *he* would eat *his* beanie."

"Well, how's it look?"

"Let me put it this way: do you think white or red sauce would go best with my beanie? I still believe old Bosco here is as



# You will enjoy music far more ...if you know what to listen for



## DAVID OISTRAKH

plays BEETHOVEN'S VIOLIN CONCERTO in D major  
MUSICAL PROGRAM NOTES BY G. WALLACE WOODWORTH,  
Professor of Music, Harvard University

## EMIL GILELS

plays MENDELSSOHN'S PIANO CONCERTO No. 1 in G minor  
(And the Kroll Quartet plays MENDELSSOHN'S OCTET FOR STRINGS)  
MUSICAL PROGRAM NOTES BY THOMAS SCHERMAN



## ALFRED WALLENSTEIN

conducts BRAHMS' SYMPHONY No. 2 in D major  
Los Angeles Philharmonic Orchestra  
MUSICAL PROGRAM NOTES BY THOMAS SCHERMAN



## LEONARD BERNSTEIN

conducts TCHAIKOVSKY'S PATHÉTIQUE SYMPHONY  
The Stadium Concerts Symphony Orchestra  
MUSICAL PROGRAM NOTES BY MR. BERNSTEIN



AS A DEMONSTRATION

You can obtain any one  
of these double-disc

# Music- Appreciation Recordings

FOR ONLY \$1<sup>00</sup>

(REGULAR PRICE FOR EACH \$3.90)

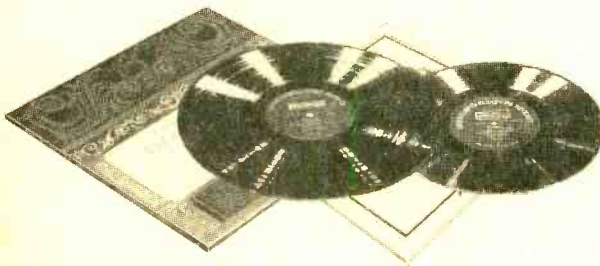

### SUGGESTION: A ONE-MONTH TRIAL SUBSCRIPTION

THE recent MUSIC-APPRECIATION selections described above feature artists recognized throughout the music world as outstanding. Because each of these recordings demonstrates, in a particularly exciting way, the MUSIC-APPRECIATION RECORDS idea, we will be happy to send you your choice of any one of them for only \$1.00.

The regular price of each of these double-disc recordings is \$3.90 (plus a small mailing charge). Should you want to receive other great works of music performed and analyzed in this

way, you can allow this one-month trial to continue for as short or as long a time as you please. If, however, the idea of these Musical Program Notes does not come up to your expectations, you may cancel immediately.

If you decide to continue you will not be obligated to take any specified number of records. A different work is announced in advance each month, described interestingly by Deems Taylor. As a subscriber you may take only those you are sure you want for your permanent record library.

### THE SENSIBLE PLAN:

1. YOU RECEIVE THE COMPLETE PERFORMANCE OF A GREAT WORK OF MUSIC WITH AN OUTSTANDING ARTIST, ORCHESTRA OR CONDUCTOR ON A 12-INCH 33 $\frac{1}{3}$  R.P.M. RECORD
2. AND IT IS ALWAYS ACCOMPANIED (WHEN YOU WANT IT) BY MUSICALLY ILLUSTRATED PROGRAM NOTES—THAT IS, A 10-INCH RECORD PRESENTING AN ABSORBING COMMENTARY FILLED WITH MUSICAL ILLUSTRATIONS TO ENHANCE YOUR ENJOYMENT AND UNDERSTANDING OF THE MUSIC

### PLEASE RETURN ONLY IF YOU HAVE A 33 $\frac{1}{3}$ R.P.M. RECORD PLAYER

Music Appreciation Records R68-8  
c/o Book-of-the-Month Club, Inc.  
345 Hudson Street, New York 14, N. Y.

Please send me at once the 12-inch 33 $\frac{1}{3}$  R.P.M. Demonstration Record I have indicated below, together with the 10-inch Musical Program Notes Record, billing me \$1.00, and enroll me in a one-month Trial Subscription to MUSIC-APPRECIATION RECORDS, with the privilege of canceling at any time. I understand that, as a subscriber, I am not obligated to buy any specified number of records, but may take only those I want. Also, I may cancel my subscription after hearing the Demonstration Recordings, or any time thereafter at my pleasure.

Beethoven's Concerto  Mendelssohn's Concerto  
 Brahms' Symphony  Tchaikovsky's Symphony

Mr. }  
Mrs. }  
Miss } (Please Print Plainly)

ADDRESS.....  
Postal Zone No. ....  
CITY..... (If any) STATE.....

Record prices are the same in Canada, and the Club ships to Canadian Members, without any charge for duty, through Book-of-the-Month Club (Canada), Ltd.  
MAR 80

# FREE

## 1956 EICO® CATALOG

tells you how to **SAVE 50%**  
on your test equipment costs!

46 EICO KITS & INSTRUMENTS to choose from!



5" PUSH-PULL  
OSCILLOSCOPE  
#425  
KIT \$44.95  
Wired \$79.95

VACUUM TUBE  
VOLTMETER  
#221  
KIT \$25.95  
Wired \$39.95



For Laboratory Precision at Lowest Cost—  
buy EICO!



1000 Ohms/Volt  
MULTIMETER  
#536  
KIT \$12.90  
Wired \$14.90



TUBE TESTER #625  
KIT \$34.95  
Wired \$49.95

You build EICO KITS in 1 evening, but—  
they last a lifetime!



NEW! UTILITY  
TESTER #540.  
KIT \$12.95  
WIRED \$15.95

6V & 12V BATTERY ELIMINATOR  
& CHARGER #1050

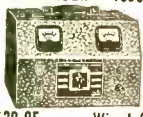

KIT \$29.95  
Wired \$38.95

EICO—performance-proved by TV manufac-  
turers, electronic schools and over 100,000  
servicemen! OVER 1/2 MILLION in use today!



NEW! COLOR &  
BLACK-&WHITE  
5-MC TV SCOPE  
#460  
KIT \$79.95  
Wired \$129.50

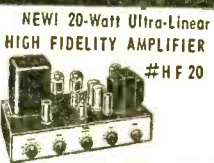

NEW! 20-Watt Ultra-Linear  
HIGH FIDELITY AMPLIFIER  
#HF 20  
KIT \$49.95  
Wired \$79.95

MAIL COUPON NOW. Prices 5% higher on  
West Coast. Electronic Instrument Co., Inc.,  
84 Withers St., Brooklyn 11, N. Y. ©56

EICO 84 Withers St., Brooklyn 11, N. Y.

Send FREE 1956 Catalog and name of  
neighborhood EICO distributor. PE-8

Name .....

Address .....

City..... Zone..... State.....

Occupation .....

Carl & Jerry (Continued from page 8)

smart as any dog that ever chased a cat, but I learn to my sorrow that he has a serious physical defect: he can't smell."

"Can't smell! I thought all dogs had a keen scent."

"So did I, but you can take my word for it that Bosco couldn't follow the trail of a ten-pound limburger cheese dragged over the ground 30 seconds before. By actual scientific tests, I have found that the absolute limit of his sense of smell is sniffing out a dog biscuit at a distance of two feet. Beyond that—nothing! I don't mind losing the bet so much, but I do hate to have poor Bosco made to look like a dummy simply because he can't smell so hot."

"Maybe you could teach him to locate the bird by sight."

"Not a chance. I have to hide the bird for Golden Arrow, and Merrill will hide it for Bosco. I know from watching him that he'll hide the bird down under leaves and stuff so it can't be seen. And, anyway, I can't make Bosco *want* to find that little cloth-covered ball. He's too smart to work for nothing and displays about as much interest in locating that artificial bird as I show in helping Mom find the castor oil bottle when I'm not feeling well."

"LET'S NOT give up too easy," Jerry said, as his interest in the problem began to mount. "Maybe we can appeal to one of Bosco's baser instincts. What does he like?"

"That's easy. Bosco's interested in just one thing, twenty-four hours a day: *food!* He's a real glutton."

"Then we'll start with that. I'm getting an idea. Remember that description of the transistorized golf ball in POPULAR ELECTRONICS some months back? You'll recall that the golf ball had a tiny transistor transmitter built right into it which sent out a continuous signal. This signal was picked up on a transistor-type receiver and led the owner of the ball right to it, no matter how well it was hidden."

"What's that got to do with making a bird dog out of Bosco?"

"Suppose we build a tiny transmitter into the artificial 'bird' you hide from Bosco. Then we'll fit him with a hidden receiver that will pick up the signal from the transmitter. In a short time, he should learn that when the signal gets stronger he must be getting closer—that is, he should be able to learn it if he's as smart as you say he is."

"Oh, he can learn that all right if he wants to, but what's going to make him want to?"

"We'll 'condition' him to expect food as

Always say you saw it in—POPULAR ELECTRONICS



**LOOK THEM OVER!**

A wide variety of opportunities awaits the Trained Man in the Fast Growing Fields of

# TELEVISION

## RADIO • ELECTRONICS

CHECK THESE OUTSTANDING OPPORTUNITIES!



- 1. YOUR OWN BUSINESS—Selling, installing, servicing Television (including Color TV) and Radio receivers, sound systems, etc.
- 2. MILITARY ELECTRONICS—Automatic weapons control and communications technician, etc.
- 3. RADAR TECHNICIAN—Operation and maintenance of navigation devices, etc.
- 4. TV-RADIO BROADCASTING—Studio technician, control room operator, TV cameraman. FCC licensed operator.
- 5. INDUSTRIAL TELEVISION—Installation, operation servicing of closed circuit TV systems.
- 6. AIRCRAFT RADIO—Flight tester, control tower operator, radio operator.
- 7. AUTOMATION ELECTRONICS—Specialist on electronic instruments and automatic controls.
- 8. TWO-WAY RADIO—Operation and maintenance of police, taxi, bus, truck communications systems.
- 9. REMOTE CONTROLS—Laboratory specialist on servo-mechanisms, guided missiles, radio-controlled devices.
- 10. COMPUTERS—Install and maintain Electronic "Brain" devices for office and industry.

... PLUS MANY OTHERS

Scores of jobs like those above in the technical end of Television-Radio-Electronics are open to men with proper training. Hundreds of DeVry graduates hold jobs like those. Many prepared at home and then we helped them get started. Hundreds had no previous technical training, no high school diploma, and while training never left home nor quit their jobs. Many were married men. Some paid for their training by repairing TV and Radio sets in their spare-time.

DTI's program helps you do this because it is different. You get on-the-job type experience, clear explanations. You build and keep your own test equipment, as you perform over 300 practical projects. You use visual training HOME MOVIES and the remarkable Elect-a-Lab. You may even build a fine quality 21-inch Television set, if you wish.

### TRAIN IN OUR WELL-EQUIPPED LABORATORIES

If you prefer, you can get all of your training in our great Chicago Laboratories. Friendly, capable instructors work closely with you, as you learn about the commercial equipment you encounter later in the field. Students use this fine equipment, including the broadcast-type cameras, monitors, microphones, etc. in our TV-Radio studios ... the color TV sets ... the test instruments, etc. Send coupon for details.

### EMPLOYMENT SERVICE

Placement is the "payoff" in any training program. We have close contact with many employers in our field. We are proud of our graduates—for they have done us proud! That's why we believe we can help you get started. And if you are thinking of going into business for yourself, we help you there too.

**IMPORTANT FACTS ABOUT MILITARY SERVICE**  
We have valuable information showing how to make the most of your service in the Armed Forces. Mail the coupon.

### HOME MOVIES

We loan you a projector and many reels of instructive film. Run them off yourself. How clear the basic principles of Electronics can be with this helpful training aid—a DTI exclusive!



### EXCLUSIVE ELECTRO-LAB

Wiring diagrams show up through the transparent base. You follow each diagram, making scores of circuits. Parts are mounted quickly and easily with spring clip connectors. Over 300 projects include the building of a 5-inch Oscilloscope and a Vacuum Tube Voltmeter ... both valuable test instruments.

VACUUM TUBE VOLTMETER

### HERE'S ALL YOU DO

If you are 17 to 55 and want to prepare to get into a field with good pay and promising future, just fill in the coupon and send it to us. We will tell you how you may get ready for a wonderful future for yourself and your loved ones.

Member of National Home Study Council

### SEND COUPON! GET FREE BOOKLET!

DEVRY TECHNICAL INSTITUTE  
4141 Belmont Ave., Chicago 41, Ill., Dept. PE-8-M

I would like a copy of "Electronics and YOU" showing many opportunities in Television-Radio-Electronics, and how DTI may prepare me for a start in this billion dollar field.

Of the opportunities listed above, I am interested in No. \_\_\_\_\_

Name \_\_\_\_\_ Age \_\_\_\_\_

Street \_\_\_\_\_ Apt. \_\_\_\_\_

City \_\_\_\_\_ Zone \_\_\_\_\_ State \_\_\_\_\_  
1038 DTI's training is also available in Canada



One of America's Foremost Electronics Training Centers  
**DEVRY TECHNICAL INSTITUTE**

Formerly DeForest's Training, Inc.

4141 BELMONT AVENUE, CHICAGO 41, ILLINOIS

## Carl & Jerry (Continued from page 10)

a reward for finding the bird and bringing it to you," Jerry explained. "After he gets used to wearing the receiver, which we'll conceal in some sort of headgear, we turn on the receiver and let him hear the sound of the hidden bird. Then we drag him to the bird, put it into his mouth, clamp the mouth shut, and drag him back to where you're standing. The instant you take the bird out of his mouth, you replace it with a dog biscuit. After we do this a few dozen times, he should get the idea and go find the bird by himself."

"So let's get going!" Carl exclaimed, as he slapped his hands on his knees and rose to his feet. "I'm willing to try anything, even an idea as crazy as that."

**W**ITH THE ENTHUSIASM of youth that enables it to undertake blithely something an older and wiser person—fully appreciating the difficulties—would never start, the two boys dashed down into Jerry's basement laboratory and immediately started building up the electronic equipment designed to convert Bosco from a biscuit dog to a bird dog.

Carl built the small one-transistor transmitter according to a plan for an i.f. signal

alignment generator. This tiny little unit delivered an r.f. signal, tone-modulated, on a frequency that could be adjusted from about 400 to 500 kilocycles. Two extra-small penlite batteries furnished the power, and the whole thing fitted neatly into a safety match box that in turn was mounted inside a cloth-covered little plastic box selected to serve as the body of the artificial bird.

Jerry had the harder job of building a fixed-tuned receiver for picking up the weak signal from the tiny transmitter. In order to keep size to a minimum, he used a circuit employing two transistors and a crystal diode in a regenerative circuit. Careful planning and layout, dispensing with sockets and soldering leads directly, employing the smallest of miniature parts . . . and similar space-conserving measures . . . produced a receiver on a very tiny flat fiberboard chassis. This chassis was sewn into the crown of a boldly checked "Sherlock Holmes" type of hat the boys cajoled Carl's mother into making for them. Bosco was then made to wear this hat in a rather unconventional manner. The normal fore-and-aft projections were pulled down tightly over his ears and fastened under his chin, and a dynamic earphone was concealed in one of the flaps so that



# DO-IT-YOURSELF HIGH FIDELITY CRYSTAL DIODE AM TUNER KIT

**NO POWER REQUIREMENTS •  
SELECTIVITY (20 KC) • LOW  
COST • NO NOISE • LIFETIME  
TROUBLE FREE OPERATION •  
SENSITIVITY • GAIN CONTROL  
SMALL SIZE 4"x7"x3½" DEEP  
VERNIER DIAL • NOTHING TO  
CAUSE DISTORTION • FREQ.  
540 KC-1700 KC**

*The No. 565 tuner kit is fully guaranteed. Buy with confidence from your Radio and TV Parts Distributor. It is one of the lowest priced quality tuner kits on the market.*

**Net Price \$14.70**

**J. W. MILLER COMPANY**  
5917 S. MAIN ST., LOS ANGELES 3, CALIF.

The Miller No. 565 Tuner Kit is the result of masterful engineering and careful planning. Previously sold only as a factory assembled unit the tuner has received overwhelming acceptance by the most critical audophiles, and is far superior to all other such tuner kits. Only recently have materials become available which make possible the construction of extremely high "Q" coils. Coils used in our tuner have a "Q" in the order of 600. Assembly and wiring of this tuner is not difficult. Step by step instructions with exploded views, pictures and circuit diagrams are supplied with each kit.

**Completely Wired No. 595 Tuner also available. Price \$19.50 plus Excise Tax**



# PICK YOUR OWN SUCCESS STORY FROM THIS PAGE

These are the true stories of people who seemed trapped in routine, low-pay shaky jobs. Handicapped by lack of proper training, they couldn't get the things they wanted out of life—more money, a job they liked, security and happiness.

They are a small sample of the thousands of men and women—young and old—who turn to I. C. S. for help. Their will-to-learn plus I. C. S. training have changed the course of their lives.

Are you discouraged with your job and pay and feel you can't improve yourself because of lack of specialized education? Well, these men and women were in the same boat. With I. C. S. training, one of these success stories could be about you.

**I. C. S.** is the oldest and largest correspondence school, 256 courses. Business, industrial, engineering, academic, high school. One for you. Direct, job-related. Bedrock facts and theory plus practical application. Complete lesson and answer service. No skimping. Diploma to graduates.



**Wins \$3000 contest**—"After my I. C. S. courses I secured a new position," says Mr. Cecil Rhodes. "My income has more than doubled and I recently won a \$8000 sales contest."



**From clerk to Assistant Estimator, thanks to I.C.S.** "Any way you look at it," writes Mrs. Edna James, "the time and money one spends for I. C. S. Courses will be repaid a thousandfold."



**"As a college graduate, I found I. C. S. very valuable."** Robert Lee took the I. C. S. Course in Advertising, is now Promotion Manager for a large corporation. "I. C. S. got me started on the way up," he says.



**From \$152 to \$395 a month**—"I.C.S. made my engineering work more interesting," Frank Bachtik tells us. "I was a Jr. Draftsman making \$152 a month. My present income is \$395.25 a month."

**3 FREE BOOKS**—a 36-page pocket-size guide to advancement, a gold mine of tips on "How to Succeed." Also a big catalog outlining opportunities in your field of interest and a sample I.C.S. lesson (Math.).

**For Real Job Security—Get an I. C. S. Diploma!** I. C. S., Scranton 9, Penna. Member, National Home Study Council

## INTERNATIONAL CORRESPONDENCE SCHOOLS

65<sup>TH</sup>  
YEAR

BOX 92622G, SCRANTON 9, PENNA.

(Partial list of 256 courses)

Without cost or obligation, send me "How to SUCCEED" and the opportunity booklet about the field BEFORE which I have marked X (plus sample lesson):

- |  |   |  |   |  |
|--|---|--|---|--|
| <p><b>ARCHITECTURE and BUILDING CONSTRUCTION</b></p> <ul style="list-style-type: none"> <li><input type="checkbox"/> Air Conditioning—Refrig.</li> <li><input type="checkbox"/> Architecture</li> <li><input type="checkbox"/> Architectural Interiors</li> <li><input type="checkbox"/> Building Contractor</li> <li><input type="checkbox"/> Building Estimator</li> <li><input type="checkbox"/> Building Maintenance</li> <li><input type="checkbox"/> Carpentry and Mill Work</li> <li><input type="checkbox"/> Heating</li> <li><input type="checkbox"/> Painting Contractor</li> <li><input type="checkbox"/> Plumbing</li> <li><input type="checkbox"/> Reading Arch. Blueprints</li> </ul> <p><b>ART</b></p> <ul style="list-style-type: none"> <li><input type="checkbox"/> Cartooning</li> <li><input type="checkbox"/> Commercial Art</li> <li><input type="checkbox"/> Fashion Illustrating</li> <li><input type="checkbox"/> Magazine Illustrating</li> <li><input type="checkbox"/> Show Card and Sign Lettering</li> <li><input type="checkbox"/> Sketching and Painting</li> </ul> <p><b>AUTOMOTIVE</b></p> <ul style="list-style-type: none"> <li><input type="checkbox"/> Auto Body Rebuilding</li> <li><input type="checkbox"/> Auto Elec. Technician</li> <li><input type="checkbox"/> Auto-Engine Tune Up</li> <li><input type="checkbox"/> Automobile Mechanic</li> </ul> | <p><b>AVIATION</b></p> <ul style="list-style-type: none"> <li><input type="checkbox"/> Aeronautical Engineering Jr.</li> <li><input type="checkbox"/> Aircraft &amp; Engine Mechanic</li> </ul> <p><b>BUSINESS</b></p> <ul style="list-style-type: none"> <li><input type="checkbox"/> Advertising</li> <li><input type="checkbox"/> Bookkeeping and Accounting</li> <li><input type="checkbox"/> Business Administration</li> <li><input type="checkbox"/> Business Correspondence</li> <li><input type="checkbox"/> Public Accounting</li> <li><input type="checkbox"/> Creative Salesmanship</li> <li><input type="checkbox"/> Federal Tax</li> <li><input type="checkbox"/> Letter-writing Improvement</li> <li><input type="checkbox"/> Office Management</li> <li><input type="checkbox"/> Professional Secretary</li> <li><input type="checkbox"/> Retail Business Management</li> <li><input type="checkbox"/> Sales Management</li> <li><input type="checkbox"/> Stenographic-Secretarial</li> <li><input type="checkbox"/> Traffic Management</li> </ul> <p><b>CHEMISTRY</b></p> <ul style="list-style-type: none"> <li><input type="checkbox"/> Analytical Chemistry</li> <li><input type="checkbox"/> Chemical Engineering</li> <li><input type="checkbox"/> Chem. Lab. Technician</li> <li><input type="checkbox"/> General Chemistry</li> <li><input type="checkbox"/> Natural Gas Prod. &amp; Trans.</li> <li><input type="checkbox"/> Petroleum Engineering</li> <li><input type="checkbox"/> Plastics</li> <li><input type="checkbox"/> Pulp and Paper Making</li> </ul> | <p><b>CIVIL, STRUCTURAL ENGINEERING</b></p> <ul style="list-style-type: none"> <li><input type="checkbox"/> Civil Engineering</li> <li><input type="checkbox"/> Construction Engineering</li> <li><input type="checkbox"/> Highway Engineering</li> <li><input type="checkbox"/> Reading Struct. Blueprints</li> <li><input type="checkbox"/> Sanitary Engineering</li> <li><input type="checkbox"/> Structural Engineering</li> <li><input type="checkbox"/> Surveying and Mapping</li> </ul> <p><b>DRAFTING</b></p> <ul style="list-style-type: none"> <li><input type="checkbox"/> Aircraft Drafting</li> <li><input type="checkbox"/> Architectural Drafting</li> <li><input type="checkbox"/> Mechanical Drafting</li> <li><input type="checkbox"/> Mine Surveying and Mapping</li> <li><input type="checkbox"/> Plumbing Drawing and Estimating</li> <li><input type="checkbox"/> Structural Drafting</li> </ul> <p><b>ELECTRICAL</b></p> <ul style="list-style-type: none"> <li><input type="checkbox"/> Electrical Engineering</li> <li><input type="checkbox"/> Electrical Maintenance</li> <li><input type="checkbox"/> Electrician <input type="checkbox"/> Contracting</li> <li><input type="checkbox"/> Lineman</li> </ul> <p><b>HIGH SCHOOL</b></p> <ul style="list-style-type: none"> <li><input type="checkbox"/> Commercial <input type="checkbox"/> Good English</li> <li><input type="checkbox"/> High School Subjects</li> <li><input type="checkbox"/> Mathematics</li> </ul> | <p><b>LEADERSHIP</b></p> <ul style="list-style-type: none"> <li><input type="checkbox"/> Foremanship</li> <li><input type="checkbox"/> Industrial Supervision</li> <li><input type="checkbox"/> Leadership and Organization</li> <li><input type="checkbox"/> Personnel-Labor Relations</li> </ul> <p><b>MECHANICAL AND SHOP</b></p> <ul style="list-style-type: none"> <li><input type="checkbox"/> Gas—Electric Welding</li> <li><input type="checkbox"/> Heat Treatment <input type="checkbox"/> Metallurgy</li> <li><input type="checkbox"/> Industrial Engineering</li> <li><input type="checkbox"/> Industrial Instrumentation</li> <li><input type="checkbox"/> Industrial Supervision</li> <li><input type="checkbox"/> Internal Combustion Engines</li> <li><input type="checkbox"/> Machine Design-Drafting</li> <li><input type="checkbox"/> Machine Shop Inspection</li> <li><input type="checkbox"/> Machine Shop Practice</li> <li><input type="checkbox"/> Mechanical Engineering</li> <li><input type="checkbox"/> Quality Control</li> <li><input type="checkbox"/> Reading Shop Blueprints</li> <li><input type="checkbox"/> Refrigeration</li> <li><input type="checkbox"/> Sheet Metal Worker</li> <li><input type="checkbox"/> Tool Design <input type="checkbox"/> Toolmaking</li> </ul> <p><b>RADIO TELEVISION</b></p> <ul style="list-style-type: none"> <li><input type="checkbox"/> Industrial Electronics</li> <li><input type="checkbox"/> Practical Radio TV Eng'ing</li> <li><input type="checkbox"/> Radio and TV Servicing</li> <li><input type="checkbox"/> Radio Operating</li> </ul> | <ul style="list-style-type: none"> <li><input type="checkbox"/> Television Technician</li> </ul> <p><b>RAILROAD</b></p> <ul style="list-style-type: none"> <li><input type="checkbox"/> Air Brake Equipment</li> <li><input type="checkbox"/> Car Inspector</li> <li><input type="checkbox"/> Diesel Engineer &amp; Fireman</li> <li><input type="checkbox"/> Section Foreman</li> </ul> <p><b>STEAM AND DIESEL POWER</b></p> <ul style="list-style-type: none"> <li><input type="checkbox"/> Combustion Engineering</li> <li><input type="checkbox"/> Diesel—Elec. <input type="checkbox"/> Diesel Eng's</li> <li><input type="checkbox"/> Electric Light and Power</li> <li><input type="checkbox"/> Stationary Fireman</li> <li><input type="checkbox"/> Stationary Steam Engineering</li> </ul> <p><b>TEXTILE</b></p> <ul style="list-style-type: none"> <li><input type="checkbox"/> Carding and Spinning</li> <li><input type="checkbox"/> Cotton, Rayon, Woolen Mfg.</li> <li><input type="checkbox"/> Finishing and Dyeing</li> <li><input type="checkbox"/> Loom Fix'g <input type="checkbox"/> Textile Des'ing</li> <li><input type="checkbox"/> Textile Eng'g <input type="checkbox"/> Throwing</li> <li><input type="checkbox"/> Warping and Weaving</li> </ul> <p><b>MISCELLANEOUS</b></p> <ul style="list-style-type: none"> <li><input type="checkbox"/> Domestic Refrigeration</li> <li><input type="checkbox"/> Marine Engineering</li> <li><input type="checkbox"/> Ocean Navigation</li> <li><input type="checkbox"/> Professional Engineering</li> <li><input type="checkbox"/> Short Story Writing</li> <li><input type="checkbox"/> Telephony</li> </ul> |
|--|---|--|---|--|

Name \_\_\_\_\_ Age \_\_\_\_\_ Home Address \_\_\_\_\_

City \_\_\_\_\_ Zone \_\_\_\_\_ State \_\_\_\_\_ Working Hours \_\_\_\_\_ A.M. to P.M.

Occupation \_\_\_\_\_

Canadian residents send coupon to International Correspondence Schools, Canadian, Ltd., Montreal, Canada. . . . Special tuition rates to members of the U. S. Armed Forces.

# LOOK

what \$35<sup>90</sup> buys...

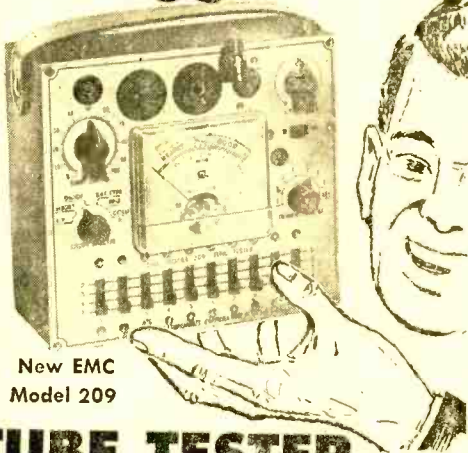

New EMC  
Model 209

## TUBE TESTER AND REJUVENATOR\*

"YOU CAN HOLD THIS MINIATURIZED INSTRUMENT IN ONE HAND... a revolutionary new development, it gives fast, absolutely accurate checks for tube quality, shorts, leakages, continuity, and opens on all modern and future tubes... uses standard emission test for quick readings on modern, 3 1/2" plastic meter... flexible switching system prevents obsolescence. This professional instrument also rejuvenates picture tubes with the Model CRA (Picture Tube Test Adaptor)\*... specially designed by advanced engineering techniques, its handy size (6 3/4" x 7 1/2" x 4") makes it ideal for home calls."

EMC Model 209  
(as illustrated in Hammertone metal case) \$35.90



In oak carrying case 38.50  
Kit form 25.90  
Complete with plastic-covered, detailed instruction book and tube listings.

\*EMC Model CRA  
(Picture Tube Adaptor) 4.50

Yes, send me full technical information about Model 209 and a complete catalog of other EMC Instruments. FE-8

NAME \_\_\_\_\_

STREET \_\_\_\_\_

CITY \_\_\_\_\_ STATE \_\_\_\_\_

**EMC** ELECTRONIC MEASUREMENTS CORP.  
280 LAFAYETTE STREET  
NEW YORK 17, N.Y.  
EXPORT DEPT. - 370 BROADWAY, N.Y. 43, N.Y.

### Carl & Jerry (Continued from page 12)

it would be held close to the dog's ear.

Do not think that all this was done overnight and that everything worked perfectly as soon as it was put together. Designing electronic equipment just doesn't work that way, not even in commercial laboratories where the finest engineers work with the best equipment. There is always a period of de-bugging, adjusting, and peaking. It took the boys a full three days to build up the two pieces of equipment, to squeeze the last microwatt of power out of the little transmitter, and to peak up the receiver for maximum stable sensitivity. Finally, though, the receiver was capable of picking up the transmitter over the restricted radius that Carl said would be more than adequate for the test that was planned.

Then the equipment was introduced to Bosco, and it certainly was not a case of love at first sight. He spent the first half hour after the cap was fastened on him in a determined effort to shake it off, rub it off on the ground or the trunks of trees, and—finally—to claw it off with all four paws. But the boys had anticipated this, and the cap stayed firmly in place. Finally Bosco gave up and stared at his masters with a hurt look that said plainly, "How can you guys do this to me?"

The boys promptly started his training along the lines Jerry had outlined. It was quickly apparent that Jerry's estimate of "a few dozen" times being needed to show Bosco what was expected of him was highly optimistic. By the time he began to show some faint interest whenever the hidden switch in his cap turned on the receiver and let him hear the signal from the concealed transmitter, the sod of Jerry's backyard was deeply furrowed with hundreds of tracks made by Bosco's stubbornly braced legs as he was dragged back and forth, and both boys were worn to a frazzle. But they stuck at it. Finally, on the last evening before the test, things looked pretty good; and as Jerry wearily took leave of his friend, he said:

"That's about all we can do. Don't feed Bosco tomorrow morning, for we really want him eager."

"Okay, but Bosco the Bottomless Pit would be eager anyway. I'll see you tomorrow."

WHEN THE BOYS and Bosco arrived at the little field in which the test was to take place, Merrill, Golden Arrow, and a gentleman with a stopwatch prominently displayed in his hand were already there.

"Boys, I thought we should have an im-



**RCA** offers you the  
 finest training  
 at home in  
**Radio-TV**  
 electronics,  
 TV servicing,  
 Color TV

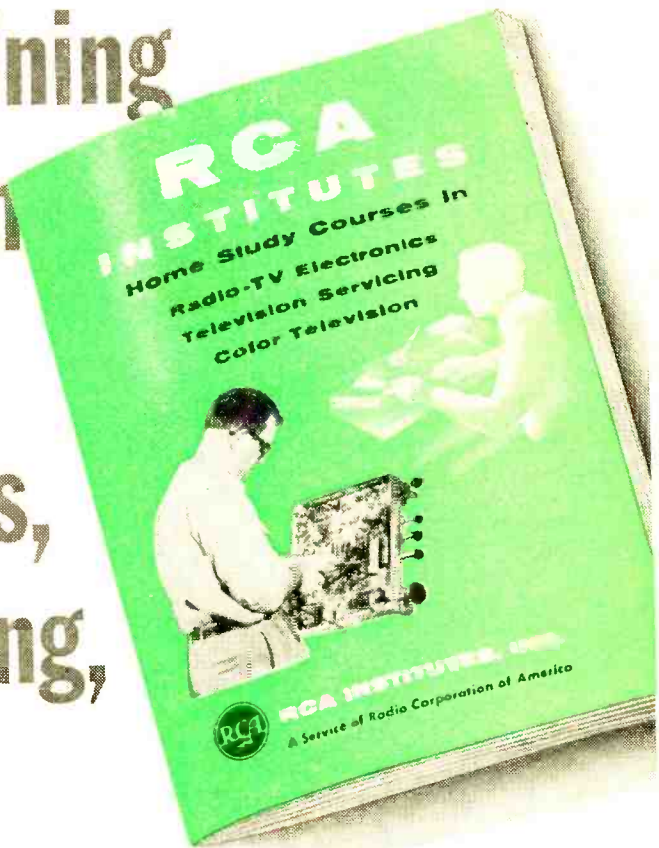

**SEND FOR THIS FREE  
 BOOK NOW!**

The instruction you receive and equipment you get (and keep) will start you on your way. Pay-as-you-learn. You pay for only one study group at a time. This 52 page book contains complete information on Home Study Courses for the beginner and the advanced student.



**RCA INSTITUTES, INC.**  
 A SERVICE OF RADIO CORPORATION of AMERICA  
 350 WEST FOURTH STREET, NEW YORK 14, N.Y.

RCA Institutes, Inc., Home Study PE-86  
 350 West Fourth Street New York 14, N. Y.  
 Without obligation, send me FREE CATALOG  
 on Home Study Courses in Radio, Television  
 and Color TV. No salesman will call.

Name .....  
 Please Print  
 Address .....  
 City ..... Zone ..... State .....

VETERANS  
 KOREAN G.I  
 P.L. 550  
 CHECK HERE

# HERSHEL'S SUMMER SPECTACULARS!

**OIL CONDENSER**  
**\$165**  
 2 MFD. 3000 VDC. Pyranol Oil W. Mounting Bracket.  
 1-1 MFD. 3000 VDC. New, removed from equip. 4 3/4" x 4 1/4" x 2 1/2"

**PHOTO ELECTRIC CELL**  
**95¢**  
 CE Vacuum Cell, used in A. M. P. R. O. Sound Projector. Also useful for opening garage doors and Alarm Systems.

**GE Pyranol Oil CONDENSER**  
 12 MFD. 330 VAC. 60 Cy. Removed from equip. **95¢**

**30 TUBE SOCKETS.** Subminiatures, 7 & 9 pin miniatures, 4 to 8. Pins, Micro-tipped & ceramic; shield base type, too!

**2000 PCS. HARDWARE.** Radio, TV, shop, wood, working, screws, springs, grommets, etc.

**40 MOULDED CONDENSERS.** Best known makes! 0005 to 0.1 mf to 1000V.

**30 CERAMIC DISC CONDENSERS.** .01 mf. to 3000V. TV repairmen note!

**8 TUBULAR ELECTROLYTICS.** Popular values to 450V. Top makes, axial leads.

**60 KNOBS.** Instrument, radio, TV types. Push-on & set screw types. Some 35c ea.

**10 PANEL SWITCHES.** Micro, car, momentary, push & rotary. Wide variety.

**60 TUBULAR CONDENSERS.** 25 values! 0005 to 1 mf., up to 6000V. Oils, too!

**10 FP & TWIST ELECTROLYTICS.** Ass'd. to 1000 mfd., to 450V. Some multiples.

**100 COIL FORMS.** Experimenters, note! Wide variety of shapes & sizes. Ceramic and bakelite.

**60 CARBON RESISTORS.** Insulated; 35 values, 15 ohms to 10 megs. 1/2, 1 & 2W; 5% too! Incl. famous Allen Bradley!

**SAVE \$7.07**  
 on this new **6-Position INDOOR ANTENNA**  
 Reg. \$10.95  
**\$3.88**  
 Complete  
 • Improves TV Reception or You Get Your MONEY BACK



**YOUR CHOICE ANY KIT LISTED IN THIS AD 97¢**

**60 MICA CONDENSERS.** Rare offer! Positive stamp types, 25 values. 00001 to .01 to 1200 WVDC. Many silver. 5% too!

**125 CARBON RESISTORS.** 30 values! 100 ohms to 1 meg; 1/2, 1 & 2W. Many 5%. Un-insulated.

**30 POPULAR BULBS.** Special! Wide variety standard, miniature, screw and bayonet types 1.1 thru 6V.

**12 LINE CORDS.** AC/DC cords; molded plugs. For all electrical eqpt. Stock up now!

**50 CERAMIC CONDENSERS.** Tubular, disc, button & standoffs! 5 to .01 mfd to 1000V.

**12 VOLUME CONTROLS.** Handy shop asst. of radio, TV, lab units. Some WW.

**50 RF COILS & CHOKES** and slug-tuned coils for TV, radio, lab. 20 types.

**20 POWER RESISTORS.** Wirewound; 20 values, 5 ohms to 12,000 5 to 50 watts. Candelum & tubular types.

**All New MYSTERY PACKAGE of ELECTRONIC PARTS**  
 It's the surprise of your life! 20 pounds of BRAND NEW usable GOVT. surplus. The ideal gift for hams, etc.  
 Worth \$40.00  
 Our Price **\$395**  
 Ship. Wt. 20 lbs.



**PICTURE TUBE BRIGHTENER 94¢**

TERMS: Cash with order or 25% DOWN—BALANCE C.O.D.  
 ALL PRICES NET F.O.B. DETROIT MINIMUM ORDER \$2.00

**HERSHEL RADIO CO.**  
 TYler 8-9400  
 5249 GRAND RIVER Detroit 8, Mich.

## Carl & Jerry (Continued from page 14)

partial judge for this test; so I brought along my Uncle Milford. He's known all over the country for his work with bird dogs," Merrill explained.

"Thank you, Nephew," Uncle Milford said, with a fond smile. "Now I suppose we may as well get on with this. To be fair, I think the winner should be the dog that finds his bird quickest in three times out of five trials. You can hide the bird for Golden Arrow, boy, and Merrill can hide it for—for—what on earth is that on your animal's head?" he exclaimed to Carl as he took a good look at Bosco jauntily wearing his ludicrous cap.

"Bosco is a dog of many parts," Carl explained glibly, "and he likes to dress for each role he plays. Since he feels he's playing a sort of detective right now, he insisted on wearing his Sherlock Holmes cap this morning."

Uncle Milford looked strangely at Carl as he muttered, "I see," in tones that clearly indicated he didn't. "Well, you hide Arrow's bird and we'll start."

Carl tucked the artificial bird Merrill handed him beneath a bush some 75 feet away, and then Merrill sent Golden Arrow in search of it with a wave of his hand. Instantly the dog started quartering the ground in a methodical manner that was beautiful to watch, and in a short time his body stiffened as he caught the scent of the hidden bird; then at a command from Merrill he moved forward, picked it up in his mouth, and returned it to his master.

"Forty-seven seconds!" Uncle Milford announced triumphantly. "Now let's see what the other dog can do."

Merrill tucked Bosco's bird under a

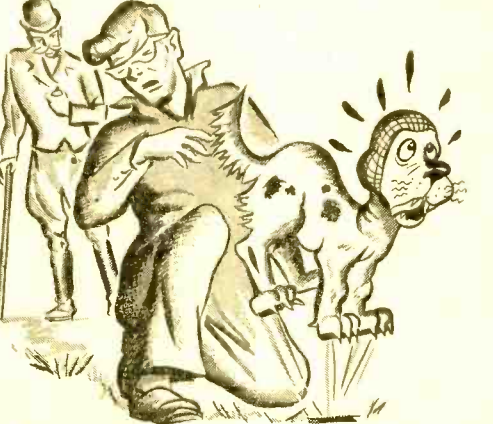

... When Uncle Milford gave the signal, stopwatch in hand, Carl flipped the hidden switch in Bosco's cap with results that were truly galvanic ...



# LIFETIME GUARANTEED

# TUBES

**SAVE**

## BRAND NEW PICTURE TUBES

- RCA Licensed
  - One Year Unconditional Guarantee.
- | Type  | Price   | Type  | Price   |
|-------|---------|-------|---------|
| 10BP4 | \$11.90 | 17BP4 | \$20.63 |
| 12LP4 | 14.38   | 19AP4 | 24.81   |
| 14BP4 | 16.85   | 21AP4 | 28.79   |
| 16RP4 | 19.38   | 21EP4 | 28.79   |
| 16LP4 | 19.38   | 24AP4 | 42.50   |

Picture Tubes shipped F.O.B. Harrison, N. J.

• We guarantee to replace tubes labeled MAJOR BRAND forever. Each tube individually boxed and guaranteed for life. Over A Half Million Tubes Always In Stock • Immediate Shipment • Free Postage On All Orders With Full Remittance.

## HERE'S HOW LIFETIME GUARANTEED TUBES

## SAVE YOU MONEY

• There are fewer "call backs" • There are no "out of date" tubes • "Peak Performance" testing in our fully equipped Testing Department before shipment guarantees quality.

## NEW INDOOR ANTENNA

Both UHF and VHF. Brings better reception than most outdoor antennas. Use on top of TV.

Lot of 3 **YOUR PRICE \$3.29** each  
 List price \$9.95 \$3.99 each

## FREE BONUS BOX With Every \$25 Order

- 1 RCA Cheater Cord
- 10 Assorted resistors
- 10 Assorted 2 Color "blank" tube cartons
- 1 6B2GT tube
- 1 6AU6 tube
- 1 6CB8 tube

## FREE CLOCK RADIO

Within 30 Days With Every \$125 Purchase with famous Sessions clock radio wakes you up to music or alarm. May be purchased outright from MAJOR BRAND for \$17.95. In ivory or rust.

## FREE GIFT CERTIFICATE\*

Worth \$5 toward the purchase of any of our merchandise on future orders will be sent with any order of \$50 or more. \*Free Gift Certificate cannot be used to obtain another certificate unless order is \$55 or more.

## USED TV SETS

Picture Tube	Guaranteed To Work!	GE
• Emerson	• RCA • Philco • Others	\$16.95
• Motorola	• Zenith	\$19.95
10" SET	Table Model	\$22.95
	Console Model	\$24.95
12" SET	Table Model	\$27.95
	Console Model	\$31.00
14" SET	Table Model	\$32.00
	Console Model	\$34.95
16" SET	Table Model	\$37.00
	Console Model	\$39.00
17" SET	Table Model	\$37.00
	Console Model	\$39.00

All prices on request for 19", 20", 21" and 24" sets.

F.O.B. Harrison, N. J. prices

02A	.43	5BQ7	.89	6BK5	.68	6V6GT	.46	12BZ7	.61
1A4P	.33	5AW4	.75	6BK7	.76	6W4GT	.39	12C6	.95
1A7GT	.43	5J6	.63	6BL7GT	.75	6WG7	.53	12SA7	.45
1B3GT	.65	5T4	.69	6BN6	.58	6X4	.34	12SJ7	.45
1C5GT	.41	5U6	.43	6BQ6GT	.78	6X5	.34	12SK7	.45
1D5GT	.43	5UB	.74	6BQ7	.78	6X8	.73	12SN7GT	.56
1E7GT	.41	5V4G	.59	6BY5G	.58	6Y6G	.55	12SQ7	.37
1G6GT	.41	5Y3	.31	6BZ7	.88	7A4	.45	12SR7	.45
1H4G	.43	5Y4G	.36	6C4	.37	7A5	.53	12V6GT	.45
1H5GT	.47	5Z3	.41	6C5	.35	7A6	.45	12X4	.37
1J6GT	.47	6A7	.57	6C6G	.49	7A7	.43	14B6	.38
1L4	.45	6A8	.45	6C6GG	1.15	7A8	.45	14Q7	.50
1L6	.55	6A84	.43	6D6	.48	7B5	.39	19BG6G	1.15
1LA4	.57	6AC7	.67	6E5	.44	7B6	.42	19T8	.65
1LA6	.47	6AF4	.79	6F5	.37	7B7	.41	24A	.39
1LB4	.57	6AG5	.50	6F6	.38	7B8	.45	25AV5GT	.78
1LC5	.49	6AG7	.69	6G6	.40	7C4	.39	25BQ6GT	.78
1LC6	.47	6AH6	.69	6H6	.39	7C5	.43	25L6GT	.47
1LD5	.57	6AJ5	.57	6K6	1.79	7C6	.43	25W4GT	.43
1LE3	.57	6AK5	.54	6J5	.39	7C7	.45	25Z5	.37
1LG5	.57	6AL5	.59	6J6	.47	7E5	.45	25Z6	.37
1LM4	.64	6AQ5	.46	6J7	.43	7E6	.55	35A5	.46
1LN5	.47	6AR5	.46	6J8G	.85	7E7	.70	35B5	.50
1N5GT	.50	6A55	.48	6K6GT	.37	7F7	.59	35C5	.50
1R5	.50	6A56	1.70	6K7	.39	7F8	.70	35L6GT	.47
1S5	.42	6A57G	2.10	6M8	.65	7G7	.75	35W4	.34
1U4	.47	6AT6	.39	6L6	.68	7H7	.50	35Y4	.34
1U5	.42	6AU4GT	.65	6L7	.42	7J7	.75	35Z3	.39
1V2	.65	6AU5GT	.59	6N7	.60	7K7	.75	37	.29
1X2	.61	6AU6	.42	6Q7	.40	7L7	.75	50A5	.46
2A3	.55	6AV5GT	.65	6S4	.40	7N7	.50	50B5	.50
2A5	.57	6AV6	.39	6S7	.45	12AT6	.37	50C5	.50
2A7	.55	6AX4GT	.60	6SCT	.48	12AT7	.66	50L6GT	.43
3A4	.51	6AX5GT	.57	6SCT	.41	12AZ7	.63	75	.42
3A5	.50	6B4G	.52	6SHT	.43	12AUG	.41	76	.42
3A15	.45	6B8	.69	6SJT	.43	12AUV	.53	77	.38
3A15	.45	6BA6	.47	6SK7	.45	12AV6	.35	78	.38
3A15	.45	6BA7	.58	6SL7G	.55	12AV7	.67	80	.34
3A15	.45	6BA8	.47	6SN7GT	.55	12AX4GT	.65	84/624	.44
3A15	.45	6BC5	.47	6SQ7	.39	12AX7	.58	117L7GT	1.09
3B6	.70	6BC7	.80	6S7	.42	12B4	.68	117N7GT	1.09
3C86	.52	6BE6	.45	6S7	.42	12BA6	.46	117P7GT	1.09
3Q4	.46	6BF5	.40	6S7	.41	12B6G	.48	117Q7	1.09
3Q5GT	.57	6BF6	.50	6T4	.95	12B6E	.46	117Z3	1.35
3S4	.47	6BG6G	1.15	6T8	.68	12B7	.60	117Z6GT	.63
3V4	.47	6BM6	.50	6U8	.75	12B7	.60		
4BZ7	.95	6BJ6	.47	6V3	.80	12B7	.60		

ALL PARTS SHIPPED F.O.B., HARRISON, N. J.

WE PAY ALL POSTAGE on orders shipped in USA, Territories and APO's. Send only purchase price of merchandise. Please include approximate postage on foreign shipments. All orders subject to prior sale. Add 25c handling on orders under \$5.00. Quantity users write for special discount.

Write For FREE Tube List—Order Blank—and FREE Sample Tube Carton. We want Y-O-U On Our Mailing List!

**SPECIAL SURPRISE**  
 Mention where you saw our ad and we will send you FREE three 6SN7GT's with any order of \$10.00 or more.

# MAJOR BRAND TUBE CO.

Romano Bldg. Harrison, N. J.  
 Write Dept. 8-PE ESsex 4-1106

# Learn at Home

in your spare time

## to Fix Electric Appliances



### Better Pay—More Opportunities

Get into a field where there is important work and opportunity for the trained man. Millions of electric appliances are sold every year. Every wired home now has an average of 8. Many of them need service and repair. Owners pay well to have them fixed quickly, properly. This is your opportunity for a better job, your own part time or full time business. NRI can give you the training you need, at home, in your spare time.

### A Way to Extra Money

Soon after starting you will be able to earn extra cash fixing toasters, clocks, fans, vacuum cleaners, etc., for neighbors and friends. Keep your job while learning and earning. Put spare time to work for you. Work in your basement, garage, spare room. You'll be amazed how easily, quickly you, too, can start earning many extra dollars. NRI shows you how. Even before you finish training your spare time earnings may pay for the course and equipment.

### NRI Sends Tester to Learn and Earn

You need proper equipment to service today's automatic appliances. With this course you get parts to build professional type, multi-use Appliance Tester. You learn to use it. Takes guess work out of servicing. Mail coupon for FREE book and Sample Lesson. See how easy it is to learn. Find out about NRI—a school that for more than 40 years has been training men, through home study, for success, good pay jobs. Our reputation, record, experience back up this course. Write now to: Electric Appliance Training, NRI, Dept. D4H6, Washington 9, D. C.



**FREE Lesson and Book**  
Mail this NOW!

**NATIONAL RADIO INSTITUTE**

Dept. D4H6, Washington 9, D. C.

Send me Lesson and Book Free. No Salesman will call.

Name ..... Age .....

Address .....

City ..... Zone ..... State .....

APPROVED MEMBER NATIONAL HOME STUDY COUNCIL

### Carl & Jerry (Continued from page 16)

clump of leaves about the same distance away that Golden Arrow's had been. When Uncle Milford gave the signal, Carl flipped the hidden switch in Bosco's cap with results that were truly galvanic. Bosco gave a whimper of eagerness as he stood straight up on his hind legs and waltzed crazily about. Then he dropped to all fours and went dashing madly about the place without apparent rhyme or reason, but in an amazingly short time he rooted down through the leaves to the hidden bird and came galloping back to Carl with slobbers of anticipation dripping from his mouth.

"Fourteen seconds!" Uncle Milford said, in an awed voice. "It doesn't seem possible. I've never seen anything like it. It must have been an accident."

But it was no accident, as the next two trials quickly proved. Golden Arrow III, displaying the same beautifully consistent method and form, turned in times very close to forty-five seconds on both occasions; but Bosco, using his own crazy system that sent him dashing full tilt, only to come to such an abrupt halt that he often went rolling end over end before he scrambled up and took off on a tangent, located his second bird in twenty-two seconds and his third in the astounding time of six seconds flat.

"WELL, Merrill, I guess there's no question about the winner," Uncle Milford said, with a stunned look. "I've never seen anything like the way that dog performs. Very unorthodox! Very! Would you consider entering him in some field trials, boy?"

"Aw, no," Carl said casually, as he unfastened the cap from Bosco's head and let the dog give himself an ear-slapping shake. "Bosco doesn't mind putting on a little show like this now and then, just for relaxation, but he's got much more serious things on his mind than fiddling around with anything so silly as hunting artificial birds."

There was a long pause, and then Uncle Milford inquired timidly: "May I ask what sort of things?"

Carl looked cautiously around before he answered in hushed tones: "All I'm allowed to tell you is that it's top-secret research in the commissary department. And speaking of eating, Merrill, as soon as you've decided how you're going to prepare your beanie, let Jerry and me know and we'll be glad to drop over to watch you eat it."

"All right, fellows," Merrill said weakly. "I'll let you know."



# Lafayette Brings You Super Values!

**4 TRANSISTOR SUPERHET POCKET RADIO KIT WITH BUILT-IN ANTENNA**  
**POCKET SIZE 1 3/8" x 2 1/2" x 3 3/4" REQUIRES NO EXTERNAL ANTENNA OR GROUND**  
**A POWER PACKED RECEIVER WITH 2 I.F. STAGES AND 2 RC COUPLED AUDIO STAGES**

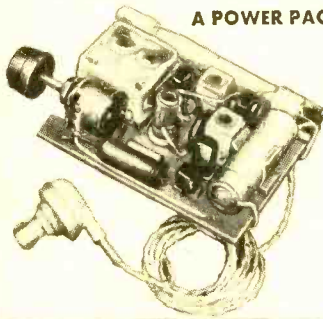

**COMPLETE PARTS INCLUDING TRANSISTORS**

The exceptional sensitivity characterizing this receiver, making external antenna and ground unnecessary, stems from the use of the new Poly-Vari-Con miniature variable condenser and properly matched loop, oscillator coil and I.F.'s. This circuit performs amazingly over the entire broadcast band. The four transistors (2 high frequency and 2 audio types) plus a germanium diode provide a miniature earpiece with power to spare. Truly miniaturized, the entire set can be mounted on a bakelite board 2 1/2" x 3 3/4" as illustrated, and can be mounted in an inexpensive plastic box.

**COMPLETE LIST OF PARTS LESS EARPHONES AND CASE**

We supply all the basic electronic components including 3" x 3 3/4" undrilled mounting board and leave cabinet size and layout to your ingenuity. Four G.E. transistors, (1-2N136; 1-2N135, 2-2N107) are included as well as the matched RF and IF components and crystal diode detector. All other parts such as resistors, condensers, brackets, hardware, etc. including miniaturized electrolytic condensers, volume control and battery are provided. Construction aids and schematic diagram included.  
**CI-101...Complete parts, less earphones and case...Net 19.10**  
**MS-260...Super powered dynamic earphone.....Net 3.95**

**FM-AM TUNER KIT**

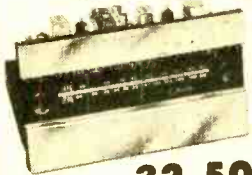

**32.50**

Basic FM-AM Tuner having outstanding specifications and delivering astonishing performance — all at a budget price in easily assembled kit form.

- AFC DEFEAT CIRCUIT WITH FRONT PANEL CONTROL
- FOSTER-SEELEY DISCRIMINATOR CIRCUIT
- GROUNDED GRID TRIODE AMPLIFIER
- 20-20,000 CPS RESPONSE

Choose this 7 tube compact high-fidelity FM-AM tuner whose characteristic features are found in units costing many times as much, and whose performance is unheard of at this low price. There are two front panel controls, a function control for AM, FM, PHONO, TV and a tuning/AFC defeat control. Features Armstrong FM circuit with limiter and Foster-Seeley discriminator. Simplified tuning with slide-rule dial and flywheel counter-weighted mechanism, high impedance phono input and high impedance audio output.

**SPECIFICATIONS**

**FREQUENCY RANGE:** FM 88-108MC, AM, 530-1650 KC. **ANTENNA INPUT:** FM, 300 ohms, AM Ferrite loopstick and high impedance external antenna. **DISTORTION:** Less than 1% at rated output. **FREQUENCY RESPONSE:** FM, ± 5 db 20 to 20,000 cps, AM ± 3 db 20 to 5000 cps. **SENSITIVITY:** FM, 5 UV for 30 db quieting, AM, Loop sensitivity 80 UV/meter. **SELECTIVITY:** FM, 200 KC bandwidth, 6 db down; 375 KC FM discriminator peak to peak separation, AM, 8 KC bandwidth, 6 db down. **IMAGE REJECTION:** 30 db minimum. **HUM LEVEL:** 60 db below 100% modulation. **TUBE COMPLEMENT:** 2-12AT7, 1-6BE6, 1-BA6, 2-6AU6, 1-6AL5 plus selenium rectifier. **SIZE:** 5 1/4" high x 9 3/4" wide x 9 1/2" deep (excluding knobs). **CONSUMPTION:** 30 watts. For 110-120V 60 cycles AC. Attractive etched copper-plated and lacquered finish. Less metal case. Shpg. wt., 9 lbs.

- KT-100.....NET 32.50**  
**ML-100...Metal cage for above, Shpg. wt., 3 lbs. .... 5.00**

**IMPORTED BINOCULARS**

All have coated lenses — clamped in prisms — light weight all metal bodies. Complete with case and straps.

F-162	6x.15	I.F.	NET 10.75
F-105	8x.10	I.F.	NET 14.95
F-15	7x.35	I.F.	NET 17.95
F-183	7x.35	C.F.	NET 20.95
F-103	7x.50	I.F.	NET 21.50
F-164	7x.50	C.F.	NET 24.95
F-117	10x.35	C.F.	NET 23.95
F-104	12x.50	C.F.	NET 27.95
F-118	16x.50	C.F.	NET 31.50
F-185	20x.50	C.F.	NET 37.50

Add 10% Fed. Tax to Prices

**VICTOREEN RADIATION COUNTER TUBE**



The most popular tube used in Geiger Counters, these 1B85 tubes are brand new, fully guaranteed. Beta-gamma aluminum wall. Active length 2 3/4".  
**TYPE 1B85.....Net 5.45**

**R/C RECEIVER AND TRANSMITTER**  
**RANGE OF APPROXIMATELY 1 MILE**

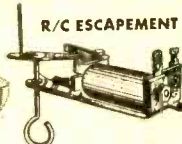
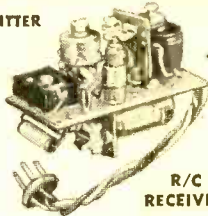

**R/C Receiver** is completely assembled and wired, with tube and ready to operate on exam-free 27.255 MC remote control band. Size: 1 3/4" x 1-15/16" x 3". Wt. 3.3 oz. Requires one 1.5 volt and one 45 volt battery.  
**F-208.....Net 7.95**

**R/C Transmitter** is completely assembled, tested and guaranteed, and includes tube and 27.255 MC crystal, 6 section telescoping antenna. Size: 4" x 4" x 12". Less batteries. Shpg. wt.: 3 lbs.  
**F-249.....Net 19.95**

**TRANSMITTER** 1 Burgess, 2D or RCA VS069 Net. Ea. .45  
**BATTERIES:** 2 Burgess XX45 or RCA VS016.....Net. Ea. 2.28

**R/C Escapement** is completely wired, sturdy and self-neutralizing. Weighs 1/2 oz. Low current drain. Size: 1 3/8" L x 1 1/2" W Shpg. wt. 5 oz.  
**F-194.....Net 2.45**

**SPECIAL COMBINATION OFFER**

Consists of R/C Transmitter (F-249), R/C Receiver (F-208) and Escapement (F-194). All three at a super special price.  
**F-250.....Net 28.95**

**Lafayette Radio**  
**100 SIXTH AVE.**  
**NEW YORK, N.Y.**

DEPT. 111

BOSTON 10, MASS., 110 Federal St.  
 NEWARK 2, N. J., 24 Central Ave.  
 PLAINFIELD, N. J., 139 W. Second St.  
 BRONX 58, N. Y., 542 E. Fordham Rd.

Include postage with order.



Send FREE 96-Page Lafayette Catalog

FREE

Name \_\_\_\_\_

Address \_\_\_\_\_

City \_\_\_\_\_ Zone \_\_\_\_\_ State \_\_\_\_\_

# POP'tronics

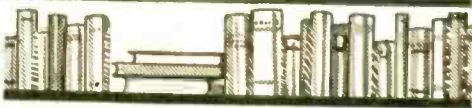

## BOOKSHELF

"RADIO RECEIVER LABORATORY MANUAL" by A. W. Levey. Published by John F. Rider Publisher, Inc., 480 Canal St., New York 13, N.Y. 112 pages. Paper bound. Price, \$2.00.

This workbook of 33 experiments starts with basic components and concludes with trouble-shooting procedures. Such topics as power supplies, i.f., and use of modern test equipment are treated. Excellent photos and diagrams enhance the text.

*Recommended:* as a first-rate supplement to workshop or laboratory training.



"COLOR TV TRAINING MANUAL" by C. P. Oliphant and Verne M. Ray. Published by Howard W. Sams & Co., Inc., 2201 E. 46 St., Indianapolis 5, Ind. 258 pages, with 9 color plates and 4 color fold-

out charts. Paper bound. Price, \$6.95.

Color TV has proved to be one of the most demanding of new electronic developments not only because of its unique circuits but because it calls for a study of colorimetry, more math, and a re-examination of how radio waves are propagated. The present book was prepared by men well aware of these problems and equally capable of furnishing accurate and comprehensible information on them.

Printed in double columns on oversized pages, and liberally illustrated with top-notch photos and drawings—many in full color—this volume covers basic color principles, receiver circuits, and servicing. It is suited for use in school courses or for private reading by people with previous grounding in receiver fundamentals.

*Recommended:* as a competent study of color television for the fairly advanced technician.



"BUILDING YOUR RECORD LIBRARY" by Roy H. Hoopes, Jr. Published by McGraw-Hill Book Co., Inc., 330 W. 42 St., New York 36, N.Y. Cloth bound. 250 pages. Price, \$3.95.

As a sprightly and well-informed guide through the forest of recorded music, this literate volume will prove invaluable to

**DUMONT**  
and  
**RCA lic.**  
**TV PICTURE**  
**TUBES**

- Guaranteed one full year
- In original factory sealed carton
- No replacement duty required.

Picture tubes shipped F.O.B. Passaic, N. J. via Railway Express.

**LARGEST TUBE SELECTION ANYWHERE!**

All tubes "Circuit Tested" for peak performance. Individually boxed—1 year RTMA Guarantee—Best Brands.

024	1U4	6AG5	6BQ7A	6SA7	7C7	12SK7GT
1A3	1U5	6AC7	6BY5G	6SA7GT	7E5	12SL7GT
1A5GT	1V	6AN4	6BZ7	6SC7	7E6	12SN7GT
1A6	1V2	6AH6	6C4	6SG7	7E7	12SQ7GT
1A7GT	1X2A	6AJ5	6C5GT	6SH7GT	7F7	12Z3
1A85	2A5	6AK5	6CF6	6SJ7	7F8	14A5
1AX2	2A6	6AL5	6CB6	6C6	7G7	14A7
1B3GT	2A7	6AL7GT	6C86	6SK7	7H7	14Q7
1B4P	2B7	6A06	6CDEG	6SK7GT	7K7	198G6G
1B5	3A4	6AQ6	6C56	6SL7GT	7M7	1916
1B7GT	3A5	6A07GT	6D6	6SN7GT	7Q7	1978
1C5GT	3A8G1	6A55	6E5	6SQ7	7S7	24A
1C6	3B7	6AT6	6F5GT	6SQ7GT	7X6	25AV5GT
1C7G	3D6	6AU4	6FG6T	6SR7	7Y4	25B06G7
1C8	3O4	6AU5GT	6F7	6SR7GT	7Z4	25L6GT
1D5GP	3Q5GT	6AUG	6G6G	6S7	12A6	25Y5
1D5GP	354	6AV5GT	6H6GT	6T8	12AT6	25Z5
1E8	3V4	6AV6	6J5	6U8	12AT7	27
1F7G	5AX4	6AX4	6J6	6V6GT	12AU6	32L7GT
1G6GT	5T4	6AX5GT	6J7	6W4GT	12AU7	35A5
1H6GT	5U4G	6B5	6J7GT	6W6GT	12AV6	35B5
1L4	5V4G	6BG6	6J9G	6X4	12AV7	35C5
1L6	5X4G	6BG6	6KGT	6XGT	12AX7	35L6GT
1LA6	5Y3G	6BBG	6K6GT	6YG	12AY7	35W4
1LC5	5Y3GT	6BA6	6K7	7A4-XXL	12BA6	35Z3
1LC6	5Y4G	6BA7	6K7GT	7A5	12BA7	35Z5GT
1LD5	5Z3	6BC5	6K8G	7A6	12B4	45Z5GT
1LE3	5Z4	6BD5GT	6K8GT	7A7	12BE6	50A5
1LG5	6A3	6BE6	6L6CA	7A8	12BH7	50B5
1LN5	6A5G	6BF5	6L7G	7AC7	12BY7	50C5
1NSGT	6A7	6BG6G	6N7	7B4	12JS5GT	50L6GT
1PSGT	6A8	6BH6	6P5GT	7B5	12K8	70L7GT
1QS5GT	6A8GT	6BJ6	6Q7	7B6	12SA7	75
1RS	6AB4	6BK5	6Q7GT	7B7	12SA7GT	77
1S4	6AB7	6BK7A	6R7	7B8	12SG7	78
1S5	6AC5GT	6BL7GT	6S4	7C4	12SH7	80
1T4	6AC7	6BN6	6S7G	7C5	12SJ7GT	83V
1TSGT	6AF4	6BQ6GT	6S8GT	7C6	12SK7	

**TAKE**  
**YOUR**  
**CHOICE!**  
**ANY**  
**ASSORTMENT**  
**RECEIVING**  
**TUBES**

**47¢**  
**EACH**

Unconditionally Guaranteed for one year.

**FREE POSTAGE**  
on all prepaid continental U.S.A. orders.

**HARD-TO-GET TUBES ALWAYS IN STOCK**

Write for NEW FREE CATALOG! LOWEST PRICES ANYWHERE

Picture Tubes—Transmitter Tubes—Radio & TV Parts

TERMS: FREE POSTAGE on all prepaid continental U.S.A. orders on receiving tubes only. 50¢ handling charge on all orders under \$5. 25% deposit on all C.O.D.'s. Subject to prior sale.

935 MAIN AVE., PASSAIC, N. J.  
Dept. PE-8, Gregory-1-2498

**STANLEY**  
ELECTRONICS CORP



# Want To Double Your Pay

Get into Radio-TV-Electronics



# Get all 3 FREE

## **FIND OUT** what the FCC license means

Your FCC license is recognized by employers as proof of your technical ability.

## **FIND OUT** how the FCC license helps you get a better job or increase your pay on your present job

"Due to your Job-Finding Service, I have been getting many offers from all over the country, and I have taken a job with Capital Airlines in Chicago, as a Radio Mechanic."  
Harry Clare,  
4537 S. Drexel Blvd., Chicago, Ill.

"I have obtained a position at Wright-Patterson Air Force Base, Dayton, Ohio, as Junior Electronic Equipment Repairman. The Employment Application you prepared for me had a lot to do with me landing this desirable position."  
Elmer Powell,  
Box 247, Sparta, Tenn.

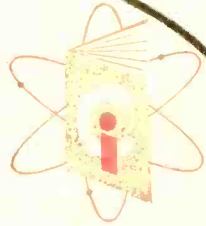

## **FIND OUT** how to get your FCC license in a minimum of time

Harry G. Frame, Box 429, Charleston, W. Va.  
Charles Ellis, Box 449, Charles City, Iowa  
Kenneth Rue, Dresser, Wisconsin  
B. L. Jordan, Seattle, Washington

License	Time
2nd Class	13 weeks
1st Class	28 weeks
2nd Class	20 weeks
1st Class	20 weeks

**MAIL COUPON TODAY!**  
you'll be glad you did

## **FIND OUT** how we guarantee your FCC license

WE GUARANTEE to train and coach you at home until you pass the all-important FCC examination. . . . If you fail to pass after completing our course, we will continue your training without additional cost until you successfully obtain your commercial license.

## **FIND OUT** how employers make job offers like this to CIRE graduates every month

Letter from nationally known manufacturer of high quality AM and FM transmitters, "We are very much in need at the present time of radio-electronics technicians and would appreciate any helpful suggestions that you may be able to offer. Salary up to \$412 per month to start."

CLEVELAND INSTITUTE OF RADIO ELECTRONICS  
CARL E. SMITH, Consulting Engineer, President  
Desk PE-15, 4900 Euclid Bldg., Cleveland 3, Ohio  
Member, National Home Study Council

CLEVELAND INSTITUTE OF RADIO ELECTRONICS  
4900 Euclid Ave., Desk PE-15  
Cleveland 3, Ohio (Address to Desk No. to Avoid Delay)  
I want to know the facts, without obligation, how I can get my FREE FCC ticket in a minimum of time. Rush me your FREE booklet "How to Pass FCC License Examinations" (does not cover exams for Amateur License) as well as sample FCC-type exam and the amazing new booklet, "Money-Making FCC License Information."  
**PLEASE PRINT CLEARLY**

Name ..... Age .....

Address .....

City ..... State .....

**FOR PROMPT RESULTS, SEND AIR MAIL**

Special Tuition Rates to Members of the U. S. Armed Forces. Electronic Training Also Available to Canadian Residents.

# Buy Low; Trade High . . . at WRL!

"The World's Largest Distributor of Amateur Radio Eqpt."

## WRL'S NEW 65A GLOBE SCOUT STURDY . . . HANDSOME . . .

Popular  
Screen-Plate  
Modulation

Only **\$795**  
per mo.



ONLY 10% DOWN Cash: \$99.95

New cabinet styling, new metering, new foolproof standby switch, new speech tubes. Completely bandswitching, 160-10M, for 65 watts on CW, 50 watts on fone. Pi network antenna tuner. Built-in power supply. 100% modulation of Final. TVI-screened cabinet. Compact: 8"x16"x8". Kit price: \$89.95.

### YOU PAY ONLY 10% DOWN!

ON

- ✓ Ham Gear
- ✓ Hi-Fi Equipment
- ✓ Parts, Tubes, etc.
- ✓ All Accessories
- ✓ Kits
- ✓ WRL Manufactured Eqpt.
- ✓ Leading National Lines

Ask About Our  
E-Z Credit Plan!

### UP TO 50% SAVINGS ON RECONDITIONED EQUIPMENT

Here's Just a Sample  
of More Than 800 Items

Eldico TR-75 Watt  
Xmtr. . . . . \$35.00  
Hallicrafters HT-17 . . . 24.50  
Heath AT-1 Xmtr. . . . 24.50  
Hallicrafters  
S-38B Rcvr. . . . . 32.50

1 Full Year  
Factory-New  
Guarantee!

Send for Details on

- ✓ WRL's New VFO
- ✓ WRL's Globe King
- ✓ WRL's 6M Converter
- ✓ Code Oscillator Kit
- ✓ WRL's Globe Spanner Beams
- ✓ Wall-Sized Radio Map (25c)
- ✓ Reconditioned Eqpt.

## FREE CATALOG!

Over  
15,000  
Items



PE-8

## WORLD RADIO LABORATORIES

3415 W. Broadway Council Bluffs, Ia.

Please send me your FREE Catalog  
and full information on items listed below

1) \_\_\_\_\_ 2) \_\_\_\_\_

3) \_\_\_\_\_

NAME: \_\_\_\_\_

ADDRESS: \_\_\_\_\_

CITY & STATE: \_\_\_\_\_

countless music lovers and audio enthusiasts. The current field of the spinning disc is treated by grouping different types of records according to general subject matter. Something of the background of the selections and artists is included, as well as recommended releases. Technical evaluation and artistic criticism are provided for many records. The scope of the book is literally world-wide, including a bit of everything from pre-Bach music to the latest "Sound, Test, and Show-off Records."

*Recommended:* for all record collectors and audio fans.

"R-F TRANSMISSION LINES" by A. Schure. Published by John F. Rider Publisher, Inc., 480 Canal St., New York 13, N.Y. 72 pages. Paper bound. Price, \$1.25.

Special lines are required for carrying r.f. energy, in the propagation as well as the reception of signals. In order to understand any complete communications system, therefore, a technician must have a grasp of the theory and application of the r.f. lines used. While not covering all aspects of the subject, a worthy introduction to this area is provided by this book. Among the topics covered are constants, impedances, standing waves, line losses, and various types of lines.

*Recommended:* for all communications technicians.

"AUDIO AMPLIFIERS AND ASSOCIATED EQUIPMENT" (AA-7), compiled and published by Howard W. Sams & Co., Inc., Indianapolis 5, Ind. Spiral-paper bound. Price, \$3.50.

This is the seventh volume in the Sams series on amplifiers and tuners, and it contains technical data on models of all makes up to late 1955. Readers who are acquainted with this series know of the excellent photos, schematic diagrams and complete specifications given for each component. Readers who have never seen one of these volumes, and who are technically developed to the point of being able to find their way through a schematic and under the chassis, might do well to investigate this storehouse of data. These manuals have become, in the past few years, more or less standard guides for audio and service technicians.

*Recommended:* for audio enthusiasts with previous technical background.

"PUBLIC ADDRESS" by N. H. Crowhurst. Published by Norman Price Ltd., London, England. Distributed in the USA by British Radio Electronics, 1883 Jefferson Place



# STUDY AT HOME

## for a career in radio-tv-electronics

CREI prepares you quickly for success in Radar, Guided Missiles, Servomechanisms, Computers, Aeronautical Electronics, Broadcasting (AM, FM, TV), Military, Navy, CAA Electronics, Communications, Electronics Manufacturing.

### THE FUTURE IS IN YOUR HANDS!

The signs for the future are plain for trained men in the electronics industry. It is a tremendous industry, and—at the *present time* there are more jobs than there are trained men to fill them. But—when there's a choice between a trained and untrained applicant, the trained man will get the job.

### CREI HOME STUDY . . . THE QUICK WAY TO GET THERE

Since 1927, CREI has given thousands of ambitious young men the technical knowledge that leads to more money and security. The time-tested CREI procedure can help you, too—if you really want to be helped. CREI lessons are prepared by experts in easy-to-understand form. There is a course of instruction geared to the field in which you want to specialize. You study at your convenience, at your rate of speed.

### INDUSTRY RECOGNIZES CREI TRAINING

CREI courses are prepared, and taught with an eye to the needs and demands of industry, so your CREI diploma can open many doors for you. Countless CREI graduates now enjoy important, good-paying positions with America's most important companies. Many famous organizations have arranged CREI group training for their radio-electronics-television personnel. To name a few: All America Cables and Radio, Inc.; Canadian Broadcasting Corporation; Columbia Broadcasting System; Hoffman Radio Corporation; Glenn L. Martin Company; Magnavox Company; Pan American Airways, Atlantic Division; Radio Corporation of Amer-

ica; Trans-Canada Air Lines; United Air Lines. Their choice for training of their own personnel is a good cue for your choice of a school.

### BENEFITS FELT RIGHT AWAY

Almost immediately, you feel the benefits of CREI training. Your employer, when informed of your step toward advancement (only at your request), is certain to take new interest in you and in your future. What you learn in CREI Home Study can start helping you do a better job immediately.

**PAYS FOR ITSELF QUICKLY.** Your very first raise could repay your investment in CREI training, and leave you a profit the very first year. Your increases in pay thereafter are all pure profit, and you'll be prepared for many more promotions and pay raises in the future years of your life.



### CREI ALSO OFFERS RESIDENCE INSTRUCTION

at the same high technical level—day or night, in Washington, D. C. New classes start once a month. If this instruction meets your requirements, check the coupon for Residence School catalog.

**INFORMATION FOR VETERANS.** If you were discharged after June 27, 1950—let the new G. I. Bill of Rights help you obtain resident instruction. Check the coupon for full information.

### GET THIS NEW FACT-PACKED BOOKLET—IT'S FREE

Called "Your Future in the New World of Electronics," this free illustrated booklet gives you the latest picture of the growth and future of the gigantic electronics world. We'll promptly send your copy. The rest—your future—is up to you.

## MAIL COUPON FOR FREE BOOKLET

To help us answer your request intelligently, please give the following information:

EMPLOYED BY .....

TYPE OF PRESENT WORK .....

SCHOOL BACKGROUND .....

ELECTRONICS EXPERIENCE .....

IN WHAT BRANCH OF ELECTRONICS ARE YOU MOST INTERESTED? .....

### CAPITOL RADIO ENGINEERING INSTITUTE

Accredited Technical Institute Curricula—Founded in 1927  
3224—16th St., N.W., Dept. 123-C, Washington 10, D. C.

Send booklet "Your Future in the New World of Electronics" and course outline.

CHECK  PRACTICAL RADIO ELECTRONICS ENGINEERING  
FIELD OF  BROADCAST RADIO ENGINEERING (AM, FM, TV)  
GREATEST  PRACTICAL TELEVISION ENGINEERING  
INTEREST  PRACTICAL AERONAUTICAL ELECTRONICS ENGINEERING

Name .....

Street .....

City..... Zone..... State.....

Check:  Home Study  Residence School  Korean Veteran

# LEARN basic electricity electronics

## THE EASY "PICTURE BOOK" WAY!



**Just Released: The fabulous ILLUSTRATED Training Course now used by the U. S. Navy!**

### You Learn by Pictures

Over 25,000 Navy trainees have already learned Basic Electricity and Basic Electronics this easy, "Picture Book" way! Now, for the first time, YOU can master the basics of Electricity and Electronics with this same "Learn-by-Pictures" training course! Over 1,700 simple, easy-to-understand drawings explain every section—these "teaching" pictures actually make up more than half the entire course! No other Basic Electricity or Basic Electronics course in America uses this revolutionary illustrative technique! You learn faster and easier than you'd dream possible!

### A Complete Idea on Every Page

Here's how this easy, illustrated course works: every page covers one complete idea! There's at least one big illustration on that same page to explain it! What's more, an imaginary instructor stands figuratively at your elbow, doing "demonstrations" that make it even easier for you to understand. Then, at the end of every section, you'll find review pages that highlight the important topics you've just covered. You build a thorough, step-by-step knowledge at your own pace—as fast as you yourself want to go!

### Everyday English—A Course Anyone Can Understand

Sponsored by the Navy to turn out trained technicians in record time, this modern course presents Basic Electricity and Basic Electronics in a simple way that everyone can grasp—regardless of previous education! Every phase is made instantly clear—explained in plain, down to earth English—with hundreds of easy-to-understand illustrations to help you!

### 10 Complete Volumes

Volumes 1 and 2 of "Basic Electricity" cover DC components and circuits; Volumes 3 and 4 cover AC components and circuits; Volume 5 covers AC and DC motors and machinery. Volume 1 of "Basic Electronics" covers Diodes and Power Supplies; Vols. 2 and 3 cover Amplifiers and Oscillators; Vols. 4 and 5 cover Transmitters and Receivers.

### Home Study Without Correspondence

This course is so different, so complete—there's no need for the usual letter writing, question and answer correspondence! Learn at home—at your own pace!

### 10-Day Examinations—Money Back Guarantee

Send today for these exciting new training courses—you risk nothing! When you receive the volumes, examine them in your own home for 10 full days. If, at the end of that time, you're not completely satisfied, simply return the books to us and we'll gladly refund your full purchase price! Total cost for either 5-volume course is only \$9.00! In Canada, prices approximately 5% higher.

### ORDER TODAY!

These books are sold by electronics parts jobbers and book stores. If YOUR dealer doesn't have these books, mail this coupon to us!

**JOHN F. RIDER PUBLISHER, INC.**  
480 Canal Street, N. Y. C.

- I have enclosed \$..... Please send me  
 5-vol. Basic Electricity set @ \$9 set  
 5-vol. Basic Electronics set @ \$9 set  
 Both sets. I understand I may return the books in 10 days, and receive a complete refund or the full purchase price if I am not satisfied.  
 Add state or city sales tax where applicable.

Name.....  
 Address.....  
 City & State..... P-8A

N.W., Washington 6, D.C. Paper bound. 62 pages. Price. \$1.25.

This handy little volume contains valuable pointers for setting up public address systems of all sizes and for a multitude of purposes. At first glance, a p.a. installation may seem disarmingly simple, consisting basically of microphone, amplifier, and loudspeaker. But, as in most things electronic, there's a lot more to it than meets the eye or greets the ear. Acoustics, extraneous sounds, selection and hookup of equipment, area coverage, power, impedance lines, controls, speaker phasing, and the type of building to be serviced are only some of the factors that must be considered in rigging a decent p.a. system. This book tells a good deal about all of them.

**Recommended:** for the professional "sound man" as well as advanced amateurs.



## Free Literature Roundup

Properties and uses of "thin-based" magnetic recording tape are discussed in "Sound Talk Bulletin No. 32," available from Minneapolis Mining & Manufacturing Co., 900 Fauquier Ave., St. Paul 6, Minn.

More than 40 standard accessories used in electronics and TV installations are described in Catalog No. 257, issued by JAVEX, P.O. Box 646, Redlands, Calif. Included are hints for using the items.

Probes for use with volt-ohm-milliammeters are catalogued in a six-page brochure available from Futuramic Co., 2500 W. 23rd St., Chicago 8, Ill.

VECO brand thermistors, varistors, and assemblies are listed in a new catalog. Copies are available upon request from Victory Engineering Corp., 90 Springfield Rd., Union, N. J.

The new edition of Triad's "Catalog No. TR-56" describes and illustrates nearly 700 items, 76 of which are new to the line. For a copy, write to Triad Transformer Corp., 4055 Redwood Ave., Venice, Calif.

Data on over 250 TV picture tubes are included in "Bulletin PA-2." To obtain a copy, write to Advertising Service Dept., CBS-Hytron, Salem, Mass.

A bulletin on "Type EP" Audiotape, an "extra-precision" magnetic tape for special recording applications, may be obtained from Audio Devices, Inc., 444 Madison Ave., New York 22, N.Y.

Speaker enclosures and hi-fi furniture in kit and factory-finished form are described in a catalog available from Cabinart, 99 North 11th St., Brooklyn, N. Y.





# HIGH-PAY CAREERS

## IN ELECTRONICS — TELEVISION — RADIO

### Await Men with COMPLETE Training!

Nationally-recognized, accredited Central training is designed to get you into high-paying career positions in the shortest possible time. In addition, Central's "Progressive Plan" is so arranged that each phase of training you complete qualifies you for a more important, better-pay position. In just a few short weeks you are qualified for certain basic jobs. Then, with every additional training phase that you complete, you qualify "up the ladder" for more advanced types of positions. Central offers complete Electronics-TV-Radio training leading to an Associate of Science degree, and qualifying you as an *Electronics Engineering Technician!*

*Thousands of Central graduates have been placed at almost every technical level in the electronics industry. Free nation-wide placement service.*

### 3 PROVEN TRAINING PLANS

(Choose the one that fits your requirements)

- 1. HOME STUDY COURSE** (with 9 kits of equipment)—Qualifies you for diploma, FCC license, and a variety of electronics jobs (or transfer into advanced resident training).
- 2. HOME STUDY-RESIDENT COURSE** (with 9 kits of equipment)—Home study, followed by short period of resident training. Qualifies you for diploma, FCC license, and a wide variety of Electronics-TV-Radio positions (or continue with advanced resident training). An accredited technical institute curriculum.
- 3. FULL RESIDENT COURSE**—Qualifies you for Associate of Science (A.S.) degree and top-pay employment opportunities as Electronics Engineering Technician. Part-time employment opportunities available for students while training. An accredited technical institute curriculum.

**Don't limit yourself!** Get the facts on Central's complete training that can take you just as far as you want to go in the electronics technician field. Send coupon *today* for FREE brochure on your opportunities in Electronics.

### VETERANS! Central offers courses approved under G. I. Bill

## CENTRAL TECHNICAL INSTITUTE

Dept. A-86, 1644 Wyandotte St., Kansas City 8, Mo.

Tell me more about how you can qualify me for a high-pay Electronics career.

Name \_\_\_\_\_ Age \_\_\_\_\_

Address \_\_\_\_\_

City \_\_\_\_\_ State \_\_\_\_\_

If Korean veteran, give approximate discharge date \_\_\_\_\_



# VHF receivers

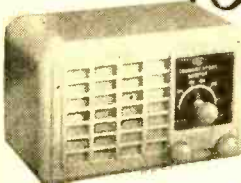

High performance  
top quality  
low price

Ideal for novice . . . amateur . . .  
emergency or communications monitoring  
in police, fire, taxi, airport or  
aircraft, C-D, CAP etc.

#### FOUR MODELS

- FM . . . . . 30 to 30 mcs.
- AM . . . . . 112 to 132 mcs.
- AM . . . . . 132 to 152 mcs.
- FM . . . . . 152 to 174 mcs.

Featuring high sensitivity . . . excellent selectivity . . . Includes famous Gonset noise limiter and wholly electronic adjustable squelch for silent standby. All receivers have 8 tubes, built-in speaker and power supplies for 115V, AC/DC. Full vision calibrated dials. Adjustable strip-type antenna. Complete! Ready to operate!

At your distributor

**GONSET CO.**

801 South Main St., Burbank, Calif.

any model **59.50**

## SAVE HOURS OF WORK

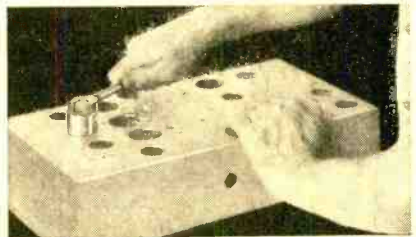

### quickly make round, square, key and "D" openings with Greenlee Radio Chassis Punches

In 1½ minutes or less you can make a smooth, accurate hole in metal, bakelite or hard rubber with a GREENLEE Punch. Easy to operate . . . simply turn with an ordinary wrench. Wide range of sizes. Write for details. Greenlee Tool Co., 2388 Columbia Ave., Rockford, Ill.

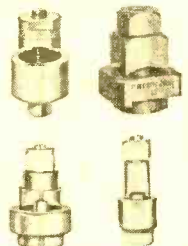

**BUILD THE BEST!**

**BUILD ALLIED'S OWN knight-kits**

fascinating... easy... and you SAVE MORE



**Sensational "SPACE-SPANNER"**  
Band-Switching Receiver Kit  
THRILLING SHORT WAVE AND BROADCAST

Model S-243 **\$13.95**  
less cab.

All-new 2-band receiver—easy to build—a great value! Pulls in thrilling short wave including amateur, aircraft, police and marine radio (6 to 17 mc), and standard broadcast. Features special highly sensitive regenerative circuit. Has 4" PM speaker and beam-power output tube for strong volume. Kit includes calibrated panel, punched chassis, all parts and tubes, detailed instructions (less wire and solder). 7x10 1/2x6"; for 110-220 v. 50-60 cycles AC or DC. 4 1/2 lbs.

Model S-243. Net F.O.B. Chicago..... **\$13.95**  
S-247. Matching cabinet for above..... **2.85**

**New knight-kit Transistor Radio Kit**

Printed Wiring Circuit  
Model S-775

ONLY **\$6.75**

with Headphones and Antenna

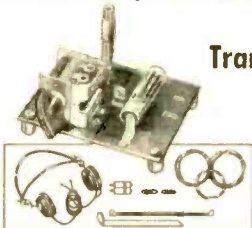

Experiment with the marvel of transistors! Printed circuit requires no wiring—just assemble with a few solder connections and enjoy excellent reception over the complete AM broadcast band. Compact—fits in the palm of your hand—operates for months from a single penlight cell. Transistor provides plenty of audio power for strong headphone reception. Complete with all parts, penlight cell, antenna, 4000-ohm headphones and instructions (less solder). Shpg. wt., 2 lbs.

Model S-775. Net F.O.B. Chicago..... **\$6.75**

**WRITE FOR CATALOG**

See the complete line of famous Knight-Kits, including Oscilloscope, VTVM, VOM, Signal Tracer, Tube Checker, Hi-Fi Amplifiers, Amateur Transmitter and dozens of others. Write today for the 324-page ALLIED Catalog—the leading buying guide to everything in Electronics.

**FREE**



**ALLIED RADIO**

Allied Radio Corp., Dept. 79-H-6  
100 N. Western Ave., Chicago 80, Ill.

OUR 35TH YEAR

Please ship the following Knight-Kits: \_\_\_\_\_

My check , money order  for \$\_\_\_\_\_ enclosed  
 Please send FREE 1956 Catalog.

Name: \_\_\_\_\_

Address: \_\_\_\_\_

City: \_\_\_\_\_ Zone: \_\_\_\_\_ State: \_\_\_\_\_

**LETTERS FROM OUR READERS**

**Better Tape Coupling Method**

■ I think that an improvement to provide radio or TV audio to a tape recorder can be easily worked with receivers having a single-ended power amplifier.

Usually these sets have a cathode bias resistor and bypass capacitor. The bypass capacitor can be disconnected (resulting in an improvement in audio capacity, by the way) and the tape recorder input attached to the cathode of the power amplifier so that this stage now operates as a cathode follower.

Normally, a coupling capacitor is required between the cathode of the output tube in the receiver and the input of the amplifier or tape recorder. The value of the capacitor will depend upon the input impedance of the recorder.

C. W. MARTEL  
Raytheon Mfg. Co.

**Rally Timer**

■ I like your article about the radar speed meters. How about an electronic speed timer for "hot rod" races, rallies, and drags?

FRED RIDEL  
Cleveland, Ohio

*Glad to have your suggestion, Fred, and we know you'll be pleased to hear that we are working in co-operation with Sports Car Illustrated on the development of just such a timer. The project is off the drawing boards and is now being tested. Look for published details soon.*

**Citizens Band**

■ What happens to the Novice ham who now holds a license but is younger than 18? Can he obtain a Citizens band license?

BEN MOSES, KN9CNC  
Mt. Vernon, Ill.

■ I would like to build a Citizens band transmitter using some 2G21 tubes that I have.

D. J. SCHINKER  
Omaha, Nebr.

*Reader Moses' problem does not seem to be fully covered in the FCC Rules. Apparently the FCC feels that if you're a ham you will have no use for a Citizens band license. We'll check into this further.*

*In reply to the gentleman from Omaha, we must point out that Citizens band equipment must bear an FCC approval—if it is to be used for radiotelephone communication.*

**Radar Speed Meters**

■ Since you didn't say anything in your July issue, what was the reaction to the radar speed meter story? Did someone complain, or what?

ARTHUR RAYBURN  
Newark, N. J.

*In reply to reader Rayburn's inquiry, as well as others along the same line, we can report that we were deluged with mail. Approximately 98%*



# BUD 16 RADIO

## CIRCUITS AT HOME

only \$19.95

Reg. U.S. Pat. Off.



### A Practical Home Radio Course

Now includes  
TESTER, SOLDERING IRON, HIGH FIDELITY, SIGNAL TRACER, CODE OSCILLATOR, PRINTED CIRCUIT SIGNAL INJECTOR

- No Knowledge of Radio Necessary
- No Additional Parts or Tools Needed
- Excellent Background for TV

### NOW! FREE TOOLS WITH "EDU-KIT"

### WHAT THE "EDU-KIT" OFFERS YOU

The "Edu-Kit" offers you an outstanding PRACTICAL HOME RADIO COURSE at a rock-bottom price. Our Kit is designed to train Radio & Electronics Technicians, making use of the most modern methods of home training. You will learn radio theory, construction practice and servicing.

You will learn how to build radios, using regular schematics; how to wire and solder in a professional manner; how to service and trouble-shoot radios. You will work with the standard type of punched metal chassis as well as the latest development of Printed Circuit chassis.

You will learn the basic principles of radio. You will construct, study and work with RF and AF amplifiers and detectors, receiving test equipment. You will learn and practice code, using the Progressive Code Oscillator. You will learn and practice trouble-shooting, using the Progressive Signal Tracer, the Progressive Signal Injector, the Progressive Dynamic Radio & Electronics Tester and the accompanying instructional material.

You will receive training for the Novice, Technician and General Classes of F.C.C. Radio Amateur Licenses. You will build 16 Receiver, Transmitter, Code Oscillator, Signal Tracer and Signal Injector circuits, and learn how to operate them. You will receive an excellent background for Television.

Absolutely no previous knowledge of radio or science is required. The "Edu-Kit" is the product of many years of engineering and teaching experience. The "Edu-Kit" will provide you with a basic education in Electronics and Radio, worth many times the complete price of \$19.95. The Signal Tracer alone is worth more than the price of the entire Kit.

### THE KIT FOR EVERYONE

You do not need the slightest background in radio or science. If you are interested in Radio & Electronics because you want an interesting hobby, a well paying business or a job with a future, you will find the "Edu-Kit" a worth-while investment.

Here is an excerpt from a letter that we received from Loren DePriest, 1496 4th St., Mansfield, Ohio: "I have spent many pleasant hours in constructing the radios from the schematics in your book, and have learned a great deal from them. Being as I am interested in Radio, I consider the money spent for your course as a wise investment. I have learned more from your course by actually doing than I did from an expensive course."

Many thousands of individuals of all ages and backgrounds have successfully used the "Edu-Kit." In more than 79 countries of the world the "Edu-Kit" has been carefully designed, step by step, so that

you cannot make a mistake. The "Edu-Kit" allows you to teach yourself at your own rate. No instructor is necessary.

The "Edu-Kit" is also used for courses of study, extra-curricular activities, industrial, personnel training and rehabilitation. The "Edu-Kit" is used by Jr. High Schools, High Schools, Technical Schools, Jr. Colleges, Colleges, Universities, Industrial Firms, Rehabilitation Hospitals, Boards of Education, U.S. Govt. agencies, United Nations Educational, Scientific and Cultural Organizations (UNESCO), Veterans Administration, and numerous adult, radio and young peoples' groups and clubs. The "Edu-Kit" is also popular with servicemen throughout this country and abroad.

Designed for universal use, the "Edu-Kit" operates on any voltage from 105 to 125 volts, AC and DC. For use in countries employing higher line voltages, a 210-250 Volt AC/DC model is available.

### PROGRESSIVE TEACHING METHOD

The Progressive Radio "Edu-Kit" is the foremost educational radio kit in the world, and is universally accepted as the standard in the field of electronics training. The "Edu-Kit" uses the modern educational principle of "Learn by Doing." Therefore you construct, learn schematics, study theory, practice trouble-shooting—all in a closely integrated program designed to provide an easily-learned, thorough and interesting background in radio.

You begin by examining the various radio parts of the "Edu-Kit." You then learn the function, theory and wiring of these parts. Then you build a simple radio. With this first set you will enjoy listening to regular broadcast stations, learn theory, practice testing and trouble-shooting. Then you build a more advanced radio, learn more advanced theory and techniques. Gradually, in a progressive manner, and at your own rate, you will find yourself constructing more advanced multi-tube radio circuits, and doing work like a professional Radio Technician.

### THE "EDU-KIT" IS COMPLETE

You will receive all parts and instructions necessary to build 16 different radio and electronics circuits, each guaranteed to operate. Our Kits contain tubes, tube sockets, variable electrolytic and paper dielectric condensers, resistors, six strips, coils, hardware, tubing, punched metal chassis, Instruction Manuals, etc.

In addition, you receive Printed Circuit materials, including Printed Circuit chassis, special tube sockets, hardware and instructions. You also receive a useful set of

tools, a professional electric soldering iron, and a self-powered Dynamic Radio & Electronics Tester. The "Edu-Kit" also includes Code Instructions and the Progressive Code Oscillator, in addition to F.C.C.-type Questions and Answers for Radio Amateur License training. You will also receive lessons for servicing with the Progressive Signal Tracer and the Progressive Signal Injector, a High Fidelity Guide and a Quiz Book. You receive all parts, tools, instructions, etc. Everything is yours to keep.

**FREE**  
Hi-Fi, Radio & TV Servicing Manuals on request (see coupon below)

### SERVICING LESSONS

You will learn trouble-shooting and servicing in a progressive manner. You will practice repairs on the sets that you construct. You will learn symptoms and causes of troubles in home, portable and car radios. You will learn how to use the professional Signal Tracer, the unique Signal Injector and the dynamic Radio & Electronics Tester. While you are learning in this practical way, you will be able to do many a repair job for your friends and neighbors, and charge fees which will far exceed the price of the "Edu-Kit." Our Consultation Service will help you with any technical problems you may have.

J. Statatits, of 25 Poplar Pl., Waterbury, Conn., writes: "I have repaired several sets for my friends, and made money. The "Edu-Kit" paid for itself. I was ready to spend \$240 for a course, but I found your ad and sent for your Kit."

### FROM OUR MAIL BAG

Ben Valerio, P. O. Box 21, Magna, Utah: "The Edu-Kits are wonderful. Here I am sending you the questions and also the answers for them. I have been in Radio for the last seven years, but like to work with Radio Kits, and like to build Radio Testing Equipment. I enjoyed every minute I worked with the different kits! The Signal Tracer works fine. Also like to let you know that I feel proud of becoming a member of your Radio-TV Club."

Robert L. Shuff, 1534 Monroe Ave., Huntington, W. Va.: "Thought I would drop you a few lines to say that I received my Edu-Kit, and was really amazed that such a bargain can be had at such a low price. I have already started repairing radios and phonographs. My friends were really surprised to see me get into the swing of it so quickly. The Troubleshooting Tester that comes with the Kit is really swell, and finds the trouble if there is any to be found."

### PRINTED CIRCUITRY

At no increase in price, the "Edu-Kit" now includes Printed Circuitry. You build a Printed Circuit Signal Injector, a unique servicing instrument that can detect many Radio and TV troubles. This revolutionary new technique of radio construction is now becoming popular in commercial radio and TV sets.

A Printed Circuit is a special insulated chassis on which has been deposited a conducting material, which takes the place of wiring. The various parts are merely plugged in and soldered to terminals.

### UNCONDITIONAL MONEY-BACK GUARANTEE

### FREE EXTRAS

- SET OF TOOLS • RADIO & ELECTRONICS TESTER • ELECTRIC SOLDERING IRON • TESTER INSTRUCTION MANUAL • HIGH FIDELITY GUIDE • QUIZZES • TELEVISION BOOK • MEMBERSHIP IN RADIO-TV CLUB • CONSULTATION SERVICE

### ORDER DIRECT FROM AD

### RECEIVE FREE BONUS RESISTOR KIT WORTH \$5

- Send "Edu-Kit" Postpaid. I enclose full payment of \$19.95.
  - Send "Edu-Kit" C.O.D. I will pay \$19.95 plus postage.
  - Send me FREE additional information describing "Edu-Kit." Include FREE valuable Hi-Fi, Radio and TV Servicing Literature.
- (Outside U.S.A.—No C.O.D.'s. Send check on U.S. bank or Intern'l M.O. "Edu-Kit" for 105-125 V. AC/DC \$20.95; 210-250 V. AC/DC \$23.45.)

Name .....  
Address .....

### PROGRESSIVE "EDU-KITS" INC.

497 Union Ave., Room 523D, Brooklyn 11, N. Y.

of it was favorable, although some readers did think that unveiling the mystery behind the radar speed meter might encourage lawlessness.

A list of those writing in to recommend publication of a speed meter detector would consume several pages. Most readers have received a form letter reply. If you did not, please accept this note as a word of appreciation for comments and suggestions.

No definite decision on whether to publish or not to publish detector plans has been effected. That subject is being investigated with great care and consideration.

### Geiger Counter Works Well

■ I built the Geiger counter in the June issue which uses the output transformer to develop the high voltage (p. 92). It works very well, and I must compliment you on the choice of material.

A. KRUEDENER-STRUVE  
New York, N. Y.

### OABT OABT Mystery Solved (We Hope!)

■ Concerning the letter from S. Swerling in your June issue, I wonder if this could be a station located in Ohio. It could mean Ohio Aviation Broadcasting Transmitter.

I have picked up signals on 535 kc. that read SSC and which I believe to be located in Greater Huntington, W. Va. This is an aircraft beam station.

W. L. HARRIS  
Lafayette, Ind.

■ The station call OABT is not listed in the 17th edition of the International Telecommunications Union listing. Probably it is a ship under the Peruvian registry, since the call signs OAA-OCZ are assigned to that country.

W. B. WOODINGTON  
Philadelphia, Pa.

■ I hear OABT in Philadelphia on my HRO.  
W. A. DUFF, W3AMF

■ In answer to Swerling's letter, the call OAB is that of a radio range station on 540 kc. The station is located at Otis Air Force Base, near Falmouth, Mass.

The range station operates as an aid to radio navigation. The long tone at the end of the call is not a "T," but a signal transmitted for DF purposes. More information on this station can be found on radio Facility Charts.

THOMAS DiMILLA, JR.  
Medford, Mass.

Reader Tom DiMilla seems to be right, and his information was verified by readers Frohock, Jones, Jecuso, Sewell, Alley, and many others.

### Make Visible the Invisible

■ Has anyone come up with a good idea for making the tube numbers legible again once they have faded out?

GERARD GRENIER  
Quebec City, Que.

This is a perennial problem and is probably one which has many solutions. Would any of our readers care to offer suggestions?

-30-

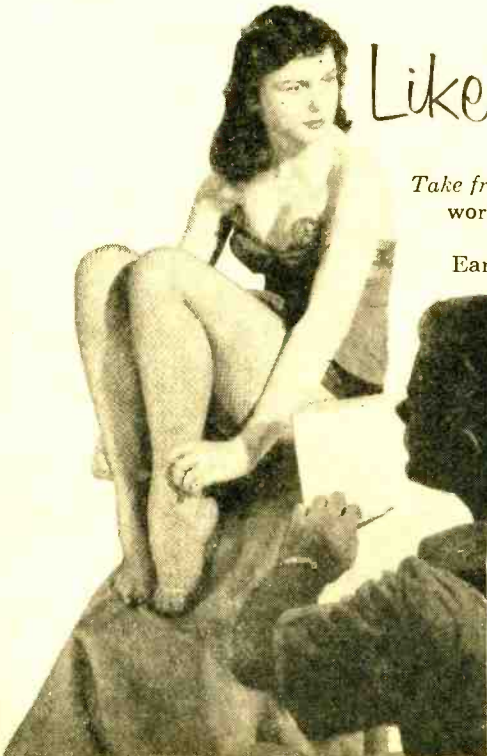

## Like to be an Artist?

Take free Art Talent Test! Find out if you have talent worth training. Demand for artists is increasing— for advertising, cartooning, illustrating.

Earnings range up to \$500 a week. Thousands got started by taking this simple

Art Talent Test. You take it at home in spare time. Test was developed

by professional artists to

uncover new talent. Offered free.

No obligation. Mail coupon today for your copy!

ART INSTRUCTION, INC. • STUDIO 8166  
500 South 4th Street, Minneapolis 15, Minnesota  
Send me your Talent Test, without cost or obligation.  
(PLEASE PRINT)

Name \_\_\_\_\_ AGE \_\_\_\_\_  
Address \_\_\_\_\_ Phone \_\_\_\_\_  
City \_\_\_\_\_ Zone \_\_\_\_\_ State \_\_\_\_\_  
County \_\_\_\_\_ Occupation \_\_\_\_\_



# NATIONAL SCHOOLS

*proudly presents*

**FOR MEN  
WHO WANT  
TO EARN  
MORE MONEY**

## • ALL BRANCHES OF TELEVISION • ELECTRONICS • RADIO IN DYNAMIC, MODERN SHOP METHOD, HOME TRAINING COURSE

\*Registration applied for

Another great advance in **HOME STUDY TRAINING**. Let National Schools, of Los Angeles, a practical Technical Resident Trade School for over 50 years, train you at home by Shop-Method, for today's unlimited opportunities in **ALL 8 BRANCHES** of the Television, Electronics, Radio Industry

Check all you receive in *One Master Course* at One Low Tuition

1. Television — Including Color TV
2. Radio — FM and AM
3. Industrial Electronics
4. Sound Recording and Hi-Fidelity
5. Preparation for FCC License
6. Automation
7. Radar and Sonar
8. Communications

ALL OF THIS MODERN NEWEST PRACTICAL EQUIPMENT IS YOURS TO KEEP!

- Parts to Build a modern TV set, including large screen Picture Tube
- Parts to build a powerful Superhet Receiver, standard broadcast and short wave
- Parts to conduct many experiments and build Community Checker, RF Oscillator, TV Circuits, Audio Oscillator, TRF Receiver, Signal Generator
- Professional Multimeter
- These are a MUST for all technicians

### YOU DO MANY PRACTICAL JOBS

You do servicing, circuit analysis and many other down-to-earth experiments. You build a modern TV set from the ground up — with equipment kits we give you, including a new large screen picture tube and professional Multimeter, at no additional charge

**EARN AS YOU LEARN!** Many of our students earn their entire tuition and more in Spare Time jobs we show them how to do while learning. **YOU GET GRADUATE ADVISORY SERVICE, TOO**

**ALL YOURS  
TO KEEP**

**L. J. ROSENKRANZ**  
President of NATIONAL SCHOOLS



This Master-Shop-Method course is completely up-to-date. Here in Los Angeles, the TV and Electronics center of the world, we are able to keep in constant touch with the industries' latest developments. As a student, you will quickly master all phases at home — in your spare time. Your earning power will grow with every lesson. Just as thousands of National Schools graduates do every day, you can handle servicing, manufacturing, repairing, hundreds of other jobs, or make good money in your own business. **SECURE YOUR FUTURE—NOW SEND COUPON BELOW**



**IN THESE MODERN TV STUDIOS, SHOPS AND LABORATORIES**, your Shop Method Home Study Course was developed by experienced instructors and engineers. What an advantage that is to you at home — each lesson is tested, proved, easy to understand. You can master the most up-to-date projects, such as color TV set repair, printed circuits — even prepare for F.C.C. License and industrial electronics without taking a special course. **TAKE YOUR FIRST STEP NOW TO A TOP-PAY JOB IN TV, ELECTRONICS, RADIO. SEND COUPON BELOW TODAY.**

**APPROVED FOR  
VETERANS  
AND  
NON-VETERANS**

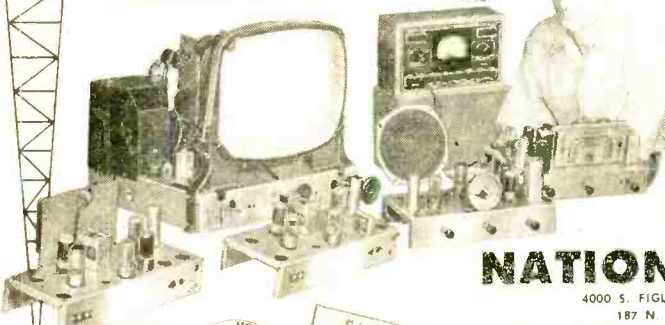

## NATIONAL SCHOOLS

4000 S. FIGUEROA ST., LOS ANGELES 37, CALIF  
187 N. LA SALLE ST., CHICAGO 1, ILL

IN CANADA: 811 W. Hastings St., Vancouver, B. C.



### FREE!

Fully illustrated "CAREER" BOOK in TV, Radio, Electronics. AND actual Sample Lesson—yours at no cost, no obligation. **SEND COUPON NOW—TODAY!**



### NATIONAL SCHOOLS TECHNICAL TRADE TRAINING SINCE 1905 Los Angeles, California

**GET FAST SERVICE—MAIL NOW TO OFFICE NEAREST YOU!**

NATIONAL SCHOOLS, DEPT. R2G-96  
4000 S. FIGUEROA ST. LOS ANGELES 37, CALIF. OR 187 N. LA SALLE ST. CHICAGO 1, ILL

Rush free TV-Radio "Opportunity" Book and sample lesson. No salesman will call.

NAME \_\_\_\_\_ BIRTHDAY \_\_\_\_\_ 19 \_\_\_\_\_

ADDRESS \_\_\_\_\_

CITY \_\_\_\_\_ ZONE \_\_\_\_\_ STATE \_\_\_\_\_

VETERANS: Give Date of Discharge

# Know how to choose YOUR LOUDSPEAKER SYSTEM

for true  
**HIGH FIDELITY**  
enjoyment!

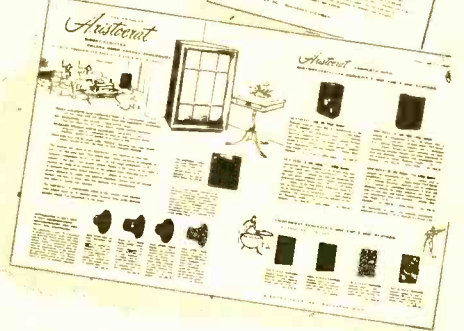
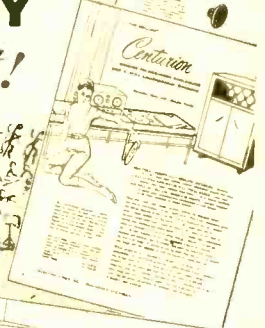
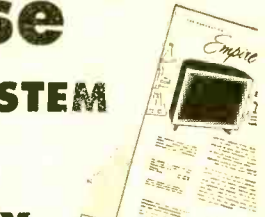
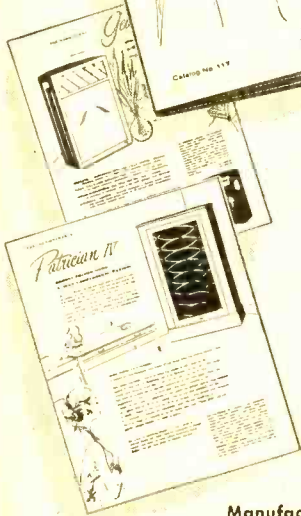

- Use this latest guide and catalog for quick facts and easy understanding of the all-important loudspeaker. Tells you what to choose and why—for true high fidelity reproduction in your home music system. Explains how E-V multiple-way speaker systems and folded-horn enclosures give you full range reproduction in proper musical balance. Provides the background you need to make your own selection regardless of how much or how little you want to spend. Also shows you how you can start modestly and easily make additions to achieve the ultimate in high-fidelity listening pleasure.

Manufacturers of High-Fidelity Speaker Systems, Amplifiers, FM-AM Tuners, Ultra-Linear Cartridges and Microphones

## Electro-Voice®

### Get this helpful book now!

Because the loudspeaker system is so vital in determining the quality of reproduction you finally hear...it will pay you to read this interesting and colorful new Electro-Voice catalog-guide. Contains the widest selection of true high-fidelity speaker systems, enclosures and enclosure kits—to suit your musical taste, space, decor and budget.

Look and listen...  
for your own satisfaction

**WORTH MANY DOLLARS TO YOU!**

Only 25c brings you this new Catalog and Guide postpaid.

Send for it today!

ELECTRO-VOICE, INC., BUCHANAN, MICHIGAN

Please send Catalog No. 117 "Guide to High-Fidelity Loudspeaker Systems." 25¢ enclosed to cover handling cost.

Name \_\_\_\_\_

Address \_\_\_\_\_

City \_\_\_\_\_ Zone \_\_\_\_\_ State \_\_\_\_\_



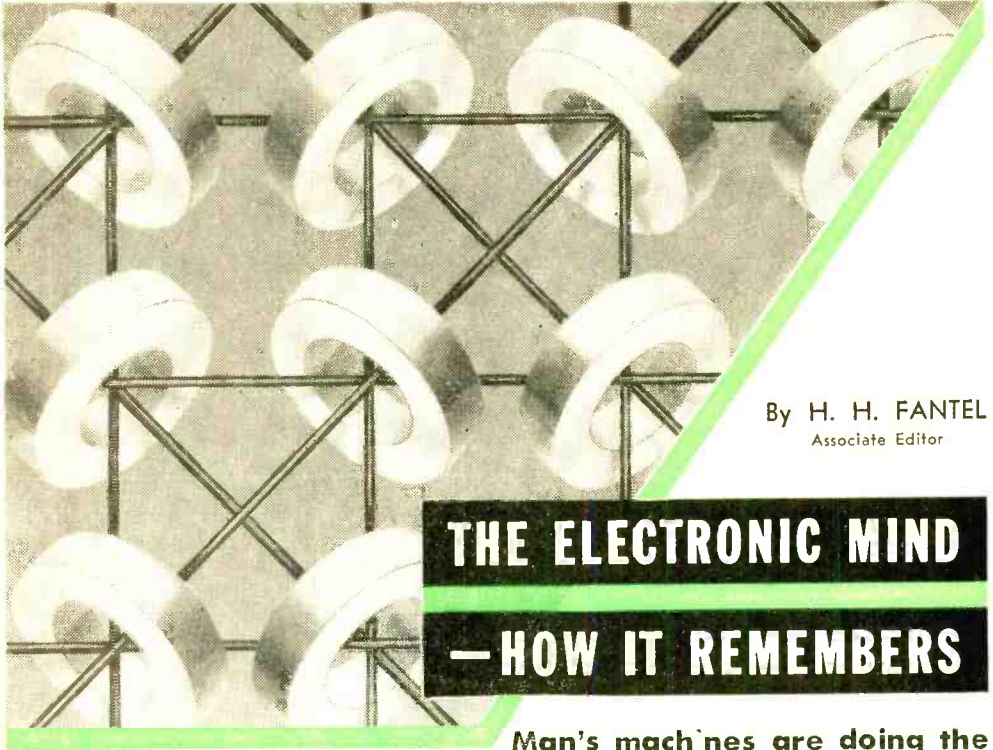

By H. H. FANTEL  
Associate Editor

## THE ELECTRONIC MIND —HOW IT REMEMBERS

**Close-up** of magnetic core memory consisting of small ferrite rings retaining information imparted through pulses from the wire network.

**W**HEN I WAS about five years old, I always carried a piece of string in my pocket. I used to tie knots in it to remind myself of things I shouldn't forget. Without knowing it at the time, I had, in effect, developed a "machine mind." To be sure, it wasn't capable of very fine mental distinctions. But it could tell the difference between yes and no. A knot meant "yes" (= there is something I ought to do). No knot meant "no" (= relax and do nothing).

Today's digital computers use essentially the same system. Instead of a string, there is a wire. Instead of a knot, there is a voltage pulse. Otherwise, it's the same. The pulse means: go ahead and do something. No pulse means: rest.

In the language of computer engineers, each "pulse" or each "no-pulse" is called a "bit," because each represents one specific bit of information. Together, and arranged in logical sequence, billions of bits make up the complex patterns which direct the computers toward the solution of a problem. Yet everything the machine needs to know is broken down into simple yes-or-no propositions. "Pulse" or "no-pulse" is all that any part of the machine ever needs to distinguish, all it ever needs

**Man's machines are doing the work of his muscles . . . now, electronics explores ways to take the load off his mind**

to remember. The computer's memory is therefore a device for storing electrical pulses in predetermined patterns.

**External and Internal Memory.** Most electronic computers have two basic types of memory—external and internal. As the names imply, the *external* memory is a sort of auxiliary, tacked onto the central computer mechanism. The *internal* memory is located right within the works of the computer.

The external memory acts as a go-between for the machine and its human masters. It remembers the instructions given to the computer by human mathematicians. By setting up the external memory, scientists can "program" the computer to do a given job. This memory also acts as a sort of "time transformer" to match the slow speed of human beings to the high speed of the machine. Scientists might take days to punch a set of instructions into the external memory. Later, the memory can reel out this row of instructions fast enough to keep up with a computer when it zooms through the whole problem.

Physically, the external memory takes

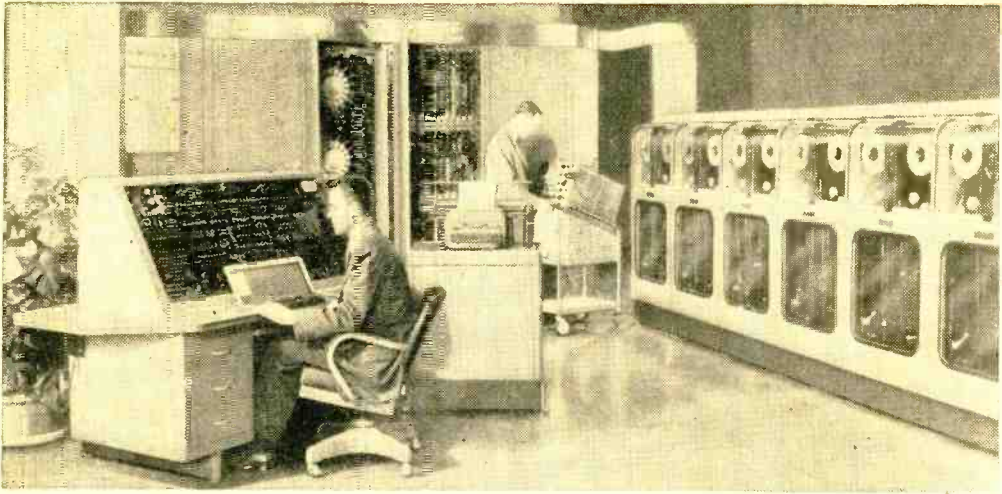

**Over-all view** of the basic components of a Univac computer. Behind the control desk in foreground, the central computer mechanism occupies cabinet at rear. The two round objects showing through open center door are mercury delay lines, part of the machine's "internal memory." The array of tape recorders at right serves as "external memory." Automatic typewriter in center spells out answers to problems.



**Human concepts** expressed through words and numbers must be broken down into simple yes-or-no "bits," somewhat like playing "20 Questions," except that here the elementary items of information run into billions. This machine converts numerical data from keyboard into monosyllabic computer code recorded on tape. The information is then retained in the computer's "external memory."

**Punched cards** (right) are also used to give instructions to the computer. The pattern of holes is then converted into a sequence of electric pulses.

the form of punched cards, magnetic tape, or punched paper tape.

Punched cards and paper tape have long been in use with conventional office equipment as data storage media—punched-card tabulating equipment, for example, has become commonplace in American business, and the paper-tape-driven automatic typewriter has relieved many a typist of repetitive labor. The data storage principle in each of these cases is extremely simple: information is recorded on the card or tape in the form of punched holes. A hole means an electric pulse; no hole, no pulse. Because of the wide use of these storage devices, some computers have been equipped with punched-card and punched-tape readers, and a number of machines have been developed to convert these media automatically to magnetic tape.

In magnetic tape storage, the most commonly used form of external storage for

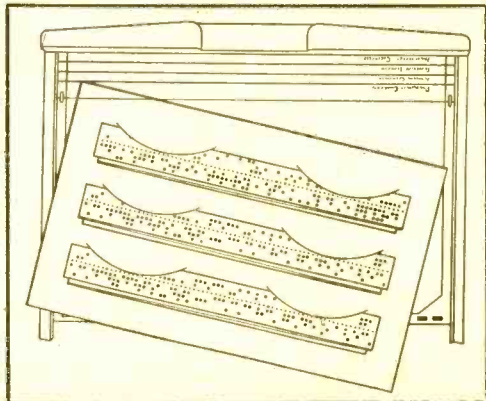

POPULAR ELECTRONICS



the electronic computer, characters are represented by combinations of tiny magnetized and unmagnetized spots, each representing a "bit" of information. When data recorded on the tape is fed into the computer, the magnetic tape reader translates the combination of magnetized and non-magnetized spots to a series of electronic pulse/no pulse combinations which, in computer language, have a definite meaning.

The great advantage of magnetic tape over other external memory devices is its tremendous capacity. One reel of magnetic tape, eight inches in diameter and one-half inch wide, can store approximately 2,880,000 characters, with up to 200 characters recorded per linear inch. The tape will preserve data permanently and will not corrode. It can be "erased" and used again for new data.

The machine uses its internal memory in the same way that human beings use scratch pads in solving a math problem. It is a place to put down intermediate results and the auxiliary numbers in the course of a calculation. Since such figures—in the form of electronic pulses—must be quickly jotted down, stashed away, or shifted from one place to another, some very tricky mechanisms were developed to do all this

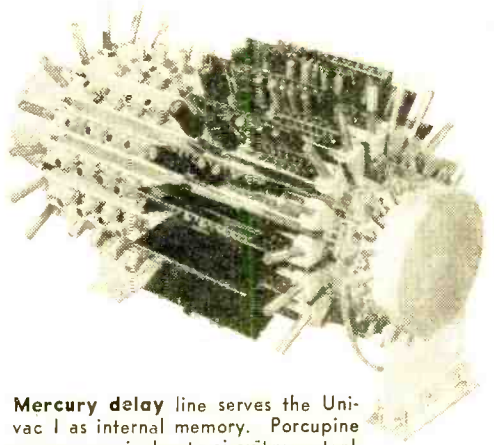

**Mercury delay line** serves the Univac I as internal memory. Porcupine appearance is due to circuitry on tank surface, amplifying and re-shaping pulses for endless repetition in this "talk-to-yourself" mumble-tub.

juggling of "bits." Mainly, they are storage devices permitting information bits to be quickly put in, quickly taken out, and accurately placed in a meaningful over-all pattern.

**Electrostatic Storage.** These storage devices are cathode-ray tubes resembling picture tubes in television sets. The screen of such a tube acts like a checkerboard of

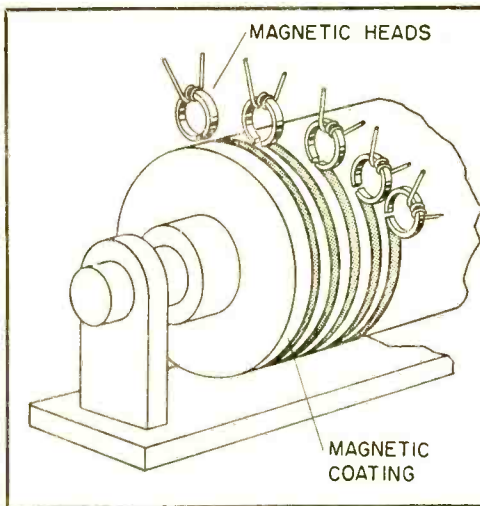

Magnetic drum principle is illustrated in simplified drawing above. Each magnetic head reads or writes pulses received from the computer onto its own track on the magnetically coated rotating drum.

Family of drums, ranging from giant roller to small twirler held by the engineer (upper right), make a veritable "memory lane" for Remington Rand.

Small drum rotor (right) whirls within the Univac at 16,500 rpm in an atmosphere of helium, which reduces friction and draws off excess heat.

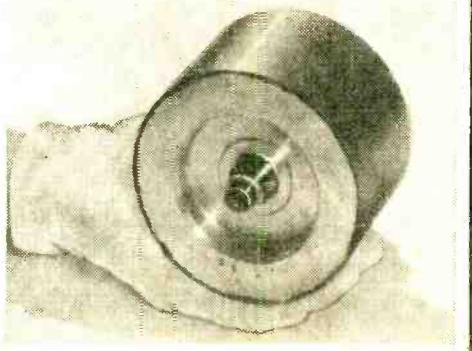
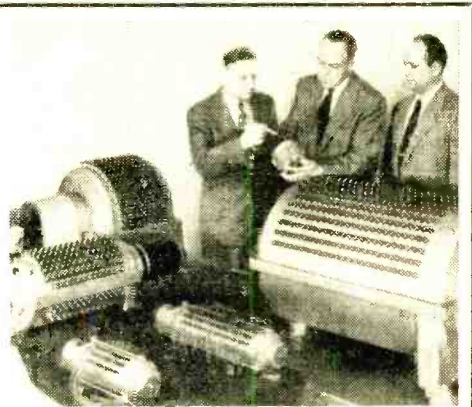

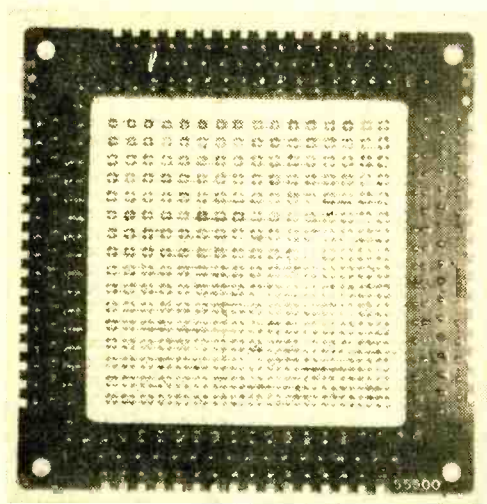

**Magnetic core matrix** is a net of tiny ferrite rings, each storing one "bit" of information.

small capacitors. Whenever the "writing beam" of the tube hits one of the "squares" on this checkerboard, its capacitor effect stores up an electric charge imparted to it by the beam. The guided beam places a pattern of charged and uncharged areas on the checkerboard screen. Each area is a "bit," and the arrangement of the bits on the board spells out a numerical meaning. This pattern of electrostatic charges can be "read" by another beam scanning the area.

Information stored in such a way can be reached very quickly. It only takes between five- and ten-millionths of a second to "read out" a digit of information and shift it to wherever it is needed for the next logical operation of the computer. Because the computer must spend much of its operating time searching its memory for data and instructions, the speed of access to specific information largely determines the over-all speed of the system.

The storage capacity of a single tube is limited usually to about 1000 bits. Tubes can, of course, be used in combination to form large-capacity storage units.

One disadvantage of electrostatic storage is that the data are lost from the tube's surface unless they are constantly regenerated by the writing beam. In other words, the machine has to keep talking to itself to remember what it is saying. Although this is done entirely by automatic circuitry, the stored data are lost in the event of a power failure.

A certain unreliability stems from the fact that beam guidance is highly critical. A small temporary voltage change on the deflection plates can direct the beam to the wrong checkerboard area on the face

of the tube, resulting in false information. Frequent adjustment by engineering personnel is essential for operating reliability.

**Electro-Acoustic Delay Line.** One of the first memory systems to gain wide commercial acceptance for electronic computers was the electro-acoustic delay line. In simplest terms, a delay line memory stores electronic data by constantly recirculating the information pulse pattern in the form of sound through a delay element, usually a tank of mercury. At the precise moment when the information must be inserted into the calculation, it is picked up by a "listening" device at the far end of the tank and transferred to where it is needed. The memory tank can then stop mumbering to itself.

The process may be likened to the short-range human device of repeating a phone number to oneself from the time it is located in the phone book until it has been dialed.

A mercury delay line memory channel consists simply of a mercury tank capped at each end by a transducing crystal, and a closed recirculation circuit. As pulses are delivered to the memory from the computer's control circuits, the crystal at one end acts as a sort of loudspeaker and sends a series of pulse/no-pulse tones through the mercury. These pulses thus travel through the mercury at the speed of sound, much lower than the speed of electronic pulses through wire. This provides the delay needed to hold information for controlled lengths of time.

As the pulses reach the end of the mercury column, they strike the second transducing crystal—which acts as a microphone—and produce small electrical voltages that can be amplified and fed back to the input. In this way, the bits continually go in circles until they are replaced by other data from the control circuits. Then the whole cycle starts anew.

Each tank has automatic counting devices, which count the number of times a message is repeated. This provides accurate timing within a few thousandths of a second for picking up the message when it is needed.

**Magnetic Drum Storage.** The magnetic drum is an aluminum cylinder or "drum" coated with a magnetic material and equipped with a row of read-write heads. As the drum spins at high speed, each head monitors a narrow "track" around the circumference.

When data are to be stored, the pulse combinations are flashed to the heads and are recorded in the form of magnetized and unmagnetized areas on the drum's surface. The operation is very much like re-

*(Continued on page 122)*



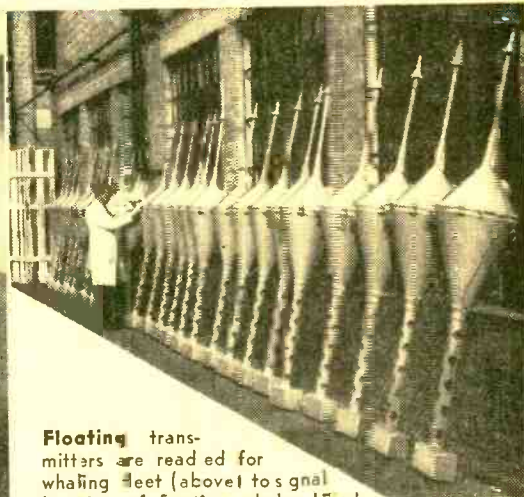

Floating transmitters are readied for whaling fleet (above) to signal location of floating whales killed by catcher boats to the factory ship which gathers them in. Transmitter is shown on buoy at left.

## Dead Whale "Calls" Ship by Radio Buoy

**D**EAD MEN supposedly tell no tales. For whales, however, it's different now. With this new radio buoy tied to his body, the late whale, killed by a catcher ship, broadcasts a macabre dirge telling the factory ship to come and pick up his floating corpse.

After the whale is harpooned, the buoy, made by Venner Electronics Ltd. of England, is fastened to the whale by means of a line long enough to keep the buoy

from being dragged under in case the whale rolls over. Operated automatically by clockwork, the floating transmitter works intermittently, making its batteries last 22 hours.

Each buoy sends out an individual call sign and a long continuous signal for direction-finding purposes. In the radio silence of polar whaling regions, the signal is heard over 150 miles, assuring recovery of killed whales regardless of visibility.

## "EVA" Paints Hot and Cold for Thermal Study

**T**HE ARMY Signal Corps recently declassified a new device which is able to "see" in total darkness by painting a picture with infrared heat rays. The new Evaporograph, called "EVA" for short, was developed by Baird Associates from a German wartime idea. It detects heat variations of as little as 1°. Working somewhat like a camera, it focuses the heat rays on an oil film, which then evaporates according to the temperature pattern. Hot and cold are thus translated into varying film thicknesses, which, in turn, show up as different colors in refracted light.

In EVA's picture of the girl holding a glass of water (lower right), cold areas appear light, hot areas dark. Above, EVA maps thermal flow in a radio chassis by simply looking at it. Presenting a "live" picture of heat spreading through electronic devices, EVA spots potential trouble sources and lengthens the life expectancy of the equipment.

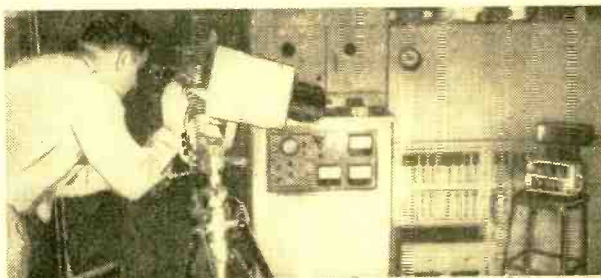

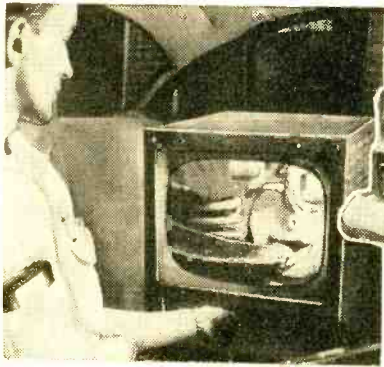

Action of underchassis spring is observed on TV screen located in rear of the car while vehicle undergoes strenuous road test.

## TV Checks Your Bounce

**I**F IT'S "LIVE" television you want, try going along with General Motors engineers on one of their road tests of a new car. These boys put an automobile through a motorized obstacle course and see how its critical parts behave under stress by means of a television screen. Cameras to pick up the action are located in spots about the vehicle that no human observer could squeeze into during a rough road run.

A small, rugged, bomb-shaped TV camera is used. The picture is transmitted, via a closed-circuit system, to a 14" monitoring screen in the rear of the test car. It is also possible to flash the picture to a larger screen in an office or laboratory miles away. The driver of the car careens around curves, jolts over bumps, and generally commits automotive havoc while the engineers conveniently watch what is happening.

The equipment for this unique application of closed-circuit TV was developed for GM by General Precision Laboratory of

Pleasantville, N. Y. For watching the action of a car's suspension system, a camera is attached to the underside of the car's front or rear bumper and focused on the suspension system. It can also provide on-the-spot observations of tire roll when a car is making a sharp turn.

In other tests, GM men have mounted the TV "eye" beneath the car's hood. This helps them observe engine "rock," fan blade "bending," and the action of throttle and choke controls. By teaming the TV camera with a strobe light, the whirling engine fan blades can be "stopped" for first-hand study.

In addition to its use on moving cars, this type of TV is also employed in test rooms to observe close-up action of high-speed rotating parts, where direct observation might prove too hazardous.

## No Sleeping at This Switch!

**A** GADGET THAT SOUNDS an alarm the minute you doze off may have wide use as a safety device for drowsy drivers, sleepy sentries, and exhausted electricians—or in any situation where catching a catnap may be your last living act.

Invented and patented by Hugo Campisi, P. O. Box 304, Belmont, Calif., the device resembles a pair of spectacles that is worn by the user. An invisible light beam is focused from each bow of the frame onto the nosepiece. Should the wearer shut his eyes and not reopen them promptly, the interrupted light beam triggers a circuit which sounds a loud warning buzz.

The photo shows the complete gear. Invet-erate flirterers need have no fears; the alarm—it is claimed—will not respond to "normal winking and blinking of the eyelids."





# Dodging the Weather—with Radar

## Radar picks safe spots amid stormy skies

**H** EADING for the clouds can be tricky business if you haven't got your feet on the ground. In fact, unexpected weather fronts constitute one of the main hazards of flight.

Collins Radio Company has recently developed an airborne weather radar system that provides immediate indication of the weather ahead. The information is displayed in the form of a weather map showing conditions within a radius of 150 miles and approximately 240 degrees around the nose of the aircraft. This map-like image on the radar screen shows the location of weather fronts in terms of range and azimuth bearing relative to the position of the aircraft. It identifies areas potentially dangerous to flight, such as thunderheads, hailstorms, or turbulent areas associated with heavy rainfall. With this map as a guide, pilots can investigate aircraft to avoid storms or turbulent areas, usually by detours of five miles or less from the planned flight path.

The weather map is created by the reflection of high-frequency radar waves from rain, hail, snow and ice. When these elements are not present in a cloud structure, energy is not reflected and hence no warning weather map is displayed on the cockpit indicator. Such "empty" clouds can be traversed with little or no difficulty.

To allow aircraft to be piloted safely through thunderstorms, information regarding turbulence, rain, snow and icing conditions must be obtained. Such information is based upon rainfall gradients (i.e., varying rainfall densities at different distances) which can be displayed on the radar screen by a unique circuit.

These rainfall gradients are pictured by insertion of a so-called "iso-echo" circuit, which shows areas of heavy rainfall as dark areas—or black holes within the brighter image of areas with only light precipitation. In this way it is possible for the pilot to spot the more dangerous areas within the cloud formations themselves.

Turbulence is recorded indirectly. Varying degrees of turbulence exist in the areas of heavy rainfall. While turbulence itself cannot be seen on a weather map, it is known to be greatest where the rainfall gradient is highest, i.e., where the pattern is



**Radar indicator** installed in cockpit of Delta airliner tells pilot at a glance the kind of cloud formation he is heading for. Analyzing the radar pattern, he can steer the plane clear of turbulent areas, avoiding risks and bumpy ride.



**Compact cockpit control** features special adjustment to gage cloud density, turbulence and force of precipitation.

**Top:** Indicator at right shows plane flying toward a weather front approximately 10 miles ahead. Rings indicate distance.

**Center:** Aircraft is approaching "soft" spot with rain centers (showing black) about seven to ten miles out on each side.

**Bottom:** Plane is now cutting through minimum turbulence area with clear sky straight ahead.



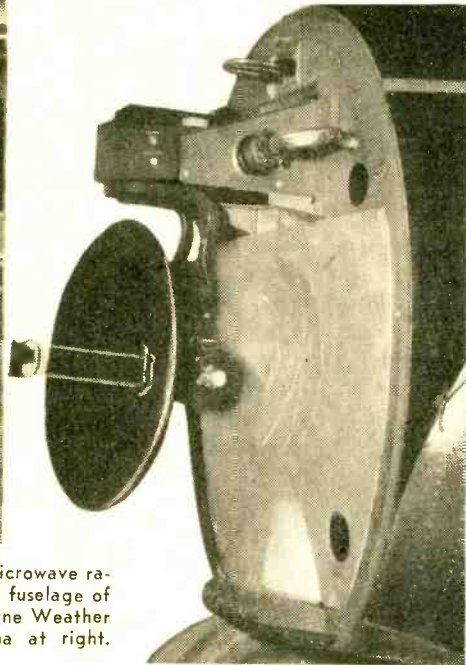

**Radome nose**, made of special plastic transparent to microwave radiation with only minimum power loss, is bolted onto the fuselage of Delta airliner housing the first commercial Collins Airborne Weather Radar. With radome removed, you can see antenna at right.

dark. The system may also be used to provide a ground map which gives a visual display of cities, rivers, lakes, shorelines, mountains and other terrain conformations. This ground map serves as an invaluable navigation aid, effectively extending the vision of the pilot during all conditions which restrict visibility.

To enhance reliability, magnetic amplifiers and mineral diodes are used wherever practical since these components have no filaments and thus avoid the possibility of filament failure. In addition, this assures an efficient system with low heat dissipa-

tion, low current drain and power demand.

The system can be used with two indicators operating simultaneously. This arrangement offers the advantage that each indicator can be set to a different range, so that both nearby and distant conditions are depicted simultaneously.

Printed wiring is used to provide physical strength and to insure precise placement of components and proper length of leads. Delta Airlines, the first to use this installation, has thereby added another safety factor as well as passenger comfort to its flights.

-30-

## Soviets Use British TV Equipment

**R**EPORTS reaching us from Russia tell of the growing popularity of television in the cities of the Soviet Union. While programs lean heavily on propaganda, they nevertheless excel in the artistic quality of theatrical and musical productions. Of course, there is no private telecasting, and no commercials. All activities of the Russian Broadcasting Authority are state-controlled.

To improve their technical facilities, Russian telecasters recently bought the remote pickup truck shown in the picture at right and various associated microwave relays from Marconi's Wireless Telegraph Company, Ltd., of England. The purchase is evidence of the improving trade relations between Russia and the Western World. Electronics, for once, plays a peaceful role.





**Talking letters and tape clubs  
spur world-wide traffic in  
music, ideas, fun and friendship**

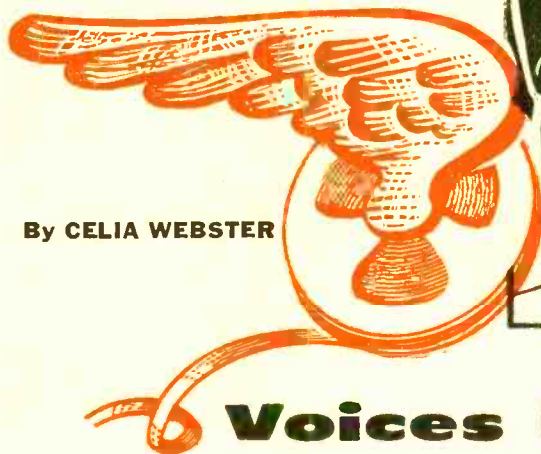

By CELIA WEBSTER



## **Voices in the Mail**

**F**ROM COAST TO COAST, round the world and back again, the mails are now carrying small, flat boxes. Inside the boxes are voices. And the voices are spoken letters on magnetic tape.

Tape recording helps form friendships through various clubs which have been organized throughout the world. The four leading tape correspondence clubs which have appeared in the past few years are World Tape Pals, International Tape-worms, Tape Respondents International, and Voicespondence.

Instead of being "pen pals," the members of these organizations talk with each other on tape. They have found it a fascinating and deeply rewarding hobby. Magnetic tape brings friendship to the lonely, knowledge to those eager to learn, reading to the blind, and adventure to armchair travelers.

Often the narrow strip of tape forms a firm bridge between people of different countries and continents. It acts as an emissary of better international relations, carrying the human voice, warm and convincing, across all geographic and political barriers.

People from all walks of life make up the rosters of the tape clubs. They include teachers, firemen, business executives, artists, writers, professors, doctors, students, farmers, truck drivers, policemen, bankers, grocery men, and many others.

**Hobby Exchange.** The tape correspondence clubs act as clearing houses to bring members with similar tastes and hobbies

in contact with one another. The brochures of these clubs contain long lists of varied subjects in which the members are interested. A new participant chooses a few members as his special tape pals, and tape-responds with them. The same tape can be erased and used over and over again, continually sent back and forth between the same two members; or a spoken letter can be permanently retained.

Here are some typical listings from the Membership Roster of World Tape Pals:

**John J. Pollock**, Red Deer, Alberta, Canada. High school woodwork instructor; age 38, married. Revere T-700 and Revere T-1100 recorders. Two daughters: Carolyn 14, and Susan, a toddler. Wife, Mary, also interested in WTP. Photography in color, and in black and white, and processing. We like music and radio programs not available on commercial records—folk music of other countries—and clever disc jockeys; good drama. Let's discuss current affairs, philosophy, history (modern and ancient), archaeology, and education in other lands. Send me some of your favorite music, and a little chin-wag so we can get going. English only spoken.

**Richard A. Drost**, 1743 W. Nelson St., Chicago 13, Ill. Operatic singer; age 20, single. Wilcox-Gay 3A10. Also three-speed disc recorder. Operatic and classical vocal music. English, Italian, and some Swedish spoken. I am handicapped to a small extent with muscular dystrophy and have about 90 disc-recorded complete Met radio operas which might be of interest to some WTP. Also would like to receive some vocal music taken from RAI (Italy), the BBC (England), or from German radio.

**Henk Johan Mulder**, Fisherstr. 88, The Hague, Netherlands. Grocer; age 31, married. Philips recorder. I would like to receive a real impression of the American way of life. Dutch and English spoken.

The cost of mailing a 3" tape reel in the United States is only a few pennies—two



**Prof. James H. Boren** heads the International Committee on Tapes for Education, sponsored by World Tape Pals to encourage exchange of tapes among students and teachers of various countries.



**Chile**—Fernando Ceruti of Vina del Mar won first place at the International Amateur Recording Contest. Ceruti entered his binaural recordings of Chilean orchestral music through World Tape Pals.



**Harry Matthews**, a printer from Dallas, Texas, is the founder and secretary of World Tape Pals.

flung of all tape clubs, reaches 48 countries and their colonies. "We trade a lot of music since it is the international language," says Harry Matthews of World Tape Pals. "But where there is no language barrier, we start off more long-distance conversations on such subjects as freedom." Far from being inane gab-fests, these exchanges are conducted on a surprisingly mature level.

Of course, tape corresponding is an ideal way to improve one's knowledge of a foreign language once the fundamentals are mastered. You not only get the proper accent of native speech, but you also gain insight into the opinions, customs and attitudes of different people. It is precisely this kind of interchange that creates more good will at the grass-roots level (where it counts) than all sorts of official state visits. Next to traveling in person, tape exchange with people in other countries is one of the best ways to develop a broader understanding of the world in which we live.

If you have no knowledge whatever of any foreign language, you can still get plenty of fun and satisfaction from international tape correspondence. English, after all, has become an internationally spoken language and most overseas tape correspondents can speak it. Lars Svensson, a Swedish member of the Voicespondence Club, uses the English language so much with his foreign tape friends that he finds it strange communicating in Swedish when he talks to his tape-pal countrymen. Many members of the various organiza-

cents for third class, six cents for first.

Tape correspondents consider "talking" letters infinitely superior to written ones because they can add a background of authentic sound effects. Erik Lindgren, of Sweden, puts it like this:

"How exciting it is to listen to tapes from a friend in Beirut, recorded against a background of the exotic cries of Arab hawkers from the street."

**Words and Music.** Exchanging folk songs with people in all parts of the world is in itself a fascinating sideline. What's more, this exchange can take place even where language difficulties prevent the exchange of elaborate personal messages. For example, World Tape Pals, the most far-



**England**—A warm friendship has been formed by the tape exchanges of Margery Elliott of Birmingham with the B. Sam Taylor family of Medford, Oregon. She plans to travel over 14,000 miles to visit them this summer and to see the United States.

tions, after having exchanged taped messages for a period of time, often plan their vacations in other cities and different parts of the world where their tape pals live.

Even the old-fashioned round-robin letter has its tape equivalent. This works on the principle of combining different recordings on a single tape. With the help of a church organist, the originator of the idea, Bob Crouse, a Voicespondence member, chose a familiar hymn and taped it on his recorder. He then mailed the tape to a tape pal in another state who played it on his own machine while re-recording it on a borrowed machine and at the same time singing in harmony with the original. The re-recorded tape was then sent on to another member who played the tape, re-recorded on another machine and sang simultaneously to complete the master tape. A bit complicated, but fun! They now have three master tapes of the trio who blended their voices in three different states.

Tape fans catch on quickly to the tricks of the audio trade. Often their letters are imaginative blends of talk, background sound effects and music, edited with a skill that would do credit to professional producers of radio shows. Of course, tape correspondents swap tips and ideas about the technical side of their hobby. Often they transcribe and trade radio programs, live entertainment, or lectures from their particular countries. Such tapes sometimes have real documentary value.

World Tape Pals was founded by Harry Matthews, a printer from Dallas, Texas. It grew out of Harry's former hobby of short-wave amateur radio. As a ham, he liked to chat by radio with people from practically everywhere. But often unfavorable atmospheric conditions kept him and his friends from getting through to one another. Harry then thought of tape correspondence to supplement his ham contacts. While this lacks the spontaneous give and take of ham radio conversations, he found that by carefully preparing and editing his tapes, inserting on-the-spot items, etc., he could exchange a wider range of more meaningful news with his friends. He also gets out

**Switzerland**—Wilfred Francfort tapes a news commentary in his role of reporter. A dentist by profession, he is head of the Swiss Sound Chasers Association and assists news agencies and radio stations with on-the-spot recordings.



**Germany**—Erich Bomke of West Germany uses technical skill and excellent equipment to send German folk music to his friends all over the world.



**New Zealand**—John E. MacDonald, headmaster, and six pupils from Taupaki School, Auckland, make a tape recording to be sent to Shady Cove School, Oregon, USA. MacDonald is known to other World Tape Pals for his excellent recordings of Maori children singing folk music, and for the interesting 35-mm. slide shows with tape commentary which he exchanges with other members.



**"Snoopy"** the cat (at left), took up the tape hobby of his roommates, Don and Millie Edwards. He exchanges meows with lots of other cats.

efforts on the men and women in the Armed Services. Art Rubin, top Tape-worm, records the messages for them on his recorders and the families pay the postage. When the tapes are received at camp, they are taken to the Red Cross headquarters where they can be played. Many service men and women who have been away from home for a long time find this warm, gratifying method of communication much more satisfying than a letter because it brings the actual voices of their families to them.

a small newspaper called "Tape Topics."

Mrs. Matthews has been swapping tape-recorded recipes with housewives from other countries. One from Australia suggested kangaroo-tail soup made like oxtail soup. Mrs. Matthews taped back a sad report about the perennial shortage of kangaroos in Texas.

**Special Projects.** World Tape Pals has organized a "tape bank." This is a sort of lending library consisting of hundreds of interesting and worthwhile tapes from practically everywhere on a wide variety of subjects. Lately, the tape bank has branched out into projects that present a real challenge to the imagination of tape correspondents. They set up a group called "World Tapes for Education." This is a planned program for interchanging tapes chiefly between schools, teachers, and students the world over.

Other tape clubs also have their special projects. The Voicespondence Club, under the guidance of Charles and Melva Owen, organized what they call a Committee For The Blind to aid the blind members in getting the best results from their recorders. They are also enlisting volunteers to read to them via tape.

Another group called International Tape-worms has been concentrating its recording

The broader meaning of the tape clubs extends far beyond their actual membership to all of us who are interested in electronics. For in a world where electronics must often serve purposes of war and build barbed fences of propaganda between people, the unifying work of the tape clubs and their human sidights set a heartening counter-theme.

-30-

#### WANT TO JOIN A CLUB?

##### TAPE RESPONDENTS INTERNATIONAL

Jim Greene, Secretary  
P. O. Box 21, Dept. T.  
Little Rock, Ark.

##### THE VOICESPONDENCE CLUB

Charles Owen, Secretary  
Noel, Virginia

##### WORLD TAPE PALS

Harry Matthews, Secretary  
P. O. Box 9211  
Dallas, Texas

##### INTERNATIONAL TAPEWORMS

Art Rubin, National Chairman  
P. O. Box 215  
Cedarhurst, L. I., N. Y.

##### GLOBAL RECORDING FRIENDS

Alfred L. Sferra, D.D.S., Secretary  
125 Hamilton St.  
Bound Brook, N. J.





Direction center and computer are housed in this windowless, reinforced concrete blockhouse at Lincoln Laboratory—the nerve center of the SAGE system.

Department of Defense Photos

## Whirlwind Defense Quarterback Goes into Operation

**T**HE DESTRUCTIVE power of atomic warfare coupled with the growing array of aerial weapons which could reach our shores raises frightening misgivings. A swift and efficient defense must be instantly available to counter an attack if we are to survive. Fortunately, the same brand of ingenuity that developed these offensive means has been working to give us the weapons and organized control of them that a defense requires.

The task of assignment and control of interceptors, ground-to-air guided missiles, and anti-aircraft guns—the means by which we must defend ourselves—has led to the development of a huge electronic quarterback called the “SAGE” system. The name “SAGE” is derived from its more formal title, the Semi-Automatic Ground Environment system.

**Directing Defense.** One of the world's largest, fastest and brightest electronic computers is the heart of this fantastic system. It relieves men of the hopeless task of sorting, weighing and evaluating the thousands of pieces of information our radar networks and other detection means can supply. It determines the best assignments of our defensive means to cope with the situation. Then, it directs these aerial weapons until the attacking plane or missile is downed.

By E. D. MORGAN

***Plunging through the enemy line  
of aerial and atomic attack,  
SAGE is ready to make a  
touchdown for national defense***

The first of these fabulous systems is centered at Lincoln Laboratory in Lexington, Mass. At this secret laboratory, operated by the Massachusetts Institute of Technology, the system was conceived and developed for the military forces. In all, 32 similar systems will be constructed, protecting our borders with the largest electronic defensive system ever constructed.

At the outer boundaries of the system is a ring of radar detection stations. Long-range surveillance radars and height finders are included, as well as smaller gap-filler radars to detect low-flying planes trying to slip beneath the skirts of the longer range detection systems.

The edge of the system is not confined to coverage from land stations, however;

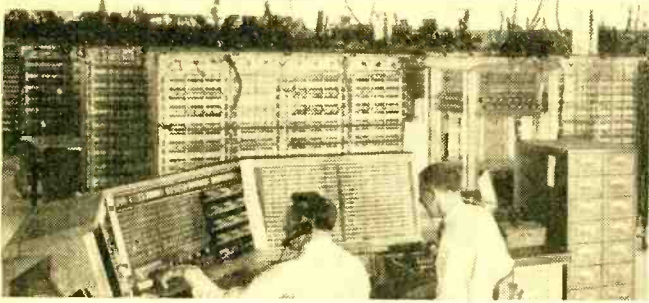

The computer which forms the nucleus of the SAGE system is known as an AN/FSC-7. One of the world's largest and fastest, it contains 25,000 vacuum tubes. Maintenance console is shown above.

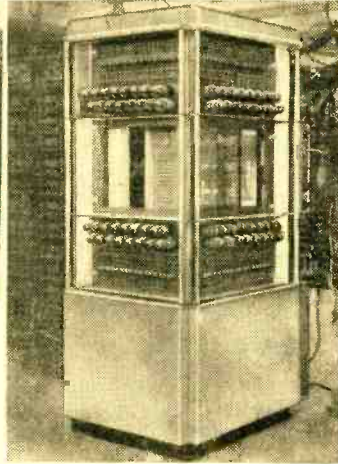

Memory unit of computer (right), made up of three-dimensional array of ferrite cores, receives a constant stream of flight data.

"Texas Towers" constructed far from the shore extend the coverage seaward. These man-made islands are huge platforms standing on legs which reach to the ocean floor. Their name comes from a technique used successfully for offshore oil well rigs in the gulf of Mexico.

Other seaward defensive lines are manned by radar, picket ships and AEW (Airborne Early Warning) planes carrying powerful radars. Constant patrols insure that the system remains on the alert.

**Interpreting Signals.** The mass of information provided by these surveillance systems is transmitted continuously and automatically by either telephone lines or ultra-high-frequency radio networks to a direction center.

Also pouring into this direction center is additional data from other sources: flight plans of friendly aircraft to aid in their identification, up-to-date weather data vital to the successful interception of an enemy, reports from the Ground Observer Corps, data on the readiness of our defensive weapons, etc.

This constant stream of courses, speeds, altitudes and locations is continually digested by the computing facilities. The direction center is located in a windowless

concrete blockhouse. It houses the dual-channel computer built by IBM. One channel is on a standby basis, but all the pertinent information is fed into it so that it is immediately ready for action if necessary.

The computer busily compares reports and compiles, sorts and processes the input information. Composite pictures of the air situation are displayed on 30" cathode-ray tubes in a television-like manner. Locations of all aircraft and their identifications can be observed. In addition, the computer weighs all the possible means of eliminating enemy planes or missiles and indicates them. The different weapons that might be used, and the time and place of the interception, are all available to the men making the tactical decisions.

When a particular type of defensive strategy is decided upon, the computer continues its work. It can direct an interceptor or missile until it contacts the enemy. If radio data links and automatic pilots are in an interceptor, it actually flies the plane to its destination. After the kill has been made, the computer continues its task to bring the plane back to its home base.

If the air battle nears the boundary of a

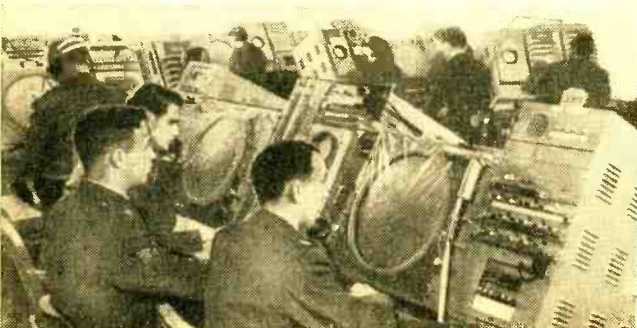

Cathode-ray tubes are used to display composite pictures of the changing air situation in a television-like manner. Locations of all aircraft and their identifications can be observed. The consoles at the left are part of Whirlwind I, a forerunner of the present computer.





**Electronic equipment** shown above is installed in one of the gap-filler radar stations which are located between more powerful long-range search transmitters.

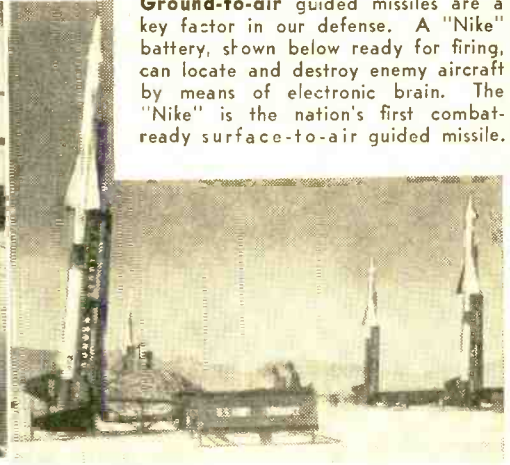

**Ground-to-air** guided missiles are a key factor in our defense. A "Nike" battery, shown below ready for firing, can locate and destroy enemy aircraft by means of electronic brain. The "Nike" is the nation's first combat-ready surface-to-air guided missile.

**Many radar locations** have control centers where the search and height-finding radars work as a team (right). The information is then relayed to the system's direction center for processing.

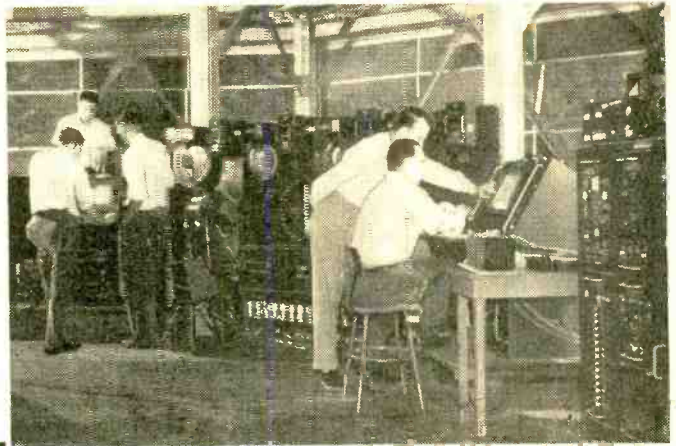

**Interceptors** like this all-weather F-86D Sabre provide one means of downing enemy planes. The SAGE computer is capable of flying the plane to its destination using a u.h.f. data link and automatic pilot. "Mighty Mouse" 2.75-inch rockets are fired from a retractable pod beneath the fuselage.

particular system, it transfers the problem to the computer in the adjacent sector. With its speed, accuracy and capacity, it can handle many intercepts simultaneously while continuing its function of surveillance.

**Over-All Picture.** The immensity of the task has involved the cooperation of companies like Western Electric, IBM, Bell Labs, Burroughs and Rand along with Lincoln Laboratory.

The computer contains 25,000 vacuum tubes and covers 10,000 square feet. While it is supervised and monitored by men, it

releases them from the overwhelming task of coping with thousands of details. This frees them for the more important job of making tactical decisions. Even in this category, they are guided and aided by the electronic machines.

SAGE changes the basic building block in our defense picture from a single radar and its operator to an entire geographical area treated as a unit. The capacity and efficiency of this technique serve to keep our defensive ability in step with the growing offensive might which may someday be directed against us.

## R/C Drone Is Television-Equipped

**F**LYING TELEVISION CAMERAS, carried aloft in radio-controlled "drone" aircraft, are being tested by the U. S. Army Signal Corps for possible use as instantaneous reconnaissance devices. Live TV shots can be made of strategic territory and then transmitted to a ground control station. This, it is expected, will aid

Converted L-17 is drone; box in foreground is ground control.



combat commanders in evaluating ground conditions prior to taking any action.

The pilotless system consists of an L-17 aircraft modified for television "photo-drone" operation; an auto-pilot which provides effective remote control by means of off-on type radio signals; and a ground control station that can be carried in a jeep.

Signals sent from the ground station to the L-17's 42-pound auto-pilot regulate stability, altitude, and air speed. Complying with remote commands, the aircraft will perform a scheduled climb or glide. Special control provisions prevent stalls, over-speeding, excessive loss of altitude, and other hazardous conditions.

When the drone's mission is completed, the ground controller flicks an "approach" switch which automatically positions land-

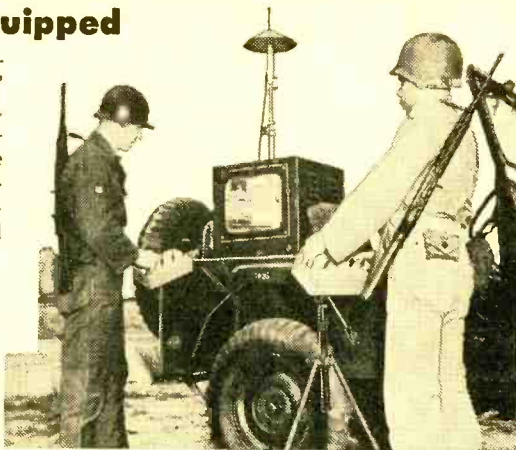

Pictures taken by drone in flight are flashed to television monitor screen. Receiver and ground control unit may be carried in jeep.

ing gear, flaps, prop pitch, and power in proper sequence for landing.

The modified L-17 may be used pilotless, or it may carry a safety pilot who can operate the aircraft himself, or turn command over to a ground controller.

Both weather- and shock-resistant, the 250-pound ground station includes radio links for commanding the drone as well as for communicating with the safety pilot. Still photos may also be made using this system. The ground control operator can, by actuating the proper switches, maintain complete out-of-sight command.

The complete system was built for the Signal Corps by Temco Aircraft Corp., Dallas, Texas. Company spokesmen claim they telescoped more than a year's quota of research and development into six months in order to achieve an early flight of the prototype.

Present range of the converted L-17's is a 25-mile area, to be augmented later by the use of radar.

## Ultrasonics Slices Quartz



**C**UTTING critical slabs from a chunk of quartz is as easy as slicing bread with a new "sound slicer" developed by Raytheon for the Signal Corps. The device uses ultrasonic energy at 25,000 cps to cut 21 paper-thin wafers of the tough mineral without ever touching it. As a result, three times as many usable crystals for frequency control in electronic equipment can be obtained from a block of the strategic mineral than with the best diamond saw.



# "Ears" for the CD Observer Post

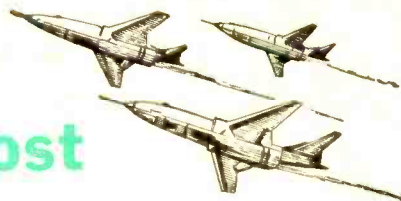

By LOUIS E. GARNER, JR.

WHILE you may never be able to provide your feet with Seven League Boots, if you're an electronics hobbyist who likes "off-beat" projects, you can provide your ears with similar long-range facilities. By using the instrument shown in the photographs, you can listen to birds chirping in trees at distances of hundreds of feet . . . or you can eavesdrop on conversations a hundred yards, or more, away.

In addition to its use in "just for fun" activities, this long-range listening device has many practical applications. A naturalist might couple its output to a tape or wire recorder and use it to pick up woodland sounds, bird songs, insect chirps, or animal calls. And since it is battery-operated, and thus completely portable, it might well be carried to desolate areas and used to listen for calls from lost hunters and campers, or survivors of airplane accidents—its directional pickup charac-

**You can intercept conversations held in normal tone of voice more than 100 yards away with this sensitive "Listening Post"**

teristics will aid in locating survivors and in guiding rescuers to the proper place. Other possible applications include its use as an adjunct to a Ground Observer Corps listening post and by police or detectives to obtain evidence on suspected criminals.

The complete "Listening Post" consists of two relatively independent units—a directional pickup assembly and a high-gain transistorized audio amplifier. Only standard commercial parts, available both through local distributors and mail order parts supply houses are used in constructing the project. While assembling the complete instrument in the exact form shown in the photographs may be a little costly for the average experimenter, the basic

Cover Photo by Al Gruen



Listening for distant sounds. If you build this device, you can start your own private Civil Defense project. It consists of two relatively independent units—a directional pickup assembly and a high-gain transistorized audio amplifier. Only standard commercial parts are used.



Using the "Listening Post." Three "cobra" type loudspeaker paging trumpets are connected in series to form pickup unit. In the model, these trumpets are mounted along a support arm made of aluminum.

design, as we shall see later, is subject to considerable modification. By applying your ingenuity, you should be able to tailor the design to fit both your technical inclinations *and* your budget. For the moment, however, let's discuss the assembly of the model.

**Horizontal Arm and Pickup.** Three University "cobra" type loudspeaker paging trumpets were connected in series and used as the sensitive pickup unit. "Cobra" type trumpets were chosen because they provided both a directional pickup charac-

teristic and a proper match to the low input impedance of the transistorized amplifier.

The pickup trumpets were mounted along a horizontal support arm which, in turn, was built up from four pieces of extruded aluminum stock. Standard 6' lengths of Reynolds "do-it-yourself" aluminum angle stock in  $\frac{1}{16}$ " x 1" x 1" and  $\frac{1}{8}$ " x  $\frac{3}{4}$ " x  $\frac{3}{4}$ " sizes were cut in half and bolted together to make up the 3'-long arm. (You can obtain this aluminum angle stock at most hardware stores.) Mounting plates of  $\frac{1}{16}$ " aluminum, measuring  $2\frac{1}{2}$ " x 3" over-all, were bolted to the ends and middle of the arm—both for reinforcement and to provide smooth mounting surfaces for the trumpet support brackets.

Three holes,  $\frac{3}{8}$ " in diameter and fitted with rubber grommets, were spaced along the horizontal support arm alongside each trumpet mounting bracket, to permit the connecting leads to pass to the back of the arm. These leads were too short to reach the length of the arm, so extra lengths of hookup wire were added, with each splice protected by short pieces of spaghetti tubing. The leads were then twisted together and run under protective "U-Channel" stock to the rear center of the support arm, where the amplifier was to be mounted.

If mechanical construction isn't one of

Fig. 1. Schematic wiring diagram and parts list for the transistorized audio amplifier.

- B1—6-volt battery (Burgess Type Z4)
- C1—25- $\mu$ d., 6-volt electrolytic capacitor (Barco No. P6-25)
- C2, C4—8- $\mu$ d., 6-volt electrolytic capacitors (Barco No. P6-8)
- C3—0.005- $\mu$ d. disc ceramic capacitor
- C5—500- $\mu$ d., 6-volt electrolytic capacitor (Sprague No. TVA-1103)
- J1—Open-circuit phone jack
- PT1, PT2, PT3—"Cobra" type paging trumpets, used as pickups, 45 ohms impedance (University Type CMIL-45)—see text
- R1—1000-ohm carbon potentiometer, audio taper (with switch)
- R2, R4—180,000-ohm,  $\frac{1}{2}$ -watt carbon resistor
- R3, R5, R7—47-ohm,  $\frac{1}{2}$ -watt carbon resistor
- R6—270,000-ohm,  $\frac{1}{2}$ -watt carbon resistor

- R8—8200-ohm,  $\frac{1}{2}$ -watt carbon resistor
- S1—S.p.s.t. switch (on R1)
- T1, T2—Interstage transistor transformer, 20,000-ohm primary to 1000-ohm secondary (Argonne No. AR-104)
- TR1, TR2, TR3—P-n-p junction transistors (G.E. Type 2N107)
- 1— $2\frac{1}{8}$ " x  $5\frac{1}{4}$ " x 3" case (ICA No. 29410)
- 1—Knob
- 3—"In-Line" transistor sockets
- 1—Subchassis (bent from piece of aluminum 2" x  $3\frac{1}{4}$ ")
- 1—Pair of headphones (accessory)
- 1—Standard camera tripod, preferably heavy-duty (accessory)
- Misc. terminal strips, decals, ground lugs, wire, solder, machine screws and nuts, etc.

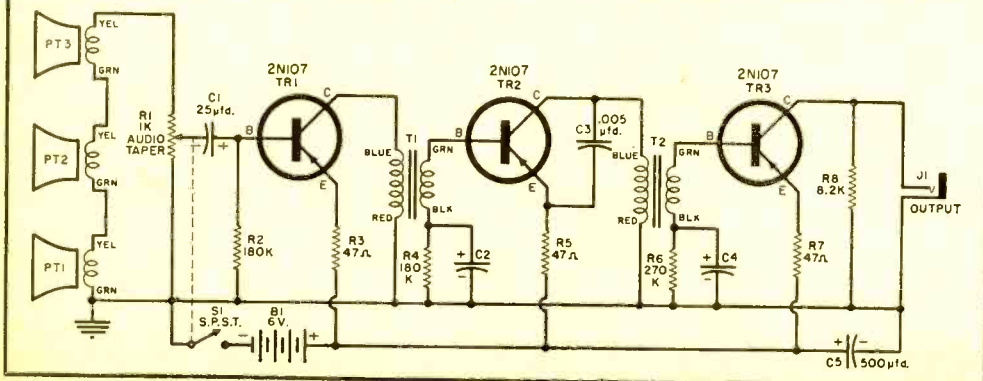



Details of "L" bracket used to support entire assembly. Be sure to mount the bracket at the balance point in the center of the arm.

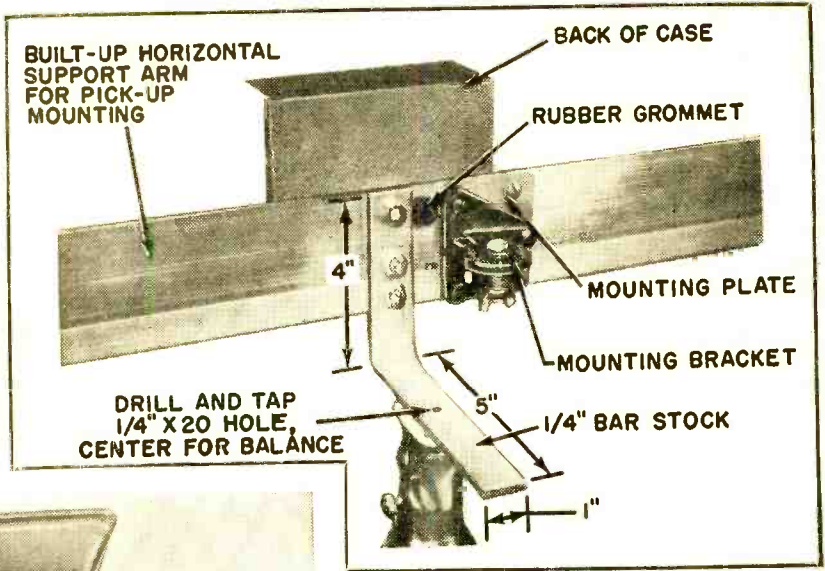

Rear view of the listening post with close-up of amplifier. Assembly is mounted on a standard camera tripod.

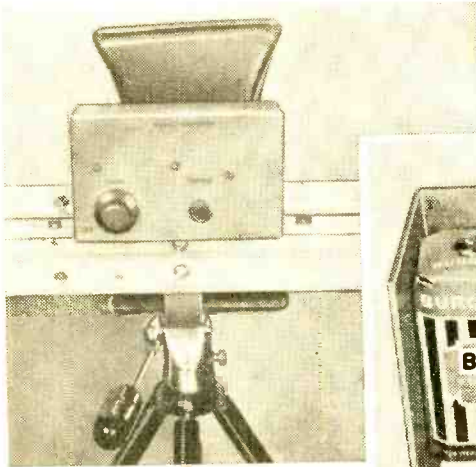

Above-chassis view of the completed amplifier showing location of components. The transistorized circuit insures light weight and long battery life.

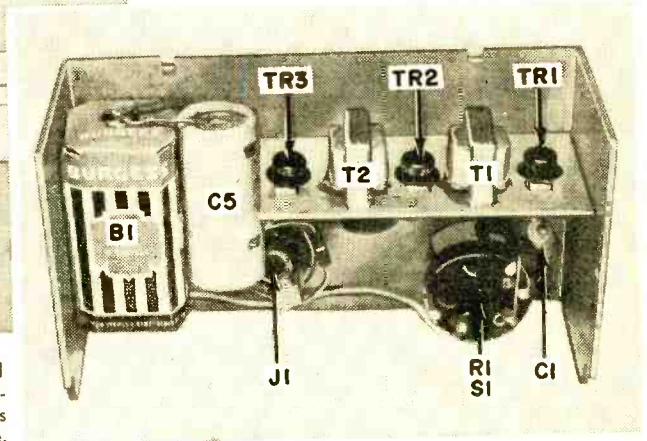

your strong points, you needn't follow the rather elaborate construction used by the author in assembling the horizontal support arm. A quite satisfactory support arm may be made from a 3' or 4' length of 2" x 4" or 4" x 4" timber, available at any lumber yard. Use wood screws to mount the pick-up trumpets.

But whether you use an elaborate metal arm or a simple wooden support, you'll want to mount a strong "L" bracket at the balance point in the center of the arm. In the model, this was bent from a 9" length of 1/4" x 1" aluminum bar stock. Three 1/4-20 x 3/4" machine bolts were used to attach this bracket to the horizontal arm, and a 1/4-20 tapped hole was provided to permit mounting the entire assembly on a standard camera tripod.

**Audio Amplifier.** The schematic diagram of the three-stage transistorized

audio amplifier used is given in Fig. 1. In order to provide maximum gain, transformer coupling has been employed between stages. A single long-life six-volt battery serves as the power supply.

You'll have no trouble assembling the amplifier in the standard 3" x 5 1/4" x 2 1/8" aluminum case specified in the parts list. The back of the case is permanently mounted on the horizontal support arm, together with a four-terminal tie-point strip which serves as a common connection point for the trumpet pickup leads. In the model, the small audio transformers and transistor sockets were mounted on an aluminum sub-chassis which, in turn, was bolted to the aluminum case with two machine screws and hex nuts.

The battery is held in place against the side of the case with a simple "L" bracket. Connections are made by soldering leads to

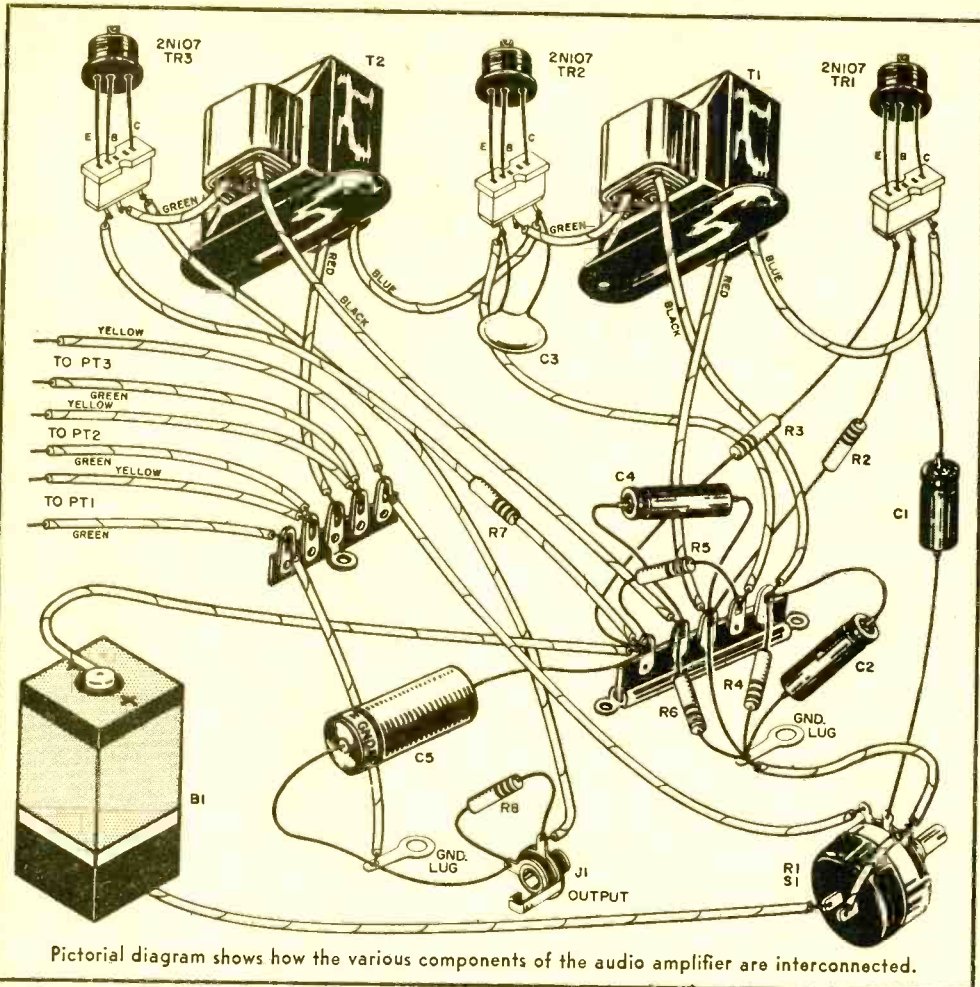

Pictorial diagram shows how the various components of the audio amplifier are interconnected.

### HOW IT WORKS

Loudspeaker paging trumpets (*PT1*, *PT2*, and *PT3*) serve as directional microphone pickups, converting sounds into audio electrical signals. These signals appear across control *R1*, with the setting of this potentiometer determining the amount of signal fed through coupling capacitor *C1* to the first stage.

The audio signal coupled through *C1* is amplified by *p-n-p* transistor *TR1* and coupled through transformer *T1* to the second stage. Both transformers (*T1* and *T2*) serve to match the high output impedance of a transistor amplifier to the low input impedance of the following stage.

Additional amplification is provided by the second transistor, *TR2*, with the output signal coupled through transformer *T2* to the final stage. Capacitor *C3* serves to detune the primary winding of *T2* to reduce the possibility of over-all oscillation at the "natural" resonant frequencies of the transformers. Transistor *TR3* serves as the output amplifier stage, with the output signal appearing across collector load resistor *R8*.

Base bias current for transistors *TR1*, *TR2* and *TR3* are provided by resistors *R2*, *R4*, and *R6*, respectively. Resistors *R4* and *R6* are bypassed by miniature electrolytic capacitors *C2* and *C4* to minimize the effect of these resistors on the audio signal. Dynamic and d.c. stabilization is provided by unypassed emitter resistors *R3*, *R5* and *R7*.

the terminals. Again, to avoid heat damage, make these connections as quickly as possible.

**Final Test.** With the amplifier wiring completed, *double-check* for errors *before* installing the transistors. Pay particular attention to the polarity of battery and electrolytic capacitor connections. Make sure you've made connections to the proper transistor terminals.

Next, give the amplifier a quick "operational" test. Install the transistors in their sockets and plug a pair of headphones (crystal or magnetic, 1000 ohms or higher impedance) into output jack *J1*. Listening to the headphones, turn the amplifier "on" and the gain full up. Touch the "hot" side of the gain control with your finger. You should hear noises, and possibly hum, in the earphones. If there is a strong broadcast station nearby, you may even hear some music!

Once you've checked out the amplifier, (Continued on page 123)



## The Batteries in Your Portable

**D**OES YOUR PORTABLE radio have that weak and run-down feeling? Did it serve you better in December than it did in July? If so, check for battery trouble. The batteries in your portable are simply boxes of chemicals in a zinc container. They inevitably deteriorate with use, are sometimes affected by temperature and humidity, and are impossible to store over long periods of time.

Two types of batteries are required in most portables. The tube filaments are supplied a fairly heavy current of perhaps a tenth of an ampere from an A battery at 1.5 volts. The tube plates require a much lower current drain of several milliamperes from a B battery at 90 volts; this might be provided by two batteries in series. Some sets use a single "battery pack" in which both types of battery are enclosed.

Batteries are made to do a specific job under certain limiting conditions. They will give maximum performance if you will observe a few simple precautions:

**1.** When the batteries are so weak that the portable plays only at low volume—or fades out after a short period, replace them.

**2.** Don't leave dead batteries in the portable. They may leak and cause corrosion or other damage to set or case. Remove the batteries from the radio if you don't plan to use the set for long periods.

**3.** Test batteries under load. Even partially worn-out batteries may show somewhere near normal voltage on open circuit test. Your dealer has the proper tester.

**4.** When buying batteries, see if they have a date stamped on them, and don't accept any on which the date has expired.

**5.** Keep batteries snug in the case. Shim them lightly if necessary with wooden blocks. Don't jam them in.

**6.** Dry batteries are made for intermittent use, so don't play your portable for seven or eight hours at a time. Even a brief rest between use periods is helpful.

**7.** While portable radios generally can't afford the drain of a pilot light, they are sometimes provided with a "flag" visible through an opening in the panel when the set is turned on. Make sure this works, and repaint the flag in a brighter color if necessary to assure maximum "noticeability."

**8.** If the set has an on/off switch operated by the case lid, make sure the switch really turns the set off when the lid is closed.

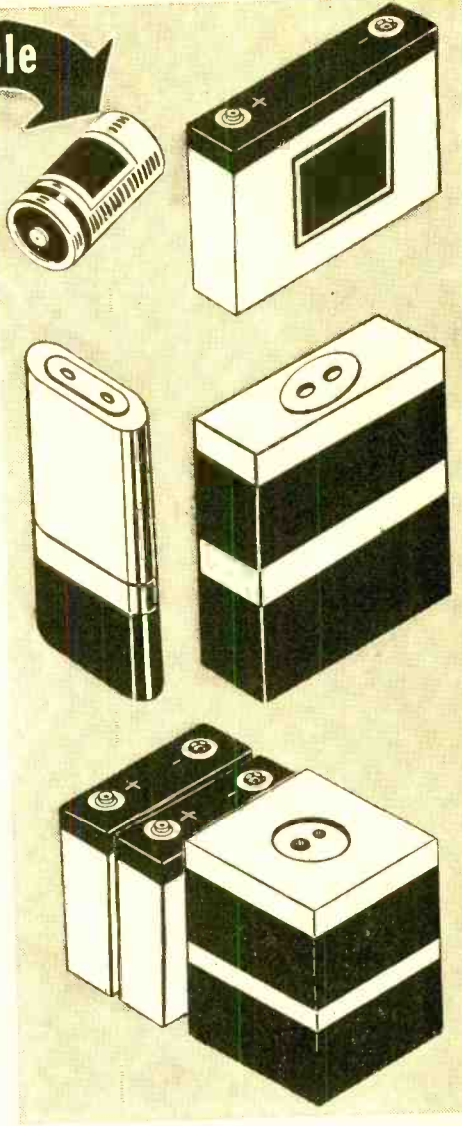

**9.** Don't store batteries—or sets with batteries—in a warm place. Heat speeds up the action of the battery chemicals and shortens battery life. For the same reason, try to provide some shade for your radio at the beach.

**10.** On the large a.c.-d.c. battery portables with short-wave bands, which use a single battery pack, additional hours of service can often be obtained from the pack by paralleling its "A" section with nine volts of A battery. There is sometimes room in the case for the extra battery, or it can be attached externally to the back panel, thereby reinforcing the pack "A" section which often fails before the "B" section.

—Eugene F. Coriell, Lt. Col., USAF

# AM Tuner for Low-Cost Hi-Fi

By JOHN A. NORMAN



Attractive and efficient, the Miller AM tuner fits right in with other components that comprise low-cost system.

Photos by Maynard Frank Wolfe

**Small in size and modest in price, this tuner—connected to a hi-fi system—puts out sound that is both “clean” and “big”**

**R**EADERS WHO assembled the low-cost hi-fi system described in our June issue have asked about a likely AM tuner to add to the system. Interest in AM reception is gaining among hi-fi enthusiasts, what with improved AM facilities and the growing trend toward “binaural” reception. In answer to the requests, POPtronics put out its editorial scanners and surveyed the field. What we found should meet the demand quite adequately.

The old principle of crystal detection has been pressed into service for hi-fi AM reception. A recent application of the germanium-diode crystal as a detector, surrounded by a clever—but simple—circuit, has produced a top quality tuner. Its fidelity on local stations is almost unbelievable in view of its price.

The little giant in question is the Miller No. 595 AM tuner (net price, \$19.50). Using no tubes and no a.c. power, and measuring a mere 7" x 4" x 3½", this unit pulls in

signals with a measure of linearity and stability formerly associated only with sets selling for much more.

**Trouble-Free Circuit.** The secret lies in the tuning circuit. A germanium diode is used as the detector. Two antenna coils, tuned by a two-gang capacitor, are coupled through a third coil. This circuitry produces broad tuning characteristics with no sideband cutting. Sensitivity is a neat compromise between being high enough for stations within a 25-mile radius and low enough to reject spurious signals and provide very “clean” reception. Selectivity is assured by the use of high-*Q* coils.

The advantages of this type of circuit are many, adding up to low-cost, high-quality, trouble-free operation. Audio response is not limited by any design factors in the receiver; this set is ready to handle anything the AM broadcast station can throw its way.

No tubes are used. The audio signal, after detection by the diode, is fed to the external amplifier. No tubes in the tuner mean no power supply. Consequently, the 595 is completely free of both hum and tube microphonics. What's more, there is nothing to wear out and replace. The germanium diode itself is inherently rugged and resistant to shock. A long and economical life expectancy can be claimed for this component.

On listening tests conducted, using the low-cost hi-fi system mentioned earlier, audio response was clocked very close to 10,000 cps. This was checked with the tuner

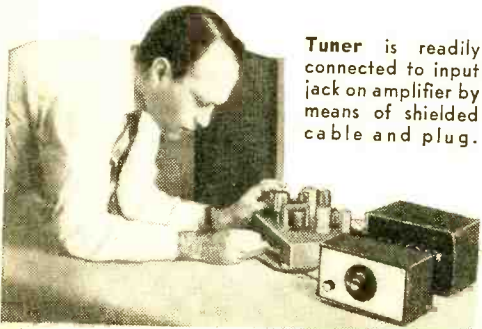

Tuner is readily connected to input jack on amplifier by means of shielded cable and plug.



plugged into the "AUX" input jack of the 10-watt amplifier. The general impression, aurally, was one of very clean sound. An undistorted response up to 10,000 cycles may prove more satisfying than a distorted response that goes higher. As things stand now, many AM stations do not transmit audio frequencies above 10,000 cycles, although they may if it doesn't interfere with other stations. The average inexpensive AM radio will not, ordinarily, handle frequencies in this range.

**Installing the Tuner.** To use the Miller tuner, insert the signal output lead (already fitted with a standard phono plug) into the "AUX" or "SPARE" jack on the amplifier. Two controls are provided: a station selector and a gain adjustment. We recommend setting the gain to maximum. Then you get the full benefit of the detected radio signal and can use the amplifier's volume and tone controls to suit your own listening tastes.

Incoming signal strength depends largely on the length of the antenna used. A 75' length of ordinary lamp cord will serve nicely as the antenna.

**Available As Kit.** For those who want to build their own, and "get their feet wet" on a simple, foolproof, and rewarding proj-

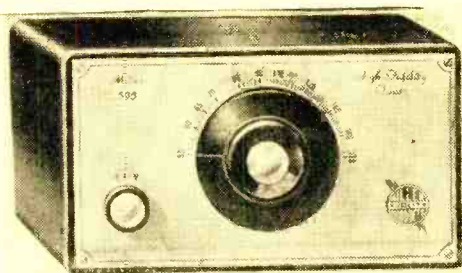

Two controls are used on the Miller 595 AM tuner. Knob on left is a gain control; the center dial is a station selector. There is no "on-off" switch needed because the tuner uses no power supply.

ect, the tuner is available as a kit (Model No. 565) for \$14.70 net. Everything needed is supplied. Instructions included presume no previous electronic training on the part of the builder. Anyone who can follow simple directions and hold a soldering iron can successfully complete this tuner—and have it playing—in less than two hours. When assembled, the kit version is identical to the factory-made job.

Either way—kit or factory-assembled—this tuner is a worthy addition to low-cost, good-quality audio.

-30-

## 90-Volt Neon Lamp Runs on 4½-Volt Battery

**A**N EXCELLENT demonstration of the storage and conversion of electrical energy in an electromagnetic field can easily be accomplished with a few simple parts in the experimenter's junkbox.

When an electric current is sent through a coil of wire, or solenoid, it does not reach its full value instantly because it must first expand an electromagnetic field around the coil. If an iron core is placed in the solenoid, this space-storage-of-electrical-energy effect can be greatly increased. When the current flow is suddenly cut off, it does not instantly return to zero; as the electromagnetic field collapses, energy is returned to the circuit where it is dissipated. This energy will often build up its voltage even to an intensity far above the original voltage which was causing the current to flow.

The above-mentioned phenomenon can be demonstrated by taking a neon lamp, say the NE-48, that will not operate until the applied d.c. voltage is at least 90 volts, and connecting it in a circuit which includes a high-speed buzzer in accordance with the schematic drawing. Note that this circuit is so wired that the current from the battery can flow through the electromagnet of the buzzer up to the instant the magnet attracts the armature; then the current is immediately cut off.

The energy stored in the electromagnetic field space surrounding the buzzer is now returned to the coil and the voltage builds up to a peak sufficiently high to jump the open gap between the plates of the neon lamp, where it appears as a flash of red light that proves it has reached at least 90 volts. The current is d.c. and flows in the same direction as the original current when building up and maintaining the electromagnetic field.

All this has happened in spite of the fact that the original pressure could not have exceeded 4½ volts. The buzzer keeps on starting and breaking the current at a high rate of speed, so to all appearances the lamp is continuously burning—although actually it is being lit and extinguished about 1000 times per second.

—George P. Pearce

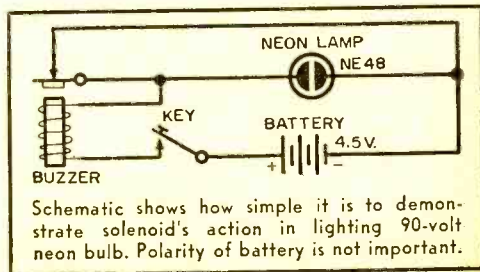

Schematic shows how simple it is to demonstrate solenoid's action in lighting 90-volt neon bulb. Polarity of battery is not important.

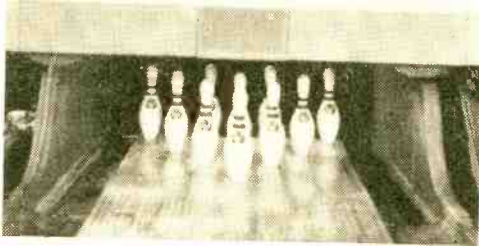

# Automatic Pin Boy

**Electronic brain spots pins  
and returns ball to bowler**

**A**UTOMATION, guided by electronics, has invaded the American bowling alley with the development of an "Automatic Pinspotter." Produced by American Machine and Foundry Company, more than 10,000 of these devices have been installed in bowling centers throughout the United States. Completely automatic, the Pinspotter does everything that the familiar "pin boy" used to do, except pick up tips and call to bowlers.

Respotting pins and returning balls, the AMF Pinspotter is a mechanical system controlled by electronics. Details of its operation in a typical sequence are shown on the next page.

So complex is the Pinspotter's design—including power relays, circuit breakers, potentiometers, signaling systems, and a special "Radaray" which detects fouls—that AMF has found it necessary to institute its own schools for training electronic technicians. Fifteen hundred students, from every state in the union, are attend-

ing company schools set up at the plant in Shelby, Ohio, and a recently opened branch at Los Angeles, Calif. The course covers the elements of electronics and mechanics and goes on to train personnel to dismantle, overhaul, and service the Pinspotter.

This is one case where the problem of automation replacing people on jobs is no serious issue. In the first place, the pin boy has become a scarcity on the scene because of new opportunities that have opened up for youths in more lucrative and less strenuous areas. Secondly, use of these automatic pin boys has created a new demand for trained technicians to service them, to say nothing of the personnel employed in their manufacture and distribution.

For more information, contact American Machine & Foundry Co., 261 Madison Ave., New York 16, N. Y.

-30-

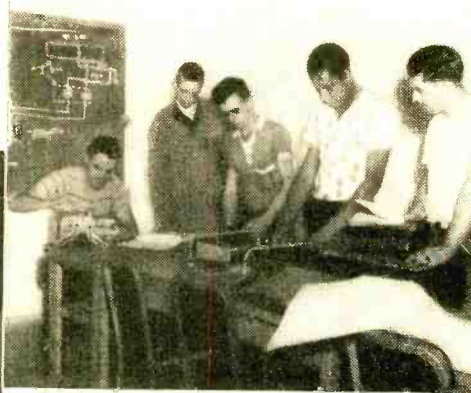

"Brain" of the Automatic Pin Boy is shown at left. Hundreds of AMF employees are being trained at schools set up by the company to dismantle, service, and reassemble this intricate electromechanical system. A large part of the training program consists of a course in basic electronics. Other needed subjects, including mechanics, are also taught. Company expects to train 1500 technicians by end of year.

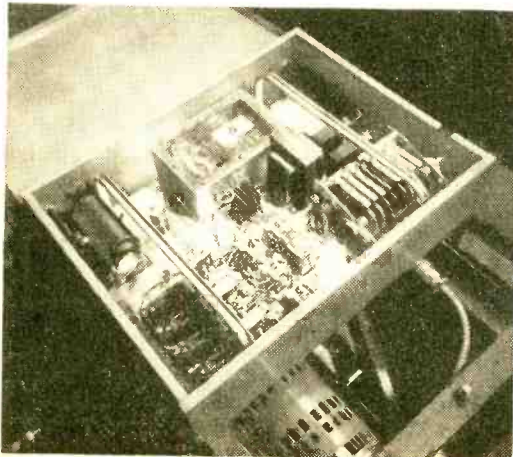



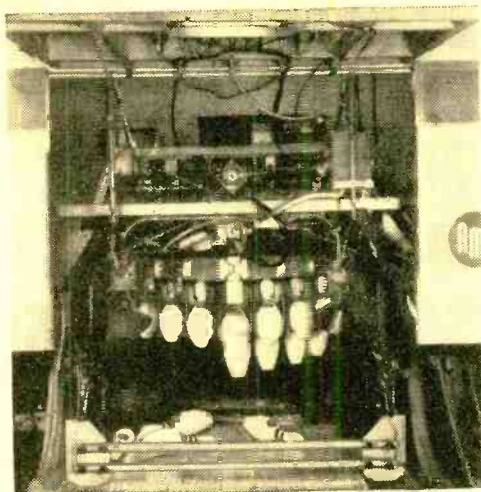

**1** First ball sets the AMF Pinspotter in motion by hitting pit cushion, thereby tripping switch, as in above photo. The ball will be moved to "ball lift door" (lower left corner), lifted to return track, and sent on its way back to bowler. Meanwhile, machine's spotting table has lifted standing pins from alley, permitting moving bar to clear deadwood into pit, thence under pit cushion to a "pinwheel" conveyor for reloading. After the alley bed is swept free of fallen pins, table descends and respots the pins, in preparation for next ball.

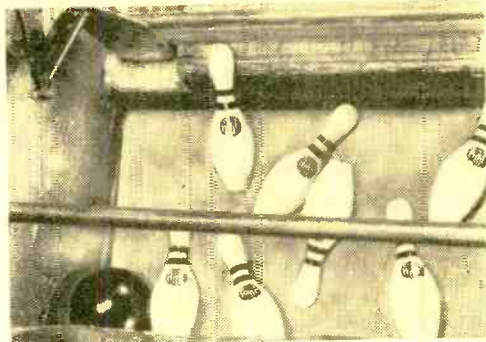

**2** Constantly revolving "magic carpet," an endless belt in pit, moves deadwood to "pinwheel" conveyor which lifts pins to top to be deposited into spotting table cups. Ball is moved by carpet to door of belt-type ball lift in the kickback. This door remains closed at all times except when opened by ball, which keeps pins from jamming lift.

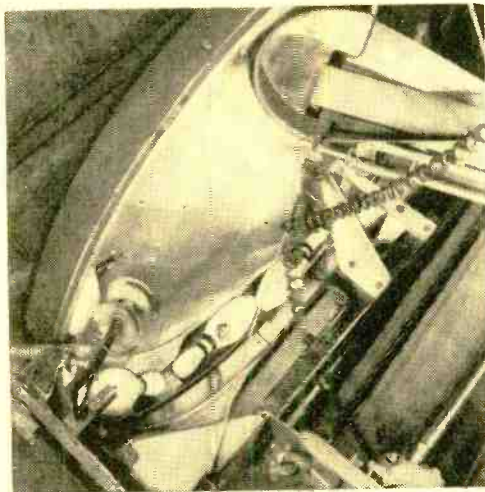

**3** "Pinwheel" conveyor at rear receives deadwood carried beneath pin cushion by machine's endless belt. Pins fall into wheel's compartments, are held in place by steel pin and carried to top of wheel where they are released into an "orientor."



**4** At top of "pinwheel," steel bar holding pin in place retracts and pins are oriented—base first—onto telescoping distributor whose endless belt indexes pins into cups of spotting table. This action takes place whenever the table needs pins, even when the spotting table is being lowered to respot pins for next throw, as in above photo.

**5** "Off-spot" pins (right) are respotted on alley bed for second ball. AMF Pinspotter's action conforms to American Bowling Congress rules which dictate that position of "off-spot" pin cannot be altered in any way. When frame is completed, rail descends to protect new pins as they are spotted. Sequence repeats itself automatically.

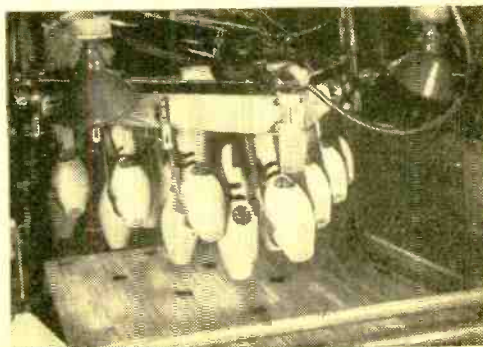

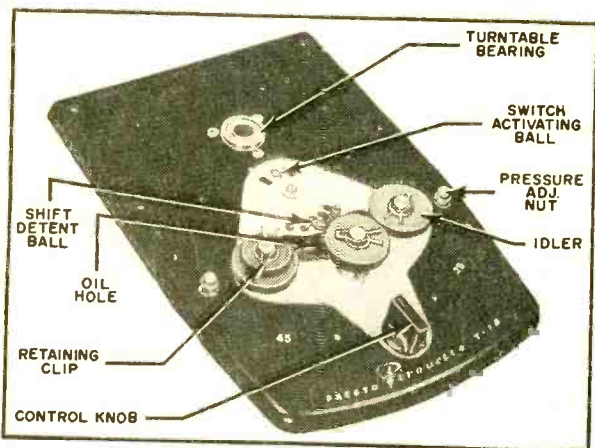

With turntable removed from its shaft, record player base (sometimes called a "motor board") looks like the unit shown at left. Although photos here are of the Presto "Pirouette," maintenance techniques outlined apply to any turntable.

Toothpick may be used for applying two or three drops of oil to the motor bearings (below). Wicks inside the circular openings carry the oil to vital parts. Access to motor is gained by turning base plate upside down. Careful treatment adds years to turntable's life.

## Low-Down on Turntable Upkeep

**A** FEW MINUTES and as many drops of oil—when needed—can assure top performance from your record turntable. First, remove the turntable from its shaft and apply two or three drops of medium motor oil to the motor bearings. Next, make a light grease by mixing the motor oil with petroleum jelly and apply a small amount to the turntable shaft. Third, remove the idler wheels by slipping off the retaining clips, apply grease to their shafts, wash the wheels with warm water and soap, and wipe them dry before replacing them.

To avoid friction in the speed changing mechanism, apply some grease to the switch-activating and shift-detent balls. Lubricate the mechanism's shaft with a drop or two of the motor oil. Before replacing the turntable, use a soft dry cloth to dust and wipe the entire mechanism. Work in a dust-free area; oiled surfaces attract abrasive particles. Do this regularly, and you'll reduce rumble, wow, and flutter.

-30-

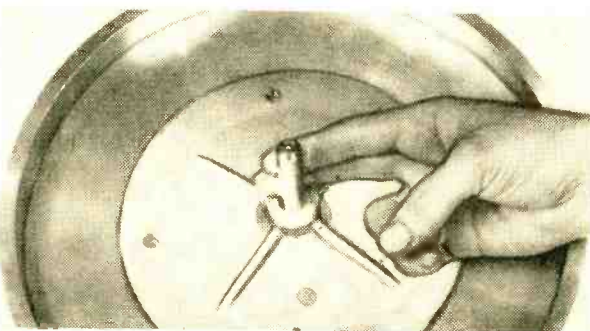
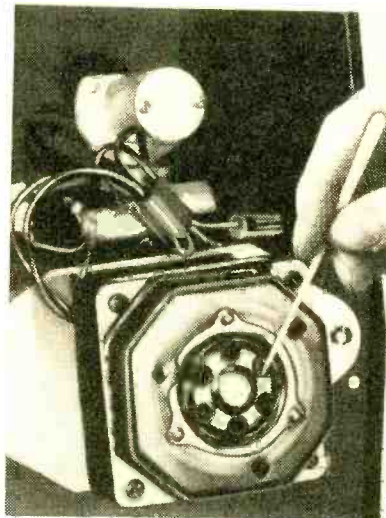

Mixture of grease and oil may be applied to shaft of turntable by using the fingers, as shown above. Solution is made by mixing medium motor oil with ordinary petroleum jelly. Small amount, just enough to cover shaft with light film, is all that is needed for smooth operation.

Detent balls, indicated by toothpick and arrow at left, get the same grease treatment as the turntable shaft. Proper maintenance of these parts assures smooth operation of the speed-changing mechanism, prevents friction and binding. Shaft for this mechanism should receive a drop or two of oil (not grease). Caution: oil must be kept off idler wheels.







# MAGNETIZE FOR FUN AND UTILITY

By Rhys Samuels

**Just pass a tool through the coil of this easy-to-build unit; it will be magnetized in seconds**

**M**AGNETS by the dozen can be yours when you build this simple, inexpensive magnetizer unit. In seconds, you can magnetize hand tools or toys for the youngsters, or you can make your own magnetic cabinet latches and dozens of other devices simply by passing them through the coil of this easy-to-build magnetizer. And you can demagnetize them just as easily by resetting the panel switch.

A magnet is made by passing hardened iron steel or a suitable alloy through a strong magnetic field. This type of field is created whenever a direct current flows through an electrical conductor. If the current flow is increased, or if the conductor is wound into a coil of many turns, such as the one used in this magnetizer, the strength of the magnetic field is greatly increased.

The strength and life of a magnet depend upon the composition of the metal used in the magnet. The best permanent magnets are made of hardened steel or certain alloys such as Alnico (used in many loudspeakers) which is composed of aluminum, nickel, cobalt, and iron. Soft iron loses its magnetism easily and is not recommended for permanent magnets. A magnet can be demagnetized by passing it through an alternating-current field.

This magnetizer is built around an RCA-202D1 focus coil taken from an RCA Model 630TS television receiver, although any focus coil designed to handle a direct current of 120 milliamperes or more can be

used. The only operating control is a two-pole, three-position switch. Switch positions are "M" (magnetize), "OFF," and "D" (demagnetize). When the switch is set to "M," the magnetizer supplies direct current to the coil winding, thereby creating a strong unidirectional magnetic field. When the switch is set to "D," the direct current is removed and the coil is connected across the a.c. line, causing an alternating field to be set up around the coil.

The circuit of the magnetizer is shown

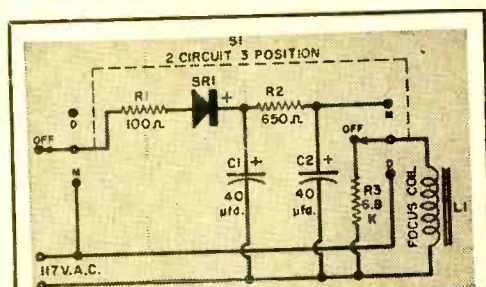
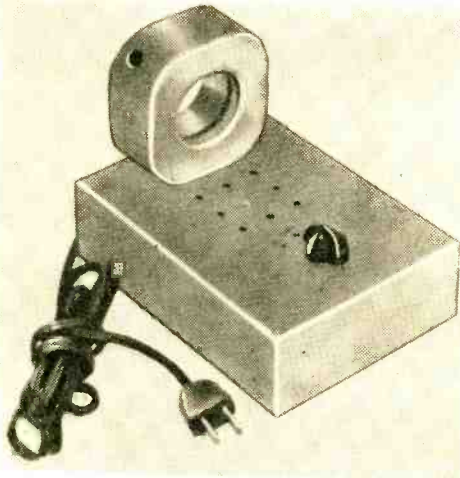

Fig. 1. Schematic diagram. See parts list below.

- C1-C2—40/40- $\mu$ fd., 150-volt dual electrolytic capacitor with mounting clip (Cornell-Dubilier UFE-4415)
- L1—Focus coil (RCA 202D1)
- R1—100-ohm, 2-watt composition resistor
- R2—650-ohm, 2-watt resistor
- R3—6800-ohm, 1-watt composition resistor
- S1—2-circuit, 3-position rotary switch, shorting type (Mallory 3123)
- SR1—150-ma. selenium rectifier (RCA 201G1)
- 1—5" x 7" x 2" chassis with ventilated bottom plate



Looking down at the magnetizer, you can see the focus coil, the ventilating holes drilled in top of chassis directly over rectifier, and the three-position switch which is the only operating control.

in Fig. 1. The simple power-supply circuit utilizes a selenium rectifier which rectifies the alternating current from the line, delivering a pulsating direct current on the "plus" side of the rectifier. Resistor *R1* is a protective resistor which limits the surge current through the rectifier when the switch is first set to "M." Capacitors *C1* and *C2* and the resistor *R2* filter out any ripple voltage so that substantially pure direct current is applied to the coil. *R3* is connected across the coil in the "OFF" position, and helps to reduce arcing

at the switch contacts when the switch is operated. When the switch is set to "D," the rectifier-filter circuit is inoperative.

**Construction and Operation.** A chassis base measuring 5" x 7" x 2" was used by the author. Because the selenium rectifier can become hot under continuous operation, this part should be mounted vertically on a small angle bracket and ventilating holes drilled in the top of the chassis directly over the rectifier.

Before applying power to the magnetizer, trace out all connections and wiring to make sure they correspond to the schematic and pictorial diagrams. Set the switch at "M" and pass a screwdriver or other steel instrument slowly through the hole in the coil. The field should be strong enough to pull the metal piece against the coil frame. Pass the part completely through the coil, removing it from the other side. The part is now magnetized.

Similarly, magnetize another piece of steel, and note that while the two pieces attract each other when brought together at any angle they have maximum attraction in only one position. This characteristic is important and should be considered when installing homemade magnets as cabinet-door latches.

To de-energize a magnet, or magnetized part, simply throw the switch to "D" and pass the part slowly through the coil, continuing along the center axis for a distance of several inches after the part has passed completely through. In some cases, it may be necessary to pass the magnetized part through the coil two or three times. -30-

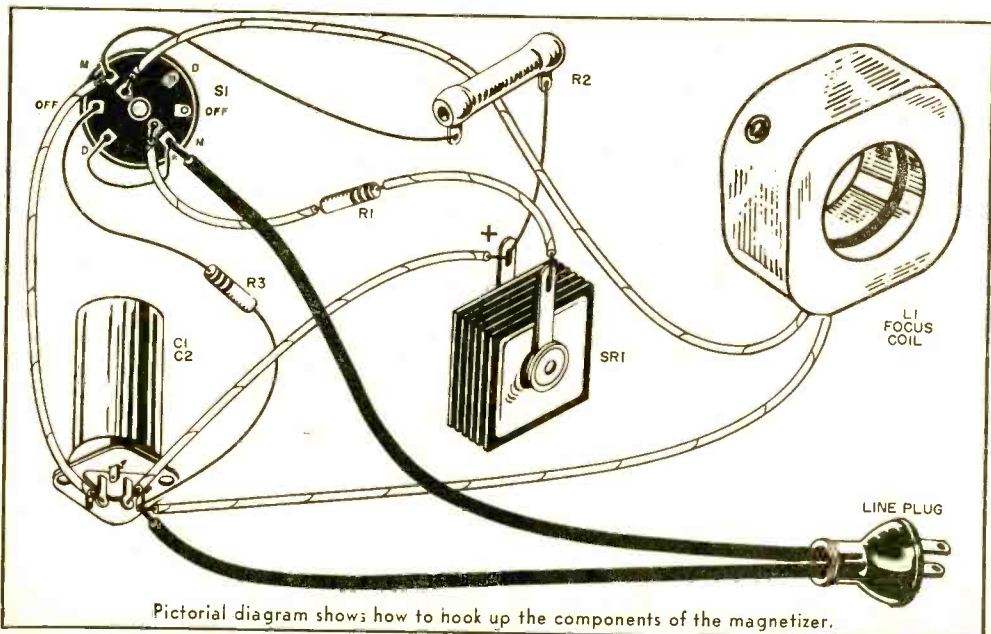

Pictorial diagram shows how to hook up the components of the magnetizer.



# "Printed Wiring" Techniques for the Experimenter



Courtesy of Bell Telephone Labs.

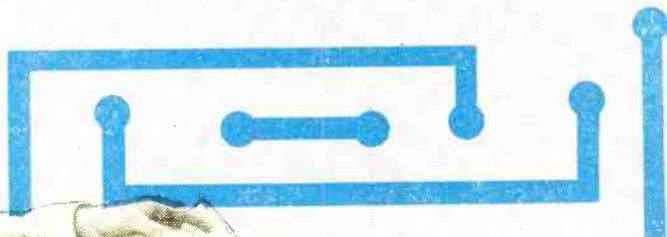

By LOUIS E. GARNER, Jr.

**Part I of two-part series  
discusses methods of printed  
wiring and tells how to  
make an etched circuit board**

**A** RADIO RECEIVER "wired" *without* hookup wire! An audio amplifier assembled *without* terminal strips! A television receiver with hundreds of soldered connections . . . but all made *without* a soldering iron!

Far-fetched? No. All of these production miracles may occur as a matter of course when a manufacturer substitutes "printed" wiring methods for conventional hand wiring. Since the elimination of hand wiring can cut labor production costs as much as 50%, manufacturers have a sound economic reason for using such methods.

But the savings in labor costs is not the only reason for going to printed wiring. The finished equipment may be more compact, work better, and require fewer adjustments. Finally, since every unit is wired exactly alike, wiring errors are virtually eliminated, "rejects" are minimized, and inspection time and costs are reduced.

**METHODS OF PRINTED WIRING.** The general term "printed wiring" is used to describe any electrical or conductive pattern reproduced on an insulating base, although technically the term applies only to wiring and circuits reproduced with the aid of printing techniques . . . that is, using conductive inks printed in the desired pattern. Commercially, printed wiring may be of two general forms—"deposit" and "stripped."

If a "deposit" method is used, the con-

ductive pattern is *applied* to the insulating base plate. Typical "deposit" methods include printing with metallic inks, spraying liquid metal onto the base through a stencil, and pressing a metallic foil pattern into a plastic base, using a heated die.

Where a "stripping" method is used, the insulated base is covered with the conducting material. The desired pattern is applied to the surface, and the excess conductor "stripped" away. The more popular "stripping" techniques include etching and embossing.

Use of printed wiring methods offers advantages to the home experimenter, student, or gadgeteer making up a single circuit as well as to the manufacturer producing thousands of units. When reasonable skill is acquired through practice, it is often possible to lay out, produce and assemble a piece of equipment using printed wiring in less time than it takes to make up the same circuit using conventional wiring techniques . . . and with the final equipment much more "professional" in appearance, more compact, and likely to work better.

With the advantages to the experimenter in mind, several manufacturers are offering printed-circuit kits. These kits include all the materials necessary to make up etched circuit boards. Basic printed wiring techniques have been described briefly in past issues of POP'tronics in regard to specific



In making up a printed-circuit layout, you start with a schematic wiring diagram of the project you plan to assemble, redrawing it until you have eliminated all circuit wiring crossovers. See text for more details.

projects. See H. J. Carter's, "Making an Etched Preamp" (November, 1955, p. 87), and Paul F. Runge's "Printed Circuitry for R/C" (August, 1955, p. 74). But now we'll discuss these techniques in detail and show how you can apply printed wiring methods to virtually any project that you wish to assemble.

Of the various printed wiring techniques used industrially, the techniques of "etching" and "painting" are best suited to home use. Of the two, etching is by far the most popular and is, in fact, the most widely used commercial technique. The majority of printed-circuit kits utilize etching techniques.

**MAKING ETCHED CIRCUITS.** The basic steps in producing an etched wiring board and assembling a circuit are illustrated in Fig. 1 (p. 62). The raw material is a laminated board consisting of an insulating base with a layer of metal foil bonded to its surface. The foil may be on either one or both sides. In most work, a copper-foil clad laminated paper-base phenolic is used.

You can make up your own etched circuit boards by following these essential steps—plus the additional steps of making up the original circuit pattern layout and transferring the layout to the board. Follow the procedure detailed below:

**Step 1—Making a Layout.** Start with the schematic wiring diagram of the project you plan to assemble. Redraw the schematic one or more times, trying to eliminate all circuit wiring crossovers. When you have a tentative circuit, gather the components you plan to use and *make a full-size scale drawing* of the final circuit. Locate components where they will serve

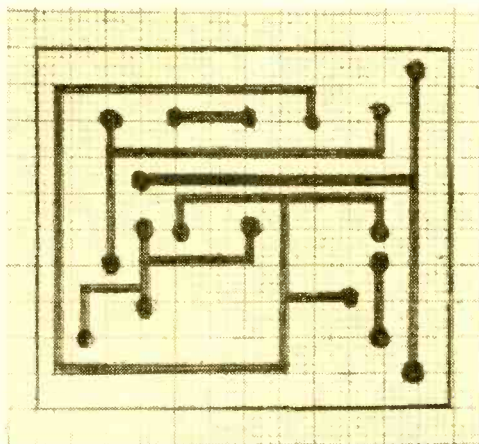

Typical etched circuit layout on cross-section paper. Drawing should be made to full-size scale.

to bypass conductor crossovers which are not easily eliminated. Individual leads or "wires" should have a thickness of at least  $1/32"$ , with the spacing between adjacent conductors not less than  $1/32"$ . Thicker leads may be used if desired, and you may find it easier to work with  $1/16"$ - or even  $1/8"$ -wide conductors on the first few boards you make up.

Where components are to be mounted or leads attached to the board, draw small circles. Entire patches of foil conductor may be used for shielding, although it is generally best to "break up" solid areas with diagonal bars. The spacing between adjacent bars may approximate or be slightly greater than the width of the bars. Where  $90^\circ$  turns are made, the conductor may follow a smooth curve or make a sharp bend,



as preferred. Where eyelets are to be used, plan on holes large enough to accommodate them. Use slightly smaller holes when leads are to be attached directly to the copper foil.

In general, component and wiring leads can be soldered directly to the copper foil for permanent connections, but if the leads may be removed often, plan on using copper or brass eyelets at such points. Space component mounting holes for the actual parts you plan to use. If the components are to be mounted by their leads (resistors, capacitors, and small coils are generally mounted in this fashion), space the mounting holes with the thought of using a gradual bend in the component leads instead of a sharp bend close to the body . . . sharp bends may cause the leads to break off or can place an undue strain on the component. You will find that cross-section (graph) paper is useful for making up the scale wiring layout.

A "typical" printed wiring layout is illustrated in Fig. 2. This layout has been designed to illustrate important points to remember when making up your own layouts and *it does not represent a specific circuit.*

Upon completing a circuit wiring layout, check and double-check for errors. While still in the layout stage, an error may be corrected simply by erasing and redrawing the layout . . . but once the board is etched, it may be necessary to make up an entire new board to correct mistakes.

**Step 2—Preparing the Board.** The copper-clad phenolic board and other materials you'll need may be purchased individually or in "kits." (See list of suppliers on page 62.) At the beginning, however, you'll find it best to purchase a complete "kit" of materials. Once you've gained a little experience in making up circuit



Clean the copper-clad phenolic wiring board of dirt and tarnish prior to applying the resist.

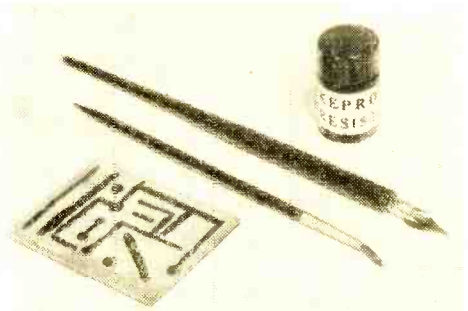

Ink resist is applied with brush and pen. Only those parts covered will remain after etching.

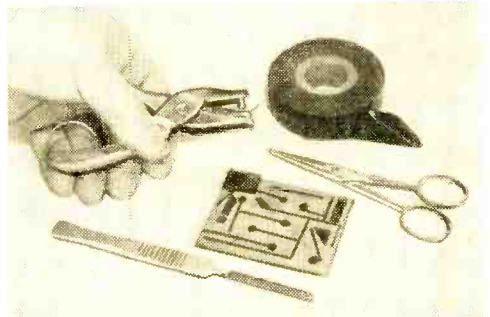

Scotch electrical tape may be used as a tape resist. Circles are cut out with a paper punch.

boards, you can purchase individual items in the quantities needed.

Depending on the circuit layout, use either single-sided (single-clad) or double-clad boards. But until you gain experience, you'll find it best to stick to simple layouts and single-clad board.

Cut a piece of the copper-clad board to fit your circuit layout, using a fine-toothed hacksaw, a jigsaw, or a scroll saw. Cut from the copper side, and back up the thin phenolic board with a piece of hardboard or plywood. If any large holes or cutouts are needed (for tube sockets, for example), they should be cut at this time. Use a hole saw or "flying bar" cutter for cutting large round holes . . . not a conventional chassis punch, which may crack the board. Only the large holes and cutouts are made at this time . . . smaller holes are drilled after the board is etched.

With the board cut to size and rough machine work completed, clean the copper surface of dirt and tarnish, and roughen it slightly to permit the etchant to get a better "bite" on the foil. You can do this by scrubbing the surface with a stiff brush dipped in powdered pumice stone (check your local hardware dealer) or, if pumice stone is unavailable, by using an abrasive household cleanser. Sprinkle the household

cleanser lightly on the foil and scour vigorously with a slightly dampened cloth. With the surface properly prepared, the copper should be bright and shiny, and should have many small scratches . . . visible when the foil is examined through a small magnify-

ing glass. Then you should rinse and dry the prepared board.

**Step 3—Transferring Layout.** First, obtain a few sheets of "pencil" carbon paper from your local stationer or office supply store. Cut a piece to fit your circuit board and attach the carbon paper and your scale wiring layout to the board with Scotch tape. *Make sure the layout cannot shift its position.* Finally, using a moderately hard pencil, trace the layout onto the copper foil.

Locate small mounting holes by pricking the copper right through the layout and tracing carbon, using a small center punch or a sharp scribe. Use hand pressure or a *very light* hammer tap when locating these holes to avoid cracking the board. Back up the board with a solid piece of hardboard or wood. And double-check your tracing before removing the layout sheet and carbon paper.

**Step 4—Applying the Resist.** With the circuit layout transferred to the copper-clad board, the acid "resist" may be applied. For experimental "single-shot" circuits, two types of resist are popular: (1) *ink resist* and (2) *tape resist*.

Ink resist is an asphalt-based acid-resistant paint or ink. It is supplied as a part of most printed-circuit kits but is also available from many art supply houses. Apply ink resist to the copper foil using a small ruling pen, a small brush, or a "Speedball" pen. Cover all parts of the layout, for only those parts of the copper foil covered by the ink will remain after etching. Allow the ink to dry.

Ordinary plastic-base Scotch electrical tape makes an excellent tape resist. It is furnished in some kits. Narrow strips may

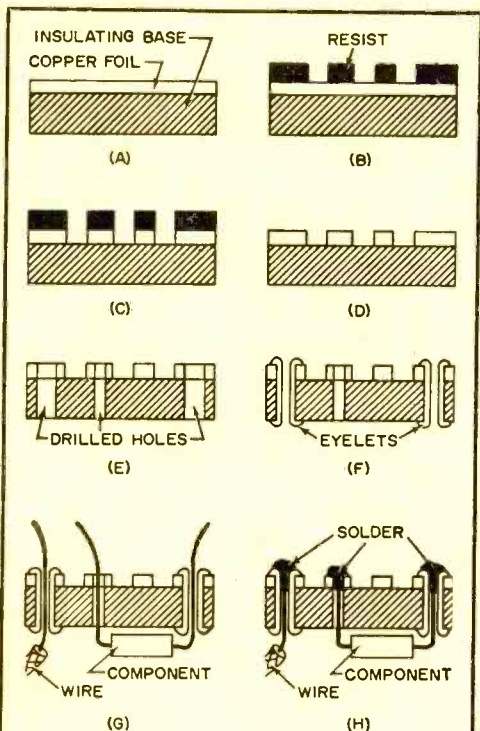
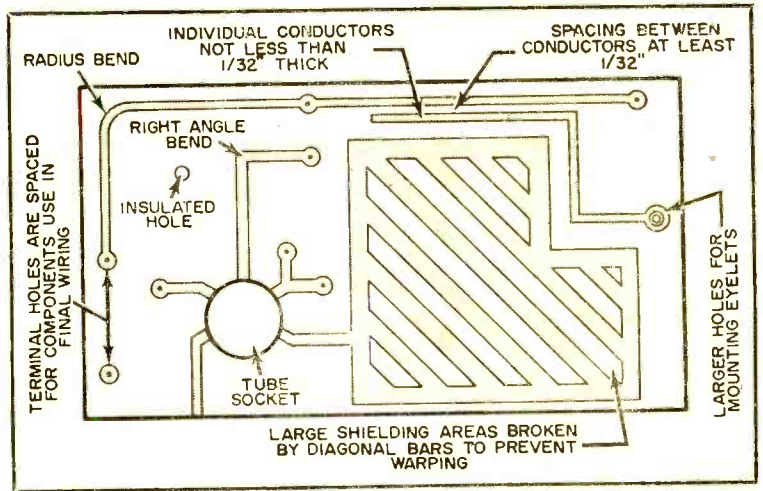

Fig. 1. In the commercial production of etched circuit boards, the plain metal clad board shown at (A) is covered with a special material which resists chemical action. This "resist" is applied in the pattern of the desired final circuit, as shown at (B), using photographic, plating, spraying, stenciling, or printing techniques. With the resist applied, the foil-clad board is placed in a chemical etchant which attacks and eats (etches) away all unprotected metal, leaving only the foil pattern protected by the resist (C). After that, the resist is removed, exposing the bare metal foil (D). Machining is next (E), with mounting and wiring holes drilled or punched at appropriate places in the board. Metal eyelets, if used, are now mounted in the board (F). With step (F), the wiring board itself is completed. To complete the circuit, electrical components are mounted on the back of the board by passing their leads through appropriate holes in the board (G). Finally, the board is soldered and excess lead lengths cut off, resulting in the completed circuit shown at (H). In production work, the entire board is generally soldered in one operation by dipping it into a "pot" of solder—with the operation called, appropriately, "dip soldering." Thus, hundreds of soldered connections may be made at one time without a soldering iron!

MATERIALS	SUPPLIERS
Complete Kits	KEPRO KITS— Keil Engineering Products 4356 Duncan Ave. St. Louis 10, Mo. TECHNIQUES KITS— Techniques, Inc. 135 Belmont St. Englewood, N. J.
Solder and Fluxes	General Cement Mfg. Co.* Rockford, Ill.
Copper-Clad Lami- nate** and Pre-etched Circuits	Harcon Brandywine, Md.
*This firm also manufactures "Silver Print" and a number of special-purpose tools for working with printed circuits.	
**Copper-clad laminate and other supplies are also available as individual items from the firms supplying complete "kits."	



Fig. 2. A "typical" board which illustrates the important points that you should remember in making up your own printed-circuit layout. It does not represent specific circuit.



be cut from the standard width using an "Xacto" knife, a razor blade, scalpel, or similar tool. Small circles, for terminal connections, can be punched out with a small hand paper punch. The tape is simply applied to the copper foil to cover the traced layout pattern, then burnished down with a smooth, hard tool. A good burnishing tool can be made quite easily by

rounding the end of a wooden dowel peg. Double-check the circuit board after applying the resist. Compare it to the original layout. If you find you've made an error, correct it. Ink resist may be removed by using a hard (ink) eraser. Tape resist is simply peeled off. Reapply the resist to correct the error.

*(To be continued next month)*

## Microphone-to-Stand Adapter

**T**HIS MICROPHONE stand attachment does double duty—it connects a mike through the stand socket when mounted

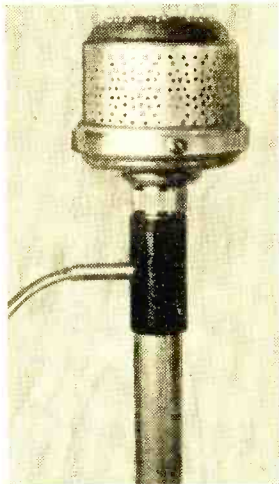

on a solid draw-rod, and it insulates the mike from the stand to reduce danger of shock. The body of the adapter is simply a Bakelite shell removed from a standard phone plug. Such shells have standard  $\frac{5}{8}$ -27 threads on the large opening end, and  $\frac{3}{8}$ "-diameter holes on the smaller end.

Drill a hole in one side of the Bakelite shell for a 1" length of curtain spring, or any other steel spring that will pass your mike cable. The spring should fit the hole snugly, since it serves as a cable protector. Now slip one end of your mike cable through the spring and into the Bakelite shell, slip a hex nut over the cable, and push the end of the

cable up and out of the small opening in the end of the Bakelite shell. Then connect the end of the cable to an Amphenol 75-PC1M chassis unit in the usual manner, except that the shield of the cable should be soldered directly to the end of the threaded shank of the chassis unit.

Slip the chassis unit into the hole in the Bakelite shell, tighten the hex nut, and the adapter is complete. A standard Amphenol 75-MC1F female cable connector is used on the other end of the cable. The adapter will fit all American-made mike sockets (except RCA), and standard  $\frac{5}{8}$ -27 desk and floor mike stands. —Art Trauffer

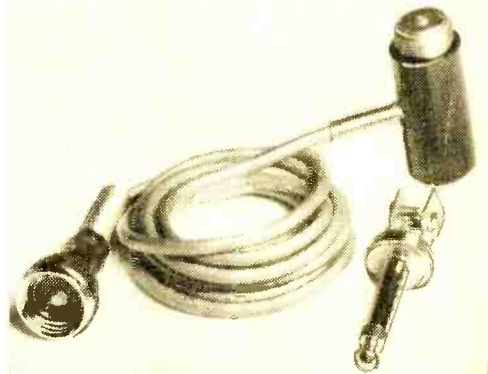



## Vintage '39 Fortress Now Missile Target

Precision instruments, operated by highly skilled men, are used to land the QB-17 (upper left), as well as have it take off on new flight (upper right).

**T**HE NOW-OBSOLETE "Flying Fortress" B-17 bomber, famous during World War II, is being used to help perfect tomorrow's supersonic guided missiles.

Guided from the ground completely by radio control, these erstwhile bombers, now designated as "QB-17's," are the largest remotely controlled planes in history and serve as targets for ground-to-air and air-to-air missiles.

In a typical mission, the pilotless planes, known as "drones," are launched from the ground with engines running. Signals from ground radio equipment activate the air-

craft's controls. Soon the drone is far out to sea. Then, a missile is launched on a course leading to the bomber.

A camera in the drone's nose relays the action to the ground crew via a special television channel. Other equipment records the hit and damage data.

The missiles used in these tests are armed with small explosive charges instead of regular warheads. The charges are enough to cripple the drone. After a hit, the QB-17 plummets seaward, but the cameras and recording gear are parachuted slowly to the water in floatable wing pods. They are then picked up by crash boats. If the missile fails to find its mark, the drone is brought back and landed, also by radio control.

These drones are filling the need for large, bomber-type aircraft that can be tested accurately under fire without hazard to human life.

### Computer Goes Aloft

**C**IRCUITS ARE CHECKED (at left) in the new airborne digital computer developed at North American Aviation, Los Angeles, Calif. Transistors have replaced vacuum tubes in this electronic brain, used for automatically and continuously processing in-flight data.

Etched from sheets of copper-clad plastic, the circuits are designed in the form of standardized panels—which can be pulled out of the equipment like file cards for testing or replacement.

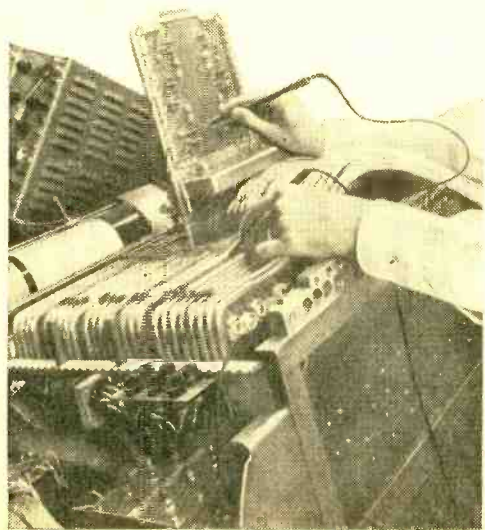



# Transistor Topics

By LOU GARNER

**B**ACK AGAIN! This is getting to be a habit . . . a habit which I—and I hope you—like. These monthly visits, through the pages of your favorite magazine, POP'tronics, are becoming real fun . . . something to look forward to. And so far as *your* letters and postcards are concerned . . . every one is given a personal reading, not just glanced at and filed. Need I say more?

Most writers and editors have what they call a "tickler file" . . . notes of things they should remember, or should check on at a later date. With so much happening so fast in the transistor field, a monthly "tickler file" should be of value to every reader. For a start, here are two noteworthy items:

(1) Raytheon's new r.f. transistor, Type CK768. At only \$1.50, it's a real buy.

(2) Lafayette's Transistor Brochure No. T4-56 (write to 100 Sixth Ave., New York 13, N. Y.). Free! The most complete offering of transistors and components cataloged anywhere.

Both of these items were mentioned in earlier columns. And from now on we'll try to remind you of special items of real interest each month . . . in a regular transistor *Tickler File*.

**Reader's Circuit.** There's only one circuit this month, and it's a lulu! Interest in receiver circuits continues at a high pitch, but there is an increasing shift from simple detector-amplifier arrangements to higher gain regenerative circuits. S. A. Sullivan, W6WXU, of 20565 Fifth E., Sonoma, Calif., sent in the regenerative receiver circuit shown below. He has assembled his model in a small plastic case, making it a "personal portable" receiver.

According to W6WXU, sensitivity is unusually good. He indicates that local stations (up to 30 miles distant) can be received with adequate volume *without an external antenna* . . . and that, at night, he has received clear-channel stations up to 600 miles away! Pretty good for a three-transistor set!

Referring to the schematic diagram, this receiver consists of a regenerative r.f. amplifier followed by a voltage-doubling diode detector (note that *two* crystal diodes are used), followed, in turn, by a two-stage resistance-coupled audio amplifier. Only *p-n-p* transistors are used, and the grounded-emitter configuration is employed in all three stages. The feedback necessary to regenerative action is obtained through *C4* and regeneration control *R1*. As *R1* is reduced in value, the circuit can be thrown into oscillation.

Tuning coil *L1* is a large ferrite core antenna coil (Lafayette No. MS-166). R.f. choke *L2* is determined experimentally from whatever chokes you may have in your junkbox . . . in Sullivan's model, *L2* consists of two TV peaking coils in series. In order to keep his model compact, Sullivan used a compression-type mica trimmer capacitor for *C1*, switching in fixed capacitors *C2* and *C3* with subminiature switch *S1*, in order to cover the complete AM broadcast band. You could use the same arrangement if you want to duplicate his model, but you might prefer one

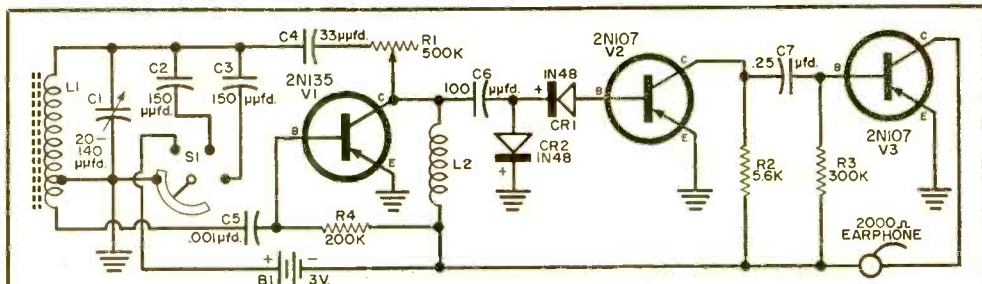

S. A. Sullivan's regenerative receiver circuit which is described above. Sensitivity of his model is so good that he can receive local stations without an external antenna.

of the new miniature tuning capacitors recently introduced by Lafayette Radio (100 Sixth Ave., New York 13, N. Y.). Two types are available . . . their numbers are MS-274 and MS-215. Use of either in place of *C1* should eliminate the need for *S1* and *C2* and *C3*.

The battery consists of two penlite cells in series to provide three volts. It is controlled by *S1*. If this switch is eliminated by employing a larger variable capacitor in place of *C1* (as suggested above), a

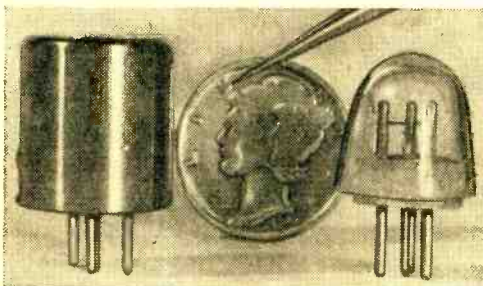

Experimental high-frequency transistors developed by Bell Telephone Laboratories operate up to 500 or 600 mc. Note size in comparison with a dime.

small s.p.s.t. slide switch may be used to turn the power supply on and off.

This receiver is operated in much the same manner that any regenerative set is used, whether vacuum-tube or transistor operated. The regeneration control is adjusted just below the point of oscillation for maximum gain. On strong local stations, very little regeneration should be needed.

**Tech Talk.** Many readers have written to ask about the use of transistors at *very-high* and *ultra-high* frequencies (v.h.f. and u.h.f.) . . . and their possible application in such equipment as television receivers and FM sets. Here's the scoop . . .

The major factor controlling the use of transistors at high frequencies is their *alpha cutoff frequency*. This is the frequency at which their gain, in the common-base configuration, is approximately 70% of their gain at low frequencies. Most transistors can be used as *oscillators* at frequencies far *above* their nominal cutoff frequencies, but must be used *below* their cutoff frequencies in *amplifier* applications.

A typical example is a transistor having an alpha cutoff frequency of, say, 1 megacycle. This unit *would not* make a very good i.f. amplifier at 455 kc., but could probably be used as an oscillator up to 1.5 or even 2 mc.

High-frequency transistors have been built! The above photograph shows a unit developed by Bell Telephone Labora-

tories which can be used at frequencies up to 500 or 600 mc. Motorola has developed units operating up to 1000 mc. Unfortunately, such transistors have been produced in small laboratory quantities only and *are not available* on an "across-the-counter" basis.

As far as available transistors are concerned, Raytheon has *p-n-p* junction triodes with cutoff frequencies up to 20 mc. (Type CK762/2N114), CBS-Hytron has *n-p-n* triodes with cutoff frequencies up to 20 mc. (Type 2N184), and G.E. has recently introduced a 50-mc. *tetrode*. The highest frequency unit presently available on an "across-the-counter" basis with which your columnist is familiar is Germanium Products' Type 3N23C *tetrode*. . . nominally rated at 60-80 mc., some of these can be selected for operation as oscillators up to 100 mc. As far as triodes are concerned, Philco's SB-100 series of *surface barrier* transistors, rated at 50 mc., are probably the highest frequency units available to the average experimenter.

"In the works" . . . probably for official release later this year . . . are a 110-120 mc. *tetrode* and a 150-mc. *triode* transistor. The triode is a "field effect" or "drift" transistor . . . a unit which depends on fairly high voltages for operation.

Unfortunately for the average experimenter, prices on these high-frequency units are relatively high . . . due primarily to the fact that they are in limited production. Prices range from about \$10.00 to about \$50.00 *each* in small quantities. Many are available direct from the manufacturer only and are not handled by distributors.

**Transistor Transformers.** Not all transistor transformers are small! On the next page is a photo which shows the range of

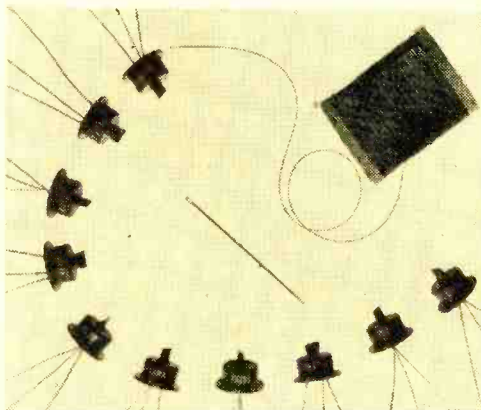

Ten new "power output" and "driver" transistors were recently announced by General Electric Company. In the above photograph, their relative size is shown by the needle and spool of thread.



sizes you can encounter if you do much work with transistor circuits. The small transformer, to which the pencil is pointing, is one of Chicago Standard's UM series, designed for hearing-aid and subminiature radio applications. The larger transformer, about the same size as audio output transformers used in moderate-sized p.a. systems, is a unit designed for use with "high-power" transistors such as Sylvania's Types 2N68 and 2N95 . . . it is available from Lafayette Radio, 100 Sixth Ave., New York 13, N. Y.

**Product News.** G.E. has announced ten new inexpensive transistors, designed for use in both high-fidelity amplifiers and broadcast-band receivers. All ten units are *p-n-p* germanium transistors: six are "power output" types, four are "driver" units. The power types have a collector dissipation rating of 180 milliwatts with a pair—in Class B push-pull—supplying up to 750 milliwatts output ( $\frac{3}{4}$ 's of a watt!) at less than 5% distortion.

Your columnist was recently given the opportunity of examining and testing a transistor radio kit offered by the Superex Electronics Corporation, 4-6 Radford Place, Yonkers, New York. The receiver assembled with the kit uses a diode detector and transistor amplifier, and has about the same gain and selectivity as the usual set employing this type of circuit. But the set has two interesting features. It is designed so that it can be assembled with a *screwdriver only*—no soldering iron is needed! And although it is a low-cost kit and uses an adjustable iron "slug" for tuning, it features a rather unique *slide rule dial*.

The Goldak Company, 1544 West Glenoaks Blvd., Glendale 1, Calif., familiar to POP'tronics readers as a manufacturer of metal detectors and other prospecting instruments, has announced the first in a planned series of transistorized products. Called "Plane-Talk," the new device is a transistorized intercom designed for instructor-student use in light aircraft.

Experimenters will welcome the new *n-p-n* transistor just introduced by G.E. The first low-cost *n-p-n* unit to be offered by a major manufacturer, the 2N170 has a frequency cutoff of 4 mc. Full details are given in a small folder available through all G.E. tube distributors.

Regency, one of the first manufacturers of transistorized "personal portable" receivers, is offering a fully transistorized *amateur band converter*. Featuring a surface barrier transistor, the instrument covers the 80, 40, 20, 15 and 10 meter bands. Sensitivity is 5 to 10 microvolts for 6-db signal-to-noise ratio. Features include a drum-type slide rule dial, with only the band in use actually visible, and operation

on its own self-contained power supply, consisting of three penlite cells . . . battery life approaches normal "shelf life." Only two connections are needed to install the unit . . . one to an antenna and one to

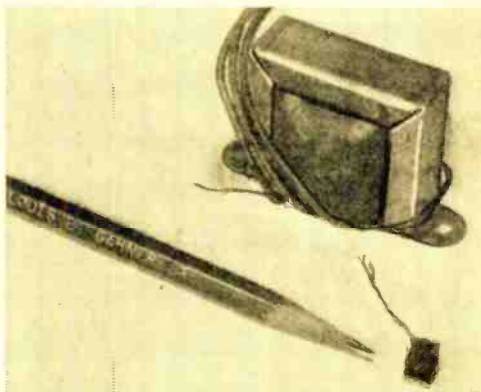

If you do much work with transistor circuits, you are likely to encounter units as small as the miniature transformer to which the pencil is pointing, or as large as the unit shown in the background.

a broadcast-band receiver. Output frequency is about 1200 kc.

You can add another transistor tester to those described in last month's column. EMC (Electronic Measurement Corporation) is producing a simple *transistor checker* in both "kit" and "assembled" form . . . selling for \$7.95 and \$10.95, respectively.

On the components front, Thordarson-Meissner offers a whole line of transistor coils and transformers, covering both audio and r.f. applications. The line includes 36 audio transformers, 10 i.f. transformers, 7 antenna coils, 5 oscillator coils, and a miniature tuning capacitor.

**Things to Come.** Higher frequency transistors are on the way—watch for 100-mc. tetrodes, 150-mc. "drift" transistors, medium-frequency "power" transistors. . . . Several transistor manufacturers, aware of Sylvania's success with its "kit," have special-purpose transistor "kits" in the works—for the experimenter, this will mean a price break over purchasing the transistors individually, plus valuable circuit information. . . . There are rumors of a portable TV receiver in which four transistors are used in place of tubes—rest of the set uses tubes, however. . . . Several transistorized and "hybrid" (part tube, part transistor) auto receivers are expected to be announced this fall. . . . Watch for a transistorized superhet receiver in a forthcoming issue of POP'tronics!

That's the "show" for now, fellows. See you next month.

Low

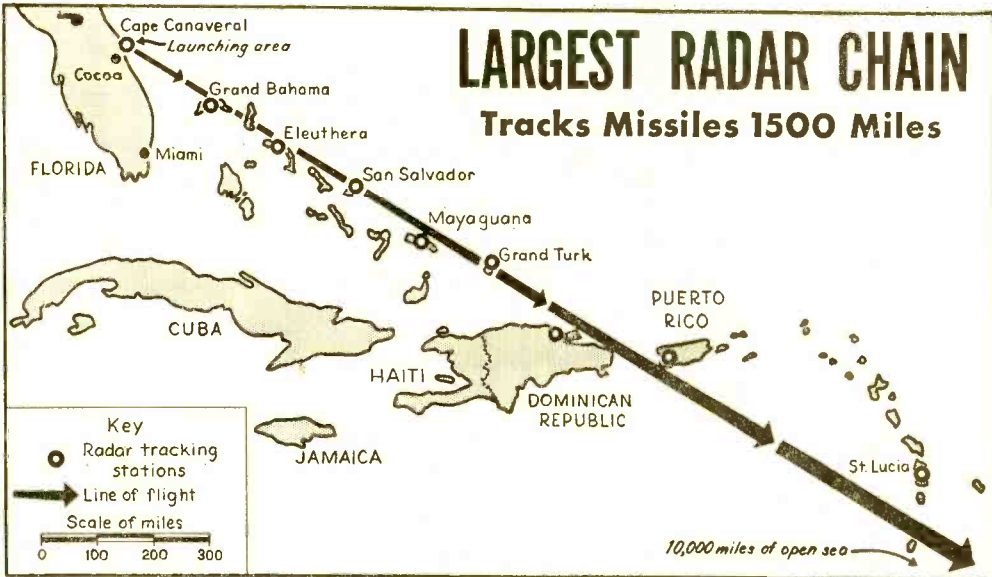

**T**HE WORLD'S LARGEST chain radar tracking system, capable of checking the flights of supersonic rockets and missiles over the full length of the U.S. Air Force Air Research and Development Command's Florida Guided Missile Range, has been announced by Reeves Instrument Corporation, subsidiary of Dynamics Corporation of America.

Built at a cost of some \$10,000,000, this chain of 21 gigantic radar installations extends from the Florida coast across eight islands to the South Atlantic to provide long-range continuous tracking.

The new system can record and report

One operator can handle each unit. Systems are designed to respond at once to push-button control. Once radar "locks" on missile, operation goes on automatically.

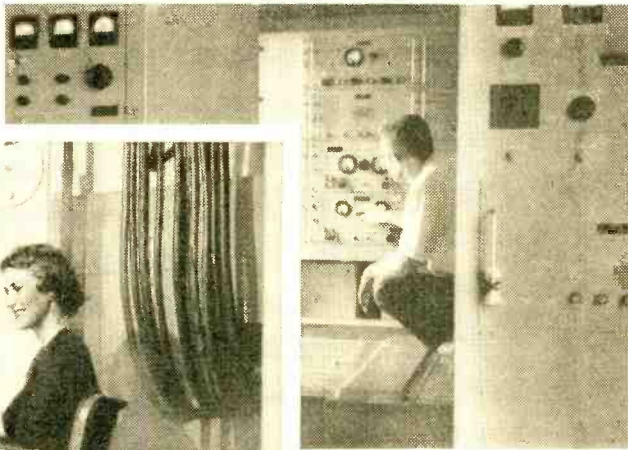
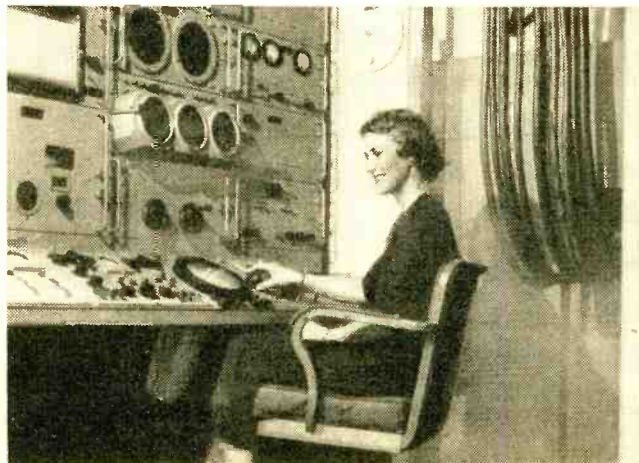

**Technician** (above) checks part of vast array of equipment that comprises radar system. Each installation weighs five tons, consists of thousands of electronic units.

back to the Flight Control Test Center in the launching area on the missile being tested to an accuracy within .002°. Radars "lock" on the missile the instant it is fired and track its position, course, velocity, and accelerations until the missile hits its target or is, itself, destroyed.

Data from these radars is of vital use to the In-Flight Range Safety Officer who is entrusted with the responsibility of insuring that life and property are not endangered by the missiles being tested. Because of the high precision of the data available through these radars, the Test Range has been completely accident-free.

-30-



# Tuning the Short-Wave Bands

—with Hank Bennett—

**O**UR "POP'tronics short-wave reporter" this month is Gordon Nelson, of 1019 South Fir Ave., Inglewood, Calif. A student at Inglewood High School, Gordon is 14 years old and an avid DX'er on the West Coast.

He is a fairly recent newcomer to the s.w. ranks, having started his DX'ing in



Gordon Nelson is shown with his SX-99 receiver.

early 1955 with a Hallicrafters S-38B receiver. In February of this year, he "graduated" to an SX-99 and is very satisfied with its performance. He uses no other equipment, although he does own a Patterson preselector. To bring signals from far-

If anyone is interested in participating in the British Broadcasting Corporation's Audience Research, he should write to the BBC, Overseas Audience Research, 630 Fifth Avenue, New York 20, N. Y.

away places into his shack, he employs three 60' long-wire antennas.

Gordon has 52 verifications from such stations as *R. Sarawak*, *R. Omroep* (New Guinea), *R. Nigeria*, ELWA (Monrovia, Liberia), and the Windward Islands. In addition to these stations, he lists the following as being among his best DX catches: *Radio Baghdad*; Djeddah, Saudi Arabia; *R. Abidjan*; *R. Hong Kong*; and *R. Sabah* (Jesselton, British North Borneo). His favorite DX band is 31 meters, and *R. Aus-*

*tralia* is his favorite s.w. station (for their excellent DX program), but Gordon is also a fairly steady monitor for *R. Tahiti* at Papeete—their consistently strong signal and programs of Tahitian music command his attention. He adds that he DX'es for the short-wave broadcast stations only—no hams . . . yet.

The photographer for his school, Gordon has had a number of his photographs appear in newspapers in the Los Angeles area. Besides radio, he is interested in anything along scientific lines, especially physics. A member of the International Short Wave League, he sends reports to the League with regularity. He enjoys reading *POPULAR ELECTRONICS* and thinks that our column is excellent. To which we add, "Thank you!"

## Club Notes

The recent Annual Dinner of the Newark News Radio Club, which was held at the Far Hills Inn, Somerville, N. J., was the usual success. Your Editor was especially pleased to meet Lou Marcarelli (our featured DX'er in the May issue). James Hart, of Irvington, N. J., was the recipient of the Peter J. McKenna Memorial Award.

Phil Finkle, Burbank, Calif., has succeeded David Morgan as Western Editor of the Universal Radio DX Club's s.w. section. Mr. Morgan is currently enjoying a stay in Europe.

(Continued on page 116)



Eric Bristow, Paris, Ill., at his listening post.



## Fish Need Sunlight to Find Way

**C**AREFULLY lowering a photoelectric cell into Lake Michigan is University of Wisconsin scientist Arthur D. Hasler. Voltages generated by the light intensity beneath the lake's surface have led Dr. Hasler to believe that fish use the sun as a navigational aid. If proven correct, this information will further support the evidence that birds, bees and ants all use the sun to direct their travels. Results of Dr. Hasler's work were recently presented to a group of scientists attending a symposium on marine biology which was held at the Scripps Institute of Oceanography in La Jolla, Calif.

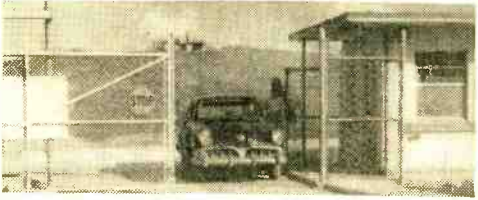

## TV Guards the Gate

**V**ISITORS to the Ninemile Point generating plant of the Louisiana Power & Light Co., Inc., just above New Orleans, are stopped at the outer gate and closely examined by a TV camera. Part of a closed-circuit system (see POP'tronics, July, 1956, page 67), the receiving end is mounted near a secretarial desk. Picking up a microphone, the secretary can talk to the visitor through an intercom system. Unless the visitor can state his business and be



immediately identified, he is not permitted entry to the generating plant. On holidays, when the office is empty, a second TV receiver is put into operation; this receiver is operated by the main control board personnel of this 319,000-kilowatt station.

## Poly Bags Hold Valuable Parts

**D**OUGLAS Aircraft Co., Inc., has introduced the use of polyethylene bags to store miniature radio subassemblies. These bags were developed by the Polyfab Company, Los Angeles, Calif., and are fitted with a self-locking pressure closure. Edges of the closure are easily pried open and can be relocked again and again. Once locked, a bag is sealed from the effects of moisture, oxidation and dirt. Use of the transparent plastic, which makes contents clearly visible, also facilitates sorting and inventories. Various sizes and shapes are utilized for different parts, and the bags are also made in multiple-pouch form to prevent contact between parts.





## Bass Reflex, Jr.



By FRANK H. TOOKER

**Small enclosure sounds swell, costs little to build, and uses a "secret tunnel" for better bass response**

**Y**OU MAY NOT see the "port" on this bass reflex enclosure, but you certainly can hear it! Hidden under the bottom panel and opening into a wooden tunnel within the enclosure, the all-important cutout for bass notes is neatly tucked out of sight. The result is good bass in a little space. You can build this "Bass Reflex, Junior" (BR, Jr.) with hand tools and use any of several low-priced 12" speakers in it for some fine listening.

The design is based on an idea contained in the article on bass reflex enclosures published in a recent issue of POPULAR ELECTRONICS ("Resonators—Large and Small," March, 1956). Essentially, it involves reducing the over-all dimensions of the enclosure by adding a duct, or interior tunnel for bass notes, directly behind the port.

In the BR, Jr., the port is cut out of the bottom panel. The duct is positioned vertically, right over the port, and the panel is raised off the floor. The critical duct length, plus the air space between the port opening and the floor, combine to enhance the speaker's bass response and provide good acoustical loading at low frequencies. Details on how this is done are given in the "How It Works" box on page 74.

**Making the Sides and Duct.** Cut the six sides from  $\frac{3}{4}$ " plywood. Along the long edges of the left and right side panels, and along the long edges of the top and bottom panels, fit the lengths of 2" x 2" pine. As shown in the photo, each "two-by-two"

must be set back from the edge of the plywood by exactly  $\frac{3}{4}$ ", and centered lengthwise to allow room on either end for the pieces that will butt up against it. These "two-by-twos" act as glue blocks and supports for all adjoining plywood panels. *Note:* the phrase "two-by-two" refers to pieces that are actually  $1\frac{3}{4}$ " by  $1\frac{3}{4}$ " after planing.

Construct the duct, using the  $\frac{1}{2}$ " plywood. Cut out the required port opening on the bottom panel, and mount the duct over this opening. A safe method would be to nail a 1" by 1" strip of pine to each side of the duct, around one end. Then glue and screw the entire assembly over the port so that it forms a tunnel which enters the enclosure.

**Speaker Cutout.** The cutout on the front panel was made octagonal because it was easier to fashion than the conventional round opening. Either type of cutout works equally well, of course. To make the octagonal cutout, bore eight holes at 45° intervals, using a 1" auger bit fitted into a carpenter's brace. Then cut from hole to hole with a compass or keyhole saw.

To prevent the panel from splitting, back it up with a heavier piece during the drilling, or else bore in halfway from one side and then halfway from the other side. When finished, the cutout should measure  $10\frac{1}{2}$ " between any pair of opposite corners.

**Assembling the BR, Jr.** Once all panels are cut and planed, and the "two-by-twos"

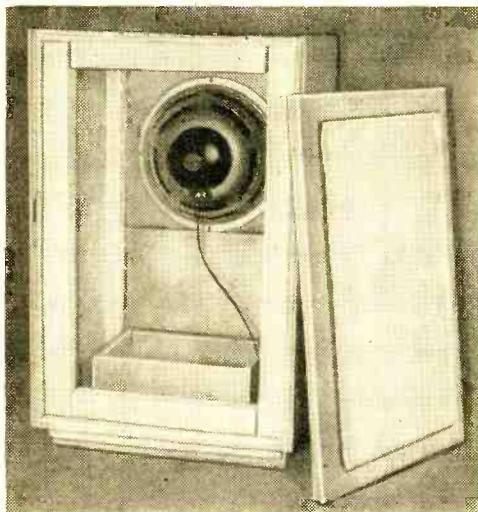

Two views of the BR, Jr. clarify details of its construction. At left is the completed enclosure with the back removed. Note how the "one-by-one" strips are used for securing proper fit of all panels. Speaker leads trail through duct and emerge under the box's raised bottom. Below, details of underside showing two legs and back panel piece.

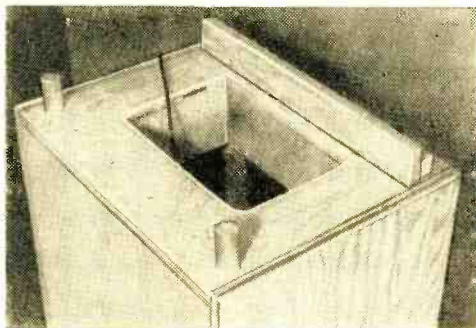

have been fitted as required, final assembly is fairly simple.

Remember to "glue and screw" all joinings of all panels—except the back panel. This must be left removable to permit access to the speaker. Therefore, do not glue the back panel—but *screw* it on as snugly as possible.

One way to assure perfect fits of all panels is to check each stage of the construction with a carpenter's square. A trick, often used by professional cabinet makers, is to put the rear panel in place without screwing it. Fit everything else around the snugness of the back panel. To prevent glue from running onto the rear panel during this stage, insert a single thickness of household wax-paper between the panel's four edges and its adjacent panels.

When all other panels have been glued and screwed in place, remove the rear panel. Do not replace it until the next steps are completed.

**Acoustic Insulation.** The interior padding for the BR, Jr. consists of a layer of heavy undercarpet felt (ozite) plus a layer of  $\frac{1}{2}$ " thick "extra-fine" fiberglass wool. Fasten the fiberglass to the Ozite with long, loose stitches of heavy thread. Then, cement the felt side to the inner surfaces of the enclosure, using underfelt paste—the kind that's used to cement felt to floors.

Allow this paste to dry 24 hours before installing the speaker. As shown in the photo, the acoustic padding is applied to all interior surfaces except the bottom panel and its duct.

**Legs and Back Reflector.** The BR, Jr., is raised off the floor by two simple legs at the front, and a strip of plywood at the rear. The legs are made of 1"-diameter round dowels. To fit them to the underside of the bottom panel, first make two holes in this

panel with the 1"-diameter auger bit. Locate the holes accurately and bore to a depth of about two inches. This depth should engage the previously attached "two-by-two."

Next, drive a length of dowel as far as it will go into the hole. Cut off the dowel, squarely and accurately, two inches beyond the bottom panel. If the legs do not fit tightly, insert them with a coating of glue.

As shown in the photo, the back plywood strip is first secured to a bracing strip ("one-by-one"). The assembly is then fastened to the bottom panel.

**Finishing Touches.** While the acoustical felt paste is drying, you can finish the exterior of the cabinet in any desired way. The front panel can be dressed up with a covering of grille cloth. Staple or tack the

## Bill of Materials

### PLYWOOD

- 2—17½" x 26½" x ¾" pieces
- 2—17½" x 15" x ¾" pieces
- 2—15" x 28" x ¾" pieces
- 1—2" x 17½" x ¾" piece
- 2—10¾" x 4" x ½" pieces
- 2—8¼" x 4" x ½" pieces

### WHITE PINE

- 4—2" x 2" x 26½" pieces
- 4—2" x 2" x 13½" pieces
- 1—1" x 1" x 17" piece
- 2—1" x 1" x 10" pieces
- 2—1" x 1" x 6" pieces
- 1—1-foot, 1"-dia. dowel

### HARDWARE, ETC.

- 1—Box of No. 9, 2" wood screws
- 1—Box of 1½" finishing nails
- 8—1" wood screws
- 1—Spool of carpet thread
- 1—Quart of underfelt paste
- Wood glue
- Undercarpet felt, ¾" thick (Ozite or equal)
- Glass wool insulation, ½" thick



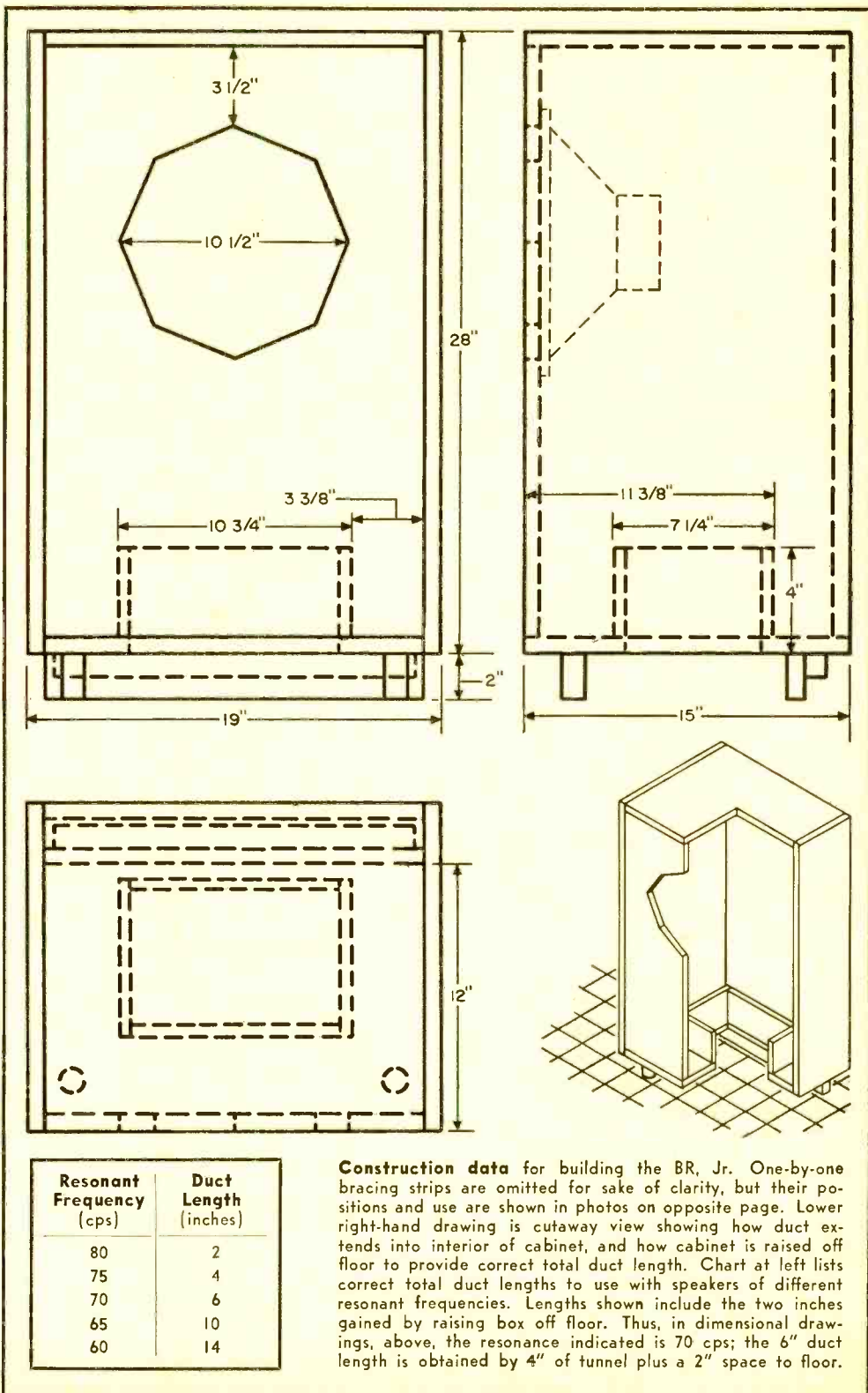

**Construction data** for building the BR, Jr. One-by-one bracing strips are omitted for sake of clarity, but their positions and use are shown in photos on opposite page. Lower right-hand drawing is cutaway view showing how duct extends into interior of cabinet, and how cabinet is raised off floor to provide correct total duct length. Chart at left lists correct total duct lengths to use with speakers of different resonant frequencies. Lengths shown include the two inches gained by raising box off floor. Thus, in dimensional drawings, above, the resonance indicated is 70 cps; the 6" duct length is obtained by 4" of tunnel plus a 2" space to floor.

cloth's edges into the plywood edges. Then cover the edges with strips of decorative wood molding to provide a really professional touch.

Paste dried and finishing accomplished, you can now install the speaker. Mount it on the inside of the front panel, using 1" wood screws. These are long enough to hold the speaker securely without breaking through the front of the panel. Tighten the screws enough to hold the speaker fast, but not so much that the speaker frame will become warped.

Run the voice-coil leads through the duct and out of the bottom of the enclosure. Now replace the back panel. Do not use glue, but screw it firmly to the "two-by-twos" along all four edges. The BR, Jr. is now ready for use.

**Which Speaker to Use?** The BR, Jr., built to dimensions given here, was designed to house a particular speaker the author owned and wanted to use. It happens to be the General Electric S1201D. This is a single-cone unit with a response from 50 to 13,000 cps, and a resonant frequency of 70 cps. Net price is about \$20.

This speaker, however, is not the only type available with similar characteristics at a similar price. Other likely candidates for this project are made by such companies as Electro-Voice, Jensen, Oxford, Quam, RCA, University, Utah, and others. A visit to your local parts jobber, or a study of an audio catalog, can turn up any number of similar speakers.

The important thing to remember here is the resonant frequency of the speaker used. This resonance must be matched by the enclosure's own resonance if decent bass response is expected. When both resonances are matched, the enclosure is said to be "tuned" to the speaker. Then, the speaker's bass peak is pulled down and broadened. This action eliminates the one-note bass-boom effect and actually extends bass response below resonance.

When the enclosure is not tuned correctly to the speaker in it, the resultant mismatch can cause boom, distortion, and loss of bass notes. This principle applies to any bass reflex enclosure. The BR, Jr. is no exception.

**For Best Sound.** This is all by way of pointing out that a speaker whose resonant frequency is much higher or lower than 70 cps would not sound its best in this enclosure. The present duct is six inches in length—from floor to top of the tunnel. At this length, in this size of enclosure, the enclosed air will resonate at about 70 cps. To use a speaker with a higher resonant frequency, you must shorten the duct. To use a speaker with a lower resonance, you must lengthen the duct.

The chart on page 73 shows total duct lengths for different resonant frequencies most often encountered in modestly priced speakers. Note that the duct length increases very rapidly for only small decreases in resonance. Consequently, a speaker whose resonance is much below 60 cycles would be wasted in the BR, Jr. To resonate at 55 cycles, the duct would have to be 26" long. In a cabinet whose total height is only 28", such a duct would be utterly impossible for purely physical reasons.

In other words, a speaker with a lower resonant frequency actually requires a larger enclosure. As is the case with most hi-fi "short-cuts" or scaled-down versions of larger units, the BR, Jr. is no substitute for the very deep bass possible with a high-quality speaker in a full-sized enclosure. But if you want to use a low-priced speaker, whose resonance is somewhere between 60 and 80 cps, the BR, Jr. will provide "near-senior" performance with it. —30—

## HOW IT WORKS

The conventional bass reflex enclosure for a 12" speaker requires an internal volume, or "air cavity," of about 10,000 cubic inches (6 cubic feet). An auxiliary opening below the speaker cutout (the "port") permits the cavity to be "tuned" to the speaker mounted within it. This means that the cavity's own resonance will match that of the speaker's. The resonant point is, of necessity, a bass frequency. When both cavity and speaker so resonate, their respective peaks buck each other. As a result, the over-all response is "pulled down" from a sharp peak, and broadened. This action (lowering the *Q* of the speaker system) reduces "one-note" bass, and boom effects. It permits the speaker to respond to bass notes well below its resonant frequency.

At the same time, the port provides a passageway for the resonating cavity to release its sound energy. Stimulated by the speaker's back wave, the cavity energy emerges from the port in phase with the speaker's front wave. Thus the bass notes are not only smoothed and extended, but actually reinforced in strength by the port action. A similar effect can be obtained using a smaller enclosure (smaller air cavity) if a duct, or tunnel, is added directly behind the port. The cavity of the enclosure combines with the air confined to the duct to provide optimum loading on the speaker cone.

In the BR, Jr., total duct length is obtained by the interior tunnel plus the space provided by raising the box off the floor. The area thus created is backed by a panel which holds the enclosure upright and—at the same time—acts as a critical part of the total duct. A 12" speaker was planned for use in this system. Consequently, a duct was needed whose cross-sectional area came to 78 inches. Such a duct—of the length used here—placed in a cavity of 5000 cubic inches (the interior volume of the BR, Jr.) produces resonance at about 70 cps.

As shown in the chart on page 73, speakers whose resonant frequencies vary from 60 to 80 cps may also be used in the BR, Jr. with small changes in duct length. These changes are feasible within the over-all dimensions. Resonant frequencies beyond the 60 to 80 cycle limits could not be obtained because the length of the duct increases rapidly for only small decreases in cavity volume, as well as in resonant frequencies required. Similarly, speakers other than 12" units are not recommended for use in the BR, Jr.



## Myrtle—the (Electronic) Turtle— Knows Its Way Around

**M**YRTLE is the second turtle at the Hildebrand household in Berlin. Her predecessor was a flesh-and-blood model who, after a winter's hibernation, never woke up again. To soothe his children's grief, Herr Hildebrand, by electronic experiments, begat Myrtle II, who never hiber-

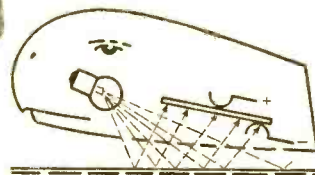
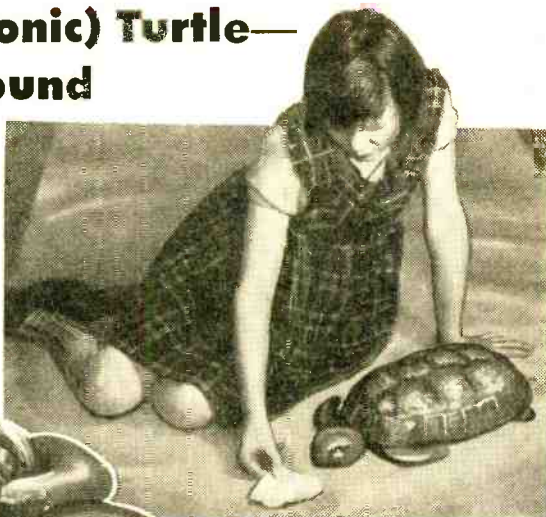

nates and whose life is renewable with fresh batteries.

Myrtle's tail literally "switches" and turns on a motor and brake system governed by the action of a photocell. She goes after paper "lettuce," which reflects her "headlight" against the cell. If the paper is arranged in a strip, Myrtle waddles down the line in a searching zigzag, swinging head and shoulders sagely from side to side. Every time she walks off the paper path, her electronic eye—blinded by the darker surface—pulls the front-wheel brake on the opposite side. Result: head and shoulders swing back on the track. As soon as the light track is "seen" again, transistors and relays release the brake, and Myrtle rolls off the

**Reflected light** from paper "lettuce" laid out on floor acts on selenium photocell to guide Myrtle in her explorations. An outgoing personality, Myrtle sometimes sheds her hard shell (left) to show what makes her tick.

track on the other side. The process then repeats itself in reverse until, in this halting seesaw gait, Myrtle finally reaches her goal.

For this kind of rock-and-roll locomotion, one naturally needs a swivel-jointed hip. Myrtle has just that. But since that lively joint is normally hidden beneath her shell, no proprieties are compromised.

## Print-Out Voltmeter Keeps Triple Record

**A** VOLTMETER produced for Hycon Electronics, Inc., of Pasadena, Calif., prints a permanent record of measured voltages on adding machine tape. Any variation in line voltage or resistance is permanently noted down. Uses of the new print-out system are virtually endless. Principal applications are seen in the fields of temperature and pressure controls, liquid level recording, preservation of telemetered information from airborne sources, and control of chemical processes.

The print-out device, looking like an ordinary adding machine, sits astride the digital counter shown in the accompanying photograph.





# Building a "See-Thru" Radio

By

**PHIL McCAFFERTY**

Lay out case parts on paper covering of plastic sheet (left). A sheet of 1/8"-thick Lucite or Plexiglass 12 1/2" x 18" is ample for building a 5" x 7" x 5" case—which is big enough to house a five-tube superhet radio. Cut parts to size and groove the edges of the mating parts.

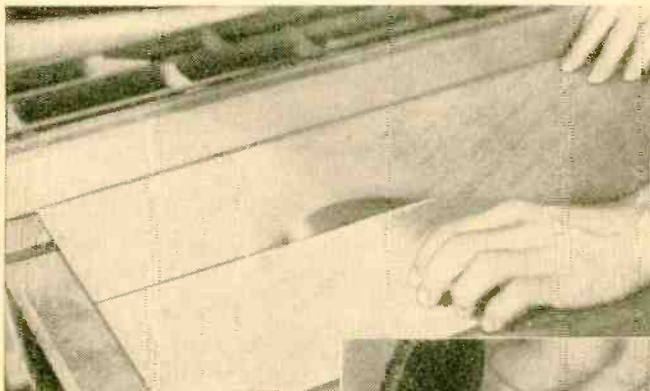

Find logical position for the components on the plastic chassis, then drill holes and mount the parts (see photo at right). Leave the paper on the plastic until wiring is done. When wiring, note that the wires which go to the chassis in normal construction should all be connected together to form a common ground.

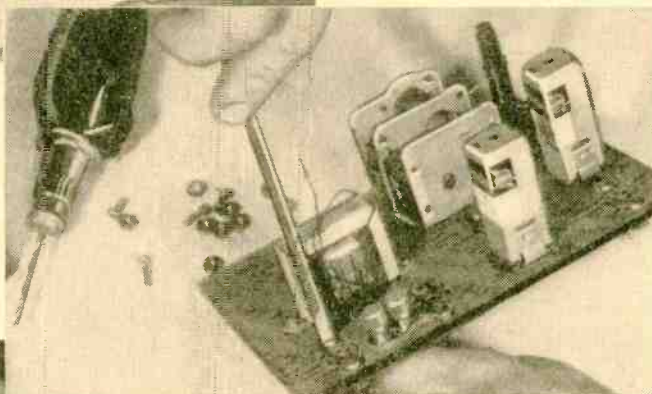

Locate speaker on the case front, and also the tuning capacitor drive and volume control potentiometer. Drill rows of 1/8" holes to form speaker grille (left). Model follows design of a.c.-d.c. superhet with all miniature tubes found in the RCA Receiving Tube Manual. When set is finally turned on, light from the tubes and pilot give whole case a warm glow.



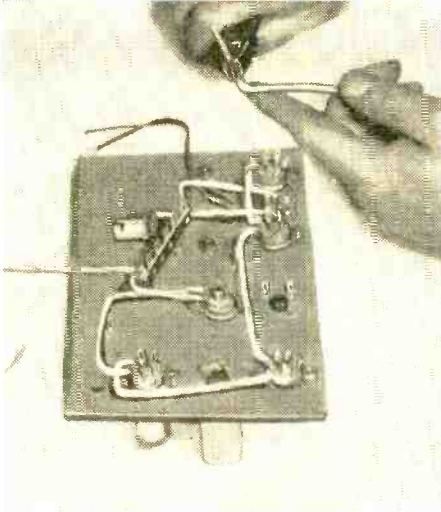

**Wire up** the components (left). Start with the filament wiring and power supply. Keep the wiring neat—it will be seen. Heat a suitable portion of a 1'-long, 1/2"-diameter clear plastic rod until it becomes pliable (about 10 minutes in an oven set at 300°), then bend softened rod into a handle and let it cool.

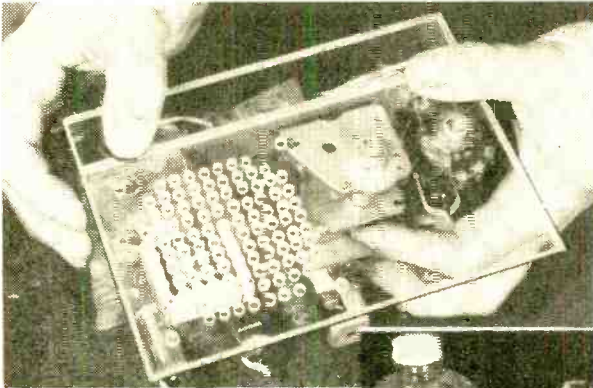
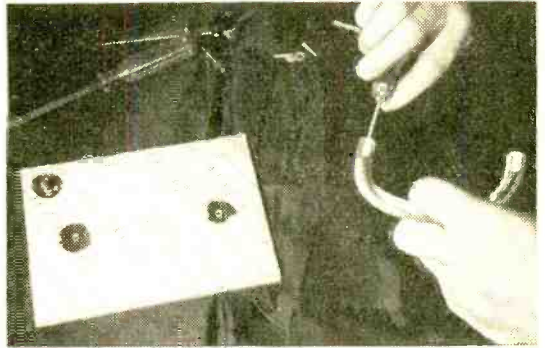

**Drill** holes in case cover, then drill and tap holes in handle for mounting with small cap screws (above). Mount a socket on top of case for extra antenna if you intend to use one. Drill holes for ventilation where necessary.

**Check** to make sure that the parts will fit before gluing (left). Now is the time to remove the paper from the plastic parts. If the plastic becomes dirty as you work, it can be quickly cleaned with a little alcohol.

**Glue** parts of case together with plastic cement (right). Both plastic and cement are available at hobby shops. Round the edges smooth with sandpaper backed up with a pliable sponge, then polish sanded surfaces by hand or with buffing wheel. Use a fine abrasive such as jeweler's rouge; tooth powder made into a paste with water works well.

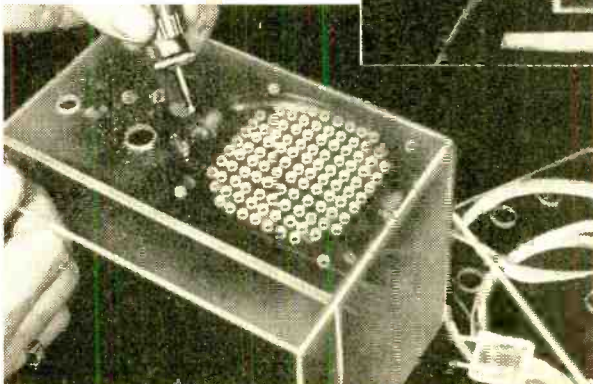
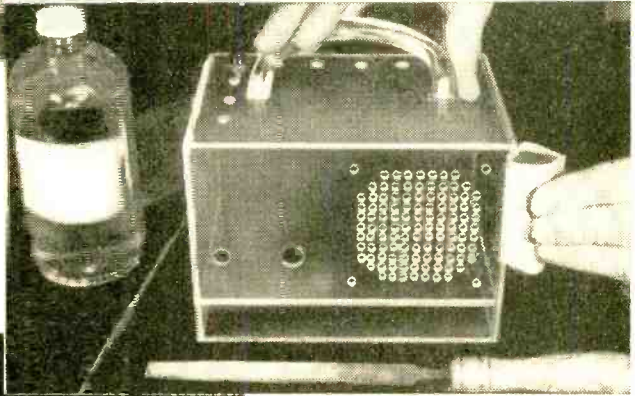

**Cut** the dial markings into the front of the case. Knobs are made from ends of plastic rod; dial pointer can be made from a scrap of plastic. Note how the chassis slides into the grooves—for removal if servicing is needed. Back of case is secured with screws threaded into short rod ends. And your "see-thru" radio is complete . . . even to the transparent power cord which consists of 300-ohm TV lead.

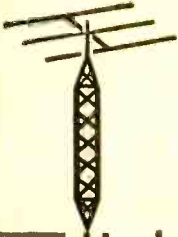

# THE TRANSMITTING TOWER

Herb S. Brier, W9EGQ

**B**ESIDES GRANTING the privilege of operating an amateur station, the possession of an amateur license imposes a few obligations, too. Among them is the obligation to operate within the authorized frequency bands and not to interfere unnecessarily with other services.

No conscientious amateur does either intentionally. Unfortunately, good intentions alone are not enough. When signals from distances up to 1000 miles or so are strong on the 7000 to 7300 kc. band, listen between 7300 and 8000 kc., concentrating on the 7400 to 7500 kc. region. The number of amateur signals you will hear may almost make you believe that the FCC has authorized a new amateur band.

Actually, these signals are the second harmonics generated in transmitters operating in the 3500 to 4000 kc. band. You could also hear them down to 7000 kc. if it were possible to tell a harmonic from a fundamental signal in this region. Second harmonics of 1800 to 2000 kc. phone signals are frequently heard in the 3500-kc. band, too.

More rarely, third harmonics of 3500-kc. signals may be heard between 10,500 and 12,000 kc., and second harmonics of 7000-kc. signals may be heard in the 14,000-kc. region. Furthermore, you can probably hear harmonics from your own transmitter in your receiver to as high a frequency as the receiver will tune, with the higher harmonics gradually getting weaker.

That you can hear harmonics from your own transmitter is not necessarily any cause to worry. All transmitters generate them. It is only when they get out in public that they disgrace us.

**Harmonic Energy.** In the April and May, 1956, *Transmitting Towers*, we discovered that a radio-frequency power amplifier tube usually delivered power to its associated tuned circuit in the form of pulses, full of harmonic energy. This is because the tube is normally operated at a high negative grid bias and driven into the grid-current region to produce maximum power output.

The tuned plate circuit then smooths out

the pulses into virtually undistorted sine waves, before they reach the antenna. It does this by converting the pulses into circulating tank current, which oscillates between the coil and the capacitor. In this manner, the tube and tuned circuit work together much like a one-cylinder engine with a flywheel on its drive shaft. The engine delivers a power thrust during only a small part of each cycle, but the flywheel absorbs the thrust and releases the energy contained in it uniformly over the complete cycle.

In a tuned circuit, "flywheel" action is obtained when its circulating current is large compared to the exciting current.\* A ratio between the two of 10:1 to 15:1 usually represents the best compromise be-

\*This is not a something-for-nothing proposition. The tube supplies low current at high voltage, while the high circulating current is at low voltage; thus, the power involved is the same.

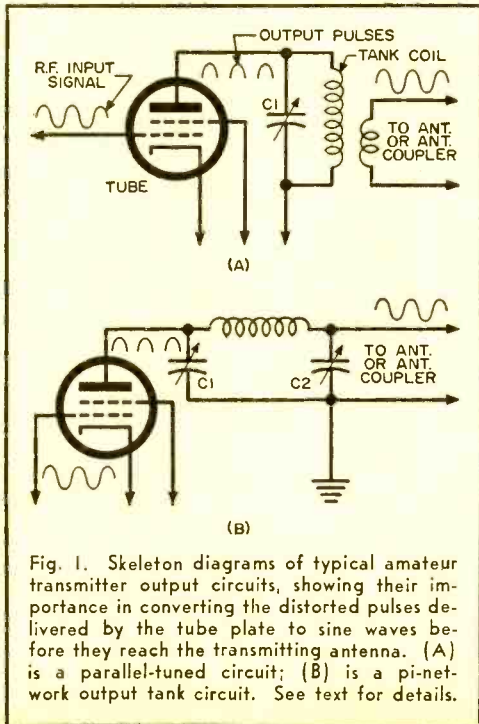

Fig. 1. Skeleton diagrams of typical amateur transmitter output circuits, showing their importance in converting the distorted pulses delivered by the tube plate to sine waves before they reach the transmitting antenna. (A) is a parallel-tuned circuit; (B) is a pi-network output tank circuit. See text for details.



tween high harmonic attenuation and low losses.

Such a tank circuit is said to have a  $Q$  (quality factor) of 10 to 15. It will attenuate second-harmonic energy fed into it 30 to 40 db (5 to 7 "S" units), compared to an untuned coupling device, and it will deliver about 95% of the power it receives to a load. A higher  $Q$  would increase harmonic attenuation only slightly, but would increase losses rapidly. Conversely, reducing the  $Q$  below 10 decreases harmonic attenuation rapidly.

**Calculating Tank Circuit  $Q$ .** Three things determine the  $Q$  of a transmitter tank circuit. They are the tube plate voltage and current and the size of the tuning capacitor ( $C1$  in Fig. 1). Both the *ARRL* and the *Radio Amateur Handbooks* contain charts showing the capacitance to be used in different circuit arrangements to obtain a  $Q$  of 12 to 15 at different voltages and currents. But a simplified method for use in the circuits of Fig. 1 follows:

Divide the plate voltage by the plate current in milliamperes. If the answer is approximately 5,  $C1$  should have a capacitance of approximately 250  $\mu\text{fd.}$  for 3.5-mc. operation, 125  $\mu\text{fd.}$  for 7 mc., 62  $\mu\text{fd.}$  for 14 mc., 42  $\mu\text{fd.}$  for 21 mc., and 30  $\mu\text{fd.}$  for 28 mc.

If the answer obtained by the division differs from 5 by more than about 20%, divide 5 by the number obtained and multiply the capacitance values given above by the result. For example, a plate voltage of 750 divided by a plate current of 100 ma. equals 7.5. And  $5/7.5 \times 250 = 167 \mu\text{fd.}$  Optimum capacitance for 75-watts input on 80 meters at a plate voltage of 750 volts is, therefore, about 165  $\mu\text{fd.}$  A voltage of 600 at 300 ma. gives a ratio of 2. And  $5/2 \times 250 = 625 \mu\text{fd.}$  So, optimum capacitance for 180-watts input on 80 meters at 600 volts is approximately 625  $\mu\text{fd.}$

The inductance of the coil is adjusted to achieve resonance on the desired frequencies with the calculated capacitance values.

Unfortunately, high-quality capacitors with capacitance values above about 200  $\mu\text{fd.}$  are fairly expensive and sometimes a bit difficult to come by. Also, high values of capacitance make tuning rather critical on the higher frequency bands. Consequently, some designers skip a bit on capacitance on the 3.5-mc. band. This is one big reason why most troubles from second-harmonic output stem from 80-meter (or 160-meter) transmitters.

**Checking for Radiation.** Determining if a transmitter radiates excessive harmonics is not difficult. A harmonic-reception report from the FCC is the most convincing evidence. But it is advisable to avoid this method. It jangles the nerves.

A well-shielded communications receiver can be used instead.

Remove the antenna from the receiver and tune in the transmitter signal. Adjust the receiver sensitivity control for a comfortably strong signal from the loudspeaker or phones. Now, tune the receiver to the second-harmonic frequency of the transmitter. It should be very weak or completely inaudible, until the receiver

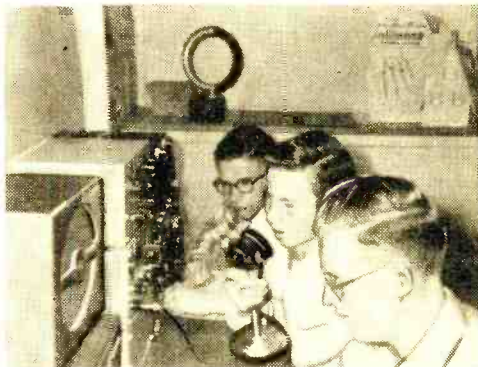

Three of the 12 members of the Roosevelt High School Amateur Radio Club, in Fresno, Calif., are operating the club station, W6PMW. Shown are KN6RPM, KN6RPN, and Jim Ratzliff. The president of the club is K6KLQ, and the sponsor is W6HYR.

sensitivity control is advanced considerably. Measured on the receiver "S"-meter, the difference in strength between the fundamental and harmonic signal should be at least 50 db (8 or 9 "S" units).

An inexpensive receiver may not be satisfactory for this test because of excessive signal pickup, even with the antenna removed, unless it can be removed a distance from the transmitter and powered from a power line separate from that powering the transmitter.

You can also enlist the aid of another amateur within a mile of you. If he hears your harmonic at all, it should be at least 50 db weaker than your fundamental signal.

**Reducing Harmonic Output.** Should your tests indicate that you are radiating a strong harmonic, the first step is to check your tuning procedures carefully. With many transmitters, it is possible to tune the output circuit to 80 meters with the tank capacitor plates well meshed and to the second harmonic frequency with them well open. Too, with a pi-network output circuit, decreasing the output capacitance ( $C2$ ) too much in order to put power into a high-impedance antenna may make it impossible to tune the circuit to 80 meters at all.

In any event, do not load the transmit-

## HELP US OBTAIN HAM LICENSES

In this section of the Transmitting Tower, the names of persons requesting help and encouragement in obtaining their amateur licenses are listed. To have your name listed, write to Herb S. Brier, W9EGQ, % POPULAR ELECTRONICS, 366 Madison Ave., New York 17, N. Y. Names are grouped geographically by amateur call areas.

### W1/K1 CALL AREA

Arthur McDonald (14), 29 Robinson St., S. Portland, Maine. (Code and theory)

Taylor Washburn, 70 School St., Lisbon, N. H.

Arthur R. Taylor, R.F.D. #1, Lyndonville, Vt. (Code)

Laurence Jaffe, 47 Hadwen Rd., Worcester 2, Mass. (Code and theory)

Doug Moody, 45 Sylvan Rd., Rumford 16, R. I. (Code and theory)

David Duncan, 127 Blue Hill Ave., Milton 87, Mass.

Norman Finkelstein, 71 Bellingham St., Chelsea 50, Mass.

### W2/K2 CALL AREA

D. F. Aldridge, 108-23 63rd Ave., Forest Hills, N. Y. (Information on clubs or other groups in the New York area giving instructions to prospective amateurs)

David L. Bergdall, 113 Elmwood St., Valley Stream, L. I., N. Y. (Pen pals)

Ronnie Tobin (13), 640 West 231 St., Riverdale 63, N. Y.

Freddie Childs (14), 20 Redoubt St., Highland Falls, N. Y.

David F. Kovach, KN2RSM (12), 161 La-Grange St., Vestal, N. Y. (Theory)

John H. Ryan, Tonawanda Creek Rd., East Amherst, N. Y. (Code and theory)

Harold Pietrucha, 3 Summit St., Newark, N. J. (Code and theory)

George Kerr, 5 10th St., Beach Haven, N. J. (Code)

Robert Shea, Indian Rd., Milton, N. Y. (Novice theory and regulations)

Roy Krause (14), 6 Sparrow Lane, Huntington, N. Y. (Code)

Emil Vandevelde, Oswego St., Oakland, N. J.

Martin Ewing, 1656 Lenox Rd., Schenectady 8, N. Y. (Code)

O. J. Demarest, 89 West St., Green Island, N. Y.

Robert Selkowitz, 114 Old Commack Rd., Kings Park, N. Y.

Frank Ryon (17), 49 Mitchell St., Norwich, N. Y.

George Kimal, % Kambu, 293 Saw Mill R. Rd., Yonkers, N. Y.

George DeSalvo, 1097 East 3rd St., Brooklyn 30, N. Y. (Code and theory)

Louis Winkler, 100 Catherine St., Valley Stream, N. Y. (Code and theory)

Dick Kohler, 151 East 80th St., New York 21, N. Y. (Code and theory)

John Wasyluk, 333 Semel Ave., Garfield, N. J.

Earl Kohn, 63-60 102 St., Forest Hills 74, N. Y. (Code and theory)

Hermann Beck, 78-28 65th St., Brooklyn 27, N. Y.

Robert Makuh, 60-27 80th Ave., Brooklyn 26, N. Y.

Thomas Walsh, Bethel Cem. Cypress Hills St., Brooklyn 27, N. Y.

Carolee Atkins, 302 N. Union St., Lambertville, N. J. (Theory)

### K3/W3 CALL AREA

Joseph W. Smith, 2990 York Way, Dundalk 22, Md.

Howard A. Lurkins, Mission Road 199, Jessups, Md.

### K4/W4 CALL AREA

Bruce Tuten, 433 East 49th St., Savannah, Ga. (Help in getting his license and in starting an SWL club)

Stuart Looney, Grundy, Va.

Tom Creech, Box 497, Cumberland, Ky. (Code and theory)

Harold Schwarz (13), 2225 Meridian Ave., Miami Beach, Fla. (Code and theory)

Larry Beufield (16), Route #1, Mount Ulla, N. C.

Ronnie Chase, 7009 Jahnke Rd., Richmond 25, Va. (Code)

Noel Edwards (18), P. O. Box 3, Marble, N. C. (Code)

Mike Fletcher (18), 300 West Redbud Drive, Knoxville, Tenn.

Isaiah Singletary (17), 1770 Bridger St., Fayetteville, N. C.

### K5/W5 CALL AREA

Don Blackburn (12), 4132 Travis St., Dallas, Texas. (Help on choosing equipment; would also like to receive QSL cards)

Jim Pickett (14), 611 N. Main St., Sand Springs, Okla.

Paul Alexander (15), P.O. Box 1, Conroe, Texas.

Bill O'Brien, Jr., Box 367, Pilot Point, Texas. (Code)

Freddy Frost, 121 Tarrant St., San Antonio 4, Texas. (Code)

### K6/W6 CALL AREA

Steve Dubnoff, 1930 N. Normandie, Los Angeles 27, Calif. (Interested in radio clubs around Los Angeles that extend help and welcome to prospective Novices)

Robert Sanders (13), 2749 10th Ave., Sacramento, Calif. (Code)

Dennis Carter, 510 Terraceway, Bakersfield, Calif. (Code)

Mike Miller, P. O. Box 368, Rancho Mirage, Calif.

John C. Pennington, 5540 S. 2200 West, Roy, Utah.

### K7/W7 CALL AREA

Thomas D. Wurth, 7310 E. 8th Ave., Spokane 63, Wash.

Roger Hatton (15), Route #4 East, Missoula, Montana.



Dick Quam, 4209 Eastern Ave., Seattle 3, Wash. (Code and theory)

#### K8/W8 CALL AREA

Michael P. Solomon (13), 2441 Laurelhurst Drive, University Heights 18, Ohio. (Code)

Pat Vosburg, Box 308, 3040 Avalon St., Auburn Heights, Mich.

Charlie Parker, Jr., 6401 Quimby Ave., Cleveland 3, Ohio. (Wants to get started right; had a minimum of radio experience in Army)

Edward Gansen, 203 N. Rosevere, Dearborn, Mich. (Code)

Paul Saplak, Box 84, Glen White, W. Va. (Code and theory)

Robert Craft, Box 116, Kilsythe, W. Va. (Code and theory)

#### K9/W9 CALL AREA

I. A. Smith, 3146 West 15th St., Chicago, Ill.

Carl Mattson, RR1, Sand Lake, Phelps, Wis. (Code and theory)

Tom Bertrand (15), 729 E. Central Ave., Greensburg, Ind. (Theory)

#### K0/W0 CALL AREA

David J. Zimmer (13), 225 Dessa Lane, S. St. Paul, Minn.

John Young (12), Box 716, Waynesville, Mo. (Code)

David Waite (14½), 810 S. Maguire, Warrensburg, Mo. (Code and theory)

Lynn Yecum (13), Route #2, Nankato, Kansas. (Code and theory; would like pen pals)

Lawson Hart (13), 5332 Willow, Kansas City 29, Mo.

Byron Nordby, Edinburg, N. Dakota. (Code)

Larry Peacock, 1608 S. Steel St., Denver, Colo. (Code and theory)

Charles O'Rear, 303 W. Ft. Scott, Butler, Mo.

Dick Carochi, 606 East 2nd St., Florence, Colo. (Code and theory)

Thomas E. Storm, 527 Pott, Leavenworth, Kansas. (Code and theory)

#### VE, AND OTHERS

Donald Knight (14), Box 209, Medford, Ontario, Canada.

Duncan MacAdams, R.R. #1, Maple Bag Rd., Duncan, B.C., Canada.

Peter Norton, 4634 W. 2nd Ave., Vancouver, B.C., Canada.

Rolf Strömberg, Box 514, Vindeln, Sweden. (Pen pals, SWL's)

Alfred Celestin, Jr., 151 Grand'Rue, 151, Port-au-Prince, Haiti, W.I. (Code and theory)

To help prospective amateurs obtain their Novice licenses, the Radio-Electronics-Television Manufacturers Association offers a set of code records (recorded at a speed of 33½ rpm) and a Novice Theory Course for \$10.00, post-paid. The complete course or more information on it is available from RETMA, Suite 800, Wyatt Bldg., 777 Fourteenth St., N. W., Washington 5, D. C.

ter to a power input in excess of the manufacturer's recommendations. As we saw above, the ability of a tuned circuit to discriminate against harmonics depends largely on how heavily it is loaded. Excessive loading can easily push harmonic output above the danger line.

Next, check the grid current to the final amplifier tube. Most low-power transmitters require only two or three milliamperes of grid current to the final amplifier tube for maximum output. But the preceding stage is usually capable of delivering several times this amount on the lower frequency bands at least. The extra grid drive simply increases harmonic output, without increasing fundamental output. Reduce the excitation to the point where the output from the transmitter just begins to decrease. In the future, do not exceed the amount of grid current which is then flowing.

Many small transmitters incorporate no means of varying excitation to the final stage, except by detuning the preceding stage. A much better method is to install a variable resistance in series with the screen lead of the preceding stage as an excitation control.

If harmonic output is still excessive, check the amount of capacitance actually used to tune the output tank circuit to resonance at the operating frequency. If it is appreciably less than the values indicated earlier, short out or remove turns from the coil, so that more of the available capacitance is used to tune the circuit to resonance. If the capacitor is too small, it may be desirable to replace it with one of greater capacitance.

When it is not desirable to make such modifications in the transmitter, and an antenna coupler is not already in use, an antenna coupler may be installed between the antenna and the transmitter. It will reduce the strength of harmonics reaching the antenna. See recent *Handbooks* for constructional details.

#### Taped Code Course

An interesting new code course just received for review is the *Tapedcode Course*. The complete course consists of one 7" reel and five 5" reels of magnetic recording tape, dual-track recorded at a speed of 3¾" per second. The 7" tape gives two hours of basic code instruction and practice, and each of the 5" ones gives an hour of practice material. Speed on the last tape is about 17 wpm.

Every effort has apparently been made in this course to teach the code by the most modern methods. After carefully listening to it—I heard only one error, a  
(Continued on page 114)

## Portable Detector Spots Deadly "Nerve" Gas



**S**ELF-CONTAINED and portable, an electronic device developed by RCA detects "nerve" gas. This toxic agent is said to be the deadliest gas developed in recent years. It is over a thousand times more effective than any gas previously in use. "Nerve" gas is so lethal and quick-acting that it will produce fatal spasms and convulsions within 45 seconds after contact or inhalation unless the proper antidote can be administered immediately.

Classified as secret until very recently, RCA's device for spotting the odorless, colorless gas weighs only 24 pounds and, as shown in the photo, can be carried in the field. Upon contacting the gas, the unit triggers a built-in audible alarm. At the same time, it activates a flashing red warning light.

In civilian applications, in industrial or population centers, the audio alarm can be rigged to sound through a public address system, or an air raid siren. The device works by passing air over a special detector tape constantly scanned by a photo-tube.

## Automation Idea Used in Tube Tester

**C**ONVENIENT and speedy testing of tubes is expedited by the use of automation techniques in a uniquely designed tube checker. Introduced by the TeleTest Instrument Co., Flushing, N.Y., and known as the "Dynamic Mutual Conductance Tube Tester, Model DM-456," the instrument uses pre-punched cards to adjust its internal circuitry for running tube tests. This technique eliminates the conventional roll chart and multiple-socket panels.

Among the tests performed are mutual conductance, gas content, grid emission, life expectancy, shorts, and leakage. New cards are issued as new tube types are announced. The DM-456 nets for \$125.00.

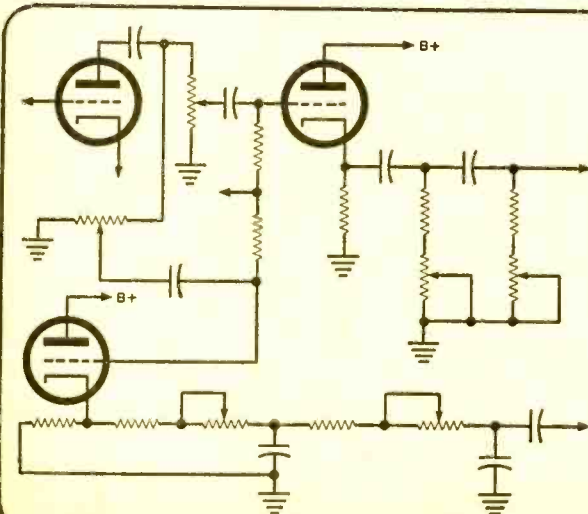

## WHERE ARE YOU?

This is the first of a new series of monthly puzzlers. The idea is to guess (or if you are really good—diagnose) the type of circuit shown in the accompanying schematic. The answer will be found on page 125.

The circuit is an application of several well-known theories. Do you think it is practical? What type of signal would you put into this circuit? What would you expect to get out of it? Where would you be most likely to see this circuit in operation—if it is practical?

We will welcome suggestions on circuits to puzzle our readers. Such circuits should not be overly complicated and should be operative. Usable circuits will be paid for at our usual editorial rates.



**T**HE JUNKBOX has long played a traditional role in the hobby of electronic experimenting. But if your junkbox is anything like the writer's, it contains a rather large proportion of parts for which capacitance, inductance or resistance values cannot be identified. This state of affairs stems partly from the fact that many manufacturers of mass-produced equipment purchase parts to their special order, in which the value is never stated except through a company part number. And we seem to be "unable" to throw these parts away.

Here is a solution to this chaotic situation. The instrument to be described is about as simple as any instrument can get, but its range encompasses the most commonly encountered values of inductance, capacitance and resistance. It will measure capacitances from 500  $\mu\text{fd.}$  to slightly over 1.0  $\mu\text{fd.}$ , inductance from 1.0 millihenry to 2.0 henrys, and resistance from 200 ohms to 2.0 megohms.

Cost of this device should be on the



## Junkbox Parts Checker

By RICHARD GRAHAM

order of six dollars; depending on what parts you already have available, the cost will be proportionately less. No special precision parts are used, nor is there any loss in accuracy because of this, since each model is calibrated to the parts used.

**Calibration** is quite simple. If the procedure below is followed, excellent accuracy plus all the intermediate calibration points can be obtained with only a few known components. The classical method of calibrating devices of this sort cannot be employed. Such a method would dictate that components of known electrical value be used for every calibration point. Fortunately, this instrument can be calibrated—including all the intermediate points—with only four known parts per scale, i.e., 4 capacitors, 4 inductances, and 4 resistors. Later checks with additional known components will verify its accuracy.

Basically, the method is to plot the known calibration points on a graph in order to obtain a curve from which all the intermediate points can be determined. The first step is to make a blank dial scale calibrated from 0 to 10. Then obtain a sheet of graph paper. Mark off one edge of the graph paper from 0 to 10 to correspond to the dial calibration. Mark off the other edge with the values of capacity, inductance, and resistance. For example, one edge will have three scales marked off in capacity from 500  $\mu\text{fd.}$  to

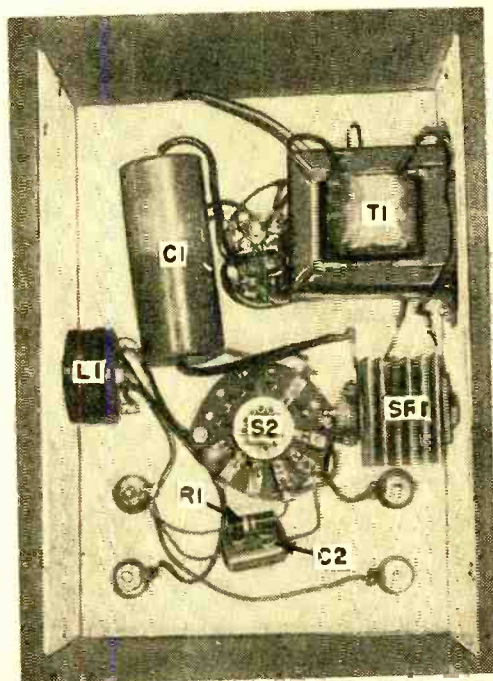

Front and rear (open) views of the model, built in a 7" x 5" x 3" aluminum case. As parts layout is not critical, any available housing may be used.

## HOW IT WORKS

This is basically a bridge circuit in which the unknown component is balanced by adjusting potentiometer  $R2$  for an audio null or minimum sound in the earphones. The bridge consists of four arms.  $R2$  forms the two resistance arms of the bridge. The unknown  $R$ ,  $L$ , or  $C$  forms the third arm; and an internal  $R1$ ,  $L1$ , or  $C2$ , which is selected by the switch  $S2$ , forms the fourth arm of the bridge.

Balanced condition of the bridge occurs for a different setting of  $R2$  for each different value of an unknown component. That is, a minimum sound or null will be heard in the earphones when the voltage at the tap point of  $R2$  is equal to the voltage at the junction of the unknown part and the internal  $R$ ,  $L$  or  $C$ . If the voltage at these two points is the same (with respect to either end of the transformer), no current can flow through the headphones, and thus there is no sound.

The remainder of the circuit ( $C1$ ,  $SRI$ , and  $T1$ ) consists of a 60-cycle harmonic generator. A straight 60 cycles is unsuitable for powering the bridge. If this 60-cycle sine wave is severely distorted, then the higher frequency harmonics of 60 cycles can be heard quite plainly. This is important if one expects to find the audio null easily and reliably.

The 60-cycle harmonic generator uses a selenium rectifier which serves to distort the 60-cycle 117 volts severely before it is applied to the transformer. The 1.0- $\mu\text{fd.}$  capacitor serves as an additional distortion-

producing element so that a clearly audible tone can be heard in the earphones when connected to the appropriate terminals.

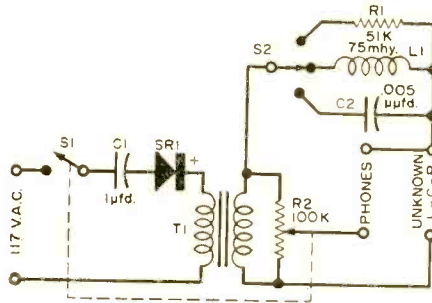

- $C1$ —1- $\mu\text{fd.}$ , 400-volt capacitor
- $C2$ —.005- $\mu\text{fd.}$ , 400-volt capacitor
- $L1$ —75-mh., 100-ma. r.f. choke
- $R1$ —51,000-ohm, 1-watt resistor
- $R2$ —100,000-ohm potentiometer with switch
- $S1$ —S.p.s.t. switch (on  $R2$ )
- $S2$ —S.p., 3-pos. rotary switch
- $SRI$ —150-ma. selenium rectifier
- $T1$ —6.3-volt, 2-amp. filament transformer

1.0  $\mu\text{fd.}$ , inductance from 1 millihenry to 2 henrys, and resistance from 200 ohms to 2 megohms.

Now, obtain four known values each of capacitance, inductance and resistance, spread as uniformly as possible over the range of the instrument. Attach them to the "unknown" binding posts, and find the number on the dial (between 0 and 10) of the null. Plot these number and component values on the graph paper. Then, preferably with a French curve, draw a

smooth curve through the points obtained on the graph paper for the capacity, then the inductance, and finally the resistance.

From the curves so obtained, all the intermediate points (for example, .01, .02, .03, .04  $\mu\text{fd.}$ , etc.), can be found in terms of numbers from 0 to 10, which corresponds to the 0-to-10 calibration on the dial. These values can now be transferred to the dial with India ink, making the calibration permanent, and the penciled-in scale from 0 to 10 can be erased.

-30-

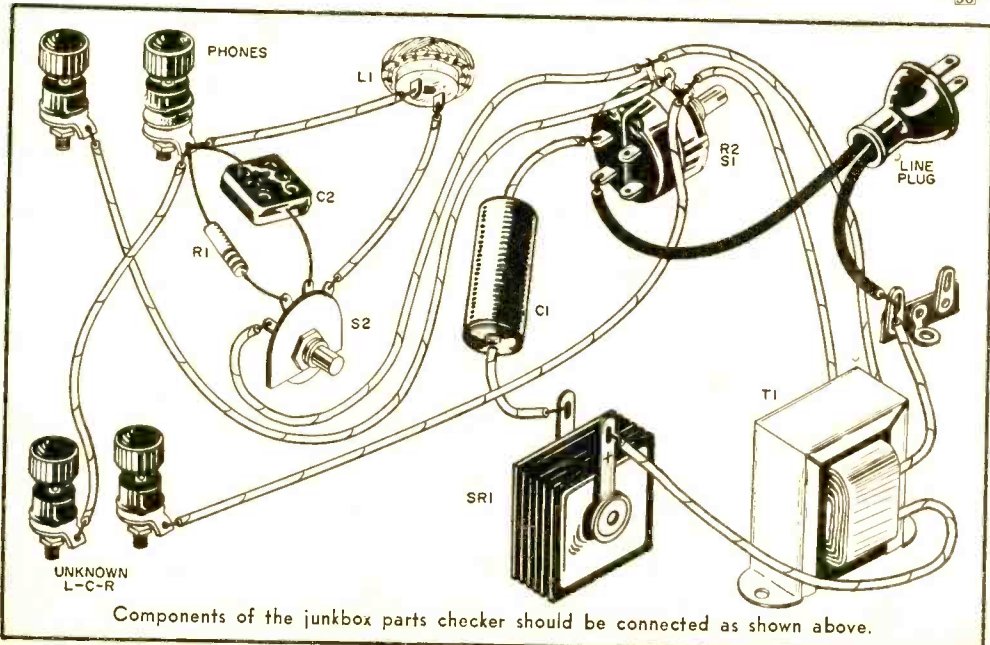

Components of the junkbox parts checker should be connected as shown above.



# AFTER

# CLASS



## SOME FACTS ABOUT ELECTRETS

SOME TIME during the opening phase of World War II, a detachment of American soldiers captured a complete mobile communications system at an advanced Japanese post. Although much of the equipment had been unimaginatively copied from standard Allied gear, one item in particular was apparently new in concept. It was a capacitor microphone with no perceptible source of polarizing voltage! Included in the mike case was a resinous mass of wax whose function eluded our scientists for some time. This was the way the electret was first introduced to the Western world.

Let's brush up a bit on static electricity before tackling the electret, since its construction and performance are based upon static electric fields.

**Electrification.** The classic demonstration in which a hard rubber rod is electrified by stroking it with fur or flannel is performed at least twice a year in over 20,000 secondary schools and colleges throughout the world. If you have never witnessed it, you can duplicate it by rubbing a good vulcanite comb or fountain

pen on any rough cloth. The electrified object then attracts bits of paper or thread by inducing opposite charges in these small bits of matter.

Stroke an inflated balloon on your suit-

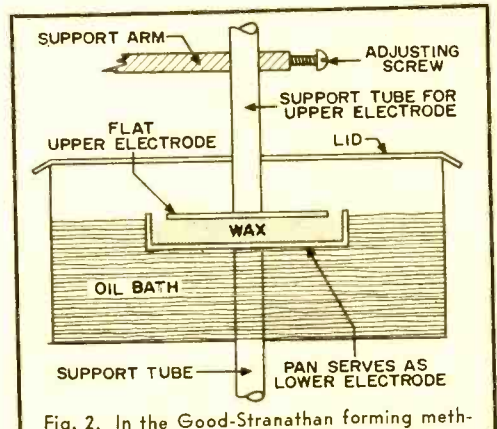

Fig. 2. In the Good-Stranathan forming method used at the University of Kansas, the temperature of the oil bath is thermostatically controlled. This method is considered highly efficient and permits the forming of electrets of various shapes and thicknesses for experimental purposes. The forming potential is regulated to about 8000 volts per centimeter of electret thickness for effective charging.

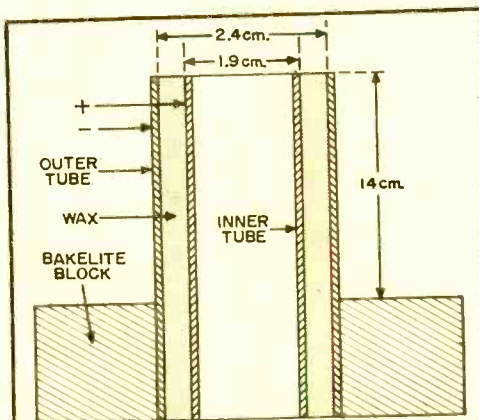

Fig. 1. In the forming method used by Edwin P. Adams of Princeton University, wax is poured between two concentric tubes held in a Bakelite block. The tubes are then connected to a source of 4000 volts d.c. as the wax solidifies. Solidification is retarded by placing the assembly in a thermostatically controlled oven. When the concentric tubes are removed, a hollow cylindrical electret is obtained.

coat, then gently place it against a wall; it will hang there as though glued. Shuffle your feet on a high-nap wool rug when the weather is cold and clear, then bring your fingertip close to a grounded pipe or radiator . . . you can sometimes get a half-inch spark to leap between them. The Van der Graaf high-tension generator used for atom-smashing, the famous voltaic electrophorus, and the whirling Wimshurst static machine are all based on the same fundamental principle: the generation of static electricity by friction.

This kind of electrification is termed "superficial" because the charge produced by friction quickly decays and disappears, particularly when the air is humid. It results from the transfer of free electrons from one substance to another, leaving one with a deficiency of these negative particles and the other with an excess. For this reason, objects charged by friction

take on opposite charges which last for a short time.

Before 1919, no device was known which could be electrified permanently; but in that year a Japanese scientist, Motoaro Eguchi, is reported to have been successful for the first time. He melted together a

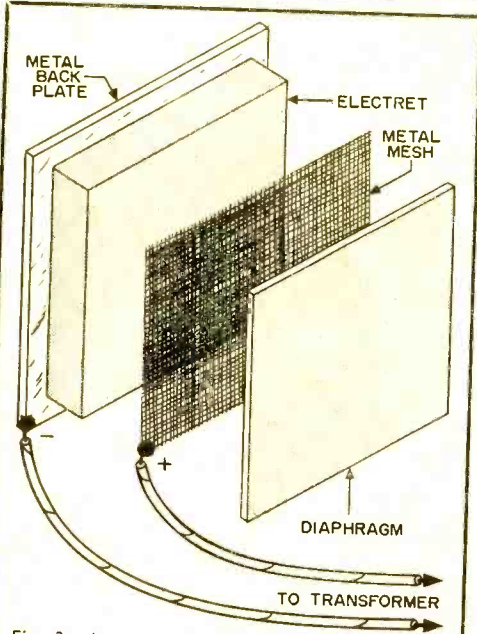

Fig. 3. A proposed capacitor electret microphone. The charge which appears on the metal mesh depends upon the capacitance between the mesh and the electret surface and upon the potential of the electret. As sound waves cause the diaphragm to vibrate, the capacitance changes, causing a corresponding alternating voltage waveform to appear at the terminals of the transformer.

50-50 mixture of rosin and carnauba wax. Then he allowed it to solidify between two electrodes across which a high d.c. voltage was applied. After hardening was complete, the waxy mass was kept between the activated electrodes for an additional period of 12 hours. After removal, it was found to have a permanent charge; that is, one side was charged positively and the other side negatively, so that it was surrounded by an external electrostatic field that showed little or no tendency towards decaying.

Methods for manufacturing electrets have undergone very little change in the 37 years that have passed since Eguchi's initial experiments. Improvements have been made in dielectric materials by using various combinations of waxes and applying higher forming potentials to thermosetting plastics and ceramics. (For forming methods, see Figs. 1 and 2.) When properly stored, an electret made by these

simple methods can retain its charge for 20 years or more.

**Electret Formation.** One currently popular theory which attempts to explain electret formation may be outlined in the following way:

(a) A material mass contains neutral atoms and charged atoms (ions). In a dielectric material, the ions cannot move about readily because of the nature of the substance. Since positive and negative free ions are usually approximately equal in number, a dielectric containing scattered ions displays zero net charge because the individual little electric fields effectively cancel each other.

(b) When a molten dielectric is situated between two highly charged electrodes, the free ions migrate toward the electrode bearing a charge opposite from theirs. This accumulation of a positive charge on the negative face of the electret and a negative charge on the positive face is called the *heterocharge* (meaning charge that is different from the electrode polarity). The heterocharge is a temporary manifestation which disappears within a day or two.

(c) During the forming period, it is believed that "sprays" of electric charges enter the molten mass and are frozen there when the dielectric hardens. As these charges have the same polarity as the electrodes near the surface at the point of entry, they produce the *homocharge*. This is the electret's permanent charge.

(d) For the first day or two, the heterocharge is very strong and the net charge on the electret at this time is the reverse of what it will finally be. As ions carried by the air come in contact with the electret surfaces, the heterocharge ions are quickly neutralized. Thus, the heterocharge disappears altogether in a relatively short time.

(e) The homocharge, consisting of elementary electric charges rather than ions, penetrates the surface more deeply, becomes embedded, and is thereby protected from ionic assault. Once the dielectric has hardened, the charges are further guaranteed long life by the fact that ions move through solids only with great difficulty.

**Properties and Applications.** Some of the properties of electrets are quite interesting. They tend to lose their charge tem-

Ed. Note: Your comments on the above type of material, currently appearing in this department, are earnestly solicited. As pointed out a couple of months ago, "After Class" has been redesigned to incorporate subjects felt to be of interest, but which do not appear in the usual radio textbooks—how do you like our new subject matter?



porarily under the action of certain solvents, surface planing, high humidity, x-rays, and gamma rays; but the charge is self-restoring after the depolarizing agent is removed. And the larger an electret is made, the greater its total charge and external electric field. The charge pattern on the electret faces may be controlled by suitably shaped forming electrodes. When heated above certain critical temperatures, electrets emit electrical pulses having a definite frequency range, peaking at about 500 pulses per minute. Wrapping stored electrets in metallic foil retards homocharge deterioration so much that very little charge decay occurs for many years.

Thus far, electrical devices based upon other phenomena perform better and for longer periods than those which involve the electret principle. For example, a standard capacitor microphone which requires a source of polarizing potential has been constructed using an electret (Fig. 3). Unless foil-shorting provisions are made, however, the electret charge decays quickly, and the microphone fails after six months.

Electrets have been tried without encouraging results as x-ray dosimeters. The dosage of x-rays, as you have probably discovered in your dentist's chair, must be precisely controlled to avoid damaging body tissue. X-ray machines therefore contain integral timers of high accuracy. Since an electret is temporarily discharged by x-rays, it seems to afford a method of timing exposure based upon both ray intensity and period of application. Unfortunately, the reaction of the electret is not sufficiently precise for safety.

Patents have been issued for electret dust-filters, sparking devices, and electrostatic generators; but none of these competes seriously with existing units based upon older principles.

Yet, this is a very familiar pattern in scientific research. Some day—perhaps very soon—a specialized job will be found for electrets, a job that will elevate them to the same proud status that quartz crystals and transistors now occupy.

## TRANSFORMER QUIZ

THE FOLLOWING QUIZ will test your knowledge of transformers and their applications. A score of 100 is excellent, 90 is very good, 80 is good, 70 is fair, and 60 or less is poor.

- If the secondary of a transformer has three times as many turns as the primary:
  - the secondary voltage will equal the voltage applied to the primary;
  - the secondary voltage will be three times as great as the voltage applied to the primary;
  - the secondary volt-

age will be nine times as great as the voltage applied to the primary.

- The transformer shown in Fig. A is:
  - an output transformer;
  - an i.f. transformer;
  - a push-pull transformer;
  - a power transformer.
- The transformer shown in Fig. B is:
  - an autotransformer;
  - a push-pull transformer;
  - an output transformer;
  - a power transformer.
- The transformer shown in Fig. C is:
  - a push-pull transformer;
  - a power transformer;
  - an output transformer;
  - an i.f. transformer.
- The transformer shown in Fig. D is:
  - an autotransformer;
  - an i.f. transformer;
  - a power transformer;
  - an output transformer.
- The transformer shown in Fig. E is:
  - an i.f. transformer;
  - an output transformer;
  - push-pull transformer;
  - autotransformer.
- If the primary of a filament transformer is connected to a 110-volt power line and the 6.3-volt secondary is connected to a 0.3-ampere filament, the primary current will be approximately:
  - 5.2 amperes;
  - 0.3 amperes;
  - 17 milliamperes;
  - 30 milliamperes.
- Laminated rather than solid iron cores are used in transformers in order to:
  - increase eddy currents;
  - reduce power losses in the core;
  - facilitate removal of burned-out windings.
- A Faraday shield is used to:
  - reduce the capacitive coupling between the

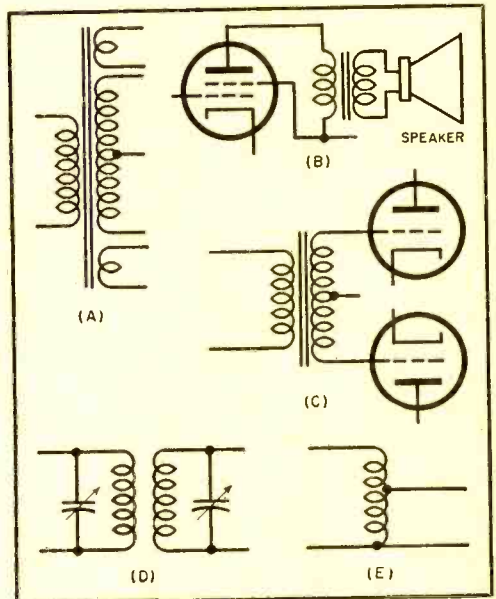

windings of a transformer; (b) decrease core losses; (c) prevent mutual inductance.

- A filament transformer has two 6.3-volt windings each rated at 4 amperes. If these two windings are connected in parallel, the combination will have a rating of:
  - 6.3 volts at 4 amperes;
  - 6.3 volts at 8 amperes;
  - 12.6 volts at 8 amperes.

(Answers appear on page 123)

# Tube Tester Plug-In Accessories

## Double Value and Quadruple Versatility

Blank panel, in upper left-hand corner of tube checker, is removed to permit installation of accessory—in this case, a filament current tester. Other accessories are installed in a similar manner.

Accessory is fitted into space provided on chassis. Connection to power supply and meter is made by means of the 10-conductor plug shown. Accessory does not interfere with normal tube check operations.

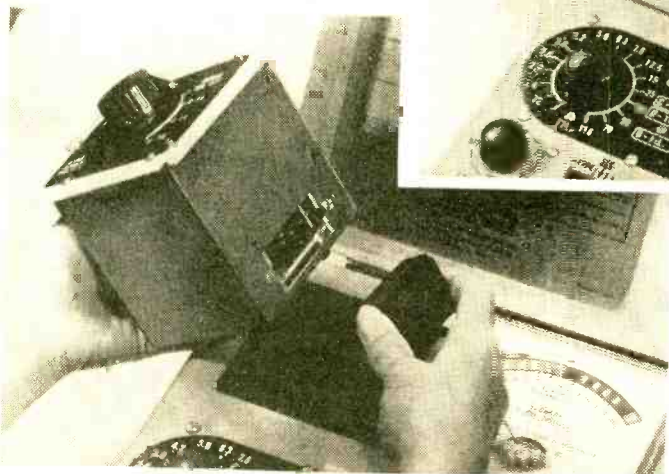

Test of a selenium rectifier is made with special accessory fitted into place. Hookup is made with the 10-conductor plug. Right-hand side of instrument contains tube sockets; a special adapter plate permits checking of subminiature and older tubes. Tube test data is listed on roll chart. Same 4 1/2" meter is used for all tests.

**A** PPLYING THE MODULE idea to test instruments, the Jackson Electrical Instrument Co., Dayton, Ohio, has come up with a low-cost tube checker which becomes a versatile test instrument with many other applications by adding plug-in accessories.

The basic tube tester, which sells for \$49.95, furnishes regular tests on most standard tubes. Sockets for older types as well as subminiatures are provided on an accessory panel. Accessory units include: a high-resistance shorts tester for measuring interelement leakage to 2 megohms; a heater current tester; and a selenium rectifier checker.

Other accessories, expected to become available in the future, include a signal tracer, r.f. oscillator, and a capacitor checker. Use of accessories such as these is made possible by adapting the tube tester's meter and power supply for purposes other than simply testing the emission of standard tubes. The accessory units ac-

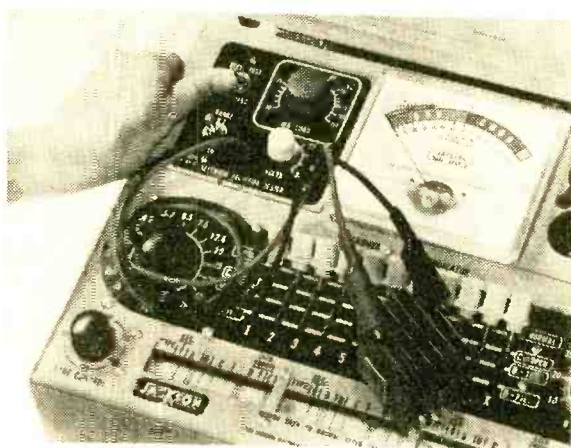

complish this without interfering with the checker's main function of testing tube quality. A special connector is plugged into the desired accessory, which is then slipped into the instrument's "accessory port." For additional information, contact the manufacturer at 16-18 S. Patterson Blvd., Dayton 2, Ohio.



# Electronic Phono Speed Changer

By  
H. J. CARTER

**Would you like to convert your old 78-rpm phonograph to a 3-speed model? Here's how—**



**YOU CAN EASILY** convert a 78-rpm electric phonograph to a three-speed phonograph with the simple control circuit described in this article. Any *shaded-pole* electric motor can be run at reduced speed by adding three inexpensive parts: a switch, a rectifier, and an adjustable resistor. The parts cost less than a new three-speed motor, and take about half an hour to install.

Before adding this speed control circuit to an old phonograph, you should inspect the motor. If it runs noisily, uneven, or at low speed, dismantle it and clean the parts in grease solvent. Reassemble the motor carefully and oil sparingly with a good grade of thin sewing-machine oil.

A shaded-pole motor can be slowed by simply inserting series resistance in the

field coil circuit, but the rapid drop of torque in this method of speed control makes the motor useless for record players where good speed regulation is essential. The torque developed by the phono motor running at the reduced speed in this circuit decreases very little, inasmuch as full power a.c. pulses are present on alternate half-cycles.

The resistance of *R1* is not critical; any value from 300 to 500 ohms will work. An extra slider must be added to tap the resistor at the value required to run the motor at 45 rpm. All of the parts can be mounted easily on the bottom side of the motor board. The selenium rectifier may be polarized either way. If the motor board is wood, keep *R1* at least  $\frac{3}{4}$ " away to allow for heat dissipation.

**Adjustment.** It is easy to correct the speed if a stroboscopic disc is used (see *POPULAR ELECTRONICS*, October, 1954, page 71). Be sure to be playing a record while making the speed adjustment in order to include the effect of needle drag on turntable speed. *Before adjusting* the sliders *SL1* and

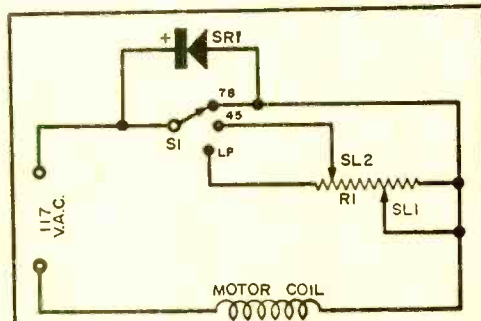
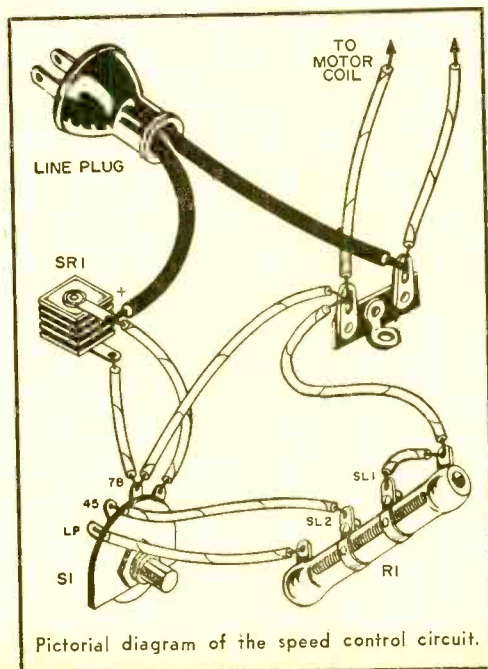

Schematic wiring diagram and necessary parts.

- R1*—300-500 ohm, 10-watt adjustable wire-wound resistor with two sliders (*RL1* and *RL2*)
- S1*—Centralab No. 1461 switch
- SR1*—115-volt, 100-ma. selenium rectifier

*SL2, always be sure to disconnect the power line cord!*

Switch the selector to the 33½-rpm (LP)

### HOW IT WORKS

In this circuit, selenium rectifier *SRI* blocks on alternate a.c. half-cycles, switching resistor *R1* in series with the motor field; on the other a.c. half-cycle, it shorts *R1*, leaving the field coil directly connected to the line. The reduced current pulse on alternate 60-cycle a.c. half-cycles is equivalent to a direct current level superimposed on the a.c. waveform.

In normal motor operation, the rotor does not quite keep up with the rotating stator field, but lags behind by what is known as the *slip angle*. Motor speed is varied by varying the slip angle—either by varying the motor load or slowing the rotating magnetic field by electrical means.

The rotor activated in this circuit is subject to current pulses which tend to rotate it with the stator field, and to pulses which tend to let it slip further behind the field. These opposite effects are smoothed by the turntable and rotor inertia so that the average slip angle is increased, thus reducing the motor speed.

position and check the speed. If the turntable is slow, move *SL1* toward *SL2*, tighten the clamp screw, and check the speed again. Continue adjusting the slider until the speed is correct, then switch to the 45-rpm position and repeat the adjustment procedure, moving *SL2* toward *SL1* if the turntable speed is slow. Remember to readjust *SL2* if you have to readjust *SL1*. The position of *SL2* does not affect the LP speed adjustment.

**Precautions.** When starting the motor, switch to the 78-rpm position before selecting a slower speed. If the motor is started in a slow speed position, it generally will not run at the correct speed.

There is nothing critical about the mounting of the parts, but you should locate them away from the pickup in order to avoid hum trouble.

-30-

## Magnifying Sun Battery Power

**T**HIS IDEA should interest electronics experimenters who must do most of their experimenting indoors during the evening hours. You can practically double the output of a single B2M "Sun Battery" under the workbench lamp by the addition of a cheap magnifying glass mounted on a simple stand.

Take a magnifying glass having a 2"-diameter lens with a focal length of 4" (which costs about 98 cents), and set it up on a stand made from a block of wood, a piece of clothes-hanger wire, and an ink eraser. Two holes are punched in the eraser, as shown (below, right), so that the reading glass may be adjusted at any height.

A "Sun Battery" mounted to a wood block directly under the lens and connected to a 0-1 d.c. milliammeter should provide a reading around 0.4 milliampere—using a 100-watt lamp in a reflector about 20" above the lens. Without the magnifying lens, the

reading will be slightly over 0.2 milliampere, or about one-half the output obtained when the lens is used.

Of course, the output could be increased by simply moving the lamp closer to the B2M, but 20" is a safe distance since the temperature under the author's lens did not rise over 100°. When the lamp was placed 12" above the lens, a reading of over 140° was obtained with the bulb of the thermometer placed directly under the lens.

It goes without saying that the lens should not be used on the B2M in direct sunlight, as the intense heat would ruin the selenium cell—which should not be exposed to temperatures over 185°.

While an increase from 0.2 milliampere to 0.4 milliampere doesn't look like much on the meter, it produced a substantial increase in volume when the author used the "Sun Battery" to power a transistorized crystal radio.

—Art Trauffer

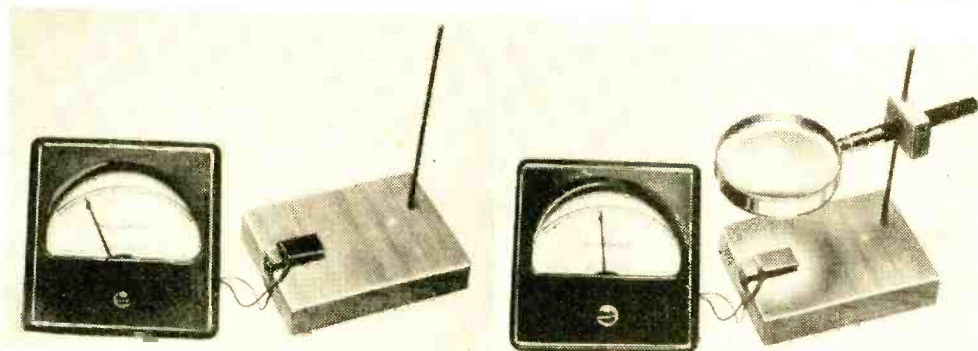

Without magnifying glass, the "Sun Battery"—mounted on a wood block and connected to a 0-1 d.c. milliammeter—provides a reading of about 0.2 milliampere when a 100-watt lamp is used.

With the magnifying glass, the "Sun Battery" should give a reading of about 0.4 milliampere—twice that obtainable without the lens. Two holes are punched in eraser for adjusting height of lens.



## You CAN Phone From Your Boat

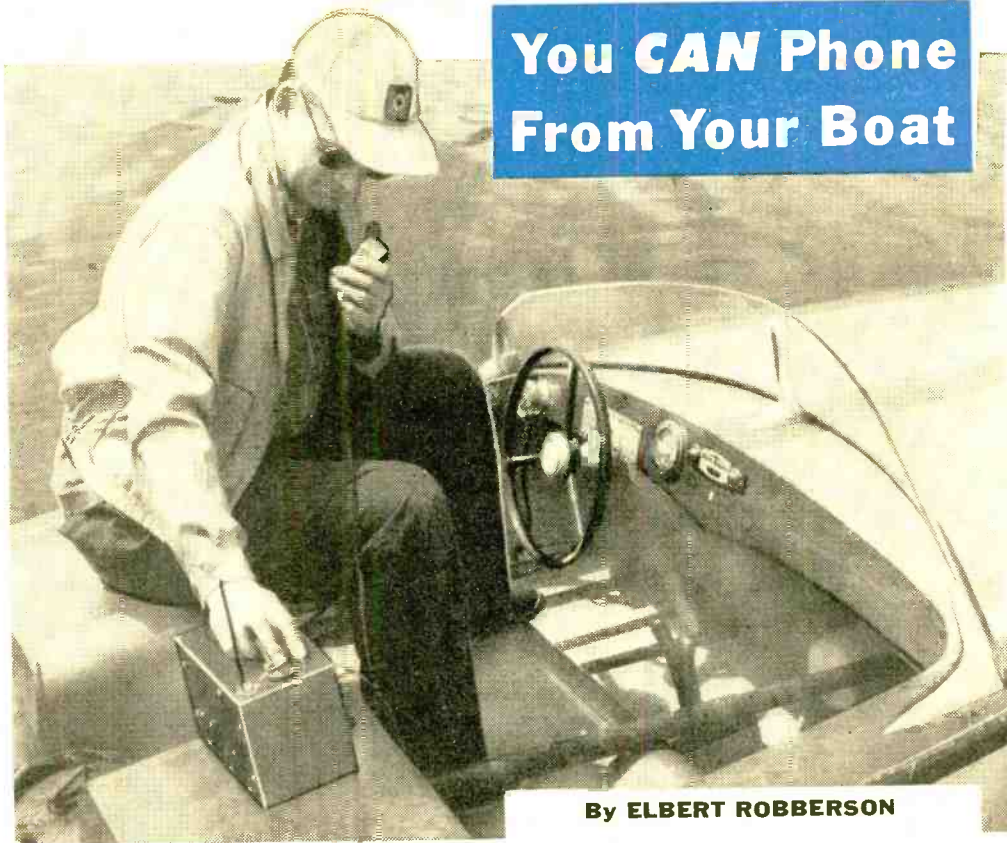

By **ELBERT ROBBERSON**

### **Marine radiotelephones make communication possible over u.h.f. and medium frequencies**

**T**HE FIRST sea-going two-way radio station I ever saw was a room full of wire on a bucket sailing out of Seattle for Alaska. To operate "the wireless," you needed a "Junior Marconi" button; and to raise another ship, your best bet was to maneuver alongside them before calling. Then, without turning on their receiver, they could hear the buzz of the rotary spark gap.

But things have happened in this field! For example, today I was out zipping around Manhasset Bay (off Long Island Sound) in an open 14-foot outboard speedboat. I picked up a microphone, pressed a button on a little grey box alongside me, and said: "2A1499 calling home station—come in please."

My wife's voice came blasting out of a speaker in the little box: "Home station back to 2A1499."

"Come down and meet me at the dock in ten minutes," I told her. "I'm going to tie up for the day."

"Okay," she said. "2A1499 home station off."

The process of evolution from the ship's "wireless" I first saw to the neat grey box has taken more years than I like to recall. But now that manufacturers have developed such small and efficient equipment, a new era is waiting to be enjoyed. While small boatmen used to brave the briny deep in magnificent isolation, sometimes out of sight and always out of touch with land, today anyone—in any size of boat—can take a radiotelephone along.

**The kind of radiotelephone** you have on your boat depends upon the boat's size, the motive power, and your budget. Among the equipment to be described, there is a radiotelephone for just about everybody. Some of them are portable, operating from their own batteries. Others can be permanently installed and operated from a boat's engine battery.

The smallest radiotelephones have their own antenna systems built on as a part of the equipment. Larger units are designed



This bag totes a medium-frequency radiotelephone good for a hundred miles under favorable conditions. The "center-loaded" whip antenna telescopes into a socket on the side of the equipment, which is made by Sonar Radio Corporation. Unzip the cover, extend the antenna, connect ground, and you're ready to operate the portable six-channel unit.



to connect to a wire in the boat's rigging, or to a specially engineered whip antenna. More people have outboards than any other kind of boat. Even if you don't own one, you're likely to ride in one before the year is out—just about everyone heads for the water on a hot day, and about one out of five piles into a small boat. If you are in this group, look into the portable u.h.f. radiotelephones which have recently been developed for the 465-mc. Citizens band.

A good example of this gear is the Vocaline radio transceiver (see also the June, 1956, issue of *POPULAR ELECTRONICS*, page 40) which is priced at \$69.75. Licensing is the simplest and easiest formality you can imagine. Just send FCC Form #505—stating your name and address, and giving the identification and type-approval numbers on your equipment—to the nearest FCC district office. Applicants must be over 18 and citizens of the United States.

The transceiver and power supply are contained in one cabinet, complete with loudspeaker and a plug-in quarter-wave antenna rod. One tube is used as the transmitting oscillator, with a two-tube speech amplifier and modulator.

For reception, the same tubes are used. The oscillator turns into a superregenerative detector, and the other tubes make up the audio amplifier to feed the loudspeaker. Pressing a button on top of the cabinet performs all the switching necessary to go from "receive" to "transmit."

The Vocaline transceiver has a dual-purpose power supply. It is hooked up for standard a.c. operation in which a conventional transformer, selenium rectifier and RC filter are used. To operate from 6 volts d.c. for portable use, an internal vibrator chops input current into a.c. and applies it to a tap on the same transformer. The switching from 117-volts a.c. to 6-volts d.c. input is automatically accomplished by a system of jumpers in the power cord plugs.

Normally, the station on shore uses a.c. power, while on the boat a small 6-volt battery is all that is required. Current drain at 6 volts is only 3 amperes, so the very smallest storage batteries will serve very well.

Transmission range is line-of-sight, and may extend as far as ten miles "in-the-clear." Through trees and buildings, you can talk over a distance of ½ to 1 mile, depending on how high the sets are from ground (or water) level. Plug-in antennas are available which extend ten feet in the air to improve the working range.

Although u.h.f. telephony is entirely practical for limited-range operation, users must set up their own communication networks, which may be inconvenient. If this is the case, equipment for the medium-





**Available** commercial radiotelephones include: a Hudson American "Privateer V" low-powered unit (above); Ray Jefferson 'phone (above, right); a Pearce-Simpson "Islander 30" radiotelephone (right); and Raytheon's newest small telephone.

frequency marine channels is the answer. Let out a yawp on the radiotelephone International Distress frequency of 2182 kc. that you're stuck on a rock or out of gas, and you can be sure that somewhere ears perk up.

And you can do more than just call the Coast Guard or other boats. Shoreside telephone companies maintain ship-to-shore stations in all the large ports; so you can place a call over the land lines just as easily as at the corner soda fountain, for about a dollar more per call.

Until very recently, equipment for these frequencies was not only costly, but inefficient, large, heavy and hungry for amperes. There was no use thinking about a marine 'phone unless your boat carried a husky battery that could be charged fairly continuously by the engine. In addition, you'd have to shinny up the mast with an antenna wire, or mount a long whip antenna somewhere on the superstructure. Naturally, if you didn't have a battery-equipped engine, or a mast or substantial superstructure for supporting a whip, you just didn't think about radio.

But, here again, things are different today. For example, the Sonar Radio Corp. builds a portable six-channel 2 to 3.5 mc. radiotelephone that takes up less than a cubic foot of space. Besides an 8-tube superheterodyne receiver and a 35-watt input crystal-controlled phone transmitter, the unit includes a vibrator power supply, and a 6-volt rechargeable battery. It is completely pre-tuned and will communicate on any of five channels selected by a panel switch. In addition, it can be used to receive the regular AM broadcast band.

A "center-loaded" whip antenna telescopes into a socket on the side of the equipment. To transmit, you just extend

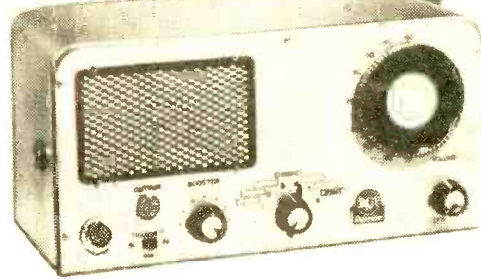

the antenna full length, connect the ground terminal to the motor (or some other metal in contact with the water—the larger the better), turn the band-switch to the desired channel, and go on the air. Talking range is from about 10 to 100 miles, depending upon conditions.

Cost of this radiotelephone is \$339.50, ready to operate. A license to use it on a particular boat, or on any boat you may go aboard, is obtained by filling out FCC application Form #501A.

In addition to the station license, a Restricted Radiotelephone Operator's Permit must be obtained to operate a marine radiotelephone in the medium-frequency band. No examination is required.

**A small 'phone installation** can be made if your boat has any kind of cabin or shelter to protect the equipment. You don't need an engine electrical system. In fact, boats as small as a 16-foot racing sloop have had telephones installed with

an 80-ampere car battery for power. By using the telephone sparingly, the battery will last several weeks between charges—and you can either lug it home for a boost whenever needed, or carry a small charger aboard which can be hooked up occasionally to shore current. (*Caution:* In case the charger does not have completely isolated input and output circuits, be sure to disconnect the battery from the radio equipment and the ground connection before charging. Otherwise, harmful electrolysis might attack underwater metal fittings.)

But, of course, if there is an engine storage battery aboard, it is simplest to connect the radiotelephone to this battery. There is nothing tricky about installing a permanent-type radiotelephone—just follow the manufacturer's instructions on input polarity and the size of power wiring and the antenna and ground conductors. However, the final tuning and testing must be performed by an FCC-licensed marine-radio technician. The people who sell the equipment can take care of this.

On powerboats, a telescoping or folding whip antenna mounted to the cabin or windshield framing by heavy stand-off insulators can be used. There are several coil-loaded models designed for this purpose. The higher the antenna, the better the transmitting efficiency and range.

On sailboats, a length of rigging—such as a permanent backstay—can be insulated

and used for the antenna. If this is not possible, a satisfactory "skyhook" can often be made by hoisting a wire on the signal halliard, or cleating it to the mast.

Medium-frequency radiotelephones require a ground connection. A twelve-foot or greater area of metal in contact with the water will suffice, although larger surfaces give better efficiency. Metal keels, rudders, or the engine (grounded through shaft and propeller) are often used.

The ignition system of a boat's engine will interfere with reception on the medium frequencies. Usually, the noise can be reduced to a satisfactory level through use of suppressors (or special suppressor spark plugs) and the same kind of capacitors used in silencing auto engines.

Prices of the smallest permanent-type telephones start at just under \$300. An idea of the features available can be gained from the accompanying summary of the smallest models in the leading makes. In addition to the 'phone channels enumerated, all of them include broadcast reception—unless otherwise noted—and have press-to-talk hand microphones. To convert the drain wattages given in the table to current consumption at the various input voltages, divide the watts figure by battery voltage.

Your "yacht" doesn't have to be a 60-footer to carry two-way radio today. You can phone from your boat even if the only spare space is on your lap.

-30-

Manufacturer and Model	Channels	Frequencies (mc.)	Carrier Output (watts)	D.C. Input Voltages	Approx. Standby Drain (watts)	Approx. Transmitting Drain (watts)
APELCO: AE-18-A	6	2-6	11	6, 12	36	84
BENDIX: "Skipper 28"	6	2-5	15	6, 12	33	84
BLUDWORTH: BRT-1025	4	2-3	10	6, 12	39	90
HUDSON AMERICAN: "Privateer V"	4	2-3	8	6, 12	42	90
RAY JEFFERSON: Model 535	4	1.6-3.5	20	6, 12, 32	54	84
KAAR: Model 37	5	2-4.5	27	6, 12	30	150
MUNSTON: MRT-15	5	2-4.5 (no broadcast)	15	6, 12	60	120
PIERCE-SIMPSON: "Islander 30"	5	2-4.5	14	6, 12	23	108
RADIOMARINE: "Golden Sentry"	5	2-3	12	6, 12	33	102
RAYTHEON: RAY 10A	5	2-6	10	6, 12	39	84
SONAR: M35W	5	2-3.5	25	6, 12	15	90



# Super-Safe Testing Assures Survival at Supersonic Speeds

**H**ELPING human beings keep pace with the stepped-up tempo of machines in a supersonic age is one of the really big jobs being tackled by the experts using electronics.

The problem is many-sided, involving the obvious factor of safety to personnel within the framework of constantly rising hazards. A more subtle problem is the one which involves man's psychological reactions to machinery that literally moves faster—and has things going on at greater speeds—than most people are accustomed to. How can you be sure that a man's body will react to strain in time to make certain adjustments, when the strain might hit at supersonic speed?

In line with this safety factor is the question of developing better survival equipment, pressure suits, etc. The entire problem is a complex one, impinging on such former widely separated areas of study as physics and psychology.

Helping scientists bridge the gap between man and the new machines he is creating, and must learn to live with, are new and ingenious computers. For example, the Psychology Branch of the Wright Air Development Center's Aero Medical Laboratory has developed a machine that electronically computes various factors to permit an operator to control an airplane or missile traveling at Mach 2 (twice the speed of sound, or roughly, 1500 mph).

On another front in the battle for safety is a giant computing machine that enables engineers to "fly" jet planes before they are actually built. Control tests, performed behind the safety of a data processing board, can predict performance characteristics and smooth over "bugs" that could otherwise cost lives, dollars, and valuable time. This instrument was built for the Air Research and Development Command by General Electric. —30—

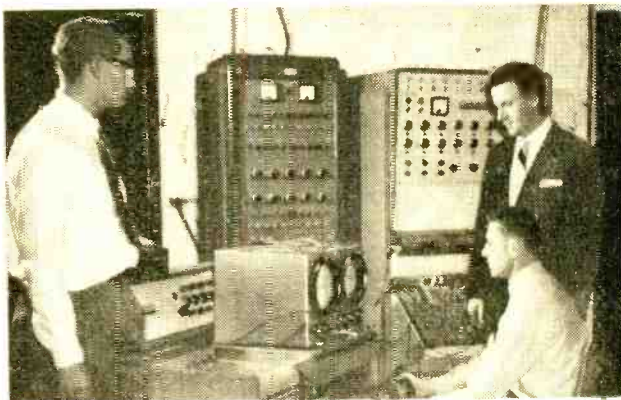

Testing a man's reactions to supersonic flight speeds by seating him at a computer is a lot safer than doing it by putting him into an unproved flying model. Data machines against wall compute factors that simulate flight at "Mach 2" speed.

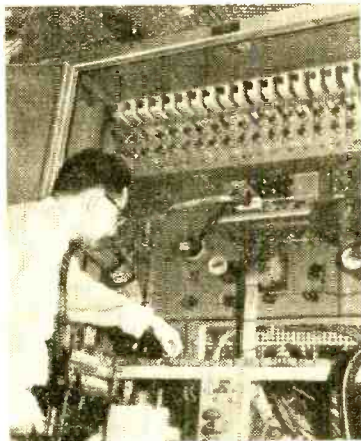

Engineer adjusts section of giant computer. Built by G.E., this equipment checks out advanced design jet engines before they are built. Millions of dollars, and two years time, are expected to be saved by its use. Twenty-seven miles of wire, 6000 vacuum tubes, 300,000 soldered connections, and an air-conditioning system are among its features.

Control console of jet engine simulator built by G.E. for the ARDC is shown below. Machine occupies floor space equivalent to three average dwellings. Controls, manned by special staff, include 1700 indicating lights and 2750 dials.

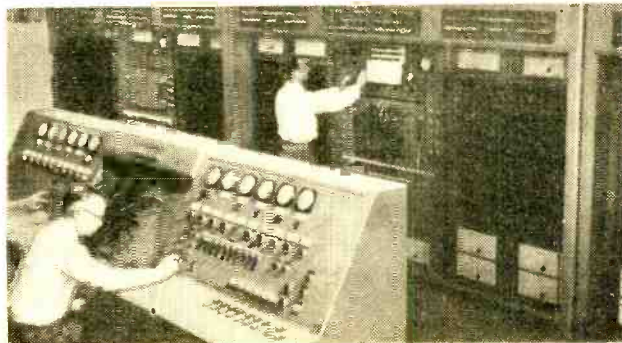

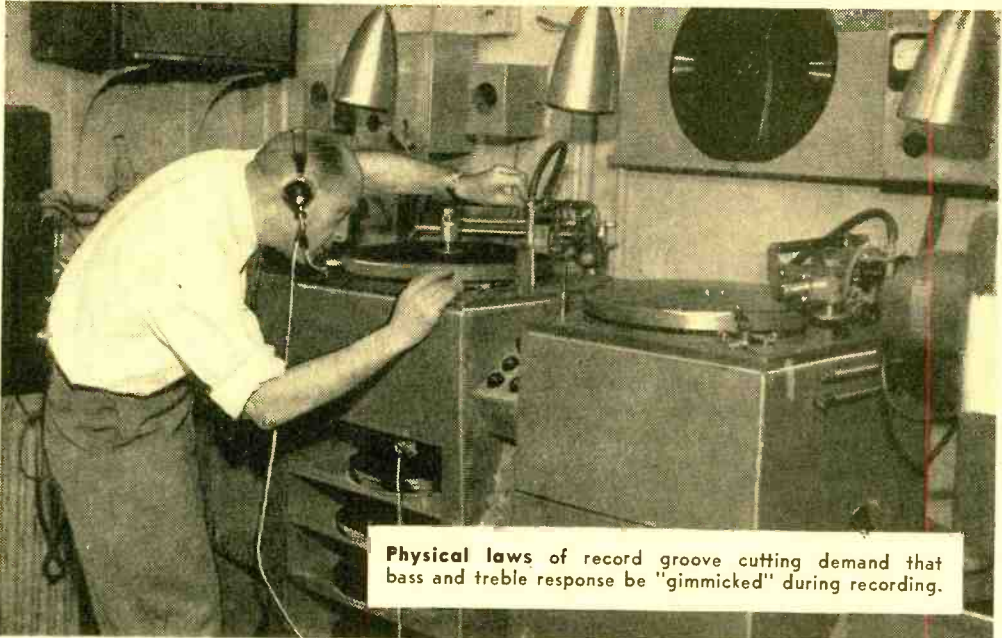

Physical laws of record groove cutting demand that bass and treble response be "gimmicked" during recording.

Photo, Courtesy Presto Recording Corp.

## Why We Equalize Our Hi-Fi

**R**ECORDS may be discs, but they're far from being "flat." The frequency response curve of a modern LP record shows a marked dip in the bass region and a definite rise in the treble area. Most listeners have experienced the "different" tonal quality of different recordings—played on the same hi-fi system with all controls left in the same positions.

Obviously, the hi-fi system may be "flat"—but not for every record. A new element of "unflatness" is introduced by the record itself. The "unequal" response is due to a deliberate skewing of the frequency curve gimmicked into the recording by the people who made it. During playback, the curve

By **LEON FIELDS**  
and **R. M. JOHNSON**

*To release completely  
all the music trapped in your  
record grooves, use  
the correct curve on playback*

must be counter-gimmicked, or "equalized." Once equalized, the recorded signal assumes the tonal balance it had when it was performed live originally.

If records were to be made without their frequency curves being deliberately "unflattened," there would be no need for equalization. But records are made "unflat" for very good reasons, which have a direct bearing on the quality and fidelity of the recorded music.

**Low-Frequency Turnover.** The record groove is made by a magnetic cutter. This device has an excellent frequency response but one major drawback—it tends to swing quite wide at low frequencies. If allowed to go unchecked, the magnetic cutter would describe a groove whose amplitude would be too great for practical use. Such a groove would take up too much space on the record; what's more, during playback the pick-

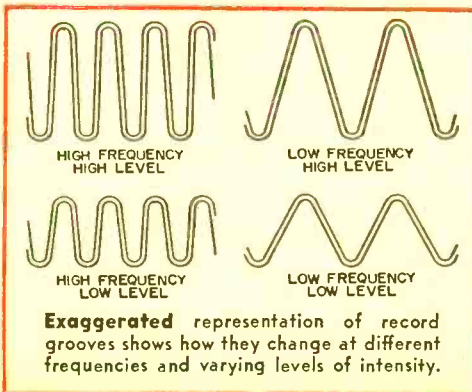



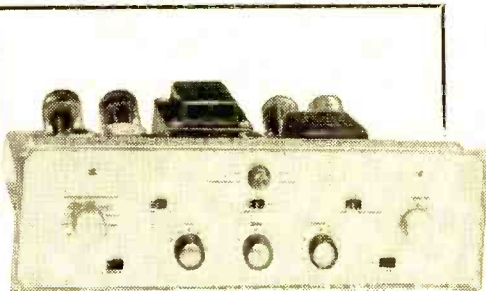
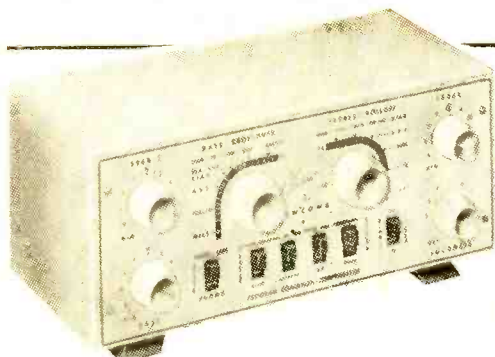

**Equalization** settings on representative amplifiers. Separate controls for turnover and roll-off are included on Newcomb "Classic" (above). Scott 99-B (upper right) has six equalization positions on input selector switch; simplification is achieved by grouping several similar curves under one heading. Altec "Melodist" (right) simplifies problem even further, with only four equalization settings on selector switch. General idea is to provide low-cost unit with enough versatility to handle most records.

up would have a very hard time indeed tracking such a groove.

To overcome these problems, the recording engineer resorts to a trick: he records all the bass notes but restricts the lateral excursions of the cutter doing the job. Consequently, frequencies below a certain point in the audio range (the "bass turnover" point) are actually recorded with less intensity than frequencies above that point. To hear them correctly, then, some kind of "boost" must be provided on playback. More of this later.

**Pre-Emphasis and Roll-Off.** As the low end of the audio band is restricted in amplitude on a record, so is the high end artificially boosted. At high frequencies, the magnetic cutter would produce grooves of such tiny amplitudes that the desired signal would be overwhelmed by noise—high-frequency noise from the cutting process itself and from the very structure of the record surface material. To obtain the added signal strength needed by the highs in order to ride over the noise, the recording engineer forces the cutter to describe grooves whose amplitudes are somewhat greater than they would be "normally."

The additional amplitude for these grooves is obtained by treble boost or "pre-emphasis" in the recording process. Frequencies above a certain point in the audio range (the treble "roll-off" point) are actually recorded with more intensity than frequencies below that point. To hear them correctly, some kind of high-frequency reduction, or cut, or "roll-off" must be provided on playback.

As a result of these bass and treble tricks

#### GLOSSARY OF TERMS

**Boost**—Increasing the amplitude, or relative intensity, of a signal from a completely flat or uniform level.

**Constant amplitude**—A method of record cutting in which the side-to-side, or lateral, excursions of the cutter are held to a fixed limit on the record. Also, a type of playback cartridge (specifically, a crystal or ceramic cartridge) in which changes in frequency correspond to changes in the amplitude of the groove being tracked.

**Constant velocity**—A method of record cutting where lateral speed of the cutting stylus is the same regardless of frequency. Also, a type of playback cartridge (magnetic) in which changes in frequency correspond to the changes in the lateral velocity of the tracking stylus.

**Cut**—Decreasing the amplitude of a signal from a flat level (opposite of "boost").

**Lateral excursion**—The side-to-side movement, or undulation, of either the cutting stylus or the playback stylus in following the record groove.

**Magnetic cutter**—A magnetic head, fitted with a cutting stylus, and driven by a high-powered amplifier. The cutter impresses the groove on a record.

**Playback**—Converting the recorded signal into sound by means of a pickup, amplifier, and speaker.

**Pre-emphasis**—Providing boost for treble frequencies above their normal intensity level. When used in recording, it must be equalized by roll-off during playback.

**Recording**—Converting live sound into a record by means of a microphone, amplifier, and magnetic cutter. The amplifier required to drive a cutter is of much higher power rating than that needed to drive a loudspeaker for playback.

**Roll-off**—Reducing the intensity of the recorded treble frequencies during playback. Roll-off is accomplished by a gradual—rather than sharp—decrease in treble intensity.

**Tracking**—The movement of a stylus as it follows the record groove.

**Turnover**—A frequency below which all bass notes are attenuated or reduced in amplitude during recording. Also, the same frequency below which all notes must be "boosted" during playback.

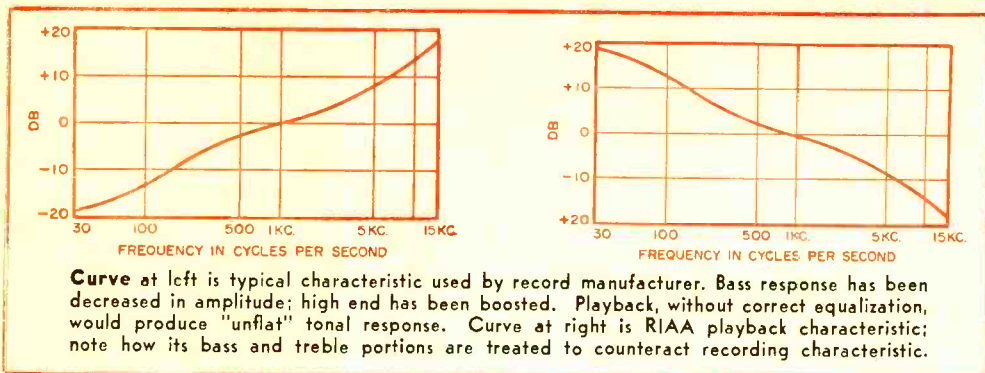

employed during the cutting of the record, the frequency curve impressed on the disc is anything but "flat." Such a curve, played back with no equalization, would produce very weak bass and screechy treble.

For proper playback, the bass must now be boosted, and the treble cut. The recording characteristic curve must be matched by its exact opposite—or inverse—curve. This curve, called the "playback equalization curve," is obtained from fairly simple circuits which are inserted after the cartridge in a playback system. Such circuits are invariably incorporated in all modern amplifiers.

**Why Different Curves?** A few years ago, when hi-fi recording came into its own with the development of improved equipment and record surface materials, engineers had to grapple with the problem of

extended frequency range. The methods of turnover and roll-off, just described, were given more attention.

The big trouble was the lack of universal agreement on selecting the exact frequency for bass turnover and the precise degree of treble roll-off. Objective considerations of stylus velocity and groove amplitude were often compounded and confounded with subjective opinions of "what sounded right." As a result, there were almost as many recording curves as there were recording companies. The table on this page lists the more prominent of these curves.

In mid-1953, the Recording Industry Association of America (RIAA)—an organization made up of nearly all the record manufacturers in this country—agreed on one curve to do the job. By May, 1954, the RIAA curve was adopted throughout the

SWITCH POSITION	FULL NAME OF CURVE	COMMENTS
AES	Audio Engineering Society	Dates from 1951.
BBC	British Broadcasting Corp.	Not used in USA.
COL	Columbia Records	Used prior to 1954.
DEC, or DEC-FFRR	Decca Records, British Div.	See "FFRR."
DEC-LON	Decca Records, London Div.	Similar to "COL" curve.
EMI-78	EMI Studios, Ltd., London	Used only in Great Britain.
EUR	"European"	Makeshift curve conforming to no specific recording characteristic, but approximating a playback curve for old foreign records.
FOR	"Foreign"	See "EUR."
FFRR	"Full frequency range recording"	Dates from 1949. "FFRR" is trade-mark of American Division, Decca.
HMV	"His Master's Voice"	RCA, British Div.
LON	London Records, Inc.	See "DEC-LON."
LP	"Long-playing"	See "COL."
NAB	National Ass'n. of Broadcasters	Dates from 1949.
NARTB	National Ass'n. of Radio and Television Broadcasters.	Evolved from old NAB curve; now taken to mean same as RIAA curve.
ORTHA	"Orthacoustic"	Similar to old NAB curve with response extending down to 30, and up to 15,000 cps.
ORTHO	"Orthophonic"	Used by RCA; same as RIAA curve.
POP	"Popular"	Another makeshift curve designed to boost bass and provide sharp treble roll-off; makes for "juke-box" effect.
RIAA	Recording Industry Association of America	The standard curve in the USA since 1954; same as NARTB and ORTHO (see text).

**Playback curves** that have been used in recent years. Each curve equalizes the pickup to provide a flat response for a given recording characteristic. Because of similarities among curves, many amplifiers group several curves under the same switch position. Such settings make for lower cost amplifiers and come close enough for practical use. Since mid-1954, all records made in the USA follow the RIAA curve.



industry. Virtually all new discs cut since then follow this curve.

The RIAA curve represents a carefully worked out compromise which combines the best features of all older curves. It is an excellent curve for recording, and when properly equalized on playback provides full frequency range, tonal balance, proper dynamics, etc.

**Equalization Settings.** The record collector may now ask: "What about my records made before the use of the RIAA curve? Don't I need at least two dozen different equalization settings on my playback equipment for them?"

Well, to be completely precise and scientific, you might need more than that. But let's be realistic—the table on this page shows the deviation of two widely used older curves from the new RIAA curve. Note that the average discrepancy in response is hardly more than 2 decibels. This figure constitutes about the lowest perceptible change in level that most human ears can detect under any circumstances.

True, we have picked two curves for comparison which are fairly close to the RIAA curve. But there is a significant pair of controls on your equipment to help solve the problem: the treble and bass tone controls. The range of compensation available on most hi-fi tone controls is wide enough to simulate any playback characteristic. A slight degree of bass or treble adjustment, superimposed on the RIAA response curve, will approximate or equal virtually any recording characteristic dreamed up by recording engineers.

Amplifiers which incorporate a variable equalizer control, with several control settings for different curves, simplify the job for you. All you have to do is select the correct equalization position for a given record. This position is stipulated by the record manufacturer or by the amplifier manufacturer.

Such a control is, of course, a great con-

FREQUENCY	AES	LP
30	-3.9	+4.6
50	-1.0	+3.7
100	+1.1	+1.6
300	+1.0	0.0
400	+0.8	-0.2
500	+0.7	-0.3
1000	0.0	0.0
2000	-0.4	+0.4
5000	-1.1	+1.3
10,000	-1.7	+1.8
15,000	-1.7	+0.4

Two widely used older curves were the AES and Columbia's LP. This chart shows the amount of error incurred when playing records made with such curves and using the new RIAA playback curve instead of the AES and LP curves theoretically required. Average discrepancy is about two decibels, scarcely audible. Bass control handles frequencies below 1000 cycles; treble, above 1000 cycles. Increase setting to compensate for minus error; decrease to compensate for plus error.

venience and provides a simple and accurate means of compensating for the particular recording curve used. The less costly amplifiers may have anywhere from three to six such equalization settings on one rotary switch. The more expensive units, particularly those which use a separate chassis for the preamp-control, may provide separate switches for five positions of turnover and five positions of roll-off, thus affording a total of  $(5 \times 5) = 25$  different playback curves.

Using an amplifier with a built-in variable record equalizer frees the treble and bass controls for the ultimate in subtle adjustments to suit all listening moods and room acoustics. This is a sometimes complex subject to be handled in a subsequent article. Also to be discussed in a future issue are the newer types of crystal and ceramic pickups which handle the problem of playback equalization in a different and quite intriguing way. -30-

## Accessories Clean, Store Records

**N**EW ACCESSORIES, designed to make life easier for hi-fi enthusiasts, and safer for their prized records, have been announced by Robins Industries Corp., 214-26 41st Ave., Bayside 61, N.Y. Shown in the photo is "Audio-File" AF-50—a series of suspended plastic containers. Each container is transparent and self-closing. Besides holding up to 50 records safely and keeping them free from warp-age, the unit permits you to file discs in any fashion. Retail price is \$24.99.

For cleaning records, Robins has produced "Jockey Cloth" SC-1. Chemically treated, the cloth eliminates the static charges on records that attract dust and grime. The cleaned record sounds better and lasts longer. Needle wear is also reduced. The cloth sells for \$1.00.

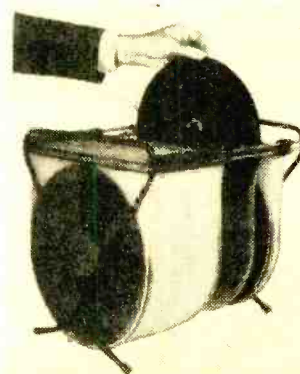

# It's a Cinch To Check Your Camera Synch

By  
**R. L. WINKLEPLECK**

The synch tester is used by looking through open back of camera and observing image of the shutter when it is tripped.

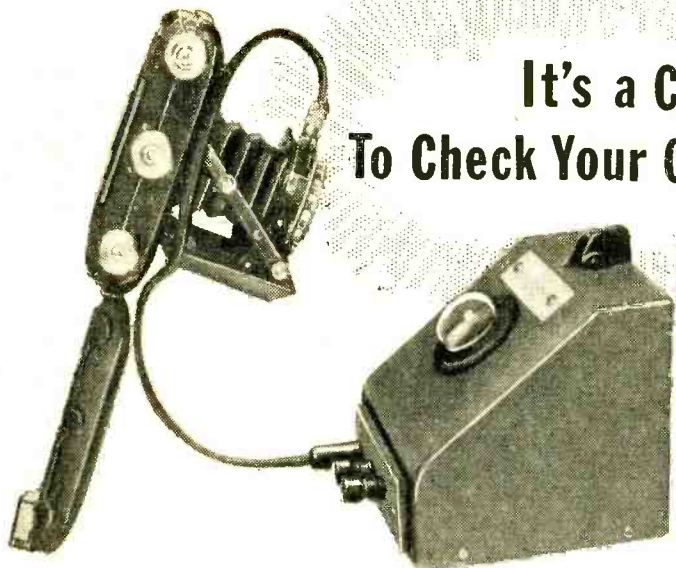

**A**LMOST EVERY amateur photographer must wonder many times whether or not his flash gun is properly synchronized with his camera shutter. For the benefit of the casual photographer, "synchronization" is the happy state when the camera shutter reaches its maximum opening simultaneously with the peak light output of the flash bulb. A few photographic repair shops have synchronization checking devices. Generally, however, an effort is made to match flash and shutter either by eye or by actually making a few test shots.

The average between-the-lens shutter is wide open for only a few thousandths of a second (milliseconds), and most flash bulbs are at rated output for a similarly short period. Consider further that the flash bulb reaches its rated output, not instantaneously, but either 5 or 20 milliseconds after the flash circuit is closed. If flash synchronization is to be even closely approached, an exact test method is needed.

## HOW IT WORKS

This circuit places a 150-volt charge across the OA4G tube's cathode and anode, which are shunted by a 1.0- $\mu$ fd. capacitor. The flash contacts of the camera or synchronizer, when closed, apply a voltage to the starter anode which triggers the tube instantly. This is the setting to use when synchronizing electronic flash guns that have a zero delay. When a resistance of 350,000 ohms is placed in the starter circuit, the tube flashes five milliseconds after the contacts are closed to match the delay of Class "T" flash bulbs such as SF and SM. By increasing this resistance to 1.5 megohms, a delay of 20 milliseconds is achieved which corresponds to that found in Class "M" flash bulbs such as Press 25 and #3. Power for the OA4G is supplied by a simple rectifier circuit consisting of *SRI*, *CI* and *R<sub>o</sub>*.

Probably not one flash gun in fifty in use today is really and truly synchronized. In most instances, peak flash brilliance and open shutter occur closely enough to produce a picture. However, a lot of valuable flash light is wasted. This means that money must be spent on large bulbs when small, less expensive ones would do the job, or else it's necessary to use a large aperture when a smaller one with greater depth of field would give a better picture. It means standing too close to the subject to get enough light and, even worse, it frequently means underexposed negatives.

**Here is a straightforward design** for an electronic flash synchronization tester which is entirely accurate and so simple that almost anyone with a soldering iron can put it together in an evening. Best of all, the essential parts cost well under ten dollars—and this figure can be easily chopped in half by digging into the ever-present junkbox.

The heart of the tester is an OA4G cold-cathode thyatron tube which emits a weak, blue-white light when it is "triggered." It has especial merit for this job since it flashes very dependably under a given set of conditions and the flash is of very short duration. Light intensity is increased in this application by temporarily overloading the tube.

Wiring the tester is simplicity itself. Lead length or arrangement is unimportant. It's only necessary to observe good construction practice. By taking advantage of the otherwise unused tube-socket connections, most of the parts can be soldered directly to the socket. This may



conveniently be done before the socket is fastened in place. The flash contact posts and the triple-throw switch provide additional tie points. Be sure to observe correct polarity of the electrolytic capacitor.

**To use the synch tester,** attach the camera or synchronizer flash contacts to the tester's contact posts. Open the aperture wide and set the shutter at the speed recommended for flash. Open the back of the camera and aim the lens at the OA4G. When shutter is tripped, tube will fire.

Watch through the open back of the camera and, if the synchronization is perfect, the light of the tube will be seen through the wide-open lens. If the synchronization is nearly right, the light will



Binding posts and sockets on front panel permit connections of various types of camera flash cords.

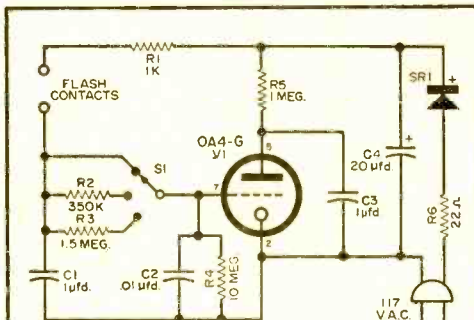

- C1, C3—1- $\mu$ fd. capacitor  
 C2—.01- $\mu$ fd. capacitor  
 C4—20- $\mu$ fd., 150-volt electrolytic capacitor  
 R1—1000-ohm, 1-watt resistor  
 R2—350,000-ohm,  $\frac{1}{2}$ -watt resistor  
 R3—1 $\frac{1}{2}$ -megohm,  $\frac{1}{2}$ -watt resistor  
 R4—10-megohm,  $\frac{1}{2}$ -watt resistor  
 R5—1-megohm,  $\frac{1}{2}$ -watt resistor  
 R6—22-ohm,  $\frac{1}{2}$ -watt resistor  
 S1—1-pole, 3-pos. switch (Centralab Type 1461)  
 SR1—65-ma. selenium rectifier  
 V1—OA4G tube  
 1—Octal socket  
 2—Binding posts

Schematic wiring diagram and parts list.

shine through the partially open lens with the individual leaves of the shutter outlined in sharp detail. The extremely short flash duration stops shutter motion dead.

Slight adjustment of the synchronization will show whether the shutter is opening early or late, and a bit more adjustment will put it right on the nose. If no light can be seen through the lens, the synchronization is way off and adjustment will gradually bring shutter and flash into alignment. It's as simple as that.

This tester can be put together as a breadboard layout, but it will be more satisfactory housed in any convenient size and shape of box. An inclined front meter box is very good, and the addition of several receptacles to take the various types of flash cords serves to make the unit quite versatile.

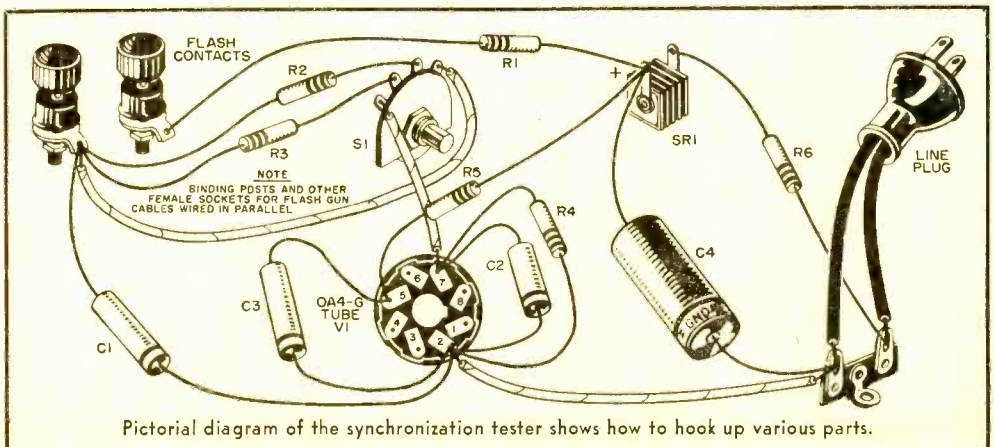

Pictorial diagram of the synchronization tester shows how to hook up various parts.

# TOOLS and GADGETS



## STEEL SLIDE FOR RECORD CHANGERS

A low-cost sliding device for record changers and tape recorders now makes it possible to pull out these units to their full

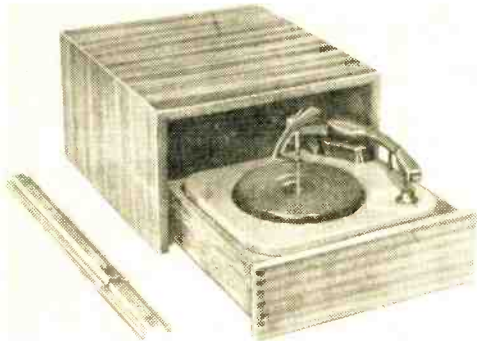

depth, thus providing easy access for proper operation. It is supplied with neoprene mountings which cushion the transmission of vibration and shock, and features a quick release and a positive-lock stop. Only one such device is required for each instrument—eliminating the need for careful alignment, and reducing installation costs. (*Steel Slides, Inc.*, Dept. SS310-12, 1 Lawton St., Yonkers, N. Y.)

## HOT WIRE STRIPPER

Wherever a hand stripper is needed for plastic insulated wire, you can use this hot wire stripper to advantage. With a heated nichrome wire to sever the insulation, a simple twist of the wrist cleanly strips the

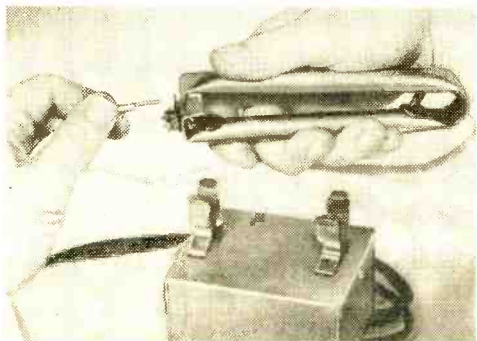

wire. It is impossible to cut or nick even the finest wire strands since no sharp blades are used.

Made from durable stainless steel tubing, the stripper unit is lightweight and easily

operated. Power is supplied from the regular 117-volt a.c. supply through a step-down transformer housed in a grey metal box. Also provided are an "on-off" switch and a handy metal clamp for holding the stripper when it is not in use. Price, \$18.95. (*Western Electronic Products Co.*, 655 Colman St., Altadena, Calif.)

## "DO-IT-YOURSELF" TUBE TESTER

You can test your own TV and radio tubes—and even your picture tube—easily and safely with this A.B.C. tester. Just plug the lead cord into any a.c. or d.c. outlet, insert the tube in the socket, and the pilot light on the tester will instantly indicate whether the tube needs to be replaced. If the test light fails to go on, the tube is bad. One service call saved will pay for this precision instrument which is housed in a



rugged metal case. Only \$3.95 postpaid, or c.o.d. plus charges. (*Omega Electronics*, 4700 W. Washington Blvd., Chicago, Ill.)

## RADIO OR TV VOLUME CONTROL

"Tello" automatically turns down your radio's volume as you pick up the telephone—when you finish talking, the original volume is restored. "Tello" is a device which clips onto the telephone stand; its two leads are connected to the speaker terminals of the radio or TV set. Lifting the receiver activates the device by shunting a suitable load across the speaker voice coil. Replacing the telephone receiver cuts out the "Tello" action. Retail price, \$5.79. (*Tello Corp.*, 342 Madison Ave., New York 17, N. Y.)

## BRASS CLIP FOR TAPE REELS

"Magi-Clip" keeps recording tape from unreeling. A non-magnetic brass clip, it holds the tape securely and reduces tape wear. Snapping over one flange of a tape reel, it lets you handle, mail or store neat

(Continued on page 104)





"Table-model" hearing aid, vintage 1924, weighed about 124 lbs. This pioneer design by Radioear Corporation created a sensation in its day by allowing two hard-of-hearing people to conduct normal office work, such as dictation, with one another. The telephone was also wired into the audio amplifier, flashing a light whenever the bell rang.

By contrast, the latest model by the same company (below), is completely contained in ear pieces of glasses—including microphone and battery.

**M**ODERN hearing aids are a direct outgrowth of radio. Both are based on the same principles of sound amplification through vacuum tubes. The development of hearing aids has largely paralleled that of radio in the growing electronic sophistication of circuits as well as in their physical design.

Back in the nineteen-twenties, people with impaired hearing first discovered that they could understand spoken words far better on the radio through earphones, turning up the volume control. The idea then suggested itself to construct electronic amplifiers exclusively for the improvement of hearing. These early models were huge six-foot table-type monsters powered by 6-volt automobile batteries and huge 135-volt B batteries.

As radio components grew progressively smaller over the years, the bulk of hearing aids sprang to the portable dimensions of a small suitcase and later to the still familiar pocket models.

The next step in miniaturization came in 1953 when transistors took the place of the relatively large and fragile tubes. This also eliminated the need for the B battery since transistors need only an A battery to function. It is historically noteworthy that these hearing aids were the first commercial application of the then newly developed transistor.

The pictures on this page are dramatic proof of the miniaturization achieved in hearing aids, which set the trend for all fields of electronic design.

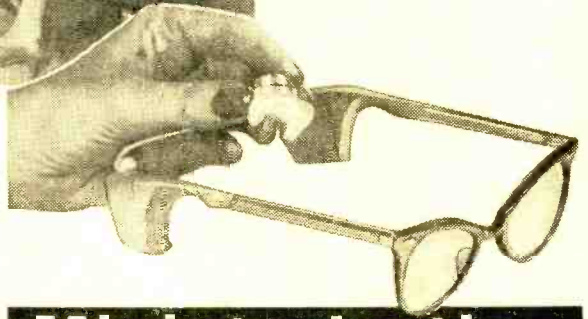

## Miniaturization Shrinks Hearing Aids

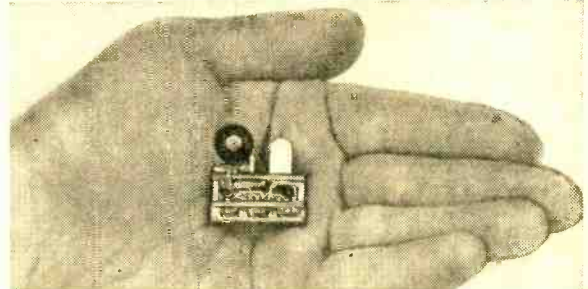

**Heart** of the modern eyeglass hearing aid is this tiny three-transistor amplifier (above) weighing less than half an ounce. Black "knob" on left is volume control which protrudes through slot in case. Next to it is the clip, which holds a battery of aspirin tablet size that lasts about 130 hours. Battery is shown in center of picture below, flanked by a dime and the former battery model for size comparison.



reel without fear of either unwinding or wrinkling.

You can apply or remove a "Magi-Clip" with one hand. Fitting any size of reel, it can be used on either full or slightly less

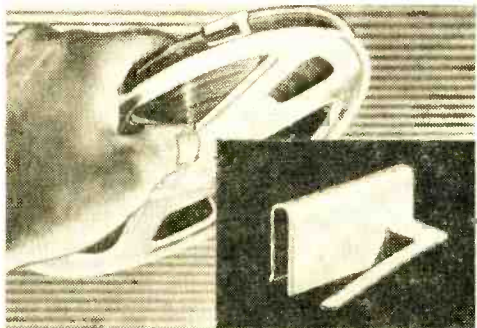

than full reels. Four for \$1; 10 for \$2; 30 for \$5. (Niblack Thorne Co., Dept. P-1, Box 86, Scottsdale, Arizona)

### SCINTILLATION COUNTER FOR CARS

If you want to go prospecting in an automobile—this is for you! The built-in loudspeaker of the Model 143 scintillation counter starts giving out a tone when your car is driven in the vicinity of a radioactive deposit (i.e., when a preset gamma radiation level is reached). And the sound increases in pitch proportionately as your car

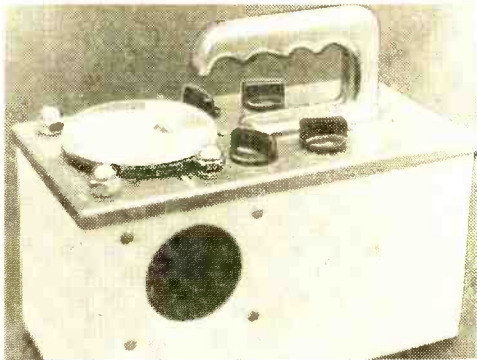

comes closer to the deposit (when the preset level is exceeded).

The Model 143 can be used with headphones in an airplane or in a noisy place, and it features a built-in battery tester that individually tests each battery in a few seconds. It has an eight-range sensitivity switch and five time constants. All tubes are of the plug-in type and most of them can be obtained at any radio store. (Gardiner Electronics Co., Phoenix, Arizona)

### TRANSISTOR RADIO KIT

Listing at only \$8.95, the "Trans-Atomic" transistor radio kit features matched germanium transistor and diode, calibrated

slide rule dial for precision tuning, world-famous "Loopstick" for added power, and an unbreakable palm-sized plastic case. The set will operate for months on its self-contained 10-cent flashlight batteries. It can be assembled in one evening with only a screwdriver. (Superior Electronics Corporation, 4-6 Radford Place, Yonkers, N. Y.)

### "PUSH-PULL" ELECTRIC PLUG

Wiring is easy and fast (five seconds) with the Jiffy "Push-Pull" plug. There are no moving parts to misalign or get out of order, and it is said to give eight times the contact area of a standard automatic plug. Common No. 18 parallel cord is pushed through one slot into the other and then pulled tightly—that's all it takes.

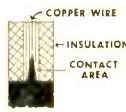
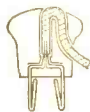
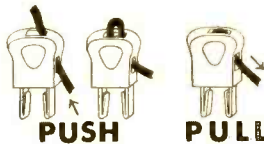

A metal wedge 3/16" long enters directly into the cord end, without piercing any insulation. The cord comes from the side of the plug where it should be; so it lies close to the wall, out of the way. The plug is available in brown or ivory Bakelite. (Eagle Electric Mfg. Co., Inc., 23-10 Bridge Plaza South, Long Island City 1, N. Y.)

### "SEE-THRU" DRAWER CABINETS

If you're a find-it-yourselfer as well as a do-it-yourselfer, you'll appreciate the STAK-UP "See-Thru" drawer cabinets which keep contents dust-free, easily accessible, and in full view at all times. The drawers are made of heavy-gauge clear plastic. An interlocking feature lets you stack each cabinet quickly and safely to any practical height. The sturdy metal cabinet frames come in five different colors to match most office and workshop decors. Removable dividers provide three compartments in each drawer. Two different models are available: No. ST-130 has one double and two single drawers, and No. ST-150 offers the double and four single drawers. (Jayem Sales Corporation, 31 Coffey St., Brooklyn, N. Y.)

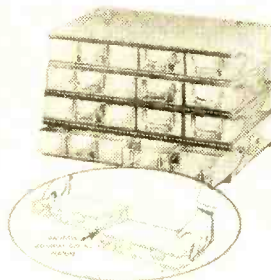



# TIPS and TECHNIQUES

## AMMETER CONVERTS TO VOLTMETER

By connecting a suitable resistor in series with the meter element, an ammeter may be converted into a voltmeter. The photo shows a 15-milliamperere meter with a 1000-

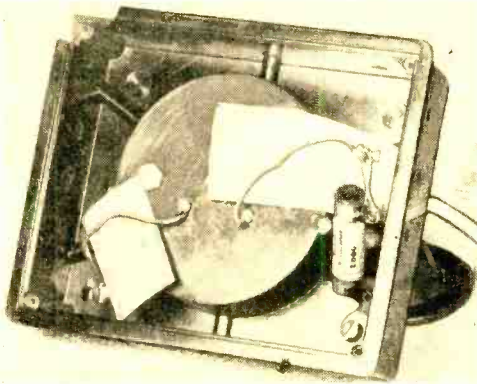

ohm resistor connected to it. The scale to be used for measuring volts will, of course, be the 0-15 scale.

To convert this scale, use Ohm's law:

$$R = E/I$$

$$R = 15/.015$$

$$R = 1000 \text{ ohms.}$$

Similarly, a 10,000-ohm resistor in series with the meter element converts the meter for measuring up to 150 volts. —H.L.

## "SELF-STIRRING" ENAMELS

It is not unusual to find several cans of enamels or varnishes in the typical electronics workshop. Glossy enamels and crystalline and wrinkle varnishes are used for finishing metal panels and cabinets. Thick "undercoat" varnishes serve as reflocking for phono turntables. Conventional varnishes and paints may be applied for finishing radio and TV cabinets as well as loudspeaker enclosures.

In most cases, these finishes are used at infrequent intervals, with the result that the pigments tend to settle in the bottoms of the cans.

You can convert your cans of enamels and varnishes into "self-stirring" cans simply by adding a half-dozen or more pieces of heavy buckshot. Steel balls from discarded ball bearings will also do nicely. Use

balls with at least a ¼" diameter. If you prefer buckshot, use at least the #00 size, or larger.

With buckshot or balls added, a vigorous



shaking of the can prior to use will do a topnotch mixing job. —L.E.G.

## EASILY MADE MOUNTING HOLES

Laying out mounting holes on a chassis for transformers, chokes, and other components can be an easy job.

Take any two short, equal lengths of metal strips and bolt them together at one end to form a "V" (see drawing). A bolt and wing nut will hold them in place. Two 4"

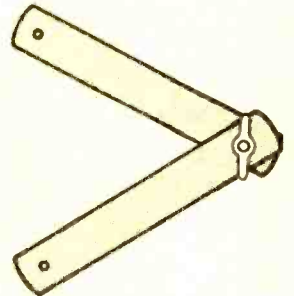

pieces of aluminum strip with ⅛" holes drilled ½" from both ends work fine—so do the strips from an Erector set. To use the "V," spread the pieces till the holes match those on the part being mounted. Transfer the "V" to the desired mounting place on the chassis, mark the holes and drill. You'll find this to be an accurate method. —B.E.

## TIN FOIL AIDS TV RECEPTION

If the picture on your TV set is marred by interference from an FM station or any other nearby transmitter, here is an easy stunt that may effect an improvement.

Wrap a 2" x 2" length of household aluminum foil snugly around the twin-line antenna lead where it is connected to the set. Slide the foil slowly along the twin line in the direction of the antenna while watching the TV picture for an improvement. What you are actually doing is using the inductance and capacitance of the twin line and the foil to tune out the interference.

When the point of best reception is found,

squeeze the foil tightly around the twin line and tape it in place. Wrap a second piece of foil around the twin line on the antenna side of this point and move it along the line toward the antenna, as before, until a second point of improvement is found. Squeeze and tape this one in place. If desired, additional pieces of foil may be added in the same manner.

### NEW USES FOR OLD COAX INSULATION

Old coaxial insulation can be used to advantage in many applications. Large insulation, such as is used on RG8/U, provides

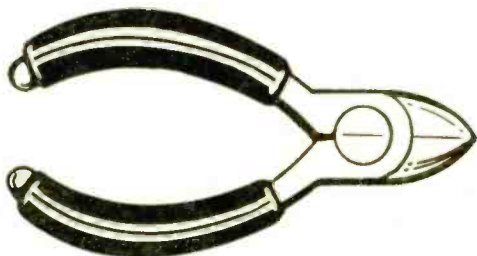

insulated handles for tools. Simply cut to desired length and slip over handle.

The inner covering can serve to insulate small screwdrivers. Melt the end with a



soldering iron to keep the insulation firmly in place on the shank.

Another use for outer insulation is as a substitute for spaghetti. Also, two pieces of spaghetti can be joined with coax insulation to form a continuous connection.

Holes in the workbench can be filled in with insulation. Melt enough to fill the hole, stuff it in, and wait for it to cool. Then file off the excess until the insert is flush with the bench surface.

And finally, feedthrough insulators and grommets can be fashioned from the coax insulation. —D.M.D.

### PAPER-BOX CHASSIS

It is customary to use a breadboard when hooking up temporary circuits. But some-

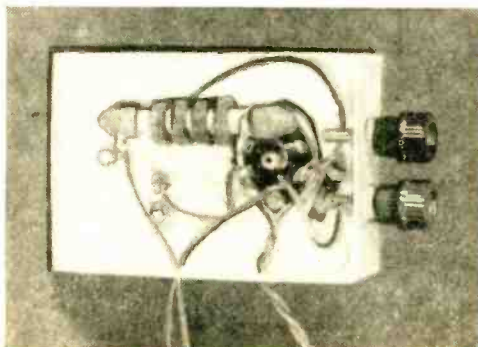

times the flatness of breadboard-type construction is not nearly as desirable as the "boxiness" of chassis-type construction. However, chassis work involves drilling and cutting and expensive spoilage.

A simple solution is to use a cardboard box for the experimental chassis. You can work it with scissors, knife, scratch awl, and razor blade. No hard drilling, sawing, filing, or cutting is required. If you don't need the shielding that a metal chassis provides and if your circuit components won't get hot enough to set paper on fire, the paper box chassis works fine. The accompanying photograph shows a box-mounted Pierce crystal oscillator. —R.P.T.

### SOURCE OF SUBMINIATURE WIRE

Sizes #20 and #22 hookup wire, popular for conventional wiring and circuit assembly, are much too large for proper wiring of subminiature circuits, such as are used in hearing aids, tiny radios, transistor gadgets, and similar devices. Unfortunately, few parts distributors stock hookup wire in really small gauges, and the limited stock that is available is generally priced quite high.

But if you've a typical shop, you have a ready and *inexpensive* source of subminiature wire already in stock. *Simply strip moderate-size stranded wire!* The resulting



fine wire may be used bare, or may be given several coats of clear plastic (simply by dipping) for insulation. For moderate and higher voltage insulation, use small-size spaghetti tubing. —L.E.G.

### FULLY ERASED TAPE

When making a new recording on a tape containing a previously recorded program whose signal level is fairly loud, the erase head on some home machines may not completely erase the original recording. This program then remains in the background under the new recording. It is well known that in such cases the old recording can be erased satisfactorily by running the tape through the machine prior to making the new recording, with the controls set for

(Continued on page 112)



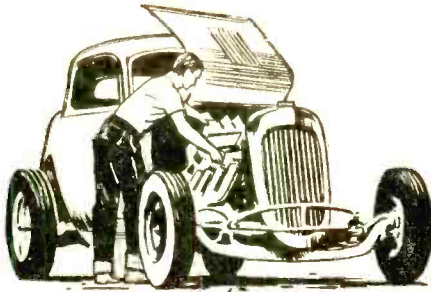

**MECHANICAL  
SKILLS  
CAN GET  
YOU  
AHEAD  
IN THE  
U. S.  
AIR FORCE**

**Here's why —**

If you're interested in mechanics, join the U. S. Air Force. As an Airman you may develop your technical ability and learn a skill that will pay well...and win you extra stripes. Such interesting career fields as Aircraft and Engine Maintenance, Rocket Propulsion and Intricate Equipment Maintenance are open to you, if you qualify. Don't delay—see your local Air Force Recruiter or mail the coupon.



**PASTE COUPON ON POSTCARD  
and mail to**

M-19-PE4

**YOU GO  
PLACES  
FASTER  
IN THE  
U. S. AIR FORCE**

AIRMAN RECRUITING INFORMATION BRANCH  
BOX 2202, WRIGHT-PATTERSON AFB, OHIO

Please send more information on my opportunities for enlisting in the U. S. Air Force. I am between the ages of 17-34 and reside in U. S. A. or possessions.

NAME \_\_\_\_\_

ADDRESS \_\_\_\_\_ AGE \_\_\_\_\_

CITY \_\_\_\_\_ ZONE \_\_\_\_\_ STATE \_\_\_\_\_

*build your own*

# HEATHKIT



*... and have fun doing it!*

Circuit boards cut assembly time in half

1% resistors insure instrument accuracy.

High impedance and high sensitivity.

Attractive styling—functional design.

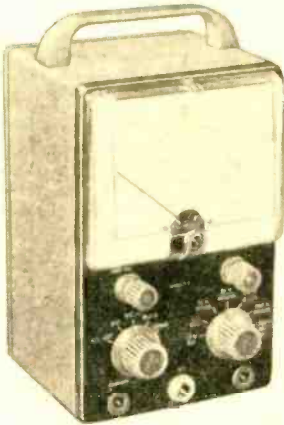

MODEL V-7A

**\$24<sup>50</sup>**

SHIPPING WT. 7 LBS.

Every Heathkit comes complete with detailed step-by-step instructions and large pictorial diagrams that insure successful construction—even for the beginner. Enjoy both the satisfaction and the economy of "building it yourself."

*etched circuit vacuum tube*

## voltmeter kit

In addition to measuring AC (rms), DC, and resistance, the modern-design V-7A incorporates facilities for peak-to-peak measurements. These are essential in FM and television servicing.

AC (rms) and DC voltage ranges are 1.5, 5, 15, 50, 150, 500, and 1500. Peak-to-peak AC voltage ranges are 4, 14, 40, 140, 400, 1400, at 4,000. Ohmmeter ranges are X1, X10, X100, X1000, X10K, X100K, and X 1 megohm. A db scale is also provided. Polarity reversing switch provided for DC measurements, and zero center operation is within range of the front panel

controls. Employs a 200 microampere meter for indication. Input impedance is 11 megohms.

Etched metal, pre-wired circuit boards insure fast, easy assembly and result in reliable operation. Circuit board is 50% thicker for more rugged physical construction. 1% precision resistors used for utmost accuracy.

### *Heathkit*

#### HANDITESTER KIT



MODEL M-1  
**\$14<sup>50</sup>**

Shpg. Wt. 3 lbs.

The Model M-1 measures AC or DC voltage at 0-10, 30, 300, 1000, and 5000 volts. Measures direct current at 0-10 ma and 0-100 ma. Provides ohmmeter ranges of 0-3000 (30 ohm center scale) and 0-300,000 ohms (3000 ohms center scale). Features a 400 microampere meter for sensitivity of 1000 ohms per volt. Handy and portable. Will fit in your coat pocket, tool box, glove compartment, or desk drawer.

### *Heathkit* VOM KIT

20,000 ohms/v. DC and 5,000 ohms/v. AC sensitivity. Ranges (AC and DC) are 0-1.5, 5, 50, 150, 500, 1500, and 5000 v. Direct current ranges are 0-150 ua, 15 ma, 150 ma, 500 ma, and 15 a. Resistance ranges provide center-scale readings of 15, 1500 and 150,000 ohms. DB ranges cover -10 db to  $\pm 65$  db.

Features  $4\frac{1}{2}$ " 50 ua meter and 1% precision resistors.



MODEL MM-1

**\$29<sup>50</sup>** Shpg. Wt. 6 lbs.

**HEATH COMPANY** A Subsidiary of Daystrom, Inc.  
BENTON HARBOR 5, MICHIGAN



## Heathkit 3" oscilloscope kit

ETCHED CIRCUIT

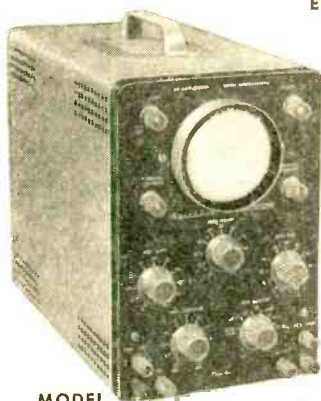

MODEL  
OL-1

**\$29.50** Shpg. Wt.  
14 Lbs.

This compact little oscilloscope is just the ticket for use in the ham shack or home workshop. Measures only 9½" H. x 6½" W. x 11¾" D. Weighs only 11 pounds.

Employing etched metal circuit boards, the Model OL-1 features vertical response with in  $\pm 3$  db from 2 cps to 200 kc. Vertical sensitivity is 0.25 volts rms per inch, peak-to-peak, and sweep generator operates from 20 cps to 100,000 cps. Provision for direct RF connection to deflection plates. Incorporates many features not expected at this price level. The 8-tube circuit features a type 3GP1 cathode ray tube.

Push-pull vertical and horizontal amplifiers.

Light weight and small size for portability.

Good sensitivity and broad frequency response.

Etched metal circuit boards for simplified assembly.

Attractive panel and case styling.

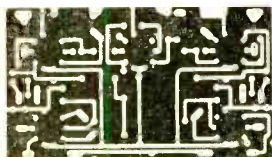

Cathode-follower output for isolation.

No oscillator calibration required.

Covers 160 kc to 220 mc (including harmonics).

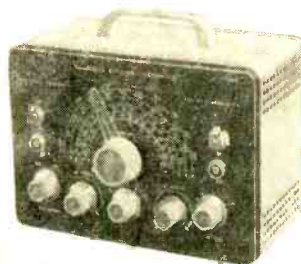

Heathkit

## signal generator kit

This signal generator covers 160 kc to 110 mc on fundamentals in 5 bands. Calibrated harmonics extend its usefulness up to 220 mc. The output signal is modulated at 400 cps, and the RF output is in excess of 100,000 microvolts. Output controlled by both a continuously variable and a fixed step attenuator. Audio output may be obtained for amplifier testing.

MODEL  
SG-8

**\$19.50**

Shpg. Wt.  
8 Lbs.

This is one of the biggest signal generator bargains available today. The tried and proven Model SG-8 offers all of the outstanding features required for a basic service instrument or for use in experimenting in the home workshop. High quality components and outstanding performance. Easy to build, and no calibration required for ordinary use.

Heathkit

## grid dip meter kit

This extremely valuable instrument is a convenient signal source for determining the frequency of other signals by the comparison method. Range is from 2 mc to 250 mc. Uses 500 ua meter for indication, and is provided with a sensitivity control and headphone jack. Includes prewound coils and rack. For hams, experimenters, and servicemen.



MODEL GD-1B

**\$19.50**

Shpg. Wt. 4 Lbs.

Heathkit ANTENNA

## impedance meter kit

Used in conjunction with a signal source, the Model AM-1 will enable you to measure RF impedance. Valuable in line matching, adjustment of beam and mobile antennas, etc. Will double as a phone monitor or relative field strength indicator. A 100 micro-ampere meter is employed. Covers the impedance range from 0 to 600 ohms. An instrument of many uses for the amateur. Easily pays for itself through the jobs it will perform.



MODEL  
AM-1

**\$14.50** Shpg. Wt.  
2 Lbs.

**HEATH COMPANY** A SUBSIDIARY OF  
DAYSTROM, INC.

BENTON HARBOR 5, MICHIGAN

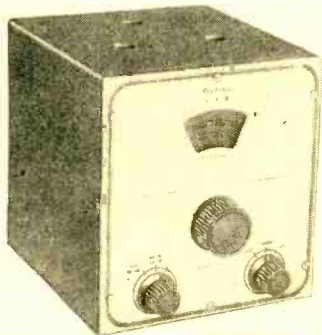

MODEL VF-1

**\$19.50**

Shpg. Wt. 7 Lbs.

a socket on the Heathkit Model AT-1 transmitter, or supplied with power from most transmitters.

Features illuminated and pre-calibrated dial scale. Cable and plug provided to fit crystal socket of any modern transmitter.

## Heathkit vfo

### KIT

This variable frequency oscillator covers 160-80-40-15-11 and 10 meters with three basic oscillator frequencies. RF output is better than 10 volts average on fundamentals. Enjoy the convenience and flexibility of VFO operation at no more than the price of crystals. May be powered from

- ☆ 6AU6 electron-coupled oscillator.
- ☆ 0A2 voltage regulator tube for stability.
- ☆ Smooth-acting illuminated dial.
- ☆ Easy to build and attractively styled.

Extra features include copper-plated chassis, ceramic coil forms, extensive shielding, etc. High quality parts!



### SPECIFICATIONS:

RF Amplifier Power Input... 25-30 watts  
Output Connection... 52 ohms  
Band Coverage... 80, 40, 20,  
15, 11, 10 Meters

### Tube Complement:

5U4G... Rectifier  
6AG7... Oscillator-Multiplier  
6L6... Amplifier-Doubler

## Heathkit CW amateur transmitter kit

This CW transmitter is complete with its own power supply and covers 80, 40, 20, 15, 11, and 10 meters. Incorporates such outstanding features as key-click filter, line filter, copper plated chassis, pre-wound coils, and high quality components. Em-

### MODEL AT-1

**\$29.50**

Shpg. Wt.  
15 Lbs.

ploys a 6AG7 oscillator, 6L6 final amplifier. Operates up to 30 watts plate power input.

Single-knob band-switching for 80, 40, 20, 15, 11 and 10 meters.

Plate power input  
25-30 watts.

Panel meter monitors final grid or plate current.

Best dollar-per-watt buy on the market.

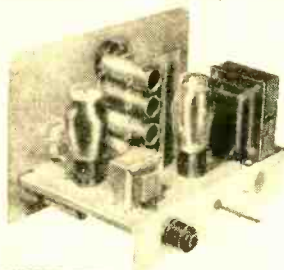

Slide-rule dial-electrical band-spread-ham bands marked.

Slug-tuned coils and efficient IF transformers for good sensitivity and selectivity.

Transformer-operated power supply for safety and high efficiency.

## Heathkit COMMUNICATIONS TYPE all band receiver kit

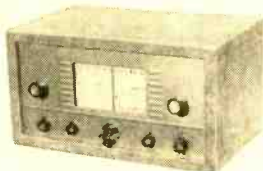
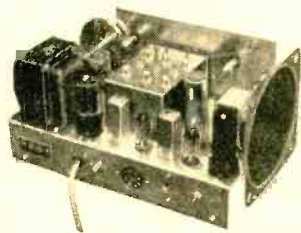

**\$27.95**

### MODEL AR-3

Shpg. Wt. 12 Lbs.

CABINET: Fabric-covered cabinet available. Includes aluminum panel, speaker grille, and protective rubber feet. Measures 12-1/4" W. x 8-3/4" H. x 7-3/4" D. No. 91-13. Shpg. Wt. 6 Lbs. \$4.50.

The Model AR-3 covers from 550 kc to 30 mc on 4 bands. Covers foreign broadcast, radio hams, and other interesting short wave signals.

Features good sensitivity and selectivity. Separate RF and AF gain controls—noise limiter—AGC—VFO, headphone jack—5 1/2" PM speaker and illuminated tuning dial.

### SPECIFICATIONS:

Frequency Range... 550 kc to 30 mc on four bands

Tube Complement... 1—12BE6 oscillator and mixer

1—12BA6 IF amplifier

1—12AV6 second detector, AVC, first audio amplifier and reflex BFO

1—12A6 beam power output

1—5Y3 full wave rectifier

**HEATH COMPANY** A SUBSIDIARY OF DAYSTROM, INC.  
BENTON HARBOR 5, MICHIGAN



HEATHKIT ECONOMY 7-WATT  
HIGH FIDELITY  
**amplifier  
kit**



**MODEL A-7D**  
\$16.95 Shpg. Wt.

This is a 7-watt high fidelity amplifier that will produce more than adequate output for normal home installations. Its frequency characteristics are  $\pm 1\frac{1}{2}$  db from 20 to 20,000 cps. Output transformer is tapped to match speakers of 4, 8, or 16 ohms. Separate bass and treble tone controls provided. Features potted transformers, push-pull output, and detailed construction manual for easy assembly.

**MODEL A-7E:** Provides a preamplifier stage with two switch-selected inputs and RIAA compensation for low-level cartridges. Preamplifier built on same chassis as main amplifier. Model A-7E. Shipping weight 10 lbs. **\$18.50.**



**Free 52-Page 1956 Catalog**  
Describes more than 65 interesting "build-it-yourself" projects. Amateur equipment, hi fi amplifiers, and the complete Heathkit line of test instruments. Get yours today!

HEATHKIT BROADCAST BAND  
**receiver  
kit**



**MODEL BR-2**  
Shpg. Wt. **\$17.50** Less Cabinet  
10 Lbs.

You can build this table model radio and learn about radio circuit and parts during assembly. Complete instructions simplify construction, even for the beginner. Covers 550 to 1600 kc and features miniature tubes,  $5\frac{1}{2}$ " PM speaker, and built-in antenna.

**CABINET:** Fabric-covered plywood cabinet as shown. Parts #91-9, shipping wt. 5 lbs. **\$4.50**

HEATHKIT HIGH FIDELITY  
**fm tuner kit**



**MODEL FM-3**  
**\$24.50**  
Shpg. Wt. 7 Lbs.

Tunes from 88 to 108 megacycles and features sensitivity and selectivity not expected at this price level. Cabinet supplied with the kit. Built-in power supply and a stage of audio to insure adequate output. Easy to build from step-by-step instructions and large pictorial diagrams.

MAIL TO **HEATH COMPANY** A Subsidiary of Daystrom, Inc. **BENTON HARBOR 5, MICH.**

order  
blank

From \_\_\_\_\_  
\_\_\_\_\_  
\_\_\_\_\_

- SHIP VIA**
- Parcel Post
  - Express
  - Freight
  - Best Way

PLEASE PRINT

QUANTITY	ITEM	MODEL NO.	PRICE

Enclosed find ( ) check ( ) money order for \_\_\_\_\_ pounds. On Express orders do not include transportation charges — they will be collected by the express agency at time of delivery. Please ship C.O.D. ( ) postage enclosed for \_\_\_\_\_

ON PARCEL POST ORDERS insure postage for weight shown. **ORDERS FROM CANADA and APO'S must include full remittance.**

## TIPS (Continued from page 106)

recording and the volume control turned down. But it is less generally known that when this treatment fails in stubborn cases success can sometimes be achieved by storing the poorly erased tape at room temperature for a few days. For this reason, tapes with recordings no longer needed should be stored in the erased condition.—*E.F.C.*

### COMBINING TEST INSTRUMENTS

Test instruments that are often used together, and have about the same size cases,

can be fastened one to the other to make a single, convenient unit. Machine screws through the bottom and top of the cases will hold the two instruments securely. An alternate method would be simply to strap the two units together around their sides. The photo shows a signal generator, with a signal tracer mounted above it. This combination is both handy and portable.

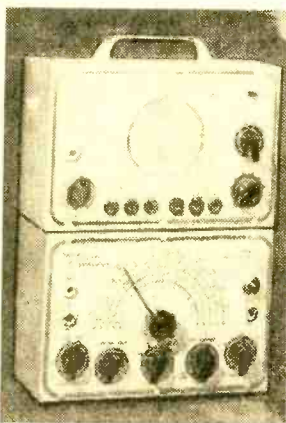

—*H.L.*

### SAVE THOSE TUBE LAYOUTS!

The chassis layout diagram that is usually furnished with a radio set or other electronic equipment is an invaluable guide to future maintenance and service. Generally, such a diagram is pasted to the back of the set. If it isn't, it's a good idea to paste it there. Also, when the diagram shows signs

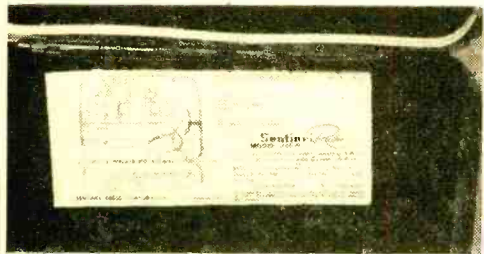

of peeling off, fasten it back in place. The positions of tubes and other data included on such a diagram can save a lot of time at some future date.

—*H.L.*

### INSULATED HANDLES FOR TIP PLUGS

The front ends of tip jacks are insulated; why not the cord tips too? Then, you will be safe if you use the jacks and tips in high-

voltage applications. Also, the insulated knobs serve as convenient handles to insert and remove the tips.

As shown in the photo, a couple of binding posts from a discarded "hot-shot" bat-

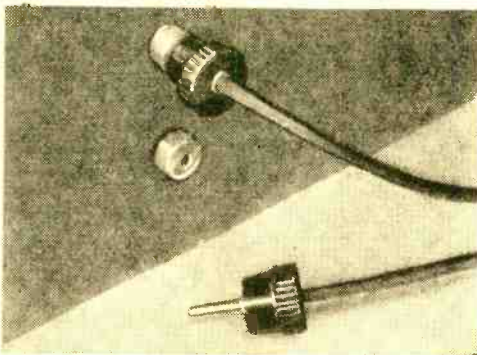

tery can be used. Simply drill a hole through the knob and slip knob onto large end of tip using a little Duco cement. Let set until the cement dries. The knobs should be cemented onto the tips *after* the cords have been soldered into the tips.

—*A.T.*

### A SHORT DIPOLE FOR "75"

Center-loading a short dipole is one answer to the problem of lack of space for a 120' dipole. The photo shows the hookup used for an antenna half that length. A center-fed dipole, cut to resonance at 7.2 mc., was lowered to within reaching dis-

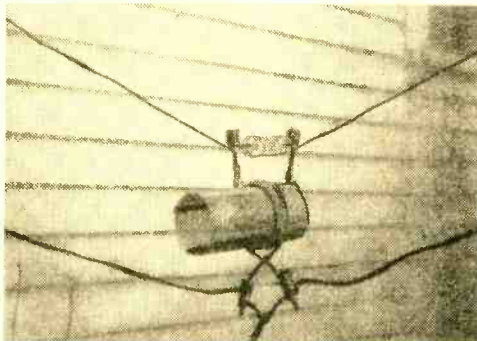

tance of the ground. The 72-ohm twin lead being used was disconnected.

Twenty-five turns of commercial inductance (2½" in diameter; 8 turns per inch) were clipped across the insulator in the center of the dipole. Then, three turns of No. 12 insulated weatherproof wire were wrapped around the center of the loading coil. The feedline was then reconnected to the three-turn link.

At 3.9 mc., the antenna loads easily, with a standing wave ratio of 1.25 to 1. Using slotted binding posts, the loading coil can be removed readily, and the feedline reconnected to its original position for operating on "40."

—*W.H.B.C.*



# A NEW APPROACH TO HI-FI STEREOPHONICS!

Learn how you can provide spatial effects by filtering! Read August **RADIO & TELEVISION NEWS** for details on a new system for recording and reproducing tape with excellent stereophonic quality.

**Look for August  
RADIO & TELEVISION NEWS  
at your favorite newsstand!  
On sale July 26 - only 35¢**

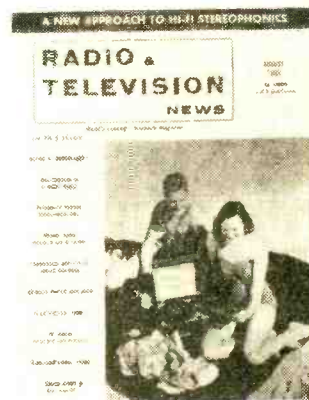

## INDUSTRIAL ELECTRONIC- AUTOMATION TECHNICIANS Desperately Needed!



Never in history has there been such a tremendous demand for Electronic technicians at the servicing, maintenance and assistant Engineering level, in all fields of electronics. Industries, Businesses, large and small are turning to Electronically controlled machinery... **AUTOMATION!**

Whether it's a Robot airplane, an automobile plant with an integrated line of machines, a Sensing Device, Computing System or Communications—each re-

quire electric power applied through automatically controlled processes. This means **there are positions open at all levels and phases for Electronic Technicians.**

- **TOP PAY**
- **UNLIMITED OPPORTUNITY**
- **SECURE FUTURE**

Bailey electronic students learn Industrial Television on specially designed equipment such as this panelboard, which is a multiple camera and screen control. The Bailey Electronic course includes an outstanding comprehensive program in radio and TV receiver servicing.

Let us send you **FREE**, without obligation, complete details of our Resident Electronic Training Program—originated by Bailey Schools—acclaimed by Electronic Engineers. See how you save time as you learn-by-doing with intensive laboratory work on the most recently developed Electronic equipment, plus classroom required physics, mathematics, etc.

We help you find part time work while in our school—help place you with America's leading companies after graduation. Act now—mail coupon today!

VETERAN APPROVED

**Bailey Technical Schools**  
1626 S. Grand • St. Louis 4, Mo.

### MAIL TODAY

Please mail immediately this free booklet without obligation.

**FREE BOOKLET** →

Name \_\_\_\_\_

Address \_\_\_\_\_

City \_\_\_\_\_ State \_\_\_\_\_



## LMB BOX CHASSIS OFFERS FREE Inside LMB boxes

10 tested kit diagram projects for the builder. Each one of these kit diagrams built by a recognized expert. Kit projects are complete in every detail. Circuit diagram, photo of project both front and rear photo. Rear photo shows wiring and parts. Detailed instructions for building, complete parts list and approximate cost. Complete to build except parts and your distributor can supply the parts. Ask your distributor for the list of LMB kit Diagram Projects. If he does not have them, write to

**LMB** 1011 Venice Blvd.  
Los Angeles 15, Calif.

### SELF CHARGING TRANSISTORIZED GEIGER COUNTER

Includes • Hoister • Radioactive Source • Uranium Official Yearbook (Reg. \$2.00) • Crystal Headphones

New! Revolutionary, reliable! Sensitive to gamma rays from all radioactive ores. Guaranteed. Free Literature, or send for Uranium Official Yearbook plus radioactive source... both for \$1.50

WESTWOOD RESEARCH & DEVELOPMENT LABORATORIES, INC.  
14945 Ventura Blvd., Dept. A, Sherman Oaks, California



only \$19.95 p.p.d.

Send check or m.o. (Postage extra on C.O.D.'s)

## LEARN TELEVISION

"AT THE MOST PRACTICAL SCHOOL IN THE WEST" WORK ON LATE MODEL SETS—USING MODERN SERVICING EQUIPMENT AND TECHNIQUES—UNDER QUALIFIED TECHNICIAN INSTRUCTORS (SHORT RESIDENT) AND CORRESPONDENCE COURSES—NO UNNECESSARY MATH OR THEORY—ALSO UHP AND COLOR TV.

APPROVED FOR VETS—ENROLL NOW!  
Day and Night Classes Write for Free Literature  
Dept. 2A—Correspondence  
Dept. 2R—Resident

V. S. I. TELEVISION SCHOOL 4570 Firestone Blvd.  
South Gate, Calif.

# 298

### RESISTORS, WIRE CAPACITORS, FUSES, SOLDER, HARDWARE AND MANY OTHERS

100 Asstd. Electronic Parts

SEND TO-DAY PARTS SALES  
731 FEDERAL ST.  
CAMDEN, N. J.

## VHF AM-FM RADIO

Supersensitive sub-miniature tube set receives television, FM broadcast, C.A.P. and amateurs without antenna or ground. Tunes from 75 mc. to 150 mc. Similar models available in frequency bands from 27 mc. to 225 mc. Pocket size—measures only 2" x 2" x 2". Highest quality components used. Specify battery or AC model. Use with any magnetic headphone or can be connected to audio amplifier for loudspeaker operation. Thousands in use by amateurs, experimenters, and civil defense. Factory wired and tested chassis complete with special tube only \$2.98 postpaid. In kit form \$3.98. Postage extra on COD orders. New transistor audio amplifier for extra loud reception only \$2.00 including transistor.

SPRINGFIELD ENTERPRISES

Box 54-E Springfield Gardens 13, N. Y.

# ATTENTION

- Hobbyists
- Club Members
- Study Groups

Subscriptions to POPULAR ELECTRONICS at special bulk rates are available to club members, study groups, employee groups, schools, etc.

For information, write to:

POPULAR ELECTRONICS, Dept. 1016  
366 Madison Ave. New York 17, N. Y.

## The Transmitting Tower

(Continued from page 81)

comma identified as a question mark—I would recommend it as a good buy to anyone with a tape recorder who is interested in learning the code.

The course is available from Tapedcode, Box 31, Langhorne, Pa. The six-reel course sells for \$20, and a three-reel Novice course (8 wpm) is \$11. Individual tapes may also be purchased.

### Notice to 160-Meter Operators

As a result of changes in the Loran radio navigation system operating on 1850 kc. and 1950 kc., the Federal Communications Commission has reduced the operating privileges of some U. S. amateurs who operate in the 160-meter band.

In the states of Washington, Kansas, Missouri, Arkansas, Illinois, Indiana, Kentucky, Tennessee, Ohio, West Virginia, Virginia, North Carolina, South Carolina, and Texas (west of 99° W or north of 32° N), permissible power has been reduced from 500 watts day, and 200 watts night, to 200 watts day, and 50 watts night.

No 160-meter operation is permitted in the states of Texas (east of 99° W and south of 32° N), Louisiana, Mississippi, Alabama, Georgia, Florida, Puerto Rico, Virgin Islands, Alaska, Guam, and other territories and possessions of the U. S., with the exception of Hawaii.

In the remaining states and Hawaii, the old power limits continue to apply. The new regulations went into effect July 9, 1956, and are expected to continue for approximately one year. No changes in frequency assignments have been made.

### News and Views

**Larry Puccio, KN2QDY**, 132-22 84th St., Ozone Park 17, N. Y., reports: "I had my license and transmitter last November, but no receiver until January, when Ed, W2LJF, lent me one. So far, I have worked 23 states, with California as my best DX. My antenna is 66' long fed in the center with coaxial cable. It doesn't work half as well as the last beauty I had up, but it stays there."

**Pete Duncan, KN6ONH**, San Francisco, Calif., tells us what he has been doing. "In six months of operating, I have cards from 25 states, Alaska and Hawaii (three each). Just the other night, I was fortunate enough to work OQ5AM in Kolwezi, Belgian Congo, on 7185 kc. This is my best DX, so far. I have a witness, too—W6KTP was here at the time. I run 60 watts to a 6146, my receiver is an NC-120, and my antenna is a 40-meter 'zepp.'"

**Ronnie Stay**, 53 Lynch St., Plattsburgh, N. Y., offers encouragement to prospective Novices. "After a month with the RETMA Novice Course, I took my examination. I passed the code without difficulty, and I am sure that I



passed the theory as well. K2OGQ and K2-HLY helped me along. I don't see how anyone could fail the exam with this course and the help of a couple of ham friends. I have a Globe Scout 65-A and a 30-watt, home-built

meters, and I have worked 26 states. I would be glad to schedule anyone wanting a Texas QSO between 3:30 a.m. and 6:45 a.m. on 40 or 80 meters. I would appreciate a little help with General Class theory."

### Response to Letters

If you have ever wondered what happens after one of these "letters" appears in the *Transmitting Tower*, read the following comment received recently. "... Since my short note appeared in the column, I've been busy answering letters from 20 states and Canada. Questions have ranged all the way from 'Will a TV antenna work on 80 meters?' to 'Will 180 watts be enough power to use as a Novice?' Most wanted to know how to get started and what books to get. Some of the questions were hard to answer, but I did my best." (Normally, a TV antenna works well only on the TV bands. The Novice power limit is, of course, 75 watts input at all times—Herb.)

**Gary Towner, KN9BNJ**, 1017 W. 42nd Ave., Hobart, Ind., supplements his last report: "I was very much surprised to see the diagram of the r.f. amplifier in the May, 1956, *Transmitting Tower*. Here I thought I had something original! Mine is complete with a pi-network output circuit, too. I use a 1625 tube, and I drive it with a home-built 10-watt transmitter. The amplifier really works. Although it runs only 30 watts, I had a hard time making local contacts without it. With it, I have worked four states. My antenna is a 40-meter wire, but I work 80 meters only."

From 1920 Ave. C, Gothenburg, Nebr., **Brian, KNØEHY**, reports: "I've had my license a month and five days, and I have worked 18 states. Both my transmitter and receiver are home-built, but I am getting an AR-3 receiver in a few months. My antennas are a 126' doublet 35' high for the 3.7-mc. band and a 65' one for the 7.15-mc. band. I QSL 100%."

transmitter and an NC-98 receiver waiting for the license to come."

**Gerhard S. Plessinger, KN5DNQ**, (14½), Box 665, Lindale, Texas, says: "I run 33½ watts to an AT-1 transmitter, feeding ½-wave antennas on 80 and 40 meters. My receiver is a BC-342. My best DX is JA1 (Japan) on 40

From **Howard Mac Walp**, 526 Washington Ave., Girard, Ohio, comes another offer of help. "... In addition to holding a General Class license, I also hold a commercial license, and I would like to be of assistance to prospective amateurs around Youngstown, Ohio."

**Eddie Barnes, KN9CXS**, 24 Parkway Dr., Sullivan, Ill., says: "My rig is a Johnson Ad-

# WHICH TRANSMITTER KIT TO BUY?



**I JUST GOT MY NOVICE TICKET, BUT WHICH KIT SHOULD I BUY?**



**SAY, THIS VIKING "ADVENTURER" LOOKS LIKE THE ONE FOR ME!**



**YOU MEAN YOUR RIG WAS MADE FROM A KIT?**



**SURE, IT'S TVI SUPPRESSED--WORKS ALL BANDS--80 THRU 10--LOADS ALMOST ANY ANTENNA--AND IT'S PUNCHED AND DRILLED FOR YOU, TOO!**



**THAT'S EASY! CHOOSE THE KIT THAT GIVES YOU THE MOST FOR YOUR MONEY!**



**NOW YOU'RE TALKING!! I'VE GOT ONE AND IT'S GOT 'EM ALL BEAT!**



**LATER SAY! STEP BY STEP INSTRUCTIONS! I'LL BE FINISHED TONIGHT!**



**EVERYTHING IS SUPPLIED. ALL YOU NEED IS YOUR OWN KEY AND CRYSTAL.**



**JOHNSON MAKES A COMPLETE LINE OF TELEGRAPH KEYS, TOO. WRITE FOR FULL INFORMATION.**



**VIKING "ADVENTURER" CW KIT**  
Compact, completely self-contained 50 watt transmitter kit. Single knob bandswitching—effectively TVI suppressed. Easy assembly by novice or experienced amateur. 80, 40, 20, 15, and 11-10 meters. Cat. No. 240-181-1 complete with tubes. **\$54<sup>95</sup>**

**MAIL TODAY**

**E. F. JOHNSON COMPANY**  
3002 Second Ave., S.W., Waseca, Minnesota

Please send me a copy of Bulletin 727, which describes the Viking "Adventurer" in detail.

NAME \_\_\_\_\_  
ADDRESS \_\_\_\_\_  
CITY \_\_\_\_\_ STATE \_\_\_\_\_

venturer transmitter and an S-38D receiver. In about six weeks of operation, I have worked 16 states, with 11 confirmed. I'll sked anyone needing Illinois for any reason. (Who needs Illinois?) I need skeds with 32 states."

**George Kinal** (13), 293 Saw Mill River Rd., Yonkers, N. Y., makes the first year report on his ham activity. "I have just received my General Class license after a year as a Novice. I used a 10-watt transmitter and a 2-tube regenerative receiver. Then, I got an AR-2 receiver, which I still use. I built a preselector for it from POPULAR ELECTRONICS, and I have an extra 15- and 20-meter preamplifier for it. A Q-multiplier and a DX-35 are on the way now. I'll be glad to help anyone around here obtain his license."

**George Harlem, WN3CMN**, (13), 22 South School Lane, Lancaster, Pa., says: "Since I went on the air last October, nearly all my spare time is spent in the ham shack. My transmitter is a Johnson Adventurer, running 50 watts to a long-wire antenna. My receiver is a National NC-88. I work 80, 40, and 15 meters, but 15 is my favorite. I have worked 27 states, with 15 of them confirmed. My best DX is England, Washington, and California on 15 meters. As long as I have QSL's, I'll QSL 100%, and I'll answer any and all correspondence. I'd like especially to talk to some WN7's and to someone younger than myself."

**Steve Frankel, KN20TT**, (13), 247 Parkview Ave., Bronxville, N. Y., gets the final say this month. "My rig is a slightly modified AT-1, and the receiver is a Howard 435-A. But my antenna is the real problem. I live on the first floor of an apartment house in which not even TV antennas are allowed. So my antenna is really makeshift. Still, I have managed to work 18 states and Canada on 80 and 40 meters; so I actually have nothing to complain about."

As always, I remind you that this is *your* column; so let us hear of your experiences, and send along a clear snapshot of yourself and your station. 73,

Herb

## Tuning the Short-Wave Bands

(Continued from page 69)

The following is a resume of the many reports that have been received in the past month. All times shown are Eastern Standard, 24-hour system. Add five hours if your log is kept in GMT; subtract three for PST.

**Afghanistan**—*Kabul*, 9975 kc., has an English session daily at 1150-1210 with news; on Wednesday and Saturday at 1215 with a request program. There are two 100-kw. stations under construction. (DQ)

**Australia**—*R. Australia* is now on winter schedule. Australian DX'ers' program will be heard as follows: Saturday—at 1700 on 15,160 kc. for Japan; Sunday—at 0030 on 17,800 kc. (Africa); at 0215 on 11,740 and 15,160 kc. (Europe, New Zealand and South Pacific); at 0830 on 11,740 kc. to Eastern North America; at 1100 on 11,740 kc. to Western North America; at 1100 on 7220 and 11,900 kc. to Asia and Europe. The Eastern North America xmsn is

now heard at 0714-0845, the Western North America session at 1014-1115—both xmsns replacing 9615 kc. (BV, WRH)

VLX9, 9610 kc., Perth, was noted s/off at 0500, giving call letters and frequencies. This is rarely heard from the ABC regional stations. (SW)

R. Puckapunyal, 7850 kc., is scheduled on Tuesday at 0400-0600 but may change. A let-

### ABBREVIATIONS

A—About this frequency  
 ABC—American Broadcasting Company  
 BBC—British Broadcasting Corp., London, England  
 BC—Broadcasting service or station  
 kc.—Kilocycle  
 kw.—Kilowatt of power  
 mc.—Megacycle  
 m.w.—Medium wave  
 QTH—Exact location  
 R.—Radio  
 s/off—Sign-off of station  
 s/on—Sign-on of station  
 V—Verified frequency  
 xmsn—Transmission from a radio station  
 xmtr—Transmitter used by station

ter from the station gives the following information: "This station is operated by Army personnel and is primarily intended for entertainment of troops within a ten-mile radius. The equipment used is a control panel of our own manufacture, a transmitter of 75-watt output, using parallel 813's fed into a 15' vertical rod antenna." (WF)

**Belgium**—ORU4, Brussels, 15,335 kc., is very strong in Canada and Eastern USA with an all-French and Dutch program from 1615 to 1800. Identification is *Ici Bruxelles*. (DK, MP)

A letter from the station reads in part: "... despite the protests concerning the closing of our English programs and the discontinuance of our international good will programs that have been made to the responsible authorities, we cannot give you the slightest assurance that they will be resumed." (All for-

### S.W. REPORTERS WELCOME!

"How can I be a reporter for your s.w. column?" This question pops up frequently in our mail and we'd like to answer it by saying that anyone owning a s.w. receiver is welcome to write in and report what he is hearing. If you have but one report, write it on a postcard and send it in. It may be just enough to help another listener log a new country. If you have questions or need help, let me know. Our mail is heavy and at times we get behind schedule, but you will definitely receive an answer. Write to: Hank Bennett, Short-Wave Editor, % Popular Electronics, 366 Madison Ave., New York 17, N. Y. —HB

eign language programs were cancelled over a year ago, for material reasons.) (GH)

**Brazil**—*R. Nacional de Sao Paulo*, Sao Paulo, 6126 kc., has been noted at 0400 with a strong signal and Portuguese announcements. They use a 14-bell interval signal four times. The first bell is low, the second high, and the remaining 12 descending slowly. (SW)

A new station in Sao Paulo is operating on 11,855 kc. at 1900-2200. The slogan has not yet been determined for this station. (RL)



**BIG  
TRADE-  
IN**

\*you  
pay  
shipping  
charges

get up to  
\$5 for your  
old dud\*

**TRADE-IN ALLOWANCE**

for your old dud deductible from T. M. 11st price.  
10"-14" \$2, 15" \$2.50, 16"-17" \$3.50,  
19" \$4, 20" \$4.50, 21" \$5.

**BRAND NEW TV  
PICTURE TUBES**

RCA and DUMONT Licensed  
Partial Listing  
No dud required

Type	T.M. Price	Type	T.M. Price
10BP4	\$10.95	16RP4	\$17.00
12LP4	12.95	17BP4	19.00
12QP4	10.00	17GP4	21.00
14CP4	15.25	17LP4	18.00
15DP4	16.95	19AP4	23.00
16DP4	18.50	20CP4	24.00
16GP4	19.25	21ALP4A	24.00
16KP4	17.00	21EP4	24.00

Picture Tubes Shipped F.O.B.  
Passaic, N. J. Via Railway Express  
Dept. PE-8

Here's where you get

**THE RIGHT PRICES!**

**ALL TUBES UNCONDITIONALLY  
GUARANTEED FOR 1YEAR**

- PRETESTED TUBES
- INDIVIDUALLY BOXED

0Z4	6AU6	6SH7	12BA6
1B3GT	6AU5GT	6SJ7GT	12BE9
1H5GT	6AV5	6SL7GT	12A27
1LC5	6AV6	6SN7GT	12BH7
1LN5	6AX4GT	6SQ7	12BY7
1NSGT	6AT6	6SR7	12SA7
1Q5GT	6AH4GT	6T8	12S7
1R5	6BA6	6UB	12S7GT
1S4	6BC5	6V3	12SK7
1S5	6BE6	6V6GT	12SL7GT
1T4	6BG6G	6W4GT	12S07
1T5GT	6BJ6	6W6GT	12SR7
1U4	6BK5	6X4	19T8
1U5	6BK7	6X5GT	19BG6G
1X2	6BL7GT	6Y6G	25BQ6GT
3Q4	6BO6GT	7C5	25L6GT
3S4	6BQ7	7C6	25Z5
3V4	6BY5G	7E7	25Z6GT
5U4G	6BZ7	7F7	35B5
5V4G	6C4	7F8	35C5
5Y3	6CB6	7N7	35L6GT
6AB4	6CD6G	12ALS	35W4
6AC7	6F6	12AT7	35Y4
6AC5	6HG6T	12AU6	35Z6GT
6AG7	6J5GT	12AU7	50A5
6AF4	6J6	12AV6	50B5
6AK5	6K6GT	12AV7	50C5
6ALS	6L6	12AX7	50L6GT
6AQE	654	12AX4GT	117Z3
6AS5	6SBGT	12BY7	
6AT6	6SA7		

**ANY  
ASSORTMENT**

**RECEIVING  
TUBES  
41c ea.**

Quantity Buyers!

**100 Tubes — \$38.00**

FREE POSTAGE on all pre-paid continental U. S. A. orders. 25c handling charge on all orders under \$5.00. 25% Deposit on all C.O.D.'s. Subject to prior sale.  
PRescott 3-0330

**TUBE MART**

**DISCOUNT  
HOUSE**

The Lokpet Bldg. Passaic, N. J.

**35mm  
CAMERA FANS!**

**A Special Issue of  
POPULAR PHOTOGRAPHY  
Just For You!**

If you own a 35mm camera . . . or plan to buy one soon . . . you'll want to read the big Special 35mm Issue of POPULAR PHOTOGRAPHY, now on sale at all newsstands.

It's the most complete roundup on 35mm photography ever published—filled with scores of tips and suggestions for getting better pictures with your 35mm camera in features such as:

- HOW TO GET MAXIMUM SHARPNESS
- HOW TO USE A NON-RANGEFINDER CAMERA
- SINGLE LENS REFLEX VS. THE RANGEFINDER
- HOW TO GET THE BEST NEGATIVE FOR 35MM
- WIDE-ANGLE, TELEPHOTO AND 50MM LENSES
- WHAT'S NEW IN 35MM PRODUCTS

**PLUS** A large portfolio of 35mm pictures in both color and black-and-white showing a wide variety of techniques!

Don't miss this Special 35mm Issue!

Ask your newsdealer for the August issue of POPULAR PHOTOGRAPHY, now on sale—only 35¢.

Ziff-Davis Publishing Company, 366 Madison Ave., New York 17, N. Y.



August, 1956

# THE BIGGEST BARGAIN

IN TEST  
EQUIPMENT

**\$7.95**  
COMPLETE

PAT.  
PEND.

## CIRCUIT ANALYZER and TUBE CHECKER

First miniaturized test instrument to fit in the palm of your hand. Tests radio, Hi-fi and TV tube filaments, voltages, shorts, leakage, continuity and electronic components. Test prods and service manual simplify diagnosis of TV, radio, Hi-hi, appliances, auto and electrical circuits. Powerful search lantern on reverse side handy for trouble shooting or emergency. Write for data sheet or order now.

APPARATUS DEVELOPMENT CO., INC.  
DRAWER 86, WETHERSFIELD 4, CONN.

## TALK - LISTEN - AROUND THE WORLD!



RADIO AMATEUR TRANSMITTER-RECEIVER  
SENDS AND RECEIVES THOUSANDS OF MILES on Amateur 80 and 40 meter bands—also, Aircraft and foreign bands 15 to 8 mc. PORTABLE SELF-CONTAINED BATTERY POWERED! NO AC PLUG-INS. NO DANGEROUS HI-VOLTAGES. Low cost battery lasts for MONTHS. Crystal controlled TRANSMITTER—Power input up to 2 watts—ENOUGH TO TALK 1 MILE OR 1000. REGENERATIVE RECEIVER—Taps in weakest stations. Front Panel Send-receive switch. No troublesome relays or complicated hookups. Uses any standard antenna. Size only 6" x 4" x 4". We'll send postpaid. Complete kit includes all parts, tubes, coils, full instruction, less batteries and crystal—or COMPLETELY WIRED AND TESTED FOR \$19.95! Rush order today. NOW.

WESTERN RADIO DEPT. BNE-8 KEARNEY, NEBRASKA

## PEE WEE BATTERYLESS TUBELESS "LIFETIME" RADIO



REALLY WORKS—FOR LIFE!  
WORKS WITHOUT TUBES, BATTERIES OR ELECTRICAL PLUG-INS. Will never run down or burn out. World's smallest, SMALLER THAN A PACK OF CIGARETTES! GUARANTEED TO RECEIVE LOCAL RADIO STATIONS ANYTIME—ANYWHERE YOU GO! Sensational new Ferrite Selective Tuner—Permalloy Crystal diode, Super SPEAKER—PHONE, durable black and gold plastic case.

SEND ONLY \$2.00 (bill, ck. mo) and pay postman \$4.99 COD postage on arrival or send \$6.99 for postpaid delivery. SENT COMPLETE READY TO LISTEN WITH LIFETIME GUARANTEE. Nothing extra to buy—ever. Available only from MIDWAY COMPANY Dept. WPL-8 KEARNEY, NEBRASKA

## INVENTORS

Send for PATENT INFORMATION Book and INVENTOR'S RECORD without obligation  
**GUSTAVE MILLER**  
86-PE WARDER BUILDING WASHINGTON 4, D. C.

REGISTERED PATENT ATTORNEY  
ASSOCIATE EXAMINER  
U.S. PAT. OFF. 1922-1929  
Patent Attorney & Advisor  
U. S. NAVY DEPT. 1930-1947  
**PATENT LAWYER**

**British North Borneo**—Radio Sabah, Jesselton, 7185 kc., can be heard around 0622 with a relay of BBC news. (JB)

**British Somaliland**—Radio Somali, Hargeisa, operating on 7126 kc., has extended transmission time 15 minutes and is now closing at 1000. (WRH)

**Canada**—R. Canada, CKLX-3, 15,395 kc., replaces CKLX-1, 15,415 kc., with English programs for Canadians in Europe between 0655 and 0905. They usually broadcast at 0655-0730 (Monday-Friday) and at 0830-0905, which at times is in French. CKNC, 17,820 kc., is in parallel. (SW)

**Ceylon**—According to a news item heard from Radio Japan, the Voice of America relay facilities of Radio Ceylon are likely to be abandoned (upon request from the Government of Ceylon). This policy may be somewhat in effect already, as R. Ceylon is again using its 15,120-kc. outlet for relay of the Commercial Service. (WF)

**Chile**—CE960, Santiago, 9598 kc., is heard at 2200-2230 with Spanish musical programs. Identification is Radio la Americana and is usually easy to catch. (GN)

**Cyprus**—Sharq Al Adna, ZJM7, 11,720 kc., is noted daily in Arabic at 0930-1100 with news, plays, music, and Arabic commercials. The signal is usually strong on the West Coast. (PF)

ZJM8, 9650 kc., can be tuned on the East Coast after 0000 until 0100 with Arabic talks and music. (PR)

**Denmark**—The current schedule of the Danish State Radio is as follows. On 9520 kc.: at 1915-2015 (daily) to Greenland, at 2030-2130 and 2200-2300 (daily) to North America, at 0830-0930 (Sunday only) to Faroe Islands, at 1730-1830 (Monday, Wednesday and Friday) to South America; for Danish ships—at 1830-1900 (Monday, Wednesday and Friday), at 2130-2200 (Tuesday, Thursday, Saturday), at 1200-1230 (Tuesday, Thursday and Saturday). On 15,180 kc.: at 0000-0100 (Tuesday, Friday) to Africa and Middle East. On 15,165 kc.: at 0400-0500 (Tuesday, Thursday, Saturday) to Far East, Australia, and New Zealand, and at 0900-1000 (Tuesday, Thursday, Saturday) to South Asia; program for Danish ships—at 0500-0530 and 1000-1030 (Tuesday, Thursday, Saturday). On 6060 kc.: at 1240-1615 relaying Home Service (daily). (WRH)

**Dominican Republic**—HITT, Ciudad Trujillo, is being tuned on 3285 kc. around 2245 in Spanish. This one usually has good signals when in the clear. (TL)

**Dutch New Guinea**—Radio Sorong, Sorong, is a private station using 500 watts on 3395 kc. The schedule is: Monday and Thursday at 0430-0700, Tuesday and Friday at 0400-0700, Saturday at 2000-2230 and Sunday at 0430-0700. No transmitter is planned for Hollandia. Biak and Sorong are the only stations operating in the country. (WRH)

**Egypt**—Cairo can be heard daily on 9475 kc. at 1300-1600 in English and French. This transmission is beamed to Europe. (DR)

**England**—The BBC has been radiating a special program for the men of the Antarctic Expedition. These xmsns, entitled "Calling The Antarctic," primarily intended for recep-



tion in the vicinity of Vahsel Bay, are on the air Tuesdays at 1715-1800 on 9825 and 12,095 kc. and are repeated Wednesdays at 1100-1145 on 21,640 kc. The International Time Signals of the Royal Greenwich Observatory are being transmitted: at 0500 over GBR, 16 kc., and GIC33, 13,555 kc., and GIC37, 17,685 kc.; and at 1300 over GPB30, 10,332.5 kc., in addition to the outlets on 16 and 17,685 kc. GIC33 is located at Leafield, the others at Rugby. This schedule will be on until August 31. (WRH)

**France**—"The English Service of R. N. F." from Paris, 15,400 kc., is heard at very good level at 1500-1600, all in English. News is at 1500, discussion program at 1515. At 1600 s/off, they gave the schedule as 1500-1600 on 49- and 31-meter bands (no mention of this channel), 0245-0300 on 41 meters, and 1445-1500 on 25 meters. The 31-meter outlet can be found on 9625 kc. (SW, CM)

**French Cameroons**—According to a QSL card, *La Radiodiffusion de Cameroun* is now operating: on 6115 kc., Douala, 1 kw.; on 3333 kc., 4 kw., and on 9270 kc., 1 kw., from Yaounde. (WRH)

**French Equatorial Africa**—R. Brazzaville is operating to Indochina and the Far East at 0900-1000 on 15,420 kc. instead of on 15,995 kc. (SW)

**Germany**—*Deutsche Welle*, Cologne, has moved from 15,275 kc. to 15,370 kc. for its Latin-American xmsn. It is being heard at 1830-2000 s/off with music, a German discussion at 1900, news in German at 1945. (SW)

The outlet on 11,795 kc. is noted around 2130-2140 with English news, dual with 9640 kc. S/off time is 2330 with announcements in German, English, and French. (RB, SD, KB, and many others)

**Greece**—*Radio Athens* now broadcasts in French at 1200-1230, followed by English at 1230-1300 on 15,345 and 17,775 kc. (WRH)

**Haiti**—4VWI, Cap Haitien, 15,418V kc., is being heard Saturday from 0840 to 1034 s/off. "Listeners Post," noted at 0930, said this mail-bag program is repeated at 1630 on Saturday, 2130 on Monday, and 0400 on the following Saturday (the latter xmsn being for South Pacific listeners). 4VEH, Cap Haitien, operates on 9637 kc. in the mornings, on 9657 kc. at 1500-1700 and 2000-2230, and on 9663 kc. at 1700-2000. (SW)

**Iceland**—TFJ, Reykjavik, 12,175 kc., is noted Sundays from 1115 to 1130-close in Icelandic. Usually severe QRM from teletype stations makes this a hard one to log. (PF)

**India**—VUD, Delhi, *All-India Radio*, is on a new channel on 17,820 kc. at 1915-2015 in Tamil, dual to 15,160 kc. VUD, 17,780 kc., is heard at 1930-1940 with 15,380 kc. with English program for Burma, followed by program in Burmese language. (RL, SW)

**Iran**—*Radio Teheran*, 15,100 kc., has English news at 1522, s/off at 1530; it is back on at 1530 with gongs and anthem, and then off again. (DX)

**Iraq**—*Radio Baghdad* is heard with fair to good signals on 11,702 kc. in Arabic at 1030-1130. This station has music often, and the interval signal is a bird chirping. Do not confuse it with Cairo on 11,674 kc. (GN)

**Jamaica**—R. Jamaica, ZQI, 4950 kc., is

# YEAR'S 35 BIGGEST ONE-DOLLAR BUYS!

FAMOUS "KIT KING" DOLLARKITS

PLUS—ANY ITEM IN THIS AD FREE WITH EACH \$10 ORDER.

Write for our FREE SUMMER FLYER!

- 16 PRINTED CIRCUITS.** Scoop! On 9 x 18" boards. Eliminates wiring. Hobbyists take note! Never before at this price! Reg. \$2. Wt. 1 lb. \$1
- 10 "POLY" BOXES.** Ass'd. sizes, hinged & snap lock clear plastic boxes for pocket radios, parts, etc. Hundreds of uses! Reg. \$2.50. \$1
- TEN 10 VAC SWITCHES.** Panel type. SPDT solder lug terminals. Bakelite handles. Transistor model. Esters. Wt. \$1 1/2 lb. Reg. \$4.50.
- 20 PRECISION KNOBS.** "Hi-Fi." Instrument, cap. types. Knurled, skirted. Some 65¢ ea. Brass inserts & set screws. \$1 Wt. 1 lb. Reg. \$9.
- 7 ROLLS HOOKUP WIRE.** 25-ft. rolls. #18 to #24. Ass'd. stranding, insulation, colors. Wt. 1/2 lb. Reg. \$4.
- 12 AC-DC LINE CORDS.** For chassis, coils, etc. 14' w/molded plugs. Stock up now! Wt. 1 lb. Reg. \$3.
- 10 PANEL SWITCHES.** Micro. AC rating. 1000V. 100mA. Wonderful assortment. \$1 Wt. 2 lbs. Reg. \$12.
- 2000 PCS. HARDWARE.** Radio-TV. shop screws, springs, washers, etc. other items. Wt. 3 lbs. Reg. \$15.
- FOUR SILICON DIODES.** Sylvania type. IN21, IN22 and two 1N23s. Most used types. Reg. \$11.
- 6 PANEL LITES.** Amber bulbs. For standard bayonet. \$7.50. Wt. 1/2 lb. Reg. \$1
- 10 TRANSISTOR SOCKETS.** For 4-, 5-pin subminiatures. 3-pin transistors. Reg. \$3. \$1
- 60 TUBULAR CONDENSERS.** 25 values: .00035 to 0.5 mf to 1000V. 50¢ tool! Wt. 2 lbs. Reg. \$12. \$1
- 50 COILS & CHOKES.** RF, ant., use., coils & chokes. 20 types, incl. air-tuned. \$1 Wt. 2 lbs. Reg. \$17.
- 30 DISC CONDENSERS.** Ceramic. 5mmf to .01 mf up to 1000V. Ass'd. values. 1V rep. must! Reg. \$12. \$1
- 20 Wirewound RESISTORS.** All different values. 5 ohms to 12,000; 5 to 50W. Candohm. lbs. Reg. \$10. \$1
- 20 Precision RESISTORS.** Top makes: 20 values. Carbon & WW. 1/2 to 2 w. 5¢ ohms to 1 meg. 1¢ tool. \$1 Wt. 1/2 lb. Reg. \$18.
- 8 PC. MOTOR DRIVER KIT.** Plastic handle. 3, 16, 7/32, 1/4, 5/16, 11/32, 3/8, 7/16" steel socket wrenches; plastic case. Wt. 1 lb. \$3. \$1
- 40 MOLDED CONDENSERS.** Top makes. .001 to .1 mf up to 1000V. Black, brown ceramic cases. Wt. 1 lb. \$1
- 150 ASSTD. PARTS.** Biggest parts buy ever! Large ass't. resistors, ceramic, paper & oil condensers, 35 fields and 6¢ more! Wt. 3 lbs. Reg. \$25. \$1
- "KIT KING" RADIO KIT.** Germanium crystal set, complete w/pre-drilled table case, pictorial, simple instructions. Wt. 1/2 lb. Reg. \$3. \$1
- G-E PRE-AMP KIT.** Chassis, condensers, resistors, wire socket, schematic for famous equalizer. (Uses 6SC7 or 88¢ extra.) Wt. 1 lb. Reg. \$1 \$1.50
- 60 MICA CONDENSERS.** Postage stamp type. 30 values: .0001 to .01 mf to 1200V. Sil. fields. 5¢ tool! Wt. 1/2 lb. Reg. \$21. \$1
- 12 VOLUME CONTROLS.** Wide variety up to 0.5 meg. incl. WW. For radio, TV. lab. Wt. 1 lb. Reg. \$8. \$1
- 60 ASSTD. KNOBS.** Push-on and screw types for radio, TV, lab. appliances. Some 55¢ ea. Wt. 2 lbs. Reg. \$12. \$1
- 30 STANDARD BULBS.** Handy ass't. min., bay, screw types. 1.1 to 6V. \$1 Reg. \$3-30
- 15 CERAMIC VARIABLE CONDENSERS.** Popular ass't. trimmer types. 10 values; singles & duals. Wt. 1/2 lb. \$1 Reg. \$14.
- 125 RESISTORS.** Insulated & uninsulated. 30 values; 5¢ ohms to 2 meg. 1/2 to 2 w. 50¢ tool. Wt. 1 lb. \$1 Reg. \$17.
- 2 CRYSTAL DIODES.** Hughes subminiature and 1N48, 1N51 diodes. \$1 Reg. \$4.
- 60 TERMINAL STRIPS.** Wide variety solder lug (ie strips, clips, boards. 1 to 10 terminals. Wt. 1 lb. Reg. \$4. \$1
- 50 CERAMIC CONDENSERS.** Tubulars, discs, button, standard types. 30 values, 5mmf to .01 mf. Wt. 1/2 lb. \$1 Reg. \$14.
- 10 ELECTROLYTICS.** Metal & paper types; singles, duals, triplex. Some \$2 ea. Wt. 3 lbs. Reg. \$15.
- 60 CARBON RESISTORS.** Insulated incl. famous A-B. 5 ohms to 4.7 meg. 35 values. 1/2, 1 & 2W; 1 & 5¢ tool! Wt. 1/2 lb. Reg. \$18. \$1
- 25 TUBE SOCKETS.** Subminiature, 7, 9, octals, locals; mica & ceramic shield base types also. 10 types! \$1 Wt. 1 lb. Reg. \$9.
- 40 SUBMINIATURE RESISTORS.** Carbon: 1/5 w. For ohms to 4.7 meg. 10 \$1 model, transistor projects, 5¢ values. Reg. \$8.
- 30 OIL CONDENSERS.** Rectangular, tubular types. Long life. Wide variety: .02 to 1 mf to 600 V. \$1 Wt. 3 lbs. Reg. \$15.

HOW TO ORDER

Check items wanted. Return entire ad with check of \$10. Incl. sufficient postage, excess returned. C.O.D. orders, 25% down. Rated, net 30 days. PE-8

NAME ..... (Please PRINT)

STREET .....

CITY ..... ZONE ..... STATE .....

Enclosed: \$..... for kits; \$..... for postage.

**LEKTRON SPECIALTIES**

28 GARDINER STREET CHELSEA 50, MASS.

Visit our salesroom at 131 Everett Ave., Chelsea

heard well from 1930-2300 s/off with news, music, and commercials—all English. (SF)

**Japan**—Tokyo is operating on 17,845 kc. to Eastern North America at 1800-1830 and 1930-2000, and on 17,825 kc. to Western North America at 2230-2330, both in parallel with 15,235 kc. JOB3, 9675 kc., is heard well at 0415-0515 in South American beam with Spanish and Portuguese during first half hour, Japanese for remainder of program. JOA4, 11,705 kc., operates in dual. AFRS, Camp Drake, 6160 kc., is noted at 0850-0915 with news at 0900. (RL, CM, SW, GF, RH)

**Luxembourg**—R. Luxembourg is now relayed on 6090 kc. with English program. The exact schedule is 1300-1900 (Saturday to 1930) during the winter. During summer months, the s/off is at 1800 (1830 on Saturday). (WRH, CM)

**Mauritius**—Forest Side, 15,092V kc., is readable but with poor signals from 2225 to 2315 s/off. English news is presented at 2300. Signal usually becomes progressively worse. (DX, PF)

**Netherlands**—R. Netherlands, 17,775 kc., can be tuned at 1045-1125 in English in the South Asia and Africa beam. After the interval signal at 1125-1130, the station goes into Arabic. (GQ)

Program #3 signs on at 1630 for Spain, Portugal, and Latin America. This channel was announced as being "experimental" and was dual with 15,425 kc. (SW)

**Peru**—OBX4C, Radio El Sol, Lima, 15,193A kc., was noted with test xmsn at 1950-0005 and later with American and Latin-American music, news in Spanish, and a baseball relay in conjunction with Radio Carve, Montevideo, and Radio Splendid, Buenos Aires. Identification signal is three chords on an organ and Spanish is used throughout. (WF)

**Philippine Islands**—The National Civil Defense Administration (NCDA), Independence Grandstand, Luneta, Manila, operates two stations: NCDA-1, Manila, on 3305 kc., and NCDA-2, Iloilo City, on 3365 kc. NCDA-1 operates at 0400-0700 (daily except Sunday) on 3305 kc. and at 2000-2100 on 5970 kc. NCDA-2, on 3365 kc., operates at 0400-0700, and after this takes broadcasts from DYRI in Iloilo City. NCDA-1 has English at 0600-0700, consisting of news, sports, editorials, and talks. (WRH)

**Saudi Arabia**—Jidda, 11,950 kc., is noted weakly in Arabic around 1000. This very rarely noted station is not to be confused with Cairo on 12,030 kc. (GN)

**Spain**—R. Nacional de España, Madrid, 15,420 kc., is now often heard at 0600 s/on in Spanish. S/on at 0830 is in Oriental language, and signature tune is again heard at 0900 as if starting another xmsn, but this is too weak to read. The regular interval signal and march is used at each sign/on. (SW)

**Surinam**—AVROS, Paramaribo, 15,406 kc., is heard Mondays at 2030-2040 with weekly English news program. They announce as AVROS, without mentioning any call letters, and give frequencies in use as being 15,405 kc. and 4742.5 kc. (SW)

**Sweden**—R. Sweden has a broadcast beamed to North America at 0815 on 15,155 kc., and again at 2045 on 11,880 kc. The English ses-

sion to Canada begins at 2000 on 11,880 kc. (JM, JH)

**Switzerland**—HEI9, Berne, is operating on a new frequency of 21,605 kc. at 0945-1130, beamed to India. (RL)

HER3, 6165 kc., is noted on the West Coast at 2319 with English to North America, with a signal strong enough to penetrate local CBUX on 6160 kc. (JB)

**Syria**—Syrian Broadcasting Service, Damascus, has English to Europe on 9555 kc. at 1630-1730. There is no service to North America although one is planned for the near future. (DQ)

**Thailand**—HSK9, Bangkok, 11,670 kc., is heard well in English with news at 0530, weather at 0540, talk at 0615, and native music at 0545-0615 and 0622-0630, in parallel with 6060 kc. After closing announcements at 0630, they switch over to a foreign language. (AB, SW)

**Trinidad**—R. Trinidad, Port-of-Spain, operates on 790 and 3275 kc. between 1900 and 2200, and on 6085 kc. for the 0500-1700 period. (WRH)

**Union of South Africa**—Since May 1, SABC has been testing from 0730 to 0845 (Monday-Friday, except on public holidays) on 25,800

#### SHORT-WAVE CONTRIBUTORS

Anson Boice (AB), New Britain, Conn.  
J. Ross Brownell (JB), Vancouver, B. C.  
Ken Bale, W7VCB, (KB), Bellingham, Wash.  
Rocky Brockwell (RB), McKenzie, Tenn.  
Silas Dunn (SD), Little Rock, Ark.  
Grady Ferguson (GF), Charlotte 8, N. C.  
Phil Finkle (PF), Burbank, Calif.  
Stuart Fidler (SF), Jordan, N. Y.  
William Flynn (WF), Berkeley, Calif.  
Grace Humbert (GH), Greenville, N. C.  
John Huettner (JH), Cleveland, Ohio  
Raymond Huss (RH), Lakewood, Calif.  
David Kington (DK), Cobourg, Ontario  
Roger Legge (RL), McLean, Va.  
Ted Leveque (TL), Bracebridge, Ontario  
Chuck Maxant (CM), Baldwin, N. Y.  
John Mann (JM), Montreal, Quebec  
Gordon Nelson (GN), Inglewood, Calif.  
Martin Potter (MP), London, Ontario  
David Quarterston (DQ), Farrell, Pa.  
George Quay (GQ), Allentown, Pa.  
David Robinson (DR), Providence, R. I.  
Peter Risse (PR), Atlanta, Ga.  
Bruce Tuten (BT), Atlanta, Ga.  
John Beaver (BV), Pueblo, Colo.  
Stewart C. West (SIV), Union, N. J.  
Gerry Dexter (DX), Waterloo, Iowa  
World Radio Handbook (WRH)  
(Full addresses available on request)

kc., announcing as *The Africa Service* of SABC. Reports are much appreciated. (WRH)

**Vatican City**—HVJ, 9550 kc., has English at 1000 on this channel and on 11,685, 11,740, and 15,120 kc., and at 1315 on the same outlets. In winter they may use 5963, 7280, 9550, and 11,685 kc. for the latter period. (BT)

**Venezuela**—Le Voz de la Patria, YVKKX, Caracas, has moved from 3390 kc. to 3305 kc. and is heard from 2000 to 2230 s/off. (RL)

**Unknown**—Listeners in South Africa have been hearing a station that identifies as *Freedom Radio*. No frequencies or times have been given as yet. This station is allegedly broadcasting anti-government propaganda. The interval signal is V-for-Victory in Morse code and the opening bars of Beethoven's *Fifth Symphony*. Further details on this station are requested. (WF, Editor) —50—



# 40 TYPE

FOR ANY



we will not be undersold

**REMEMBER, MR. CUSTOMER!**

Over 30,000 satisfied TV servicemen can't be wrong. You can buy with confidence from VIDEO, a reputable firm with over 10 years experience. We are the sole distributor of Video Brand tubes.

**DON'T PAY MORE FOR SET TESTED LONG LIFE DEPENDABLE RADIO & TV TUBES • BUY VIDEO INDIVIDUALLY BOXED—ALL GUARANTEED FOR ONE YEAR OR YOUR MONEY BACK 37.00 Per Hundred**

Some Standard Brand—Others With Famous VIDEAC Brand

**We Have OVER 1000 USED TV SETS**

At All Times In Our Huge Warehouse. Buy one or more of these WORKING TVs to sell or use as your own second set! All Sets in GOOD WORKING condition! Your Choice—Console or Table Model.

10"	..... \$23.00	19"	..... \$58.00
12"	..... \$28.00	20"	..... \$64.00
14"	..... \$33.00	21"	..... \$72.00
16"	..... \$40.00	24"	..... \$99.00
17"	..... \$46.00		

When ordering TVs, state whether table model or console is desired. Also preference on make of set. All TVs sent railway express F.O.B. Newark. On any quantity WIRE or CALL today!

**FREE BONUS ANTENNA GIVEN WITH ANY TV SET ORDER!**

**Also On Hand . . . ANY MAKE OR MODEL BRAND NEW TV OR APPLIANCE**

Prices on request! We will beat any quoted price!

**SEND for our FREE complete TUBE & PARTS LIST and order blank.**

**FREE POSTAGE** in U.S.A. and Territories on orders over \$5.00. 25¢ handling charge on orders under \$5.00. 25% deposit required on C.O.D.s. Please send approximate postage or freight on Canadian and foreign orders. Subject to prior sale.

0A2	3BC5	6A07GT	6H6GT	6Y6G	12SJ7GT
0A3	3CB8	6A55	6J4	7A5	12SK7
0A4	3C4	6A57G	6J5GT	7A7	12SN7GT
0B2	3Q5GT	6AT6	6J6	7B5	12SQ7
0C3	3S4	6AU4GT	6K6GT	7B7	12V6GT
0Z4	3V4	6AUSGT	6L6	7C5	12X4
1A7GT	4B27	6AU6	6N7GT	7C6	14A7
1B3GT	4B97	6BV5GT	6S4	7C7	14B6
1C7G	5AN8	6AV6	6S7G	7F7	14Q7
1F4	5AN8	6AX4GT	6SA7	7F8	19BG6G
1H4	5AQ5	6AX5GT	6SB7Y	7N7	19T8
1H5GT	5AT8	6R6	6SC7	7Q7	24A
1J6GT	5AW4	6R5	6SF5	7Y4	28AV5GT
1L4	5AZ4	6B7	6SF7	7Z4	28BQ6GT
1L6	5J6	6B6	6SG7	12A6	28CD6G
1LA6	5T4	6BF5	6SH7	12AH7GT	28CU6
1LC5	5T8	6BGG	6SJ7GT	12AT6	28L6GT
1LH4	5U4G	6BGG	6SK7GT	12AT7	28W4GT
1LNS	5UB	6B16	6SL7GT	12AUG	28Z6GT
1NSGT	5V4G	6BK5	6SN7GT	12AU7	35L6GT
1S4	5V6GT	6BK7	6ST7	12AV6	35W4
1S5	5Y3	6B17GT	6S57	12AV7	35Y4
1T4	5Y4G	6BN6	6S7	12AX7GT	35Z3
1U4	6AB4	6BQ6GT	6T8	12AX7	35Z6GT
1US	6AC7	6BQ7	6U4GT	12AZ7	50A5
1V2	6AG5	6B5G	6U7G	12B4	50B5
1X2	6AF4	6B7	6UB	12BA6	50C5
1Y5	6AR4GT	6C4	6V3	12BE6	50L6GT
2D21	6AK5	6CB6	6V6GT	12BH7	80
2X2	6AL5	6CP6G	6W4GT	12BY7	117N7GT
2A44	6AW8	6CF6	6W6GT	12CU6	117P7GT
3A5	6AN4	6CS6	6X4	12SA7	117Z3
3AL5	6N8	6CU6GT	6X5GT	12SG7	
3AU6	6AQ5	6C5	6X5	12SH7	

**SAME DAY SHIPMENT OF ALL ORDERS!**

**FREE RCA "CHEATER" CORD GIVEN WITH ANY TUBE ORDER OF \$7.00 OR MORE!**

# VIDEO ELECTRIC COMPANY

79 CLINTON PL. NEWARK, N. J.  
Phone HUmboldt 4-9848

**CALLING ALL SWL'S**

Just what YOU'VE been waiting for! KEN BOORD'S Summer 1956 SHORTWAVE LOG AND GUIDE FOR SUCCESSFUL SWL—"THE WORLD AT A TWIRL." Current (SUMMER) schedules, frequencies—collected VIA AIRMAIL IN LATE MAY FROM THROUGHOUT THE WORLD. Arranged by COUNTRY, GMT, STRESSES "MOVES" TO HIGHER CHANNELS, FULLY ILLUSTRATED. PROFESSIONALLY PRINTED BY MULTI-GRAPH PROCESS. Approximately 100 pages.

FEATURES GALORE (Aids For Beginners—"The WORLD AT YOUR Fingertips!"—How to Verify—ENGLISH Newscast Times—"Tuning the HAM Bands"—"There's A CLUB For YOU!"—LAST-MINUTE FLASHES!

SEND MONEY ORDER (no checks, please) TODAY for \$2.50 PER COPY—DIRECT to KEN BOORD, 948 Stewart, Morgantown, West Virginia, USA. SENT IMMEDIATELY TO ANY ADDRESS IN THE WORLD BY FIRST-CLASS SURFACE MAIL.

**LEARN**

## RADAR MICROWAVES TRANSMITTERS

### CODE TV RADIO

Phila. Wireless Technical Institute  
1533 Pine St. Philadelphia 2, Penna.

A Non-Profit Corp. Founded in 1908

Write for free catalog "P"

## RADIO CONTROL Headquarters

For model airplanes, boats, cars, etc. **FREE CATALOG**. No operator's license required. **FREE-SEND FOR FCC FORM 505** Garage Door Radio Control Transmitters & Receivers Kits Available.

Most **POWERFUL 5 Watt TRANSMITTER—LOWEST PRICE.** Famous 2 Tube MAC II circuit, with **GYRO MAGIC TUNING INDICATOR.** Completely Tested, includes: 9 1/2 ft. sect. Antenna, Remote "Clicker," Keying Switch, Meter, Beautiful Cabinet 12x7x6. **MODEL X3 \$24.95**  
**MODEL X1 w. 2V Storage stry. charger, Vibr. pack, \$39.95**  
**2" METERS, 150 MicroA, \$3.95; 500 MicroA, \$3.95**  
**R C TRANSMITTER & RECEIVER KIT: 27 1/4 Mc. 5 Watt 2-Tube Simple Transmitter & Supersens. 2-Tube Simple Receiver—Part, incl. Drilled Base, Wound Coil, Res., Cond., SIGMA Relay, instruc. **\$9.95****  
**SIGMA 4F RELAY: 8.000 ohm, \$3.85; 6 Reed Relay 14.95**  
**2.6V Battery Charger Kit 4.95; wired 6.95**  
**R C BOOKS: Model Control \$1; Radio Control \$1; Handbook \$ 2.25**  
**CRYSTALS: 27.255 Mc. Peterson 29A \$3.95; HOLDER .15**



**STROBOSCOPE** "Freezes" or Slows Down Motion of Machinery w. High-Speed Electronic Flash 10,000 ohm incl. Sensitive 10,000 ohm 1201 Tube Complete ready-to-operate, 110V AC. **18.95**  
**RELAY CONTROL UNIT** Sigma Relay 1 1/2 Mil Thermal Bimetal Strip, Heating Element, Hi Z Audio Choke, Mini Alnico V Magnet, Neon Lamp, Resistors, Capacitors (1 1/2 only) .99  
**TUBES: XF61, RK61, 3A4, 3A5, 1A6A, 6K4, TRANSISTORS 2.75**  
**Storage BATTERIES: Mini. 6V, NT6 \$2.45; 2 Volts 27A/Hour 1.95**  
**Dicht PR MIDGET MOTOR, 27 VDC 10,000 RPM, 2"x1"x1" .85**  
**Sens. Sigma RELAYS: 100 ohm 2 Ma DC or 110V AC .85**  
**SPDT 95c; SPST .85**

## GYRO ELECTRONICS 325-P CANAL ST., N. Y. 13, N. Y.

# Shrinks Hemorrhoids New Way Without Surgery

Science Finds Healing Substance That Relieves Pain—Shrinks Hemorrhoids

For the first time science has found a new healing substance with the astonishing ability to shrink hemorrhoids and to relieve pain—without surgery.

In case after case, while gently relieving pain, actual reduction (shrinkage) took place.

Most amazing of all—results were so thorough that sufferers made astonishing statements like "Piles have ceased to be a problem!"

The secret is a new healing substance (Bio-Dyne\*)—discovery of a world-famous research institute.

This substance is now available in *suppository* or *ointment form* under the name *Preparation H*. \* Ask for it at all drug counters—money back guarantee. \*Reg. U.S. Pat. Off.

## WANT A BETTER JOB? BECOME AN ELECTRONIC ENGINEER

ONLY 32 MONTHS TO EARN A BACHELOR OF SCIENCE DEGREE IN ELECTRONIC ENGINEERING

Class enrollment limited to allow for individual instructions. Chartered by state of California. Nonprofit-nonsectarian, co-educational—established 26 years.

APPROVED FOR VETS—ENROLL NOW!

SEND FOR FREE CATALOG

### PACIFIC STATES UNIVERSITY

1516 S. WESTERN AVE., Dept. M, LOS ANGELES, CALIF.

## VOCALINE CITIZENS RADIO TRANSCEIVER

Any U. S. Citizen 18 years old or more may obtain a station license. No operators license is required. Operates on 465 MC. 117 volts AC or DC or 6 volts DC. Only \$89.75 per unit, \$139.50 per pair.

### SPERA ELECTRONICS SUPPLY

37-10 33 St., Long Island City, N. Y.

Please Include Sufficient Postage

Dealer Inquiries Invited

## RADIO COURSES

FCC LICENSE PREPARATION

- COMMERCIAL
- CODE BRUSH-UP
- AMATEUR
- THEORY

TELEVISION AND RADIO SERVICING

Residence Courses Only

Personal Counseling Approved for Veterans

**YMCA TRADE & TECHNICAL SCHOOL of N. Y.**  
 15 West 63 St, New York 23, N. Y.  
 EN 2-8117 Catalog P. E. 53rd Year

## The Electronic Mind

(Continued from page 34)

ording data on a broad, endless loop of tape with many channels.

An important advantage of magnetic drums is their capacity; such drums are made to hold as many as 2,552,000 bits, or about 350,000 characters. Other favorable features are their low cost and the fact that they retain stored data indefinitely.

**Magnetic Core Memory.** In recent years, pure physical research has opened up new horizons through the discovery of a new basic material: the ferrites. Their impact on electronics is a whole story in itself. Here we are concerned only with their possibilities as memory devices.

Magnetic polarity can be established in ferrites by a current of sufficient strength. Once established, the magnetic field resists change until an equally strong current is passed in the other direction. Thus, for example, the magnetic field of a ferrite with positive polarity can be reversed by applying a sufficiently strong negative current.

In computers, this physical fact forms the basis of a memory system. The ferrites are shaped into doughnut-like rings, called toroidal cores, which are wired together in checkerboard "matrices." A pair of wires, one horizontal and one vertical, intersect at each core. To store an electronic "bit," it is only necessary to apply a polarizing voltage to the pair of wires meeting at a certain core. The magnetic field of that particular core will then shift and hold its new polarity, i.e., it will hold one "bit" of pulse-type information. None of the other cores will be affected, since the current in any one wire is not strong enough to reverse the cores' polarity. Only at the intersection point of the two pulsed wires, i.e., at the desired core location, do the two currents summate and thus achieve sufficient strength to evoke magnetic response.

Magnetic core memory is the current favorite among computer engineers. The reasons are easy to see. To "read out" the information stored in the core memory requires no more time than it takes to send a "sensing" pulse along the diagonal lines to pick up the pattern of magnetic shifts. Six characters can be transferred into or out of the memory in about 20-millionths of a second. At this rate of figuring, the answers come up fast.

Here, with the most advanced of memory devices, we are actually closest to my erstwhile piece of string with the knots tied in it. We may quite literally think of the pulsing wires as strings and of the magnetized cores as the knots. The mag-

Always say you saw it in—POPULAR ELECTRONICS



netizing pulses "tie" the knots, and the sensing pulses "feel along" the string to locate the knots.

Of course, my string didn't know the meaning of the knots. Only I did. Neither does the machine mind know the meaning of its memories. Only the creative mind of a human being is able to translate pulses, "bits." characters, or even words and numbers into the kind of living sense from which men build their world. —30—

## "Ears" for CD Observer Post

(Continued from page 50)

make the final connections to the pickup leads on the support arm and mount the amplifier in place. *A word of caution*—make sure that the pickup leads (PT1, PT2, etc.) are connected in series-aiding, as shown in Fig. 1. If any of the leads are reversed, the signal picked up by that unit will tend to oppose and to cancel the signals picked up by the remaining trumpets, greatly reducing over-all sensitivity.

**Modifications.** Good results can be obtained if only one or two trumpets are used. Construction and wiring are essentially the same, but the horizontal support arm's design may be modified. In fact, if a single trumpet is used, the support arm is not needed at all—a simple bracket will suffice!

The trumpet may be eliminated altogether if you have a military surplus store nearby. Simply pick up a surplus radar antenna (a parabolic reflector or "dish" measuring about 3' to 5' in diameter), and mount a small microphone cartridge at its focal point to pick up the reflected and concentrated sound waves. This makes an excellent pickup and has even better directional characteristics than the trumpets. Use a low-impedance microphone (such as the Shure MC-11) or a crystal "MIC." cartridge (such as the Argonne AR-52) together with a step-down matching transformer (such as the Argonne AR-129).

Some experimenters may find that the high gain provided by the three-stage amplifier is more than is needed for their applications. Where this is the case, the second stage may be dropped out entirely, saving a transistor, socket, transformer, and associated components. Simply connect the "green" and "black" leads of transformer T1 to feed the TR3 stage di-

### TRANSFORMER QUIZ

(Answers to questions on page 87)

- |      |      |      |      |       |
|------|------|------|------|-------|
| 1. b | 2. d | 3. c | 4. a | 5. b  |
| 6. d | 7. c | 8. b | 9. a | 10. b |

# ASSEMBLE YOUR OWN WALKIE-TALKIE RADIOPHONE



for as little as

**\$6.50**

plus accessories

Specifications: 1 to 5 mile range with 18-inch antenna and much more with directional beam antenna. Tunes from 144 to 148 mcs. High level amplitude modulation. Silver plated tank circuit and many other exclusive features assure maximum efficiency and long battery life. Fully portable—no external connections ever needed. Meets FCC requirements for general class amateur license. No minimum age requirement.

The following components are all you need to assemble a complete walkie-talkie as illustrated. Factory wired and tested transceiver chassis complete with special dual tube ..... \$6.50  
High output carbon mike ..... \$1.49  
Miniature mike transformer ..... \$.98  
Powerful alnico magnet headpiece ..... \$1.25  
Strong 16 gauge aluminum case (8"x5"x2") with battery compartment, battery switch plus all hardware and fittings including 18 inch antenna ..... \$3.98

Uses standard batteries available at your local radio store.

All components except tubes guaranteed for one year.

Please include 5% for postage. COD's require \$1.00 deposit. Thousands sold throughout the world. Foreign currency of equivalent exchange value plus sufficient amount for postage accepted.

All orders immediately acknowledged.

**SPRINGFIELD ENTERPRISES**

Box 54-E

Springfield Gardens 13, N. Y.

## NOW The Short Cut to Learning You've Been Waiting for



**Learn Anything  
FASTER...more easily  
with amazing  
Dormiphone Memory Trainer**

*The Scientific Discovery That Works for You... Awake or Asleep*

- Keep ahead in your work
- Memorize more quickly
- Make school subjects easier
- Help break bad habits
- Help induce sleep
- Learn a language
- Correct your speech

Now, at last, science shows you how to learn "by ear." With Dormiphone Memory Trainer, you start learning when awake, continue while asleep... save time, effort... learn 20% to 35% faster. So simple a child can operate it—so easy and practical it is used by educators, psychologists, people of all ages and occupations.

**Break Down Barriers to Learning**

Find out HOW the Dormiphone

Memory Trainer works FOR YOU!

how it can help you learn anything in less time, without intensive self-application.

Write for FREE Book, "A New Dimension in Learning," or call for FREE DEMONSTRATION—Get the Scientific Evidence Today.

MODERNOPHONE, INC.

292-086 Rock Plaza, New York 20, N. Y.

Gentlemen: Please send me your FREE Booklet. I am interested in learning more about the DORMIPHONIC Memory Trainer and what it can do for me. No obligation—no salesman will call.

If under 18, check here for Special Booklet A

NAME \_\_\_\_\_

ADDRESS \_\_\_\_\_

CITY \_\_\_\_\_ ZONE \_\_\_\_\_ STATE \_\_\_\_\_

My main interest in Dormiphonics is for:

- Learning a language       Speech Improvement  
 Memorization  
 Habit Correction       Sleep Inducement





A	B	C	D
0.01 $\mu$ fd.	100 $\mu$ fd.	47 $\mu$ fd.	0.5 $\mu$ fd.
0.1 $\mu$ fd.	0.001 $\mu$ fd.	220 $\mu$ fd.	1.0 $\mu$ fd.
	0.005 $\mu$ fd.	470 $\mu$ fd.	
	0.05 $\mu$ fd.	0.002 $\mu$ fd.	
		0.02 $\mu$ fd.	
Table 2.		0.25 $\mu$ fd.	

Table 1 should be read from left to right and from top to bottom. The resistor value in Column A is assumed to be needed 100% of the time. With this as a base, the values in Column B will be used about 50% of the time, those in Column C—11 to 25%, Column D—6 to 10%, and Column E—5% or less of the time. The values near the top of each column are used more frequently than those near the bottom. A typical stock might consist of 10 resistors of the value shown in Column A, 5 each of those in Column B, 3 each in Column C, and 1 or 2 each of those in Column D. Those in Column E may be neglected unless you want to go in for a 100% stock.

Table 2 should be read in a similar manner, except that the vertical arrangement of the capacitor values has no significance. Values in Column A are used most frequently and should be stocked in the greatest quantity; those in Column D are used only 5 to 10% of the time.

Use of these tables won't guarantee that you'll have all the 1/2-watt resistors and capacitors you will need for any particular project but—statistically at least—you'll be closer to it than you would be with any hit-or-miss system.

—B. W. Blachford

## WHERE ARE YOU?

The circuit shown on page 82 is part of the "Van Amp" as manufactured by General Apparatus Company.

A hi-fi audio signal fed into these two cathode-follower stages is essentially divided as a function of frequency by the double RC output networks. These signals are then used to drive two different power amplifiers and separate speakers for optimum hi-fi acoustical balance. The four potentiometers in the double RC networks vary the dividing frequency over a range of from 90 to 1100 cycles. The input potentiometers adjust the voltage gain of the two channels.

Further information on the "Van-Amp" may be obtained from the manufacturer at 346 East 32nd St., New York 16, N. Y.

Don't forget—we are interested in seeing suggested circuits that might puzzle our readers. Send them to Puzzle Editor, POPULAR ELECTRONICS, 366 Madison Ave., New York 17, N. Y.

## Write Now for Our New Bonus Catalogs

### INFRARED SNOOPSCOPE

SEE IN DARK TUBE  
Selected GTD. Image Converter Tube. Hi-sensitivity  
standard design 2" dia. Willemite screen—Hi-Res-  
olution. Tube & Data... \$3.90; 2/57.50

**SNOOPSCOPE POWER SUPPLY**  
Model PS2001—450VDC 35MA Supply using dual  
diode ckt. Housed in metal cabinet... \$21.95  
KIT. Same as above, parts only, less cabinet \$13.95



## TUBES "TAB" Guaranteed

TESTED OUR 12TH YEAR IN BUSINESS

0A2	.70	6AQ5	.45	6S4	.45	12AX4	.70
OZ4	.42	6AS5	.75	6SA7	.45	12AX7	.55
1R3	.60	6AT6	.35	6SN7	.40	12BH7	.65
1L4	.40	6AU6	.75	6SJ7	.45		
1R5	.49	6AV6	.40	6SK7	.45	CK1028	3.25
1S4	.64	6AX4	.60	6SL7	.55		
1S5	.40	6BA6	.45	6SN7	.55	12BY7	.70
1T4	.49	6BC5	.45	6SQ7	.45	12SA7	.65
1U4	.45	6BE6	.45	6T4	1.00	12SK7	.43
1U5	.40	6BE7	.50			12SQ7	.55
1X2A	.60	6BG6	1.12	1N21	.25	12SXT	.45
2V3	.75	6BK5	.75			14A7	.55
3A4	.48	6BL7	.80	GTR	.75	1986B	1.25
3A5	.75	6BN6	.65	GUR	.75	25BQ6	.90
3Q4	.45	6BQ6	.90	GV6	.45	25Z6	.45
3Y4	.60	6C4	.35	6W6	.55	35C6	.50
5U4G	.42	6C4	.35	6X4	.30	35L6	.50
5Y3G	.65			7AR	.50	35W4	.45
5Y4	.40	2D21	.75	7C7	.55	50C5	.45
6AC7	.64			7F7	.55	50A5	.45
6AQ5	.45	6CB6	.48	7F8	.68	50B5	.55
6AH4	.75	6CD6	1.12	7N7	.55	50C6	.45
		6C8	.45	7Q7	.75	50L6	.40
		6E5	.38	12AT6	.40	75	.45
5B1	1.75	6I6	.45	12BD6	.55	75	.45
6AH6	.85	6J6	.45	12BT6	.50	77	.40
6AK5	.52	6K7	.35	12AV6	.75	117L7/N	1.75
6AL5	.38	6L6	.65	12AV7	.75		

### NEW "TABLITE" ELECTRONIC FLASH KITS



AC & Battery Operation Inbuilt  
All in One Camera Case

Uses new to cost to voltage SUPER CIRCUIT  
constant bright light output; light duration  
1/600 sec.; color K6800; cost per flash less  
than .1¢. 1000 to 2000 flashes per set of bat-  
teries. All kits with inbuilt AC pack. Kits do  
not include batteries. Easy to follow instruc-  
tions.

MODEL 400B, 60 WATT Sec'd, color 75+; B&W 225+... \$29.95  
Recycles 2 sec'ds, less than 4 lbs.  
MODEL 600B, 120 WATT Sec'd, color 100+; B&W 300+... \$44.95  
Recycles 5 sec'ds, less than 5 lbs.  
KIT 2-340 VOLT BATTERIES... \$10  
KITS ASSEMBLED, Additional... \$10

## KITS! KITS!

Each "TAB" Kit Contains the Finest Selection of Top Quality Components in the Most Popular Values & Sizes

- EXTRA:** Free Kit with Each \$10 Kit order
- 25 Precision Resistors
  - 10 Switches
  - 25 Knobs
  - 75 Carbon Resistors\*
  - 36 Panel Lamps
  - 10 Electrolytic Cond's
  - 15 Volume Controls
  - 25 Tube Sockets
  - 50 Tubular Condensers
  - 500 Lugs & Eyelets\*
  - 10 Bathub Oil Cond's
  - 5 lbs. Surprise Package
  - 10 Xmit Mica Cond's
  - 40 Insulators
  - 25 Power Resistors
  - 65 Mica Condensers
  - 5 Crystal Diodes
  - 250 ft. Hook up Wire
  - 100 Fuses
  - 35 Ceramic Condensers
  - 10 Rotary Switches
  - 6 Crystals
  - 60 Inductors & Coils
  - 5 Microswitches
  - 10 Wheat Lamps
  - \* In Plastic Box
- 1,000's OF SATISFIED CUSTOMERS

### "TAB" GUARANTEED NEW TRANSISTORS

AT BARGAIN PRICES  
T34 Equivalent CK722 @ .95; 6/S5  
N222 Equivalent 2N107... \$1.95; 6/S5  
T20 Equivalent 2N105, CK721, CK727, 2N106, 2N64... 6 for \$15  
S260 ea... \$2.60; 6 \$15  
T109 Equivalent 2N138, 2N109... \$2.75; 6 for \$16  
T87 Equivalent 2N77... \$2.75; 6 for \$16

### "TAB" FINEST HI-FI RECORDING TAPE

7" Reel—1200 Ft. Per Reel... \$1.45  
Sold on Money Back Guarantee... Lots of 12  
Highest quality Hi-Fi Precision Coated & S.H.  
Ferro-shen process quality controlled, constant output,  
Noise FREE, Splice FREE Plastic Tape, Freq. 17 1/2 IPS, 40-15KC  
Oxide Wad In... "TAB" @ \$1.59 ea.; 3 \$1.50 ea.

### SAVE \$5—BUILD 'EM YOURSELF KITS















































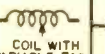



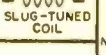



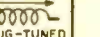





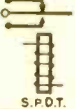











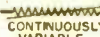







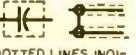









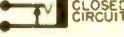
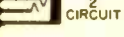

















TUBE TESTER—Professional, Tests all conventional, TV, series  
strip & picture tubes. Range 4 1/2" meter. AC DC Volts: 0-300  
VTVM—Precision built, range 100-1000, constant output,  
10, 100-500, 1000, Ohms: 0.2 to 1000 meg. Steel case, \$23.50  
FM-AM TUNER—20-20,000 cycle response. Less than 1% dis-  
tortion. Ideal for Hi-Fi System... \$29.65

## "TAB"

TERMS: Money Back Gtd. (cost of  
mide. only), \$5 min. order F.O.B.  
N.Y.C. Add ship. charges for  
C.O.D. 25% O.P.D. Tubes Gtd. via  
R-Exp. price. Ships shown are sub-  
ject to change.

Dept. 8PE6, 111 Liberty St., N.Y. 6, N.Y., Rector 2-6245

# STANDARDIZED WIRING DIAGRAM SYMBOLS

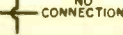
<b>ANTENNAS</b>  GENERAL  DIPOLE  LOOP  FERRITE TYPE		<b>MICROPHONE</b> SINGLE BUTTON  DYNAMIC DOUBLE BUTTON  VELOCITY CAPACITOR  CRYSTAL		<b>TELEGRAPH KEY</b> 	
<b>BATTERIES</b> SINGLE-CELL  MULTI-CELL 		<b>NEON BULB</b>  <b>PILOT LIGHT</b> 		<b>TRANSFORMERS</b> AIR CORE  IRON CORE  AIR CORE VARIABLE 	
<b>BELL</b>  <b>BUZZER</b> 		<b>PHONO PICKUPS</b> CRYSTAL  MAGNETIC 		<b>IRON CORE VARIABLE</b>  <b>POWDERED IRON CORE</b>  <b>AUTO</b> 	
<b>CAPACITORS</b> FIXED MICA OR PAPER  ELECTROLYTIC  VARIABLE CAPACITORS GANGED  TRIMMER OR PADDER  SPLIT-STATOR  FEED-THRU  T-DESIGNATES TRIMMER OR PADDER		<b>RECEPTACLE 117 V.</b>  <b>RECORDING HEAD</b> MAGNETIC 		<b>POWER TRANSFORMER</b> PRIMARY  117 V.  CT.  FILAMENTS CT.  HIGH VOLTAGE FILAMENTS	
<b>COILS</b> FIXED R.F. COIL  COIL WITH FIXED TAP  COIL WITH VARIABLE TAP  IRON CORE OR CHOKE  BIFILAR  VARIABLE COIL OR CHOKE  SLUG-TUNED COIL 		<b>RECTIFIER</b> SELENIUM TYPE 		<b>TUBES</b> DIODE  PLATE  GRID  CATHODE TRIODE TETRODE 	
<b>CRYSTALS</b> CRYSTAL DETECTOR  PIEZOELECTRIC CRYSTAL 		<b>RELAYS</b> S.P.S.T. NORMALLY OPEN  S.P.S.T. NORMALLY CLOSED  S.P.D.T. 		DIODE  SURPRESSOR SCREEN CONTROL  PLATE CAP.  GRID CAP.  DIODE PLATE 	
<b>FUSE</b>  <b>GROUNDS</b> WIRING  CHASSIS 		<b>RESISTORS</b> GENERAL  TAPPED OR ADJUSTABLE  POTENTIOMETER OR RHEOSTAT  CONTINUOUSLY VARIABLE 		PENTODE  SURPRESSOR SCREEN CONTROL  PLATE CAP.  GRID CAP.  DIODE PLATE 	
<b>HEADPHONES</b> DOUBLE  SINGLE 		<b>SHIELDING</b>  <b>SPEAKERS</b> P.M.  ELECTRO-MAGNETIC 		PENTODE  SURPRESSOR SCREEN CONTROL  PLATE CAP.  GRID CAP.  DIODE PLATE 	
<b>JACKS</b> OPEN CIRCUIT  CLOSED CIRCUIT  2 CIRCUIT  SHORTING TYPE 2 CIRCUIT  PHONE PLUG  PIN PLUG  PIN JACK 		<b>SWITCHES</b> S.P.S.T.  S.P.D.T.  PUSH-BUTTON  D.P.S.T.  D.P.D.T.  BOTH TYPES GANGED  ROTARY TYPE S.P.G.P.  WAFER 		PENTODE  SURPRESSOR SCREEN CONTROL  PLATE CAP.  GRID CAP.  DIODE PLATE 	
<b>METER</b>  <b>MOTOR</b> 		<b>TRANSISTOR (JUNCTION)</b> BASE  COLLECTOR  EMITTER  P-N-P TYPE N-P-N TYPE SAME SYMBOL EXCEPT ARROW IS REVERSED		PENTODE  SURPRESSOR SCREEN CONTROL  PLATE CAP.  GRID CAP.  DIODE PLATE 	
		<b>VIBRATOR</b> 		<b>WIRES</b> CONNECTION  NO CONNECTION 	



## RESISTOR COLOR CODE

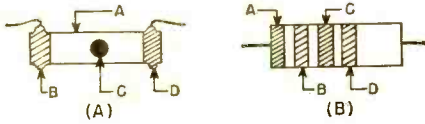

The ohmic value of a resistor can be determined by means of the color code. There are two standard methods of indicating this value.

In Fig. A, the body (A) and end (B) indicate the first and second digits of the value while the dot (C) indicates the multiplier to be used. The tolerance of the unit is indicated by the end color (D). For example, if the body (A) is green the number is 5; if the end (B) is grey the second number is 8. If the dot (C) is red the multiplier is 100 or two zeros should be added. The resistor is then a 5800 ohm unit. If the end (D) has no color, the tolerance is  $\pm 20\%$ .

In Fig. B, the first two stripes indicate the first two digits; the third stripe the multiplier; the fourth stripe the tolerance. Thus, if stripe (A) is green, (B) is grey, (C) is red, and (D) is silver, the resistor is a 5800 ohm,  $\pm 10\%$  unit.

### RETMA COLOR CODE CHART

COLOR	VALUE	MULTIPLIER
Black	0	1
Brown	1	10
Red	2	100
Orange	3	1000
Yellow	4	10,000
Green	5	100,000
Blue	6	1,000,000
Violet	7	10,000,000
Grey	8	100,000,000
White	9	1,000,000,000

#### TOLERANCE CODE

Gold— $\pm 5\%$	Silver— $\pm 10\%$
No Color— $\pm 20\%$	

## CAPACITOR COLOR CODE

MOLDED PAPER			MOLDED MICA			CERAMIC	
Color	Multiplier	Tolerance	Multiplier	Tolerance	Multiplier	Tolerance	
Black	1	20%	1	20%	1	20% or 2.0 $\mu$ fd.*	
Brown	10		10		10	1%	
Red	100		100	2%	100	2%	
Orange	1000		1000	3% (RETMA)	1000	2.5% (RETMA)	
Yellow	10,000	5%	10,000	5% (RETMA)	10,000	5% or 0.5 $\mu$ fd.*	
Green							
Blue							
Violet					0.01	0.25 $\mu$ fd.*	
Gray					0.1	10% or 1.0 $\mu$ fd.*	
White		10%					
Gold	0.1	5%	0.1	5% (JAN)			
Silver		10%	0.01	10%			
None		20%				*Capacitance less than 10 $\mu$ fd.	

Capacitance is given in  $\mu$ fd. Colors have same values as on resistors, except as indicated in tables. Colors (A) and (B) are for first two digits; (C) is for multiplier. (D) is for tolerance. (E) and (F) give voltage rating in hundreds of volts; (E) is used only for ratings less than 1000 volts, (E) and (F) for first two digits of ratings 1000 volts or more. Values of colors for (E) and (F) are same as in resistance values. (G) is class or characteristic of capacitor, (H), (I), and (J) give temperature coefficient. (G), (H), (I), and (J) are not listed in the tables, since this information is seldom needed by the average home builder.

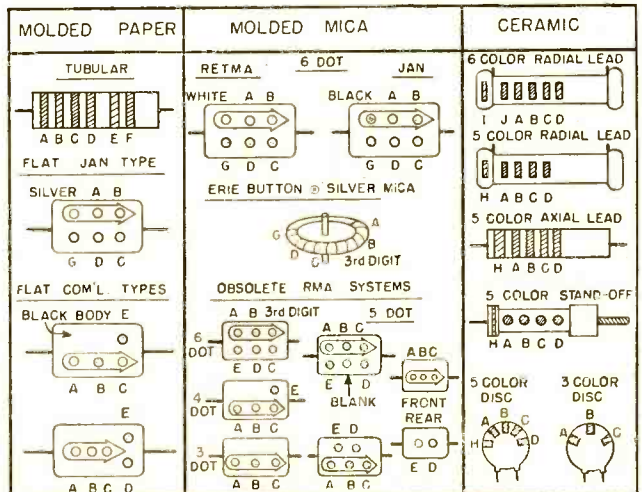



## WANTED

### Willing to pay cash for Early Phonographs with outside horns

WANT Cornet (Illustrated), Double Bell Wonder, Victor Types A, C, D, E, and O, Monarch Special, and Improved Monarch. Also Edison Tin-foil (replica) machine and his Idealia, Excelsior, Treadle Phonographs. Want early Bell-Tainter, American Gramophones and Graphophones. Also catalogues or old literature on phonos made prior to 1906. Want unusual machines and coin-in-slot cylinder phonographs. Need a few early reproducers (sound boxes) for Victor, Columbia, and Edison.

A few duplicate Edisons and graphophones are now available for sale or trade.

Send clear snapshot and full information to

Box 50, RADIO & TELEVISION NEWS,  
366 Madison Ave., New York 17, N. Y.

## WIN with ELECTRONICS

LEARN ELECTRONICS-RADIO-TV at this accredited public college. Founded 1925 as a non-profit co-educational school of higher learning. Earn Associate in Applied Science Degree in 18 months. Engineering option, VA approved. Excellent placement record. Fine equipment—experienced instructors—campus life—low tuition and living costs. FREE catalog. Write: DEAN OF STUDENTS.

TRINIDAD STATE JUNIOR COLLEGE

Trinidad Dept. EE Colorado

## GARAGE DOOR OPENER

Actuator Mechanism \$24.50

EASY TO INSTALL, SAFE, RELIABLE

WRITE for interesting free information . . . TODAY

P. E. HAWKINS CO.

631 PROSPECT

KANSAS CITY 24, MO.

## LEARN PLASTICS



COMPLETE LOW COST SHOP METHOD HOME TRAINING NOW AVAILABLE

Get in on Big Money opportunities in Plastic molding, casting, forming, carving, etc. Earn as you learn with Interstate's professionally prepared course. All plastic materials furnished.

WRITE FOR FREE BOOKLET

INTERSTATE TRAINING SERVICE

DEPT. C-95, PORTLAND 13, OREGON

## GET INTO ELECTRONICS

You can enter this uncrowded, interesting field. Defense expansion, new developments demand trained specialists. Study all phases of radio & electronics theory and practice: TV, FM; broadcasting; servicing; aviation, marine, police radio. Prepare for good pay, 18-month course. Graduates in demand by major companies. H. S. or equivalent required. Begin January, March, June, September. Campus life. Write for Catalog.

VALPARAISO TECHNICAL INSTITUTE

Dept. PE

Valparaiso, Indiana

## HOME-BUILT ENCLOSURE

### Looks Good with Burlap Finish

**A**N EASY and inexpensive way to finish your home-built loudspeaker enclosure—so that it will “belong” in the living room—is to cover it with decorator's burlap. Costing only about six cents a square foot, this fabric comes in a variety of solid colors. It is sold in 3' and 4' widths—dimensions that tie in nicely with the sizes of panels on the average enclosure. What's more, the fabric's loose weave permits all the sound from the speaker to come through unimpeded.

**Prepare Wood Surface First.** Fill in all screw-holes and other surface defects on the wooden panels with Plastic Wood or spackle. Then, sandpaper until smooth. If a light shade of burlap is to be used, your preparation is done.

If a dark color of burlap is desirable, the raw wood may show through the fabric's loose weave. To prevent this, paint the wood a dark color—it need not match the burlap. Using paint provides you with another advantage: if you let the paint set until it is not quite dry, its tacky surface will make for a good bond between the burlap and the wood.

If you don't paint the wood, you can bond the burlap to the enclosure with rubber cement or any neutral-colored glue.

In most cases, one long strip of burlap can be wrapped around the sides and front of the enclosure, with a separate piece covering the top. This leaves a few edges of the fabric that must be secured to the wood. Fasten these edges of fabric where they won't show, along the bottom and back of the cabinet.

**Secure the Edges.** One way to secure an edge of burlap is to fold it under itself to create a narrow hem, and then tack it to the wood with upholstery nails. Another method is to glue and staple the burlap without first making a hem.

With darker colors of burlap, a metallic glint may show if staples are used. To prevent this, simply daub the top of the strip of staples with a dark-colored paint before loading them into the stapling machine. Let the paint dry thoroughly so that it will remain on each staple and not interfere with the stapling process.

Incidentally, a few staples driven at random into the larger surfaces covered by the burlap will give you extra insurance against sags or bulges.

Neatly applied, burlap will prove a cheap but effective way of getting your home-built enclosure to look good as well as to sound good.

—Wm. B. Rasmussen



# Classified

RATE: 50¢ per word. Minimum 10 words prepaid. October issue closes August 3rd. Send order and remittance to: POPULAR ELECTRONICS, 366 Madison Avenue, N. Y. C. 17.

## FOR SALE

**TUBES-TV, Radio, Transmitting And Industrial Types** At Sensibly Low Prices. New, Guaranteed 1st Quality Top Name Brands Only. Write For Free Catalog or call Walker 5-7000, Barry Electronics Corp., 512 Broadway, New York 12N, N. Y.

**DIAGRAMS** for repairing radios \$1.00. Television \$2.00. Give make, model. Diagram Service, Box 672-PE, Hartford 1, Conn.

**USED** Television sets \$14. Jones, 1115 Rambler, Pottstown, Penna.

**SECRET** Beam Transmitter, New, Five Mile Range, White & Infrared. Portable, Flashlight battery operation. Includes Signal Gun, Gunstock, Tripod, Infrared Goggles, Remote Control, Carrying Case, Manual. Government paid over \$50. Yours for only \$10 postpaid. Illustrated Signal Corps Manual 50c. Surplus. Box 118, Jersey City 4, N. J.

**TV Trade-In Sets:** Philco, RCA, Emerson, others. List available. 10"—\$12; 12" to 17"—\$15 up. Washtek Service—Dept. PE, 956 Southern Blvd.—Bronx, N. Y.

**TAPE** Recorded Code Course, Novice \$11. Individual practice tapes \$3.50. Write for details, Tapedcode, Box 31, Langhorne, Pa

**"AUTOMATIC** Garage Door Control" Book (POPtronics Bookshelf, March, 1956): standard parts: radio or post control. Complete assembly instructions, plans photos, exploded view: \$1.50. R-L Books, 13339-A Debby, Van Nuys, California. Guaranteed!

**AUTOMATIC** Headlight Dimmer. Transistorized. Kit or ready to install. Nagog, Littleton, Massachusetts.

**AMAZING** Superhet Pocket Radio. Distant Stations With No Antenna. Complete With Batteries \$24.50, Kit-Form \$15.85 Postpaid. Electronic Outlet, 5-C Wollcott Avenue, Lawrence, Mass.

**"20 CRYSTAL** Set Plans" (SW record 5800 miles), catalog and "Radiobuilder" magazine—25c. Laboratories, 328-L Fuller, Redwood City, California.

**WALKIE-TALKIE.** Build wireless portable radiophone for less than \$10.00. Plans for variable frequency and crystal control types, only 50c for both. Springfield Enterprises, Box 54-E8, Springfield Gardens 13, N. Y.

**TRANSISTOR** devices, walkie-talkies, VHF AM-FM portable radios, wireless mikes, etc. at wholesale prices direct from our factory. Free literature. Springfield Enterprises, Box 54-E8, Springfield Gardens 13, N. Y.

**ELECTRIC** Guitars. Amplifiers. parts, wholesale, Free Catalog, Carvin, PE287, Covina, Calif.

**TELEPHONE** Transmitter. Hand set type. Suitable for inter-house phones, speakers or any communication purpose. Delivered two for \$1.00. No C.O.D.'s. Telephones, Dept. C-429, 1760 Lunt, Chicago 26.

**SOLAR** Battery—miniature selenium cell. With data and experiments. \$1.00 to Lab "L", P. O. Box 3096, University Station, Columbus 10, O.

**BARGAIN.** Victoreen 1B85 geiger tubes. \$4.50 each. Limited Quantity available. Catalog, geiger counters, parts, etc. American Laboratories, Dept. PE, 471 Clifton Ave., Newark 4, N. J.

**"AN Unqualified Bargain"** . . . at \$24.75, says High Fidelity Magazine. . . . Equivalent to many larger and more costly speakers . . . says Audio Magazine. Ask for complete reports, specifications and enclosure recommendations on the famous Panasonic 8" high fidelity speaker. Better yet—try the Panasonic at our risk in your home with your equipment. Now save 20%—send only \$19.80 postpaid. Ten day money back guarantee. Windsor International Company, Inc., P. O. Box 15C, Riverside, Connecticut.

**DIAGRAMS!** Repair Information! Radios—Amplifiers—Recorders \$1.00. Televisions \$1.50. Give Make, Model, Chassis, Norelco-Philips and Amperex tubes in stock! TV Miltie, Box 101-PE, Hicksville, New York.

## WANTED

**CYLINDER** and old disc phonographs. Edison Concert, Balmoral, Conqueror, Opera, and Oratorio models. Berliner Gramophones and Zono-o-phones, Columbia disc and cylinder Graphophones, Bettini micro-reproducer. Want old catalogues and literature on early phonos prior to 1919. Will pay cash or trade late hi-fi components. POPULAR ELECTRONICS, Box 50.

**TUBES** and equipment bought, sold and exchanged. For action and a fair deal write B. F. Gensler, W2LNI, 56 Crosby St., N. Y., 12N, N. Y.

## HELP WANTED

**FOREIGN** jobs list. Guaranteed. \$1. Rathe, Box 26131, Los Angeles 26, California.

## INVENTIONS WANTED

**INVENTIONS** wanted. Patented: unpatented. Global Marketing Service, 2420 77th, Oakland 5, Calif.

## BUSINESS OPPORTUNITIES

**TO** \$100.00 Weekly. Spartime, Home Operated Mail-order Business. Successful "Beginner's" Plan. Everything Supplied. Lynn, 10420-E National, Los Angeles 34.

**VENDING** Machines—No Selling. Operate a route of coin machines and earn amazing profits. 32-page catalog free. Parkway Machine Corporation, Dept. 12, 715 Ensor St., Baltimore 2, Md.

**FREE** Booklet "Money-Making Facts" tells mechanically-inclined men how to start sparetime business at home. Lee Foley Company, Columbia Heights, Minnesota.

**\$70 WEEKLY**—home, spare time. Simplified mail book-keeping. Immediate income—easy! Auditax, 34757Y, Los Angeles 34.

**LEARN** big money mail order. Full or part time. Work from home or any address. Free information. National Printing Service, Box 12B, Highland Park, N. J.

**\$150 WEEK**—easy! Start home Venetian Blind Laundry. Revealing book free. E. O. Co., 101 So. 44th, Philadelphia 4, Penna.

## EMPLOYMENT INFORMATION

**JOBS**—High Pay. South America, the Islands, USA, foreign countries. All trades. Clerical, labor, engineers, drivers, others. Women also. Fare paid. Application forms. For information. Write Section 92B, National Employment Information, 1020 Broad, Newark, N. J.

## INSTRUCTION

**FINISH** High School at home, spare time. No classes. Diploma awarded. Write for Free catalog. Wayne School, Catalog HET-12, 2527 Sheffield, Chicago 14.

**BECOME** Tax Consultant. Graduates earn \$3,000 every tax season preparing returns evenings. State approved. Union Institute, 68 Hudson, Hoboken 3L, N. J.

## RECORDS

**PHONOGRAPH** Records Cheap. Catalogue. Paramount, TD—313 East Market, Wilkes-Barre, Penna.

## TAPE RECORDERS

**TAPE** Recorders. Tape. Unusual Values. Free Catalog. Dressner, 69-02F, 174 St., Flushing 65, N. Y.

**RECORDED** Tape Music. Recording tape. Accessories. Discounts. Elisco, 270A Concord, West Hemstead, N. Y.

## AUGUST 1956 ADVERTISERS' INDEX

ADVERTISER	PAGE NO.	ADVERTISER	PAGE NO.
Algeradio Electronics Co.	124	Major Brand Tube Co.	17
Allied Radio Corp.	112	Midway Company	118
Apparatus Development Co.	118	Miller, Gustave	118
Art Instruction, Inc.	28	Miller Co., J. W.	12
Auto Mechanic	130	Modernophone, Inc.	123
Bailey Technical Schools	113	Moss Electronics	3rd & 4th Covers
Boord, Ken	121	Musical Masterpiece Society	9
Capitol Radio Engineering Institute	23	National Radio Institute	3, 18
Central Technical Institute	25	National Schools	29
Cleveland Institute of Radio Electronics	21	Pacific States University	122
Coyne Electrical School	5	Parts Sales	128
Denson Electronics Corp.	124	Philadelphia Wireless Technical Institute	121
DeVry Technical Institute	11	Popular Photography	117
Electro-Voice	30	Progressive "Edu-Kits," Inc.	27
Electronic Instrument Co., Inc. (EICO)	10	RCA Institutes	15
Electronic Measurements Corp.	6	Radio TV Training Association	7
Garfield Company, Oliver	2nd Cover	Radio & TV News	113
Gonset Company	25	Raytheon Manufacturing Co.	14
Grantham School of Electronics	124	Rider Publishing Co., John F.	24
Greenlee Tool Co.	25	Rockbar Corporation	8
Gyro Electronics Co.	122	Spera Electronic Supply	122
Hawkins Co., P. E.	128	Springfield Enterprises	114, 122
Heath Company	108, 109, 110, 111	Stanley Electronics	20
Hershel Radio Co.	16	TAB	125
Indiana Technical College	124	Tube Mart, The	117
Indianapolis Electronic School	124	U. S. Air Force	107
International Correspondence Schools	13	V.S.I. Television School	114
Interstate Training Service	128	Valparaiso Technical College	128
Johnson Co., E. F.	115	Video Electronics	121
LMB	114	Western Radio	118, 124
Lafayette Radio Corp.	19	Westwood Research & Development Co.	114
Lektron Specialties	119	Whitehall Pharrnacal Co.	122
		World Radio Labs	22
		YMCA Trade Schools	122

# STOP CAR TROUBLE BEFORE IT BEGINS!

A simple maintenance check of your car this weekend could easily spare you the cost and bother of a highway breakdown! And it's easy to check the car *yourself*, make minor repairs and adjustments . . . even if you've never tinkered with your automobile before.

Let the Preventive Maintenance Issue of **AUTO MECHANICS** show you how to stop car trouble before it starts.

Buy your copy of August **AUTO MECHANICS** today!

**NOW ON SALE  
AT ALL NEWSSTANDS—  
ONLY 35¢**



Ziff-Davis Publishing Company,  
366 Madison Ave., New York, 17, N.Y.





Superior's New Model TC-55

Streamlined

# TUBE TESTER

**FOR**

The Experimenter or Part-time Serviceman, who has delayed purchasing a higher priced Tube Tester.  
The Professional Serviceman, who needs an extra Tube Tester for outside calls.  
The busy TV Service Organization, which needs extra Tube Testers for its field men.

Speedy, yet efficient operation is accomplished by: Elimination of old style sockets used for testing obsolete tubes (26, 27, 57, 59, etc.) and providing sockets and circuits for efficiently testing the new Noval and Sub-Minar types.

• You can't insert a tube in wrong socket. Separate sockets are used, one for each type of tube base. • "Free-point" element switching system Any pin may be used as a filament pin and the voltage applied between that pin and any other pin, or even the "top-cap". • Checks for shorts and leakages between all elements. Provides a super sensitive method of checking for shorts and leakages up to 5 Megohms between any and all of the terminals. Continuity between various sections is individually indicated. • Elemental switches are numbered in strict accordance with R.M.A. specification. The 4 position fast-action snap switches are all numbered in exact accordance with the standard R.M.A. numbering system.

Model TC-55 comes complete with operating instructions and charts and streamlined carrying case.

**\$26<sup>95</sup>**

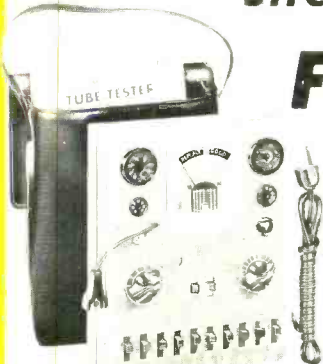

Superior's New Model TV-11

Standard Professional

# TUBE TESTER

- ★ Tests all tubes including 4, 5, 6, 7, Octal, Lock-in, Peanut, Bantam, Hearing Aid, Thyatron Miniatures, Sub-miniatures, Novals, Sub-minars, Proximity fuse types, etc.
- ★ Uses the new self-cleaning Lever Action Switches for individual element testing. Because all elements are numbered according to pin-number in the RMA base numbering system, the user can instantly identify which element is under test. Tubes having tapped filaments and tubes with filaments terminating in more than one pin are truly tested with the Model TV-11 as any of the pins may be placed in the neutral position when necessary.
- ★ The Model TV-11 does not use any combination type sockets. Instead individual sockets are used for each type of tube. Thus it is impossible to damage a tube by inserting it in the wrong socket.

- ★ Free-moving built-in roll chart provides complete data for all tubes.
- ★ Newly designed Line Voltage Control compensates for variation of any Line Voltage between 105 Volts and 130 Volts.
- ★ NOISE TEST: Phone-jack on front panel for plugging in either phones or external amplifier will detect microphonic tubes or noise due to faulty elements and loose internal connections.

The model TV-11 operates on 105-130 Volt 60 Cycles A.C. Comes housed in a beautiful hand-rubbed oak cabinet complete with portable cover.

**\$47<sup>50</sup>**

EXTRA SERVICE — The Model TV-11 may be used as an extremely sensitive Condenser Leakage Checker. A relaxation type oscillator incorporated in this model will detect leakages even when the frequency is one per minute.

## SHIPPED ON APPROVAL NO MONEY WITH ORDER — NO C. O. D.

We invite you to try before you buy any of the models described on this and the following page. If after a 10 day trial you are completely satisfied and decide to keep the Tester, you need send us only the down payment and agree to pay the balance due at the monthly indicated rate.

**NO INTEREST  
OR FINANCE  
CHARGES ADDED!**

If not completely satisfied, you are privileged to return the Tester to us, cancelling any further obligation.

**SEE OTHER  
SIDE**

CUT OUT AND MAIL TODAY! ▶

MOSS ELECTRONIC DISTRIBUTING CO., INC.

Dept. D-251 3849 Tenth Avenue, New York 34, N.Y.

Please send me the units checked. I agree to pay down payment within 10 days and to pay the monthly balance as shown. It is understood there will be no finance or interest charges added. It is further understood that should I fail to make payments when due, the full unpaid balance shall become immediately due and payable.

- |   |  |
|---|--|
| <input type="checkbox"/> Model TV-11... Total Price \$47.50.<br>\$11.50 within 10 days. Balance<br>\$6.00 monthly for 6 months. | <input type="checkbox"/> Model 670-A... Total Price \$28.40<br>\$7.40 within 10 days. Balance<br>\$3.50 monthly for 6 months   |
| <input type="checkbox"/> Model TC-55... Total Price \$26.95<br>\$6.95 within 10 days. Balance \$5.00<br>monthly for 4 months.   | <input type="checkbox"/> Model TV-50... Total Price \$47.50<br>\$11.50 within 10 days. Balance<br>\$6.00 monthly for 6 months. |

Name \_\_\_\_\_

Address \_\_\_\_\_

City \_\_\_\_\_ Zone \_\_\_\_\_ State \_\_\_\_\_

All prices net, F.O.B., N.Y.C.

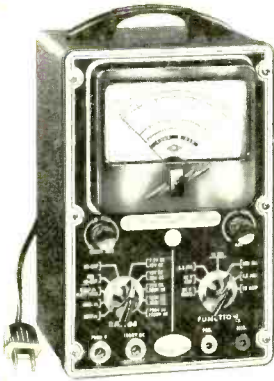

Superior's New  
Model 670-A

# SUPER-METER

A COMBINATION VOLT-OHM MILLIAMMETER PLUS  
CAPACITY REACTANCE INDUCTANCE AND DECIBEL MEASUREMENTS

**SPECIFICATIONS:**

D.C. VOLTS: 0 to 7.5/15/75/150/750/1,500/7,500 Volts  
A.C. VOLTS: 0 to 15/30/150/300/1,500/3,000 Volts  
OUTPUT VOLTS: 0 to 15/30/150/300/1,500/3,000 Volts  
D.C. CURRENT: 0 to 1.5/15/150 Ma. 0 to 1.5/15 Amperes  
RESISTANCE: 0 to 1,000/100,000 Ohms 0 to 10 Megohms  
CAPACITY: .001 to 1 Mfd. 1 to 50 Mfd. (Good-Bad Scale for checking quality of electrolytic condensers.)  
REACTANCE: 50 to 2,500 Ohms 2,500 Ohms to 2.5 Megohms  
INDUCTANCE: .15 to 7 Henries 7 to 7,000 Henries  
DECIBELS: -6 to +18 +14 to +38 +34 to +58

**ADDED FEATURE:**

Built-in ISOLATION TRANSFORMER reduces possibility of burning out meter through misuse.

The Model 670-A comes housed in a rugged crackle-finished steel cabinet complete with test leads and operating instructions.

**\$28<sup>40</sup>**

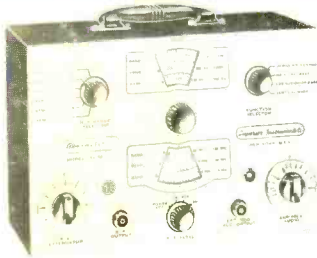

Superior's New  
Model TV-50

# GENOMETER

A versatile all-inclusive GENERATOR which provides ALL the outputs for servicing:  
A.M. Radio • F.M. Radio • Amplifiers • Black and White TV • Color TV  
7 Signal Generators in One!

- ✓ R. F. Signal Generator for A.M.
- ✓ R. F. Signal Generator for F.M.
- ✓ Audio Frequency Generator
- ✓ Bar Generator
- ✓ Cross Hatch Generator
- ✓ Color Dot Pattern Generator
- ✓ Marker Generator

**R. F. SIGNAL GENERATOR:** The Model TV-50 Genometer provides complete coverage for A.M. and F.M. alignment. Generates Radio Frequencies from 100 Kilocycles to 60 Megacycles on fundamentals and from 60 Megacycles to 180 Megacycles on powerful harmonics.

**CROSS HATCH GENERATOR:** The Model TV-50 Genometer will project a cross-hatch pattern on any TV picture tube. The pattern will consist of non-shifting, horizontal and vertical lines interlaced to provide a stable cross-hatch effect.

**DOT PATTERN GENERATOR (FOR COLOR TV)** Although you will be able to use most of your regular standard equipment for servicing Color TV, the one addition which is a "must" is a Dot Pattern Generator. The Dot Pattern projected on any color TV Receiver tube by the Model TV-50 will enable you to adjust for proper color convergence.

**VARIABLE AUDIO FREQUENCY GENERATOR:** In addition to a fixed 400 cycle sine-wave audio, the Model TV-50 Genometer provides a variable 300 cycle to 20,000 cycle peaked wave audio signal.

**MARKER GENERATOR:** The Model TV-50 includes all the most frequently needed marker points. The following markers are provided: 189 Kc., 262.5 Kc., 456 Kc., 600 Kc., 1000 Kc., 1400 Kc., 1600 Kc., 2000 Kc., 2500 Kc., 3579 Kc., 4.5 Mc., 5 Mc., 10.7 Mc., (3579 Kc. is the color burst frequency.)

**BAR GENERATOR:** The Model TV-50 projects an actual Bar Pattern on any TV Receiver Screen. Pattern will consist of 4 to 16 horizontal bars or 7 to 20 vertical bars.

THE MODEL TV-50 comes absolutely complete with shielded leads and operating instructions.

**\$47<sup>50</sup>**

Only

**SHIPPED ON APPROVAL  
NO MONEY WITH ORDER — NO C. O. D.**

**BUSINESS REPLY CARD**

No Postage Stamp Necessary if Mailed in the U. S.

POSTAGE WILL BE PAID BY —

MOSS ELECTRONIC DIST. CO., INC.

3849 TENTH AVENUE

NEW YORK 34, N. Y.

FIRST CLASS

Permit No. 61430

New York, N. Y.

We invite you to try before you buy any of the models described on this and the preceding page. If after a 10 day trial you are completely satisfied and decide to keep the Tester, you need send us only the down payment and agree to pay the balance due at the monthly indicated rate. (See other side for time-payment schedule details.)

**NO INTEREST  
OR FINANCE  
CHARGES ADDED!**

If not completely satisfied you are privileged to return the Tester to us, cancelling any further obligation.

**SEE OTHER  
SIDE**

CUT OUT AND MAIL TODAY!