

POPULAR ELECTRONICS

APRIL
1956

25
CENTS

in U. S. and Canada

HI-FI • AMATEUR RADIO • R/C • SWL • GADGETS

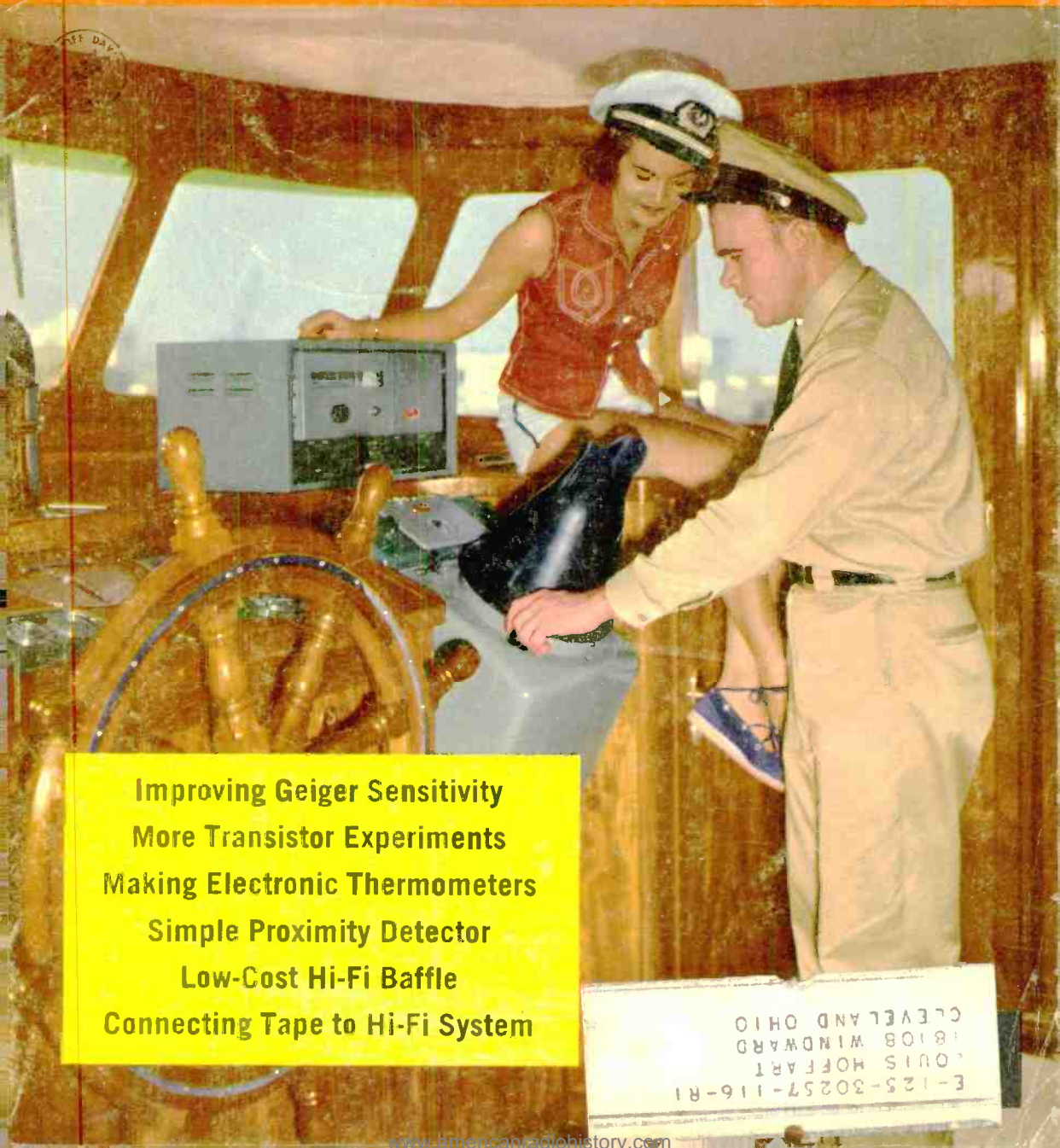

Improving Geiger Sensitivity
More Transistor Experiments
Making Electronic Thermometers
Simple Proximity Detector
Low-Cost Hi-Fi Baffle
Connecting Tape to Hi-Fi System

E-125-30257-116-R1
LOUIS HOFFART
18108 WINDWARD
CLEVELAND OHIO



why build a high fidelity turntable like a battleship ?

A high fidelity turntable, like a battleship, must be rugged, heavy, massive . . . yet easy to control. Both must be completely dependable, smooth in performance, and quiet in operation.

52 POUNDS OF LISTENING PLEASURE

Imagine the pound by pound advantages found only in Gray's turntable assembly designed exclusively for High Fidelity recordings:

- A 1/4" steel motorboard for complete rigidity.
- A 23 lb. flywheel action turntable with a 4-inch tapered bearing that positively eliminates wobble forever.
- A turntable and motorboard assembly that is 10 times the mass of the motor, prevents the transference of all mechanical disturbance.

For the gentle touch, Gray's floating action, Viscous Damped Tone Arm, and the novel cue light for accurate starting groove location, add the ultimate in operating enjoyment.

Be assured you are obtaining maximum performance from your High Fidelity system. Only Gray has a turntable "built like a battleship". Styled by one of the country's leading designers, this unit adds a note of distinction to any surroundings. The standard finishes are pebbled gray, red, green, or yellow. Deluxe models are available in mahogany, walnut, and blonde.

Write for more information
or see your local dealer.



Models \$89.00 to \$169.50 depending
upon the completeness of assembly
and choice of motor.

GRAY RESEARCH & DEVELOPMENT COMPANY, INC.
Manchester, Connecticut

Subsidiary of The Gray Manufacturing Company

You Practice **SERVICING** with Kits I Send You



Nothing takes the place of PRACTICAL EXPERIENCE. That's why NRI training is based on LEARNING BY DOING. You use parts I send to build many circuits common to Radio and Television. With my Servicing Course you build the modern Radio shown at left. You build a Multitester and use it to help make \$10, \$15 a week fixing sets in spare time while training. All equipment is yours to keep. Coupon below will bring book of important facts. It shows other equipment you build.

You Practice **BROADCASTING** with Kits I Send You



As part of my Communications Course I send you parts to build low-power Broadcasting Transmitter at left. Use it to get practical experience. You put this station "on the air" . . . perform procedures demanded of broadcasting station operators. An FCC Commercial Operator's License can be your ticket to a bright future. My Communications Course trains you to get your license. Mail coupon. Book shows other equipment you build for practical experience.

I Will Train You at Home in Spare Time to be a **RADIO-TELEVISION** Technician

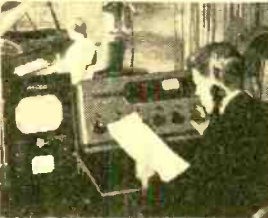

TELEVISION

Making Jobs, Prosperity

25 million homes have Television sets now. Thousands more sold every week. Trained men needed to make, install, service TV sets. About 200 television stations on the air. Hundreds more being built. Good job opportunities here for qualified technicians, operators, etc.



America's Fast Growing Industry Offers You Good Pay, Success

Training PLUS opportunity is the PERFECT COMBINATION for job security, advancement. When times are good, the trained man makes the BETTER PAY, gets PROMOTED. When jobs are scarce, the trained man enjoys GREATER SECURITY. NRI training can help assure you and your family more of the better things of life. Radio is bigger than ever with over 3,000 broadcasting stations and more than 115 MILLION sets in use, and Television is moving ahead fast.

N.R.I. Training Leads to Good Jobs Like These

I TRAINED THESE MEN

"I have progressed very rapidly. My present position is Studio Supervisor with KEDD Television, Wichita."—Elmer Frewald, 3026 Stadium, Wichita, Kans.

"Fix sets part time in my shop. Made about \$500 first three months of the year. Could have more but this is about all I can handle."—Frank B-r-r, Lorain, Ohio.

"I've come a long way in Radio and Television since graduating. Have my own business on Main Street."—Joe Travers, Asbury Park, New Jersey.

"I didn't know a thing about Radio. Now have a good job as Studio Engineer at KMMJ."—Bill Delzell, Central City, Nebraska.

BROADCASTING: Chief Technician, Chief Operator, Power Monitor, Recording Operator, Remote Control Operator. **SERVICING:** Home and Auto Radios, Television Receivers, FM Radios, P.A. Systems. **IN RADIO PLANTS:** Design Assistant, Technician, Tester, Serviceman, Service Manager. **SHIP AND HARBOR RADIO:** Chief Operator, Radio-Telephone Operator. **GOVERNMENT RADIO:** Operator in Army, Navy, Marine Corps, Forestry Service Dispatcher, Airways Radio Operator. **AVIATION RADIO:** Transmitter Technician, Receiver Technician, Airport Transmitter Operator. **TELEVISION:** Pick-up Operator, Television Technician, Remote Control Operator.

Start Soon to Make \$10, \$15 a Week Extra Fixing Sets

My training is practical, complete; is backed by 40 years of success training men at home. My well-illustrated lessons give you basic principles you need and my skillfully developed kits of parts "bring to life" things you learn from the lessons. I start sending you special booklets the day you enroll, that show you how to fix sets. Multitester you build with my parts helps you discover and correct set troubles, helps you make money fixing neighbors' sets in spare time while training. Many make \$10, \$15 a week extra this way.

Mail Coupon — Find Out What Radio-Television Offer You

Act now to get more of the good things of life. I send actual lesson to prove NRI home training is practical, thorough. My 64-page book "How to be a Success in Radio-Television" shows what my graduates are doing and earning. It gives important facts about your opportunities in Radio-Television. Take NRI training for as little as \$5 a month. Many graduates make more than the total cost of my training in two weeks. Mail coupon now to: J. E. SMITH, President, Dept. 6DD4, National Radio Institute, Washington 9, D. C. Our 40th year.

AVAILABLE to all qualified VETERANS UNDER G. I. BILLS

Good for Both — FREE

MR. J. E. SMITH, President, Dept. 6DD4 National Radio Institute, Washington 9, D. C. Mail me Sample Lesson and 64-page Book, FREE. (No salesman will call. Please write plainly.)

Name Age

Address

City Zone State

VETS write in date of discharge



Mail Today-Tested Way to Better Pay

POPULAR ELECTRONICS is published monthly by Ziff-Davis Publishing Company, William B. Ziff, Chairman of the Board (1946-1953), at 84 E. Lake St., Chicago 1, Ill. Entered as second class matter August 27, 1954 at the Post Office, Chicago, Illinois. SUBSCRIPTION RATES: One year U.S. and possessions, and Canada \$3.00; Pan-American Union Countries \$3.50; all others foreign countries \$4.00.

POPULAR ELECTRONICS

Registered U. S. Patent Office

CONTENTS

Drones Put R/C into War Games.....	E. D. Morgan	31
Profit from Your Electronics Hobby.....		34
TV Show Features "Wires and Pliers".....		37
Lab on Wheels.....		39
New TV System Turns Night into Day.....		41
Transosonde Intercontinental Weather Balloon.....	E. D. Morgan	42
Electronic Realism in Disneyland.....	John A. Norman	44
Solving the Jet Crash Mystery.....	John L. Kent	46
Telemetry a Heart Beat.....		49
Amplify Those Geiger Clicks.....	E. G. Louis	50
Five New Jobs for Two Transistors.....	Louis E. Garner, Jr.	54
Review Your Soldering Habits.....		60
Make Your Own Electronic Thermometer.....	Harvey Pollack	62
Simple Proximity Detector Works Like Magic.....	Paul Harvey	65
Potentiometer Boxes Speed Circuit Experiments.....	Rufus P. Turner	68
An Amazing Converter.....	Frank H. Tooker	70

POPULAR ELECTRONICS Audio and Hi-Fi Section

Disc and Tape Review.....	Bert Whyte	71
Turning Out the Turntable.....		73
Introducing the "Octahedral".....	J. H. Owens	74
Horns—Folded and Loaded.....	H. H. Fantel	78
Recommended Tape Recorder Hookups.....	R. S. Ianier	82

DEPARTMENTS

Letters from Our Readers.....		10
POP'tronics Bookshelf.....		14
This Month's Cover.....		20
What's the PE Answer?.....		24
Carl & Jerry.....	John T. Frye	69
Tuning the Short-Wave Bands.....	Hank Bennett	86
The Transmitting Tower.....	Herb S. Brier	88
After Class.....		90
Tips and Techniques.....		92
Tools & Gadgets.....		112
Glossary of Electronic Terms.....		126

(Also see page 6)

Copyright 1956 by Ziff-Davis Publishing Company. All rights reserved.

APRIL 1956

VOL. 4—NUMBER 4

EDITOR
OLIVER READ, W1ETI

MANAGING EDITOR
O. P. Ferrell

SENIOR EDITOR
Robert Gorman

TECHNICAL EDITOR
H. S. Renne

FEATURE EDITOR
Norman Eisenberg

ASSOCIATE EDITOR
M. C. Magna

ART EDITOR
A. J. Reich

CONTRIBUTING EDITORS
H. Bennett L. E. Garner, Jr.
H. S. Brier H. Pollack
H. H. Fantel R. P. Turner
J. T. Frye

ART DEPARTMENT
Frank Sayles (Director)
J. A. Golaneck M. Whelpley
W. K. Vahlsing

ADVERTISING DEPARTMENT
NEW YORK (MU 7-8080)
L. L. Osten—Adv. Dir.
Wm. G. McRoy—Adv. Mgr.
Bert Covit
CHICAGO (AN 3-5200)
Jim Weakley, Midwest Adv. Mgr.
LOS ANGELES (Mich. 9856)
John E. Payne



Member
Audit Bureau of
Circulations

ZIFF-DAVIS PUBLISHING COMPANY

W. B. ZIFF (1898-1953) FOUNDER

Also Publishers of
RADIO & TELEVISION NEWS
Editorial and Executive Offices
366 Madison Ave., New York 17, N.Y.

PRESIDENT
B. G. DAVIS

VICE-PRESIDENTS
H. J. MORGANROTH M. FROELICH

SECRETARY-TREASURER
G. E. CARNEY

CIRCULATION MANAGER
M. MICHAELSON

BRANCH OFFICES
Chicago (1), 64 E. Lake St.
Los Angeles (14), Stalter Center
900 Wilshire Blvd.

SUBSCRIPTION SERVICE:
All communications concerning subscriptions should be addressed to Circulation Dept., 64 E. Lake St., Chicago 1, Ill. Include your old address as well as new—enclosing if possible an address label from a recent issue of this magazine. Allow at least 4 weeks for change of address.

CONTRIBUTORS:
Contributors are advised to retain a copy of their manuscripts and illustrations. Contributions should be mailed to the New York Editorial Office and must be accompanied by return postage. Contributions will be handled with reasonable care, but this magazine assumes no responsibility for their safety. Any copy accepted is subject to whatever adaptations and revisions are necessary to meet the requirements of this publication. Payment covers all author's, contributor's and contestant's rights, title, and interest in and to the material accepted and will be made at our current rates upon acceptance. All photos and drawings will be considered as part of material purchased.

POPULAR ELECTRONICS



THE MUSICAL MASTERPIECE SOCIETY INVITES YOU TO ACCEPT

FREE

BEETHOVEN'S 9th SYMPHONY (The Chorale)

The Most Majestic Symphony in All Music in a New High-Fidelity Performance
by the Netherlands Philharmonic Orchestra and Chorus Under the Baton of Walter Goehr.

Internationally Famous Artists: **CORRY BIJSTER**, soprano; **ELIZABETH PRITCHARD**, alto soprano;
DAVID GAREN, tenor; **LEONARDO WOLOVSKY**, bass

Plus Beethoven's 1st and 8th SYMPHONIES

ALL THREE SYMPHONIES COMPLETE TO THE LAST NOTE!

THE MOST ASTOUNDING
RECORD OFFER
EVER MADE!



To demonstrate the amazing value, the magnificent artistry of the Society's recordings take this majestic new album of BEETHOVEN'S NINTH... plus Beethoven's 1st and 8th symphonies—as a FREE GIFT! No obligation to buy another record ever. We simply want to introduce you to the enjoyment awaiting you in all the new releases listed below. Great masterpieces performed by world renowned artists and orchestras... reproduced on high-fidelity discs encompassing the entire range of human hearing... from 50 to 15,000 cycles!

Save Over 40% off usual cost

When you send for your FREE GIFT Recordings, you

also become eligible to audition FREE any or all of these 30 additional discs at the rate of two a month. Those you choose to hear will be delivered, free of charge. Pay only \$1.89, plus shipping, for each long-playing disc you decide to keep. Pay nothing for those you don't want after 5 day trial. FREE GIFT is yours in any case. Mail coupon now!

Internationally Acclaimed
"The discs can be recommended without reservation to record lovers."
—The Action, Zurich, Switzerland.
"Excellent series of records." —The Saturday Review, New York.

Just Imagine the Fabulous Record Collection You Can Build From This List!

1. DVORAK: Symph. No. 5, "New World"
2. TCHAIKOVSKY: Violin Con.
3. MOZART: Piano Con. No. 24
4. BACH: Magnificat in D
5. BEETHOVEN: Piano Concerto, "Emperor"
6. BIZET: Symphony in C
7. VIVALDI: The Four Seasons
8. SCHUMANN: Piano Concerto
9. HAYDN: Trumpet-Concerto, and Flute-Concerto
10. SCHUBERT: Piano Quintet, "Trout"
11. MOZART: "Jupiter" Symph., and Symph. No. 17
12. CHOPIN: Piano Concerto No. 1
13. BACH: Violin Concerto No. 2; Chaconne
14. RIMSKY-KORSAKOFF: Capriccio Espagnol; Intro. & March from "Coq d'Or"; Mussorgsky: Intro. to "Khovantchina"
15. DEBUSSY: Quartet in G; and Sonata for Cello and Piano
16. BEETHOVEN: "Appassionata" and "Moonlight" Sonatas
17. BRUCH: Violin Concerto; PAGANINI: La Campanella
18. MOZART: Clarinet Quin. in A
19. SAINT-SAENS: Violin Concerto No. 3; Havanaise
20. MOZART: Symph. Nos. 40 & 34
21. GOLDMARK: Rustic Wedding Symphony
22. BEETHOVEN: Symph. No. 7
23. CHOPIN: Sonata No. 2; Fantaisie Impromptu
24. HAYDN: "Surprise" and "Military" Symphonies
25. FRANCK: Symph. in D minor
26. STRAVINSKY: Firebird, and Piano Concerto
27. SCHUBERT: Symph. No. 3, and Fantasy and Rondo for Piano and Orchestra.
28. PROKOFIEFF: Violin Concerto No. 1 and Piano Concerto No. 1
29. MENDELSSOHN: "Scotch" Symphony
30. DVORAK: "American" Quartet; and Carnival Overture

Orchs. include: Netherlands Phil., Utrecht Symph., Vienna State Op. Orch., Pascal String Quartet, etc.; Cond.: W. Goehr, Otto Ackermann, P. Hupperts, H. Swoboda, etc.; Soloists: Pozzi, Odnoosoff, Kaufmann, Mewton-Wood, etc.

THE MUSICAL MASTERPIECE SOCIETY, Dept. 60-4

43 W. 61st St., New York 23, N. Y.
Rush my FREE GIFT album of Beethoven's 9th, 1st and 8th symphonies. I have crossed off (at right) the future releases I don't want to audition. The others will be delivered for 5 day free trial, two discs a month. Those I decide to keep will be billed to me at the Society's low price of only \$1.89, plus shipping, per long-playing high-fidelity disc—a saving of 40% off usual retail cost.

I may return any recording and pay nothing. I may cancel my Trial Membership at any time. The FREE GIFT album is mine without charge in any case.

NOTE: Records are not listed in order of release.

Name.....

Address.....

City.....Zone..State...

CANADA: 105 Bond St., Toronto 2, Ont.

the most
versatile
low-cost
crystal probe
microphone!



The **SHURE** Slim-X Model "777"

**METAL SEALED FOR PROTECTION
IN HUMID CLIMATES!**

This slim, sturdy, rugged little microphone weighs only 6 ounces and is designed for good quality voice and music reproduction. When mounted on either cradle or swivel, the Slim-X "777" can be removed instantly *without tools* simply by lifting it out of the holder.

The SHURE Slim-X Model "777" is ideal for

- Home Recording
 - Public Address
 - Remote Broadcasting
 - Professional Entertainers
 - Ham Transmitting
- and many other uses
too numerous to mention!*



Use it in the hand, on a desk stand, on a floor stand, around the neck—can be removed instantly, no matter where you use it. Model 777A furnished with stand, swivel adapter, mounting cradle and lavalier cord. Model 777 furnished with mounting cradle and lavalier cord. Each model furnished with 7 ft. single-conductor cable. Output at end of 7 feet of cable is -62.0 db (0 db = 1 volt per microbar). Both models priced so low you'll hardly believe it!

SHURE *The Mark of Quality*

SHURE BROTHERS, INC.
225 WEST HURON STREET
CHICAGO 10, ILLINOIS

ITEMS OF INTEREST

Electronic Switch Helps Monitor Progress of Surgery	36
Sun-Powered Receiver	36
World's Tiniest TV Camera	36
Air Force Uses "Cat Eye"	38
Battery is Size of Paper Clip	38
Television Goes to Work on the Railroad	38
Pocket-Sized Radio Used in Private Paging System	40
This Radio Talks and Types	40
Transistorized Sound Detector	40
POP'tronics Checks the Radar That Checks Your Speed	48
R.F. Energy Powers Incandescent Lamp	48
Telephones Will "Ring" with Musical Tones	48

**COMING NEXT MONTH
POPULAR ELECTRONICS**

Radar on the Highway

Cover feature story on how radar speed detectors operate—a discussion of their accuracy, possible means of detecting and defeating them.

Multiplying Q

Every SWL with a receiver costing less than \$100 will want to read this story. It describes a device which will vastly improve selectivity with a \$10 investment.

Mark II—A \$3 Speaker Baffle

A big brother (for 12" speakers) to the \$2 speaker baffle described in our November, 1955, issue.

Electronic Gadgets for the Gardener

This how-to-do-it story describes methods of watering the lawn by electronic control. Rest up during the summer by building this device now.

High-Fidelity Audio ■ Kits ■ Radio Control
■ Short-Wave Listening ■ What's New ■
How It Works ■ How to Make It ■ How to
Use It ■ Carl & Jerry ■ Tips & Techniques

**IN THIS MONTH'S
RADIO & TELEVISION NEWS**

(April)

- A Portable Geiger Counter
- High-Fidelity Performance with Mullard's
520 Circuit
- 5-Watt Transistorized Audio Amplifier
- Realistic High Fidelity

THEY SAID HE COULDN'T LEARN TV AT HOME



... but now he repairs their sets

Read this letter from one of my students — It can help YOU!



I. C. Lane, B.S., M.A.
President, Radio-Television
Training Association
Executive Director, Pierce
School of Radio & Television.

**I CAN DO FOR YOU WHAT
I DID FOR THIS MAN!**

YOU can get top pay in the fast-growing Television-Radio-Electronics field just as this man did. My easily understood lessons — especially prepared for home study — can bring you the same success they brought hundreds of men, many of them with no more than grammar school training.



C-W Telephone Transmitter



Super-Het Radio Receiver



Combination Voltmeter-Ammeter-Ohmmeter

LEARN BY DOING



AF-RF Signal Generator



Public Address System

You work with actual parts and equipment I send you as part of your course. You get enough equipment to set up your own home laboratory and prepare for a top-pay TV job. You build and keep an Electromagnetic TV RECEIVER designed and engineered to take any size picture tube up to

"Dear Mr. Lane:
"How to begin this letter, I don't really know, I can never begin to tell you how happy I am with the outcome of your Radio and Television course. I'll never regret clipping your ad out and sending it to you. Believe me, it has changed my whole outlook on life. I believe this is the beginning of a bright new future for me, thanks to RTTA.
"Already I have established a small reputation in our city and I am looking to the very near future when I go into the radio and TV repair business full time. The last few months I've been very close to doubling my weekly income with very little time spent at it.
"Now it is my turn to laugh at the people who said I was wasting my time, that I couldn't learn anything through the mail. I've repaired television sets for some of these people and they admit that they were wrong.
"I look back now just a short year and remember how I stayed up many a night until after midnight studying and experimenting. At the same time I was wondering whether something would really come of it. Now I can proudly say it did. Because I reached out and grasped the opportunity RTTA gave me. For that I'll be forever grateful."
A. F. Duschl, Lancaster, Pa. 1,24 55

21-inch. (10-inch tube furnished. Slight extra cost for larger sizes.) ... Also a Super-Het Radio Receiver, AF-RF Signal Generator, Combination Voltmeter-Ammeter-Ohmmeter, C-W Telephone Transmitter, Public Address System, AC-DC Power Supply. Everything supplied, including all tubes.

FCC COACHING COURSE

Important for BETTER-PAY JOBS requiring FCC license. You get this training AT NO EXTRA COST! Top jobs go to FCC-licensed technicians.

CHOOSE FROM THREE COMPLETE COURSES
covering all phases of Radio, FM and TV

RADIO-FM-TELEVISION TECHNICIAN COURSE — no previous experience necessary.

FM-TV TECHNICIAN COURSE — previous training or experience in radio required.

TV CAMERAMAN AND STUDIO TECHNICIAN COURSE — advanced training for men with Radio or TV training or experience.

EXTRA TRAINING IN NEW YORK CITY AT NO EXTRA COST!

After you complete either the Radio-FM-TV Technician or the FM-TV Technician course you get two weeks of Lab work on modern electronic equipment at our associate resident school in New York City, Pierce School of Radio & Television. Available if you want it — AT NO EXTRA COST WHATSOEVER!

FREE



I'll send you my new 40-page book, "How to Make Money in Television, Radio, Electronics," a Free sample lesson, and other literature showing how and where you can get a top-pay job in Television.

VETERANS

My school fully approved to train Veterans under new Korean G.I. Bill. Don't lose your school benefits by waiting too long. Write discharge date on coupon.

MAIL THIS COUPON TODAY!

Mr. Leonard C. Lane, President
RADIO-TELEVISION TRAINING ASSOCIATION
Dept. E-46 52 East 19th Street New York 3 N Y

Dear Mr. Lane: Send me your NEW FREE BOOK, FREE SAMPLE LESSON, and FREE aids that will show me how I can make TOP MONEY IN TELEVISION. I understand I am under no obligation.

(PLEASE PRINT PLAINLY)

Name _____ Age _____

Address _____

City _____ Zone _____ State _____

I AM INTERESTED IN:

- Radio-FM-TV Technician Course
- FM-TV Technician Course
- TV Cameraman & Studio Technician Course

VETERANS!

Write discharge date

NO OBLIGATION!

Radio Television Training Association

52 EAST 19th STREET • NEW YORK 3, N. Y.
Licensed by the State of New York • Approved for Veteran Training

SAVE HOURS OF WORK

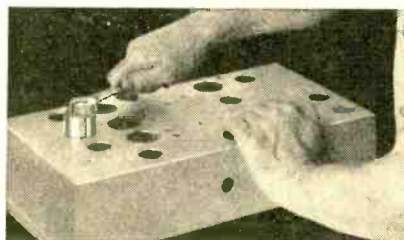

quickly make round, square, key and "D" openings with Greenlee Radio Chassis Punches

In 1½ minutes or less you can make a smooth, accurate hole in metal, bakelite or hard rubber with a GREENLEE Punch. Easy to operate... simply turn with an ordinary wrench. Wide range of sizes. Write for details. Greenlee Tool Co., 2384 Columbia Ave., Rockford, Ill.

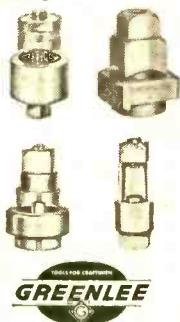

Gigantic Savings On TV & RADIO TUBES

20,000 Satisfied Customers Attest To Rad-Tel's Superior Record Of

QUALITY, PERFORMANCE, DEPENDABILITY

Same Day Service, Full Year Guarantee. All Tubes Individually Boxed.

Here is a Partial List of Savings

Type	Price	Type	Price	Type	Price
1B3GT	.73	6BA6	.49	6W4GT	.47
1X2A	.68	6BQ6GT	.98	12A7	.72
5U4G	.55	6BQ7	.90	12AU6	.60
5Y3GT	.37	6BZ7	.90	12BA6	.49
6AF4	.90	6CB6	.54	35W4	.47
6AG5	.56	6J6	.64	35Z5GT	.47
6AL5	.42	6SN7GT	.59	50C5	.51
6AU6	.46	6U8	.78	50L6GT	.61
6AV6	.45	6Y6GT	.50		

Attention! Schools, Hobbyists, Radio Technicians CATHODE RAY SCOPE TUBES Made by Sylvania

3AP1 . . . JAN! Electrostatic focus and deflection medium 7-pin base. Individually cartoned. Packed for export. Reg. net \$15.75. Individually packed 4 to a carton.

79c ea. (7 lbs. to cart. of 4) Single 95¢ Each

FREE TUBE & PARTS CATALOG LISTING OVER 400 HIGH QUALITY TUBE TYPES. WRITE DEPT. PE-4.



TERMS: 25% deposit must accompany all orders—balance C.O.D. All shipments F.O.B. Irvington, N. J. warehouse. **ORDERS UNDER \$5.00—50¢ Handling Charge.** PLEASE: Send full remittance. Allow for postage and save C.O.D. charges. Unused money refunded. Subject to prior sale.

115 COIT ST., IRVINGTON II, N. J.



Train for Better Jobs in

ELECTRICITY OR TELEVISION-RADIO

in Great Shops of COYNE

GREAT OPPORTUNITY FIELDS

Conditions are changing. Many "one operation" jobs that have paid well will not last. *Don't be satisfied with a "no future" job.* Whether 17 or up to 45 years of age, train the Coyne way for a better job and a real future in **ELECTRICITY or TELEVISION-RADIO, fields that offer a world of opportunities.**

YOU can TRAIN in great CHICAGO SHOPS

Train on real, full-size equipment at COYNE where thousands of successful men have trained for over 56 years—largest, oldest, best equipped school of its kind—established in 1899. No advanced education or previous experience needed. **TRAINING APPROVED FOR VETERANS.**

B. W. COOKE, President

COYNE FOUNDED 1899
ELECTRICAL SCHOOL

A TECHNICAL TRADE INSTITUTE OPERATED NOT FOR PROFIT
500 S. PAULINA STREET, CHICAGO, Dept. 46-71H

ELECTRICITY ★ RADIO ★ TELEVISION ★ REFRIGERATION ★ ELECTRONICS

START NOW—PAY LATER—Finance Plan and Easy Monthly Payment Plan. Also part-time employment help for students.

Get FREE Book

Send coupon for 48 page illustrated book "Guide to Careers in Electricity and Television-Radio." No cost; no obligation; no salesman will call. Get vital facts now!

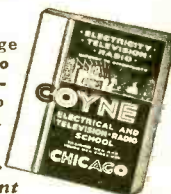

B. W. COOKE, President
COYNE ELECTRICAL SCHOOL
500 S. Paulina St., Chicago 12, Ill., Dept. 46-71H

Send **BIG FREE** book and details of your training offer. This does not obligate me and no salesman will call. I am interested in:

Electricity Television-Radio

Name _____

Address _____

City _____ State _____

POPULAR ELECTRONICS

NOW—BUILD IT YOURSELF in a few hours!

Amazing *electric* Brain

COMPUTES, PLAYS GAMES, "REASONS"!

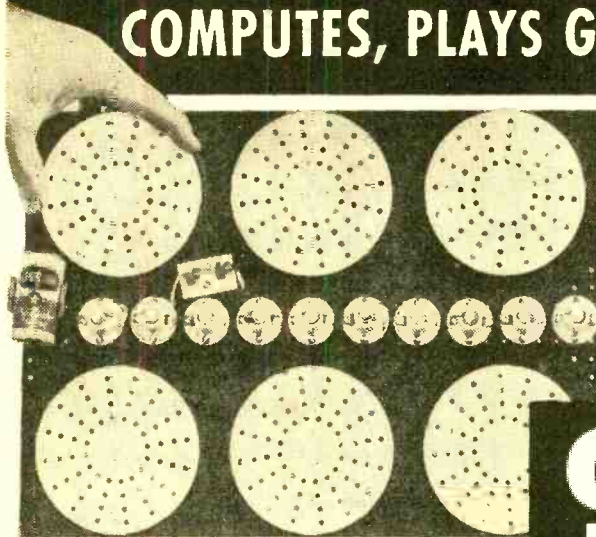

Here's a wonderful kit that gives you a fascinating introduction to the logic machines of our modern age! The devices you can build test intelligence, code and decode, count, play Tic-tac-toe, solve problems! Converts from binary to decimal—reasons in syllogisms—computes! Send for your kit today!

GENIAC

ELECTRIC BRAIN

You can build 33 different machines, including

- | | |
|----------------------------|------------------------------------|
| Binary Adding Machine | Automatic Oil Furnace Circuit |
| Secret Code & Decoder | Machine for a Space Ship's Airlock |
| Machine for Arithmetic | Intelligence Tester |
| Carrying Comparing Machine | Burglar Alarm |
| Reasoning Machine | Puzzle Solvers |
| General Combination Locks | Adder |
| Games Requiring Logic | Subtractor |
| | Multiplier |
| | Divider |

Some Firms and Institutions that have ordered GENIAC:

- | | |
|----------------------------------|--|
| Allis-Chalmers Remington-Rand | Albert Einstein Medical College |
| International Business Machines | Naval Research Laboratories |
| Wheeldex Mfg. Co. | Board of Education, Tecumseh, Nebraska |
| Manuel Missionary College | Marshfield Public Schools |
| Walter V. Clark Associates | Los Angeles Public Schools |
| Barnard College | Jefferson Union High School |
| Westinghouse Electric | Oklahoma A&M |
| Phillips Laboratories | Kansas State University |
| General Insurance Co of America | Duke University |
| Lafayette Radio | Coral Gables Senior High School |
| Rohr Aircraft Co. | Courtland Jr. High School |
| Southwest Missouri State College | Bell Telephone Laboratories |

YES, you build any one of 33 exciting electric brain machines in just a few hours by following the clear-cut, step-by-step directions given in a thrilling booklet! No soldering required... no wiring beyond your skill! GENIAC is a genuine brain machine—not a toy. The only logic machine kit that not only adds, subtracts, etc., but presents the basic ideas of cybernetics, Boolean algebra, symbolic logic, automatation, etc. So simple to construct that even a twelve-year-old can make a machine that will fascinate people with advanced scientific training!

OVER 400 COMPONENTS AND PARTS. Circuits operate on one flashlight battery, and the use of ingeniously designed parts makes building circuits one of the most fascinating things you've ever done! You set up problems in a variety of fields—and get your answers almost quicker than you can set them up! Play games with the machine—nim, tic-tac-toe, etc.—and pit your brain against its logic! Solve puzzles in a few seconds that would take you hours without the aid of the ma-

chine. You actually see how computing and problem—solving is analyzed with algebraic solutions transferred directly into circuit diagrams.

YOUR COST FOR GENIAC KIT: only \$19.95 postpaid. The 1956 Model GENIAC KIT contains: (1) a complete 200-page text, "Minds and Machines"—a basic introduction to computers. (2) "How to Construct Electrical Brains At Home"—a fully illustrated text book on basic computer design theory and circuits with specific instructions for building circuits. (3) Wiring Diagram Manual. A special booklet with full scale diagrams that you can tear out and place on your work bench for easy assembly. (4) Beginners' Manual. Starting from scratch, the manual adds fifteen extra experiments, thoroughly tested using GENIAC components to teach the basic symbols of electric circuits. (5) Over 400 components and parts.

So—mail the coupon for your GENIAC today! (Teachers: take advantage of 10% deduction if ordered for use in institutions). Your money back if not delighted!

**ORDER
GENIAC
ON OUR
MONEY
BACK
Guarantee!**

SCIENCE KITS, Dept. PE-46
Oliver Garfield Co., 126 Lexington Ave., New York 16, N. Y.

Please send me:

1 GENIAC Electric Brain Construction Kit and Manuals.

\$19.95 (East of Mississippi)

\$20.95 (Elsewhere in United States)

\$21.95 (Outside the United States)

Returnable in seven days for full refund if not satisfied. I enclose \$..... in full payment.

Name.....

Address.....

City..... Zone..... State.....

FREE

1956 EICO® CATALOG

tells you how to **SAVE 50%**
on your test equipment costs!

46 EICO KITS & INSTRUMENTS to choose from!



5" PUSH-PULL
OSCILLOSCOPE
#425
KIT \$44.95
Wired \$79.95

VACUUM TUBE
VOLTMETER
#221
KIT \$25.95
Wired \$39.95



For Laboratory Precision at Lowest Cost—
buy EICO!



1000 Ohms/Volt
MULTIMETER
#536
KIT \$12.90
Wired \$14.90

TUBE TESTER #625

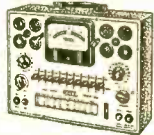

KIT \$34.95 Wired \$49.95

You build EICO KITS in 1 evening, but—
they last a lifetime!

RF SIGNAL GENERATOR #320



KIT \$19.95 Wired \$29.95

6V & 12V BATTERY ELIMINATOR
& CHARGER #1050

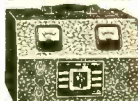

KIT \$29.95 Wired \$38.95

EICO—performance-proved by TV manufac-
turers, electronic schools and over 100,000
servicemen! OVER 1/2 MILLION in use today!



NEW! COLOR &
BLACK-&WHITE
5-MC TV SCOPE
#460
KIT \$79.95
Wired \$129.50



NEW! 20-Watt Ultra-Linear
HIGH FIDELITY AMPLIFIER
#HF 20
KIT \$49.95 Wired \$79.95

MAIL COUPON NOW. Prices 5% higher on
West Coast. Electronic Instrument Co., Inc.,
84 Withers St., Brooklyn 11, N. Y.

EICO 84 Withers St., Brooklyn 11, N. Y.

Send FREE 1956 Catalog and name of
neighborhood EICO distributor. PE-4

Name

Address

City..... Zone..... State.....

Occupation

LETTERS FROM OUR READERS

We Think You're Grand, Too!

■ I am writing to thank all the people who make it possible for me and many other thousands to read POPULAR ELECTRONICS.

ROBERT PAULSEN
Jasper, Mich.

■ I think your magazine is the greatest!

T. C. NEWHAMS
Pittsburgh, Pa.

■ Keep up the good work. I think P. E. is a fine magazine.

EDWARD NOVAK, JR.
Jonesboro, Ark.

■ We enjoy reading POPULAR ELECTRONICS very much. Keep up the good work.

TED SMIGLEY
Hollywood, Fla.

■ Let me commend you on the fine job you are doing. I find your articles readable and clear. No other magazine meets my needs so well.

LEWIS YOUNG
Oberlin, Ohio

■ Your "POP'tronics" is the greatest magazine for those working in electronics.

H. L. SHOEMAKER
Kenn, Wash.

Ah hem! Pardon us for tooting our own horn (at least once in a while). Mail like the above does make us feel good and certainly goes a long way towards insuring us here that our job is appreciated.

Electronic Stethoscope: Get With It!

■ As a science teacher, I am interested in the letter from Dr. Asche (January, 1956, issue). I sincerely hope that you will prepare such an article for a very early issue.

GEORGE GALLIPEAU
Barrington, R.I.

■ By all means investigate use of electronic stethoscope. I am trying to work up an amplifier covering 0 to 60 cycles.

R. C. BERNETT
Pearisburg, Va.

The electronic stethoscope idea attracted considerable interest among the doctors in our audience. Numerous letters and postcards were received. The project has been placed in the hands of Lou Garner. He reports progress in the development with sights set on publication in the June issue.

Canadian \$2 Baffle

■ Friends in Canada interested in building the \$2 baffle described in the November, 1955, issue should try a material called "Donaconda." It is easier to obtain than Celotex and costs only 6½ cents per square foot.

MICHAEL SALUSOO
Toronto, Ont.

POPULAR ELECTRONICS

Now . . . In Your Own Home **LEARN**

AUTOMATION *ELECTRONICS* **TELEVISION** **RADIO-ELECTRONICS** THE AMAZINGLY EFFECTIVE **D.T.I. WAY**

NO PREVIOUS TECHNICAL EXPERIENCE NEEDED
NOW . . . get EVERYTHING YOU NEED
for real Laboratory-type training **AT HOME**

-with the aid of BOTH HOME LAB EQUIPMENT and HOME MOVIES

What will mailing the coupon below do for YOU? Just this! You'll find out about one of today's most remarkable . . . practical ways to prepare to get into America's amazing billion dollar opportunity field of TELEVISION-RADIO-ELECTRONICS. You'll see how to get into highly interesting work that pays well . . . that offers one of America's most promising futures . . . that enables you to start your own business almost "on a shoe string," if you prefer this to a job opportunity.

And above all, you'll get some GOOD NEWS especially welcomed by men anxious to earn REAL MONEY in this growing field. For you'll see that NOW you can get the kind of practical, laboratory-type training so desirable for making real progress in Television-Radio-Electronics AND WITHOUT LEAVING HOME.

You'll see that DeVRY Technical Institute sends everything needed to set up your own HOME LABORATORY. You get and keep the same type of basic electronic equipment used in our modern Chicago Training Laboratories. You get home training that includes the knowledge and experience gained from training thousands of students first hand in Chicago. And to top it all, you use DTI's amazingly effective and exclusive home training aid—INSTRUCTIVE MOVIES. But why not get the complete story? Mail coupon today for complete facts.

1. Build over 300 fascinating experiments from 16 BIG SHIPMENTS of Electronic-Radio parts which you KEEP.
2. Build valuable commercial-type test equipment—as shown to the left—which you KEEP. This includes a quality 5-INCH oscilloscope and vacuum tube voltmeter—both highly useful for Television work.
3. Build and keep a big 21 INCH TV Set. (D.T.I. offers another home training in Television-Radio-Electronics, but without the TV set.)
4. Use a 16 mm. movie projector and new series of highly instructive movies—a wonderful aid to help you grasp important fundamentals faster . . . easier . . . better.
5. Enjoy well-illustrated, easy-to-read lessons with handy FOLD-OUT diagrams.
6. Get an honest-to-goodness EMPLOYMENT SERVICE to help you get a good job after graduating—or assistance in starting your OWN SALES AND SERVICE BUSINESS. Mail coupon today for the complete details.



21 INCH

Build and keep this BIG DTI Engineered TV set—easily converted to UHF. (DTI offers another home training, but without the TV set.)

Above: Work over 300 interesting experiments with this equipment

Get this information-packed publication **FREE!**

89 WAYS TO EARN MONEY IN TELEVISION RADIO ELECTRONICS

MODERN LABORATORIES
If you prefer, get all your preparation in our new Chicago Training Laboratories—one of the finest of its kind. Ample instructors, modern equipment. Write for details!

MILITARY SERVICE!
If you're subject to military service, the information we have for you should prove very helpful. Mail coupon today.



"One of America's Foremost Electronics Training Centers"

DEVRY TECHNICAL INSTITUTE
CHICAGO 41, ILLINOIS
FORMERLY
DEFOREST'S TRAINING, INC.



Member of National Home Study Council

DEVRY TECHNICAL INSTITUTE
4141 BELMONT AVE., CHICAGO 41, ILL. Dept. PE-4-M

I would like your valuable information-packed publication showing how I can get started toward a good job or my own business in Television-Radio-Electronics.

Name _____ Age _____
Please Print

Street _____ Apt. _____

City _____ Zone _____ State _____

D.T.I.'s Training is available in Canada

1014A

What's new in magnetic recording

How to Splice Tape. That's a question many of you have been asking recently. You'll find it a good idea to save this column for ready reference if you should break the magnetic recording tape or do any editing. Actually, there's no trick to splicing. Just

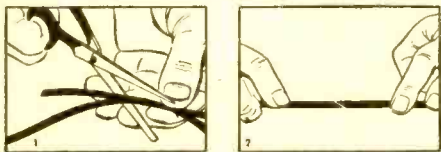

overlap the two ends of the recording tape and cut them at a 60° angle. FIG. 1. Then bring the ends together so that they just touch. Align them with their *uncoated* sides up. FIG. 2. (The uncoated side of plastic tape is always the *shiny* surface).



For Best Results join the ends of your magnetic tape with a good quality splicing tape. "Scotch" Brand Splicing Tape No. 41 is specially made to give a tight, noise-free joint. Apply it diagonally, covering the ends of the magnetic tape. FIG. 3. Then, trim off the excess Splicing Tape, cutting into the recording tape slightly. FIG. 4. Detailed and illustrated splicing instructions come with every box of "Scotch" No. 41 Tape.

HERE ARE 2 GOOD REASONS why you should use "Scotch" "Extra Play" Magnetic Tape No. 150 on your recorder. First, No. 150 Tape is made to last longer because it's backed with DuPont "Mylar"*, tough super-strength polyester. Secondly, "Extra Play" Tape offers you 50% more tape than a standard-size reel. Two reels of the new tape give you as much recording time as three conventional reels. And if you prefer an acetate backing, you can now buy famous "Extra Play" Tape 190 at a special new economy price.

*"Mylar" is a registered DuPont trademark



Hi-Fi Tape Recordings are easier to make when you know a few useful tips. There are plenty of them in a new free booklet—"You Don't Have to be a Recording Expert...". Send to: Minnesota Mining and Manufacturing Company, Dept. 1J-46, 900 Fauquier Ave., St. Paul 6, Minn.

The term "Scotch" and the plaid design are registered trademarks for Magnetic Tape made in U.S.A. by MINNESOTA MINING AND MFG. CO., St. Paul 6, Minn. Export Sales Office: 99 Park Avenue, New York 16, N.Y.

Battery for Fumalux Lighter

■ Is the storage battery in the Fumalux cigarette lighter rechargeable? I hear that it is 2.3 volts and requires a 100-ma. charge for 24 hours. Can you give me some information?

J. A. MOCHAR
Vancouver, B.C.

Sorry, but this is a new one on us. How about it gang, do you have any dope?

Who Wants to Tackle These?

■ I would like to see an R/C automobile starter. One could then start the car and sit in the house while it warms up.

LOUIS RENO
Berkeley, Calif.

■ Don't forget us Technician Class guys. Print some diagrams for 220- and 420-mc. gear. Two- and three-tube jobs would do FB.

DICK MILLS, W7AMH
Tucson, Ariz.

■ Please publish details on plug-in intercom utilizing the house wiring.

H. J. KNERR
Coral Gables, Fla.

■ I would like to see plans on an electronic weather vane and wind indicator.

W. LORD
Montreal, Que.

■ How about a sound meter so that we can accurately measure the output of speakers, annoying noises, etc.?

JESSE W. REEVE
Knoxville, Tenn.

■ Having completed a Heathkit grid dip meter, I would like to have more dope on how it is used.

HERB CLARK
Oakland, Calif.

The six projects mentioned above are but a small fraction of those suggested by you readers. Each of them is being explored, but at this writing the field is wide open. Authors take note: we pay a good solid rate for usable material. Query us before submitting to prevent wasting your time.

Tape Recorders in Kit Form

■ I would like to do experimental work with tape recorders. Your advertisers give me no idea of from whom parts of tape recorders can be purchased.

DAVID MCLEES
Little Rock, Ark.

■ Some reference to sources of materials necessary to construct tape recorders would be appreciated.

HARRY GRASSER
Southern Pines, N. C.

These letters from Dave and Harry are typical of numerous inquiries which we have been using to urge manufacturers to sell a tape recorder kit. So far, we've seen little effect. We suggest that interested parties write to Viking of Minneapolis and Pentron (both advertisers) for information on their partially disassembled equipment.

-30-

ARE YOU TOO OLD TO LEARN?

not at all, scientists say

New tests show that: your ability to think increases with age; your powers of deduction are greater; your judgment is better.

In the I. C. S. files are thousands of cases of men and women of every age. Their successes, their promotions, their raises prove that men and women past school age can learn!

I. C. S. GIVES YOU EXPERT GUIDANCE FREE! Do you have the feeling you're "stuck" in your job? Your trained I. C. S. counselor will appraise your abilities, help you plan for the future.

IT'S NEVER TOO LATE TO GET STARTED! You study with I. C. S. at home, in your spare time. There's no interference with business or social activity. Famous I. C. S. texts make learning easy. Don't delay. Pick your field from the coupon below. And mail it today!



3 FREE BOOKS

86-page, pocket-size guide to advancement, a gold mine of tips on "How to Succeed." Big catalog outlining opportunities in your field of interest. Also sample lesson (Mathematics).

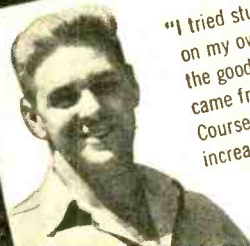

"I tried studying my work on my own, but I never got the good out of it that came from my I. C. S. Course. My salary has been increased 73.3%!"
E.L.B.
Ohio

"I am president of a small corporation. A year ago I enrolled with I. C. S. as the most practical means available to me to learn what I needed."

W.J.A.
Michigan



"It's been so long since I went to school, I've forgotten much. But now that I'm taking an I. C. S. Course, I have confidence in my ability again."

H.A.R.
New Jersey



Actual statements. Posed by models.

For Real Job Security—Get an I. C. S. Diploma! I. C. S., Scranton 9, Penna. Member, National Home Study Council

INTERNATIONAL CORRESPONDENCE SCHOOLS



BOX 59622C, SCRANTON 9, PENNA.

(Partial list of 277 courses)

Without cost or obligation, send me "HOW TO SUCCEED" and the opportunity booklet about the field BEFORE which I have marked X (plus sample lesson):

- | | | | | |
|--|---|--|--|--|
| <p>ARCHITECTURE and BUILDING CONSTRUCTION</p> <ul style="list-style-type: none"> <input type="checkbox"/> Air Conditioning—Refrig. <input type="checkbox"/> Architecture <input type="checkbox"/> Architectural Interior <input type="checkbox"/> Building Contractor <input type="checkbox"/> Building Maintenance <input type="checkbox"/> Carpenter and Mill Work <input type="checkbox"/> Estimating <input type="checkbox"/> Heating <input type="checkbox"/> Painting Contractor <input type="checkbox"/> Plumbing <input type="checkbox"/> Reading Arch. Blueprints <p>ART</p> <ul style="list-style-type: none"> <input type="checkbox"/> Cartooning <input type="checkbox"/> Commercial Art <input type="checkbox"/> Fashion Illustrating <input type="checkbox"/> Magazine Illustrating <input type="checkbox"/> Show Card and Sign Lettering <input type="checkbox"/> Sketching and Painting <p>AUTOMOTIVE</p> <ul style="list-style-type: none"> <input type="checkbox"/> Auto Body Rebuilding <input type="checkbox"/> Auto Elec. Technician <input type="checkbox"/> Auto-Engine Tune Up <input type="checkbox"/> Automobile | <p>AVIATION</p> <ul style="list-style-type: none"> <input type="checkbox"/> Aeronautical Engineering Jr. <input type="checkbox"/> Aircraft & Engine Mechanic <p>BUSINESS</p> <ul style="list-style-type: none"> <input type="checkbox"/> Advertising <input type="checkbox"/> Bookkeeping and Accounting <input type="checkbox"/> Business Administration <input type="checkbox"/> Business Correspondence <input type="checkbox"/> Public Accounting <input type="checkbox"/> Creative Salesmanship <input type="checkbox"/> Federal Tax <input type="checkbox"/> Letter-writing Improvement <input type="checkbox"/> Office Management <input type="checkbox"/> Professional Secretary <input type="checkbox"/> Retail Business Management <input type="checkbox"/> Sales Management <input type="checkbox"/> Stenographic-Secretarial <input type="checkbox"/> Traffic Management <p>CHEMISTRY</p> <ul style="list-style-type: none"> <input type="checkbox"/> Analytical Chemistry <input type="checkbox"/> Chemical Engineering <input type="checkbox"/> Chem. Lab. Technician <input type="checkbox"/> General Chemistry <input type="checkbox"/> Natural Gas Prod. & Trans. <input type="checkbox"/> Petroleum Engineering <input type="checkbox"/> Plastics <input type="checkbox"/> Pulp and Paper Making | <p>CIVIL, STRUCTURAL ENGINEERING</p> <ul style="list-style-type: none"> <input type="checkbox"/> Civil Engineering <input type="checkbox"/> Construction Engineering <input type="checkbox"/> Highway Engineering <input type="checkbox"/> Reading Struct. Blueprints <input type="checkbox"/> Sanitary Engineering <input type="checkbox"/> Structural Engineering <input type="checkbox"/> Surveying and Mapping <p>DRAFTING</p> <ul style="list-style-type: none"> <input type="checkbox"/> Aircraft Drafting <input type="checkbox"/> Architectural Drafting <input type="checkbox"/> Electrical Drafting <input type="checkbox"/> Mechanical Drafting <input type="checkbox"/> Mine Surveying and Mapping <input type="checkbox"/> Plumbing Drawing and Estimating <input type="checkbox"/> Structural Drafting <p>ELECTRICAL</p> <ul style="list-style-type: none"> <input type="checkbox"/> Electrical Engineering <input type="checkbox"/> Electrical Maintenance <input type="checkbox"/> Electrician <input type="checkbox"/> Contracting <input type="checkbox"/> Lineman <p>HIGH SCHOOL</p> <ul style="list-style-type: none"> <input type="checkbox"/> Commercial <input type="checkbox"/> Good English <input type="checkbox"/> High School Subjects <input type="checkbox"/> Mathematics | <p>LEADERSHIP</p> <ul style="list-style-type: none"> <input type="checkbox"/> Foremanship <input type="checkbox"/> Industrial Supervision <input type="checkbox"/> Leadership and Organization <input type="checkbox"/> Personnel-Labor Relations <p>MECHANICAL AND SHOP</p> <ul style="list-style-type: none"> <input type="checkbox"/> Gas—Electric Welding <input type="checkbox"/> Heat Treatment <input type="checkbox"/> Metallurgy <input type="checkbox"/> Industrial Engineering <input type="checkbox"/> Industrial Instrumentation <input type="checkbox"/> Industrial Supervision <input type="checkbox"/> Internal Combustion Engines <input type="checkbox"/> Machine Design-Drafting <input type="checkbox"/> Machine Shop Inspection <input type="checkbox"/> Machine Shop Practice <input type="checkbox"/> Mechanical Engineering <input type="checkbox"/> Quality Control <input type="checkbox"/> Reading Shop Blueprints <input type="checkbox"/> Refrigeration <input type="checkbox"/> Sheet Metal Worker <input type="checkbox"/> Tool Design <input type="checkbox"/> Toolmaking <p>RADIO, TELEVISION</p> <ul style="list-style-type: none"> <input type="checkbox"/> Industrial Electronics <input type="checkbox"/> Practical Radio TV Eng'ing <input type="checkbox"/> Radio and TV Servicing <input type="checkbox"/> Radio Operating | <ul style="list-style-type: none"> <input type="checkbox"/> Television Technician <p>RAILROAD</p> <ul style="list-style-type: none"> <input type="checkbox"/> Air Brakes <input type="checkbox"/> Car Inspector <input type="checkbox"/> Diesel Locomotive <input type="checkbox"/> Locomotive Engineer <input type="checkbox"/> Section Foreman <p>STEAM AND DIESEL POWER</p> <ul style="list-style-type: none"> <input type="checkbox"/> Combustion Engineering <input type="checkbox"/> Diesel—Elec. <input type="checkbox"/> Diesel Eng'g <input type="checkbox"/> Electric Light and Power <input type="checkbox"/> Stationary Fireman <input type="checkbox"/> Stationary Steam Engineering <p>TEXTILE</p> <ul style="list-style-type: none"> <input type="checkbox"/> Carding and Spinning <input type="checkbox"/> Cotton, Rayon, Woolen Mfg. <input type="checkbox"/> Finishing and Dyeing <input type="checkbox"/> Loom Fix'g <input type="checkbox"/> Textile Des'ing <input type="checkbox"/> Textile Eng'g <input type="checkbox"/> Throwing <input type="checkbox"/> Warping and Weaving <p>MISCELLANEOUS</p> <ul style="list-style-type: none"> <input type="checkbox"/> Domestic Refrigeration <input type="checkbox"/> Marine Engineering <input type="checkbox"/> Ocean Navigation <input type="checkbox"/> Professional Engineering <input type="checkbox"/> Short Story Writing <input type="checkbox"/> Telephony |
|--|---|--|--|--|

Name _____ Age _____ Home Address _____

City _____ Zone _____ State _____ Working Hours _____ A.M. to P.M. _____

Occupation _____

Canadian residents send coupon to International Correspondence Schools, Canadian, Ltd., Montreal, Canada. . . . Special tuition rates to members of the U. S. Armed Forces.

When You Want To Build
Transistorized Equipment...



You Can't Beat This

RAYTHEON Combination

The 116 page Raytheon Transistor Applications Book contains everything you need to know, including wiring diagrams, illustrations and parts lists, to build receivers, timers, oscillators, geiger-counters, metal locators, more than 50 practical, useful transistor applications. Available at your Raytheon Tube Supplier or send 50¢ to Department P7.

ONLY
50¢

The RAYTHEON CK722 TRANSISTOR is used in most of the circuits in the book. You'll find it tops in quality and tops in performance yet the Raytheon CK722 is rock bottom in price. Available *only* through your Raytheon Tube Supplier.

ONLY
99¢



Excellence in Electronics

RAYTHEON MFG. CO.

Receiving and Cathode Ray Tube Operations
Newton 58, Massachusetts



BOOKSHELF

"BEAM ANTENNA HANDBOOK" by William I. Orr, W6SAI. Published by Radio Publications, Inc., Danbury Rd., Wilton, Conn. 128 pages. Price, \$2.70.

In all probability, the title of this book will be sufficient to insure interest among hams, Novices and SWL's. If that doesn't immediately sell those prospects, let us add that the full dope on parasitic beams is really here. OM Bill Orr has a refreshing style that puts a lot of down-to-earth practical information in a few words. The drawings and photos are clear-cut and enable readers to design their beams for maximum gain and effectiveness.

Recommended: for those working any band from 4 to 420 mc. This is a book that has been sorely needed.



"RADIO PHILATELIA" by Herbert Rosen. Published by Audio Master Corp., 17 East 45th St., New York 17, N. Y. 48 pages of plates. Price, \$2.00.

Book reviewers seldom have the time or inclination to read a new release from cover to cover, but this paper-bound book succeeded where others have failed. The author has assembled a fascinating history of radio and communications using the "topical collecting" philatelic technique. It will attract stamp collectors through its easily absorbed, accurate background information. Electronics experimenters will find that over 500 stamps have been issued which develop radio broadcasting themes. If you have ever collected stamps (and there are few that haven't), you will enjoy this stimulating book.



"SCIENTIFIC AMERICAN BOOKS," by the Editors of *Scientific American*. Published by Simon and Schuster, 630 Fifth Ave., New York 20, N. Y. Five volumes, boxed. Total pages, 1080. Price, \$5.00.

These volumes are the first five in a new series designed to present first-hand information on a variety of scientific subjects. Written for the lay reader as well as for the specialist, the contents—originally articles in the magazine *Scientific American*

POPULAR ELECTRONICS

YOU can make MORE MONEY with an FCC LICENSE

What is
the FCC?

How will a
license help me?

How can I get my
FCC License?

Will Cleveland Institute
help me get a job?

get the answers to the above questions **FREE!**
FIND OUT HOW:

Your FCC license and
CIRE diploma will qual-
ify you for the really fine
jobs in Electronics.

*Write today for
complete information*

NO SALESMAN WILL CALL

- **An FCC license insures your future**

- **The entire industry needs technicians**

- **Cleveland Institute guarantees license**

- **the CIRE Job Finding Service will work for you!**

FILL OUT COUPON BELOW AND MAIL IT TODAY

CLEVELAND INSTITUTE OF RADIO ELECTRONICS
Desk PE11, 4900 Euclid Bldg., Cleveland 3, Ohio

I want to know how I can get my FCC ticket in a minimum of time. Send me your **FREE** booklet, "How To Pass FCC License Examinations" (does not cover exams for Amateur License), as well as a Sample FCC-type lesson and the amazing new booklet, "Money-Making FCC License Information." Be sure to tell me about your Television Engineering Course. **PLEASE PRINT CAREFULLY**

NAME _____ AGE _____

ADDRESS _____

CITY _____ ZONE _____ STATE _____

For prompt results, send air mail.
Special tuition rates to members of the U. S. Armed Forces.
Electronic Training Available To Canadian Residents.



FIX TV SETS TWICE AS FAST!



PIX-O-FIX TV TROUBLE- FINDER GUIDES

**CUT TIME
IN HALF on
2 jobs out of 3**

Now! Handle television receiver troubles by easy picture analysis. Let these famous PIX-O-FIX Guides tell you what is wrong . . . then show exactly how to fix it.

Just turn the PIX-O-FIX dial until the picture in its window shows the same trouble symptoms (wavy lines, snow, no raster, "squeezing" distortion,

etc.) as the picture on the TV set you're repairing. PIX-O-FIX then tells the possible trouble causes and gives step-by-step repair instructions. It's as easy as that!

The two PIX-O-FIX units No. 1 and No. 2 cover 47 different television troubles . . . just about anything you're likely to be called on to fix. No. 1 identifies 24 of the most common troubles and gives 192 causes and 253 remedies. No. 2 covers 23 more advanced troubles not included in No. 1. Together, they are a comprehensive guide to quick "picture analysis" servicing of any TV set . . . AND THE PRICE IS ONLY \$2.00 FOR THE TWO. Use coupon.

DON'T THROW OLD RADIOS AWAY!



This giant book shows exactly how to fix them . . . without a lot of previous experience!

There's a "secret" to repairing old radios fast and profitably . . . and this big RADIO TROUBLESHOOTER'S HANDBOOK is it!

Just look up the old make and model you want to fix. This 3 1/2 pound 744-page Ghirardi handbook tells what the trouble is likely to be . . . AND SHOWS YOU EXACTLY HOW TO FIX IT. No useless testing! No wasted time! Even beginners can handle jobs "slick as a whistle." The only guide of its kind . . . cuts repair time in half!

Included are common trouble symptoms and remedies for over 4,800 old models of home and auto radios and record changers. Actual case histories cover practically every model made by 202 manufacturers between 1925 and 1942—Airline, Apex, Arvin, Atwater Kent, Belmont, Bosch, Brunswick, Clarion, Crosley, Emerson, Fada, G.E., Kolster, Majestic, Motorola, Philco, Pilot, RCA, Silvertone, Sparton, Stromberg AND DOZENS MORE. Gives how-to-do-it data on SPECIFIC jobs—NOT general theory. Includes hundreds of pages of invaluable tube and component data, service short cuts, etc. Price \$6.50. 10-day free trial.

USE COUPON TO ORDER

Dept. PE-46, Rinehart & Co., Inc.
232 Madison Ave., New York 16, N. Y.

- Enclosed is \$2.00 for PIX-O-FIX Nos. 1 and 2. You guarantee to refund my money if I return them in 10 days.
- Send book RADIO TROUBLESHOOTERS' HANDBOOK for 10 days FREE EXAMINATION. If I like book, I will promptly send \$6.50 (plus postage) in full payment. Otherwise I will return book and owe you nothing.

Name _____

Address _____

City, Zone, State _____

RINEHART BOOKS ARE SOLD BY LEADING BOOKSTORES

—should interest many of the POP'tronics readers.

Two volumes are titled, respectively, *Automatic Control* and *Atomic Power*. Sections of *The New Astronomy* deal with "Electricity in Space," photocells, and radio telescopes. *Physics and Chemistry of Life* includes a chapter on "The Electrical Activity of the Brain," while material on "sonar" in bats and birds can be found in the *First Book of Animals*.

Although paper bound, these books are well printed on good stock. Texts are lucid and occasionally illustrated. One could only wish that the editors had included more of the fine artwork that appeared with the articles when they ran originally in the magazine.

Recommended: as worthwhile additions to the library of the scientifically minded.



"A-M DETECTORS" edited by Alexander Schure. Published by John F. Rider Publisher, Inc., 480 Canal St., New York 13, N. Y. 58 pages. Paper bound. Price, \$1.25.

AM detectors remain, even in this day of FM, a vital part of most equipment . . . and a survey like this is part of the overall picture of modern electronics. Another in Rider's "Review Series," it includes principles and representative circuits. Linear detection, square law detection, a.v.c., and d.a.v.c. are covered, as well as the "classical" types of AM detectors.

Free Literature Roundup

DO-IT-YOURSELF kits for building University's line of "Decor-Coustic" speaker enclosures are described in this company's brochure No. 78A8. For your copy, write to Desk LA8, University Loudspeakers, Inc., 80 S. Kensico Ave., White Plains, N. Y.

METAL HOUSINGS for chassis, shelves, cabinets, and general use are shown in an illustrated booklet (catalog No. 550), issued by Premier Metal Products Co., 337 Manida St., New York 59, N. Y.

"TABTRON" BRAND rectifiers, power supplies and related components are listed in catalog No. PR156, available at parts distributors or directly from the manufacturer, Technical Apparatus Builders, 109 Liberty St., New York 6, N. Y.

A 4-PAGE illustrated folder describing hi-fi speaker systems and enclosures of the infinite-baffle type is available from The R. T. Bozak Mfg. Co., Box 966, Darien, Conn.

—30—

TUNING METER FOR BOTH AM AND FM
 Now you can tune distant stations perfectly. Helps you adjust your antenna for best reception.

PLANETARY DRIVE TUNING
 Edge lighted lucite tuning dials with separate logging scales. Big easy to read numbers. Quick or vernier tuning on both FM and AM sections.

FM RF SECTION
 Highly sensitive cascade front end and heavy copper plated chassis gives 3 microvolts sensitivity for 20 db quieting.

NEW AM DETECTOR
 Exclusive H. H. Scott design means distortionless reception even if stations modulate to 100%. High frequencies come through perfectly. Conventional detectors distort AM above moderate modulation percentages, and distort high frequencies.

SUPER SELECTIVE FM IF'S
 Such sharp tuning that you can separate stations so close together ordinary tuners would pass them by.

WIDE-RANGE AM
 3 position adjustable bandwidth including 'Ultra-Wide-Range' position for receiving the full 10 kc frequency range broadcast by the better AM stations. Perfect reception under any signal conditions.

WIDE BAND FM DETECTOR
 Radically new design makes drift a thing of the past. Stations stay in tune. Strong and weak signals can be tuned with equal ease.

BINAURAL OUTPUT JACKS
 from the completely separate FM and AM sections. Monaural output also provided.

inside story on the

MOST ADVANCED AM-FM TUNER EVER DEVELOPED

Engineered by the same H. H. Scott team that has won every important High Fidelity award, this sensational tuner not only looks different . . . it sounds different — better than any tuner you've ever heard.

The AM side features radically new detector design . . . it's the first really wide-range AM tuner on the market . . . you actually get fine AM sound to 10 KC! The FM side has 3 microvolt sensitivity . . . you pull in stations you've never heard before.

TECHNICAL SPECIFICATIONS
 FM Section: 3 mv. sensitivity for 20 db quieting — 2 megacycle wide-band detector — 80 db rejection of spurious cross-modulation response by strong local signals — automatic gain control assures optimum adjustment under all signal conditions — equipped for multiplex.
 AM Section: 1 mv. sensitivity — 10 kc whistle filter — extended frequency response to 10 kc. Output jacks for binaural — can be panel-mounted with one simple cut-out — beautiful accessory case \$9.95*
 Dimensions in case: 15 1/4" x 4 3/4" x 12 1/2".

FREE!
 New H. H. Scott Catalog and Hi-Fi Guide. Just off the press. Write for your free copy.



"The Professional"
 Model 330 AM-FM (Binaural) Tuner
 Styling and dimensions provide a perfect match to the 99-B and 210-D complete amplifiers. \$199.95*
 *Slightly higher west of Rockies

H. H. Scott, Inc., Dept. P-4 385 Putnam Ave., Cambridge, Mass. Export Dept.: Telesco International Corp. 270 Park Ave., N. Y. 17

FOR MEN
WHO WANT
TO EARN
MORE MONEY

NATIONAL

proudly

TELERAMA ... ALL 8 TELEVISION IN ONE DYNAMIC, MODERN

Another great advance in **HOME STUDY TRAINING**. Let National Schools, of Los Angeles, a practical Technical Resident Trade School for over 50 years, train you at home by Shop-Method, for today's unlimited opportunities in **ALL 8 BRANCHES** of the Television, Electronics, Radio Industry.

Check all you receive in *One Master Course* at One Low Tuition

1. **Television — Including Color TV**
2. **Radio — FM and AM**
3. **Industrial Electronics**
4. **Sound Recording and Hi-Fidelity**
5. **Preparation for FCC License**
6. **Automation**
7. **Radar and Sonar**
8. **Communications**

YOU DO MANY PRACTICAL JOBS.

You do servicing, circuit analysis and many other down-to-earth experiments. You build a modern TV set from the ground up . . . with equipment kits we give you, including a new large screen picture tube and professional Multitester, at no additional charge.

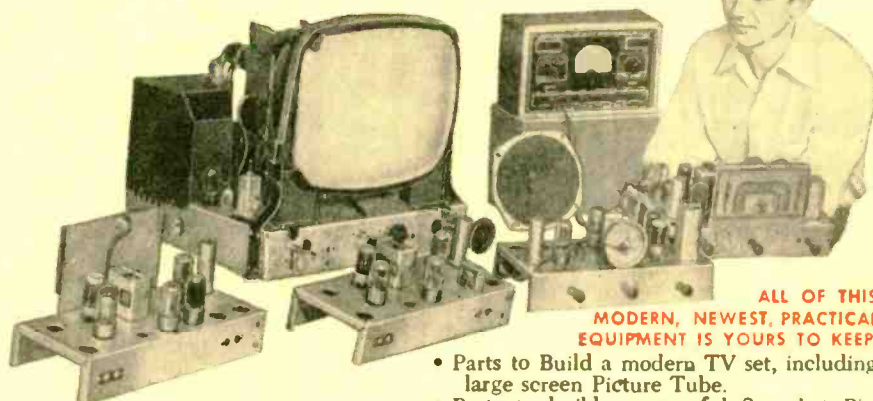

**ALL OF THIS
MODERN, NEWEST, PRACTICAL
EQUIPMENT IS YOURS TO KEEP!**

EARN AS YOU LEARN! Many of our students earn their entire tuition and more in Spare Time jobs we show them how to do while learning. **YOU GET GRADUATE ADVISORY SERVICE, TOO.**

- Parts to Build a modern TV set, including large screen Picture Tube.
- Parts to build a powerful Superhet Receiver, standard broadcast and short wave.
- Parts to conduct many experiments and build Continuity Checker, RF Oscillator, TV Circuits, Audio Oscillator, TRF Receiver, Signal Generator.
- Professional Multitester
- These are a MUST for all technicians.

POPULAR ELECTRONICS

SCHOOLS

presents

BRANCHES OF

• ELECTRONICS • RADIO

SHOP-METHOD, HOME-TRAINING COURSE

WE BRING NATIONAL SCHOOLS TO YOU!

These are the world headquarters of National Schools' famous Shops, Labs and Studios. Get your HOME TRAINING and DIPLOMA direct from a world leader in practical resident technical trade training.



* Registration applied for

L. J. ROSENKRANZ

President of
NATIONAL SCHOOLS

This Master-Shop-Method course is completely up-to-date. Here in Los Angeles, the TV and Electronics center of the world, we are able to keep in constant touch with the industries' latest developments. As a student, you will quickly

master all phases at home . . . in your spare time. Your earning power will grow with every lesson. Just as thousands of National Schools graduates do every day, you can handle servicing, manufacturing, repairing, hundreds of other jobs, or make good money in your own business. **SECURE YOUR FUTURE—NOW. SEND COUPON BELOW TODAY!**



IN THESE MODERN TV STUDIOS, SHOPS AND LABORATORIES, this great National Schools Home Study Course was developed by experienced instructors working with thousands of resident students from all over the world. What an advantage that is to you at home—each lesson is tested, proved, easy to understand. You can master the most up-to-date



projects, such as color TV set repair, printed circuits, — even prepare for F.C.C. License and industrial electronics without taking a special course. Take your first step now to a top-pay job in TV, Electronics, Radio. Send Coupon below today.

**APPROVED FOR
VETERANS
AND
NON-VETERANS**

MEMBER

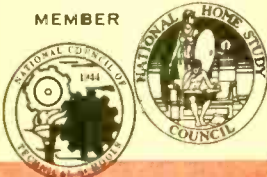

FREE!

Fully illustrated "CAREER" BOOK in TV, Radio, Electronics. AND actual Sample Lesson—yours at no cost, no obligation SEND COUPON NOW—TODAY!

IMPORTANT

Most employers in the TV industry now require new employees to have an F.C.C. License, as evidence of proficiency.



NATIONAL SCHOOLS

4000 S. FIGUEROA ST., LOS ANGELES 37, CALIF.

187 N. LA SALLE ST., CHICAGO 1, ILL.

In Canada: 811 W. Hastings St., Vancouver, B. C.

NATIONAL SCHOOLS

TECHNICAL TRADE TRAINING SINCE 1905
Los Angeles, California

GET FAST SERVICE—MAIL NOW TO OFFICE NEAREST YOU!

NATIONAL SCHOOLS, DEPT. R2G-46

4000 S. FIGUEROA ST. OR 187 N. LA SALLE ST.
LOS ANGELES 37, CALIF. CHICAGO 1, ILL.

Rush free TV-Radio "Opportunity" Book and sample lesson. No salesman will call.

NAME _____ BIRTHDAY _____ 19 _____

ADDRESS _____

CITY _____ ZONE _____ STATE _____

VETERANS: Give Date of Discharge _____

Ektachrome Photograph by Meyers

free!

**1956
ALLIED**

**ELECTRONIC
SUPPLY
CATALOG**

**324
value-packed
pages**

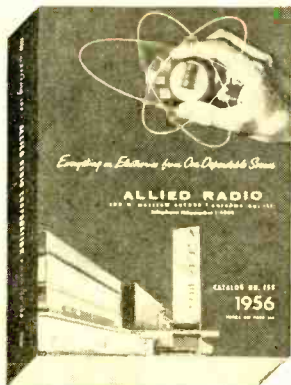

**Save on Everything
in TV and Radio
Parts & Equipment**

**Everything for Experimenters,
Builders, Amateurs, Servicemen,
Engineers & Hi-Fi Specialists**

Send for ALLIED's big 324-page value-packed guide to *everything* in TV, Radio and Electronics! Select from the world's largest stocks of High Fidelity systems and components; recorders and phono equipment; TV tubes, antennas and accessories; Amateur station equipment and supplies; P.A. systems; test instruments; latest build-your-own kits; industrial electronic supplies—plus *everything* in electronic parts, tubes, transistors, tools and books. Save on everything in Electronics—send today for your FREE 1956 ALLIED Catalog.

**Everything in Electronics
From One Reliable Source**

send for it

**FREE
CATALOG**

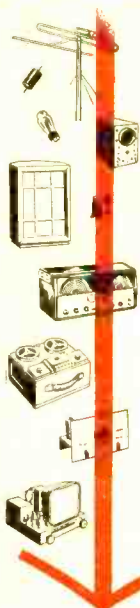

ALLIED RADIO CORP., Dept. 79-D-6
100 N. Western Ave., Chicago 80, Ill.

Rush FREE 1956 ALLIED 324-Page Catalog

Name _____

Address _____

City _____ Zone _____ State _____

As leisure-time activity increases, pleasure boating reaches new heights of popularity. Coincident with the numbers of new boats being put into the water, various electronics manufacturers are offering equipment that will effect the same maritime guidance and protection afforded commercial fleets.

A leader in this field is the Marine Equipment Division of the Raytheon Manufacturing Co. Our cover shows a typical Raytheon radar installation. It was made on the famous *Souris II*. In the photo, Warren H. Humes of the Boston Yacht Basin is tutoring Cele Ward in its simplicity of operation.

This particular piece of equipment is the Model 1500 "Mariners Pathfinder." It provides dependability and performance equal to U. S. Navy gear in a very small space. Actually only two units are required. The transmitter (operating in the u.h.f. bands) and antenna are mounted atop the mast. A plan position indicator and receiver are mounted in the housing shown in the photo. Power required to operate a marine radar installation is not excessive. In some yachts it is well within the power output of the present generators. On smaller crafts a special motor generator set can be used to advantage.

When at sea, the skipper can obtain radar reflections from other ships and coastlines, as well as special buoys marking important channels. Windstorms and squalls are also revealed on the radar screens.

While radar will not replace the capable skipper with his seamanship and skill, it does provide important information in a greatly simplified form. Proper use of marine radar may well make our seaways safer than our notorious highways.

Next Month

Look for the blurred image of a "hot-rod" speeding past a radar-equipped traffic officer on the cover of the May issue. This is another example of electronics in our everyday lives. Radar on the highway could be the title of this cover photo. If you drive a car (and 90% of our readers do), you will not want to miss one of the most important and revealing stories ever published in *POPtronics*.

INSTALLATION SIMPLIFIED

with the

Collaro RC-54

Automatic Intermit
RECORD CHANGER

Pre-Mounted
and Pre-Wired



If installation is the big reason you've been 'putting off' that high fidelity system . . . then here's good news. The famous Collaro RC-54 Record Changer is now pre-mounted and pre-wired . . . 'ready-for-use' in your home music system.

Supplied with pre-cut, unfinished mounting board, the RC-54 can be installed into consoles or record cabinets with a minimum of carpentry . . . very much like an ordinary shelf. And all electrical work is eliminated. The unit is supplied with power cord and audio connecting cable already soldered in position. Just plug the power cord into an electrical outlet; connect the audio cable to your

TV, radio or component amplifier . . . and you're ready for a new thrill in record reproduction.

The Collaro RC-54 is supplied with automatic 45 rpm spindle adapter, and offers a choice of pickup cartridges: either the G.E. dual-sapphire magnetic or Collaro Studio O dual-sapphire crystal.



Also available
on hardwood base
in Mahogany or Blond



Priced from \$56 00

The Collaro RC-54 is featured as standard equipment
by leading high fidelity manufacturers.

Write for complete specifications to Dept. ED-18

ROCKBAR CORPORATION • 215 East 37th Street, New York 16, N. Y.



Made in England

April, 1956

21

OLSON RADIO FOR GREATEST BUYS IN RADIO AND TV SUPPLIES



SPLICE-FREE RECORDING TAPE

Plastic Base—Hi-Fidelity
MONEY-BACK GUARANTEE
1200 FEET ON
7-INCH REEL

STOCK NO. X-249
LOTS OF 12, EA. **\$1.59**
Lots of 6, Ea. 1.79
Single, Ea. 2.19

Meets the most critical recording requirements for professional or home use. Perfect noise-free reproduction. Splice-free! Mirror polished red oxide coating bonded to smooth, strong plastic base. You get up to 2 full hours of recording time when played at 3 3/4" per sec. Guaranteed to be equal to much higher priced brands. Wide frequency response—50-15,000 cps. high signal to noise ratio, low distortion and uniform output. Standard 1 1/2" wide—fits most all recorders. Packed in 1200 ft. reels in attractive 2-piece storage carton.

New Shield Splice-Free 1800' L-o-n-g-e-r Play Tape

All the fine features of above tape, plus added feature of being 1800 ft. long. This gives you 30% longer playing or recording time—up to 3 hours when played at 3 3/4" per second.

STOCK NO. X-583
1800'—LOTS OF 12 **\$245**
EA.

Lots of 6, Ea. \$2.59 • Single, Ea. \$2.99

GOLDEN GATE 8" SPEAKER



With "Whizzer" Sound Dispenser

STOCK NO. S-229
List Price \$12.50
Olson's Price, Ea. **\$4.95**
2 for \$9.50

Finely finished in all gold lacquer. Dealers, order these speakers for installation where space is a factor. Will outperform many 12" units. Employs two concentrically mounted cones for extremely smooth reproduction of high or low volume. Small cone in center of large cone is called a "Whizzer" and provides extended treble response, good overall balance and wide dispersion angle. Equipped with heavy Alnico 5 magnet and cover. Power handling capacity 8 watts. Response 40-12,500 cps. Speaker cone 8" diameter, voice coil 8 ohms. Shpg. wt. 5 lbs.

ELECTROSTATIC HIGH FREQUENCY TWEETER

STOCK NO. S-228
EA. **\$249**
2 FOR \$4.50



For use with present speaker systems to provide the ultimate in high-frequency reproduction. Raises response to 20,000 cycles. Operates on condenser principle. Can be used on either single or push-pull output stages. A set of two can be used for even better sound dispersion. Size only 2 3/4" dia. x 1 1/2" thick. Complete with instructions for connection and operation. SHPG. wt. 1 lb.

TELEPHONE PICKUP

STOCK NO. **\$295**
M-80

Price slashed nearly one half! Record or amplify both sides of a telephone conversation without connections direct to telephone. Just lay pickup under any cradle type phone and connect lead to high impedance input or any disc, wire or tape recorder or any amplifier. Operates by induction. Shpg. wt. 1 lb.

Compact Power Supply Kit

STOCK NO. **\$399**
KB-26 EA.



3 FOR \$11.00
Delivers 115 Volts @ 30 MA at LESS THAN 1/10 of 1% Ripple plus 6.3 Volts AC @ .5 Amp.

Excellent for hams, experimenters and labs. Will supply power for amplifiers, preamps, test equipment, etc. Kit includes all components: power transformer, choke, dual filter condenser, binder post strip, switch, line cord, selenium rectifier, prepunched chassis, all hardware and even solder. Illustrated detailed instructions make assembly easy, interesting, and fast. For 110-120 Volts 50-60 cycles. Shpg. wt. 3 lbs.

2000 OHMS HEADPHONES

STOCK NO. X-542. Pr. \$1.95

INTERPHONE AMPLIFIER

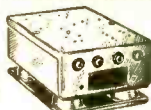

STOCK NO. AM-15
\$1.99 3 FOR \$5.00
EA.

Signal Corps No. BC-709. Brand new in factory sealed cartons. Original cost \$32.00. Contains a wealth of valuable parts including 5 x 2 1/2 x 8" aluminum case, 354 tube socket, condensers, resistors, 4 jacks, input and output transformers, battery holders, etc. For operation on 2 flashlight cells and one 67 1/2 Volt battery. Ready to operate or can be rewired for many other uses, such as: baby-sitter, amplifier, SW or BC receiver, transceiver, crystal set audio amplifier, etc. The polished aluminum case alone is worth more than the \$1.99. Get yours—while they last. Circuit diagram and instruction book included. Shpg. wt. 5 lbs.

18-PIECE ELECTRIC DRILL & GRINDER ACCESSORY KIT

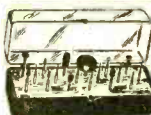

STOCK NO. TL-77
\$1.89

Deluxe economy all-purpose kit consisting of 18 tools for sawing, cutting, grinding, chanking, polishing, deburring, drilling and burnishing. Each tool with 3/8" diameter shank for 1/2" drill. Ideal for working with steel, plastic and all non-ferrous metals. Complete with attractive plastic case with snap lock. SHPG. wt. 2 lbs.

CONTROL KITS



YOUR CHOICE PER KIT **69¢**
3 KITS FOR \$2.00

Volume, tone, width, contrast controls—single and dual, carbon and wirewound. \$18.00 List Value.

KIT NO. AS-44
10 Controls

KIT NO. AS-176
7 Controls

Single and dual carbon element controls for radio and TV. Fine assortment.

Contains all wirewound controls for TV contrast, etc. Fine assortment.

HOW TO ORDER

Mail your order to 283 E. Market St., Akron 8, Ohio. Send remittance with order (add for postage 5¢ for each dollar's worth ordered—10¢ for each dollar's worth if you are more than 1,000 miles away). OLSON REFUNDS EVERY CENT NOT USED. Or—send no money—we'll ship C.O.D. and you pay mail or expressman for merchandise and postage. ALL MERCHANDISE 100% GUARANTEED. PLEASE—MINIMUM ORDER \$5.00.

JUNCTION TRANSISTOR



STOCK NO. **69¢**
X-621
3 FOR \$2.00

Special one-time Buy on this Hermetically-Sealed Junction Transistor. Precision-built, metal encased, moisture-proof. Characteristics similar to famous Raytheon CK-722. Average ratings with grounded emitter using collector voltage of 1.5 Volts; emitter current .5 MA; input resistance 1000 ohms; power gain, matched load, 34 DB; maximum amplification factor 22 and cutoff frequency 800 KC. Ideal for building radios, amplifiers, preamps, etc. Perfect for miniaturization—size only: 1/8" x 3/16" x 1/4", with 1 1/2" bare wire leads. Includes base diagram. SHPG. wt., ea. 8 oz.

NEW! SUN BATTERY



Convert SUNLIGHT To Electric Current

STOCK NO. RE-1
Reg. Ea. \$2.50
\$1.50
ONLY 3 FOR \$4.00

Sunlight striking selenium layer of cell generates 2 MA under a 10 ohm load. 60 microamps current output is generated at 100 foot candles with a 55 ohm load. Can be connected to any milliammeter for use as a light meter. Any number of these cells may be connected in series or series-parallel to increase voltage and current. Size 3/4" x 1 1/2". Open circuit voltage output 1/2 volt. 6" leads. Use for automatic light dimming, counting, burglar alarms, light meters and countless interesting experiments. With full instructions. Lasts indefinitely—will not wear out. Shpg. wt. 1 lb.

JACK & CONTROL BOX

1¢ SALE

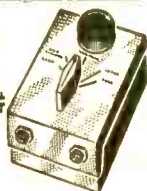

STOCK NO. SW-62
Each **79¢**
Get One More for Only 1¢

Yes, it's true! Order one at only 79¢ and get another for only 1¢. This handy Jack and Control Box is a genuine Signal Corps No. BC-1366. A rare bargain for experimenters. A two piece cast aluminum box 3 1/4 x 4 1/2 x 2 1/2". Contains 2 phone jacks, a 5 position rotary switch with one spring return position, an eleven contact male and female contact board with silver plated terminals and 2 knobs. Shpg. wt. 2-2 1/2 lbs.

TELEPHONE SET



Sound Powered Includes Headset and Microphone

STOCK NO. **\$3.95**
M-98 SET
2 Sets for \$7.50

Brand New—original cost \$30.00. No batteries needed—self powered. Permits 2-way talking up to 25 miles over any two wire connection. Each set contains a pair of sound powered high impedance dynamic headsets with felt padded rubber cushions and leather covered head-band. Both microphone and ear-phones have cone diaphragms and are extremely rugged and sensitive. Units may be removed from headsets to make efficient high powered miniature speakers. Useful for Antenna installations where beaming of antenna is critical. Shpg. wt. 5 lbs.

OLSON BARGAIN STORES IN

CHICAGO—623 W. Randolph St.
CLEVELAND—2020 Euclid Ave.
PITTSBURGH—5918 Penn Ave.
MILWAUKEE—423 W. Michigan Ave.
BUFFALO—711 Main Street

SEND FOR NEW FREE CATALOG

OLSON RADIO WAREHOUSE 283 E. MARKET ST. • AKRON 8, OHIO

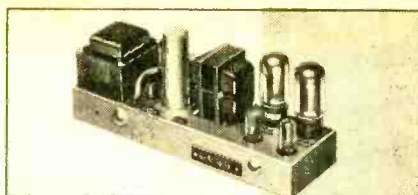

20-watt Hi-Fi Amplifier and

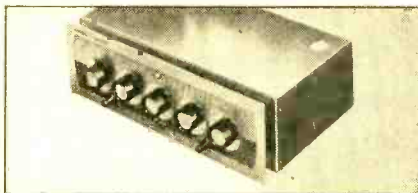

a Pre-Amp with controls

NEW G-E "CONVERTIBLE" in one flexible unit, only \$99⁹⁵

The G-E Convertible is a dual chassis design, mounting a 20-watt Hi-Fi amplifier, plus a pre-amp with 7 controls. There are 5 inputs and 4 outputs for every home audio need.

New Installation Flexibility, too! The amplifier and pre-amp may be custom-mounted independently. Or, the Convertible may be

placed on a shelf or table as one complete unit.

Write for new hi-fi ideas and your dealer's name. *General Electric Co., Special Products, TV Receiver Dept., Sect. R5846, Syracuse, N.Y.*

GENERAL  ELECTRIC

COYNE QUALITY

TELEVISION RADIO - COLOR TV

Home Training
at Unbelievably Low Cost



The future is YOURS in TELEVISION!

A fabulous field—good pay—fascinating work—a prosperous future in a good job, or independence in your own business!

Coyne brings you MODERN-QUALITY Television Home Training; training designed to meet Coyne standards at truly lowest cost—you pay for training only—no costly "put together kits." Not an old Radio Course with Television "tacked on." Here is MODERN TELEVISION TRAINING including Radio, UHF and Color TV. No Radio background or previous experience needed. Personal guidance by Coyne Staff. **Practical Job Guides** to show you how to do actual servicing jobs—**make money early in course.** Free Lifetime Employment Service to Graduates.

COYNE
ELECTRICAL SCHOOL
A TECHNICAL TRADE INSTITUTE OPERATED
NOT FOR PROFIT
500 S. Paulina Street, Chicago 12, Dept. 46-HT7

B. W. COOKE,
President



Coyne—the Institution behind this training—the largest, oldest, best equipped residential school of its kind. Founded 1899.

Send Coupon for Free Book

and full details, including easy Payment Plan. No obligation, no salesman will call.

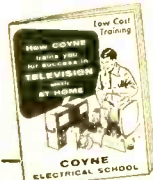

COYNE Television Home Training Division
500 S. Paulina St., Chicago 12, Ill.
Dept. 46-HT7

Send Free Book and details on how I can get Coyne Quality Television Home Training at low cost and easy terms.

Name _____

Address _____

City _____ State _____

STANLEY ELECTRONICS

TUBES & Parts

PAY LESS HERE!



150,000 BRAND NEW
SYLVANIA TUBES
MUST BE SOLD

100 TUBES for \$18

Bulk packed in original cartons in lots of 100 only.

- 19 1C6
- 32 1C7G
- 26 1D7G
- 39/44 1E7GT
- 35/51 1F4
- 49 2A7

BEST BRANDS - TUBES

Individually boxed. 1 year RTMA guarantee.

* partial listing *

Type	Price	Type	Price	Type	Price
0Z4	.45	6H6GT	.40	6A7	.59
1B3GT	.79	6J4	2.00	6AB	.59
1L4	.51	6J5GT	.49	6AB4	.45
1L6	.51	6J6	.49	6AF4	.80
1LA4	.57	6J7	.45	6AG5	.52
1LB4	.66	6KGT	.39	6AH6	.80
1LC6	.66	6K7	.40	6AK5	.80
1LD5	.57	6L7	.44	6ALS	.42
1LE3	.57	7C6	.45	6AL7GT	.70
1LQ5	.57	7F8	.70	6AS5	.50
1LM4	.66	7Y4	.35	6AS6	2.00
1LN5	.47	12AT6	.41	6AS7G	2.25
1NSGT	.55	12AV7	.68	6AT6	.40
1R4	.66	12AU6	.46	6AU5GT	.70
1R5	.51	12AU7	.58	6AU6	.43
1S4	.59	12AV6	.42	6AV5GT	.73
1S5	.51	12AX7	.63	6AX5GT	.59
1T4	.53	12AY7	.90	6B4G	.90
1U5	.50	12BA6	.46	6BAC	.49
1V	.57	12B4	.70	6BC5	.50
1X2A	.62	12BE6	.46	6BE6	.46
2D21	1.00	12BH7	.60	6BGGG	1.18
2V3G	.80	12BY7	.64	6N7	.61
2X2A	.90	12SA7	.52	6Q7	.45
3D6	.45	12SH7	.47	6S4	.47
3LF4	.69	12SK7GT	.60	6S7G	.47
6BH6	.53	12SL7GT	.60	6SA7GT	.50
6BJ6	.59	12SN7GT	.40	6SC7	.50
6BK5	.70	12SQ7GT	.40	6SG7	.43
6BK7A	.78	14A5	.59	6SH7	.45
6BN6	.59	14A7	.49	6S7GT	.48
6BL7GT	.77	14B6	.40	6SK7	.50

FREE GIFTS!

All purpose ELECTRIC TESTER equipped with genuine neon glow lamp. Tests loads from 90 to 500 volts. AC or DC with every \$3 or more order.

Reg. \$4.95 5-pc. SYLVANIA REPAIR KIT. Inc. flashlight head, screwdrivers, alignment tool and case, with every order of \$25 or more.

FREE GIFT COUPONS with every order. SEND for free premium catalog.

TERMS: 25% deposit required on all orders. Balance C.O.D. Save C.O.D. charges; send full remittance plus postage with tube and parts list. Subject to prior sale.

Dumont and RCA

licensed
TV PICTURE TUBES

No Duds Required

* All brand new * one year guarantee

Discounts for the Quality Purchaser

10BP4	\$10.95
12LP4	12.95
14CP4	15.25
15DP4	16.95
16DP4	18.50
16GP4	19.25
16KP4	17.00
16RP4	17.00
17BP4	19.00
17GP4	21.00
17LP4	18.00
19AP4	23.00
20CP4	24.00
21ALP4A	24.00

* partial listing *

Stanley ELECTRONICS CORP.

935 MAIN AVENUE - PASSAIC, N. J.

Dept. PE-4

GRegory 1-2498

WHAT'S THE PE ANSWER?

HIGHS ON FM VS. DISCS

When I turn up the "Presence" control on my tweeter, I notice that I get more highs from the FM tuner than from the records I play. Why should this be so?

R. A. SMITH
Chicago, Ill.

This effect can be due to a number of important factors. First, your own record equalizer could be cutting off the highs. Determine if this is the case by running records "flat" through the equalizer. If not, a second possibility is high-frequency loss in the cable between your cartridge and amplifier; such cables should be reasonably short and made of a good grade of coaxial shielded cable.

Another possibility is loss of the highs in the cartridge itself. The older models of the very popular G.E. reluctance cartridge will not effectively reproduce anything above 11,000 cycles. Most FM broadcast stations use high-quality cartridges and microphones which will handle all of the highs out to 15,000 cycles.

THEATER FREQUENCY RESPONSE

The sound system in most movie theaters is terrific. I've bet a friend of mine that it goes all the way down to 25 cycles. He says that darn few of them can do this. What do you say?

A. COPE
Burlington, N. J.

Sorry, but you lose that one. The better-than-average theater sound system cuts off between 45 and 50 cycles. Some very special installations will go as low as 32 cycles, but these are few and far between. The impression that they do go pretty far down in frequency is due to the playback sound level.

POLARITY OF CRYSTAL RECTIFIERS

In the "After Class" article in the November, 1955, issue of POPULAR ELECTRONICS, you stated that the rectangle in the schematic representation of a crystal diode was the cathode, and the arrowhead the receiver of electrons. If this is so, then why is the + sign next to the cathode. Isn't the cathode negative with respect to the receiver of electrons?

ALLAN LEVINS
Brooklyn 34, N. Y.

In a rectifier circuit, the cathode of the rectifier is at a positive d.c. potential. Therefore, the cathode is usually marked with a "+" sign. This does not mean that electrons can flow to the plate when the plate is negative with respect to the cathode. In a rectifier cir-

RCA offers you the
 finest training
 at home in
Radio-TV
 electronics,
TV servicing,
Color TV



**SEND FOR THIS FREE
 BOOK NOW!**

The instruction you receive and equipment you get (and keep) will start you on your way. Pay-as-you-learn. You pay for only one study group at a time. This 52 page book contains complete information on Home Study Courses for the beginner and the advanced student.



RCA INSTITUTES, INC.
 A SERVICE OF RADIO CORPORATION of AMERICA
 350 WEST FOURTH STREET, NEW YORK 14, N.Y.

April, 1956

RCA Institutes, Inc., Home Study EP-64
 350 West Fourth Street New York 14, N. Y.
 Without obligation, send me FREE CATALOG
 on Home Study Courses in Radio, Television
 and Color TV. No salesman will call.

Name.....
 Address..... Please Print
 City..... Zone..... State.....

IMPORTANT
 Be sure to write
 for RCA Institutes
 catalog before
 signing up for any
 Radio-TV course

LEARN basic electricity electronics

THE EASY "PICTURE BOOK" WAY!



Just Released: The fabulous ILLUSTRATED Training Course now used by the U. S. Navy!

You Learn by Pictures

Over 25,000 Navy trainees have already learned Basic Electricity and Basic Electronics this easy, "Picture Book" way! Now, for the first time, YOU can master the basics of Electricity and Electronics with this same "Learn-by-Pictures" training course! Over 1,700 simple, easy-to-understand drawings explain every section—these "teaching" pictures actually make up more than half the entire course! No other Basic Electricity or Basic Electronics course in America uses this revolutionary illustrative technique! You learn faster and easier than you'd dream possible!

A Complete Idea on Every Page

What's more, an imaginary instructor stands figuratively at your elbow, doing "demonstrations" that make it even easier for you to understand. Then, at the end of every section, you'll find review pages that highlight the important topics you've just covered. You build a thorough, step-by-step knowledge at your own pace—as fast as you yourself want to go!

Home Study Without Correspondence

This course is so different, so complete—there's no need for the usual letter writing, question and answer correspondence! Learn at home—at your own pace!

10 Complete Volumes

Volumes 1 and 2 of "Basic Electricity" cover DC components and circuits; Volumes 3 and 4 cover AC components and circuits; Volume 5 covers AC and DC motors and machinery. \$9.00 per set.

Volume 1 of "Basic Electronics" covers Diodes & Power Supplies; Vols. 2 and 3 cover Amplifiers & Oscillators; Vols. 4 and 5 cover Transmitters & Receivers. \$9.00 per set.

Learn All About Hi-Fi Loudspeakers and Enclosures

HI-FI LOUDSPEAKERS and ENCLOSURES

by Abraham B. Cohen

For the first time a chance to really learn all about hi-fi loudspeakers and enclosures.

Here is the "classic" in hi-fi literature . . . really an education. . . . A book which teaches every hi-fi fan loudspeakers and enclosures—and does it in a way that is easy to absorb—does not require any special background!

The book is supremely authoritative and brilliantly written. It is a picture course. . . . Among its 368 pages are many hundreds of illustrations which whet your appetite . . . not to stop reading until you have finished it.

Its coverage is tremendous! EVERYTHING about ALL kinds of loudspeakers . . . EVERYTHING about ALL kinds of enclosures . . . Inexpensive ones and costly ones. Not only does this book tell you all about them—but what you learn will enable you to make wise decisions when you want to buy—or build—whichever is your desire. Includes 18 blueprints of enclosures for home construction.

368 pages. 5½x8½". Leather Finish Marco Cover. \$4.60.

ORDER TODAY!

These books are sold by electronics parts jobbers and book stores. If YOUR dealer doesn't have these books, order them from—

**John F. Rider Publisher, Inc.
480 Canal St., N.Y.C.**

cuit, the plate is positive with respect to the cathode during a small fraction of the input waveform and electrons flow during this time only.

This discussion applies to crystal or selenium rectifiers if we remember that the cathode represents the source of electrons, and the plate the receiver of electrons.

TURNTABLE BUZZ

When I connected a new turntable and tone arm to my amplifier (in place of an older changer), I found a loud annoying buzz coming through the speaker. This buzz seems to be something like an a.c. hum, but not exactly like it.

**ELMER C. JOHNSON
Van Nuys, Calif.**

Look at the connections through the tone arm to your pickup cartridge. The impression we get is that the shielded lead from the cartridge may not be grounded to the turntable. Make sure that the cartridge shielded lead is not "floating" in the tone arm and turntable assembly.

CHASSIS AND CIRCUIT GROUNDS

When you published the page of Standard Wiring Symbols, you always included symbols for wiring ground and chassis ground. On looking over published diagrams, I don't find a single one where symbols indicate a ground to chassis. How about straightening me out?

**TRAVIS C. BROWN
Taft, Calif.**

It has been our custom to use the "circuit" ground symbol almost exclusively. The only time we use the "chassis" ground symbol is in circuits where the two grounds must be kept separate. Many times the "circuit" ground is actually connected to the chassis, but this will be indicated in the text or pictorial diagram. The use of both symbols for a common circuit point would be confusing.

RADIO PAGING SYSTEMS

I would like to know what the ladies are transmitting at 32.4 megacycles or thereabouts—in the following group of numbers for example: "116 182 205 222 280 319 347 350 495 502 724 946 KEA860K4 New York."

**JOHN R. WILLIS
Caldwell, N. J.**

You were tuned to the "Page Boy, Inc." station in New York City, which operates from the Empire State Building on 35.58 mc. This is a message service for doctors and other professional men. Each subscriber is given a number and carries with him a small receiver. He listens periodically, and if his number is called, it means that he has a message waiting for him. As soon as he calls in and gets his message, his number is removed from the list being broadcast until another call comes in. Many of the large cities now have such service available, and several companies in addition to the one mentioned above are in the business.

—30—

FREE!

LAFAYETTE

CATALOG



132 PAGE ELECTRONIC CATALOG

Packed with the largest selection of Electronic, Radio and T.V. Parts, and equipment, PA, Hi-Fi systems, tubes, antennas, Transistor Kits, parts and components, Test Equipment, new build your own kits, tools, books, Microscope, drafting equipment, Binoculars, Telescopes, All Radio, TV and Ham supplies — ALL AT GREAT SAVINGS — For the economy minded servicemen, dealer, engineer and technician. **CHUCK FULL OF BUYS! SEND FOR YOUR FREE COPY TO-DAY.**

TRANSISTOR EXPERIMENTERS LAB KIT

AS SHOWN IN MARCH ISSUE OF POPULAR ELECTRONICS

5 "EASY TO ASSEMBLE" TRANSISTOR DEVICES

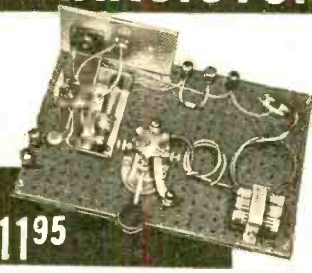

1195

1. SIMPLE RECEIVER
2. REGENERATIVE RECEIVER
3. CODE TRANSMITTER
4. LIGHT POWERED RECEIVER
5. CODE PRACTICE OSCILLATOR

Perfect for the beginner or advanced worker. Five circuits designed to demonstrate practical transistor applications. Gain the practical knowledge of transistor application. Interesting and educational to assemble and test — and fun to use. Kit is complete with all necessary parts for assembly-instructions-schematics-and pictorials. Less headphone, scrap metal, tape and solder.

- KT-88 Net **11.95**
- Headphone-EC-1 Net **1.13**
- MS-278 New Supersensitive Earpiece Net **1.95**

13-IN-1 EXPANSION KIT

- WIRELESS MICROPHONE
- ELECTRONIC METRONOME
- HIGH GAIN RECEIVER
- LIGHT-POWERED OSCILLATOR
- SIMPLE PHOTO CELL RELAY
- ELECTRONIC RELAY
- SENSITIVE PHOTO CELL RELAY
- RAIN ALARM

An exciting addition to the KT-88 kit to enable you to continue this fascinating and educational program of instruction, including the making of printed (etched) circuitry. The additional parts, diagrams and instructions (along with the parts in the basic 5-in-1 kit) cover the 8 added projects listed above. You'll be able to do such interesting things as broadcasting through your radio without connecting wires, detect moisture or rain, make light actuated relays and much more. And when you've done all these, you can look forward to more Lafayette expansion kits to increase the utility of the kits you already have. Kit is complete with all parts and instructions. Shpg. wt., 3 lbs.

- KT-89 . . . EXPANSION KIT Net **7.50**
- KT-88 and KT-89 . . . Kit bought together Net **18.75**



NEW! ALL-PURPOSE DYNAMIC EARPHONE

- FOR RADIO AND TV LISTENING
- FOR SUBMINIATURE, MINIATURE AND TRANSISTOR RECEIVERS

A sensitive all-purpose earphone designed for your listening pleasure. Combines the range of a dynamic earphone with the performance of its special magnet to give you excellent reproduction. Lightweight and equipped with ear support that slips comfortably over your ear. You can relax! The support is practically invisible — the earphone can't slip out — it can't fall off. Ideal for use with TV and radio sets, amplifiers, miniature and transistor receivers etc. Complete with 3 ft cord. A super value for the price!

- MS-278 — 3000 ohm impedance, 1000 ohm DC resistance, with phone tip plugs. Net **1.95**
- MS-277 — 6 ohm impedance, with phone tip plugs. Net **1.95**
- MS-273 — 3000 ohm impedance, 1000 ohm DC resistance, with subminiature phone plug and matching phone jack. Net **2.39**
- MS-279 — 6 ohm impedance, with subminiature phone plug and matching phone jack. For Silent Radio and TV Listening or Viewing. Net **2.39**

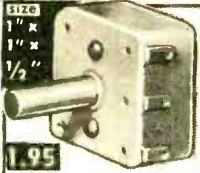

1.95

NEW MINIATURE 2 GANG VARIABLE CONDENSER

Here is Lafayette's super midget variable! Only 1" x 1" x 1/2" — 2 gang for transistor super hets! 10 to 208 mmf. on the ant. section. 10 to 100 mmf. on the cut oscillator section! Self contained variable trimmers. Tunes through 180°. Entirely enclosed in a transparent plastic case! The smallest complete 2 gang variable for super hets in the world! Offers unlimited possibilities to the experimenter.

- MS-270 Net **1.95**
- MS-274 single gang condenser Capacity 10 to 365 mmf. Net **1.25**
- For Miniature 2 Gang Variable Cond.
- MATCHED } MS-271 Osc. Coil Net **.79 ea.**
- COIL SET } MS-272 Ant. Coil Net **.95 ea.**

2 TRANSISTOR POCKET RADIO KIT



Packed into a 2 1/4" x 3 1/2" x 1 1/4" plastic case. This Two Transistor plus crystal diode radio kit offers many surprises, utilizing a regenerative detector circuit with transformer coupled audio stage, gives you high gain and excellent selectivity. Pulls in distant stations with ease with more than ample earphone volume. Kit comes complete with two transistors, crystal diode, icopstick, Arrone transistor audio transformer, resistors, condensers, plastic case, etc. Including schematic and instructions.

- KT-68A Complete Kit less earphones. Net **11.80**
- MS-260 New Super Power Dynamic Earphone. Ideal for Transistor Circuit Imp. 8000 ohm. D.C. 2000 ohm. Net **3.95**

NEW YORK, N.Y.	100 Sixth Ave.
BRONX, N.Y.	542 E. Fordham Rd
NEWARK, N.J.	24 Central Ave.
PLAINFIELD, N.J.	139 West 2nd St.
BOSTON, MASS.	110 Federal St.

LAFAYETTE RADIO
100 SIXTH AVE., NEW YORK, N.Y.

Send FREE 132-Page Lafayette Catalog

Name _____

Address _____

City _____ Zone _____ State _____



Electrical Appliance Repairs MADE EASY

New Repair Manual Covers EVERY Repair on ALL Home Appliances

NO repair job is too tough with the help of this big new Guide. TELLS and SHOWS how to service ALL home appliances. SAVE MONEY keeping your own appliances like new—or MAKE MONEY with a home repair shop of your own... full or spare time.

OVER 850 "how-to-do-it" pages, packed with pictures, drawings, diagrams. Sectional charts locate "trouble spots" in a jiffy... make it easy to dismantle and reassemble appliances correctly. A-B-C directions tell "why" as well as "how." Book covers fundamentals of electricity for beginners. Over 150 manufacturers supplied the servicing and repair data.

FREE 10-DAY EXAMINATION—Coupon will bring you "Electrical Appliance Servicing" to examine FREE—without obligation. Mail it NOW!



Covers ANY Service or Repair on:

- Irons • Toasters • Heaters • Vacuum Cleaners • Sewing and Washing Machines • Refrigerators • Air-Conditioners • Fans • and much more.

McGraw-Hill Book Co., Inc., Dept. PEL-4
327 West 41st St., New York 36, N. Y.

Send Crouse's Electrical Appliance Servicing for 10-DAY FREE EXAMINATION. If not satisfied I will return it—pay nothing. Otherwise, I will keep it—send only \$3.00 (plus small delivery charge) then—and \$3.00 a month for 2 months to complete payment.

Name.....

Address.....

Employed by.....

City..... State.....

WE'LL PAY DELIVERY if you remit (check or M.O.) WITH coupon. Same Return Privilege. (Offer applies to U.S. only.)

NOW AVAILABLE IN ALUMINUM AND STEEL



this new PREMIER chassis is stronger



...because it features GUSSETS spot-welded to the bottom flanges for rigidity.

easier to mount

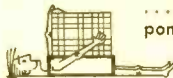

...you can mount components in the corners... because new construction eliminates double metal thickness.

no sharp edges



...corners have a rounded effect.

SEE THEM DISPLAYED AT YOUR DISTRIBUTOR
SEND FOR COMPLETE CATALOG P

P R E M I E R
M E T A L P R O D U C T S C O .
337 MANIDA STREET NEW YORK 59, N. Y.

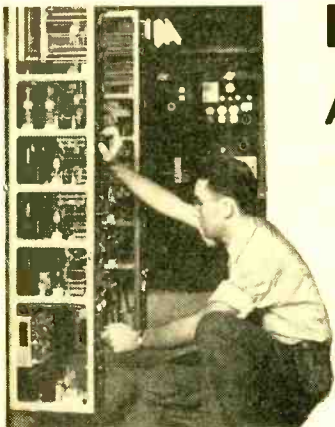

HIGH-PAY CAREERS

IN ELECTRONICS — TELEVISION — RADIO

Await Men with COMPLETE Training!

Nationally-recognized, accredited Central training is designed to get you into high-paying career positions in the shortest possible time. In addition, Central's "Progressive Plan" is so arranged that each phase of training you complete qualifies you for a more important, better-pay position. In just a few short weeks you are qualified for certain basic jobs. Then, with every additional training phase that you complete, you qualify "up the ladder" for more advanced types of positions. Central offers complete Electronics-TV-Radio training leading to an Associate of Science degree, and qualifying you as an *Electronics Engineering Technician!*

Thousands of Central graduates have been placed at almost every technical level in the electronics industry. Free nation-wide placement service.

3 PROVEN TRAINING PLANS

(Choose the one that fits your requirements)

1. **HOME STUDY COURSE** (with 9 kits of equipment) —Qualifies you for diploma, FCC license, and a variety of electronics jobs (or transfer into advanced resident training).
2. **HOME STUDY-RESIDENT COURSE** (with 9 kits of equipment) —Home study, followed by short period of resident training. Qualifies you for diploma, FCC license, and a wide variety of Electronics-TV-Radio positions (or continue with advanced resident training). An accredited technical institute curriculum.
3. **FULL RESIDENT COURSE** —Qualifies you for Associate of Science (A.S.) degree and top-pay employment opportunities as Electronics Engineering Technician. Part-time employment opportunities available for students while training. An accredited technical institute curriculum.

Don't limit yourself! Get the facts on Centrals complete training that can take you just as far as you want to go in the electronics technician field. Send coupon today for FREE brochure on your opportunities in Electronics.

VETERANS! Central offers courses approved under G. I. Bill

CENTRAL TECHNICAL INSTITUTE

Dept. A-46, 1644 Wyandotte St., Kansas City 8, Mo.

Tell me more about how you can qualify me for a high-pay Electronics career.

Name..... Age.....

Address..... Phone.....

City..... State.....

If Korean veteran, give approximate discharge date.....

BUILD 16 PRINTED CIRCUIT and METAL CHASSIS RADIO CIRCUITS

ONLY **\$19.95** COMPLETE

WITH THE NEW DELUXE 1956

PROGRESSIVE RADIO "EDU-KIT"

Build 16 Receiver, Transmitter, Code Oscillator, Signal Tracer,
Signal Injector Circuits

- Absolutely No Knowledge of Radio Necessary
- Learn Practical Radio Theory and Construction
- No Additional Parts Needed
- Excellent Background for Television
- 30 Day Money-Back Guarantee
- Free Soldering Iron, Tester & Other Extras
- School Inquiries Invited
- Used in 79 Countries
- Learn High Fidelity

WHAT THE "EDU-KIT" OFFERS YOU

You will learn how to build radios using regular punched metal chassis and professional radio schematics. You will learn how to wire and solder radio circuits. You will learn the basic principles involved in radio. You will build sixteen receiver, transmitter, code oscillator, signal tracer and signal injector circuits, and learn how to operate them. You will learn the principles of RF and AF amplifiers, detectors, RF and AF oscillators, rectifiers, etc. You will learn how to service and troubleshoot radios. You will build a Printed Circuit Signal Injector, and learn the principles and practical aspects of this revolutionary new method of radio building. You will learn and practice code, using the Progressive Code Oscillator. You will receive instructions for F.C.C. Novice License. In brief, you will receive practical basic training in Radio, worth many times the small price you pay.

THE EDUCATIONAL RADIO KIT FOR EVERYONE

You do not need the slightest background in radio or science. The "Edu-Kit" is designed for the complete beginner. It is used by young and old, by radio schools and clubs, by Armed Forces personnel and Veterans for training and rehabilitation. No instructor is required. The "Edu-Kit" Instruction Manuals are exceedingly clear and complete in all details.

"EDU-KIT" IS USED THROUGHOUT THE WORLD

The Progressive Radio "Edu-Kit" is used in every state of the U.S.A., the District of Columbia, Alaska, Virgin Islands, Puerto Rico, Hawaii, Guam and the Canal Zone. It is used in 79 countries in all parts of the world, including Canada, Philippines, Korea, South Africa, Saudi Arabia, Venezuela, Israel, France, England, Japan, India, etc. The "Edu-Kit" is very popular with American servicemen stationed overseas.

THE PROGRESSIVE RADIO "EDU-KIT" IS COMPLETE

You will receive every part necessary to build sixteen different radio circuits. You will receive all tubes, tube sockets, variable electrolytic and paper condensers, resistors, tie strips, coils, hardware, tubing, Printed Circuit chassis, Printed Circuit tube sockets and hardware, Printed Circuit Instruction Manual, custom punched steel chassis, Instruction Books, etc. Selenium Rectification is used throughout.

In addition, you receive an electric soldering iron as well as a Radio and Electrical Tester. All parts are fully guaranteed, brand new, carefully selected and matched. The "Edu-Kit" now also contains lessons for servicing with the Progressive Signal Tracer and the Progressive Signal Injector. High Fidelity, F.C.C. Novice License instructions, Quizzes. The Progressive Radio "Edu-Kit" is a practical home radio course at a rock bottom price.

"EDU-KIT" Now Includes PRINTED CIRCUITRY in addition to Regular Wired Punched Metal Chassis Construction

At no increase in price, the "Edu-Kit" now includes Printed Circuitry. You build a Printed Circuit Signal Injector, a unique servicing instrument that can detect many Radio and TV troubles. This revolutionary new technique of radio construction is now becoming popular in commercial radio and TV sets as well as in hearing aids, computers, business machines, etc.

A Printed Circuit is a special insulated chassis on which has been deposited a conducting material, which takes the place of wiring. The various parts are merely plugged in and soldered to terminals.

MAIL TODAY • ORDER SHIPPED SAME DAY RECEIVED • 30 DAY MONEY-BACK GUARANTEE

FREE EXTRAS

- included with "EDU-KIT"
- Radio & Electrical Tester
 - Electric Soldering Iron
 - Tester Instruction Manual
 - Television Book
 - High Fidelity Guide
 - Quizzes
 - Consultation Service



Reg. U. S. Pat. Off. Pend.

FREE

Radio-Television
Servicing Literature
on request

(See Coupon below)

"LEARN BY DOING"—

THE PROGRESSIVE TEACHING METHOD

The Progressive Radio "Edu-Kit" uses the principle of "Learn by Doing." Therefore you will build radio circuits, perform jobs, conduct experiments, and make repairs in order to illustrate the principles which you learn. You begin by examining the various radio parts, which are individually packaged and identified. You then learn the function, theory, wiring of these parts. Then you build a simple radio. With this first set you will enjoy listening to regular broadcast stations, learn theory, practice Testing and Troubleshooting. Then you construct a more advanced radio, learn more advanced theory and techniques. Gradually, in a progressive manner, and at your own rate, you will find yourself constructing more advanced multi-tube radio circuits, and doing work like a Professional Radio Technician. The "Edu-Kit" Instruction Manuals are exceptionally clear in their explanations, illustrations and diagrams. In addition to regular wired punched metal chassis radios, you now learn about Printed Circuits and actually build a Printed Circuit Signal Injector. These sets operate on 105-125 V. AC-DC. For use in foreign countries having 210-250 V. source, an Adaptor for 210-250 V. AC-DC is available.

LEARN TROUBLESHOOTING AND SERVICING

You will learn how to recognize and repair troubles. You will build and learn to operate the Progressive Signal Tracer and the Progressive Signal Injector. You receive a Radio and Electrical Tester. You learn how to use these instruments for radio testing and repairs. While you are learning in this practical way, you will be able to do many a repair job for your neighbors and friends, and charge fees which will far exceed the cost of the "Edu-Kit." Our Consultation Service will help you with any technical problems which you may have.

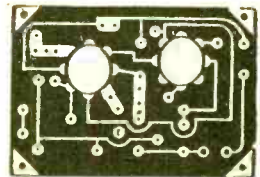

- Send "Edu-Kit" Postpaid. I enclose full payment of \$19.95.
 - Send "Edu-Kit" C.O.D. I will pay \$19.95 plus postage.
 - Send me FREE additional information describing "Edu-Kit." Include FREE valuable Radio and TV Servicing Literature. No obligation.
- (Outside U.S.A.—No C.O.D.'s. Send check on U.S. bank or Intern'l M.O. "Edu-Kit" for 105-125 V AC/DC \$20.95; 210-250 V AC/DC \$23.45.)

Name

Address

PROGRESSIVE "EDU-KITS" INC.

497 Union Ave., Room 519-D, Progressive Bldg., Brooklyn 11, N. Y.

NOW! SAVE up to 50%

BUILD YOUR OWN

E-V HIGH FIDELITY Speaker Enclosure



EVERY PIECE PRECUT

in *Ready-to-Assemble* **KITS**

Now you can own an acoustically correct *Electro-Voice* high-fidelity folded-horn speaker enclosure for your home music system and *save up to one-half!* Build it yourself...seven models to choose from...wall types...corner types...for full range loudspeaker...for separate two, three and four-way speaker systems.

All parts are pre-cut—ready to assemble. Exterior surfaces are clear-grained birch. Easy, step-by-step instructions show you how to "Do-it-Yourself."

Beautiful furniture finish is easily obtained with an E-V Finishing Kit.* E-V Decorative Trim Kit* adds the final touch. (*Available separately.)



See your E-V Hi-Fi Distributor for Construction Books and K-D Kits —or write for Bulletin 211. E64

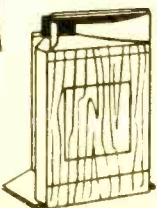

THE PATRICIAN IV KIT. An interior assembly kit for those desiring the finest. This augmented design of the Klipsch corner folded-horn bass section delivers an added full octave of bass. Designed for use with E-V Model 103C Patrician IV four-way driver components. For built-in installations or to be decorated as you choose. Finished size: 57½ in. high, 34½ in. wide, 26¾ in. deep. Shpg. wt. 150 lb.

Model KD1 Net, \$99.00



THE BARONET KIT. Phenomenal reproducer for such small size. This folded-horn corner enclosure is designed for use with E-V Model SP88 8-in. Radax speaker. E-V T35 or T35B Super Sonax UHF driver can be added for a separate two-way system. Finished size: 23 in. high, 14 in. wide, 13 in. deep. Shpg. wt. 24 lb.

Model KD7 Net, \$24.00



THE ARISTOCRAT KIT. Folded-horn corner enclosure designed for 12-in. speakers and separate 2 and 3-way systems. For use with Electro-Voice SP12 or SP12B coaxial speakers, 12TRX or 12TRXB triaxial reproducers, and 108, 111 2-way and 108A, 111A 3-way systems. Smooth reproduction down to 35 cps, with remarkable purity and efficiency. Finished size: 29¾ in. high, 19 in. wide, 15¾ in. deep. Shpg. wt. 37 lb.

Model KD6 Net, \$36.00

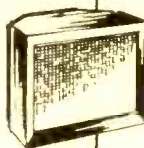

THE EMPIRE KIT. Economical, folded-horn enclosure for use in a corner or flat against one wall. Designed for 15-in. speakers and separate 2 and 3-way systems. Particularly effective when used with SP15B coaxial speaker, 15TRXB triaxial reproducer, or 116 2-way or 116A 3-way system. Recommended components for Regency kit may also be employed. Finished size: 29¾ in. high, 32 in. wide, 16 in. deep. Shpg. wt. 45 lb.

Model KD5 Net, \$48.00

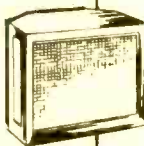

THE REGENCY KIT. Most popular low-boy style folded-horn enclosure that can be used in corner or flat against one wall. Improves the bass range and response of any 15-in. speaker. Makes an outstandingly efficient reproducer when used with E-V SP15 coaxial speaker, 15TRX triaxial reproducer or 114A 2-way or 114B 3-way system. Finished size: 29¾ in. high, 33½ in. wide, 19 in. deep. Shpg. wt. 70 lb.

Model KD4 Net, \$69.00

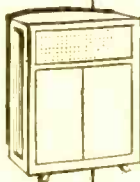

THE CENTURIAN KIT. Four-way system folded-horn, corner enclosure. Uses exclusive E-V "W" type single-path indirect radiator for propagation of extended bass. Sealed cavity behind 15 in. low-frequency driver cone promotes superlative transient response, subdues cone excursions, lowers distortion. For use with E-V Model 105 or Model 117 package of driver components. Finished size: 42½ in. high, 29 in. wide, 22½ in. deep. Shpg. wt. 75 lb.

Model KD3 Net, \$79.00



THE GEORGIAN KIT. An interior assembly kit that creates authentic Klipsch indirect radiator type corner folded-horn bass section for 15 in. 4-way speaker system. Exceeded in range only by the Patrician IV. For use with E-V Model 105 or Model 117 package of 4-way driver components. For built-in installations or to be decorated as you choose. Finished size: 38½ in. high, 26¾ in. wide, 22½ in. deep. Shpg. wt. 88 lb.

Model KD2 Net, \$58.00

POPULAR ELECTRONICS



DRONES

Put R/C into War Games

By E. D. MORGAN

HIGH over the atomic test site in Nevada, three F-80 "Shooting Star" jet fighters orbited along precise flight paths. Their brilliant red fuselages glistened in the sunshine which soon would be dimmed by a man-made fireball from below. Would the planes withstand the blast about to be unleashed? Their mission: to find out.

And find out they did. All three survived, although damage to two of them was severe. One crash-landed on a dry lake, preserving its precious instruments and records. One landed safely at a nearby Air Force base. The third was unfortunately lost in the mountains to the east. The Atomic Energy Commission announced: mission successfully executed.

But what of the pilot lost in the mountains? As you have undoubtedly guessed, there was no pilot. The operation was but a routine demonstration of remote-controlled flight.

Nor is this example an isolated one. Automatic gunfire control systems, as well as new type guns and shells, are regularly checked by the Navy using pilotless planes

which dive and maneuver about the ships.

Sleek gas- and jet-driven target models sharpen the shooting eyes of Army anti-aircraft batteries. And the little craft have all the tricks that are known to their bigger, piloted counterparts.

Other nuclear missions greatly aid atomic energy research. Radioactive clouds have been probed with special instruments, and laboratory animals exposed to determine the radio-biological effects.

A few years ago, unmanned B-17's crash-landed in the water to secure valuable information about the effects upon structures and to check the ditching procedures in use. They landed precisely at a predetermined spot already surrounded with elaborate equipment waiting to record the results . . . without the risk of a single human life.

Radical types of aircraft designs are tested, new techniques evaluated, and new procedures checked for flaws without endangering our flying personnel. To those versed in flying radio-controlled models, this will come as no surprise.

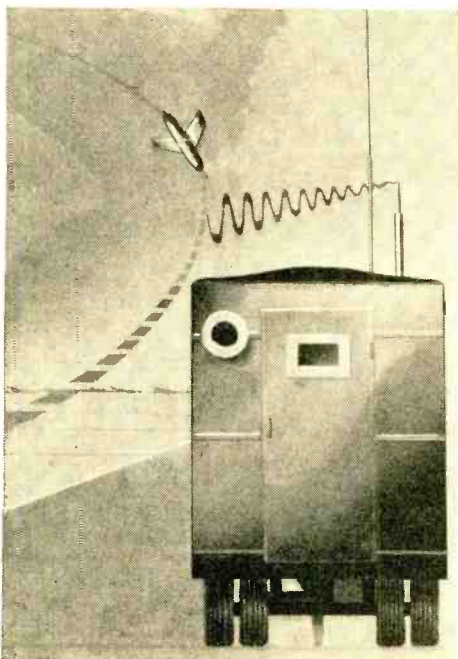

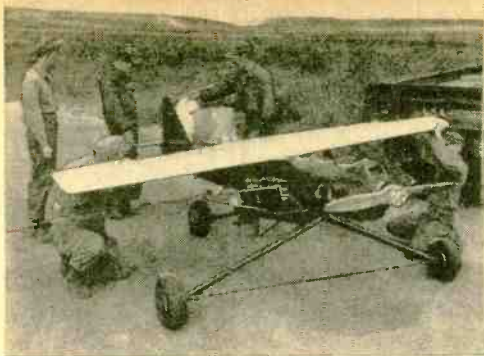

Army aerial target is shown being prepared for flight. After use, damaged target models are rebuilt whenever possible so they can be flown again.

The "drones," as the pilotless planes are called, have advanced to a state of real precision.

Most of this progress has been made since World War II, although during that struggle four Flying Fortresses were loaded with explosives and directed toward enemy lines. Pilots flew the planes from allied bases and bailed out once they were airborne. Of these, only one reached its German target. Today's techniques are a far cry from that meager start.

Converted jet fighters and four-engined bombers fly entire missions from take-off



Pilotless "Shooting Star" about to be flown off runway by controller. Director aircraft takes over during climb-out.

Ground radar control station commands exact flight path of QF-80 jets through an atomic cloud or other precision test.



to landing under control of operators on the ground or in nearby planes. Many models have been designed specifically for remote control operation. They range from small aerial gunnery targets (called R-CAT's by the Army for Radio-Controlled Aerial Targets) to powerful jet engine models like the Ryan "Firebee." The Navy recently announced that it even had a drone helicopter undergoing flight tests, while the Army has unveiled a photographic drone for reconnaissance missions.

The electronic systems required to control these planes in flight cover a like span of complexity. "Beeper" pilots, so-called because of the characteristics of the control signals, have an array of control sys-



of small drone air-planes may be done in a number of ways. Above, a catapult is being used to provide Navy target drone with JATO assist.

Recovering small target drones is usually accomplished by parachute (below). Damage to essential parts by gunfire automatically releases the chute.

tems ranging from a simple joystick control to elaborate truck-mounted consoles. Some systems require the operator to "fly" the plane, i.e., use his judgment on how long or short a signal to transmit to cause the desired reaction. Others use proportional control and the operator merely turns a dial to the compass heading or altitude he wishes the drone to fly.

Take-off and recovery techniques vary as much as the models themselves. The converted military planes are flown down the runway and into the air exactly as their piloted brothers are. Small drones are launched in a variety of ways. Sometimes a rotary launcher is used and the drone released after it is airborne and under control of the operator. In other cases a special catapult provides JATO (Jet-Assisted Take-Off) for a running start. Landings range from conventional wheel landings on long runways to parachute recoveries of the small target drones. On many of the target missions, of course, accurate gunfire makes recovery unnecessary.

(Continued on page 108)

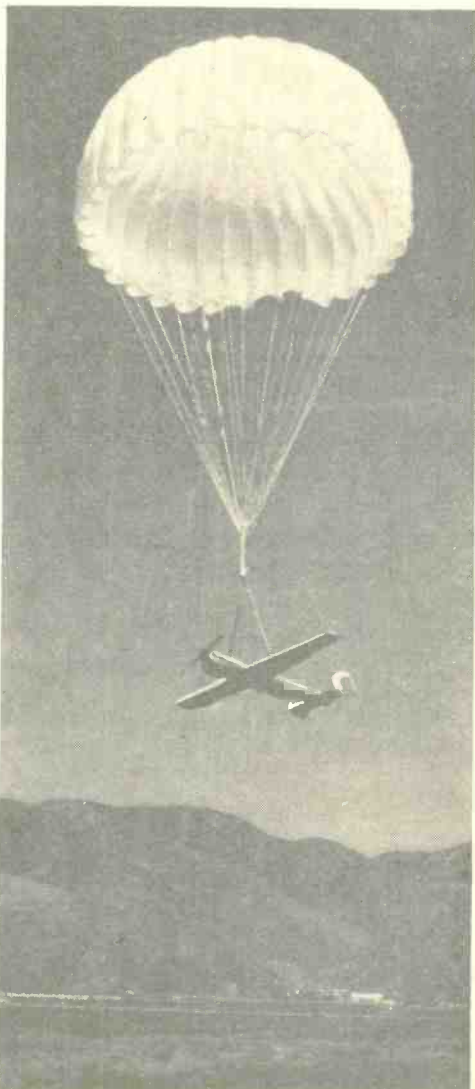

Radar corner reflectors in wing-tip appendages of drone insure that radar-controlled guns receive echo from craft.

ELECTRONICS hobbyists differ considerably in their fields of special interest; many like to work with R/C equipment but care little for hi-fi. On the other hand, the serious audiophile may not care, especially, which end of a resonant reed relay has terminals. And then there are the hams, receiver enthusiasts, SWL's, transistor tinkerers and, of course, the gadgeteers. But regardless of their special interests, most of the hobbyists agree on one thing—there is seldom enough money to support the hobby in the manner they would like.

Some fellows have met this problem by applying a little ingenuity and liberal quantities of elbow grease. They have come up with ways to make the electronics hobby pay—without becoming full-time professional electronics engineers, servicemen, or technicians! One of these chaps is Philip N. Bridges of 5100 Randolph Road, Rockville, Md.

A quiet, unassuming man in his thirties, Phil is—by profession—a government employee. He's one of the thousands of civil servants who live in the suburbs of Washington, D. C. When we heard that Phil had found a method to make his hobby pay its own way, a visit with him resulted in the interview outlined below.

Q: JUST HOW DO YOU MAKE YOUR HOBBY PAY ITS WAY, PHIL?

A: I "do it" for "do-it-yourselfers"!

Q: THAT DESERVES SOME EXPLANATION, DOESN'T IT?

A: Well, you know that there are a lot of inexpensive electronic assembly kits offered for sale. These are designed to be put together by the individual purchaser, who is generally a "do-it-yourself" fan. But there are a number of people who like the economy and performance of kit equipment, and who don't have the time or—perhaps—the inclination to assemble the kits themselves. So I do it for them.

Q: THAT'S AN INTERESTING APPROACH. DO YOU GET MUCH BUSINESS?

A: When I started a couple of years ago, I had around \$50 worth of shop and laboratory equipment. Today, I have better than \$500 in equipment and I'm grossing almost \$100 per month—all in my spare time.

Q: DO YOU NEED MUCH EQUIPMENT TO START A BUSINESS LIKE THIS?

A: Not to start. I had a v.t.v.m., a test speaker, soldering iron, and a few hand tools when I started. Today, I've got a signal generator, additional hand tools and other electronic equipment. I plan to add a tube tester, oscilloscope, and extra test gear, as well as an electric drill and more



ESTIMATING COSTS. Quoting firm prices prior to "doing it" for "do-it-yourselfers" is one of the first steps in Philip N. Bridges' method of making his electronics hobby pay.



Profit

power-operated tools. One advantage to kit assembly over other spare-time work, such as servicing, is that you can get by with a minimum of equipment. Most kits are fairly complete and include pre-punched chassis.

Q: I IMAGINE IT'S A LITTLE DIFFICULT TO PRICE SUCH WORK. HOW DO YOU CHARGE FOR YOUR SERVICE . . . BY THE HOUR?

A: No. I *had* planned to use hourly rates, but I soon found that my customers wanted firm quotations in advance. So after assembling a few "trial" kits, I established rates based on the average amount of work involved. My basic price for kit assembly is 25% of the kit's net cost, with a \$10 minimum charge. But there are exceptions. If the kit is complicated, I may charge as high as one-third of its cost. On the other hand, if the kit is partially prefabricated, I charge less than the 25% rate. But even with the assembly charges added, the final cost to the customer is still competitive with—and often much less than—the cost of comparative "factory-built" equipment.

Q: DO YOU RESTRICT YOURSELF TO COMMERCIAL KIT ASSEMBLY?

A: No. I've often worked up quotations on complete hi-fi installations. On special order, I'll assemble instruments and hi-fi gear described in construction articles appearing in popular magazines.



ASSEMBLING A PROJECT. In addition to putting together kits for people in his spare time, Phil can also handle complete hi-fi installations. Here, he is starting to assemble a hi-fi AM tuner.



DELIVERY. Phil presents a kit that he has just finished to one of his local customers. He does much out-of-town work and occasionally takes on an export job.

from Your Electronics Hobby

Q: HOW DO YOU PRICE THOSE JOBS?

A: Generally, where I have to lay out and punch and drill a chassis, my assembly fee is one-third of the net cost of all parts needed. But if the customer wants me to, I work up a special quotation for the job.

Q: LET'S GO BACK A WAY. WHEN DID YOU FIRST BECOME INTERESTED IN ELECTRONICS?

A: I've been casually interested in radio and the mechanical reproduction of music for just about as far back as I can remember. But my active interest in electronics crystallized in the fall of 1949 when I heard a talk on color television given by Lou Garner at a meeting of the Washington Science-Fiction Association. Shortly afterward, I started taking a correspondence course in radio. It took me between two and three years to complete it. During the course, I had assembled a few kits for my own use; so after graduation, I started looking around for some spare-time work in electronics.

Q: WHAT'S YOUR MOST INTERESTING ASSEMBLY JOB?

A: All are interesting to me, but every now and then a really unusual job comes along. One I remember best is a job I had assembling several Heathkits for a chap in Venezuela. I assembled and tested the kits, then shipped him the completed instruments. Although I do a lot of out-of-state work, this was my first "export" job.

And I've met a lot of interesting people in my work . . . I've even quoted on jobs for congressmen.

Q: HOW DO YOU GO ABOUT GETTING YOUR BUSINESS?

A: Mostly by word-of-mouth advertising on local jobs, but I use classified magazine advertisements to obtain out-of-state work. I find that ads in magazines appealing to good music lovers, like *The Saturday Review*, have the greatest "pull" . . . at least as far as hi-fi work is concerned.

Q: WHAT ADVICE WOULD YOU GIVE OTHERS WHO MIGHT LIKE TO TRY A SIMILAR BUSINESS?

A: The most important thing is to develop mechanical proficiency and to become skillful in soldering and other hand work, for almost all of the work is mechanical. It's a good business for those who like to work with their hands. In addition, I believe that anyone considering this type of business should first take a course in radio and television servicing . . . either through correspondence or at a resident school. From a legal viewpoint, before starting in business, the individual should check local laws and regulations to make sure he obtains any necessary licenses. And, finally, after starting, my advice would be . . . do good work and charge fair prices. Always meet your deadlines, and—most important—always stand behind your work.



Sun-Powered Receiver

AN EXPERIMENTAL pocket-sized radio receiver, powered by energy from the sun, weighs only 10 ounces and will work more than eight months in total darkness without recharging. Developed by General Electric, the set uses a miniature storage battery, four transistors, and seven solar cells. During the day, light rays hit the solar cells which convert the sun's energy to electrical current. This current powers the transistors and, at the same time, charges the storage battery which takes over at night. Artificial light, such as an ordinary 100-watt bulb, may be substituted for sunlight.

Electronic Switch Helps Monitor Progress of Surgery

TWO SEPARATE displays instead of one—employing an ordinary cathode-ray oscilloscope—are possible with an inexpensive and compact switch developed recently at the National Heart Institute of the U.S. Public Health Service. Housed in a small box that sits atop the scope, the switch alternates and re-directs the light beam in a single-beam scope so that the screen effectively presents displays of two separate signals. Used in heart surgery, this setup enables doctors to monitor such delicate things as a patient's blood pressure and electrocardiogram simultaneously. Formerly, only expensive double-beam scopes could do this job.



World's Tiniest TV Camera

TELECASTING of programs by means of a TV camera palmed in the operator's hand is forecast as a result of the recent development of a new electronic device in West Germany. As shown in the photo (left), the video pickup is smaller than many microphones. Heart of the instrument is a miniature tube called the 'Mini-Resitron.'

This camera works in pretty much the same way as conventional, larger TV "eyes," converting optical images into electrical signals. Operation depends largely on a sensitive layer of semi-conductor material developed by Prof. I. Walter Heilmann. The inside of the camera is an amazingly compact array of tiny components and intricate wiring. Subminiature tubes and other parts are clustered around the "Mini-Resitron," while a flexible metal hose is wrapped around the cable that leads from the camera.

Still in the experimental stage, the new unit will probably go into production some time later this year.

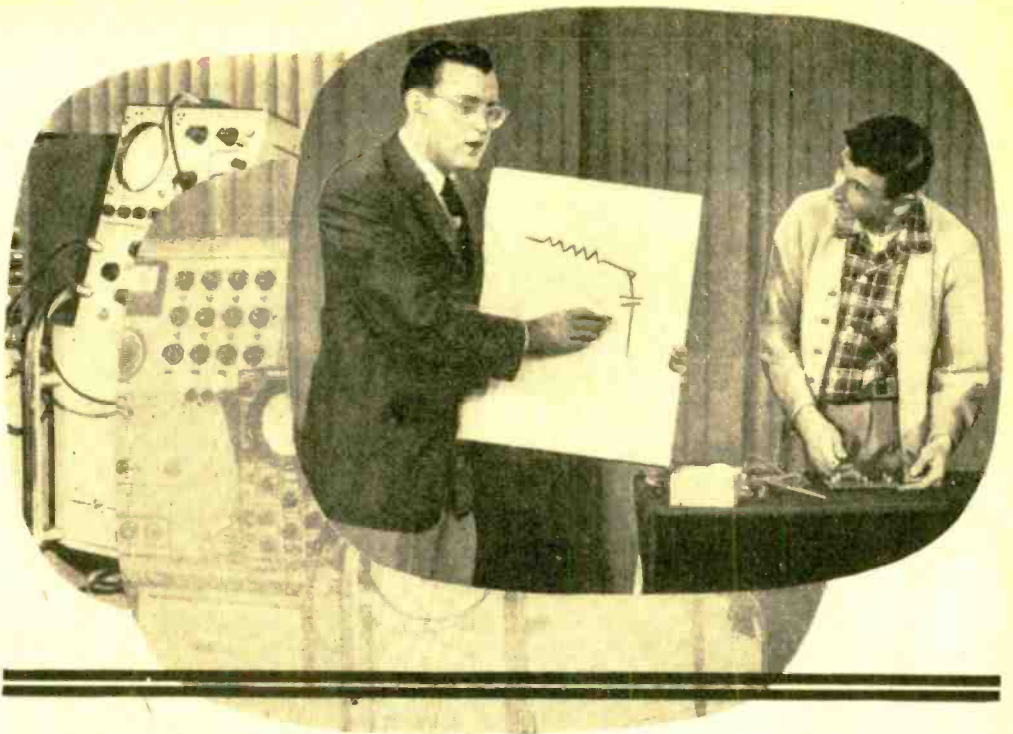

TV Show Features "Wires and Pliers"



Part of each program is devoted to explaining the function of involved electronic apparatus.

THEY'RE trying a new experiment on TV in Los Angeles. Every Saturday, those who want to see popular electronics at work can watch Dr. Martin L. Klein on the "Wires and Pliers" show, Station KCOP. Dr. Klein, a well-known electronics designer, and Harry C. Morgan, another electronics engineer, have found a novel way to interest viewers in the subject. Morgan designed a complete series of simple useful circuits, each one costing less than five dollars to build. With the help of a super-fast electronics technician, Aram Solomonian, they have put together on the program a crystal radio (this took Solomonian five minutes), a transistor amplifier (seven minutes), and an electronic puzzle (eight minutes). What's more, they then prove to the audience that the circuits really work. And the Electronic Engineering Company of California, sponsor of the show, is packaging the circuits in kit form at nominal cost.

-30-



Air Force Uses "Cat Eye"

SAID TO BE about a thousand times more sensitive than the standard television camera is the "Cat Eye" system announced recently by the U.S. Air Force. It permits pilots to "see in the dark with daylight clarity." Development work on the system began almost three years ago at the Physics Branch, Aeronautical Research Laboratory, Wright Air Development Center, Dayton, Ohio. The key tube used in the system is shown in the photo at left. It is being perfected at the Elmira, N.Y., plant of the Westinghouse Electric Corporation.

Battery Is Size of Paper Clip

NOT MUCH LONGER than a small-size paper clip is a new type of silver oxide-zinc battery. It uses a pile-type construction instead of plates. In dry-charged condition, it is capable of shelf storage for months.

The battery is activated by injecting a hypodermic needle into the top of each cell. Designed by the Raleigh, N.C., Engineering Laboratories of the American Machine & Foundry Co., under contract with the Air Research and Development Command, it will power special electronic gear where weight and size are important.

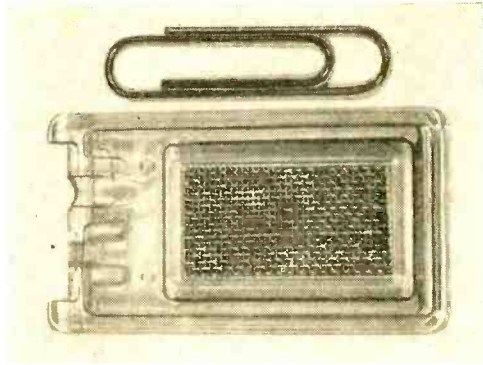

Television Goes to Work on the Railroad

IN THE FIRST permanent installation of its kind in the United States, railroads have introduced closed-circuit television to

lights which provide clear pictures around the clock and in any weather.

Pictures of the cars are flashed to TV receivers (below) in the yard's office, about a mile and a half away. The clerk watches the TV screens and records, by speaking into a tape machine, the initials and numbers of all cars. Before the TV setup, clerks had to go out on foot, stamping around for miles in all kinds of weather, to get the needed information on arriving trains.

Not only is the new system easier on the health of the employees, but it has proven a factor in speeding up freight shipments.



keep accurate tabs on arriving freight cars with maximum efficiency.

At the Potomac Yards in Arlington, Va., terminus of five railroad systems, TV cameras maintain a constant watch over trains arriving from the South. As they roll into the freight yard, cars must pass through a shed in which TV cameras have been installed.

The shed is illuminated by 60 flood-



POPULAR ELECTRONICS

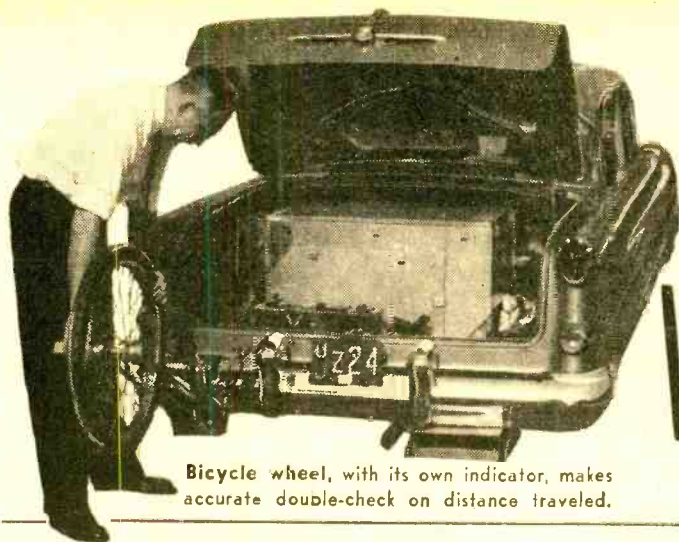

Bicycle wheel, with its own indicator, makes accurate double-check on distance traveled.

Lab on Wheels

Rolling Test Shop Puts Car Facts on Tape

A CAR full of electronic gear is helping Esso Research and Engineering Company to record the life cycle of an auto.

The mobile laboratory shown here is equipped to make simultaneous—and instantaneous—measurements of car and engine speed, torque, rate of acceleration, distance traveled, weather, wind direction, air friction, road angle, tire pressure, and many other variables.

The inside of the Oldsmobile 98 sedan is crammed so full of equipment that there's only enough room left over for a solitary driver. Since he has his hands full without trying to read the constantly bobbing dial indicators, measurements are recorded for him by a high-speed camera. It is claimed that a 15-second film record contains 25,000 pieces of scientific information. A micro-

phone on the sun visor permits the driver to tape-record additional data and his own observations.

Ultimately, Esso hopes to use this fund of information about operating variables to put test cars through their paces on an indoor proving ground. As a first step, the filmed and taped data collected on each run are being transcribed onto a single tape that can be used to "program" an electronic brain.

Future cars, driven by the computer-like brain, would work out on a chassis dynamometer inside the shop. The program tape fed to the electronic brain could simulate thousands of different road and engine conditions. Indoor tests run in exact imitation of these conditions would yield more information in less time.

—30—

Instrumented car was built at Esso's Linden, N. J., research center under the direction of project engineer Oliver G. Lewis, right. Its hundreds of pieces of measuring and recording equipment take as much electricity as is needed to run an average home. The large box that can be seen in the trunk at top conceals a gas-powered generator.





Transistorized Sound Detector

TERMITE NOISES, leaking pipes, and movements of mechanical parts are some of the sounds that can be detected with "Audio-Scope." This pocket-sized transistorized amplifier provides gains up to 85 db. Its three transistors are powered by a single, small dry cell battery said to be good for about 100 hours of normal use. A single calibrated control governs response.

As shown in the photo at the left, the device is being used to locate a leak in a water pipe. Other suggested uses include many industrial applications, such as detecting faulty bearings in a machine.

Sounds picked up by the probe are amplified and heard via the headphones. The entire unit fits into a leather carrying case supplied by the manufacturer. Weight is 15 oz. (*Fisher Research Laboratory, Inc.*, 1961 University Ave., Palo Alto, Calif.).

Pocket-Sized Radio Used in Private Paging System

PRIVATE AND INDIVIDUAL paging of personnel in plants and offices is possible with Motorola's pocket-sized "Handie-Talkie." Weighing only 10 ounces and slightly larger than a package of king-size cigarettes, the set is carried on the person. Its use eliminates the need for public-address type paging and loud call devices such as bells.

A typical paging system, using the "Handie-Talkie," consists of a selector console with individual buttons for key personnel, and an FM transmitter that radiates alerting tones and voice messages within a confined induction loop area. The receiver is powered by a 4-volt mercury battery and is free from the noise interference common to many industrial establishments. Up to several hundred persons can be paged individually. (*Motorola Communications and Electronics, Inc.*, 4501 Augusta Blvd., Chicago 51, Ill.).

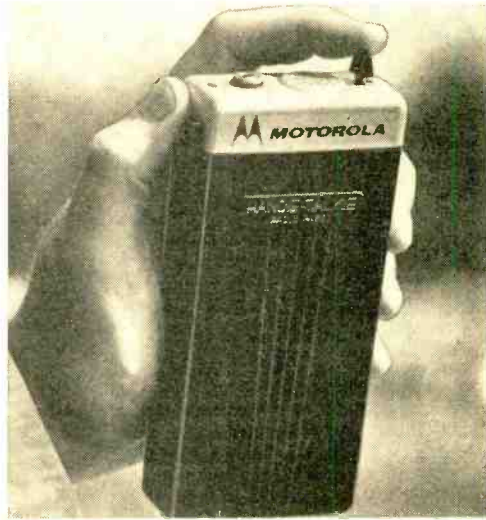

This Radio Talks and Types

RADIOMAN Cpl. Albion D. Parsons, of Hamstead, Md., talks to distant headquarters with the Army Signal Corps' versatile new long-range unit. He can also use the set to send or receive messages at 100 words per minute on a high-speed teletype. The radio can be set up for operation in a matter of minutes. Jointly developed by the Signal Corps Engineering Laboratories, Fort Monmouth, N. J., and Collins Radio Co., Cedar Rapids, Iowa, it talks farther—up to 2000 miles in tests, turns out louder signals, and gets through more often than any comparative rig.

New TV System Turns Night into Day



TELEVISED by the glow of a single cigarette, the picture above demonstrates the light sensitivity of a closed-circuit television that is said to amplify light up to 40,000 times.

The new video system, known as the Lumicon, may vastly expand the vision of doctors, astronomers, industrial inspectors, and researchers in many other fields. Complete camera and monitor outfits are scheduled for production by the Friez Instrument Division, Bendix Aviation Corp.

Since it is primarily a light amplifier, the Lumicon may be used with any type of radiation that can be converted into visible light. In hospital tests, it has been found that the system gives more readable x-ray pictures with lower levels of radiation, so doctors can make extended diagnostic studies without exposing themselves or their patients to overdoses of harmful rays.

In industry, the light-amplifying system could be used to speed x-ray or fluoroscope examination of metal forgings, castings, and other manufactured parts. At airports and customs stations, luggage could be ex-

amined as it moved rapidly along a conveyor belt. The system would spoil camera film carried in the baggage, but it might prevent smuggling or sabotage by revealing bombs, small weapons, or other suspicious cargo.

Because of the Lumicon's ability to see in almost total darkness, it is expected to find wide use as a "night watchman" in stores and manufacturing plants. As many separate cameras as might be needed to scan an area could be switched through a central monitor.

Images on the Lumicon screen can be recorded photographically, and higher light levels will make it possible to reduce exposure time. It's believed this feature will have special value in astronomy and that the Lumicon will effectively increase the power of a 200-inch telescope to the equivalent of a 1200-inch lens.

For increased picture clarity and resolution, the television circuitry built into the Lumicon has a scanning rate of 1029 lines for each picture, instead of the 525 lines of standard broadcast TV. —30—



Amplified light provides clearer, brighter x-ray images, and makes possible fluoroscopic examination in a lighted room (above). At right, Ralph E. Sturm, co-inventor of the Lumicon demonstrates how the device might be used to inspect luggage.



April, 1956

41

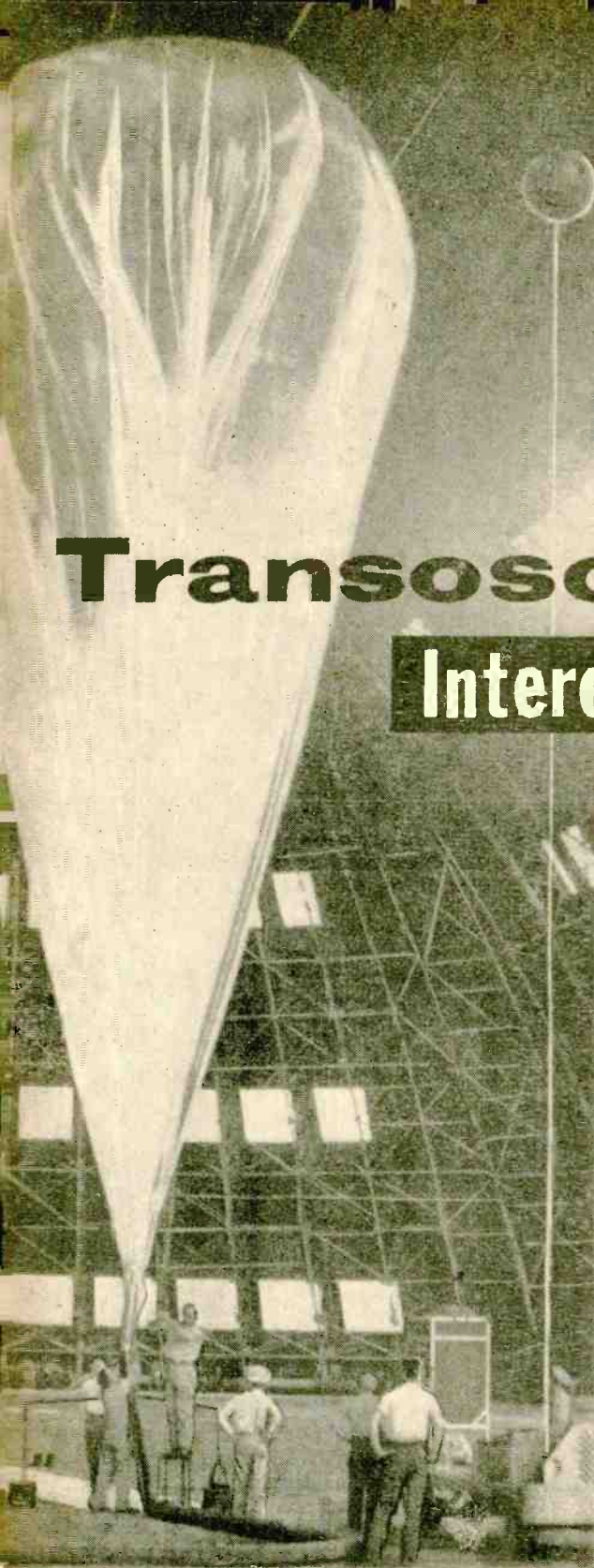

FORECASTING the weather is a precise and sometimes unrewarding task. And its difficulty is increased by the scarcity of weather information from many parts of the world . . . vast, seldom-traveled ocean areas have little or no weather coverage. To get regular reports from such areas, the U.S. Navy has developed a telemetered, high-altitude, drifting weather station.

This new way of obtaining weather information is known as the Transosonde System, a contraction of "trans-ocean

Transosonde

Intercontinental

sounding." Large, free-flight balloons carry mobile transmitters over thousands of miles. Meteorological data is reported regularly, while standard position-finding techniques keep track of the flight path.

The electronic equipment is assembled in a vertical train carried beneath each balloon. Every two hours, transmissions are made which give the weather information and enable direction-finder stations to establish bearings on the balloon. Direction-finding facilities of both the Navy and the FCC are being used.

Initial evaluations indicate that extremely long flights can be made; positions have been tracked as far as 3000 miles from the nearest direction-finder station. The more familiar radiosonde technique also uses small balloons and telemetering, but the reports are essentially local, and flight duration much shorter.

Balloons are preset to remain at a 300-millibar pressure surface, which corresponds roughly to 30,000 feet above

POPULAR ELECTRONICS

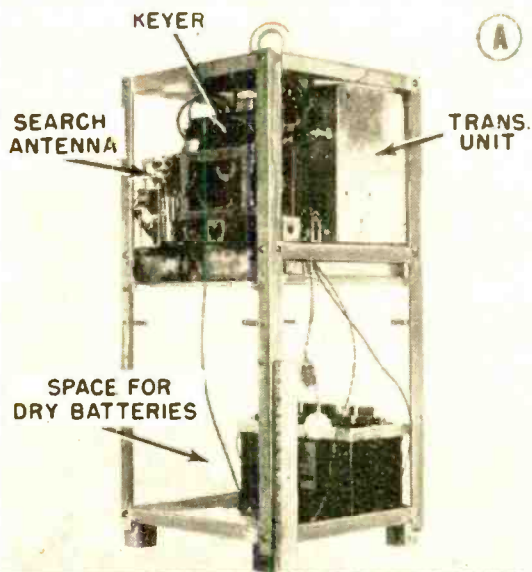

(A)

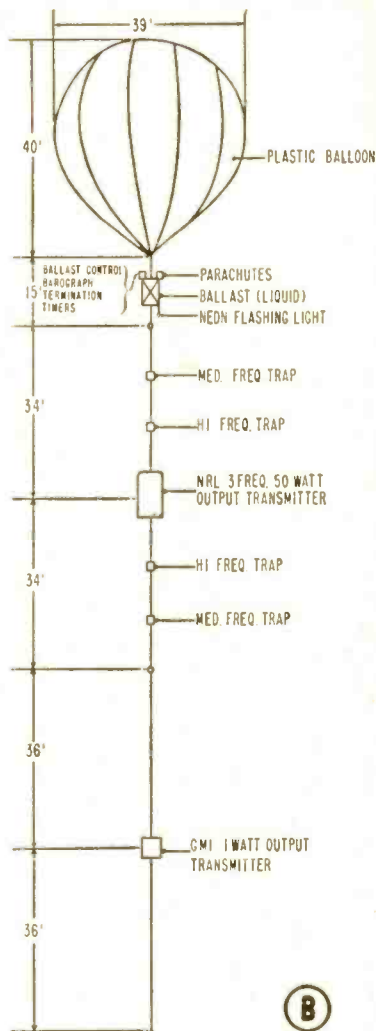

(B)

Weather Balloon

sea level. From position fixes, data can be obtained on the speed and course of the wind, contour spacing, and "troughs" and "ridges" in the atmospheric flow pattern.

The Transosonde System was developed jointly by the Bureau of Aeronautics and the Naval Research Laboratory, and further studies are now being undertaken. While only the weather at home is of much concern to most of us, any improvement that promises better forecasting will certainly be welcome.—*E. D. Morgan*. —50—

(A) The transmitter and power supply for the Transosonde System. Frequencies used are 6420 kc., 12,855 and 19,282 kc. Meteorological reports are transmitted every two hours.

(B) Schematic diagram of a balloon and its train of electronic equipment. The balloons are made by heat-sealing huge polyethylene plastic sections into an inverted tear drop 39' across.

(C) Trajectory of ten balloon flights launched from Minneapolis shows the extent of some of the flight paths. Black dots indicate location of FCC direction-finder stations.

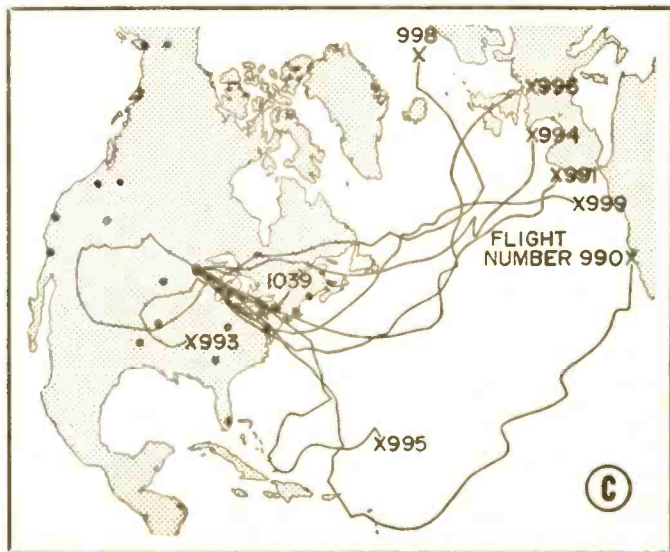

(C)

Electronic Realism in DISNEYLAND

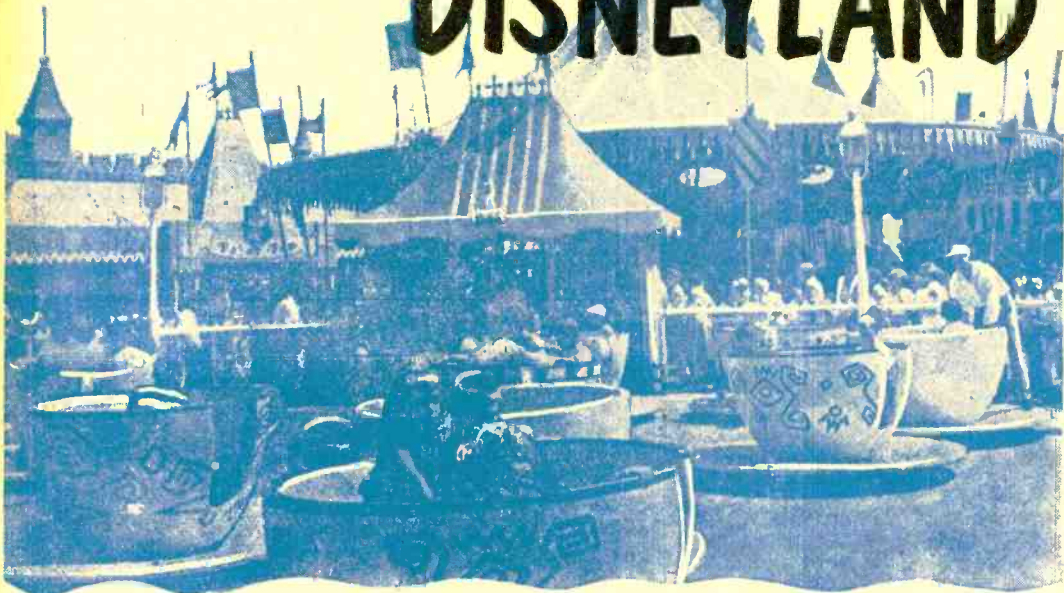

Sound effects liven scenic make-believe at mammoth park

WHETHER you want a rocket trip to the moon or a riverboat ride through the African jungle, you can find it in Disneyland, the super dream-and-play area created by the famous Walt Disney in Anaheim, California.

But more than a land of fun and fantasy, Disneyland has proven to be a vast laboratory and workshop where engineers and technicians have let their imaginations run wild in creating new equipment and startling visual and sound effects.

The sky was the limit in setting up Disneyland, and hundreds of specialists from such companies as Altec Lansing, Ralke, Berger Electric, Graybar Electric, etc., combined their talents to create illusions of sight and sound.

One hundred and sixty acres of flat, sandy ground were transformed into an intricate terrain of make-believe mountains, valleys, rivers, lakes, and forests. Artists, architects, earth-movers, builders, studio technicians, and electronics men teamed up to change a wasteland into the many little worlds that comprise Disneyland. These include: *Adventureland*, *Fantasyland*, *Frontierland*, and *Tomorrowland*.

The sound installation, made by Altec,

simulates the noises of dozens of beasts and birds that inhabit the banks of the jungle rivers. Prerecorded tapes are the storehouse of such sounds.

In the *Adventureland* control room, trumpeting elephants, roaring lions and rhinos, chattering monkeys—as well as the beating of native drums—originate from a bank of tape players. These machines play continuously a tape of any desired sound, repeating it at 10-second intervals. Operating in this manner, the tape machines repeat their messages 4320 times daily.

Finding the sounds to go on these tapes was a job in itself. It required months of searching through the sound track morgues of movie studios, broadcast stations, and universities.

Seventy-four separate loudspeaker systems, each carefully camouflaged beside animals and in the trees, reproduce the sounds. Six miles of cable connect these speakers to power amplifiers.

One difficult problem encountered was how to move the sound of birds that were supposed to be flying from one spot to another. Complete realism was required; the system had to do the job without the customary relay clicking and time delay

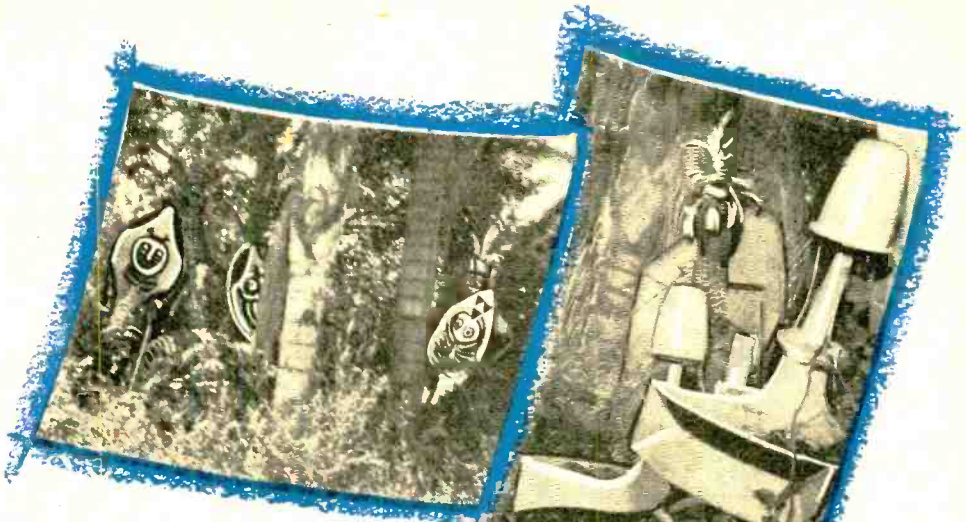

Cruising down jungle river, visitors see and hear warlike savages, drum-beats, wild-animal cries. Close-ups at right reveal behind-the-scenes Altec Lansing speakers, camouflaged to resemble huge mushroom growths in foliage. Carousel (opposite page) uses 10 speakers around canopy for musical rides.

switching. Invented solely for this task was a unique unit dubbed a "rotation audio fader." This device transfers the bird calls from one set of speakers to another so neatly that visitors to *Adventureland* swear they actually see the non-existent birds flying in the dense foliage.

All other sounds in Disneyland blend into their surroundings so well that it is impossible to identify them as being artificially produced. The myriad of voices, music, and background sound is so vital to the operation and success of Disneyland that a full-time sound crew has been hired to stand by constantly to service the equipment.—*John A. Norman.*

—30—

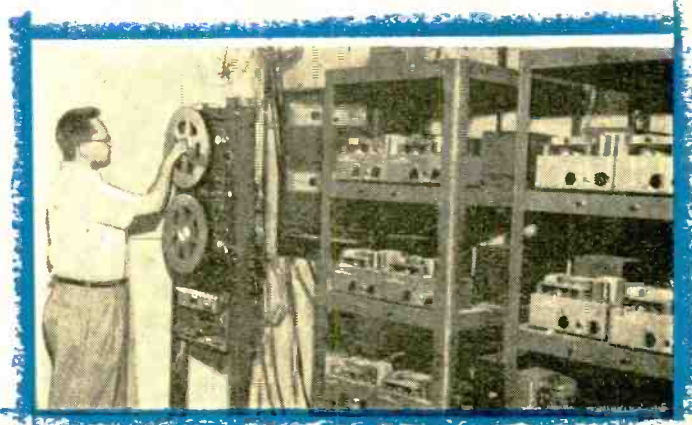

Maze of equipment and wiring is electronic heart of Disneyland. Technician Jim Hervey adjusts tape system that is sound source for all audio effects heard throughout 160 acres of play area.

Solving the JET CRASH

Mystery

Oscillograph Reveals Freak Cause of F-100 Disaster

By
JOHN L. KENT

SHE had checked out beautifully in 47 previous tests. Known simply as No. 764, the new F-100 Super Sabre jet was ready for a routine flight test that morning at the Palmdale, Calif., airport. The weather was bright and clear. Pre-flight inspection showed that the plane was in perfect condition. And as North American Aviation's Chief Test Pilot George Welch settled into the cockpit, he had no way of telling that this flight would be her last—as well as his own.

At 10:58 a.m., Welch radioed that he was ready for the long dive before a pull-up test. At 11:00, he reported his position as directly over the Mojave Desert—the

dive aiming point was to be Rosamond Dry Lake.

That was the last message received from No. 764.

Moments later, North American received a hurried call from the Palmdale tower: two parachutes had opened 20,000 feet above Rosamond Lake . . . it was believed that a mid-air collision had occurred.

Immediately, two planes took off and were circling the parachutes before they touched ground. It was soon apparent that only one plane was involved in the disaster: Welch's "No. 764." One parachute carried the pilot's body; the other was the drag-chute from the jet's tail. The



Aerodynamicists of North American Aviation—Don Beck, Don Parker, and Dick Peticolas—study oscillograph record which eventually solved jet crash.



Using electronic records salvaged from jet plane, NAA engineers recreate its position and probable movements just before crack-up.

F-100 had fallen apart during its power dive. The big question was: "Why?"

Design and flight engineers were flown to make on-the-spot studies. The Air Force sent its investigators. They examined the pattern of pieces found on the ground and made a thorough search to recover every bit of wreckage. The pieces were then taken to North American's plant in Los Angeles for detailed study.

As reports from various engineering groups took shape, it appeared that something very unusual had caused the tragedy. There seemed to have been no malfunctioning of the power plant. Neither were the hydraulic system nor electrical systems at fault. The stabilizer was in its correct position, and the landing gear had been up and locked.

What finally cracked the mystery was a series of almost illegible scrawls found on a battered roll of photo-sensitive paper. Actually, these were light-beam traces made by oscillographs that had been installed in the F-100. Using such sensing devices as vibration and pressure pickups to generate electrical signals, the oscillographs produced a continuous record of critical flight conditions.

Among the items recorded were data on strain, stress, vibration, pressure. Parts of the aircraft that had thus been electronically studied included control stick, rudder pedals, ailerons, etc. The records, though light-struck, were salvaged and made readable by a delicate and painstaking developing operation.

In these oscillograph tracings, the engineers "read" an unexplainable phenomenon. They tried to visualize it in terms of a maneuver that the plane must have

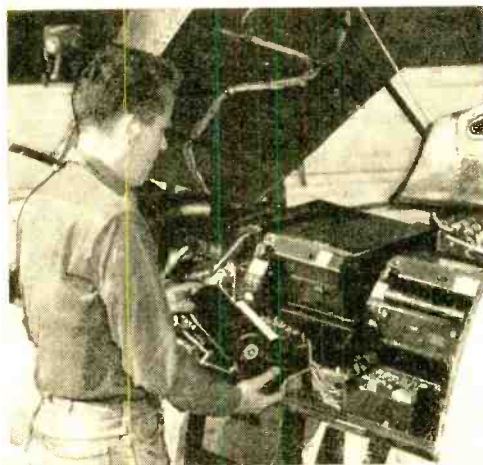

Technician installs loaded film magazine in recording oscillograph. This is the precision-built instrument which provided the clue to the mystery.

April, 1956



An oscillograph revealed flight secrets no human could relate. Bottom view shows beating it took in plane crash. Despite this, its data was accurate.

made to record this information. As they reconstructed the last few seconds shown on the oscillograph records, they got this picture:

The pilot began his dive. In some freak action the nose shot upward and to the right. In a split second, before the pilot had time to get the plane under control, it went into a high, nose-right yaw, and began to disintegrate. (A yaw is a condition in which the airplane rotates around a vertical axis drawn up through the center of its fuselage.)

The exact degree of yaw experienced during Welch's dive is a secret. But North American engineers say it was considerable. The opposing forces resulting from the sudden change of direction, made while the plane was flying at supersonic speed, ripped the plane apart.

No one can measure the true value of a man's life by the yardstick of technical progress. George Welch, like scores of test pilots before him, will remain one of our nation's heroes who gave his life to help perfect a new weapon for our defense. But thanks to electronics, we can understand the cause of the disaster and take precautions to prevent future crackups. -30-

R.F. Energy Powers Incandescent Lamp

Powered by radio-frequency energy, an incandescent lamp developed by Sylvania

is said to be the world's brightest. Its strong, uniform light is especially useful in movie-making. Other uses include color television tube processing, medical research, radar and air traffic control, and computers.

The lamp is not connected by wires to the source of its activating energy. It is heated by induction—the r.f. is carried to the outside of the lamp via a copper coil wrapped around it. A d.c. voltage energizes the oscillator; varying the d.c. controls the brightness of the lamp. In addition, a water line can be connected to the oscillator to cool both lamp and coil. The lamp uses a disc of special material, instead of tungsten filaments, for its light element.



Telephones Will "Ring" With Musical Tones

Telephone users will welcome the news that the Bell Telephone Laboratories is experimenting with a new device that will eliminate the *b-r-r-r-ing* of present-day instruments. The gadget, using transistors, will produce pleasant musical tones resembling those of a clarinet. Sound emanates through the louvred area at the base of the set, shown in the photo with a white background.

This device requires less than 1 volt for operation; the ordinary telephone bell needs about 85 volts. A full-scale field trial of the new equipment is expected to provide enough technical data and customers' reactions to help determine its future.



POP'tronics Checks the Radar That Checks Your Speed



Personnel of Eastern Industries, manufacturer of radar speed meters (center, Paul Green; right, J. Barker), show equipment to POP'tronics Managing Editor O. P. Ferrell. Field trials to check accuracy of speed meters and a visit through the manufacturing plant form background for May issue feature article.

HOW often have you passed a roadside sign that read "Speed Checked By Radar" and wondered: *Does it really work? Are they just trying to scare us? If it's real, can you beat it?*

The May, 1956, issue of POPULAR ELECTRONICS will answer these, and many more, questions regarding radar speed meters. For the first time in any publication, such devices will be treated from a factual viewpoint rather than as "scare" propaganda.

We will tell how they operate and whether or not they can be wrong.

Descriptions of the equipment will be included to enable positive identification.

Various schemes that have been used to bilk the public will be discussed.

No one who drives or owns an automobile can afford to miss this article!

TELEMETERING A HEART BEAT

THE telemetered electrocardiograph—a new version of the conventional instrument so important to heart specialists—enables a patient to go about his normal occupations while he is being examined. A portable set of electrodes, radio transmitter and batteries are carried by the patient, while a receiving system permits medical men to examine the heart's operation and record its performance.

Five miniature tubes make up the transmitter, which is frequency-modulated, has about 1/10-watt output, and can be received a quarter of a mile away. As the patient tends to become accustomed to the equipment, his heart beat is not affected by any emotional reaction to the test. Results may be simultaneously seen on a cathode-ray oscilloscope, heard on a high-fidelity speaker system, and traced on a pen-and-ink recorder.

This unusual version of the electrocardiograph was developed at the Naval Medical Research Institute in Bethesda, Md. A Navy doctor, Captain Norman Barr, has demonstrated its ability to provide additional knowledge on the functioning of the heart.

-30-

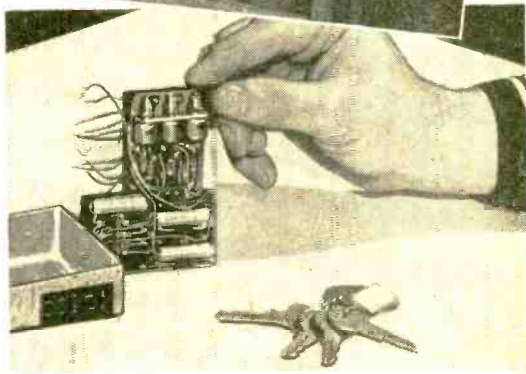

Three electrodes are used, generally two on the chest and one on the back of the patient. Shown directly above is the circuit that amplifies the feeble heart currents picked up by the electrodes. At left, Captain Barr examines the receiving equipment used with the broadcasting electrocardiograph. The large meter shows the heart rate. Signal pulses can be examined in detail on an oscilloscope (not shown in photo). Pen-and-ink recorder is at Captain Barr's right.

Amplify Those

Double Your Prospecting Chances with

By E. G. LOUIS

DO YOU DEPEND on headphones to hear the clicks from your Geiger counter? If so, you have probably suffered from sore ears more than once. And, during your prospecting trips, you have undoubtedly been annoyed because you could not hear certain noises which might be useful to your general welfare (such as the buzz of a rattlesnake!). Or, perhaps your counter is equipped with a meter, and you are forced to watch it continually for indications of increased radioactivity, thus finding yourself stumbling over every root and stone in your path.

You don't need to put up with these petty annoyances any longer. Here is a device

that will solve your problems—a transistor amplifier which will boost the audio output of your Geiger counter until the clicks can be clearly heard over a small loudspeaker. This frees your ears and eyes from a continual strain, and makes uranium prospecting much more pleasurable. Volume is sufficient to permit the clicks to be identified in the presence of extremely high levels of background noise, yet does not mask those "other" sounds so important to anyone prowling around in the great outdoors.

There are minor disadvantages in using this amplifier—you may be slightly inconvenienced by the extra weight and bulk of the unit, and you will have to replace the batteries at infrequent intervals. You may rest assured, however, that the advantages far more than offset the disadvantages. If you don't believe it, try building one and see for yourself!

You don't have to be an experienced builder to make this unit—in fact, it can be the first construction project you ever tackled. Follow the general layout shown in the photographs, and then check your wiring against the schematic. It is well to double-check your wiring before turning on the switch, because the wrong battery polarity can ruin all three transistors.

The author used printed circuit techniques in building the amplifier shown in the photos, but don't let this scare you. With the aid of a kit, such as the Techniques etched circuit kit, the procedure is greatly simplified. Furthermore, if you don't want to employ this method, you can still use conventional wiring without making any changes in the general layout. Merely choose a piece of Bakelite or phe-

In operation, amplifier is fastened to your belt by means of two metal straps on the rear of the enclosure.



Geiger Clicks

Greater Geiger Counter Sensitivity

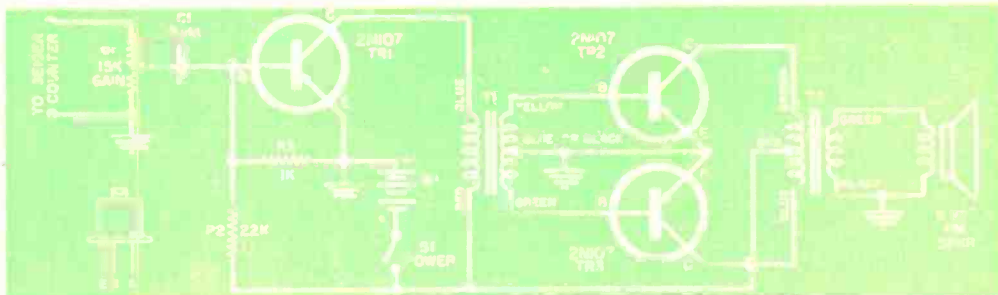

Schematic diagram and parts list for the transistor amplifier. Transistor terminals for the type 2N107 are shown in the lower left-hand corner.

- B1—Four mercury cells in series (Mallory RM-1R)
- C1—0.5- μ d., 200-volt capacitor
- R1—15,000-ohm subminiature carbon potentiometer (Lafayette No. VC-35)
- R2—22,000-ohm, $\frac{1}{2}$ -watt resistor
- R3—1000-ohm, $\frac{1}{2}$ -watt resistor
- S1—S.p.s.t. slide switch
- T1—Transistor driver transformer, 10,000 ohms to 2000 ohms center-tapped (Argonne No. AR-109)
- T2—Transistor output transformer, 500 ohms center-tapped to 3.2 ohms (Argonne No. AR-119)
- TR1, TR2, TR3—Junction transistor, p-n-p (G.E. 2N107)
- I—Miniature PM speaker, 3.2-ohm voice coil (Lafayette No. SK-9 or equivalent)
- 1—Etched circuit board, made with Techniques kit (available from Techniques, Inc., 135 Belmont St., Englewood, N. J.)
- 1—Aluminum chassis, $3\frac{1}{4}$ " x $3\frac{1}{2}$ " x 2" (cut down from ICA No. 29077 or equivalent)
- 1—Back cover, from Reynolds do-it-yourself sheet aluminum (see text)
- 1—Battery assembly made from $\frac{5}{8}$ "-I.D. x $2\frac{3}{8}$ "-long piece of plastic tubing, plus straps (see text and photo below)
- 2—Phone tip jacks
- 1—3' length of twin-conductor lamp cord
- Misc. machine screws, grommets, wire, solder, brackets, etc.

Photo shows in detail how battery holder is made. The author used scrap aluminum for the straps. Battery drain is about 5 ma., and normal battery life should be around 200 hours.

FRONT STRAP HELD WITH SCOTCH TAPE

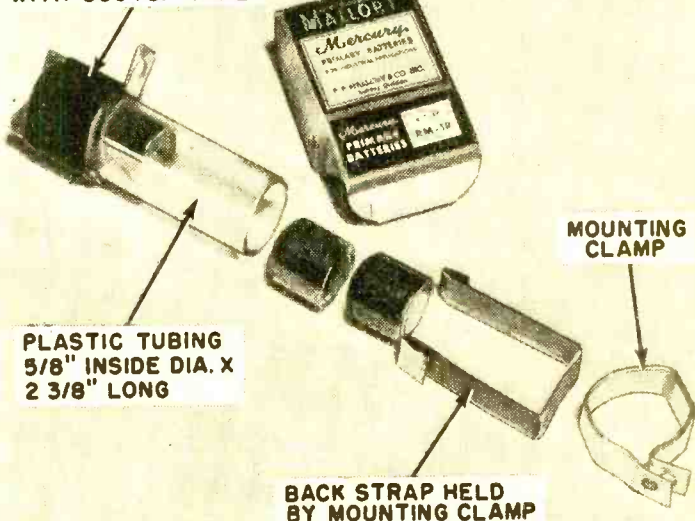

PLASTIC TUBING
5/8" INSIDE DIA. X
2 3/8" LONG

MOUNTING CLAMP

BACK STRAP HELD BY MOUNTING CLAMP

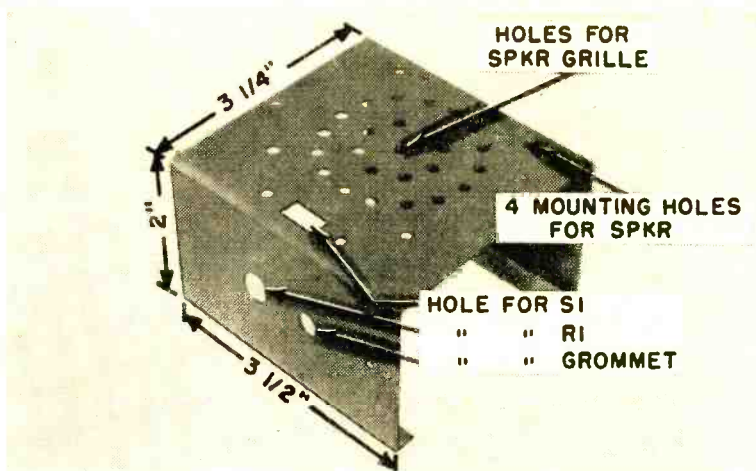

Enclosure is cut down from standard aluminum chassis. Exact hole sizes and spacings must be determined from the specific components which you use in building this unit.

nolic for the mounting board, and follow the schematic diagram when wiring the components.

The photo of the printed-wiring board shows the required dimensions and the circuit layout. Follow the instructions received with your kit in preparing the panel. But be careful when you solder the transistors into the circuit. Use a hot, well-tinned iron, and solder as rapidly as possible. Leave short leads for connecting the board to the switch *S1*, gain control *R1*, ground, and the loudspeaker.

Mount the two transformers with glue, cement, or small metal brackets, or tie

them in place with hookup wire. Fasten the chassis mounting brackets to the panel with small eyelets or machine screws.

You can use your ingenuity in arranging the battery mounting—the photo on page 51 shows one way of doing it. Just remember that the batteries *do* have to be replaced once in a while, so don't make it too difficult for yourself! Of course, you could use four penlite cells in place of the mercury cells (if you had room!) but they wouldn't last as long.

All parts—amplifier, battery, power switch, volume control, and loudspeaker—are mounted on the cabinet, which is made from a standard aluminum chassis cut to a length of 3½". Use lock washers under all machine screws and nuts. You can form a back cover from a piece of Reynolds do-it-yourself aluminum, or you may have a scrap piece of aluminum lying around. Two belt straps are fastened securely to this cover.

The signal is fed to the amplifier from your Geiger counter by means of a suitable length of ordinary lamp cord—two or three feet should be adequate. Use terminals to fit your particular counter.

Now you are ready to try out the amplifier. Connect it to your counter by means of the lamp cord, turn on the switch, and turn up the gain control. You should hear clicks on the loudspeaker. Adjust the gain control to the point where you get maximum volume, then back it off very slightly. Beyond this, overloading takes place.

You may be somewhat disappointed at the audio volume obtainable. The clicks are essentially sharp peaks, and contain very little energy. Therefore, the volume will be low unless the clicks are coming in at a fairly rapid rate. And that's when you really want high volume, as a high clicking rate indicates a probable strike! —30—

HOW IT WORKS

Basically, this unit is simply a two-stage transistorized audio amplifier, with the second stage consisting of two transistors in push-pull. The "grounded emitter" configuration is employed, and power for both stages is provided by a single battery.

The audio signal from the Geiger counter is fed to the gain control potentiometer *R1*. Here, a portion of the signal is tapped off and fed through capacitor *C1* to the base of transistor *TR1*. *C1* serves to isolate *TR1* from any d.c. which might come from the counter, and also prevents the base of *TR1* from being grounded when the gain control is in its minimum volume position. Resistors *R2* and *R3* constitute a voltage divider to provide the proper bias for *TR1*.

Transformer *T1* serves a dual purpose. First, it converts the single-ended input signal to a push-pull signal for driving the output stage. Secondly, it matches the relatively high output impedance of *TR1* to the lower input impedance of the *TR2-TR3* combination, thus insuring maximum energy transfer.

The purpose of the output stage *TR2-TR3* is to provide power to drive the loudspeaker. *T2* matches the output of this stage to the voice coil impedance, again to insure maximum energy transfer. Operation of the output stage is class "B," without bias, for best battery economy. Battery drain is very low under "no signal" conditions. Distortion will be quite high, but this is not a disadvantage in the present application. However, the amplifier should not be used for high-quality audio reproduction.

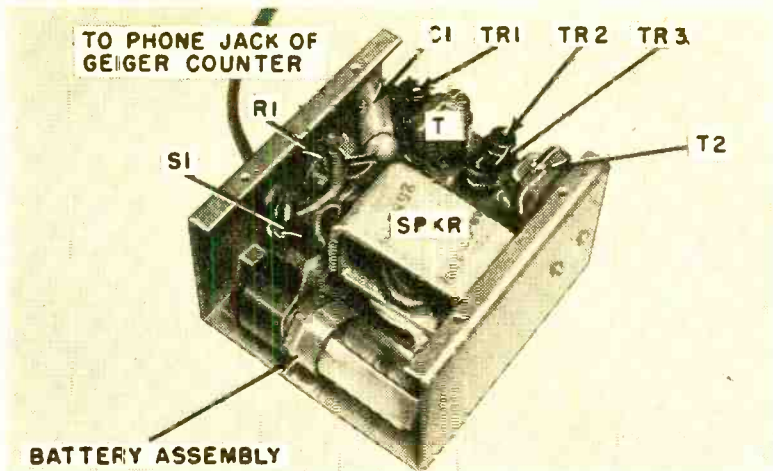

Although assembly is very compact, all components can be easily mounted with a little care. A larger chassis would simplify wiring without affecting performance adversely.

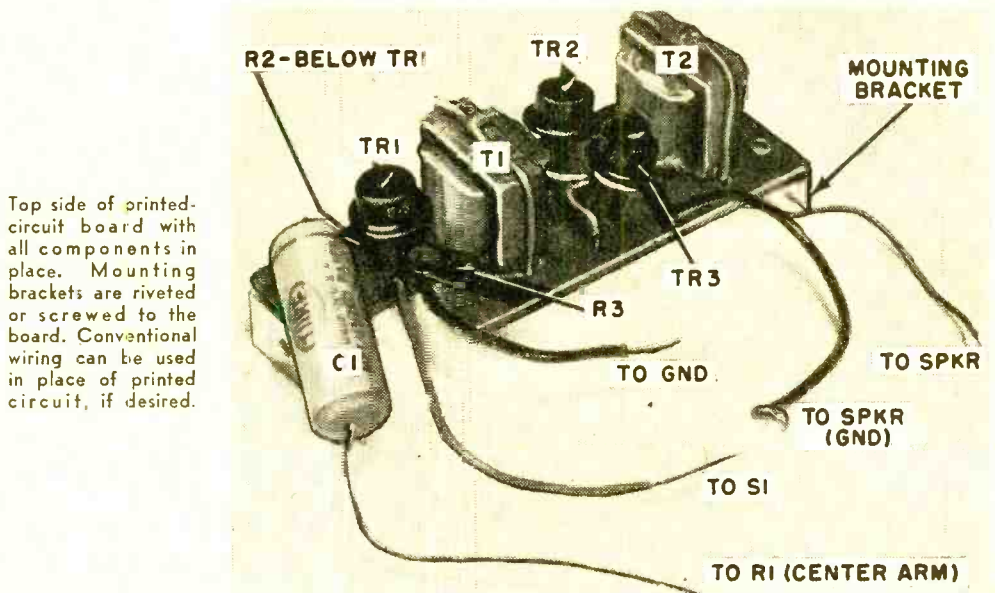

Top side of printed-circuit board with all components in place. Mounting brackets are riveted or screwed to the board. Conventional wiring can be used in place of printed circuit, if desired.

Dimensions and layout of the printed circuit can be obtained from this photo, or you can devise your own layout.

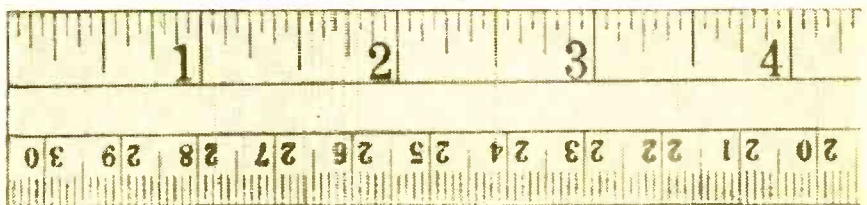
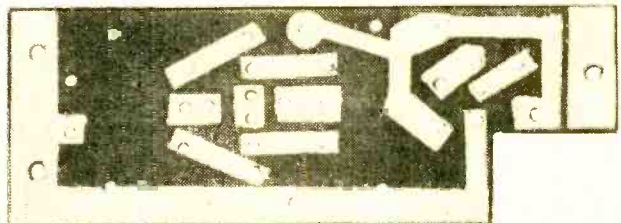

FIVE NEW JOBS FOR TWO TRANSISTORS

You'll find many practical
uses for these simple,
low-cost circuits

PART II

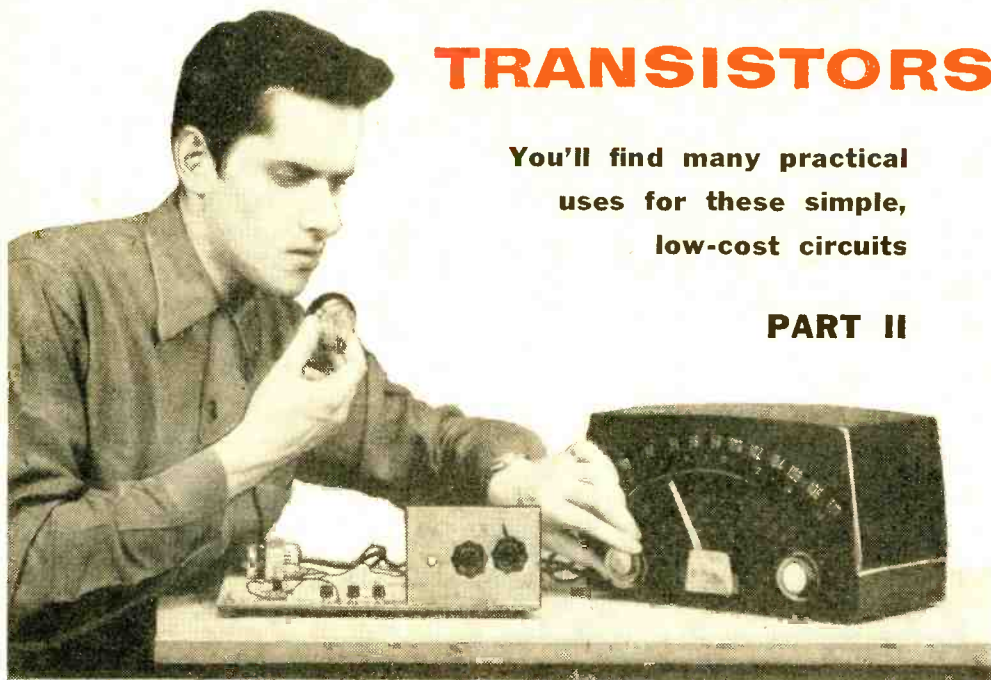

By Louis E. Garner, Jr.

TRANSISTORS were born with a couple of important advantages that vacuum tubes never enjoyed. They're tiny and they draw very little current—you can use two, three, or a dozen with a very modest power supply.

Each of the five projects described last month was built around a single transistor. Most of the circuits on the following pages employ a second transistor and a few additional parts. The small increase in bulk and cost makes possible a great increase in the range, the power, and the variety of new devices you can build. As before, these breadboard units are designed for knock-down construction.

Transistors—p and n. A junction transistor is a sort of sandwich made up of three layers of semiconductor material (a material which is neither a good conductor nor a good insulator) such as germanium. The center of the sandwich, known as the *base*, is flanked on one side by the *collector* and on the other by the *emitter*. The two types of junction transistors available to hobbyists can be distinguished by the way the layers are arranged.

In an *n-p-n* transistor (such as the 2N35 used in the first group of projects), the base or central layer is a *p*-type semiconductor and the outer layers are both *n*-type material. The *p-n-p* transistor (like the Raytheon CK722 added to these circuits) is exactly opposite—its *n* base is flanked by two *p*-type layers.

As you've probably guessed, the letters *p* and *n* stand for positive and negative. In a *p*-type semiconductor, one or more electrons are missing from the crystal structure; each missing electron leaves a positive charge that is known as a "hole." In the *n*-type semiconductor there is a surplus of electrons which are free to move, or "diffuse," through the material.

Aside from polarity, the two types of transistors are very much alike and can be used in similar circuits. In general, *n-p-n* units have somewhat better high-frequency response.

From a construction point of view, the main difference between these two kinds of junction transistors is that they need opposite d.c. voltages on their electrodes. As you'll see in the projects that follow, this fact can actually simplify coupling circuits, when *n-p-n* and *p-n-p* transistors are used in combination.

1 WIRELESS MICROPHONE

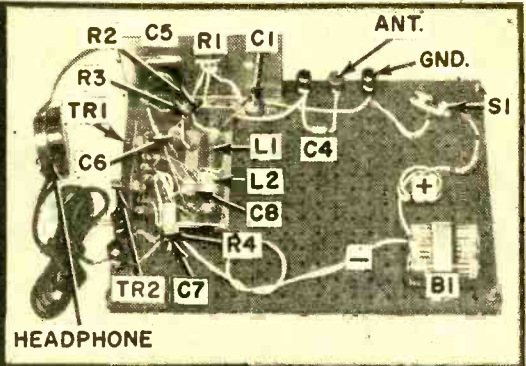
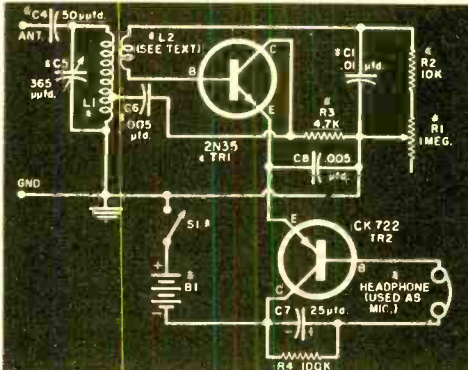

● Good party fun and serious electronics experimenting have a happy meeting ground in this wireless mike. For with the low-powered voice transmitter, you can surprise or amuse your friends by broadcasting home-grown announcements through any AM receiver in the house. The headphone, generally used for listening, doubles here as an inexpensive microphone.

The circuit requires a feedback winding ($L2$) in addition to the store-bought parts; make this coil by winding 10 to 15 turns of ordinary hookup wire around the center of antenna coil $L1$.

The *n-p-n* transistor, $TR1$, serves here as an r.f. oscillator, and its frequency is determined by the tuned circuit made up of $L1$ and variable capacitor $C5$. "Tickler" winding $L2$ provides the feedback needed to start and sustain oscillation. Base bias current—governing amount of feedback—can be regulated by potentiometer $R1$.

The *p-n-p* transistor, $TR2$, acts as both audio amplifier and modulator. Since the two transistors are effectively in series across the d.c. power supply, the same

emitter current flows through both units. Normally, current variations in one would appear in the other. Bypass capacitor $C8$, however, grounds r.f. variations in the common emitter. It thus keeps r.f. out of the audio stage while permitting the signal developed in $TR2$ to modulate the r.f. in $TR1$. This arrangement eliminates the need for a modulation transformer.

To use the wireless mike, connect it to a good ground and run an antenna lead to within a few feet of a standard receiver. Tune the receiver to a dead spot near the middle or lower end of the dial. Set $R1$ at nearly maximum resistance. Then gradually tune $C5$ and listen for either a live background hiss or a motorboating "putt-putt" sound. If you get no signal, reverse the connections to $L2$ and try again.

If the set "putt-putts," back off $R1$ until the sound just disappears. Then recheck the tuning of the receiver, and you should be ready to go on the air.

Use the headphone as a mike. It's not tremendously efficient, however, so hold it close to your mouth and talk up. ●

• LIST OF PARTS •

- *B1—9-volt battery (6 series-connected penlite cells)
- B2, B3—Penlite cells (divided into 7.5- and 1.5-volt batteries; see Project 2, "Photocell Relays")
- *C1, *C2—0.01- μ f. capacitor
- *C3—0.1- μ f., 200-volt paper capacitor
- *C4—50- μ f. capacitor
- *C5—365- μ f. miniature variable capacitor (Lafayette MS-215)
- *C6—0.005 μ f. capacitor
- C7—25- μ f., 25-volt electrolytic capacitor
- C8—0.005 μ f. capacitor
- C9—0.25- μ f., 200-volt paper capacitor

- *CRI—IN34A germanium diode
- *L1—Transistor antenna coil (Lafayette No. MS-166)
- *L2—Feedback winding (10-15 turns hookup wire; see Project 1, "Wireless Microphone")
- *R1—1-megohm potentiometer, linear taper
- *R2—10,000-ohm, 1/2-watt resistor
- *R3—4700-ohm, 1/2-watt resistor
- R4—100,000-ohm, 1/2-watt resistor
- R5—100-ohm, 1/2-watt resistor
- RL1—S.p.d.t. relay, 4000-ohm coil (Advance No. 50/1C/4000D or equivalent.)
- *S1—S.p.s.t. slide switch
- *SPI—Selenium photocell or "Sun

- Battery" (International Rectifier Corp. Type B2M)
- *TR1—Junction transistor, *n-p-n* (Sylvania Type 2N35)
- TR2—Junction transistor, *p-n-p* (Raytheon Type CK722)
- *1—1000-ohm magnetic headphone
- *1—8" x 12" perforated Masonite
- 2—5-pin subminiature tube sockets
- 1—Sensor plate (see Project 3, "Rain Alarm")
- 1—Flashlight lens
- 1—Piece of cardboard tubing
- Misc. solder, binding posts, rubber feet, knobs, machine screws

*Asterisks in parts list and diagrams indicate components used in Part I of this series.

MORE TRANSISTOR PROJECTS →

WIRING HINTS

- Make a breadboard wiring assembly for each transistor by mounting a 5-pin subminiature tube socket and a 3-lug terminal strip on an L-shaped strip of scrap aluminum. Wire the lugs to the first, third, and fifth socket pins. Make all circuit connections to the lugs.

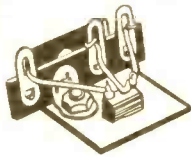

- Trim transistor leads to $\frac{1}{4}$ " to fit the sockets. Leave the pigtails of other components full length so you can wire—and rewire—them in different circuits.

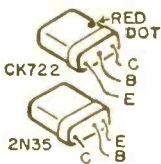

- Pay special attention to the wiring of the two transistors. Socket connections can be identified by lead spacing on the 2N35 and a red dot on the CK722.

- Always install transistors last—after double-checking the wiring. Don't switch on the power until you're sure the right transistor is in the right socket.

- Each time you wire the 1N34 diode (CR1), grip the lead with a pair of long-nose pliers to carry off the heat of the soldering iron.



- Use simple lap joints when soldering leads.

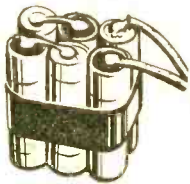

- Make up a 9-volt power supply (B1) by wiring six penlite cells in series. Batteries B2 and B3 (in the photocell relay on the opposite page) are made by using one cell separately and five in series.

2 PHOTOCELL

- Would you like your porch lamp to blink on automatically when the sun goes down? It's no trick to use light—or the absence of it—to flip a switch.

A selenium photocell—used in the sun-powered receiver last month as a power source—does a little switch of its own in these layouts and becomes a signal source. Actually, of course, the sun battery continues to do exactly what it did before: it generates current when it is exposed to light. After it's amplified, the current triggers a relay.

Two photocell units are shown here. Under strong light conditions, the one-transistor amplifier is all you need. However, the two-stage circuit will give better results over a wider range of applications.

Adjustment screws on the relay switch allow you to vary both spring tension and the spacing of the contacts. In general, lowering spring tension and narrowing the gap between armature and pole pieces make the relay responsive to smaller signal impulses. It is worth noting, however, that relay adjustment can be very tricky. If you haven't worked with these switching devices before, you will probably find it best to go along with the "factory adjustment" of the spring and gaps.

Under "no-light" conditions (with either of these circuits), there is very little base current flow in TR1. The emitter-collector circuit of the transistor therefore has a high resistance and current in the coil isn't enough to operate the relay.

However, when light strikes the selenium cell, current in the base-emitter circuit increases and is amplified by the transistor so it can close the relay.

Any interruption of the light source restores the circuit to a *no-current* condition and lets the relay drop open. Resistor R5 and capacitor C7 are connected across the

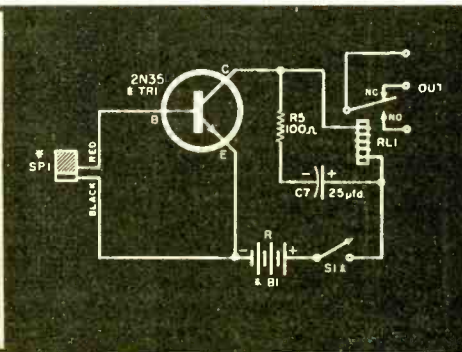
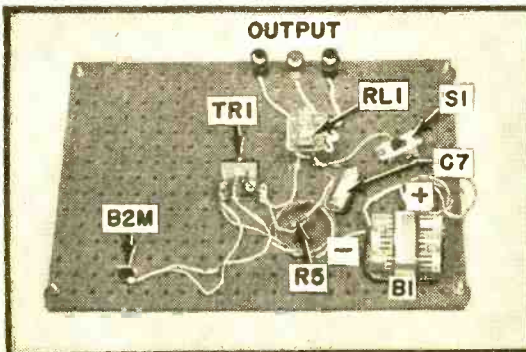

RELAYS

relay's coil to absorb any inductive "kicks" that may develop because of sudden changes in coil current.

Because of its greater sensitivity, the two-stage layout can be used where it is necessary to focus on a single source of light. Thus, if you want sunlight to switch some appliance, you can shield the photocell from surrounding glare that might give a false signal. Use a cardboard tube for a shield. Mount it over the cell and point its open end at the "control" light.

To allow for a wide range of operating adjustments, a potentiometer is included in the two-stage circuit and the 9-volt battery pack is tapped to provide a 7½-volt (5-cell) "E" supply and a 1½-volt (1-cell) bias voltage. To set up the switching mechanism, close battery switch *S1* and focus the control light on the photocell. You should be able to set the potentiometer to an almost hairline balance that will close the relay as soon as light strikes the cell and open it when the beam is broken.

You can also "tune" *R1* to a less sensitive spot. With the right adjustment, the unit should operate as if it were a "latched" switch. That is, once the contacts are closed, they will stay closed even if the light beam is broken. Or conversely, the relay will open when the light goes off and stay open after it comes on again.

To control a lamp, snip one conductor in the power cord and wire the cut ends across the relay's output terminals. Plug the altered appliance cord into a 117-volt outlet as usual.

If you want the controlled device to turn on when *no* light strikes the photocell, connect the lamp cord in series with the "normally closed" contacts. For a directly opposite switching service—that is, if you want a lamp to *turn off* when light reaches the photocell—use the "NO" pair.

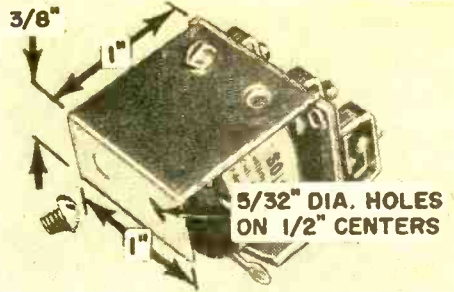

Make a bracket for the relay from scrap metal. Space mounting holes to match your relay and leave top screws accessible for adjustment.

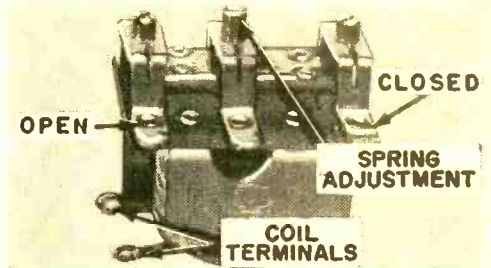

Screw adjustments vary the relay's sensitivity. Center screw alters spring tension; outer ones change gaps on "open" and "closed" contacts.

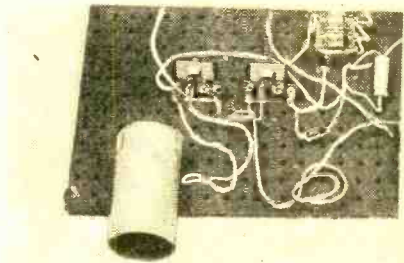

Light-shield tube can be 3" to 12" long. Paint the inside flat black. For maximum sensitivity, insert a flashlight lens in tube to concentrate rays.

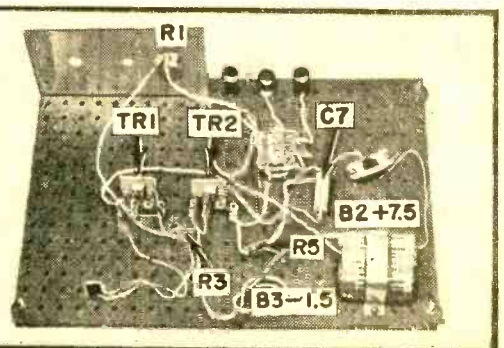
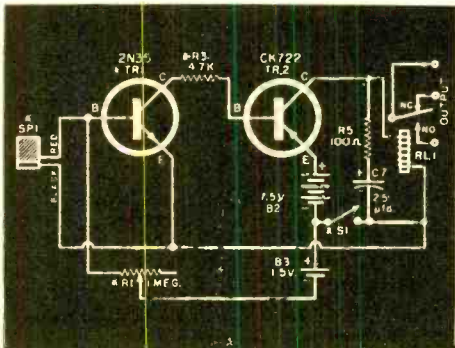

3 MORE TRANSISTOR PROJECTS

3 RAIN ALARM

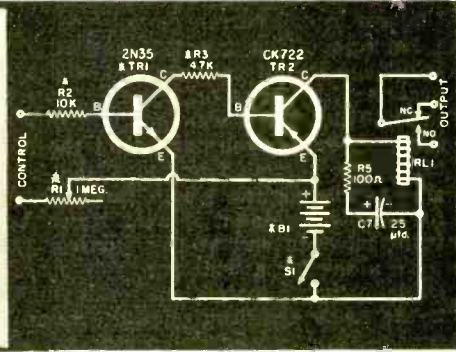
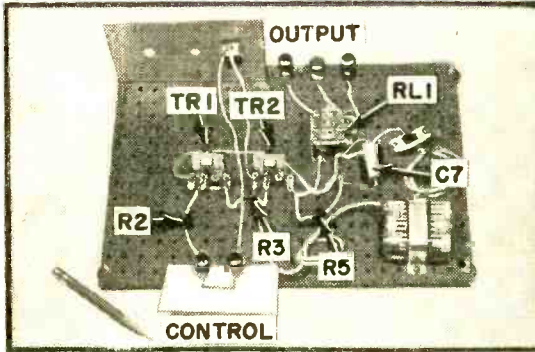

● It's no fun getting up in the middle of the night to close windows, but it's a lot less fun when you have to mop the floors in the morning because you slept through a rainstorm the night before.

You don't have to be caught with your windows up, however, if you provide yourself with an electronic rain watcher. This one will flash a warning when moisture short-circuits its "sensor" plate.

The transistorized relay circuit, similar to that of the two-stage photocell layout on the preceding page, has a rain-sensitive

signal source in place of the light-sensitive source.

You can make a suitable rain "sensor" in several ways. The basic plate consists of two exposed, narrowly separated conducting elements on an insulating board. A drop of moisture that bridges the gap between the conductors completes the circuit and causes the relay to snap closed.

One way to make the moisture detector is to start with a sheet of copper-clad plastic of the kind used for printed circuits. With an etching compound made for this pur-

4 HIGH-GAIN RECEIVER

● If you built the simple battery-powered receiver described last month, you need only make a few additions to complete this de luxe version. To the earlier model it adds a direct-coupled stage of audio amplification for greatly increased station pickup, sound power and clarity.

Since the receiver isn't regenerative, it

doesn't need the tickler winding ($L2$ of the "Wireless Microphone" project). However, if you have added these extra turns of wire, just leave its two leads unconnected.

The most interesting feature of this circuit is the direct coupling between the collector of the $n-p-n$ transistor ($TR1$) and the base of the $p-p-p$ unit ($TR2$). This

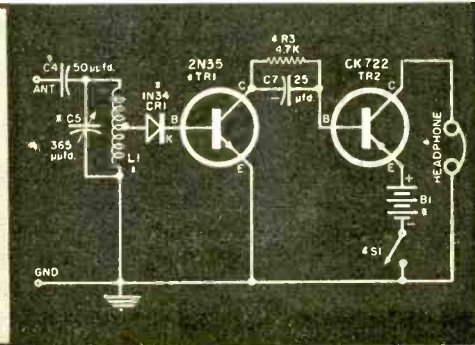
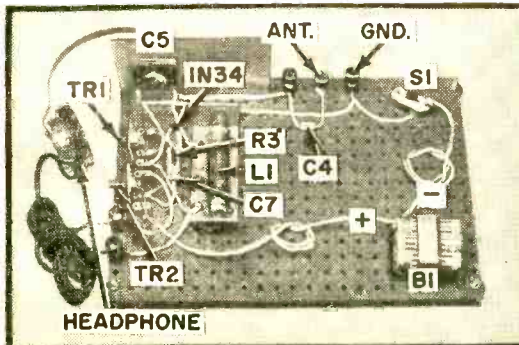

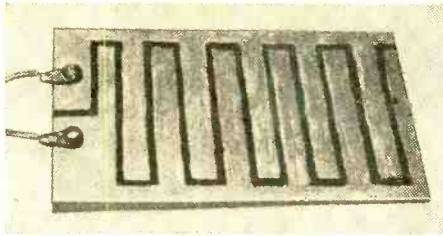

Rain "sensor" can be made by etching copper-clad plastic as above, or by painting or cementing conductive strips on a non-conductor.

pose, you can cut a narrow insulating canal through the metal face.

Or you can turn the procedure upside down and "print" conducting lines on a base of non-conductive plastic. Use a silver paint (such as General Cement's No. 21-1) or cut strips of aluminum foil and cement them to the base. Leave a narrow insulating gap between the conductors and lay them out in a winding pattern to increase the total area of exposure.

Wire the leads from the "sensor" plate to the terminals marked "control." For the alarm, connect a lamp, bell, or buzzer to the "normally open" relay contacts. The alarm itself, of course, must be plugged in to a suitable power source.

simple hookup is made possible by the opposite d.c. characteristics of the two types of transistors. As far as operation is concerned, in fact, you could omit the coupling network consisting of R_3 and C_7 and wire the collector of TR_1 directly to the base of TR_2 . Resistor R_3 is used for safety only; it serves to limit the current on the electrodes which might otherwise run too high under some conditions. When it is included, bypass capacitor C_7 is also needed to minimize the effect of the resistor on the signal level.

Broadcast signals picked up by a good antenna-ground system are coupled through C_4 to the tuned circuit. Variable capacitor C_5 selects the desired signal and the low-impedance tap on L_1 transfers it to the base of TR_1 .

The germanium diode detector (CR_1) and the base-emitter circuit of the first transistor separate the audio signal from the r.f. The sound is amplified by TR_1 and is fed through capacitor C_7 to the input of TR_2 . In this audio-amplifier stage, the signal is given a further boost and is then routed to the headphone.

5 METRONOME

Music students—and even advanced performers—can make good use of this electronic timekeeper. Its tempo beat, heard through a single headphone, is clearly separated from distracting outside sounds.

Essentially, the metronome is an oscillator circuit similar to one you might use for practicing code. The frequency of the metronome's "beat rate" is determined by the feedback capacity and the total resistance in the return path of TR_1 . To bring the operating frequency well below that of a code oscillator, two feedback capacitors— C_3 and C_9 —are wired in parallel.

Potentiometer R_1 can be used to tune the metronome; its series resistor, R_4 , is included merely to limit the frequency-adjustment range. If R_4 were omitted (or rather replaced by a direct-wire connection), tuning might be slightly more critical. Otherwise there should be no difference under normal operating conditions.

Resistor R_3 , between the collector of the first transistor and the base of the second, plays a similar role. It could also be replaced by a direct-wire lead. But while it does not affect operation, it does protect the transistors against excess current.

If you can't get the metronome to pulse out the beat rate you want by adjusting potentiometer R_1 , experiment with slightly different values for fixed-resistor R_4 and feedback capacitors C_3 and C_9 .

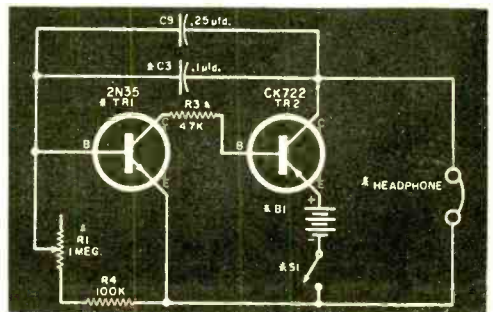
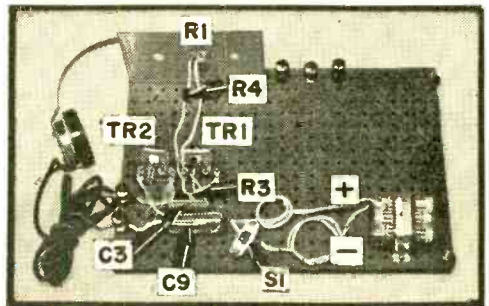

Review Your Soldering

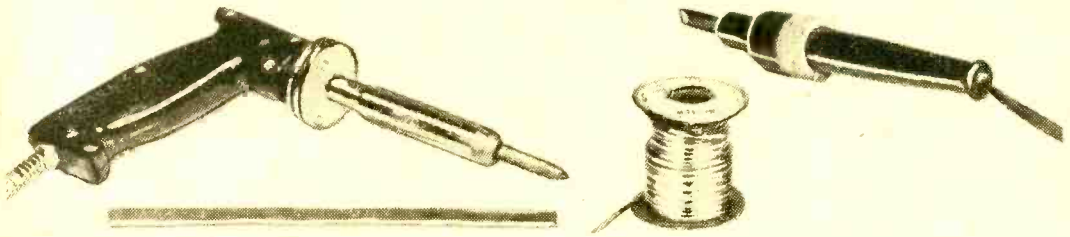

SOLDERING techniques were originated, believe it or not, by artisans of the early Middle Ages. When you solder two pieces of metal together, you're doing something that the great Italian artist, Benvenuto Cellini, did long before you.

Today, in radio and TV repair shops, in electronic laboratories and home workshops, electric soldering irons or soldering guns are a "must." They're highly efficient, and many of them were especially designed for special jobs.

The modern electric soldering gun, or soldering iron, is really a multiple-use tool, and as such has a place in every electronics craftsman's kit along with the other simple necessities of soldering: steel wool pads to clean the work, fluxes, bar and ribbon solders, and coils of resin and acid flux-cored wire solder.

Flux. Soldering "flux" is a substance that facilitates "wetting" of a metal by molten solder. The function of the flux is to remove oxidized surface film (likely as not to be totally invisible) in order that metallic contact may be established, and so that the solder may penetrate the pores of metal pieces to assure a bond.

The flux itself doesn't react with the

metals being soldered or become part of the joint. Although its action is strictly a surface cleansing phenomenon, the flux plays a vital part in the preparation of the work. It is important to remember, too, that the flux copes only with oxides; it does not remove paint, sulfides, dirt, or other matter adhering to metal surfaces. Steel wool is used to clean flat surfaces, and a knife blade scrapes wires to bright cleanliness.

Another term we all know is "tinning." This is the process of applying a light coating of bright solder to the hot copper tip of the soldering iron or gun. "Tinning the tip" is done to insure quickest possible transfer of heat from tool to work. Cleaning the work, using the proper flux, and keeping the soldering tool tip tinned and bright, combined with an adequate and quick source of heat, are the "secrets" of professional-looking, efficient solder joints.

Solder. Three forms of solder are available—bar, ribbon and wire. Most popular is the hollow wire type, the core of which is filled with either acid or resin flux. Acid flux is corrosive; the residue must be washed away after the joint is completed. Resin flux is non-corrosive, and

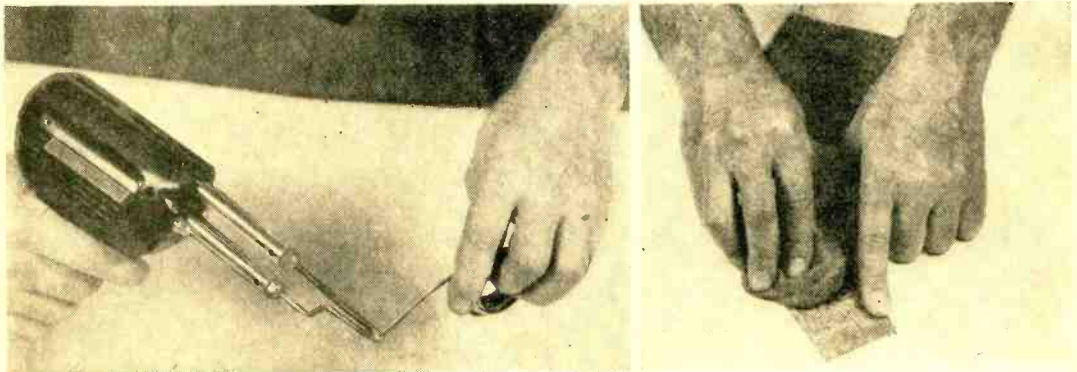

Tinning the tip of the soldering gun insures quickest possible transfer of heat from tool to work. Steel wool may be used to clean flat surfaces of metal; proper soldering flux removes oxidized surface film.

Habits

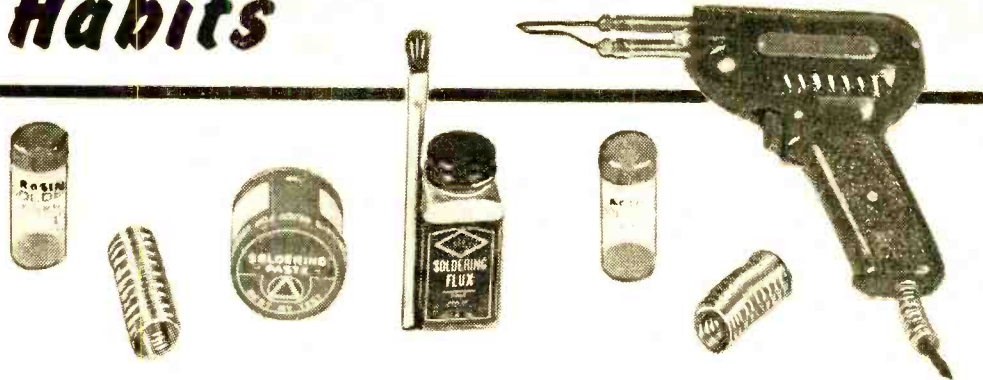

is *always* used for soldering radio, television and electrical connections.

The Gun. The electric soldering gun, invented quite recently, is primarily a source of quick heat for radio and TV servicemen. With its on-off trigger switch, and instant-heating feature, the gun can be picked up, used and laid aside at will.

The 100-watt gun is small, lightweight, and handles easily. This type of gun is adequate and efficient for joining wires, and for making connections to tie lugs, pigtail resistors, capacitors or terminal strips. It is particularly handy for quick-skipping plastic-covered hookup wire.

A 250-watt gun or iron is preferable for rugged general shop use. But either one is excellent for removing and replacing soldered chassis-mounted components, such as "twist-lok" type electrolytic capacitors and audio transformers.

The narrow tip of the soldering gun is especially useful for getting into deep, dark, inaccessible places. Extra-long electrodes insure that no damage will occur to surrounding parts. The tips may be bent to reach extreme out-of-the-way points. Dual focused lights in some gun "barrels" light up those dark corners.

BASIC GUIDES TO PERFECT SOLDERING

Here are some basic guides which, if observed, will assure good electrical connections at all soldered joints:

1. The metal surface must be absolutely clean.
2. Metals to be solder-jointed must be heated to a point (approximately 450° F) above the melting point of the solder (about 415° F). If either metal or solder is not hot enough, the result will be a strengthless "cold joint" that will be dull and granulated in appearance.
3. The surfaces to be joined must be sufficiently heated so that the flux does its cleaning thoroughly, then "boils off."
4. Tiny points of solder sticking up indicate too little heat (metal and solder were not sufficiently heated to permit the solder to flow freely when the tip was removed).
5. Keep the work as level as possible, because hot solder flows like water.
6. Once the tip has been removed, the joint should be allowed to cool undisturbed until the solder has completely hardened. Don't test by "jiggling."

-30-

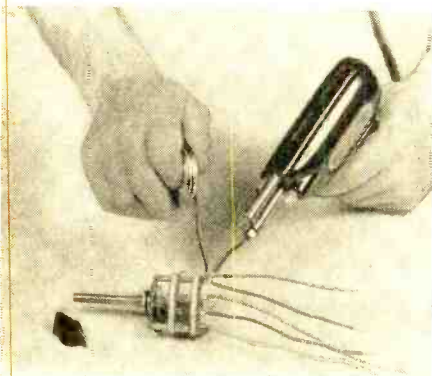

Joining wires, or making connections to tie lugs, pigtail leads or terminal strips, is accomplished efficiently with a 100-watt gun. Instant-heating feature of electric gun is useful for work on printed circuits.

April, 1956

61

Make Your Own Electronic Thermometer

By HARVEY POLLACK

HOW WOULD YOU like to be able to read the temperature at five, six or even more different locations, both inside and outside your home, from a single, central point? You can do it with the multiple thermometer described here at little expense and without much work. In fact, you don't need to have any knowledge of electricity or electronics; nor do you need any previous experience to embark on this project.

Basic operating theory of this device is covered elsewhere in the article, but we will include enough here to give you a general idea of the principles involved. Heart of the device is a *thermistor*, a relatively new component which is coming into wide use. This component has a very interesting and useful property—its resistance changes very rapidly as its temperature changes. What we do then, essentially, is convert the actual resistance of the thermistor into a reading on a meter; and by proper calibration, this meter reading indicates temperature at the point where

the thermistor is located. Simple, isn't it?

For added versatility, you can install any number of thermistors you want, at various locations, and connect them to a switch. Then, by placing the switch in the proper position, you can read the temperature at each of the locations in turn. Each thermistor is connected to the central unit by two wires. Since the voltages and currents involved are very small, you can use practically any type of wire available. Ordinary bell wire is very satisfactory. Also, you may run the wires inside the walls, on the surface, or even suspend them in air, as the occasion demands. The thermistor itself should be suspended in air by its leads, so that it will indicate air temperature.

At the central control unit is a simple bridge circuit, a 0-1 ma. meter, switches,

B1—30-volt battery (RCA VS085 or equivalent)
M1—0-1 ma., 2" meter (Triplet Model 221 or equivalent)
R1—250,000-ohm potentiometer, "range" control

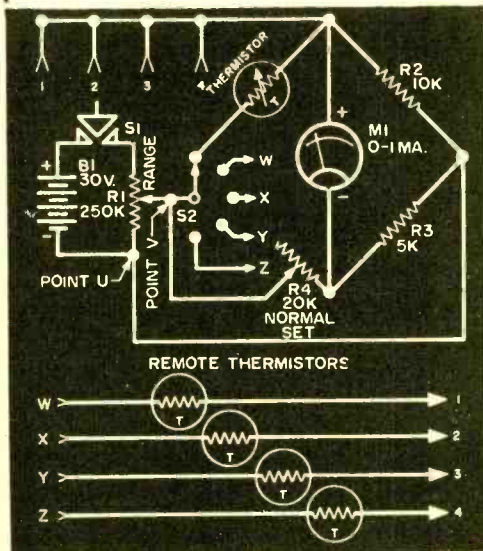

- R2—10,000-ohm, 1/2-watt resistor
R3—5000-ohm, 1/2-watt resistor
R4—20,000-ohm potentiometer, "normal set" control
S1—Normally open push-button switch (Grayhill 4001 or equivalent)
S2—S.p., 5-pos. rotary switch (Mallory Type 3215-J or equivalent)
5—Thermistors, 1200 ohms @ 25° C. (VECO Model 31D7—a kit of thermistors and varistors containing a 31D7 is available from Victory Engineering Corp., Springfield Road, Union, N. J., for \$10.00 by mail)
- 1—Battery holder (homemade, or Acme No. 19—available from Acme Model Engineering Co., 8120 7th Avenue, Brooklyn 9, N. Y., at 35 cents each)
1—Panel, scrap plywood or other material to match room decor
1—4-lug tie point
1—Aluminum bracket for mounting potentiometers
1—Pointer knob, 1 1/4"
2—Bucket washers, 1/4" I.D.
1—Miniature 5-pin tube shield
Wire—as required for remote units (ordinary bell wire is satisfactory)
Misc. machine screws, wire, solder, solder lugs, etc.

Schematic diagram and parts list for the device. Any desired number of thermistors may be used if connected to proper switch terminals.

**Get acquainted with
thermistors the easy
way -- build and use
this remote-reading
temperature indicator**

This photo shows how assembly may be mounted on a piece of striated plywood. The small black dot at the center is the "room temperature" thermistor. The thermometer is optional.

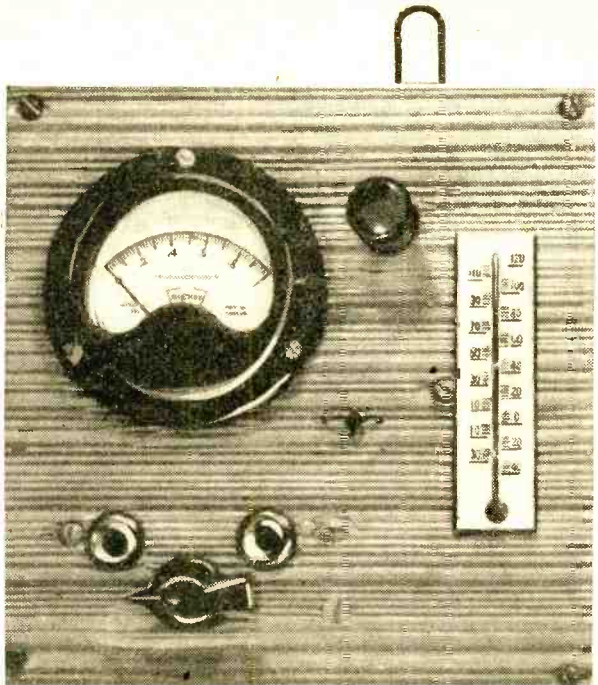

battery, and other necessary components as indicated in the parts list and photographs. You can mount these components in just about any way you wish—there are no tubes or transistors involved, and only a small amount of d.c. current is required. As the battery will have to be replaced occasionally, arrange your mounting so that such replacement won't be too difficult.

The author mounted his unit on a piece of striated plywood to match the decor of the room in which it was installed. You can do the same—or perhaps you would rather use a small metal box of some kind. Just remember that the meter should be located where it can be read easily, and the on-off switch *S1* must be in an accessible location. The two potentiometers, *range (R1)* and *normal set (R4)* have slotted shafts for screwdriver adjustments, as they do not have to be disturbed very often after the initial calibration. You may wish to include a conventional thermometer, as shown, or you can omit it.

A suggested enclosure for outdoor mounting of a thermistor is indicated in photo at the right. It makes use of a grooved piece of wood for bringing in the leads, and a tube shield for protection. Make certain that the thermistor itself is suspended in air inside the shield, and that it does not touch the wood or metal. Use your ingenuity to work out other mounting techniques.

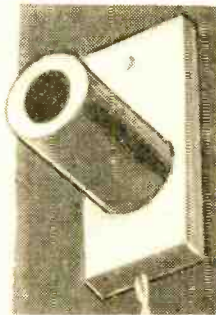

Exterior thermistor may be protected by means of a tube shield mounted on a block of wood. Leads are brought out through groove in the wood block.

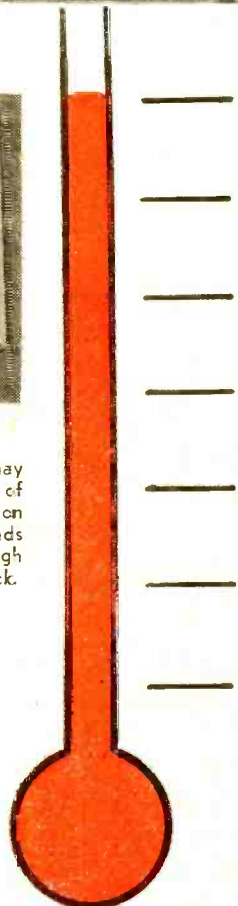

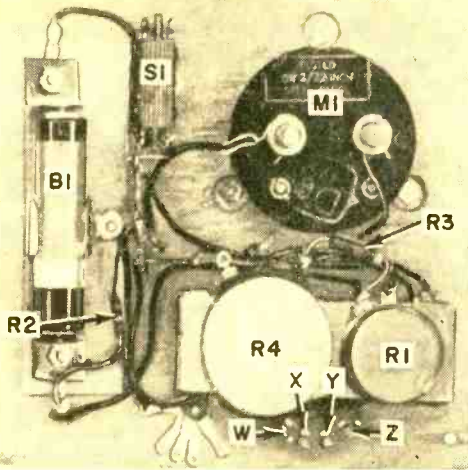

Top: rear view of panel, showing location of components and method of mounting. Switch *S2* is hidden beneath the potentiometer mounting bracket. Top right: mounting bracket for the two potentiometers. Lower right: thermistor compared in size with point of a lead pencil.

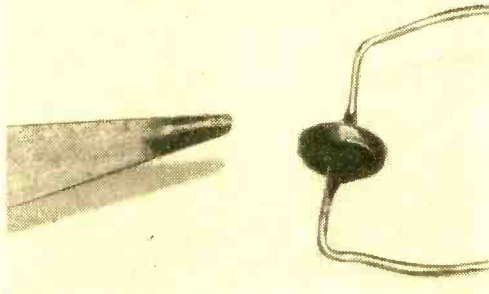
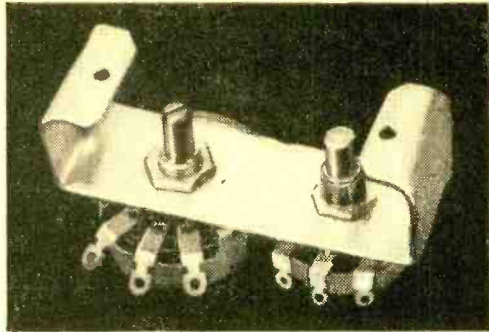

When you have the central control unit finished, you are ready for the calibration procedure. The main object of this procedure is to make your instrument direct-reading, i.e., a zero reading indicates 0° F, and full scale indicates 100° F. Other ranges can be covered, if desired, but such a range will be satisfactory for the large majority of applications.

Rotate both potentiometers counter-clockwise, and connect a low-range voltmeter between point *U* and point *V*. Press the push-button switch *S1* and release

quickly—neither meter should read. Now, with the push button held down, turn up *range* potentiometer *R1* until the milliammeter reads about 0.7 ma. Adjust *R4* until the meter reads zero. Continue advancing *R1* until the voltmeter reads about 8 volts. At this point, adjust *R4* until the meter reads room temperature. (Make sure that *S2* is switched to the correct thermistor—the one mounted on the panel!) This completes the rough calibration.

You are now ready for the final fine adjustment. This requires that one of the thermistors be located where the temperature is considerably below room temperature (outdoors in the winter, perhaps in the refrigerator in the summer). Actual temperature in this location must be known accurately. Switch *S2* to this thermistor, depress *S1*, and read the meter. If it reads too low, back off *R1* slightly; if too high, increase it a little. Then re-adjust *R4* for room temperature. Work back and forth between these adjustments until both temperatures are read accurately on the meter as *S2* is set to the proper position. Although this procedure sounds rather tedious, actually it doesn't take much longer to do it than it does to read about it.

Once the instrument has been calibrated, you will not need to touch *R4* again. You may have to touch up *R1* every three months or so as the battery ages, and again when the battery is replaced. Battery life is very long—about equal to shelf

(Continued on page 110)

HOW IT WORKS

Since the thermistor is a temperature-sensitive device, we connect it into an ordinary Wheatstone bridge circuit in such a way that changes in temperature (and thus changes in resistance) unbalance the bridge, and cause the null indicator (*M1*) to read. For a balanced bridge, the meter reading is zero, corresponding to 0° F. The adjustment of *R4* in effect balances the bridge with the thermistor at 0° F.

As soon as the temperature of the thermistor changes, its resistance changes. The meter *M1* then deflects. The amount which the meter deflects depends upon the constants in the bridge circuit, and upon the bridge voltage. *R1* adjusts the bridge voltage, and is set so that *M1* reads the correct temperature at some point other than 0° F, e.g., room temperature. Since the bridge voltage must be kept constant, *R1* may have to be readjusted as the battery voltage changes.

Resistance of the thermistor is large compared to lead resistance, so any kind of wire may be used for the leads, and runs as long as several hundred feet may be employed if desired. The change in resistance of the leads with temperature is so much smaller than that of the thermistor that it is negligible, so neither the initial resistance nor the change in resistance of the leads need be considered.

You can't fail to control this
capacity-operated device—it
"senses" warning objects
unnearby

• The proximity
is easily adjusted
by the control knob.
The light will flash warn-
ing you near a doorway.



Simple Proximity Detector Works Like Magic

WOULD you like to protect your home from intruders . . . warn your children when they get too close to your power saw . . . count the people passing through a doorway . . . mystify your friends by making bells ring and lights flash as they approach certain objects? You can do these and countless other "tricks" with the simple "proximity detector" or capacity-operated relay described here.

A capacity-operated relay is merely a device that closes a circuit or gives a signal of some kind when an object such as a human being approaches the "sensing element"—which may be a wire strung around a doorway, or a metal plate fastened to a window, or any of a number of other arrangements. By letting your imagination run freely, you can probably think of many useful and mystifying applications for such a device.

April, 1956

By **PAUL HARVEY**

Don't be scared by the term "capacity-operated relay" because of any stories you may have heard about how difficult they are to build and adjust. This unit is extremely simple to build and operate—it does not contain an oscillator of any kind, and it does not require careful "tuning up" every time it is used.

Operation of this device depends on a peculiar and little-known characteristic of the type 2D21 thyatron tube. Its grid bias is adjusted so that the tube is just on the verge of triggering or firing. Then, if some object approaches a "feeler" wire connected to the tube's grid, the tube will fire—or conduct—and the resulting plate current can be used to operate a relay,



Top left, over-all view of control unit with sensitivity control and a.c. outlet at far left, bull's eye pilot lamp on front. Lower left, inside of cabinet; transformer is at left, relay at right. Top, under-chassis view.

flash a light, or perform any other desired function. Because the plate of the tube is fed with alternating current, the plate current will stop flowing as soon as the object moves away from the feeler electrode.

This tube is quite sensitive, and may be triggered by line voltage surges and transients resulting from switching heavy ma-

Schematic diagrams of the simple proximity detector (left) and the voltage-regulated unit (below). Parts list applies to both versions.

- C1—12- μ fd., 150-volt electrolytic capacitor
- PL1—117-volt, 7 $\frac{1}{2}$ -watt pilot lamp and bull's eye socket
- R1—1000-ohm, 10-watt resistor
- R2—33,000-ohm, $\frac{1}{2}$ -watt resistor

- R3—10,000-ohm carbon potentiometer
- R4—3.3-megohm, $\frac{1}{2}$ -watt resistor
- RL1—S.p.s.t. relay, normally open contacts, 5000-ohm coil (Potter & Brumfield LB-5 or equivalent)

- SO1—A.c. outlet receptacle
- SR1—Selenium rectifier, 65 ma.
- T1—Transformer, 6.3 volts @ 1.2 amp. secondary (Stancor P-6134 or equivalent)

- V1—Type OB2 tube
- V2—Type 2D21 tube
- 1—Line cord and plug
- 1—Insulated binding post for "feeler" connection

- 1—Knob for sensitivity control
- 2—7-pin miniature tube sockets
- 1—Aluminum cabinet, 3" x 4" x 5" (Premier PMC 1005 or equivalent)
- 1—Aluminum chassis to fit cabinet (Premier 1353 or equivalent)

- 2—4-lug tie points
- 4—Vent plugs to fit 1" holes
- A.c. plug, cord, buzzer and batteries as required for alarm circuit
- Misc. grommets, machine screws, wire, solder, etc.

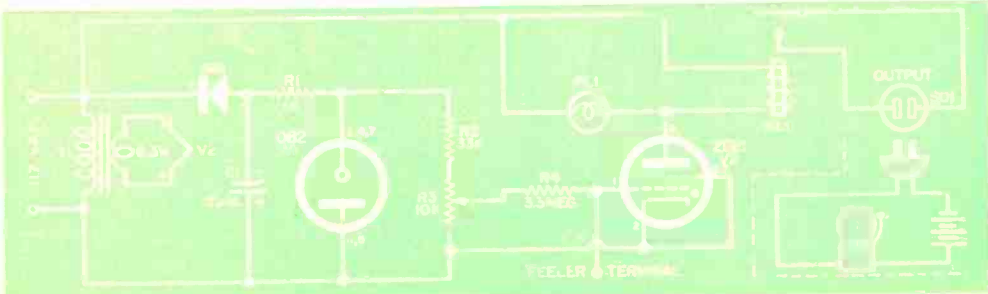
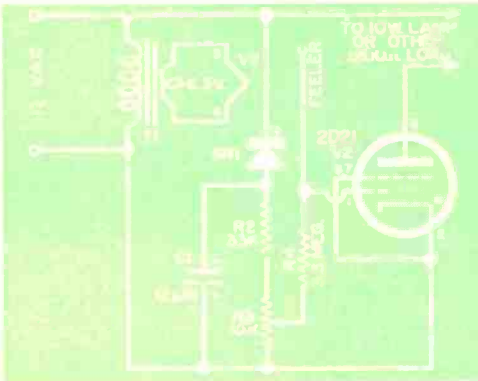

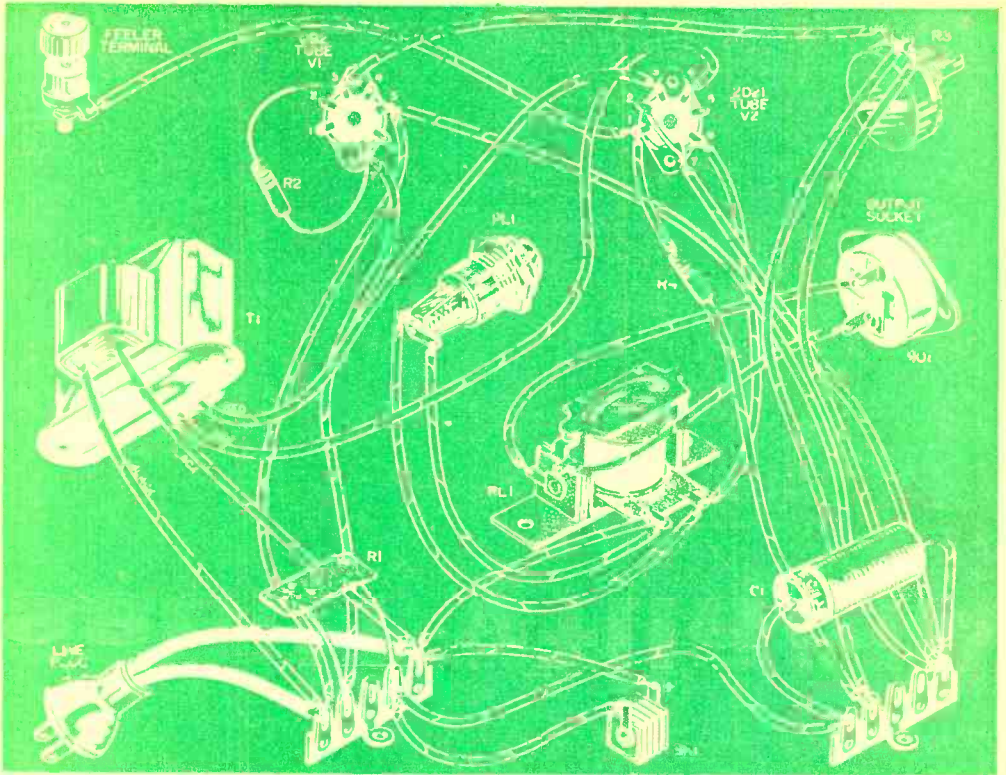

chinery or highly inductive loads on the line in the vicinity. If you live in an area where such transients occur, you should add the OB2 voltage regulator indicated in the larger circuit diagram. This will minimize the effects of transients.

Two possible output circuits are indicated in the schematics. In the simpler version, without the regulator tube, plate current of the 2D21 flows through a light bulb. When this bulb is lit, you know that some object is close to the feeler wire. The bulb may be located at some distance from the unit . . . but remember that this circuit is connected directly to the 117-volt a.c. house current, and use wiring suitable for the purpose.

For greater versatility, the second version includes both a relay and an indicating light. The relay can then be used to control an alarm, a counter, or any other device as desired. In the schematic, the relay is shown controlling a doorbell actuated by a suitable battery. You can locate this bell at any desired distance from the relay.

For maximum ease of construction, you would do well to follow the author's layout as indicated in the diagrams and photographs. However, exact layout is not at all critical, and you can make any alterations you wish. Just be sure that the joints

Pictorial diagram of the voltage-regulated unit, showing how components are connected.

HOW IT WORKS

The 2D21 is a grid-controlled thyratron gas-discharge tube, and as such has "all-or-none" properties, i.e., it is either conducting or nonconducting . . . with no in-between stages. D.c. grid bias is provided by the selenium rectifier *SR1* and filter capacitor *C1*. Actual bias . . . and so the firing point . . . is adjusted by *R3*. With *R3* set so that the tube is just ready to fire, any small positive voltage impressed on the grid will cause firing to take place.

In practice, this small positive voltage is produced by an object approaching the feeler wire, increasing the capacity of the wire to ground and causing a very slight current to flow through *R4*. The voltage drop produced by this current is sufficient to cause triggering. When the object is removed from the vicinity of the feeler circuit, capacity to ground decreases and the tube stops its discharge, permitting the grid to regain control.

With a.c. on the plate of the thyratron, the relay would chatter badly unless something were done to prevent it. Here a pilot lamp is used to bypass the a.c. component, and serves the additional purpose of providing an indication of relay triggering. The same purpose could be achieved with a large electrolytic capacitor.

Function of the voltage regulator tube OB2 is to make certain that the grid bias does not change with changes in line voltage, surges, and the like. Actual voltage across *V1* stays constant at about 108 volts with wide variations in current. Resistor *R1* reduces the rectified voltage to the desired value for *V1*. Note that this voltage is negative, and provides a negative bias for the grid of *V2*.

are properly soldered, and that there is adequate clearance to prevent undesired short circuits. Don't make any connections to the metal cabinet. And don't omit the ventilating plugs—the 2D21 develops a considerable amount of heat, and this heat must be allowed to escape.

Test the relay on the workbench before installing it in its final location. Connect a length of insulated wire (three feet or so) to the feeler binding post, keeping it well away from grounded conduits or other direct ground points. Rotate the sensitivity control $R3$ fully counterclockwise, and plug the line cord into a 117-volt, a.c., outlet. Let the unit warm up for about one minute, then slowly advance the sensitivity control. Be sure to stand clear of the feeler wire during this adjustment.

At some point of adjustment, the pilot lamp will glow, indicating that the thyatron has fired. If your unit contains a relay, it should click on at the same time. Now back the control off slowly until the lamp just goes off. Leave the control at this point, and test the sensitivity of the device by moving your hand close to—and then away from—the feeler wire. At each

approach, the lamp should light, and then go out as the hand is drawn away. If erratic action is experienced, try reversing the line plug.

When you install the unit permanently, you can use a feeler wire up to 20 or 30 feet in length, depending on proximity to grounded objects, or you can use a metal plate as the feeler electrode. You don't have to worry about any shock hazard—the feeler terminal is isolated from the line by a 3.3-megohm resistor ($R4$). If you want to use a still longer wire or larger metal plate, you may have to substitute a 15,000-ohm resistor for $R2$ in place of the 33,000-ohm unit specified. In any case, you will find that sensitivity is maximum with $R3$ rotated as far clockwise as possible without accidental triggering.

Drape the feeler wire around a doorway if you want to be warned when someone passes through. Or fasten a small metal plate to the inside of a display window if you want passing people to actuate an animated display or turn on the window lights. Connect this small metal plate to the feeler wire, and you are in business!

—30—

Potentiometer Boxes Speed Circuit Experiments

IN EXPERIMENTING with new circuits, continuously variable resistors are very handy for determining best resistance values. After the correct values are located by setting the resistor for best circuit operation, fixed resistors of approximately the same values may be installed in place of the variable units. This prevents much of the soldering and unsoldering of fixed re-

resistor boxes, especially in transistor circuit work, since they stay in the circuit at all times while the step-type units open the circuit between steps. Such "opens" sometimes cause transistor burn out when they result in loss of a critical bias.

The variable resistors are simply potentiometers of the volume control type mounted in small boxes provided with direct-reading resistance scales. One or two pots may be installed in each box. Three binding posts are provided for connection to the three terminals of each potentiometer. The direct-reading resistance scales are calibrated with an accurate ohmmeter; they give true ohm readings when connections are made to the center and right-hand terminal posts.

Any desired number of potentiometer resistance values may be employed. The writer finds that 200, 1000, and 10,000 ohms, 1 megohm and 10 megohms meet all of his test and experimental requirements.

—Rufus P. Turner.

—30—

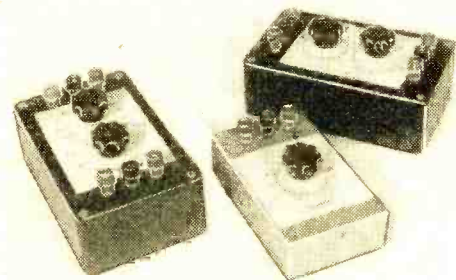

Potentiometers mounted in plastic or metal boxes are handy to have around the workshop or test bench. Paper scales, calibrated with a VOM or v.t.v.m., are glued to top of box. Binding posts connect the potentiometers to the circuit under construction,

sisters that ordinarily goes on in this kind of work.

Continuously variable resistors are superior to step-type decade and substitution

Tests at Ohio State University indicate that most people have a "dominate telephone ear" (usually the left). Audibility of radio messages in a noisy background is enhanced when the "telephone ear" receives the sound 0.06 second before the other ear.

POPULAR ELECTRONICS

CARL & JERRY

By

JOHN T. FRYE

Gold Is Where You Find It

THE BRIGHT first-day-of-April sunshine put new life into a fellow; so Carl vaulted nimbly over the low fence that separated his yard from that of his chum, Jerry Bishop. But he stopped short as he caught sight of his friend out on the lawn near the street. On Jerry's head was a pair of huge muff-type airplane earphones that were plugged into a small aluminum box slung from his shoulder. From this box a cord led to the strange device he held in his hands. It consisted of a long broom handle attached to the crosspiece on a large, flat wooden hoop so as to hold this hoop parallel to the ground. Jerry's round face wore a faraway look of abstract concentration as he shuffled along, waving the hoop back and forth over the sprouting grass.

"Hey, Jer, what're you doing?" Carl demanded, when he managed to catch Jerry's vacant eye.

"What did you say?" Jerry asked, sliding the phones forward on his head so that he could hear.

"I asked what you thought you were doing with that contraption."

"You mean my worm-warmer here?" Jerry asked, with bland innocence. "I'm just doing my bit for be-kind-to-worms-week. This is an r.f. induction coil that heats the ground beneath it and makes things comfy for the poor little worms that are still chilled from winter."

"Ask an intelligent question and you get a smart answer," Carl muttered. "Are you going to tell me what that thing is, or am I going to have to squeeze that narrow hoop down over your fat and flabby body?"

"All right; this is a metal locator. I built it from an article by Harvey Pollack that appeared back in the June, 1955, issue of POPULAR ELECTRONICS."

"How does it work?"

"Inside this aluminum box is an oscillator operating on about two megacycles. Shielded from it is another oscillator whose tank coil, electrostatically shielded, is wound inside this wooden hoop. Shielded wire connects the out-board tank coil to the rest of its circuit inside the box. The two oscillators are tuned to very nearly the same frequency, so that a low audio difference-frequency beat note is produced by them. This beat note is detected, amplified, and fed to the earphones. When a metallic object appears in the extensive field of the large coil in the hoop, its presence affects this field and so causes a slight frequency shift in the oscillator connected to it. This, in turn, produces an easily detected change in the beat note frequency heard in the phones and warns the operator that the probe coil is nearing

some metallic object. Here," Jerry said, as he freed one of the earphones from the headband; "you walk along behind me and listen, and I'll show you what I mean."

When Carl held the earphone to his ear, he heard a low-pitched musical tone. Suddenly, as Jerry moved the hoop over the grass, the note rose to a high pitch; then it went back down as Jerry kept walking. Probing the area with the coil established that there was a line perpendicular to the curb which gave the same high-pitched sound as the probe was moved along the narrow path; but if the coil were moved to either side of this path, the note in the phones returned to the normal low value.

"What's down there?" Carl asked.

In answer, Jerry followed the invisible object beneath the surface with the metal locator right to the curb, where a large "G" was chiseled in the cement.

"It's the gas line," he explained. "The gas people marked the curb this way when the

(Continued on page 104)



Jerry's round face wore a faraway look of abstract concentration as he shuffled along, waving the wooden hoop back and forth over the sprouting grass.

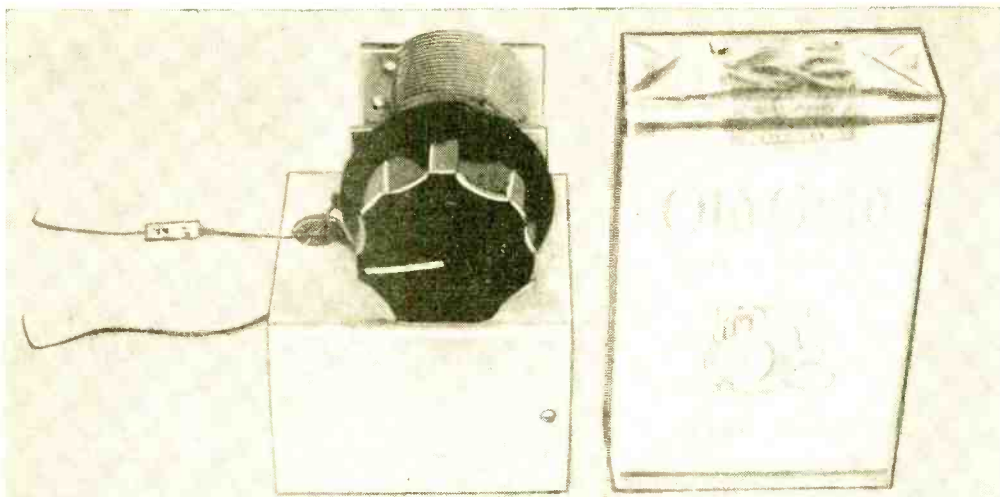

An Amazing Converter

THIS amazingly simple little converter will tune in amateur and short-wave broadcast stations. Just connect it to an ordinary AM broadcast receiver.

The unit is no more than a crystal diode and variable capacitor connected across a few turns of wire wound on any convenient coil form. Any 365- μf d. broadcast-type variable capacitor will do. Try values of 50 to 250 μf d. if you don't have the broadcast type at hand. The coil consists of 45 turns of No. 24 magnet wire close-wound on a $\frac{3}{4}$ "-diameter form. If you use a larger form, employ fewer turns of wire. A polystyrene or ceramic coil form is best, of course, but a Bakelite or plastic form—or even a cardboard tube or broomstick—will work in many instances.

As shown in the photos, this converter was built on a tiny inverted U-shaped chassis, made by bending a thin piece of sheet aluminum in an ordinary vise. The tuning capacitor is mounted on the top, and the coil and antenna coupling capacitor *C1* are below deck. As a matter of fact, you don't really need the chassis; breadboard construction, with parts mounted on a small piece of wood, may be used instead.

One lead of the 1N34 crystal diode must be soldered to the stator terminal of the tuning capacitor and the other lead directly to the receiver's antenna terminal. Grip the diode lead being soldered with a pair of
(Continued on page 108)

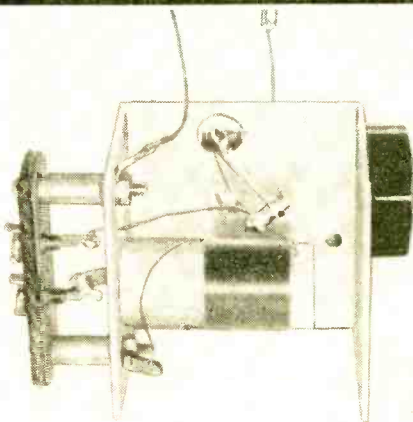

Variable capacitor essentially constitutes this little unit, compared in size with a pack of cigarettes at top of page. Construction is shown directly above, wiring diagram below.

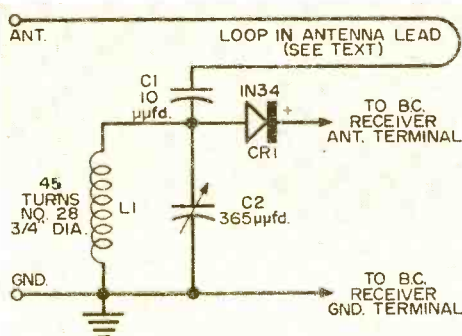

POPULAR ELECTRONICS

Audio and Hi-Fi Section

- | | | |
|----|--|---------------------|
| 71 | Disc and Tape Review..... | <i>Bert Whyte</i> |
| 73 | Turning Out the Turntable..... | |
| 74 | Introducing the "Octahedral"..... | <i>J. H. Owens</i> |
| 78 | Horns—Folded and Loaded..... | <i>H. H. Fantel</i> |
| 82 | Recommended Tape Recorder Hookups..... | <i>R. S. Lanier</i> |

Disc and Tape Review

THE YEAR 1956 is only four months old, but it has already established itself as "the year that prerecorded tape got off the ground." Each successive month has seen the entry of more and more organizations into this field with a future. To be sure, many of the entrants are small struggling companies with a totality of output that is still—by disc standards—very insignificant. But the giants are stirring, too!

RCA continues to release tapes, albeit at a slow rate. Berkshire tapes, using the catalogs of the Haydn Society and Urania Records, have a fair-sized initial release, and more are planned soon. Westminster had a splendid first release with its Sonotapes, and has just announced an equally imposing second release. It should be mentioned in regard to Sonotapes that this organization is following the laudable practice of not confining itself exclusively to older master tapes in the Westminster catalog but is issuing some brand-new material, some of which has not even been issued in disc form as yet!

Livingston tapes continue to draw on the catalogs of many of the small disc companies they have in their fold, and the quality and variety has been improving steadily. Rumors are flying about tapes from many of the majors . . . what will actually happen is anybody's guess, but I have fairly positive information that at least two of the big disc companies with large and attractive catalogs will issue tapes before the end of the year.

The Future of Prerecorded Tapes

It would seem that although the prerecorded tape market is still quite small, the various disc outfits have begun to realize that it would be unwise to be caught napping. I guess

April, 1956

By BERT WHYTE

that the sales figures on tape recorders are beginning to make themselves felt in the right quarters. In the last two years, over one million machines of all types were sold. Add such a figure to the sizeable sales prior to that, and you can see the potential of this market.

Tape price, which has long been the Achilles heel in the prerecorded market, is finally getting down to a fairly reasonable level—although there is still plenty of room for improvement. Incidentally, “off-the-air” and other forms of recording have had a recent shot in the arm because of a considerable drop in the cost of “raw” tape. Standard brands of the best quality are now selling for \$2.34 for the 1200-foot, 7-inch reel; and the new 1-mil mylar base tape, which permits 48 minutes of recording from a 1200-foot reel at 7½ inches per second full track (96 minutes half track), has also been reduced.

Naturally, no industry is without its growing pains. One of the chief complaints about the various prerecorded tapes is their lack of availability. I don't know whether it is caused by duplication problems or poor distribution or what . . . all I know is that I've had plenty of people ask where they can buy tapes. In the case of the Victor stereo tapes, for example, it's like pulling teeth to pry some copies loose! This is a situation where the need for immediate correction should be glaringly evident to the sales managers of the various companies.

So far as this column is concerned, I shall try to obtain and review as many of the new tapes as possible. I will interject one word of caution, however, which is particularly intended for the newly minted hi-fi fan and for those about to take the plunge and buy equipment. In spite of the rosy picture as regards tape, *don't* make the mistake of eliminating disc from your thinking. Remember, there are thousands of magnificent recordings in the LP catalog, and it will be years before the prerecorded tape industry ever catches up. Use tape as an auxiliary to your disc collection. If you have a particularly favorite piece of music, and there is a fine prerecorded tape of it, you probably won't mind spending a little more money to acquire the tape.

There is little doubt that eventually all music will be recorded via the tape medium, and most likely stereophonic. But to wait for this eventuality would be to wait quite a long time, I'm afraid, and you would deprive yourself of years of musical enjoyment!

This month we'll continue to hop around in the LP catalog for some interesting additions to your record library.

Grieg's Symphonic Dances

Mention Edward Grieg's name and most people think of his famous *A Minor Piano Concerto*, or perhaps his *Peer Gynt Suites*. These are justly famous but quite naturally do not constitute his entire output as a composer. He wrote many other interesting works and a goodly number have been recorded on LP. One of his most colorful scores is the *Symphonic Dances*.

This is a collection of gay and spritely dances more highly orchestrated than most

Grieg works. In fact, there is so much material in this score which lends itself perfectly to hi-fi exploitation that it is quite surprising to find only two recordings of the work in the LP catalog. These are the Sevitky/Indianapolis reading on Victor and the Eric Tuxen/Danish National Symphony on Mercury. Of the two, only the Mercury disc can hold its head up in hi-fi company.

The Victor disc is quite an old recording and is definitely below today's standards. Sevitky's performance was quite good, but not outstanding enough to override the dull sound.

The Mercury disc is one of a good number issued a year or so ago which were devoted to the works of Scandinavian composers, and were—for the most part—recorded in Denmark, Sweden, etc. Not by any means having the fabulous quality of Mercury's famed Olympian Series, nonetheless it is more than acceptable. Frequency response and dynamics are fairly wide, and there is little distortion. Most notable features are the splendor of the brasses, which have a full-throated clean brilliance, and the accurate percussion—although one must admit to a lack of sufficient impact now and then. This occasional dullness is minimized by the exceptionally good acoustic perspective which affords the music a fine sense of fullness and “presence.” Tuxen gives a rousing performance, showing an easy familiarity with his native idiom. His tempi are sensible, his phrasing deft, and from his very good orchestra he elicits some exceptionally well-balanced and altogether splendid playing. While this Tuxen performance will not be easy to top, the field is wide open for a new recording embodying full use of today's hi-fi techniques and resplendent sound.

Sigurd Jorsalfar

Another Grieg work that is largely unknown to the average music lover has the tongue-twisting title of *Sigurd Jorsalfar*. The name is derived from an opera, and in actuality, this should really be reckoned as a suite. Again, this is very stirring music, largely orchestrated, which lends itself to hi-fi techniques. Here the record companies have not been sleeping, as there are two top-flight recordings in the LP catalog and one that is passably good.

The best of the three is the London recording with Thor Johnson conducting the Cincinnati Symphony. This was possibly the most successful of the recordings made by the London people in this country. Why they abandoned their American recording project I don't know . . . most likely the matter of cost. At any rate, they did well enough with this recording so that it finds frequent use as demonstration material. The last movement is particularly thrilling with its huge bass drum sounds, ultra-sonorous trumpets and trombones, and clean string tone. Here is wide frequency and dynamic range, little—if any—groove or other distortion, low rumble and good surfaces, with the whole clothed in very live spacious acoustics. Johnson has a good feeling for the music, and he gives a brisk vigorous reading, well modeled and forcefully

(Continued on page 120)

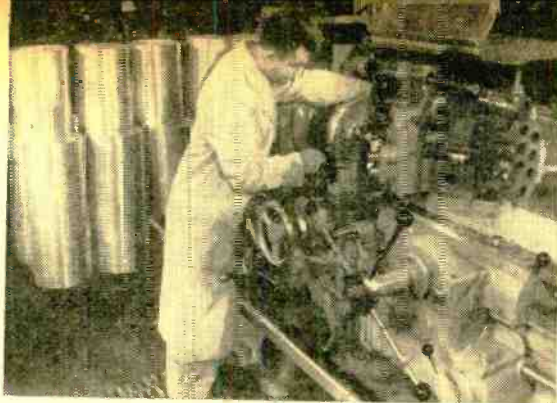

Turntable arrives at plant as platter of cast aluminum. Edges and surfaces are trimmed, cleaned, and polished on power lathes. Center shaft is fitted at perfect 90° angle by huge hydraulic press.

Turning Out the Turntable



Drive motors are disassembled and inspected. Shafts are checked for balance on specialized machine; any unbalance is drilled out. Motors then undergo test runs before assembly with turntables.

THE increasing popularity of quality turntables for home use has focused much attention on the design and performance of these units. In a recent issue (October, 1955), we examined a representative grouping of turntables that would gladden the heart of any hi-fi enthusiast. For additional insight into these devices, a series of photos . . . made at the plant of a leading turntable manufacturer . . . highlights some of the critical operations and tests that go into the making of a top-quality turntable.

Turntables cannot be mass-produced . . . every part of every finished product has been carefully made and rigidly inspected by skilled craftsmen using precision equipment and special machinery. Constant quality control, in-process tests, painstaking adjustments to satisfy consumer suggestions . . . all help account for their unerring performance.

-30-



Micrometers are used after every machine operation to check for dimensional accuracy. When all parts, including motor, have been assembled, turntable is operated for long periods at all of its speeds. Final adjustments are made at this stage.



Last test of Rek-O-Kut turntable is made under operating conditions, using hi-fi equipment. Wow or flutter is indicated on meter; performance defects show up on oscilloscope. If unit passes test, it is ready for use.

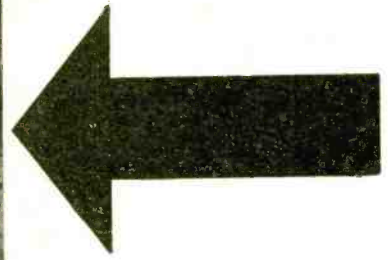
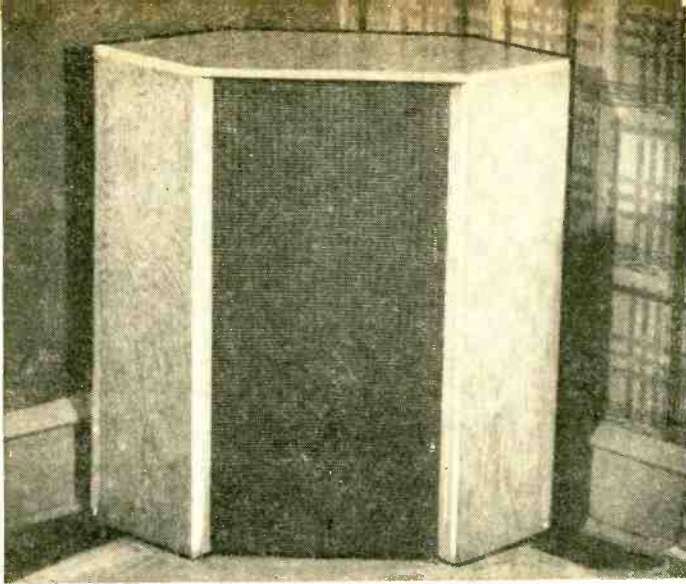

Enclosure can be used as infinite baffle, bass reflex, or folded horn. Design permits wide choice of speaker systems, with room for expansion; cost is about \$10.00.

NAME YOUR CHOICE—if it's a corner horn, bass reflex, or infinite baffle—this is for you.

What's more, this enclosure—which can be used in any of three ways—may be built at home in a few hours with the simplest of hand tools at a cost of less than ten dollars.

Once assembled, it occupies only four cubic feet of space. It may be placed against a flat wall, or used in a corner. It will mount any 8" or 12" speaker. For greater power-handling capacity, you can install two speakers. And the cabinet is ideal for using tweeters. Two tweeters, one mounted on each of the angled sides, will really spray the room with high-frequency sounds.

Designed for Best Sound. Styled for the modern look, this enclosure's design is based on really "sound" principles. Its diamond-shaped ends make it a natural for corner placement to improve bass response and—at the same time—provide wide angle dispersion of highs. Also, the design avoids large-surface parallel sides—in the interest of reducing boominess, peaks, and standing waves.

Another thing: all of the panels used are cut from a single sheet of half-inch 4' x 4' plywood. The panel layout drawing shows how the wood is cut—a job that you can

have done at the lumber yard. The recommended procedure for making the cuts is shown in the diagram. Hint: if cuts No. 7 and 8 are made at home, use a crosscut handsaw. For greater accuracy on these cuts, use panels "E" and "F" to mark off the 8 $\frac{7}{8}$ " lines. And—in marking the 10 $\frac{3}{8}$ " line—let panels "A" and "B" serve as your guide, plus an additional half-inch to allow for the plywood thickness.

While at the yard, you can also get the speaker opening or openings cut in the front panel. The yard's jigsaw will do the job neatly with little strain on your pocketbook and none on your back. Don't be too afraid of making mistakes in ordering speaker cutouts: a hole made for a 12" speaker can always be reduced to hold an 8" speaker. Similarly, if you make two speaker openings and then decide to use only one speaker, you can always block up one of the openings with an additional square section of wood.

In addition to the plywood, you'll need $\frac{3}{4}$ " x $\frac{3}{4}$ " cleats. At the lumber yard, these may be called "one-by-ones." Regardless of their label, they should measure $\frac{3}{4}$ " x $\frac{3}{4}$ " (square).

And finally, you'll need the skewback strips—the triangle-shaped moldings that help hold the front panel in place. They must measure 1 $\frac{1}{8}$ " across the hypotenuse of the triangle. Using the skewback strips does away with the need for critical and expensive beveling of the plywood edges. It also eliminates the need for exactness in the panel dimensions to get perfect fits. All lumber, hardware, glue, etc., is listed in the Bill of Materials.

Assembling the Enclosure. Start putting the pieces together by cutting a $\frac{3}{4}$ " x $\frac{3}{4}$ " piece to a length of 18". Now glue and screw this cleat flush to one of the long

BILL OF MATERIALS

- 1—4' x 4' piece of fir plywood
- 2— $\frac{3}{4}$ " x $\frac{3}{4}$ " x 6' strips of stock lumber
- 2—1 $\frac{1}{8}$ " skewback strips, 6' long (see text)
- 72—1 $\frac{1}{4}$ " wood screws, No. 6
- 12— $\frac{3}{4}$ " wood screws, No. 6
- 1—can of white paste wood filler
- 8—ounces of white shellac or sealer
- 1—2' x 3' piece of grille cloth
- Wood glue
- Plastic Wood

Introducing

the "OCTAHEDRAL"

-a New Low-Cost Hi-Fi Baffle

By J. H. OWENS

edges of panel "A"—use three No. 6 wood screws, 1¼" long. Center the cleat lengthwise, so that it will be about five inches short of each end. Next, fit panel "E" to panel "A;" glue the joint between the two panels, and between the cleat and panel "E." Then screw the cleat firmly to panel "E." You now have assembled the left side of the enclosure as shown in the photo.

The right side is made in the same way as the left side. Incidentally, the wood screws will work best if clearance holes are drilled in the cleats and starting holes drilled in the panels.

Next comes the skewback. Cut four pieces, each 28" long. Glue and screw them flush to the inner edges of the front and rear side panels. Drive the ¾" No. 6 screws through the skewback into the plywood panels, making sure that the screw heads do not protrude above the surfaces of the skewback. The side panels are now ready to accept the front and rear panels. These will be screwed—but not glued—in place later.

Brace the enclosure at the bottom by installing the two gussets. The gusset made

by cut No. 8 will be somewhat larger than the gusset made by cut No. 7. Trim the former down so that both gussets measure the same. Then cut off their corners, as shown. To make the gussets fit flush, the six-inch ¾" x ¾" cleats should be glued and screwed about one-half inch from the bottom ends of panels "B" and "F," and "A" and "E." The gussets will then fit snugly against the ends of the four side panels.

To prepare the side panels to receive the top panel, use the six-inch ¾" x ¾" cleats. These are screwed and glued nearly flush with the top ends of panels "B" and "F." Do the same for the left-side panels "A" and "E." The side panels can now be glued and screwed to the top panel "G" by driving screws through the cleats into the underside of "G." Additional bracing is secured by screwing two more ¾" x ¾" cleats into the top ends of the front and rear panels. These are glued and screwed in place a "short" half-inch from the outside panel-edge line.

Surface Finishing. The cabinet is now assembled and ready to receive the speak-

Stages of assembly are shown at right. Two side panels ("A" and "E") are joined. The other two side panels ("B" and "F") should be similarly joined. Then, top panel is secured in place. Note the use of cleats to brace the structure. Note also the skewback strips. These are for mounting front and rear panels that run from top to bottom.

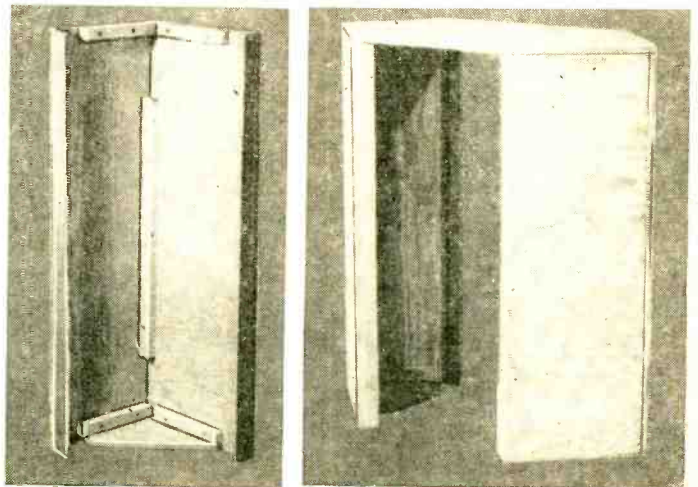

er or speakers. However, if a surface finish is desired, this is the time to apply it—before the speaker units have been put inside the cabinet.

One way to get the enclosure to look like something other than low-cost plywood is to cut an artificial grain into it which will be more prominent than the plywood's natural grain. To do this, you need no special tool. You can use a photographic film clip if you cut it into two pieces so that the four sharp teeth on end are exposed. An alternate tool would be a wire brush of the type bristled with steel bands rather than round wires.

To get the new "grain" on the surface, you simply use the tool to gouge the wood—draw the tool over the plywood surface in the direction of the grain, making grooves in the wood. Use enough pressure, and repeat the process until the natural grain is subdued. Then sand over the surface lightly to remove splinters. Use plastic wood to fill any cracks or edge-voids.

Next, apply wood-filler. Use a white paste type, thinned to the proper consistency according to instructions on the can. Brush it on thickly, stroking in line with the grain. Let it set; then wipe it off. Now, apply more filler across the grain. The artificial "grain" previously gouged will stand out boldly. (An alternative, of

course, is to spend a few extra dollars for a better grade of plywood with its own surface grain of mahogany, walnut, etc.)

Now you can treat the skewback surfaces and the exposed edges of the plywood. A cream or ivory interior enamel will do—just smooth it on with the tip of your finger—not quite thick enough to hide the grain completely. The edges will blend nicely with the plywood surfaces. If you used a dark veneer plywood, such as mahogany, the edges should be surfaced with an enamel paint of suitable color, such as deep maroon, to match the tone of the wood.

After the filler and enamel have dried overnight, a coat of white (clear) shellac or sanding-sealer can be applied. From then on, you can make the finish smoother and glossier by rubbing with steel wool, and applying varnish, Rotten Stone, and wax—in the order stated.

During the waiting periods of the finishing process, the front and rear panels can be prepared for installation. The rear panel "C" is a cinch—all that it needs is a series of holes, three on each side and one at the top. It will be screwed (not glued) in place later.

The front panel "D" requires the same treatment, but in addition it should be painted a flat black so that the speaker

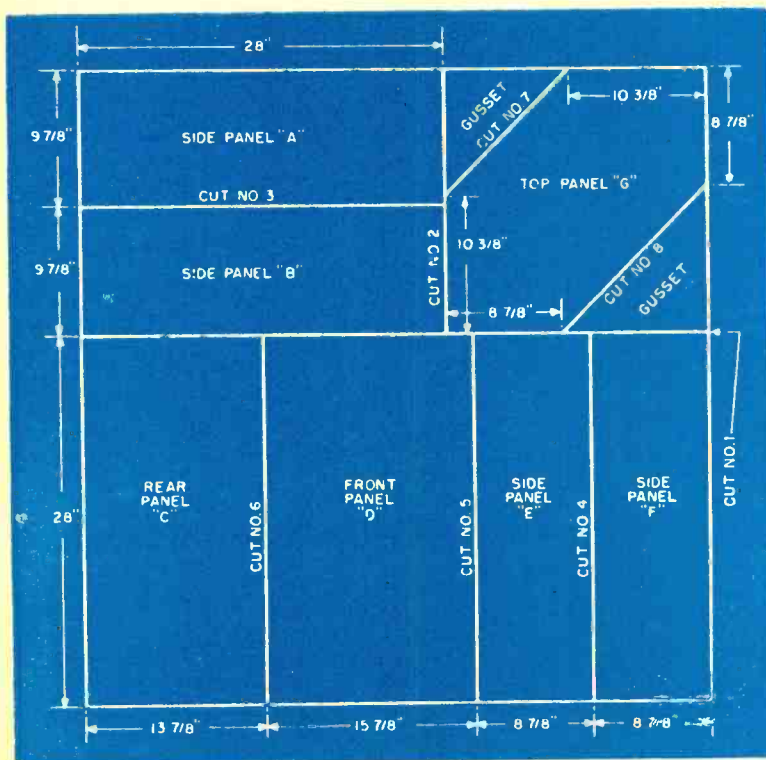

How to lay out a sheet of 4' x 4' plywood to provide all the panels needed for building the enclosure. For best results, follow numbered cutting instructions. Dimensions shown are correct and allow for cutting waste resulting from saw's groove. Plywood's good surface should face up during all cutting operations. Your best bet is to have cuts made at lumber yard. If you cut the wood yourself, the best single tool is a crosscut handsaw.

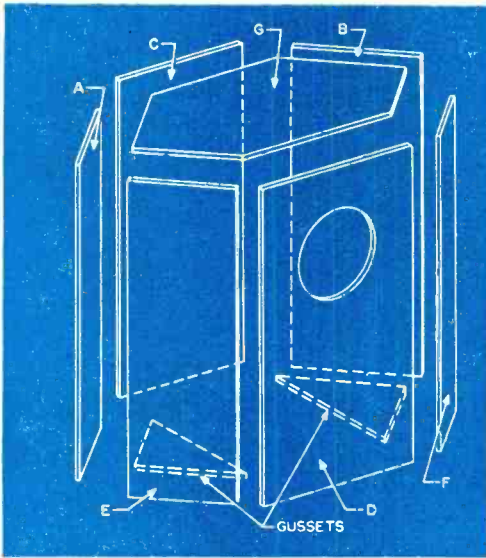

opening will not be visible through the grille cloth. Then the grille cloth can be pulled tightly over the face, around the edges, and tacked to the back side. This panel is now screwed, not glued, in place.

Using the Enclosure. Mount the speaker, using No. 6 wood screws $\frac{3}{4}$ " long, and washers. Slip the rear panel "C" in place and screw it tightly from the outside. Do not glue panel "C." The job is done, and you're ready to listen to this unusual sound-box.

If you let the enclosure rest flush on the floor, it becomes a completely sealed enclosure of the infinite baffle type. Bass response will be extended by about half an

(Continued on page 108)



Construction details are given in these two diagrams. Exploded view, above, shows relation between all pieces cut from the 4' x 4' piece of plywood. With exception of the two gussets, the enclosure's bottom is left open; the opening provides access to the speaker and also can serve as a port for bass reflex action. When rested flush on floor, bottom is automatically sealed to provide infinite baffle. Top and front views are detailed in drawing at right. Lengths of cleats and spacing of wood screws are not critical. Hole cut in front panel will mount 12" speaker; other openings may be made for any size and number of speakers. Holes on angled sides are good idea for mounting separate tweeters.

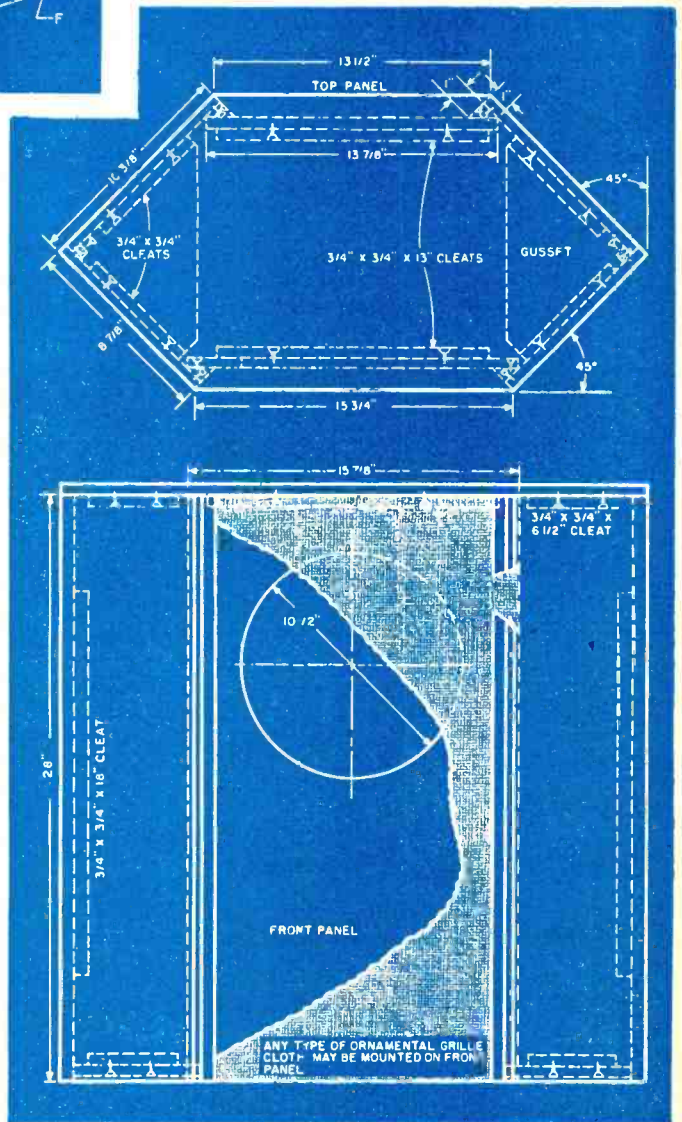

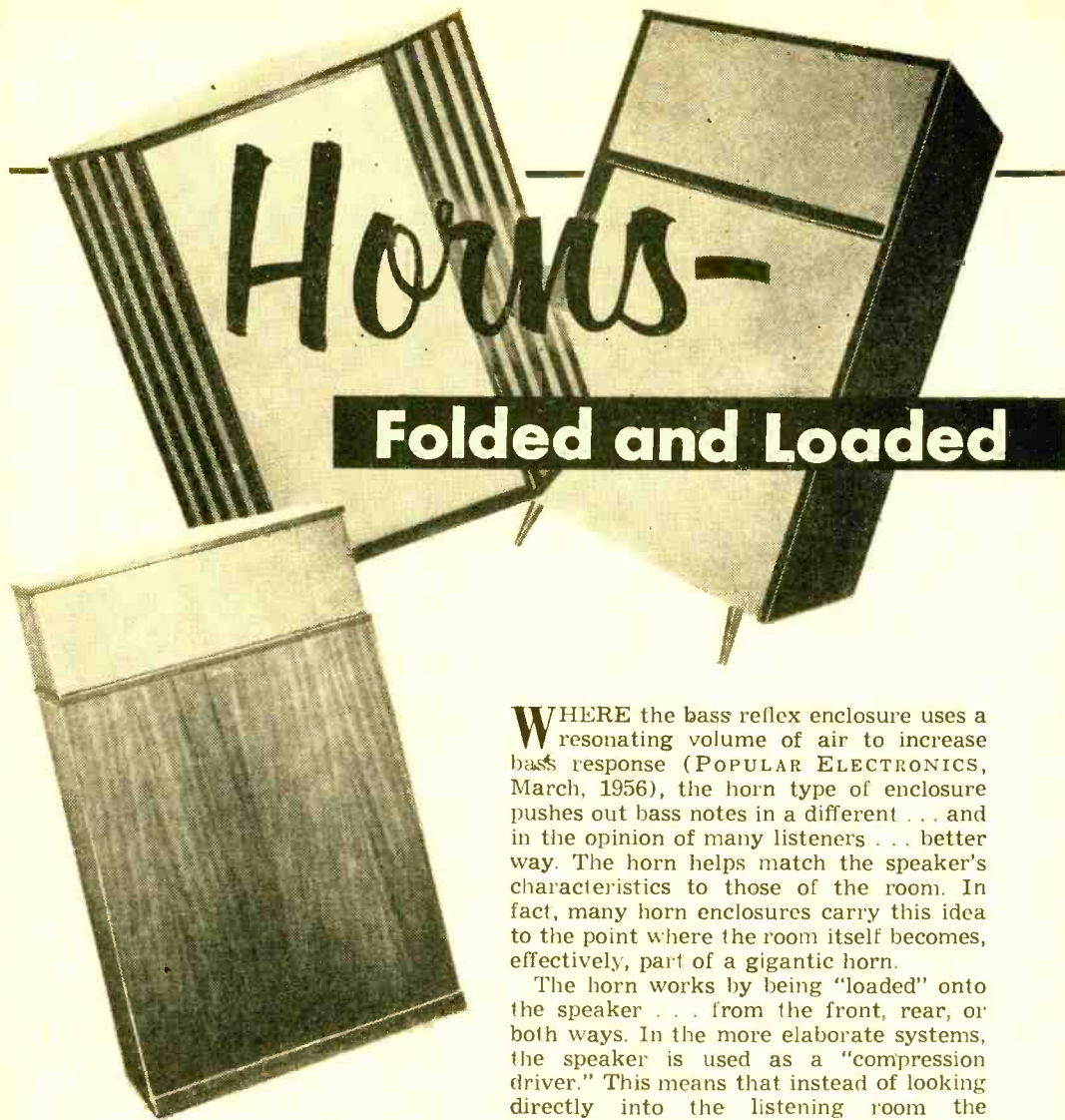

Folded and Loaded

By H. H. FANTEL

**Thinking of getting a horn
for your hi-fi system?**

**Here's the low-down on all
types . . . Part 3 of series**

WHERE the bass reflex enclosure uses a resonating volume of air to increase bass response (POPULAR ELECTRONICS, March, 1956), the horn type of enclosure pushes out bass notes in a different . . . and in the opinion of many listeners . . . better way. The horn helps match the speaker's characteristics to those of the room. In fact, many horn enclosures carry this idea to the point where the room itself becomes, effectively, part of a gigantic horn.

The horn works by being "loaded" onto the speaker . . . from the front, rear, or both ways. In the more elaborate systems, the speaker is used as a "compression driver." This means that instead of looking directly into the listening room the speaker is installed at the beginning, or apex, of a long horn. The horn's throat expands gradually until its flared mouth opens into the listening area.

Rear horn-loading only is quite effective, very popular, and more economical. The speaker looks into the room for some amount of direct radiation (usually of highs), while the horn is loaded onto the speaker's back to help push out more bass. This type of enclosure is available from many manufacturers in kit form.

Regardless of the way horn-loading is accomplished, in all modern horn-type enclosures for home use, the horn is *folded*. This means that it is bent, angled, or curved in some way, doubling back on itself any number of times until its mouth is reached and the sound enters the room.

POPULAR ELECTRONICS

Huge enclosures at left put out some of finest sound ever heard. Bottom, Klipschorn Style 7 (52" high); center, Tannoy's "G.R.F." (48" high); top, Stan White "4-D" (67" high). Prices range up to \$1500. Smaller and less expensive models are made by these outfits.

Think of the bass tuba or the slide trombone with their convolutions of flared pipes and you get a fair picture of a folded horn.

Horns are free from false resonance and are virtually immune to distortion. Their efficiency is unequalled and permits as much as 50% of the electrical output fed to the speaker coil actually to be converted into sound. In the largest horn systems, these qualities of efficiency and clearness reach down into the 30-cps region. The deep, powerful foundations of musical structure, heavy organ bass, the velvet thud or biting crash of tympani, the sonorities of low strings . . . all of these are encompassed in an illusion of reality. This feeling of "presence" stems partly from the ability of large horns to generate the elusive "difference tones," powerful but almost sub-audible beats near the lower limit of hearing.

On the minus side of the ledger is the structural complexity of folded horns and the relatively high cost of factory-built models. The home builder may be discouraged by the difficult angle cuts required for the many interior panels, but simplified versions are available in kit form.

The horn, truly a king among baffles, traces its ancestry to the ancient megaphone, which carried sailors' voices from ship to ship. Essentially, a horn enclosure is a funnel with the speaker at the narrow end. The funnel taper usually follows an exponential curve, i.e., the cross section increases by a constant factor per unit length. This is known as an "exponential horn."

How the Horn Works

The horn works as an acoustic transformer by matching the high acoustic impedance of the speaker to the low acoustic impedance of the air. The impedance transformation is continuous as in microwave transformer lines, rather than stepwise as in ordinary coil-and-core transformers. The horn itself is anti-resonant.

A wasteful mismatch commonly exists between the speaker (representing a high-impedance point source of energy) and the air of the listening room (representing a spacious, low-impedance load). To visualize this, it might be compared to an attempt at moving a large pile of cotton by poking a stick at it. Only the small portion of the

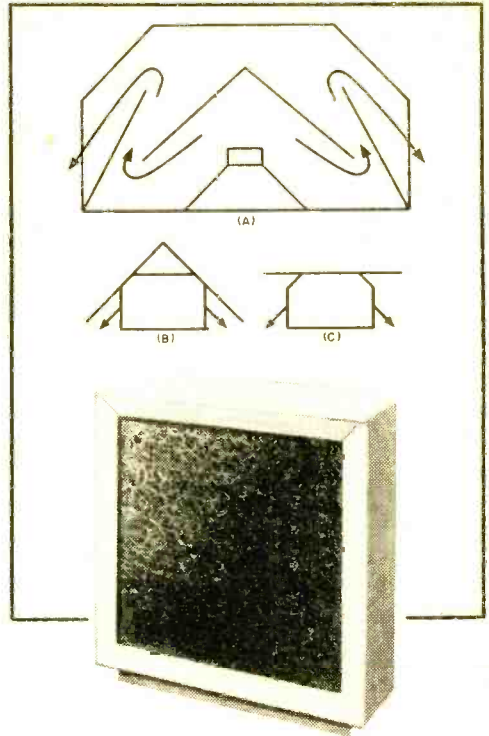

Sound path in Stephens enclosure (above) is shown by arrows. Horn is formed by the cabinet's internal paneling which permits placement against wall if corner is not handy. Below, Cabinart's Model KR-3, which depends on corner placement for proper horn loading. Sound path provided by KR-3's structure is somewhat shorter, needs room walls. In both types, highs radiate from front of speaker, bass from rear via the path of the folded horn.

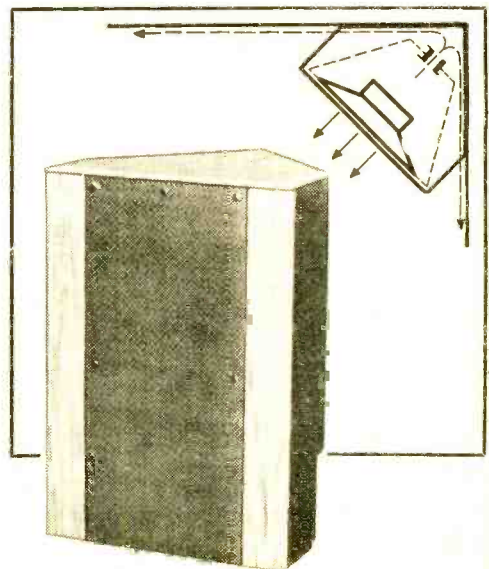

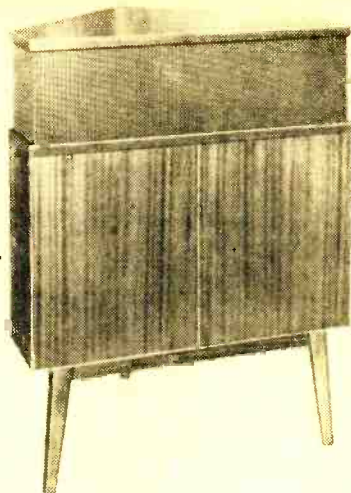
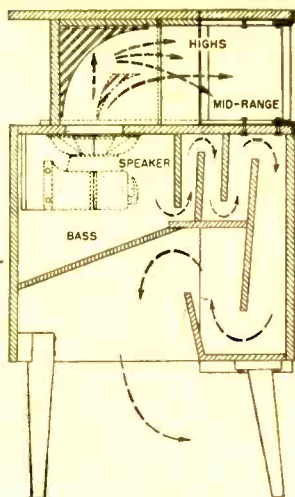

Appealing to many because of its modern "floating" look as well as its fine sound output, the Brociner Model 4M corner horn is a complete speaker system. The speaker (used as a compression driver) is designed especially for the enclosure. Highs and mid-range emerge from behind the grille cloth; bass follows the long path of the folded horn to come out the open bottom of the enclosure which is raised off the floor. Another version of this system rests flush on the floor, with bass coming out of the sides.

cotton pile directly contacted by the rigid (high impedance) end of the stick (point source of energy) would actually move, because the compliance (low impedance) of the cotton would quickly dissipate the energy without moving the rest of the pile. An analogous impedance and area mismatch accounts for the poor energy transfer between inadequately baffled speakers and the surrounding air.

The horn enclosure remedies this situation. At the horn apex, the speaker works against a small and confined body of air, whose relative incompressibility more nearly matches the speaker's own acoustic impedance. It is as if the air were solidly attached to the speaker cone, accepting throughout itself the full measure of every move. The cone is then said to be properly "loaded" and maximum energy transfer takes place. Such cone loading also aids speaker damping since it gives the speaker something "solid" to work against. This results in good transient response and clean over-all sound.

Once the air at the apex is activated by the speaker, the excitation propagates itself down the horn, whose flare provides a gradual and continuous impedance change to the low terminal impedance at the mouth. There the sound flows into the listening room with a minimum impedance step and minimum energy loss.

Small horns have been used on phonographs ever since Edison. But only a very gradual taper—and hence a very long horn

—and a wide mouth diameter provide sufficiently low bass. To qualify as hi-fi, a straight horn would have to be about 16' long and 12' wide across the mouth. In the early days of talking pictures, such monsters were actually installed behind the screen! Horns did not get housebroken until 1940, when Paul Klipsch of Arkansas patented his idea of folding the horn on itself and arranging it within an attractive enclosure. Klipsch also saves space by letting the sound emerge at the sides and setting the horn into a corner, so that the walls of the room act as extensions of the horn itself. Most horn enclosures currently on the market are direct offsprings of the original "Klipschorn," which still ranks at the top of its clan.

Designs for Home Use

Variations and simplifications of the original Klipsch design have been devised to reduce price and size. In addition to the large "Klipschorn," Klipsch himself produces the excellent "Shorthorn" economy model. Among the other moderate-sized horn enclosures are the Electro-Voice line and the Cabinart "Rebel" series. The Brociner "Model 4" horn provides both front and back loading to its special speaker.

Many of these later horn adaptations do not require multiple speaker systems, as do full-sized horn installations, but permit the economy of a single wide-range speaker or a coaxial speaker. The speaker is then mounted on a front panel hole so that

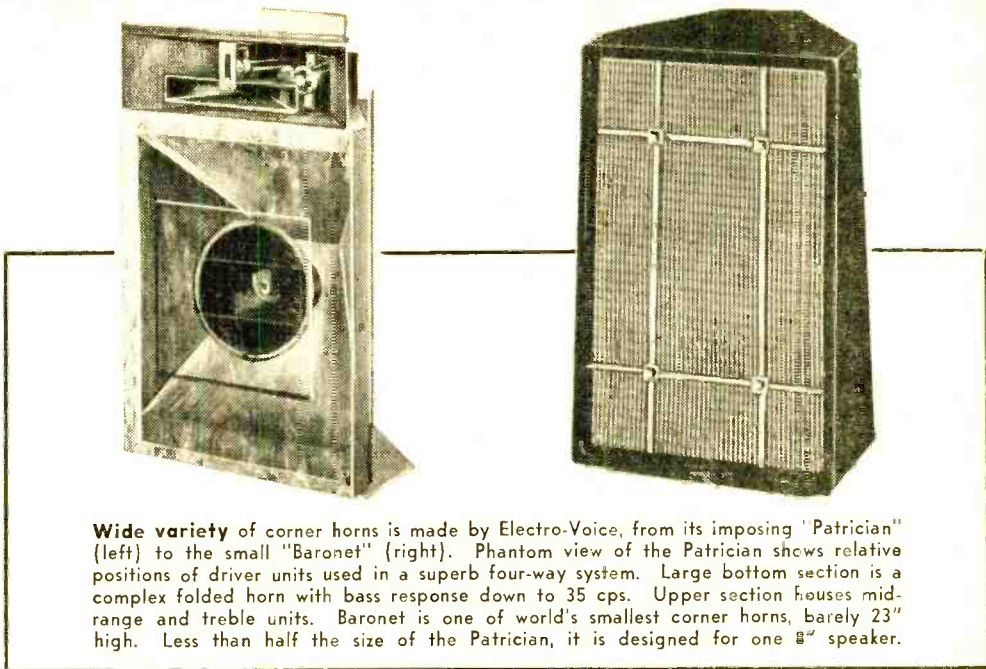

treble radiates directly from the front of the speaker while only the bass of the back wave is used to energize the horn. However, this combination of direct frontal radiation and rear horn loading is a compromise in which, for the sake of balance, the efficiency of the horn must be reduced to the efficiency of the frontal direct radiator. This necessary curtailment of horn efficiency naturally entails some minor increase of distortion (though often negligible) as compared with a true, front-loaded horn.

Placement and Choice

The position of speaker and enclosure in the listening room has a decisive effect on the tonal result. In most horn-type baffles, corner placement is mandatory. Yet any type of baffle sounds far better when placed in a corner. The reason for this is that mirror images of the sound source form on the walls, enlarging the effective radiation area and aiding in the generation of long wavelengths without bouncing the sound directly back into the speaker. Besides, corner placement assures uniform treble distribution over the entire listening area.

Choice of a particular enclosure for a particular situation usually depends on the available speaker. Some speakers—for instance, the Bozak woofer—work best in infinite baffles. Altec-Lansing recommends bass reflex enclosures for its speakers, while Electro-Voice and many others favor

some version of the folded horn. Finally, there are the contingencies of available space and cash to add to the hi-fi enthusiast's "bafflement."

Recent enclosure types . . . which combine the features of bass reflex, infinite baffle, and folded horn, or which use new design principles . . . will be examined in the next article in this series. —30—

Cutaway view reveals complexity of original Klipschorn. This enclosure is credited with providing speaker response down to 25 cps with only a 10-watt amplifier driving it. Simpler versions, many in kit form, are available at moderate prices.

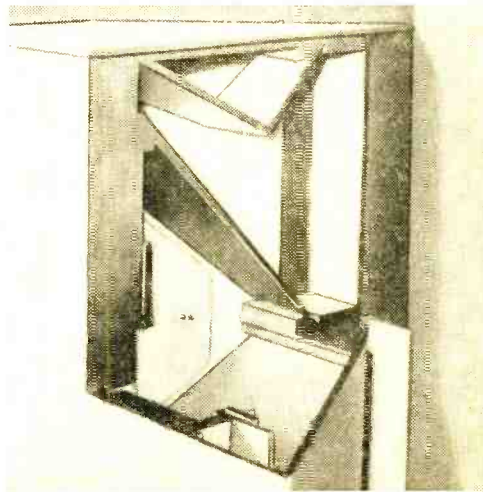



Berlant "Broadcast Recorder" is one of many top-quality tape machines requiring an external amplifier and speaker for playback.

By R. S. LANIER

*The secret of making
good recordings
is to make the right
connections first!*

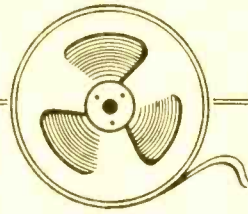

Recommended Tape Recorder Hookups

WHEN you bring home a tape machine, you naturally want it to settle into a comfortable, happy life with the rest of your sound system. In the first article in this series (POPULAR ELECTRONICS, March, 1956), some important rules for doing just that were explained. Briefly, these were:

1. Signals fed into the tape recorder must be strong enough to modulate the tape fully, but without distortion.

2. The impedance of any input to the tape machine must be considerably higher than the output impedance of the signal source before the interconnection.

3. The signal to be recorded should be flat. If it goes through tone and loudness controls on the way to the tape, it may become distorted when it passes through these controls again on playback.

How can these rules be applied, using representative commercial equipment?

Tape Recorder Inputs

The majority of tape machines used at home today are of the "all-in-one" type, with recording and playback functions, power amplifier, and speaker all in a single package. Such a machine may have one input jack, marked "Radio-Phono-Microphone," or some other such all-inclusive legend. This means that the input is high-

level, requiring a signal of about $\frac{1}{2}$ to 2 volts. Such an input is also high-impedance—100,000 ohms or more. No other type of input could handle all the signal sources listed. What's more, the phono and microphone used would have to furnish signals that are high-level and come from a high-impedance source.

Now, the impedance of any input and the signal level for which it is designed are basic facts that you must know in order to combine the tape machine properly with other electronic components. If these facts are not clear from the markings on the unit, get them from specifications or by asking the manufacturer or the dealer who sold it to you.

Many tape machines have two input jacks—one marked "Microphone" and another marked "Radio-Phono." Usually, the mike input is high-impedance but low-level, useful for signals as low as 5 millivolts. If you feed a 2-volt signal into such an input, the first stage of the amplifier in the tape recorder will become overloaded. Serious distortion will result—and there will be no way of curing it. The tape's volume control will not help because it comes after the first audio stage. Hence, you must know how big the incoming signal is, and further, what kind of signal a

particular input is intended to accept. In this case, you would, of course, use the other input—marked "Radio-Phono"—which is a high-level input.

Off-the-Air Recording

The easiest way to record a radio program onto tape is to connect the radio's loudspeaker voice-coil terminals to the high-level tape input. This method has two advantages: first, it enables you to use ordinary lamp cord, since the low-impedance source at the speaker terminals makes the connecting wires insensitive to hum. Second, it permits a maximum transfer of signal voltage from the radio to the tape recorder with no drain on the receiver's power, inasmuch as the low-impedance source will be feeding into a high-impedance input at the tape machine.

To make such a connection, fit a pair of alligator clips onto one end of the lamp cord, and a suitable plug to the other end. The clips go on the speaker terminals, the plug into the tape recorder.

This voice-coil clip-on method works well because the voltage across the voice coil in an average receiver happens to be the right amount—about 2 volts at 1-watt power output. Don't disconnect the radio's speaker; usually the receiver needs the speaker load to work properly. If you want to be able to cut out the speaker during recording, wire in a switch and a dummy load, consisting of a resistor equal to the speaker impedance. Better yet, use an adjustable pad, so that you can set the volume in the speaker at any level you want and still feed maximum signal strength into the tape recorder (see Fig. 1).

If you are experimentally inclined, and want better quality in your off-the-air recordings, take the radio signal from a point ahead of the receiver's output stage. This will avoid the distortion which is almost always present in the output stages of low-priced sets. Some good take-off points are shown in Fig. 2. These are high-impedance points. To use them without upsetting the radio's operation, the take-off point must be connected to a very high impedance. Two ways of doing this—using the large series resistor or the cathode-follower tube—are shown in Fig. 3. The cathode follower method, while more complicated and expensive, has the added advantage that its own output impedance is low. This permits using a long cable between it and the tape recorder. With the series resistor (cheap, but effective), the cable should not be more than 3' long.

If you use either of these methods, be sure you get enough signal to drive the tape recorder. Consult specifications to

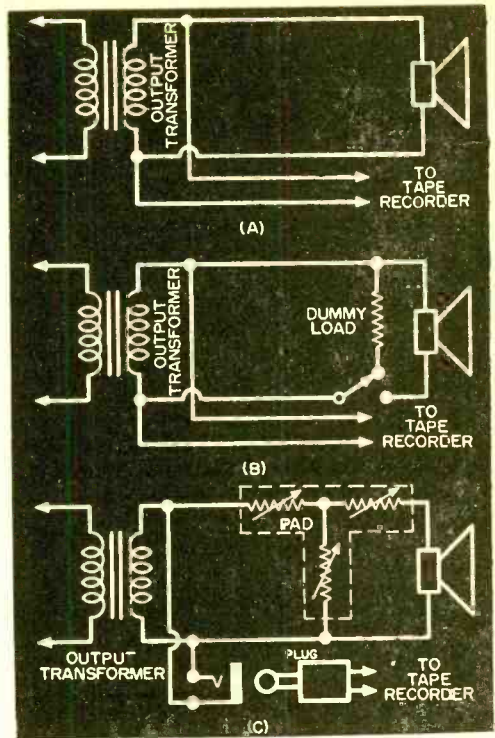

Fig. 1. Three ways of taking radio signals for tape recording from the radio's own speaker connections. See text for details.

learn what signal you can expect at various points in the receiver. Generally, you can expect about $\frac{1}{10}$ to $\frac{1}{2}$ volt at the detector, and 10 to 20 volts at the grid of an output tube.

Phono Disc to Tape

To tape-record a phono disc played with a high-level pickup (crystal or ceramic), plug the phono's output into the high-level input jack on the tape machine.

If your phono uses a low-level (mag-

Fig. 2. Two take-off points in a radio, before the speaker, which will provide clean signals.

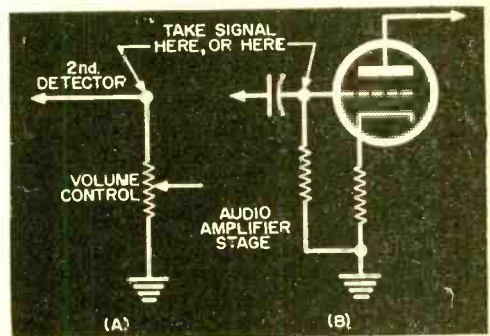

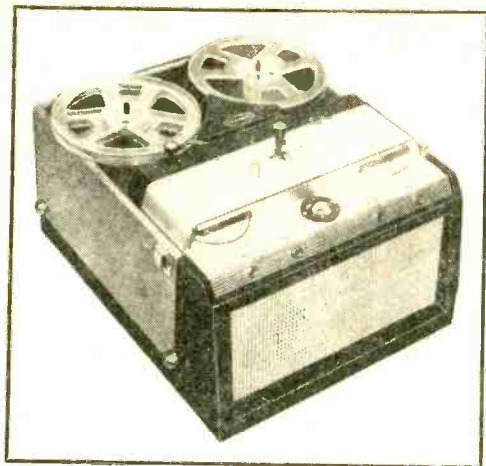

This "all-in-one" tape machine (Pentron "Pace-maker") has its own power amplifier and speaker, but can easily be connected to hi-fi components for best results in home recording and playback.

netic) pickup, its signal must first pass through a phono preamp-equalizer, just as it would for ordinary listening. The output of this preamp may then be fed into the high-level input on the tape recorder.

If the low-level phono preamp is already plugged into a radio, or if the high-level phono is plugged directly into a radio, or even if the phono is part of a radio-phono combination set, you can use the procedure outlined above for taping radio programs. Phonos that are part of a hi-fi system using separate components (tuner, amplifier, etc.) may be tape-recorded by following the rules listed below under "Tape in the Hi-Fi System."

There are *some* tape recorders which provide an input solely for the signal from a magnetic pickup, with phono equalization built right into the tape machine. If your recorder has such an input, you may plug the low-level phono signal directly into it.

Playing Back the Recorded Tape

The "all-in-one" machine has its own power amplifier and speaker. A flick of a switch, and the unit is ready to play back what has been taped. In addition, most of these machines have two other outputs. One permits connection to an external speaker; the other permits feeding the tape signal to an external amplifier. The latter connection (usually a cathode follower before the final amplifier stage in the tape machine) is the best one to use for feeding tape playback into a hi-fi system. In such a situation, the tape playback signal can be compared to the signal from a tuner being fed into a hi-fi system.

Handle it the same way—simply connect it to an appropriate input jack on the amplifier.

A so-called "professional" tape machine (or "tape deck") has recording and playback heads and preamplifiers—but no power amplifier or speaker of its own. To listen to this machine, you *must* connect its output to an external amplifier and speaker. For those who do not need the on-the-spot playback and portability of the "all-in-one" machine, the professional tape deck is a wise choice for use in a home hi-fi system—particularly when tuner, amplifier, etc., are of fairly high quality.

Signal output of a tape deck is similar to the output of the all-in-one tape machine when the latter's output is taken from the jack marked "External Amplifier." This high-level, low-impedance signal is what we will mean, from now on in this article, when we speak of "tape output."

Tape in the Hi-Fi System

A typical hi-fi system includes a record player, a radio tuner, preamplifier-control unit, power amplifier, and speaker. The preamp-control section may be a separate unit, or part of the tuner, or part of the power amplifier. In any case, it usually has input jacks for the following: magnetic phono pickup; crystal or ceramic phono pickup; radio tuner; tape; and a

Fig. 3. Either of the signal points shown in Fig. 2 can be connected to a tape recorder by either of the hookups shown below. The circuit in (B) is more costly and complex, but provides top results.

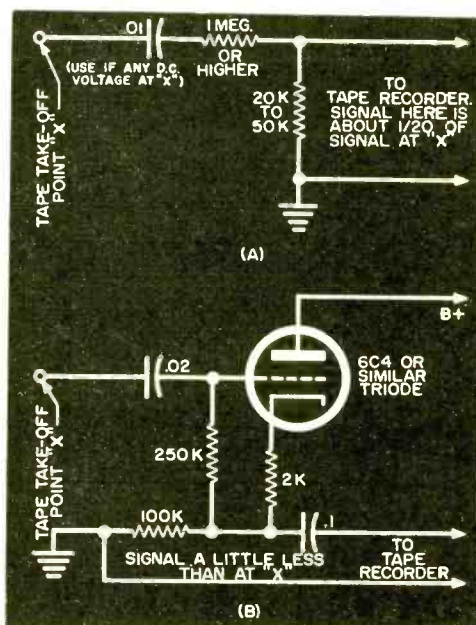
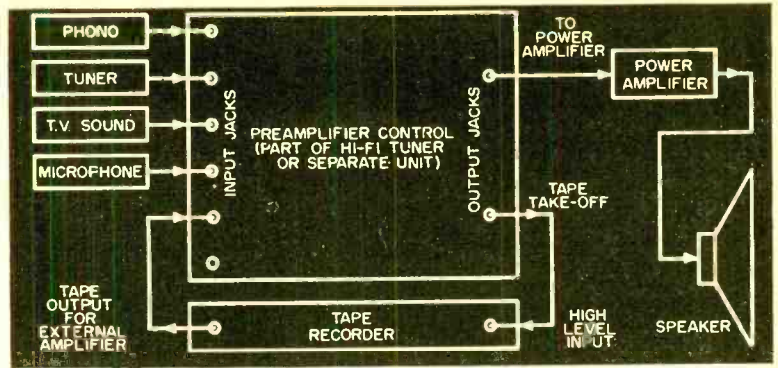

Fig. 4. This shows how several program sources may be plugged into a hi-fi preamp. Note how the tape recorder fits into the picture. Selector switch on preamp chooses any signal for recording, or listening, or both.



spare high-level source (such as TV sound or microphone).

Newer models have two outputs: one for connecting to a power amplifier (or speaker if the power amp is on the same chassis as the preamp); and a second—before the last preamp stage—for feeding the program source into a tape recorder. For convenience, let's call this the "tape take-off point."

To set up the system so that you can record any program source as well as listen to tape playback via the hi-fi amplifier and speaker, simply make the connections called for by the labels on the jacks (see Fig. 4). Connect the "tape output" to its correct input jack on the hi-fi preamp. Connect the preamp's "tape take-off point" to the high-level input ("Radio-Phono") on the tape recorder. Now, to listen to any program source, proceed as you would normally by using the selector switch on the preamp. If you want to tape-record this program, simply turn on the tape machine's power switch, and move its "Play-Record" switch to "Record" position.

Here are a few cautions which will insure better results: first, you may have two volume controls in the signal path—one in the preamp and one in the tape recorder. Therefore, follow the "no loafing" rule. Don't set one control way down so that part of the system is loafing, and the other control way up to get the signal back. This will only raise the noise level of your recordings. Keep all amplifying sections as fully and evenly loaded as possible.

Second, while you are recording, watch for a reduction of signal level when you turn down the preamp's volume control for comfortable listening. This reduction may occur if the "tape take-off point" comes after the preamp's volume control. If you can't tell about this beforehand—from the instructions supplied with the equipment—your best bet is to watch the signal level

indicator on the tape recorder while you operate the preamp volume control.

Third, check to see if the signal being taped is passing through tone and loudness controls in the preamp. It shouldn't, if the preamp is designed correctly. If it is, a change is definitely in order. This change requires some circuit-gimmicking, and will be discussed in a later article in this series.

Finally, don't ever select "Tape" on your preamp with the tape machine in "Record" position. Always turn the tape machine to "Play" position before turning the selector switch on the preamp to "Tape." Otherwise, a furious positive feedback loop can be set up which will create wild howls.

Input Level Controls

Many preamps have level controls for each input jack. You can adjust them to control the incoming signals from the various program sources. Such adjustments help assure that any signal being taped will arrive at the tape recorder at a comfortable level. "Comfortable level" may be defined as being strong enough to modulate the tape fully with the tape machine's volume control turned two-thirds or three-quarters of the way up.

For playback, make sure that the tape output signal is not too high for the preamp input to which it is connected. If it is too high, it may overload the first stage of the preamp and distort what you are trying to hear. Use the preamp input level control to control such a signal.

Connecting a Microphone

A high-level microphone may be plugged into a suitable input jack on the preamp and selected like any other program source. By turning the selector switch to the position which selects that particular input jack, and putting the tape machine into "Record" operation, you can speak into the microphone and be taped.

Another way of using a mike for tape
(Continued on page 115)

Tuning the Short-Wave Bands

=with Hank Bennett

THIS MONTH we dedicate our short-wave column to all those who have written in asking for more information on how to become an SWL. Judging from the mail, quite a number of readers would like to join the SWL ranks but don't quite know how to go about it.

First of all, SWL means "Short-Wave Listener." You do not need a license to become an SWL—only a receiver that is capable of tuning in short-wave (s.w.) stations.

There are no rules written that specify what you have to do to become an SWL. To put it very simply, you are an SWL as soon as you have switched your receiver onto the s.w. bands and have picked up a s.w. station. An inexperienced SWL should have no trouble in hearing some of the higher-powered European stations such as London, Oslo, Stockholm, or Paris; he probably would be able to get Moscow, Brazzaville, or *Radio Australia* without too much effort. A more experienced DX'er would be able to pull some of the harder stations through, such as Kuwait, Delhi, Sao Tome, or Forest Side. As in most everything, you have to start with the easy ones, become used to all forms of QRM (symbol for interference) and conditions, and in time—with patience—you'll be able to get those hard ones.

In addition to having a s.w. receiver, you should have a clock or watch that is accurate,

and a handy reference book. When you begin sending reports to stations, you have to include program details, musical selections, and announcements with the time shown for each item. If you are accurate in your listings, it might help you to receive a quicker reply. As for a reference book, the best currently available is the *World Radio Handbook*, distributed by Gilfer Associates, P. O. Box 239, Grand Central Station, New York 17, N. Y. Priced at \$2.00, this book is practically a "must" if you are going to DX. It contains station addresses, identification signals, schedules, and slogans.

Many readers have asked about SWL cards. Probably the primary purpose of these cards is card-swapping. Over a period of time, one can collect quite a number of them, ranging from billfold-size to larger-than-postcard size. The average card is about postcard size and contains information about the DX'er's equipment. Many of them bear call-letters of the SWL. This latter item is merely "SWL-W6" or "W1-SWL," or nearly any formation of letters showing that the owner is an SWL in a certain radio call area. (See call area map of Canada and USA in my next column.) It is important, however, that your card have a hyphen between the call area and the "SWL" to denote that you *are* an SWL, because the Federal Communications Commission has issued licenses to amateurs in certain areas with call letters of W2SWL, W6SWL and W9SWL. Probably the best method to employ when ordering your cards is to have them printed with the "SWL" first, e.g., "SWL-W5." Then you won't receive any complaints from amateur operator "W5SWL" that you are "borrowing" his call letters.

With regard to card printers, a goodly list can be found in the classified ads in *QST* magazine. Several of the printers require that you send a dime when asking for samples; this dime is usually refunded upon receipt of an order for cards. One of our own group is currently printing SWL cards that are certainly first-rate. He is Floyd Backus, 5318 Walker Avenue, Richmond 28, Va.

In the above paragraphs I have only skimmed the top of the SWL subject. Should you have any questions, please don't hesitate to write. I'll help you as much as I can.

Station Reports

Because of the large volume of mail that has been received during the past month, it will be necessary to omit several reports due



Bill Rose, Jr., of West Point, Miss., stands beside his Hallicrafters portable short-wave receiver.

to space limitations. If your report isn't included, kindly bear with me. All times shown are Eastern Standard, 24-hour system.

Albania—Shkoder, 8215 kc., 200 watts, has been heard afternoons around 1330 with an all-Albanian mixed program. (GC)

Angola—Radio Angola at Luanda is fair-to-good some days at 1600-1630 on 11,860 kc., with popular music and Portuguese songs and music. The call is *Aqui Radio Angola, Emissora Especial*. (PM)

Argentina—LRA, Radio del Estado, Buenos Aires, 9690 kc., is still carrying news in Spanish, Portuguese, German, Italian, English, and French (10 minutes of each) at 2100-2200. The s/off is at 2200. This transmission is parallel to 6180 and can be noted earlier at 1700-1800. (RH, JH, GN)

Australia—VLA11, Melbourne, 11,900 kc., has replaced 11,740 kc. with English in the S. E. Asia service, daily at 1130-1230, with a resulting increase in signal strength in Western USA. VLC9, 9615 kc., Melbourne, is beamed to North America at 0700. This xmsn begins with the laughing call of the Kookaburra bird, followed by the chimes from the Melbourne Post Office. VLC9 is also noted at 1030 with news to Western North America. (JB, SG, BW)

Austria—Radio Osterreich, Austria, transmits daily in English from Vienna between 0600-0700 over OEI38, on 25,615 kc., with 20 kw. This news is from the President of the Austrian DX Club. QSL's should be sent to the Austrian DX Club, Landgutgasse, 41/19, Vienna 10, Austria. (BH)

Brazil—Radio Brazil Central, Goiania, is now heard on 11,815 kc. regularly at 1800-2200, dual to 9755 kc. (RL)

British North Borneo—VS4S, Radio Sabah, Jesselton, can be heard on 7237 kc. on the following schedule: 0430-0515, Chinese; 0515-0600, Malay; 0600-0700 s/off. in English. This one runs 250 watts and requires patience in logging. (PF)

Ceylon—For anyone not having Ceylon, here is a good one: Commercial Service of Radio Ceylon from Colombo can be tuned on 11,760 kc. with American recordings at 2030 on Mondays; BBC news relay after 2100 station announcement; s/off at 2200. (ER)

China—Radio Peking is noted on 11,300 kc. at 0300 with English news, read by a woman; music follows to 0320, at which time they present a commentary. At the 0330 closing, the woman gave the schedule as 2200, 0400, and 0930 for English. The outlet on 11,650 kc. is usually weaker with c.w. QRM. (GC)

11. — **Costa Rica**—TIFC, Faro del Caribe (Lighthouse of the Caribbean), 9647 kc., San Jose, carries English on Monday through Thursday and on Saturday at 2300-0000, Friday ONLY at 2300-2330. This period is dual to 6037 kc. All programs on both 2-kw. xmtrs are missionary and religious. (JB, BE)

12. — **Cuba**—Radiocentro CMQ, Havana, is audible on 9670 kc. at 2130-0030. This one cannot be heard earlier due to heavy QRM. They announce as CMQ Radiocentro La Habana. Included in a verification was a QSL from the radio and TV stations of CMQ. (LM)

Egypt—Cairo has English as follows: to S. E. Asia at 0745-0815 on 17,765 kc. and at

1300-1700 on 9475 kc. to Europe (both xmtrs are 100 kw.). The 9790-kc. channel is currently not in use to North America. Weekly program of week's top song hits can be heard around 1315 on 9475 kc. They are asking for reports. (SG, BJ, JM)

Cairo also schedules Arabic to North America at 1900-2000 on 6215 kc. (BJ)

French Equatorial Africa—Radio Brazzaville, 11,970 kc., can be heard easily at 1445-

BAD KREUZNACH, GERMANY
SIG. CO. APO 42

DL-SWL/M

30 DECEMBER, 1955...

BRITISH TAP RECORDING AND BROADCAST LISTENING POST
3 BELL HILL DANBURY
CHELMSFORD ESSEX
ENGLAND

G SWL

Member ISWL (London) 1955

ATLANTA 6, GA.

W4-SWL

ADIC	Special New York U.S.A.	LAS
WYBBA		LAC
DCC (4)	3 Canal Zone	VAS
LAZ		VAC
VAZ		

K2-SWL

Radio WQPN Hrd U call / work — at 1800 EST
On — Mtrs. 1/43 1956 Ur mgr RST 549 QRM — QRM —
Receiver: Hallicrafters EC3 Atlanta 15 Meter Vee Remarks
HERE'S MY NEW CARD, THANKS.
CONDN: F.B.

PSE QSL THX 73 DE *Red Hatter* / BOB HATTER
— 25WL

These SWL cards give an idea of general card layout and show how "call" is usually printed.

2100. English newscasts were noted at 1445-1500, 1545-1555, and 1845-1900. French news has been tuned in at 1555, with s/off at 1600, and return to the air at 1605. Many good musical programs have been noted evenings between newscasts. (RJ, KA, BW, SG, GA)

Radio AEF, Brazzaville, has moved from 9965 kc. to 9935 kc., and is heard well afternoons around 1430. (GC)

French West Africa—Radio Dakar, 5960 kc., is noted at 1730-1815 with an English period at 1745-1800 to Gambia, Gold Coast, and Sierra Leone. This one may be difficult because of usually heavy QRM. (EK)

Haiti—4VEH, La Voix Evangelique, Cap Haitien, 9656 kc., 3 kw., has English daily except Thursday at 0800-0930. This station carries religious programs. (JB)

India—If you haven't added India to your log as yet, try the External Services of All- (Continued on page 123)



THE TRANSMITTING TOWER

Herb S. Brier, W9EGQ

ALL AMATEURS know the importance of tuning a transmitter correctly. In fact, it appears that the less they know about how to do it, the more time they spend trying to tune their transmitters.

When a radio receiver is being tuned, turning one knob selects different stations; if it is not correctly adjusted, the sounds emitted by the loudspeaker will be distorted. Turning another knob makes the sounds heard louder or softer, and turning still other knobs have immediately observable effects. Therefore, without any idea of why it happens, proper tuning of a broadcast receiver is easily accomplished.

But in tuning a transmitter, one normally depends upon the movement of the pointer of a meter to tell the effect of each adjustment. What makes this difficult is that sometimes the correct adjustment is indicated by the pointer swinging upward, and at other times it is indicated by the pointer swinging downward. To learn how to tune a transmitter intelligently, it is necessary to learn enough about transmitter operation to be able to interpret the meter readings correctly. Fortunately, doing so is less difficult than splitting an atom with a meat cleaver, although it is a bit more difficult than peeling a banana.

Figure 1 is the diagram of a crystal-controlled oscillator often used by amateurs. With the addition of a power supply and a

suitable antenna, it forms a practical, low-power code (c.w.) transmitter, capable of transmitting a signal over 1000 miles or more under favorable conditions. More important for our purpose—once you understand its operation, you are well on the way to understanding the operation and adjustment of any transmitter, no matter how complicated it may appear.

How A Transmitter Works

At the left of the diagram is the crystal, which controls the transmitter frequency. It is a precisely ground piece of quartz about 1/2" square mounted between metal plates in a plug-in holder. If a pulse of voltage is applied across its plates, the crystal will flex in a direction determined by the polarity of the voltage. Then, it will unflex in that direction and flex in the opposite direction. This mechanical oscillation will continue at a frequency determined almost entirely by the crystal dimensions, especially its thickness, until the energy imparted to the crystal by the exciting pulse is dissipated.

Now comes the reason that the crystal can control the frequency of a transmitter. As it oscillates mechanically, an alternating voltage is generated across its surfaces. Because the crystal is connected between the control grid of the tube and ground, this voltage is impressed on the grid. There, it causes the cathode current of the tube to vary at the oscillating frequency.

The cathode current flows through the radio-frequency choke in the cathode lead and generates an alternating voltage on the cathode and C1. From the cathode, part of this voltage is fed back to the crystal via C2, to keep it oscillating.

If you are wondering where the first voltage pulse to kick the crystal into oscillation comes from, that is easily explained. As the electrons flow from the cathode towards the screen grid and plate inside the tube, a few of them strike the control grid and create a voltage disturbance on it that is sufficient to shock the crystal into oscillation. Incidentally, it is not necessary to have plate voltage on the tube to sustain oscillation. The screen current alone is sufficient.

Examining the diagram closely reveals that there is no external source of grid bias for the tube. Instead, on the positive swings of the oscillating grid voltage, the grid draws current. This current flows through resistor R1, and the voltage drop across it becomes the operating grid bias. This type of bias has

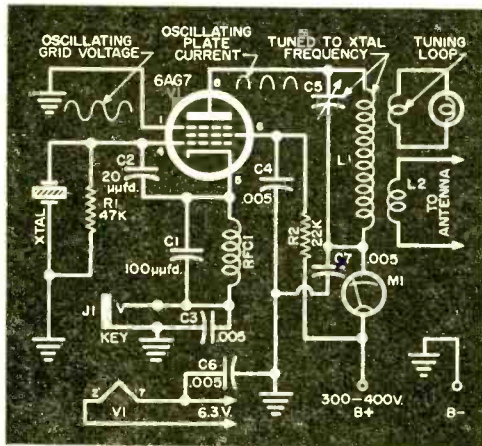

Fig. 1. Diagram of a typical, crystal-controlled oscillator. With power supply and antenna, this oscillator forms a practical, low-power c.w. transmitter, operation of which is discussed in the text.

the advantage that it is self-adjusting to the amount of excitation available, but it has the disadvantage that no bias is developed if the circuit is not oscillating—and the tube draws excessive plate current.

Crystals can be ground to oscillate at frequencies up to 30,000,000 cycles per second (30 mc.). However, such crystals are very thin and fragile; therefore, most crystals for amateur use are ground for the 3.5- and 7-mc. bands. For higher frequency operation, a frequency multiplier is used after the oscillator.

Plate Tank Circuit

Following the oscillating plate current from the tube, we see that it flows through the parallel-tuned circuit consisting of *C5* and *L1*. One of the characteristics of such a circuit is that it represents a very high impedance at its resonant frequency, but to currents of other frequencies it represents a very low impedance. Consequently, when it is tuned to the crystal frequency, the plate current flowing through it produces a large voltage drop across the circuit.

As the total voltage available is that delivered to the circuit by the power supply, the drop in voltage across the tuned circuit reduces the actual instantaneous plate voltage by the same amount. This limits the height to which the plate current can go on positive peaks when the tank circuit is tuned to resonance.

On the negative half-cycles, however, the plate current decreases; it may actually be cut off (reduced to zero) over an appreciable part of the negative half-cycle if the grid is driven sufficiently negative—and it usually is in transmitter oscillators. As a result, the plate current flows as a series of spurts, one spurt per cycle of grid voltage.

The above action explains why instructions for tuning a transmitter usually include something like: "Tune the plate circuit to resonance as indicated by a sharp dip in plate current." The limited peak current that can flow on the positive half-cycles, combined with the zero plate current on the negative half-cycles, reduces the average plate current when the tank circuit is tuned to resonance.

The spurdy signal delivered by the plate of the oscillator tube to the tank circuit is obviously far from being an undistorted sine wave. But it is smoothed out by another characteristic of the resonant tank circuit. It does not burn up the power that is fed into it. Instead, the power is converted into an oscillating current that flows back and forth between the coil and the capacitor at the frequency of the excitation pulses. At the same time, an alternating voltage appears across the circuit, and during the process practically all of the spurdy characteristics of the exciting pulses are removed, to produce a virtually distortionless sine wave.

This action sounds a great deal like what happens in an oscillating crystal. doesn't it? Actually, the coil and capacitor do electronically what the crystal does by electromechanical or piezoelectrical means. Furthermore, such a resonant circuit could be substituted for the crystal, and the circuit would



This neat setup at KNØCRV uses a WRL "Globe Scout" transmitter, Hallicrafters S-40B receiver.

perform almost exactly as described here.

The difference would be that the oscillating frequency would change if either the inductance or the capacity were changed. Unfortunately, vibration, heat, aging of components, and variations in tube voltages and circuit loading—among other things, all of which have very little effect on a crystal oscillator—will completely destroy the stability and purity of the signal emitted from a variable-frequency oscillator (v.f.o.). Also, it is all too easy to get off frequency with such an oscillator; this is the main reason why Novices are required to use crystal-controlled transmitters.

Tuning Loop

We now need a tuning loop. It may consist of a two-turn loop of stiff, insulated wire about the diameter of *L1* and a 6.3-volt, 0.25-ampere pilot bulb. Solder one end of the loop to the metal tip of the bulb and the other end to its metal shell. Tape a wooden or plastic rod about six inches long to the loop as a handle.

Bring the loop near one end of *L1* and parallel to it, and the bulb will glow. Obviously, it is absorbing power from the circuit. As the bulb gets brighter, the plate milliammeter *M1* will read higher, showing that power is being drawn from the power supply to replace that consumed by the bulb.

Now, hold the loop near *L1* and detune *C5* from its resonant setting. Immediately, the plate current will increase, but the bulb will dim and go out. Moral: do not operate any transmitter stage with its plate tank circuit detuned. Doing so reduces output and will usually ruin the tube in a short time.

If the low-impedance feed line of a half-wave doublet antenna (see *Transmitting Tower*, December, 1955) is connected to *L2*, it will extract energy from *L1* in the same manner as the tuning loop. Varying the number of turns in *L2* and their spacing from *L1* will determine how much power the antenna will absorb. They should be adjusted for rated plate current when *C5* is resonated or until

(Continued on page 116)

AFTER CLASS

GAS-FILLED DIODES

THE HEAD of a great electronics laboratory was once asked what quality he considered most important in his engineers.

"Technical dissatisfaction," the lab boss answered promptly. "After he finds ways of doing something well, a good engineer still dreams of doing it better."

The evolution of the gas diode is due—at least in part—to this never-ending effort to make good things better. Although the standard vacuum tube does an admirable job in literally thousands of applications, it shows an understandable reluctance about doing things beyond its design capabilities.

Take, as an example, rectification. A vacuum diode makes a fine rectifier in low-current circuits. But the moment the current demands are increased, the voltage drop across the tube rises, and output voltage falls off. Thus, a variation in load produces a varying, unregulated voltage.

But when a gas such as mercury vapor is introduced into the tube, the problem of unregulated voltage comes close to solution. Electrons moving from the cathode to the anode collide with gas molecules and knock electrons out of their atomic orbits. The atoms that lose electrons become positively charged and move toward the cathode of the tube. These charged atoms, called *ions*, act as provisional carriers of electricity. They increase the conductivity of the space in the tube, which is another way of saying that they lower its internal resistance. As the current demand in-

creases, more and more ions are formed, and the resistance goes down and down.

If you apply Ohm's law, you can see what effect this must have. In an ordinary circuit containing a resistance through which a current flows, the voltage drop across the resistance can be figured by the equation: $E=IR$. If the resistance remains constant, an increase in the current (I) must result in a larger voltage drop (E).

But what happens if the resistance decreases proportionately as the current increases? If, say, the initial current flowing through a resistance of 100 ohms is 2 amperes, then the voltage drop across the resistance must be 2×100 , or 200 volts.

Assume that the current then rises to 4 amperes but—at the same time—the resistance drops to 50 ohms. The IR formula gives you 4×50 , or 200 volts, as before.

For these conditions, then, the voltage drop remains unaltered even though the current has changed. A power supply incorporating a rectifier that has such fluctuating resistance would provide much better voltage regulation than one using a fixed-resistance vacuum tube. A typical mercury-vapor full-wave rectifier such as the type 83 develops a constant voltage drop of approximately 15 volts over a load-current range of anywhere from 25 ma. to over 200 ma. Tubes like this make it possible to construct power supplies with excellent regulation.

Now, while a gas diode can "sense" current variations and make suitable adjust-

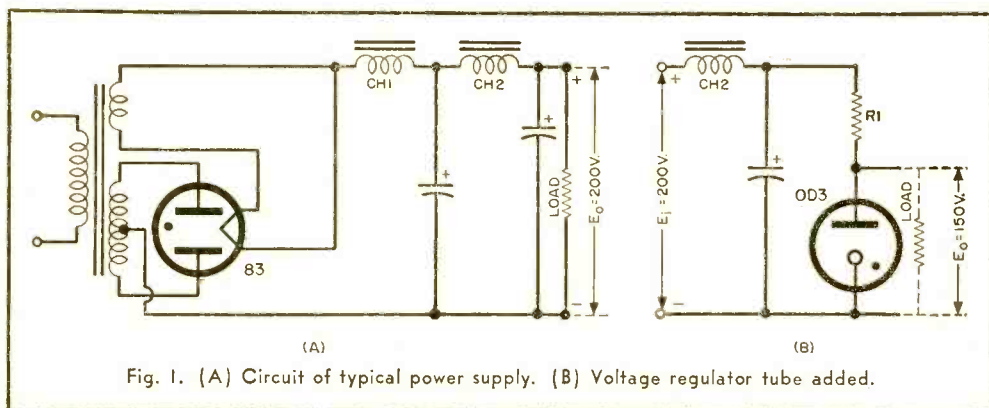

Fig. 1. (A) Circuit of typical power supply. (B) Voltage regulator tube added.

ments, other elements in a power-supply circuit still have to be reckoned with. Figure 1 (A) illustrates a common type of full-wave power supply using a mercury-vapor rectifier. Although this tube makes a substantial contribution to the stability of the supply, the constant resistance of the filter chokes (*CH1* and *CH2*) is still present in the circuit. Hence, changes in load that cause varying drops in potential across these components will still be responsible for serious output fluctuations.

But once more the constant-potential characteristic of a gas-filled tube comes to the rescue. This time it appears in the form of a cold-cathode tube filled with argon, helium, neon, or a combination of these gases. Having the voltage-juggling nature typical of its family, it may be connected into the output section of the power supply, as shown in Fig. 1 (B), to yield a usable voltage upon which moderate load variations have no appreciable effect.

Here's the way it works: The load resistor is preceded by a series resistor *R1* and a voltage-regulator diode such as the OD3. This is a cold-cathode diode (one requiring no heater voltage) and designed to maintain a voltage drop of 150 volts across its terminals. Assume for a moment that there is no external load on the circuit and that the resistance of *R1* permits about 40 ma. to flow through the voltage regulator tube. If the input voltage is 200 volts and the drop across the VR tube is 150 volts, the fall of potential along *R1* must be 50 volts at 40 ma. ($R = E/I = 50/.04 = 1250$ ohms).

Now, let's connect the load—a circuit which draws, say, 20 ma. This additional current must flow through *R1*. If nothing else happened, the output voltage would drop by 25 volts ($E = IR = .02 \times 1250 = 25$ volts). However, as soon as this additional voltage drop *tends* to occur across the series resistor, less voltage is applied

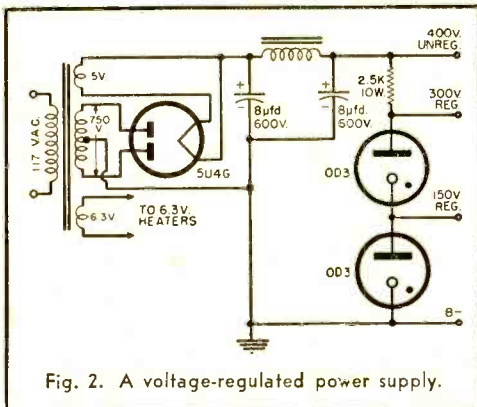

Fig. 2. A voltage-regulated power supply.

Type Number	Voltage Output	Operating Current (ma.)
OA3/VR-75	75	5-40
OB3/VR-90	90	5-40
OC3/VR-105	105	5-40
OD3/VR-150	150	5-40
OB2	108	5-30
OA2	150	5-30
OG3	85	1-6

Table 1. Characteristics of some VR tubes.

to the VR tube. Its current drops, and its ionization diminishes.

But this last effect causes its resistance to increase, as previously explained. The VR tube now draws less current than before, i.e., less than 40 ma.; in fact, the current through it will drop by 20 ma.—the same amount of the new current through the load—so total current through *R1* is again 40 ma. This holds the voltage at the terminals of the VR tube at 150 volts. In other words, the VR tube automatically adjusts its ionization level to a varying load and thus maintains a constant output voltage.

The list of popular VR tubes given in Table 1 shows that the highest output voltage available from a single tube is 150 volts. Output may be increased by connecting two or more regulator tubes in series. With the typical voltage-regulated power supply illustrated in Fig. 2, you could obtain approximately 400 volts of unregulated output, as well as 300 and 150 regulated volts.

QUIZ

1. What significant advantage does a gas-filled rectifier, such as the mercury-vapor filled type 83, have over high-vacuum rectifiers?
2. What else besides the internal rectifier drop may produce poor power supply voltage regulation?
3. To improve voltage regulation, what must the internal resistance of a rectifier do as the load current rises?
4. What is the heater voltage requirement of a VR tube like the OC3?
5. How many greater output voltages be obtained if common VR tubes develop a maximum of only 150 volts across their terminals?

(Answers appear on page 116)

A.C. POWER MEASUREMENT

MULTITESTERS and vacuum-tube voltmeters seldom have provisions for measuring alternating current but almost invariably have an a.c. voltage setting as well as the usual resistance and d.c. scales.

Suppose you want to measure a.c. power consumed by some device with such an instrument. If the apparatus is purely

(Continued on page 110)

TIPS and TECHNIQUES

KEEP COMPONENTS IN ORDER

When repairing or assembling a piece of electronic equipment, you can keep the resistors, capacitors, coils and similar small components in order for proper assembly simply by *taping* them to the top of your workbench. Use painter's masking tape,

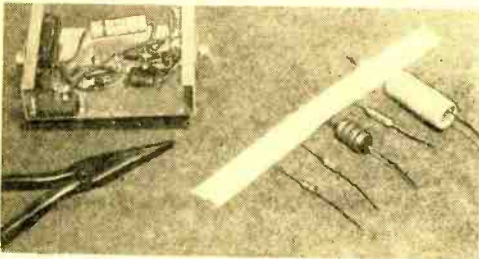

available at most hardware stores. This tape will adhere to virtually any surface but does not make a permanent bond. Nor will it leave a sticky residue on either the workbench surface or parts themselves.

If you are working on a rather large job, requiring more parts than can be conveniently arranged on the workbench top at one time, complete the job in easy stages—taping down only the few parts needed for each stage as you come to it.

This taping technique is also handy for keeping parts in order as they are removed from a piece of equipment undergoing major overhaul, permitting easy identification and reinstallation when the job is done.

MAKING SMALL-VALUE CAPACITORS

Readers who were interested in the article on rolling their own capacitors, which appeared in the January, 1956, issue of *POPULAR ELECTRONICS*, might note that they can also make small-value capacitors with excellent r.f. characteristics from a short length of coaxial cable, as shown in the diagram (A). The center conductor of the coax becomes the "inside foil," and the braided outer conductor—with a lead soldered to it to facilitate making circuit connections—becomes the "outside foil." The inner conductor can usually be loosened, and slipped in and out to vary the capacitance over a small range if desired.

A unit like this makes a good emergency

neutralizing capacitor for a screen-grid amplifier tube in a low-power transmitter. It also works nicely as an antenna coupling capacitor in a regenerative receiver when the antenna is capacitance-coupled directly to the grid circuit of the detector.

Small-value capacitors with low r.f. losses can also be made from 75- or 300-ohm twin line, as shown in the diagram (B). Each lead of the twin line acts as a

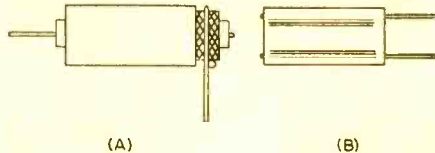
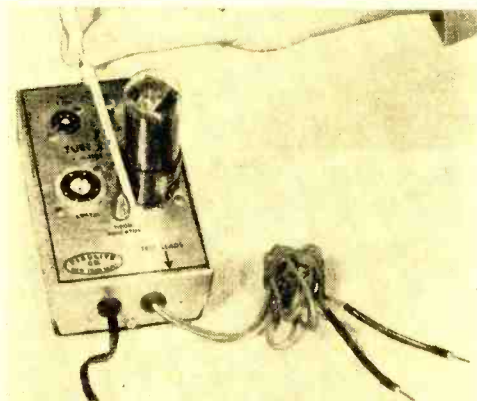

plate of a small capacitor. Units like these are useful where especially small capacitances are needed for coupling the oscillator to the grid of a mixer in a super-heterodyne receiver, coupling a beat-frequency oscillator to a detector, etc.

In the above units, increasing the length of the coax or the twin line increases the capacitance.

QUICK TUBE CHECKS

Small testers are now available for making quick checks to find tubes with open heaters. One such tester—about 5" x 3" x 1 3/4" over-all—is shown in the photo. Its line cord is plugged into a wall outlet and



a suspected tube placed in the proper socket. A good heater will cause the neon lamp to glow. Another pair of wires lets the neon lamp test tubes or special equipment independently of the sockets.

"PROFESSIONAL" SOLDERING

Your solder connections will look neater if you get rid of the excess rosin flux over and around the connection. Gently scrub the area with fingernail polish remover on a small piece of cloth or a pipe cleaner. Alcohol—in some cases, ordinary gasoline—will also work. A truly professional ap-

(Continued on page 98)

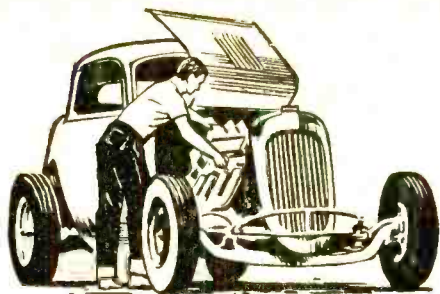

**MECHANICAL
SKILLS
CAN GET
YOU
AHEAD
IN THE
U. S.
AIR FORCE**

Here's why —

If you're interested in mechanics, join the U. S. Air Force. As an Airman you may develop your technical ability and learn a skill that will pay well...and win you extra stripes. Such interesting career fields as Aircraft and Engine Maintenance, Rocket Propulsion and Intricate Equipment Maintenance are open to you, if you qualify. Don't delay — see your local Air Force Recruiter or mail the coupon.



**YOU GO
PLACES
FASTER
IN THE
U. S. AIR FORCE**

**PASTE COUPON ON POSTCARD
and mail to**

M-19-PE3

AIRMAN RECRUITING INFORMATION BRANCH
BOX 2202, WRIGHT-PATTERSON AFB, OHIO

Please send more information on my opportunities for enlisting in the U. S. Air Force. I am between the ages of 17-34 and reside in U. S. A. or possessions.

NAME _____

ADDRESS _____ AGE _____

CITY _____ ZONE _____ STATE _____

build your own

HEATHKIT



... and have fun doing it!

Circuit boards cut assembly time in half

1% resistors insure instrument accuracy.

High impedance and high sensitivity.

Attractive styling—functional design.

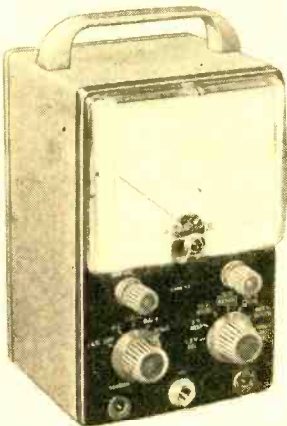

MODEL V-7A

\$24.50

SHIPPING WT. 7 LBS.

Every Heathkit comes complete with detailed step-by-step instructions and large pictorial diagrams that insure successful construction—even for the beginner. Enjoy both the satisfaction and the economy of "building it yourself."

etched circuit vacuum tube

voltmeter kit

In addition to measuring AC (rms), DC, and resistance, the modern-design V-7A incorporates facilities for peak-to-peak measurements. These are essential in FM and television servicing.

AC (rms) and DC voltage ranges are 1.5, 5, 15, 50, 150, 500, and 1500. Peak-to-peak AC voltage ranges are 4, 14, 40, 140, 400, 1400, at 4,000. Ohmmeter ranges are X1, X10, X100, X1000, X10K, X100K, and X 1 megohm. A db scale is also provided. Polarity reversing switch provided for DC measurements, and zero center operation is within range of the front panel

controls. Employs a 200 microampere meter for indication. Input impedance is 11 megohms.

Etched metal, pre-wired circuit boards insure fast, easy assembly and result in reliable operation. Circuit board is 50% thicker for more rugged physical construction. 1% precision resistors used for utmost accuracy.

Heathkit

HANDITESTER KIT



MODEL M-1

\$14.50

Shpg. Wt. 3 lbs.

The Model M-1 measures AC or DC voltage at 0-10, 30, 300, 1000, and 5000 volts. Measures direct current at 0-10 ma and 0-100 ma. Provides ohmmeter ranges of 0-3000 (30 ohm center scale) and 0-300,000 ohms (3000 ohms center scale). Features a 400 microampere meter for sensitivity of 1000 ohms per volt. Handy and portable. Will fit in your coat pocket, tool box, glove compartment, or desk drawer.

Heathkit VOM KIT



MODEL MM-1

\$29.50 Shpg. Wt. 6 Lbs.

20,000 ohms/v. DC and 5,000 ohms/v. AC sensitivity. Ranges (AC and DC) are 0-1.5, 5, 50, 150, 500, 1500, and 5000 v. Direct current ranges are 0-150 ua, 15 ma, 150 ma, 500 ma, and 15 a. Resistance ranges provide center-scale readings of 15, 1500 and 150,000 ohms. DB ranges cover -10 db to ±65 db.

Features 4 1/2" 50 ua meter and 1% precision resistors.

HEATH COMPANY A Subsidiary of Daystrom, Inc.
BENTON HARBOR 5, MICHIGAN

Heathkit 3" oscilloscope kit

ETCHED CIRCUIT

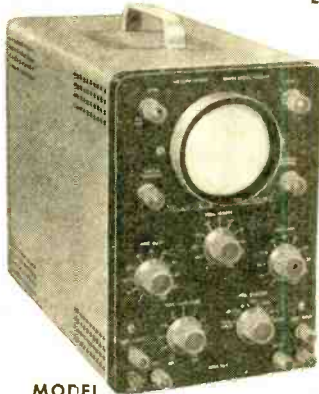

MODEL
OL-1

\$29.50 Shpg. Wt.
14 Lbs.

This compact little oscilloscope is just the ticket for use in the ham shack or home workshop. Measures only 9½" H. x 6½" W. x 11¼" D. Weighs only 11 pounds.

Employing etched metal circuit boards, the Model OL-1 features vertical response with in ±3 db from 2 cps to 200 kc. Vertical sensitivity is 0.25 volts rms per inch, peak-to-peak, and sweep generator operates from 20 cps to 100,000 cps. Provision for direct RF connection to deflection plates. Incorporates many features not expected at this price level. The 8-tube circuit features a type 3GP1 cathode ray tube.

Push-pull vertical and horizontal amplifiers.

Light weight and small size for portability.

Good sensitivity and broad frequency response.

Etched metal circuit boards for simplified assembly.

Attractive panel and case styling.

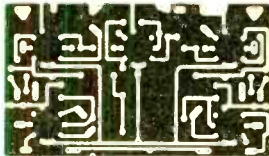

Cathode-follower output for isolation.

No oscillator calibration required.

Covers 160 kc to 220 mc (including harmonics).



Heathkit

signal generator kit

This signal generator covers 160 kc to 110 mc on fundamentals in 5 bands. Calibrated harmonics extend its usefulness up to 220 mc. The output signal is modulated at 400 cps, and the RF output is in excess of 100,000 microvolts. Output controlled by both a continuously variable and a fixed step attenuator. Audio output may be obtained for amplifier testing.

MODEL
SG-8

\$19.50

Shpg. Wt.
8 Lbs.

Audio output may be obtained for amplifier testing.

This is one of the biggest signal generator bargains available today. The tried and proven Model SG-8 offers all of the outstanding features required for a basic service instrument or for use in experimenting in the home workshop. High quality components and outstanding performance. Easy to build, and no calibration required for ordinary use.

Heathkit grid dip meter kit

This extremely valuable instrument is a convenient signal source for determining the frequency of other signals by the comparison method. Range is from 2 mc to 250 mc. Uses 500 ua meter for indication, and is provided with a sensitivity control and headphone jack. Includes prewound coils and rack. For hams, experimenters, and servicemen.



MODEL GD-1B

\$19.50

Shpg. Wt. 4 Lbs.

HEATH COMPANY A SUBSIDIARY OF
DAYSTROM, INC.
BENTON HARBOR 5, MICHIGAN

Heathkit ANTENNA impedance meter kit

Used in conjunction with a signal source, the Model AM-1 will enable you to measure RF impedance. Valuable in line matching, adjustment of beam and mobile antennas, etc. Will double as a phone monitor or relative field strength indicator. A 100 micro-ampere meter is employed. Covers the impedance range from 0 to 600 ohms. An instrument of many uses for the amateur. Easily pays for itself through the jobs it will perform.



MODEL
AM-1

\$14.50 Shpg. Wt.
2 Lbs.



MODEL VF-1

\$19⁵⁰

Shpg. Wt. 7 Lbs.

Heathkit vfo

KIT

- ☆ 6AU6 electron-coupled oscillator.
- ☆ OA2 voltage regulator tube for stability.
- ☆ Smooth-acting illuminated dial.
- ☆ Easy to build and attractively styled.

Extra features include copper-plated chassis, ceramic coil forms, extensive shielding, etc. High quality parts!

This variable frequency oscillator covers 160-80-40-15-11 and 10 meters with three basic oscillator frequencies. RF output is better than 10 volts average on fundamentals. Enjoy the convenience and flexibility of VFO operation at no more than the price of crystals. May be powered from

a socket on the Heathkit Model AT-1 transmitter, or supplied with power from most transmitters.

Features illuminated and pre-calibrated dial scale. Cable and plug provided to fit crystal socket of any modern transmitter.

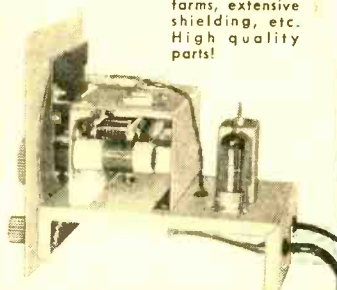

SPECIFICATIONS:

RF Amplifier Power Input... 25-30 watts
Output Connection... 52 ohms
Band Coverage... 80, 40, 20, 15, 11, 10 Meters

Tube Complement:

5U4G... Rectifier
6AG7... Oscillator-Multiplier
6L6... Amplifier-Doubler

Heathkit CW amateur transmitter kit

This CW transmitter is complete with its own power supply and covers 80, 40, 20, 15, 11, and 10 meters. Incorporates such outstanding features as key-click filter, line filter, copper plated chassis, pre-wound coils, and high quality components. Employs a 6AG7 oscillator, 6L6 final amplifier. Operates up to 30 watts plate power input.

MODEL AT-1

\$29⁵⁰

Shpg. Wt. 15 Lbs.

Single-knob band-switching for 80, 40, 20, 15, 11 and 10 meters.

Plate power input 25-30 watts.

Panel meter monitors final grid or plate current.

Best dollar-per-watt buy on the market.

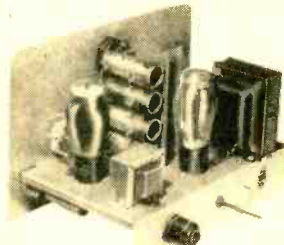

Slide-rule dial-electrical band-spread-ham bands marked.

Slug-tuned coils and efficient IF transformers for good sensitivity and selectivity.

Transformer-operated power supply for safety and high efficiency.



Heathkit COMMUNICATIONS TYPE all band receiver kit



\$27⁹⁵

MODEL AR-3

Shpg. Wt. 12 Lbs.

CABINET: Fabric-covered cabinet available. Includes aluminum panel, speaker grille, and protective rubber feet. Measures 12-1/4" W. x 8-3/4" H. x 7-3/4" D. No. 91-15. Shpg. Wt. 6 Lbs. \$4.50.

The Model AR-3 covers from 550 kc to 30 mc on 4 bands. Covers foreign broadcast, radio hams, and other interesting short wave signals.

Features good sensitivity and selectivity. Separate RF and AF gain controls—noise limiter—AGC—VFO, headphone jack—5 1/2" PM speaker and illuminated tuning dial.

SPECIFICATIONS:

Frequency Range... 550 kc to 30 mc on four bands
Tube Complement... 1—12BE6 oscillator and mixer
1—12BA6 IF amplifier
1—12AV6 second detector, AVC, first audio amplifier and reflex BFO
1—12A6 beam power output
1—5Y3 full wave rectifier

HEATH COMPANY A SUBSIDIARY OF DAYSTROM, INC.
BENTON HARBOR 5, MICHIGAN

pearance will be obtained, and corrosion will be largely prevented, if all permanently soldered connections are lightly coated with red fingernail polish. You can raid the XYL's dressing table for most of the items you need to carry out this suggestion!

COMBINED PILOT LIGHT AND FUSE

An ordinary pilot lamp of suitable rating connected in the transformer high-voltage center-tap lead of a power supply, as

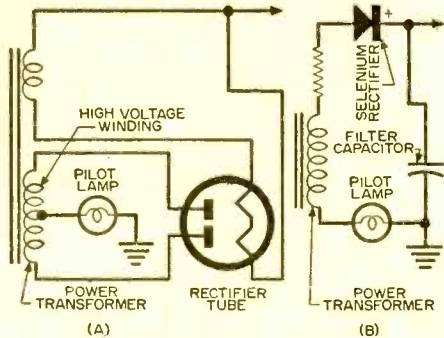

shown in the diagram (A), will act as both a pilot light and a fuse. The lamp should have a current rating approximating the amount of current drawn from the supply. For instance, a 60-milliampere lamp may be used if a current of 50 to 60 milliamperes is being drawn.

The lamp will light normally as long as the normal amount of current is drawn, but it will flash brilliantly and burn out in the event of a severe overload or short circuit. A similar lamp may be used in a selenium rectifier power supply as shown in (B).

SIMPLE WIRING HARNESS

You can give your home-built equipment a professional appearance by employing a wiring "harness." But instead of using expensive, hard-to-get lacing twine, simply cable the various leads together using short strips of Scotch electrical tape. Pull

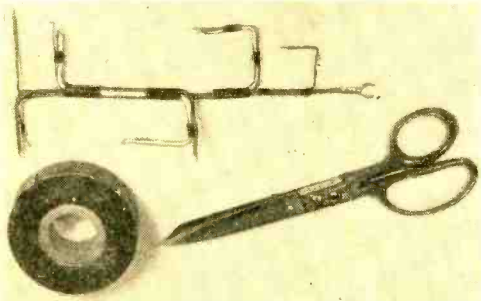

each strip tight to bundle the various wires together. Space the strips at from 1" to 4" intervals, depending on the num-

ber of wires in the cable and on the size of the completed harness. An additional strip of tape is used to hold the cable together wherever a lead branches off.

If you are assembling several identical pieces of equipment, you can make the wiring harness in advance, completing the wiring simply by dropping the harness in place and connecting the free ends of the proper leads to appropriate terminals. Make up a "cabling frame" by placing nails in the correct positions in a scrap piece of plywood. The various wires and leads are then shaped between the nails and cabled together using Scotch tape.

PHASING TWIN SPEAKERS

Two small speakers will often produce better sound than a poor quality speaker of large size. To be effective, the two speakers must be properly phased. This means that both speaker cones must move in the same direction at the same time.

To phase the speakers, connect a dry cell to the voice coil terminals of one

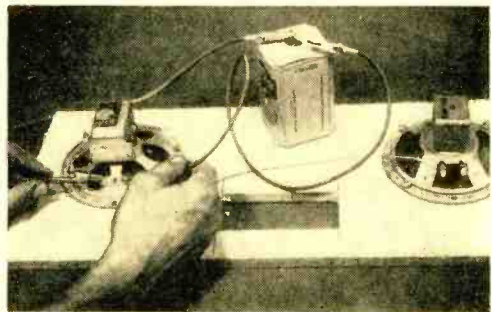

speaker and note the direction in which the speaker cone is moved. Label the terminals according to battery polarity. Do the same with the second speaker, reversing the battery leads if necessary in order to obtain the same direction of cone movement as with the first speaker. Label the terminals, and connect the two speakers with the speaker cord.

Recheck the phasing by momentarily connecting the dry cell across the speaker cord plug; both speaker cones should move in the same direction.

TIME SWITCH FOR A FEW CENTS

With a mercury switch, a lamp-cord extension, and two metal strips, you can easily convert that old alarm clock you have lying around the house into a simple but effective time switch.

First, clip the clock's bell hammer. This will make the unit silent. Next, fasten the metal strips and the switch clip to the clock's alarm wind. Splice the switch's leads into one side of the extension, and your timer is complete.

(Continued on page 100)

CREI prepares you quickly for success in

- BROADCASTING
- TELEVISION
- MANUFACTURING
- COMMUNICATIONS
- SERVICING
- AERONAUTICAL ELECTRONICS

The future is in your hands!

The signs for the future are plain for trained men in the electronics industry. It is a tremendous industry, and—at the present time there are more jobs than there are trained men to fill them. But—when there's a choice between a trained and untrained applicant, the trained man will get the job.

CREI Home Study . . .

The Quick Way to Get There



Since 1927, CREI has given thousands of ambitious young men the technical knowledge that leads to more money and security. The time-tested CREI procedure can help you, too—if you really want to be helped. CREI lessons are prepared by experts in easy-to-understand form. There is a course of instruction geared to the field in which you

want to specialize. You study at your convenience, at your rate of speed. Your CREI instructors guide you carefully through the material, and grade your written work personally (not by machine).

Industry Recognizes CREI Training

CREI courses are prepared, and taught with an eye to the needs and demands of industry, so your CREI diploma can open many doors for you. Countless CREI graduates now enjoy important, good-paying positions with America's most important companies. Many famous organizations have arranged CREI group training for their radio-electronics-television personnel. To name a few: All America Cables and Radio, Inc.; Canadian Broadcasting Corporation; Columbia Broadcasting System; Hoffman Radio Corporation; Glenn L. Martin Company; Magnavox Company; Pan American Airways, Atlantic Division; Radio Corporation of America; Trans-Canada Air Lines; United Air Lines. Their choice for training of their own personnel is a good cue for your choice of a school.

Benefits Felt Right Away

Almost immediately, you feel the benefits of CREI training. Your employer, when informed of your step toward advancement (only at your request), is certain to take new interest in you and in your future. What you learn in CREI Home Study can start helping you do a better job immediately.

PAYS FOR ITSELF QUICKLY. Your very first raise could repay your investment in CREI training, and leave you a profit the very first year. Your increases in pay thereafter are all pure profit, and you'll be prepared for many more promotions and pay raises in the future years of your life.

CREI also offers

Residence Instruction

at the same high technical level—day or night, in Washington, D.C. New classes start once a month. If this instruction meets your requirements, check the coupon for Residence School catalog.

INFORMATION FOR VETERANS. If you were discharged after June 27, 1950—let the new G.I. Bill of Rights help you obtain resident instruction. Check the coupon for full information.

Get this fact-packed booklet—it's free

Called "Your Future in the New World of Electronics," this free illustrated booklet gives you the latest picture of the growth and future of the gigantic electronics world. We'll promptly send your copy. The rest—your future—is up to you.

To help us answer your request intelligently, please give the following information:

EMPLOYED BY

TYPE OF PRESENT WORK

SCHOOL BACKGROUND

ELECTRONICS EXPERIENCE

IN WHAT BRANCH OF ELECTRONICS ARE YOU MOST INTERESTED?

MAIL THIS COUPON . . . TODAY!

CAPITOL RADIO ENGINEERING INSTITUTE

Accredited Technical Institute Curricula—Founded in 1927
3224 16th St., N.W., Dept. 124C, Washington 10, D. C.
Send booklet "Your Future in the New World of Electronics" and course outline.

CHECK

FIELD OF

GREATEST

INTEREST

Name

Street

City

Zone

State

Check: Home Study

Residence School

Korean Veteran

- PRACTICAL RADIO ELECTRONICS ENGINEERING (F.M., TV)
- BROADCAST RADIO ENGINEERING (AM, F.M., TV)
- PRACTICAL TELEVISION ENGINEERING
- AERONAUTICAL ELECTRONICS ENGINEERING



HERSHEL SPECIALS

All New MYSTERY PACKAGE of ELECTRONIC PARTS



Worth \$40.00

Our Price
\$3.95

Ship. Wt. 20 lbs.

It's the surprise of your life! 20 pounds of BRAND NEW USA B10 GOVT. surplus. The ideal gift for ham, etc.

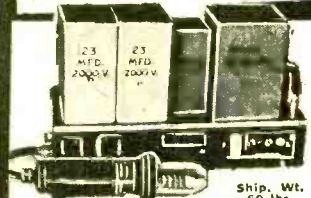

BRAND NEW Electronic PHOTO FLASH

Ship. Wt. 100 Watt
60 lbs. Sec.

Operates on any 12 or 24 VDC. source. Complete. With Ignition coil, trigger housing and strobe light. Assembly includes 20 ft. cord with SYLVANIA A-1073. (Similar to Sylv. 4330). Extra Parts Kit has Extra 1073 bulb, fuses, vibrator, Instruction Manual.

\$29.95

ARC-5 COMMAND TRANSMITTER



\$6.95

7 to 9.1 MC. Brand New in Certens. with tubes.

Hottest Buy in the Country

OIL CONDENSER



\$1.65

2 MFD. 3000 VDC. Pyranol Oil. W/ Mounting Brackets. 1-1 Mfd. 3000 VDC. New. Removed from equip. 4 1/4" x 4 1/4" x 2 1/2"

GE Pyranol Oil CONDENSER

32 MFD. 330 VAC. 60 Cy. Removed from equip. NEW.

95¢

PHOTO ELECTRIC CELL



95¢
CE Vacuum Cell used in AMPRO Sound Projector. Also useful for opening garage doors and Alarm Systems.

ALL-PURPOSE FIL TRANSFORMER



PRI. 117 v. 60 cyc. sec.

0.4 v.12A
0.8 v.10A
1.6 v.5A
2.5 v.3A
3.2 v.2.5A

\$4.95

BRAND NEW

SWING CHOKE

2H-7H 550 MA. Thordarson T48003.

\$5.95

1 KW ANT. CHANGEOVER

110 VAC RELAY

\$9.95

60 Cycle
15 Amp
2500 Volt
D.P.D.T.

VARIABLE TRANSFORMER



\$4.95

PRI. 115 VAC
4 Amp 50-80
0.5 Sec. 50
to 135V. 25
AMP. Used
with Dic-
phona Electro-
ducer MFD.
U.T.C.

ALLIGATOR CLIP

Piercing type with 5 Ft. cord and spade lug. Ideal test clip. TL-137.

TERMS: Cash with order or 25% DOWN—BALANCE C.O.D.
ALL PRICES NET F.O.B. DETROIT
MINIMUM ORDER \$2.00

HERSHEL RADIO CO.

5249 GRAND RIVER Detroit 8, Michigan

TYler 8-9400

When the alarm goes off, the wind lifts the switch which, in turn, makes or breaks the circuit. The short strip stops the ac-

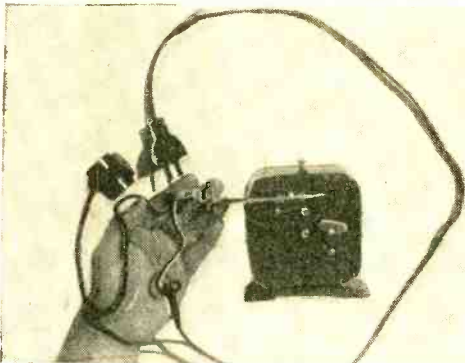

tion of the switch before it affects the circuit again. Reverse the position of the switch in the clip, and your timer will turn devices either on or off.

SPEAKER DOUBLES AS MICROPHONE

To use a permanent magnet speaker as a microphone, make connections as shown in the diagram. The transformer may be the type used as an output transformer in small radio sets. Hum pickup will be reduced by using the shielded can and shield-

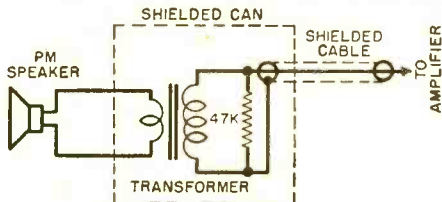

ed leads. For better frequency response, load the high impedance winding of the transformer with the 47,000-ohm resistor, as shown.

SOLDERING SUBMINIATURE PARTS

Subminiature components can be soldered easily by the method shown in the



photo. Clamp the iron in a bench vise. This frees both hands for holding parts and applying flux and solder. Parts should be

POPULAR ELECTRONICS

Electron Tubes With Energy Like The Sun

SOLAR ELECTRONICS

To insure only top quality merchandise Solar Electronics "set tests" each electron tube in powerfully loaded chassis!

Here is Our New Guarantee Policy:

Money back within 5 days of receipt of merchandise PLUS 5 year free factory replacement.
ALL TUBES ARE CODED BY MONTH AND YEAR!

FREE INTRODUCTORY Clip This Ad

With every order of \$15 or more—one 6SN7GT, one 6W4GT, 5 assorted resistors, 5 assorted attractively colored tube cartons; or with every order of \$30 or more—1 RCA Cheater Cord, 5 assorted resistors, one 6SN7GT, one 6W4GT, one 6K6GT and Vidaire 2 set Coupler.

FREE BONUS OFFER!



Model 625K

A terrific Eico tube Tester or TV FM Sweep Generator FREE when you buy \$200 worth of receiving tubes or more within 60 days at Solar. Tester or generator may be bought outright from Solar for \$33.50

ANTENNA SPECIALS

COMPLETE OUTDOOR ALL CHANNEL CONICAL

Includes: 8 element antenna with cross-bar, 5 ft. seamless aluminum mast chimney mount or 7" wall bracket, 8 stand offs, 50 ft. of 300 ohm wire. State your need! List \$15

\$8.45

NEW INDOOR ANTENNA

Brings in UHF and VHF. Use on top of TV.

List \$9.95
YOUR PRICE \$3.75

USED TV SETS

Picture tube guaranteed to work.

	Table Model	Console
10 inch set.....	\$17.50	\$20.00
12 inch set.....	\$22.50	\$25.00
14 inch set.....	\$27.50	\$30.00
16 inch set.....	\$32.50	\$35.00
17 inch set.....	\$36.00	\$38.50
19", 20", and 24" Sets—Prices on request.		

FAMOUS MAKE TEST EQUIPMENT!

TUBE TESTER KIT

In carrying case! Factory wired, \$44.95. **\$33.25**

VACUUM TUBE VOLTMETER KIT

Factory wired, \$37.50. **\$24.95**

FLYBACK TRANSFORMER and YOKE TESTER KIT

Factory wired, \$31.75. Test Equipment Factory Guaranteed For One Year! **\$21.75**

ALL PARTS SHIPPED F.O.B. HARRISON, N. J.

EASY TERMS!

We pay all postage or freight in U.S.A. Territories and APOs. 25¢ handling on orders less than \$5. Please send 25% deposit with C.O.D.'s. Remember! Your money cheerfully refunded within 5 days if you are not completely satisfied.

Visit our tube and parts showroom next time you're in Harrison. A free gift awaits you!

PICTURE TUBE SPECIALS!

Brand New—RCA Licensed—One Year Guarantee

Type	Price	Type	Price	Type	Price	Type	Price
10BP4 or A	\$11.25	16AP4 or A	\$18.95	16JP4 or A	\$18.75	15BP4 or A	\$23.80
10FP4	\$14.95	16CP4 or A	\$18.95	16LP4 or A	\$18.75	19FP4	\$24.25
12LP4 or A	\$13.95	16DP4 or A	\$18.95	16KP4 or A	\$18.50	20CP4 or A	\$24.50
12QP4	\$13.95	16EP4 or A	\$18.75	16RP4 or A	\$18.50	20DP4 or A	\$24.50
12JP4	\$13.25	16FP4 or A	\$19.45	16ZP4 or A	\$19.25	21AP4	\$27.95
12UP4	\$14.95	16GP4 or A	\$19.25	17BP4	\$19.85	21FP4	\$28.25
12BP4 or A	\$15.95	16HP4 or A	\$18.75	17CP4	\$20.85	21GP4	\$28.50
14CP4	\$15.95	16JP4 or A	\$18.75	19AP4	\$23.95	21DP4	\$44.95
14DP4 (for Dumont)	\$17.95						

All Picture Tubes shipped F.O.B. Harrison, N. J.

BIGGEST VALUES! BIGGEST SELECTIONS!

PARTIAL LIST ONLY!

Type	Price	Type	Price	Type	Price	Type	Price
0A2	.87	6AC7	.85	6SQ7	.37	12J57	.44
OD3/VR150	.90	6AF4	.85	6S57	.42	12K7	.43
0Z4	.44	6AG5	.50	6T4	.89	12L7GT	.59
1A4P	.30	6AG7	.75	6T8	.85	12SN7GT	.53
1A7GT	.48	6AH4GT	.65	6U3	.73	12SQ7	.35
1A2Z	.85	6AH6	.65	6V3	.77	12V6GT	.44
1B3GT	.63	6AK5	.57	6V6GT	.44	12X4	.35
1R4P	.88	6AL5	.38	6W4GT	.38	14A5	.90
1CSGT	.45	6AN4	1.25	6W6GT	.55	14A7	.44
1DSGP	.40	6AN8	.99	6X4	.35	14B6	.39
1E7GT	.40	6AQ5	.45	6X5GT	.35	14E6	.48
1H4C	.35	6A36	1.50	6X5	.75	14E7	.59
1HS7	.45	6AT5	.39	6Y6G	.49	14F7	.59
1L4	.47	6AU4GT	.70	7A4	.44	14F8	.69
1L6	.53	6AUSGT	.60	7A5	.53	14N7	.69
1LA4	.55	6AU7	.85	7A6	.44	19B6GG	1.10
1LA6	.55	6AV5GT	.65	7A7	.44	19T8	.64
1LB4	.55	6AV8	.38	7B4	.43	24A	.35
1LC6	.51	6AX4GT	.65	7B5	.40	25B6GT	.45
1H4C	.35	6AX5GT	.65	7B6	.44	25C8	1.10
1LN5	.51	6B8	.75	7B7	.44	25L6GT	.45
1NSGT	.53	6BA6	.45	7B8	.44	25W4GT	.42
1R5	.58	6BA7	.55	7C4	.44	25Z5	.39
1S5	.41	6BC5	.50	7C5	.44	25Z6GT	.35
1T4	.49	6BE6	.48	7C6	.44	28	.48
1T5GT	.57	6BF5	.42	7E	.37	50A5	.48
1U4	.55	6BG6G	1.10	7F4	.35	50B5	.48
1U5	.41	6BH6	.52	7F6	.69	52L7GT	.53
1V2	.83	6BJ6	.49	7H7	.69	35/51	.33
1X2	.65	6BK5	.75	7J7	.69	35A4	.44
2A7	.50	6BL7GT	.69	7K7	.69	35B5	.48
2X2A	.55	6BN6	.60	7N7	.54	35C5	.48
3A4	.55	6BQ6GT	.75	7T4	.35	35L6GT	.45
3AL5	.48	6BQ7	.80	7Z4	.36	35W4	.35
3AU6	.48	6BY5G	.60	7Z4	.36	35Z4	.35
3BC5	.56	6C4	.35	12A7E	.36	35Z5GT	.35
3BN6	.85	6CB6	.50	12A77	.65	37	.30
3CB6	.56	6CD6G	1.10	12A8U	.42	39/44	.35
3Q4	.45	6C8U	.90	12A8V	.52	50A5	.48
3Q5GT	.88	6C8	.45	12A9V	.37	50B5	.48
3V4	.52	6F8	.40	12AV7	.73	50C5	.48
4BQ7	.92	6H6	.42	12AX7	.69	50L6GT	.45
4BZ7	.97	6J4	1.50	12AZ7	.65	75	.40
5AQ5	.52	6J5	.38	12B4	.65	77	.40
5B6	.80	6J6	.50	12AB6	.45	78	.40
5U4G	.46	6K6GT	.36	12BA7	.58	80	.35
5U8	.68	6L8	.65	12BE6	.49	84/6Z4	.41
5V4Q	.86	6S8GT	.74	12BH7	.59	11Z7GT	1.29
5X8	.78	6SA7	.44	12BV7	.64	11Z7GT	1.29
5Y3	.29	6SC7	.50	12CUG	1.09	11P7GT	1.29
5Y4G	.35	6SF5	.60	12K7	.49	11Z3	.35
5Z3	.40	6SH7	.43	12Q7	.44	11Z6GT	.60
6A7	.55	6SJ7	.43	12S47	.43	807	1.49
6AB4	.45	6SK7	.44	12S47	.59	1619	.59
		6SL7GT	.53	12S47	.59	9002	1.19
		6SN7GT	.53	12S47	.59		

TO QUANTITY USERS!

Your initial order of \$150 or more entitles you to our special 10% discount or free Deluxe "60" Remington Razor. State your choice. This offer not good if you are taking advantage of free tube tester or generator offered elsewhere in this ad.

SOLAR ELECTRONICS

Post Office Square
Harrison, N. J.

ESsex
4-5300

SELF CHARGING GEIGER COUNTER

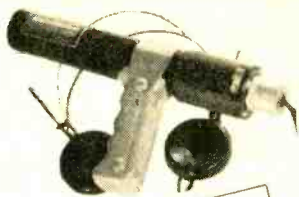

NEW!
REVOLUTIONARY
GEIGER-COUNTER
 1956 MODEL ONLY \$19.95

TRANSISTORIZED
 #MIC-10

INCLUDES

- HOLSTER
- RADIO ACTIVE SOURCE
- URANIUM OFFICIAL YEAR BOOK
- DOUBLE CRYSTAL HEADPHONES

The 1956 Model MIC-10 Geiger-Counter is a sensitive instrument embodying many new scientific principles. A unique, self-rectifying electrostatic generator furnishes the 900 volts required to operate the Geiger Tube. You may obtain only The Uranium Official Year Book (regularly \$2.00) including our radio active source both for \$1.50.

WESTWOOD RESEARCH & DEVELOPMENT LABORATORIES, INC.
 14945 Ventura Boulevard Sherman Oaks, California

Enclosed is \$19.95 for my MIC-10 Geiger-Counter including holster, radio active source, year book, & headphones.

Enclosed is \$1.50 for my Uranium Official Year Book, including radio active source.

C.O.D. ORDERS ACCEPTED Name:

DISTRIBUTORS ENCOURAGED Address:

City: State:

You Are Invited To OPEN HOUSE

Tuesday, May 22—3 P.M. to 9 P.M.

see Radar in Operation
 T-V Laboratory
 Transmitter Lab.
 FM Broadcast Station

Phila. Wireless Technical Institute
 1533 Pine St. Philadelphia 2, Penna.

A Non-Profit Corp. Founded in 1908

Write for free catalog "P"



ROAD TO RICHES

You can be the next uranium millionaire! Government guarantees huge bonus! PRI instruments from \$29.95. See your local dealer today! FREE CATALOG!

Write PRI, 4223 PT W. Jefferson
 Los Angeles 16, California



POPULAR ELECTRONICS KITS

Complete Kits for Projects Featured in This Issue.

- Transistor Projects for the Beginner.....\$13.35
- Amplify Those Geiger Clicks..... 22.15
- Our Simplest Capacity Relay..... 15.85
- Make Your Own Electronic Thermometer..... 21.60

Will ship express collect if full postage is not included.

ALGERADIO ELECTRONICS CO.

236 N. Franklin St. IV 9-0808 Hempstead, N. Y.

pre-tinned. A drop of solder melted on the tip of the iron will form a tiny droplet. Then, the parts may be held to the iron. The droplet will serve as a miniature "soldering pot." This same technique, used in reverse, will help disassemble parts used in earlier projects. Hold the soldered joint to the tip of the iron until the solder melts; then flip the parts downward quickly. They will come apart easily and cleanly.

PROTECTING VARIABLE CAPACITORS

Due to their small size, single-hole mount, and smooth operation, little 365-µµfd. variable capacitors are becoming very popular. However, their operation is spoiled when dust and grit work down between the plates and thin plastic separa-

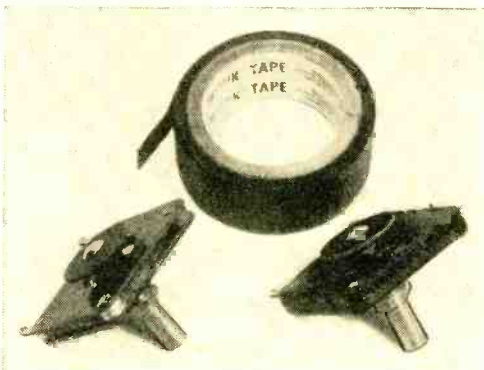

rators. To prevent this, seal the four open sides. The capacitor at the left is shown as it came from the factory. The capacitor at the right was sealed on all four sides with a 1/2"-wide strip of Mystik tape. Any type of pressure tape could have been used instead.

PAPER STOPS SOLDER DROPPINGS

When building miniature equipment inside of a small plastic container, it's a good idea to cut a piece of paper the size of the bottom of the container and insert it. This will keep hot solder from dropping down and marring the plastic. The paper, together with the solder it has collected, can be removed readily when the job is completed.

SAVE THOSE FUSES!

A good way to save fuses when using a fused plug is to employ fuses of unequal values. If, for example, your equipment requires two 1-amp. fuses, insert a 1-amp. fuse along with another fuse of any higher value that does not exceed the rating of the plug itself. On a direct short, both fuses may blow if their values are too close to each other. On an overload, only the lower value fuse will burn out. —30—

TELTRON TUBES

Guaranteed! Lowest Prices Ever!

GIFT OFFER!
One 6BG6G tube will be shipped FREE with any \$10 order accompanying this ad.

All tubes individually boxed . . . unconditionally guaranteed for one year.

FREE

\$7.50 list value Bonus Box of three 6SN7 tubes and 25 assorted resistors with each order of \$25 or more of receiving tubes only.

PICTURE TUBES

BRAND NEW RCA LICENSED 1 YR. GUARANTEE

10BP4	11.19
10BP4	13.79
12UP4	14.25
14BP4	15.77
14BP4	15.77
15BP4 (for Dumont)	18.53
16BP4	18.79
16CP4	18.79
16DP4	18.69
16EP4	19.29
16FP4	19.29
16HP4	18.79
16JP4	18.79
16LP4	18.79

SPECIALS

16KP4	15.99 ea.
16RP4	15.99 ea.
16TP4	19.19
16UP4	17.99
17CP4	20.79
17EP4	21.79
19AP4	23.49
19DP4	23.19
19EP4	23.19
20DP4	24.19
21AP4	27.49
21EP4	27.49
21FP4	27.99
21YP4	27.99
24AP4	43.99
24CP4	43.99
27EP4	64.99

WE WANT NEW ACCOUNTS

If you are rated, your credit is good with us. Send for Free complete tube listing and monthly special! Get on our mailing list. We are "Eico" distributors. Write us about special deals on test equipment.

NEW INDOOR ANTENNA
Brings in UHF and VHF. Use on all types of TV. **List \$9.95 \$3.49**

Complete Outdoor ALL CHANNEL CONICAL ANTENNA
Includes: 8 element antenna with crossbar, 5 ft seamless aluminum mast chimney mount or 7" wall bracket (state your need), 8 stand offs, 50 ft. of 300 ohm wire. **List \$15 \$8.29**

ANTENNA COMPONENTS
300 Ohm TV Lead-In Wire 24 ft. 2¢
3" Standoffs 24¢
7" Standoffs 36¢
5 Ft. Aluminum Seamless Mast 89¢
7" Wall Bracket 89¢
Aluminum Chimney Mount \$3.49
Philco 8-Element All Channel Antenna \$4.49

PICTURE TUBE BRIGHTENER 94¢

Boland & Boyce PICTURE TUBE TESTER AND REJUVENATOR \$59.95

Sheldon Hi-Po 6SN7 .89¢
Sheldon Hi-Po 5U4 .79¢

RCA CHEATER CORD 29¢

Eico Tube Checker. Completely wired! List \$49.95 \$39.25

WELLER DUAL-LITE SOLDER GUN KIT
135 watt gun with dual spotlight illuminates work when iron is on. Kit includes wire soldering brush, Weller soldering aid to make tight wire twists and reopen old solder joints. page of Kester Solder **\$9.49**

UNIVERSAL 4-Prong Auto Radio Vibrator. Takes care of 00% of 6 volt auto a.c.s. List \$4.90 **\$1.19**

Send for Free complete tube listing and monthly specials. Get on our mailing list.

TYPE	PRICE	TYPE	PRICE	TYPE	PRICE	TYPE	PRICE
024	.43	6AU6	.43	6K6GT	.39	12BA6	.43
147GT	.53	6AV5GT	.60	6K7	.40	12SA7	.53
183GT	.62	6AV6	.37	6L6	.37	12BE6	.46
115GT	.51	6AX4GT	.60	6Q7	.40	12BH7	.61
114	.51	6AX5GT	.60	6S4	.41	12X7	.50
116	.51	6BA6	.39	6S8T	.65	12H6	.50
11C6	.49	6BA7	.39	6SA7	.45	12J5	.49
115GT	.51	6BC5	.48	6SK7	.45	12K7	.48
115	.43	6BE6	.46	6S17	.45	12S7	.45
174	.51	6BF5	.48	6SN7GT	.60	12SJ7	.45
1U4	.51	6BF6	.48	6SQ7	.40	12SK7	.45
1U5	.43	6BG6G	1.18	6T8	.71	12SL7	.60
1X2	.65	6BH6	.51	6TB	.78	12SN7GT	.56
2A5	.85	6BJ6	.51	6V3	.80	12SQ7	.38
3Q4	.53	6BK5	.75	6V6GT	.48	14A7	.43
3Q5GT	.61	6BK7	.78	6W4GT	.43	14BE6	.36
354	.48	6BL7GT	.78	6W6GT	.53	14Q7	.52
484	.48	6BM8	.90	6X5GT	.38	19B6G	1.48
5R4	.95	6BQ6GT4	.83	6X5GT	.38	19T8	.71
5U4G	.43	6BQ7	.85	6X8	.80	25B6GT	.82
5V4	.43	6BY5G	.60	6Y6G	.81	25W4GT	.43
5Y3	.30	6BZ7	.95	7A8	.48	25Z6GT	.36
5V4G	.37	6C4	.41	7A8	.48	25Z6GT	.36
6A8	.40	6C5	.46	7C5	.44	35A5	.48
6AB4	.43	6CB8	.81	7F7	.39	35A5	.48
6AC7	.65	6CD6G	1.83	7F8	.77	35B5	.48
6AQ5	.65	6CU8	.93	7N7	.37	35L6GT	.41
6A4GT	.65	6D6	.90	12AT6	.37	35L6GT	.41
6AF4	1.02	6E5	.80	12AT7	.71	35U4	.43
6AK5	.96	6F5	.44	12AU7	.58	35V4	.43
6AL5	.43	6F6	.42	12AV6	.42	35Z3	.41
6AQ5	.48	6H6	.50	12AV7	.73	35Z5GT	.35
6AR5	.48	6J5	.49	12AX4GT	.60	37	.55
6AS5	.37	6J6	.61	12AZ7	.61	45	.55
6AT6	.60	6K5	.60	12B4	.72	50A5	.45
6A5GT	.37	6K6	.61	12A27	.61	45	.55

We have thousands of tube types too numerous to list here. Ordering types not listed take 75% off current list price for cost of tube.

USED TV SETS

10" Working Condition!	Model \$22.50 Console \$25.00
12" Table	Model \$27.50 Console \$31.00
14" Table	Model \$32.50 Console \$35.00

16" Table	Model \$39.50 Console \$44.00
17" Table	Model \$45.00 Console \$49.50

Shipped F.O.B. Harrison, N. J.

NEW LIBERAL TERMS

NO MIN. ORDER. POSTAGE PAID ON ORDERS OVER \$10.00 IN U.S.A., A.P.O.'s AND TERRITORIES. 100% DEPOSIT ON C.O.D.'s TO OUR CANADIAN AND FOREIGN FRIENDS: PLEASE SEND APPROX. FRGT. EXCESS WILL BE REFUNDED. ORDERS SUBJECT TO PRIOR SALE. All parts and test equipment F.O.B. Harrison, N. J.

TELTRON ELECTRIC COMPANY

428 HARRISON AVE.

DEPT. PE-4

Phone HUmboldt 4-9848

HARRISON, N. J.

Get This Valuable Book

Just for Examining COYNE'S New 6-Volume Set

FREE



"Applied Practical Radio-Television"

ON 7 DAY FREE TRIAL!



Yes, you get this big, brand new book, "150 Radio-Television Picture Patterns and Diagrams Explained", absolutely FREE! Just off the press! Gives complete wiring circuits and diagrams on the latest Radio and Television Sets. Easy-to-read, large 8 1/2 x 11" pages, with full instructions on how to read and use the diagrams. A "must" in every Radio and Television service-man's repair kit. You get this valuable book as a FREE Gift for asking to see Coyne's great new 6-book set, "Applied Practical Radio-Television"! Here's "Know-How" That Makes You Worth More!

Coyne's great new 6-volume set gives you all the answers to servicing problems—quickly! For basic "know-how" that is easy to understand, you'll find everything you want in volumes 1 to 5 which contain over 5000 practical facts and data. They cover every step from principles to installing, servicing, trouble-shooting and aligning all types of radio and TV sets. So up-to-date it includes COLOR TV and UHF. Also covers very latest information on TRANSISTORS.

900-Page Television Cyclopedic Included

And then, for speedy on-the-job use, you get volume 6—the famous COYNE TELEVISION CYCLOPEDIA. It answers today's television problems on servicing alignment, installation and others. In easy-to-find ABC order, cross indexed. Use this 6 volume TV-RADIO LIBRARY free for 7 days; get the valuable Servicing Book ABSOLUTELY FREE!

Educational Book Publishing Division

COYNE

ELECTRICAL SCHOOL

500 S. Paulina St., Dept. 46-PE Chicago 12, Ill.

SEND NO MONEY! Just mail coupon for 6-volume set on 7 days free trial. We'll include book of 150 TV-Radio Patterns & Diagrams. If you keep the set, pay \$2 in 7 days and \$2 per month until \$22.50 plus postage is paid. (Cash price \$20.95). Or you can return the library at our expense in 7 days and owe nothing. YOU BE THE JUDGE. Either way, the book of TV-Radio Patterns is yours FREE to keep! Offer is limited. Act NOW!

FREE BOOK—FREE TRIAL COUPON!

Coyne Electrical School, Educational Book Publ. Div., Dept. 46-PE 500 S. Paulina St., Chicago 12, Ill.

YES! Send 6-volume "Applied Practical Radio-Television" for 7 days FREE TRIAL per your offer. Include TV-Radio Patterns & Diagram Book FREE.

Name.....Age.....

Address.....

City.....Zone.....State.....

Where Employed.....

Check here if you want library sent COD. You pay postman \$20.95 plus COD postage on delivery. 7-day money-back guarantee.

Get Your **F. C. C. LICENSE** Quickly!

Correspondence or residence preparation for F. C. C. examinations. Results guaranteed.

An FCC commercial operator license means greater opportunities and higher pay. We are specialists in preparing you, in a MINIMUM OF TIME, to pass FCC examinations in all classes of licenses. Beginners get 2nd class license in 8 weeks and 1st class in 4 additional weeks.

Regularly scheduled resident classes are held in Washington, D. C. and Hollywood, California. Correspondence courses are conducted from Washington. Write for our free booklet which contains complete details.

GRANTHAM School of Electronics

Dept. 40-D
5910 Sunset Blvd.
Hollywood 28, Calif.

OR

Dept. 40-D
821 19th St. N. W.
Washington, D. C.

PEE WEE BATTERYLESS "LIFETIME" RADIO



REALLY WORKS—FOR YOUR LIFETIME!
Works without tubes, batteries or Electrical Plug-in! Runs continuously for years. Never runs down—nothing to burn out. Weighs only 4 oz. SMALLER THAN A PACK OF CIGARETTES! Easily fits in ANY SMALL POCKET OR PIPOE. GUARANTEED TO RECEIVE LOCAL RADIO STATIONS ANY TIME—ANYWHERE YOU GO! Guaranteed to work for Your Lifetime or we will replace or repair. FREE SELECTIVE, NEWLY DEVELOPED FERRITE Rotary station selector. Perma-diode crystal. Super Speaker-phone all in Durable Black Gold Plastic cabinets. **SEND ONLY \$2.00**

today—Available only from: **MIDWAY COMPANY** Dept. WPL-4 KEARNEY, NEBRASKA

GIANT CATALOG

NEW LISTINGS — 1956 ELECTRONIC SPECIALS

Listing thousands of surplus electronic and mechanical bargains for experimenters, hobbyists, engineers—10c coin or stamps.

Rectifiers @ 25¢ ea. Transformers @ 49¢ ea.
Controls @ 29¢ ea. Bulbs 2¢ ea.
Switches @ 6¢ ea. Motors 99¢ ea.
Automatic Steppers @ 95¢ ea.

SOUNDTRONICS LABS Dept. P-9
632 ARCH STREET PHILADELPHIA 6, PA.

Short Wave Coil with adjustable regeneration and slug. Range 2 MC-15 MC. **\$100**

PRECISION ELECTRONICS
7 Daly Cross Rd. Mt. Kisco, N. Y.

WALKIE-TALKIE

Build a real wireless portable radiophone for the 2 meter amateur band with the following precision components. Factory wired and tested transceiver chassis complete with special dual tube \$6.50. UTC "ouzer" mike transformer \$.98. High output carbon mike \$1.49. Super Alnico headphone \$1.25. 2" x 5" x 9" aluminum case \$2.00. Wiring diagram \$.50. Uses standard batteries available at your local radio store. Please include 5% for postage. COD's require \$1.00 deposit.

SPRINGFIELD ENTERPRISES

Box 54-E Springfield Gardens 13, N. Y.

WANT A BETTER JOB: BECOME AN ELECTRONIC ENGINEER

ONLY 32 MONTHS TO EARN A BACHELOR OF SCIENCE DEGREE IN ELECTRONIC ENGINEERING. Class enrollment limited to allow for individual instruction. Chartered by state of California. Nonprofit-nonsectarian, co-educational—established 26 years.

APPROVED FOR VETS—ENROLL NOW!
SEND FOR FREE CATALOG

PACIFIC STATES UNIVERSITY

1516 S. WESTERN AVE., Dept. M, LOS ANGELES, CALIF.

Carl & Jerry

(Continued from page 69)

cement street was laid so that they could find their service lines easily."

"What else is the gadget good for?"

"Locating electric cables and pipes in walls or finding any metallic objects buried in the ground, such as pipes, tanks, or—" Jerry paused dramatically, "—buried treasure!"

Carl's eyes opened wide behind his horn-rimmed glasses. "You're holding out on me!" he accused. "Give!"

Jerry leaned on the handle of the metal locator as he talked: "Saturday, a week ago, old Mr. Gruber and I went up Eel River to the mouth of Tick Creek fishing. They didn't bite very lively, and we did a lot of talking. For once I managed to get him off his favorite subjects of flying saucers and space travel, and he told me an old legend he had heard from his father.

"A flock of years ago, the government bought all this land from an Indian tribe that lived on it. The government paid the Indians \$80,000 in gold and gave them a new reservation in the Northwest. An escort of soldiers was to accompany the tribe to its new home.

"While still in the assembly encampment, the Indians heard the soldiers talking and decided, rightly or wrongly, that these soldiers planned to rob them of their gold on the journey; so, secretly, during the dead of night, the elders of the tribe buried the gold on the banks of Eel River. Unfortunately, smallpox broke out among the Indians on their march to their new home, and not a single member of the party that buried the gold survived; consequently, it's still there waiting for someone to find it.

"According to Mr. Gruber, when he was a boy, he and his friends used to hunt for the gold all up and down the river. Later, when he was grown, the legend became a sort of hobby with him, and he read every scrap about it he could find. Out of this study came the conviction that the assembly encampment must have been very near the mouth of Tick Creek and that the gold is buried in that vicinity. Of course, this still leaves a lot of territory to be explored by tedious digging; but with a gadget like this, a person could go over a lot of ground in a hurry—"

"Well, what are we waiting for?" Carl demanded. "I'll get a couple of shovels and a pick, and a tow sack to bring back the loot, and you get your bike. Yo ho ho, and a bottle of rum!"

Tick Creek emptied into Eel River only a short distance above the town; so within the hour the boys had hidden their bicycles in the bushes along the road and were trudging across the cornfield that lay between the road and the thin line of trees marking the river bank.

"Hey, Jer," Carl said, as he strode along with the digging tools cradled in his arms, "do you think we ought to ask permission from Mr. Sloan, who owns this farm, before we start looking for the gold?"

"Naw," Jerry replied. "In the first place, he's an old crab and would say no automatically. Then, too, I'd feel kind of silly telling

Whatever your interest . . .

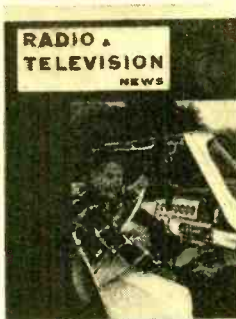

there are exciting

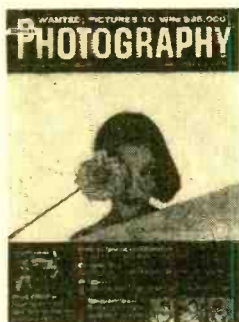

Ziff-Davis special interest

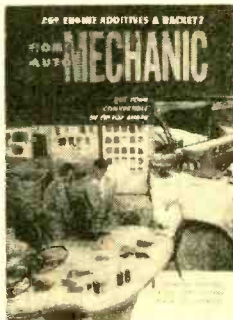
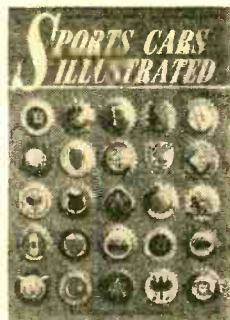

magazines for you!

LOOK FOR THEM AT YOUR FAVORITE NEWSSTAND TODAY!



ZIFF-DAVIS PUBLISHING COMPANY
366 Madison Ave., New York 17, N.Y.

Publishers of: POPULAR PHOTOGRAPHY, PHOTOGRAPHY DIRECTORY & BUYING GUIDE, PHOTOGRAPHY ANNUAL, COLOR PHOTOGRAPHY ANNUAL, RADIO & TELEVISION NEWS, HI-FI ANNUAL, POPULAR ELECTRONICS, FLYING, MODERN BRIDE, SPORTS CARS ILLUSTRATED, AMAZING STORIES, HOME AND AUTO MECHANIC, FANTASTIC, and G.I. JOE.

April, 1956

GREATEST VERSATILITY!

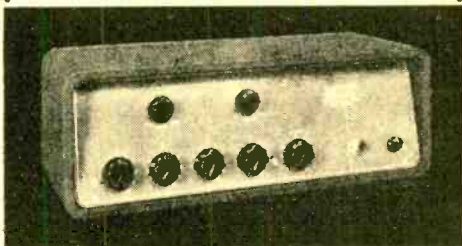

NEW Altec 342A AMPLIFIER with the "input-matcher" feature

typical specification

- Gain: 110 db
- Input Sensitivity: .0042 volts rms for rated output
- Power Output: 20 watts at less than 2.0% thd, 40—20,000 cps
- Frequency Response: ± 1 db, 20—20,000 cps
- Input Impedance: Nominal 100,000 ohms
- Source Impedance: 30/50, 250/300, 500/600 with 4665 plug-in transformer
- Load Impedance: 4, 8, 16 ohms and 70 v line
- Output Impedance: Less than 20% of nominal load impedance
- Noise Level: Equivalent input noise—123 db, output noise—13 dbm
- Controls: 4 mixer controls, 1 master volume control, 1 each bass treble equalizer control; all cont. variable composition
- Power Supply: 117 volts, 60 cps, 110 watts
- External Power Available: 117 volt AC receptacle at rear of chassis
- Tubes: 3—12AX7, 1—6CG7, 2—6L6GB, 1—5U4GB
- Dimensions: 7" H, 19 1/2" W, 8 1/4" D overall
- Color: Green
- Weight: 22 lbs.
- Accessories: 4665 Plug-in Transformer
12227 Assembly—plug-in phono equalizer
12210 Assembly—rack mounting assembly
Cannon XL-3-12 straight cord plug.

The new Altec 20 watt public address amplifier is truly outstanding in its flexibility of function. Pick any combination of four inputs, plug in the convenient "input-matcher" for each source and the Altec 342A amplifier is matched to your exact circuit needs. In minutes the 342A can be input-matched to any high or low impedance microphone, crystal or magnetic phono pickup, tuner or tape recorder—merely plug in the proper "input-matcher."

The 342A has individual volume controls for each of four inputs, a master volume control and separate bass and treble tone controls. DC operation of the heaters of the input tubes insures hum-free performance and eliminates the need for tube selection. The quality, reliability and amazing flexibility of the new Altec 342A amplifier make it ideal for every public address use either permanent or portable.



ALTEC FIDELITY IS HIGHEST FIDELITY

Dept. 4-P
9356 Santa Monica Blvd., Beverly Hills, Calif.
161 Sixth Avenue, New York 13, New York

SAVE TWO Precious YEARS 1 2 3 4



ENROLL IN NORTHROP INSTITUTE'S ENGINEERING TRAINING PROGRAMS

Northrop training programs recognize the tremendous part Electronics is playing in Creative Aeronautics today. That is part of the reason why there is a waiting list for Northrop graduates — why Northrop graduates are making such rapid progress with the nation's largest companies, whose interests merge in both Aviation and Electronics.

And think what the Northrop two-year training program can mean to you in terms of dollars saved and extra dollars earned. Long before others are out of school you will be well on your way toward success in the career of your choice.



COURSES APPROVED FOR VETERANS

Take your first step now
Mail coupon for Free Catalog

NORTHROP AERONAUTICAL INSTITUTE
1187 W. Arbor Vitae Street, Inglewood 1, California

Please send me immediately the Northrop catalog, employment data, and schedule of class starting dates. I am interested in:

- Aeronautical Engineering Technology
- Aircraft Maintenance Engineering Technology
- Master Aircraft and Engine Mechanic
- Jet Engine Overhaul and Maintenance

Name..... Age.....

Address.....

City..... Zone..... State.....

Veterans: Check here for Special Veteran Training Information.

AMAZING NEW PERSONAL POCKET RADIO



LISTEN WHILE YOU
WALK DOWN THE STREET!

Slips in any pocket—wt. only 7 ozs. Size 2 3/4" x 4 1/4" x 1 1/4". Beautiful Black Gold Plastic Case. NO HOOKUPS—NO WIRES—NO PLUG-INS! Self-contained. 150-hour life flashlight batteries and BUILT-IN ANTENNA. POSITIVELY NO AERIAL HOOKUPS. EVERY GUARANTEED RECEPTION OF RADIO STATIONS TO 30 MILES up to 1500 miles for powerful stations! New patented Super-regenerative Diode tube and transformer audio stage for sharp selectivity and sensitivity! Easy to use top tuner (while walking). (Tiny, plastic personal ear plus LETS YOU ALONE LISTEN WHILE YOU WALK, VISIT, WORK, RIDE OR SLEEP ANYTIME—ANYWHERE MONEY-BACK GUARANTEE AND ONE YEAR

SERVICE GUARANTEE.

SEND ONLY \$5.00 (ok mo) and pay postman \$14.95 plus postage on delivery or send \$19.95 for postpaid delivery. GET YOUR TINY TONE REAL POCKET RADIO now and be ready to listen to without bothering those around you. NOT AN UNWORKABLE, INCOMPLETE KIT OR PLAYTHING. BUT A REAL POCKET RADIO! Shipped complete with batteries—Ready to listen! Available only from: WESTERN RADIO, Dept. APL4, Kearney, Neb.

GARAGE DOOR OPENER

Actuator Mechanism **\$24.50**

EASY TO INSTALL, SAFE, RELIABLE

Write for information
P. E. HAWKINS CO.

631 PROSPECT

KANSAS CITY 24, MO.

EASY TO LEARN CODE

Learn or increase speed with an Instructograph—the Radio-Telegraph Code Teacher that takes the place of an operator-instructor and enables anyone to master code without further assistance. Available tapes from beginners alphabet to cryptical messages on all subjects. Speed range 5 to 40 WPM. Always ready—no GEN. Thousands have "acquired the code" with the Instructograph System. Write today for convenient rental and purchase plans.

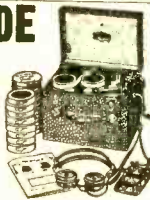

INSTRUCTOGRAPH COMPANY
4713-F Sheridan Road, Chicago 40, Illinois

him we wanted to go treasure hunting on his farm. He'd think we'd both blown our corks for sure. Of course, if we find anything, we'll tell him and divide up with him."

By the time this serious matter was settled, the boys had reached the point where shallow Tick Creek flowed into Eel River, thrusting a flat sandbar halfway across the larger stream. Jerry at once unlimbered his metal locator and began a systematic survey of the area, while Carl tagged along at his heels breathing down the back of his neck. The boys had been prospecting for scarcely ten minutes when Jerry suddenly stopped dead in his tracks so abruptly that Carl stumbled into him.

"What is it? What do you hear?" Carl shouted anxiously.

"There's something down there," Jerry said slowly, as he moved the probing hoop around in an exploring circle. "It's right here, and it seems to be about as big around as a small washtub."

As Jerry finished speaking, Carl thrust him aside and began digging feverishly at the spot where the metal locator had given the strongest indication. Even Jerry, who ordinarily had a strong aversion to any kind of physical exercise, grabbed up the other shovel and began turning over the soft earth. The boys quickly sank a shaft about three feet in diameter, and when it had reached such a depth that the edge of the hole came about to Carl's chest, his shovel suddenly gave forth with the hair-raising sound of metal scraping on metal.

"Easy now," Jerry admonished, as he knelt at the side of the hole and peered intently down to where Carl was gently scraping the dirt away with the edge of the shovel.

"Aw, heck!" Carl suddenly said, with deep disappointment. "It's just a roll of old fence wire."

"And what did you expect?" a gruff voice asked from behind him.

The heads of both boys jerked up to see a scowling farmer, carrying a pitchfork, towering over them.

"What do you young rascals think you're doing?" he demanded. "Now, climb right out of that hole and start filling it up. You think I want one of my cows stepping in that and breaking her leg and making it necessary for me to destroy her? What are you trying to do, anyway?"

As the boys meekly started shoveling the earth back into the hole, they told him about the legend and tried to explain the operation of their metal locator.

"A likely cock-and-bull story!" Mr. Sloan sneered. "I've never held with these scientific gadgets since I gave a fellow with a peach tree fork ten dollars to twitch a well site for me. We drove straight down a hundred and forty feet right where he said and never struck a drop of good water. You just gather up your junk, and I'll personally escort you off my property. And if you know what's good for you, you'll never set foot on it again."

Jerry rigged himself up in his metal locator, and Carl gathered up the tools. All three started across the cornfield toward the road, with Mr. Sloan—his pitchfork cradled in the crook of his arm—following behind Jerry. When they were about halfway across the field, Jerry stopped so abruptly that Mr. Sloan

narrowly averted thrusting the tines of the pitchfork into the boy's leg.

"What are you trying to do . . . make me hurt you so you can sue me?" Mr. Sloan bel-lowed. "Keep moving."

"Wait a minute," Jerry said, as he moved the search coil about over the broken corn-stalks. "I'm getting an indication of some-thing down here."

He set the probe down, dropped to his knees, and began to scrape away at the soft earth where he had obtained the strong read-ing. In a moment he stood up, dangling some-thing from a dirt-encrusted chain that glistened yellowly in the sun.

"Here, let me see that," Mr. Sloan said sharply. He brushed aside more of the clinging dirt and then exclaimed, "Well I'll be danged if it's not my pappy's old watch that I lost when I was checking corn last spring. I sure thought I'd never set eyes on it again, and that grieved me sorely, for I put a great store in that old turnip. The case is heavy gold, and it was given to my father by my mother on their wedding day. See, here's an inscription on the inside. I wouldn't trade it for the finest diamond-studded watch you could buy."

He paused a moment and then went on:

"I'm mighty obliged to you boys for finding it for me, and here's five dollars each for you. Take it; I won't have it any other way. What's more, I'm downright ashamed of acting so crabby with you before."

"Aw, that's all right, Mr. Sloan," Jerry said. "We really should have asked your permission before we trespassed on your property anyway. What tickles me, though, is that we were able to prove to you that this gadget, unlike that fellow's peach tree fork, really does what it's supposed to do."

"Well, you certainly convinced me," Mr. Sloan said heartily, with a broad and friendly grin; "and I'll tell you what! I have to take a load of steers to the sales barn today; but if you fellers can come back tomorrow after-noon, I'll get my shovel and go along with you, and we'll comb this old farm of mine with that gold-sniffing gadget of yours to a fare-you-well . . . that is, if you don't mind letting a crabbed old cuss like me in on the fun."

"Tickedled to have you, Mr. Sloan!" the boys chorused together.

-30-



"I'll be danged if it's not my pappy's old watch that I lost when I was checking corn last spring."

April, 1956

ANNIVERSARY SALE!

FREE! BIG ANNIVERSARY FLYER OF OP-TICS, TOOLS, PHOTO, WEATHER, ELECTRONIC and GADGET ITEMS

FREE! YOUR CHOICE OF ANY \$1 ITEM WITH EVERY \$10 ORDER

FREE GIFT WITH EVERY ORDER!

- 60 TUBULAR CONDENSERS. 25 Values! .00035 to 1 mf. up to 6000V. Oils, too. \$1 Wt. 2 lbs. Reg. \$10.
- 10 FP & TWIST ELECTRO-LYTICS. Asstd. to 1000mf. to 450V. Some multiples. \$1 Wt. 2 lbs. Reg. \$12.
- 1500 PCS. SPAGHETTI TUBING. Asstd. sizes, col-ors, length to 3 ft. Wt. \$1 1/2 lb. Reg. \$7.
- 8 PC. NUTDRIVER KIT. Plastic handle: 3/16, 7/32, 1/4, 5/16, 11/32, 3/8, 7/16" steel socket wrenches; plastic case. Wt. 1/2 lb. \$3.50 \$1 value.
- G.E. PREAMPLIFIER KIT. Chassis, condensers, resis-tors, wire, socket, schematic (less 6SC7 tube) for famous equalizer. Wt. 1 lb. Reg. \$1 \$4.50.
- 2000 PCS. HARDWARE. Radio, TV, shop woodwork-ing screws, springs, grommets, etc. Wt. 2 1/2 lbs. Reg. \$1 \$12.
- 40 MOULDED CONDENSERS. Best known makes! .0005 to 0.1 mf to 1000V. Wt. \$1 1/2 lb. Reg. \$13.
- 30 CERAMIC DISC CON-DENSERS. 5 mmf to .01 mf. to 3000V. TV repairmen note! Wt. 1/2 lb. Reg. \$1 \$13.
- 8 TUBULAR ELECTRO-LYTICS. Popular values to 450V. Top makes, axial leads. Wt. 1 lb. Reg. \$11.
- 60 KNOBS. Instrument, radio, TV types. Push-on & set screw types. Some 3/8" ea. Wt. 1 lb. Reg. \$9.
- 10 PANEL SWITCHES. Mi-cro, car, momentary, push & rotary. Wide variety. Wt. \$1 1 lb. Reg. \$12.
- 3 LBS. HOOKUP WIRE. Hundreds of Pre-cut, tinned lengths, to 18". Asstd. col-ors, sizes, stranding. Reg. \$1 \$10.
- 20 POWER RESISTORS. Wirewound. 20 values. 5 ohms to 12,000. 5 to 50 watts. Candohm, and tubular types. \$1 Wt. 2 lbs.
- 60 MELCA CONDENSERS. Rare offer! Postage stamp type. 25 values. .00001 to .01; to 1200WDC. Many sil-ver. 5% foot Wt. 1/2 lb. \$1 Reg. \$21.
- 50 RF COILS & CHOKES and air-tuned coils for TV, radio, lab. 20 types. Wt. \$1 1 lb. Reg. \$15.
- 125 CARBON RESISTORS. 30 values: 100 ohms to 1 meg. 1/2, 1 & 2W. Many 5%. Uninsulated. Wt. 1 \$1 lb. Reg. \$21.
- 30 VOLUME CONTROLS. Handy shop asst. of radio, TV, lab units. Some WW. \$1 Wt. 1 lb. Reg. \$9.
- 30 POPULAR PULSARS. Spe-cial! Wide variety, standard, miniature, screw and bayonet types. 1.1 thru 6V. \$4 \$1 value!
- 12 LINE CORDS. AC/DC cords; molded plugs. For all electrical eqpt. Stock up \$1 now! Wt. 1 lb. Reg. \$3.
- 100 COIL FORMS. Experi-menters, note! Wide variety of shapes & sizes. Ceramic and bakelite. Wt. 2 lbs. \$1 Reg. \$25.
- 60 CARBON RESISTORS. Insulated: 35 values, 15 ohms to 10 megs. 1/2, 1 & 2W; 5% foot incl; famous to Allen Bradley! Wt. 1/2 lb. Reg. \$1 \$18.
- 7 PC. MAGNETIC SCREW-DRIVER SET, w/mtr, rack. Fireproof, nonbreakable plastic handles; to 7" lonk. Wt. 2 \$1 lbs. \$3 value!
- SAW & RULER SET. Heavy duty coping saw, blade and 3 ft. spring-type rule in case. Wt. 1 lb. Reg. \$2.50 \$1 value.
- 110 RADIO PARTS. Asstd. molded, mica, paper tubu-lar condensers & carbon resis-tors. Mid. on term, strips. Wt. 2 lbs. Reg. \$15.
- 25 TUBE SOCKETS. Scoop! Subminiatures, 7 & 9-pin miniatures; 4 to 8-pin. Mica-filled & ceramic; shield base. \$1 type, too. Wt. 1 lb. Reg. \$9.
- 50 CERAMIC CONDENSERS. Tubular, disc, button & standard. 5 to .01 mmf to 1000V. Wt. 1/2 lb. Reg. \$14. \$1
- 60 TERMINAL STRIPS. Solder term. strips & boards; 2 to 9 lugs. Builders, note! \$1 Wt. 1/2 lb. Reg. \$4.
- KNIFE & OIL STONE SET. Wonderful gift or pick one up for yourself! 5 in 1 stag handle SCOUT knife, with pocket sharpening stone. Wt. 1 lb. \$1 Reg. \$4.

ANNIVERSARY SALE SPECIALS!

- ELECTRIC DRILL and ACCESSORY SCOOP! Top make, trigger type, hand chuck; PLUS 3-pc. polisher-sander kit, 9 twist drills! Reg. \$24. . . . **\$12.44 COMPLETE**
- PRECISION MICROSCOPE, 100-200-300 X. Quality high-power instrument. 8" high; complete w/slides, wooden case. Wt. 5 lbs. Reg. \$17. . . . **\$ 5.88 COMPLETE**
- ELECTRIC FAN SCOOP! Get ready for summer heat! 115 VAC motor; 3000 RPM, 1/250 HP. Fan blade, AC cord incl. Reg. \$5. . . . **\$ 2.19**

PE-4

HOW TO ORDER

Check items wanted. Return entire ad with check or MO. Include sufficient postage, excess returned. C.O.D. orders 25% down. Rated, net 30 days.

Name

(Please print)

Street

City Zone State

Enclosed \$..... for kttg; \$..... for postage.

LEKTRON SPECIALTIES
28 GARDINER ST. CHELSEA 50, MASS.

Visit Our New Showroom at 131 Everett Ave., Chelsea

107

Introducing the "Octahedral"

(Continued from page 77)

octave, and the purity of fundamental tones will be greatly preserved. Efficiency will be lowered somewhat by the heavy cone loading of the 3¾ cubic feet of inside air.

By raising the enclosure slightly off the floor (on wooden strips or legs), you can use the open vent at the bottom as a port for bass reflex action. Tune this port by varying the distance between the vent and the floor. With a correctly adjusted port, the enclosure will put out bass down to 60 cycles, with some boost in this region.

If you have an available corner and want the added efficiency possible with a horn, cut two inches from the bottom end of the rear panel. This will create an acoustical low-pass filter that allows frequencies below 100 cycles to feed into the corner of the room. By positioning the cabinet so that its sides are about two inches from the room's walls, you can load the rear of the speaker with a horn-like air column that helps push out the deep bass tones.

Of course, corner placement is a good idea even if the enclosure is used as an infinite baffle or bass reflex. But it works almost as well placed against a flat wall.

Yours is the final choice as to where and how to use the enclosures, depending on your own listening tastes and available speakers. But whatever your choice, the results are bound to please—and there's always the thrill of being able to say, "I built it myself!"

-30-

Drones Put R/C Into War Games

(Continued from page 33)

Average life of a drone is difficult to determine. The Navy's base at Chincoteague, Va., supplies drones for operations off the Virginia Capes. Using F6F's almost entirely, about 85% of their losses are from fleet gunnery, and the average life is about 2.75 missions. Other bases have reported drones which survived over 20 gunnery flights, although this is exceptional.

"Armchair pilots" who fly these drones have to undergo extensive training. Flying full-sized converted fighters and bombers requires a skill possessed by only the best of "live" pilots chosen for the task.

Safety pilots usually go along to check out the equipment initially, and on training flights, but the real McCoy is flown NOLO (NO Live Operator). Control is usually transferred to a director or chase plane after take-off which then controls the drone throughout the rest of its mis-

sion, returning control to the ground operator for the landing operation.

Visual observation of the drone is not always required, however. Remote-controlled flights have ranged as far as 100 miles from the operator. In such cases, the drone's position is reported by radar tracking.

New jobs are continually being found for the drones, and these jobs are being done more effectively, more efficiently, and at less human risk than with piloted airplanes. A more subtle but far-reaching benefit is the backlog of skills, equipment and manpower which will be available for the guided missiles of the future.

-30-

An Amazing Converter

(Continued from page 70)

pliers, and solder the lead quickly to prevent heat from reaching the diode element. Make sure the solder connection is cold before removing the pliers. If the diode becomes hot, it may be ruined and the converter will not work.

Operating the Converter

A broadcast receiver using a loop antenna will not work well because regular broadcast stations will tend to come in at full volume along with the short-wave reception. Remove the loop, and wire in a small "Vari-loopstick" or a "Ferri-tenna" in its place. Wind a coil of about ten turns of any small-diameter insulated wire on the form immediately below the present coil. Then, connect the two leads from the 10-turn primary to the two output leads of the converter. Make sure that the primary coil and its leads are well insulated, and *don't make any direct connections to the chassis*. To use the converter with any other type of broadcast set, disconnect the antenna and ground leads from the receiver and connect the converter leads in their place, as shown in the wiring diagram.

Poke a fair-sized loop of the antenna lead (assuming it is insulated) into the receiver close to the tuning capacitor. Turn the plates of the converter tuning capacitor C2 full out, and set the tuning dial of the broadcast receiver at the 1600-kc. mark. Finally, turn on the receiver, and rotate the tuning knob very slowly. You should hear plenty of squeals and c.w. beats, and . . . now and then . . . a short-wave broadcast or amateur station. Adjust the converter's tuning for loudest and best reception of the desired station.

Reception depends to a large extent on the type of antenna used. In some cases, more turns or fewer turns on the converter

ESSE SPECIALS • NEW AND SURPLUS



110 V. 60 CYCLE SELSYNS \$4.95 ea.

Popular Navy size 5 (approx. 6 1/2" L by 3 1/2" dia.). Order either motors, generators, differentials, or control transformers at this price. Used but guaranteed good. Ship. wgt. approx. 6 lbs. ea. **Choice, ea. \$4.95**

Supreme 542-B Multimeter—New \$14.95
Reg. \$25.20 Net
(For complete description see Feb. PE 1956)

OAV-1 Test Signal Generator 150-250 Mc. Range. See Jan. PE for description. New—close-out..... \$15.00 ea.

Command Equipment: 274N, ARC-5

Receivers	Model	Used	New
190-550 Mc.	453		\$17.50
6-9.1 Mc.	455	\$4.50	6.00
100-156 Mc.	R-28/ARC-5	13.95	22.50
Transmitters	Model	Used	New
3-4 Mc.	(both)	\$6.50	\$9.95
4-5.3 Mc.	(both)	3.95	6.00
5.3-7 Mc.	(both)	3.95	5.00
100-156 Mc.	T23/ARC5	14.95	22.50
Modulator MD-7			\$7.50
"	BC-456		3.95
Controls: C-29, C-30, C-38, C-39, C-43			
C-48/ARC-5 for above equip. Choice.			\$1.50 ea.
Mounting racks, dual Xmtr., triple Rec.			\$2.50 ea.

ESSE RADIO CO. Dept. P-4
42 WEST SOUTH ST. INDIANAPOLIS 25, IND.

LEEDS & NORTHRUP MICROMAX RECORDERS

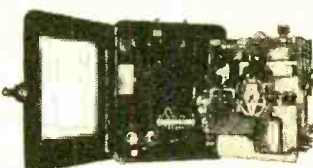

Strip type recorders used for controlling and recording a wide variety of processes. Used originally for temp. range for 350-550 degrees C. May be changed for other applications. Operated on Wheatstone bridge principle using AC galvanometer movement. Original cost several times our price. Units were removed from demilitarized equipment which in many cases was new, but all instructions sold as used and guaranteed. Money back if **\$179.50** not satisfied. PRICE ea.

R-1/ARR-1 RECEIVER—For use as 220 Mc. converter. Essentially a two stage RF acorn tube superhet converter. Also can be used for a preselector. Small enough for mobile. Wgt. 6 lbs. Cover not shown but included. From demilitarized equipment. **\$2.95**
PRICE, Brand new \$2.95
Altit-1 Antennas for above. New, ea. \$1.25
Co-axial antenna-relay for above or other combination. New, ea. \$1.25

Dynamotors:

Type	Input	Output	Used	New
DM-34	12 V. 2.8 A.	220 V. 80 Ma.	\$2.50	\$3.75
DM-40	12 V. 3.4 A.	172 V. 138 Ma.		2.95
DM-42	12 V.	1030 V. 260 Ma.	8.95	14.75
PE-94	522 dynamotor		3.50	5.00

CLOSE-OUTS:

MN-26 Radio Compass. Used, good condition.... \$20.00
RA-10 Receiver, Used \$15.00.....New 25.00
BC-433 ADF Rec., Used \$15.00.....New 35.00
BC-229 Rec. less coils & tubes.....Used 2.50 ea.
Torque Amps. (as in Jan. '56 PE), only a few.... 5.00 ea.
Instrument Test Sets (as in Jan. '56 PE), only a few 20.00 ea.
T-39/APQ-9 Radar Xmtr.....Used 4.95
RL-42 Reel Motors, Used \$1.50.....New 2.50
Power transformer, 110 V. 60 cy. input 400/800 V.
CT OutputNew 10.00

INDUSTRIAL ELECTRONIC— AUTOMATION TECHNICIANS Desperately Needed!

Never in history has there been such a tremendous demand for Electronic technicians at the servicing, maintenance and assistant Engineering level, in all fields of electronics. Industries, Businesses, large and small are turning to Electronically controlled machinery... AUTOMATION!

Whether it's a Robot airplane, an automobile plant with an integrated line of machines, a Sensing Device, Computing System or Communications—each re-

quire electric power applied through automatically controlled processes. This means there are positions open at all levels and phases for Electronic Technicians.

- TOP PAY
- UNLIMITED OPPORTUNITY
- SECURE FUTURE

Let us send you FREE, without obligation, complete details of our Resident Electronic Training Program—originated by Bailey Schools—acclaimed by Electronic Engineers. See how you save time as you learn-by-doing with intensive laboratory work on the most recently developed Electronic equipment, plus classroom required physics, mathematics, etc.

We help you find part time work while in our school—help place you with America's leading companies after graduation. Act now—mail coupon today!

VETERAN APPROVED

Bailey Technical Schools
1626 S. Grand • St. Louis 4, Mo.

Bailey electronic students learn Industrial Television on specially designed equipment such as this panelboard, which is a multiple camera and screen control. The Bailey Electronic course includes an outstanding comprehensive program in radio and TV receiver servicing.

MAIL TODAY

Please mail immediately this free booklet without obligation.

FREE BOOKLET

Name _____

Address _____

City _____ State _____



TECHNICIANS WANTED



RADIO TELEVISION AND ELECTRONIC INDUSTRIES NEED WELL TRAINED MEN.

The man who really has the "know-how" will win the best rank and position and the highest pay in the years ahead. Engineering Opportunities shows how you can be thoroughly trained by specialized home study courses. It lists details of over ninety courses in all branches of engineering and academic fields. Get your free copy of "Engineering Opportunities" to-day by mailing the coupon below.

Canadian Institute of Science & Technology Limited, 610 Century Bldg., 412, 5th St., N.W., Washington, D.C.
Please forward free of cost or obligation of any kind your 105-page handbook, "ENGINEERING OPPORTUNITIES".
Name.....

Address.....

Course interested in..... Age.....

Canadian Enquiries: Canadian Institute of Science & Technology, 263 Adelaide St. W., Toronto, Ont.

SCHEMATICS—CONVERSIONS FOR SURPLUS GEAR

NEW LIST DI MANY ADDITIONS!

Send stamped, self addressed envelope for List D. Add 25¢ for chart explaining AM nomenclature. DO IT TODAY!

**R. E. BOX 1220—PE
GOODHEART BEVERLY HILLS, CAL.**

LEARN TELEVISION

"AT THE MOST PRACTICAL SCHOOL IN THE WEST" WORK ON LATE MODEL SETS—USING MODERN SERVICING EQUIPMENT AND TECHNIQUES: UNDER QUALIFIED TECHNICIAN INSTRUCTORS (SHORT RESIDENT) AND (CORRESPONDENCE COURSES)—NO UNNECESSARY MATH OR THEORY—ALSO UHF AND COLOR TV.

APPROVED FOR VETS—ENROLL NOW!
Day and Night Classes Write for Free Literature
Dept. 2A—Correspondence
Dept. 2R—Resident

**V. S. I. TELEVISION SCHOOL 4570 Firestone Blvd.
South Gate, Calif.**

WANTED FOR CASH New Electronic Tubes

Transmitting—Special Purpose—Receiving—Any Quantity from one to thousands. Immediate response to all offers.

**JACK KAY 129B 5th Ave.
N.Y.C. 3, N.Y.**

YOUR F.C.C. LICENSE

GUARANTEED PREPARATION
Your License for F. C. C. Commercial Operator Examination in a minimum of time.
A specialist in your home through correspondence or on the spot in resident classes.

Write Now For Free Information

EMIG SCHOOL OF ELECTRONICS

6331 Hollywood Blvd. Hollywood 28, Calif.

coil may improve reception. The author's unit works best with both receiver and converter set at the high end of the range, i.e., with plates of all tuning capacitors turned almost full out. Many amateur stations in the 40- and 80-meter bands and short-wave broadcast stations have been heard loud and clear with an antenna consisting only of a six-foot length of hookup wire!—*Frank H. Tooker.* —30—

Electronic Thermometer

(Continued from page 64)

life—as current is drawn only when readings are actually being taken.

You will find this remote thermometer a lot of fun to build, as well as a very practical device. You can connect as many thermistors as you like—just make certain that switch *S2* has enough positions to take care of your needs! As you can see, the author used a five-position switch, enabling temperature measurements to be made at five different locations. —30—

After Class

(Continued from page 91)

resistive, this is easy, because all you need do is measure the resistance of the device with the ohmmeter setting of your instrument, determine the a.c. voltage applied, and substitute in the equation: $P = E^2/R$. Power (*P*) is in watts, voltage (*E*) in volts and resistance (*R*) in ohms.

But with a reactive load such as the primary of a transformer, this procedure is unsatisfactory because of the difference in phase between the current and voltage. To get around this, use the power equation $P = I^2R$. The problem is to measure a.c. current without an a.c. ammeter.

Connect a 5- or 10-ohm resistor in series with the primary of the transformer and measure the a.c. voltage drop across the resistor. Calling this drop *E*, the current through the primary may be found by substituting in the equation: $I = E/R$, where *R* is the resistance of the added resistor. Use this value of current to find the power consumption. —30—

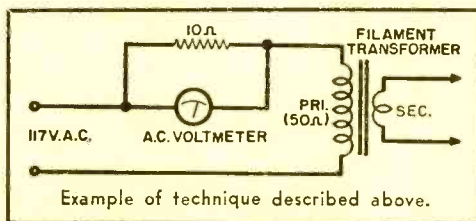

Example of technique described above.

hi-fi

ANNUAL & AUDIO HANDBOOK

NOW ON SALE!



Whatever your interest in Hi-Fi—as a builder of your own rig, or simply as a lover of good music—you'll find a wealth of practical and authoritative information in HI-FI ANNUAL & Audio Handbook, on sale at newsstands and radio parts stores March 6, 1956.

Edited by the staff of RADIO & TELEVISION NEWS, the World's Leading Electronics Magazine, HI-FI ANNUAL & Audio Handbook brings you—between the covers of a single volume—a total of 42 carefully selected articles on everything in Hi-Fi . . .

- SELECTING HI-FI EQUIPMENT
- PREAMPLIFIERS
- EQUALIZERS & TONE CONTROLS
- POWER AMPLIFIERS
- LOUDSPEAKERS & ENCLOSURES
- TAPE TRICKS WITH YOUR HOME RECORDER

. . . plus a complete bibliography of Hi-Fi technical books and a handy product directory.

If you're a Hi-Fi fan—and who isn't today?—HI-FI ANNUAL & Audio Handbook is "must" reading . . . will save you money . . . show you the way to more enjoyment from your hobby. Only \$1.00.

**BE SURE TO GET YOUR COPY
TODAY**

at Newsstands and Radio Parts Stores

HI-FI ANNUAL and Audio Handbook

366 Madison Ave., New York 17, N.Y.

TOOLS & GADGETS

MINIATURE TELEPHONE RELAY

The 7MS is a miniature telephone relay for motor control, mobile radio, and many other control circuits where there is a need for a small relay to handle heavy currents. It has a minimum life of 100,000 operations under a 5-ampere, 125-volt, a.c., contact load.

Minimum operating power of this fast-acting d.c. relay is 100 milliwatts, maximum coil dissipation is 1.5 watts, and maximum coil resistance is 6000 ohms. (*Kurman Electric Co., Inc.*, 35-18 37th St., Long Island City, N. Y.)

TAPE SPLICERS

"Gibson Girl" tape splicers cut tape ends diagonally and trim the tape edges without the use of scissors or razor blades. The newest

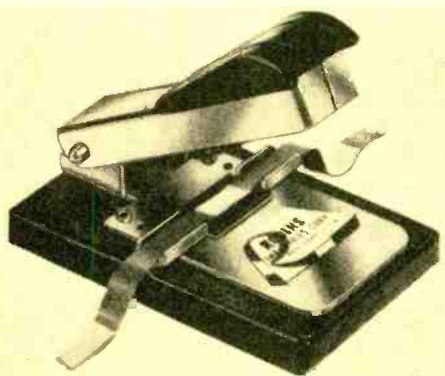

model, "Gibson Girl Junior" (TS-4 Jr.), is smaller, lighter and lower in cost than the other models, and was designed for carrying in pocket, purse or equipment bag. These splicers produce a slightly narrow (Gibson Girl) waist at the splice which prevents contact of adhesive with recorder parts. (*Robins Industries Corp.*, 214-26 41st Ave., Bayside 61, N. Y.)

"TROL-GUN" AND "TROL-KLEENER"

Eliminating noisy volume controls is the main duty of "Trol-Gun" and "Trol-Kleener," the radio-television cleaner and lubricator available from *General Cement Mfg. Co.*, Rockford, Ill. They may also be used on push buttons, switch contacts and tuners, and will not harm finishes of wood, acetate, metal, and the like.

The "G-C Trol-Gun" is loaded just like a fountain pen. Constructed of solid aluminum, it easily fits over a set's volume control shaft, where the operation of the tool's piston forces the cleaner-solvent into the area around the shaft. It lists for \$6.25 (net, \$3.75). A 16-oz.

bottle of "G-C Trol-Kleener" lists for \$3.25 (net, \$1.95); 32-oz. and 1-gallon sizes are also available.

EASY-TO-USE LINE CHECKER

Triplet's Model 3000 "Line Chek" checks the condition of a line under load and en-



ables the user to connect an electrical load equal to the load of the appliance to be installed on the line. Only three simple steps are necessary to operate it: (1) plug wall cord into outlet to be checked; (2) set load switch No. 1 to the load position

to be checked, i.e., 500-, 1000- or 1500-watt load; (3) press button No. 2, and hold down only long enough for the meter pointer to stop moving.

Model 3000 comes in a black molded case, 2¾" x 5½" x 7½", and weighs only four pounds. Net price is \$34.50. (*Triplet Electrical Instrument Co.*, Bluffton, Ohio)

"CAPACITESTER"

Trouble-shooting of printed circuit equipment can be simplified by using the "Capaci-

Tester." Said to be the first instrument capable of in-circuit testing of all types and capacities of coupling capacitors for leakage up to 40 megohms, it eliminates the delicate, hazardous and time-consuming operation of unsoldering or clipping one end of the capacitor from the printed board, and precludes the possibility of cold-solder reconections.

The "CapaciTester" will not damage capacitors and gives positive indication of the relative amount of leakage present between any two points where it may occur. A high-accuracy Wien bridge is also included for the measurement of capacitance from 10 μfd. to 50 μfd. (*TeleTest Instrument Corp.*, 30-01 Linden Place, Flushing 54, N. Y.)

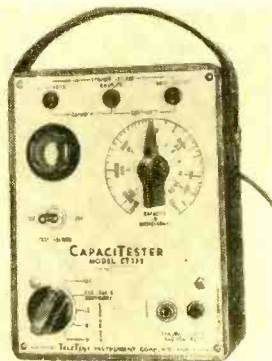

ALL-PURPOSE MULTIMETER

Model TV-60 "Allmeter" is a complete all-purpose 20,000 ohms-per-volt multimeter.

POPULAR ELECTRONICS

LIFETIME GUARANTEED TUBES

BRAND NEW PICTURE TUBES

RCA Licensed.
 • One Year Unconditional Guarantee.
 Type Price Type Price
 10BP4 \$11.90 17BP4 \$20.63
 12LP4 14.38 19AP4 24.81
 14BP4 16.85 21AP4 28.79
 16PP4 19.38 23BP4 28.79
 16LP4 19.38 24AP4 42.50
 Picture Tubes shipped F. O. B. Harrison, N. J.

NEW INDOOR ANTENNA

Both UHF and VHF. Brings better reception than most outdoor antennas. Use on top of TV.
 List price \$9.95 \$3.99 each

Lots of 3 **YOUR PRICE \$3.29** each

FREE BONUS BOX

With Every \$25 Order

- 1 RCA Cheater Cord
- 10 Assorted resistors
- 10 Assorted 2 Color "blank" tube cartons
- 1 6B2GGT tube
- 1 6AU6 tube
- 1 6CB6 tube

FREE CLOCK RADIO

With Every \$25 Purchase Within 30 Days Wakemaster clock radio with famous Sessions clock movement wakes you up to music or alarm. May be purchased outright from MAJOR BRAND for \$17.95. In ivory or rust.

FREE GIFT CERTIFICATE*

Worth \$5 toward the purchase of any of our merchandise on future orders will be sent with any order of \$50 or more.
 *Free Gift Certificate cannot be used to obtain another certificate unless order is \$55 or more.

USED TV SETS

Picture Tube Guaranteed To Work!

- Emerson • RCA • Philco • GE • Motorola • Zenith • Capehart • Others
- 10" SET
 Table Model \$16.95
 Console \$19.95
- 12" SET
 Table Model \$22.95
 Console \$24.95
- 14" SET
 Table Model \$27.95
 Console \$31.00
- 16" SET
 Table Model \$32.00
 Console \$34.95
- 17" SET
 Table Model \$37.00
 Console \$39.00

All prices F.O.B. Harrison, N. J. Prices on request for 19", 20", 21" and 24" sets.

• We guarantee to replace tubes labeled MAJOR BRAND forever. Each tube individually boxed and Guaranteed For Life. Over A Half Million Tubes Always In Stock. • Immediate Shipment • Free Postage On All Orders With Full Remittance.

HERE'S HOW LIFETIME GUARANTEED TUBES

SAVE YOUR MONEY

• There are fewer "call backs" • There are no "out of date" tubes • "Peak Performance" testing in our fully equipped Testing Department before shipment guarantees quality.

024	.43	3CB6	.52	6B4G	.52	6L7	.42	7E5	.45	19BG6G	1.15
JA4P	.33	3Q4	.46	6B8	.69	6N7	.60	7E5	.55	19T8	.65
JA70T	.43	3Q5GT	.57	6BA6	.47	6Q7	.40	7E7	.70	2A4	.39
IB3GT	.65	3S4	.47	6BA7	.58	6S4	.40	7E7	.59	25AV5GT	.78
1C5GT	.41	3V4	.47	6BC5	.47	6SA7	.45	7F8	.70	25BQ6GT	.78
1D5GP	.43	5BQ7	.89	6B0T	.80	6S0T	.48	7G7	.75	25L6GT	.47
1E7GT	.41	4BZ7	.95	6DEG	.45	6S0T	.41	7H7	.50	25W4GT	.43
1G6GT	.41	5AW4	.75	6BF5	.40	6SH7	.43	7J7	.75	25Z5	.37
1H4G	.43	5J6	.63	6BF6	.50	6S17	.43	7K7	.75	25Z6	.37
1HSQT	.47	5T4	.69	6BGG	1.15	6S17GT	.55	7L7	.75	27	.25
1J6GT	.47	5U4G	.43	6BH6	.50	6S17GT	.55	7N7	.50	35A5	.46
1L4	.45	5UB	.74	6BJ6	.47	6SN7GT	.55	12AT6	.37	35B5	.50
1L6	.55	5V4G	.59	6BK5	.68	6S0T	.39	12AT7	.65	35C5	.50
1L84	.57	5V3	.31	6BK7	.76	6S0T	.42	12AZ7	.63	35L6GT	.47
1LA6	.47	5Y4G	.36	6BL7GT	.75	6S57	.41	12AU6	.41	35W4	.34
1L84	.57	5Z3	.41	6BN6	.58	6T4	.95	12AU7	.53	35Y4	.34
1LC5	.49	6A7	.57	6B0GT	.78	6T8	.68	12AV6	.35	35Z3	.39
1LC6	.47	6A8	.45	6BQ7	.78	6T8	.68	12AV7	.67	35Z5GT	.34
1LD5	.57	6AB4	.43	6BY5G	.58	6V3	.80	12AX4GT	.65	37	.29
1LE3	.57	6AC7	.57	6BZ7	.88	6U8	.55	12B06	.48	50A5	.46
1LG5	.57	6AF4	.79	6C4	.37	6V6GT	.46	12B4	.68	50B5	.50
1LH4	.64	6AG5	.50	6C5	.35	6W6GT	.53	12BA6	.46	50C5	.50
1LE3	.57	6AG7	.57	6C6	.48	6W6GT	.53	12BA6	.46	50L6GT	.43
1NSGT	.49	6AH6	.69	6C0GG	1.15	6X4	.34	12BE6	.46	75	.42
1R5	.50	6AJ5	.70	6D6	.48	6X5	.34	12BH7	.60	76	.42
1S5	.42	6AK5	.54	6E5	.44	6X8	.73	12BY7	.65	77	.38
1T4	.50	6AL5	.39	6E5	.37	6Y6G	.55	12BZ7	.61	78	.38
1U4	.47	6AQ5	.46	6F6	.38	7A4	.45	12C06	.95	80	.34
1U5	.42	6AR4	.46	6G6	.40	7A5	.45	12C5A7	.45	84/6Z4	.44
2A5	.49	6AS5	.48	6H6	.38	7A6	.45	12C07	.45	117L7GT	.43
1X2	.61	6A56	1.70	6J4	1.79	7A7	.43	12K7	.45	1.09	
2A3	.55	6A57G	2.19	6J5	.39	7A8	.45	12N7GT	.56	117N7GT	1.09
2A4	.57	6AT6	.39	6J6	.47	7A8	.45	12S07	.37	1.09	
2A7	.55	6AU4GT	.65	6J7	.43	7B6	.42	12SR7	.45	117P7GT	1.09
3A4	.51	6AU5GT	.59	6J8G	.85	7B8	.45	12V6GT	.45	1.09	
3A5	.45	6AU6	.42	6K6GT	.37	7C4	.39	12X4	.37	117Z3	.35
3AL5	.45	6AV5GT	.65	6K6GT	.37	7C4	.39	12X4	.37	117Z6GT	.63
3AU6	.46	6AV6	.39	6K7	.39	7C6	.43	14A7	.42		
3BC5	.54	6AX4GT	.60	6K8	.65	7C6	.43	14B6	.38		
3BN6	.70	6AX5GT	.57	6L6	.68	7C7	.45	14Q7	.50		

ALL PARTS SHIPPED F.O.B., HARRISON, N. J.

WE PAY ALL POSTAGE on orders shipped in USA, Territories and APO's. Send only purchase price of merchandise. Please include approximate postage on foreign shipments. All orders subject to prior sale. Add 25¢ handling on orders under \$5.00. Quantity users write for special discount.

Write For FREE Tube List—Order Blank—and FREE Sample Tube Carton. We want Y-O-U On Our Mailing List!

This Ad is Worth M-O-N-E-Y
 Clip out this ad and attach it to your order. Three 6SN7GT's will be shipped FREE with any order of \$10 or more.

MAJOR BRAND TUBE CO.

Romano Bldg. ESsex 4-1106 Harrison, N. J.

VHF AM-FM RADIO

Supersensitive sub-miniature tube set receives television, FM broadcast, CAP, and amateurs without antenna or ground. Tunes from 25 mc. to 150 mc. Similar models available in frequency bands from 27 mc. to 225 mc. Pocket size—measures only 2" x 2 1/4". Highest quality components used. Specify battery or AC model. Use with any magnetic head-phone or can be connected to audio amplifier for loudspeaker operation. Thousands in use by amateur, experimenters, and civil defense. Factory wired and tested chassis complete with special tube only \$5.98 postpaid. In kit form \$3.98. Postage extra on COD orders. New transistor audio amplifier for extra loud reception only \$2.00 including transistor.

SPRINGFIELD ENTERPRISES

Box 54-E Springfield Gardens 13, N. Y.

EYE GLASSES by MAIL As low as \$1.95

WRITE for FREE CATALOG with 14 LENS SAMPLE CARD
 Thousands of Customers
 Est. 1939



QUALITY READING-MAGNIFYING OR BIFOCAL GLASSES FOR FAR AND NEAR
ADVANCE SPECTACLE COMPANY, Inc.
 537 S. Dearborn St., Dept. PE-4 Chicago 5, Illinois

MAIL COUPON FOR A

FREE BOOK & LESSON SHOWING HOW YOU CAN BUILD AND KEEP A POWERFUL GIANT SCREEN TV SET!

STUDY IN CALIFORNIA ABSOLUTELY FREE!!
 (Two weeks free training in our Los Angeles laboratory)

GREATEST OFFER IN OUR 23 YEARS!
 LOOK AT THESE ADVANTAGES FROM C.E.T.I.!! TRAIN AT HOME in your spare time and get into the high-paying Radio & Television field. "LEARN BY DOING" by building your own radio and TV SET and performing 100's of experiments in your own home. All kits are yours TO KEEP. COLOR TELEVISION is included in your training course. FCC COACHING COURSE qualifies you for higher pay!! LOS ANGELES TRAINING is yours at no additional expense (two weeks in our laboratory). MAKE MONEY while you are still training. ACT TODAY!! Send for our free book explaining in detail the many advantages you receive ONLY FROM C.E.T.I. YOU OWE IT TO YOURSELF TO SEE HOW YOU CAN STEP INTO HIGH-PAYING RADIO & TELEVISION JOBS WHILE YOU STUDY AT HOME IN YOUR SPARE TIME!!

CALIFORNIA ELECTRONICS & TELEVISION INSTITUTE
 1121 W. PICO BLVD., LOS ANGELES 15, CALIF.
 Send, without obligation, your Big Book containing hundreds of TV-RADIO Facts and Ideas plus Free Lesson. (No salesman will call.) Dept. 12

Name _____
 Address _____
 City _____ Zone _____ State _____

STUDY IN SPARE TIME AT HOME

MAIL COUPON TODAY! GET FREE TV FACTS-TV IDEAS

BONUS OF 12 BIG KITS OF RADIO PARTS

CALIFORNIA ELECTRONICS & TELEVISION INSTITUTE
 1121 W. PICO BLVD., LOS ANGELES 15, CALIF.

Featuring a giant recessed 6½" 40-microampere meter with mirrored scale, it assures accuracy and easy reading. All calibrations are printed in large, easy-to-read type.

This instrument can be used as a direct-reading capacity meter, a kilovoltmeter, an



r.f. signal tracer and an audio signal tracer. Specifications include: eight d.c. voltage ranges (at a sensitivity of 20,000 ohms per volt); seven a.c. voltage ranges (5000 ohms per volt); three resistance ranges, two capacity ranges, five d.c. current ranges and three decibel ranges. (Superior Instrument Co., 2435 White Plains Rd., New York 67, N. Y.)

"GLIDE-O-MATIC" TV ANTENNA

Designed for improved reception in metropolitan areas, the "Glide-o-Matic" indoor TV antenna is said to be the only antenna on the market to have a gliding switch. This is an easy-to-operate six-position switch which helps eliminate ghosts, snow, and other picture problems.

The "Glide-o-Matic" can be used with all black-and-white and color TV sets. It is mounted on an attractive, tip-proof base with protective padding. Brass models are available with bases of ivory, mahogany, and ebony; aluminum models are available with ebony bases. Retail price is \$9.95. (Channel Master Corporation, Ellenville, N. Y.)

TUBE PIN LOCATOR

A simplified vacuum tube computer, known as the "Quick-Way Tube Pin Locator," will be made available to all radio and TV parts jobbers in the United States. It is claimed to be the quickest method yet devised for determining what each tube pin signifies at the socket base.

Retailing at \$1.00, this unit operates with a simple turn of the dial which covers hundreds of receiving tube types. When set to the tube number, it automatically identifies all pin connections. (Airport Television & Radio Co., 188 Airport Rd., Reno, Nevada)

MOISTURE-PROOF BOX CHASSIS

The "Flangelock" series box chassis is said to be 100% shielded, dust-proof, and moisture-proof. When sealed, it can be used as an outdoor rain-proof installation. A catalog describing the series, which comprises 33 different sizes and shapes, may be obtained from the manufacturer. (LMB, 1011 Venice Blvd., Los Angeles 15, Calif.)

METAL WALL SPEAKER BAFFLE

Sturdily constructed of No. 18 gauge steel, the new Premier metal wall speaker baffle has a perforated grille spot-welded behind the speaker opening. The interior is sprayed with a special undercoating to eliminate metallic sound, while the exterior is finished in either brown hamertone or buff enamel. Available in two sizes for 8" and 12" speakers, the baffle is supplied with a bracket for simple wall mounting. (Premier Metal Products Co., 337 Manida St., New York 59, N. Y.)

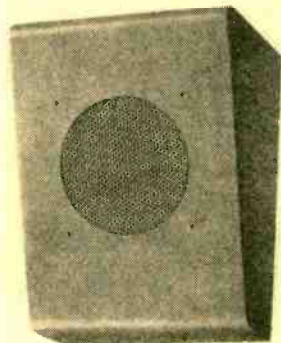

PLUG-IN STRIP

This new plug-in strip is available in both the CF-4 standard receptacle and the CF-4G with grounding outlet. It allows an extra

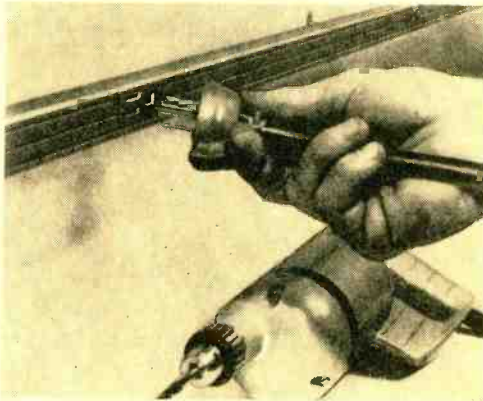

channel for additional wiring needs. (National Electric Products Corp., Gateway Center, Pittsburgh, Pa.)

Tape Recorder Hookups

(Continued from page 85)

recording is to plug the mike directly into the "Microphone" jack on the tape machine, if such an input is provided. Or, you might use a separate "mixer" unit which would enable you to mix your mike with any other program source. Some of the more expensive tape machines have a built-in mixer. Using a mixer to produce some really professional-sounding tapes will be described in detail in another article in this series.

Tape Deck With Playback Only

A fairly recent unit is the tape deck for playback only—no recording. Also called a "tape phono," such a device is used for playing prerecorded tapes. It is an instrument for those who want to listen to the many new taped programs that are available, but who have no interest in making their own recordings. This playback machine may or may not include its own playback preamplifier. If it does, you simply plug its output into a high-level input jack on your regular amplifier, just as you would a radio tuner.

If, however, the tape deck has no integral preamplifier, it requires a special kind of preamplification to be heard. The signal—coming directly from the playback head—is on the order of 5 millivolts, and must be raised to a level your own preamp can use. Also, that signal must be equalized. Most magnetic recordings employ the NARTB playback curve. To get this curve, as well as the needed signal boost, you have three recourses: (1) some of the more expensive hi-fi preamp-control units now include a special channel for tape playback heads with the NARTB equalization built in, or (2) the manufacturer of the tape deck may offer a preamp-equalizer as an accessory, or (3) if you are experimentally inclined, you can build your own preamp.

Units Needing Special Hookups

The connections described in this article can be made easily with most modern equipment. Don't despair, however, if the components you have do not boast such conveniences as a ready-made tape take-off jack, or if your present tape take-off point is not providing best results. The next article in this series will discuss special hookups with particular emphasis on do-it-yourself aspects for adapting your equipment to first-class home tape recording. Also to be discussed are the various methods of monitoring a recording while it is being made.

-50-

April, 1956

168
PAGES

Over
15,000
Items
Listed!

SEND FOR
YOURS
TODAY!



NOW
IN OUR
20th
YEAR
OF
SERVICE

to the
Amateur
Experimenter
Industrialist
Hi-Fi Fan

Ask About Our
★ E-Z CREDIT
PLAN

★ RECONDITIONED EQUIPMENT



SAVE
UP
TO 50%

FREE! FREE!
1956 CATALOG



Here's Just A Sample
of Top-Bargain Merchandise
from

World Radio

WRL's Globe King Xmtr.
WRL's Globe Scout Xmtr.
WRL's New VFO
Complete Hi-Fi Components
Complete Line of Kits
"Plumber's Delight" Beams
WRL's 6 Meter Converter
Wall-Sized Radio Map (25c)
All the Leading Lines of
Receivers, Transmitters, etc.

plus

TOP-TRADES

PE-4

WORLD RADIO LABORATORIES

3415 W. Broadway Council Bluffs, Ia.

Please send me your FREE Catalog
and full information on items listed below

1) _____ 2) _____

3) _____

NAME: _____

ADDRESS: _____

CITY & STATE: _____

Another **MARCUS** radio book!

HELPS YOU LEARN RADIO BY BUILDING YOUR OWN RECEIVERS

Written in simple, easy-to-understand language by the famous author of **ELEMENTS OF RADIO**. (Over 1,000,000 copies sold!)

RADIO PROJECTS

by **ABRAHAM MARCUS**

Ten easy-to-follow projects from the simple crystal set to the modern superheterodyne receiver. Over 80 drawings and photographs.

Table of Contents

- How to solder
- Crystal detector receiver
- Diode detector receiver
- Regenerative receiver
- Two power supplies
- Audio-frequency amplifier
- Tuned-radio-frequency tuner
- AC-DC superheterodyne receiver
- Code oscillator
- Color code for mica capacitors
- Color code for fixed resistors
- International Morse code

Published by Prentice-Hall. Get your copy today!

The Transmitting Tower

(Continued from page 89)

there is only a small—but definite—dip in plate current as C5 is resonated, whichever occurs first.

This discussion on transmitters will be continued next month.

News and Views

Dick Curtiss, WN8CXG, (17), Rte. 1, Vassar, Mich., says: "The very day I got my license last July, I went on the air with the 6L6 transmitter described in the booklet, *How To Become A Radio Amateur*. It ran about 10 watts. With it, I worked 24 states, with Utah being my best DX. My receiver was an S-38B.

"Then, I got an SR-75 (a combined receiver-transmitter unit no longer manufactured—*Herb*) and added a few more states with the built-in 10-watt transmitter. Now, I have an AT-1 transmitter and still use the SR-75 receiver. My states-worked total is 34, with California and Washington being the best DX on 80 meters.

"My antenna is a half-wave doublet, fed through a homemade antenna tuner. 73."

Jack Cohen, KN0CRV, 2626 Monaco Pkwy., Denver 7, Colo., has been a busy ham. "Since receiving my license, I have had about 200 QSO's (contacts) in 42 states in two months. Colorado must be a pretty 'rare' state. Most of the amateurs east of the Mississippi that I work tell me that I am their first Colorado contact. I'll be glad to schedule anyone who needs Colorado, provided that I don't have to get up too early.

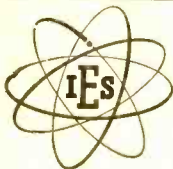

ELECTRONIC TECHNICIANS

ARE IN DEMAND

TRAINED MEN ARE NEEDED NOW!

In just 15 months, you can complete Electronic Technicians training to enter this ever-growing industry. Day or evening classes. Opportunity for employment in local industry. Approved for Korean Veterans.

Terms beginning Jan., April, July, September

Write for Catalog 224 TODAY

INDIANAPOLIS ELECTRONIC SCHOOL

312 E. Washington St. Indianapolis 4, Indiana

Shrinks Hemorrhoids New Way Without Surgery

Science Finds Healing Substance That Relieves Pain — Shrinks Hemorrhoids

For the first time science has found a new healing substance with the astonishing ability to shrink hemorrhoids and to relieve pain—without surgery.

In case after case, while gently relieving pain, actual reduction (shrinkage) took place.

Most amazing of all—results were so thorough that sufferers made astonishing statements like "Piles have ceased to be a problem!"

The secret is a new healing substance (Bio-Dyne*)—discovery of a world-famous research institute.

This substance is now available in *suppository* or *ointment form* under the name *Preparation H*.* Ask for it at all drug counters—money back guarantee.

*Reg. U.S. Pat Off.

RADIO COURSES

FCC LICENSE PREPARATION

- COMMERCIAL
- CODE BRUSH-UP
- AMATEUR
- THEORY

TELEVISION AND RADIO SERVING

Personal Counseling Approved for Veterans

YMCA TRADE & TECHNICAL SCHOOL of N. Y.

15 West 63 St. New York 23, N. Y.

EN 2-8117

Catalog P. E.

53rd Year

GAS-FILLED DIODE QUIZ

(Questions on page 91)

1. At normal current levels it has a lower internal voltage drop. This drop tends to remain constant, thus providing better voltage regulation.
2. The drop in voltage across series elements like filter chokes and filter resistors.
3. It must fall in proportion to the rise in load current.
4. None. These voltage regulators are cold-cathode types.
5. These tubes may be connected in series so that their output voltages add up.

PHOTO CREDITS

PAGE	CREDIT
31, top	U. S. Navy
31, center	Bell Aircraft Corp.
32, top	U. S. Army
32, center, bottom	Sperry Gyroscope Co.
33	U. S. Navy
41	Carl Byoir & Associates, Inc.
42, 43	U. S. Navy
44, 45	Altec Service Corp.
46	North Amer. Aviation, Inc.
47	Consolidated Electroynamics Corp.
49	U. S. Navy
54	Daniel R. Rubin
73	Rek-O-Kut
82	Minnesota Mining & Mfg. Co.

"My transmitter is a Globe Scout at 65 watts, and the receiver is an S-40A. My 40-meter antenna is a vertical, and I use a 'Windom' on 80.

"I'll be glad to help anyone in the Denver area to get a ticket; and I'd like a few skeds, especially WN1's. 73."

Frank F. Longenecker, 1742 North Mariposa, Apt. 5, Hollywood 27, Calif., reports: "Herb, the *Transmitting Tower* really 'gets out.' So far, I've gotten over a dozen letters as a result of my item in the *December Tower*. SWL's, Novices and Generals wrote. Also, several young readers here in Los Angeles called me on the telephone to offer help and advice. It was a surprise to me that any kid would have any interest in helping an old guy learn about radio.

"One of the letters was from WN5KNG, now with the U. S. Army in Germany. 73."

Norman Hayes, K6LKG, 1420 Ivesbrook St., Lancaster, Calif., who is 15, says: "I got my Novice license in May and my General in August. I am still using my Novice equipment—an AT-1 transmitter running 35 watts, a 40-meter doublet, and an S-40A receiver.

"I have added a Q-multiplier to the receiver, which really brings the stations in out of the interference. You would have trouble getting it away from me. It really works.

"I have worked 35 states, Puerto Rico, Hawaii, Mexico, Canada, and Australia, all on 40 meters. I'll be glad to schedule anyone needing California for his WAS (worked all states). 73."

Jack Palmer, KN4GTW, 615 S. Federal Hwy., Ft. Lauderdale, Fla., writes: "I have had my license for about five weeks and have worked 22 states in all call areas, except the sixth and seventh. The transmitter is a *Johnson Adventurer*, feeding a 65' wire, which has given me 589 reports from New England and Minnesota; so I don't think I'll change it. My receiver is an S-40. I am on 40 meters almost every evening and 15 meters during the day on week ends. I'll be glad to work anyone needing a contact with Florida, and would like to work a W6 and a W7 myself.

"I am 31 years old, and I have a small business here in Ft. Lauderdale, which does not leave me with too much free time, but I am studying hard to get my General Class license to insure the continuation of my ham career."

Mike Kroot, KN9BHM, Cary Hall, Box 531, Purdue University, West Lafayette, Ind., writes: "I have worked ten states in umpteen contacts over the Cary Hall Radio Club station, W9CLY, where we use a Viking II transmitter and an old NC-240D receiver—ever hear of it? My code speed is about 12 wpm.

"Our club has 14 members. Half are studying for their Novice licenses, two are Novices, one is an Extra Class, and the rest are Generals. All a freshman in college has to do to get on the air is to finish his homework on such subjects as analytic geometry, chemistry, engineering drawing, and a few others. Then he *might* find a little time to make a few contacts."

WHICH TRANSMITTER KIT TO BUY?

I JUST GOT MY NOVICE TICKET, BUT WHICH KIT SHOULD I BUY?

THAT'S EASY! CHOOSE THE KIT THAT GIVES YOU THE MOST FOR YOUR MONEY!

SAY, THIS VIKING "ADVENTURER" LOOKS LIKE THE ONE FOR ME!

YOU MEAN YOUR RIG WAS MADE FROM A KIT?

SURE, IT'S TVI SUPPRESSED--WORKS ALL BANDS--80 THRU 10--LOADS ALMOST ANY ANTENNA--AND IT'S PUNCHED AND DRILLED FOR YOU, TOO!

LATER **SAY! STEP BY STEP INSTRUCTIONS! I'LL BE FINISHED TONIGHT!**

EVERYTHING IS SUPPLIED. ALL YOU NEED IS YOUR OWN KEY AND CRYSTAL.

JOHNSON MAKES A COMPLETE LINE OF TELEGRAPH KEYS, TOO. WRITE FOR FULL INFORMATION.

MAIL TODAY

VIKING "ADVENTURER" CW KIT
 Compact, completely self-contained 50 watt transmitter kit. Single knob bandswitching—effectively TVI suppressed. Easy assembly by novice or experienced amateur. 80, 40, 20, 15, and 11-10 meters. Cat. No. 240-181-1 complete with tubes. **\$54.95**

E. F. JOHNSON COMPANY
 3002 Second Ave., S.W., Waseca, Minnesota

Please send me a copy of Bulletin 727, which describes the Viking "Adventurer" in detail.

NAME _____
 ADDRESS _____
 CITY _____ STATE _____

Craig P. Stoll, Willardshire Rd., Orchard Park, N. Y., seems happy. "After trying to teach myself the code using a key, a lantern battery and a buzzer, I managed to borrow a set of code records from a friend. Two weeks later, I took the Novice examination at the Radio Association of Western New York. According to my examiner, I passed; so I am now patiently waiting for my license.

"I received a wonderful Christmas present, too, an AT-1 transmitter kit. I plan to feed the antenna described in the December column first with 75-ohm ribbon and eventually with coax (especially with coax at 13.5 cents a foot.) I'll let you know as soon as I get my call letters."

Ronald Kiuru, R.F.D., Lunenburg, Mass., says: "I've been preparing for a Novice license, and I was planning to build a receiver and a transmitter. But I was told that I would cause interference to our neighbors' TV sets. Please give me some advice on this problem."

To Ronald and others worried about causing TVI (television interference) by operating an amateur transmitter, my best advice is—don't worry. Modern amateur transmitters, especially when used in the 80- and 40-meter bands where most beginners operate, seldom cause any TVI; therefore, if you follow instructions in building or assembling a transmitter and operate it properly, TVI should be no problem. When interference is caused, it is usually quite easily cured by following methods outlined in the *ARRL* and *Radio Handbooks*.

A future *Transmitting Tower* will discuss

this matter more thoroughly. In the meantime, how about a few of you fellows dropping Ronald a note to reassure him? And let the rest of us in on your experiences, too.

Code Practice

On Monday and Wednesday evenings at 9:00 p.m., EST, **Dick Pitzeruse**, **K2KTK**, 128 Fulton St., Clyde, N. Y., sends code practice at eight to ten words per minute on 3551 kc., using text material from *POPULAR ELECTRONICS*. On Tuesdays and Thursdays, **Andrew De Leo**, **K2KQS**, 205 Lock St., Clyde, N. Y., transmits code practice at 15 wpm on 3638 kc., also at 9:00 p.m., EST.

Both stations have good signals; so they should be audible over a wide area. Andy (K2KQS) listens for stations calling him at the conclusion of the code-practice sessions at 9:30 p.m.

To help prospective amateurs obtain their Novice licenses easily, the Radio-Electronics-Television Manufacturers Association (RETMA), offers a complete Novice code and theory course (reviewed in the *Transmitting Tower*, March, 1956) for \$10.00, postpaid. A record-player capable of a 33½-rpm speed is required to play the code records. The course or more information on it can be obtained from RETMA, Suite 800, Wyatt Building, 777 Fourteenth St., N.W., Washington 5, D.C.

That uses up all our space again. But don't forget that this is *your column*; send in your thoughts, problems, pictures, and "Help Wanted" requests to me, C/O *POPULAR ELECTRONICS*. Until next month, 73.

Herb, W9EGQ

HELP WANTED

In this section of the *Transmitting Tower*, the names of persons requesting help and encouragement in obtaining their amateur licenses are listed. To have your name included, address a request to Herb S. Brier, W9EGQ, C/O *POPULAR ELECTRONICS*, 366 Madison Ave., New York 17, N. Y.

Ron Crouse, 124 South 9th St., St. Helens, Ore.

William W. Merow, D.D.S., Professional Building, Grafton, W. Va. (phone 74).

Joseph H. Stark, 73-36 197 St., Flushing 66, N. Y. (adult).

Edward J. Wright, 4004 E. 10th Avenue, Tampa 5, Fla.

Dr. W. Tschannen, P. O. Box 663, Jackson, Ala.

Lenard Berger (15), 946 Kelly St., Bronx 59, N. Y. C.

Bill Beckham, Box 1613, Shafter, Calif.

John Desloge, 6807 Pershing Ave., St. Louis 5, Mo. (phone: VO 3-4208).

Gerald M. Patratz (14), Box 113, Parkers Prairie, Minn.

Edward J. Wright, 4004 E. 10th Ave., Tampa 5, Fla.

Walter E. (Gene) Roberts, 209 W. Maple St., Portales, New Mexico

Terry Swords, 1824 Yale, Fresno, Calif.

Melvin T. Rautanen, 6156 Kimbark Ave., Chicago 37, Ill.

Joe Augustine (14), 806 Jackson, Box 626, Brenham, Texas

Milton Bixler, 15491 Cloverlawn, Detroit 38, Mich.

Marshall Mackler (15), 400 S. Sterling Rd., Elkins Park 17, Pa.

Tom Braunger, 3241 Virginia, Sioux City, Iowa

Paul Edward Paige, Bronaugh, Mo.

Larry Jan Vosdinger (14), 1018½ 7th Ave., Marion, Iowa

Joseph Lofreddo, KN2PVB (13), 79 Bregnan Ave., New Hyde Park, N. Y.

James Matuszewski, R.R. #2 R. 113-S, Kankakee, Ill. (phone 2-9971)

Henry Spencer, 7812 Bruton Rd., Dallas 17, Texas

John F. Shaeffer, 32 Ennis Ave., Bedford, Ohio

Dewey Kribs (14) 286 East Main, Gouverneur, N. Y. (phone 1061)

Lawrence McLaughlin, Pleasant St., Rowley, Mass.

Richard Bentley (15) 116 Locust St., Valley Stream, N. Y.

INDUSTRY NEEDS

ELECTRONIC SKILLS!

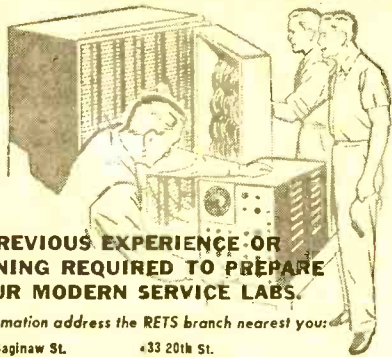

NO PREVIOUS EXPERIENCE OR TRAINING REQUIRED TO PREPARE IN OUR MODERN SERVICE LABS.

For information address the RETS branch nearest you:

4900 N. Saginaw St.
Flint 5, Michigan

78 E. Chestnut St.
Columbus, Ohio

215 N. E. 15th St.
Miami, Florida

Rm 222 Summit Cherry Bldg.
622 Summit Street
Toledo 4, Ohio

124 E. Seventh St.
Cincinnati 2, Ohio

101-03 Campau N. W.
Grand Rapids, Michigan

433 20th St.
Oakland, Calif.

1807 St. Laurent Blvd.
Montreal, Quebec, Canada

261 Spadina Ave.
Toronto 2B, Ontario, Canada

1065 Howe St.
Vancouver 1, B. C., Canada

235 Garry St.
Winnipeg, Manitoba, Canada

377-379 Talbot
London, Ontario, Canada

136 N. St. Clair St.
Dayton, Ohio



Main school address:

RADIO ELECTRONIC TELEVISION SCHOOLS

3730 Woodward Avenue Detroit 1, Michigan

Training Electronics Specialists since 1935

ENGINEERS—TECHNICIANS

Electronics, the fabulous New tool of industry—COMMUNICATIONS, INSPECTION, WELDING, AIRCRAFT CONTROLS, GUIDED MISSILES, COMPUTERS, AUTOMATION, TV AND RADIO are a few of its many applications offering untold opportunity to the trained man.

ELECTRONICS-TV SERVICEMEN

R. E. T. S., the largest resident electronic training organization in the world, has developed a specialized training program in TV AND ELECTRONIC SERVICING that permits you to remain fully employed during training and still receive the PRACTICAL TRAINING AND EXPERIENCE in our MODERN SERVICE SHOPS. There is one near you!

Leading electronic concerns regularly request RETS graduates for positions as ENGINEERS and TECHNICIANS through our placement services. Part time jobs arranged while in training. Mail coupon—TODAY!

Please send me FREE booklet and complete information without obligation.

NAME _____ AGE _____

ADDRESS _____

CITY _____ STATE _____

IF VETERAN GIVE DATE OF DISCHARGE _____

INSTALLING YOUR OWN HI-FI?

Don't overlook the advantages of a good separate Pre-amplifier!

MODEL M 100 \$39.95
(Self powered slightly higher)

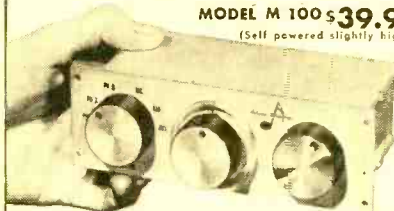

AT LAST! A quality equalizer-pre-amplifier at a price you can afford... Outperforms units costing twice as much. Low noise, low distortion, and high gain... Record noise and distortion filter... Exclusive TREBLE PRESET... Full equalization and tone compensation... Takes standard magnetic pickups, radio tuners, tape recorders, etc... Sturdy, well built, attractive... Specifically designed for complete Hi-Fi recording and playback control... Available at all leading dealers...

- COMPLETE CONTROL OF EQUALIZATION, TONE AND SIGNAL.
- INPUTS FOR ALL PHONO PICKUPS, TUNERS, TAPE, ETC.
- EXTREMELY LOW NOISE, HUM AND DISTORTION.
- VARIABLE RECORD NOISE AND RUMBLE FILTERS.
- SELF POWERED AND UNPOWERED MODELS.
- SPACE SAVING, SIMPLE TO OPERATE.
- RUGGEDLY BUILT.

Miniature Pre-amplifier by



SEE YOUR DEALER OR WRITE FOR SPECIFICATIONS

ARTISANS, Inc. 396 MILL, HAWTHORNE, NEW YORK

DESIGNED FOR THE BOOKSHELF with LARGE SYSTEM PERFORMANCE

Only 17 1/4" x 11 1/4" x 10"
Only 1 Cubic Ft.

- Complete line of Models
- FIR PLYWOOD KIT \$1790 (Model 8K)
 - ASSEMBLED PLYWOOD UNIT \$2844 (Model 8U)
 - PEBBLE-TONE FINISHED UNIT \$3450 (Model 8P)
 - KARLSONITE FINISHED UNIT \$4950 (Model 8B & 8M)



KARLSON "8" FOR 8" SPEAKERS

INCREDIBLE!

- Cleanness of Response
- Bass Response
- Dispersion Of The Highs

KARLSON ULTRA-FIDELITY ENCLOSURES

Please send copy of your latest book "The Karlson Enclosure"



KARLSON ASSOCIATES, INC.

DEPT. D

1610 Neck Road • Brooklyn 29, New York

**READ THIS
EXCLUSIVE
REPORT ON THE
WORLD'S
FASTEST
SPORTS CAR!**



How has the Mercedes-Benz 300SLR been able to beat all competition in the world's greatest races? Why has this amazing sports car finished every meet—never dropped out of competition because of mechanical failure? You'll find these questions answered completely for the first time *anywhere* in an exclusive, fully-illustrated article in April

SPORTS CARS ILLUSTRATED!

This first-hand report is typical of the exciting features you'll find month after month in

SPORTS CARS ILLUSTRATED

—America's finest sports car magazine.

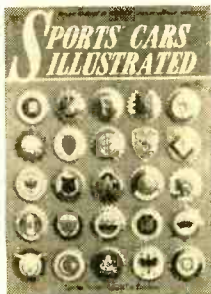

**READ APRIL SPORTS CARS ILLUSTRATED
ON SALE AT ALL NEWSSTANDS—35c**



SPORTS CARS ILLUSTRATED

366 MADISON AVENUE NEW YORK 17, N.Y.

Disc and Tape Review

(Continued from page 72)

projected. The Cincinnati men are first-class executants, and I think it is a shame that some company doesn't sign them up for a series of recordings.

Hollingsworth and the Covent Garden Orchestra give a less athletic reading of the score on an MGM record. Hollingsworth has not the firmness of tempi, nor is he as sure of his ground as Johnson, but his performance has its virtues. The sound, while lacking the over-all splendor of the London, is quite good. Frequency and dynamic range are right up with today's best, strings are clean albeit a trifle "edgy" in some sections. And there is good brass, percussion and some smooth woodwind sound here. Unfortunately, in their attempt to create presence, the MGM engineers have gone a little overboard in matters of acoustic spaciousness.

The Graunke/Bavarian Symphony disc on Decca is a distant third in this race. Sound is very spotty—good in some places, coarse and distorted in others. The reading is rather perfunctory and does not reflect much credit on Graunke, who can do better.

If you can get by the formidable title, I think you will find the London recording of *Sigurd Jorsalfar* the best. In any case, it is an interesting work, and you will enjoy it.

Massenet's Le Cid

One of the most charming works of ballet music is Jules Massenet's *Le Cid*. This music has a decidedly Spanish flavor to it, and in fact, is often confused by many people with the more familiar *L'Arlesienne Suite* by Bizet. There are four recordings of the work in the LP catalog, all of which can qualify as hi-fi in sound to a greater or lesser degree.

The Fiedler Boston Pops recording on Victor is getting a little ancient, but it is still a good-sounding recording—principally because of the fine orchestral balance. And as far as performance is concerned, Fiedler takes the plum. His is a happy blending of good rhythmic drive and lyric expression. His tempi are brisk and unflagging, but he does not fall into the trap of losing the romantic aspects of the work as so many other conductors do in trying to maintain a clean beat. Fiedler, of course, is blessed with the magnificent players of the Boston Symphony, and the sheer beauty of their sound is unsurpassed in any of the other versions.

From the hi-fi standpoint, the Robert Irving/London Symphony Orchestra reading on a London disc is at the head of the class. Here, the colorful score comes to life with the magic of modern hi-fi recording. Clean, soaring string tone, bright crackling brass, percussion of great impact and sharp, precise authority, sweet-toned woodwinds . . . all are heard in the widest of frequency and dynamic range, with little distortion. And the acoustics are that special London blend of liveness coupled with orchestral detail. Irving is an old hand with ballet scores and can usually be counted on to give a good performance. And this is a fine reading, although it was

Save Time - Save Steps

INTERCOM KIT

The handy Intercom Kit that every home can use! Simple to assemble... yet YOU save over \$20! Latest electronic advancements such as printed circuit... all brand new materials, not surplus... all metal case with 2-tone colors. Uses flashlight batteries for inexpensive, easy replacement. Portable for set-up in different rooms, 50 ft. cable. Additional Sub-Stations available for every room in your home.



Complete with
**MASTER and
SUB-STATION**
\$29⁵⁰
F.O.B. L.A.

SIERRA SCIENTIFIC CO. 5415 York Blvd., Dept. 6,
Los Angeles 42, Calif.

OSCILLOGRAPH: HICKOK MODEL RFO-5

This precision instrument originally cost \$400.00! Contains 0-3 Mc vertical amplifier, 10-30 and 100-300 Kc. frequency modulated sweep, 0-40 Kc. sawtooth sweep, Demodulator input. Voltage calibrated vertical control. New in original package. Get this high quality lab and service test instrument at fraction of former price! Quantity limited. **\$59.50**

MINIATURE HAND CRANK GENERATOR

Latest type, light weight. From recent model field phone. Many uses. Brand new. Terrific buy! **\$1.49**

FREE! On request with every purchase of \$3.00 or more, one J-51 Hand Code Key!

COMMAND TRANSMITTERS
2-3 MC. Good condition... \$4.95
3-4 MC. Good condition... 4.95
4-5 MC. Good condition... 3.95
ARB RECVR. 180 Kc-9.5 MC. Good cond... 14.95
1-222 SIGNAL GENERATOR MICRO-VOLTER
Freq. range: 8-15 MC. and 150-230 MC. Complete with all tubes and 3 MC. calibration crystal. Self-contained 110V. 60 cyc. power supply. Good condition. **\$19.95**
CATALOGUE NO. 105 IS OFF THE PRESS!

Get your free copy today!
All items FOB, L.A. Prices subj. to change without notice. Calif. buyers add tax. Send 25% deposit with C.O.D. orders.
J. J. GLASS ELECTRONICS CO. Dept. PE
1624 S. Main St. Los Angeles 15, Calif.

SHOOT TV TROUBLE FAST

With H. G. Cisin's Copyrighted RAPID "TV TROUBLE SHOOTING METHOD"

Without experience or knowledge, this guaranteed new method of servicing TV sets enables you to DIAGNOSE TV troubles as rapidly as an expert. NO THEORY—NO MATH—you can locate all faults in record-breaking time regardless of make or model. "TV TROUBLE SHOOTING METHOD" is the most valuable aid to TV servicing ever written. Be a TV Trouble Diagnostician. Increase your present earnings. Open your own Profitable Business or get a high-paying skilled job.

It's all in this book...
Nothing more to Pay—Nothing else to Buy

85 picture troubles, over 58 raster and 17 sound troubles. By this unique copyrighted method you know EXACTLY WHERE the trouble is; plus step-by-step instructions, including 69 RAPID CHECKS, enabling you to find the faulty part.

13 IMPORTANT PRELIMINARY CHECKS NEED NO INSTRUMENTS! Of the 69 Rapid Checks, OVER 65 ALSO REQUIRE NO INSTRUMENTS! Rapid checks include emergency checks for distorted pictures, defective tubes including PIX tube, plus 57 others. ALL EXPLAINED IN SIMPLE LANGUAGE PERFORMED WITHOUT INSTRUMENTS. MANY CHECKS USE THE PICTURE TUBE AS A GUIDE.

H. G. Cisin, the author, is the inventor of the AC/DC midjet radio. He licenses RCA, AT&T, etc. He has also trained thousands of technicians now owning their own prosperous TV service organizations or holding highly paid TV positions. His years of experience are embodied in this remarkable new book.

Guaranteed Money Back in 5 Days if Not Satisfied!

ABSOLUTELY FREE with each order: H. G. Cisin's newest book "TV & RADIO TUBE SUBSTITUTION GUIDE." Gives direct replacements of set and picture tubes. Most valuable servicing aid! ACT NOW—get both books postpaid at cost of only one!

\$1 Post-paid

RUSH COUPON NOW!

H. G. CISIN, CONSULTING ENGINEER,
Amagansett, N. Y. Dept. P-16
Enclosed find \$1. Rush both books.

Name
Address
City Zone State

NO FREE GIFTS! NO COUPONS! NO BONUSES EXCEPT THE

LOWEST TUBE PRICES

ALL TUBES UNCOND. TIONALLY GUARANTEED FOR 1 YEAR

PRETESTED TUBES			INDIVIDUALLY BOXED		
0Z4	GAC7	3BK5	6SK7GT	12AL5	12SQ7
1B3GT	GAG5	3BK7	6SL7GT	12A77	12SR7
1H5GT	GAG7	-BL7GT	6SN7GT	12AUG	19T8
1LC5	6AF4	*B06GT	6SQ7	12AU7	19BG6G
1LN5	6AK5	*BQ7	6SR7	12AV6	25B06GT
1N5GT	6AL5	*BY5G	6T8	12AV7	25L6GT
1Q5GT	6AQ5	*BZ7	6U8	12AX4GT	25Z5
1R3	6AS5	*C4	6V3	12AX7	25Z6GT
1S4	6AT6	*CB6	6V6GT	12BY7	35B5
1S5	6AU6	*CD6G	6W4GT	12BA6	35C5
1T4	6AUSGT	*F6	6X4	12BE6	35L6GT
1T5GT	6AV5	*GH6GT	6X5GT	12AZ7	35W4
1U4	6AV6	*GJ5GT	6Y6G	12BH7	35Y4
1U5	6AX4GT	*G6	6Y6GT	12BY7	35Z5GT
1X2	6AT6	*K6GT	6Z5	12SA7	50A5
3Q4	6AH4GT	*L6	7C5	12SG7	50B5
3S2	6BA6	*E4	7C6	12SJ7GT	50C5
3V4	6BC6	*S8GT	7E7	12SK7	50L6GT
5U6G	6BE6	*SA7	7F7	12SL7GT	117Z3
5V4G	6BE6	*SA7	7F8	12SN7GT	
5Y3	6BG6G	*SH7	7N7		
6AB4	6BJ6	*SJ7GT			

BRAND NEW TV PICTURE TUBES

RCA and DUMONT Licensed		No dud required	
10EP4	\$9.95	15DP4	\$16.95
12LP4	12.95	16PP4	17.95
12QP4	13.95	16GP4	21.00
14CP4	15.25	16KP4	17.00
		17LP4	18.00
		19AP4	\$23.00
		20CP4	\$24.00
		21ALP4A	24.00

Picture Tubes Shipped F.O.B. Passaic, N. J.

Take your pick!
Any Assortment!

TUBES 41c ea.

Quantity Buyers!

100 Tubes — \$38.00

FREE POSTAGE on all prepaid U. S. A. orders. 25¢ handling charge on all orders under \$5.00. 25% Deposit on all C.C.D.'s. Subject to prior sale. Write for transmitter and special purpose tube list.

PRescott 3-0330

TUBE MART DISCOUNT HOUSE

The Lokpet Bldg. Passaic, N. J.

NEW! PRINTED CIRCUIT Transistor Radio

Pocket size—works anywhere

- Features P-N-P Junction Transistor
- Permeability tuning, Diode detection
- Printed circuit eliminates extra wires
- Batteries last for months
- Expensive hearing aid headset included
- Furnished complete, nothing else to buy

\$9.95 Postpaid
in kit form

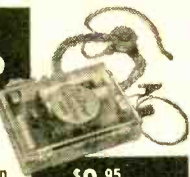

Here is a powerful, completely portable radio, employing the latest type of transistor audio amplification and printed circuitry. Tiny size, only 2 3/8" x 3 1/2" x 3/4" fits in pocket or purse. Uses so little current, batteries last for months. Kit can be assembled by anyone with just a soldering iron. Or furnished complete and tested, ready to use. Guaranteed to work. Comes complete with plastic case, batteries, headset, all parts. Nothing else to buy. Send for yours, today!

Send no money. Just pay postman \$9.95 plus C.O.D. charges, or send check or money order for \$9.95 and we pay postage.

TRADYNE, INC., 11 W. MONUMENT AVE., DAYTON 2, OHIO Dept. E-4

RADIO CONTROL Headquarters

For model airplanes, boats, cars, etc. FREE CATALOG "P." No operator's license required. FREE-SEND FOR FCC FORM 505 Garage Door Radio Control Transmitters & Receivers Kits Available.

Most POWERFUL 5 Watt TRANSMITTER—LOWEST PRICE. Famous 2 Tube MAC II circuit, with GYRO MAGIC TUNING INDICATOR. Completely Tested, includes: 9 1/2 ft. sect. Antenna, Remote "Clicker," Keying Switch, Meter, Beaut. Cabinet 12x7x6. MODEL X3 \$24.95
MODEL X1 w. 2V Storage btry. charger, Vibr. pack \$39.95
R/C TRANSMITTER & RECEIVER KIT: 2714 Mc. 5 Watt 2-Tube Simple Transmitter & Supersens. 2-Tube Simple Receiver—Parts incl. Drilled Bases Wound Coil. **\$9.95**
Res., Cond., SIGMA Relay, instruc. Only
SIGMA 4F RELAY: 8,000 ohm, \$4.25; 6 Reed Relay 14.95
Mini. VIBRATOR SUPPLY 6V, input 90VDC. 30 Ma. 3.45
R/C BOOKS: Model Control \$1; Radio Control \$1; Handbook 5 2.25
CRYSTALS: 27,255 Mc. Petersen Z9A. \$3.95; HOLDER
RELAY CONTROL—w. Sigma 10K Relay, Hi-impedance Audio Choke, Thermal Switch, Alnico Magnet, Neon Lamp, etc. 1.25
Sensitive Carbon MIKE, Str. Carl., new \$8.95; 6V
Teleph. STEPPER SWITCH 2-Deck 10-Pos. 24V. 9.95
TUBES: XFG1, RK61, 3A4, 3AS, 1A6A, 6K4; TRANSISTORS99
2—6V CHARGER KIT, \$4.95 New Diode
Storage BATTERIES; Mini. 6V. NTC \$2.45; 2V med. 27A/Hour
RELAY, 110 V. AC. 95¢; MINI 2 V. btry. 2.75
Code Practice Oscillator Kit 95¢; Single Head Set. 1.29
"Simplest CAPACITY RELAY," complete kit of parts incl. case, relay, etc., less tubes. 12.45



GYRO ELECTRONICS 325-P CANAL ST., N. Y. 13, N. Y.

DYNAMIC POCKET RADIO

\$3.95



Satisfied users report up to 1500 mile range with this electronic tube (NOT A CRYSTAL SET) complete KIT. Originally sold at \$5.99, production costs slashed! Assembles easily in one hour, with simple directions. Batteries and all parts kit in case. BATTERIES INCLUDING EXTRA "A" BATTERY \$1.25. Dynamic radio headphone \$1.45. SUPER QUALITY American made hearing aid earset \$3.98, guaranteed \$7.00 value (FACTORY WARE) \$7.95 SET ONLY.) C.O.D.'s accepted with \$1.00 deposit.

PRECISION ELECTRONICS, Dept. E, Cupertino, Calif.

HI-FI COMPONENT CABINET AT LOW COST

Famous Concert Cabinetry Rack-55

Easily accommodates all HI-FI components. Natural Birch with tempered hard board shelves. Black iron legs and grille. Size 36"x24"x18" deep. Send check or M.O. We pay shipping. No C.O.D.

\$3950 BIG CITY WOOD PRODUCTS CO.
5204 N. Lamon, Chicago 30, Ill.

GET INTO ELECTRONICS

You can enter this uncrowded, interesting field. Defense expansion, new developments demand trained specialists. Study all phases of radio & electronics theory and practice. TV, FM, broadcasting, servicing, aviation, marine, police radio. Prepare for good pay. 18-month course. Graduates in demand by major companies. H. S. or equivalent required. Begin January, March, June, September. Campus life. Write for Catalog.

VALPARAISO TECHNICAL INSTITUTE
Dept. PE Valparaiso, Indiana

something of a surprise to hear his rather exaggerated tempi. His pace is a bit too fast for cohesion, and some of the lyricism is lost. Outside of that fall from grace, he does quite well; and the London Symphony players perform nobly.

Braithwaite and the Royal Opera Orchestra on an MGM disc give a fair performance, a few of the conductor's mannerisms keeping it out of the top bracket. Sound is wide range and modern all right, but . . . the MGM engineers can't seem to get over the hurdle of edgy string tone or adjust their acoustic balance properly. This is rather surprising, because many of their recordings made in this country are splendid examples of hi-fi sound.

The reading on the Concert Hall label has neither the authority of interpretation to permit competition with these other versions nor a saving aspect in the sound which, although wide in range, is not otherwise particularly distinguished. In a final consideration, you can choose between Fiedler's best performance and passable sound, and the acceptable performance of Irving with the most thrilling hi-fi sound.

Jazz Corner

The Benny Goodman Carnegie Hall Jazz Concert, Volume 1, Columbia CL 814, 12" LP, NAB curve, \$3.98 is not a new item by any means. The original two-disc album of this concert has been one of the biggest selling jazz albums in Columbia's history. But it is now available on single discs and with—to my ears—sound that has been somewhat "enhanced" since the original album.

This newly packaged Volume 1 is only one of a torrent of Benny Goodman recordings that have recently been released. The reason behind all this Goodman activity is the soon-to-be-released Columbia picture, "The Great Benny Goodman." Every company that has a Goodman master in its vaults is digging it out in anticipation of the renewed interest in the music of the "King of Swing." However commercial this activity might be, Goodman fans are certainly in for a bonanza!

Volume 1 starts off with a Goodman favorite, *Don't Be That Way*, continues with the famous *One O'clock Jump* and other perennial favorites. The second side of the disc is devoted entirely to a jam session on *Honey-suckle Rose*.

Considering the illustrious "names" with Goodman on that night in Carnegie Hall will make understandable some of the incredible solo work heard in this session. As always, the Goodman band had the cleanest beat in the jazz world, and it is too bad that with the passing years and the dispersal of so many members of the original band the fire and spontaneity have been lost. I recently heard a brand-new recording of Benny and many of the old gang on one of Benny's most famous numbers. Well, it just wasn't the same kind of music you can hear on this disc. The essential drive was missing, the sparkle dimmed. About the only thing that hadn't changed very much was Benny himself, seemingly ageless and as good as he ever was!

This is all the more reason for cherishing

POPULAR ELECTRONICS

Volume 1 and many of the other "old" sessions which are being released. Sure, you can hear the rather crackly noisy surfaces from the old 78-rpm masters, and the frequency range and dynamics are definitely limited, but it still is a thrilling experience.

You young fellows who weren't around for the heyday of Benny Goodman should take a listen to this disc and also to Volume 2, which contains his immortal classic, *Sing, Sing, Sing*. Few jazz records ever had the excitement of that number.

Late Tape News

Things move awfully fast in this hi-fi business . . . sometimes! Between the time I started this column and now, when I am finishing it, the tape situation has changed slightly. I have just received word that the Westminster Sonotapes will no longer be sold by mail, but will be available through your hi-fi dealer and other selected channels of recorded music distribution. This is certainly a step in the right direction, as I firmly believe that in order to sell tape properly it must be demonstrated—preferably on a high-quality tape machine operating through as good a hi-fi system as possible.

With this development and other plans I have in mind, I think that next month I will be able to devote at least half of this column to new prerecorded tapes and at the same time continue our disc survey.

-50-

Tuning the Short-Wave Bands

(Continued from page 87)

India Radio on 11,630 kc., in the English session at 0845-0945. (KM, MM)

Indonesia—YDQ2, Makassar, 9552 kc., has a native program at 0715-0745 with local music and singing; native language news. YDF6, Djakarta, 9710 kc., (*The Voice of Indonesia at Djakarta*) has English daily at 0600-0700 and 0930-1030 beamed to Western N.A. and to South & S.E. Asia and Japan. They operate parallel to YDB2, 4910 kc. YDF8, Djakarta, 9865 kc., can be noted afternoons around 1400 with symphonic music, English news at 1415 and variety music at 1430; this one duals with a weaker 11,797.5-kc. outlet. (JB, GC, ER)

Israel—*The Voice of Zion, Jerusalem* is heard on 9008 kc. with an English period at 1600-1700. News is heard at 1615. Music and talks about Israel round out the session. S/off is at 1700. Their address is: *Voice of Zion*, P. O. Box 754, Jerusalem, Israel. (AE, JH, BE)

Japan—AFRS, (Far East Network), Camp Drake, Japan, operates on 11,750 kc., parallel with 6160 kc., from 1730 to past 2033. This xmsn relays a medium-wave English-speaking Tokio station. News in dictation speed is heard at 1853-1900. (JB, GC)

Jordan—JYQ, *Radio Hashemite Ramallah*, Amman, operates on 6060 kc. only and not on 7200 kc. as reported. This information is from the station manager. (HA)

Libya—*Forces Broadcasting Service*, Benghazi, 4930 kc., is heard often at 0000-0115 in English with good music programs. It has

April, 1956

Pilot

designed

a

\$90 amplifier

and

produced it
to sell for

\$69⁵⁰

Prices slightly higher West of the Rockies

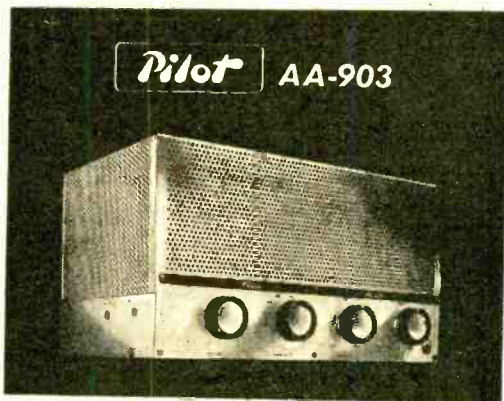

with built-in phono preamp
and dual tone controls

Illustrated with metal enclosure \$4.95 additional

PILOT Radio Corp. Dept. RD-8

37-06 36th St., L.I.C. 1, N.Y.

Please send me complete information
about the Pilot AA-903 Amplifier.

Name

Address

City Zone State

LMB BOX CHASSIS

Flangelocking Precision Engineered Interlocking



65 sizes and shapes for the laboratory, manufacturer, Industrial, experimenter, builder, and general applications where metal boxes are required. Stocked by all electronic and geophysical distributors. Send for free catalog.

LMB 1011 Venice Blvd.
Los Angeles 15, Calif.

INVENTORS

If you believe that you have an invention, you should find out how to protect it. We are registered Patent Attorneys. Send for copy of our Patent Booklet "How to Protect Your Invention," and an "Invention Record" form. No obligation. They are yours for the asking.

McMORROW, BERMAN & DAVIDSON
Registered Patent Attorneys
349-L Victor Building Washington 1, D. C.

MINIATURE METERS

1" 0-10 MA basic mounts in a 1" hole. \$2.96
 1 1/2" Weston 0-1 MA basic. 3.96
 1 1/2" Weston 0-500 Micro-amps. 4.56
 Sensitive Relay 5000 ohms operates on 1 MA. S.P.D.T. adj. contacts and armature tension, will also operate on 110 AC \$1.86

PEAK ELECTRONICS CO.
66 West Broadway, New York 7, N. Y. WOrth 2-5439
Leon I. Sprung, General Mgr.

Announcing Dramatics Script Writing Elec
 tronics
FCC FIRST CLASS PHONE

After 18 years successfully training men for radio and television, the Don Martin School is now offering a home study course available to you at your own home. This is the same course that has been so successfully taught at our resident school.

Write the **DON MARTIN SCHOOL** Dept. PE
1653 North Cherokee Hollywood 28, California

Sales T.V. Direction Lighting Stagecraft Cinematog

BUILD YOUR OWN JENSEN HI-FI SPEAKER SYSTEM

SEND FOR NEW BOOK TODAY!

Save money . . . build your choice of 18 different hi-fi speaker systems with 8 new 2-way and 3-way Jensen speaker kits. 36-page Manual 1080 gives complete instructions for building enclosures, selecting your Jensen speaker kit and assembling. Send 60c in coin today!

JENSEN MFG. CO. Dept. F 6601 S. Laramie, Chicago 38



INVENTORS

Send for PATENT INFORMATION Book and INVENTOR'S RECORD without obligation

GUSTAVE MILLER
46-PE WARNER BUILDING WASHINGTON 4, D. C.

REGISTERED PATENT ATTORNEY
ASSOCIATE EXAMINER
U.S. PAT. OFF. 1922-1929
Patent Attorney & Advisor
U. S. NAVY DEPT. 1930-1947
PATENT LAWYER

CODE SENDING RECEIVING SPEED

Be a "key" man. Learn how to send and receive messages in code by telegraph and radio. Commerce needs thousands of men for jobs. Good pay, adventure, interesting work. Learn at home quickly through famous Candler System. Qualify for Amateur or Commercial License. Write for FREE BOOK. **CANDLER SYSTEM CO.**
Dept. S-C, Box 928, Denver 1, Colo., U.S.A.



also been heard a few times at 1530-1700 with record request program. (PM, EK)

Luxembourg—Junglinster, 6090 kc., is noted at 0309-0333 with recorded American pop tunes and French announcements. Signal is usually very strong; some deep fading. (EK)

Monaco—Monte Carlo has moved from 7349 kc. to 7140 kc. It is noted with excellent signal round 0100, dual to 6036 kc., and has also been heard afternoons around 1445 with French programs. (GC)

Netherlands—PCJ, Hilversum, 9590 kc., has an English news period at 1645. This one is usually heard well in the East. (SG)

Nigeria—Radio Kaduna, 3326 kc., is a good catch. It can be heard on the West Coast at 0545 in native chanting, at 0600 with English identity followed by the news.

Pakistan—Radio Pakistan, 9740 kc., has been noted in British beam at 2015 with English news. Music followed. It closed at 2045. This might possibly be the 9755-kc. outlet. English for S.E. Asia can be noted on APK4, 11,885 kc., parallel with 15,230 kc., at 1945-2015 daily. Signal is strong but badly modulated. Acknowledgment is quick with a colorful QSL depicting the Pakistani seal. Address is: Radio Pakistan, c/o The Directorate General, Karachi-3, Pakistan. (BH)

Peru—OAX4T, Radio Nacional del Peru, Lima, 9562 kc., can be heard nightly at 1700-0100 with perfect signals. All programs are in Spanish. If anyone knows of any English periods, please contact LM. (LM, WL, JM)

Philippines—In verifying, the Far East Broadcasting Co. lists English at the following times: 1830-2100, 2200-2230, 2330-2345, 0300-0400, 0500-0515, 0700-0730, 0900-1030. The FEBC operates the following stations: DZH6, 6030 kc.; DZH7, 9730 kc.; DZH8, 11,855 kc.; DZH9, 15,300 kc.; DZO6, 17,805 kc.; and over DZAS, 680 kc.; DZFE, 1030 kc.; and DZB2, 3345 kc. Best USA reception is over DZH8 at 0700-0730 in English. A new DX session has been noted over DZH7, 9730 kc., dual with DZH8, 11,855 kc., at 1000-1015 on Wed. ONLY, called "Short-wave Mailbag." This is from Don Smith, Xmr. Spvr. FEBC, Manila. (BH)

Portugal—CSA32, 11,996 kc., and CSA36, 15,125 kc., Emissora Nacional, Lisbon, has English daily at 0930-1030 with news at 0930-0945. CSA32 is usually best in Western USA, CSA36 best in the East. (PM, JB)

Sarawak—Sarawak Broadcasting Service, Kuching, 5052 kc., is noted around 0723 with music and news in Chinese dialect; English news at 0800-0810; then local news to 0815. (ER, RR)

Spain—The Voice of Spain, Madrid, 9360 kc., is heard around 1615 with news and music, and in English to North America at 2230-2300 s/off. (JJ, SG)

Spanish Guinea—Bata, Rio Muni, 8800 kc., was noted from 1553 with instrumentals and Spanish announcing. It was noted later at 1658 giving identity as Aquí Radio Equatorial, La Voz de Espana en Guinea, then closing with an anthem. S/off varies from 1655 to 1700. (GC)

Switzerland—HER2, 6055 kc., and HEU3, 9665 kc., Berne, operate in English to Ireland and the United Kingdom in the European Service daily at 1345-1530. HER4, 9535 kc.,

and HER2, 6055 kc., operate in English to North America daily at 2315-0000. (JB, HS)

Thailand—HSK9, Bangkok, 11,670 kc., has English news at 0530; news in Thai at 0830-0845; Thai music at 0845-0859; English announcement at 0859, continuing with Home Service. Channel then closes. (GF, PM, ER)

Turkey—TAT, Ankara, 9515 kc., has English to North America at 1815-1900; news at 1815. There is a question-and-answer session about Turkey on Sundays at 1845. (SG, LS)

Uruguay—CXA10, 11,896 kc., Montevideo, is NOT off the air but was recently heard at 1901 identifying as *Servicio Oficial de Difusion, Radio Electrica*, followed by a talk. It is about the strongest station in the 25-meter band at this time. (GC)

Windward Islands—The Windward Islands Broadcasting Service, in St. George's, Grenada, can be heard on 3395 kc. and 14,820 kc. with English at 1700-2115. BBC news relays are at 1800 and 2100. (PR)

Venezuela—YVKF, *Ondas Populares*, Caracas, 4880 kc., has an English program mornings at 0645 s/on, 0730 s/off. There is news at 0650. The program is called "The Early Bird Show" and features American records, frequent ads and time checks. Evening Spanish xmsn signs off at 2300. (RR)

Denmark (Late report)—OZF, Copenhagen, 9520 kc., has two periods to North America as follows: 2030-2130 and 2200-2300; first half-hour in Danish, rest in English; all Danish on Sundays. (AE)

SHORT-WAVE CONTRIBUTORS

Alfred Ewer (AE), Dartmouth, N. S.
Bill Evans (BE), Port Arthur, Ontario
Bob Hatter (BH), Syosset, N. Y.
Bob Jacobs (BJ), New York, N. Y.
Bob Wilkins (BW), Honey Grove, Texas
Ed Krejny (EK), Cleveland, Ohio
Emmet Riggle (ER), Massillon, Ohio
Gary Alexander (GA), Chariton, Iowa
George Cox (GC), New Castle, Del.
Grady Ferguson (GF), Charlotte, N. C.
Harwood Shepard (HS), Auburn, N. Y.
James Hart (HA), Irvington, N. J.
John Beaver (JB), Pueblo, Colo.
John Huetter (JH), Cleveland, Ohio
Joie Jones (JJ), Abilene, Texas
Joseph McGerald (JM), New Britain, Conn.
Kenneth deAnnis (KA), Philadelphia, Pa.
Kent Mueller (KM), Youngstown, Ohio
Larry Seidman (LS), Brooklyn, N. Y.
Louis Marcarelli (LM), Medford, Mass.
M. Robert Meltzer (MM), Syracuse, N. Y.
Paul Mathieu (PM), Southbridge, Mass.
Peter Risse (PR), Atlanta, Ga.
Phil Finkle (PF), Burbank, Calif.
Raymond Huss (RH), Lakewood, Calif.
Rodney Johnson (RJ), Hampton, Va.
Roger Legge (RL), McLean, Va.
Rolan Riker (RR), San Bernardino, Calif.
S. George (SG), Ottawa, Ontario
William Ladd (WL), Dallas, Texas

HIGH COSTS OF HOME AND AUTO REPAIRS GOT YOU DOWN?

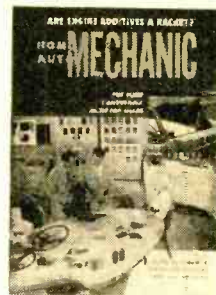

Now—with the help of HOME and AUTO MECHANIC every month—you can keep your home, your car in tip-top shape . . . have fun doing it . . . and save money, too! HOME and AUTO MECHANIC shows you how to make your home more attractive, your car more efficient. You'll save on home repairs . . . cut down your car expenses. Here's a typical monthly lineup of HOME and AUTO MECHANIC features:

- ELECTRIC WIRING FOR YOUR HOME
- ADD SAFETY LOCKS TO YOUR CAR
- HOW TO SELECT SPARK PLUGS
- DOCTOR YOUR CAR BEFORE YOU TRADE
- CONVERT YOUR BATTERY TO AC
- PUT YOUR CONVERTIBLE IN TIP-TOP SHAPE

You'll go for the easy-to-understand, step-by-step construction articles in HOME and AUTO MECHANIC that will help you build, repair, improve.

**GET YOUR COPY OF
HOME and AUTO MECHANIC TODAY!**

At all newsstands—only

35c



HOME and AUTO MECHANIC

is published by Ziff-Davis Publishing Co., 366 Madison Avenue, New York 17, N.Y., also publishers of: POPULAR PHOTOGRAPHY, PHOTOGRAPHY ANNUAL, PHOTOGRAPHY DIRECTORY & Buying Guide, COLOR PHOTOGRAPHY ANNUAL, RADIO & TELEVISION NEWS, HI-FI ANNUAL, POPULAR ELECTRONICS, FLYING, MODERN BRIDE, AMAZING STORIES, SPORTS CARS ILLUSTRATED, FANTASTIC and G. I. JOE.

GLOSSARY OF ELECTRONIC TERMS

This glossary, which has been published in serial form, started in August, 1955. It has consisted of a selected group of definitions taken from the booklet "A Dictionary of Electronic Terms," published by Allied Radio Corp., 100 N. Western Ave., Chicago, Ill. The complete dictionary, containing over 3500 terms, is available from Allied at 25 cents a copy.

very low frequencies—A band of frequencies in the radio spectrum extending from 10 to 30 kc.

vibration pickup—A microphone designed to respond to mechanical vibrations rather than to sound waves.

vibrator—An electromagnetic device which converts a d.c. voltage to pulsating d.c. or a.c. It is used in the power packs of auto radios and some public address amplifiers to convert the auto storage battery voltage to a low a.c. voltage. The a.c. voltage is then stepped up by a power transformer, and converted into a high d.c. voltage either by a conventional rectifier tube circuit or by an extra set of contacts on the vibrator itself.

video—Latin word for "I see." Applied as a prefix to the names of television parts or circuits which carry picture signals.

video amplifier—A stage in a television circuit which amplifies video frequencies after demodulation.

video detector—In television, the demodulator circuit which extracts the picture information from the modulated carrier.

video frequencies—Frequencies existing in the demodulated output of a television camera as a result of scanning the image being transmitted. The range is from almost zero to well over 4 mc. Also called **visual frequencies**.

video signal—The picture signal in a television system.

vinylite—A translucent plastic with a vinyl resin base, used in the pressing of phonograph records when absence of needle scratch is preferable to long life. Frequently, the record is tinted in various shades of red, green, blue, etc.

voice coil—The moving coil that is attached to and activates the diaphragm or cone of a dynamic loudspeaker.

volt—The practical unit of voltage, potential or electromotive force. One volt is the electromotive force which will send one ampere through a resistance of one ohm.

voltage doubler—A transformerless rectifier circuit that provides double the output voltage of a conventional vacuum-tube rectifier by charging a capacitor during one half-cycle, and discharging it in series with the output voltage of a similar unit in the full-wave version during the next half-cycle. Similar circuits have been designed for trebling or quadrupling voltage.

voltage drop—The voltage developed between the terminals of a circuit component by the flow of current through the resistance or impedance of that part.

voltage gain—Voltage amplification. A rating of an amplifier stage obtained by dividing the a.c. output voltage by the a.c. input voltage. It is less than the

amplification factor of the tube by the ratio of the external plate impedance to the total plate impedance. As the external impedance becomes larger in comparison to the plate impedance, the value approaches the amplification factor.

voltage regulator—A device or circuit that functions to maintain terminal voltage at a predetermined value, or varies the voltage according to a predetermined plan.

voltaic cell—A cell consisting of a conducting liquid (electrolyte) and two dissimilar electrodes. Such a cell can function as a source of electrical energy (from chemical energy). This is voltaic action. It is always possible to use such a cell across an external power source. This is electrolytic action, which may result in charging the cell, in electrolysis, or in rectifying action.

voltammeter—(1) A wattmeter. (2) An instrument that may be used either as a voltmeter or ammeter.

volt-ampere—The unit of apparent power in an alternating-current circuit containing reactance. It is equal to the voltage in volts multiplied by the current in amperes without taking phase into consideration.

voltmeter—An instrument for measuring voltage.

volt-ohm-milliammeter—A test instrument having provisions for measuring voltage, resistance and current. It consists essentially of a single meter having the necessary number of scales, and a switch which places the meter in the correct circuit for a particular measurement.

volume—(1) In an audio-frequency circuit, the power usually expressed in decibels. (2) In general, the intensity or loudness of the sound produced by a headphone or loudspeaker.

volume compression—Limitation of the volume range of audio frequency sound amplitude to a variation of about 30 to 40 db at the transmitter, to permit using a higher average percentage modulation without risk of overmodulation.

volume control—A potentiometer or rheostat used to vary the audio-frequency output of an audio amplifier. It is used in radio receivers, p.a. systems, and radio-telephone transmitters.

volume expander—A special audio-frequency circuit arrangement to increase the volume range of a radio program or phonograph record by making weak sounds weaker and loud sounds louder, thereby counteracting volume compression at the transmitter or in the record.

volume indicator—A type of high-impedance voltmeter, usually of the vacuum-tube type, designed to measure volume in an audio-frequency circuit.

volume unit—A unit used to specify the audio-frequency power level in decibels above a reference level of 1 milliwatt (0.001 watt). A volume unit (abbreviated vu) differs from a db in that the reference level need not be specified because it is included in the definition, which is not true of db.

wafer socket—A vacuum-tube socket consisting of pin contacts fastened between two joined wafers of insulating material, into which are inserted the terminal pins of a vacuum tube.

wall outlet—A device installed at an outlet and permanently connected to the power-line wiring. It permits connecting a radio, television receiver or other electrical appliances to the power line. Also referred to as **convenience receptacle** or **receptacle**.

watt—The practical unit of electric power. In a direct-current circuit, watts are equal to volts multiplied by amperes. In an alternating-current circuit, true watts are equal to effective volts multiplied by effective amperes, then multiplied by the circuit power factor.

wattage rating—A rating expressing the maximum power which a device or component can safely absorb or handle. To determine how high a wattage rating is required for a particular resistor, multiply the value of the resistor in ohms by the square of the current which is to flow through the resistor (resistance \times current \times current), and choose a resistor having a wattage rating approximately twice the computed value so as to give ample margin of safety in operation.

watt-hour—A unit of electrical energy equal to the power of one watt being consumed continuously for one hour.

wattmeter—A meter used to measure the power in watts or kilowatts which is being consumed by a device, chiefly in a.c. circuits.

watt-second—One watt acting for one second; equal to one joule.

wave—A propagated periodic disturbance such as a radio, light or sound wave.

waveform—The graphical representation of the shape of a wave, showing variations in amplitude vs. time.

wave guide—A hollow, round or rectangular pipe, commonly called plumbing, used as a transmission line for the propagation of microwaves.

wavelength—The distance measured along the direction of propagation, between two points which are in phase on adjacent waves. A wavelength is the distance traveled by a wave in a time of one cycle. Electromagnetic waves, including both light and radio waves, have a velocity or speed in space of approximately 300,000,000 meters per second. Thus, from the above, wavelength equals 300,000,000 divided by frequency. Light waves have wavelengths which are very small and therefore are measured in terms of microns, millimicrons and Angstrom units, which are very small fractions of a meter. Wavelength is the characteristic which distinguishes light of one color from light of another color.

wavemeter—A calibrated variable frequency resonator used to determine wavelengths of radio waves or frequency of oscillations.

wave trap—A device sometimes connected to the aerial system of a radio receiver to reduce the strength of signals at a particular frequency, such as at the frequency of a strong local station which is interfering with reception of other stations.

Wheatstone bridge—An instrument for measuring resistance.

wheel static—Interference encountered in auto-radio installations due to friction between tires and pavement.

Wien bridge—Type of capacitance bridge circuit for measuring dielectric losses. Two of the arms are RC branches—one series-connected, the other parallel.

The circuit is the basis of an oscillator in which feedback is frequency-sensitive.

Williamson amplifier—An amplifier designed by the British experimenter, D. T. N. Williamson, which uses pentode output tubes connected as triodes. This circuit has gained wide renown because of its extremely low distortion and wide frequency range characteristics.

wireless record player—A motor-driven turntable and phono pickup mounted in the same cabinet with an r.f. oscillator. The phono pickup converts a recording into a.f. signals which modulate the r.f. carrier of the oscillator. The resulting signal is radiated through space, as a broadcast signal, and can be picked up by any radio receiver in the vicinity merely by tuning that receiver to the broadcast-band frequency on which the wireless record player is operating.

wire recorder—Instrument similar to a tape recorder, except that it utilizes a round, stainless steel wire about .004" in diameter instead of the tape.

wire gauge—A system of numerical designations of wire sizes, starting with low numbers for the largest sizes. The American wire gauge, abbreviated AWG (formerly the Brown and Sharpe gauge, abbreviated B & S gauge) is in common use in this country and starts with 0000 as the largest size, going to 000, 00, 0, 1, 2, and up to 40 and beyond for the smallest sizes. Wire of size No. 40 is approximately 3 mils in diameter; No. 18 is about 40 mils in diameter. The cross-sectional area doubles every three sizes, the diameter every six sizes.

wire-wound resistor—A resistor which is constructed by winding a high-resistance wire on an insulating form. The resulting element may or may not be covered with a ceramic insulating layer.

woofer—A large loudspeaker designed to reproduce low audio frequencies (30-2000 cycles) at relatively high power levels. Generally used in combination with a high-frequency loudspeaker called a tweeter.

working voltage—The voltage rating of a fixed capacitor. It is the recommended maximum voltage at which the unit should be operated.

wow—Term used to denote distortion in a sound-reproducing system, caused by periodic variation in speed of the tape, turntable, wire or film.

x-rays—Radiation that has frequencies between the higher ultraviolet and the lower gamma rays. Produced by the impinging of electrons on a solid (called a target), x-rays can penetrate opaque objects and affect photographic plates or produce fluorescence.

x-ray tube—A high-vacuum, high-voltage, hot-cathode, two-electrode tube which produces x-rays. Streams of electrons emitted from the cathode are directed on a target, usually of tungsten, producing x-rays by bombardment.

zero beat—The condition in which a given circuit is oscillating at the exact frequency of an external radio wave so that no beat tone is produced or heard when the combined waves are demodulated.

zero bias—A condition in which the control grid and cathode of a vacuum tube are at the same potential.

zero potential—An expression usually applied to the potential of the earth, as a convenient reference for comparison.

(The End)

Classified

RATE: 50¢ per word. Minimum 10 words prepaid. May issue closes March 2nd. Send order and remittance to: POPULAR ELECTRONICS, 366 Madison Avenue, N. Y. C. 17.

FOR SALE

TUBES-TV, Radio, Transmitting And Industrial Types At Sensibly Low Prices. New, Guaranteed 1st Quality Top Name Brands Only. Write For Free Catalog or Call Walker 5-7000, Barry Electronics Corp., 512 Broadway, New York 12N, N. Y.

DIAGRAMS for repairing radios \$1.00, Television \$2.00. Give make, model. Diagram Service, Box 672-PE, Hartford 1, Conn.

USED Television sets \$14. Jones, 1115 Rambler, Pottstown, Penna.

ELECTRIC Guitars, Amplifiers, parts, wholesale, Free Catalog. Carvin, PE287, Covina, Calif.

"20 CRYSTAL Set Plans" (SW record 5800 miles), catalog and "Radiobuilder" magazine—25c. Laboratories, 328-L Fuller, Redwood City, California.

BUY Surplus radios, receivers, electronic equipment. Direct from Government. List \$1.00 Box 1842R, Hartford 1, Connecticut.

ILLUSTRATED pocket radio plans. 50c, Jay Cook, 4003-E Roosevelt, Midland, Texas.

SUPER Experimenter's Special: Complete Plans, Parts List for Transistor Pocket Radio, Only \$1.00. Order now, Receive Free PNP Junction Transistor & Germanium Diode! Box 175, 1101 Troy, Dayton 4, Ohio.

SUPERSENSITIVE VHF radio receives television, FM broadcast, special services and amateurs without antenna or ground. Factory wired and tested chassis including special tube \$5.98. In kit form \$3.98. Thousands in use by experimenters, amateurs, civil defense. Transistor audio stage complete with transistor for extra loud reception only \$2.00 extra. Springfield Enterprises, Box 54-E4, Springfield Gardens 13, New York.

SECRET Beam Transmitter, New, Five Mile Range, White & Infrared, Portable, Flashlight battery operation. Includes Signal Gun, Gunstock, Tripod, Infrared Goggles, Remote Control, Carrying Case, Manual. Government paid over \$50. Yours for only \$10 postpaid. Illustrated Signal Corps Manual 50c. Surplus, Box 118, Jersey City 4, N. J.

WALKIE-talkie. Build wireless portable radiophone for less than \$10.00. Plans for variable frequency and crystal control types, only 50c for both. Springfield Enterprises, Box 54-E4, Springfield Gardens 13, N. Y.

TAPE Recorded Code Courses. None other comparable, stamp for full particulars. Tapecode Box 31, Langhorne, Pa.

NAVY Headphones New, Low Impedance, Waterproof Cord & Plug \$4.00 postpaid. Surplus, Box 118, Jersey City, N. J.

ELECTRIC Pencil: Engraves all Metals, \$1.50. Beyer Mfg., 10511-P Springfield, Chicago 43.

SOLAR Battery—miniature selenium Cell. Generates 25 volts. With data and experiments. \$1.00 to Lab "L", P.O. Box 3096, University Station, Columbus 10, Ohio.

ARMY Field Telegraph Set, New including Key, Headphone, Manual, Carrying Case \$10 postpaid. Surplus, Box 118, Jersey City 4, N. J.

WANTED

CYLINDER and old disc phonographs. Edison Concert, Balmoral, Conquerer, Opera, and Oratorio models. Berliner Gramophones and Zono-o-phones, Columbia disc and cylinder Graphophones, Bettini micro-reproducer. Want old catalogues and literature on early phonos prior to 1919. Will pay cash or trade late hi-fi components. POPULAR ELECTRONICS, Box 50.

TUBES and equipment bought, sold and exchanged. For action and a fair deal write B. F. Gensler, W2LNI, 56 Crosby St., N. Y. 12N, N. Y.

INVENTIONS WANTED

INVENTIONS wanted. Patented, unpatented. Global Marketing Service, 2420 77th, Oakland 5, Calif.

INVENTIONS wanted immediately for promoting. Special booklet Free. Kessler Corporation, 1841 W, Fremont, Ohio.

BUSINESS OPPORTUNITIES

TO \$100.00 Weekly. Sparetime, Home Operated Mail-order Business. Successful "Beginner's" Plan. Everything Supplied. Lynn, 10420-E National, Los Angeles 34.

VENDING Machines—No selling. Operate a route of coin machines and earn amazing profits. 32-page catalog free. Parkway Machine Corporation, Dept. 12, 715 Ensor St., Baltimore 2, Md.

FREE Booklet "Money-Making Facts" tells mechanically-inclined men how to start sparetime business at home. Lee Foley Company, Columbia Heights, Minnesota.

\$70 WEEKLY—home, spare time. Simplified mail Bookkeeping. Immediate income—easy! Auditax, 34757Y, Los Angeles 34.

MAKE \$100 weekly spare time, with your Tape Recorder. Send 25c. LP Discs Made From Tapes: 10"—30 minutes, \$4.25; 12"—45 minutes, \$5.75. For other Speeds write Artistic Sound, 24110 Rensselaer, Oak Park 37, Michigan.

UP To 80% Discounts On Name Brands! Giant 100 page catalog. BTS Products, Box 217, Oakland 2, N. J.

EMPLOYMENT INFORMATION

JOBS—High Pay. South America, the Islands, U.S.A., foreign countries. All trades. Clerical, labor, engineers, drivers, others. Women also. Fare paid. Application forms. For information Write Section 92B, National Employment Information, 1020 Broad, Newark, N. J.

TAPE RECORDERS

TAPE Recorders, Tapes, Accessories. Unusual values. Dressner, Box 66E, Peter Stuyvesant Station, N. Y. 9.

LARGEST selection. Best buys. Tape recorders, Accessories, Tapes. Free price list. Hi-Fi Hobbies, 975PE East 178 St., New York 60, N. Y.

PATENTS

HERMAN Lewis Gordon, Registered Patent Attorney, Patent Investigations and Opinions, Warner Building, Washington 4, D. C.

MINERALS & PROSPECTING

GEIGER Counter and Metal Detector Kits. Inexpensive, Educational. Free Literature. Electronic Applications, Dept. B, 5024 Lee Highway, Arlington 7, Va.

SCINTILLATION Counter, transistorized, no tubes or vibrators, 1"x1½" crystal, 2 flashlight cells, weighs only 2 lbs. complete. \$389.00, guaranteed. Revolutionary. Write Ute Company Inc., 200 So. 4th, Montrose, Colorado.

MISCELLANEOUS

FREE Condenser & Resistor Code Chart! Get yours now Plus new value-packed catalogue! K. & L. Radio Parts Co., 1406 Venice Blvd., Los Angeles 6, California.

RULE Others With Thoughts. Full Course. (Adults.) \$2. Delmar Wisdom, 846-S8 Sunnyside, Chicago 40.

EX-RAY Mind! Hypnotize, one glance Guaranteed, \$3.00. Womstoker, Box 10, Ottery, Cape, South Africa.

HAMS, Experimenters Send one buck for a real Surprise: Reynolds, 755 Marietta, Lancaster, Pennsylvania.

BAILEY PNEUMATIC FLOW TRANSMITTER
 TYPE CC138 * 3500 PSIG
 53", 120", AND 212" HEADS

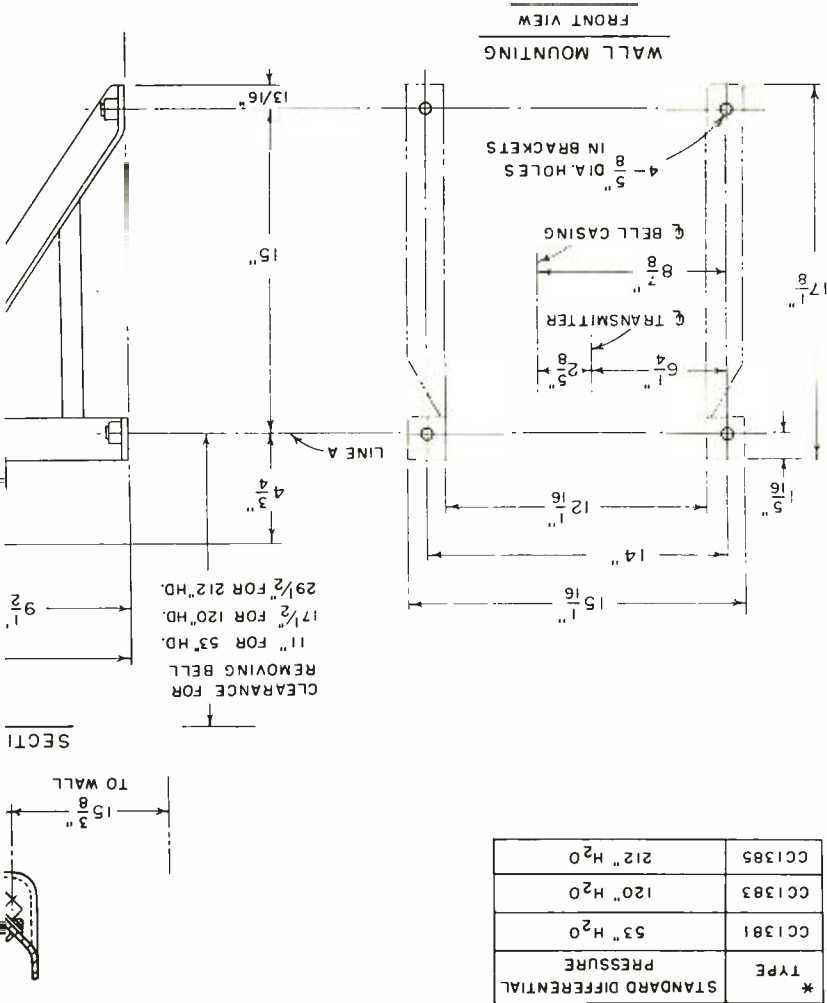

ADVERTISER'S INDEX

ADVERTISER	PAGE NO.
Advance Spectacle Co.	113
Algeradio Electronics Co.	102
Allied Radio Corp.	20
Altec Lansing Corp.	123
Audio Artisans, Inc.	102
Bailey Technical Schools	109
Big City Wood Products Co.	122
California Electronics & Television Institute	113
Canadian Institute of Science	110
Candler System Co.	124
Capitol Radio Engineering Institute	99
Central Technical Institute	28
Cisin, Harry G.	121
Cleveland Institute of Radio Electronics	15
Coyne Electrical School	8, 23, 103
DeVry Technical Institute	11
Electronic Instrument Co., Inc. (EICO)	10
Electronic Measurements Corp.	4th Cover
Electro-Voice	30
Emig School of Electronics	110
Esse Radio Co.	109
General Electric Company	23
Glass Electronics, J. J.	121
Goodheart, R. E.	110
Grantham School of Electronics	104
Gray Research & Development Co.	2nd Cover
Greenlee Tool Co.	8
Gyro Electronics Co.	122
Hawkins, P. E.	106
Heath Company	94, 95, 96, 97
Hershel Radio Co.	100
Hi-Fi Annual	111
Home & Auto Mechanic	125
Indianapolis Electronic School	116
Instructograph, Inc.	106
International Correspondence Schools	13
Jensen Manufacturing Co.	121
Johnson Co., E. F.	117
Karlson Associates	119
Kay, Jack	110
LMB	124
Lafayette Radio Corp.	27
Lektron Specialties	107
McGraw-Hill Book Co., Inc.	26
McMorrow, Berman & Davidson	124
Major Brand Tube Co.	113
Martin School, Don	121
Midway Company	104
Miller, Gustave	124
Minnesota Mining & Mfg. Co.	112
Moss Electronics Distributing Co., Inc.	130, 3rd Cover
Musical Masterpiece Society	5
National Radio Institute	3
National Schools	18, 19
Northrop Aeronautical Institute	106
Olson Radio Warehouse	22
Pacific States University	104
Peak Electronics	124
Philadelphia Wireless Technical Institute	102
Pilot Radio Corp.	112
Precision Electronics (Miniature Radio)	122
Precision Electronics Instruments, Inc.	102
Premier Metal Products	56
Prentice Hall	116
Progressive "Edu-Kits," Inc.	29
RCA Institutes	25
Radio Electronic Television School	119
Radio TV Training Association	7
Rad-Tel Tube Co.	104
Raytheon Manufacturing Co.	14
Rider Publishing Co., Inc. John F.	26
Rinehart Books	16
Rockbar Corporation	21
Science Kits	9
Scott, Herman Hosmer	17
Shure Brothers	6
Sierra Scientific Co.	121
Solar Electronics	101
Soundtronics Labs	104
Springfield Enterprises	104, 113
Sports Cars Illustrated	120
Stanley Electronics	24
TAB	129
Teltron Electric Co.	103
Tradyne, Inc.	122
Tufo Mart, The	121
U. S. Air Force	93
V.S.I. Television School	110
Valparaiso Technical College	122
Western Radio	106
Westwood Research & Development Lab.	102
Whitehall Pharmaceutical Co.	116
World Radio Labs	115
YMCA Trade Schools	116

WRITE FOR OUR NEW BONUS HI-FI GRAM

NEW SHAWLITE ELECTRONIC FLASH KIT

Uses new 10-volt 10-watt SUPER CIRCUIT constant bright light output 60 watt sec. 1/600 sec. duration; color K 6800; color 2/84; H&V 2200. Cost per flash less than 3¢. 1000 to 2000 flashes per set of (2/240V) batteries. Recycles 2 sec. Parabolic reflector. Assembled gun. Less batteries. Compact. Wgt. 2 3/4 lbs.

MODEL 40011 @ \$29.95
 SET OF TWO (2) 240V Batteries @ \$10
 "TABLITE"-400V-AC & Battery, @ \$38.95
 SHAWLITE 60011-120W/sec. Battery oper. @ \$43.95
 "TABLITE" 600V-AC & Battery, 120W/sec. @ \$59.95
 "TABLITE" 100CV-240V/sec. AC & Battery @ \$69.95



Write For Complete Data & Specifications

INFRARED SNOOPERSCOPE

Selected G.T.D. Image Converter Tube. Hi-sensitivity simplified design 2" dia. Willemite screen—Hi Resolution. Tube & Data @ \$3.90; 2/\$7.50

SNOOPERSCOPE POWER SUPPLY
 4500 VDC/35MA. Using Dual Output Crkt., Transformer, Rectifiers, Sockets, Resistors, Capacitors & Diagram 115V/60 cy Oper. @ \$13.50



"TAB" FINEST HI-FI RECORDING TAPE

7 1/2" Reel—1200 Ft. Per Reel
 S S S Back Guarantee

Precision Coated & Slit Gtd. Splice Free, Quality Controlled, Plastic Base, Gtd. Constant Output, Freq. 7 1/2 IPS 40-15KC. Oxide Wnd in. "TAB" Special @ \$1.68 ea.; 3 @ \$1.62 ea.; 12 @ \$1.55 ea.; 24 @ \$1.45 ea.; 72 @ \$1.35 ea.



NEW ELECTROSTATIC HI-FI TWEETER

New 3D Tone Range, Linear Response, range 7000-20,000 cycles. Model TH5 70, 2 1/2" dia., depth, 55" @ \$5.25; 2/\$8.50; Model TH516—Rectangular, 2"x8 1/4" depth @ \$6.95; 2/\$12.



"TAB" BUILD-IT-YOURSELF SPECIALS

HI-FI MUSIC LOVER'S AMPLIFIER—Finest quality. Rated: 10 Watt. Distortion: 1 1/2%. Freq. = 10B (20 to 20,000 CPS). Output: 4, 8, 16 Ohms. Brown Hammerhead finish. Size: 6 1/2" x 6" x 8". Wt. 9 lbs. 115V/60 cy. Complete & detailed inst. Anyone can build & assemble with enjoyment. Model T11-10. Only \$21.00

20 Watt Hi-Fi Amplifier Kit. Ultra linear Williamson type ckt. With Features found in the most expensive amplifiers. Write for complete specs.

10-In-1 Kit. Learn by building 10 different ckt. that work. You build a Broadcast recr. photo or mike amplifier, phono oscillator, Broadcasting station, Code practice oscillator, Capacity photo cell relay. Complete with all tubes & parts less headphones, photo cell & socket, wire & solder. @ \$12.95

Pocket Radio Kit. Only 3"x5"x1 1/4". Hi sensitivity & selectivity. Superhet ckt. with hearing aid type earphone. Complete with tubes & inst. Less batteries. @ \$11.75



EMC 208 Tube Tester, \$24.90 Reg. "TAB" @ \$18.50

TUBES TESTED Guaranteed

OUR 12th YEAR IN BUSINESS

0A2	.70	6AQ5	.45	6SA7	.45	12AX4	.70
0Z4	.42	6AS5	.75	6X4	.75	12AT7	.55
1B3	.60	6AT6	.35	6SH7	.40	12BH7	.55
1L4	.40	6AU6	.75	6SL7	.45		
1R5	.49	6AU6	.75	6SK7	.45		
1S4	.64	6AX4	.60	6SL7	.55		
1S5	.40	6BE6	.45	6SN7	.55		
1T4	.49	6BE6	.45	6SN7	.55	12BY7	.70
1U4	.45	6BE6	.45	6T4	1.00	12SA7	.65
1U5	.40	6BF6	.50			12SQT	.45
1X2A	.60	6BG6	1.12	1N21	.25	12X7	.45
2V3	.75	6BK5	.75			12Y7	.55
3A4	.45	6BL7	.60	6TR	.75	19BG6	1.25
3AS	.48	6BN6	.65	6U8	.75	25BQ6	.90
3Q4	.45	6BQ6	.90	6V6	.45	25Z6	.45
3V4	.55	6BQ7	.85	6W6	.55	35C5	.50
5U4G	.42	6C4	.35	6X4	.30	35L6	.50
5Y3G	.65			7A8	.50	35W4	.45
6AB4	.40	2D21	.75	7C5	.35	50A5	.45
6AC7	.64			7F8	.68	50B5	.55
6AG5	.45	6CB6	.48	7F7	.55	50C5	.45
6AH4	.75	6CD6	1.12	7N7	.55	50D5	.45
		6H6	.45	7Q7	.75	50L6	.40
		6J5	.38	12AT6	.40	75	.45
		6J6	.45	12AT7	.65	75	.45
		6K6	.39	12AU7	.50	77	.40
6AG6	.85	6K7	.35	12AV7	.75	117L7/N7	1.75
6AK5	.85	6L6	.35				
6AL5	.38	6L6	.35	12AV7	.75		



NEW VARIABLE 0 to 6 & 12 VOLT/12 AMP DC Power Supply

Battery Eliminator, Charger, Model RR, plater Aircraft, Marine or any DC requirement. Extra Hi-duty Selenium Rectifier, 2 meters V & A. Designed for cont. service & up to 20 amps intermittent overload.
 MODEL T612V12AC @ \$29.95

NEW "TABTRON" SELENIUM RECTIFIERS

FULL WAVE BRIDGE
 Dated—One Year Guarantee

18VAC/14VDC—1 Amp. \$1.40; 2A \$2.00; 3A \$2.90;
 1A \$3.50; 6A \$3.95; 10A \$5.85; 12A \$7.20.
 35VAC/28VDC—1 Amp. \$2.30; 2A \$2.95; 3A \$4.10;
 1A \$6.40; 6A \$7.70; 10A \$11.35; 12A \$14.25.



"TAB"

TERMS: Money Back Gtd. (cost of mds. only), \$5 min. order F.O.B. N.Y.C. Add shpg. charges or for C.O.D. 25% Dep. Tubes Gtd. via R-Exp. only. Prices shown are subject to change.

111 Liberty St., N.Y. 6, N.Y., Rector 2-6245, Dept. 4PE6

New Model
670-A

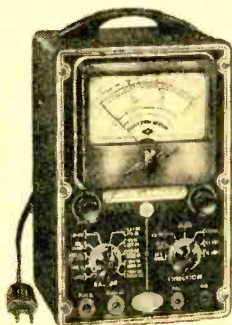

New! **SICO** SUPER-METER

A Combination VOLT-OHM MILLIMETER PLUS
CAPACITY REACTANCE INDUCTANCE AND DECIBEL MEASUREMENTS

SPECIFICATIONS

D.C. VOLTS: 0 to 7.5/15/75/150/750/1,500/
7,500 Volts
A.C. VOLTS: 0 to 15/30/150/300/1,500/3,000
Volts
OUTPUT VOLTS: 0 to 15/30/150/300/1,500/
3,000 Volts
D.C. CURRENT: 0 to 1.5/15/150 Ma. 0 to
1.5/15 Amperes
RESISTANCE: 0 to 1,000/100,000 Ohms 0 to
10 Megohms
CAPACITY: .001 to 1 Mfd. 1 to 50 Mfd. (Good-
Bad scale for checking quality of electrolytic
condensers.)
REACTANCE: 50 to 2,500 Ohms 2,500 Ohms
to 2.5 Megohms
INDUCTANCE: .15 to 7 Henries 7 to 7,000
Henries
DECIBELS: -6 to +18 +14 to +38 +34 to
+58

ADDED FEATURE:

Built-in ISOLATION TRANSFORMER reduces pos-
sibility of burning out meter through misuse.

The Model 670-A comes housed, in a rugged
crackle-finished steel cabinet complete with
test leads and operating instructions.

\$2840
NET

New Model TV-60
20,000 OHMS PER VOLT



ALLMETER

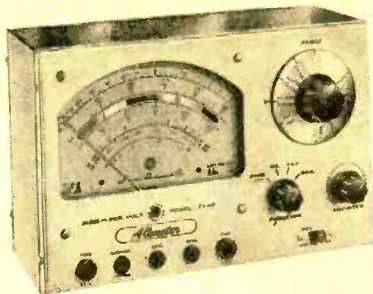

FEATURES

- ✓ Giant recessed 6½ inch 40 Microampere meter with mirrored scale assures accuracy and easy-reading. All calibrations are printed in large easy-to-read type. Fractional divisions are easily read with the aid of the mirrored scale.
- ✓ The line cord, used only when making Capacity measurements, need be plugged in only when that service. It is out of the way, stored in its pliofilm compartment at all other times.
- ✓ A built-in Isolation Transformer automatically isolates the Model TV-60 from the power line when the capacity service is in use.
- ✓ Selected, 1% zero temperature coefficient metalized resistors are used as multipliers assuring unchanging accurate readings on all ranges.
- ✓ Use of the latest type of printed circuit guarantees maintenance of top quality standard in the production runs of this precise instrument.
- ✓ A new improved type of high-voltage probe is used for the measurement of high voltages up to 30,000 Volts. This service will be required when servicing color TV receivers.
- ✓ Simply plug-in the R.F. probe and convert the Model TV-60 into an efficient R.F. SIGNAL TRACER permitting the measurement of stage-gain and cause of trouble in the R.F. and I.F. circuits of A.M., F.M., and TV receivers.
- ✓ Plug in the Audio probe and convert the Model TV-60 into an efficient AUDIO SIGNAL TRACER. Measure the signal levels and comparative efficiency of hearing-aids, public-address systems, the amplifier sections of Radio & TV receivers etc.

Includes services never before provided by an
instrument of this type. Read and compare fea-
tures and specifications below!

SPECIFICATIONS

- 8 D.C. VOLTAGE RANGES: (At a sensitivity of 20,000 Ohms per Volt) 0 to 15/75/150/300/750/1500/7500/30,000 Volts.
- 7 A.C. VOLTAGE RANGES: (At a sensitivity of 5,000 Ohms per Volt) 0 to 15/75/150/300/750/1500/7500 Volts.
- 3 RESISTANCE RANGES: 0 to 2,000/200,000 Ohms, 0-20 Megohms.
- 2 CAPACITY RANGES: .00025 Mfd. to .3 Mfd., .05 Mfd. to 30 Mfd.
- 5 D.C. CURRENT RANGES: 0-75 Microamperes, 0 to 7.5/75/750 Milliampers, 0 to 15 Amperes.
- 3 DECIBEL RANGES:
 - 6 db to + 18 db
 - + 14 db to + 38 db
 - + 34 db to + 58 db

R.F. SIGNAL TRACER SERVICE: Enables following the R.F. signal from the antenna to speaker of any radio or TV receiver and using that signal as a basis of measurement to first isolate the faulty stage and finally the component or circuit condition causing the trouble.

AUDIO SIGNAL TRACER SERVICE: Functions in the same manner as the R.F. Signal Tracing service specified above except that it is used for the location of cause of trouble in all audio and amplifier systems.

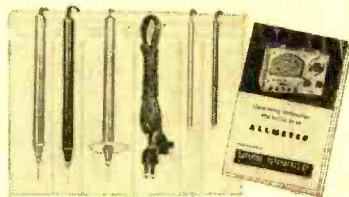

Model TV-60 comes complete with book of instructions; pair of standard test leads; high-voltage probe; detachable line cord; R.F. Signal Tracer Probe and Audio Signal Tracer Probe. Pliofilm bag for all above accessories is also included. Price complete. Nothing else to buy. Only

\$52⁵⁰
NET

EXAMINE BEFORE YOU BUY!
USE APPROVAL FORM ON NEXT PAGE

New!



Streamlined TUBE TESTER

New Model TC-55

QUICKLY AND EFFICIENTLY TESTS RADIO AND TV TUBES INCLUDING: SEVEN PIN MINIATURES; EIGHT PIN SUBMINARS, OCTALS AND LOCTALS; NINE PIN NOVALS



YOU CAN'T INSERT A TUBE IN THE WRONG SOCKET.

It is impossible to insert the tube in the wrong socket when using the new Model TC-55. Separate sockets are used, one for each type of tube base. If the tube fits in the socket it can be tested.

"FREE-POINT" ELEMENT SWITCHING SYSTEM.

The Model TC-55 incorporates a newly designed element selector switch system which reduces the possibility of obsolescence to an absolute minimum. Any pin may be used as a filament pin and the voltage applied between that pin and any other pin, or even the "top-cap."

The Model TC-55 comes complete with operating instructions and charts. Use it on the bench—use it for field calls. A streamlined carrying case, included at no extra charge, accommodates the tester and book of instructions.

CHECKS FOR SHORTS AND LEAKAGES BETWEEN ALL ELEMENTS.

The Model TC-55 provides a super sensitive method of checking for shorts and leakages up to 5 Megohms between any and all of the terminals.

ELEMENTAL SWITCHES ARE NUMBERED IN STRICT ACCORDANCE WITH R.M.A. SPECIFICATIONS.

One of the most important improvements we believe, is the fact that the 4 position fast-action snap switches are all numbered in exact accordance with the standard R.M.A. numbering system. Thus, the element terminating in pin No. 7 of a tube is under test, button No. 7 is used for that test.

\$26⁹⁵ NET

**SHIPPED ON APPROVAL
NO MONEY
WITH ORDER
NO C.O.D.**

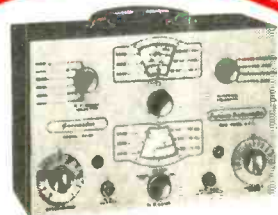

New Model TV-50 GENOMETER

A versatile all-inclusive GENERATOR which provides ALL the outputs for servicing:
A.M. Radio • F.M. Radio • Amplifiers • Black and White TV • Color TV

R. F. SIGNAL GENERATOR: Provides complete coverage for A.M. and F.M. alignment. Generates Radio Frequencies from 100 Kilocycles to 50 Megacycles on fundamentals and from 50 Megacycles to 180 Megacycles on powerful harmonics. • **VARIABLE AUDIO FREQUENCY GENERATOR:** In addition to a fixed 400 cycle sine-wave audio, the Genometer provides a variable 300 cycle to 20,000 cycle peaked wave audio signal. • **BAR GENERATOR:** Projects an actual Bar Pattern on any TV Receiver Screen. Pattern will consist of 4 to 16 horizontal bars or 7 to 20 vertical bars. • **CROSS HATCH GENERATOR:** Genometer will project a cross-hatch pattern on any TV picture tube. The pattern will consist of non-shifting horizontal and vertical lines interlaced to provide a stable cross-hatch effect. • **DOT PATTERN GENERATOR (FOR COLOR TV):** The Dot Pattern projected on any color TV Receiver tube by the Model TV-50 will enable you to adjust for proper color convergence. • **MARKER GENERATOR:** The following markers are provided: 189 Kc., 262.5 Kc., 456 Kc., 600 Kc., 1000 Kc., 1400 Kc., 1600 Kc., 2000 Kc., 2500 Kc., 3579 Kc., 4.5 Mc., 5 Mc., 10.7 Mc. (3579 Kc. is the color burst frequency.)

MODEL TV-50 comes absolutely complete with shielded leads and operating instructions. Only

\$47⁵⁰ NET

TRY ANY

of the instruments on this or on the facing page, for 10 days before you buy. If completely satisfied then send down payment and pay balance as indicated on coupon. **No Interest or Finance Charges Added!** If not completely satisfied return unit to us, no explanation necessary.

MOSS ELECTRONIC DISTRIBUTING CO., INC.
Dept. D-220, 3849 Tenth Ave., New York 34, N. Y.

Please send me the units checked. I agree to pay down payment within 10 days and to pay the monthly balance as shown. It is understood there will be no finance, interest or any other charges, provided I send my monthly payments when due. It is further understood that should I fail to make payment when due, the full unpaid balance shall become immediately due and payable.

- Model 870-A . . . Total Price \$28.40 \$7.40 within 10 days. Balance \$3.50 monthly for 6 months.
- Model TV-80 . . . Total Price \$52.50 \$12.50 within 10 days. Balance \$8.00 monthly for 5 months.
- Model TC-55 . . . Total Price \$28.85 \$8.85 within 10 days. Balance \$5.00 monthly for 4 months.
- Model TV-50 . . . Total Price \$47.50 \$11.50 within 10 days. Balance \$6.00 monthly for 6 months.

Name _____
 Address _____
 City _____ Zone _____ State _____

QUALITY INSTRUMENTS BY EMC

Save More . . . Service Better



**A COMPLETE "ECONOMY-LINE"
WITH HIGH-PRICED FEATURES.**

Advanced production techniques and extensive quality controls assure you of a high quality, reliable instrument at the lowest possible price . . . compare and you'll agree — it's smart to buy EMC.



* VOLOMETER — EMC Model 102

Durable molded bakelite case, pocket size. Features 800 micro amperes D'Arsonval-type meter, 3½ inch plastic meter, accurate to within 2%. Three AC current ranges — and the same zero adjustment for both resistance ranges.

\$14.90 wired & tested \$12.50 kit form
*Reg trade mark for volt-ohm milliamper

VOLOMETER — EMC Model 104

This precision-engineered instrument features a 4½ inch, 50 microampere meter, with alnico magnet . . . with 3 AC current ranges to 3 amps and three resistance ranges to 20 megohms.

\$26.95 wired & tested \$19.25 kit form



MUTUAL CONDUCTANCE TUBE TESTER — EMC Model 206 P

One of the finest pieces of tube testing equipment at a price comparing favorably with emission-type testers. This completely flexible model using lever-type switches offers extremely accurate results with ease of operation.

\$83.50 (hand rubbed carrying case)



TUBE TESTER and REJUVENATOR — EMC Model 209

Miniaturized instrument gives fast, absolutely accurate checks for tube quality, shorts, leakages, continuity, and opens on all modern and future tubes . . . uses standard emission test for quick readings on modern, 3½" plastic meter. \$38.50 in hand rubbed carrying case.

\$35.90 (hammertone metal case)
\$25.90 kit form

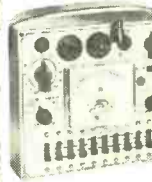

VACUUM TUBE VOLTMETER — EMC Model 106

Specially designed for field alignment of TV and radio sets. Uses 1% precision resistors for voltage multipliers. 5 db ranges. Full scale deflection of 1½ volts for both AC-DC volts. Housed in compact portable bakelite case. Size 4¼" x 5¼" x 2¾". Net weight 3 lbs.

\$35.00 wired and tested \$23.90 kit form

VOLT-OHM-CAPACITY METER — EMC Model 107

Directly measures capacity, resistance and complex waveforms peak to peak. Some of the high quality features at no extra cost are: expanded scale cannot burn out . . . measures 50 mμfd to 5000 mfd . . . inductance from 1.4 henries to 140,000 henries in 4 ranges . . . 1% multipliers for voltage capacity and resistance measurements.

\$48.90 wired & tested \$34.50 kit form



NEW RF SIGNAL GENERATOR — EMC Model 501

A professional, 6 band (115 kc to 220 mc) generator produces dependable signals for precision alignment tuning and adjustment of all types of circuits including TV. Electrostatically shielded transformer for 115 v 60 cycle operation.

\$37.90 wired & tested \$24.90 kit form



RF—AF CRYSTAL MAKER TV Bar-Generator — EMC Model 700

The popular 700 has three extra features — bar generator for TV adjustment with a variable number of bars available for horizontal or vertical alignment. Complete coverage from 18 cycles to 108 megacycles on fundamentals.

\$55.90 wired and tested



WIDE BAND OSCILLOSCOPE FOR COLOR AND MONOCHROME TV EMC Model 601

EMC Model 601 oscilloscope gives you the highest quality features ever found in this price field. Exclusive features: full 5 mc bandwidth for color TV servicing — push-pull vertical amplifier, .02 volt per inch sensitivity — 5 UP1-5" scope tube — 60 cycle phasing control — DC positioning controls eliminates overshooting and bounce — built-in peak-to-peak calibration reference — 2-step compensated attenuator input — multivibrator sweep, from 15 cycles to over 75 kilocycles.

\$117.90 wired and tested — \$70.90 kit form

Write today for FREE illustrated catalog and technical information on the EMC economy line.

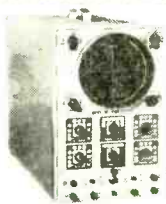

EMC

ELECTRONIC MEASUREMENTS CORP.
280 Lafayette Street • New York 12, N. Y.
EXPORT DEPT. - 370 BROADWAY, N. Y. 13, N. Y.