

POPULAR ELECTRONICS

FEBRUARY
1956

25
CENTS

In U.S. and Canada

HI-FI · AMATEUR RADIO · R/C · SWL · GADGETS



**Can We Detect a Sneak Sub Attack?
Low-Down on Speaker Baffles
Shoot to Kill—TV Commercials
Build Your Own Electronic Banjo**

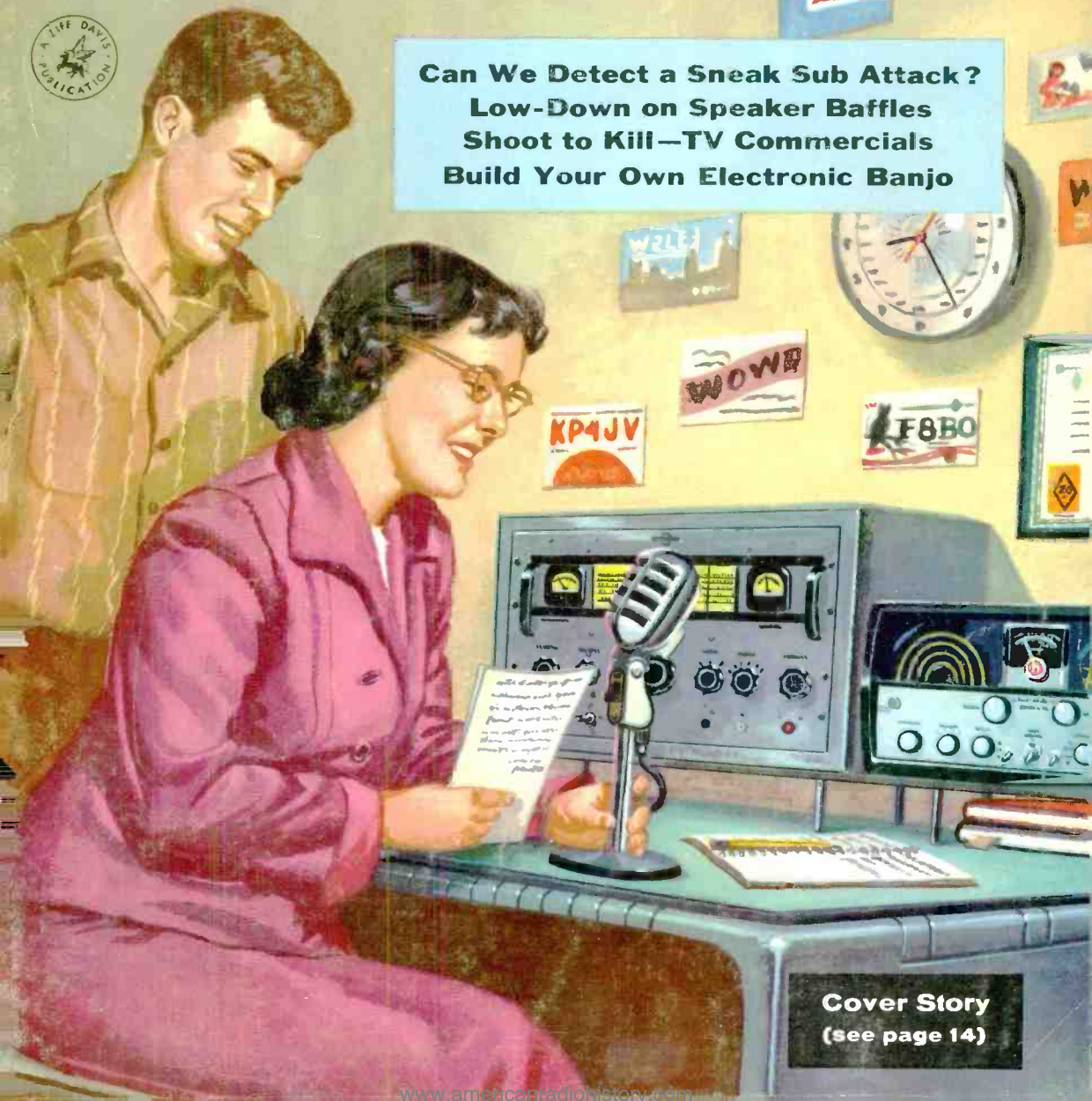

Cover Story
(see page 14)

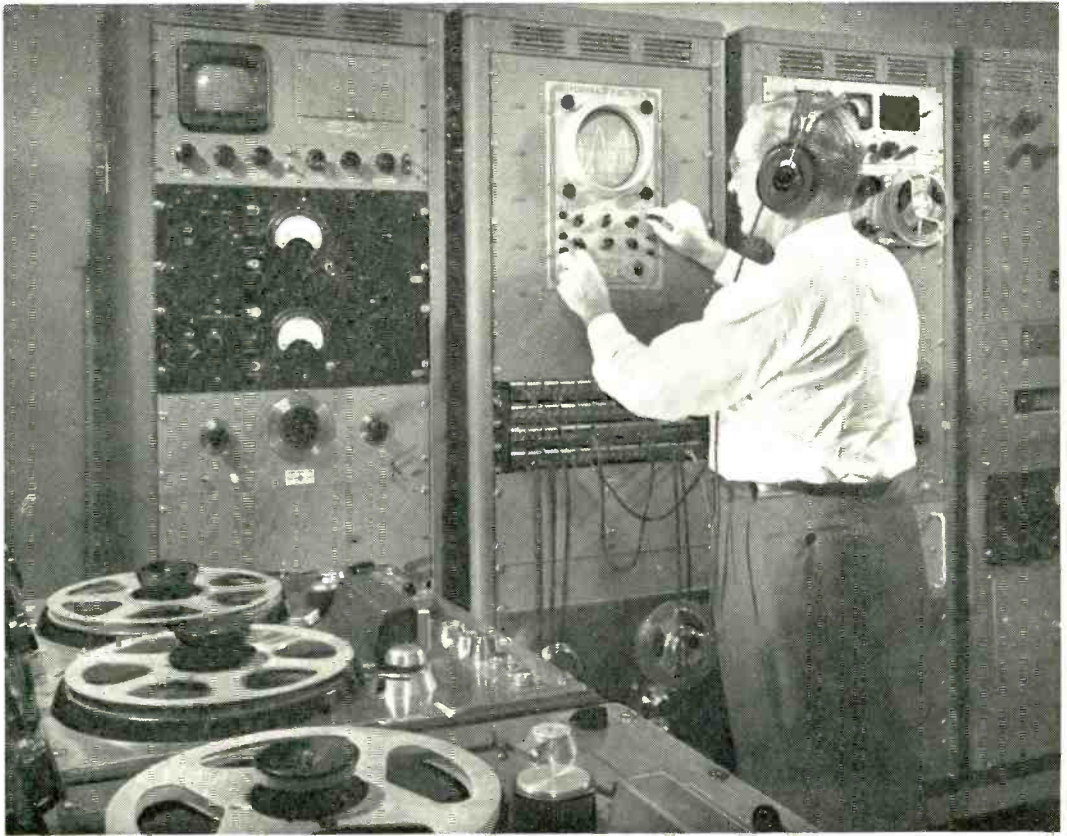

"SCOTCH" BRAND JUGGLES ATOMS to produce the finest long play magnetic tape!

Years ago "SCOTCH" Brand pioneered modern magnetic tape—and solved a knotty technical problem at the same time. The problem? How to produce recording tape with a uniform, magnetically-responsive oxide surface for finest recording results.

"SCOTCH" Brand does it by making its own oxide coatings. It's a difficult job and *only* "SCOTCH" Brand does it — splitting atoms to transform un-magnetic oxide into a *super*-magnetic coating sensitive enough to *record* even a whisper! But this extra work is worth the effort, as you'll hear yourself. *Today*—listen to a reel of new "SCOTCH" Brand

Extra Play Magnetic Tape 190. It offers you 50% more recording time on a standard-size reel, *plus* complete fidelity and purity of sound.

New! "LOOP-LOK" reel for easier threading!

Saves time...saves tape! It's "Scotch" Brand's exclusive "Loop-Lok" reel. Just loop tape around the new-design center pin for instant threading. Tape locks tight without necessity of wasteful wrap-around, yet releases fast at end of reel. Enjoy this "Scotch" Brand feature at no extra cost!

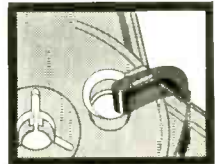

SCOTCH REG. U.S. PAT. & TM. OFF. *Extra Play* Magnetic Tape 190
BRAND with 50% more recording time

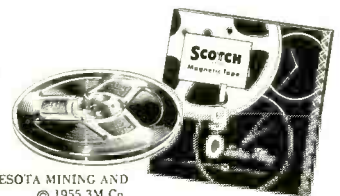

The term "SCOTCH" and the plaid design are registered trademarks for Magnetic Tape made in U.S.A. by MINNESOTA MINING AND MFG. CO., St. Paul 6, Minn. Export Sales Office: 99 Park Ave., New York 16, N.Y.

© 1955 3M Co

BUILD 16 PRINTED CIRCUIT and METAL CHASSIS RADIO CIRCUITS

ONLY **\$19.95** COMPLETE

WITH THE NEW DELUXE 1956 PROGRESSIVE RADIO "EDU-KIT"

- Absolutely No Knowledge of Radio Necessary
- Learn Practical Radio Theory and Construction
- No Additional Parts Needed
- Excellent Background for Television
- Build 16 Receiver, Transmitter, Code Oscillator, Signal Tracer, Signal Injector Circuits
- 30 Day Money-Back Guarantee
- Free Soldering Iron, Tester & Other Extras
- School Inquiries Invited
- Used in 79 Countries
- Learn High Fidelity

WHAT THE "EDU-KIT" OFFERS YOU

You will learn how to build radios using regular punched metal chassis and professional radio schematics. You will learn how to wire and solder radio circuits. You will learn the basic principles involved in radio. You will build sixteen receiver, transmitter, code oscillator, signal tracer and signal injector circuits, and learn how to operate them. You will learn the principles of RF and AF amplifiers, detectors, RF and AF oscillators, rectifiers, etc. You will learn how to service and troubleshoot radios. You will build a Printed Circuit Signal Injector, and learn the principles and practical aspects of this revolutionary new method of radio building. You will learn and practice code, using the Progressive Code Oscillator. You will receive instructions for F.C.C. Novice License. In brief, you will receive practical basic training in Radio, worth many times the small price you pay.

THE EDUCATIONAL RADIO KIT FOR EVERYONE

You do not need the slightest background in radio or science. The "Edu-Kit" is designed for the complete beginner. It is used by young and old, by radio schools and clubs, by Armed Forces personnel and Veterans. No instructor is required. The "Edu-Kit" Instruction Manuals are exceedingly clear and complete in all details.

"EDU-KIT" IS USED THROUGHOUT THE WORLD

The Progressive Radio "Edu-Kit" is used in every state of the U.S.A., the District of Columbia, Alaska, Virgin Islands, Puerto Rico, Hawaii, Guam and the Canal Zone. It is used in 79 countries in all parts of the world, including Canada, Philippines, Korea, South Africa, Saudi Arabia, Venezuela, Israel, France, England, Japan, India, etc. The "Edu-Kit" is very popular with American servicemen stationed overseas.

THE PROGRESSIVE RADIO "EDU-KIT" IS COMPLETE

You will receive every part necessary to build sixteen different radio circuits. You will receive all tubes, tube sockets, variable, electrolytic and paper condensers, resistors, tie strips, coils, hardware, tubing, Printed Circuit materials, punched metal chassis, Instruction Manuals, etc. No solder or wire included. In addition, you receive an electric soldering iron as well as a Radio and Electrical Tester. All parts are guaranteed, brand new, carefully selected and matched. The "Edu-Kit" now also contains lessons for servicing with the Progressive Signal Tracer and the Progressive Signal Injector, High Fidelity, F.C.C. Novice instructions, Quizzes, Printed Circuit instructions.

"EDU-KIT" Now Includes PRINTED CIRCUITRY in addition to Regular Wired Punched Metal Chassis Construction

At no increase in price, the "Edu-Kit" now includes Printed Circuitry. You build a Printed Circuit Signal Injector, a unique servicing instrument that can detect many Radio and TV troubles. This revolutionary new technique of radio construction is now becoming popular in commercial radio and TV sets as well as in hearing aids, computers, business machines, etc.

A Printed Circuit is a special insulated board on which has been deposited a conducting material, which takes the place of wiring. The various parts are merely plugged in and soldered to terminals.

MAIL TODAY • ORDER SHIPPED SAME DAY RECEIVED • 30 DAY MONEY-BACK GUARANTEE

FREE EXTRAS

- included with "EDU-KIT"
- Radio & Electrical Tester
 - Electric Soldering Iron
 - Tester Instruction Manual
 - Television Book
 - High Fidelity Guide
 - Quizzes
 - Consultation Service



Reg. U. S. Pat. Off. Pend.

FREE

Radio-Television
Servicing Literature
on request
(See Coupon below)

"LEARN BY DOING"—

THE PROGRESSIVE TEACHING METHOD

The Progressive Radio "Edu-Kit" uses the principle of "Learn by Doing." Therefore you will build radio circuits, perform jobs, conduct experiments, and make repairs in order to illustrate the principles which you learn. You begin by examining the various radio parts, which are individually packaged and identified. You then learn the function, theory, wiring of these parts. Then you build a simple radio. With this first set you will enjoy listening to regular broadcast stations, learn theory, practice Testing and Troubleshooting. Then you construct a more advanced radio, learn more advanced theory and techniques. Gradually, in a progressive manner, and at your own rate, you will find yourself constructing more advanced multi-tube radio circuits, and doing work like a professional Radio Technician. The "Edu-Kit" Instruction Manuals are exceptionally clear in their explanations, illustrations and diagrams. In addition to regular wired punched metal chassis radios, you now learn about Printed Circuits and actually build a Printed Circuit Signal Injector. These sets operate on 105-125 V. AC-DC.

LEARN TROUBLESHOOTING AND SERVICING

You will learn how to recognize and repair troubles. You will build and learn to operate the Progressive Signal Tracer and the Progressive Signal Injector. You receive a Radio and Electrical Tester. You learn how to use these instruments for radio testing and repairs. While you are learning in this practical way, you will be able to do many a repair job for your neighbors and friends, and charge fees which will far exceed the cost of the "Edu-Kit."

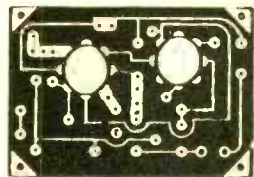

- Send "Edu-Kit" Postpaid. I enclose full payment of \$19.95.
 - Send "Edu-Kit" C.O.D. I will pay \$19.95 plus postage.
 - Send me FREE additional information describing "Edu-Kit." Include FREE valuable Radio and TV Servicing Literature. No obligation.
- (Outside U.S.A.—No C.O.D.'s. Send check on U.S. bank or Intern'l M.O. "Edu-Kit" for 105-125 V AC/DC \$20.95; 210-250 V. AC/DC \$23.45.)

Name

Address

PROGRESSIVE "EDU-KITS" INC.

497 Union Ave., Room 517-D, Progressive Bldg., Brooklyn 11, N. Y.

POPULAR ELECTRONICS is published monthly by Ziff-Davis Publishing Company, William B. Ziff, Chairman of the Board (1946-1953), at 84 E. Lake St., Chicago 1, Ill. Entered as second class matter August 27, 1954 at the Post Office, Chicago, Illinois. SUBSCRIPTION RATES: One year U.S. and possessions, and Canada \$3.00; Pan-American Union Countries \$3.50; all other foreign countries \$4.00.

POPULAR ELECTRONICS

Registered U. S. Patent Office

FEBRUARY 1956

VOL. 4—NUMBER 2

EDITOR
OLIVER READ, W1ET1

MANAGING EDITOR
O. P. Ferrell

TECHNICAL EDITOR
H. S. Renne

COPY EDITOR
Robert Gorman

FEATURE EDITOR
Norman Eisenberg

ASSOCIATE EDITORS
M. C. Magna
Charles Tepfer

ART EDITOR
A. J. Reich

CONTRIBUTING EDITORS
H. Bennett L. E. Garner, Jr.
H. S. Brier H. Pollack
J. T. Frye R. P. Turner

ART DEPARTMENT
Frank Sayles (Director)
J. A. Golaneck M. Whelpley
W. K. Vahlsing

ADVERTISING DEPARTMENT
NEW YORK (MU 7-8080)
L. L. Osten—Adv. Dir.
Wm. G. McRoy—Adv. Mgr.
Bert Covit

CHICAGO (AN 3-5200)
Jim Weakley, Midwest Adv. Mgr.
LOS ANGELES (Mich. 9856)
John E. Payne



Copyright 1956
(All Rights Reserved)

Member
Audit Bureau of
Circulations

ZIFF-DAVIS
PUBLISHING COMPANY
W. B. ZIFF (1898-1953) FOUNDER

Also Publishers of
RADIO & TELEVISION NEWS
Editorial and Executive Offices
366 Madison Ave., New York 17, N.Y.

PRESIDENT

B. G. DAVIS

VICE-PRESIDENTS

H. J. MORGANROTH M. FROELICH

SECRETARY-TREASURER

G. E. CARNEY

CIRCULATION MANAGER

M. MICHAELSON

BRANCH OFFICES

Chicago (1), 64 E. Lake St.
Los Angeles (14), Stailer Center
900 Wilshire Blvd.

SUBSCRIPTION SERVICE:

All communications concerning subscriptions should be addressed to Circulation Dept., 64 E. Lake St., Chicago 1, Ill. Include your old address as well as new—enclosing if possible an address label from a recent issue of this magazine. Allow at least 4 weeks for change of address.

CONTRIBUTORS:

Contributors are advised to retain a copy of their manuscripts and illustrations. Contributions should be mailed to the New York Editorial Office and must be accompanied by return postage. Contributions will be handled with reasonable care, but this magazine assumes no responsibility for their safety. Any copy accepted is subject to whatever adaptations and revisions are necessary to meet the requirements of this publication. Payment covers all author's, contributor's and contestant's rights, title, and interest in and to the material accepted and will be made at our current rates upon acceptance. All photos and drawings will be considered as part of material purchased.

POPULAR ELECTRONICS

CONTENTS

Submarines—Are We Open to Sneak Attack?.....	E. D. Morgan	33
Electronics Maps Brain Waves.....	R. E. Atkinson	38
Giant Console Controls America's Voice.....		41
Shoot to Kill—TV Commercials!.....	Louis E. Garner, Jr.	42
Power Supply for Transistor Experiments.....	Frank H. Tooker	47
Four Dollar Frequency Standard.....	Neil A. Johnson, W20LU	50
Building an All-Band Preselector.....	Frank H. Tooker	52
Miniature Tuning Capacitors.....		57
How to Assemble a Multimeter.....	Phil McCafferty	58
Emergency Crystal Receiver.....	Art Trauffer	60
Electronic Banjo.....	Louis E. Garner, Jr.	61
How to Use Ohm's Law.....	E. G. Louis	88
Tubeless Audio Amplifier.....	Rufus P. Turner	92
Compass Galvanoscope.....		94
I Married a Superheterodyne!.....	Sylvia Kohler	96

POPULAR ELECTRONICS Audio and Hi-Fi Section

Disc and Tape Review.....	Bert Whyte	73
Hi-Fi in a Chest of Drawers.....	L. E. Maahs	75
Audio Oscillator for Hi-Fi Testing.....	Rufus P. Turner	78
No Confusion... Just Baffling!.....	H. H. Fantel	82
Music Distribution System for Home.....		87

DEPARTMENTS

Letters from Our Readers.....		10
POP'tronics Bookshelf.....		18
What's the PE Answer?.....		26
The Transmitting Tower.....	Herb S. Brier	64
Tuning the Short-Wave Bands.....	Hank Bennett	66
Carl & Jerry.....	John T. Frye	68
Transistor Topics.....		70
R/C Notes.....		72
After Class.....		98
Tools & Gadgets.....		106
Tips and Techniques.....		110
Glossary of Electronic Terms.....		128

(Also see page 6)

Cover Painting by Ed Valigursky



Train for Better
Jobs in

ELECTRICITY OR TELEVISION-RADIO

in Great
Shops of COYNE

GREAT OPPORTUNITY FIELDS

Conditions are changing. Many "one operation" jobs that have paid well will not last. *Don't be satisfied with a "no future" job.* Whether 17 or up to 45 years of age, train the Coyne way for a better job and a real future in **ELECTRICITY** or **TELEVISION-RADIO**, *fields that offer a world of opportunities.*

YOU can TRAIN in great CHICAGO SHOPS

Train on real, full-size equipment at COYNE where thousands of successful men have trained for over 56 years—**largest, oldest, best equipped school of its kind**—established in 1899. No advanced education or previous experience needed. **TRAINING APPROVED FOR VETERANS.**

B. W. COOKE, President

COYNE
ELECTRICAL SCHOOL

FOUNDED 1899

A TECHNICAL TRADE INSTITUTE OPERATED NOT FOR PROFIT
500 S. PAULINA STREET, CHICAGO, Dept. 26-71H

ELECTRICITY ★ RADIO ★ TELEVISION ★ REFRIGERATION ★ ELECTRONICS

START NOW—PAY LATER—Finance Plan and Easy Monthly Payment Plan. Also part-time employment help for students.

Get FREE Book

Send coupon for 48 page illustrated book "Guide to Careers in Electricity and Television-Radio." No cost; no obligation; no salesman will call. Get vital facts now!

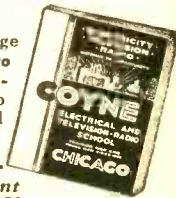

B. W. COOKE, President
COYNE ELECTRICAL SCHOOL
500 S. Paulina St., Chicago 12, Ill., Dept. 26-71H

Send **BIG FREE** book and details of your training offer. This does not obligate me and no salesman will call. I am interested in:

Electricity Television-Radio

Name _____

Address _____

City _____ State _____

COYNE offers
LOW COST

TELEVISION RADIO-ELECTRONICS

Training in
Spare Time **AT HOME**

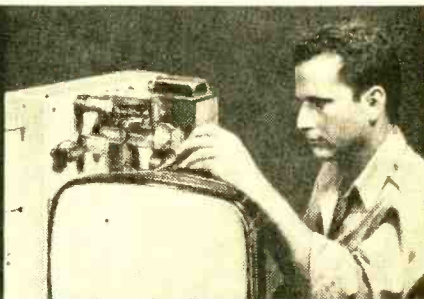

The future is **YOURS** in TV-RADIO!
A fabulous field—good pay—fascinating work—
a prosperous future! Good jobs, or independence
in your own business!

Coyne brings you the first **truly lower cost, MODERN—QUALITY** Television Home Training; training designed to meet Coyne standards. Not an old Radio Course with Television "tacked on". Here is **MODERN TELEVISION TRAINING** including working knowledge of Radio. Includes **UHF** and **COLOR TV**. No Radio background or previous experience needed. Personal guidance by Coyne Staff. **Practical Job Guides** to show you how to do actual servicing jobs—**make money early in course.** With Coyne Television Home Training you pay only for your training, **no costly "put together kits"**.

B. W. COOKE, President



Coyne—the Institution behind this training... the largest, oldest, best equipped residential school of its kind. Established 1899.

COYNE
ELECTRICAL SCHOOL

500 S. Paulina St., Dept. 26-HT7, Chicago 12
A TECHNICAL TRADE INSTITUTE OPERATED
NOT FOR PROFIT

SEND COUPON FOR FREE BOOK

and full details,
including easy
Payment Plan.

**No obligation, no
salesman will call.**



COYNE ELECTRICAL SCHOOL
Television Home Training Div.
500 S. Paulina St., Chicago 12, Ill.,
Dept. 26-HT7

Send Free Book and details on Television Home Training. This does not obligate me and no salesman will call.

Name _____

Address _____

City _____ State _____

How to build transistorized

- TIMERS
- RECEIVERS
- OSCILLATORS
- GEIGER-COUNTERS
- METAL LOCATORS

All in this Informative book

ONLY 50¢

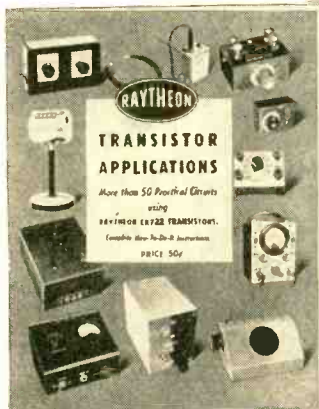

RAYTHEON CK722 TRANSISTORS ONLY 99¢

Most of the circuits in the Raytheon Transistor Application Book use low cost, high quality Raytheon CK722 Transistors. Buy them through your local Raytheon Tube Supplier.



Excellence in Electronics

RAYTHEON MFG. CO.

Receiving and Cathode Ray Tube Operations
Newton 58, Massachusetts

ITEMS OF INTEREST

Electronic Blueprints	40
Magnet in Speaker Housing	40
Master TV System Package	40
Sun-Powered Rural Telephone	40
Computer in Kit Form	49
Navy Uses Faster-Than-Light Oscilloscope Trace	95

NEW PRODUCTS

Kit Adapts Tape Recorder for Stereosound	76
Ultra-Linear Amplifier Operates at Two Power Levels	77
Wide-Band FM Tuner	77
Wide-Range Tape Transport for Hi-Fi System	77
Complete Speaker Systems Built from Kits	86
"Silent Viewer" Permits Private TV Listening	86
Single-Chassis Amplifier Boasts 35-Watt Output	86

COMING NEXT MONTH POPULAR ELECTRONICS

Transistor Experiments for the Beginner

This is the first part of a series describing numerous transistor experiments. The required equipment is kept to a minimum, and parts purchased for use in early experiments are utilized in subsequent experiments.

Thermistor Fire Alarm

A simple device that can be preset to determine changes in room temperature uses new, readily available \$1.25 thermistor.

Tool Shop—Twists and Turns

If you are wondering what tools to buy for your home laboratory or workshop, this article analyzes the value of wrenches, screwdrivers, etc.

Adding a Tape Transport to Your Hi-Fi

A discussion of the methods used to install tape transports in existing hi-fi systems; cautions to be observed, and solutions to all the problems that may arise.

- High-Fidelity Audio ■ Kits ■ Radio Control
- Short-Wave Listening ■ What's New ■
- How It Works ■ How to Make It ■ How to Use It ■ Carl & Jerry ■ Tips & Techniques

IN THIS MONTH'S RADIO & TELEVISION NEWS

(February)

- Power Transistors
- Turntables Versus Record Changers
- A Tape System You Can Build—
A Compatible Tape Deck
- Transistor Radios
- Unusual Sounds Sell Radio "Spots"
- A Transistorized Signal Tracer

L. C. Lane, B.S., M.A.
President, Radio-Television Training Association, Executive Director, Pierce School of Radio & Television.



VETERANS--NON-VETERANS TRAIN NOW FOR A TOP-PAY JOB IN TELEVISION



No Experience Needed—I train you AT HOME in your SPARE TIME

NOW — while the Television-Radio-Electronics industry is expanding at the fastest rate in history — is the time for you to prepare for a top-pay lifetime job . . . or your own profitable business.

New TV stations are going up constantly . . . sales of TV sets are breaking all past records . . . new products are being announced almost every day . . . new plants are

springing up to meet the heavy demand for these products.

Trained men are needed urgently. The head of CBS-Columbia product service department estimates that the industry will need 200,000 service men by 1959. The best jobs will go to the men who are ready for them. *Right now* is the time for you to prepare yourself. Delay can be costly.

LEARN BY DOING

As part of your training I give you the equipment you need to set up your own home laboratory and prepare for a **BETTER-PAY TV JOB**. You build and keep an Electromagnetic TV RECEIVER designed and engineered to take any size picture tube up to 21-inch, (10-inch tube furnished. Slight extra cost for larger sizes) . . . also a Super-Het Radio Receiver, AF-RF Signal Generator, Combination Voltmeter-Ammeter-Ohmmeter, C-W Telephone Transmitter, Public Address System, AC-DC Power supply. Everything supplied, including all tubes.

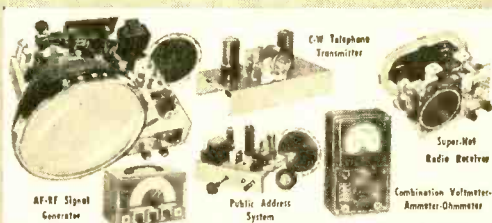

STUDY NEWEST DEVELOPMENTS

My training covers all the latest developments in the fast-growing Television-Radio-Electronics industry. You learn about FM — RADAR — COLOR TV — TRANSISTORS — PRINTED CIRCUITS, etc.

CHOOSE FROM THREE COMPLETE COURSES covering all phases of Radio, FM and TV

1. Radio, FM and Television Technician Course — no previous experience needed.
2. FM-TV Technician Course — previous training or experience in radio required.
3. TV Cameraman and Studio Technician Course — advanced training for men with Radio or TV training or experience.

EXTRA TRAINING IN N.Y.C. AT NO EXTRA COST!

After you finish your home study training in Course 1 or 2 you can have two weeks, 50 hours, of intensive lab work on modern electronic equipment at our associate resident school, Pierce School of Radio & Television. **THIS EXTRA TRAINING IS YOURS AT NO EXTRA COST WHATSOEVER!**

FCC COACHING COURSE

Important for **BETTER-PAY JOBS** requiring FCC license! You get this training **AT NO EXTRA COST!** Top TV jobs go to FCC-licensed technicians.

Radio Television Training Association

52 EAST 19th STREET • NEW YORK 3, N. Y.

Licensed by the State of New York • Approved for Veteran Training

February, 1956

EARN WHILE YOU LEARN

Almost from the very start of your course you can earn extra money by repairing sets for friends and neighbors. Many of my students earn up to \$25 a week . . . pay for their entire training with spare time earnings . . . start their own profitable service business.

VETERANS

My School fully approved to train Veterans under new Korean G. I. Bill. Don't lose your school benefits by waiting too long. Write discharge date on coupon.

MAIL THIS COUPON TODAY!

Mr. Leonard C. Lane, President
RADIO-TELEVISION TRAINING ASSOCIATION
Dept. E-2C, 52 East 19th Street, New York 3, N.Y.

Dear Mr. Lane: Send me your **NEW FREE BOOK, FREE SAMPLE LESSON, AND FREE aids** that will show me how I can make **TOP MONEY IN TELEVISION**. I understand I am under no obligation.

(PLEASE PRINT PLAINLY)

Name _____ Age _____

Address _____

City _____ Zone _____ State _____

I AM INTERESTED IN:

- Radio-FM-TV Technician Course
 FM-TV Technician Course
 TV Cameraman & Studio Technician Course

VETERANS!

Write discharge date

NO OBLIGATION!

KNOW YOUR P'S AND Q'S ABOUT GOOD TEST EQUIPMENT

only EMC
instruments
give you ...

Precision
components
and assembly
techniques
insuring
unexcelled

Performance
and accuracy
never before
at such a low

Price
with the
famous EMC
standards of

Quality
all of which means
you get a greater

Quantity
of modern equipment
far better,
faster servicing.



NEW RF Signal Generator

EMC Model 501
with leads \$37.90 (Wired &
Tested)
\$24.90 (Kit Form)

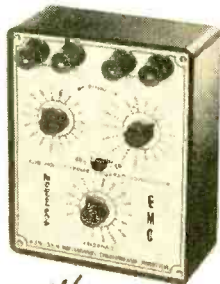

NEW
Resistance-Capacity
Substitution Box
EMC Model 900
\$17.90 (Wired &
Tested)
\$10.25 (Kit Form)



Free

Yes, tell me more, send me — FREE — a detailed catalog of the complete EMC line.

Name

Street

City State PE-2

EMC ELECTRONIC MEASUREMENTS CORP.
280 LAFAYETTE STREET
NEW YORK 12, NEW YORK
EXPORT DEPT - 370 BROADWAY, N. Y. 13, N. Y.

Lily
Pons



Lily Pons

Comments on
Diamond
Phonograph
Needles

"As a singer I am naturally interested in hearing phonograph records played back as perfectly as they were recorded. For that reason I play my records only with a diamond phonograph needle."



Be sure your phonograph is equipped with a DIAMOND stylus

PLAY SAFE
FLAT DILRHOOD

TETRAD

WORLD'S LARGEST
MANUFACTURER
OF DIAMOND STYLUS

For further information write to: Dept. NA2 62 St. Mary St., Yonkers, N. Y.

"TOOK IN \$217 FIRST 10 DAYS"

Some make more, some less
We help you to start Your
Own All-Year Business

Make Big Money! With our easily operated, highly efficient wall washer, Chas. Stelle took in \$217 gross in first ten days. E. L. Goss took in more than \$10,000 in one year. E. C. Taber wrote, "I made \$400 gross in two weeks." And no wonder—this machine washes walls 6 times faster and better than by hand. **Your Money-making Opportunity.** Enjoy independence—freedom from bosses, layoffs. Customers everywhere—homes, offices, schools, etc. Expenses low, profits high. No shop necessary; operate from home. Can start spare time until your full time is available.



Loss no time. Get all facts without obligation

FREE BOOK! MAIL COUPON TODAY!

• VON SCHRADER MFG. CO. •
• 244 "W" Pl., Racine, Wisconsin •
• Send at once (no obligation) your FREE •
• booklet containing information about your •
• WALL WASHING MACHINE and how I can start •
• my own permanent, profitable business. •
• Name •
• Address •
• City Zone State •

ALLIED'S OWN KNIGHT ELECTRONIC KITS... better by far...easiest to build...and you SAVE MORE



NEW!

Sensational Value
"Space Spanner"
Band-Switching
Receiver Kit

THRILLING SHORT WAVE AND BROADCAST

Model S-243 All-new 2-band receiver in easy-to-build kit form at a very low price. Pulls in thrilling short-wave (6 to 17 mc) and standard broadcast, plus amateur, aircraft, police and marine radio. Features special regenerative circuit; highly sensitive on broadcast band. Bandswitch selects broadcast or short wave. Has 4" PM speaker and beam-power output tube for plenty of volume; headphone connectors for weak signal listening; slide switch cuts out speaker. Employs 12AT7 regenerative detector and audio amplifier; 50C5 power output; 35W4 rectifier. Six controls; Bandspread; Main Tuning; Antenna Trimmer; Bandswitch; Regeneration; Audio Gain. Panel finished in attractive gray with black knobs. Includes all parts, punched chassis and tubes. Less wire and solder. 7 x 10½ x 6"; for 110-120 v. 50-60 cycles AC or DC. 4½ lbs.

Model S-243. Net F.O.B. Chicago, only **\$13.95**
Model J-110. Dual Headset for above. Net **\$1.79**
Model C-100. Antenna Kit for above. Net **\$1.05**

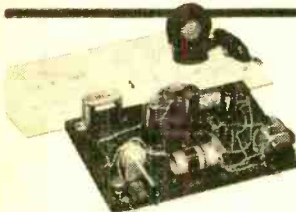

**Famous Knight
10-in-1 Electronic
Lab Kit**

Model S-265
\$12.45

BUILD ANY OF 10 FASCINATING PROJECTS

Instructive! Ideal for experimenters, beginners—fun to build! Construct a sensitive Broadcast Receiver; Amplifier (for phono or mike); Wireless Phono Oscillator; Home "Broadcast Station"; Code Practice Oscillator; Capacity-Operated Relay, or any one of *four* other fascinating projects. Kit includes mounting board, tubes, all parts, hardware, microphone, and 12-page builders' manual. For 110-120 v., 50-60 cycle AC. Less wire and solder. 10 lbs.

Model S-265. "10-in-1" Kit. Net F.O.B. Chicago... **\$12.45**
Model J-112. Headphone. Net **98c**
Model P-003. Phototube for Photo Relay project. Net. **2.00**
Model H-024. 4-Prong Socket for Phototube. Net. **8c**

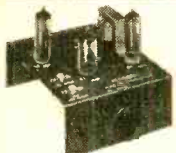

**Knight Wireless
Broadcaster Kit**

Model S-705 Featured in
"Popular Electronics"
\$8.75 May 1955 issue

Highly efficient wireless broadcaster for "broadcasting" with phonograph or mike to any standard radio up to 50 ft. away with no connection to set. Use with crystal or magnetic cartridge or mike (crystal or high-impedance dynamic). Delivers clear, well-modulated signal with minimum distortion. 4½ x 5 x 6". A fascinating project. For 110-120 v., 50-60 cycles AC or DC. Complete with tubes, chassis, all parts and easy instructions. Shpg. wt., 3 lbs.

Model S-705. Wireless Broadcaster Kit. Net **\$8.75**
Model S-556. Crystal Microphone. Net **\$3.95**

SAVE! Order from ALLIED today!

KNIGHT Kits are the last word in electronic design, fascinatingly easy to build, satisfying to use. They're a pleasure to assemble—you just follow the outstanding easy "Step-and-Chek" instructions. All KNIGHT Kit parts are premium quality to assure top performance. ALLIED—the reliable name in Electronics—offers you the very best equipment in KNIGHT Kits—and SAVES YOU MONEY!



**Knight Vacuum Tube
Voltmeter Kit (VTVM)**
NEWEST PRINTED CIRCUIT

Model F-125 New, stable, accurate. Entire chassis is a printed circuit board. Maximum convenience in arrangement of scales and controls. With peak-to-peak scale for FM and TV work. Ranges: AC peak-to-peak volts, 0-4-14-40-140-1400-4000; AC rms volts and DC v., 0-1.5-5-15-50-150-500-1500; ohms, 0-1000, 10K, 100K; 1-10-100-1000 megs; db scale, -10 to +5. Complete kit, ready for easy assembly. Shpg. wt., 6 lbs. Prices are net F.O.B. Chicago.

Model F-125. Printed Circuit VTVM Kit. Net. **\$24.95**
Model F-126. Hi-Voltage Probe; extends DC to 50,000 v. . . **4.50**
Model F-127. Hi-Freq. Probe; extends AC to 250 megs. . . **3.45**



SAVE ON HI-FI

**Popular Knight
10-Watt Hi-Fi
Amplifier Kit**

Model S-234
\$20.95

Famous for wide response, smooth reproduction, low cost. Frequency response: ± 1 db, 30-20,000 cps at 10 watts. Harmonic distortion less than 0.5% at 10 watts. Intermod. distortion less than 1.5% at full output. Controls: on-off, volume, bass, treble. Input for crystal phono, tuner. Chassis punched for preamp kit. Matches 8 ohm speakers. 14 lbs.

Model S-234. Amplifier Kit. Net F.O.B. Chicago. **\$20.95**
Model S-235. Preamp Kit for above. Net. **2.75**

ALLIED RADIO

Allied Radio Corp., Dept. 79-B-6
100 N. Western Ave., Chicago 80, Illinois

Please ship me the following KNIGHT Kits:

My check , money order , for \$..... enclosed.

Name.....

Address.....

City..... Zone..... State.....

**AN IMPORTANT NEW
CONCEPT IN EXTENDED
RANGE TAPE EQUIPMENT
FOR THE HOME MUSIC SYSTEM**

Gentle
as a Lamb

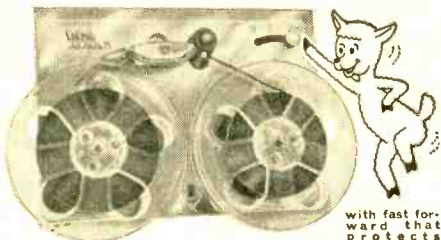

with fast forward that protects "thin base" tape.

**VIKING *ff* 75 MONAURAL
PLAYBACK DECK... \$59.95 user net**

PAY-AS-YOU-GROW in this fascinating new magic of recorded tape. With VIKING, you can add one unit at a time until you have complete professional quality, full-fidelity playback and recording equipment... a high fidelity complement to your home music system. Unbelievably economical, too, for components of this quality!

**INSTALLS AS EASILY
AS A RECORD CHANGER**

Start with the basic VIKING #75 MONAURAL PLAYBACK DECK... linear tape transport of exceptionally simple design with truly outstanding performance, actually operating with less than 0.2% flutter or wow. It features the revolutionary Dynamu head for frequency response beyond any ordinary tape equipment; 40 to 14,000 cycles within 3 db at 7.5 IPS.

Add the VIKING PB60 PLAYBACK PREAMPLIFIER for exact NARTB equalization and 55 db preamplifier gain.

As your needs and desires grow, you can convert this basic deck for full stereophonic sound by the addition of simple, easily installed head assemblies. (A new VIKING head assembly plays both "staggered" and "in-line" tape.)

Add an erase head and a VIKING RP61 RECORD-PLAYBACK AMPLIFIER for superb recording and dubbing. This unit is designed for extended range recording, featuring 70 kc bias, more than 60 db gain and NARTB equalization.

Buy your tape system a unit at a time, or buy it assembled and tested in Monaural, Binaural, and Record-Playback models.

YOU TAKE IT FROM HERE!

Order by model no. from your dealer.
Write for information.



VIKING OF MINNEAPOLIS

Dept. PE-2

3520 E. 43rd St., Minneapolis, Minn.

Distributed in Canada by Musimart of Canada, 901 Bleury St., Montreal

**LETTERS
FROM OUR READERS**

Invisible Light Burglar Alarm

Where can I find a circuit that uses invisible light as a burglar alarm? I would like to wrap it around the house with mirrors.

LOREN WOODLEY
Culver City, Calif.

Burglar alarms using ultraviolet light seem to be in demand by our readers. Cadmium sulfide cells are sensitive in both the infrared and ultraviolet regions. Plans are now under way to build an invisible light "intrusion alarm" for POPtronics readers.

Multimeter for Lie Detector

I want to use the lie detector described in your May, 1955, issue with a 20,000 ohms-per-volt multimeter. How can I modify the circuit or increase the per-volt sensitivity of my meter?

DAVID C. SCHIELE
Meeting Creek, Alberta

Sorry to report, Dave, that neither scheme will work as well as using a regular v.t.v.m. The lie detector uses a delicately balanced bridge circuit and a 20,000 ohms-per-volt meter would load it down too much. Increasing your meter sensitivity calls for rewiring your multimeter or adding an external amplifier—neither of which is really very practical.

Metal Locator Operation

If a shield is needed to keep your metal locator (June, 1955, issue) from reacting with non-magnetic metals, does this mean that it will only react to metals such as iron and steel, and not to zinc and copper?

GARY BROCK
Chillicothe, Mo.

Sorry, Gary, maybe we didn't explain that clearly enough. The shield prevents the search coil from capacitively reacting to metallic and non-metallic objects. When in operation, it will respond to any conducting substance within range of the coil's magnetic field.

English Language Announcements

The recent short-wave column by Hank Bennett which included listings of the times when English language announcements could be heard from foreign stations was a real help.

DONN WOODMAN
Schenectady, N. Y.

\$2 Baffle Again

I built the \$2 baffle described in the October, 1955, issue, and I must say that it certainly does justice to any speaker. I am using a University Model 308 triaxial here and plan on making this a permanent installation.

JACQUE SHUBERT
Parshall, N. Dak.

POPULAR ELECTRONICS

Now .. In Your Own Home **LEARN**

TELEVISION

RADIO-ELECTRONICS

THE AMAZINGLY EFFECTIVE

D.T.I. WAY

NO PREVIOUS TECHNICAL EXPERIENCE NEEDED

NOW... get EVERYTHING YOU NEED

for real Laboratory-type training **AT HOME**

-with the aid of BOTH HOME LAB EQUIPMENT and HOME MOVIES

What will mailing the coupon below do for YOU? Just this! You'll find out about one of today's most remarkable ... practical ways to prepare to get into America's amazing billion dollar opportunity field of TELEVISION-RADIO-ELECTRONICS. You'll see how to get into highly interesting work that pays well ... that offers one of America's most promising futures ... that enables you to start your own business almost "on a shoe string," if you prefer this to a job opportunity.

And above all, you'll get some GOOD NEWS especially welcomed by men anxious to earn REAL MONEY in this growing field. For you'll see that NOW you can get the kind of practical, laboratory-type training so desirable for making real progress in Television-Radio-Electronics AND WITHOUT LEAVING HOME.

You'll see that DeVry Technical Institute sends everything needed to set up your own HOME LABORATORY. You get and keep the same type of basic electronic equipment used in our modern Chicago Training Laboratories. You get home training that includes the knowledge and experience gained from training thousands of students first hand in Chicago. And to top it all, you use DTI's amazingly effective and exclusive home training aid—INSTRUCTIVE MOVIES. But why not get the complete story? Mail coupon today for complete facts.

1. Build over 300 fascinating experiments from 16 BIG SHIPMENTS of Electronic-Radio parts which you KEEP.
2. Build valuable commercial-type test equipment—as shown to the left—which you KEEP. This includes a quality 5-INCH oscilloscope and vacuum tube voltmeter—both highly useful for Television work.
3. Build and keep a big 21 INCH TV Set. (D.T.I. offers another home training in Television-Radio-Electronics, but without the TV set.)
4. Use a 16 mm. movie projector and new series of highly instructive movies—a wonderful aid to help you grasp important fundamentals faster... easier... better.
5. Enjoy well-illustrated, easy-to-read lessons with handy FOLD-OUT diagrams.
6. Get an honest-to-goodness EMPLOYMENT SERVICE to help you get a good job after graduating—or assistance in starting your OWN SALES AND SERVICE BUSINESS. Mail coupon today for the complete details.



Above: Work over 300 interesting experiments with this equipment

Get this information-packed publication **FREE!**

89 WAYS TO EARN MONEY IN TELEVISION RADIO ELECTRONICS

MODERN LABORATORIES
If you prefer, get all your preparation in our new Chicago Training Laboratories—one of the finest of its kind. Ample instructors, modern equipment. Write for details!

MILITARY SERVICE!
If you're subject to military service, the information we have for you should prove very helpful. Mail coupon today.

Member of National Home Study Council

DEVRY TECHNICAL INSTITUTE
4141 BELMONT AVE., CHICAGO 41, ILL. Dept. PE-2-M

I would like your valuable information-packed publication showing how I can get started toward a good job or my own business in Television-Radio-Electronics.

Name _____ Age _____
 Street _____ Please Print _____ Apt. _____
 City _____ Zone _____ State _____

D.T.I.'s Training is available in Canada



DEVRY TECHNICAL INSTITUTE
FORMERLY
DEFOREST'S TRAINING, INC.
CHICAGO 41, ILLINOIS

FREE

1956 EICO® CATALOG

tells you how to **SAVE 50%**
on your test equipment costs!

46 EICO KITS & INSTRUMENTS to choose from!



5" PUSH-PULL
OSCILLOSCOPE
#425
KIT \$44.95
Wired \$79.95

VACUUM TUBE
VOLTMETER

#221
KIT \$25.95
Wired \$39.95



For Laboratory Precision at Lowest Cost—
buy EICO!



1000 Ohms/Volt
MULTIMETER
#536
KIT \$12.90
Wired \$14.90

TUBE TESTER #625

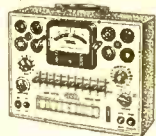

KIT \$34.95 Wired \$49.95

You build EICO KITS in 1 evening, but—
they last a lifetime!

RF SIGNAL GENERATOR #320



KIT \$19.95 Wired \$29.95

6V & 12V BATTERY ELIMINATOR
& CHARGER #1050

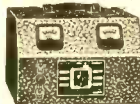

KIT \$29.95 Wired \$38.95

EICO—performance-proved by TV manufac-
turers, electronic schools and over 100,000
servicemen! OVER 1/2 MILLION in use today!



NEW! COLOR &
BLACK-&-WHITE
5-MC TV SCOPE
#460
KIT \$79.95
Wired \$129.50

NEW! 20-Watt Ultra-Linear
HIGH FIDELITY AMPLIFIER

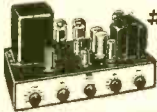

#HF 20
KIT \$49.95 Wired \$79.95

MAIL COUPON NOW. Prices 5% higher on
West Coast. Electronic Instrument Co., Inc.,
84 Withers St., Brooklyn 11, N. Y.



84 Withers St., Brooklyn 11, N. Y.

Send FREE 1956 Catalog and name of
neighborhood EICO distributor. PE-2

Name

Address

City Zone State

Occupation

Technician Class Licenses

- I would appreciate further information on how to get a "technician's class" license.

FRED DEAN
Fort Gay, W. Va.

Okay, Fred, here's the dope for you and for the rest of our readers who have requested further details. The "technician's class" license is similar to the regular ham license—except that the code test is five words per minute and the frequencies which can be used are all above 50 mc. The written exam is identical to the "general class" ham license. The license term is five years. Consult the License Manual published by the A.R.R.L. for further details and examination points. The "technician's class" is particularly useful to the experimenter who wants to work with v.h.f. or u.h.f. radio waves.

TV "Cheater" Cords

- I had occasion to go on a TV service call without a "cheater cord" and learned much to my surprise that the cord from an electric razor can be used instead. Hope someone can benefit from my experience.

ARTHUR PORRAS
New Brighton, Minn.

Whyte's Wit Appreciated

- Enjoy your "Tape and Disc" material. Those selections by Bert Whyte are tops, and it is easily worth the price of the magazine to read them. Stokowski with the baronet at his heels is a picture I won't forget for some time.

W. B. DAVIS
Las Cruces, N. Mex.

Apologies to the AR-1

- I feel that the speaker system modification in the article by Jack Coriell (December, 1955, page 71) is similar to the principle recommended by Edgar Villchur. Is this true?

L. RUBIN

Yes, it is, and a set of apologies are due to author Coriell and to the acoustic suspension speaker system for which a patent is pending. During the editing of this article, the source material was inadvertently omitted. Interested readers can buy an improved version of this speaker system (the AR-1) from Acoustic Research, 23 Mt. Auburn St., Cambridge 38, Mass.

Self-Powered Preamp

- Is an a.c./d.c. self-powered hi-fi preamp practical? The circuit I have in mind would consist of two or three tubes.

FRANK McCAFFREY
New Rochelle, N. Y.

There has been very little call for a.c./d.c. hi-fi equipment. Undoubtedly such a preamp could be constructed and would work without creating insoluble problems. A number of preamps are available directly from our advertisers or from local radio parts jobbers. A typical design is the Model MP100 produced by Audio Artisans, Inc., which is self-powered (a.c. only) and sells for about \$45.

We will invest these

3 FREE BOOKS

in your future

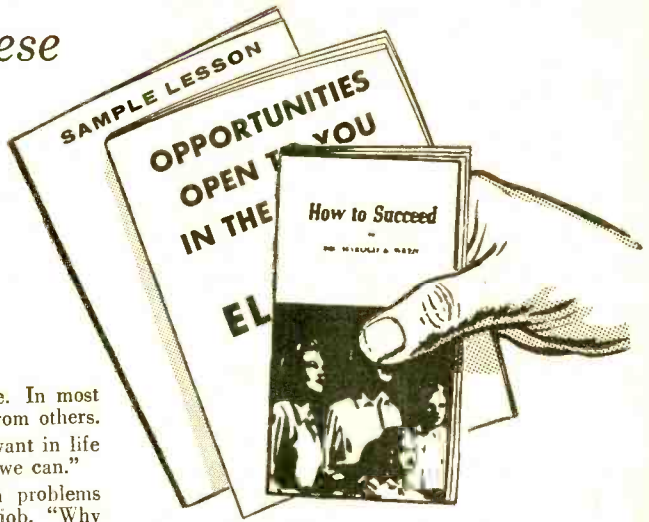

Life's problems are never simple to solve. In most cases they require help and inspiration from others.

It was Emerson who said—"Our chief want in life is somebody who shall make us do what we can."

Perhaps one of today's most common problems has something to do with an individual's job. "Why can't I make more money?"... "Will I be the next to be fired?"... "Why are others promoted over me?" are some of the questions that plague most of us at some time or another.

If you wonder about your job security, about your future, here's help that is yours for the asking. Three FREE BOOKS—any one of which could change the course of your entire life.

Don't put it off. If you are really interested in succeeding, send for these three free books today. Remember, hesitation is one of the greatest causes of failure.

Book No. 1, "How to Succeed," is a gold mine of tips on how a hundred little things about you, your personality, your outlook on life can affect your future. It will help you discover hidden talents in yourself, it will show you how others—less educated,

less intelligent than you, perhaps—have overcome all sorts of obstacles and have gone on to success.

Book No. 2 is a complete catalog that outlines opportunities in the field in which you are most interested. It gives you the facts on just what your chances are of succeeding in a given field.

Book No. 3 is a sample I. C. S. lesson text (Mathematics). Literally thousands and thousands of men and women of all ages have won promotions, pay raises, the respect of friends and community through I. C. S. training.

I. C. S. is the oldest and largest correspondence school. 277 courses. Business, industrial, engineering, academic, high school. One for you. Direct, job-related. Bedrock facts and theory plus practical application. Complete lesson and answer service. No skimping. Diploma to graduates.

For Real Job Security—Get an I. C. S. Diploma!

I. C. S., Scranton 9, Penna. Member, National Home Study Council

INTERNATIONAL CORRESPONDENCE SCHOOLS



BOX 25622A, SCRANTON 9, PENNA.

(Partial list of 277 courses)

Without cost or obligation, send me "HOW TO SUCCEED" and the opportunity booklet about the field BEFORE which I have marked X (plus sample lesson):

- | | | | | |
|--------------------------------------------------------------------------------------------------------------------------------------------------------------------------------------------------------------------------------------------------------------------------------------------------------------------------------------------------------------------------------------------------------------------------------------------------------------------------------------------------------------------------------------------------------------------------------------------------------------------------------------------------------------------------------------------------------------------------------------------------------------------------------------------------------------------------------------------------------------------------------------------------------------------------------------------------------------------------------------------------------------------------------------------------------------------------------------------------------------------------------------------------------------------------------------------------------------------------------------------------------------------------------------------------------------------------------------------------------------------------------|-------------------------------------------------------------------------------------------------------------------------------------------------------------------------------------------------------------------------------------------------------------------------------------------------------------------------------------------------------------------------------------------------------------------------------------------------------------------------------------------------------------------------------------------------------------------------------------------------------------------------------------------------------------------------------------------------------------------------------------------------------------------------------------------------------------------------------------------------------------------------------------------------------------------------------------------------------------------------------------------------------------------------------------------------------------------------------------------------------------------------------------------------------------------------------------------------------------------------------------------------------------------------------------------------------------------------------------------------------------------------------------------------------------------------------------------------------------------------------------------------------------------------------------------------------------------------------------------|----------------------------------------------------------------------------------------------------------------------------------------------------------------------------------------------------------------------------------------------------------------------------------------------------------------------------------------------------------------------------------------------------------------------------------------------------------------------------------------------------------------------------------------------------------------------------------------------------------------------------------------------------------------------------------------------------------------------------------------------------------------------------------------------------------------------------------------------------------------------------------------------------------------------------------------------------------------------------------------------------------------------------------------------------------------------------------------------------------------------------------------------------------------------------------------------------------------------------------------------------------------------------------------------------------------------------------------------------------------------------------------------------------------------------------------------------------------------------------------|-------------------------------------------------------------------------------------------------------------------------------------------------------------------------------------------------------------------------------------------------------------------------------------------------------------------------------------------------------------------------------------------------------------------------------------------------------------------------------------------------------------------------------------------------------------------------------------------------------------------------------------------------------------------------------------------------------------------------------------------------------------------------------------------------------------------------------------------------------------------------------------------------------------------------------------------------------------------------------------------------------------------------------------------------------------------------------------------------------------------------------------------------------------------------------------------------------------------------------------------------------------------------------------------------------------------------------------------------------------------------------------------------------------------------------------------------------------------------------------------------------------------------------------------------------------------------------------------------------------------------------------|---------------------------------------------------------------------------------------------------------------------------------------------------------------------------------------------------------------------------------------------------------------------------------------------------------------------------------------------------------------------------------------------------------------------------------------------------------------------------------------------------------------------------------------------------------------------------------------------------------------------------------------------------------------------------------------------------------------------------------------------------------------------------------------------------------------------------------------------------------------------------------------------------------------------------------------------------------------------------------------------------------------------------------------------------------------------------------------------------------------------------------------------------------------------------------------------------------------------------------------------------------------------------------------------------------------------------------------------------------------------------------------------------------------------------------------------------------------------------------------------------------------------------------------------------------------------------------------------------------------------------------------------------------------------------------------------------------|
| <p>ARCHITECTURE and BUILDING CONSTRUCTION</p> <ul style="list-style-type: none"> <input type="checkbox"/> Air Conditioning—Refrig. <input type="checkbox"/> Architecture <input type="checkbox"/> Architectural Interior <input type="checkbox"/> Building Contractor <input type="checkbox"/> Building Maintenance <input type="checkbox"/> Carpenter and Mill Work <input type="checkbox"/> Estimating <input type="checkbox"/> Heating <input type="checkbox"/> Painting Contractor <input type="checkbox"/> Plumbing <input type="checkbox"/> Reading Arch. Blueprints <p>ART</p> <ul style="list-style-type: none"> <input type="checkbox"/> Cartooning <input type="checkbox"/> Commercial Art <input type="checkbox"/> Fashion Illustrating <input type="checkbox"/> Magazine Illustrating <input type="checkbox"/> Show Card and Sign Lettering <input type="checkbox"/> Sketching and Painting <p>AUTOMOTIVE</p> <ul style="list-style-type: none"> <input type="checkbox"/> Auto Body Rebuilding <input type="checkbox"/> Auto Elec. Technician <input type="checkbox"/> Auto-Engine Tune Up <input type="checkbox"/> Automobile | <p>AVIATION</p> <ul style="list-style-type: none"> <input type="checkbox"/> Aeronautical Engineering Jr. <input type="checkbox"/> Aircraft & Engine Mechanic <p>BUSINESS</p> <ul style="list-style-type: none"> <input type="checkbox"/> Advertising <input type="checkbox"/> Bookkeeping and Accounting <input type="checkbox"/> Business Administration <input type="checkbox"/> Business Correspondence <input type="checkbox"/> Public Accounting <input type="checkbox"/> Creative Salesmanship <input type="checkbox"/> Federal Tax <input type="checkbox"/> Letter-writing Improvement <input type="checkbox"/> Office Management <input type="checkbox"/> Professional Secretary <input type="checkbox"/> Retail Business Management <input type="checkbox"/> Sales Management <input type="checkbox"/> Stenographic-Secretarial <input type="checkbox"/> Traffic Management <p>CHEMISTRY</p> <ul style="list-style-type: none"> <input type="checkbox"/> Analytical Chemistry <input type="checkbox"/> Chemical Engineering <input type="checkbox"/> Chem. Lab. Technician <input type="checkbox"/> General Chemistry <input type="checkbox"/> Natural Gas Prod. & Trans. <input type="checkbox"/> Petroleum Engineering <input type="checkbox"/> Plastics <input type="checkbox"/> Pulp and Paper Making | <p>CIVIL, STRUCTURAL ENGINEERING</p> <ul style="list-style-type: none"> <input type="checkbox"/> Civil Engineering <input type="checkbox"/> Construction Engineering <input type="checkbox"/> Highway Engineering <input type="checkbox"/> Reading Struct. Blueprints <input type="checkbox"/> Sanitary Engineering <input type="checkbox"/> Structural Engineering <input type="checkbox"/> Surveying and Mapping <p>DRAFTING</p> <ul style="list-style-type: none"> <input type="checkbox"/> Aircraft Drafting <input type="checkbox"/> Architectural Drafting <input type="checkbox"/> Electrical Drafting <input type="checkbox"/> Mechanical Drafting <input type="checkbox"/> Mine Surveying and Mapping <input type="checkbox"/> Plumbing Drawing and Estimating <input type="checkbox"/> Structural Drafting <input type="checkbox"/> Electrical Engineering <input type="checkbox"/> Electrical Maintenance <input type="checkbox"/> Electrician <input type="checkbox"/> Contracting <input type="checkbox"/> Lineman <p>HIGH SCHOOL</p> <ul style="list-style-type: none"> <input type="checkbox"/> Commercial <input type="checkbox"/> Good English <input type="checkbox"/> High School Subjects <input type="checkbox"/> Mathematics | <p>LEADERSHIP</p> <ul style="list-style-type: none"> <input type="checkbox"/> Foremanship <input type="checkbox"/> Industrial Supervision <input type="checkbox"/> Leadership and Organization <input type="checkbox"/> Personnel-Labor Relations <p>MECHANICAL AND SHOP</p> <ul style="list-style-type: none"> <input type="checkbox"/> Gas—Electric Welding <input type="checkbox"/> Heat Treatment <input type="checkbox"/> Metallurgy <input type="checkbox"/> Industrial Engineering <input type="checkbox"/> Industrial Instrumentation <input type="checkbox"/> Industrial Supervision <input type="checkbox"/> Internal Combustion Engines <input type="checkbox"/> Machine Design-Drafting <input type="checkbox"/> Machine Shop Inspection <input type="checkbox"/> Machine Shop Practice <input type="checkbox"/> Mechanical Engineering <input type="checkbox"/> Practical Radio TV Eng'ing <input type="checkbox"/> Reading Shop Blueprints <input type="checkbox"/> Refrigeration <input type="checkbox"/> Sheet Metal Worker <input type="checkbox"/> Tool Design <input type="checkbox"/> Toolmaking <p>RADIO, TELEVISION</p> <ul style="list-style-type: none"> <input type="checkbox"/> Industrial Electronics <input type="checkbox"/> Practical Radio TV Eng'ing <input type="checkbox"/> Radio and TV Servicing <input type="checkbox"/> Radio Operating | <ul style="list-style-type: none"> <input type="checkbox"/> Television Technician <p>RAILROAD</p> <ul style="list-style-type: none"> <input type="checkbox"/> Air Brakes <input type="checkbox"/> Car Inspector <input type="checkbox"/> Diesel Locomotive <input type="checkbox"/> Locomotive Engineer <input type="checkbox"/> Section Foreman <p>STEAM AND DIESEL POWER</p> <ul style="list-style-type: none"> <input type="checkbox"/> Combustion Engineering <input type="checkbox"/> Diesel—Elec. <input type="checkbox"/> Diesel Eng's <input type="checkbox"/> Electric Light and Power <input type="checkbox"/> Stationary Fireman <input type="checkbox"/> Stationary Steam Engineering <p>TEXTILE</p> <ul style="list-style-type: none"> <input type="checkbox"/> Carding and Spinning <input type="checkbox"/> Cotton, Rayon, Woolen Mfg. <input type="checkbox"/> Finishing and Dyeing <input type="checkbox"/> Loom Fixing <input type="checkbox"/> Textile Des'ing <input type="checkbox"/> Textile Eng'g <input type="checkbox"/> Throwing <input type="checkbox"/> Warping and Weaving <p>MISCELLANEOUS</p> <ul style="list-style-type: none"> <input type="checkbox"/> Domestic Refrigeration <input type="checkbox"/> Marine Engineering <input type="checkbox"/> Ocean Navigation <input type="checkbox"/> Professional Engineering <input type="checkbox"/> Short Story Writing <input type="checkbox"/> Telephony |
|--------------------------------------------------------------------------------------------------------------------------------------------------------------------------------------------------------------------------------------------------------------------------------------------------------------------------------------------------------------------------------------------------------------------------------------------------------------------------------------------------------------------------------------------------------------------------------------------------------------------------------------------------------------------------------------------------------------------------------------------------------------------------------------------------------------------------------------------------------------------------------------------------------------------------------------------------------------------------------------------------------------------------------------------------------------------------------------------------------------------------------------------------------------------------------------------------------------------------------------------------------------------------------------------------------------------------------------------------------------------------------|-------------------------------------------------------------------------------------------------------------------------------------------------------------------------------------------------------------------------------------------------------------------------------------------------------------------------------------------------------------------------------------------------------------------------------------------------------------------------------------------------------------------------------------------------------------------------------------------------------------------------------------------------------------------------------------------------------------------------------------------------------------------------------------------------------------------------------------------------------------------------------------------------------------------------------------------------------------------------------------------------------------------------------------------------------------------------------------------------------------------------------------------------------------------------------------------------------------------------------------------------------------------------------------------------------------------------------------------------------------------------------------------------------------------------------------------------------------------------------------------------------------------------------------------------------------------------------------------|----------------------------------------------------------------------------------------------------------------------------------------------------------------------------------------------------------------------------------------------------------------------------------------------------------------------------------------------------------------------------------------------------------------------------------------------------------------------------------------------------------------------------------------------------------------------------------------------------------------------------------------------------------------------------------------------------------------------------------------------------------------------------------------------------------------------------------------------------------------------------------------------------------------------------------------------------------------------------------------------------------------------------------------------------------------------------------------------------------------------------------------------------------------------------------------------------------------------------------------------------------------------------------------------------------------------------------------------------------------------------------------------------------------------------------------------------------------------------------------|-------------------------------------------------------------------------------------------------------------------------------------------------------------------------------------------------------------------------------------------------------------------------------------------------------------------------------------------------------------------------------------------------------------------------------------------------------------------------------------------------------------------------------------------------------------------------------------------------------------------------------------------------------------------------------------------------------------------------------------------------------------------------------------------------------------------------------------------------------------------------------------------------------------------------------------------------------------------------------------------------------------------------------------------------------------------------------------------------------------------------------------------------------------------------------------------------------------------------------------------------------------------------------------------------------------------------------------------------------------------------------------------------------------------------------------------------------------------------------------------------------------------------------------------------------------------------------------------------------------------------------------|---------------------------------------------------------------------------------------------------------------------------------------------------------------------------------------------------------------------------------------------------------------------------------------------------------------------------------------------------------------------------------------------------------------------------------------------------------------------------------------------------------------------------------------------------------------------------------------------------------------------------------------------------------------------------------------------------------------------------------------------------------------------------------------------------------------------------------------------------------------------------------------------------------------------------------------------------------------------------------------------------------------------------------------------------------------------------------------------------------------------------------------------------------------------------------------------------------------------------------------------------------------------------------------------------------------------------------------------------------------------------------------------------------------------------------------------------------------------------------------------------------------------------------------------------------------------------------------------------------------------------------------------------------------------------------------------------------|

Name _____ Age _____ Home Address _____

City _____ Zone _____ State _____ Working Hours _____ A.M. to P.M. _____

Occupation _____

Canadian residents send coupon to International Correspondence Schools, Canadian, Ltd., Montreal, Canada. . . . Special tuition rates to members of the U. S. Armed Forces.

HERSHEL SPECIALS

All New MYSTERY PACKAGE of ELECTRONIC PARTS



Worth \$40.00
Our Price
\$3.95
Ship. Wt. 70 lbs.

It's the surprise of your life! 20 pounds of BRAND NEW usable GOVT. surplus. The ideal gift for hams, etc.

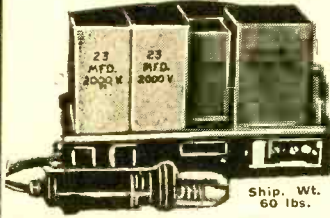

BRAND NEW Electronic PHOTO FLASH

100 Watt Sec.
Ship. Wt. 60 lbs.

Operates on any 12 or 24 VDC source. Complete with ignition coil, trigger housing and strobe light. Assembly includes 20' ft. cord with SYLVANIA A-1073. (Similar to Sylv. 4330.) Extra Parts Kit has Extra 1073 bulb, fuses, vibrator. Instruction Manual.

\$29.95

ARC-5 COMMAND TRANSMITTER



YOUR CHOICE
\$6.95

2.1 to 3 MC. 7 to 9.1 MC. B and New in Cartons, with tubes.

Hottest Buy in the Country

PHOTO ELECTRIC CELL



95¢ CE Vacuum Cell used in A M P R O Sound Projector. Also useful for opening garage doors and Alarm Systems.

Modulation & Driver Transformer

BRAND NEW. Both Units Only
Modulation trans. 815 class AB2 56 Watt output. Driver 6SN7 to Modulator.

\$4.95

SWING CHOKE

2H-7H 550 MA. Thordarson T48003.

\$5.95

KIT 1. HARDWARE

Over 1,000 pcs. Assorted. For Radio & TV

99¢

KIT 2. CERAMICONS

100 Assorted 75 mmfd. to 6,000 mmfd.

\$2.50

KIT 4. Rotary Switches

25 Assorted. Terrific Buy!

\$2.50

KIT 5. RESISTORS

100 Assorted 1 ohm to 15 meg. 1/2 to 5 watts.

\$1.75

ALLIGATOR CLIP

Piercing type with 5' Ft. cord and splice lug. Ideal test clip. TL-137.

2 for 25¢

OIL CONDENSER



\$1.65

2 MFD. 3000 VDC. Pyranol Oil W Mounting Brackets. 1-1 Mfd. 3000 VDC. New. Removed from equip. Size 4 3/4" x 4 1/4" x 2 1/2".

GE-Pyranol oil CONDENSER

12 MFD. 350 VAC. 60 Cy. Removed from equip. NEW.

95¢



RCA Output Transformer

P.P. 6L6'S 25 WATTS
Pri. 5000 ohms output SEC. ±1 500 ohms, ±2 600 ohms sidetone 15 to 15,000 cy. flat.

\$1.95

Gain Dynamic Mike Kit

Uses UTC Transformer & Western Electric Mike. Ideal for Hams, PA., CAP. Recording Mobile Equip. -50 DB BO to 7500 CPS. Diagram Furnished.

\$1.95

KIT 7. TOGGLE AND SLIDE SWITCHES

25 Assorted D.P.S.T.-D.P.D.T. S.P.S.T., etc.

\$3.25

KIT 8. PAPER AND CAN CONDENSERS

25 Assorted Range from 4Mfd-150V to 50Mfd-450V.

\$2.75

KIT 9. KNOBS

100 Assorted Push-On and Set Screw types

\$1.75

TERMS: Cash with order or 25% DOWN—BALANCE C.O.D. ALL PRICES NET F.O.B. DETROIT MINIMUM ORDER \$2.00

HERSHEL RADIO CO. \$249 GRAND RIVER Detroit 8, Michigan Phone TYler 8-9400

Superregen for FM

Your response to the letter in the November issue regarding FM reception with a superregenerative receiver leaves much to be desired. I feel that superregeneration can be used to make an FM detector. Keep three things in mind: (1) voltage regulation, (2) antenna coupling, and (3) grid leak value. With modern tubes, it should be quite easy.

J. G. O'SHEA
Pittsburgh, Pa.

There is no reason to suspect that superregenerative receivers cannot be made better with up-to-date tubes. For the information of our readers, we must point out that "slope" superregenerative detection affords an easy way to hear FM signals, but it does not permit maximum fidelity to be received from the broadcasting station. Nor does it have the quiet background characteristic of a true FM receiver. However, we will publish plans on some superregen FM receivers within the near future so that readers may form their own conclusions.

Tops for Experiments & Hi-Fi

We experimenters have long been in want of a magazine of the POP'tronics type. The best comment I can make is put into the one word — "TOPS!" I would like to see more articles on transistors and hi-fi, and hope you can see fit to run them as soon as possible.

FRANCIS J. LITZ
Inglewood, Calif.

Thanks, Francis, and keep right on reading POP'tronics. Watch for the new series on transistor experiments which is scheduled to start next month.

-30-

This Month's Cover

The welfare and morale of our Armed Service personnel overseas should be of concern to everybody. Often stationed in desolate and isolated locations dictated by military tactics, the soldier, sailor, or airman has only two contacts with his home and family.

One of these is through the mails, the other through radio communications. The latter situation is being depicted here, as a mother talks to her son several thousand miles away using a neighbor's ham radio station.

The ham standing in the background is typical of the hundreds of amateur radio stations that can, and do, offer "free" point-to-point communication between servicemen and their families . . . facilities that cannot be provided by commercial communications links. Also deserving of our thanks are the Military Affiliate Radio Systems and the American Radio Relay League for their efforts in boosting morale.



Get more money!
More security! More out of life!



Learn TELEVISION • RADIO • ELECTRONICS

Get the best!

Get National Schools' SHOP-METHOD HOME TRAINING!

Start now! Why wait around for that raise or promotion that may never come? Get started now in high-paying TV-Radio-Electronics! National Schools' SHOP-METHOD Home Training prepares you for success in a top-salary job or in your own business. You learn all three... Television, Radio, Electronics... in one complete course. Our Shop-Tested lessons and manuals help you master all phases in shortest possible time! Send coupon, find out today!

WHY NATIONAL SCHOOLS LEADS THE FIELD
Located in the "Television Center" of the world, our staff is in close touch with latest developments and opportunities. We give you personalized job placement assistance. We also give you confidential help with both technical and personal problems relating to your training. We show you how to make Part Time Earnings as you progress. Whether you live 30 miles away, or 3,000, you will always be pleased with our prompt, friendly service!

DRAFT AGE? Our home training helps you achieve specialized ratings and higher pay grades if you go in service.

We send you this precision-tested Multitester! Plus parts to build Oscillators, Receivers, Signal Generator, Continuity Checker, Combination Short Wave and Standard

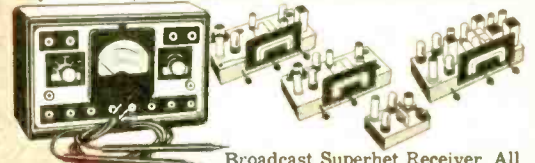

Broadcast Superhet Receiver. All this equipment is part of your National Schools course. **NO EXTRA CHARGES!** Send coupon for free books!

NATIONAL SCHOOLS, world-famous technical trade school. Now in our 50th year!



NATIONAL SCHOOLS
TECHNICAL TRADE TRAINING SINCE 1905
LOS ANGELES 37, California • CHICAGO: 323 West Polk St.
IN CANADA: 811 West Hastings Street, Vancouver, B. C.

- APPROVED FOR G. I. TRAINING
- BOTH HOME STUDY AND RESIDENT COURSES OFFERED

30 MILLION TV SETS

need regular repair! Color TV means more sets than ever before. NOW is the golden opportunity to cash in on this multi-billion-dollar industry. Or "write your own ticket" in broadcasting, manufacturing, and other specialized phases!

**YOUR AGE
IS NO
OBSTACLE!**



Send for
FREE LESSON!
FREE BOOK & SAMPLE LESSON will convince you
SEND COUPON TODAY!

MAIL NOW TO OFFICE NEAREST YOU!

(mail in envelope or paste on postal card)

NATIONAL SCHOOLS, Dept. R2G-26

4000 SOUTH FIGUEROA STREET 323 WEST POLK STREET
LOS ANGELES 37, CALIFORNIA OR CHICAGO 7, ILLINOIS

Please rush **FREE BOOK**, "My Future in Radio-Television-Electronics," and **FREE LESSON** at once. I understand there is no obligation, and no salesman will call.

NAME _____ BIRTHDAY _____ 19____

ADDRESS _____

CITY _____ ZONE _____ STATE _____

Check if interested **ONLY** in Resident Training at Los Angeles.

VETERANS: Give date of discharge _____

LEARN basic electricity electronics
THE EASY "PICTURE BOOK" WAY!



Just Released: The fabulous
ILLUSTRATED Training Course
now used by the U. S. Navy!

You Learn by Pictures

Over 25,000 Navy trainees have already learned Basic Electricity and Basic Electronics this easy, "Picture Book" way! Now, for the first time, YOU can master the basics of Electricity and Electronics with this same "Learn-by-Pictures" training course! Over 1,700 simple, easy-to-understand drawings explain every section—these "teaching" pictures actually make up more than half the *entire* course! No other Basic Electricity or Basic Electronics course in America uses this revolutionary illustrative technique! You learn faster and easier than you'd dream possible!

A Complete Idea on Every Page

Here's how this easy, illustrated course works: *every page* covers one complete idea! There's at least one big illustration on that *same* page to explain it! What's more, an imaginary instructor stands figuratively at your elbow, doing "demonstrations" that make it even *easier* for you to understand. Then, at the end of every section, you'll find *review pages* that highlight the important topics you've just covered. You build a thorough, step-by-step knowledge at your own pace—as fast as you yourself want to go!

Everyday English--A Course Anyone Can Understand

Sponsored by the Navy to turn out trained technicians in record time, this modern course presents Basic Electricity and Basic Electronics in a simple way that *everyone* can grasp—regardless of previous education! Every phase is made *instantly* clear—explained in plain, down to earth English—with hundreds of easy-to-understand illustrations to help you!

10 Complete Volumes

Volumes 1 and 2 of "Basic Electricity" cover DC components and circuits; Volumes 3 and 4 cover AC components and circuits; Volume 5 covers AC and DC motors and machinery.

Volume 1 of "Basic Electronics" covers Diodes & Power Supplies; Vols. 2 and 3 cover Amplifiers & Oscillators; Vols. 4 and 5 cover Transmitters & Receivers.

Home Study Without Correspondence!

This course is so *different*, so *complete*—there's no need for the usual letter writing, question and answer correspondence! Learn at home—at your own pace!

10 Day Examination--Money Back Guarantee

Send today for these exciting new training courses—you *risk nothing!* When you receive the volumes, examine them in your own home for 10 full days. If, at the end of that time, you're not completely satisfied, simply return the books to us and we'll gladly *refund your full purchase price!* Total cost for either 5-volume course is only \$9.00! In Canada, prices approximately 5% higher.

ORDER TODAY!

These books are sold by electronics parts jobbers and book stores. If YOUR dealer doesn't have these books, mail this coupon to us!

JOHN F. RIDER PUBLISHER, INC.
480 Canal Street, N.Y.C.

I have enclosed \$..... Please send me
 5-vol. Basic Electricity set @ \$9 set
 5-vol. Basic Electronics set @ \$9 set
 Both sets. I understand I may return the books in 10 days, and receive a complete refund of the full purchase price if I am not satisfied.
 Add state or city sales tax where applicable.

Name.....
 Address.....
 City & State..... P-2A

NEW—Best Buy in Hi-Fi
Grommes

BUILD-IT-YOURSELF KIT



\$21⁹⁵
NET

**The Famous Lille Jewel
MUSIC LOVERS AMPLIFIER**

Most popular hi-fi amplifier in its field, featured by Life Magazine.

Enjoy . . . Building Your Own.

Most complete set of instructions.

Sold only through selected distributors.

Grommes Division of Precision Electronics, Inc.
9101 King Ave., Franklin Park, Ill.



**corner horn
speaker system**

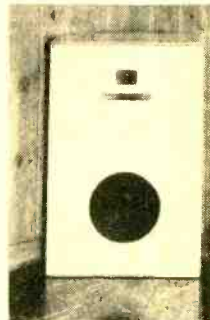

Designed and manufactured by the originator of the Klipschorn speaker system, the Shorthorn is second only to the Klipschorn system in performance. Using coordinated acoustic elements, including filters, it offers exceptionally smooth response, free from distortion. Back loading horn extends bass range without resonance.

Available in kit form, with or without drive system. Prices from \$39 for the do-it-yourself horn kit to \$209 for assembled horn with Klipsch Ortho 3-way drive system installed. *Write for literature.*

KLIPSCH & ASSOCIATES

HOPE, ARKANSAS

POPULAR ELECTRONICS

WHICH OF THESE WELL-PAID JOBS* DO YOU WANT

JOB #1179

1

VHF AND MICRO-WAVE. Large oil company needs young man to service micro-wave and VHF units. Must have FCC license. Opportunity for advancement.

JOB #1158

2

AIRLINE RADIO. Nationally known airline has openings for ground radio operators. FCC License required. Many company benefits plus opportunity for advancement.

JOB #1111

3

ELECTRONIC MANUFACTURER. Leading producer of electronic equipment offers opportunities in the electronic and aviation electronic field. Knowledge of basic electronic theory essential (FCC License desirable).

JOB #1143

4

MOBILE RADIO. Two-way communications company needs men for mobile telephone installation and maintenance. First and second class FCC license holders only. Some travel. Many company benefits.

*We certify that these jobs are currently available. Full details on these and hundreds more will be sent on request.

**YOUR FCC LICENSE
AND CIRE DIPLOMA**
Qualify you for the good
jobs in Electronics and Radio
**WRITE NOW FOR
COMPLETE INFORMATION**

HERE'S PROOF THAT CIRE TRAINEES GET JOBS LIKE THESE

AIRLINES

"I replied to the Job Opportunities you sent me and I am now a radio operator with American Airlines. You have my hearty recommendation for your training and your Job-Finding Service."

James A. Wright, Beltsville, Md.

INDUSTRIAL ELECTRONICS

"Upon my discharge from the Navy I used your Job-Finding Service and as a result I was employed by North American Aviation in electronic assembly (final checkout)."

Glen A. Furlong, Fresno, Calif.

CLEVELAND INSTITUTE OF RADIO ELECTRONICS

CARL E. SMITH, Consulting Engineer, President

4900 Euclid Bldg.

Cleveland 3, Ohio

FILL OUT COUPON BELOW AND MAIL IT TODAY

**GET ALL 3
FREE**

Materials shown include:
- FCC License
- CLEVELAND INSTITUTE OF RADIO ELECTRONICS
- SAMPLE FCC LESSON: MASTER COURSE IN RADIO COMMUNICATION
- MONEY MAKING: FCC COMMERCIAL LICENSE INFORMATION
- NATIONAL TELEVISION ENGINEERING COUNCIL logo

CLEVELAND INSTITUTE OF RADIO ELECTRONICS
Desk PE-9, 4900 Euclid Bldg., Cleveland 3, Ohio

I want to know how I can get my FCC ticket in a minimum of time. Send me your FREE booklet, "How To Pass FCC License Examinations" (does not cover exams for Amateur License), as well as a Sample FCC-type lesson and the amazing new booklet "Money-Making FCC License Information." Be sure to tell me about your Television Engineering Course.

PLEASE PRINT CAREFULLY

NAME _____ AGE _____

ADDRESS _____

CITY _____ ZONE _____ STATE _____

For prompt results, send air mail.
Special tuition rates to members of the U. S. Armed Forces.
Electronic Training Available To Canadian Residents.



**build your own
FORESTER
3-way
Low Distortion
SPEAKER
SYSTEM
for as little as
\$129.00**

... with 1M distortion below that of systems costing more than \$350.00. Intermodulation distortion or "blurring" of the most-listened-to middle and high frequencies is prevented by complete electrical and acoustical isolation of each speaker. This results in less than 0.5% IM distortion to provide exceptionally clean middle tones and clear highs with no harshness.

The Forester system contains 3 low distortion speakers. (A) a 12" woofer, 30-300 cps, with a 1 lb. magnet; (B) an 8" mid-range unit, 300-5000 cps with a 14.6 oz. magnet and (C) a 5" tweeter, 5000-18,000 cps with a 2.15 oz. magnet and lightweight, spiderless cone. These three speakers are controlled by a 6-element, 300:5000 cps, 12 db/octave crossover network. The entire cabinet measures 32" high, 25" wide, 14½" deep.

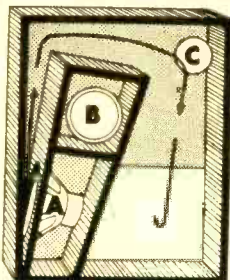

Front View

COMPLETE SYSTEMS

SF1	Spkrs., network, cabinet drawings.....	\$ 79.50
SF1/SFK	Spkrs., network, cabinet kit.....	\$129.00
SF1/SFP	Spkrs., network and assembled ¾" unfinished plywood cabinet.....	\$154.00
SF1C	Spkrs., network, in finished bleached mahogany cabinet (illustrated).....	\$189.00

MODERNIZATION SYSTEMS

For use with your present 12" speaker, instead of the Sherwood Woofer.

SF2	Same as SF1, less 12" woofer.....	\$ 49.50
SF2/SFK	Same as SF1/SFK, less 12" woofer.....	\$ 99.00
SF2/SFP	Same as SF1/SFP, less 12" woofer.....	\$124.00

CROSSOVER NETWORKS (16 ohms)

For your own speaker system.

SFX35	300/5000 cps, 12 db/octave.....	\$ 19.50
SX2	200 cps, 12 db/octave.....	\$ 26.00
SX55	500/5000 cps, 12 db/octave.....	\$ 18.50
SX6	600 cps, 12 db/octave.....	\$ 16.90
SX8	800 cps, 12 db/octave.....	\$ 15.50
SX36	3500 cps, 12 db/octave.....	\$ 6.50

See the Forester Speaker System at your hi-fi dealer or write for free descriptive catalogue. Construction manual also available at 50c.

Other Sherwood products include: Low Distortion Amplifiers from \$99.50 and FM-AM Tuners from \$139.50



Dept. 27 • 2802 W. Cullom Ave. • Chicago 18, Illinois

POP'ronics
BOOKSHELF

"PRACTICAL RADIO SERVICING" by William Marcus and Alex Levy. Published by McGraw-Hill Book Co., Inc., 330 W. 42 St., New York 36, N. Y. 559 pages. Cloth bound. Price, \$8.50.

Assuming no previous knowledge of radio on the part of the reader, this book attempts to guide the beginner from a basic interest in radio servicing to the point where he can operate as a proficient repairman.

The authors explain how to test, repair, and replace parts of a.c.-d.c. superheterodyne receivers, battery receivers, three-way portables, and small phonograph combinations. Operation and correct usage of test instruments is described, and troubleshooting short-cuts are listed for identifying faults. What tools to employ—and how they should be employed—is also discussed. Practical job sheets are included for use with an actual receiver to give the reader real experience with servicing problems.

Different types of sets are explained by a circuit common to most sets. Once the basic circuit has been mastered, the reader is shown the important variations likely to be encountered in other sets of the same general type. Service data charts are provided throughout the book for on-the-job reference. These list trouble symptoms and tell what to look for when making tests.

Amplly illustrated with live drawings and photographs, this exhaustive volume should find a welcome place in the radio classroom, or on the reference shelves of libraries and home experimenters.

Recommended: for every serious student or experimenter in the general field of broadcast receivers.

"FREQUENCY MODULATION" edited by Alexander Schure. Published by John F. Rider Publisher, Inc., 480 Canal St., New York 13, N. Y. 46 pages. Paper bound. Price, 90 cents.

A recent addition to the publisher's "Review Series," this volume provides a comprehensive survey of the highlights of frequency modulation. Concepts, designs, and theory differences between FM and

Electron Tubes With Energy Like The Sun

SOLAR ELECTRONICS

To insure only top quality merchandise Solar Electronics "set tests" each electron tube in powerfully loaded chassis!

Here Is Our New Guarantee Policy:

Money back within 5 days of receipt of merchandise PLUS 5 year free factory replacement.
ALL TUBES ARE CODED BY MONTH AND YEAR!

FREE INTRODUCTORY Gifts Clip This Ad

With every order of \$15 or more—one 6SN7GT, one 6W4GT, 5 assorted resistors, 5 assorted attractively colored tube cartons; or with every order of \$30 or more—1 RCA Heater Cord, 5 assorted resistors, one 6SN7GT, one 6W4GT, one 6K6GT and Vidair 2 set Coupler.

PICTURE TUBE SPECIALS!

Brand New—RCA Licensed—One Year Guarantee

Type	Price	Type	Price	Type	Price	Type	Price
10BP4 or A	\$11.25	16AP4 or A	\$18.95	16JP4 or A	\$18.75	19DP4 or A	\$23.50
10FP4	\$14.95	16CP4 or A	\$18.95	16KP4	\$18.50	19FP4	\$24.25
12LP4 or A	\$13.95	16DP4 or A	\$18.95	16RP4	\$18.50	20CP4 or A	\$24.50
12QP4	\$13.95	A	\$18.75	16ZP4 or A	\$19.25	20DP4 or A	\$24.50
12JP4	\$13.25	16EP4	\$19.45	17BP4	\$19.85	21EP4A	\$27.50
14BP4 or A	\$14.95	16FP4	\$19.25	17CP4	\$20.85	21FP4	\$28.25
A	\$15.95	16HP4 or A	\$18.75	17GP4	\$21.25	21YP4	\$28.25
15CP4	\$15.95	16JP4 or A	\$18.75	19AP4	\$23.95	24AP4	\$44.95
15DP4 (for Dumont)	\$17.95	A	\$18.75				

All Picture Tubes shipped F.O.B. Harrison, N. J.

BIGGEST VALUES! BIGGEST SELECTIONS!

PARTIAL LIST ONLY!

Type	Price	Type	Price	Type	Price	Type	Price
O2	.67	6AC7	.65	65Q7	.37	12SJ7	.44
OD3 VR150	.90	6AF4	.85	65S7	.43	12SK7	.43
OZ4	.44	6AG5	.50	6T4	.89	12SL7GT	.59
1A4P	.30	6AG7	.75	6T8	.65	12SN7GT	.53
1A7GT	.45	6AH4GT	.65	6U8	.73	12SQ7	.35
1A2Z	.85	6AH6	.65	6V3	.77	12V6GT	.44
1B3GT	.63	6AK5	.57	6V6GT	.44	12X4	.35
1R4P	.88	6AL5	.38	6W4GT	.38	14A5	.90
1CSGT	.45	6AN8	.99	6W6GT	.55	14A7	.44
1D5GP	.40	6AQ5	.45	6X4	.35	14B6	.39
1E7GT	.40	6AS6	1.50	6X5GT	.35	14E6	.59
1E7GT	.40	6AT6	.36	6X8	.75	14E7	.59
1H4G	.35	6AT6	.36	6Y6G	.49	14F7	.59
1H5GT	.45	6AU4GT	.70	7A4	.44	14F8	.69
1L4	.47	6AU7	.85	7A5	.53	14N7	.69
1L6	.53	6AV5GT	.65	7A6	.44	19B6GG	1.10
1LA4	.55	6AV6	.36	7A7	.34	19T8	.64
1LA6	.55	6AX4GT	.65	7B4	.43	24A	.35
1LB4	.55	6AX5GT	.59	7B5	.40	25R6GGT	.75
1LC6	.51	6AX5GT	.59	7B5	.40	25R6GGT	.75
1LM4	.55	6B8	.75	7B6	.44	25UC6	1.10
1LN5	.51	6BA6	.45	7B7	.44	25L6GT	.45
1N5GT	.53	6BA7	.55	7B8	.44	25W4GT	.42
1R5	.58	6BC5	.50	7C4	.44	25Z5	.39
1S5	.41	6BE6	.46	7C5	.44	25Z6GT	.35
1T4	.49	6BF5	.42	7C6	.44	26	.48
1T5GT	.57	6BG6G	1.10	7E5	.59	27	.29
1U4	.55	6BH6	.52	7F7	.59	32L7GT	.53
1U5	.41	6BJ6	.49	7F8	.69	35	.32
1V2	.63	6BK5	.75	7H7	.69	35/51	.33
1X2	.65	6BL7GT	.69	7I7	.69	35A1	.44
2A7	.50	6BN6	.60	7K7	.69	35B5	.48
2X2A	.55	6BQ6GT	.75	7N7	.54	35C5	.48
3A4	.55	6BQ7	.80	7X7	.69	35L6GT	.45
3A5	.55	6BY5G	.60	7Y4	.39	35W4	.35
3AL5	.48	6BZ7	.80	7Z4	.39	35Z4	.35
3AUG	.48	6C4	.35	12A7C	.38	35Z5GT	.35
3BC5	.56	6C6B6	.50	12A7T	.65	37	.30
3BN6	.65	6CDE6	.60	12AUG	.42	39/44	.35
3CB6	.56	6CU6	.90	12AUT	.52	50A5	.44
3Q4	.45	6CC6	.45	12AV6	.38	50B5	.48
3Q5GT	.55	6F6	.40	12AV7	.73	50C5	.48
3S4	.52	6H6	.42	12AX4GT	.67	50L6GT	.45
3V4	.52	6J4	1.50	12AX7	.69	75	.40
4BQ7	.92	6J5	.38	12AZ7	.65	76	.40
4BZ7	.97	6J6	.50	12B4	.65	77	.40
5A05	.52	6K6GT	.38	12B6G	.45	78	.40
5J6	.60	6L6	.65	12B7	.59	80	.35
5U4G	.45	6S6GT	.74	12B8E	.45	84/6Z4	.41
5U8	.68	6SA7	.44	12BH7	.59	117L7GT	1.39
5V4G	.56	6SC7	.50	12B7	.64	117N7GT	1.29
5X8	.78	6SF5	.60	12CUG	1.09	117P7GT	1.29
5Y3	.29	6SH7	.43	12K7	.49	117Z3	.35
5Y4G	.35	6SJ7	.43	12Q7	.44	117Z6GT	.60
5Z3	.40	6SK7	.44	12S7	.43	807	1.49
6A7	.55	6SL7GT	.53	12S7C	.59	1619	.59
6AB4	.45	6SN7GT	.83	12SH7	.89	9002	1.19

FREE BONUS OFFER!



Model 625K

A terrific Eico Tube Tester or TV FM Sweep Generator FREE when you buy \$200 worth of receiving tubes or more within 60 days at Solar. Tester or generator may be bought outright from Solar for \$33.50

ANTENNA SPECIALS

COMPLETE OUTDOOR ALL CHANNEL CONICAL
Includes: 8 element antenna with cross-bar, 5 ft. seamless aluminum mast chimney mount, or 7' wall bracket, 8 stand offs, 50 ft. of 300 ohm wire. State your need! List \$15!

\$8.45

NEW INDOOR ANTENNA
Brings in UHF and VHF. Use on top of TV.
List \$9.95.
YOUR PRICE

\$3.75

USED TV SETS

Picture tube guaranteed to work.

	Table Model	Console
10 inch set	\$17.50	\$20.00
12 inch set	\$22.50	\$25.00
14 inch set	\$27.50	\$30.00
16 inch set	\$32.50	\$35.00
17 inch set	\$36.00	\$38.50
19", 20", and 24" Sets—Prices on request.		

FAMOUS MAKE TEST EQUIPMENT!

TUBE TESTER KIT

In carrying case!
Factory wired, \$44.95.

\$33.25

VACUUM TUBE VOLTMETER KIT

Factory wired, \$37.50.

\$24.95

FLYBACK TRANSFORMER and YCKE TESTER KIT

Factory wired, \$31.75.

\$21.75

Test Equipment Factory Guaranteed For One Year!

EASY TERMS!

We pay all postage or freight in U.S.A. Territories and APOs. 25% handling on orders less than \$5. Please send 25% deposit with C.O.D.'s. Remember! Your money cheerfully refunded within 5 days if you are not completely satisfied.

Visit our tube and parts showroom next time you're in Harrison. A free gift awaits you!

TO QUANTITY USERS!

Your initial order of \$150 or more entitles you to our special 10% discount or free Deluxe "60" Remington Razor. State your choice. This offer not good if you are taking advantage of free tube tester or generator offered elsewhere in this ad.

SOLAR ELECTRONICS

Post Office Square
Harrison, N. J. ESsex 4-5300

the famous

Collaro

RC-54

Record Changer

now featured

in

2 New Units

Ready-for-Use

in Your

Home Music System

Supplied Complete —
with Cartridge —
Special 45 rpm Spindle
Adapter — Power Cord —
Audio Connector —
and Pre-Cut Mounting Board
or Finished Hardwood Base.
Priced from \$56.00

Write for complete information

ROCKBAR CORPORATION, Dept. BB-18
215 East 37th St., New York 16, N. Y.

Tell me all about the new
Ready-for-Use Collaro Units

NAME _____

ADDRESS _____

CITY _____ ZONE _____ STATE _____

AM are explained. By comparing the two, the book draws upon the reader's basic familiarity with AM to clarify the new topics in FM. Many diagrams and schematics are included but the discussion avoids a heavy mathematical approach.

Various chapters cover the fundamental concepts of FM, the production of FM, the relation of phase modulation to FM, and the propagation and reception of FM broadcasts. It should be mentioned, however, that not all points are covered which might be of value to those interested in FM. For example, FM detectors and limiters are omitted, since they form the subject of a separate booklet in this "Review Series."

Recommended: as a refresher to highlight certain basic points in FM; as an introduction to FM for someone with an understanding of AM.



"CRYSTAL OSCILLATORS" edited by Alexander Schure. Published by *John F. Rider Publisher, Inc.*, 480 Canal St., New York 13, N. Y. 64 pages. Paper bound. Price, \$1.25.

The crystal oscillator—widely used in amateur, commercial, and military radio applications—forms the subject of this book. Included are descriptions of the nature of the piezoelectric field, crystal characteristics, mounting methods, and practical circuits.

Another in the Rider "Review Series," this little volume is somewhat more than a mere review, since it covers much ground omitted in many standard texts.

Recommended: as a handy reference guide for all active experimenters and users of equipment containing crystal oscillators.



"COLOR TELEVISION RECEIVER PRACTICES" edited by Charles F. Dean. Published by *John F. Rider Publisher Inc.*, 480 Canal St., New York 13, N. Y.

Color television has developed to the point where its basic concepts and principles are fairly well established and not likely to change very much in the next few years. Technicians in the field will be especially interested, therefore, in a book such as this, which explains a good deal of the technology that is being developed.

The authoritative source of much of the material included in this book was a series of lectures given by *Hazeltine Corporation* for visiting engineers from TV manufacturing companies. Many of the points discussed were worked out by staff technicians in the laboratories at *Hazeltine* and, as such, represent first-hand accounts

POPULAR ELECTRONICS

STUDY AT HOME

for a career in radio-tv-electronics

CREI prepares you quickly for success in Broadcasting, Television, Manufacturing, Communications, Servicing, Aeronautical Electronics.

THE FUTURE IS IN YOUR HANDS!

The signs for the future are plain for trained men in the electronics industry. It is a tremendous industry, and—at the *present time* there are more jobs than there are trained men to fill them. But—when there's a choice between a trained and untrained applicant, the trained man will get the job.

CREI HOME STUDY . . . THE QUICK WAY TO GET THERE

Since 1927, CREI has given thousands of ambitious young men the technical knowledge that leads to more money and security. The time-tested CREI procedure can help you, too—if you really want to be helped. CREI lessons are prepared by experts in easy-to-understand form. There is a course of instruction geared to the field in which you want to specialize. You study at your convenience, at your rate of speed. Your CREI instructors guide you carefully through the material, and grade your written work personally (not by machine).

INDUSTRY RECOGNIZES CREI TRAINING

CREI courses are prepared, and taught with an eye to the needs and demands of industry, so your CREI diploma can open many doors for you. Countless CREI graduates now enjoy important, good-paying positions with America's most important companies. Many famous organizations have arranged CREI group training for their radio-electronics-television personnel. To name a few: All America Cables and Radio, Inc.; Canadian Broadcasting Corporation; Columbia Broadcasting System; Hoffman Radio Corporation; Glenn L. Martin Company; Magnavox Company; Pan American Airways, Atlantic Division; Radio Corporation of Amer-

ica; Trans-Canada Air Lines; United Air Lines. Their choice for training of their own personnel is a good cue for your choice of a school.

BENEFITS FELT RIGHT AWAY

Almost immediately, you feel the benefits of CREI training. Your employer, when informed of your step toward advancement (only at your request), is certain to take new interest in you and in your future. What you learn in CREI Home Study can start helping you do a better job immediately.

PAYS FOR ITSELF QUICKLY. Your very first raise could repay your investment in CREI training, and leave you a profit the very first year. Your increases in pay thereafter are all pure profit, and you'll be prepared for many more promotions and pay raises in the future years of your life.



CREI ALSO OFFERS RESIDENCE INSTRUCTION

at the same high technical level—day or night, in Washington, D. C. New classes start once a month. If this instruction meets your requirements, check the coupon for Residence School catalog.

INFORMATION FOR VETERANS. If you were discharged after June 27, 1950—let the new G. I. Bill of Rights help you obtain resident instruction. Check the coupon for full information.

GET THIS FACT-PACKED BOOKLET—IT'S FREE

Called "Your Future in the New World of Electronics," this free illustrated booklet gives you the latest picture of the growth and future of the gigantic electronics world. We'll promptly send your copy. The rest—your future—is up to you.

MAIL COUPON FOR FREE BOOKLET

To help us answer your request intelligently, please give the following information:

EMPLOYED BY

TYPE OF PRESENT WORK

SCHOOL BACKGROUND

ELECTRONICS EXPERIENCE

IN WHAT BRANCH OF ELECTRONICS ARE

YOU MOST INTERESTED?

CAPITOL RADIO ENGINEERING INSTITUTE

Accredited Technical Institute Curricula—Founded in 1927
3224—16th St., N.W., Dept. 122-C, Washington 10, D. C.

Send booklet "Your Future in the New World of Electronics" and course outline.

CHECK PRACTICAL RADIO ELECTRONICS ENGINEERING
FIELD OF BROADCAST RADIO ENGINEERING (AM, FM, TV)
GREATEST PRACTICAL TELEVISION ENGINEERING
INTEREST PRACTICAL AERONAUTICAL ELECTRONICS ENGINEERING

Name

Street

City..... Zone..... State.....

Check: Home Study Residence School Korean Veteran

the most
versatile
low-cost
crystal probe
microphone!



The SHURE Slim-X Model "777"

METAL SEALED FOR PROTECTION
IN HUMID CLIMATES!

This slim, sturdy, rugged little microphone weighs only 6 ounces and is designed for good quality voice and music reproduction. When mounted on either cradle or swivel, the Slim-X "777" can be removed instantly *without tools* simply by lifting it out of the holder.

The SHURE Slim-X Model "777" is ideal for

- Home Recording
 - Public Address
 - Remote Broadcasting
 - Professional Entertainers
 - Ham Transmitting
- and many other uses
too numerous to mention!

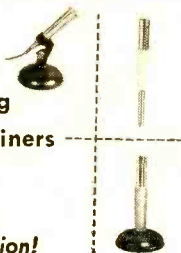

Use it in the hand, on a desk stand, on a floor stand, around the neck—can be removed instantly, no matter where you use it. Model 777A furnished with stand, swivel adapter, mounting cradle and lavalier cord. Model 777 furnished with mounting cradle and lavalier cord. Each model furnished with 7 ft. single-conductor cable. Output at end of 7 feet of cable is -62.0 db (0db = 1 volt per microbar). Both models priced so low you'll hardly believe it!



The Mark of Quality

SHURE BROTHERS, INC.

225 WEST HURON STREET
CHICAGO 10, ILLINOIS

of the basic principles being incorporated in most TV color sets.

The volume covers such topics as the color signal, the three-gun shadow-mask kinescope, decoders, color synchronization, i.f. and video amplification, and laboratory apparatus. Numerous illustrations and an index add to the book's usefulness.

Recommended: as a comprehensive survey of color TV for technicians having a good knowledge of monochrome (black-and-white) TV, and some familiarity with algebra and trigonometry.



Free Literature Roundup

EQUIPMENT for the music lover and hobbyist is described in a 100-page booklet issued by the *Goody Audio Center, Inc.*, 235 W. 49th St., New York 19, N. Y. Fully illustrated, this catalog lists a wide variety of components designed for home music systems. A special introduction contains hints on buying hi-fi units. Free copies may be had by writing directly to *Goody*.

HOW TO OBTAIN A HI-FI system for as low as \$88.50 is one of the many subjects of an attractive booklet called "This Is High Fidelity" and available on request from *Allied Radio Corp.*, 100 N. Western Ave., Chicago 80, Ill. Information on components functioning, ideas for setting up home installations, and extensive catalog listings of most brands of equipment are included.

CIRCUIT CONSTRUCTION enthusiasts will welcome the "high-fidelity library" offered by *Chicago Standard Transformer Corp.*, 3587 Elston Ave., Chicago 18, Ill. Technical data and plans are provided for building Williamson amplifiers of three different power ratings: 8, 25, and 100 watts.

A BROCHURE describing a new hi-fi phono cartridge may be had by writing to *Shure Brothers, Inc.*, 225 West Huron St., Chicago 10, Ill. In addition to an explanation of this company's "Music Lover" cartridge, the brochure discusses the operation of a hi-fi pickup and the potentialities of using barium titanate cartridges.

A SEVENTEEN PAGE, full-color catalog describing the complete *Harman-Kardon* line of hi-fi components has been released. Copies are available from hi-fi dealers or by writing to *Harman-Kardon, Inc.*, Westbury 10, Long Island, N. Y.

SPEAKERS, ENCLOSURES, and accessories are described on catalog sheets that fit into a handsome folder. The complete package may be obtained from *The Stephens Manufacturing Corp.*, 8538 Warner Drive, Culver City, Calif.

-30-

RCA offers you the
 finest training
 at home in
Radio-TV
 electronics,
 TV servicing,
Color TV

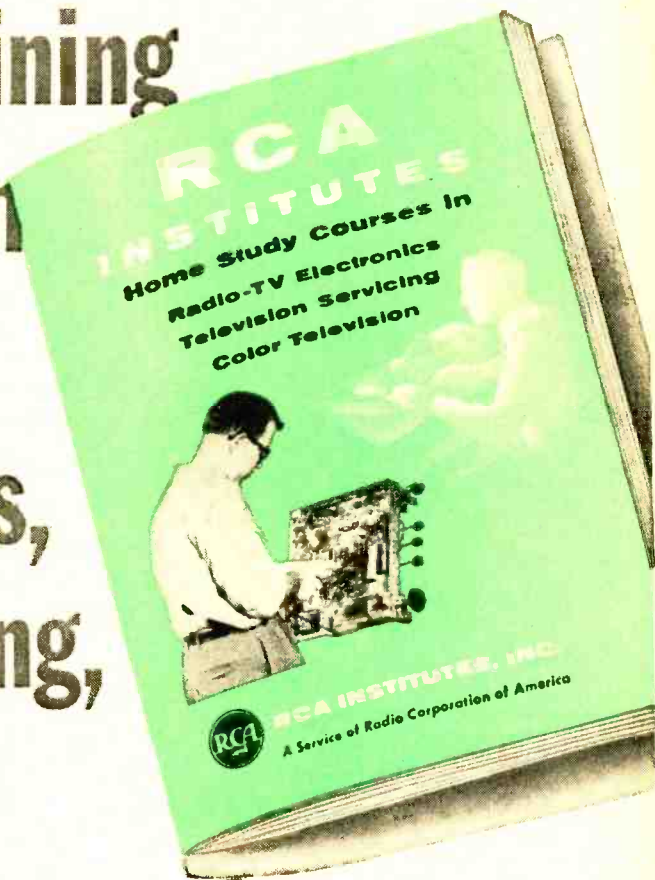

**SEND FOR THIS FREE
 BOOK NOW!**

The instruction you receive and equipment you get (and keep) will start you on your way. Pay-as-you-learn. You pay for only one study group at a time. This 52 page book contains complete information on Home Study Courses for the beginner and the advanced student.



RCA INSTITUTES, INC.
 A SERVICE OF RADIO CORPORATION of AMERICA
 350 WEST FOURTH STREET, NEW YORK 14, N.Y.

RCA Institutes, Inc., Home Study EP-62
 350 West Fourth Street New York 14, N. Y.
 Without obligation, send me FREE CATALOG
 on Home Study Courses in Radio, Television
 and Color TV. No salesman will call.

Name Please Print
 Address
 City Zone State

IMPORTANT
 We urge you write
 for RCA Institutes
 catalog before
 signing up for any
 Radio-TV course

Mammoth 1956 Wholesale Tool Catalog

TOOL CATALOG

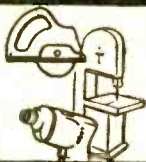

YOUR NAME

\$1

**Puts You In
Business**

The opportunity now awaits you to own and operate your own business on a part time or full time basis in the lucrative field of **HARDWARE, HAND TOOLS, FANS, POWER TOOLS, MOTORS, PAINTS, etc.,** or **BUY TOOLS FOR YOUR INDUSTRIAL OR INSTITUTIONAL USES.**



Buy Nationally Advertised Tools for Resale or Industrial or Institutional Use

NO INVESTMENT REQUIRED, BUY AS YOU NEED IT. A MILLION DOLLAR INVENTORY AT YOUR FINGER TIPS.

Discount
UP TO **50%**

\$1.00 refund on first purchase or refund if you are not 100% satisfied.

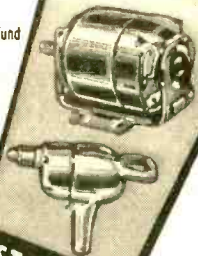

Every one needs tools. Meet the demands of the growing "Do-it Yourself" markets. Sell direct from the jumbo buying guide—your cost is known only to you.

ENCLOSE \$1.00 FOR DEALER'S CARD & 1956 MAMMOTH TOOL CATALOG.

**JUST FILL OUT
COUPON**

SILVO HARDWARE COMPANY

Dept. PE-2, 108 Market St., Philadelphia 6, Pa.

I am enclosing \$1.00. Rush me your dealer's card and big Catalog Today. If I am not completely satisfied with your plan, I understand that I can return the Dealer's Card and Catalog for refund, and if I decide to order, my \$1.00 will be deductible from my first order.

NAME

ADDRESS

CITY ZONE STATE

**NOW! Custom Install
your own Hi-Fi Recorder**
Low Cost! Plugs into any amplifier & speaker



**Staff OK Tested by
Tape Recording Magazine**

Tape mechanism has sensational UniMagic control, 2-speed record and playback, instant, automatic braking, special record-playback and erase heads. **Matching preamplifier**—Response: 50-12000 cps ±3db, signal-noise ratio 47 db. Professional controls include illuminated VU recording meter. Finished in brushed copper and jet black. Carries famous Pentron warranty. TM-56 tape mechanism \$89.95 list. P-4 preamplifier \$79.95 list.

Write for **FREE Bulletin** . . . Name of Nearest Dealer!

PENTRON

The Pentron Corporation

767 S. Tripp Ave.
Chicago 24, Ill.

Canada: Atlas Radio, Ltd., Toronto

LINGUAPHONE

MAKES IT EASY TO LISTEN and LEARN to

Speak

SPANISH [American or European] • **FRENCH**
JAPANESE • **GERMAN** • **ITALIAN**

MODERN GREEK—Any of 34 languages available
for **10 DAY FREE TRIAL—AT HOME**

With LINGUAPHONE—The World's Standard Conversational Method—You Start to SPEAK another language TOMORROW—or IT COSTS YOU NOTHING!

For just 20 Minutes a Day you listen to Linguaphone's life-like recordings. It is easy—AND FUN—to learn another language AT HOME with LINGUAPHONE—the same natural way you learned to speak before you went to school.

That's why Linguaphone is used 'round the world by educators, governments and business firms. More than a million home-study students of all ages.

10-DAY FREE TRIAL

Send today for Free booklet, "Passport to a New World," and details on how you may obtain a COMPLETE Course-unit in the language you choose on FREE TRIAL.



Linguaphone Institute. Phone: Circle 7-8830
T-89-026 Rock Plaza, New York 20, N. Y.

Please send me
 FREE Book Information on FREE Trial.
No obligation, of course.

My language interest is

Name

Address

City..... Zone..... State.....

The World's Standard Conversational Method
for Over Half a Century

CHECK THESE PARTS & TUBE SPECIALS!

- 900,000 Radio & TV Tubes Individually Boxed
- One year RTMA guarantee. Best Brands Available
- Same day service

Type	Price	Type	Price	Type	Price	Type	Price
024	.45	6H5GT	.40	6A7	.59	7A4	.47
183QT	.79	6J4	2.00	6AB	.59	7A5	.55
1L4	.51	6J5GT	.40	6AB4	.45	7A6	.47
1L6	.51	6L6	.49	6AF4	.80	7A7	.45
1LA4	.57	6J7	.45	6AG5	.52	7A8	.46
1L84	.66	6K6GT	.39	6AH6	.80	7B5	.41
1LC6	.66	6K7	.40	6AK5	.81	7B7	.43
1LD5	.57	6L7	.44	6AL5	.42	7B8	.47
1LE3	.57	7C6	.45	6AL7GT	.70	7C4	.40
1LG5	.57	7D6	.70	6A7	.53	7C5	.44
1LH4	.66	7Y4	.35	6AS6	2.00	19T8	.66
1LN5	.47	12AT6	.41	6AS7G	2.25	19T8	.70
1NSGT	.53	12AT7	.68	6AT5	.40	25A7GT	1.50
1R4	.66	12AU6	.46	6AU5GT	.70	25B6G	.80
1R5	.51	12AU7	.58	6AU6	.43	25B6G	.98
1S4	.59	12AV6	.42	6AV5GT	.75	25B6G	.82
1S5	.30	12AX7	.63	6AX5GT	.59	25Z5	.45
1T4	.51	12AY7	.90	6B4G	.90	25Z6GT	.42
1U5	.50	12BA6	.46	6BA6	.49	35A5	.48
1V4	.57	12B4	.70	6BC5	.50	35A5	.48
1X2A	.52	12BE6	.46	6BE6	.46	35A5	.48
2021	1.00	12BH7	.60	6BE6G	1.18	35B5	.48
2V3G	.57	12C7	.69	6N7	.47	35C5	.48
2X2A	.90	12SA7	.52	6Q7	.45	35L6GT	.48
3D6	.45	12SH7	.47	6S4	.48	35W4	.39
3L4	.28	12SK7GT	.50	6S7G	.40	35Y4	.40
6BH6	.55	12SL7GT	.60	6SA7GT	.50	35Z3	.41
6BJ6	.49	12SN7GT	.57	6SC7	.50	35Z5GT	.39
6BK5	.77	12TA7	.40	6K7	.40	50B5	.48
6BK7A	.78	14A5	.59	6M7	.45	50C5	.43
6BN6	.59	14A7	.45	6S7GT	.45	50L6	.48
6BL7GT	.77	12B7	.40	6K7	.50	50L6GT	.44
6BQ6GT	.80	14Q7	.52	6SL7GT	.70	50L6GT	.48
6BQ7A	.80	19B6G	1.18	6SN7GT	.57	55	.39
6BZ7	.60	6YAG	.60	6S7GT	.44	77	.39
6BY5G	.50	3Q5GT	.63	6V6GT	.48	78	.39
6C4	.39	3V4	.58	6W4GT	.40	80	.35
6C5	.36	5T4	.70	6W6	.60	83V	.60
6C6	.50	5U4G	.49	6WG6T	.53	117L7GT	2.00
6CB6	.51	5V4G	.71	6X4	.35	117N7GT	2.00
6CD8G	1.18	5Y3GT	.89	6X5	.39	117P7GT	2.00
6D8	.50	5Y4G	.60	6X5GT	.35	117P7GT	2.00
6E5	.46	5Z3	.45	6X8	.75	117Z3	.37
6F6	.40	5Z4	.54	6Y6G	.60	117Z6GT	.65

Dumont and RCA licensed CATHODE TUBES

• All brand new • One year guarantee

Discounts for the Quantity Purchaser

Type	List Price	Price	Type	List Price	Price
10BP4	\$19.95	\$11.99	17LP4	\$4.00	18.00
12LP4	24.25	14.99	19AP4	48.75	23.00
14BP4	26.50	15.99	20CP4	39.00	24.00
16EP4	34.25	21.75	21AP4	47.00	22.00
16LP4	41.50	17.99	21FP4	40.75	24.00
17BP4	32.00	19.00	24AP4	120.00	42.00

WELLER DUAL-LITE SOLDER GUN KIT



100 watt gun provides the proper heat for most applications. Dual spot light illuminates work. Kit includes gun, wire soldering, brush, soldering aid, Kester solder..... **\$5.83**

Visulite TV Tube Checker and CONTINUITY TESTER automatically checks all tubes, tests electrical defects such as fuses, lamps, resistors... **\$3.85**

Thin Line 300 Ohm Wire For VHF 100 ft. reel..... \$ 1.80
1,000 ft. reel..... 12.50

Special purpose and transmitting tubes

Stanley ELECTRONICS CORP.

935 MAIN AVENUE - PASSAIC, N. J.

Dept. PE12

Gregory 1-2498

TERMS: 25% deposit required on all orders, balance C.O.D. Save C.O.D. charges send full remittance plus postage with order. All unused money refunded with order. NO MINIMUM ORDER. Subject to prior sale.

FREE GIFTS!

All purpose ELECTRIC TESTER equipped with genuine neon glow lamp. Tests loads from 90 to 500 volts. AC or DC with every \$3 or more order.

Reg. \$4.95 5-pc. SYLVANIA REPAIR KIT, Inc. flashlight head, Phillips and flat head screwdrivers, alignment tool and case, with every order of \$25 or more.

FREE GIFT COUPONS with every order. Send for free premium catalog.

Learn to Repair ELECTRIC APPLIANCES at Home in Spare Time



Fast Growing Field offers

Good Pay, Interesting Work, Security

Get into a field where you can do important work, have a secure future. Electrical appliance repair offers OPPORTUNITY FOR YOU. Every wired home has an average of 8 electrical appliances. Up to 10 million new appliances are being sold every year. Owners pay well to keep them in repair and enjoy the convenience they provide. That means a fast growing need for trained men.

Learn and Earn with Tester You Build

Our training includes the parts to build a sturdy, portable appliance tester following our illustrated, easy-to-understand instructions. This multi-use tester helps you locate electrical defects quickly and easily, equips you to do professional trouble-shooting. You use it to learn electrical appliance repair techniques. Gives you the practical training of actually building the tester and a valuable piece of equipment for future use.

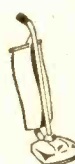

Earn \$3, \$4, \$5 an Hour Spare Time

Start soon to repair electric toasters, fans, irons, mixers, vacuum cleaners, etc. for your neighbors and friends. Spare time work done at your convenience in your basement, garage, or spare room can earn you from \$3 to \$5 an hour. See how easy it is to increase your earning power—how you can pay for this training many times over with the money you'll earn in your spare time. Mail coupon.



Train Now for Greater Security

Low Price—Easy Terms

Today's automatic electric appliances need expert servicing. The man who knows this good trade has a secure future. Put your spare time to good use. Enroll now for \$2.50 down and \$5.00 a month. A small investment can assure a better future. Address Electrical Appliance Training, National Radio Institute, Dept. D4B6, Washington 9, D. C.



FREE Lesson and Book MAIL this NOW

NATIONAL RADIO INSTITUTE
DEPT. D4B6, WASHINGTON 9, D. C.

Please send me lesson and book free. (No salesman will call.)

Name _____ Age _____
Address _____
City _____ Zone _____ State _____

**DOUBLE
YOUR
PLAYING
TIME**

WITH NEW
irish
BRAND

Double-Play
RECORDING TAPE



One 7" Reel of New *irish Double-Play* Tape
Has As Much Playing Time - 2400 Feet -
As Two 7" Reels of Ordinary Tape!



Like most tape recorders, your instrument will probably handle nothing larger than a 7" reel. This limitation often forces you to stop to change reels, leaving important material unrecorded.

A standard 7" reel of Double-Play, the newest of the *irish* Ferro-Sheen premium tapes, gives you 2 hours of continuous recording at 3 3/4 ips, (4 hours, dual-track.)

Made on Dupont's extra-tough Mylar film, *irish* Double-Play will withstand a pull of two full pounds and is recommended for all applications requiring long, uninterrupted operation, and where tape tension is not excessive.

irish
FERO-SHEEN
Double-Play

2400' on 7" reel
\$7.50 Hi-fi net



If not available at your local dealer's, write direct to:
ORRADIO INDUSTRIES, INC., Opelika 1, Ala.
Export Division: Morhan Exporting Corp., N. Y. C.
In Canada: Atlas Radio Corp., Ltd., Toronto

WHAT'S THE PE ANSWER?

FERRI-LOOPSTICK ANTENNAS

I have built a small batteryless pocket radio that works fine, except that I need a 100-foot antenna. I bought a Ferri-loopstick for it but cannot get it to work. Is there a special way that a Ferri-loopstick should be hooked up?

BILL WANDS
Calumet City, Ill.

Unfortunately, a Ferri-loopstick antenna is not a cure-all for crystal receivers. It will increase the sensitivity of such a receiver considerably, but in many cases an additional length of antenna wire is necessary. This is particularly true if there are no powerful broadcasting stations nearby. In connecting a ferrite antenna into the circuit of a receiver, manufacturers' recommendations should be followed.

ELECTRICAL CURRENT FLOW

I have just finished reading the "After Class" department of your November, 1955, issue, in which you describe the action of a germanium diode in rectifying an a.c. current. You show the flow of current as being from the positive cathode to the negative plate, and state that "the characteristics of the metal are changed so that it becomes an excellent conductor in one direction and a very poor one in the other."

In a physics book which I have (Elementary Practical Physics, Black and Davis, Revised Edition, The Macmillan Company, pp. 370-371), there is a paragraph that reads as follows: "This stream of electrons driven through a conductor is an electric current. But it should be carefully noted that the direction of this stream of electrons is from negative to positive terminal. This is just the opposite direction from that in which convention has so long assumed electricity to flow, namely, from positive terminal to negative. Since so much has already been written based on this convention, we shall assume the direction of an electric current to be the conventional one. But at the same time we shall remember, whenever we are dealing with phenomena involving electrons directly, that a stream of electrons is really flowing in the opposite direction to this conventional electric current."

Could you resolve this seeming discrepancy for me?

DANIEL J. EVANS
Williamstown, Mass.

The confusion expressed in your recent letter is quite common and is certainly understandable. It arises from the fact that the very first articles and books on electricity were written

Men with mechanical skills: measure yourself against this yardstick



Mechanics Creed

Upon my honor I swear that I shall hold in sacred trust the rights and privileges conferred upon me as a certified mechanic. Knowing full well that the safety and lives of others are dependent upon my skill and judgment, I shall never knowingly subject others to risks which I would not be willing to assume for myself, or for those dear to me.

In discharging this trust, I pledge myself never to undertake work or approve work which I believe to be beyond the limits of my knowledge; nor shall I allow any superior to persuade me to approve aircraft or equipment as airworthy against my better judgment; nor shall I permit my judgment to be influenced by money or other personal gain; nor shall I pass as airworthy aircraft or equipment about which I am in doubt, either as a result of direct inspection or uncertainty regarding the ability of others who have worked on it to accomplish their work satisfactorily.

I realize the grave responsibility which is mine as a certified mechanic, to exercise my judgment on the airworthiness of aircraft and equipment. I, therefore, pledge unyielding adherence to these precepts for the advancement of aviation and for the dignity of my vocation.

This challenging creed has made the U. S. Air Force the finest technical service in the world. If you are a man who feels a deep sense of satisfaction from the knowledge of a job well done, the U. S. Air Force offers you a rewarding and exciting life. Skills you acquire in the Air Force will help you choose and succeed in your future career.

YOU GO PLACES FASTER ON THE
ALL VOLUNTEER TEAM

THE U. S. AIR FORCE

February, 1956

Paste Coupon on Postcard
and mail to

M-45-PE

Airman Recruiting Information Branch
Box 2202
Wright-Patterson AFB, Ohio

Please send more information on my opportunities for enlisting in the U. S. Air Force. I am between the ages of 17-34 and reside in U. S. A. or possessions.

Name

Address Age

City Zone State

Complete Training

FOR BETTER RADIO-TV SERVICE JOBS



Let these two great new Ghirardi training books teach you to handle all types of AM, FM and TV service jobs by approved professional methods—and watch your efficiency and earnings soar!

Each book is brand new. Each contains the latest data on the latest methods and equipment—NOT a re-hash of old, out-of-date material. Each is co-authored by A. A. Ghirardi whose famous RADIO PHYSICS COURSE and MODERN RADIO SERVICING were, for 20 years, more widely used for military, school and home study training than any other books of their type!

THE NEW Ghirardi RADIO-TV SERVICE LIBRARY

Almost 1500 pages and over 600 clear illustrations show step-by-step how to handle every phase of troubleshooting and servicing.

1—Radio and Television Receiver TROUBLESHOOTING AND REPAIR

A complete guide to profitable professional methods. For the beginner, it is a comprehensive training course. For the experienced serviceman, it is a quick way to "brush up" on specific jobs, to develop improved techniques or to find fast answers to puzzling service problems. Includes invaluable "step-by-step" service charts. 820 pages, 417 illus., price \$6.75 separately. (Outside U.S.A. \$7.25)

2—Radio and Television Receiver CIRCUITRY AND OPERATION

This 669-page volume is the ideal guide for servicemen who realize it pays to know what really makes modern radio-TV receivers "tick" and why. Gives a complete understanding of basic circuits and circuit variations; how to recognize them at a glance; how to eliminate guesswork and useless testing in servicing them. 417 illus. Price separately \$6.50 (outside U.S.A. \$7.00).

New low price . . . you save \$1.25!

If broken into lesson form and sent to you as a "course," you'd regard these two great books as a bargain at \$50 or more!

Under this new offer, you save \$1.25 on the price of the two books—and have the privilege of paying in easy installments while you use them! No lessons to wait for. You learn fast—and right!

STUDY 10 DAYS FREE!

Dept. PE-26, RINEHART & CO., Inc.
232 Madison Ave., New York 10, N. Y.

Send books below for 10-day FREE EXAMINATION. In 10 days, I will either remit price indicated or return books post-paid and owe you nothing.

- Radio & TV CIRCUITRY & OPERATION (Price \$6.50)
- Radio & TV Receiver TROUBLESHOOTING & REPAIR (Price \$6.57 separately)

Check here for MONEY-SAVING COMBINATION OFFER . . . Save \$1.25. Send both of above big books at special price of only \$12.00 for the two. (Regular price \$13.25 . . . you save \$1.25). Payable at rate of \$3 after 10 days if you decide to keep books and \$3 a month for 3 months until the total of \$12 has been paid.

Name
Address
City, Zone, State

Outside U.S.A.—\$7.25 for TROUBLESHOOTING & REPAIR; \$7.00 for CIRCUITRY & OPERATION; \$13.00 for both books. Cash with order, but money refunded if you return books in 10 days.

Rinehart Books are sold by leading book stores.

before the existence of electrons was suspected; and at that time an arbitrary convention was set up in which it was stated that the flow of electricity was from a positive potential to a negative potential.

After the discovery of the electron, it was found that in the large majority of cases a flow of electric current consisted of a flow of electrons, and that they moved from negative to positive. This is directly the opposite of conventional current flow, but many textbooks continued—and still continue—to talk about conventional current flow. As a result, it is now necessary to specify, when talking about current flow, whether you are discussing "conventional current" or "electron current."

LONG-DISTANCE TV RECEPTION

Some time ago, while I was tuned to Channel 6, WFIL-TV, the picture from another station was superimposed on the WFIL-TV picture, causing the latter to fade out completely. I waited for the identification of this new station, and found it to be WDSU-TV, New Orleans.

Was this due to a mix-up in relaying the programs, or could it have been due to favorable receiving conditions at the time?

JOHN MESAROS
Jim Thorpe, Pa.

Distant reception of television stations is possible under certain conditions of propagation, usually referred to as sporadic-E. Reception of stations 600 to 1400 miles away is possible under these conditions, and extremely rare reports of reception up to 3800 miles have been received.

RANGE OF CRYSTAL RECEIVER

What is the range of the germanium diode crystal receiver which was described in "After Class" for November, 1955?

STUARD LOONEY
Home Creek, Va.

The range of a simple crystal diode receiver is in general quite limited. A good, high antenna, 50 to 75 feet long, and a good ground are necessary for reception up to about 25 miles. The more powerful broadcasting stations may help to extend this range somewhat.

TESLA COIL PLANS

Would it be possible for you to publish construction details of a Tesla coil? I have seen one such unit but found it unsatisfactory as it employed discontinued-type tubes. If you cannot publish such information in a future issue, will you please tell me where I may obtain plans for a Tesla coil?

DAVID MILLER
Olympia, Wash.

We have hesitated to publish plans for the construction of a Tesla coil because such a device can create a tremendous amount of interference to radio and TV reception, and may interfere with various radio communication services. Also, the high voltages required constitute a very serious shock hazard. —30—

ESSE BARGAIN SPECIALS

BRAND NEW METER BARGAINS

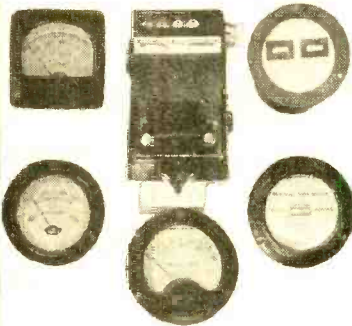

SPECIAL 3" Round Radiation Counts Meter 20-10K counts per minute. Full Scale = 1 M.A. ea.	\$3.50
Veeder Root Counter 0-99,999 6 or 12 V. DC, 5 watt solenoid operated. With reset. New ea.	\$8.50
GE 3 1/2" Round D071	
0-20 Microamps DC \$9.00	0-10 Ma. DC 5.00
0-100 Microamps DC 7.50	0-30 Ma. DC 5.00
0-200 Microamps DC 7.00	0-100 Ma. DC 5.00
0-25 Ma. AC 4.50	0-150 Ma. DC 5.00
0-50 Ma. AC 4.50	0-100 Ma. AC 5.00
SIMPSON 3" Round Model 25 & 55	
0-1 Ma. DC \$3.00	0-400 Volts DC 5.00
0-150 V. AC 3.00	0-10 Volts AC 5.00
HOYT 3" Round	0-900 Volts AC 5.00
0-30 DC Amps \$1.50	CRAMER Running time meter Type RT-2H 110 V. 60 cycle. \$9.00
0-40 DC Volts 1.50	FRAHM MSF 58-62 cy. Freq meter 200-250 V. AC \$9.00
GE 4" x 4 1/2" Rect. A058	WESTON-50-70 cycle 4" Freq. meter 110 V. AC \$9.00
0-50 Microamps DC \$8.00	0-5 Amp RF NT35 \$5.00
0-100 Microamps DC 7.50	WESTINGHOUSE 3" Round
0-200 Microamps DC 7.50	0-800 Ma. DC NX 35 3.50
0-500 Microamps DC 5.00	NC35 DB Meter F.S. 5 V. AC 5.00
0-1 Ma. DC 5.00	
0-5 Ma. DC 5.00	

SUPREME 542-B MULTIMETER—\$14.95



Regular \$25.20 pocket laboratory with following ranges:
 4—DC Ma. 0/0.3/6/30/150
 4—DC Volt 0/6/150/300/1500
 4—Ohms 0/2000/20,000/200 M/2 Meg.
 4—AC Volt 0/6/30/150/600
 4—Output 0/6/30/150/600
 4—DB ranges—6/+10; +8/+24; +22/+38; +54/+50
 Complete as shown. Ship. Wgt. approx. 3 lbs. **BRAND NEW \$14.95**

DYNAMOTORS: 12 V. types

Your chance to get top quality surplus dynamotors usually selling between \$30 to \$150. Will go up in price with increased use of 12 V. systems in cars.



- DM-34—Input 12 V. 2.8 Amp. Output 220 V. 80 Ma. (This type used on 6V. for 110 V. output for electric shavers). Mfgd. by Western Electric. Ship. wgt. 6 lbs. Used. **\$2.50**
- DM-40—Input 12 V. 3.1 Amp. Output 172 V. 138 Ma. 6 3/4" x 3 1/2" dia. Ship. wgt. 8 lbs. **\$2.95**
- New. DM-5—12 V. input @ 2.5 amp. Output 300 V. 50 Ma. Size 4 1/2" L x 2 1/2" dia. Ship. wgt. 3 lbs. **\$2.50**
- DM-42—For the high power mobile boys. 12 V. 46 Amp. Input (may be connected for 6 V. operation at reduced output). Output 515-1030-260 Volts at 260 Ma. Ship. wgt. 22 lbs. Brand New. **\$14.75**
- New with broken mounting base. **\$8.95**
- 24 V. Input type: PE-94—For SCR-522 Xmtr.-Rec. New—\$5.00 Used—3.50



BC-AS-229 RECEIVER New—\$3.95

The companion aircraft receiver for the popular BC-AS-230 transmitter. Receiver covers 200 to 12,700 Kc. with full set of plug-in coils. (Dual Coil for 201-309 Kc. and coils not in stock.) Uses 6 tubes which are included. Size 1 1/2" L x 6 3/4" x 6 3/4". Ship. wgt. 15 lbs. **Brand New \$3.95**

Only a Few left of the following items from Nov. Popular Electronics Ad.:

- RL-42 Reel mixers @ \$2.50 used. \$3.95 new.
- T-39/APQ-9 Radar Transmitter @ \$4.95 ea.
- Torque Amplifiers, New, \$9.75 ea.
- Miniature Storage Batteries. (See Nov. Ad for prices).
- Rectifier Special for Model trains—\$1.50 ea.
- TU-7 and TU-10 Tuning Units, used @ \$1.95. New @ \$2.50 ea.

110 V. 60 CYCLE SELSYNS \$4.95 ea.



Popular Navy size 5 (approx. 6 1/2" L by 3 1/2" dia.). Order either motors, generators, differentials, or control transformers at this price. Used but guaranteed good. Ship. wgt. approx. 6 lbs. ea. **\$4.95** Choice, ea.

LEEDS & NORTHRUP MICROMAX RECORDERS

Strip type recorders used for controlling and recording a wide variety of processes. Used originally for temp. range for 350-550 degrees C. May be changed for other applications. Operated on Wheatstone bridge principle using AC galvanometer movement. Original cost several times our price. Units were removed from demilitarized equipment which in many cases was new, but all instructions sold as used and guaranteed. Money back if not satisfied. **PRICE ea. \$179.50**

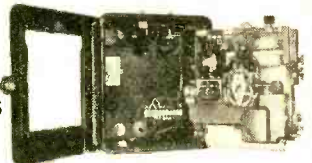

Only \$4.95 BC-455-B Receiver



Ideal receiver for mobile or fixed operation with excellent sensitivity and frequency stability. New surplus release order—new supply will not last long at this price. For 6-9.1 Mc. operation. Complete with tubes and guaranteed. Less dynamotor. **PRICE \$6.95** Used, ea. \$4.95 New, ea. \$6.95

8 Amp. 24 V. DC POWER KIT

New components include transformer, Mallory rectifier and condenser (2000 mfd. 50 V.) for construction of power supply to charge batteries or operate direct from 110 V. AC supply many surplus items. Ship. wgt. approx. 20 lbs. **PRICE for kit. \$19.95**



R-1/ARR-1 RECEIVER—For use as 220 Mc. converter. Essentially a two stage RF acorn tube superhet converter. Also can be used for a pressor. Small enough for mobile. Wgt. 6 lbs. Cover not shown but included. **PRICE, Brand new \$2.95**

ARR-1 Antennas for above. New, ea. \$1.25
 Co-axial antenna-relay for above or other combination. New, ea. \$1.25

CIRCUIT BREAKERS, NEW, \$1.95 each
 15 amp. 120 V. AC Heinemann 2 Pole Curve D Cat. No. 0322, 5/8" x 4" x 3". Ship. wgt. 3 lbs.
 1.25 Amp. 117.5 V. 2 Pole AC. Curve G. Catalog No. 2163M4, size 3/4" x 4" x 3". Ideal for radio serv. bench. Ship. wgt. 3 lbs.

POTENTIOMETERS—25 for \$1.79
 All new, assorted. Some with switches, some dual, midget, regular, wirewound, and carbons. Possibly no assortment alike. Order several. The need for any one will possibly pay for all.

Remit shipping charge and instructions with all orders, otherwise order will be shipped express collect. All items guaranteed to your satisfaction or money refunded if returned within 10 days of receipt. Minimum order \$5.00.

ESSE RADIO CO. Dept. P-2, 42 West South St., Indianapolis 25, Indiana

MUSIC IN EVERY ROOM

plus

with these MASCO DO-IT-YOURSELF KITS

Enjoy the convenience and pleasure of quality home electronic communications which, until now, have been installed only in the most expensive new homes. Adds new glamour to any home . . . remote door answering feature provides added safety . . . saves steps and time . . . Ideal for listening to activity in nursery, sickroom or basement playroom from remote point . . . Nothing more to buy . . . install it easily yourself or ask your distributor about his low installation charges.

EASY PAYMENT PLAN

Take up to three years to pay. Ask your distributor about the small, easy payments. 5% discount on payment with order.

For the names of other authorized Masco distributors in your community or information on these and other Masco products — write to — MASCO Home Music Division • 32-28 49th St., Long Island City 3, N. Y.

- ★ 2-way communication throughout the home
- ★ Instant 2-way conversation with callers at front or back door

(Prices Do Not Include Installation)



MDC-61 Master



HCM Remote



HF-5 Master

MDC-61 — 6-Room, Flush-Mounting Radio Distribution and Intercom System Kit with clock. Includes deluxe kitchen Master and 4 room stations plus weatherproof door station, and all necessary wire and hardware. Volume controls for each room station mount separately. All room stations have communication with master. Net \$166.00 plus shipping

MDC-6 — Same as MDC-61, but Music Distribution only, less intercom feature. 5 room stations, no door station. Net \$119.50 plus shipping

HCM — Inexpensive door-answering intercom with front and back door stations and electrical door-opening feature. Instant-heating tubes—no power used except when talking or listening. Net \$89.50 plus shipping

HF-5 — Five-station AM-FM high fidelity radio distribution system, with provision for phonograph. Five 8" flush room speakers, controls, wire and hardware supplied. Superior tonal reproduction. Net \$210.00 plus shipping

AUTHORIZED MASCO DISTRIBUTORS

ACE HOME APPLIANCE CO. 1101 N. E. 12th St., Ft. Lauderdale, Fla.
 AUDIO COMMUNICATIONS 3912 Peach Dr., Jacksonville, Fla.
 GOLDEN HOME MUSIC CO. 19178 Greenfield Ave., Detroit, Mich.
 HOME ELECTRONICS CO. 2215 So. St. Louis, Chicago, Ill.
 HOME MUSIC CO. 1614 Broadway, Seattle, Wash.
 SYMPHONIC SOUND & MUSIC CO. 11206 Buckeye Rd., Cleveland, O.
 ISLAND HOME MUSIC CO. 14 Hillvale Rd., Albertson, L. I. N. Y.

POTOMAC VALLEY SOUND SERVICE 3328 Buchana St., Mt. Rainier, Md.
 METALEVENT HOME IMPROVEMENT CO.
 5011 Wilkinson Blvd., Charlotte, N. C.
 SOUND SERVICES Box 706, New Canaan, Conn.
 SOUTH TEXAS ELECTRONICS 2400 Airline Dr., Houston, Tex.
 KEYSTONE STATE SOUND & MUSIC CO. Box 816, Jamison, Pa.
 LIBERTY RADIO & TV SERVICE 4908 Park Hgts. Ave., Baltimore, Md.

Masco MOST COMPLETE LINE OF QUALITY SOUND EQUIPMENT FOR OVER A QUARTER CENTURY

Perma-Power Radio Controlled Garage Door Opener

Now, the newest, finest Radio-Control Garage Door Opener styled in a modern spun-aluminum fixture that beautifies garage interiors.

Convenience and safety features galore — New automatic shut-off, positive locking of door, FCC authorized radio frequency . . . and many more plus qualities!

Write today for descriptive literature.

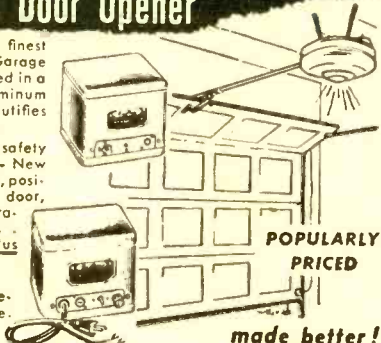

POPULARLY PRICED

made better!

Everyone can afford this modern convenience!

- ★ It's really simple to install . . . one man can do it easily!
- ★ Takes just an afternoon with common hand tools; no soldering.
- ★ Complete instructions assure professional-type installation.

MAIL THIS COUPON FOR COMPLETE FACTS!

Perma-Power COMPANY 4727 N. DAMEN AVE. CHICAGO 25, ILL.

- Please send FREE descriptive literature on your GARAGE DOOR OPENER
- Please advise name of your nearest electronic parts distributor carrying your GARAGE DOOR OPENER

NAME _____
 ADDRESS _____
 CITY _____ STATE _____

SAVE HOURS OF WORK

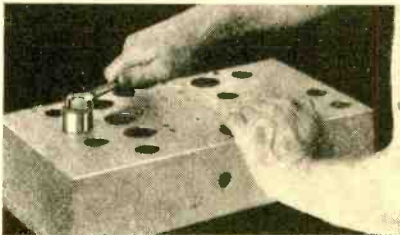

quickly make round, square, key and "D" openings with Greenlee Radio Chassis Punches

In 1½ minutes or less you can make a smooth, accurate hole in metal, bakelite or hard rubber with a GREENLEE Punch. Easy to operate . . . simply turn with an ordinary wrench. Wide range of sizes. Write for details. Greenlee Tool Co., 2382 Columbia Ave., Rockford, Ill.

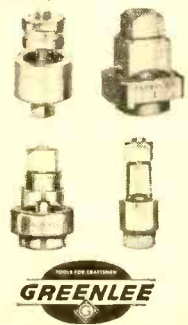

GREENLEE

LIFETIME GUARANTEED TUBES

BRAND NEW PICTURE TUBES

• RCA Licensed.
• One Year Unconditional Guarantee.

Type	Price	Type	Price
10BP4	\$11.90	17BP4	\$20.63
12LP4	14.38	19AP4	24.81
14BP4	16.85	21AP4	28.79
16RP4	19.38	21EP4	28.79
16LP4	19.38	24AP4	42.50

Picture Tubes shipped F.O.B. Harrison, N.J.

NEW INDOOR ANTENNA

Both UHF and VHF. Brings better reception than most outdoor antennas. Use on top of TV.

List price \$9.95 \$3.99 each

YOUR PRICE \$3.29 each Lots of 3

FREE BONUS BOX

With Every \$25 Order

- 1 RCA Cheater Cord
- 10 Assorted resistors
- 10 Assorted 2 Color "blank" tube cartons
- 1 6B26GT tube
- 1 6AU6 tube
- 1 6CB6 tube

FREE CLOCK RADIO

With Every \$125 Purchase Within 30 Days Wakemaster clock radio with famous Sessions clock movement wakes you up to music or alarm. May be purchased outright from MAJOR BRAND for \$17.95. In ivory or rust.

FREE GIFT CERTIFICATE*

Worth \$5 toward the purchase of any of our merchandise on future orders will be sent with any order of \$50 or more. * Free Gift Certificate cannot be used to obtain another certificate unless order is \$55 or more.

WE PAY ALL POSTAGE on orders shipped in USA, Territories and APO's. Send only purchase price of merchandise. Please include approximate postage on foreign shipments. All orders subject to prior sale. Add 25¢ handling on orders under \$5.00. Quantity users write for special discount.

Write For FREE Tube List—Order Blank—and FREE Sample Tube Carton. We want Y-O-U On Our Mailing List!

• We guarantee to replace tubes labeled MAJOR BRAND forever • Each Tube Individually Boxed and Guaranteed For Life • Over A Half Million Tubes Always In Stock • Immediate Shipment • Free Postage On All Orders With Full Remittance.

HERE'S HOW LIFETIME GUARANTEED TUBES

SAVE YOU MONEY

• There are fewer "call backs" • There are no "out of date" tubes • "Peak Performance" testing in our fully equipped Testing Department before shipment guarantees quality.

02A	.43	3BN6	.70	6AX4GT	.60	6K8	.65	7C6	.43	14B6	.38
1A4P	.33	3CB6	.52	6AX5GT	.57	6L6	.68	7C7	.45	14Q7	.50
1A7GT	.43	3Q4	.46	6B4G	.52	6L7	.42	7E5	.45	19B6GG	1.15
1B3GT	.65	3Q5GT	.57	6B8	.69	6N7	.60	7E6	.55	19T8	.65
1C5GT	.41	3S4	.47	6BA6	.47	6Q7	.40	7E7	.70	24A	.39
1D5GP	.43	3V4	.47	6B7A	.58	6S4	.40	7F7	.59	25AV5GT	.78
1E7GT	.41	5BQ7	.89	6B8C	.47	6S4T	.45	7F8	.70	25BQ6GT	.78
1G5GT	.41	4BZ7	.95	6B8C7	.80	6S6T	.48	7G7	.75	25L6GT	.47
1H4C	.43	5AU4	.75	6B8E	.45	6S6T7	.41	7H7	.50	25W4GT	.43
1H5GT	.47	5J6	.63	6B8F	.40	6S1H7	.43	7J7	.75	25Z5	.37
1J6GT	.47	5T4	.69	6B8F6	.50	6S1J7	.43	7K7	.55	25Z6	.37
1L4	.45	5U4G	.43	6B8G6G	1.15	6S1K7	.45	7L7	.75	27	.25
1L6	.55	5UB	.74	6B8G	.50	6S17GT	.55	7N7	.50	3A5	.46
1L4A	.57	5V4G	.59	6B8J6	.47	6S1N7GT	.55	12A7E	.37	3B85	.50
1L4S	.47	5Y3	.31	6B8K5	.68	6S2Q7	.39	12A7T	.66	35C5	.50
1L84	.57	5Y4G	.36	6B8K7	.76	6S8R7	.42	12A2Z7	.63	35L6GT	.47
1LCS	.49	5Z3	.41	6B17GT	.75	6S5T	.41	12A1U6	.41	35W4	.50
1LC6	.47	6A7	.57	6B8N6	.58	6T4	.95	12A1U7	.53	35Y4	.34
1LDS	.57	6AB	.74	6B8Q6GT	.58	6T8	.68	12AV6	.35	35Z3	.39
1LE3	.57	6AB4	.43	6B8Q7	.78	6B8	.75	12A1V7	.67	35Z5GT	.34
1LQ5	.57	6AC7	.67	6B8Y5G	.58	6V3	.80	12AX4GT	.65	37	.29
1L84	.64	6AF4	.79	6B8Z7	.88	6V6GT	.46	12AX7	.58	50A5	.50
1LNS	.47	6AC5	.50	6C4	.37	6W4GT	.30	50B8	.50	50C5	.50
1NS5GT	.50	6AG7	.69	6C5	.35	6W6GT	.53	12BA6	.46	50C5	.50
1R5	.50	6AH6	.69	6C86	.49	6X4	.34	12BD6	.48	50L6GT	.43
1S5	.42	6AJ5	.70	6C06G	1.15	6X5	.34	12BE6	.46	75	.42
1T4	.50	6AK5	.54	6D6	.48	6B8	.72	12BH7	.60	76	.42
1U4	.47	6AL5	.39	6E5	.44	6Y6G	.55	12BY7	.65	77	.38
1U5	.42	6AQ5	.46	6F5	.37	7A4	.45	12BZ7	.61	78	.38
1V2	.65	6ARS	.46	6F6	.38	7A5	.53	12C6	.95	80	.34
1X2	.61	6A55	.48	6G6	.40	7A6	.45	12SA7	.45	84/6Z4	.44
2A5	.55	6AS6	1.70	6G6G	.37	7A7	.43	12SJT	.45	117L7GT	.47
2A5	.57	6AS7G	2.19	6J4	1.79	7B8	.45	12SK7	.45	109	
2A7	.55	6AT6	.39	6J5	.39	7B5	.39	12SN7GT	.56	117N7GT	.47
3A5	.51	6AU4GT	.85	6J6	.47	7B6	.42	12SQ5	.37	109	
3A5	.50	6AUSGT	.59	6J7	.43	7B7	.41	12SR7	.45	117P7GT	.47
3AL5	.45	6AUE	.42	6J8G	.85	7B8	.45	12V6GT	.45	1.09	
3A5S	.46	6AUSGT	.65	6K6GT	.37	7C4	.39	12X4	.37	117Z3	.65
3BC5	.54	6AV6	.39	6K7	.39	7C5	.42	14A7	.42	117Z6GT	.35

This Ad Is Worth M-O-N-E-Y
Clip out this ad and attach it to your order. Three 6SN7G's will be shipped FREE with any order of \$10 or more.

MAJOR BRAND TUBE CO.

Romano Bldg. ESes 4-1106 Harrison, N. J.

Get This Valuable Book

FREE



Just for Examining COYNE'S New 6-Volume Set

"Applied Practical Radio-Television"

Yes, you get this big, brand new book, "150 Radio-Television Picture Patterns and Diagrams Explained", absolutely FREE! Just off the press! Gives complete wiring circuits and diagrams on the latest Radio and Television Sets, Easy-to-read, large 8 1/2 x 11" pages, with full instructions on how to read and use the diagrams. A "must" in every Radio and Television service-man's repair kit. You get this valuable book as a FREE Gift for asking to see Coyne's great new 6-book set, "Applied Practical Radio-Television"!

Here's "Know-How" That Makes You Worth More! Coyne's great new 6-volume set gives you all the answers to servicing problems—quickly! For basic "know-how" that is easy to understand, you'll find everything you want in volumes 1 to 5 which contain over 5000 practical facts and data. They cover every step from principles to installing, servicing, trouble-shooting and aligning all types of radio and TV sets. So up-to-date it includes COLOR TV and UHF, adapters and converters. Also covers very latest information on TRANSISTORS.

900-Page Television Cyclopedic Included And then, for speedy on-the-job use, you get volume 6—the famous Coyne TELEVISION CYCLOPEDIA. It answers today's television problems on servicing, alignment, installation and others. In easy-to-find ABC order, cross indexed. Use this 6 volume TV-RADIO LIBRARY free for 7 days; get the valuable Servicing Book ABSOLUTELY FREE!

Educational Book Publishing Division

COYNE

ELECTRICAL SCHOOL

500 S. Paulina St., Dept. 26-PE Chicago 12, Ill.

ON 7 DAY FREE TRIAL!



SEND NO MONEY! Just mail coupon for 6-volume set on 7 days free trial. We'll include book of 150 TV-Radio Patterns & Diagrams. If you keep the set, pay \$2 in 7 days and \$2 per month until \$22.50 plus postage is paid. (Cash price \$20.95). Or you can return the library at our expense in 7 days and owe nothing. YOU BE THE JUDGE. Either way, the book of TV-Radio Patterns is yours FREE to keep! Offer is limited. Act NOW!

FREE BOOK—FREE TRIAL COUPON!

Coyne Electrical School, Educational Book Publ. Div., Dept. 26-PE

500 S. Paulina St., Chicago, 12, Ill.

YES! Send 6-volume "Applied Practical Radio-Television" for 7 days FREE TRIAL per your offer. Include TV-Radio Patterns & Diagram Book FREE.

Name.....Age.....

Address.....

City.....Zone.....State.....

Where Employed.....

() Check here if you want library sent COD. You pay postman \$20.95 plus COD postage on delivery. 7-day money-back guarantee.

FREE! LAFAYETTE CATALOG



Big Money Saving Values!

132 PAGE ELECTRONIC CATALOG

Packed with the largest selection of Electronic, Radio and T.V. Parts, and equipment, PA, Hi-Fi systems, tubes, antennas, Transistor Kits, parts and components, Test Equipment, new build your own kits, tools, books, Microscope, drafting equipment, Binoculars, Telescopes, All Radio, TV and Ham supplies — ALL AT GREAT SAVINGS — For the economy minded servicemen, dealer, engineer and technician. **CHUCK FULL OF BUYS! SEND FOR YOUR FREE COPY TO-DAY.**

Lafayette Radio
DEPT. 18
Include postage with order

NEW YORK, N.Y. 100 Sixth Ave.
BRONX, N.Y. 542 E. Fordham Rd.
NEWARK, N.J. 24 Central Ave.
PLAINFIELD, N.J. 139 West 2nd St.
BOSTON, MASS. 110 Federal St.

LAFAYETTE RADIO
100 SIXTH AVE., NEW YORK, N.Y.

Send FREE 132-Page 1955 Lafayette Catalog

Name _____

Address _____

City _____ Zone _____ State _____

2 TRANSISTOR POCKET RADIO KIT



Packed into a 2 1/2" x 3 1/2" x 1 1/4" plastic case. This Two Transistor plus crystal diode radio kit offers many surprises, utilizing a regenerative detector circuit with transformer coupled audio stage, gives you high gain and excellent selectivity. Pulls in distant stations with ease with more than ample earphone volume. Kit comes complete with two transistors, crystal diode, loopstick, Argonne transistor audio transformer, resistors, condensers, plastic case, etc. Including schematic and instructions.

KT-68A Complete Kit less earphones. Net 11.80
MS-260 New Super Power Dynamic Earphone. Ideal for Transistor Circuit Imp. 8000 ohm, D.C. 2000 ohm. 3.95

TRANSISTOR POCKET RADIO RECEIVER KIT



Utilizing One Transistor and Crystal Diode Detector with New Miniature 365 mmf Variable Condenser.

Here is an ideal low cost transistor pocket radio kit for students, hobbyists and the experimenter, who desire to obtain a practical knowledge of transistorized circuits. The circuit utilizes a Ferris-Loopstick and a specially designed miniature 365 Variable Condenser, permitting the entire receiver to be built in a plastic case size 3" x 2" x 1". The 1N64 Crystal Diode is used as a detector. The transistor is connected as a grounded emitter amplifier. This receiver with a 50 foot antenna and good ground will bring in good reception over a 50 mile radius. The kit comes complete with transistor, crystal diode, battery holders, batteries, condensers, resistors, plastic case, etc., plus a 115 page book, showing more than 50 practical transistor circuits and How-To-Do-It-Instructions.

KT-80 Complete Kit (less earphones) 4.95
1 Miniature Crystal Ear Receiver MS-111 1.49

SLIM HIGH OUTPUT DYNAMIC MICROPHONE



Reg. Price ~~41.50~~ Net 9.95

A pencil-slim design, high output PA Dynamic Microphone of exceptional quality, at a price that is 1/3 of the price of any comparable microphone on the market today. Very smooth response, 50-11,000 cycles. Omnidirectional, tiltable head. Switch on side gives choice of either high impedance (50,000 ohms) or low impedance (250 ohms). Instantly removable bracket permits use either on stand or as hand mike. Features exceptional mechanical strength. Cast case with satin chrome finish, 3/4" -27 thread. Acoustically-treated grille head, 8" long; 1 1/4" barrel diameter. Shipping weight 2 lbs.

PA-29.....In lots of 3, Each 9.25
Singly, Each 9.95

TRANSISTOR CHECKER KIT



• Checks Shorts, Leakage, and Gain

A "must" for servicemen, experimenters and engineers. Tests both PNP and NPN type transistors. Gives 2 separate checks; first **GOOD-BAD** check for shorts and leakage, and second for **GAIN**. Gray hammertone case 5 1/4" x 3" x 2 1/4". Kit includes case, meter, all parts with full assembly and operating instructions. Simple to build. Fast, accurate. Shpg. wt. 3 lbs.

KT-86 Kit 7.95

NEW POCKET AC-DC VOM MULTITESTER 2,000 ohm per Volt on AC & DC



• Completely wired — Not a kit

Accurate VOM with a sensitivity of 2000 ohms per volt on both AC and DC. Single selector switch. 3" 160 amp. meter. Scales: DC Volts: 0-10-50-500-1000; AC Volts: 0-10-50-500-1000; Ohms: 0-10K, 0-1 Meg; DC Current: 500 ua and 500 ma; Decibel: -20 to +22, +20 to 36; Capacity: 250 mmf to 2 mfd and .005 to .01 mfd. Heavy plastic panel, metal bottom. 4 1/2" x 3 1/2" x 1 3/4". With batteries and test leads. Shpg. wt. 4 lbs.

RW-27A 7.95

SUN BATTERY

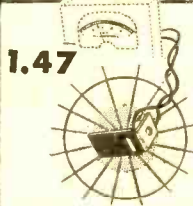

International Rectifier's Sun Battery requires no external voltage source for operation. Average sun-light will generate a 2 ma current under a 10 ohm load. Can be connected directly to a milliammeter and used as a light measuring device. Can be used in series or parallel with a power supply for transistorized equipment. Typical applications are—direct conversion of light to electricity—spectrophotometers—light measurement—traffic control—headlight dimmer—burglar alarms—timers—colorimeters—garage door opener—light beam communication. Specifications: 7.24" x .433" x .049" .60 micro amps at 100 ft. candles with 55 ohm load. 5 volt in average sun-light. .25 volts at 100 ft. candles. Complete with 1/4" mtg. bracket and 6" leads.

1.47 MS-112.....Net 1.47

By E. D. MORGAN

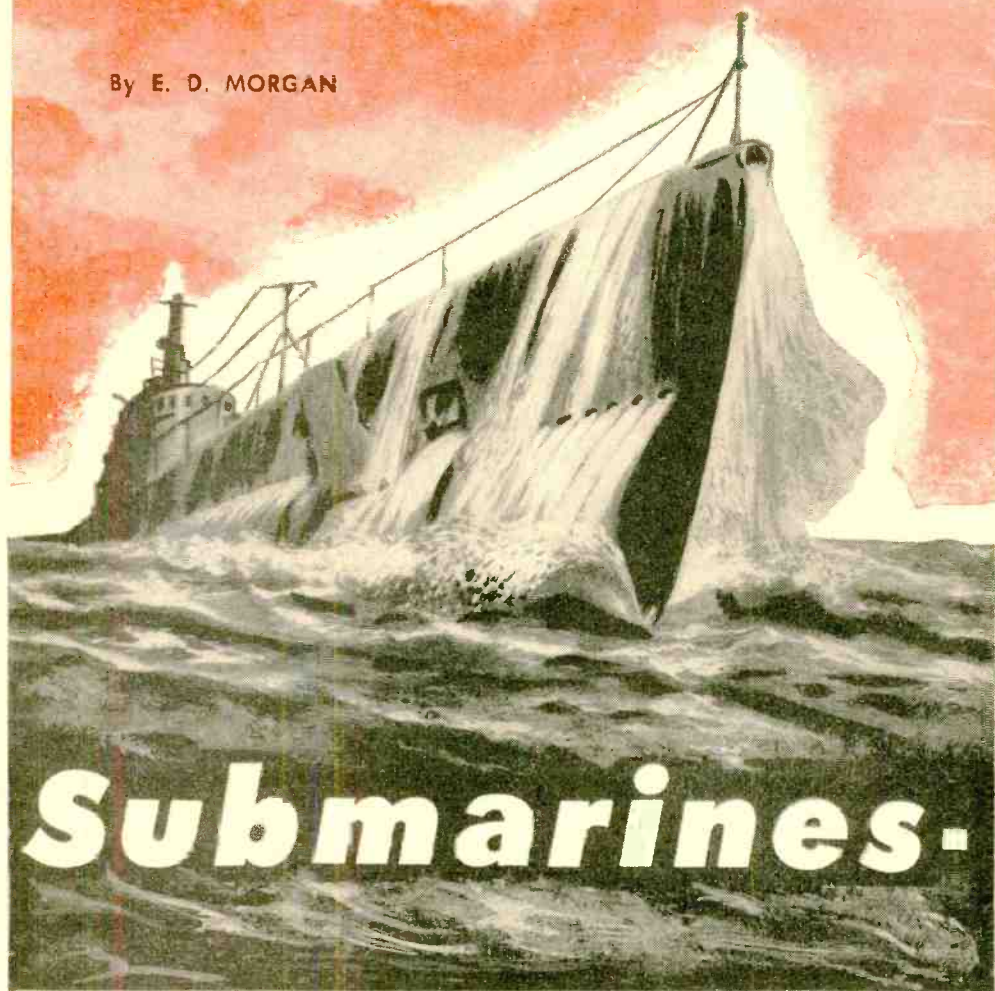

THE MODERN submarine, capable of submerged travel far from home bases, and capable of delivering missiles and rockets with atomic warheads, is a fearful weapon. Newer versions—featuring atomic power plants—appear even more formidable, and show the need for strong defenses against their attack.

The Russian Navy, for instance, has more than twice as many submarines as the United States, and over seven times the number of U-boats available to the Germans at the start of World War II. In this country, however, every available

means is being explored to insure an adequate and capable defense against enemy submarines. Electronic developments, along with the planes, ships and men needed to exploit their capabilities, are spearheading the defense.

While many of our present defense efforts are still shrouded in secrecy, some developments have been released to the American public. The methods so far perfected emphasize the versatility of modern military electronics.

One of the best ways to seek out and destroy penetrating undersea craft is from

Are We Open to Sneak Attack?

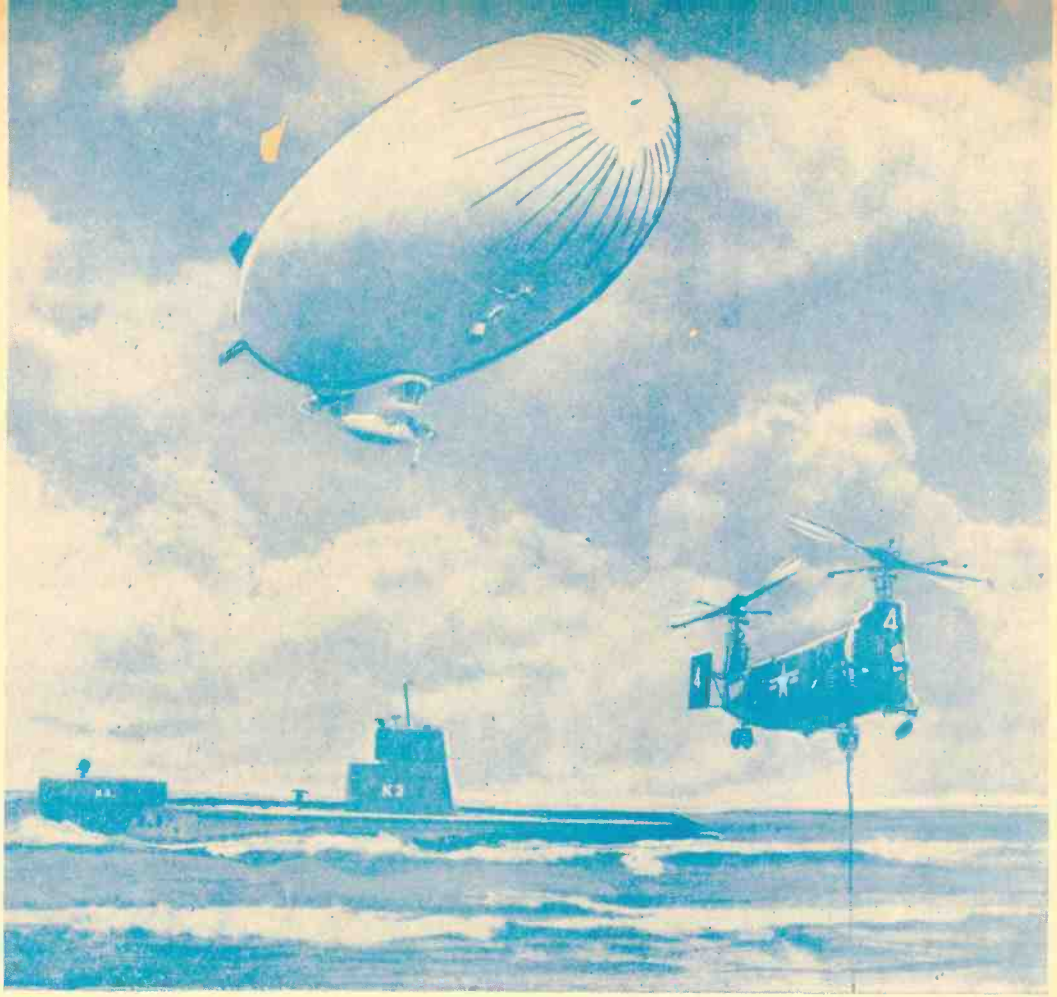

the air. Our Navy has many types of airplanes, helicopters and blimps especially equipped for this type of duty.

Carrier-based airplanes, carrying the latest in detection gear, can search out the enemy wherever he may hide. Powerful long-range radar transmitters can sweep the surface of the seas and indicate a tiny periscope or snorkel churning through the waves.

Even if the enemy submarine plunges

into the depths, it is not safe from the probing electronic eyes of our fliers. Using "MAD" gear (Magnetic Airborne Detector), the surface can be searched until the equipment receives a signal indicating the sub's hiding place. Then, sonobuoys—sensitive underwater microphones which modulate a radio carrier—are dropped in a pattern around the area. By listening to a receiver in the plane, any future movement of the enemy craft is immediately

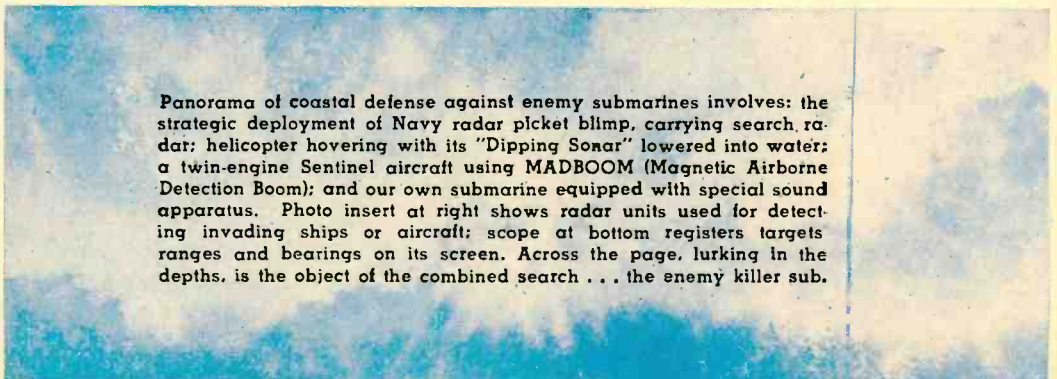

Panorama of coastal defense against enemy submarines involves: the strategic deployment of Navy radar picket blimp, carrying search radar; helicopter hovering with its "Dipping Sonar" lowered into water; a twin-engine Sentinel aircraft using MADBOOM (Magnetic Airborne Detection Boom); and our own submarine equipped with special sound apparatus. Photo insert at right shows radar units used for detecting invading ships or aircraft; scope at bottom registers targets ranges and bearings on its screen. Across the page, lurking in the depths, is the object of the combined search . . . the enemy killer sub.

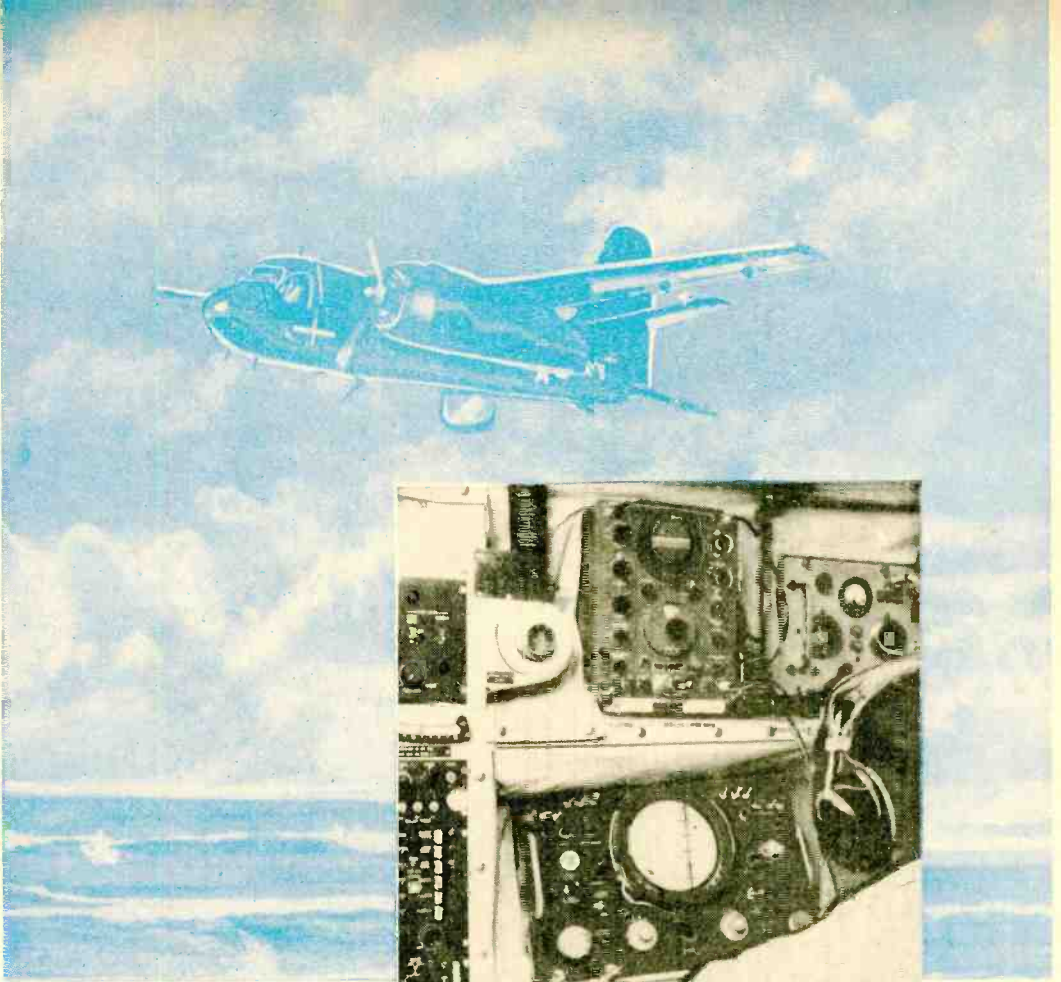

detected. This same type of equipment is carried in both helicopters and blimps. Used as patrol craft, they employ their slow speed to advantage in relentlessly hunting an enemy down for the kill. The helicopter has an additional weapon known as the "Dipping Sonar"; this sound gear is lowered beneath the surface of the water while the 'copter hovers motionless above it.

Surrounding our merchant convoys and

naval task forces, destroyers equipped with special long-range sonar equipment probe the surrounding waters for lurking undersea craft. The type of sonar used here "pings" impulses of sound into the water. Sensitive receivers then listen for a returning echo indicating the presence of an enemy hull. Mast-high radar antennas continuously scan the surface for distant indi-



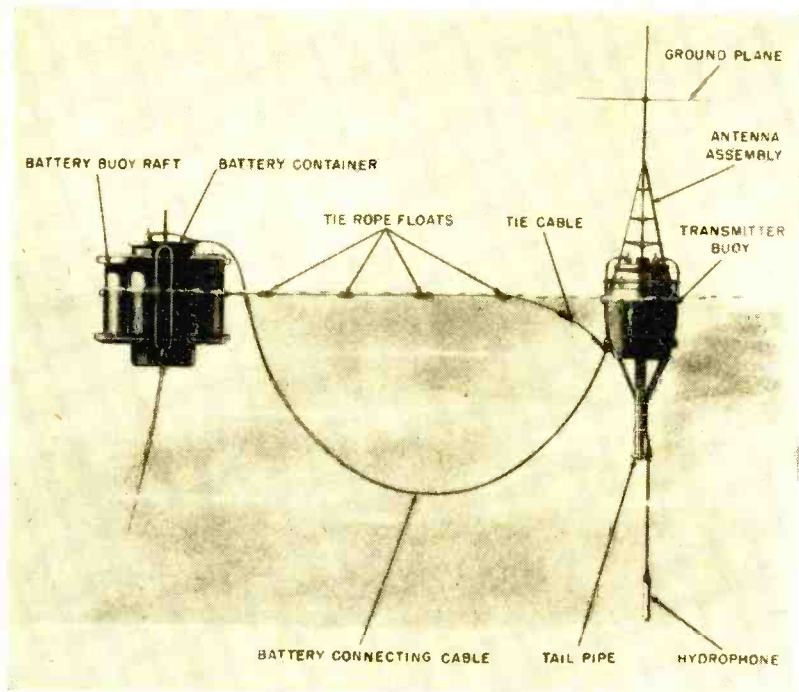

First line of defense across harbor entrance is the sono-radio buoy. Hydrophone detects underwater sounds; these signals modulate a carrier wave which is transmitted to shore receivers. Information received from network of buoys helps pinpoint enemy sub pack.

cations of surfaced or snorkeling U-boats.

Modern military warfare has even brought forth a hunter-killer submarine, especially designed to hunt down unfriendly "cousins" that menace our shipping. Equipped with ultra-sensitive "ears," it combines the best in listening equipment with the submarine's natural assets of stealth, cunning, and near-invisibility.

Guarding the approaches to our harbors, an entire array of unique electronic equipment awaits any enemy who tries to penetrate our waters. Far out on the harbor approaches, sono-radio buoys keep a relentless vigil for unexpected visitors. Like the airborne varieties, these devices combine underwater microphones or hydrophones with radio communication. Any sound which excites the sensitive pickup modulates a radio carrier and is noted by monitors on the shore.

The second line of defense is a series of cables laid in a pattern on the ocean floor. Called "Magnetic Loops," they are sensitive to changes in the earth's magnetic field. Any vessel crossing the strands immediately reveals its presence by tracing a pattern or "signature" on a pen and ink recorder on the shore. Behind the loops are strings of hydrophones which are cable-connected to monitor stations on the land. A constant listening watch is kept to insure the detection of even the weakest sound of a hostile nature.

Strategically placed along the harbor en-

trances are the "Heralds" (Harbor Echo Ranging and Listening Devices). These are remotely controlled sonar transmitters and receivers that constantly ping into the water and reveal the presence of any object by its echo. The heralds are capable of scanning the hulls of entering vessels to make sure that nothing tries to slip in "under the skirts" of a friendly ship.

The next line of defense is an even more ingenious one. Large fields of controlled mines await any "visitor" that gets beyond the sonar barrier. Controlled from the shore, the mines are equipped with hydrophones and other detection devices so that they may choose the most opportune time to blow the stranger to bits. They can be exploded by an operator listening from the shore or can be armed to fire automatically by sound, pressure, magnetic or other devices.

All of this underwater information feeds into the HECPP—Harbor Entrance Control Post—along with reports from radar operators, lookouts, and patrol craft in the harbor. From this nerve center, the entire defense of the harbor is directed—with both air and surface craft available to take up the battle if a penetration is attempted.

Electronics thus plays a leading role in this relentless battle to perfect our defenses. Men and their equipment are always ready to defend us against the submarine. This readiness may be the greatest deterrent to another war.

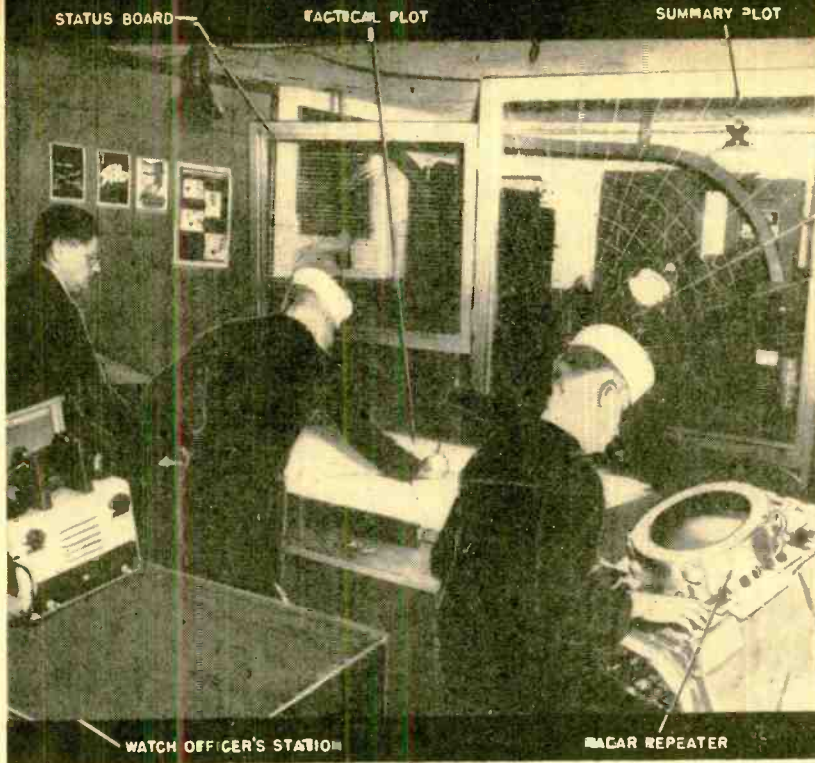

Information on enemy contacts is fed into the Harbor Entrance Control Post. Here, data is evaluated, positions plotted, and orders for action are then issued.

A glimpse behind the scenes at General Electric, Utica, N. Y., showing the assembly of radar indicators used in our coastal defense.

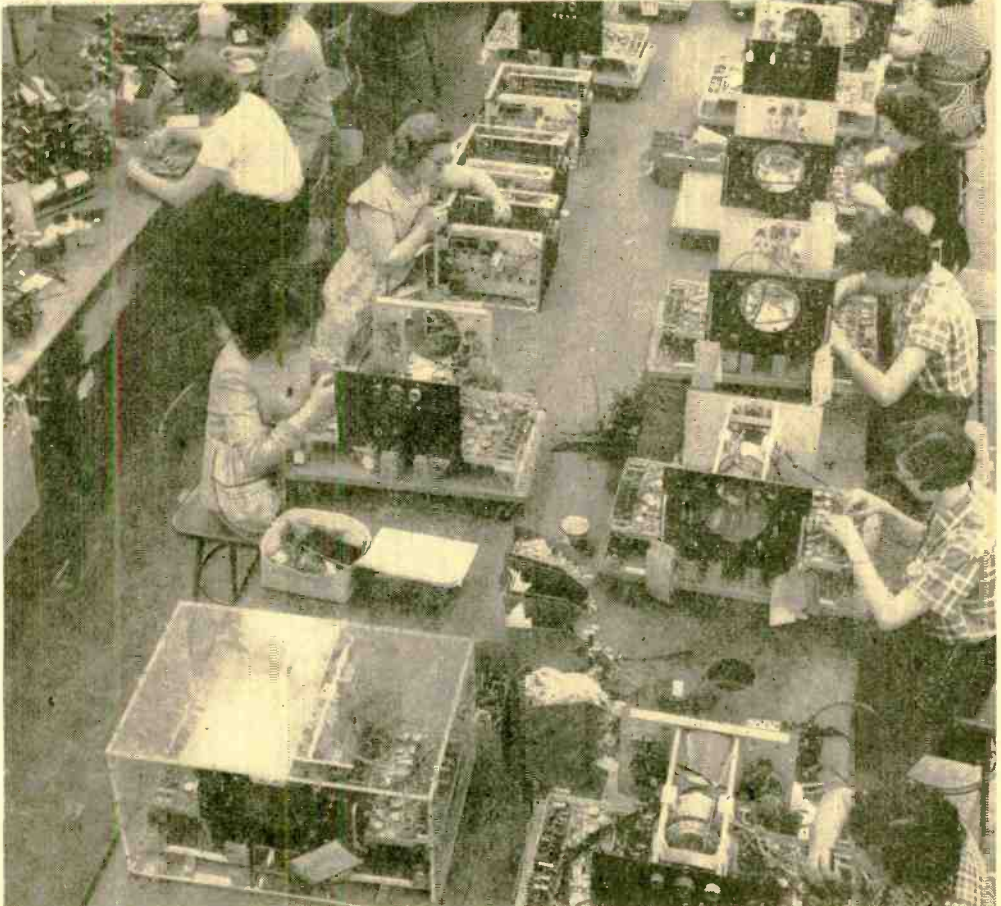

Electronics



Maps Brain Waves

By R. E. ATKINSON

Science uses the human brain as a generator of electrical waves to reveal many secrets

PROBABLY few electronic developments are more intriguing in design, application, and potential significance than the electroencephalograph (EEG). A fairly recent development, this device receives, records, and measures the electrical and sinusoidal characteristics of the thousands of tiny brain waves that accompany human thought and feeling.

Scientists have discovered that the electrical energies sent out from each person's brain are distinctly individual, personal, and different! Experts can even detect, with the EEG, differences in the ways that various people think.

It all started about a quarter of a century ago, when Hans Berger, a German psychiatrist, published accounts of the remarkable brain waves that he had produced. His pictures showed tiny electrical oscillations at about 10 waves per second. But how, asked fellow scientists ridiculing Berger, could these simple little lines reveal anything?

Though slow in developing, electroencephalography has gradually become a respected science, and rather large sums of money often are invested in the apparatus. A machine may contain dozens or sometimes hundreds of radio tubes and complex electronic controls.

The essential difference between the electroencephalograph and some of the other instruments that translate physiological information into electrograms is that an EEG represents the amplification of very,

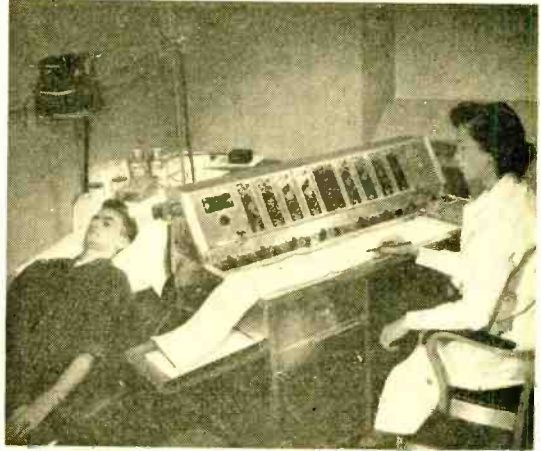

Brain waves of normal man are recorded on electronic apparatus at National Institute of Health. Many such wave patterns are on file, help establish "norms" for future research and study. Subject feels nothing, has no ill effects after half-hour test.

very minute electrical voltages into energy strong enough to move the writing pen—that is, strong enough to control the electromagnets that operate the pen. Even Berger's original oscillations (alpha rhythms) were in the frequency band between 8 and 13 cycles per second, with an amplitude of only about 30 millionths of a volt!

Translating Brain Signals

In the instrument pictured, there are eight separate panels in banks of four with a control panel separating them. The usual EEG chart shows eight or more zigzag lines, each being a signal generated from one region of the head and greatly amplified. Translating these signals meaningfully through electronics is not as easy as might be imagined. Though techniques for preamplification and stepped-up signals through a series of vacuum tubes are now commonplace, difficulties of accuracy are multiplied as the original voltage becomes



While surgeon operates on patient (operating room is behind glass panel), technician monitors progress of operation and the patient's response on EEG equipment.



Youngster is intrigued by electrode which is fastened to person's head during test. Delicate recording "pens" may be seen at lower left; they trace patterns on chart.

smaller and smaller. A skilled technician is a necessity.

Even when machine and patient have been grounded, and the source of electrical power is as constant as possible, the patient himself may affect the results of the experiment. If he perspires through nervousness, the contact of the electrodes with his skin is changed and the record is altered. Tensing or movement of muscles produces electrical currents proportionately so much greater than those generated by the brain that the muscle "artifact" obscures the brain recording. Any movement, even blinking the eyes, has an effect.

Nevertheless, carefully conducted tests regularly reveal many brain diseases which can consistently be identified by the pictures they make. During World War II, Army authorities were already checking on some mental cases with the electroencephalograph to see if the instrument would definitely establish a real brain condition, thus giving clinical evidence and also ruling out malingering.

One experiment was reported not long ago in which a subject listened to a ball game while his EEG was being taken. The pattern revealed, through electrical discharges from his brain, his sympathies for the way the game was going. But the instrument does not really read minds . . . not yet, anyway. It simply shows the electrical waves normally produced by the brain. It is much like getting a measurement of how much voltage there is in a battery.

Valuable Aid in Surgery

There is little doubt that the brain wave recordings have vastly more inherent information than scientists now can under-

stand. The possibilities for developing this science are fantastic. Even at the present threshold of knowledge, the electroencephalograph is an important aid to medicine.

In some forms of epilepsy, surgery is not feasible. Drug treatment is the only hope. At the U. S. Public Health Service's Clinical Center in Bethesda, Md., for example, volunteer research patients accept different combinations of chemicals that have shown some promise. The effect of the medicine upon the brain is monitored day-in-and-day-out by repeated EEG's.

When a lesion of the brain must be cut on the operating table, the instrument "watches" the effect of the knife from outside the operative arena, as shown in one of the photos. The graph indicates when the lesion is being reached by the surgeon. When the electrode is upon the exposed cortex, the contact is more direct than when the tissue and skull lie between the source of energy and the electrode.

The instrument panel in the center of the machine makes possible many adjustments in the "gain." The gain amplifier can be adjusted so that the range desired between the smallest and largest potential is achieved. Different combinations of readings from different electrodes are possible. Many laboratories also use special wave analyzers costing thousands of dollars in order to disentangle different and complex electrical oscillations from the brain.

EEG's may rightly be called "coded messages from the brain." As science learns how to decode these "brainprints" more thoroughly, their contents may reveal more about how the brain works as well as prove to be a valuable weapon in man's fight against disease.

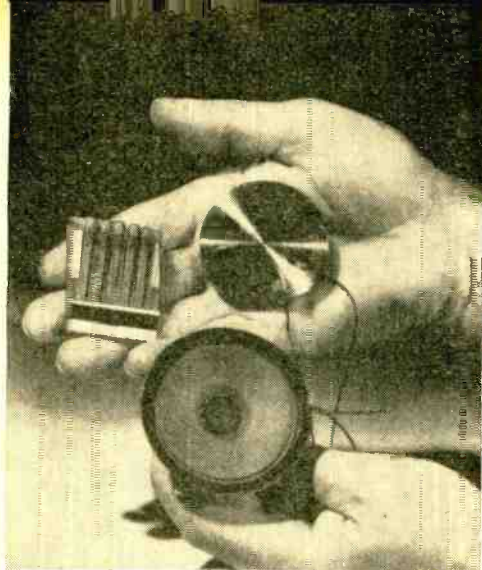

Magnet in Speaker Housing

PROBABLY THE SMALLEST LOUDSPEAKER ever built for commercial radio receivers is shown at the left. In the foreground, for comparison, is an older type of speaker with a larger diameter. The new speaker is 2½" in diameter and does not have a bulky magnet hanging out of the back of the case. Instead, the magnet is contained within the shell surrounding the vibrating speaker cone. Developed by *Radio Corporation of America*, this unit is intended to replace existing speakers in miniaturized transistor pocket receivers.

Electronic Blueprints

TO SPEED UP production of vital jet engine parts, *Bendix Aviation Corporation* has developed an electronically operated "cam machine" (below). It receives blueprint information recorded on a punched tape and translates it into lathe cutting operations. The punched tape contains all of the information required to cut a cam to exacting requirements. Instructions are electronically "read" from the tape and control the lathe cutters through powerful servomechanisms. Tolerances can be maintained to the limits exhibited by a human operator and checked for possible error while the machine tool cutting process is under way.

Although laboratory work has been done with machines of this type, the "cam machine" used by *Bendix* is the first actual production-line model to produce machine parts. Prior to its development, 400 man-hours of hand work by a skilled craftsman were required to complete a technical operation which can now be accomplished in two to four hours.

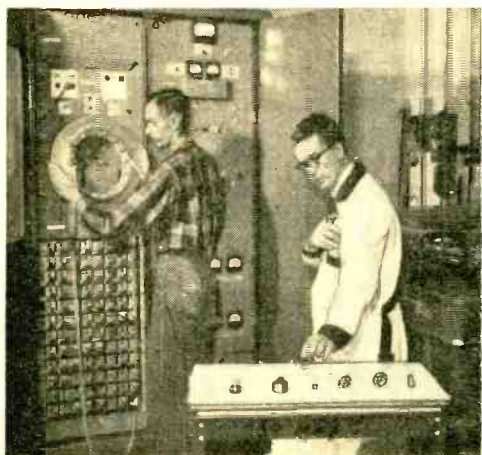

Sun-Powered Rural Telephone

BELL TELEPHONE LABORATORIES engineers have switched solar power into a new type of rural telephone system. This experimental program to improve and extend rural service is being conducted near Americus,

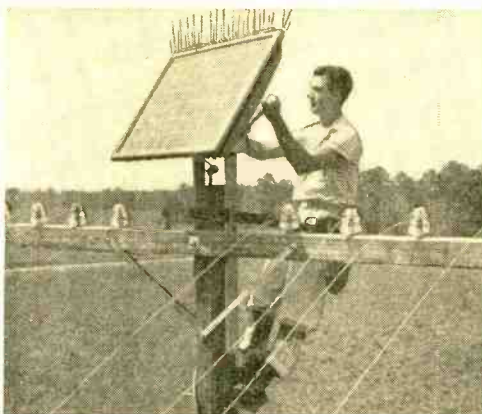

Ga., 135 miles south of Atlanta. The new system uses the "carrier" principle which allows several conversations to be sent simultaneously over a single pair of wires. Transistors replace vacuum tubes in the amplifiers and mixers, all of which are powered by solar batteries.

Master TV System Package

THE *Ampli-Vision Division* of *International Telemeter Corporation* is making available to building contractors a self-servicing, easy-to-install master TV antenna system package. This equipment enables the electrical contractor to lay out and install a master TV distribution system with only a screwdriver and conventional wire stripping tools. No electronic knowledge is required to install the system, which *Graybar Electric Company* will distribute in all TV areas.

"Master Control," manned by two technicians, channels programs from 100 different sources. It is the nerve center of an installation that includes 14 studios, 375 miles of shielded wire, and nearly 30 miles of multi-conductor cable. The system uses five million individual connections.



Giant Console Controls America's Voice

THE *Voice of America's* "Master Control" console equipment, believed to be the largest and most flexible in the world, was placed in operation recently by Theodore C. Streibert, Director of the U. S. Information Agency, marking the completion of construction work on the new radio facilities in Washington. The control equipment was specially designed and constructed to meet the unique needs of the *Voice of America* in handling 39 language programs daily.

"Master Control" is the electronic heart and brain which interconnects *Voice* studios, mobile crews, and other program sources with high-power short-wave transmitters located in three areas of the United States. It is capable of selecting programs from 100 different sources and can handle 26 separate transmissions at one time. Constructed to meet expanding needs, the equipment is now activated to select programs from 29 sources and to transmit 14 broadcasts simultaneously.

In addition to programs originating in its own studios and transcription rooms, the *Voice* has direct lines to the White House, the radio galleries of the House of Representatives, Constitution Hall, the four commercial radio networks, nine Washington stations, and its New York City studios. Through the two lines to New York, the *Voice* has direct contact with United Na-

tions headquarters and "two-way" contact with *VOA* radio centers in Munich, Germany, and Paris, France.

"Master Control" is connected to seven "feeder" bases by five direct lines to New York City, three to Cincinnati, and one to San Francisco. Other lines for monitoring purposes run to the State Department and the main headquarters of the U. S. Information Agency at 1778 Pennsylvania Avenue, N. W., Washington, D. C.

Handling over 75 different programs in 39 languages every 24 hours and a system of seven networks, the "Master Control" board was designed to permit automatic switching of all 26 channels at each program break. This automatic switching is made possible through a flexible arrangement of "presetting" the board to handle a single transmission, a group of programs, or for network operations.

The board will be operated by two radio technicians at all times except during peak periods when three engineers will be on duty. In addition to switching programs every quarter-hour, the "Master Control" technicians keep a constant check on the system, the volume level, and the work of studio engineers. The board is equipped to permit the engineers to monitor each broadcast and to have direct contact with all program sources.

-30-

Shoot to Kill—

TV Commercials!



Aim a flashlight at the photocell to control the sound on your TV set.

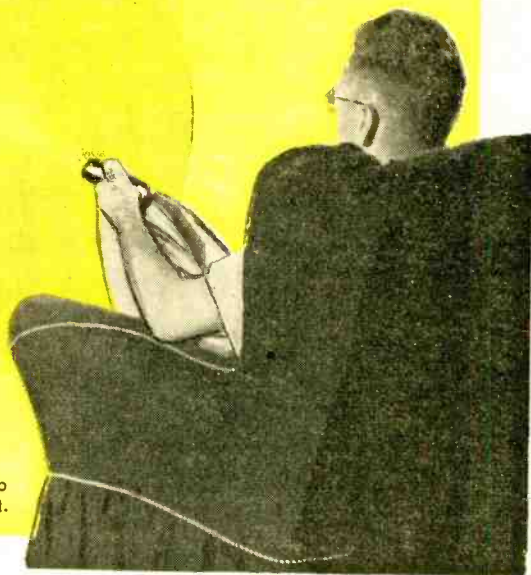

IN THE EARLY DAYS of television, when it was still pretty much of a novelty, viewers would watch every bit of each program with avid interest. But today viewers are more discriminating—they pick and choose. One thing most viewers like to discriminate against is the numerous *sponsor's messages* or "commercials."

Some TV commercials are just as interesting as the program material. But, unfortunately, not all sponsors make a real effort to present a truly interesting sales pitch. It's easy enough to avoid *looking* at a boring commercial, but the sound is difficult to eliminate without leaving one's easy chair.

Add the simple gadget shown in the photographs to any TV receiver and, without leaving the easy chair, the viewer can "shoot" a beam of light at the set and effectively "kill" a pitchman's spiel before it starts. The "Commercial Killer" is also useful for silencing the receiver while talking on the telephone, answering the door, or doing any of a dozen other tasks that can be done better in silence. And once the commercial is over, sound can be restored by casually "shooting" another beam

of light at the set. Operation is fully automatic, once triggered by the light beam—there's no need to hold the light beam on continuously either to kill or restore the sound.

The "Commercial Killer" is a self-contained instrument and, in most cases, may be installed by simply attaching two leads between it and the TV receiver. Since the unit has its own built-in power supply (a single long-life battery), it can be placed anywhere in the room; it need not be located near a wall outlet, and there's no extra line cord to add clutter to the room.

How It Works

This unit consists of two self-generating selenium photocells, *SP1* and *SP2* (see Fig. 1), followed by a two-stage transistor d.c. amplifier which, in turn, operates a relay (*RL1*). Power is supplied by a single 6-volt battery. The simple design of the instrument is based on the similar—but opposite—characteristics of *p-n-p* and *n-p-n* junction transistors. Corresponding electrode currents flow in opposite directions in the two types of transistors, permitting direct coupling between stages.

By LOUIS E. GARNER, JR.

Add this transistorized photocell relay to your TV set to allow switching the sound on and off at will with the aid of a flashlight

In operation, a small base bias current flows through the 2N34 *p-n-p* transistor. This current is established by the adjustment of sensitivity control *R1* and fixed series resistor *R2*. The fixed resistor is included simply to limit the maximum bias current that can flow, and thus to protect the transistors from accidental overload. The collector current of the 2N34 transistor is several times larger than the base current, due to the amplification of the stage; and this current is also the base current for the 2N35 *n-p-n* transistor. Additional amplification is obtained in the second stage, with the result that the collector current of the 2N35 transistor may be 100 times greater than the initial base bias current. The highly amplified current flows through the relay and controls its operation.

Under normal operating conditions, and with *R1* properly adjusted, sufficient collector current flows through the relay to

hold it closed, but not to close it (more current is required to close a relay than to hold it closed).

When light is applied to selenium photocell *SP1*, a small voltage is developed which, applied to the base-emitter circuit of the 2N34 transistor, increases the bias current slightly. This increase in bias current, amplified by two stages of direct-coupled amplification, is sufficient to close the relay. The maximum relay current is slightly over 1.0 milliamperere. The relay, once closed by the small increase in current through its coil, stays closed due to the steady current established by the initial bias, even though the light is removed from photocell *SP1*.

If light is applied to photocell *SP2*, the resulting voltage is such as to oppose the steady bias current. Note that the *SP2* photocell is connected with opposite polarity to the 2N34 transistor. This causes a drop in the output collector current which

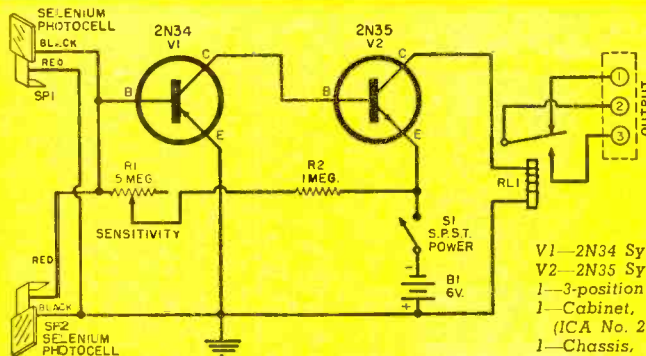

Fig. 1. Schematic diagram and parts list for control unit. Light shining on *SP1* closes relay *RL1*; light shining on *SP2* opens relay.

- E1—6-volt battery (Burgess Type Z4)
- R1—5-megohm carbon potentiometer (sensitivity)
- R2—1 megohm, $\frac{1}{2}$ -watt carbon resistor
- RL1—Sensitive relay, s.p.d.t. contacts, 5500-ohm coil (Advance No. SV/1C)
- S1—S.p.s.t. slide switch
- SP1, SP2—Selenium photocell (International Rectifier No. B2M)

- V1—2N34 Sylvania *p-n-p* junction transistor
- V2—2N35 Sylvania *n-p-n* junction transistor
- 1—3-position screw-type terminal strip
- 1—Cabinet, 3" x 2 $\frac{1}{8}$ " x 5 $\frac{1}{4}$ " aluminum box (ICA No. 29441)
- 1—Chassis, aluminum, brass or steel sheet, approx. 2 $\frac{1}{8}$ " x 2 $\frac{3}{8}$ "
- 4—Rubber feet
- 2—1" aluminum caps
- 2—5-pin subminiature tube sockets
- 1—10 $\frac{1}{2}$ " length, 1" O.D. Reynolds aluminum tubing
- 1—8 $\frac{1}{4}$ " x 7 $\frac{1}{8}$ " diameter wooden dowel
- 1—Small knob
- 1—Small, sharply focused flashlight (accessory)
- Misc. machine screws, nuts, wire, solder, etc.

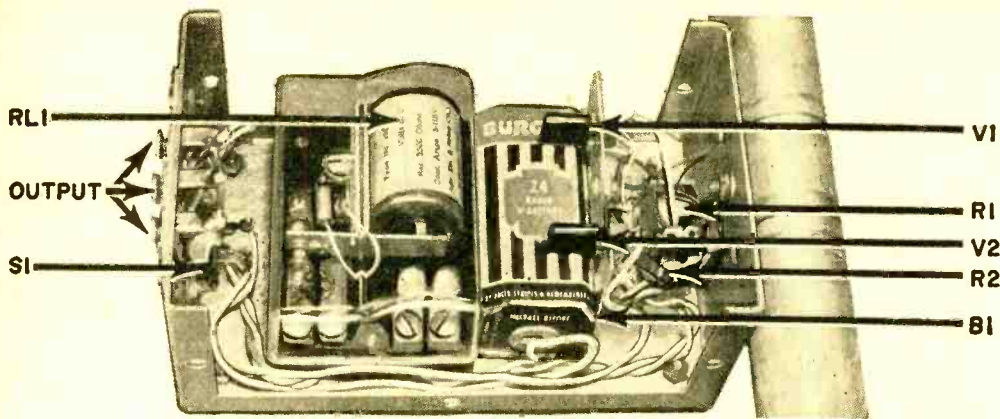

Fig. 2. Interior view of main chassis shows location of parts.

is sufficient to allow the relay to drop out or open. Once opened, the relay stays open even though the light is removed from photocell *SP2*.

Thus, by using a fixed bias and by connecting two self-generating photocells with opposite polarity to the input of a direct-coupled transistor amplifier, it is possible to obtain a "self-latching" relay action. The relay will stay either open or closed, depending on which photocell is excited last. This action is dependent on the adjustment of sensitivity control *R1*. If too little resistance is used, the initial bias current may be sufficient to close the relay and to hold it closed at all times. If too great a resistance is used, the bias current may not be sufficient to hold the relay closed.

The complete schematic wiring diagram for the "Commercial Killer" is given in Fig. 1. All the parts used are standard and should be readily available either through local suppliers or from any of the large mail order supply houses advertising

in this magazine. The control box circuit should be mounted using the chassis layout shown in Fig. 2. The subchassis may be of aluminum, steel, brass, or plastic, as preferred by the individual builder. A small scrap of *Reynolds* "Do-It-Yourself" aluminum was used for the one in the model.

Two 5-pin subminiature "in-line" tube sockets are mounted on the subchassis, but the use of these sockets is optional—the transistors may be permanently wired into position if preferred. If the tube sockets are used, however, mount them by cutting small rectangular holes in the subchassis which are slightly smaller than the tube socket bodies. The tube sockets are then forced into place, with a few drops of general purpose cement (such as *Duco* or *General Cement* No. 45-2 cement) added for additional security.

Assembling Photocell Arm

In operation, a light beam striking one photocell turns the sound off; when the

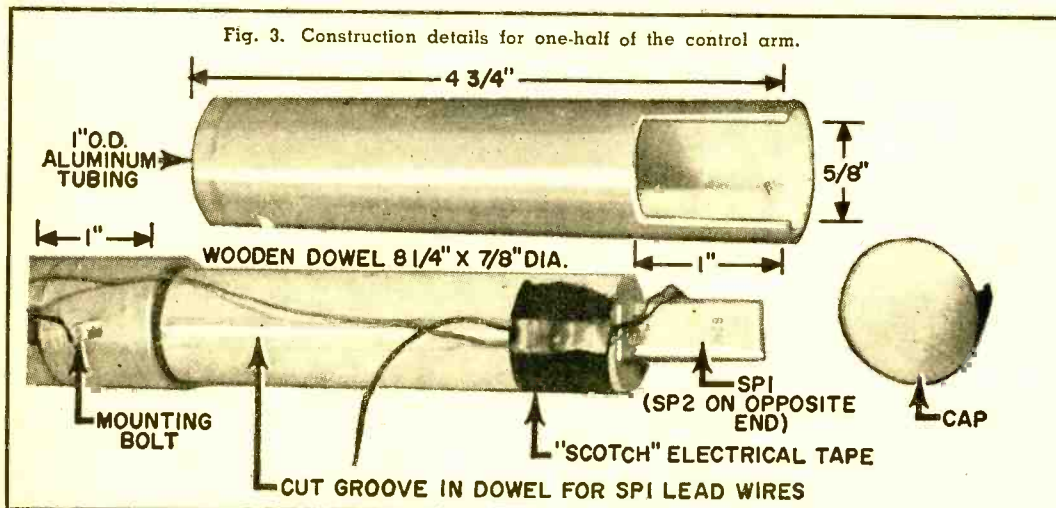
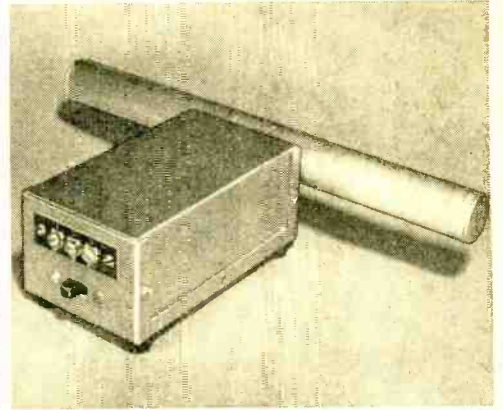
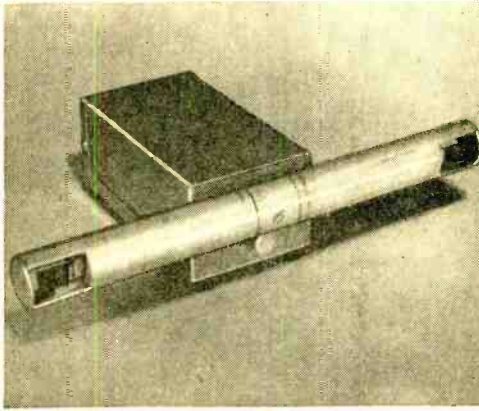

Fig. 3. Construction details for one-half of the control arm.



Front view (left) and rear view (right) of complete assembly.

beam strikes the other photocell, the sound is turned back on. Since most inexpensive flashlights do not furnish a really sharp focused beam, the two photocells are mounted at opposite ends of a control arm. Thus, it is possible to aim the light beam at the desired photocell without affecting the opposite cell. Construction details for half of the control arm are given in Fig. 3—the other side of the arm is identical.

The selenium photocells (*SP1* and *SP2*) are mounted with small wood screws at opposite ends of an $8\frac{1}{4}$ "-long wooden dowel. A plastic rod may be substituted for the wooden dowel if desired, but a metal support should not be used since the photocells are connected internally to their mounting brackets. Mounting both on a metal support will short them and prevent proper operation.

A groove is chiseled or whittled in the wooden dowel and the photocell lead wires run through it. "Scotch" electrical tape is used to hold the lead wires in position.

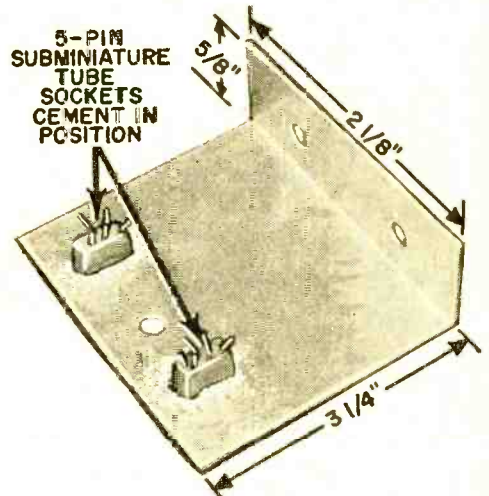

MATERIAL: 22 GA. ALUMINUM

Details of subchassis construction.

Fig. 4. Two methods for connecting the speaker to the "Commercial Killer." Photo at right shows leads connected to speaker.

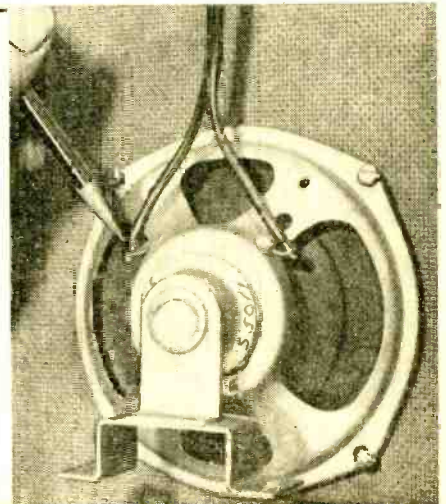
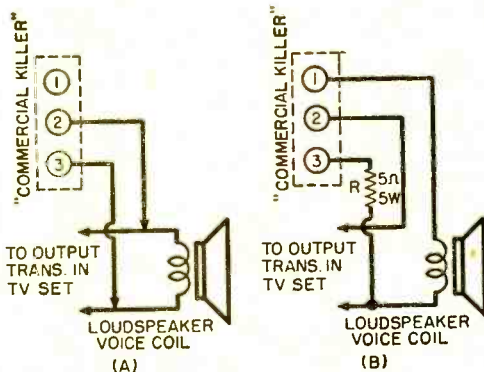

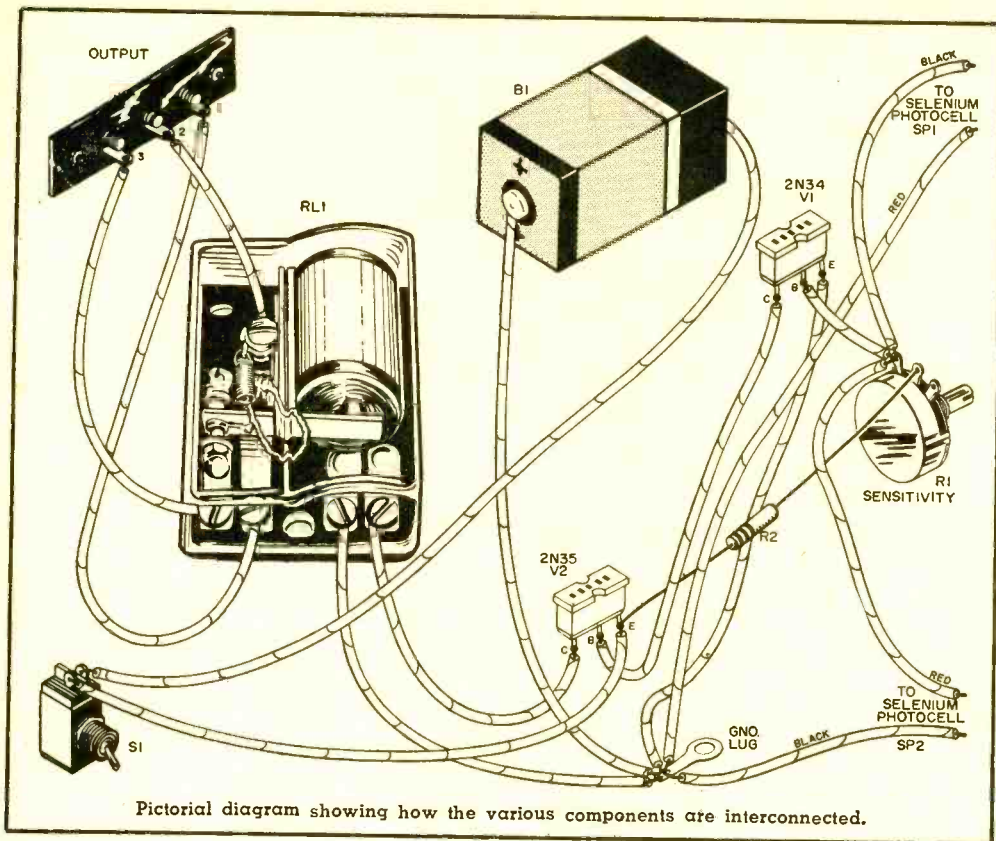

The completed assembly is covered by lengths of *Reynolds* "Do-It-Yourself" aluminum tubing, with holes cut out at each end to permit light to strike the photocells. Plastic, cardboard, or fiber tubing may be substituted for the aluminum if desired, for its only purpose is to protect the cells and to provide a "finished" appearance.

Use of a two-stage direct-coupled transistor amplifier provides considerable sensitivity and eliminates the need for a lens to focus light on the photocells. If a lens were used, the sensitivity could be increased still further, but only at the expense of a limited range of operation. With a lens, the light would have to come from almost directly in front of the unit to obtain proper operation. Without a lens, satisfactory operation can be obtained with light coming from a wide angle.

With the control box and control arm assembled, the two units may be mounted and connected together. A single long machine screw and nut may be used for mounting the control arm on the control box.

Lead dress is not at all critical, but a few general precautions should be followed to avoid damaging the components. Pay particular attention to the transistor connec-

tions—note that two different types of transistors are used in the circuit. Interchanging the transistors or connections can lead to serious damage. Identify the transistor sockets in some way. Mark the 2N35 (*n-p-n* transistor) socket with a dab of red fingernail polish.

When the wiring is completed and double-checked for errors, install the transistors in their proper sockets and turn the power switch (*S1*) on. Adjust sensitivity control *R1*. With the control turned to maximum resistance, the relay should be open; with it turned to minimum resistance, the relay should be closed. The point of proper operation is where the relay is just ready to close. If it is impossible to open and close the relay by turning *R1* to its limits of rotation, a defective part or an error in wiring is indicated—turn off the power immediately and double-check for errors!

Installation and Adjustment

With the wiring completed and the "Commercial Killer's" operation checked out, the top cover may be installed and the unit connected to the TV receiver. Connections are made to the loudspeaker's
(Continued on page 116)



POWER SUPPLY

FOR TRANSISTOR EXPERIMENTS

IF A word-association game were played with a large number of electronic experimenters, far too many of them would answer the word "transistor" with "battery." Batteries are fine for portable equipment, or for equipment where voltage requirements have been worked out and are known; but on the experimenter's test bench, it is a different story altogether. Here, requirements may run anywhere from 2 or 3 volts for one setup to perhaps 25 or 30 for another. Obtaining this range in steps of $1\frac{1}{2}$ or 2 volts requires a cumbersome, space-consuming array of cells. Obviously, the answer is an a.c.-operated supply.

Design Features

The transistor power supply shown in the photos is a high-quality unit, designed especially for experimental test-bench operation. It is capable of handling a current tremendously greater than will ever be required in the average transistor setup, and the potentiometer specified will take many, many thousands of operations before it even feels inclined to wear out. Cheaper potentiometers begin to wear relatively early after being put into operation—and once wear begins in earnest, the wiper and the resistance element "go to pot" in a hurry.

A diffused junction germanium 1N91 rectifier has been used to provide a low voltage drop. The 1N91 is very small, considering its current-handling ability, and it costs little more than a selenium unit of

By **FRANK H. TOOKER**

Build this supply for use on your experimental bench; it will provide voltages ranging from 2 to 30 volts as needed

the same rating. A pair of 25- μ fd. electrolytic capacitors and a 8.5-henry choke take care of adequate filtering. A 1000-ohm bleeder resistor connected across the input to the filter maintains a constant load on the supply. Everything runs cool except the potentiometer, which has a fairly high current running through it to overcome any tendency toward erratic operation due to varying contact resistance.

Voltage output from the supply is continuously variable from zero to 30 volts d.c. A high-quality meter, connected across the output terminals, monitors the d.c. level. Two voltmeter ranges are provided: that of the meter itself—which is 0-10 volts, and a X3 range—obtained through the use of a 20,000-ohm, 1% precision series multiplier resistor which extends the scale to 30 volts. Each subdivision on the meter scale is equivalent to 0.2 volt on the low range and 0.6 volt on the high range. It is possible to set the output voltage to within one sub-

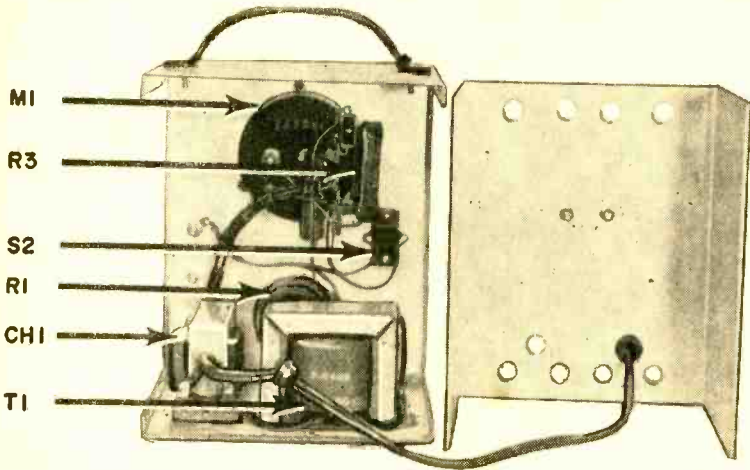

Rear view of chassis with cover removed and with some of the components identified. The unit is capable of handling currents greater than will ever be needed in the average transistor setup, and the potentiometer specified (R1) will take many thousands of operations before even beginning to wear out.

division, i.e., 0.2 volt, on the low range, and better than one subdivision on the high range.

Construction

Shown in Fig. 1 is the circuit diagram of the transistor supply. The unit fits nicely into a 4" x 5" x 6" gray hammertone aluminum box. Both "+" and "-" terminals are insulated from the box by means of ex-

truded fiber washers pressed into the holes from the inside. The Bakelite base of the terminal provides insulation on the panel side. The center or *gnd* terminal is connected directly to the box to permit the box to be grounded whenever necessary. Either the "+" or "-" terminal may be grounded to the box simply by connecting a short jumper wire between the appropriate terminal and the center terminal.

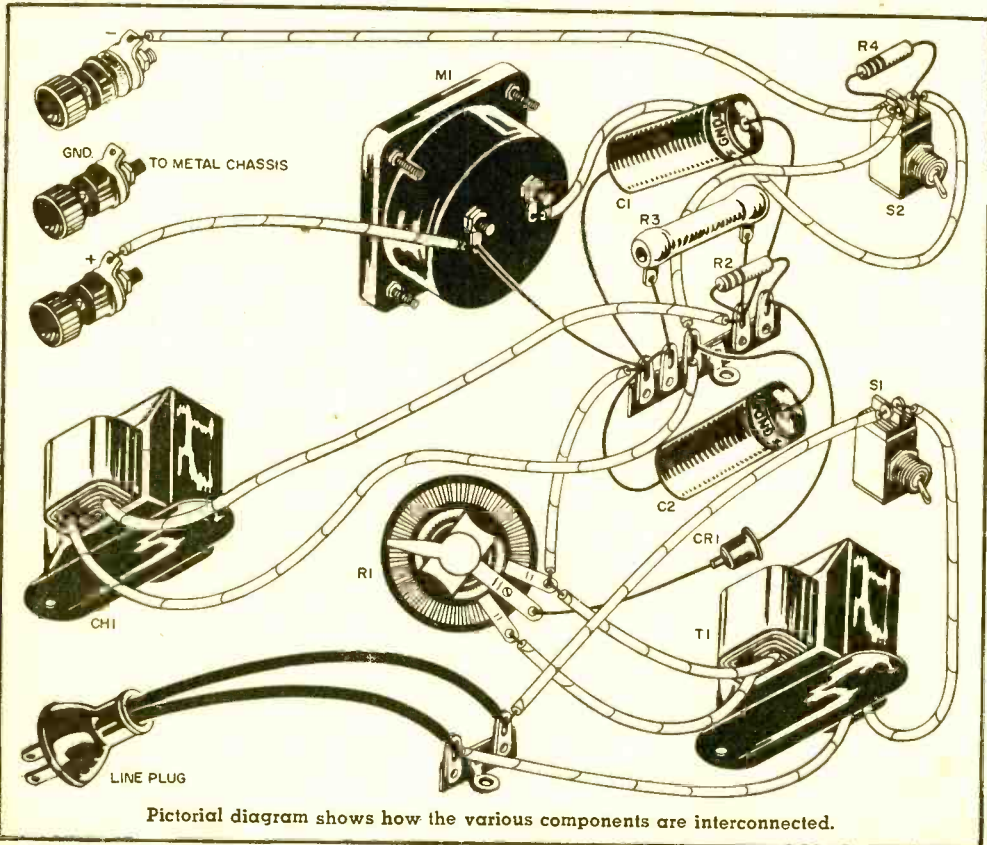

Pictorial diagram shows how the various components are interconnected.

C1, C2—25- μ fd., 25-volt electrolytic capacitor (C-D BBR-25-25 or equal)

CH1—8.5-henry, 50-ma. filter choke (Stancor C-1279 or equal)

CR1—Diffused junction germanium rectifier (G.E. Type 1N91 or equal)

M1—0-10 volt voltmeter, 1000 ohms per volt (Triplett 221-T or equal)

R1—100-ohm, 25-watt potentiometer (Ohmite H-0151 or equal)

R2—10-ohm, 1-watt composition resistor

R3—1000-ohm, 10-watt wire-wound resistor

R4—20,000-ohm, 1% precision resistor (IRC Type DCC or equal)

S1, S2—S.p.s.t. toggle switch

T1—25.2-volt, 1-ampere, filament transformer

1—4" x 5" x 6" 2-piece gray hammertone aluminum box

1—Screen door pull (for handle)

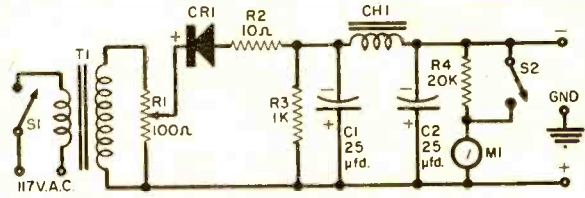

Fig. 1. Schematic diagram and parts list for power supply.

1—Rope cleat

1—Power cord

1—2-lug tie point

1—5-lug tie point

4—Sponge rubber discs (for feet)

1—Fluted knob, flange-type, 2 1/8" diameter

3—Binding posts

Misc. hardware, solder lugs, extruded fiber washers, decals, rubber grommet, wire, solder, etc.

The meter multiplier resistor is located on the meter switch. All other resistors and capacitors are secured by their leads to a 5-lug tie strip which, in turn, is secured under the nut of the negative terminal on the meter. The diffused junction germanium rectifier connects between the uppermost terminal on this strip and the center lug on the potentiometer. A 2" to 2 1/2" length of No. 20 bare, tinned copper wire is soldered to the lower lead of the rectifier to extend its length. A long lead is desirable here because the potentiometer runs hot and the greater length allows the heat conducted to the lead to be dissipated before it can reach the rectifier.

A series of 3/8"-diameter holes drilled in the back of the box permits adequate ventilation for the potentiometer. More direct ventilation may be obtained by drilling a 1"-diameter hole in the bottom of the box directly under the potentiometer. In this case, the series of holes at the bottom of the back cover of the box can be eliminated. Either method will work well since

the heat dissipated by the potentiometer is not severe. A 2-lug tie point, secured under one of the screws holding the filter choke, takes care of the power cord connections.

Using the Supply

In using this supply, it should be kept in mind that adequate series resistance should be employed in all necessary leads to prevent transistor burn out in the event of a runaway circuit. This is, of course, no different from the precautions which should be taken when batteries are used. Buy all the batteries you like for your finished transistorized equipment, but build this supply for use on your experimental bench. Not only will it give the voltage you want when you want it, but it will tell you what batteries will be needed for finished jobs as well. What is more, you can extend the life of the batteries in portable transistorized equipment by operating it from this supply whenever you're at home and an a.c. outlet is nearby. —50—

Computer in Kit Form

THE Heath Company (a subsidiary of Daystrom, Inc.), pioneer in development and manufacture of electronics kits, has made available to the public a kit of parts for building a low-cost electronic analog computer. Production of this kit will enable many universities and small industries to enjoy the advantages of an analog computer at a bare fraction of the cost of fully assembled commercial units. The latter now represent investments of \$10,000 to \$60,000. Designed for the greatest possible flexibility, the Heath analog computer is a complete desk-top type unit. Although at this writing the price has not yet been finalized, it is reported that the figure will

be on the order of \$700. Further information may be obtained by writing to the Heath Company, Benton Harbor, Mich.

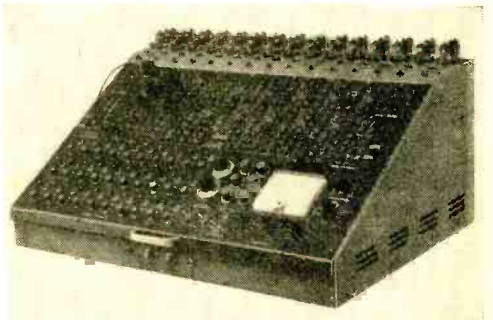

How to build a 500-kc. frequency standard quickly and cheaply

By
NEIL A. JOHNSON
W2OLU

Kitchen measuring cup serves as a "chassis" for this unit, which can be attached to the inside of any receiver having mesh- or punched-metal cabinet. Note small knob for adjusting trimmer capacitor.

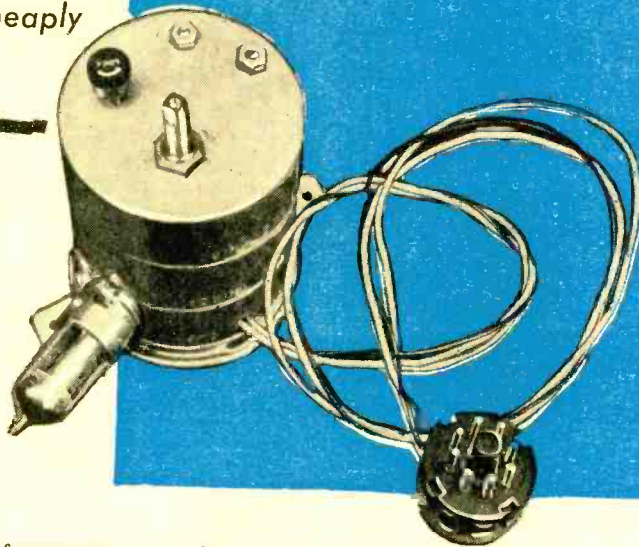

HERE IS good news: a 500-kc. frequency standard that you can build in a short time for just a few dollars. It can be calibrated against WWV and is stable enough to hold its calibration.

The oscillator uses only a few parts and they are easily available and inexpensive. The circuit, as shown in the schematic diagram, is a series-fed Hartley using a 6C4 tube. No power supply is needed; heater and plate power are obtained from the receiver with which the oscillator is used.

Frequency stability, which is the most important feature, requires good-quality parts and careful construction. Doing the job right costs so little time and money that it isn't worthwhile to sacrifice quality for the sake of a few minutes or a few cents. Suitable parts are shown in the parts list. Experienced amateurs can make substitutions and, possibly, save money by searching their junk boxes.

The r.f. choke used for *RFC1* should have an integral mounting of low-loss insulation. Normal commercial variations from the nominal inductance value of 2.5 mhy. are acceptable, since they can be compensated for by adjusting capacitance. For the Hartley circuit, a tap will have to be added to the choke.

Tuning capacitor *C1* and vernier *C2* should be either air-dielectric or NPO ceramic type. In the author's final version of the oscillator, an APC (air padder capacitor) type was used for *C1* instead of the 50- μ fd. ceramic shown on page 51. The vernier capacitor may be from 3 to 5 μ fd. maximum capacitance; its effect on the frequency is reduced by having it tapped down on the coil.

Details of the power-take-off adapter are

not shown because they will depend upon the design of the receiver with which the oscillator is used. Select a low-frequency (preferably audio) socket in the receiver. Obtain a similar socket and matching plug. Fasten them together mechanically and connect the corresponding terminals of the plug and socket. Bring out wires from the pins carrying the heater voltage and those connected to B+ and ground. *Caution:* If your receiver is of the a.c.-d.c. type, B- probably is *not* the signal ground. If you are familiar with the necessary modifications and precautions, though, you can use the oscillator with an a.c.-d.c. set.

The "chassis" shown in the photo above, which is also a shield for all of the oscillator circuit except the tube, is made from an ordinary aluminum kitchen measuring cup (standard 8-oz. size). Angle brackets are provided for mounting the oscillator on the chassis of the receiver. Since the wall of such a cup is thin, frequency stability requires the mounting of the tank circuit components to be stiffened. The internal-view photograph shows how this was accomplished in the author's model. (Incidentally, this photo is a cutaway view, the large circular plate corresponding to the bottom of the original cup.) Notice that the r.f. choke is mounted on a rectangular piece of aluminum somewhat thicker than the wall of the cup, and that the wiring between the choke and the two capacitors is of fairly large, stiff wire.

Placement of the parts can be as shown in the photographs, or varied somewhat, provided that the frequency-determining parts of the circuit are kept rigid. Although the signal frequency, 500 kc., is not particularly high, parts should be placed so

Four Dollar Frequency Standard

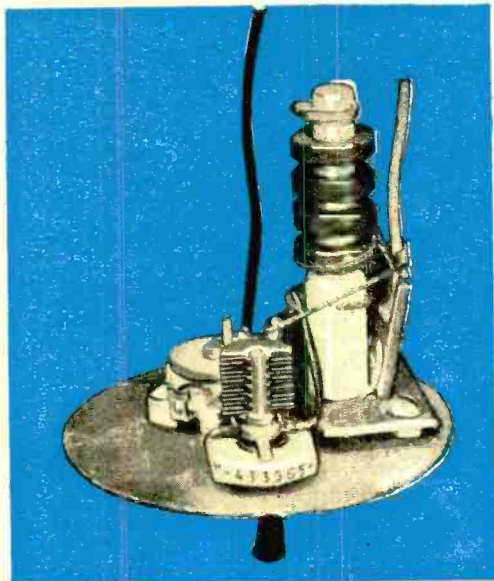

This enlarged photograph clearly shows the placement of tuning capacitor, trimmer capacitor and the tapped r.f. choke. Wires from the latter are secured to double-lug insulated terminal strip for protection.

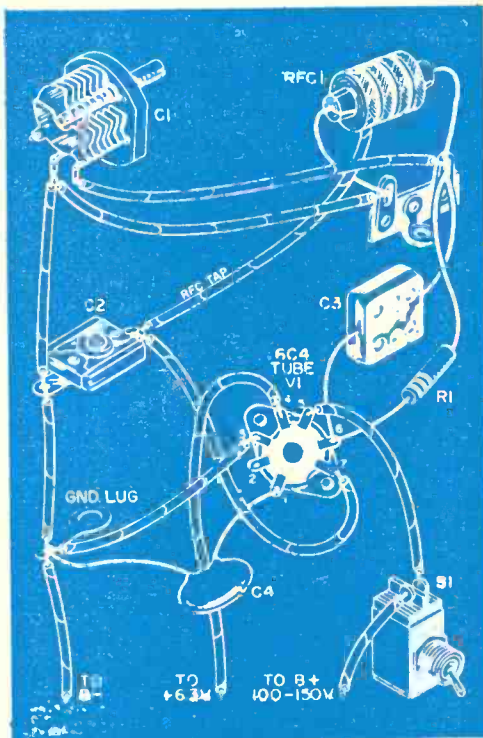

that all of the wiring in the signal circuit can be kept reasonably short. The shaft of the trimmer capacitor *C2* should be accessible for adjustment when the oscillator is mounted in the receiver. *C1* need not be accessible. Connect the parts as shown in the schematic and pictorial wiring diagrams.

That's all there is to it. It won't cost more than four or five dollars—probably less. And it won't take *much* more time to build this frequency standard than it took to read about it.

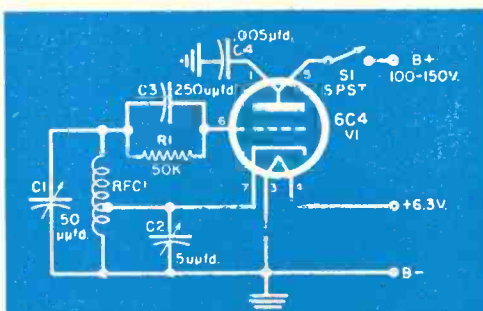

- R1—50,000-ohm, 1/2-watt resistor
- C1—25-50 μ fd. bandsetting capacitor, air type (Hammarlund Type APC-50) or ceramic (Erie Type NPO 25- μ fd. fixed capacitor and Erie Type NPO 5-25 μ fd. trimmer in parallel)
- C2—5- μ fd. air-spaced midget (Johnson Type 16C-102 or Hammarlund Type MAC-5)
- C3—250- μ fd. silver mica capacitor
- C4—005- μ fd. disc ceramic capacitor
- RFC1—2.5-mhy. r.f. choke, insulated mounting (National Type R-100S) tapped between first and second pies from ground end
- S1—3.p.s.t. toggle switch

Pictorial and schematic diagrams of frequency standard, with parts list.

- V1—6C4 tube
- 1—7-pin miniature socket, shield-base type
- 1—Adapter for power take-off (socket and plug to match desired socket in receiver)
- 1—Double-lug insulated terminal strip
- 1—Aluminum measuring cup (for "chassis")
- 1—Piece of scrap aluminum ("stiffener" to mount r.f. choke)
- Misc. machine screws, nuts, wire, and solder as required

Building an ALL-BAND PRESELECTOR



Front view of preselector. Fine tuning control is at left, gain control at right.

By FRANK H. TOOKER

Install this unit in front of your present s.w. receiver for increased gain and selectivity and greater listening pleasure

RARE indeed is the ham, SWL, or experimenter who has not experienced the need for additional gain and selectivity in his receiver—to pull a weak DX station up out of the noise level or to help get rid of those pesky images on the higher frequency bands. If your receiver is anything less than the best, the preselector described here will provide the extra “plus” in performance which gives added pleasure to listening. It tunes all frequencies from 2.2 to 30 megacycles, yet uses only one easily made coil and one tuning capacitor!

How It Works

The preselector automatically tunes two bands of frequencies at the same time. The lower band covers 2.2 to 9.5 mc., and the higher band from 7.0 to 30 mc. Therefore, when the pointer of the preselector's main tuning dial is set all the way to the left, signals on 2.2 and 7.0 mc. are being received and amplified simultaneously in the preselector. Both signals are delivered to the input of your receiver. But the receiver will pass and amplify only that signal to which its input circuit is tuned. Thus, if you tune your receiver to 2.2 mc., you will receive the 2.2-mc. signal being amplified in the preselector. The 7.0-mc. signal will be rejected. Similarly, if you tune your receiver to 7.0 mc., you will receive the amplified 7.0-mc. signal and the 2.2-mc. signal will be rejected.

The same thing occurs at the high end

of the preselector dial, i.e., when you turn the pointer all the way to the right. In this case, however, the two frequencies being received and amplified simultaneously in the preselector are at approximately 9.5 and 30.0 mc. Frequencies in between these two sets of extremes will, of course, be received at intermediate settings of the dial.

Dual-band tuning is easily accomplished by employing a single center-tapped coil. Coupling to the antenna is effectively carried out by using a primary coil coupled inductively to the bottom or ground end of the center-tapped tuning coil.

Mechanical Design

The preselector circuit is shown in Fig. 1, and the layout of parts and the wiring scheme are shown in the pictorial and photos. Construction isn't at all difficult but attention to detail is essential.

Begin construction with the panel. Dial mounting instructions are given in the sheet of directions accompanying it. Read this sheet carefully and completely before drilling any holes in the panel. If you intend to use lettering and dial decals, as are shown in the front view of the unit, do this immediately after drilling is completed. Then put the panel away to dry in a safe place while you go ahead with the remainder of the construction. After about 24 hours of drying, the panel may be finished

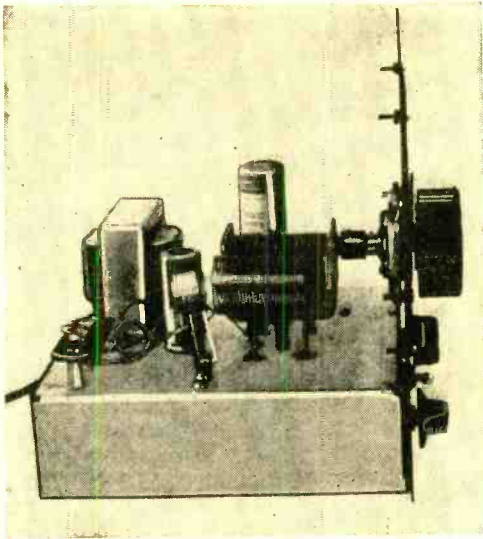

This view shows the components mounted above the chassis and on the front panel.

by giving it a couple of coats of transparent plastic spray. Complete instructions for using decals appeared in the July, 1955, issue of *POPULAR ELECTRONICS*.

Layout of the chassis can be determined from the photos. Place the major components temporarily on the chassis in their proper positions, and mark the chassis for drilling. Orientation of the socket should be such that a line drawn between pins 2 and 3 on one side of the socket, and between pins 6 and 7 on the other side, will be parallel to the back of the chassis. This line will fall through the center of the socket. Pins 1, 2 and 7 should be toward the front of the chassis.

Location of the holes for mounting the antenna-coil L-bracket will be determined by the type and size of the bracket used. The three holes to be drilled through the front of the chassis for the fine tuning, on-off, and gain controls are best located by positioning the chassis behind the panel and scribing through the holes in the panel.

The tuning capacitor specified has a $\frac{3}{8}$ "-diameter shaft, so an extender-reducer will be required to match it to the $\frac{1}{4}$ " opening in the coupling on the dial mechanism. Cut the shaft of the capacitor back to a length of $\frac{7}{16}$ ", and the $\frac{1}{4}$ "-diameter shaft of the extender-reducer back to a length of $\frac{5}{16}$ ". The coupling on the dial mechanism shown in the photos has had $\frac{1}{4}$ " removed from its length and the hole for the set-screw redrilled and retapped in the remaining portion. If it is not convenient to cut back and retap the coupling, all holes associated with the tuning capacitor, the tube socket, and the single hole for the two-lug

tie point located below deck between the capacitor and tube socket should be moved $\frac{1}{4}$ " toward the back of the chassis.

As purchased, the tuning capacitor has a small trimmer across each of the front and rear sections. The trimmer across the rear section will not be needed. As leaving it in place might adversely affect the tuning range of the circuit, it should be removed. To do this, remove the screw in the trimmer, thereby releasing the thin, narrow, copper plate immediately beneath the screw. This copper plate is attached to the metal shield which separates the front and rear stator sections of the capacitor. Using a pair of small scissors or a fine jeweler's saw, cut off the copper plate close to the rear side of the metal shield. The copper plate and the mica spacer which was between it and the stator will not be used. Leave the front trimmer (the one nearest the rotor shaft) in place.

Making the coil will be a relatively simple matter if a B. & W. "Miniductor" No. 3015 (1" dia., 16 turns per inch) is used. First, cut off a section of the "Miniductor" having exactly 29 turns. Directions for cutting the coil are given on the box in which the coil stock is purchased. Unwind $\frac{1}{2}$ turn from each end of the coil to provide leads, leaving 28 complete turns. Count them to make sure. Then find the center turn of the coil. To the left and right of this center turn, press the adjacent turns in toward the center about $\frac{1}{16}$ " to provide space for attaching and soldering the center tap.

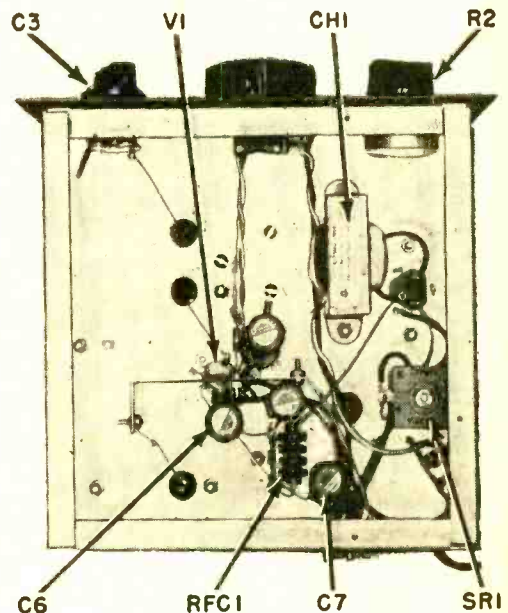

Under-chassis view of unit with major components identified to indicate layout.

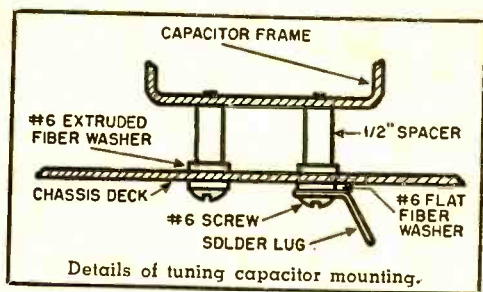

The center tap is formed from a piece of No. 20 tinned copper wire about 2" long. Make a small loop at one end. Hook the loop under the center turn of the coil in the place prepared for this purpose. Squeeze the loop closed with a small pair of needle-nose pliers. Solder the connection; only a very small amount of solder is needed. Examine the soldered joint to make sure the connection is not touching the turn on either side. There should be more than ample clearance.

Construction Hints

Stability in a high-frequency amplifier of this type is largely a matter of attention to detail. The input and output circuits should be well isolated. This is accomplished by inserting a shield across the center of the tube socket, and by keeping the components and wiring associated with the input circuit above the chassis as far as possible, and the output circuits below the chassis. Trim the shield to fit snugly down over the socket, between pins 2 and 3 on one side of the socket, and between pins 6 and 7 on the other side.

To give yourself plenty of space in which to work, mount the socket, position the shield, and solder the shield thoroughly to the small metal post in the center of the socket before mounting any of the other components. Then loosen the nut on the socket mounting screw that is on the same side of the shield as pins 1, 2 and 7, and add a solder lug. Solder lugs, held in place by No. 6 screws, should also be put on the shield as shown in the pictorial diagram. A single lug is located at each of the holes at the ends of the shield.

To keep the coil well away from the chassis and to locate the main tuning dial at a pleasing and convenient height on the panel, the tuning capacitor is elevated on 1/2" metal spacers, as shown above. Radio-frequency currents in the grid circuit are kept from flowing on the chassis by using extruded fiber washers between the spacers and the chassis deck, and flat fiber washers below deck between the screw heads and the chassis. This, plus the Bakelite coupling furnished as part of the

dial, insulates the capacitor from the chassis and panel.

A solder lug is located under the head of the capacitor mounting screw nearest the tube socket, and a short bare wire connects from this lug to the nearest lug on the tube socket shield—to ground the capacitor directly at the r.f. ground point for the cathode of the tube.

All r.f. ground connections should be made with short direct leads to the tube socket shield, with the exception of that of the fine tuning capacitor which is automatically made to the chassis when the capacitor is mounted. Since the maximum capacitance of this unit is small compared to the sum of all other capacitances in the circuit, no serious feedback results from this connection. Connect the tube socket shield to chassis ground at the lug under the socket mounting screw. The heavy line in Fig. 1 denotes the socket shield.

Mounting the Coils

Mount the center-tapped tuning coil 1 1/8" above the chassis and about 5/8" to the left of the tuning capacitor. Clip off excess lead lengths. The ground connection for the coil is made to a solder lug held in place by a No. 6 screw in one of the extra tapped holes on the underside of the capacitor frame. Since the coil leads are short, they are sufficiently stiff to hold the coil in place for all ordinary applications without any other form of support. If a more rigid support is needed or desired, a length of polystyrene strip or rod may be cemented to the center of the coil and bolted to the chassis deck.

The primary or antenna coil, which consists of eight turns of the same "Miniductor" used for the tuning coil, is made adjustable so that coupling for optimum performance may be obtained with different antennas. Provision has been made to accommodate either a balanced line, such as is used with a folded dipole, or a single-wire antenna. When a single wire is used, connect a jumper from the ground terminal to the center terminal of the three-terminal antenna strip, as shown in the top view photo of the unit.

The antenna coil is cemented to one end of a narrow strip of polystyrene. At the other end, a hole for a No. 6 screw allows the polystyrene strip to be held against a small L-bracket attached to the chassis. Mounting the three-terminal antenna strip on 1/2"-high metal spacers permits adequate clearance between its solder lugs and the chassis.

Note that two sets of hardware are required for the three controls mounted on the front of the chassis. The first set mounts the controls on the chassis and

the second set secures the chassis to the panel. This method of construction provides clearance between the chassis and the panel to accommodate the bottom lip on the cabinet.

Power Supply Details

The power supply is quite conventional, and consists of a small power transformer, a selenium rectifier, a little 50-ma. a.c.-d.c. type filter choke, and a dual-section electrolytic capacitor. An even smaller transformer might have been used since the requirements of the preselector are only 15 ma. at 160 volts, d.c., plus 0.3 ampere at 6.3 volts for the 6CB6 heater. It has been the author's experience, however, that the ultra-small power transformers tend to run very hot, while the 50-ma. types run quite cool. In addition, the transformer shown in the photos has a built-in copper shield between the primary and secondary windings—an important item when it comes to keeping noises from entering the preselector via the power lines. For these reasons, plus the fact that adequate space was available on the chassis deck, the larger unit has been used and specified.

Wiring is quite simple, as can be seen from an inspection of Fig. 1. All components can be easily identified in the below-chassis photo and the pictorial diagram. Three two-lug tie points are used, one under each of the two screws securing the power transformer, and one near mid-chassis between the tube socket and the three screws holding the tuning capacitor. None of the bypass capacitors (*C*₄, *C*₅, *C*₆, *C*₇) should be allowed to extend above the tube socket shield. As screen resistor *R*₃ is between the chassis and the screen bypass capacitor, it is not visible in the photos. The two heater leads are twisted

and run to pins 3 and 4 on the tube socket. A short bare wire runs from pin 3 to the nearby ground lug on the socket shield.

Calibrating the Preselector

Absolute calibration of the preselector dial is not really needed. A grid dip meter or an inexpensive signal generator, or a simple oscillator and the dial of your receiver, will be entirely adequate.

With the preselector out of its cabinet, make the connections between it and your receiver, using the two terminals on the back of the unit—ground to ground, plate to the receiver's antenna terminal. Turn on the preselector, the receiver, and your signal source, and allow about 10 minutes or so for everything to come up to normal operating temperature. Set the preselector's fine tuning dial at midscale, the main tuning capacitor at minimum capacitance, and the gain control potentiometer fully clockwise (maximum gain). Set your receiver and the signal source at 30 mc., and

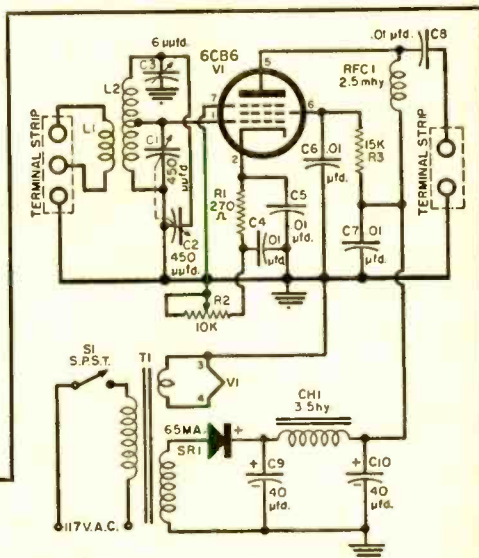

Fig. 1. Schematic diagram and parts list for preselector and power supply.

*C*₁, *C*₂—Dual-section variable capacitor, 450- μ fd. max. per section (Allied Radio Corp. Cat. No. 61H059 or equivalent)

*C*₃—Midget variable capacitor, 6- μ fd. max. capacity (Bud LC-1653 or equivalent)

*C*₄, *C*₅, *C*₆, *C*₇, *C*₈—0.01- μ fd., 600-volt ceramic capacitor

*C*₉, *C*₁₀—Dual electrolytic capacitor, 40/40 μ fd., 200/200 volts

*CH*₁—3.5-henry, 50-ma. filter choke

*L*₁—Antenna coil, 8 turns, 1" dia., wound 16 turns per inch (8 turns of B & W "Miniductor" No. 3015)—see text

*L*₂—Tuning coil, 28 turns, 1" dia., wound 16 turns per inch (28 turns of B & W "Miniductor" No. 3015)—see text

*R*₁—270-ohm, 1/2-watt resistor

*R*₂—10,000-ohm wire-wound potentiometer (gain control)

*R*₃—15,000-ohm, 1/2-watt resistor

*RFC*₁—2.5-millihenry r.f. choke

*S*₁—S.p.s.t. toggle switch

*SR*₁—65-ma. selenium rectifier

*T*₁—Power transformer, 125 volts at 50 ma., 6.3 volts at 2 amps., copper shield between primary and secondaries (Stancor PA-8421 or equivalent)

VI—6CB6 tube

1—Ceramic 7-pin miniature tube socket and tube shield

1—Tube socket shield made from copper sheet (see text)

1—Aluminum chassis, 7" x 7" x 2"

1—Cabinet and panel, 8" x 10" x 8" (ICA Type 3860 or equivalent)

1—Vernier dial

2—Knobs

1—Power cord and plug

1—2-terminal heavy-duty terminal strip

1—3-terminal heavy-duty terminal strip

Misc. machine screws, tie points, grommets, decals, wire, solder, etc.

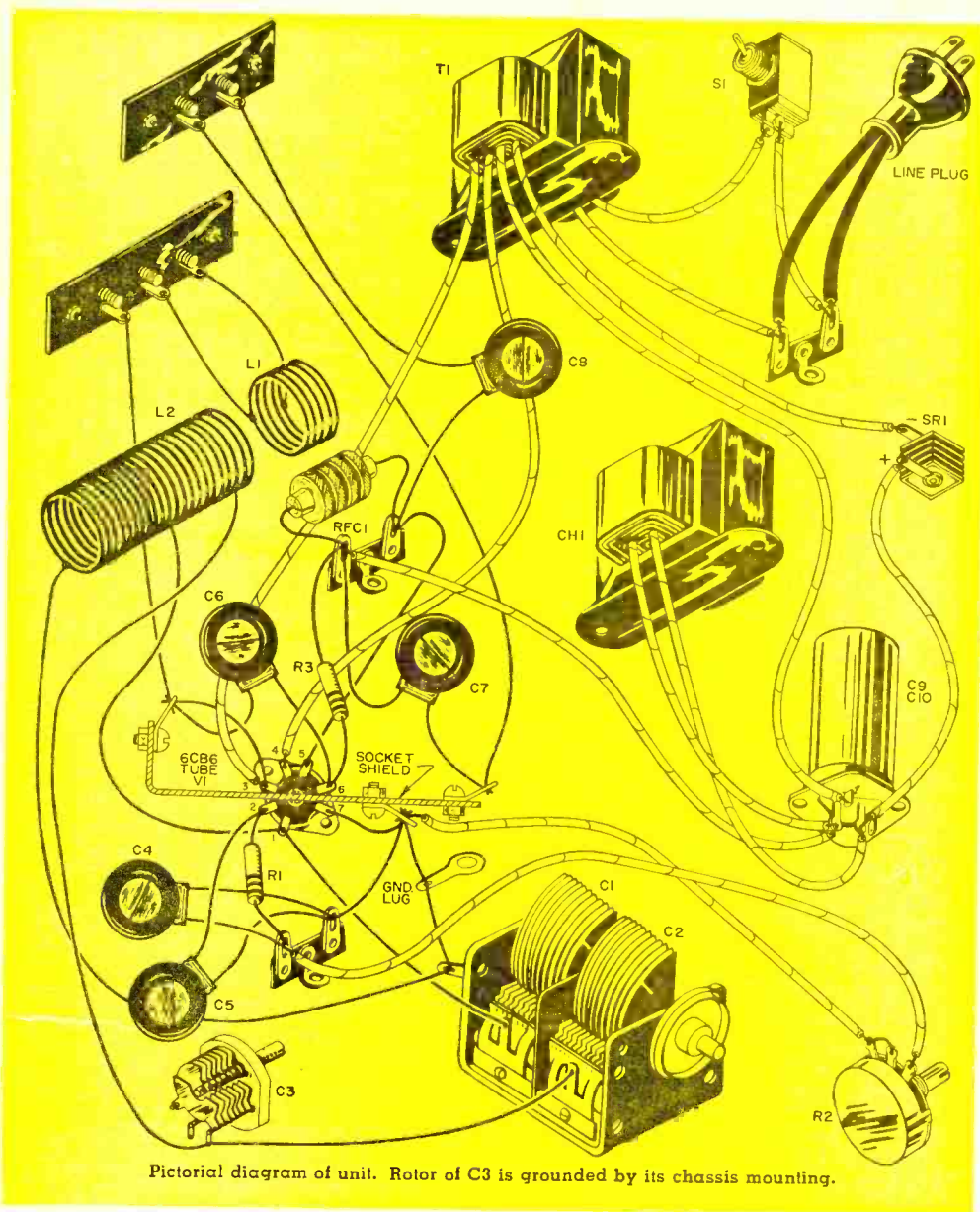

adjust the trimmer on the front section of the preselector's tuning capacitor for maximum output—maximum swing of the receiver's S-meter or maximum "rush" from the speaker.

Now, install the preselector in its cabinet and proceed with marking off the frequency calibration of the dial, using the method described in the instruction sheet accompanying the dial. If you don't have any means of calibrating the preselector, you can still build and use it by getting some idea of the dial settings from an examination of the front-view photo. The

point of exact tracking with the receiver is easily found since there will be a considerable increase in the signal level as the preselector is tuned to resonance.

Using the preselector is simply a matter of tracking it with the receiver, that is, tuning both simultaneously. It's easy once you get used to it, and the superior performance of this type of setup more than compensates for the slight inconvenience of having to turn two dials at once. Use the fine tuning control to peak up a station after you have it tuned in on your receiver.

-30-

Miniature Tuning Capacitors

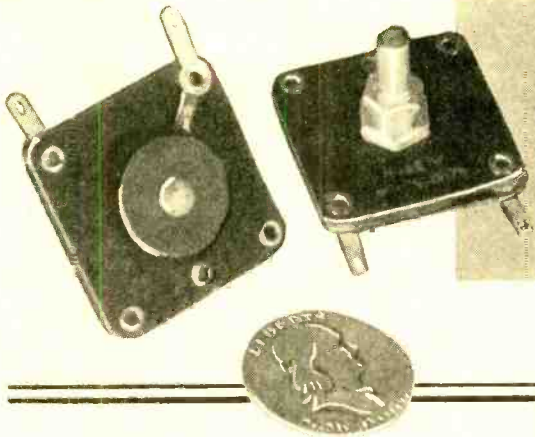

At the far left, two of the small MS-215 high-capacitance, flat tuning capacitors (back and front views) are compared in size with a half dollar.

ONE OF THE greatest drawbacks to miniature equipment construction in the amateur lab has been the lack of a small, high-capacitance tuning capacitor. Builders of pocket crystal sets and similar devices have attempted to get around this difficulty by tuning with a slug-adjusted coil. But how do you successfully put a dial on a slug screw that makes many complete revolutions to cover the tuning range?

The tuning problem now seems to be solved. Fresh prospects have been opened up by the introduction of the thin, flat tuning capacitor shown here. This component is the *Lafayette Model MS-215* (*Lafayette Radio*, New York 13, N. Y.). In a single 180° rotation of its 1/4"-diameter shaft, the MS-215 covers a capacitance range of 10 to 365 μfd . This is adequate for tuning the standard broadcast band.

The MS-215 is not just a big compression-type trimmer. It actually has a number of stator and rotor plates, with interleaving mica films. The unit is 1 1/2" square and 3/16" thick. Only a single 3/8" mounting hole is required, the same as a standard volume control mounting hole. The shaft will take standard dials and knobs.

A miniature, high-capacitance tuning unit of this type has many applications. It will be useful in those devices in which a single-gang capacitor is adequate. Such devices include pocket crystal and transistor receivers, regenerative receivers, wavemeters, wave traps, oscillators, r.f. relays and similar control devices, and dip oscillators.

Shown in Fig. 1(A) is a typical crystal tuner. A ferrite-adjusted broadcast coil (*Miller 6300*) is soldered directly to the lugs of the tuning capacitor. The crystal diode is soldered to one lug, and the headphone return lead to the other.

Initial adjustment consists of turning the MS-215 to its minimum-capacitance

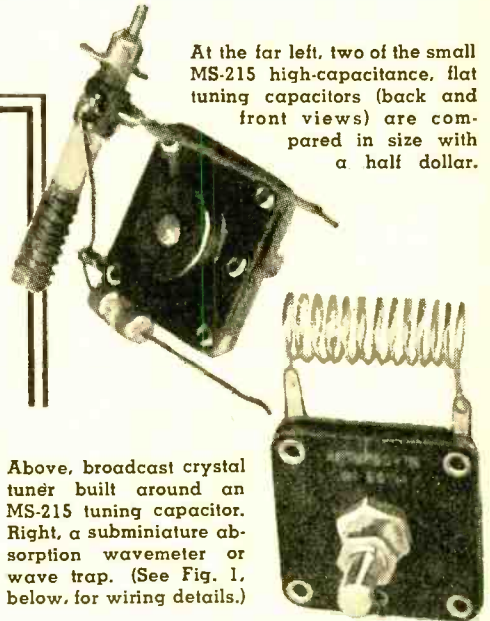

Above, broadcast crystal tuner built around an MS-215 tuning capacitor. Right, a subminiature absorption wavemeter or wave trap. (See Fig. 1, below, for wiring details.)

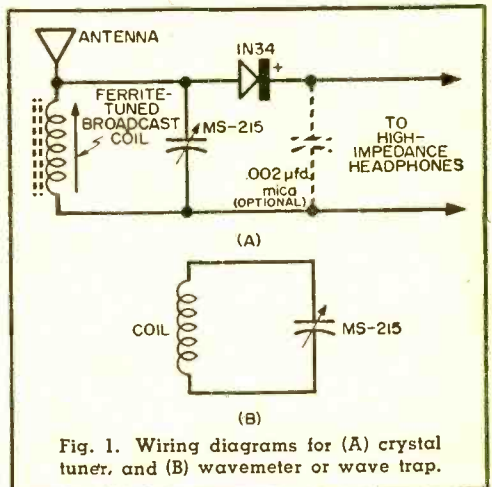

setting and adjusting the slug of the coil for peak response to a 1600-kc. modulated signal. The slug adjustment then is not disturbed subsequently, all tuning being done with the capacitor.

How

By
PHIL McCAFFERTY

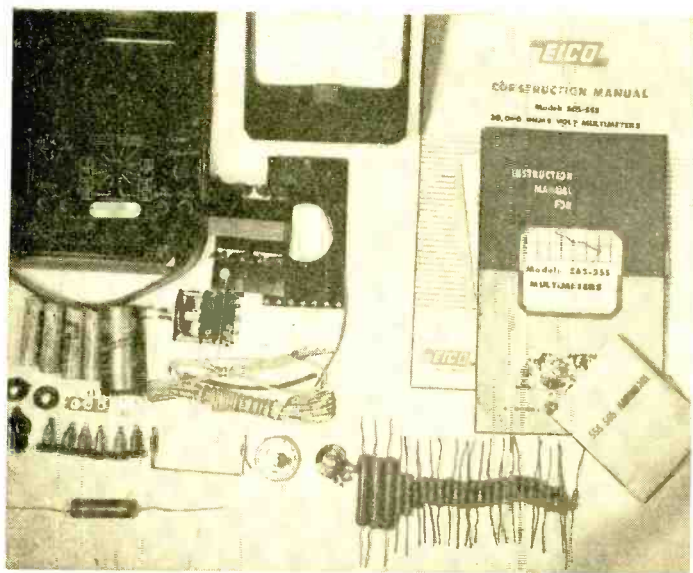

1 Upon opening the carton as it comes from the manufacturer, the display of parts appears impressive. Note the neatly calibrated meter scale above, and the polished panel and case. This is typical of most kits now being distributed by reputable companies. The instruction book contains all details on building up the multimeter as well as explanations of how all of the 31 different ranges should be employed.

2 Drawings in the instruction booklet clearly show how the instrument is assembled. The photo at right depicts the battery holder being bolted in place. One bolt is also used to secure one end of the leather carrying strap. The plastic case has tapped corners to take the flush mounting screws from the front panel.



3 Meter case, input jacks for the probes, potentiometer and switches are attached directly to the front panel. Only the most commonly available tools are required since the manufacturer had the small workbench experimenter in mind when planning this instrument. All of the really difficult work has been done before the test instrument is shipped to the constructor.

to Assemble a Multimeter

A MULTIMETER is exactly what its name implies—a multi-purpose meter. It is used for a variety of purposes in the electronic workshop, including the measurement of voltages, resistances, currents, and decibels.

Like all other pieces of electronic test equipment, the multimeter—or VOM as it is popularly called—has its place and limitations. This article is not designed to define such limits but rather to show how easily a multimeter may be built.

Quite a few multimeter kits are avail-

able to the electronic experimenter and technician. In general, all of them are simple to construct and foolproof in operation. The accuracy of the VOM is a function of the meter sensitivity and usually not influenced by the constructor.

The photos shown on these pages refer to the *ETCO* Model 565. Similar instruments are available from the *Heath Company* (Model MM-1), *Allied Radio Corp.* (stock No. 83F140), or completely wired from *Electronic Measurements Corp.* (Model 104)

-30-

4 After the multiplier resistors and selector switch are wired onto the rear panel, the entire assembly is then attached to the front panel (as shown at right). All resistors are plainly marked, thus eliminating any possibility of making errors when reading the color code.

5 The multimeter is now taking shape and the wires connecting the front and rear panels are soldered into place (below). Manufacturer includes factory-adjusted wire-wound resistors to compensate for differences in the rectifier unit for the a.c. voltages. The soldering gun is helpful and permits very rapid wiring.

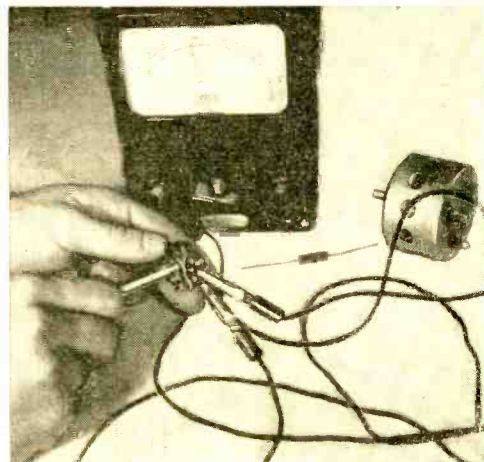
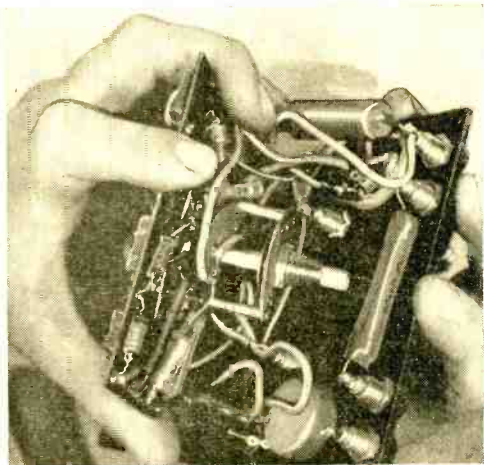

6 Try the finished multimeter out on various ranges to see that all of them are functioning. If one fails to function properly, the wiring should be checked immediately. When the job is neatly done and the instruction book carefully followed, the multimeter can be assembled in one evening.

Emergency

Crystal Receiver

By ART TRAUFFER

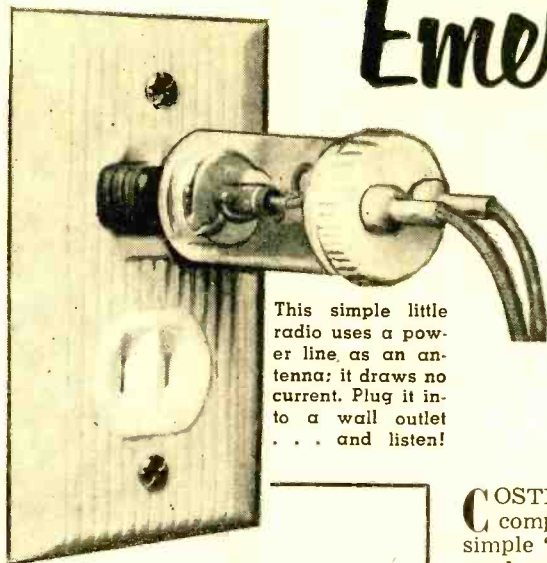

This simple little radio uses a power line as an antenna; it draws no current. Plug it into a wall outlet . . . and listen!

COSTING a little less than \$4.00 to build, complete with a crystal earphone, this simple "plug-in" crystal radio will give you good earphone volume from your nearest or most powerful local broadcaster—just plug it into the nearest wall outlet and listen! The two-crystal circuit delivers high output, although selectivity is poor due to the lack of a tuned circuit.

The drawing shows the simple construction. Most of the handle on a Bakelite a.c. line plug is sawed off, and the stub of the handle is cemented into a hole cut into the bottom of a Celluplastic pill container about 2 1/8" long. In the cap of the container, cut two 1/4"-diameter holes about 1/2" apart and mount two phone-tip-jacks.

Slip small-diameter spaghetti tubing over both leads of the two germanium diodes and solder the diodes to the tip-jacks. Note the polarity of the two diodes. Then, slip small spaghetti tubing on both leads of a ceramic disc *Sprague* "Cera-mite" .01- μ fd., 1000-volt fixed capacitor; clip one end; and solder the lead to the two remaining diode leads as shown. Cover the soldered junction with tape.

Arrange the parts and leads as shown in the drawing; slip the assembly into the container so that the bottom capacitor lead comes out of the bottom of the line plug; press the cap firmly onto the pill container; and connect the capacitor lead to one prong of the line plug. One or two turns of Scotch tape will lock the cap on the container.

When building this plug-in crystal radio, do not omit the blocking capacitor under any circumstances; the blocking capacitor makes this radio safe to use. It will work best where power lines do not run through grounded metal tubing. If you hear a hum in the phones, reverse the plug in the outlet.

-50-

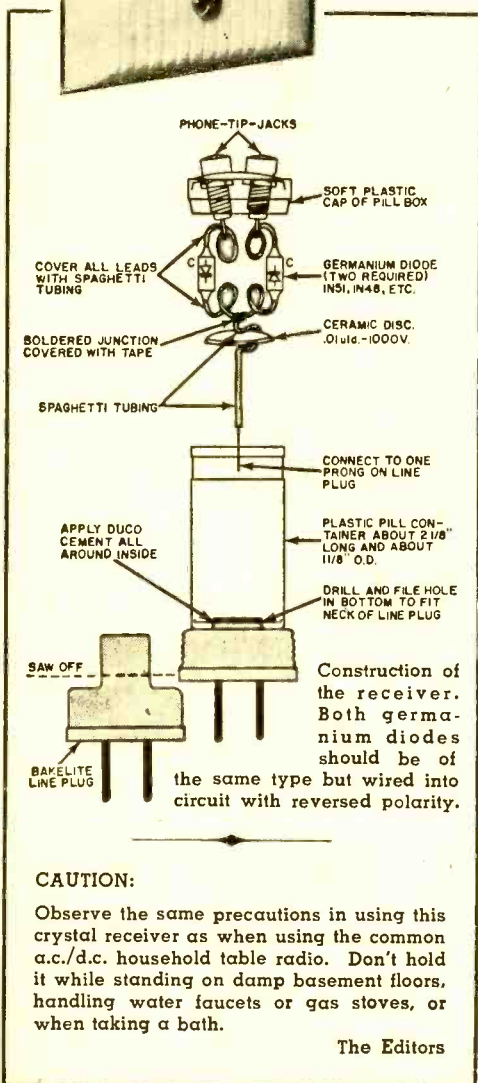

Electronic

Build and play this novel instrument resembling a banjo in shape but having a distinctive tone quality

Eight, electronic banjo being played. Below, close-up view shows tone lever.

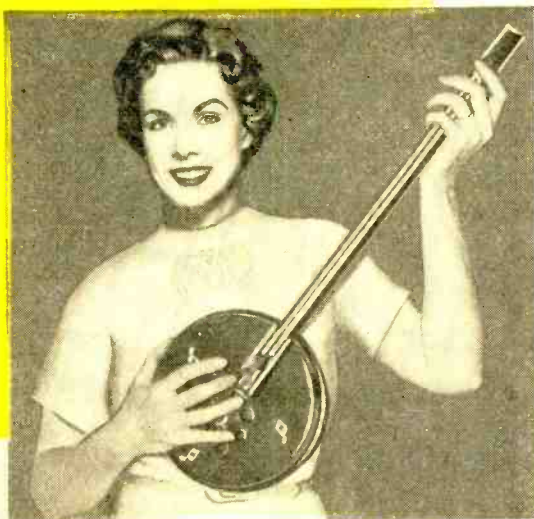

banjo

By LOUIS E. GARNER, Jr.

ELECTRONIC musical instruments that are easy to build and simple to play delight the experimenter. The instrument described here meets both qualifications, and in addition is inexpensive. Although it is shaped somewhat like a banjo, its tone quality is distinctive, resembling neither a banjo nor any other conventional musical instrument.

There were several reasons for choosing the "banjo" shape. The mechanical construction is fairly easy, costs are kept down, loudspeaker mounting is simplified, and all component parts can be mounted within the enclosure—leading to a completely self-contained instrument.

Tones are generated by a transistorized blocking oscillator using but a single transistor powered by a 22½-volt battery. Ade-

quate power output is obtained to produce medium volume in a normal room from a 4" loudspeaker. Pitch is controlled by a carbon potentiometer manipulated by the player by means of a special lever-type knob. A push-button switch in the instrument's handle serves as the on-off switch, a tone being produced when the switch is depressed.

Basic Construction

Reference to the photographs and diagrams will show the basic construction of the electronic "banjo." The body is an aluminum cake pan, the arm an 18" length of 1"-diameter aluminum tubing. These two parts must be solidly mounted together. This can be accomplished by punching a 1" hole in the side of the cake

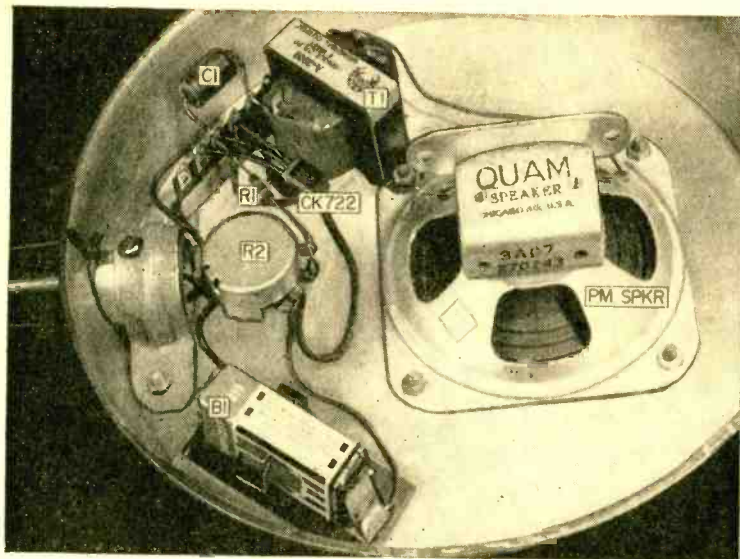

Interior view of banjo with various components identified and their relative positions indicated. The chassis is an aluminum cake pan, which contains all components except the on-off switch S1.

pan close to its base, inserting the aluminum tubing and holding it in place with a standard pipe clamp, mounted with two 6-32 machine screws and nuts. In the model shown, for additional security, a sheet metal screw was run through the pipe clamp into the aluminum tubing.

The push-button control switch (S1) is mounted about 2½" to 3½" from the end of the arm, with its leads run inside the tubing to the body of the instrument. The open end of the arm should be closed, either with a standard metal cap or with a shaped wooden plug.

Drill holes for mounting the "pitch" control (R1), the transformer (T1), the terminal strip, the battery clip, and the loudspeaker. With a little ingenuity, one mounting hole may be made to serve for two or more parts. If a satisfactory battery clip cannot be obtained locally, mount the battery in place with a simple "Z" clamp and make connections by soldering directly to its terminals. Parts location is not at all critical—follow the photographs as a guide or make up an original layout, as desired.

The loudspeaker opening may be made in one of two ways. In the model, a series of ½"- and ⅝"-diameter holes was punched to form a regular pattern. If preferred, one large opening may be cut for the speaker. However, if this is done, some provision should be made to protect the speaker cone . . . either by means of a piece of screening or a grill of perforated sheet metal over the opening.

For a really "de luxe" appearance, the instrument may be painted and decorated. This part of the job should be done after

all machine work is completed but before parts are mounted and wiring is started. The model shown was covered with two coats of enamel, applied with a "spray" can, then decorated with commercially available decals (Tekni-Labels Set No. 116). But individual designs can be easily made up and applied.

Mounting and Wiring

In the model, the back is closed with a piece of Masonite hardboard, mounted on the rear of the loudspeaker. If a speaker different from the one specified in the parts list is used, it may be necessary to design a special mounting for the back cover . . . either brackets or clips of some sort. In any case, be sure that the back does not completely cover the top of the cake pan. Either cut the back cover slightly smaller than the pan opening, leaving a gap around the outer edge, or drill a few "vent" holes in it. Otherwise, the speaker may be muffled by the closed space.

The "tone" or pitch control lever in the model was assembled from a standard bar knob, a long machine screw, and a piece of plastic tubing, colored with fingernail polish. Lever knobs are commercially available, however.

Remember that the CK722 transistor is a relatively expensive part and is easily damaged by excessive heat. Therefore, don't cut its leads too short . . . leave them at least 1½" long, protected with insulated tubing. Use a hot, clean, well-tinned soldering iron, and complete the installation of this part as quickly as possible. For maximum protection, use a heat

"sink," i.e., hold the lead being soldered with a pair of long-nosed pliers between the point where the soldering iron is applied and the body of the transistor. The pliers tend to absorb heat from the lead and prevent it from reaching the transistor proper.

In vacuum-tube circuits, an improperly installed battery generally results in little more than failure of the circuit to operate. But incorrect battery connections may ruin a transistor. Therefore, don't make final battery connections until lead polarity is assured.

Proper connections from the speaker voice coil terminals to the transformer's tapped secondary winding may be determined experimentally after the circuit is wired. Use the pair of terminals that gives the best results.

Once the wiring has been completed and operation checked, circuit modifications

may be made to "tailor" the performance of the banjo to meet individual requirements. With the parts values listed, coverage is between two and three octaves, although exact range will depend on parts tolerance.

To reduce the range, replace the potentiometer ($R1$) with a unit having a lower value of resistance. To increase the range, use a higher value of resistance here. Do not reduce the value of $R2$, however. The upper limit of the tone range may be changed by varying the size of $C1$.

How It Works

The single transistor in a blocking oscillator circuit results in efficient operation and long battery life. Transformer $T1$ acts both as an output transformer to match the high collector impedance to the low impedance of the loudspeaker voice coil

(Continued on page 117)

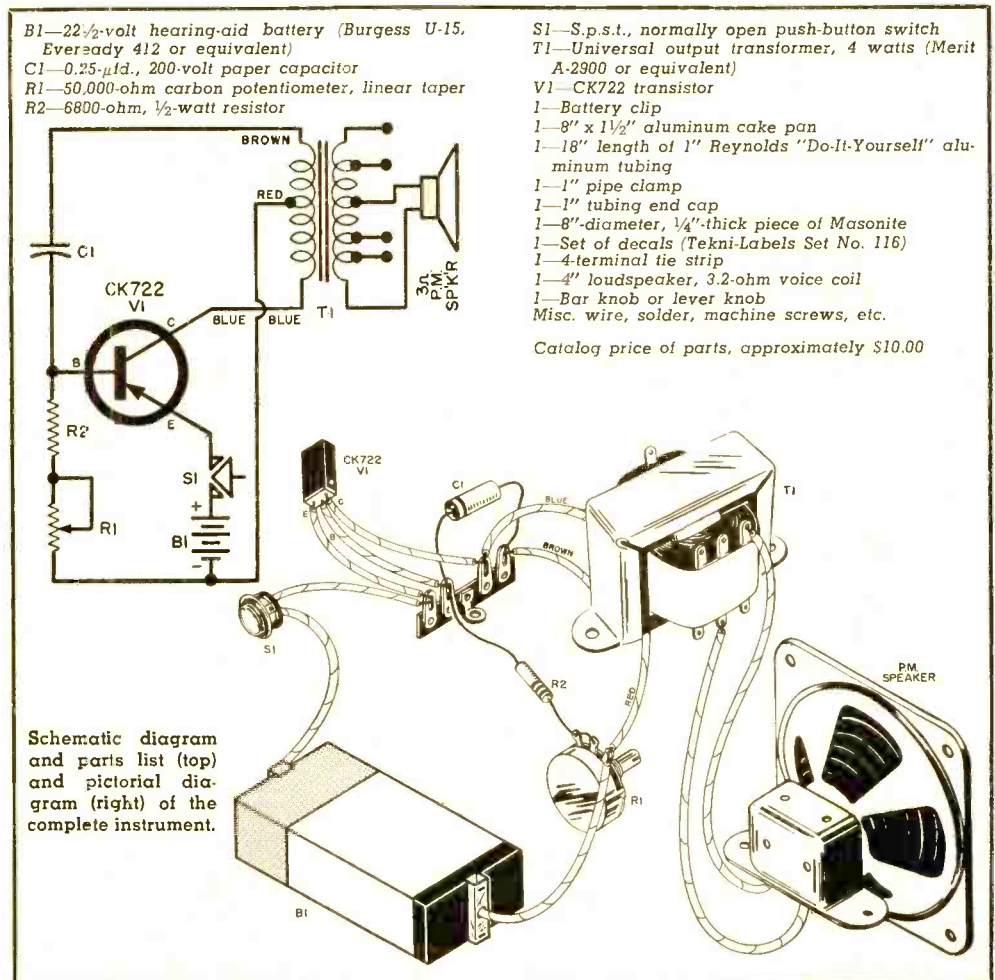

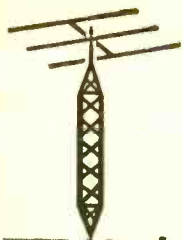

THE TRANSMITTING TOWER

Herb S. Brier, W9EGQ

FEATURED on these pages are two views of the new "Heathkit" AR-3 communications-type receiver, which I assembled from a kit furnished by the *Heath Company*, Benton Harbor, Mich., for review in the *Transmitting Tower*. It is one of the pieces of electronic equipment in kit form distributed by mail by the *Heath Company*.

The AR-3 is an improved version of the AR-2 receiver, which it replaces. The most obvious improvement in the new model is the addition of a variable antenna trimmer. It permits peaking the receiver input circuit to any frequency within its range, thereby improving its effective sensitivity.

Another major improvement is in the redesign of the bandswitching assembly. The new one is easier to put together and wire, and it is more rigidly mounted on the main receiver chassis. This change has improved the receiver stability. Signals now stay put once they are tuned in.

Less obvious changes include using higher-Q (more efficient) coils in the antenna and high-frequency oscillator circuits for better sensitivity on the higher frequency ranges, and better intermediate-frequency transformers for increased selectivity. Also, improved beat-frequency-oscillator operation causes code signals to have a more "solid" sound.

The AR-3 occupies a 11½" x 6½" copper-

plated steel chassis, and it uses a 4-tube—plus rectifier—circuit. It covers the broadcast band and the short-wave spectrum to 31 mc. in four switch-selected bands. On the short-wave bands, the calibrated dial of the main tuning capacitor is set for the portion of the band in which you are interested at the moment—an amateur band, for example—and it can be spread out over most of the bandspread dial, which controls a small variable capacitor connected in parallel with the main tuning capacitor for fine tuning.

How the AR-3 Operates

From the tuning system, the incoming signal is fed to a 12BE6 pentagrid converter (mixer) and high-frequency oscillator tube. It converts all incoming signals to 455 kc. and feeds them to the intermediate-frequency (i.f.) amplifier.

The i.f. amplifier consists of two double-tuned i.f. transformers and a 12BA6 tube. It furnishes most of the receiver's selectivity and much of its ability to amplify weak signals.

From the i.f. amplifier, the signal goes to a 12AV6 dual diode-triode tube that does more things than the performer in a one-man band. One diode acts as the second detector and feeds the modulation it removes from the signal to the audio-frequency amplifier. This

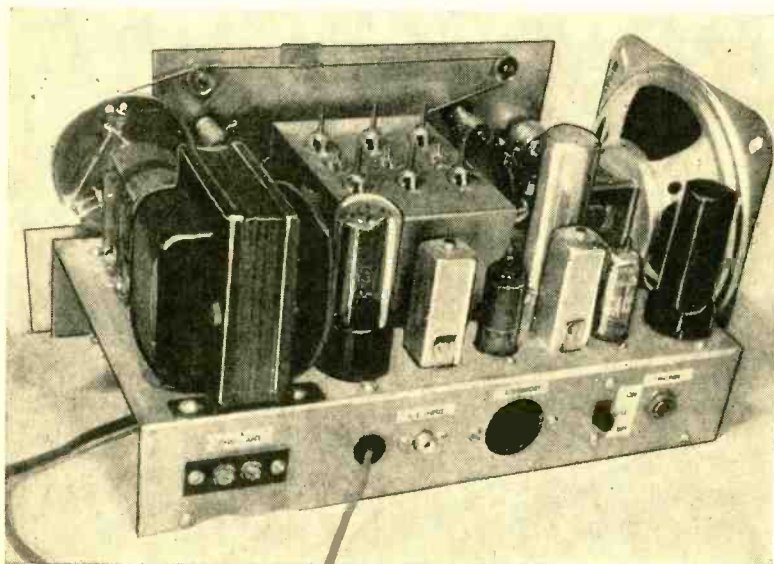

Rear view of the AR-3 Heathkit communications receiver, an improved version of the AR-2. Major improvements include the addition of a variable antenna trimmer and greater receiver stability through redesign of bandswitching assembly. It is available in kit form from the Heath Company for \$27.95.

Front view of the AR-3, which occupies a 11½" x 6½" copper-plated steel chassis. Everything required to convert the kit into a finished receiver is supplied with it. Used with a good antenna, this receiver will bring in almost any signal that can be heard on a more elaborate unit.

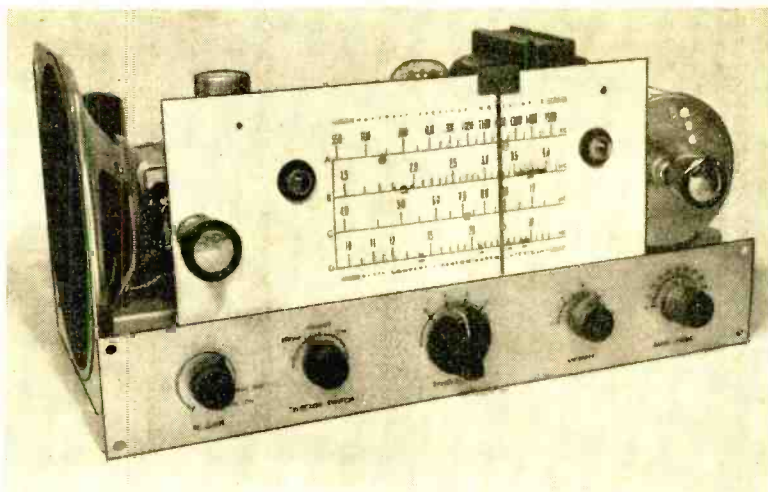

diode also develops the automatic-volume-control (a.v.c.) voltages that help hold the volume level from the loudspeaker or phones relatively constant, as the receiver is tuned to signals of different strengths.

The other diode acts as the noise limiter across the control grid of the 12A6 output tube. The noise limiter is effective in reducing the interference from the ignition systems of passing automobiles on the high-frequency bands. It also cuts down the sharp edges of static crashes.

For both phone and code reception, the triode section of the 12AV6 functions as the first audio-frequency amplifier stage. And for code reception, it simultaneously functions as the beat frequency oscillator (b.f.o.) to produce a signal within a kilocycle of 455 kc., against which the unmodulated code signals "beat" or "heterodyne" to produce the audible signal heard from the loudspeaker or phones.

This dual function is achieved in the following manner: the b.f.o. tuned circuit is coupled to the triode control grid via a 33- μ f.d. capacitor. The tube cathode is tapped up on the oscillator coil to provide feedback for oscillation, and the bottom of the coil is grounded to the receiver chassis.

The coupling capacity has low enough reactance around the intermediate frequency to permit normal b.f.o. operation. However, its reactance is so high at audio frequencies that, practically speaking, the tuned circuit is not even there for audio frequencies. Decoupling resistors at the tube grid and plate terminals keep the oscillator energy from getting into other circuits. Yet, their resistance is low enough to have negligible effect on the audio-frequency signals being simultaneously amplified in the tube.

The phone-standby-c.w. switch on the front panel disables the b.f.o. function in the "phone" position by short-circuiting the coil cathode tape to the receiver chassis.

As already mentioned, the output tube is a 12A6 beam power tetrode that feeds a built-in 5½" loudspeaker and a jack into which headphones may be plugged.

Power to operate the receiver is furnished by a transformer-type power supply. Such supplies are almost unknown in receivers selling for less than \$100; however, the improved performance that they offer is achieved at the cost of limiting the receiver to operation from 117-volt, 60-cycle power lines—the kind 99.9% of us have. The supply furnishes approximately 250 volts, d.c., through the 5Y3G full-wave rectifier and the filter system, and 12.6 volts, a.c., for the tube heaters.

Besides the panel controls already mentioned, there are separate audio and r.f. gain controls. The first one also actuates the receiver power switch, and the other one also controls the a.v.c. on-off switch.

On the rear chassis lip are mounted the noise limiter switch, accessory power socket, antenna-ground terminal strip, and an input connection to the first i.f. transformer.

Assembling the AR-3

Everything required to convert the AR-3 kit into a finished receiver is supplied with it, including a 28-page instruction book, three large pictorial diagrams and a large schematic diagram, plus a number of small, "detail" illustrations. Anyone who will follow the instructions faithfully and who can handle a small soldering iron, pliers, and screwdriver should have no trouble doing the job. Nevertheless, let me mention that there are 209 steps covered in the instruction book. Each step is easily carried out, but the fact that there are so many of them affords many chances to make errors if the constructor becomes careless. And one mistake will prevent the receiver from working, until it is tracked down and corrected.

The obvious way to prevent making such errors is to take one's time in carrying out each step and to go back each time a couple have been made and check with the instructions and pictures to be sure that the work has been done correctly. It should be realized, too, that you are not going to finish the job in a single evening or even two. Trying to

(Continued on page 118)

Tuning the Short-Wave Bands

—with Hank Bennett—



A WIDELY reported but little known station is CHU, Ottawa, Ontario, Canada. This station transmits time signals day and night and is operated by the Department of Mines and Technical Surveys. The transmitter is located in the Dominion Observatory, Ottawa. We would like to thank Mr. Malcolm M. Thomson and Mr. J. P. Henderson, engineers at CHU, for the assistance that they have rendered in sending us the following data.

Canadian Time Signals

Three observatory transmitters are on the air continuously with the call sign CHU. Frequencies are: 3330 kc., 7335 kc., and 14,670 kc. A three-wire folded dipole antenna is employed on each frequency. These transmitter frequencies are not to be considered as frequency standards. The musical pitch of 1000 cycles per second, which is characteristic of these signals, is derived from a transmitting quartz clock.

The beginnings of the beats mark the exact seconds and are reliable to a few hundredths of a second of true time. Seconds' beats are of approximately 0.25-second duration except for the zero of each minute, which is longer. Intervals between seconds' beats are correct to better than one-thousandth of a second.

The voice announcement in the CHU broadcast is introduced between 50 and 60 seconds of each minute and refers to the minute dash which follows. Time is announced on a 24-hour basis and in the following form:

"Dominion Observatory, Canada, Eastern Standard Time, .. hours, .. minutes."

At present a network of over 60 broadcast stations, located across Canada from coast to coast, transmits time signals at 1300 hours Eastern Time. Eastern Time refers to Standard or Daylight Saving, whichever prevails at Ottawa. Seconds' beats with a musical pitch of approximately 800 cycles per second commence at 12 hours, 59 minutes, 20 seconds, and continue to the hour.

Canadian time signals are broadcast according to the 5-minute period coding established originally by the Naval Observatory, Washington, D. C. The identification of each minute of a 5-minute group is determined by the omission of seconds' beats at the end of each minute as follows:

Seconds:	50	51	52	53	54	55	56	57	58	59	60
1st minute	—	—	—	—	—	—	—	—	—	—	—
2nd minute	—	—	—	—	—	—	—	—	—	—	—
3rd minute	—	—	—	—	—	—	—	—	—	—	—
4th minute	—	—	—	—	—	—	—	—	—	—	—
5th minute	—	—	—	—	—	—	—	—	—	—	—

Hence, when the 51st second is omitted and four more beats are sent, it indicates that there will be four more minutes to a 5-minute interval. At the end of the 2nd minute, 52 is omitted and three more beats are sent, indicating that there are three more minutes to the 5-minute interval, etc. The end of the 5th minute has the long gap from the 51st to the 59th beats. During the first minute of each hour, the call "CHU CANADA CHU" is sent in Morse code twice in place of the seconds. Should the voice announcement be lost due to high noise level, code may be useful.

Station Reports

Now for this month's reports. All times shown are in USA Eastern Standard Time, based on the 24-hour system.

Angola—CR6RL, Luanda, 9632 kc., 1000 watts, is currently being heard around 1920 with a musical program announced in Portuguese. This station uses the slogan "Radio Clube de la Angola". (JM)

Argentina—LRA, Buenos Aires, 9690 kc., has English news at 2135-2155 daily except Sunday. At times, there may also be news in German, Portuguese, Spanish, and Dutch. This station parallels with LRA, 6180 kc. (RR)

British Honduras—ZIK2, Belize, 3300 kc., 5 kw., is noted at good level but at times a powerhouse, as yet unidentified, appears to



The Dominion Observatory, Ottawa, Ontario, Canada, is surmounted by a dome which houses a 15-inch equatorial telescope. The Positional Astronomy Division, of which the time service described in the text is a part, has its transit instruments housed in the left wing.

be on top of them. ZIK2 transmits in English most of the evening. (DB)

Canada—In a letter from *Transcanada Communications, Ltd.*, Winnipeg, it is stated that verifications are issued only for CKRC on 630 kc., and that CKRX on 11,720 kc. has not been on the air since 1947. The QSL card from VE9AI, Edmonton, Alberta, 9540 kc., states that the power is but 200 watts and the license is experimental. This station began operating in 1941 and is one of the harder ones to find among the high-powered stations. (DB)

Costa Rica—TIFC, San Jose, 9647 kc., carries an English program at 2300-0000 weekdays. The slogan of TIFC is "The Lighthouse of the Caribbean"; address is Box 2710, San Jose, Costa Rica. (GW)

Cuba—*Radio Progreso*, COBC, 9362 kc., is being heard at 2100-0030 with all programs in Spanish. (LM)

COCO, Havana, 9530 kc., is not being heard at the present time. (RL)

Czechoslovakia—*Radio Prague*, 9550 kc., has an English session starting at 1945 featuring music and programs of public interest. (MS)

Denmark—One of the popular widely heard programs is the "Saturday Nite Club" from OZF, Copenhagen, 9520 kc. This program can be tuned at 2130. (FB)

Egypt—Cairo, 7050 kc., is being noted in its transmission to the Middle East and Africa at 2330A; at 1900-2000 to North America on 9790 kc.; Home Service at 1000-1300 fade-out. These programs are all in Arabic. (LM, RR)

England—The *BBC*, London, 15,310 kc., has "Listener's Choice" at 1420-1435 on Saturday and Sunday only. This is a program of requested recorded music from listeners in North America. Music is popular, classical, etc. At 1200 they present news; on Tuesday, at 1130-1145, Radio Newsreel; at 1145-1200, light music played on the *BBC* studio console organ (Tuesday). Many *BBC* stations are being heard on the higher frequencies including: GVS, 21,710 kc., 0915; GVR, 21,675 kc., 0900 s/off; MCX, 21,660 kc., 0900; GRZ, 21,640 kc., 1015; GST, 21,550 kc., 0930; GSJ, 21,530 kc., 1035; GSH, 21,470 kc., 0915; GRP, 17,870 kc., 1015; GSV, 17,810 kc., 1045; GRQ, 17,740 kc., 1600; GVQ, 17,730 kc., 1130; GRA, 17,715 kc., 1145; and GRD, 15,448 kc., 1305. (JB)

French Equatorial Africa—*Radio Brazzaville* has an English news period at 1840-1855 to the Western Hemisphere and another of world news at 0015-0030 on 11,970 kc., 50 kw. Other English periods can be tuned at 1100-1115 on 11,970 kc., or 9730 kc. (JB, RR, MS)

French West Africa—FHE3, Dakar, 11,895 kc. (a.s.o reported on 11,875 kc.) has a French program audible on the West Coast at 1100-1215 daily. (RR)

India—A new channel for Delhi is 17,795 kc., dual with 15,285 kc. This xmsn is noted at 0615-0730. At 0830-0930, they can be heard on 17,300 kc. and 15,245 kc. (RL)

Israel—Widely reported Israel can be tuned at 1515 with English news over *Kol Israel*, 9008 kc. Later on, *Kol Zion Lagolah* (The Voice of Zion) has an English program at 1615-1700; news at 1616. (SK, JH)

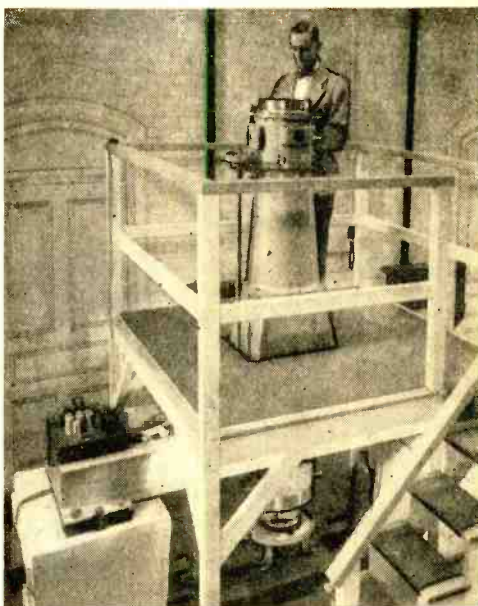

This photograph shows Malcolm M. Thomson, of the Positional Astronomy Division, loading the photographic zenith telescope used to determine the corrections and rates of several quartz crystal clocks employed as primary standards. Similar clocks, corrected daily from these standards, provide accurate time for Canadians.

Italy—The *Italian Broadcasting System*, Rome, has an English news period daily at 2130-2140. (GW)

Malaya—The *Blue Network*, Singapore, 4820 kc., is noted at 0900-0915 with a relay of *BBC* news. They verify by letter. (RR)

Mauritius—V3USE, Forest Side, 15,085V kc., was noted at 2358 on a Monday. This is one station that requires patience to log. (ER)

Mexico—A reception report to XEXE, 11,900 kc., Mexico City, was returned unopened. (DB)

(Editor's Note: This station is believed to be off the air. We have received no reports on it for months and it is not contained in the latest list of Mexican stations.)

Monaco—3AM4, Monte Carlo, 7349 kc., can be heard in French at 0100-0230; news at 0100-0110 and 0200-0210. Remainder of program is music. It can also be noted on 3AM3, 6035 kc. Interval signal is a gong. (RM)

Mozambique—CR7BH, *Radio Clube de Mozambique* at Lourenco Marques, 11,740 kc., is noted at 2245-2300 with interval signal of drum beats; at 2300, an English announcement giving time as 6:00 a.m. and opening with singing of "Lord's Prayer." (ER)

Netherlands New Guinea—Hollandia, 5045 and 7190 kc., 5 kw., now operates at 1930-2240 and 2300-0000 on 7190 kc.; at 0400-2130 on 5045 kc. This schedule is incomplete; complete schedule requested. Noted on West Coast around 0700 with Dutch and English. (MS, RR)

Okinawa—The *Voice of America* relay station
(Continued on page 124)

CARL & JERRY

By

JOHN T. FRYE

How to Haunt a House

BRIGHT MOONLIGHT BATHING the snow-covered landscape made it unnecessary for the two boys to use their flashlights as they trudged up the narrow lane toward the dark and brooding silhouette of the house set well back from the highway. The only sound was that of the snow squeaking beneath their Arctic boots, until the tall one carrying the tape recorder turned his head so that the moonlight glinted on his horn-rimmed glasses as he addressed his short and puffing companion:

"Jer, I'm still a little foggy on why Mr. Arnold is paying us twenty-five dollars, plus cost of equipment, to 'haunt' this old house."

"He wants to get even with a couple of favorite tomboy nieces who really gave him a hard time when he visited them in Florida last spring, Carl. He says that as soon as those two found out he was afraid of bugs and reptiles they really gave him the business. They chased him around the house with a hairy-legged spider that he swears could straddle the mouth of a teacup; they put little chameleon lizards in his bed; and finally, after they had coaxed him to go swimming with them in a little lake near Orlando, one distracted his attention by taking his picture with a movie camera while the other swam under water and clamped a couple of barrel staves around his leg just as the one with the camera shouted, 'Alligator! Alligator.' He vows he could feel teeth in those barrel staves, and he practically splashed the lake dry getting to the bank as the whole thing was recorded on film."

"Say, those two sound like interesting chicks," Carl said admiringly.

"Not really. They are practically old women. One is nineteen, and the other is at least twenty-two," Jerry said disparagingly. "Anyway, they're here visiting the Arnolds, and Mr. Arnold is going to 'con' them into betting they can spend tomorrow night in this old 'haunted house' on his farm without seeing any ghosts. He has run a couple of light wires through the grove that separates this old house from his home so that we can have light down in that hidden cellar room and power to operate the house-haunting gadgets that we installed yesterday afternoon. Tonight we'll check our whole installation to make sure everything works. Mr. Arnold is going to sneak off and meet us if he can get away."

As Jerry finished speaking, they reached the old house and carefully picked their way across the rotting porch to the deeply shadowed front door.

"This place looks a heck of a lot different at night than it does in daytime," Carl muttered. "If you ask me, 'spooking' this place is sort of gilding the lily. I'd not be surprised if there *were* ghosts in there."

"None of that," Jerry said briskly. "As a young scientist, you can only believe in the ghosts you see on your TV screen when an airplane flies over. Shine your flashlight on this keyhole while I—"

He stopped speaking abruptly, and stumbled backward into Carl as the door suddenly swung open with a loud screeching of rusty hinges.

"What do you know! We must not have locked it yesterday afternoon," Jerry exclaimed, as he stepped cautiously inside and probed the corners of the large, nearly empty room with his flashlight. "Now I know how the girls will feel when we *make* the door do that for them tomorrow night."

"How do we work this again?"

"The closed door compresses a little spring in the casing up at the top. Throwing a switch in the cellar allows current to flow through the coil of a solenoid mounted in the door casing by the latch. The magnetic field pulls a spring-loaded soft iron plunger down into the coil. This plunger has an extension sticking out the end of the coil so that its movement, produced by the magnetic field, can exert either a pulling or pushing action. In this case, it pushes back the catch, allowing the compressed spring at the top of the casing to shove the door open as if it had been opened by unseen hands," Jerry explained, as he closed the door and tugged at the knob to make sure that it was securely latched. "Hey," he exclaimed to Carl; "quit walking on my heels and breathing on the back of my neck, will you?"

"This place gives me the creeps tonight," Carl admitted in a half-whisper, as he nervously twitched the beam of his flashlight over the dusty floor, the cracked and cobwebbed windows, the peeling wallpaper, and the warped and sagging open staircase.

"You're just letting your imagination run away with you," Jerry said firmly. "Apparently Mr. Arnold couldn't get away; so we may as well get started. You stay here and observe while I go down in the cellar and operate things. Try to imagine you're seeing what goes on through the eyes of a frightened girl."

"That 'frightened' part will be easy," Carl said through teeth kept tightly closed to prevent their chattering. "What all are you going to do?"

"First I'll make the door come open. Then I'll turn the knob on that multiple contact wafer switch so that it activates, one after another, the solenoids fastened to the bottom of the stair treads. As the rubber-covered ends of the solenoid plungers bump their respective steps, it should sound very much as if an unseen person were walking up the stairs."

"Then what?"

"Next I'll make this rocking chair rock all by itself," Jerry said, as he carefully checked the position of the old-fashioned chair. "By sending pulses of current through the coil of the electromagnet mounted just below the surface of the floor, I'll give magnetic tugs to the piece of soft iron concealed in the chair rocker just ahead of the point where its curve now contacts the floor. Timing the pulses of current properly should make the chair rock harder and harder. And all this time I'll be working the solenoids we have hidden under the floor and in the walls and ceiling so as to produce a wide variety of plain and fancy 'spiritual knocking.'"

"Remembering how we mounted this stuff and ran wires to it, I'm glad Mr. Arnold intends to tear down this old house in the spring," Carl said.

"That's right. Having his permission to saw and bore and chisel wherever we pleased made things a lot easier. Now, after the chair-rocking act, I'll run the tape recorder into the concealed speakers and play some of those spooky recordings we made of chains rattling, bats squeaking, and hollow groans."

"My favorite is that echoing-crazy-laughter recording we made in the empty main hall of the fair grounds last Sunday afternoon," Carl remarked.

"That is a doozy," Jerry agreed. "First I'll play it through the speaker in the back bedroom upstairs, then I'll move it into the speaker at the head of the stairs, and finally

I'll feed the recording into one of the speakers in this room. That ought to give the impression of the madman moving in on you. And don't forget, I'll be able to switch any of those speakers into the input of our intercom unit so that they'll serve as microphones and let me hear what's going on in any part of the house. You can keep in touch with me all the time through them. Well, here I go."

Carl stood in the middle of the empty room and watched the rotund figure of his chum move off down the hall with the tape recorder, preceded by the bobbing pool of light furnished by the flashlight. It seemed that this had scarcely disappeared from view when Carl felt a cold draught on the back of his neck and turned around to see the door swinging open to the sound of its grating hinges.

"Man, you surely got things warmed up in a hurry," Carl said nervously, as he closed the door with a bang. "You can check off the door business as operating perfectly. . . . You hear me, Jer?" he called anxiously, after waiting several seconds for an answer that did not come.

"What are you babbling about?" Jerry's voice suddenly boomed from the ceiling. "Just as the intercom warmed up, I heard you say something about the door's working all right, but I haven't even tried it yet. If you're ready, I'll try it now."

"Somebody or something beat you to it!" Carl said hoarsely, "but go ahead."

As he said this, the door once more swung open with its "Inner Sanctum" sound effect.

"You don't need to tell me it worked," Jerry called cheerfully. "I could hear it. Now let's walk the ghost up the stairs."

Immediately there was a muffled thump at the bottom of the stairs; then came another and another and another, each sound emanating from a higher step. The sound was so much like that of the footsteps of a heavy

(Continued on page 123)

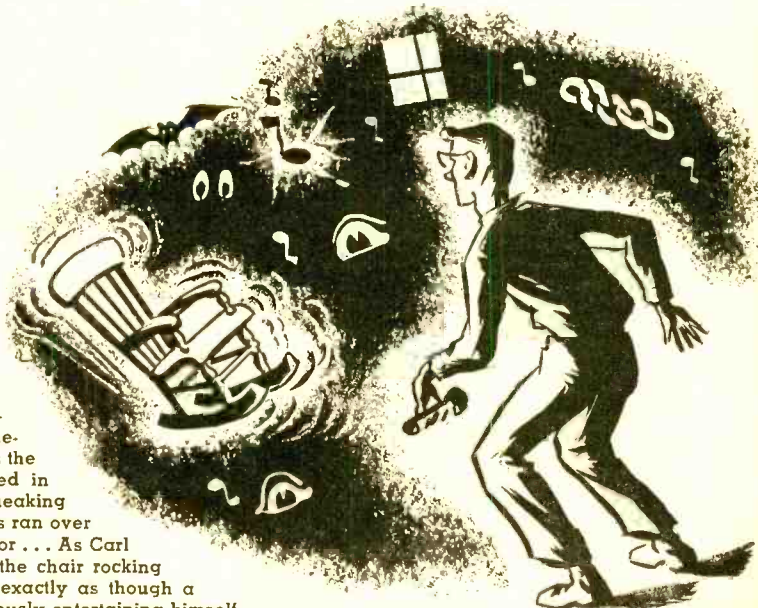

All at once the whole empty house was filled with a cacophony of discordant sound. From somewhere upstairs there was the clanking of chains mixed in with the high-pitched squeaking of bats. Ghostly rappings ran over the walls, ceiling and floor . . . As Carl stared in fascination at the chair rocking crazily away, it looked exactly as though a ghostly sitter were vigorously entertaining himself . . .

Transistor Topics

MAIL continues to pour into our editorial offices with comments, suggestions, and ideas for this department. Once again, we would like to express our thanks for your letters and to say that all of them will be acknowledged.

Combination Battery Holder and Transistorized Amplifier

The material below was submitted by Art Trauffer, whose many articles on low-budget equipment have been published in this and other magazines:

"For those who want to start with a simple one-stage transistorized audio amplifier, here is a project that solves the battery-holder and chassis problems in one crack — you simply build the amplifier onto the battery holder!

"The photos show an *Acme* battery holder made to hold four size AA penlite cells. The two top clips are used to hold two cells which are connected in series to give 3 volts, and the bottom two clips are removed to make room for the amplifier parts. The wiring diagram is shown above. Wiring is simplified by making three of the connections directly to the chassis.

"Remove eyelet and lug No. 2 shown in photo by drilling out the eyelet. Mount a short 6-32 or 8-32 flat-head brass screw in the hole. This allows the positive pole of the top battery to contact the chassis. Then drill out the four eyelets holding the bottom two battery clips, and pull off the clips.

"Swing insulated lugs No. 1 and No. 3 around so that they touch each other, and

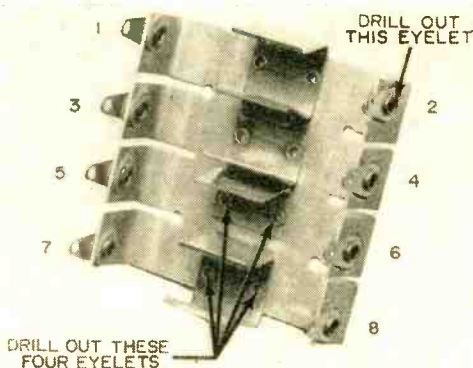

This is the battery holder as purchased from your local radio parts dealer. The soldering lugs have been clearly numbered for ease of identification with the text.

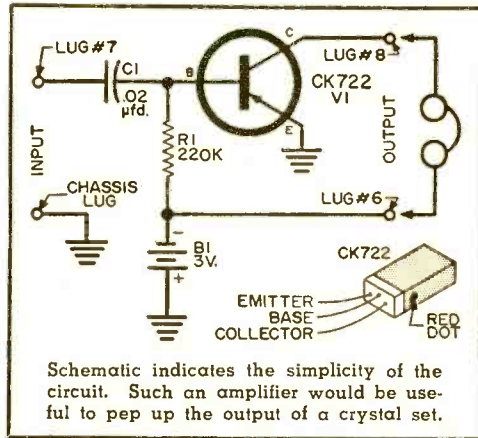

Schematic indicates the simplicity of the circuit. Such an amplifier would be useful to pep up the output of a crystal set.

then solder the lugs together, being careful not to let any excess solder short the lugs to the chassis. Now swing lug No. 4 around so that it faces eyelet No. 6.

"Straighten the wire leads of a 220,000-ohm ½-watt resistor, and insert the right-hand lead into eyelet No. 6, and the left-hand lead into eyelet No. 5. Solder the right-hand resistor lead into eyelet No. 6 and to lug No. 4, and clip off the excess wire.

"Pass one lead of the small .02-μfd. fixed capacitor through eyelet No. 5 and then solder it into the eyelet along with the left-hand resistor lead. Clip off the excess wires. The remaining capacitor lead is soldered into the No. 7 eyelet.

"Slip small spaghetti tubing over the base and collector leads of the *Raytheon* CK722 transistor. Solder the end of the collector lead into eyelet No. 8. The end of the base lead is soldered onto the left-hand resistor lead close to the No. 5 eyelet. Secure the end of the emitter lead under a soldering lug, using the lower left-hand hole remaining from the removal of the two bottom battery clips. A small round-head brass machine screw and nut hold the lug to the chassis.

"When using a *p-n-p* transistor (such as the CK722), be sure to install the two size AA cells exactly as shown in the photo. The positive pole of the top cell contacts the chassis (and emitter), while the negative end of the bottom cell contacts eyelet No. 4 (to collector).

"Bass response can be improved by increasing the capacity of capacitor C1. If you use a high-capacity low-voltage miniature electrolytic capacitor, be sure to connect the

A finished amplifier assembly with the batteries in place. Input wires are at lower left, output circuit at lower right.

negative lead of the capacitor to the base of the transistor.

"High-impedance magnetic earphones give the best results with this amplifier, and they should be connected to lugs No. 6 and No. 8 ("output" lugs). Dynamic (moving coil) earphones will give good results if they have an impedance of 600 ohms or more. Crystal earphones should not be connected to lugs No. 6 and No. 8 because they do not pass d.c. current.

"Many applications can be found for this handy little amplifier. Crystal set experimenters will want to use it to amplify those feeble DX stations, and it may also be employed in amplifying the output of crystal phone pickups for earphone listening. It



could be made even smaller, if desired, by using an *Acme* battery holder made to hold four of the smallest-size penlite cells! Construction would be essentially the same."

Clarification of Raytheon Transistor Type Designations

The novice experimenter with transistors soon finds that there are many possible substitutions. To some extent, this is due to the improvements made in packaging and testing transistors from year to year. In the case of *Raytheon* transistors, the seven most popular units are the CK721, CK722, CK725, CK727, CK760, CK761, and CK762. The latter three also bear the designations 2N112, 2N113, and 2N114.

Raytheon produces transistors identical to the first four units mentioned above in metal, hermetically sealed cartridges. Also available to the experimenter is another group of four transistors with identical characteristics in

a still smaller cartridge. This duplication is listed below, with the third designation representing the smallest cartridge in each case:

CK721 is equivalent to 2N64 and 2N131

CK722 is equivalent to 2N63 and 2N130

CK725 is equivalent to 2N65 and 2N132

CK727 is equivalent to 2N106 and 2N133

Experimenters should not be surprised to find that two CK722 transistors, for example, do not look exactly alike. This is due to improvements in packaging. Older CK722 transistors (still in excellent condition) may be found in plastic cartridges, while newer versions are being shipped in smaller, hermetically sealed cartridges.

Vest Pocket Receiver Utilizes Interstage Coupling Transformer

The receiver schematic shown at the right was designed by Carter Robertson. The secret of the circuit is in the use of an interstage coupling transformer. Matching impedances

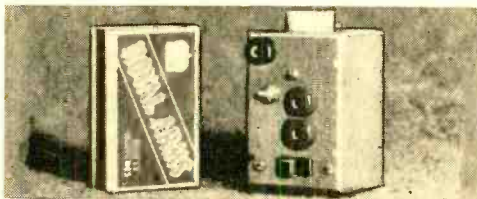

The vest pocket receiver is shown compared in size with a match box.

is important in transistor circuitry, and the use of transformers is gradually becoming more acceptable design practice. Although the author used a UTC sub-sub-ouncer SSO-7, an *Argonne* (available from *Lafayette Radio*) Model AR-104 could be substituted.

Wiring is straightforward in this circuit. Coil *L1* can be one of the many slug-tuned loop-sticks, or something similar to the *Lafayette* MS-166 (transistor loop antenna). The tuning capacitor *C1* should have a range

of from 40 to at least 380 $\mu\text{fd.}$ to tune the broadcast band, although a *Lafayette* MS-215 flat tuning capacitor (see page 57) will work. Headphones should have an impedance of at least 2000 ohms.

Like most transistorized pocket receivers, such a unit would require a short antenna. It has also been suggested that this receiver be built into a metal case and the ground return from *L1* be soldered to the case. Holding the receiver in the hand would then act as an additional ground capacity.

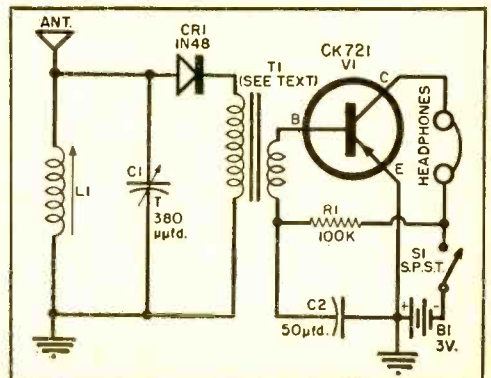

R/C NOTES

FOR MOST R/C modelers, the month of February is one that is used for designing and building new equipment to be tried out in the spring and summer months. However, after the success of the *First Winter Jamboree* held at Green Bay, Wis., last year, many fliers have been encouraged to sneak in some test flights whenever the weather presents the opportunity. Of course, extra precautions must be observed at this time of year, especially with reference to batteries which are less than reliable in cold temperatures.

If you happen to live near or be passing through Green Bay on or about February 5th, contact Robert L. Cowles, Jr., of 224 Oak Hill Drive, who is contest director of the *Second Annual Winter Jamboree*.

There is also a contest scheduled for Phoenix, Arizona, on February 19th. This Class AAA event will be directed by Quentin T. Webster of 521 E. Camelback, Phoenix.

Resonant Reed Relay

A subminiature resonant reed relay specifically designed for use in R/C model radio receivers and developed by the *CG Electronics Corp.*, 305 Dallas Street, N. E., Albuquerque, N. M., is shown below. Featuring very high sensitivity, the relay is available in two-reed (Model AR-2) or three-reed (Model AR-3) design. The coil resistance of either model is 7000 ohms, and reed frequencies range from 250 to 400 cps.

R/C³ of Chicago

In last month's column, we included some pictures taken at a recent R/C meet held by the R/C³ of Chicago. This club was



started in February, 1954, and now has 32 members. They hold meetings on the first and third Fridays of every month and have contests for members every five weeks. Trophies are awarded at each meet.

Output Indicator

Many R/C fans who use low-power transmitters would like to know for certain that a rig is giving out maximum signal when the transmit button is depressed. Field strength meters are fine but expensive, and if your object is to save money, why not investigate this hint sent in by the Rev. Robert W. L. Mark of Wellsboro, Pa.

Simply install a small No. 48 or 49 pilot

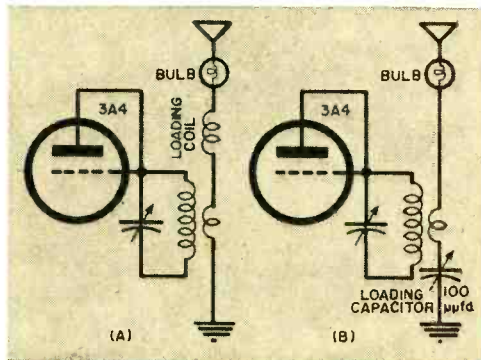

light in the transmitter antenna circuit as shown in the accompanying diagram. The light may be used for either capacitive (B) or inductive (A) loaded antennas. Since the bulb is actually in the antenna circuit, the brighter it glows the more r.f. is being transmitted. Consequently, with the antenna extended, the loading coil or capacitor is tuned until the bulb glows brightest. Make certain that the bulb lights each time the button is depressed.

R/C Passenger Train

News has come to us of two recent experiments on the use of radio control in passenger train service. The first was tried in France on a railroad train that had previously set a world speed record. The second such experiment took place a short time ago on the *New York, New Haven, and Hartford Railroad* in this country.

Equipment for the latter was developed by the *Union Switch & Signal Division* of the *Westinghouse Air Brake Co.*, and was located at the Larchmont station. An audio-modulated carrier was transmitted to the train over wires running above the train tracks. Controls possible via the use of various audio-modulating frequencies were "eastward," "westward," "stop," or "neutral." The train was loaded with automatic safety equipment to stop the train in case of emergency.

POPULAR ELECTRONICS

Audio and Hi-Fi Section

- | | | |
|----|-----------------------------------------|------------------------|
| 73 | Disc and Tape Review..... | <i>Bert Whyte</i> |
| 75 | Hi-Fi in a Chest of Drawers..... | <i>L. E. Maahs</i> |
| 78 | Audio Oscillator for Hi-Fi Testing..... | <i>Rufus P. Turner</i> |
| 82 | No Confusion . . . Just Baffling!..... | <i>H. H. Fantel</i> |
| 87 | Music Distribution System for Home..... | |

Disc and Tape Review

EVERY YEAR around Christmas time, and for some months thereafter, the record companies go on a mad orgy of new releases, and record critics are literally "snowed-under" with their listening chores. Since for the large part this column is devoted to helping you select the best recordings from the already catalogued LP repertoire, and since this column is always written some time before actual publication, many of these new releases which might be pertinent and superior to present material may not be included in our surveys. This is unfortunate, and about the only thing I can do is to start a small special section that will list any new recordings which are good enough to supersede the previous "best recordings" of a given work.

I should also mention that sometimes I have foreknowledge of a certain recording which is to be released, and I then endeavor to hold off a survey of the particular work involved until an evaluation can be made of the new recording. For example, one of the reasons I have not yet reviewed such a popular standard as Tchaikovsky's *1812 Overture* is the knowledge I have of a new recording which is to be released in a month or so. On the basis of past experience with the particular company involved, there is every reason to believe that this new recording may be best yet and thus should be included in the survey of the work.

Recorded Works of Paganini

This month we are going to review the recorded works of one of the most extraordinary composer/virtuosos in musical history . . . the great Niccolò Paganini. Born in 1782, Paganini was to exert a profound influence in his own musical times with his

By BERT WHYTE

incredible artistry on the violin, and to inspire in later years such musical giants as Brahms and Rachmaninoff to write variations on some of the themes from his famed *Caprices*. Even today these themes are the source of several new variations, the most notable of which is that of German composer Boris Blacher.

Such was Paganini's fantastic dexterity with the violin that many rivals swore he had made a pact with the devil, which gave him the power to play in this fashion! One can hardly blame these poor fellows since Paganini's music itself was almost impossible for them to play . . . old Paganini created the violin virtuoso as we know him today. Double stopping, harmonic bridging, spicato, pizzicato, and many other dazzling feats of violin gymnastics originated with Paganini. Oddly enough, in spite of its complex structure and formidable difficulties in performance, the music of Paganini is very popular in today's concert halls, and is most easily assimilated by a public which in many cases is "pre-conditioned" to cast a jaundiced ear towards too much razzle-dazzle on the violin.

Of all of Paganini's works, his violin concerti are the most interesting and most often performed. The *Concerto #1* in D has been used by many big-name virtuosos as a vehicle to display their talents. Record-wise, the *Concerto #1* exists in seven different versions. Of these, four can be called hi-fi in sound quality.

CONCERTO #1

The premier performance of this work, and one which could reasonably be labeled "definitive," is that by Zino Francescatti and the Philadelphia orchestra on Columbia ML4315. This is an altogether remarkable recording which, although made over five years ago, stands very favorable comparison with the sonic virtues of the most recent recordings. In fact, such was the thrillingly realistic sound of the Francescatti violin that it was one of the prime demonstration pieces of the hi-fi emporiums of those days. Francescatti has always had the required technical facility to cope with the enormous demands of the work, but prior to this recording he had not shown much warmth or expressive skill. This is what I think makes the record such an exciting experience . . . it is as if Francescatti had suddenly found himself, as if the innate artistry—completely in rapport with the magnificent Philadelphia Orchestra and Ormandy—had burst forth from its human chrysalis in a glorious outpouring of sublimely beautiful tone. Ever since, whatever his critics may have found in his playing to carp about, the Francescatti tone has remained a warmly rich, almost sensuously beautiful thing.

As previously noted, the sound on the Francescatti recording is quite good and its age is only betrayed by occasional overload distortion, a bass end that is somewhat lacking in definition, and other minor flaws. On the credit side are such things as a very good albeit slightly edgy string tone, brass that is brilliant without being strident, a dynamic range far superior to most other recordings of the same age, and—above all—a superb balance between the violin and the orchestra.

Very close to the Francescatti in excellence of performance is the new recording by Ruggero Ricci on London LL1215. Ricci has long been a specialist on the music of Paganini, as witnessed by his superb two-disc set of the *24 Caprices*. His reading of the *Concerto #1* is a blazing tempestuous thing . . . here is technical facility that is astounding coupled with a sumptuous tone, which does not quite match the mellow ripeness of Francescatti's.

One might also quibble that the tempi are a mite on the hurried side, but one must also admit that it is quite a heady experience being carried along on this torrent of sound.

Soundwise, the Ricci recording is ne plus ultra . . . the absolute top in London engineering. Strings have a bright smooth sheen without the concurrent penalty of edginess, the brass and woodwinds are crisply articulate. Frequency

and dynamic range are at today's practical limits and perhaps . . . at times . . . a little beyond. Gone is the usual blast-type distortion heard when the artist is double-stopping and miked very close. Pre- and post-echo, always a danger in this type of recording, is minimal. Orchestral/solo balance is very good, with the added plus of superbly live acoustics. In short, this is a recording unlikely to be surpassed for some time to come.

Michael Rabin, the talented young American artist, is a strong contender in the Paganini sweepstakes with his excellent recording on Angel 35259. Given a few more years to grow into artistic maturity, he will be formidable opposition to Francescatti and Ricci. At the moment, his tone is a little lean in comparison and his technical equipment somewhat less spectacular than that of his two rivals. Don't get me wrong . . . I'm splitting hairs here among three outstanding artists . . . and Rabin's reading has much to recommend itself. But when you are dealing with such towering talents as these three . . . I'm afraid hair-splitting is a critical necessity.

In matters of sound, the Rabin recording on the Angel disc is right up at the top with the London. Not as spectacular a recording from the standpoints of dynamics and percussive sharpness, it possesses Angel's own variety

(Continued on page 126)

Record of the Month

THE SCOTS GUARDS

Angel 35271, 12" LP

\$3.48 (standard pack)

Hoot Mon! If ye have a drap o' Scottish blud in ye (or pairhops a dram of Scots whusky), ye'll ken t' this grond bond music. Ay, with the thump and whump of the big bass drum, the stentorian shouts o' the pipe major, and the mad skirl o' the bagpipes, ye'll flip your Tam-o-Shanter! This disc is highly recommended to those of a fractious natoon as pulse-stirrin' music!

By L. E. MAAHS

Solve the problem of housing your hi-fi equipment in this unorthodox, inexpensive way



in a Chest of Drawers

A low-priced chest of drawers which has been modified to house hi-fi equipment is shown above. An alternate plan for the lower half of the chest would be to use it as an enclosure for an 8-inch speaker. Top drawer pulls out for access to turntable and arm assembly (at right); a main 10-inch turntable and separate arm assembly were used.



YEARs AGO, you might have put the baby in a chest of drawers for the night, comic-strip style, if visiting relatives were crowding you for sleeping space. But, today, another unorthodox use for a chest of drawers may be found in the audiophile's home.

The problem of housing an installation, once the components have been bought, has plagued many a hi-fi fan. One solution is to use a chest of drawers for the purpose. A great many chests are made today, in various styles, sizes, stages of finish or assembly—and at reasonable prices—which are quite suitable for hi-fi installations.

The author chose a four-drawer chest measuring 33" high, 24½" wide, and 17¾"

deep. An unfinished chest was used inasmuch as it was felt that a commercially finished unit might prove difficult to match after it had been redesigned and cut for the installation of components.

Installation of the turntable and arm required removing the bottom of the uppermost drawer. This drawer bottom, which consisted of ¼" veneered plywood, was replaced with a more substantial piece ¾" thick. The new bottom, which serves as a base for the turntable assembly, was put in place three inches below the top of the drawer. Slides were installed along the sides of the drawer to minimize friction and make for in-and-out smooth movement. A drawer stop was mounted on the



Front panel of second drawer hinges out to reveal preamplifier-equalizer and amplifier controls. Chassis are mounted behind panel.

bottom of the drawer to keep it from being pulled out too far. To assure that the turntable would be level during operation, the drawer was pulled out to its limit and the $\frac{3}{4}$ " base adjusted within it, using a carpenter's spirit level.

The second drawer provides ample space for an amplifier. To assure accurate phono reproduction, the author added a preamplifier-equalizer to his existing amplifier (which had good power output but lacked equalization facilities). Both of these units

were seated behind a recessed control panel, in which cutouts were made to accommodate the control shafts and knobs. The front panel of the drawer was removed and hinged to the drawer bottom to provide a dropleaf front.

Then, the third and fourth drawers—and their respective guides—were removed completely from the chest to provide a storage compartment for records. Vertical panels may be built into this area to act as dividers between groups of records.

The speaker for this system is located in its own enclosure elsewhere in the room. Alternate arrangements, however, will suggest themselves to the hobbyist. For example, the space created by removing the third and fourth drawers could serve as a bass reflex enclosure for an 8" speaker. In such a case, the front panel on which the speaker would be mounted should consist of $\frac{3}{4}$ " plywood, with a correctly tuned port. About one-half of the inner surfaces of the enclosure would have to be padded with sound-absorbent material, and all joints and seams securely glued and screwed to provide an airtight fit.

Another possibility would be to install a tape recorder of suitable dimensions into the area of the third and fourth drawers. Or, a radio tuner would fit easily into one of these drawers, leaving the other for miscellaneous storage.

While this type of installation does not rival the housing provided by commercially designed cabinets in terms of structure or appearance, it can do a very adequate job for the budget-minded hobbyist.

-30-



Kit Adapts Tape Recorder for Stereosound

HOME ENJOYMENT of stereophonic sound is a low-cost reality with V-M's new "Stere-o-matic" conversion kit. Selling for \$16.95, the kit—which includes a second

playback head and preamplifier—adapts V-M "Tape-o-Matic" machines to twin-channel playback.

When playing a tape on which two sound tracks have been recorded, the converted machine handles one sound track through its own built-in amplifier and speaker. The second sound track is reproduced through any external amplifier and speaker. By placing the two sound-reproducing units about ten feet apart, as shown in the photo, a stereophonic effect is achieved.

The kit can be used only on V-M machines, which were designed with the stereosound expansion idea in mind. These particular tape recorders were built with extra space provided for eventually mounting the new playback head and preamplifier tube. In addition, the power supply was designed to accommodate the additional load created by the use of the new components. (V-M Corp., Benton Harbor, Mich.)

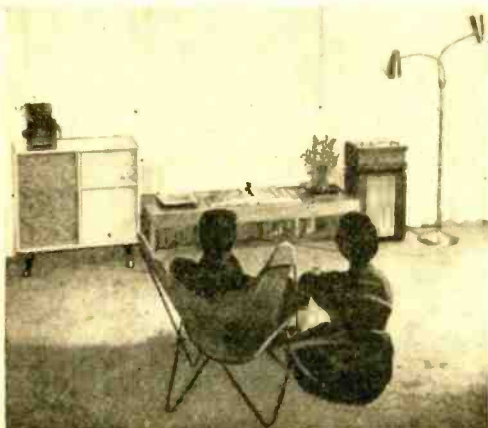

Ultra-Linear Amplifier Operates at Two Power Levels

A RECENT ENTRY into the heavyweight class of power amplifiers is the *Marantz* 40-watt (80-watt peak) ultra-linear model. Where lower power ratings are required—when using a low-power-rated speaker, for example—the amplifier can be switched to 20-watt operation.

Response at 40 watts is 20 to 20,000 cycles within .2 db, and 15 to 40,000 cycles within 1 db. Response at 1 watt is 2 to 55,000 cycles within 1 db. The amplifier goes up to 100,000 cycles with a roll-off of 2.5 db.

Average harmonic distortion and inter-modulation distortion are each less than 0.5% and hum level is better than 90 db below 40 watts. Variable damping, for greater transfer of energy to loudspeakers, is incorporated. A built-in meter and test switch assures accurate adjustment of bias, d.c. and a.c. balance.

This amplifier requires an audio front end, i.e., preamplifier-equalizer with selector,

volume, and tone controls. Net price is \$189.00. (*Marantz Company*, 44-15 Vernon Blvd., Long Island City 1, N. Y.)



Wide-Band FM Tuner

WIDE-BAND DESIGN that assures highly selective and sensitive performance, with no



drift, is featured in the new *Scott* Type 311 FM tuner. Automatic gain control keeps the tuner perfectly adjusted regardless of signal variations. Tuning is facilitated by a meter as well as by a planetary-drive mechanism. The Lucite dial is edge-lighted.

Intended for use in hi-fi systems, Type 311 features 3-mv. sensitivity for 20 db of quieting, and 80-db rejection of spurious cross-modulation responses by strong local signals; this means that it will separate two stations so close together that one would ordinarily be passed over. Net price is \$99.95. (*H. H. Scott, Inc.*, 385 Putnam Ave., Cambridge 39, Mass.)

Wide-Range Tape Transport for Hi-Fi System

ATTRACTIVELY PRICED and designed for home hi-fi installations is the new *Telectro* Model 220 tape transport. The unit includes a transport mechanism, recording amplifier, playback preamplifier, and erase oscillator. By plugging the output on playback into an external hi-fi amplifier and speaker, quality listening may be enjoyed.

The 220 can be mounted in any position and is styled to fit in with any custom installation. Frequency response at 7.5 ips is 50 to 12,000 cycles, ± 3 db, and signal-to-noise ratio is 45 db. Distortion is less than 2%, while flutter and wow are below 0.3%. A low input accommodates crystal or dynamic microphones; a high input accepts signals from tuners, TV sets, and phonos. The 220 may be run at $3\frac{3}{4}$ -ips speed for "non-hi-fi" uses, such as recording speech.

Net price is \$99.50. (*Telectrosonic Corp.*, 35-18 37th St., Long Island City 1, N. Y.)





Fig. 1. Controls include frequency (center) and output (lower right)

Audio Oscillator

for Hi-Fi Testing

By RUFUS P. TURNER

A VARIABLE-FREQUENCY audio oscillator is a useful device to have around for testing all sorts of audio equipment. The unit described here, while not comparable with expensive laboratory equipment, nonetheless has many features in its favor. It is small, inexpensive, uses only one tube, requires no range switching, and tunes from 30 to 10,000 cycles by a single rotation of its frequency dial.

The oscillator is tuned by a bridge-type resistance-capacitance circuit. Usually the capacitance is varied in such circuits, with a two-section variable capacitor employed for the purpose. But in this particular instrument the resistance is made variable. The reasons for this choice are: (1) a high-resistance dual potentiometer will provide a wider frequency range than a conventional two-gang variable capacitor; (2) the potentiometer is smaller and cheaper than the capacitor; and (3) extensive shielding is required with the capacitor but none with the potentiometer.

Circuit Details

Figure 2 shows the oscillator circuit. The frequency is controlled by a Wien bridge consisting of two 0.011- μ fd. fixed capacitance arms ($C1$ and $C2$ in parallel and $C3$ and $C4$ in parallel) and two $\frac{1}{2}$ -megohm variable resistance arms ($R3$ and $R4$) ganged together. Feedback from the plate of the output triode of the 12AU7 tube is supplied through a 1- μ fd. capacitor, $C5$.

Frequency coverage from 30 to 10,000 cycles at an output of 0 to 4 volts r.m.s. is provided by this simple, one-tube unit

Positive feedback voltage is applied to the grid of the input triode through the tuned bridge network and produces oscillation at the frequency to which the bridge is tuned. Negative feedback voltage is applied to the cathode of the input triode through a voltage divider consisting of $R5$, $R6$, and the pilot lamp, $PL1$.

The lamp, $PL1$, is used because its filament has the important property of changing its resistance in accordance with the amount of current flowing through it. This automatic variation of resistance in the cathode circuit of the tube keeps the output voltage of the oscillator constant throughout the frequency range and also keeps the signal waveform clean. $PL1$ is a 3-watt 115-volt lamp (General Electric Type 3S6/5). It is imperative that this particular type be used; others will not operate correctly in the circuit. Potentiometer $R5$ must be adjusted for good waveform; this operation is described later on in the "Initial Adjustment" section.

The tuning control (frequency dial) is attached to the shaft of the dual potentiometer, *R3-R4*. The front section of this unit is an *IRC* Type PQ-13-133 having a C-taper, while the rear section is a matching *IRC* Type M also with a C-taper. Rear unit must be attached to front unit by the builder. The process is simple, requires no special tools, and is explained thoroughly in the directions accompanying the control sections.

Connections must be made to the dual potentiometer exactly as shown in Fig. 4. An inspection of Fig. 1 shows that the

high frequencies are on the left side of the dial scale and the low frequencies on the right side. Dials usually are marked off the other way. This calibration was deliberate, however, in order to utilize the taper of the potentiometer properly.

If the potentiometer connections were reversed, placing the low frequencies on the left side in the conventional manner, three-quarters of the dial would be occupied by the first 100 cycles, leaving the remaining large portion of the audio spectrum to be crowded too severely for the frequencies to be read. As it is, the region

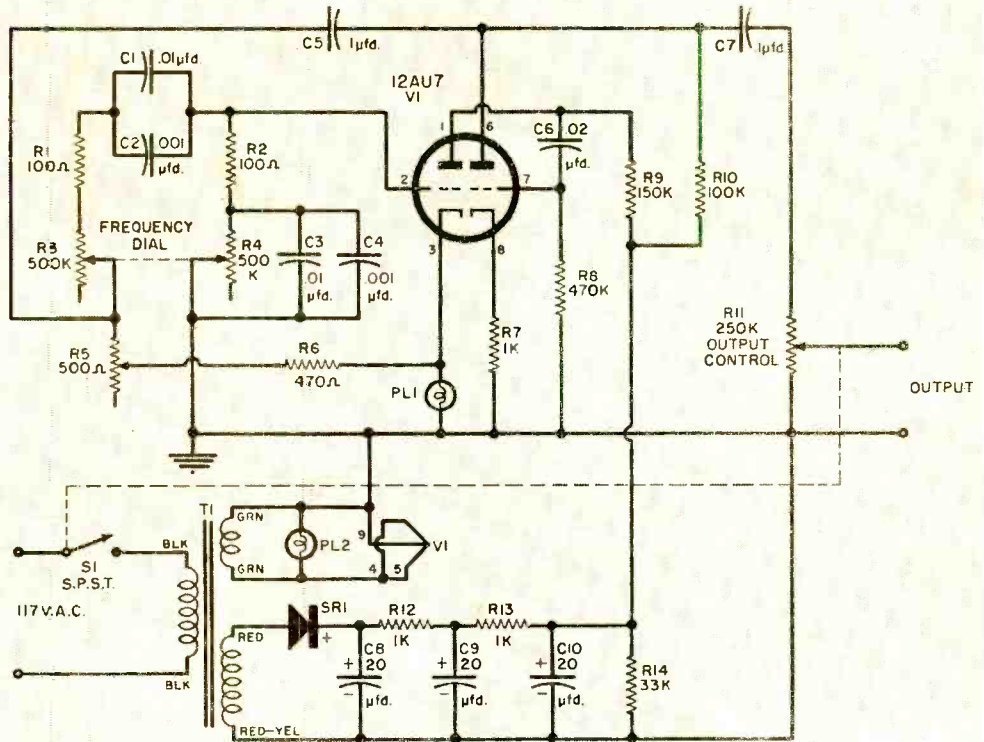

Fig. 2. Schematic diagram and parts list for the oscillator and power supply.

- C1, C3—0.01- μ fd. mica capacitor
- C2, C4—0.001- μ fd. mica capacitor
- C5—1.0- μ fd., 200-volt metalized paper tubular capacitor
- C6—0.02- μ fd., 200-volt paper tubular capacitor
- C7—0.1- μ fd., 200-volt metalized paper tubular capacitor
- C8, C9, C10—20- μ fd., 250-volt midget tubular electrolytic capacitor
- PL1—115-volt, 3-watt miniature lamp (General Electric 3S6/S)
- PL2—6.3-volt pilot light and bracket
- R1, R2—100-ohm, 1-watt composition resistor
- R3, R4—Dual 500,000-ohm, taper C potentiometer. *IRC* Type PQ-13-133 front section with matching Type M rear section (see text)
- R5—500-ohm wire-wound potentiometer (*IRC* W-500 or equivalent)
- R6—470-ohm, 1-watt resistor

- R7, R12, R13—1000-ohm, 1-watt resistor
- R8—470,000-ohm, 1-watt resistor
- R9—150,000-ohm, 1-watt resistor
- R10—100,000-ohm, 1-watt resistor
- R11—250,000-ohm potentiometer with S1
- R14—33,000-ohm, 2-watt resistor
- S1—S.p.s.t. switch (on back of R11)
- SRI—50-ma. selenium rectifier
- T1—Power transformer, 135 volts @ 15 ma., 6.3 volts @ 0.9 ampere (Triad R-2C or equivalent)
- V1—12AU7 tube
- 2—Insulated binding posts
- 1—4" dial
- 1—Pointer knob
- 1—9-pin miniature tube socket
- 1—9" x 6" x 5" aluminum box
- Misc. machine screws, terminal strips, solder, wire, etc.

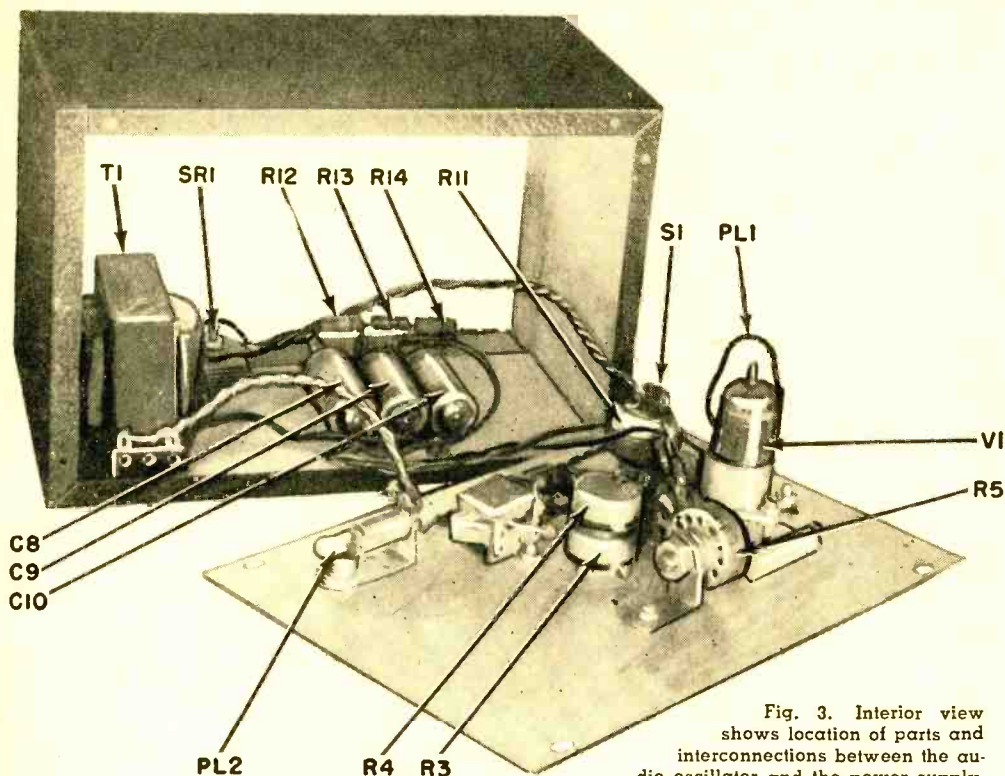

Fig. 3. Interior view shows location of parts and interconnections between the audio oscillator and the power supply.

between 5 and 10 kc. is somewhat compressed and the intermediate frequencies have not been marked on the dial. (See Fig. 1.) But this slight disadvantage is offset by the convenience of the simple, single tuning range.

As the circuit is shown in Fig. 2, only high-impedance output is provided. Adjustment of the output control potentiometer, *R11*, provides zero to 4 volts r.m.s. The output may be fed into a variety of high-impedance circuits such as amplifiers with high-impedance input, oscilloscopes, vacuum-tube voltmeters, electronic frequency meters, receiver audio channels, and similar circuits and instruments. Somewhat lower impedance output may be obtained through a 0.1- μ fd. capacitor connected to the top of cathode resistor *R7*. The output voltage at this point is 0.8 volt r.m.s.

A.c. voltage for the tube heater and d.c. for the plates are furnished by a miniature self-contained power supply. This consists of transformer *T1*, selenium rectifier *SR1*, filter resistors *R12* and *R13*, filter capacitors *C8*, *C9*, and *C10*, and bleeder resistor *R14*. If you already have an external power supply delivering 6.3 volts at 0.3 ampere and between 135 and 250 volts d.c. at 15 to 50 ma., you can use it instead of the internal supply. This will necessitate build-

ing only the upper half of the circuit, and the instrument will cost considerably less.

Construction

The instrument is built in a 9" x 6" x 5" aluminum box (*Bud AU-1040*). All of the power supply components are mounted on the "floor" of the box. Transformer *T1* is mounted in one corner to remove it as far as possible from the components making up the oscillator circuit.

Components of the oscillator circuit are mounted on the front panel. Potentiometer *R5* is mounted inside the box, since it needs to be adjusted only during the initial calibration of the oscillator and whenever the tube is replaced. The shaft of this potentiometer is saved short and slotted for screwdriver adjustment.

The three-watt lamp is held by two short pieces of No. 20 bare wire used as leads and soldered to its center terminal and brass shell. It is not necessary to use a socket for this lamp. One of the leads is connected directly to terminal 3 of the tube socket, and the other to a solder lug screwed to the front panel.

All leads in the oscillator portion of the circuit must be kept as short and rigid as possible. Connections between the oscillator and power supply may be seen in Fig. 3. The 6.3-volt filament line consists

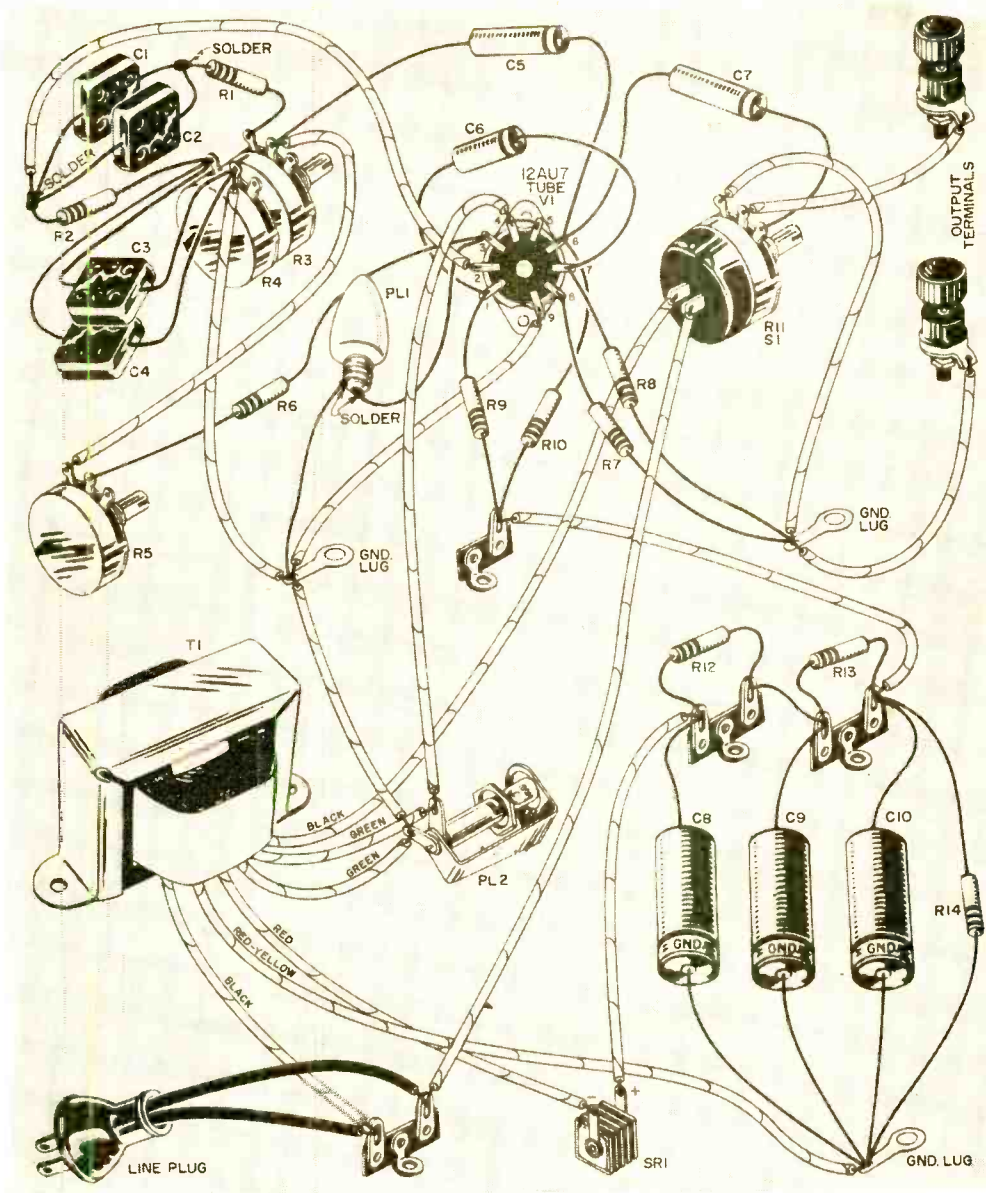

Fig. 4. Pictorial diagram shows how all parts are interconnected.

of two lengths of insulated hookup wire twisted tightly together. Another twisted pair of this type is run from the switch, *S1*, mounted on the back of the output control potentiometer, *R11*. The positive and negative d.c. leads are twisted loosely together and run to ends of resistor *R14*.

The tuning dial is a 4" unit (*ICA 2168*). First the knob is removed and a white cardboard face cemented to the metal dial plate. Then the knob is replaced and the dial attached to the shaft of potentiometer *R3-R4*.

Initial Adjustment

After the wiring has been checked as correct, the first step will be adjustment of potentiometer *R5*. This is done in the following manner: (1) With the box open as shown in Fig. 3, connect the output terminals to the vertical amplifier input of an oscilloscope. (2) Set the oscilloscope controls for internal sweep and internal sync. (3) Connect both instruments to the power line and switch them on. (4) Set the oscillator dial to its extreme counter-

(Continued on page 112)

No Confusion...

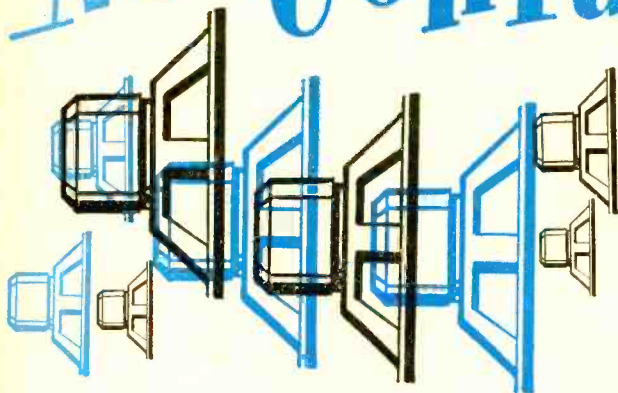

...Just

By H. H. FANTEL

A LOUDSPEAKER without an enclosure is like a string without a violin. The string and the violin interact in the same way that the speaker interacts with its enclosure. The string is an exciter element, needing the body of the violin to couple its acoustic output effectively to the air of the listening space. Precisely the same relationship exists between the speaker and its enclosure. The air, in either case, represents the load into which the exciter element works. The problem is to provide efficient transfer of acoustic energy over the entire required bandwidth.

Just as string and violin form an interdependent system, the loudspeaker and its enclosure are essentially a single functional unit in which the performance of each part depends largely upon the other. In fact, it has been seriously suggested that loudspeakers should never be sold "naked" but only in matching enclosures. Proponents of the idea argue that this would be the only way to protect the customer against impairing the performance of a speaker with an inferior or unsuitable enclosure. Manufacturers of hi-fi speakers usually specify the type and dimensions of the enclosure that brings out the best of which a certain speaker is capable.

Why Use an Enclosure?

A loudspeaker playing without an enclosure invariably sounds weak and tinny. Unmounted, even an 18" giant speaker tinkles like a pocket portable. The two principal functions of an enclosure, therefore, are: (1) adding bass, or at least permitting the full bass response of the speaker to be

heard; and (2) adding acoustic efficiency and hence power to the speaker output.

Loss of bass in unenclosed or inadequately baffled speakers is caused by the acoustic phenomenon known as "wave cancellation." A speaker radiates sound both from the front and the rear surfaces of its cone. The sound emitted from the back of the speaker is called back radiation or back wave. Front and back radiation of a speaker are always 180° out of phase with each other, because the front of the speaker compresses the air while the rear rarefies it, and vice versa. When the two phase-opposed waves from front and rear of the speaker meet, they simply cancel each other in mid-air. If this occurred uniformly at all frequencies, the result would be silence—even though the speaker might operate at full blast. However, because of the difference in the directivity of high and low frequencies, such wave cancellation takes place only in the bass region.

The high frequencies travel in straight lines from front and rear of the speaker. Therefore, the front and rear wave trains never encounter one another. The low frequencies, however, spread spherically throughout the surrounding air space. In an unmounted speaker, the base waves emitted at the back creep around the speaker edge, meeting and cancelling the opposite-phased waves from the front of the cone. The bass radiated by the speaker never reaches the listener's ear. The efficiency of an unbaffled speaker at low frequencies thus becomes, in effect, zero. This explains the tinny sound of inadequately baffled loudspeakers.

To unravel the mystery of hi-fi enclosures, a well-known author introduces a new series with a discussion of infinite baffles

Baffling!





The process is complicated by the fact that the actual phase disparity at the meeting point of front and back wave is not always precisely 180°, but varies according to the distance of the meeting point from the respective points of origin, and according to the wavelength of each of the audio frequencies to be reproduced. Partial cancellation and distortion enter the picture. However, for practical purposes, the simple concept of bass cancellation by the back wave suffices to describe the predominant aspect of the problem.

To date, three basic types of enclosures have been developed. These are, in the order of their simplicity and in the order discussed in this series: the "infinite baffle;" the bass reflex and miniaturized versions of the "Helmholtz resonator;" and the "folded horn."

Certain recently developed "special types," not accurately classifiable under any of the above categories, may utilize one or more of their basic design principles. These units will be discussed under their main generic types, with their distinguishing characteristics and innovations carefully explained. In addition, new designs which permit enclosures to function as more than one basic type (e.g., as a bass reflex or folded horn, etc.) will be discussed. Among these are the "Fold-a-Flex" developed by Editor Oliver Read, and the brand-new—as yet unnamed—enclosure developed by J. Owens of RCA.

Infinite Baffles

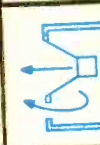
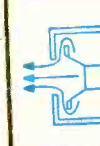
The solution to the problem of bass cancellation by the back wave is simply to keep back and front waves apart. This is the primary function of any speaker enclosure. Ideally, it can be accomplished by mounting the speaker on an infinitely large

BASIC ENCLOSURE TYPES	
	UNMOUNTED SPEAKER ALMOST COMPLETE CANCELLATION OF ALL BASS NOTES. EXTREMELY LOW EFFICIENCY. THIN, WEAK SOUND.
	POORLY MOUNTED SPEAKER CABINET WITH OPEN BACK, INCORRECT DIMENSIONS, OR NO ACOUSTICAL PADDING. SERIOUS CANCELLATION AND LOSS OF BASS NOTES, FALSE RESONANCES, PHASE DISTORTION, BASS BOOM.
	INFINITE Baffle ROOM WALL; CLOSET DOOR OR COMPLETELY ENCLOSED BOX. NO BASS CANCELLATION; BACK WAVE ABSORBED WITHIN VOLUME OF BOX AND BY ACOUSTICAL PADDING; SMOOTH RESPONSE DOWN TO NATURAL RESONANCE OF SPEAKER USED. FAIR EFFICIENCY; BEST USED WITH HIGH-POWERED AMPLIFIER AND CORRESPONDINGLY HIGH QUALITY SPEAKER.
	BASS REFLEX ENCLOSED CABINET WITH "TUNED" PORT. BACK WAVE EMERGES IN PHASE WITH FRONT WAVE TO REINFORCE LOWS. ENCLOSURE CANCELS PEAKS DUE TO SPEAKER RESONANCE. EFFICIENCY VARIES WITH SPEAKER USED.
	HELMHOLTZ RESONATOR SMALLER ENCLOSURE THAN BASS REFLEX, WITH CRITICAL SPACING BETWEEN SPEAKER AND FRONT END OF CABINET. PRINCIPLE AND PERFORMANCE ARE SIMILAR TO BASS REFLEX, WITH SOMEWHAT LESS BASS REINFORCEMENT AND LOWER EFFICIENCY DUE TO SMALLER SIZE.
	FOLDED HORN DUCTED PATHS AND FLARED OPENINGS PROVIDE HORN-LOADING ON SPEAKER. MANY VARIANTS AVAILABLE. STRONG REINFORCEMENT OF BASS NOTES, TENDING TO EXTEND SPEAKER RANGE BELOW RESONANT POINT. OUTSTANDING FEATURE IS THAT IT COUPLES SOUND TO AIR WITH MAXIMUM EFFICIENCY. GENERALLY USED AS WOOFER IN 2 OR 3 WAY SYSTEM.

How the basic types of enclosures look and operate. Details are given in text.

board. Front and back wave are then separated by the immense board so that the twain shall never meet. In actual practice, such a baffle need not be literally infinite. The board merely must extend beyond ear-shot in all directions.

Because of this illustrative analogy to an over-sized board, the term "infinite baffle" is sometimes misused to designate a large wood panel with a hole near the center for mounting the speaker. Such baffles are correctly called "flat baffles." They are obviously not infinite and therefore do not completely separate the front and back radiation. They merely lengthen the path the back wave must travel before it can join the front wave. At some frequencies, this path length actually produces an accurate

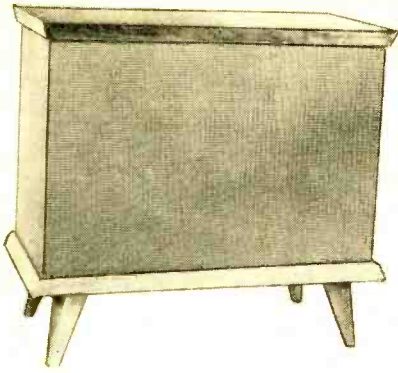

Bozak infinite baffles, designed to house Bozak speakers, are large, sturdy enclosures, braced and padded; the B-305, a 3-way system in 8 cu. ft. cabinet, is shown above. Below is the Hartley "Baffle." In this small enclosure, layers of felt are suspended to absorb back waves. Enclosure's back is of loose fiber to relieve pressure on speaker.

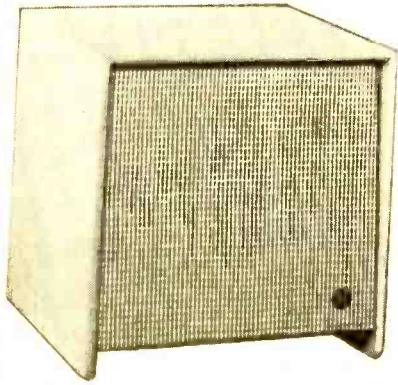

phase reversal, so that the rear radiation emerges in phase with the front radiation and no cancellation takes place. However, as was pointed out before, the phase relationship at a given distance from the speaker varies with the wavelength. Consequently, only some of the bass frequencies are fully restored, while others remain more or less suppressed. The frequency response of such flat baffles is therefore anything but flat, and unsuitable for high-fidelity use.

The principle of the infinite baffle, however, can be practically useful in the following forms: mounting the speaker (1) in a wall, so that the rear side faces into another room; (2) in the tight-fitting door of a clothes closet; or (3) in a large, sturdy box, lined with sound-absorbent material to deaden the sound from the back of the speaker. By literally "baffling," i.e., smothering the back radiation of the speaker and thus keeping it from interfering with the front radiation, all of these versions act—in effect—as "infinite baffles."

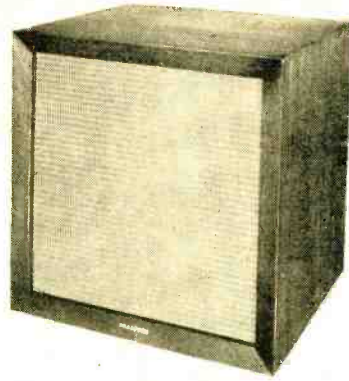

In Bradford enclosure, pressure on speaker is relieved by hinged valve on back panel. This version of an infinite baffle is only 2 inches larger than the speaker used in it.

Thanks to their simplicity, infinite baffles have often been the choice of audio fans with leanings toward carpentry. Three points must be remembered:

- (1) The baffle must contain a large air volume so that no back pressure is built up by the rearward excursions of the speaker cone. Minimum volume is $6\frac{1}{2}$ cubic feet, but a good rule is: the bigger, the better.
- (2) Like all good enclosures, the baffle must be heavily constructed and tightly fitted so that it does not vibrate along with the speaker. (In case a door-and-closet combination is used, the door must be rigidly secured and an air seal must be applied along the crack.)
- (3) The sound absorbent material lining the baffle (e.g., Celotex) must be thick enough to swallow all of the back radiation. Otherwise, the waves will reflect against the speaker and distort the motion of its cone.

Practical Considerations

A properly constructed infinite baffle is sure to provide clean, crisp sound, devoid of false resonance, with practically any make of speaker. Yet, in addition to their bulk, infinite baffles have another great drawback: inefficiency.

The causes of this inefficiency are inherent in the operating principle. All of the back radiation of the speaker, equal to precisely half the total audio output of the speaker, is absorbed by the baffle lining and turned into frictional heat. Considering the ingenuity and expense that goes into producing the high-quality audio signal which is literally burned up in an infinite baffle, it stands to reason that there ought to be cheaper ways of heating a house.

Furthermore, the infinite baffle does nothing except suppress back radiation. Its contribution is entirely negative. It pro-

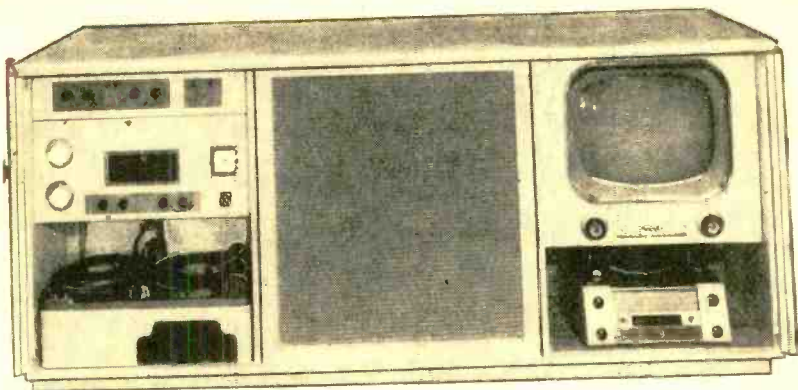

A full-sized infinite baffle enclosure is combined with a complete home entertainment center in this installation. Speaker cabinet is structurally isolated from the cabinets flanking it, is made of heavy plywood, internally braced and lined with sound absorbing material. A Bozak speaker system is used for all sound, including TV programs.

vides no acoustic assistance, such as resonance or horn loading, to couple the audio energy of the speaker to the air of the listening room. The front of the speaker cone is the only active part of the entire system.

With these reservations in mind, infinite baffles can be recommended only for installations where plenty of reserve power is available from the amplifier (preferably no less than 20 watts), where there is ample space for the baffle itself, and where the loudspeaker is large and powerful enough to make up for the lack of acoustic assistance. For best results, a 15" woofer should be used. As an alternative, the total radiant area might be comprised of multiple, properly phased speakers of smaller diameters. Obviously, such an installation will occupy a good deal of space. Commercial attempts at licking this "bass-space" problem are shown in the accompanying photographs.

Resonators, large and small, will be discussed in the next article in this series. These include the familiar bass reflex enclosure and such miniature designs as the popular "R-J" enclosure.

-30-



This installation by Fisher Radio uses available closet area for infinite baffle as well as for housing entire hi-fi system.

An ingenious solution to the "bass-space" problem is the AR-1 system designed by audio technician Edgar M. Villchur. Speaker is treated in such a way as to render it useless in any but this enclosure. Cone suspension is made very loose, requiring an "air cushion" behind it. This "cushion" is provided by an acoustic suspension system created by tightly packed sound absorbing material stuffed inside the solid wooden box. Infinite baffle performance is achieved with only 1.7 cu. ft. inside volume. Unit at right has separate compartments for 12" woofer, 8" tweeter.



Complete Speaker Systems Built from Kits

A SERIES of eight loudspeaker system kits, ready for home assembly, has been introduced by *Jensen*. Each kit contains the same components used by the speaker manufacturer in making the regular *Jensen* line of factory-built reproducers. In addition to

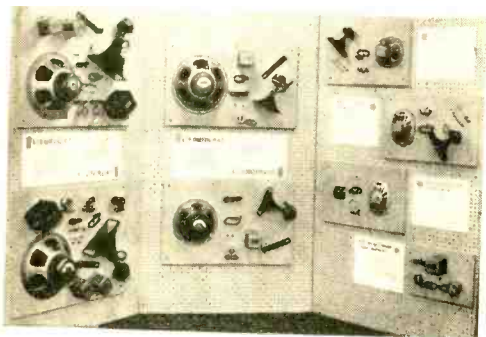

the woofer, and tweeter units, frequency dividers, controls, mounting brackets and wiring, each kit contains plans for a recommended enclosure. Full instructions for assembly of the system are included.

The kits range in type from the KT-31 Imperial (3-way system, 15" woofer, (\$184.50) to the KDU-12 Budget Duette (2-way system, 6" x 9" woofer, \$10.50). Other models include: KT-32 Tri-plex (3-way system, 15" woofer, \$169.50); KT-21 Concerto-15 (2-way system, 15" woofer, \$99.50); KT-22 Concerto-12 (2-way system, 12" woofer, \$73.00); KDU-10 Treasure Chest Duette 2-way system, 8" woofer, \$24.75; KDU-11 Table Duette 2-way system, 6" x 9" woofer, \$23.75); KTX-1 Range Extender (super-tweeter for adding highs to any system, \$43.75). (*Jensen Mfg. Co.*, 6601 So. Laramie St., Chicago, Ill.)

"Silent Viewer" Permits Private TV Listening

RECOMMENDED FOR LATE LISTENERS who do not wish to disturb others in the household or their neighbors is the "TV Remote Control Silent Viewer" introduced recently by *Lafayette Radio*. It also permits children or adults to listen to their favorite programs without annoying people not interested in the same program. The unit has sufficient gain to help hard-of-hearing persons who have difficulty in listening to loudspeakers.

This device plugs into the TV set's sound system without affecting normal use of the set. The loudspeaker may be cut off by a switch on the remote control unit. "Silent Viewer," furnished with 20 feet of cable and a single dynamic earphone, is controlled from the viewer's chair. Net price is \$6.50. An additional earphone may be

had for \$1.95. For more details, write to the manufacturer. (*Lafayette Radio*, 100 Sixth Ave., Dept. PE, New York 13, N. Y.)

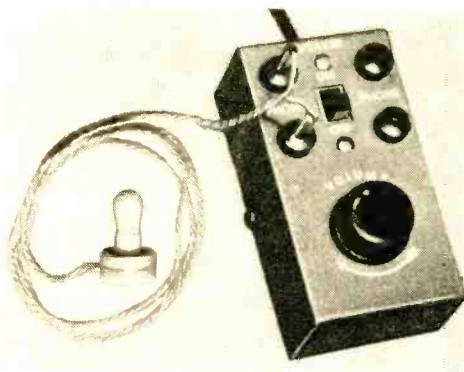

Single-Chassis Amplifier Boasts 35-Watt Output

A COMPLETE HI-FI amplifier in the 35-watt class, designed for home use, has been in-

roduced by *Pilot Radio*. Known as the Pilotone Model AA-905, the new unit incorporates on one chassis a preamplifier-equalizer and tone control circuit together with a push-pull power amplifier using KT-66 tubes.

Each of five input channels has its own level setting. Other features include a continuously variable loudness control, built-in rumble filter with switch control, and provision for inserting a dynamic damping control at slight additional cost.

The power reserves of the AA-905 assure smooth response over the entire listening range, as well as sufficient energy to drive multiple speaker systems. Net price is \$129.50. (*Pilot Radio Corp.*, 37-06 Thirty-Sixth St., Long Island City 1, N. Y.)

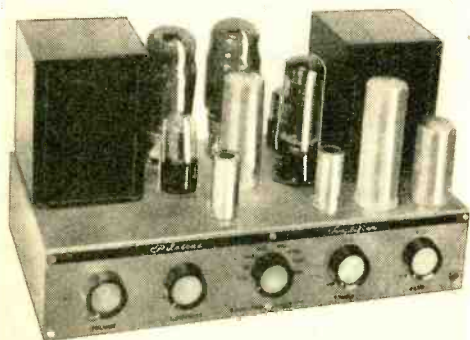

"Dinner is ready!" calls the lady of the house. Muzikom system provides direct voice contact with all parts of home. Clock may be preset to turn on radio or any appliance plugged into convenience outlet. Master control panel is flush-mounted, as are all remote station speakers. When desired, person using master panel can listen to others in any or all rooms at will.



Music Distribution System for Home

RADIO MUSIC or voice messages may be piped to any or all rooms of the house with Masco's new Muzikom system. The equipment combines a home music distribution system with the features of an intercom. Designed specifically for home

use, the system's switching facilities simplify operation, while all units may be flush-mounted in walls to present a neat appearance.

A master panel acts as nerve center. Its built-in AM radio may be turned on and off, tuned, and adjusted for volume from this panel. Manual operation, or automatic operation from a preset control on the electric clock, is provided. A channel selector switch is used for sending radio programs to any of five remote stations in other parts of the house, or to all five at once.

Another control adjusts the volume of the speaker at the master station; this does not affect the levels at remote stations. Still another knob on the master panel switches from *radio* to *intercom*. In the latter position, the local speaker doubles as a microphone by means of a "Listen-Talk" switch, and voice contact with remote stations is made.

Programs from any high-level source, such as an external tuner, tape recorder, or phono, may be sent to the rest of the house by connecting the output into a jack on the front panel.

Finally, there is an auxiliary a.c. outlet which can be used when the system is in operation, or when it is energized automatically by presetting a control on the clock. Thus, at a given hour, both the radio and an electric toaster may be turned on simultaneously and effortlessly.

Besides Muzikom, other Masco audio units can be combined into numerous systems to meet different needs—such as the "electronic butler," a two-way intercom between the front door and some part of the house. Prices vary with the type of installation. Further details are available from the manufacturer, *Mark Simpson Mfg. Co., Inc.*, 32-28 49th St., Long Island City 3, N. Y.

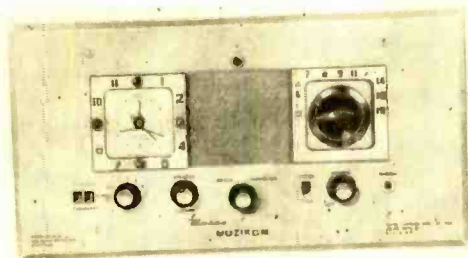

Master control panel with clock, radio, a.c. outlet, phono jack, and speaker-microphone.

Indoor remote speaker (left) and outdoor unit. Latter serves as "electronic butler."

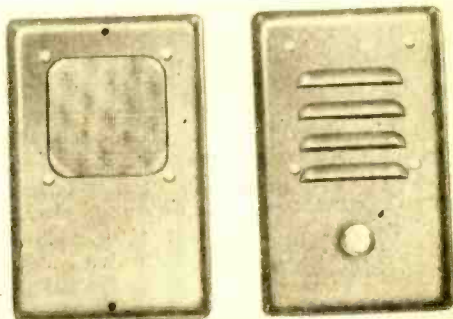

use. the system's switching facilities simplify operation, while all units may be flush-mounted in walls to present a neat appearance.

A master panel acts as nerve center. Its built-in AM radio may be turned on and off, tuned, and adjusted for volume from this panel. Manual operation, or automatic operation from a preset control on the electric clock, is provided. A channel selector switch is used for sending radio programs to any of five remote stations in other parts of the house, or to all five at once.

Another control adjusts the volume of the speaker at the master station; this does not affect the levels at remote stations. Still another knob on the master panel switches from *radio* to *intercom*. In the latter position, the local speaker doubles as a microphone by means of a "Listen-

Familiarity with this valuable tool will improve your ability to understand electronic circuits

HOW TO USE OHM'S LAW

MOST electronic experimenters steer clear of anything that smacks of theory. And with good reason, for if one gets a kick out of working with his hands and building gadgets that do things, pushing a pencil can be mighty boring. But there's one bit of theory that's both easy to learn and easy to use. Best of all, once learned, it will provide the experimenter with a powerful mental tool that will help him to undertake more difficult and more interesting projects, and may even help him to save money when buying electronic parts . . .

Ohm's law.

With a knowledge of Ohm's law, the experimenter can do such things as determine what size cathode resistor to employ in an audio amplifier, how large a dropping resistor to install in series multiplier heater strings, and what size vacuum-tube resistor to use when converting a milliammeter to a voltmeter. In many cases, he may be able to combine two resistors that he has in his junk box to use in place of one resistor that he would have to buy, thus saving money on parts purchases.

Ohm's law is not a man-made law like the laws against speeding and robbery but, rather, a statement of natural or scientific law. It is a statement of the relationship between electrical pressure (voltage), resistance to current flow (ohms), and actual current flow (amperes) in a closed electrical circuit. It is named after George Simon Ohm who, in the 1820's, formulated this relationship. The familiar unit of electrical resistance, the *ohm*, is named after the same scientist.

Ohm's law itself may be expressed in many forms, both as fact statements, and as mathematical formulas. One fact statement is as follows: the current flow (amperage) in an electrical circuit is directly proportional to the total electromotive force (electrical pressure, or voltage) in the circuit and inversely proportional to the total resistance of the circuit.

In actual practice, this fact statement of Ohm's law, as interesting as it may be, is not used nearly as much as the mathematical relationships, or formulas, which are derived from the law. These formulas are given in Fig. 1 (A) in their three basic forms. The small design at the top provides a convenient way for the beginner to remember the relationships. In using these formulas, the numerical values in the basic units of resistance (ohms), voltage (volts), and current (amperes) in every case are substituted for the symbols *R*, *E*, and *I*.

Form one states that:

$$E = IR$$

or, voltage (volts) = current (amperes) multiplied by resistance (ohms).

Form two states that:

$$I = E/R$$

or, current (amperes) = voltage (volts) divided by resistance (ohms).

And, finally, form three states that:

$$R = E/I$$

or, resistance (ohms) = voltage (volts) divided by current (amperes).

Determining Values

To use any of these forms of Ohm's law, it is only necessary to determine two of the

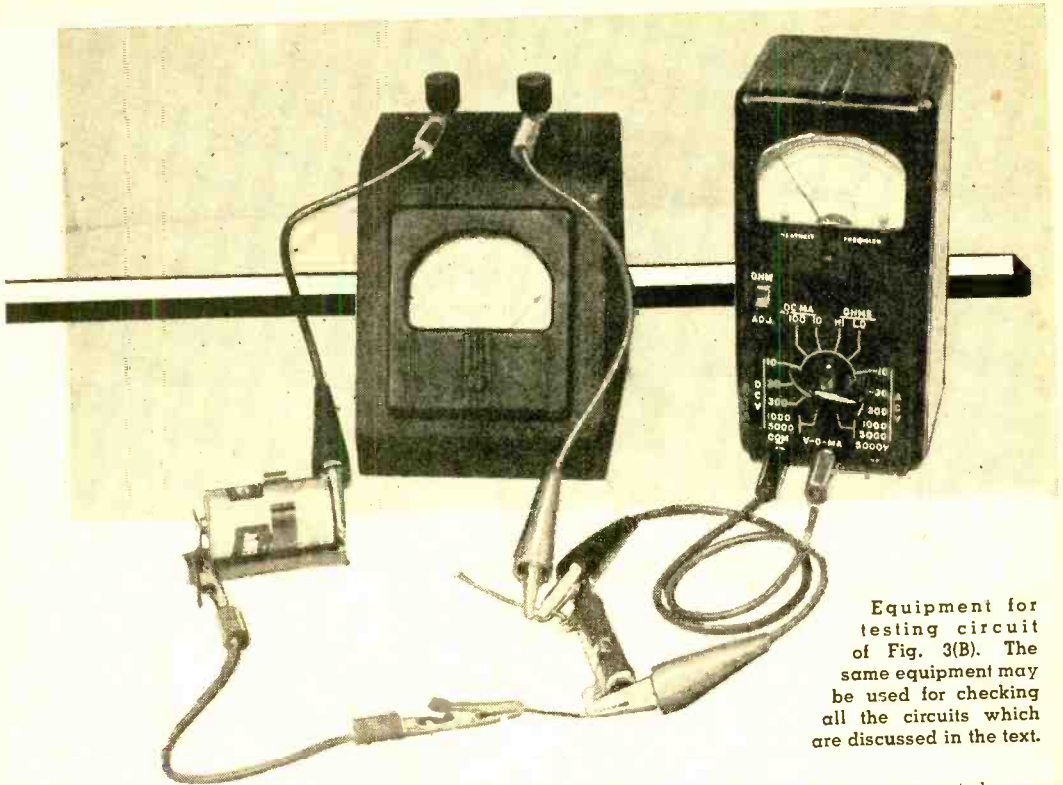

Equipment for testing circuit of Fig. 3(B). The same equipment may be used for checking all the circuits which are discussed in the text.

values in the circuit, then to substitute them in the proper formula to calculate the third value.

For example, in the basic experimental setup shown in Fig. 1 (B), the electromotive force or voltage E may be determined by a voltmeter, current flow I by an ammeter, and the resistance R may then be calculated by using the third form of Ohm's law, as shown in Fig. 1 (A). But enough of general theory; let's take up some down-to-earth practical examples.

Series Resistor: In transformerless circuits, tube heaters are frequently connected in series across a source of fairly high voltage. This may be done if each heater requires the same current for operation and if the total voltage drop is equal to the source voltage. Where the total voltage required is less than source voltage, a series dropping resistor is connected in the circuit to provide additional voltage drop and thus to limit current flow.

A typical circuit arrangement is shown in Fig. 2 (A). What size resistor should be chosen for R ? Let's use Ohm's law and see.

Using round figures, the total voltage drop in the tube circuit proper is 35 volts (35W4) plus 50 volts (50B5) plus 12 volts (12AT7), or a total of 97 volts. This can be determined by simple addition. Since the source voltage is 117 volts, it will be necessary to drop 117-97 or 20 volts across the

resistance. Current? Check the tube manual! For these tubes, heater current is 0.15 amperes. Now, let's substitute these values in form three of Ohm's law, as given in Fig. 1 (A). Resistance (R) = desired voltage drop (20)/current (0.15), or:

$$R = 20/0.15 = 133.33 \text{ ohms}$$

It's as simple as that!

But now a problem presents itself. If an experimenter went into a radio parts store and asked for a 133.33-ohm resistor, the clerk would be mighty surprised. In most cases, however, exact circuit values are not too critical, so one should simply ask for the nearest standard value resistor or, in this case, a 150-ohm unit.

Cathode Resistor: A common problem encountered in designing and building audio amplifiers is shown in Fig. 2 (B). What size cathode resistor is needed to bias this power output stage properly? As in the case of the series heater resistor, first consult the tube manual. Let's assume that a type 50C5 tube is being used, with $B+$ around 110 volts.

Referring to the tube manual, it will be seen that suggested bias voltage is -7.5 volts for this plate voltage, and that, under these conditions, the plate current will be 49 milliamperes, the screen grid current 4 milliamperes. The cathode current is the total of the plate and screen currents, or 49 plus 4 = 53 ma.

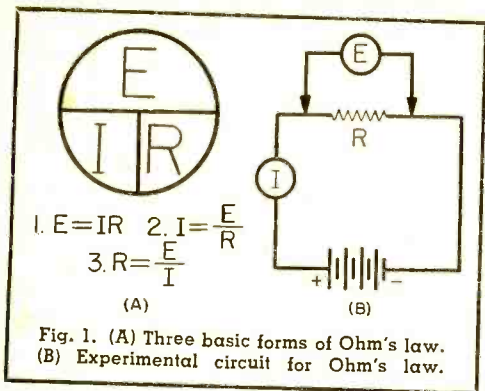

Having the voltage (7.5 volts) and the current value (53 ma.), the resistance can be calculated using Ohm's law.

Wait a minute! When using Ohm's law, *the current must be in amperes* if the values are to be determined in volts and ohms. Remembering that 1 milliamperes equals 0.001 ampere, simply take the value in milliamperes and move the decimal point three places to the left to convert the value to amperes. Thus, 53 ma. = 0.053 amperes. Now, substituting this value in the formula:

$$R = E/I = 7.5/0.053 = 141.5 \text{ ohms}$$

As a 141.5-ohm resistor cannot be purchased, one would then ask the clerk for a 150-ohm unit.

Meter Multiplier: A milliammeter or microammeter may be used as a voltmeter if it is provided with a series resistor to limit

current flow. The basic circuit arrangement is shown in Fig. 2 (C). What size *multiplier* resistor should be used in the circuit? This should be a cinch now that Ohm's law has been learned.

To measure a maximum of 100 volts, a full-scale (1-ma.) reading on the meter should indicate that 100 volts is applied across the entire circuit. Thus, both the voltage (100) and the current (1 ma. or 0.001 ampere) are known. Therefore:

$$\begin{aligned} \text{Resistance (total)} &= 100/0.001 \\ &= 100,000 \text{ ohms} \end{aligned}$$

But this is the total resistance needed in the circuit. Since the meter already has a resistance of 50 ohms, the multiplier resistor (R) should have a value of 99,950 ohms. Where maximum accuracy is desired, a special effort should be made to obtain a precision multiplier resistor having the exact value needed. However, for practical purposes, a 100,000-ohm resistor could be used in this circuit.

Series and Parallel Resistors

Suppose that a resistor is needed of a value that cannot be bought . . . or, suppose there are a lot of resistors on hand, but not of the value desired. Is there some way that two or more resistors can be combined to obtain a special value? There is.

When resistors are connected in series, the total resistance is simply the sum of the individual resistance values. A typical series connection is shown in Fig. 3 (A). If

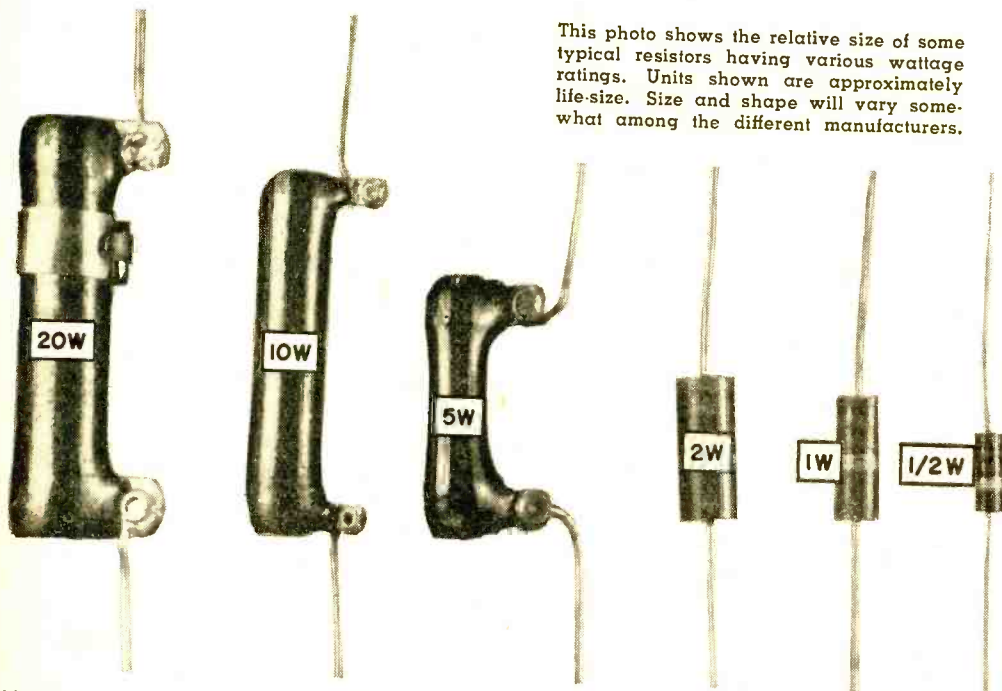

This photo shows the relative size of some typical resistors having various wattage ratings. Units shown are approximately life-size. Size and shape will vary somewhat among the different manufacturers.

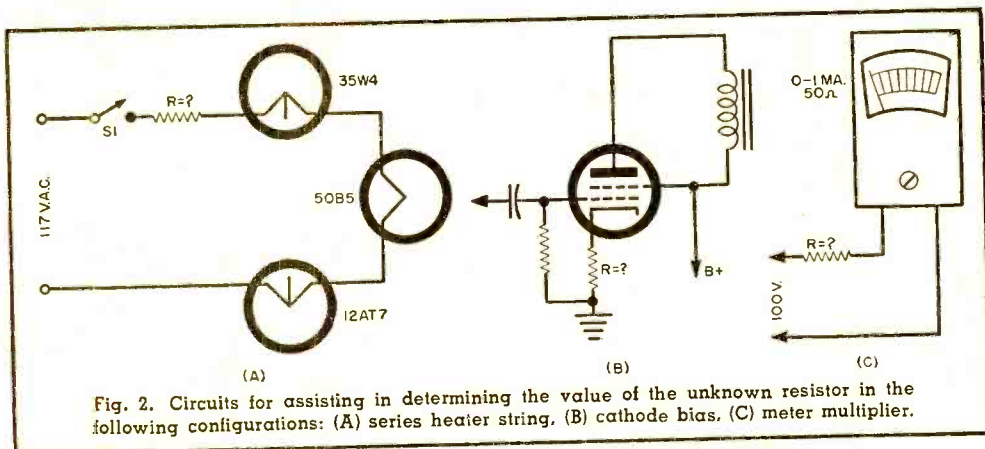

Fig. 2. Circuits for assisting in determining the value of the unknown resistor in the following configurations: (A) series heater string, (B) cathode bias, (C) meter multiplier.

the resistors shown had values of 500 ohms ($R1$), 100 ohms ($R2$) and 50 ohms ($R3$), the total resistance would be the simple sum of these values:

$$Rt = 650 \text{ ohms}$$

When resistors are connected in parallel, the total resistance is less than the value of the smallest resistor. A parallel resistor circuit, together with the mathematical formulas used to calculate total resistance, is shown in Fig. 3 (B). Where only two resistors are in parallel, a special, relatively simple formula may be employed. This formula is also given in Fig. 3 (B).

As an example, assume that a 300-ohm and 500-ohm resistor are connected in parallel. Total resistance would then be:

$$Rt = \frac{R1 \times R2}{R1 + R2} = \frac{300 \times 500}{300 + 500}$$

$$= \frac{150,000}{800} = 187.5 \text{ ohms}$$

Note that the value obtained (187.5 ohms) is less than that of the smallest resistor in the parallel network (300 ohms).

Where all the resistors are of the same value, the total parallel resistance can be determined simply by dividing the value of one resistor by the number of resistors connected in parallel. For example, suppose

there are five (5) one-thousand-ohm (1000-ohm) resistors connected in parallel. Total resistance would be 1000 divided by 5 or 200 ohms.

Wattage

When specifying a resistor size, not only the resistance must be known but also the wattage rating. All the resistors which are shown on the facing page have exactly the same resistance value, but there is a big difference in physical size . . . and in price as well.

The wattage rating of a resistor is determined by the amount of current it can handle, for its resistance, without overheating or burning out. Thus, it is determined by the power that the resistor can dissipate as heat. Naturally, a large resistor can dissipate more heat than a smaller resistor, and—as would be expected—the larger the wattage rating of a resistor, the larger its physical size.

Actual power, in watts, may be determined by the formulas given in Fig. 3 (C). When choosing a resistor for an electronic application, it is common practice to pick a wattage rating in a standard size at least two to three times the actual wattage that the resistor must dissipate as heat.

(Continued on page 114)

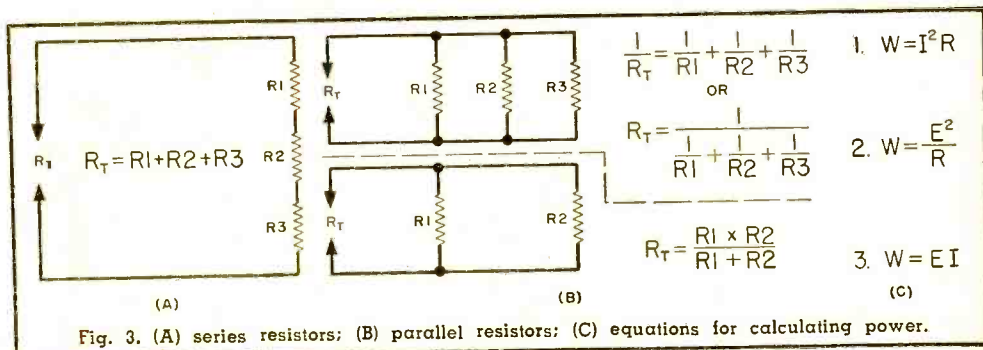
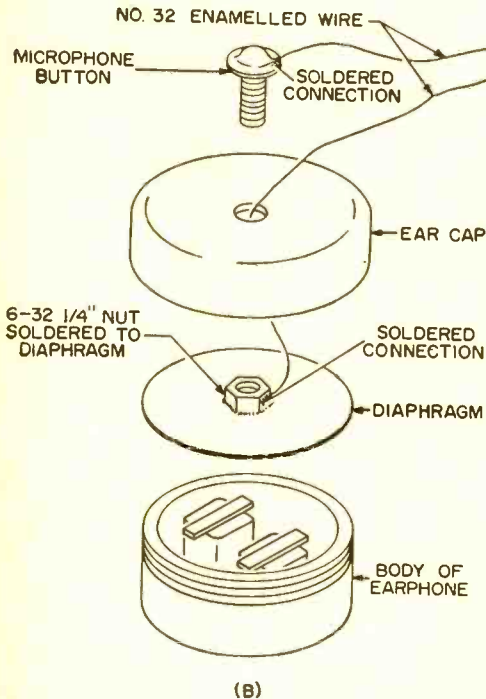
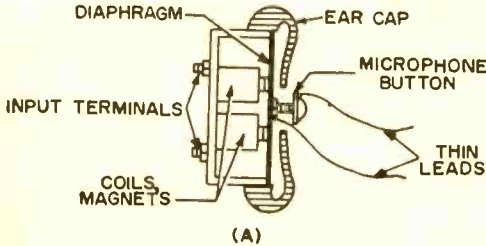
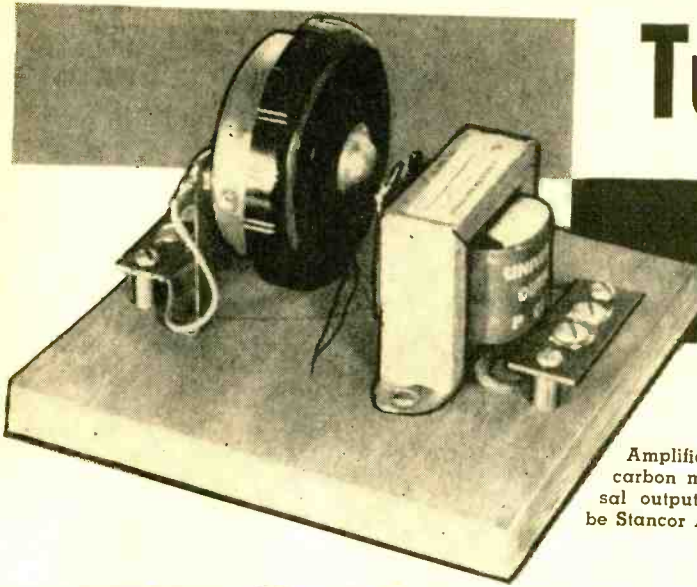

Fig. 3. (A) series resistors; (B) parallel resistors; (C) equations for calculating power.

Tubeless

By RUFUS P. TURNER

Amplifier is made from a headphone, carbon microphone button, and universal output transformer. The latter may be Stancor A-3823, A-3856, or Triad S-51X.



AN AMPLIFIER and oscillator without either tubes or transistors certainly sounds like something new under the sun. Such a device is entirely practicable and it works on an electromechanical principle. Readers may be surprised to learn that it is *not* new!

The gadget that amplifies audio signals electromechanically is a combination of headphone and microphone. They are coupled together mechanically so that vibrations of the headphone diaphragm operate the microphone. The signal to be amplified is fed into the headphone. The headphone might be said to "speak" faintly, but the microphone which it works "speaks" more loudly, since it controls a heavy "local" current. Thus, amplification results.

This amplifier was used more than 30 years ago in both telephone and radio circuits. The device was called by many names, one of them being "microphone relay," and another "carbon amplifier." A commercial version was marketed in England for a time. Years ago, the author heard a well-built two-stage electromechanical amplifier of this type operate a loudspeaker from a crystal set.

Construction

An electromechanical amplifier can be built very cheaply and much enjoyment derived from its operation. The simplest way to do the job is to attach a carbon microphone button to the diaphragm of a high-resistance, magnetic-type headphone and connect it in the circuit shown in Fig. 2(A). A satisfactory lightweight button is the No. 2988 which is sold for 50 cents by

Fig. 1. Assembly of the amplifier unit: (A) an x-ray view, and (B) exploded view.

Audio Amplifier

Johnson Smith & Co., Detroit 7, Mich.
Vibrations of the diaphragm alternately compress and loosen the carbon granules inside the button. This causes the resistance of the button to change at the same rate, and this resistance varies the battery current.

Fig. 1 shows how the microphone button is attached to the headphone. First, unscrew the ear cap from the headphone and remove the diaphragm. See Fig. 1(B). Next, scrape the paint from the center of the diaphragm to expose a clean, bright spot about $\frac{1}{2}$ " in diameter. Then remove one of the two small nuts from the mounting screw of the microphone button and solder this nut to the center of the diaphragm. Also, solder a 6" length of No. 32 enamelled wire to this spot. Pull the wire through the sound hole of the ear cap, as shown in Fig. 1(B), and screw the cap back on the headphone. With the headphone assembled, screw the microphone button tightly into the diaphragm-mounted nut. Finally, solder a 6" length of No. 32 enamelled wire to the edge of the microphone button. This completes the assembly of the unit.

Figure 1(A) shows how the various parts are put together. The thin (No. 32) wire leads allow the diaphragm to move freely without the hindrance that would be imposed by heavier, stiffer leads.

The photographs show the construction of the amplifier. Here, the parts are
(Continued on page 113)

Having no tubes or transistors, this amplifier/oscillator works on electromechanical principle

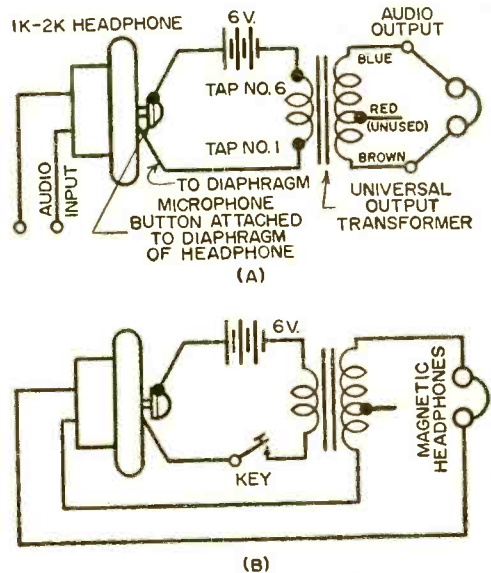
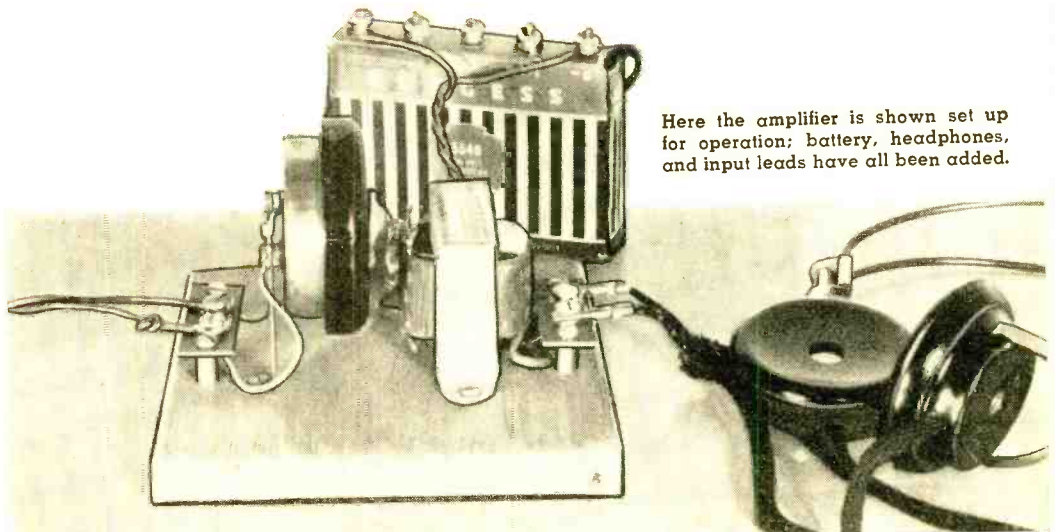
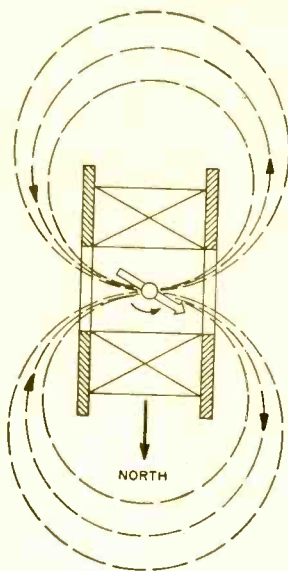
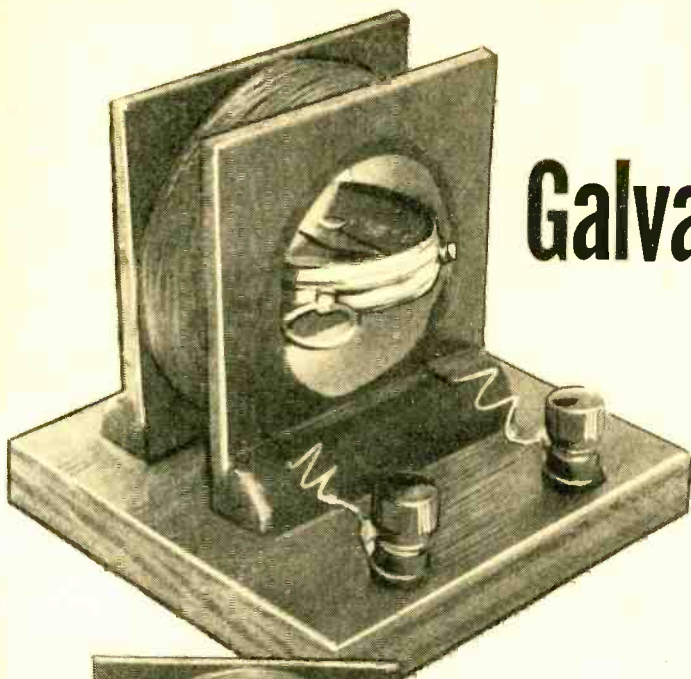

Fig. 2. Circuits of (A) electromechanical amplifier, (B) electromechanical oscillator.



Here the amplifier is shown set up for operation; battery, headphones, and input leads have all been added.

Compass Galvanoscope



Above and to the left are views of the super-sensitive galvanoscope. To the right is a presentation showing how the compass needle tends to align itself with the lines of magnetic field around the coil.

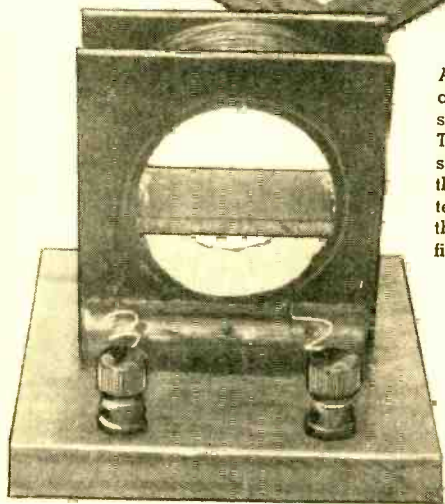

Sensitive instrument may be used to detect current flow output from solar batteries and photocells

A GALVANOSCOPE is an instrument used to detect a very small flow of electric current. It is especially useful for such applications as finding the null or balance in a d.c. Wheatstone bridge. The instrument to be described here is extremely simple and inexpensive, consisting of but a coil of wire and an ordinary north-seeking magnetic compass, yet it is so sensitive that it can detect a current flow of less than 50 microamperes!

To make the compass galvanoscope, first select a piece of Bakelite or heavy

cardboard tubing with an inside diameter just slightly larger than the compass and about $1\frac{1}{4}$ " long. Cut two square end pieces from $\frac{1}{8}$ "-thick Bakelite, wood, or hard board, with a width and depth about $\frac{3}{8}$ " to $\frac{1}{2}$ " larger than the outside diameter of the tubing. Cut a hole to the tubing outside diameter in the center of each. Cement these parts together with household plastic cement to make a coil form, and wind it with about $\frac{1}{4}$ lb. of No. 34 enameled or d.c.c. magnet wire. The size of the wire need not be exact. What is important is to

use a large number of turns of fine wire, so that the instrument will be as sensitive as possible.

After the coil is wound, mount it on a wooden base using a couple of short pieces of $\frac{1}{2}$ " quarter-round, household cement, and 1" wire brads. The coil form is cemented to the quarter-round and the brads are driven through the quarter-round into the base. Make a little platform out of the same $\frac{1}{8}$ " material used for the end plates, and cement it inside the coil form to hold the compass. Run the leads from the coil to two binding posts toward the front of the base—and the little galvanoscope is finished!

The photographs show the compass galvanoscope with and without the compass. The compass is removable so that it can be used for other purposes if desired. In using this instrument, greatest sensitivity

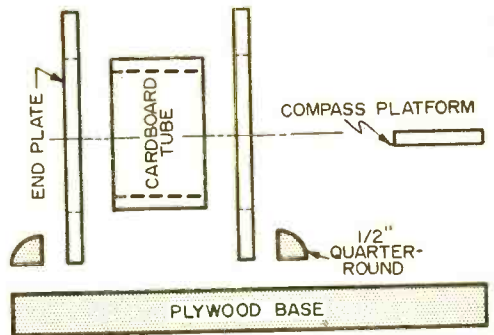

Exploded view of the galvanoscope showing the assembly of coil frame and compass platform.

will be obtained when the compass needle is initially at a right angle to the axis of the coil, i.e., parallel to the end plates.

-50-

Navy Uses Faster-Than-Light Oscilloscope Trace

AN OSCILLOSCOPE TRACE velocity of 202,000 miles per second has been recorded on film at the U.S. Naval Research Laboratory. Believed to be the fastest trace ever recorded in this country, its speed is much greater than that of light—known to be 186,000 miles per second.

Although such speed appears to be contrary to the laws of physics, NRL scientists have indicated that this is not so. Physical laws state that no object which possesses mass, no matter how small, can reach a velocity greater than that of light. Now, the sweep of an oscilloscope is the result of electrons impinging on the screen side by side. While the individual electrons have mass and are traveling at a velocity lower than that of light, it is the displacement between successive electrons that makes the trace appear to move horizontally.

Inserting recording film pack into scope.

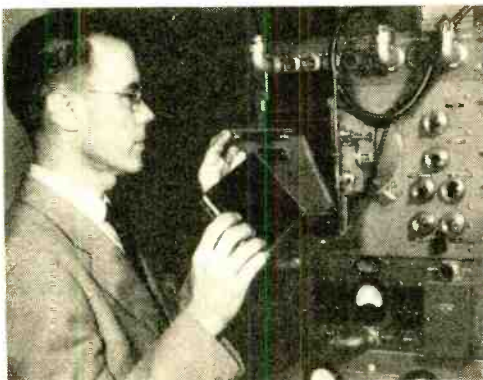

February, 1956

This effect might be explained more clearly by imagining an ocean wave striking a sea wall on the shore. If the wave comes in at a fixed speed, say ten miles per hour, and at a slight angle, the point of the wave's contact with the wall will move along the shore. The speed of this point of contact depends primarily on the angle at which it strikes the wall. If the angle is large, the point of contact moves slowly. As the angle gets smaller, a very high velocity along the sea wall is possible.

The velocity of this contact point can reach or even exceed the speed of light because it possesses no mass. The water possesses the mass and its velocity does not restrict the speed of the contact point. In fact, if the wave were to arrive at the wall so that every part of the wave struck at the same instant, it could be said that the point of contact had an infinite velocity.

This sort of velocity is scientifically called *phase velocity*. It is the same sort of velocity that is involved in an oscilloscope trace. After all, nothing really moves from one side of the screen to the other; it is just that the point of contact of the electron beam is moving. Such velocity is not limited by the laws which govern the motion of objects.

The Naval Research Laboratory in Washington, D. C., is developing high-speed oscilloscopic and recording equipment to meet the demands of present-day electronic and nucleonic sciences. These fields require study of extremely fast transient occurrences.

-30-

I Married a

SUPERHETERODYNE!

By SYLVIA KOHLER

CROUCHED in a vulnerable position and deeply engrossed in attempting to separate the fat, healthy weeds from the struggling, puny flowers . . . I paid little attention to the distant buzzing overhead.

Without warning, the sound increased in pitch and volume and, before I could lift a glance, something whacked me cruelly in the nether regions of my anatomy . . . whizzed around my startled head . . . and departed skyward again in an angry hum of resumed speed. I thought perhaps it might have been an insect with glandular trouble, but a frenzied squint at the fast-climbing model airplane put the incident back into the realm of reality.

In our neighborhood . . . if it's radio-controlled and romp-free, it belongs to none other than Friend Husband! Sure enough, a moment later he raced around a corner of the house . . . wildly manipulating an R/C transmitter and staring feverishly at the gas-model which was now doing inverted Immelmans with no instruction from the ground.

"It's the doggone receiver!" he wailed, eyes glued despairingly at the plane (now roller-coasting out of range). "I was certain it would do the trick. Designed it, myself, and just look at . . ."

There was a distant, but satisfying, sound of a minor crash . . . as might have been made by a model airplane going to smithereens against a good, solid pavement.

I smothered my glee and retreated into the house for a cup of coffee with which to celebrate temporary victory . . . temporary, that is, because I knew there were two more completed dive-bombers in miniature, downstairs in the basement, drying their glue and awaiting transfer to "Happy Boy's" workbench for installation of gas-engine and R/C receiver mechanisms.

This rude jolt in his private little world of ohms, amps and frequencies was merely the latest in a long series of misadventures.

For more years than I care to count, I have been the innocent bystander to the most electrifying succession of activities ever to come off a soldering iron and make life around any normal dwelling lively . . . if not downright horrendous. A lesser woman would have gone stark, raving nuts long ago. But not yours truly. If I catch me talking to myself, it's only the feedback from the complicated p.a. system Happy Boy has wired up throughout every nook, cranny and broom closet.

Mother warned me about a lot of things, but Mother never mentioned the rollicking anxiety of life with an electronics enthusiast . . .

possibly because crystal sets (then the rage) didn't appear as potential harbingers of threat to a girl's peace of mind.

Too naive to realize it, I stepped into a rigged arrangement right from the day of the wedding. After the ceremony he button-holed the minister, an otherwise saintly old gentleman whose secret passion for electronics bloomed in a workshop behind the church, and I went on record as the only bride who was ever left waiting at the altar *after* the wedding.

Most brides get Niagara, some take a gloriously romantic trip to a reasonably suitable city, and some have a brief interlude in the Bahamas. Know what? In the interests of time-limitations, we squandered our two weeks hanging around G-E's Electronics Park so Happy Boy could visit the site of great strides in things electronic, while I tagged along presumably dazzled with awe.

If it were necessary to pinpoint the exact day that modulated-folly was wired into our home, I'd pick the evening we were involved with synchronizing a tape-recorded narrative to the reels of 16-mm. homemade movies we'd produced of various local subjects. I noticed

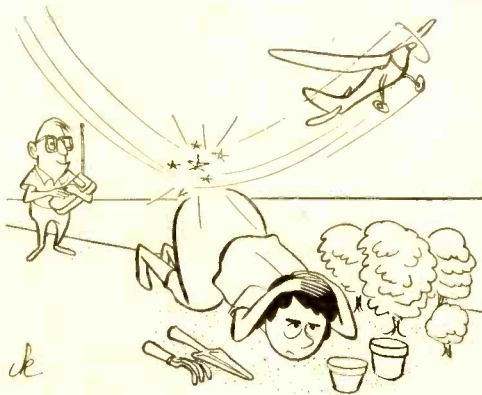

. . . whacked me cruelly in the nether regions of my anatomy . . . and departed skyward in an angry hum of resumed speed.

(call it feminine intuition since it consisted more of a vague suspicion) that Happy Boy's mind seemed to be occupied with other wisps of thought than getting the sounds on tape accurately coupled with the pictures on film.

"Okay," I said, cutting into his shifty-eyed silence, "what are you dreaming up now?"

He swung eyes loaded with boyish enthusiasm to my stern face.



... I'm learning to control my hysteria when the oven timer starts blasting forth a Sousa March the moment the roast is burnt.

"Wouldn't it be bully if we could, somehow, connect this recorder to the radio!"

"Why?" I asked, warily, but knowing that I was undoubtedly steaming full tilt into a trap. "Why, eh?"

"Just think of all the fun it would be . . . making up gag announcements and phony newscasts . . . then blending them in with actual, recorded broadcasts . . . we'd have a rare old time wowing the gang with all the craziest taped shennanigans ever! Boy, would they be fooled!"

"Boy," I said evenly.

At that moment we were standing before the portals of semi-scientific experimentation . . . the very threshold of imaginative, electronic funtimes. But I figured Happy Boy had just flipped. Everything considered, since, I'm not too sure but that I was right.

I must have inherited the emotional stamina of a double-decked Spartan, because I've weathered (and appreciated) a goodly number of electronic innovations that run the full gamut from photocell-operated sliding doors to an intercom switch opening to Junior's faintest cry and gurgle. And I have acclimated my nerves to a garage door which begins weirdly opening by itself, apparently, when I'm still thirty feet down the driveway.

Presently, I'm learning to control my hysteria when the oven to the kitchen range—by virtue of some unfathomable electronic relay timer—starts blasting a Sousa March (audible four blocks away) via any one of a dozen loudspeakers the moment a roast has burned to a rich crispness. The ensuing melody-signal is calculated to bring me trembling with girlish delight, on the double, from any given location in the house. Convenient? Yes. Relaxing? No.

Progress has its price and I've got the makings of a super'b nervous breakdown to prove it.

Somewhere I once read (and reread with persistence until it made sense) that: "A *superheterodyne* is a receiver in which all incoming radio-frequency signals are mixed

with the output of an oscillator to produce a heterodyne or beat frequency."

That's Happy Boy, all right. Give a little, take a little . . . he's a receiver with an ability to mix new ideas about electronic inventions and produce them—after alternating between just *which* one to spring on me first—with a frequency whose beat has pitilessly hammered me to a complete standstill.

Unlike an electrical mechanism, he is prone (kindness prompts understatement of the facts) to occasional error. Once, he crossed his wires somewhere, willy-nilly, while installing a fire alarm system based upon temperature-sensitive elements scattered through every room. For two days, until he found the *faux pas* (deep in the innards of the master control panel which also regulates a number of other systems), we enjoyed the improbable phenomena of hearing the doorbell blast through the hi-fi system every time the button was depressed. The blast was so devastatingly interesting that I've often wondered how it would have sounded if we only had stereophonic. Somehow, I never hear that four-note chimed phrase now without having it bring to mind startled callers and frenzied neighbors.

Yes, a lot of kilos and megs have cycled within our walls since this business began and I've decided that, if we ever design a family crest, it'll be crossed transistors on a field of decibels.

Last week, Happy Boy staggered as stealthily as a herd of steel-shod elephants into the house, carting a large box which he cleverly hid in a closet. Shortly thereafter, he began pitching proud hints that when our wedding anniversary rolls around, next month, he won't be caught with his thoughtfulness down.

Wifelike, I took the first opportunity to case the guilt-box and see if the contents were my size. I'm a very, very lucky girl. After all, how many other wives are getting telemetering equipment for their next anniversary?

I ask you . . . how many?

—50—

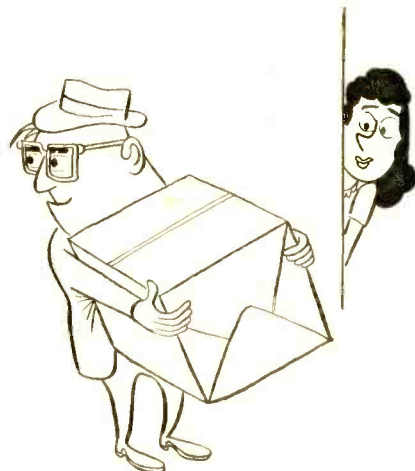

... Happy Boy staggered in carting a large box which he hid in a closet.

AFTER CLASS

THE OSCILLATING TRIODE

OSCILLATORS, like flora and fauna, come in a variety of species. In one form or another, they are encountered in modern radio receivers, television sets, transmitters, industrial control apparatus, military electronic gear, and in many pieces of test equipment.

Despite its relative antiquity, the inductive-capacitive (LC) type of oscillator still predominates over all others; in terms of sheer numbers, there are more LC oscillators in New York City alone than there are people in the State of Texas!

When a charged capacitor is connected across the terminals of a coil, it displays a tendency to discharge in an oscillatory manner, producing a gradually decaying sine-wave voltage or *damped wave* as it is commonly called (Fig. 1A). This waveform is not at all suited to present-day applications; its usefulness becomes manifold, however, when it is changed to an undamped continuous wave (Fig. 1B), a form which can be modulated for radiotelephony, broadcasting, and telecasting. This modification is easily accomplished with the aid of a vacuum tube and a few other electronic "odds and ends."

When it is realized that the damping effect is due to the losses which are suffered in the resistance of the coil and the connecting wires (Fig. 1C), it becomes almost self-evident that sustained oscillations

should be possible if this unavoidable resistance is somehow neutralized. In the case of a swinging pendulum—an excellent mechanical analogy—the vibrations may be maintained at a constant amplitude if the pendulum bob is tapped in the right direction at the right instant in each swing. So may the coil-capacitor combination be electrically "tapped" by first amplifying the original oscillatory energy and then feeding it back to the LC system for rejuvenation purposes.

As in the pendulum analogy, not only must energy be added during each swing, but the timing must be just right. Electrically, correct timing is achieved by feeding the energy back to the LC combination *in phase* with the oscillation already there, so that the additional electrical power may sustain it by making up for the resistive losses.

Figure 2A illustrates the Armstrong circuit, an ancient but still popular oscillator. When power is first applied and the cathode begins to emit electrons, plate current flows through the so-called "tickler" coil (L_t) on its way back to the power supply. The magnetic field that grows around L_t cuts through the turns of the main coil L and induces a potential across it which promptly charges the capacitor. Now the latter begins its damped oscillatory discharge through the coil; but as it does so, a similar varying voltage appears at point a and is transferred to the grid of the triode through capacitor C_1 .

The tube amplifies this fluctuating potential and passes a part of the amplified energy back into the main LC pair through the electromagnetic coupling between L_t and L , thereby adding enough energy to compensate for what might have been lost in the resistances of the circuit. As long as power is applied, the "tickler" keeps kicking energy back into the oscillatory circuit to sustain a constant surging current between the coil and capacitor.

C_1 and R_1 are necessary for reliable functioning. As the grid is influenced by the varying voltage from a , it is driven first positive, then negative, during each oscillation. Each time it goes positive, it attracts electrons from the stream in the

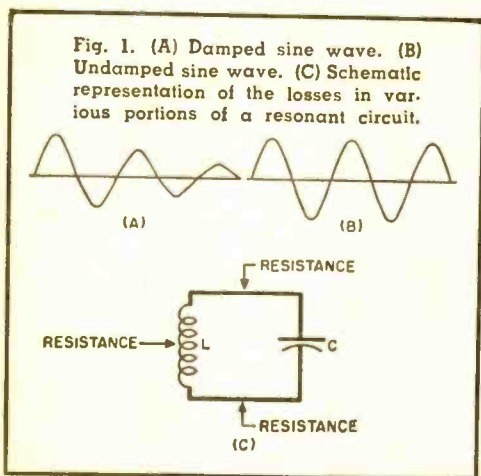



I WILL TRAIN YOU AT HOME FOR GOOD PAY JOBS IN RADIO-TELEVISION

J. E. SMITH has trained more men for Radio-Television than any other man. OUR 40th YEAR.

Fast Growing Industry Offers You Good Pay-Security-Bright Future

I Trained These Men



"I have a job working on radar equipment. Also do spare-time radio, TV servicing."

FLOYD ZAWAKE, Scranton, Pennsylvania

"I operated a successful servicing shop. Then got job with WPAQ and now am engineer for WHPE." V. W. WORKMAN, High Point N.C.



"I decided to quit my job and do TV work full time. I love my work and am doing all right financially." W. F. KLINE, Cincinnati, Ohio.



"I have a good job in a Television repair shop plus a small business in my home." VERN BARR, Toronto, Ohio.



AVAILABLE TO VETERANS UNDER GI BILLS

My Training Leads to Jobs Like These



BROADCASTING: Chief Technician, Chief Operator, Power Monitor, Recording Operator, Remote Control Operator. **SERVICING:** Home and Auto Radios, Television Receivers, P.M. Radios, P.A. Systems **IN RADIO PLANTS:** Design Assistant, Technician, Tester, Serviceman, Service Manager. **GOVERNMENT RADIO:** Operator in Army, Navy, Marine Corps, Forestry Service Dispatcher, Airways Radio Operator. **AVIATION RADIO:** Transmitter Technician, Receiver Technician, Airport Transmitter Operator. **TELEVISION:** Pick-up Operator, Television Technician, Remote Control Operator.

Approved Member, National Home Study Council.

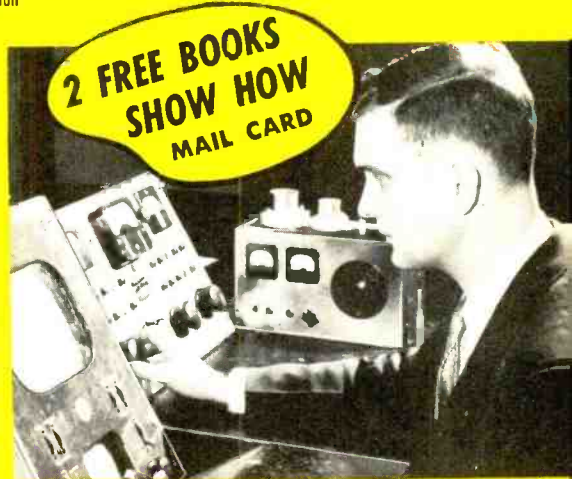

Television Making More Good Jobs—Prosperity

Think of the opportunities in Television. Over 30,000,000 Television homes now and the total growing rapidly. 400 Television stations on the air and hundreds more under construction. Color Television is here. This means more operators, installation men and service technicians will be needed. Now is the time to get ready for a successful career in Radio-Television. Mail the postage-free card today.



SEE OTHER SIDE

SAMPLE LESSON and 64-Page BOOK BOTH FREE

CUT OUT AND MAIL CARD NOW

Act now! Send for my DOUBLE FREE OFFER. Card entitles you to Actual Lesson on Servicing, plus my 64-page book.

NO STAMP NEEDED — WE PAY POSTAGE

Mr. J. E. Smith, President
National Radio Institute, Washington 9, D. C.
Mail me Lesson and Book, "How to Be a Success in Radio-Television." (No salesman will call. Please write plainly.)

NAME.....AGE.....

ADDRESS.....

CITY.....ZONE.....STATE.....

VETS write in date of discharge.....

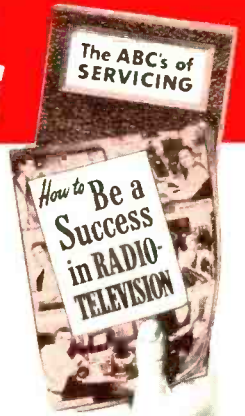

Train ^{AT HOME} to Jump Your Pay

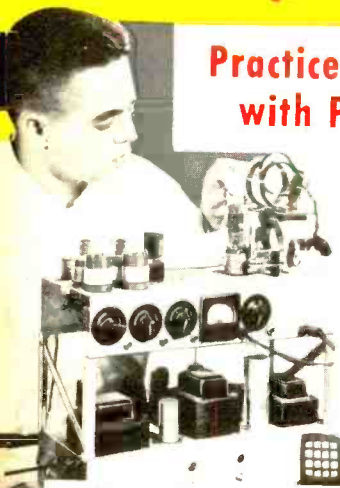

Practice Broadcasting with Parts I Send

As part of my Communications Course I send you parts to build low-power Broadcasting Transmitter at left. Use it to get practical experience. You perform procedures demanded of broadcasting station operators. An FCC Commercial Operator's License can be your ticket to a bright future. My Communications Course trains you to get your license. Mail card. Book shows other equipment you build.

Practice Servicing with Parts I Send

Nothing takes the place of PRACTICAL EXPERIENCE. That's why NRI training is based on LEARNING BY DOING. You use parts I send to build many circuits common to Radio and Television. With my Servicing Course you build the modern Radio shown at right. You build a Multitester and use it to help make \$10, \$15 a week fixing sets in spare time while training. All equipment yours to keep. Card below will bring book showing other equipment you build.



Be a Radio-Television Technician



J. E. SMITH
President
National Radio Institute
Washington, D. C.
Over 40 yrs. of success training men at home

Training PLUS opportunity is the PERFECT COMBINATION for job security, good pay, advancement. When times are good, the trained man makes the BETTER PAY, gets PROMOTED. When jobs are scarce, the trained man enjoys GREATER SECURITY. NRI training can help assure you and your family more of the better things of life. Even without Television, Radio is bigger than ever. Television is moving ahead fast and color Television will create more jobs, more opportunity. New uses for Radio-Television principles are coming in Industry, Government, Communications.

Start Building for Success—TODAY!

Naturally, my training includes Television. I have over the years added more and more Television information to my course and the equipment I furnish students gives experience on circuits common to BOTH Radio and Television.



Get the benefit of our 40 years' experience training men. My well-illustrated lessons give you basic principles you must have to assure continued progress. Read at the left how skillfully developed kits of parts I furnish "bring to life" things you learn from my lessons.

Find Out About Tested Way to Better Pay

Take your first step—cut out and mail the card below. Doing so involves no obligation. I even pay postage. I want to put an Actual Lesson in your hands to prove NRI home training is practical, thorough. I want you to see my 64-page book, "How to Be a Success in Radio-Television," because it tells you about my 40 years of training men and important facts about present and future Radio-Television job opportunities. You can take NRI training for as little as \$5 a month. Many graduates make more than the total cost of my training in two weeks. Mailing postage-free card can be an important step in making your future successful. J. E. Smith, President, National Radio Institute, Washington 9, D. C. 40 YEARS OF SUCCESS TRAINING MEN AT HOME

**SEE
OTHER
SIDE**

**CUT OUT AND
MAIL POSTAGE-
FREE CARD**

FIRST CLASS
PERMIT NO. 20-R
(Sec. 34.9, P.L.&R.)
WASHINGTON, D. C.

BUSINESS REPLY CARD

NO POSTAGE STAMP NECESSARY IF MAILED IN THE UNITED STATES

POSTAGE WILL BE PAID BY
NATIONAL RADIO INSTITUTE

16th and U Sts., N.W.

Washington 9, D. C.

Start Soon to Make \$10, \$15 a Week Extra Fixing Sets



Keep your job while training. Many NRI students make \$10, \$15 a week fixing neighbors' sets in spare time starting a few months after enrolling. E. J. STREITENBERGER, a graduate of New Boston, Ohio, writes, "By the time I graduated, had paid for my course, a car and testing equipment." Mail postage-free card now.

tube; these electrons flow down through $R1$ back to the cathode. A voltage drop thus develops across $R1$ —negative at the grid end and positive at the cathode end—which charges $C1$ with the polarity shown in Fig. 2A. Since the right-hand side of $C1$ is directly connected to the grid of the triode and the left-hand side goes to the cathode through the coil L , the grid is held negative with respect to the cathode at all times.

Just as amplifiers require negative bias on the grid, so do oscillators. Bias holds the plate current down to a safe figure and helps to provide the correct amount of amplification to sustain strong oscillations. Capacitor $C2$ provides an easy path for the oscillatory current in the plate circuit to return to the cathode and, in conjunction with the RFC , helps to keep this varying current out of the power supply.

Thus, an electronic circuit can produce sustained oscillation if three conditions are assured: (1) an oscillatory LC or *tank* circuit, (2) an amplifier, (3) provision for energy feedback in the correct phase from plate to grid circuit.

Figure 2B pictures a modification of the oscillator just discussed in which the tickler is replaced by a tap on the main coil. In this arrangement—the “Hartley” oscillator—the feedback current flows through the lower portion of L (the part labeled L_t), and induces the sustaining voltage in the remainder of the main coil by an effect called *autotransformer action*.

Still another way to get feedback in the correct phase is illustrated in Fig. 2C. This circuit, the tuned-plate, tuned-grid arrangement (TPTG, for short), relies upon the tiny capacitance between the plate and grid of the tube for feedback, represented by the dotted capacitor C_{gp} . The sequence runs somewhat like this: an oscillatory surge begins in L and C ; its effect is transferred to the grid of the triode through $C1$ as before; the oscillation is amplified by

the tube, producing a similar surge in the $LpCp$ combination; the voltage generated here is then fed back from plate to grid by interelectrode capacitive action, whence it is applied back again to L and C to make up for the resistive losses.

The frequency of the sine-wave generated by any LC oscillator is defined principally by the inductance of L (measured in henries or sub-units thereof) and the capacitance of C (in farads, microfarads, $\mu\text{fd.}$, etc.). Since oscillators of the LC type are so often used for generating radio-frequency waves in which frequency is stated in kilocycles, inductance in microhenries (millionths of henries, or $\mu\text{hy.}$) and capacitance in microfarads (millionths of farads, or $\mu\text{fd.}$), a convenient formula to use for frequency determination is:

$$f(\text{kc.}) = 159/\sqrt{LC}$$

where L is in microhenries ($\mu\text{hy.}$) and C is in microfarads ($\mu\text{fd.}$). The equation provides a very close but nevertheless approximate answer. Exact equations are available but are not necessary for run-of-the-mill work. Such equations take into consideration the high-frequency resistance in the circuit, as well as inductance and capacitance.

QUIZ

1. What three things are necessary if a triode is to provide sustained oscillations?
2. Which part of the Armstrong oscillator (Fig. 2A) is responsible for the generation of grid bias?
3. Through what part of the circuit does positive feedback take place in the TPTG oscillator?
4. In an Armstrong oscillator, the amount of feedback may be changed by varying the coupling between the tickler and the tank coil. What would be a simple way to vary feedback in a Hartley oscillator?
5. What is the frequency of oscillation of a circuit having a tank inductance of 250 microhenries and a tuning capacitance of .00035 microfarads?

(Answers appear on page 112)

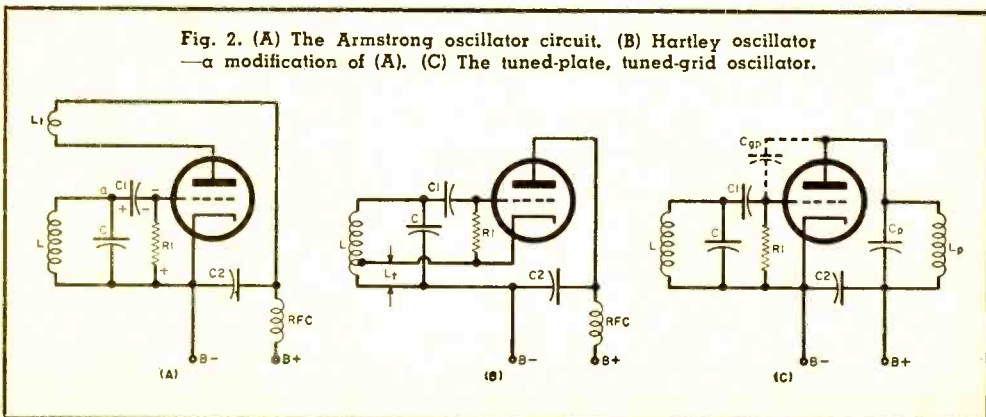

build your own

HEATHKIT



... and have fun doing it!

Circuit boards cut assembly time in half

1% resistors insure instrument accuracy.

High impedance and high sensitivity.

Attractive styling—functional design.

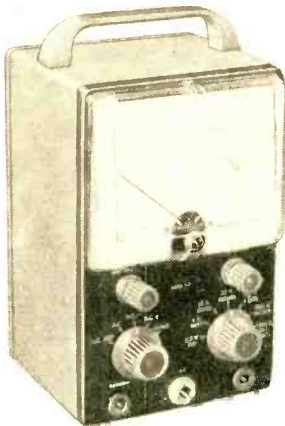

MODEL V-7A

\$24.50

SHIPPING WT. 7 LBS.

Every Heathkit comes complete with detailed step-by-step instructions and large pictorial diagrams that insure successful construction—even for the beginner. Enjoy both the satisfaction and the economy of "building it yourself."

etched circuit vacuum tube

voltmeter kit

In addition to measuring AC (rms), DC, and resistance, the modern-design V-7A incorporates facilities for peak-to-peak measurements. These are essential in FM and television servicing.

AC (rms) and DC voltage ranges are 1.5, 5, 15, 50, 150, 500, and 1500. Peak-to-peak AC voltage ranges are 4, 14, 40, 140, 400, 1400, at 4,000. Ohmmeter ranges are X1, X10, X100, X1000, X10K, X100K, and X 1 megohm. A db scale is also provided. Polarity reversing switch provided for DC measurements, and zero center operation is within range of the front panel

controls. Employs a 200 microampere meter for indication. Input impedance is 11 megohms.

Etched metal, pre-wired circuit boards insure fast, easy assembly and result in reliable operation. Circuit board is 50% thicker for more rugged physical construction. 1% precision resistors used for utmost accuracy.

Heathkit

HANDITESTER KIT



MODEL M-1
\$14.50

Shpg. Wt. 3 lbs.

The Model M-1 measures AC or DC voltage at 0-10, 30, 300, 1000, and 5000 volts. Measures direct current at 0-10 ma and 0-100 ma. Provides ohmmeter ranges of 0-3000 (30 ohm center scale) and 0-300,000 ohms (3000 ohms center scale). Features a 400 microampere meter for sensitivity of 1000 ohms per volt. Handy and portable. Will fit in your coat pocket, tool box, glove compartment, or desk drawer.

Heathkit VOM KIT

20,000 ohms/v. DC and 5,000 ohms/v. AC sensitivity. Ranges (AC and DC) are 0-1.5, 5, 50, 150, 500, 1500, and 5000 v. Direct current ranges are 0-150 ua, 15 ma, 150 ma, 500 ma, and 15 a. Resistance ranges provide center-scale readings of 15, 1500 and 150,000 ohms. DB ranges cover -10 db to ± 65 db.

Features $4\frac{1}{2}$ " 50 ua meter and 1% precision resistors.

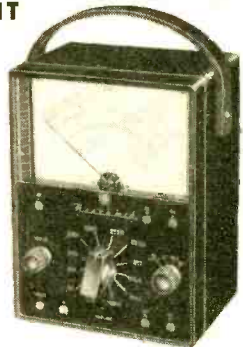

MODEL MM-1

\$29.50 Shpg. Wt. 6 Lbs.

HEATH COMPANY A Subsidiary of Daystrom, Inc.
BENTON HARBOR 10, MICHIGAN

Heathkit 3" oscilloscope kit

ETCHED CIRCUIT



MODEL
OL-1

\$29.50 Shpg. Wt.
14 Lbs.

This compact little oscilloscope is just the ticket for use in the ham shack or home workshop. Measures only 9½" H. x 6½" W. x 11¼" D. Weighs only 11 pounds.

Employing etched metal circuit boards, the Model OL-1 features vertical response with ± 3 db from 2 cps to 200 kc. Vertical sensitivity is 0.25 volts rms per inch, peak-to-peak, and sweep generator operates from 20 cps to 100,000 cps. Provision for direct RF connection to deflection plates. Incorporates many features not expected at this price level. The 8-tube circuit features a type 3GP1 cathode ray tube.

Push-pull vertical and horizontal amplifiers.

Light weight and small size for portability.

Good sensitivity and broad frequency response.

Etched metal circuit boards for simplified assembly.

Attractive panel and case styling.

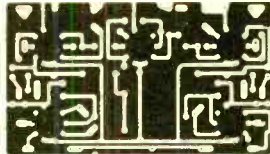

Cathode-follower output for isolation.

No oscillator calibration required.

Covers 160 kc to 220 mc (including harmonics).



Heathkit signal generator kit

This signal generator covers 160 kc to 110 mc on fundamentals in 5 bands. Calibrated harmonics extend its usefulness up to 220 mc. The output signal is modulated at 400 cps, and the RF output is in excess of 100,000 microvolts. Output controlled by both a continuously variable and a fixed step attenuator. Audio output may be obtained for amplifier testing.

MODEL
SG-8

\$19.50

Shpg. Wt.
8 Lbs.

This is one of the biggest signal generator bargains available today. The tried and proven Model SG-8 offers all of the outstanding features required for a basic service instrument or for use in experimenting in the home workshop. High quality components and outstanding performance. Easy to build, and no calibration required for ordinary use.

Heathkit grid dip meter kit

This extremely valuable instrument is a convenient signal source for determining the frequency of other signals by the comparison method. Range is from 2 mc to 250 mc. Uses 500 ua meter for indication, and is provided with a sensitivity control and headphone jack. Includes prewound coils and rack. For hams, experimenters, and servicemen.



MODEL GD-1B

\$19.50

Shpg. Wt. 4 Lbs.

Heathkit ANTENNA impedance meter kit

Used in conjunction with a signal source, the Model AM-1 will enable you to measure RF impedance. Valuable in line matching, adjustment of beam and mobile antennas, etc. Will double as a phone monitor or relative field strength indicator. A 100 micro-ampere meter is employed. Covers the impedance range from 0 to 600 ohms. An instrument of many uses for the amateur. Easily pays for itself through the jobs it will perform.



MODEL
AM-1

\$14.50 Shpg. Wt.
2 Lbs.

HEATH COMPANY A SUBSIDIARY OF DAYSTROM, INC.
BENTON HARBOR 10, MICHIGAN



MODEL VF-1

\$19.50

Shpg. Wt. 7 Lbs.

a socket on the Heathkit Model AT-1 transmitter, or supplied with power from most transmitters.

Features illuminated and pre-calibrated dial scale. Cable and plug provided to fit crystal socket of any modern transmitter.

Heathkit

vfo

KIT

- ☆ 6AU6 electron-coupled oscillator.
- ☆ 0A2 voltage regulator tube for stability.
- ☆ Smooth-acting illuminated dial.
- ☆ Easy to build and attractively styled.

Extra features include copper-plated chassis, ceramic coil forms, extensive shielding, etc. High quality parts!

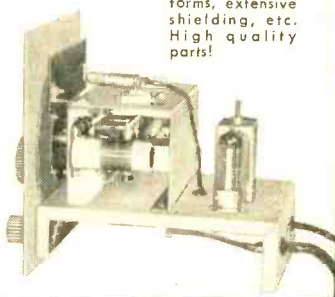

SPECIFICATIONS:

RF Amplifier Power Input... 25-30 watts
 Output Connection... 52 ohms
 Band Coverage... 80, 40, 20, 15, 11, 10 Meters
 Tube Complement:
 5U4G... Rectifier
 6AG7... Oscillator-Multiplier
 6L6... Amplifier-Doubler

Heathkit CW amateur transmitter kit

This CW transmitter is complete with its own power supply and covers 80, 40, 20, 15, 11, and 10 meters. Incorporates such outstanding features as key-click filter, line filter, copper plated chassis, pre-wound coils, and high quality components. Employs a 6AG7 oscillator, 6L6 final amplifier. Operates up to 30 watts plate power input.

MODEL AT-1

\$29.50

Shpg. Wt. 15 Lbs.

Single-knob band-switching for 80, 40, 20, 15, 11 and 10 meters.

Plate power input 25-30 watts.

Panel meter monitors final grid or plate current.

Best dollar-per-watt buy on the market.



Slide-rule dial-electrical band-spread-ham bands marked.

Slug-tuned coils and efficient IF transformers for good sensitivity and selectivity.

Heathkit

COMMUNICATIONS TYPE

all band receiver kit

Transformer-operated power supply for safety and high efficiency.

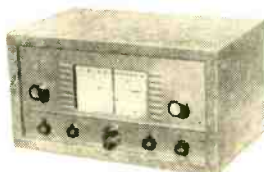
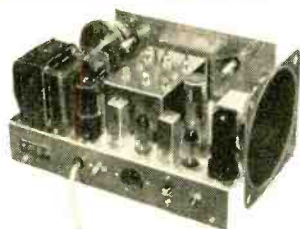

\$27.95

MODEL AR-3
 Shpg. Wt. 12 Lbs.

CABINET: Fabric-covered cabinet available; includes aluminum panel, speaker grille, and protective rubber feet. Measures 12-1/4" W. x 8-3/4" H. x 7-3/4" D. No. 91-15. Shpg. Wt. 6 Lbs. \$1.50.

The Model AR-3 covers from 550 kc to 30 mc on 4 bands. Covers foreign broadcast, radio hams, and other interesting short wave signals.

Features good sensitivity and selectivity. Separate RF and AF gain controls—noise limiter—AGC—VFO, headphone jack—5/8" PM speaker and illuminated tuning dial.

SPECIFICATIONS:

Frequency Range... 550 kc to 30 mc on four bands
 Tube Complement: 1—12BE6 oscillator and mixer
 1—12BA6 IF amplifier
 1—12AV6 second detector, AVC, first audio amplifier and reflex BFO
 1—12A6 beam power output
 1—5Y3 full wave rectifier

HEATH COMPANY A SUBSIDIARY OF DAYSTROM, INC.
 BENTON HARBOR 10, MICHIGAN

HEATHKIT ECONOMY 7-WATT
HIGH FIDELITY



amplifier
kit

MODEL A-7D
\$16⁹⁵ Shpg. Wt.

This is a 7-watt high fidelity amplifier that will produce more than adequate output for normal home installations. Its frequency characteristics are $\pm 1\frac{1}{2}$ db from 20 to 20,000 cps. Output transformer is tapped to match speakers of 4, 8, or 16 ohms. Separate bass and treble tone controls provided. Features potted transformers, push-pull output, and detailed construction manual for easy assembly.

MODEL A-7E: Provides a preamplifier stage with two switch-selected inputs and RIAA compensation for low-level cartridges. Preamplifier built on same chassis as main amplifier. Model A-7E. Shipping weight 10 lbs. **\$18.50.**



Free 52-Page 1956 Catalog
Describes more than 65 interesting "build-it-yourself" projects. Amateur equipment, hi fi amplifiers, and the complete Heathkit line of test instruments. Get yours today!

HEATHKIT BROADCAST BAND

receiver
kit

MODEL
BR-2



Shpg. Wt. **\$17⁵⁰**
10 lbs. Less Cabinet

You can build this table model radio and learn about radio circuit and parts during assembly. Complete instructions simplify construction, even for the beginner. Covers 550 to 1600 kc and features miniature tubes, $5\frac{1}{2}$ " PM speaker, and built-in antenna.

CABINET: Fabric-covered plywood cabinet as shown. Parts #91-9, shipping wt. 5 lbs. **\$4.50**

HEATHKIT HIGH FIDELITY



fm tuner kit

MODEL FM-3

\$24⁵⁰

Shpg. Wt.
7 lbs.

Tunes from 88 to 108 megacycles and features sensitivity and selectivity not expected at this price level. Cabinet supplied with the kit. Built-in power supply and a stage of audio to insure adequate output. Easy to build from step-by-step instructions and large pictorial diagrams.

MAIL TO **HEATH COMPANY** A Subsidiary of Daystrom, Inc. BENTON HARBOR 10, MICH.

order
blank

From _____

SHIP VIA

- Parcel Post
- Express
- Freight
- Best Way

PLEASE PRINT

QUANTITY	ITEM	MODEL NO.	PRICE

Enclosed find () check () money order for
Please ship C.O.D. () postage enclosed for _____ pounds.

On Express orders do not include transportation charges—
they will be collected by the express agency at time of delivery.

ON PARCEL POST ORDERS
insure postage for weight shown.

ORDERS FROM CANADA and APO'S
must include full remittance.

TOOLS & GADGETS

6-METER CONVERTER

Small in size and economical, the *Marshall* 6-meter converter enables operators to receive six meters on any standard short-wave receiver. It is only 5" long, 3¼" wide, and 3½"

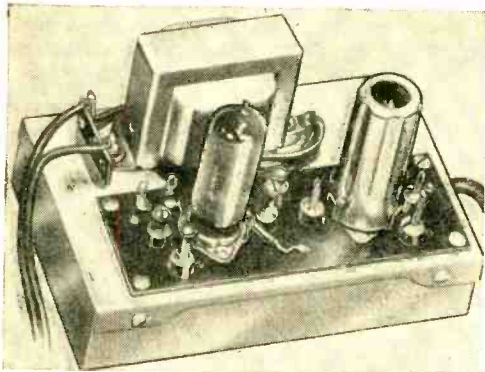

high, and is said to cost about one-third as much as a comparable unit.

A specially designed low-noise, push-pull 6J6 r.f. amplifier into a 6J6 oscillator-mixer gives a balanced line input and coaxial output. All adjustments are slug-tuned. Having an output frequency ranging from 21 to 25 mc., the unit is available completely wired with a.c. power supply and tubes.

More information may be obtained by writing to *Marshall Manufacturing Co.*, 1406 Venice Blvd., Los Angeles 6, Calif.

CATHODE-RAY TUBE CHECKER

An instrument that will quickly and accurately check all voltages of cathode-ray tubes is now available from *Electronic Test Instrument Corporation*, 13224 Livernois Ave., De-



troit, Mich. Called the "Volta-Check," it is electronically accurate, small, compact, fast and simple to use.

The "Volta-Check" tests simultaneously (with a simple manipulation) all of the voltages which are applied to the tube elements, including bias, first anode and filament, and focus. It will localize faulty circuit elements, and indicate whether a short is in the grid or cathode side. Retail price is \$14.95.

ANTI-STATIC "DEVICE"

One of the most annoying causes of foggy pictures is the accumulation of dust on TV picture tubes and masks caused by electrostatic charges which are set up during normal operation of TV sets. *Tele Matic Industries, Inc.*, 16 Howard Ave., Brooklyn 21, N. Y., has incorporated an anti-static agent into a novel "device"—called "NO-FOG"—to insure cleaner, clearer pictures. It can be applied in less than two minutes, and neutralizes the electrostatic charge indefinitely.

"NO-FOG" is a colorless, odorless liquid put up in handy, quick-spray, translucent bottles. When sprayed on the tube or mask and wiped with a clean, dry cloth, it leaves an invisible microscopic film that acts as an insulation against static. It can be applied wherever static electricity is a problem, and is especially good for cleaning phonograph records and plastic products.

OSCILLOSCOPE IN KIT FORM

A wide-range 5" oscilloscope in kit form has been announced by the *General Electronic Equipment*

Company, Easton, Pa. Known as the Model 555K oscilloscope, it has a three-stage vertical push-pull amplifier with plate follower circuit that is useful to 3.6 mc. Vertical sensitivity is 25 millivolts per r.m.s. inch. Vertical input impedance is 3.3 megohms across 30 μ fd. and the horizontal input is 500,000 ohms across 35 μ fd. Horizontal frequency response is useful up to 700 kc.

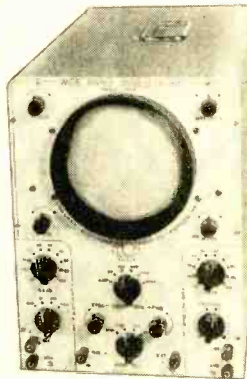

This kit may be used for servicing color TV as well as black-and-white sets, and for general service and laboratory applications. Price is given as \$59.50, complete with all tubes, illustrated wiring, assembly and operating instructions.

VERSATILE SOLDERING IRON

Weighing only six ounces, the "Pico Special" soldering iron comes equipped with four interchangeable heating elements and several different soldering tips. The tips are made from a new type of alloy and have a special coating which prevents oxidation; they are clean at all times even after long use and are freely removable from the heating element

because they are not burnt in or corroded.

Designed for a large variety of intricate work, this soldering iron is extremely adaptable and easily manipulated. The interchangeability of heating elements of different wattage makes it very useful and handy for radio and TV servicemen. *Sound Apparatus Company*, the distributor, will supply the iron with one heating unit and one tip for \$5.95, f.o.b. Stirling, N. J.

VACUUM-TUBE VOLT-OHM-METER

A moderately priced vacuum-tube volt-ohmmeter is now available from *Precision Apparatus Co., Inc.*,

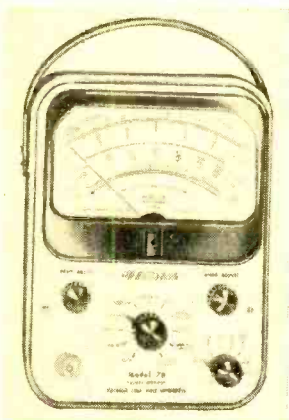

70-31 84th St., Glendale 27, L.I., N.Y. The Model 78 is a battery-operated, wide-range, general-purpose electronic test set, equipped with a $5\frac{1}{4}$ " wide-angle Pace meter of $\pm 2\%$ accuracy and 1% multipliers and shunts of both wire and deposited film types. It has six true-zero-center d.c. voltage ranges at

13½-meg. constant input resistance, five resistance ranges, and five extra-high-impedance r.m.s. a.c. voltage ranges at 8-meg. input resistance and 67- μ fd. input capacitance.

With complete freedom from power line connections, the Model 78 uses standard commercial batteries. It is priced at \$57.50, net, complete with tubes, one set of batteries, and detailed instruction manual. For additional information, write to the manufacturer.

PROJECTOR-RECORDER SYNCHRONIZER

The *Revere* projector-recorder synchronizer, an accessory for the *Revere* 888 slide projector, provides audio commentary in perfect synchronization with your slide picture. It enables you to have automatic voice or music commentary without the use of any tabs, high-frequency signals or special adaptors. Any silent period of four to eight seconds on the tape automatically initiates a slide change.

With this accessory, marketed by *Revere Camera Company*, Chicago, Ill., you can record your own commentary with silent periods for slide change or use previously recorded tape. Slides can be advanced manually or retarded at will. Retailing at \$34.50, the unit may be employed with any *Revere* tape recorder.

INSTANT SOLDER GUN

Without the use of heavy transformer or fragile thermostat, the new instant solder gun, announced by *Hexacon Electric Company*, 569 W. Clay Ave., Roselle Park, N. J., becomes soldering-hot in seconds. Heating element is in $\frac{1}{8}$ "-diameter tip, said to be

smallest tip available on an instant solder gun. Weight is but eight ounces, compared to

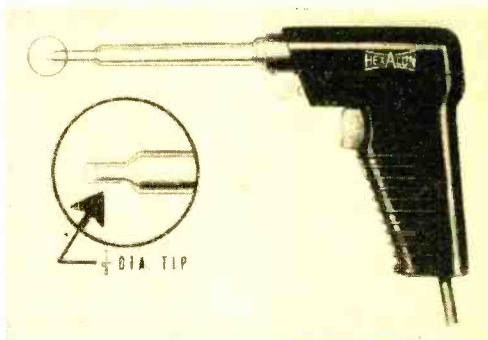

40 ounces for equivalent transformer types.

Trigger control gives any degree of heat required without danger of overheating. The special alloy "lifetime tip" cannot wear, corrode or bend, thus eliminating tip maintenance. Rated at 150 watts and available for 120 volts, the solder gun operates on d.c. as well as a.c., any cycle. List price is \$7.95.

PACKAGED CARBON RESISTORS

G-C *Stackpole* carbon resistors are now available in color-coded hinged cover plastic boxes. The "G-C 60 Line," a new development by *G-C Electronics Mfg. Co.* (division of *General Cement Mfg. Co.*) and *Stackpole Carbon Co.*, makes it easy for the serviceman to select whatever he needs in the way of resistors quickly and without confusion.

The resistors are packed six, four and three to a box, in $\frac{1}{2}$ -watt, 1-watt and 2-watt types respectively. Soldering leads are fully protected against bending. For additional information, write direct to *G-C Electronics Mfg. Co.*, 919 Taylor Ave., Rockford, Ill.

CAR RADIO POWER BOOSTER

Designed to increase car radio power, "COILTENNA" eliminates dead spots, brings in weak stations, and makes it possible for

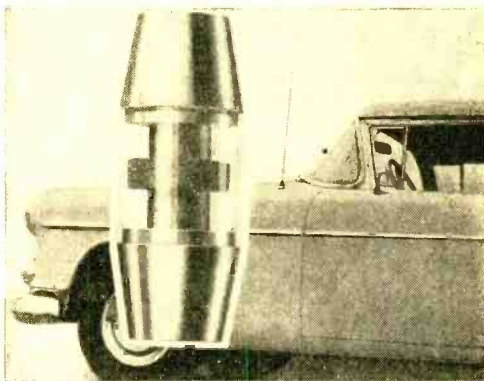

the user to tune in many additional stations. Retailing for only \$3.95, it is available in two sizes to fit all cars, and can be quickly installed on existing antennas. Complete information may be obtained from *Electrend Products Corporation*, St. Joseph, Mich. -30-

New Model
670-A

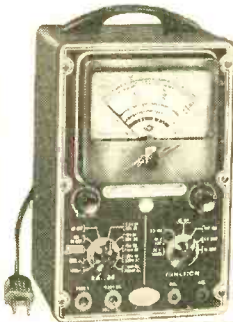

New! **SICO** SUPER-METER

A Combination VOLT-OHM MILLIMETER PLUS
CAPACITY REACTANCE INDUCTANCE AND DECIBEL MEASUREMENTS

SPECIFICATIONS
 D.C. VOLTS: 0 to 7.5/15/75/150/750/1,500/
7,500 Volts
 A.C. VOLTS: 0 to 15/30/150/300/1,500/3,000
Volts
 OUTPUT VOLTS: 0 to 15/30/150/300/1,500/
3,000 Volts
 D.C. CURRENT: 0 to 1.5/15/150 Ma. 0 to
1.5/15 Amperes
 RESISTANCE: 0 to 1,000/100,000 Ohms 0 to
10 Megohms
 CAPACITY: .001 to 1 Mfd. 1 to 50 Mfd. (Good-
Bad scale for checking quality of electrolytic
condensers.)
 REACTANCE: 60 to 2,500 Ohms 2,500 Ohms
to 2.5 Megohms
 INDUCTANCE: .15 to 7 Henries 7 to 7,000
Henries
 DECIBELS: -6 to +18 +14 to +38 +34 to
+58

ADDED FEATURE:

Built-in ISOLATION TRANSFORMER reduces pos-
sibility of burning out meter through misuse.

The Model 670-A comes housed in a rugged
crackle-finished steel cabinet complete with
test leads and operating instructions.

\$28⁴⁰
NET

New Model TV-60
20,000 OHMS PER VOLT



ALLMETER



FEATURES

- Giant recessed 6½ inch 40 Microampere meter with mirrored scale assures accuracy and easy-reading. All calibrations are printed in large easy-to-read type. Fractional divisions are easily read with the aid of the mirrored scale.
- The line cord, used only when making Capacity measurements, need be plugged in only when using that service. It is out of the way, stored in its plicofilm compartment at all other times.
- A built-in Isolation Transformer automatically isolates the Model TV-60 from the power line when the capacity service is in use.
- Selected, 1% zero temperature coefficient metalized resistors are used as multipliers assuring unchanging accurate readings on all ranges.
- Use of the latest type of printed circuit guarantees maintenance of top quality standard in the production runs of this precise instrument.
- A new improved type of high-voltage probe is used for the measurement of high voltages up to 30,000 Volts. This service will be required when servicing color TV receivers.
- Simply plug-in the R.F. probe and convert the Model TV-60 into an efficient R.F. SIGNAL TRACER permitting the measurement of stage-gain and cause of trouble in the R.F. and I.F. circuits of A.M., F.M., and TV receivers.
- Plug in the Audio probe and convert the Model TV-60 into an efficient AUDIO SIGNAL TRACER. Measure the signal levels and comparative efficiency of hearing-aids, public-address systems, the amplifier sections of Radio & TV receivers etc.

Includes services never before provided by an
instrument of this type. Read and compare fea-
tures and specifications below!

SPECIFICATIONS

- 8 D.C. VOLTAGE RANGES: (At a sensitivity of 20,000 Ohms per Volt) 0 to 15/75/150/300/750/1500/7500/30,000 Volts.
- 7 A.C. VOLTAGE RANGES: (At a sensitivity of 5,000 Ohms per Volt) 0 to 15/75/150/300/750/1500/7500 Volts.
- 3 RESISTANCE RANGES: 0 to 2,000/200,000 Ohms, 0-20 Megohms.
- 2 CAPACITY RANGES: .00025 Mfd. to .3 Mfd., .05 Mfd. to 30 Mfd.
- 5 D.C. CURRENT RANGES: 0-75 Microamperes, 0 to 7.5/75/750 Milliampere, 0 to 15 Amperes.
- 3 DECIBEL RANGES:
 - 6 db to + 18 db
 + 14 db to + 38 db
 + 34 db to + 58 db

R.F. SIGNAL TRACER SERVICE: Enables following the R.F. signal from the antenna to speaker of any radio or TV receiver and using that signal as a basis of measurement to first isolate the faulty stage and finally the component or circuit condition causing the trouble.

AUDIO SIGNAL TRACER SERVICE: Functions in the same manner as the R.F. Signal Tracing service specified above except that it is used for the location of cause of trouble in all audio and amplifier systems.



Model TV-60 comes complete with book of instructions; pair of standard test leads; high-voltage probe; detachable line cord; R.F. Signal Tracer Probe and Audio Signal Tracer Probe. Plicofilm bag for all above accessories is also included. Price complete. Nothing else to buy. Only

\$52⁵⁰
NET

EXAMINE BEFORE YOU BUY!
USE APPROVAL FORM ON NEXT PAGE

New!



Streamlined TUBE TESTER

New Model TC-55

QUICKLY AND EFFICIENTLY TESTS RADIO AND TV TUBES INCLUDING: SEVEN PIN MINIATURES; EIGHT PIN SUBMINARS, OCTALS AND LOCTALS; NINE PIN NOVALS



YOU CAN'T INSERT A TUBE IN THE WRONG SOCKET.

It is impossible to insert the tube in the wrong socket when using the new Model TC-55. Separate sockets are used, one for each type of tube base. If the tube fits in the socket it can be tested.

"FREE-POINT" ELEMENT SWITCHING SYSTEM.

The Model TC-55 incorporates a newly designed element selector switch system which reduces the possibility of obsolescence to an absolute minimum. Any pin may be used as a filament pin and the voltage applied between that pin and any other pin, or even the "top-cap."

The Model TC-55 comes complete with operating instructions and charts. Use it on the bench—use it for field calls. A streamlined carrying case, included at no extra charge, accommodates the tester and book of instructions.

CHECKS FOR SHORTS AND LEAKAGES BETWEEN ALL ELEMENTS.

The Model TC-55 provides a super sensitive method of checking for shorts and leakages up to 5 Meg-ohms between any and all of the terminals.

ELEMENTAL SWITCHES ARE NUMBERED IN STRICT ACCORDANCE WITH R.M.A. SPECIFICATIONS.

One of the most important improvements, we believe, is the fact that the 4 position fast-action snap switches are all numbered in exact accordance with the standard R.M.A. numbering system. Thus, if the element terminating in pin No. 7 of a tube is under test, button No. 7 is used for that test.

**\$26⁹⁵
NET**

**SHIPPED ON
APPROVAL
NO MONEY
WITH ORDER
NO C.O.D.**

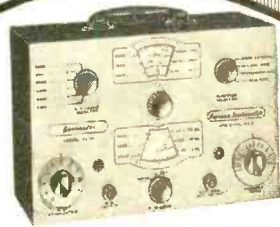

New Model TV-50 GENOMETER

A versatile all-inclusive GENERATOR which provides ALL the outputs for servicing:
A.M. Radio • F.M. Radio • Amplifiers • Black and White TV • Color TV

R. F. SIGNAL GENERATOR: Provides complete coverage for A.M. and F.M. alignment. Generates Radio Frequencies from 100 Kilocycles to 60 Megacycles on fundamentals and from 60 Megacycles to 180 Megacycles on powerful harmonics. • **VARIABLE AUDIO FREQUENCY GENERATOR:** In addition to a fixed 400 cycle sine-wave audio, the Genometer provides a variable 300 cycle to 20,000 cycle peaked wave audio signal. • **BAR GENERATOR:** Projects an actual Bar Pattern on any TV Receiver Screen. Pattern will consist of 4 to 16 horizontal bars or 7 to 20 vertical bars. • **CROSS HATCH GENERATOR:** Genometer will project a cross-hatch pattern on any TV picture tube. The pattern will consist of non-shifting horizontal and vertical lines interlaced to provide a stable cross-hatch effect. • **DOT PATTERN GENERATOR (FOR COLOR TV):** The Dot Pattern projected on any color TV Receiver tube by the Model TV-50 will enable you to adjust for proper color convergence. • **MARKER GENERATOR:** The following markers are provided: 189 Kc., 262.5 Kc., 456 Kc., 600 Kc., 1000 Kc., 1400 Kc., 1600 Kc., 2000 Kc., 2500 Kc., 3579 Kc., 4.5 Mc., 5 Mc., 10.7 Mc., (3579 Kc. is the color burst frequency.)

MODEL TV-50 comes absolutely complete with shielded leads and operating instructions.

**\$47⁵⁰
NET**

Only

TRY ANY
of the instruments on this or
on the facing page, for 10 days
before you buy. If completely satisfied
before then send down payment and pay
balance as indicated on coupon. No
Interest or Finance Charges Added!
If not completely satisfied return
unit to us, no explanation
necessary.

MOSS ELECTRONIC DISTRIBUTING CO., INC.
Dept. D-206, 3849 Tenth Ave., New York 34, N. Y.

Please send me the units checked. I agree to pay down payment within 10 days and to pay the monthly balance as shown. It is understood there will be no finance, interest or any other charges, provided I send my monthly payments when due. It is further understood that should I fail to make payment when due, the full unpaid balance shall become immediately due and payable.

Name _____
Address _____
City _____ Zone _____ State _____

- Model 670-A . . . Total Price \$28.40 \$7.40 within 10 days. Balance \$3.50 monthly for 6 months.
- Model TV-60 . . . Total Price \$52.50 \$12.50 within 10 days. Balance \$8.00 monthly for 6 months.
- Model TC-55 . . . Total Price \$28.95 \$8.95 within 10 days. Balance \$5.00 monthly for 4 months.
- Model TV-50 . . . Total Price \$47.50 \$11.50 within 10 days. Balance \$6.00 monthly for 6 months.

TIPS and TECHNIQUES

RADIO SERVES AS CODE OSCILLATOR

A radio having a phono jack will serve as a simple code practice oscillator having volume sufficient for group instruction. Just wire the key and a high-impedance earphone in series with a cord fitted to a phono plug. With the radio turned on to phono position, place the headphone near

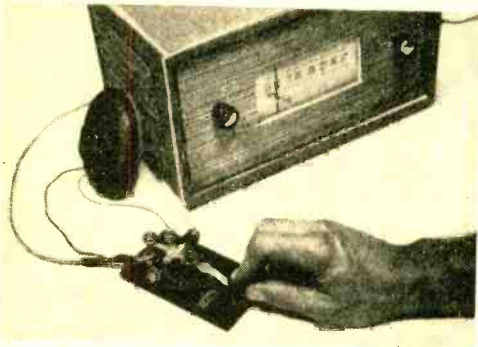

the speaker; feedback will create a high-frequency oscillation when the key is closed.

Experiment with the earphone to determine the position which produces instantaneous feedback. In some cases, it may be necessary to place the earphone near the speaker voice coil; nearness of the earphone to the speaker, as well as the volume control, will control the loudness of the signal.

PEDESTAL FOR MICROPHONE

The popular crystal mike shown in the photo can be fitted with a table pedestal in a matter of minutes and at small expense. Since the bases of such mikes are tapped, the conversion requires only a small, slotted,

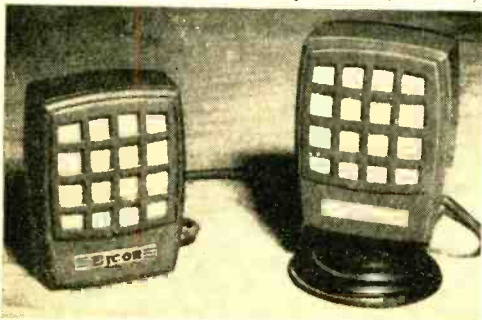

oval-head bolt and a rubber suction cup. Drill or punch a hole in the center of the cup and screw it up against the mike base.

Advantages of this pedestal are: it softens sound on hard surfaces, acts as a shock absorber to protect both furniture and microphone, and prevents slipping on slick surfaces. The suction cup will not interfere with hand operation; the one pictured is $2\frac{1}{2}$ " in diameter.

EASILY MADE TELEPHONE

A pair of headphone units, which are found on an ordinary headset, can be separated from the headband and wiring har-

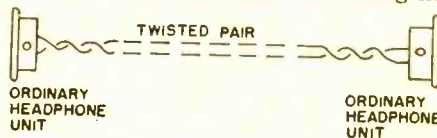

ness and used as a simple but surprisingly effective telephone over short distances—such as from kitchen to basement, from kitchen to garage, etc. All that is needed is a twisted pair of wires connecting the two phones together, using the same two terminals on each phone as were used in connecting the phones together with the original harness.

Each phone is used alternately as a transmitter and as a receiver. No switches are required. Units from a 600-ohm headset are well suited to this application. A simple buzzer system using separate interconnecting wires may be used for ringing.

SHIELD FOR CRYSTAL PROBES

The cans used for shielding miniature tubes can also be used for shielding the hot tip of a crystal probe. Need for such

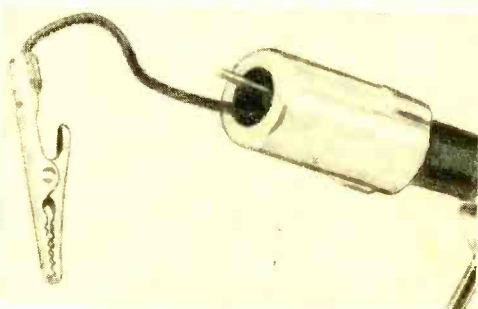

shielding can arise, for example, if the circuit under test is working at an elevated frequency and is near to the point of "spilling over" into self-oscillation.

In the photo, such a miniature shield is shown in place over the end of the crystal probe. The ground wire comes through the opening together with the hot tip of the probe. Good contact should be made between the shield can and the outer casing of the probe, which should be grounded.

NO FREE GIFTS! NO COUPONS! NO BONUSES EXCEPT THE

LOWEST TUBE PRICES

ALL TUBES UNCONDITIONALLY GUARANTEED FOR 1 YEAR

PRETESTED TUBES			INDIVIDUALLY BOXED		
1B3GT	GAC7	6BK5	6SK7GT	12AT7	19T8
1H5GT	6AF4	6BK7	6SL7GT	12AU6	19BG6G
1LC5	6AG5	6BL7GT	6SN7GT	12AU7	19BQ6GT
1LN5	6AG7	6BQ6GT	6SQ7	12AV6	25L6GT
1N5GT	6AK5	6BQ7	6SR7	12AV7	25AV5
1Q5GT	6AL5	6BY5G	6TB	12AX4GT	25W4GT
1R5	6AQ5	6BZ7	6U8	12AX7	25Z5
1S4	6AS5	6C4	6V3	12BA6	25Z6GT
1S5	6AT6	6CB6	6V6GT	12BE6	35B5
1T4	6AU6	6CD6G	6W4GT	12AZ7	35C5
1T5GT	6AUSGT	6F6	6W6GT	12BH7	35L6GT
1U4	6AV5	6H6GT	6X4	12BZ7	35W4
1U5	6AV6	6J5GT	6X5GT	12BY7	35Y4
1X2	6AX4GT	6J6	6Y6G	12SA7	35Z5GT
3Q4	6AX5GT	6K6GT	7C5	12SG7	50A5
3S4	6AH4GT	6L6	7C6	12SJTGT	50B5
3V4	6BA6	6S4	7E7	12SK7	50C5
5U4Q	6BC5	6S8GT	7F7	12SL7GT	50L6GT
5V4G	6BE6	6SA7	7F8	12SN7GT	117L7GT
5Y3	6BG6G	6SH7	7N7	12SQ7	117Z3
6AB4	6BJ6	6SJ7GT	12AL5	12SR7	

BRAND NEW PICTURE TUBES

RCA and DUMONT Licensed

12LP4	14.99	16RP4	17.00	19AP4A	23.00	21EP4A	24.00
14BP4	15.99	17BP4A	19.00	19DP4A	23.00	21AUP4A	24.00
16AP4A	19.99	17HP4	19.00	20CP4	24.00	21FP4	24.00
16GP4	20.99	17LP4	18.00	21ALP4A	24.00	24AP4	42.00

Picture Tubes Shipped F.O.B. Passaic, N. J.

TUBE MART DISCOUNT HOUSE

The Lokpet Bldg. Passaic, N. J.

Take your pick!
Any Assortment!

TUBES

41¢

ea.

Quantity Buyers!

100 Tubes — \$38.00

FREE POSTAGE on all prepaid U. S. A. orders. 25¢ handling charge on all orders under \$5.00. 25% Deposit on all C.O.D.'s. Subject to prior sale. Write for transmitter and special purpose tube list.

Will 1956 Be the Year That Changes the World?

A strange man in Los Angeles, known as "The Voice of Two Worlds," is offering, free of charge to the public, an astounding 64 page booklet analyzing famous world prophecies covering these times. It shows that four of the greatest prophecies could not come true until the present time. But now they can, and the years that change the world are at hand. Great dangers but still greater opportunities, confront forward looking people in 1956.

"The Voice of Two Worlds," a well known explorer and geographer, tells of a remarkable system that often leads to almost unbelievable improvement in power of mind, achievement of brilliant business and professional success and new happiness. Others tell of increased bodily strength, magnetic personality, courage and poise.

These strange methods were found in far-off and mysterious Tibet, often called the land of miracles by the few travelers permitted to visit it. He discloses how he learned rare wisdom and long hidden practices, closely guarded for three thousand years by the sages, which enabled many to perform amazing feats. He maintains that these immense powers are latent in all of us, and that methods for

using them are now simplified so that they can be used by almost any person with ordinary intelligence.

The 64 page booklet he is now offering free to the public gives guidance for those who wish to prepare themselves for the momentous days ahead. It gives details of what to expect, and when. Its title is "Beware of These Days!"

The book formerly sold for a dollar, but as long as the present supply lasts, it is offered free to readers of this notice. This liberal offer is made because he expects that many readers will later become interested in the entire system of mind power he learned in the Far East and which is now ready to be disclosed to the western world.

For your free copy of the astonishing prophecies covering these momentous times, as revealed in this 64 page book, address the Institute of Mental-Physics, 213 South Hobart Blvd., Dept. T-272, Los Angeles 4, Calif. Send no money. Just your name and address on a postcard or in an envelope will do. No obligation. Readers are urged to write promptly, as only a limited number of the free books have been printed.

(Advertisement)



• Hobbyists! • Servicemen! • Technicians!

More KNOW-HOW and PROFIT in ELECTRONICS with these NEW BOOKS

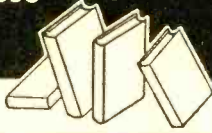

1 COLOR TELEVISION FUNDAMENTALS

Simplified Manual Fully Explains Color TV! Be ready for a big future in COLOR TV. Clear-cut guide gives you practical explanations of color theory, the FCC-approved color system, simplified discussions of actual circuits in use today, a step-by-step breakdown of several commercial receivers — PLUS information on installation, alignment, and servicing procedures. By Milton S. Kiver, author of "Television Simplified," etc. 312 pp., 220 illus., \$6.00

2 REPAIRING RECORD CHANGERS

Fix All Types of Record Changers Like an Expert! Practical guide covers repair of all models of record changers, including portable phonos, hi-fi units, and magnetic tape recorders. Clearly explains pickups, needles, motors, drives, etc. Also tells about setting up your own business, etc. By Eugene Ecklund, Allen B. DuMont Labs. 278 pp., 202 illus., \$5.95

3 PRACTICAL RADIO SERVICING

Shows How Even a Beginner Can Become an Expert Serviceman! Deals with most common types of radio—small a-c-d-c receivers, phonos, portables, etc. Gives circuit theory, servicing methods, and graded job sheets for practical experience. By William Marcus, Corona Jr. H. S., N.Y.C., and Alex Levy, Chelsea Voc. H. S., N.Y.C. 565 pp., 473 illus., \$8.50

4 RADIO OPERATING

QUESTIONS AND ANSWERS

Tested Help for Passing FCC Examinations! Quick, practical help for getting your commercial radio operator's license. Gives you correct answers to all new and revised questions in the current FCC Study Guide, plus much other material. By J. L. Hornung, Cmdr., U. S. Naval Reserve (Inactive); and Alexander A. McKenzie, Assoc. Editor, Electronics. Twelfth Ed. 571 pp., 142 illus., over 1900 answers, \$6.00

5 ELEMENTS OF ELECTRONICS

Gives You the Basic Background for Work in Any Electronic Field! Outlines the basic theory you must have before going on to advanced work in radio, television, radar, etc. Uses only simple math. Covers electricity and magnetism, vacuum tubes, types of circuits, power supplies, and components. By H. V. Hickey, Chief Radio Elec., U.S.N., and W. M. Fillines, Lt. (jg.), U.S.N., 487 pp., 408 illus., \$6.50

6 TRANSISTORS: Theory and Practice

Fully Explains This New Electronic Miracle! Here's coverage of theory, practical applications, and manufacture of transistors. Discusses both silicon and germanium types—how they are made, how they work, and how to use them. Goes step-by-step from basic concepts to advanced topics. By A. Coblenz, Transistor Product Co.; and H. L. Owens, Signal Corps Engineering Labs. 313 pp., 115 illus., \$6.00

McGraw-Hill Book Co., Dept. PEL-2
327 W. 41st St., New York 36, N. Y.

Send me book(s) circled below for 10 days' examination on approval. In 10 days, I will remit for book(s) I keep, plus few cents for delivery costs, and return unwanted book(s) postpaid. SAVE. If you remit with coupon, we pay delivery costs; same return privilege.

10-DAY
FREE
TRIAL

1 2 3 4 5 6

PRINT

Name.....

Address.....

City..... Zone..... State.....

Employed by..... PEL-2

For price and terms outside U. S. Write Mc-Graw Hill International, N. Y. C.

Audio Oscillator

(Continued from page 81)

clockwise position. (5) Advance the oscillator output control and adjust the scope frequency until two or three stationary cycles are obtained on the screen. (6) If a good sine wave is not obtained, adjust R5 for an improvement in the wave shape. (7) Swing the oscillator dial to its extreme clockwise position and adjust the oscilloscope for two or three stationary cycles at this frequency. The waveform again should be good and the vertical height of the pattern should be practically unchanged. If this is not so, a slight readjustment of potentiometer R5 will correct the condition. (8) Recheck at the counterclockwise setting of the dial, and again reset R5 if necessary. (9) Disconnect the oscillator and put it together, fastening the front panel tightly to the box.

Calibration

There are many ways to calibrate a new audio oscillator. Of these, the only entirely foolproof method—recommended for the beginner—is to use another calibrated oscillator for comparison.

The internal sweep of the oscilloscope is switched off. The signal from one oscillator is applied to the horizontal amplifier input, and the signal from the other oscillator to the vertical amplifier input. When the two oscillators are tuned exactly to the same frequency, the pattern seen on the scope screen is a stationary circle or ellipse. When the frequency of the oscillator under test is either higher or lower than that of the standard oscillator, the circle will roll or spin; but when the two frequencies are the same, the circle will stand dead still.

Following is the detailed calibration procedure: (1) Set the standard oscillator to 30 cycles. (2) Tune the test oscillator carefully near the extreme counterclockwise position of its dial until a stationary circle or ellipse appears on the scope screen. (3) Mark this point "30" on the test oscillator dial. (4) Advance the standard oscillator to 35 cycles. (5) Again, tune

OSCILLATING TRIODE QUIZ

(Questions on page 101)

- (1) an oscillator tank circuit, (2) amplification, (3) in-phase feedback, 2. R1, the grid leak resistor, 3. Through the grid-plate capacitance of the tube, 4. By changing the position of the coil tap. As the tap is moved toward the grid end of the coil, the feedback increases, 5. Approximately 538 kc.

the test oscillator for a stationary circle, and mark this point "35" on the dial. (6) Repeat the procedure at 40, 50, 60, 70, 80, 90, and 100 cycles, and at as many frequencies as possible from 100 to 10,000 cycles. (7) Set the test oscillator dial carefully to its 1000-cycle position, remove it temporarily from the R3-R4 shaft without disturbing the setting of this potentiometer, and ink in the calibration points and frequencies. Then replace the dial, checking carefully against the standard oscillator for exact resetting to 1000 cycles.

-30-

Tubeless Audio Amplifier

(Continued from page 93)

mounted on a 5" x 5" x 1/2" wooden base, but a metal chassis or box can be used instead. The headphone is supported by a bent metal bracket fastened at one end to one of the headphone terminal screws, and at the other end to the baseboard. The thin leads from the headphone and button are hung loosely so as not to restrict the vibration of the diaphragm and button.

Fig. 2 shows the amplifier circuit and oscillator circuit. AUDIO INPUT terminals are connected directly to the headphone, AUDIO OUTPUT terminals to the secondary of the transformer. The secondary center tap of the transformer is not used. Primary connections to the transformer are made to transformer lugs 1 and 6. The 6-volt supply can be a small single battery (Burgess Type 5540 or Burgess F4P1), or four flashlight cells in series.

Amplifier Operation

After completion of wiring, connect headphones to the AUDIO OUTPUT terminals. Then connect the battery. There is apt to be a slight hissing sound in the external headphones. If the hiss is loud, gently tap the microphone button one or more times as required, to quiet the circuit.

Feed an audio signal into the AUDIO INPUT terminals, listening to it in the headphones. Connect the headphones temporarily across the AUDIO INPUT terminals, and notice how much weaker the signal is as it enters the amplifier. This will give an idea of how well the amplifier is working. With the unit shown here, an input signal a little stronger than just audible gives an uncomfortably loud output signal.

When placing a new microphone button in operation for the first time, it might be necessary to tap the button gently several times with the amplifier in operation, in order to obtain greatest amplification.

Your choice of school is highly important to your career in



INDUSTRIAL ELECTRONICS

RADIO

TELEVISION

Become an
ELECTRICAL ENGINEER
or an
ENGINEERING TECHNICIAN
at
MSOE in Milwaukee

- Choose from courses in:*
- ELECTRICAL ENGINEERING**
Bachelor of Science degree in 36 to 42 months with a major in electronics or electrical power.
 - ELECTRICAL TECHNOLOGY**
Engineering Technician certificate in 12 months in electronics, radio, or electrical power.
 - Associate in Applied Science degree in 18 months in radio and television.*
 - TECHNICAL SERVICE**
Service certificate in 6 months in electricity; in 12 months in radio and television.

MSOE — located in Milwaukee, one of America's largest industrial centers — is a national leader in electronics instruction — with complete facilities, including the latest laboratory equipment, visual aid theater, amateur radio transmitter — offers 93 subjects in electrical engineering, electronics, radio, television, electrical power, and electricity.

Advisory committee of leading industrialists. Courses approved for veterans. Over 50,000 former students. Excellent placement record.



TERMS OPEN APRIL, JULY, SEPTEMBER, JANUARY,

Choose wisely — your future depends on it. Write for more information today!

MILWAUKEE SCHOOL OF ENGINEERING

Dept. PE-256, 1025 N. Milwaukee St. Milwaukee 1, Wisconsin

Send FREE career booklets on:
 Electrical Engineering Radio-Television

I am interested in _____ (Name of course)

Name _____

Address _____

City _____ Zone _____ State _____

If veteran, give discharge date _____ MS-31A

the manual record player
your system can't outgrow!



THORENS

\$52⁵⁰

CB-33P with TONEARM rated with costlier turntables ready for immediate installation

No matter how you improve your hi-fi system, you'll never have to replace your Thorens Manual Player . . . you've got the best to begin with! You'll save initial costs too . . . for you'd have to spend more for a turntable that performs as well as the CB-33P. Has Swiss-precision direct-drive motor; separate gear for each speed. Preassembled tonearm with tracking weight and cartridge alignment adjustment; 2 plug-in shells.

Also turntables and changers. Write for details and "HI-FI AND YOUR BUDGET"

Get Your F. C. C. LICENSE Quickly!

Correspondence or residence preparation for F. C. C. examinations. Results guaranteed.

An FCC commercial operator license means greater opportunities and higher pay. We are specialists in preparing you, in a MINIMUM OF TIME, to pass FCC examinations for all classes of licenses. Beginners get 2nd class license in 8 weeks and 1st class in 4 additional weeks.

Regularly scheduled resident classes are held in Washington, D. C. and Hollywood, California. Correspondence courses are conducted from Washington. Write for our free booklet which contains complete details.

GRANTHAM School of Electronics
Dept. BY 5910 Sunset Blvd. Hollywood 28, Calif. **OR** Dept. 10-A 821 19th St. N. W. Washington, D. C.

INVENTORS

Learn how to protect your invention. Specially prepared "Patent Guide" containing detailed information concerning patent protection and procedure with "Record of Invention" form will be forwarded to you upon request—without obligation.

CLARENCE A. O'BRIEN & HARVEY JACOBSON
Registered Patent Attorneys
69-A District National Bldg. Washington 5, D. C.

BUILD YOUR OWN JENSEN HI-FI SPEAKER SYSTEM SEND FOR NEW BOOK TODAY!

Save money . . . build your choice of 18 different hi-fi speaker systems with 8 new 2-way and 3-way Jensen speaker kits. 36-page Manual 1060 gives complete instructions for building enclosures, selecting your Jensen speaker kit and assembling. Send 60c in coin today!

JENSEN MFG. CO. Dept. F 6601 S. Laramie, Chicago 38



Don't expect this to be a high-fidelity amplifier, because it is not. Although light in weight, the button loads the headphone diaphragm and causes some distortion.

Oscillation

Figure 2(B) also shows how feedback can be added to the amplifier to make it oscillate. The secondary winding of the transformer (same connections as in the amplifier circuit) is connected in series with the "listening" headphones and amplifier headphone. External headphones must be of the magnetic type, since current must flow through them.

A key, connected in series with the amplifier headphone and the transformer primary to make and break the battery current, allows the oscillator to be used for code practice.

The oscillator tone frequency depends mainly upon the thickness and stiffness of the diaphragms and the weight or twisting due to the microphone button. The author's oscillator "sang" at about 700 cycles. -30-

How to Use Ohm's Law

(Continued from page 91)

As practical examples, let's determine the wattage ratings of the three resistors which were chosen for use as a series filament resistor, as a cathode bias resistor, and as a meter multiplier resistor in the previous examples.

Series Resistor: In the circuit given in Fig. 2(A), it was decided to use a 150-ohm resistor. To determine the wattage rating, the actual power dissipation must first be determined, using the first formula given in Fig. 3(C):

$$W = I^2R = (0.15)^2(150) = (.0225)(150) = 3.375 \text{ watts}$$

Twice this value would be around 7 watts, and the next standard resistor size is 10 watts. Therefore, in this application, a 150-ohm, 10-watt resistor would be specified.

Cathode Resistor: In the second example, using the circuit given in Fig. 2(B), it was determined that a cathode resistor of 150 ohms would be needed to give a bias voltage of -7.5 volts with a cathode current of 53 ma. Let's round off the current figure to 50 ma. . . . the results will be close enough for practical design work. Using the last formula given in Fig. 3(C), and changing 50 ma. to 0.050 ampere, the actual power dissipation would be:

$$W = EI = (7.5)(0.050) = 0.375 \text{ watts}$$

In this case, a 1-watt resistor would be used.

Multiplier Resistor: In the third example discussed, Fig. 2(C), it was calculated that

If servicing is one of your interests . . . you can't afford to miss next month's big **SPECIAL SERVICE ISSUE** of

RADIO & TELEVISION NEWS

Designed primarily to meet the special needs of the service technician . . . or if you just want to keep posted on every development in this vital area—

MARCH RADIO & TELEVISION NEWS will bring you the most complete roundup of service articles, features and news we've ever published.

From cover to cover, the **SPECIAL SERVICE FEATURE ISSUE** of **RADIO & TELEVISION NEWS** tells you how to broaden the scope of a servicing business . . . how to use your present equipment and "know how" to expand into allied fields . . . how to take advantage of the daily opportunities that are developing in electronics.

DON'T MISS THE MARCH SPECIAL SERVICE ISSUE ON SALE FEBRUARY 28!

**RADIO &
TELEVISION NEWS**

366 MADISON AVENUE, NEW YORK 17, N. Y.

INDUSTRIAL ELECTRONIC— AUTOMATION TECHNICIANS Desperately Needed!



Never in history has there been such a **tremendous demand for Electronic technicians** at the servicing, maintenance and assistant Engineering level, in *all* fields of electronics. Industries, Businesses, large and small are turning to Electronically controlled machinery . . . **AUTOMATION!**

Whether it's a Robot airplane, an automobile plant with an integrated line of machines, a Sensing Device, Computing System or Communications—each re-

quire electric power applied through automatically controlled processes. This means **there are positions open at all levels and phases for Electronic Technicians.**

- **TOP PAY**
- **UNLIMITED OPPORTUNITY**
- **SECURE FUTURE**

Let us send you **FREE**, without obligation, complete details of our Resident Electronic Training Program—originated by Bailey Schools—acclaimed by Electronic Engineers. See how you save time as you learn-by-doing with intensive laboratory work on the most recently developed Electronic equipment, plus classroom required physics, mathematics, etc.

We help you find part time work while in our school—help place you with America's leading companies after graduation. Act now—mail coupon today!

VETERAN APPROVED

Bailey Technical Schools
1626 S. Grand • St. Louis 4, Mo.

Bailey electronic students learn Industrial Television on specially designed equipment such as this panelboard, which is a multiple camera and screen control. The Bailey Electronic course includes an outstanding comprehensive program in radio and TV receiver servicing.

MAIL TODAY

Please mail immediately this free booklet without obligation.

FREE BOOKLET →

Name _____

Address _____

City _____ State _____



YOUR COPIES OF

POPULAR ELECTRONICS

ARE VALUABLE!



Keep them neat . . . clean . . .

Ready for INSTANT REFERENCE!

Now you can keep a year's copies of POPULAR ELECTRONICS in a rich-looking leatherette file that makes it easy to locate any issue for ready reference. Specially designed for POPULAR ELECTRONICS, this handy file—with its distinctive, washable blue Kivar cover and 16-carat gold leaf lettering—not only looks good but keeps every issue neat, clean and orderly. So don't risk tearing and soiling your copies of POPULAR ELECTRONICS—always a ready source of valuable information. Order several of these POPULAR ELECTRONICS volume files today. They are \$2.50 each, postpaid—3 for \$7.00, or 6 for \$13.00. Satisfaction guaranteed, or your money back. Order direct from:

JESSE JONES BOX CORP., DEPT. PE
 Box 5120, Philadelphia 41, Pa.
 (Established 1843)

a 100,000-ohm resistor would be needed as a meter multiplier to change an 0-1 ma. meter to a 0-100 volt voltmeter. Wattage? Let's use the second formula given in Fig. 3C.

$$W = E^2/R = (100)^2/100,000 = 10,000/100,000 = 0.1 \text{ watts}$$

And, in this case, a 1/2-watt or even a 1/4-watt resistor would be satisfactory.

Conclusion

In this discussion, the value of learning and using Ohm's law to the average experimenter has been emphasized. Remember, however, if these problems and examples seemed a little difficult, that they were so only because of unfamiliarity with Ohm's law. As practice and experience are gained, calculating resistor values with Ohm's law becomes easier and easier . . . the stage can be reached where most of the calculations are performed mentally, with pencil and paper seldom being necessary.

But one thing is certain! Learning to use and to apply Ohm's law will result in a better understanding of circuit action, making it possible to undertake and to complete successfully a greater number of projects. It will also enable the experimenter to enjoy his hobby a lot more!

-30-



Shoot to Kill—TV Commercials!

(Continued from page 46)

voice coil, using a short length of ordinary lamp cord. Two different connection methods may be used, and both are illustrated in Fig. 4.

The connection method shown in Fig. 4(A) is the simplest and is satisfactory for the majority of installations. Leads from the unit are merely connected in parallel with the voice coil terminals. When the relay closes, the voice coil is simply shorted out. This will usually "kill" the sound; but if the connection lead is long, its impedance may approach the low impedance of the loudspeaker voice coil, with the result that an imperfect "short" occurs and the sound is simply reduced in volume—without being "killed" completely.

A somewhat better installation method is shown in Fig. 4(B), but it requires one additional component (a small wire-wound resistor), three leads, and a little more work. One of the leads from the loudspeaker's voice coil to the output transformer is opened, then connected to the relay terminals of the "Commercial Killer." With this connection method, the audio output signal is fed either to a resistive load or to the loudspeaker.

Once the speaker connections have been



ELECTRONIC TECHNICIANS ARE IN DEMAND

TRAINED MEN ARE NEEDED NOW!

In just 15 months, you can complete Electronic Technicians training to enter this ever-growing industry. Day or evening classes. Opportunity for employment in local industry. Approved for Korean Veterans.

Terms beginning Jan., April, July, September
 Write for Catalog 224 TODAY

INDIANAPOLIS ELECTRONIC SCHOOL
 312 E. Washington St. Indianapolis 4, Indiana

EYE GLASSES by MAIL As low as \$1.95

WRITE for FREE CATALOG with 14 LENS SAMPLE CARD

Thousands of Customers
 Est. 1939



QUALITY READING-MAGNIFYING OR BIFOCAL GLASSES FOR FAR AND NEAR

ADVANCE SPECTACLE COMPANY, Inc.
 537 S. Dearborn St., Dept. PE-2 Chicago 5, Illinois

POPULAR ELECTRONICS KITS

Complete Kits For Projects In This Magazine For This Month

All Band S-W-L Pre-selector	\$18.35
Shoot To Kill—TV Commercial	14.90
Variable Audio Oscillator	13.60
Electronic Banjo	8.50

25% on C.O.D. orders. We ship express collect if postage is not included.

ALGERADID ELECTRONICS CO.
 236 N. Franklin St. IV 9-0808 Hempstead, N. Y.

made, the unit may be adjusted for proper operation. Place the unit either on top of the television receiver or on the floor beneath it.

With both the TV receiver and the "Commercial Killer" turned on and a TV program tuned in, use a flashlight to strike each photocell, in turn, with a beam of light. Illuminating one photocell should "kill" the sound; illuminating the other should restore sound. If the relay does not hold either on or off when the light beam is removed, readjust the sensitivity control until the desired operation is obtained. Once set, the sensitivity control usually can be left fixed in position unless the light level changes considerably, or until the battery weakens.

The design of the "Commercial Killer" is such that, once adjusted, it is more or less "self-balancing" with changes in room lighting conditions. -30-

Electronic Banjo

(Continued from page 63)

and as an oscillator transformer, with the push-pull primary winding supplying the necessary feedback between collector and base circuits to start and sustain oscillation. The "common emitter" circuit is employed and is roughly analogous to a vacuum-tube circuit in which the emitter (E) acts as cathode, the base (B) as grid and the collector (C) as plate.

Frequency of operation is determined by the time constant of the *C1-R2-R1* combination. Thus, varying either of these components will change the frequency (tone) of operation. In practice, *R1* is made variable and serves as the tone or pitch control.

Since the transistor is operated in short pulses (as individual notes are played) rather than continuously, it is safe to operate it close to or slightly exceeding its maximum ratings, permitting moderate loudspeaker volume even though the transistor is a low-power device.

The push-button switch *S1* is in series with the battery (*B1*) used as a power supply. Hence, the circuit operates only when the switch is depressed, and no "standby" current is required.

Using the Banjo

The electronic banjo is held just like a conventional instrument. One hand is placed on the arm, with one finger just above the push-button switch. The other hand holds the tone lever lightly. To play an individual note, move the lever to the proper position and depress the push but-

February, 1956

Your Best Move

IS
The World's
Largest

TO
Distributor
of Amateur

WRL
Radio
Equipment



Completely
GLOBE SCOUT

65 watts CW
50 watts Fone
IDEAL
for the
NOVICE!

TOPS IN
SERVICE...
QUALITY...
BARGAINS!

Bandswitching
65A

ONLY
\$795
per month
Cash: \$99.95
Kit: \$89.95

AND YOU PAY
ONLY
10%
DOWN



WE
CARRY
A
COMPLETE LINE
OF
High Fidelity
Equipment

AND
BIG!
BIG!
TRADE-INS

Ask About Our
NEW
Code
Oscillator
Kit!
Only \$4.95

SAVE UP TO
50%
on Top-Notch
Reconditioned
Equipment

Ask About Our
ANTENNA
KIT...
10, 20, 40 & 80M
Just \$6.95

Send
For Our Big
WALL-SIZED
RADIO MAP
Just
25c

"PLUMBER'S
DELIGHT"
BEAMS
10M \$18.75
15M 27.95
20M 49.95

WRL'S
6 METER
CONVERTER
Only \$24.95
Kit Form: \$18.95



Let us give you
a
SAMPLE
of our
famous
"Personalized
Service!"

FREE
168 PAGE
1956
CATALOG!
Listing
15,000 Items



All Prices Subject to Change Without Notice!

WORLD RADIO LABS
3415 WEST BROADWAY
COUNCIL BLUFFS, IOWA

PE-2

Please rush me your latest FREE Catalog!
Please Send; Radio Map (25c)
and complete information on items listed below:

(1) _____ (2) _____
(3) _____ (4) _____

Name: _____
Address: _____
City & State: _____

Free

ALLIED'S 1956 ELECTRONIC SUPPLY GUIDE



**Save on Everything in
TV, Hi-Fi and Radio**

Send for the leading Buying Guide to the world's largest stocks of Hi-Fi equipment, recorders, TV accessories, Ham gear, P.A., test instruments, builders' kits, parts, tubes, tools and books—everything in Electronics at lowest prices! Write for your **FREE** copy today.

**324 PAGES
packed with value**

ALLIED RADIO

**ALLIED RADIO CORP., Dept. 79-BB-6
100 N. Western Ave., Chicago 80, Ill.**

Send **FREE** 324-Page 1956 **ALLIED** Catalog

Name _____

Address _____

City _____ Zone _____ State _____

ton. Hold the button down long enough to sound the length note desired . . . 1/8, 1/4 or a full note. Release the button and move the lever to position for the next note.

The musically inclined will soon learn exactly where to place the tone lever for the desired note and won't even have to look at it. But beginners may find it easier to fasten a sheet of paper on the instrument and mark the lever positions for different notes.

As mentioned before, the electronic banjo does not sound like a regular (string) banjo despite its physical resemblance to its namesake. Rather, it has a unique tone all its own, and is capable of producing unusual sound effects impossible with a conventional banjo. For example, by holding the button depressed and rapidly moving the tone lever back and forth, it is possible to "slide" from one note to another, and, with one quick movement, cover every note in the instrument's range. With practice, the electronic banjo can almost be made to talk!

-30-



The Transmitting Tower

(Continued from page 65)

rush the job or putting in too many hours on it at once will certainly increase the possibility of making errors. In addition, working on the kit too many hours at a sitting is the best way I know for changing a fascinating task into frustrating drudgery.

Incidentally, I found only one minor discrepancy in the AR-3 instruction book. In the printed instructions, an 820-ohm resistor is specified for the cathode of the 12BA6 i.f. amplifier tube, while the diagrams indicate use of a 470-ohm resistor at this point. An 820-ohm resistor was supplied, I used it, and the receiver works. It must be okay.

After the receiver is assembled, it must be aligned. The simplest way to accomplish this is to turn the job over to a radio serviceman with a calibrated signal generator, after conducting the simple tests outlined in the instruction book to determine that the wiring has been done correctly. Or if a signal generator can be borrowed for a few hours, the constructor can easily do the aligning himself by following the instructions in the manual.

Using the AR-3

Used with a good antenna, the finished AR-3 will bring in almost any signal that can be heard on a more elaborate receiver. Selectivity—the ability to separate signals close together in frequency—is all that can be expected from a single, 455-kc., i.f. stage; and it will be adequate much of the time, although more selectivity could certainly be used in the amateur bands when interference is at its peak levels.

LMB BOX CHASSIS

Flangelocking Precision Engineered Interlocking

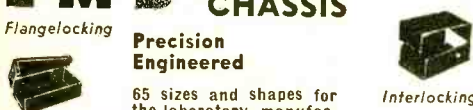

65 sizes and shapes for the laboratory, manufacturer, industrial, experimenter, builder, and general applications where metal boxes are required. Stocked by all electronic and geophysical distributors. Send for free catalog.

**LMB 1011 Venice Blvd.
Los Angeles 15, Calif.**

VHF AM-FM RADIO

Supersensitive sub-miniature tube set receives television, FM broadcast, CAP, and amateurs without antenna or ground. Tunes from 75 mc. to 150 mc. Similar models available in frequency bands from 27 mc. to 225 mc. Pocket size—measures only 2" x 2" 2 3/4". Highest quality components used. Specify battery or AC model. Use with any magnetic headphone or can be connected to audio amplifier for loudspeaker operation. Thousands in use by amateurs, experimenters, and civil defense. Factory wired and tested chassis complete with special tube only \$5.98 postpaid. In kit form \$2.98. Postage extra on COD orders. New transistor audio amplifier for extra loud reception only \$2.00 including transistor.

SPRINGFIELD ENTERPRISES
Box 54-E Springfield Gardens 13, N. Y.

EASY TO LEARN CODE

Learn or increase speed with an Instructograph—the Radio-Telegraph Code Teacher that takes the place of an operator-instructor and enables anyone to master code without further assistance. Available tapes from beginners alphabet to typical messages on all subjects. Speed range 5 to 40 WPM. Always ready—no QRM. Thousands have "acquired the code" with the Instructograph System. Write today for convenient rental and purchase plans.

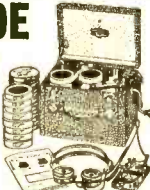

INSTRUCTOGRAPH COMPANY
4713-F Sheridan Road, Chicago 40, Illinois

The planetary, vernier drives on the main tuning and bandsread capacitors work very smoothly, and stability is very good for an inexpensive receiver—especially when the AR-3 is used in a cabinet. For this reason, and to protect it from dust and damage, I would recommend either obtaining the companion cabinet (\$4.50 from the *Heath Company*) or constructing one for the AR-3.

As is true of any short-wave receiver using a 455-ke. i.f. channel, and without an r.f. stage ahead of the mixer stage, the discrimination of the AR-3 against "images"—signals twice the intermediate frequency higher than the desired signal—becomes progressively poorer on frequencies above about 10 mc. As a result, on these higher frequencies, strong signals will be received at two points 910 kc. apart on the dial. The lower frequency setting will produce the louder signals, and it is the correct one.

No one would pretend that an AR-3 will outperform a communications receiver costing many times its price. Nevertheless, when it is carefully assembled, it does a remarkably good job considering its cost. Therefore, I would unhesitatingly recommend the AR-3 kit to the SWL or prospective amateur with a limited budget who is willing to take the time to put it together carefully.

Oh, yes, the AR-3 works well on the broadcast band, too.

"So You Want to Be a Ham"

So You Want To Be A Ham, by Robert Hertzberg, W2DJJ, published by Howard W.

Sams & Co., Inc., Indianapolis 5, Ind., (\$2.50), is based upon the series of articles of the same name that appeared in *POPULAR ELECTRONICS* (October, 1954, through April, 1955). Its 196 profusely illustrated pages describe why amateur radio is such a fascinating hobby for young and old of both sexes and tell the reader how he can join the fun.

Space does not permit reviewing the book in detail. Some of the subjects it covers include: what amateur radio is; learning the code; getting a license; equipment required, how much it costs, where to get it; amateur abbreviations and their meanings; good operating; electronics as a career; hams who have made good; etc.

With one limitation, *So You Want To Be A Ham* covers its subject quite thoroughly. However, it makes no pretense of teaching the reader what he must know to pass the written technical part of the amateur examinations. Therefore, a prospective amateur might just as well order a copy of the *License Manual* along with it. He will need it.

News and Views

Everett E. Worrell, Jr., KA2CY, Captain, USAF 849th AC&W Sq., Box 11, APO 47, C/O Postmaster, San Francisco, Calif., writes: "Dear Herb, the last time you heard from me I was WN5CTY at Keesler AFB, Miss. Now I am operating KA3CY near Nagoya, Japan, and spend most of my time on 20-meter phone. My transmitter ends up with a pair of 100TH's, and the receiver is 'home brew'."

WHICH TRANSMITTER KIT TO BUY?

I JUST GOT MY NOVICE TICKET, BUT WHICH KIT SHOULD I BUY?

THAT'S EASY! CHOOSE THE KIT THAT GIVES YOU THE MOST FOR YOUR MONEY!

SAY, THIS VIKING "ADVENTURER" LOOKS LIKE THE ONE FOR ME!

YOU MEAN YOUR RIG WAS MADE FROM A KIT?

SURE, IT'S TVI SUPPRESSED--WORKS ALL BANDS--80 THRU 10--LOADS ALMOST ANY ANTENNA-- AND IT'S PUNCHED AND DRILLED FOR YOU, TOO!

NOW YOU'RE TALKING!! I'VE GOT ONE AND IT'S GOT 'EM ALL BEAT!

VIKING "ADVENTURER" CW KIT
Compact, completely self-contained 50 watt transmitter kit. Single knob bandswitching—effectively TVI suppressed. Easy assembly by novice or experienced amateur. 80, 40, 20, 15, and 11-10 meters. Cat. No. 240-181-1 complete with tubes. **\$54⁹⁵**

LATER SAY! STEP BY STEP INSTRUCTIONS! I'LL BE FINISHED TONIGHT!

EVERY-THING IS SUPPLIED. ALL YOU NEED IS YOUR OWN KEY AND CRYSTAL.

JOHNSON MAKES A COMPLETE LINE OF TELEGRAPH KEYS, TOO. WRITE FOR FULL INFORMATION.

MAIL TODAY

E. F. JOHNSON COMPANY
3002 Second Ave., S.W., Waseca, Minnesota

Please send me a copy of Bulletin 727, which describes the Viking "Adventurer" in detail.

NAME _____
ADDRESS _____
CITY _____ STATE _____

TECHNICIANS WANTED



RADIO TELEVISION AND ELECTRONIC INDUSTRIES NEED WELL TRAINED MEN.

The man who really has the "know-how" will win the best rank and position and the highest pay in the years ahead. Engineering Opportunities shows how you can be thoroughly trained by specialized home study courses. It lists details of over ninety courses in all branches of engineering and academic fields. Get your free copy of "Engineering Opportunities" to-day by mailing the coupon below.

Canadian Institute of Science & Technology Limited, 606 Century Building, 412, 5th Street, N.W., Washington, D. C.
Please forward free of cost or obligation of any kind your 105-page handbook, "ENGINEERING OPPORTUNITIES".

Name _____
Address _____
Course interested in _____ Age _____

Canadian Enquiries: Canadian Institute of Science & Technology, 263 Adelaide St. W., Toronto, Ont.

OWN a Business

If employed, start part time. Alert dealers can gross \$5 hourly profit on own service plus \$3 on EACH serviceman. Clean, revive, moth-proof rugs & upholstery on location. No shop needed. Services nationally advertised. Repeat customers. Easy to learn. We locally train and assist you. Quickly established. Easy terms. Send today for FREE booklet. No obligation.

DURACLEAN CO., 6-232 Duraclean Bldg., Deerfield, Ill.

INVENTORS

If you believe that you have an invention, you should find out how to protect it. We are registered Patent Attorneys. Send for copy of our Patent Booklet "How to Protect Your Invention," and an "Invention Record" form. No obligation. They are yours for the asking.

McMORROW, BERMAN & DAVIDSON
Registered Patent Attorneys
349-H Victor Building Washington 1, D. C.

NEW! WRIST RADIO

Amazingly powerful! Plays while you wear it. 400-mile reception using just its own antenna. No connection needed to ground, aerial, lamp, telephone, etc. Tunes entire broadcast band with sharp selectivity. **BUILD YOUR OWN**—New book has complete instructions. How-to-do-it book \$1.98 postpaid. Also a basic kit consisting of attractive pre-drilled case, "outline" chassis, and all necessary hardware \$2.98 ppd. Combination of book and basic kit, **SPECIAL \$3.98** postpaid, C.O.D.'s, \$1 deposit. Huckert Electronics, Box 7400-L8, Washington 4, D.C.

LEARN TELEVISION

"AT THE MOST PRACTICAL SCHOOL IN THE WEST" WORK ON LATEST MODEL SETS—USING MODERN SERVICING EQUIPMENT AND TECHNIQUES: UNDER QUALIFIED TECHNICIAN INSTRUCTORS (SHORT RESIDENT) AND (CORRESPONDENCE COURSES)—NO UNNECESSARY MATH OR THEORY—ALSO UHF AND COLOR TV.

APPROVED FOR VETS—ENROLL NOW!
Day and Night Classes Write for Free Literature
Dept. 2A—Correspondence
Dept. 2R—Resident

V. S. I. TELEVISION SCHOOL 4570 Firestone Blvd. South Gate, Calif.

My SX-28A has not arrived from the states yet. I get very good reports from the USA and QSL 100%. I'll be glad to work any readers of the *Transmitting Tower*. I'll soon be on 15 meters, too."

Michael J. Grossman, K2JWM, 145 Elmsmere Road, Bronxville, N. Y., writes: "Do not let the 'General' call fool you. I am a Novice at this game, although I have been on the air for eight months. Ham radio is the most enjoyable hobby, and I have made many friends over the air. My rig is a *Johnson Ranger*, my receiver is a *Hammarlund Super Pro*, and my antenna is a 'Windom.' (A 'Windom' is a compromise 'all-band' antenna, 135' long and fed 49' from one end with 300-ohm TV lead in: *Herb*.)

"I have now worked all states and 40 countries. Recently, I have been spending a lot of time on 15 meters. That band has been opening up very nicely. I'd like to get some SWL reports, and I will answer all cards received."

Henry Roth, KN4EVY, 4537 Sheridan Ave., Miami Beach, Fla., writes: "I am 17 years old and a senior in high school. My transmitter is a modified AT-1, and my receiver is an NC-125. I will be glad to schedule anyone, whether he or she wants a new state, wants to handle traffic, or just wants to rag-chew. Also, I'd like to invite anyone, 'Generals' included, to call in on the Novice Rebel Net on 7170 kc. at 8:00 a.m., EST, on Saturdays. Our prime purpose is rag-chewing, but we do handle traffic, too."

Dennis McAlpine, W1DYE, 25 Canterbury Road, Concord, N. H., writes: "I'm 14. I got my 'General' in July after acquiring my 'Novice' last February. My equipment is a *Heath AT-1* transmitter and an *AR-2* receiver. Right now, I am modifying the transmitter to get more power out of it. I have worked 31 states and five countries in two continents. You were my first Indiana contact."

Frank Heiss, W1WJY, 112 Maplewood Ave., Cranston 9, R. I., writes: "I was a short-wave listener for 15 or 20 years before obtaining my General class license last July after four tries. In that time, I collected about 4500 confirmation cards from all around the world. I made up my mind that if I ever became a ham I would answer all SWL cards received, if the reports checked with my log. And I still stick to that resolve. I know how it feels to send a report to a station and have it ignored. Let's not snub the SWL's. Most of them eventually become hams."

Leland Anderson, 890 W. Mayfield, San Antonio 11, Texas, writes: "I am a great fan of the *Transmitting Tower*. I do not have my license yet, but I hope to have it and a *Globe Scout* transmitter by Christmas. They would make fine Christmas presents, wouldn't they?"

"I have been SWL'ing for about 18 months, and I have heard 61 countries, with 27 verified. I have three receivers, an S-38, a *Zenith 2-bander*, and a home-built 3-tuber. I also have a 2- and 6-meter converter. My antennas are a long wire for 80 and 40 meters, a folded dipole for 10, 15, and 20 meters, and the TV antenna for the v.h.f. bands.

"Herb, I hope that you print my address,

TEST and REPAIR CRT TUBES



"RIGHT on the JOB" with CENTURY'S CRT TESTIVATOR

Model 103 only \$14.95 Net

New Profits! More Calls! Save Time! Save Trouble! Here is a key to a whole new field of profits for you. With the #103 CRT TESTIVATOR you can repair picture tubes right in the set in a matter of minutes. The TESTIVATOR TELLS YOU INSTANTLY where the trouble is and then fixes it! Here are some of the major advantages of the TESTIVATOR—it TESTS: Cathode emission, Shorts and leakage between elements, Open elements, Probable useful life of the tube. It REPAIRS: Activates the CRT cathode by removing surface contamination, Restores emission giving life to weak and dim tubes, Clears inter-element shorts and leakage. So easy to use . . . you just plug in, attach the TESTIVATOR socket to the base of the CRT and the accurate, easy-to-read indicators tell you what you must know. (Complete instructions with every unit).

FREE BONUS OFFER—Order your #103 now and receive a handy, valuable booklet listing radio and TV tubes including CRT's which are interchangeable with no wiring changes. Another profit maker for you. Now you can always leave 'em with a picture. The

TESTIVATOR IS MONEY BACK GUARANTEED
—NO RISK TRIAL ORDER COUPON—

If jobber is out of stock mail order to Century Electronics Co., Dept. PE-1, 111 Roosevelt Ave., Mineola, N. Y.

Please send the Model 103 CRT TESTIVATOR on 10 day money-back guarantee.

- Send Postpaid . . . I am enclosing full payment of \$14.95
- Send C. O. D. . . . I will pay \$14.95 plus postage.

Name

Address

City State

SAVE! We pay postage on all prepaid orders.

CONSTRUCTION DATA

for the famous } STANCOR-WILLIAMSON
ULTRA-LINEAR
CHICAGO SUPER-RANGE
100 WATT

HI-FI AMPLIFIERS



Library of brochures showing schematics, parts lists, chassis layout diagrams and other construction information on these well-known, popular amplifiers. Write for your free library to:

FREE:

CHICAGO STANDARD TRANSFORMER CORP.
3589 Elston Avenue • Chicago 18, Illinois

DESIGNED FOR THE BOOKSHELF with LARGE SYSTEM PERFORMANCE

Only 17 1/4" x 11 1/4" x 10"
Only 1 Cubic Ft.

Complete line of Models

FIR PLYWOOD KIT (Model 8K) \$1790

ASSEMBLED PLYWOOD UNIT (Model 8U) \$2844

PEBBLE-TONE FINISHED UNIT (Model 8P) \$3450

KARLSONITE FINISHED UNIT (Model 8E & 8M) \$4950

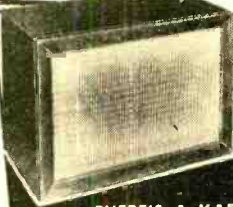

INCREDIBLE!

- Cleanness of Response
- Bass Response
- Dispersion Of The Highs

Please send copy of your latest book "The Karlson Enclosure"



KARLSON ASSOCIATES, INC.

DEPT. D

1610 Neck Road • Brooklyn 29, New York

THERE'S A KARLSON FOR YOU

MAGIC of remote RADIO CONTROL

For model airplanes, boats, cars, etc. FREE CATALOG "P"
No operator's license required. FREE-SEND FOR FCC FORM 505
Garage Door Radio Control Transmitters & Receivers Kits Available.
GYRO RADIO CONTROL TRANSMITTERS. 27.255 Mc. Most POWERFUL 5 Watt TRANSMITTER—LOWEST PRICE.
Famous 2 Tube MAC II circuit, with GYRO MAGIC TUNING INDICATOR. Completely Tested, includes: 9 1/2 ft. sect. Antenna, Remote "Clicker," Keying Switch, \$23.95
Meter, Beaut. Cabinet 12x7x6, MODEL X3. \$2.16
MODEL X1 w/ 2V Storage btry, charger, Vibe. pack \$39.50
RADIO CONTROL TRANSMITTER & RECEIVER KIT—27 1/4 mc. Band—License Free. All Parts & Diagr. (less tubes & crystal) to build Powerful 5 Watt Transmitter Unit & 2-Tube Receiver w/ SIGMA RELAY, wound coils. \$9.95
Hi-Impedance EAR PHONES, NEW. \$2.16
LORENZ 2-TUBE RECEIVER KIT w/ Tubes & Relay \$13.95
SIGMA 4F RELAY: .000ohm; \$4.25; R/C Escapement \$3.95
RADIO-CONTROL "HANDBOOK" \$2.25; Book "TRANSISTOR CRYSTALS" 27 255 Mc. Petersen Z9A \$3.95; HOLDER15
RELAY CONTROL—w/ Sigma 10K Relay, Hi-Impedance Audio Choke, Thermal Switch, Alnico Magnet, Neon Lamp, etc. 1.25
Electronic STROBSCOPE—Stops motion—110V AC, Complete. 18.95
Tiny ELECTRIC MOTOR Oper. from Flashlite Bttry. 1.00
TRANSCIEVER CABINET 12x7x6 w/ HANDLE. 2.85
Mini VIBRATOR SUPPLY 6V, Input 90VDC, 30 Ma. 3.45
TUBES: XFG1, 6X61, 3A4, 3A5, 1A6, 6K4; TRANSISTORS99
2-6V CHARGER KIT \$4.9545
Storage BATTERIES: Mini. 6V, N76 \$2.45; 2V 27A H. 2.75



GYRO ELECTRONICS 325 CANAL ST., N. Y. 13, N. Y.

LEARN

RADAR MICROWAVES TRANSMITTERS CODE TV RADIO

Phila. Wireless Technical Institute
1533 Pine St. Philadelphia 2, Penna.

A Non-Profit Corp. Founded in 1908

Write for free catalog "P"

BA's NEW 1956 FREE CATALOG

YESSIR-IT'S THE KING-SIZE CATALOG
164 KING-SIZED (8 1/4" X 10 1/2") PAGES
 OFFERS MORE ITEMS PER PAGE--IT'S EASIER TO USE...IT'S EASIER FOR YOU TO ORDER

COMPLETE GUIDE TO EVERYTHING IN RADIO, TV, ELECTRONICS

100'S OF BRAND NEW ITEMS LISTED HERE FOR THE VERY FIRST TIME

INCLUDES 21 BIG PAGES OF BARGAINS NOT FOUND IN ANY OTHER CATALOG

1956 ANNUAL CATALOG NUMBER 561

BA SINCE 1927

A Complete Buying Guide for Everything in-
RADIO TELEVISION ELECTRONICS

BURSTEIN-APPLEBEE CO.
 Dept. PE-1012-14 McGee St., Kansas City 6, Mo.
 Send Free B-A Catalog No. 561.

Name.....
 Address.....
 City..... State.....

so that I will get some mail. If I get over 100,000 letters, I'll commit suicide."

Ronald Reed, W6ODX, 11671 San Vincente Blvd., Los Angeles 49, Calif., sends code practice each Monday, Wednesday, Friday, and Saturday, from 6:30 to 7:00 p.m., PST, on 3550 kc., according to H6HOK.

George Hall, KN9AQM, of Gary, Ind., turned the tables neatly on W9EGQ recently. He wrote a very flattering article about Herb that was published in the magazine section of the Sunday edition of the *Gary Post-Tribune!*

Jimmy Robin, KN6OVK, 1759 Holt Ave., Los Angeles 35, Calif., reports: "I have had my license a week and have made 29 contacts in two states. I use an AT-1 transmitter and an NC-98 receiver. I'll be glad to schedule anyone needing a California card. I QSL (confirm) contacts 100%. I have crystals for both the 80- and 40-meter Novice bands. I would also like some pen pals and some ideas for 15-meter antennas."

HELP WANTED

In this section of the *Transmitting Tower*, the names of persons requesting help and encouragement in obtaining their amateur licenses are listed. To have your name included, address a request to: Herb S. Brier, W9EGQ, C/O POPULAR ELECTRONICS, 366 Madison Ave., New York 17, N. Y.

Chas E. Hanley (14), 2625 35 Ave., San Francisco 16, Calif., (has phone).

Tom Kopecek (13), 71 Jarvis St., Binghamton, N. Y.

David Thompson, PFC, RA-14221743, 531 Ord. Co. (DS), APO 28, C/O Postmaster, N. Y. C., wants information on how to obtain his amateur license while stationed with the USA in Germany. Hams who were licensed while overseas in the Army should be able to brief him.

Charles Steng (44), 1031 Jackson St., Topeka, Kan., is a disabled war veteran who wants "help" in learning the code and theory to obtain his amateur license. He has all the "sympathy" he needs.

Cliff Gardner, 3839 Preston St., Rockford, Ill.

Gary Kinzey, P. O. Box 152, Downingtown, Pa.

Attention the American Embassy, Rome, Italy! To the person who wrote to the *Transmitting Tower* from there about obtaining replacement tapes for tape-type, code-practice machines: any of the amateur supply houses who advertise in POPULAR ELECTRONICS can supply tapes for the particular code machines they handle. If you will write again giving details on your machine and your full address, I shall attempt to supply more details in a letter. *Herb*.

Before I run out of space again, let me remind you that this is your column. Other hams and prospective hams are as interested in reading about you and your problems as

YOUR F. C. C. LICENSE

GUARANTEED PREPARATION
 Your License for F. C. C. Commercial Operator Examination in a minimum of time.
 A specialist in your home through correspondence or on the spot in resident classes.

Write Now For Free Information

EMIG SCHOOL OF ELECTRONICS

6253 Yucca Hollywood 28, Calif.

MAKE EXTRA DOLLARS



In your spare time by installing world famous midget VARI-LOOPSTICK antennas in radios. New life... louder volume... long distance reception guaranteed. Complete with instructions, easy, quick to install. **100**
GET STARTED TODAY! Send check or money order (no COD).
 TV SALES CO., P. O. Box 44, Yonkers, N. Y.

CLOSE-OUT

Weller Solder Jr. Gun and Kit with tools and holder plus case for 5.38. Original cost 7.95.
 RF Ammeter 1-7.5 Weston 2 1/2" meter bargain @ 2.49
 Ferri-Loopstick Ant. 3 for 1.20
 1N34A Crystal Diode @ .49 or 5 for 2.00
 Phono Amp. complete less speaker \$3.99. Uses 50L6 tube

MACFARLANE INDUSTRIES

P.O. BOX 208 CULVER CITY, CALIF.

EARN WHILE YOU LEARN

UPHOLSTERY BE YOUR OWN BOSS



Practical low-cost LEARN-BY-DOING UTS Course, complete with tools, materials, frames, trains you quickly AT HOME in spare time. Start making money in Upholstery almost at once! Big FREE illustrated book and FREE sample lesson shows you how—gives full facts about business. Job opportunities for men and women. Write TODAY! Also resident Training. Approved for Veterans.

UPHOLSTERY TRADES SCHOOL
 Dept. EB-140-09 721 Broadway, New York 3

you are in reading about them; so why don't you write that letter to the *Transmitting Tower* now? Include a reasonably sharp photograph of you and your equipment, if you can. But please do not send the same picture to a couple of magazines at the same time.

The address to use is: Herb S. Brier, W9EGQ, C/O POPULAR ELECTRONICS, 366 Madison Ave., New York 17, N. Y.

Until next month, 73.

Herb, W9EGQ

Carl & Jerry

(Continued from page 69)

man climbing the stairs that Carl imagined he could see a ghostly figure ascending the worn steps. Suddenly the sound stopped for a few seconds; and then, as Jerry started turning the switch knob backwards a position at a time, the sounds started all over again; but this time the ghostly feet were coming down the stairs, toward Carl!

"Stop it!" Carl called sharply in a shrill voice. "That's a little too realistic."

"Fine, fine!" Jerry's voice came from the speaker concealed in the ceiling. "Now watch the rocking chair. I think I can time the switching by the sound of the rocker if you don't QRM me with those knocking knees of yours."

As if by magic, the rocking chair began swaying back and forth, gently at first and then harder and harder. As Carl stared in fascination at the chair rocking crazily away in the circle of light from his flashlight, it looked exactly as though some ghostly sitter were vigorously entertaining himself.

All at once the whole empty house was filled with a cacophony of discordant sound. From somewhere upstairs there was the clanking of chains mixed in with the high-pitched squeaking of bats. A hollow, echoing laugh rolled down the open stairway. And once more the door swung open and added its rasping groan to the other sounds. Ghostly rappings ran over the walls, ceiling, and floor. As the door came to a stop, wide open, revealing the moonlit snow scene outside, all of the sounds came to an abrupt halt that left the echoes still bouncing off the bare walls. The rocking chair teetered back and forth in a lessening arc.

"Quit opening the door; it's getting cold in here," Carl shouted at the ceiling.

"Who's opening the door?" Jerry demanded. "I've not touched that switch but once since I came down here."

He broke off as a deep bass chuckle suddenly swelled through the house.

"I didn't know you had a recording like that," Carl said with surprise.

"I haven't," Jerry finally said, in a small scared voice. "That didn't come from me."

All at once the rocking chair began to rock again, wilder than before.

"Are you rocking the chair?" Carl asked in a croaking voice.

"No. I've pulled out all the plugs except that of the intercom unit. Something odd is going on. I'm coming up."

Can you think faster than this Machine?

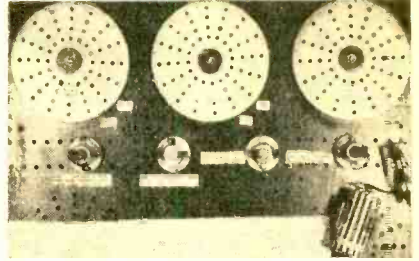

Control Panel of GENIAC set up to do a problem in check valve research

Be careful before you answer. GENIAC the first electrical brain construction kit is equipped to play tic-tac-toe, cipher and encipher codes, convert from binary to decimal, reason (in syllogisms) as well as add, subtract, multiply and divide. Specific problems in a variety of fields—actuarial, policy claim settlement, physics, etc.—can be set up and solved with the components. Connections are solderless and are completely explained with templates in the manual. This covers 33 circuits and shows how new ones can be designed.

You will find building and using GENIAC a wonderful experience; one kit user wrote us: "this kit has opened up a new world of thinking to me." You actually see how computing, problem solving, and game play (Tic-tac-toe, nini, etc.) can be analyzed with Boolean Algebra and the algebraic solutions transformed directly into circuit diagrams. You create from over 400 specially designed and manufactured components a machine that solves problems faster than you can express them.

Schools and colleges, teachers of science or math, engineering, philosophy and psychology will find these excellent demonstrators of circuitry, solutions in symbolic logic, theory of numbers, cybernetics, and automation.

Note: Teachers take advantage of our 10% discount to educational institutions and for group purchases. SEND for your GENIAC kit now. Only \$19.95 with over four hundred components and parts, fully illustrated manual and wiring diagrams. We guarantee that if you do not want to keep GENIAC after one week you can return it for full refund plus shipping costs.

MAIL THIS COUPON
SCIENCE KITS, Department PE24
Oliver Garfield Company
126 Lexington Avenue
New York 16, N. Y.

Please send me:

- 1 GENIAC Electric Brain Construction Kit and Manual.
 - \$19.95 (East of Mississippi)
 - \$20.95 (Elsewhere in United States)
 - \$21.95 (Outside the United States)

Returnable in seven days for full refund if not satisfied.

I enclose \$..... in full payment.

My name and address are attached.

WHERE TO BUY

COMPLETE PARTS KITS FOR THE
"FEATURE PROJECTS" IN POPULAR ELECTRONICS

"SHOOT TO KILL" COMPLETE KIT ONLY
TV COMMERCIALS \$17⁹⁵

A GADGET THAT ENABLES YOU TO CUT OUT TV COMMERCIALS WITH THE AID OF A FLASH LIGHT

please include 10% DEPOSIT WITH C. O. D. ORDERS
Almo RADIO CO.
509 ARCH ST., PHILA., 23, PA.
WILMINGTON, NORRISTOWN, ATLANTIC CITY, CAMDEN, TRENTON & SALISBURY, MD.

RADIO COURSES

- FCC LICENSE PREPARATION
- COMMERCIAL • CODE BRUSH-UP
- AMATEUR • THEORY
- TELEVISION AND RADIO SERVICING
- Personal Counseling Approved for Veterans

YMCA TRADE & TECHNICAL
SCHOOL OF N. Y.

15 West 63 St. New York 23, N. Y.
EN 2 - 8117 Catalog P. E.



53rd
Year

INTERNATIONAL RECTIFIER B2M SUN BATTERY



\$1.47

SELF GENERATING
SELENIUM PHOTO CELL

Generates current when exposed to natural or artificial light. Will last indefinitely under normal operating conditions. Size: .724" x .443" x .040". Open circuit voltage in average sunlight: .5 volt. Open circuit voltage at 100 ft. candles: .25 volt.

Hundreds of Applications such as:

- (Charging Batteries in Transistorized Equipment)
- Light Beam Communication
- Automatic Headlight Dimming
- Amusement Devices (Light Ray Guns)
- Burglar Alarms—Door Controls
- Timing Devices
- Garage Door Openers

WRITE FOR FREE LITERATURE
Mail Orders Promptly Filled!

ARROW ELECTRONICS, INC.
65 CORTLANDT ST., NEW YORK 7, N. Y., DIGBY 9-4714

ARROW HEMPSTEAD - 215 FRONT STREET
Vanhoe 1-1826

EXCITING HIGH FIDELITY

From your HOME TAPE RECORDER



FROM
\$19.95
COMPLETE

30 thru
15,000 cycles
at 7.5 I.P.S. to
Input of Home
Music System

DYNAMU

CONVERSION KIT

FOR YOUR Pentron, Revere, RCA

Wilcox Gay, Knight, etc.

Distributed in Canada by Muslart of Canada,
901 Bleury St., Montreal

Write: **DYNAMU, Maico Bldg., Minneapolis, Minn.**

CONVERT TO COLOR TV

COLORDAPTOR . . . Simple 9 tube circuit and rotating color wheel converts any black and white TV, direct view or projection, to receive compatible color TV. Specifications, including theory of operation, complete simplified construction plans, schematic, and sample color filters. **\$2.95**

Hdqts. for all color TV components, Xtals, delay lines

COLORDAPTOR 3471 Ramona Palo Alto, Calif.

GET INTO ELECTRONICS

You can enter this uncrowded, interesting field. Defense expansion, new developments demand trained specialists. Study all phases of radio & electronics theory and practice: TV; FM; broadcasting; servicing; aviation; marine; police radio. Prepare for good pay, 18-month course. Graduates in demand by major companies. H. S. or equivalent required. Begin January, March, June, September. Campus life. Write for Catalog.

VALPARAISO TECHNICAL INSTITUTE

Dept. PE Valparaiso, Indiana

In nothing flat, Jerry came charging down the hall, and the two boys huddled together at one end of the room and watched the chair swaying crazily back and forth, back and forth, back and forth.

"I'm getting out of here," Carl shouted as he bolted for the door, with Jerry right at his heels.

"Wait, boys!" the deep bass voice boomed from upstairs. Carl stopped in the open doorway, and the two boys shined their flashlights up the staircase. There at the top loomed a familiar laughing figure.

"It's Mr. Arnold!" Jerry exclaimed.

"That's right," Mr. Arnold said as he came down the creaking steps, still chuckling aloud. "I hope you boys won't hold it against me, but I simply HAD to find out how effective the little entertainment we have planned for my smart-aleck nieces is going to be. If I could scare you two with your own electronic goblins, I knew that we would have a sure-fire bet to straighten out those gals' permanents; and now I'm convinced that we've got what it takes."

"But how did you do it?" Jerry wanted to know.

"Very simply. I just connected switches in parallel with those operating the door-opening mechanism and the rocking chair. I was careful to splice in at a point where you would not notice. My switches are in a clothes closet near the top of the stairs. With them, I was able to take over a couple of your ghosts. For good measure, I stuck my head out of the closet door once and gave that corny laugh. Your imagination did the rest."

"Well, let me tell you," Carl said earnestly, "it gives you a very funny feeling when one of your own ghosts suddenly goes berserk."

"That I can believe," Mr. Arnold said with another chuckle. "If I live to be a hundred, I'll never forget the way you two were staring popeyed at that rocking chair when I tiptoed to the top of the stairs. I've already got my money's worth out of this prank right now, and we still have tomorrow night to go!" —30—

Tuning the Short-Wave Bands

(Continued from page 67)

tion at Okinawa on 7160 kc. is being noted at 0830-0900 with English news and commentaries. (RR)

Pakistan—Karachi, 11,885 kc., transmits to Southeast Asia with English news at 2000-2010; native music may be heard at 2015-2015 s/off. (RH)

Paraguay—A new station being heard at press time is Asuncion, 15,192 kc., around 1800-2000, with poor modulation. (RL)

Portugal—Radio Nacional, CSA27, Lisbon, 9741 kc., was tuned for first time at 2000-2045 with a good music program. This one is very rarely heard out here. (FL)

Spain—Radio Nacional de Espana, Madrid, is now operating on 12,000 kc. in addition to 9362V kc.; at 1800-1845 and 2215-2245 to North America in English. Post Exchange is heard at 1830. Latter time period is broken up into the following: at 2215-2220, English news; at

2220-2226V, music, Spanish; at 2226-2230V, English news; at 2230-2235V, music, Spanish; at 2235-2245, usually some sort of special program. (GW, FB, RR)

Switzerland—HER5, Berne, 11,865 kc., can be heard well at 2145-2215 with music; at 2215-2230 with news. Close-down at 2230. (RH)

Turkey—TAT, Ankara, 9515 kc., is noted daily from 1815 to 1900 with news at 1815-1820 and music at 1820-1900. The music usually consists of Turkish, classical, or popular American music, and varies from day to day. Close-down at 1900 is at times severely heterodyned by *Radio Moscow* on the same channel.

U S A—WBOU, New York, is the new call for WNBC. KK2XEZ, Dallas, Texas, is again being heard on 17,800 kc. around 1500-1630 relaying the *Voice of America's* "Music USA." It apparently is using a highly directional antenna to South America or the South Pacific. (RH)

Silent Stations

The following stations have not been heard for some time: YVMZ, *Radio Popular*, Caracas, Venezuela, 9527 kc.; COCO, Havana, Cuba, 9530 kc.; ZYV40, Pocos de Caldas, Brazil, 9645 kc.; HOH7, Panama City, Panama, 9683 kc.; ZYX24, *Radio Maua*, Rio de Janeiro, Brazil, 9705 kc.; CE970, Santiago, Chile, 9735 kc.; LRY, *Radio Belgrano*, Buenos Aires, Argentina, 9760 kc.; ZYX25, *Radio Maua*, Rio de Janeiro, Brazil, 11,885 kc.; *Servico Radio Difusao Educativa*, Rio de Janeiro, Brazil, 17,875 kc.; ZXA10, *Radio Electrica*, Montevideo, Uruguay, 11,895 kc.; PRK9, *Radio Inconfidencia*, Belo Horizonte, Brazil, 15,185 kc.; OAX4C, *Radio El Sol*, Lima, Peru, 15,198 kc.; and LRU, *Radio El Mundo*, Buenos Aires, Argentina, 15,290 kc. Information on any of these stations is requested. (RL)

Late Club Notes

The Newark News Radio Club has tentatively scheduled its 1956 Annual Dinner for May 12 at the Far Hills Inn, Far Hills, N. J. Further details can be obtained from your Editor.

—50—

SHORT-WAVE CONTRIBUTORS

Floyd Backus (FB), Richmond, Va.
 John Beaver (JB), Pueblo, Colo.
 DuWayne Bostow (DB), Max, N. Dak.
 Robert Hatter (RH), Syosset, N. Y.
 John Huetter (JH), Cleveland, Ohio
 Sheldon Klapholz (SK), Columbus, Ohio
 Roger Legge (RL), McLean, Va.
 Frank Longenecker (FL), Hollywood, Calif.
 Louis Marcarelli (LM), Medford, Mass.
 Richard McDonald (RM), Memphis, Tenn.
 J. McGerald (JM), Newington, Conn.
 Emmet Riggle (ER), Massillon, Ohio
 Rolan Riker (RR), San Bernardino, Calif.
 Mario Stutterheim (MS), Baltimore, Md.
 George Wright, Jr. (GW), Waco, Texas



Half the Fun Is Building It... with a TECH-MASTER Kit!

NEW Hi-Fi FM TUNER

Self-contained power supply • Tuning range 87-109 Mc • 200Kc IF bandwidth • Grounded-grid RF stage • AFC with front control cutoff • Microvernier tuning • No-drift ratio detector • 4 uv sensitivity for 20 db quieting • Standard deemphasis network • .8 volt RMS cathode-follower output • 3.2 volt RMS high-impedance output • 300 ohm input impedance • Switch-controlled AC receptacle for auxiliary equipment.

Model FM-18, complete with punched chassis, tubes, and hardware (less wire and solder).....\$29.50



NEW WILLIAMSON TYPE 20-WATT AMPLIFIER

Frequency response flat and smooth thru entire audible range • Less than .0025 distortion at normal listening levels • Excellent transient characteristics.

Model TM-15A, complete with tubes; sockets, terminal strips, and connectors mounted.....\$49.95



NEW DELUXE SELF-POWERED PREAMP-EQUALIZER

Cathode-follower output • Loudness compensating control • Input selector • 4 input channels • Independent bass and treble boost and attenuation • 5-position equalization control • AC receptacle for auxiliary equipment • Self-contained power supply.

Model TM-16 SP, complete with matching gold escutcheon.....\$24.50



Write for latest catalog of complete Tech-Master line

TECH-MASTER CORPORATION
 75 Front Street, Brooklyn 1, N. Y.



TELEVISION RADIO AUDIO

WANT A BETTER JOB: BECOME AN ELECTRONIC ENGINEER

ONLY 32 MONTHS TO EARN A BACHELOR OF SCIENCE DEGREE IN ELECTRONIC ENGINEERING

Class enrollment limited to allow for individual instructions. Chartered by state of California. Nonprofit-nonsectarian, educational—established 26 years.

APPROVED FOR VETS—ENROLL NOW!

SEND FOR FREE CATALOG

PACIFIC STATES UNIVERSITY

1516 S. WESTERN AVE., Dept. M, LOS ANGELES, CALIF.

DYNAMIC POCKET RADIO

\$3.95



Satisfied users report up to 1500 mile range with this electron tube complete KIT. Originally sold at \$5.99, production costs slashed! Assembles easily in one hour, with simple directions. Batteries and all parts fit in case. (Batteries \$1.00. Dynamic radio headphone \$1.45. SUPER QUALITY American made hearing aid earset \$3.98, guaranteed \$7.00 value. (FACTORY WIRED \$7.95 SET ONLY.) C.O.D.'s accepted with \$1.00 deposit. PRECISION ELECTRONICS, Dept. E, Cupertino, California.

Catalog of 3000 Novelties 10c



Send 10c for amazing catalog of novelties, live animals, scientific supplies, hobbies, funmakers, planes & boats, looms, magic tricks, joke articles, unusual seeds, gadget timersavers, cameras, optical goods, projectors, movies, lucky jewelry, religious novelties, disguises, musical instruments, stamps, coins, puzzles, fortune tellers, radios, auto & bike accessories, telescopes, magnifiers, compasses, banks, smokers' gadgets, artists' supplies, printing sets, engines, motors, shockers, knives, billfolds, fireworks, guns, rifles, sports, books, games, plants, etc. Send name, address & 10c to: JOHNSON SMITH & CO., Dept. 250, Detroit 7, Michigan



HANDS TIED?

—because you lack a
HIGH SCHOOL DIPLOMA

• You can qualify for an American School Diploma *in spare time at home!* If you have left school, write or mail coupon for **FREE** booklet that tells how. No obligation of any kind.

OUR 59TH YEAR

AMERICAN SCHOOL, Dept. H256
Drexel at 58th, Chicago 37, Illinois

Please send **FREE** High School booklet.

Name.....

Address.....

City & State.....

Canadian Residents: Complete Canadian Course Available.
Write American School, 1610 Sherbrooke St. West, Montreal.

Kruger Pistol Bargain \$3⁰⁰ post paid

.12 CALIBER SINGLE SHOT

.14 MG. POWDER
CHARGE

Crafted after famous
German Luger design.
Not an air or CO₂ gun.

This is a small bore gun that actually
shoots .12 caliber lead bullets fired by
light 14 mg. powder charge. Beautiful
gun... swell for target shooting. 4" steel
barrel in knurled styrene stock. Overall
length 8¾ inches. This amazingly low
price due to ball and cap design. Direct
factory-to-you sales. Comes with 50 bullets.
Send for extra bullets or available at stores.
Money back if not satisfied. Limited quantity. Delivered free.
Send \$3 cash, check or money order to **KRUGER CORP**
KRUGER BUILDING, BOX Q 709, ALHAMBRA, CALIFORNIA



BLUE-
BLACK
FINISH



Free! 75 ORIENTALS

Bring to you from the farthest ends of the
earth—these exotic valuable genuine **STAMPS**
of the Orient! 75 all-different from Borneo,
Siam, China, Japan, Hong Kong, Malaya, Sa-
rawak, Singapore—and other exciting mys-
terious lands of the Far East. **EXTRA!** Free
booklet. Bargain Catalog, other fascinating
offers. Send 10c for mailing expenses.

JAMESTOWN STAMPS, C2PE, JAMESTOWN, N. Y.

INVENTORS

Send for
PATENT INFORMATION
Book and
INVENTOR'S RECORD
without obligation

GUSTAVE MILLER
26-PE WARNER BUILDING
WASHINGTON 4, D. C.

REGISTERED PATENT
ATTORNEY

ASSOCIATE EXAMINER
U. S. PAT. OFF. 1922-1929

Patent Attorney & Advisor
U. S. NAVY DEPT. 1930-1947
PATENT LAWYER

WALKIE-TALKIE

Build a real wireless portable radiophone for the 2 meter amateur band
with the following precision components: Factory wired and tested
transceiver chassis with special dual tube \$6.50. UTC "ounce" mike
transformer \$.98. High output carbon mike \$1.49. Super Alnico
headphone \$1.25. 2" x 5" x 9" aluminum case \$2.00. Wiring diagram \$.50.
Uses standard batteries available at your local radio store. Please include
5¢ for postage. COD's require \$1.00 deposit.

SPRINGFIELD ENTERPRISES

Box 54-E

Springfield Gardens 13, N. Y.

Disc and Tape Review

(Continued from page 74)

of beautifully rounded, very live and luminous sound, softer in the details but not neglectful of their importance. Here, too, no distortion of instrument or groove is in evidence, acoustic perspective is excellent and, of course, the typically velvet-smooth Angel surfaces greatly enhance the illusion of presence.

Last of the four hi-fi versions of the Paganini *Concerto #1* is the Krebbers/Van Otterloo reading on Epic LC3143. This is also a fairly new recording and, to be quite frank, came as something of a surprise to me . . . because of its excellence of sound more than anything else. Krebbers is a good conscientious performer, with a better than average tone and good technical command, but he just doesn't have the insight into the score that the three other artists have.

I did not mean to infer in the preceding sentences that Epic records are "no good." This is far from the case, as their many fine recordings will attest. However, I must say that in the earlier days of the Epic label, the sound was best classed as miserable. I feel that the Epic people were wrongly advised as to the nature of the American hi-fi market, and that they made their records to conform to this wrong idea. In other words, in order to get their label off to a rousing start, they made the recordings deliberately bass-heavy and treble-screechy with the notion that this would sound good on the cheap units which are deficient in both highs and lows. Well, it *did* work . . . up to the point where the record critics started lambasting them and enough people with good hi-fi systems heard them. So the situation was corrected . . . but not entirely so, as the strings still seemed to have an excess of edginess.

Now, with the Krebbers recording, the Epic label has come up with something worthy of the huge Phillips organization behind it. The tone of the soloist is heard in its true perspective, and the orchestral strings are equally good. Couple an excellent balance, good frequency and dynamic range and spacious acoustics, and you have a more than satisfactory hi-fi recording.

CONCERTO #4

The real prize on the latter disc, however, is the flip side, which has the first recording of the "lost" *Concerto #4* of Paganini. This was played by Paganini in Paris, and until the manuscript turned up in a junk dealer establishment in Naples a few years ago, the concerto was presumed lost. As heard with the redoubtable Arthur Grumiaux as soloist, this is an interesting and valuable addition to the Paganini repertoire. Grumiaux plays with a sweetness of tone and versatility of execution that is a joy to the ear. There are some typically difficult and flamboyant passages in this work, and Grumiaux traverses them with great elan. The sound of the solo violin here is quite remarkable, and as far as I'm concerned, this is the best sound yet heard from Epic . . . good balance between all elements, very little pre- or post-echo, excellent fre-

quency and dynamic range, and good acoustics—although Grumiaux is miked just a little too close for my taste. All in all, it is a memorable new work, splendidly executed and with sound of compelling realism.

CONCERTO #2

With regard to the Paganini *Concerto #2*, the choice of recording is easy . . . there are only two. One, by Yehudi Menuhin, is splendidly interpretatively but is not particularly inspiring in matters of sound. This is a rather lackluster recording, surprising from HMV. The other disc is the same Ricci/London recording on which we find the *Concerto #1*, and of course is a brand-new—right up to snuff—effort, with all the remarks I made on *Concerto #1* applicable here. I am sure most of you will find *Concerto #1* a much more interesting work. However, those who like both are certainly better off with the London disc in any case since both works are recorded on it, while the Menuhin disc has the *Vieux-temps Concerto* on the flip side.

This about winds up the Paganini works, except to add that it is well worth your time to investigate the 24 *Caprices* of which the Francescatti and Ricci versions are the best. You might also look into London LL1005, which is a sort of potpourri of Paganini works played with great zeal by Ricci.

Pop Corner

The Music of Ralph Gari (EmArcy MG-36019, 12" LP, \$3.95) deserves special mention this month. Frankly, this gentleman's name was completely unknown to me, but after hearing this disc . . . I'm sold! Here is rare versatility in a jazzman . . . in various numbers Gari is heard on alto sax, flute, piccolo, clarinet and oboe! And it is not just hack work either . . . his intonation and fingering are equally facile on any of the instruments named. When he is teamed up with Clarence Shank on piano, Ed Julian on the traps and Danny Sherrett on bass, this becomes as cool and easy swingin' a disc as I've heard. There are some unique and interesting original tunes here, fully exploiting the wide range of effects possible with Gari's multi-instrument talent. But as for me, I liked their clever and highly listenable arrangements of such standards as *Dancing in the Dark*, *I've Got You Under My Skin*, *Thou Swell*, etc.

The sound here is best described as sensational . . . it is some of the liveliest, presence-type sound I've ever heard in jazz. The piano alone is worth the price of the disc . . . it can be a lovely liquid thing, and then percussively hard, all with no discernible distortion or any harsh ringing. Gari's various instruments are heard with exceptional clarity and definition, the traps and bass are very clean and articulate. There is ultra-wide frequency response here . . . excellent dynamics and acoustics which are spacious but not overdone—as is the case with so many jazz recordings. If you have a good wide-range system, this will give you an aural treat that you'll remember for a long time.

Some new tapes—including several stereos—arrived too late for this issue, but we'll have at them in the next. . . .



As always, Your Choice of
ANY KIT FREE
WITH EACH \$10 ORDER!
Amounts over \$10 are credited on your Credit Bonus card.

New "Credit Bonus Plan"! EVERY PURCHASE GOOD FOR "CREDITS" TOWARD YOUR FREE BONUS KIT!

Here's how it works: With your first purchase, you are issued a Credit Bonus Card showing 1 credit for each dollar of your purchase. You send your Card with each order, and credits are recorded. When your Card shows 10 credits, you get the kit you choose, free!

START EARNING YOUR FREE BONUS KIT TODAY!

- 30 POPULAR BULBS. Wide variety standard, miniature, screw & bayonet types. 1.1 thru 6 volts. Some pilot lite sockets. tool \$4 & tube! Wt. 1/2 lb. Reg. \$1
- G.E. PRE-AMP EQUALIZER KIT. Chassis, condensers, resistors, wire, socket and schematic. Comes with 68C7 tube (69c). Wt. 1 lb. Reg. \$1 \$4.50.
- 2 TUBE PHONO AMPLIFIER KIT. Includes all parts (except 50L6 & 35Z5 tubes) and schematic. Excellent tone, volume. Wt. 1 lb. Reg. \$1 \$2.98.
- 15 ROTARY SWITCHES. Complete! Wide variety contacts, single and dual gangs. Wt. 2 lbs. Reg. \$14.
- TEN 25-FT. ROLLS WIRE. Plastic cloth insulated solid & stranded. 18 to 24. Ass'd. colors. Wt. 1 lb. Reg. \$5.
- 25 SLUG-TUNED COILS. Variety of radio, TV slug-tuned coils—width, linearity, etc. Some \$1.50 ea. Wt. 1 lb. Reg. \$14.
- 10 TV & RADIO IF XFMRs. Popular replacement IF's. Some double trimmer types. Wt. 2 lbs. Reg. \$8.50.
- 60 CHOKES & COILS. 15 popular types Radio, TV lab. "ham" units. Wt. 1 lb. Reg. \$21.
- 20 POWER RESISTORS. Wirewound, ceramium & tubular. 20 values to 10,000 ohms; 5 to 50 w. Wt. 1 lb. Reg. \$1 \$12.
- 2000 PCS. HARDWARE. Screws, washers, lugs, grommets, etc. Wt. 3 lbs. Reg. \$1 \$11.
- 25 INSTR. KNOBS. Ass'd. bakelite round, knurled, pointer, skirted. Eqpt. types. Set screw & brass insert. Wt. 2 lbs. Reg. \$12.
- 40 MOULDED CAPACITORS. Ceramic & black encased. Wide variety values; .001 to 0.1 mf up to 1000 V. Wt. 2 lbs. Reg. \$15.
- 60 MICA CONDENSERS. Postage stamp type. 25 values: .0001 to .01 mf. Many silver, 5% tol. Wt. 1/2 lb. Reg. \$17.
- 60 TUBULAR CONDENSERS. 35 values: .00035 to 1 mf. to 1600 V. Oils & mouldeds, 1 mf. too! Wt. 2 lbs. Reg. \$22.
- 60 CARBON RESISTORS. Insulated. 35 values: 15 ohms to 10 meg.; 1/2, 1 & 2 w. Wt. 1 & 5% tol. Wt. 1/2 lb. Reg. \$18.
- 15 PRECISION RESISTORS. 15 values up to 100 meg! Carbo-film & WW. 1% tol. 2 to 2 w. Wt. 1/2 lb. Reg. \$1 \$18.
- 50 CERAMIC CONDENSERS. 25 values in disc button & tubular forms; 5 mm. to .01 mf. to 1000V. Duals, tool \$1 Wt. 1/2 lb. Reg. \$15.
- 125 CARBON RESISTORS. Uninsulated. 30 values: 100 ohms to 10 meg.; 1/2, 1 & 2 w. Many 5%. Wt. 1 lb. Reg. \$21.
- 10 ELECTROLYTICS, FP & tubular. 8 to 1000mf up to 450 V. Multiple sections, tool Some \$2.50 ea. Wt. 2 lbs. Reg. \$18.
- 150 RADIO PARTS! Large assortment of coils, electrolytics, ceramics, paper, moulded & mica condensers, resistors. Wt. 1 lb. Reg. \$30.
- 10 SWITCHES—panel, push on micro type. 10 different ON-OFF plates included. Wt. \$1 2 lbs. Reg. \$12.
- 10 TERN STRIPS, BOARDS. Wide variety. 1 to 12 solder lug points. Bonding posts, tool Builders' must! Wt. 1 lb. Reg. \$1.
- DIODE KIT #1. One each: 1N21, 1N22, 1N23, 1N24 in poly bag. Reg. \$11.
- DIODE KIT #2. One each: 1N34, 1N48, 1N51, 1N81 in poly bag. Reg. \$4.16.
- 25 TUBE SOCKETS. Subminiatures. 7 & 9-pin miniatures. 4, 7, 8 pins. Wt. 1 lb. Reg. \$9.
- 1000 PCS. SPAGHETTI. Pre-cut for shop use in lengths to 4", 8 sizes, 218 thru 5/8"; ass'd. colors, in insulation. Wt. 1/2 lb. Reg. \$7.
- 8-PC. NUTDRIVER KIT. Plastic handle; 3/16, 7/32, 1/4, 5/16, 11/32, 3/4, 7/16" steel socket wrenches in plastic case. Wt. 1 lb. \$3.50 \$1 value.
- 40 TRIMMERS. Popular mica compression trimmers in 12 ass'd. values. Singles, duals, triples. Wt. 1 lb. Reg. \$16.
- 40 XMITTING MICAS. Ass'd. values: .00025 to .01 mfd. 40 to 2500V. Some low loss; tool! Ham must! Wt. 1 lb. Reg. \$27.
- 5 CAR RADIO ASSEMBLIES. Permiability tuned front ends. Cover BC band. Push button controls. Wt. 2 lbs. \$1 Worth 35 ea.
- 100 CERAMIC INSULATORS. Wonderful assortment stand-off, panel and bush-cings. Wt. 3 lbs. Reg. \$15. \$1

POWER SUPPLY KIT!

300 VDC @ 70 MA

Reg. \$17 . . . ONLY \$3.88
Includes power transformer, IN-115V, OLT, 300-0-300 @ 70 ma; 63 @ 3A; electrolytics, resistors, tube sockets, fuse holder, assembly board, switch and tagran. Wt. 5 lbs.

0 TO 100 MICROAMP WESTON METER!

Reg. \$21 . . . ONLY \$3.33

2 1/2" x 2" in clear plastic case. Weighs only 2 oz. Accurate red hairline pointer, well damped. Brand new in original boxes!

3-TUBE PHONO AMPLIFIER—COMPLETELY WIRED!

Reg. \$4.50. ONLY \$2.44

Without output transformer. Excellent fidelity and tone. Separate volume & tone controls. Uses 50L6, 35Z5 & 12SQ7 tubes (not incl. unless ordered).

Tubes for above . . . \$1.64

WRITE FOR NEW 1956 BARGAIN BULLETIN!

Check items wanted. Return entire ad with check or M.O. incl. sufficient postage, excess returned. C.O.D. orders 25% down. Rated, net 30 days. PE-2

Name (Please PRINT)
Street
City Zone State
Enclosed \$ for kits, \$ for postage.

LEKTRON SPECIALTIES

28 GARDINER STREET CHELSEA 50, MASS.
Visit Our New Showroom At 131 Everett Avenue, Chelsea

GLOSSARY OF ELECTRONIC TERMS

This glossary, which is being published in serial form, started in August, 1955. It consists of a selected group of definitions taken from the booklet "A Dictionary of Electronic Terms," published by Allied Radio Corp., 100 N. Western Ave., Chicago, Ill. The complete dictionary, containing over 3500 terms, is available from Allied at 25 cents a copy.

QSL Card—Card exchanged by Radio Amateurs to confirm radio communication with each other.

quarter-wave antenna—An antenna electrically equal to one-fourth the wavelength of the signal to be transmitted or received.

quarter-wave transmission line—A transmission line that is an electrical quarter-wavelength of the frequency for which it is designed.

quartz crystal—Thin square or rectangular slice of quartz which, when precision-ground and smoothed, will vibrate at a frequency determined by its thickness and its original position in the natural quartz. Used to maintain high-frequency stability in a vacuum-tube oscillator of a transmitter or receiver.

radiate—To send out radiant energy into space.

radiation—Electromagnetic energy traveling outward into space, such as radio waves, infrared rays, x-rays, etc.

radiation pattern—A diagram indicating the intensity of the radiation field of a transmitting antenna as a function of plane or solid angles. In a receiving antenna, it is a diagram indicating the response of the antenna to a unit field intensity signal arriving from different directions.

radio frequency—Specifically, that part of the general frequency spectrum from very low frequencies to infrared light (about 10 kc. to 10,000,000 mc.). Generally, an a.c. frequency whose electromagnetic field can be radiated over great distances.

radio metal locator—A radio instrument which indicates the presence of metal within its operating range by a change in meter reading or a change in a tone signal heard in headphones. Used for determining positions of buried pipelines, buried metal objects, metal objects concealed in the clothes of prisoners, metal objects imbedded in logs about to be sawed, deposits of metallic minerals, etc.

radiosonde—Method of transmitting meteorological instrument readings from a weather balloon or other carrier to recording instruments on the ground. A radio meteorograph.

raster—A television term referring to an illuminated picture tube screen obtained without modulation.

RC, RC circuit—Designation for any resistor-capacitor circuit.

reactance—Opposition offered to the flow of alternating current by inductance or capacitance of a component or circuit. An inductor having an inductance L (henries) has an inductive reactance ωL (angular frequency times inductance). This is in ohms. The value increases with frequency. A capacitor having a capacitance C (farads) has a capacitive reactance $1/\omega C$ (reciprocal of angular frequency times capacitance). This is in ohms. The value decreases with increasing frequency. Reactance is designated by X . Its reciprocal is susceptance (B).

reactor—A device that introduces reactance (either inductive or capacitive) into a circuit. A coil or capacitor.

rectification—The process of converting alternating current into a unidirectional current by removing or inverting that part of the wave lying on one side of the zero amplitude axis.

rectifier—A unilateral component, usually a vacuum tube or other unidirectional current-limiting device, that accomplishes the process of rectification of alternating current. It may be a vacuum tube, gas tube, crystal, vibrator, or barrier-layer cell.

reflex circuit—A circuit in which the signal is amplified, both before and after detection, in the same amplifier tube or tubes.

regeneration—Method of securing increased output from an r.f. amplifier by feeding part of the output back to the amplifier input in such a way that reinforcement of the input signal is obtained. With this arrangement, a signal may pass through the same amplifier over and over again, with a resultant increase in amplitude. It causes oscillation when carried to extremes.

regenerative receiver—A radio receiver which employs controlled regeneration to increase the amplification provided by a vacuum-tube stage (usually the detector stage).

relaxation oscillator—(1) Generally, an oscillator having a decidedly non-sinusoidal output, resulting from abrupt transitions from one unstable state to another. (2) An oscillator in which the frequency is controlled by the charge or discharge of an inductor or capacitor through a resistor. (3) A multivibrator oscillator circuit employing two tubes (or a double-section tube) with resistance-capacitance coupling between the tubes to feed the output back and forth between them. It is used in television circuits to generate sweep voltages for cathode-ray tubes.

relay—An electromagnetic switch employing an armature to open or close contactors. A small current through the coil actuating the armature thus controls a heavy-duty circuit at the contactors.

resistance—The non-reactive opposition which a device or material offers to the flow of direct or alternating current. The opposition results in production of heat in the material carrying the current. Resistance is measured in ohms, and is usually designated by the letter R .

resistance-coupled amplifier—A vacuum-tube amplifier in which the various stages are coupled solely by resistances between output and input. A direct-coupled amplifier. Such systems are useful down to zero frequency. Often, this term is used for a resistance-capacitance-coupled amplifier, which is a more common type.

resistor—A radio part which offers resistance to the flow of electric current. Its electrical size is specified in ohms or megohms (one megohm equals 1,000,000 ohms). A resistor also has a power-handling rating in watts, indicating the amount of power which can safely be dissipated as heat by the resistor.

resonance—(1) When equivalent (combined) reactance is zero in a circuit containing inductance L and capacitance C . If L and C are in series, circuit current is a maximum at resonance. If L and C are in parallel, external current supplied to circuit is a minimum at

resonance and voltage nearly maximum. (2) At resonance, small amplitude of the periodic agency that is maintaining oscillation or vibration in a system produces large amplitude of oscillation or vibration. (3) Types of resonance: amplitude, period, phase.

resonant circuit—An oscillator circuit capable of being brought into resonance.

RETMA—Abbreviation for Radio-Electronics-Television Manufacturers' Association.

Rochelle salt crystal—A crystal of sodium potassium tartrate, having a pronounced piezoelectric effect. Extensively used in crystal microphones and phonograph pickups.

root-mean-square—When referring to an alternating current value, the value that corresponds to the direct-current value that will produce the same heating effect. It is .707 of the peak a.c. value.

scratch filter—A low-pass filter circuit inserted in the circuit of a phonograph pickup to suppress needle-scratch noises. It suppresses the higher audio frequencies as well.

screen grid—A grid placed between the control grid and plate elements of a pentode or surrounding the plate of a tetrode to decrease grid-plate capacitance.

secondary—One or more transformer windings which receive energy by electromagnetic induction from the primary.

secondary emission—Emission of electrons from a cold electrode when it is hit or bombarded by high-speed electrons.

selectivity—The characteristic which determines the ability of a radio receiver to reject undesired and untuned signals. Also called **selectance**.

selenium cell—A photocell using selenium as a photoconductive element. The resistivity of selenium decreases when the material is exposed to light.

self-bias—Referring to a vacuum-tube stage which produces its own grid bias voltage. Plate current flowing through a resistor in series with the cathode lead produces across this resistor the voltage drop used for grid bias purposes. Also called **automatic C bias**.

self-excited oscillator—A vacuum-tube oscillator that operates without external excitation and solely by the direct voltages applied to the electrodes.

semi-conductors—A class of solid materials characterized by comparatively high resistivities. Many of these are salts or oxides in which conduction is ionic. Another group, more important in communications, is composed of semi-metallic elements or oxides in which conductivity is electronic, but of two types, depending on impurities present: (a) drift of electrons which are present in excess; (b) drift of "holes" by migration of electrons in cases where there is a deficiency of electrons. By special treatments, usually thermal, the resistivity, temperature coefficient of resistance or thermoelectric power may be varied over wide ranges. Semi-conductors are finding increasing use as rectifiers, detectors and amplifiers in transistors and varistors, thermistors and thermoelectric elements.

sensitivity—(1) Characteristic of a radio or television receiver which determines the minimum input signal strength required for a given signal output value. (2) The displacement (generally measured in inches distance) of the luminous spot on the screen of a cathode-ray tube, per volt applied to deflecting plates or per ampere of current through a deflecting coil.

series—A way of arranging parts in a circuit by connecting them end to end to provide a single path for current flow.

short circuit—Low-resistance connection across a voltage source or between the sides of a circuit or line; usually accidental and usually resulting in excessive current flow which often causes damage.

short waves—A general term usually applied to wavelengths shorter than lower limit of the standard U. S. broadcast band, 200 meters. Frequency is higher than 1600 kc.

shunt—(1) A precision low-value resistor placed across the terminals of an ammeter to increase its range by allowing a definite fraction of the circuit current to go around the meter. (2) Any part connected in parallel with some other part.

signal—The form or variation of a wave with time, serving to convey the information, message, effect, or other desired intelligence in communications.

sine wave—Waveform corresponding to a pure, single-frequency oscillation. If amplitude is plotted against angle (or time, which is in proportion to angle), the curve is a sine function. From 0 to 90° (one quarter period), the amplitude increases as the sine of the angle. From 90° to 180°, it decreases symmetrically with the increase, forming an arch (of one half period). During the interval from 180° to 360° (the other half period), the arch is inverted and repeated in a trough. The periods or cycles then repeat.

smoothing filter—A filter composed of inductance and capacitance (or either alone) to remove a.c. components from the unidirectional output current of a rectifier or direct-current generator.

solder—An alloy of lead and tin which melts at a fairly low temperature (about 500° F) and is used for making permanent electrical connections between parts and wires. Silver solder, which has a much higher melting point, is composed of silver, copper and zinc.

solder gun—A soldering iron having an appearance similar to that of a pistol. It usually has a fast-heating resistance element at the tip, which operates at high current and low voltage from a step-down transformer built into the unit.

solenoid—(1) An electromagnet having an energizing coil approximately cylindrical in form, acting on a movable ferromagnetic core or plunger positioned in the center of the coil. (2) A cylindrical coil.

speech amplifier—An audio-frequency amplifier used between the microphone or audio sound converter and the input of the power amplifier to raise the output voltage of the microphone or converter to the required power amplifier input level to assure the amplifier's full output. Generally used with radiotelephone transmitters, and also with public address amplifiers.

sporadic E layer—That portion of the normal E layer in the ionosphere that sometimes breaks away and exhibits special erratic characteristics.

squelch circuit—An a.v.c. circuit that reduces or attenuates the noise otherwise heard in a radio receiver between signals by blocking some stage when the signal amplitude is below a value called the squelch level.

stagger tuning—Commonly used in television receivers and high-fidelity radio tuner circuits. A means of securing a wide bandwidth in a multistage i.f. amplifier by detuning pairs of the tuned circuits in opposite directions by a specified amount.

standard broadcast band—Frequencies extending from 535 to 1605 kilocycles.

(To be continued next month)

SURPLUS INDUSTRIAL ELECTRONICS WHOLESALE RETAIL

POWER TRANSFORMER
 Primary—115 V—3 phase—60 cycle
 Secondary—3700 Volts C.T.—1.7 AMPS
 Aircooled—MFG—Press Wireless-Type T5378
 Porcel Terminals—Open Frame—(in metal case housing
 17 x 12 1/2 x 12 1/2) **\$79.50**
 New—Crated—Ship, wt. abt. 300 lbs.

SWITCHBOARD-BD-57—(used in training set-ups.) (20
 Jacks in rows.) 3 rows—with plug and cords. The perfect
 Monitor, Control, or Demonstration Unit. 12 x 8 x 10—
 (Wooden Case) Near New (unused). **\$14.95**
 For Less than the Price of the Plugs.

DIODES—1N21, 22, New—6 for \$1.00
1N34, New—2 for \$1.00

TUBES—955, 956, 957, 958A. 4 for \$1.00; each 75c
TBY TRANSCEIVERS. (Less power supply.) **\$24.95**
 With all tubes—Excel. Condition.

ROTARY CERAMIC SWITCH—2 Deck—2P-11 Pos. 98c
 3" ea. Deck. ea.,

P.O.B. N. Y.

REX RADIO SUPPLY CO.
 88 Cortland St. New York 7, N. Y.

TRANSISTOR

WIRELESS MIKE

Now available after years of research is the first low cost transistor
 wireless mike. Actually a complete miniature wireless transmitter that
 will send your voice through any standard broadcast radio up to 50
 feet. Can be used as a wireless intercom. No license or permit required.
 Ultra-compact unit fits in pocket with self contained long life battery.
 Skillfully constructed from the finest sub-miniature components. Com-
 plete ready-to-operate unit only \$7.98 postpaid. Absolutely nothing else
 to buy. In kit form \$5.98.
 Postage extra on COD orders and \$1.00 deposit required.

SPRINGFIELD ENTERPRISES
 Box 54-E Springfield Gardens 13, N. Y.

FREE CATALOG of TV KITS

LEARN TV the practical way—

Assemble a TRANSISTION TV KIT in easy stages. Pay as
 you wire—only \$15 for Starting Package #1. Learn
 while building a superb 17" to 27" screen TV Set with
 latest features. Ideal for Fringe Areas, adaptable to UHF.
 Easy — no instruments or technical
 knowledge required. Free Catalog de-
 scribes 8 great TRANSISTION TV KITS.

Write today to Educational Dept. at—
TRANSISTION, INC., Dept. PE, NEW ROCHELLE, N. Y.



MOVING ?

BE SURE POPULAR ELECTRONICS FOLLOWS YOU. PLEASE SEND YOUR CHANGE OF ADDRESS TO

POPULAR ELECTRONICS
Circulation Department
 64 E. LAKE ST. CHICAGO 1, ILL.

Shrinks Hemorrhoids

New Way Without Surgery

Science Finds Healing Substance That
 Relieves Pain — Shrinks Hemorrhoids

For the first time science has found a new healing
 substance with the astonishing ability to shrink hem-
 orrhoids and to relieve pain—without surgery.
 In case after case, while gently relieving pain,
 actual reduction (shrinkage) took place.
 Most amazing of all—results were so thorough
 that sufferers made astonishing statements like
 "Piles have ceased to be a problem!"
 The secret is a new healing substance (Bio-Dyne*)
 —discovery of a world-famous research institute.
 This substance is now available in suppository or
 ointment form under the name Preparation H.* Ask
 for it at all drug counters—money back guarantee.
 *Reg. U.S. Pat. Off.

Classified

RATE: 50c per word. Minimum 10 words prepaid. April issue
 closes February 3rd. Send order and remittance to: POPULAR
 ELECTRONICS, 366 Madison Avenue, N. Y. C. 17.

FOR SALE

DIAGRAMS for repairing radios \$1.00. Television \$2.00.
 Give, make, model. Diagram Service, Box 672-PE,
 Hartford 1, Conn.

RADIO Plans-Pocket F-M, Four Band, Oscillator, All
 Three Only 20c And Stamped Envelope. Printed Cir-
 cuit Television Antenna \$1.98, See POPULAR ELEC-
 TRONICS Sept. Page 117 Ekeradio, 646 North Fair
 Oaks, Pasadena, California.

SECRET Beam Transmitter, New, Five Mile Range,
 White & Infrared, Portable, Flashlight battery opera-
 tion. Includes Signal Gun, Gunstock, Tripod, Infra-
 red Goggles, Remote Control, Carrying Case, Manual.
 Government paid over \$50. Yours for only \$10 post-
 paid. Illustrated Signal Corps Manual 50c. Surplus
 Box 118, Jersey City 4, N. J.

PREFABRICATED etched circuitry boards. Ready to
 assemble components. Moenco, Box 42, Haddon
 Heights, N. J.

ARMY Field Telegraph Set. New including Key, Head-
 phone, Manual, Carrying Case \$10 postpaid. Surplus
 Box 118, Jersey City 4, N. J.

NAVY Headphones New, Low Impedance, Waterproof
 Cord & Plug \$4.00 postpaid. Surplus, Box 118, Jersey
 City, N. J.

TRANSISTOR devices, walkie-talkies, VHF AM-FM
 Portable radios, geiger counters, radio control, Photo-
 electric relays all at wholesale prices direct from our
 factory. Free literature. Springfield Enterprises, Box
 54-E2, Springfield Gardens 13, N. Y.

WALKIE-talkie. Build wireless portable radiophone
 for less than \$10.00. Plans for variable frequency and
 crystal control types, only 50c for both. Springfield
 Enterprises, Box 54-E2, Springfield Gardens 13, N. Y.

TUBES-TV, Radio, Transmitting And Industrial Types
 At Sensibly Low Prices. New. Guaranteed 1st Quality
 Top Name Brands Only. Write For Free Catalog or
 Call Walker 5-7000, Barry Electronics Corp., 512 Broad-
 way, New York 12N, N. Y.

TRANSISTOR Radio Kits \$5.95 to \$11.95. Pocket and
 portable. Includes directions, all parts, drilled case,
 solder and precut wire. Free Literature. Highland
 Electric, Box 553E, Pasadena, Calif.

ELECTRIC Guitars, Amplifiers, parts, wholesale, Free
 Catalog. Carvin, PE, Covina, Calif.

USED Television sets \$14. Jones, 1115 Rambler, Potts-
 town, Penna.

NEW! Radio-Television Tube Base Pin Locator, Com-
 puter Type, \$1.00 Postpaid. Distributors Wanted.
 Electronics, Box 827, Sparks, Nevada.

ELECTRIC Pencil. Engraves all Metals, \$1.50. Beyer
 Mfg., 10511-P Springfield, Chicago 43.

15 TESTED One-tube circuits 25c, including "Radio-
 builder" magazine, catalog. Laboratories, 328-L Fuller,
 Redwood City, California.

WANTED

CYLINDER and old disc phonographs. Edison Concert,
 Balmoral, Conqueror, Opera, and Oratorio mod-
 els. Berliner Gramophones and Zono-o-phones, Col-
 umbia disc and cylinder Graphophones, Bettini
 micro-reproducer. Want old catalogues and literature
 on early phonos prior to 1919. Will pay cash or trade
 late hi-fi components. POPULAR ELECTRONICS,
 Box 50.

TUBES and equipment bought, sold and exchanged.
 For action and a fair deal write B. F. Gensler, W2LNI,
 56 Crosby St., N. Y. 12N, N. Y.

INVENTIONS WANTED

INVENTIONS wanted. Patented; unpatented. Global
 Marketing Service, 2420 77th, Oakland 5, Calif.

HELP WANTED

GET New Shirt Outfit Free: make \$90.00 weekly on
 5 average orders a day. Famous quality Made-To-
 Measure dress and sport shirts at \$3.95 up sell fast to
 all men. No experience needed. Full or part time.
 Write: Packard Shirt Co., Dept. 261, Terre Haute, Ind.

JOBS to \$1500 Monthly. All trades. So. America, The Islands, US. Fare Paid. Application Forms, Free Information. Write Dept. 72E. National, 1020 Broad, Newark, N. J.

PROFITS To 150% selling finest Everyday Greeting Cards. New 21 for \$1 Tall Cards, unusual Gifts, 129 fast-sellers. Valuable Gift Bonuses. Assortments on approval, Stationery samples Free. \$1 Gift Free for promptness! Creative Cards, 4401 Cermak, Dept. 524-C, Chicago 23.

HAVE extra money for new equipment, clothes, furnishings. Show friends amazing value new type parchment, photochrome greeting card assortments. Profits to 100% plus bonus. Write today for Feature boxes on approval. 29 free samples Personal Stationery, free Catalog, Selling Guide. New England Art Publishers, North Abington 233-N. Mass.

EARN Extra Money Selling Advertising Book Matches. Free Sample Kit furnished. Matchcorp, Dept. EZ-5, Chicago 32, Illinois.

BUSINESS OPPORTUNITIES

TO \$100.00 Weekly. Spartime. Home Operated Mail-order Business. Successful "Beginner's" Plan. Everything Supplied. Lynn, 10420-E National, Los Angeles 34.

VENDING Machines—No selling. Operate a route of coin machines and earn amazing profits. 32-page catalog free. Parkway Machine Corporation, Dept. 12, 715 Ensor St., Baltimore 2, Md.

FREE Booklet "Money-Making Facts" tells mechanically-inclined men how to start sparetime business at home. Lee Foley Company, Columbia Heights, Minnesota.

UP To 85% Discounts on name brands! Giant 100 page catalog. BTS Products, Box 217, Oakland 74, N. J.

\$70 WEEKLY—home, spare time. Simplified mail Bookkeeping. Immediate income—easy! Auditax, 34757Y, Los Angeles 34.

BECOME Tax Consultant. Our students earn to \$3,000 in 3-month season, part-time. We train you—help you start. State approved. Union Institute, 68 Hudson, Hoboken 3G, New Jersey.

TAPE RECORDERS

TAPE Recorders, Tapes, Accessories. Unusual values. Dressner, Box 66E, Peter Stuyvesant Station, N. Y. 9.

INSTRUCTION

HIGH School—No Classes. Study at home. Spare Time. Diploma awarded. Write for Free Catalog HET10. Wayne School, 2527 Sheffield, Chicago 14, Ill.

MINERALS & PROSPECTING

GEIGER Counter and Metal Detector Kits. Inexpensive, Educational. Free Literature. Electronic Applications, Dept. B, 5024 Lee Highway, Arlington 7, Va.

NEW! Uranium detector kit, \$8.49. Free catalog. CMG, Box 611-PE, Laramie, Wyoming.

MISCELLANEOUS

FREE Condenser & Resistor Code Chart! Get yours now Plus new value-packed catalogue! K. & L. Radio Parts Co., 1406 Venice Blvd., Los Angeles 6, California.

SENDING, Receiving remails, 25¢ each one year From date on Magazine. Short, Secretarial. Best service, inquire. Absolutely confidential. 435½ Third Ave., San Francisco 18, Calif.

EX-RAY Mind! Hypnotize, one glance. Guaranteed \$3.00! Womstoker, Ottery, Cape, Africa.

RULE Others With Thoughts. Full Course. (Adults.) \$2. Delmar Wisdom, 846-58 Sunnyside, Chicago 40.

February, 1956

SHOOT TV TROUBLE FAST

With H. G. Cisin's Copyrighted RAPID "TV TROUBLE SHOOTING METHOD"

Without experience or knowledge, this guaranteed new method of servicing TV sets enables you to DIAGNOSE TV troubles as rapidly as an expert. **NO THEORY—NO MATH**—you can locate all faults in record-breaking time regardless of make or model. "TV TROUBLE SHOOTING METHOD" is the most valuable aid to TV servicing ever written. Be a TV Trouble Diagnostician. Increase your present earnings. Open your own Profitable Business or get a high-paying skilled job.

It's all in this book . . . Nothing more to Pay—Nothing else to Buy

85 picture troubles, over 58 raster and 17 sound troubles. By this unique copyrighted method you know EXACTLY WHERE the trouble is; plus step-by-step instructions, including 69 RAPID CHECKS, enabling you to find the faulty part.

13 IMPORTANT PRELIMINARY CHECKS NEED NO INSTRUMENTS! Of the 69 Rapid Checks, **OVER 65 ALSO REQUIRE NO INSTRUMENTS!** Rapid checks include emergency checks for distorted pictures, defective tubes including PIX tube, plus 57 others. **ALL EXPLAINED IN SIMPLE LANGUAGE—PERFORMED WITHOUT INSTRUMENTS. MANY CHECKS USE THE PICTURE TUBE AS A GUIDE.**

H. G. Cisin, the author, is the inventor of the AC/DC midjet radio. He licenses RCA, AT&T, etc. He has also trained thousands of technicians now owning their own prosperous TV service organizations or holding highly paid TV positions. His years of experience are embodied in this remarkable new book.

Guaranteed Money Back in 5 Days if Not Satisfied!

ABSOLUTELY FREE with each order: H. G. Cisin's newest book "TV & RADIO TUBE SUBSTITUTION GUIDE." Gives direct replacements of set and picture tubes. Most valuable servicing aid! **ACT NOW—get both books postpaid at cost of only one!**

\$1 Post-paid

RUSH COUPON NOW!

H. G. CISIN, CONSULTING ENGINEER, Dept. P-14
Amagansett, N. Y.
Enclosed find \$1. Rush both books.

Name

Address

City Zone State

LEARN ELECTRONICS & COLOR TV in K.C.

UNIVERSAL TV . . . Famous for 25 Years
Thousands of Successful Grads

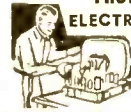

ELECTRONICS—the world's GREATEST new industry is years ahead of its manpower supply. **ELECTRONICS JOBS ARE SEEKING TRAINED TECHNICIANS,** an acute shortage of which exists today. Big companies are actually pirating men from one another because there aren't enough trained electronics experts to go around to fill the many jobs.

Wide Scope Electronics Course at UNIVERSAL: Embraces Radio, Monochrome-Television, Color TV, Industrial Electronics, Industrial Television, Atom-electronics and Automation. Automation, a terrific new field, embraced at UTS. **25 Years EXCLUSIVELY in Electronics:**

For a quarter of a century UNIVERSAL TV has been training and placing grad technicians in fascinating big-pay jobs from coast to coast. You can start earning as much as \$150 per week; no limit as time goes on, or you can open your own business.

UNIVERSAL not a Johnny-come-lately school; Not a home study or correspondence training, but a "genuine" old established resident school staffed by expert instructors and headed by America's first TV broadcasters. Costs so little to prepare yourself for life. Many middle age trainees attend; go into successful business. No previous experience needed. Approved for vets and non-vets. Send coupon for **FREE BOOK** on TV and electronic opportunities.

WRITE FOR

FREE CATALOG

FILL OUT COUPON

UNIVERSAL TV SCHOOL

1222E Admiral Boulevard, Kansas City, Missouri

PLEASE SEND ME INFORMATION FREE. Age

Name

Address

City State

Check here if Korean Veteran



INFRARED SNOOPSCOPE



Selected GTD. Image Converter Tube. Hi-sensitivity simplified design 2" dia. Willemite screen—Hi Resolution. Tube & Data @ \$3.90; 2/\$7.50
SNOOPSCOPE POWER SUPPLY
 4500 VDC/35MA. Using Dual Doubler Gklt. Transformer. Rectifiers, Sockets, Resistors, Capacitors & Diagram 115V/60 cy oper @ \$13.50

NEW POCKET AC-DC MULTITESTER

1000 Ohms Per Volt

"TAB" 27C **Only \$7.75 ea.**



Finest precision Hi-accuracy VOM. Reads AC & DC Volts: 0, 5, 25, 250, 1000 v. DCMA. 10, 100 MA. OHMS: 0, 10, 100K. Size 1 1/2" D x 4 1/2" L x 3 1/2" W. Features: 1/2% Precision resistors, extra long meter scale, 3" rectangular meter, sturdy bakelite case, rugged jeweled D'Arsonval microamp movement. Complete w/batteries and test leads. Ideal for Ham, Experimenter and Beginner. Plus 40c tip in U.S.A.

NEW VARIABLE 0 TO 6 & 12 VOLT/12 AMP Dc Power Supply

Battery Eliminator, Charger, Model RR. Plates Aircraft, Marine or any DC requirement. Extra Heavy Duty Selenium Rectifier. 2 meters V & A. Designed for cont. service & up to 20 amps intermittent overload.
 MODEL T612V12AC \$29.95

NEW "TABTRON" SELENIUM RECTIFIERS

FULL WAVE BRIDGE

Dated—One Year Guarantee

18VAC/14VDC—1 Amp \$1.60; 2A \$2.40; 3A \$3.45; 4A \$4.25; 6A \$5.20; 10A \$7.50; 12A \$9.20
 36VAC/28VDC—1 Amp \$2.70; 2A \$3.40; 3A \$4.75; 4A \$5.45; 6A \$10.05; 10A \$14.35; 12A \$18.10.



TUBES TESTED Guaranteed
 NEVER A DISSATISFIED CUSTOMER

0A2 .70	6A9S .45	654 .45	12AX4 .70
024 .42	6AS5 .75	65A7 .45	12AX7 .55
1B3 .60	6AT6 .35	6SH7 .40	12BH7 .65
114 .40	6AU4 .75	6SJ7 .45	CK1026 3.25
1R5 .45	6AU6 .40	6SK7 .45	CK722 .95
54 .64	6AX4 .60	6SL7 .55	12BY7 .70
1S5 .40	6BA6 .45	6SN7 .39	12SA7 .65
114 .49	6BC5 .45	6SQ7 .39	12SK7 .43
114 .49	6BE5 .45	6T4 1.00	12SN7 .55
1U5 .40	6BG6 1.12		12SQ7 .45
1X2A .60	6BK5 .75	6T8 .75	19BG6 1.25
2V3 .48	6BL7 .80	6U8 .75	25B06 .90
3A5 .75	6BN6 .65	6V6 .65	25Z6 .45
304 .45	6BQ6 .90	6V6 .65	35Q9 .40
3V4 .35	6C4 .35	6X4 .30	35L6 .50
5U4G .62	6C4 .35	7A6 .40	35W4 .45
5Y3G .65	6C6B .48	7F7 .55	50A5 .45
6AB4 .40	6C6B .48	7F8 .68	50B5 .55
6AC7 .64	6C6B 1.12	7N7 .50	50C5 .45
6AG5 .45	6H6 .45	7Q7 .75	50L6 .40
6AH4 .75	6H6 .45	7Q7 .75	50L6 .40
1888 7.95	6J5 .38	12AT6 .40	75 .45
6AH6 .85	6K6 .39	12AU7 .50	77 .45
6AK5 .52	6K7 .35	12AV6 .35	117L7/M7
6AL3 .38	6L6 .65	12AV7 .75	1.75

BUILD IT YOURSELF—HI-FI AMPLIFIER

HI-FI MUSIC LOVER'S AMPLIFIER—Finest quality. Rated: 10 W. Distortion: 1%, Freq. Response: 1DB (20 to 20,000 CPS). Output: 4, 8, 16 Ohms. Brown Hammerloid finish. Size: 10" x 6" x 6". Wt. 9 lbs. 115V/60 cy. Complete & detailed inst. Anyone can build & assemble with enjoyment.

Model TLL-10. Only \$21.00
FREE WRITE TODAY FOR OUR NEW CATALOGS

INSTANT HEAT SOLDERING GUN—Handiest & lightest soldering gun for fine or heavy duty soldering. Equal 120 Watt soldering iron. Special alloy non-corroding tip, automatic light, easy grip, perfect balance, rugged construction. 115V/60 cy.

PLASTIC UTILITY BOXES—Size 10 1/2" x 6 1/2" x 2 1/2". 12/18 Compartments @ \$1.59 ea. Any Seven @ \$10
 HOOK UP WIRE—Ass'd 5 Colors, 100 ft./roll; 500 ft. @ \$1.98 ea.
 "TAB" Special Wrench—With 1001 Uses. Fits 95% all sizes Square & Hex head nuts & bolts 1/4" to 9/16". Precision sizes. Guaranteed Rustproof. Brkproof @ 50c ea.; 12 \$5
 THOR ELECTRIC SPEED DRILLS—2011 1/4" with Jacobs chuck. 2400 RPM/115 VAC with 9 Drills in case, Special @ \$14.95
 325 3/8" with geared chuck. 1000 RPM/115 VAC... \$23.25

SAVE \$\$\$ on "TAB" PART KITS

Most Popular Values and Sizes

100 CARBON RESISTORS
 10 ELECTROLYTIC COND.
 48 TERMINAL STRIPS
 10 TOGGLE SWITCHES
 25 TUBE SOCKETS
 50 INSULATORS

95¢ ea.



"TAB"

TERMS: Money Back Gtd. (cost of mfg. only) \$4 m. order F.O.B. N.Y.C. Add shpg. charges or for C.O.D. 25% Dep. Tubes Gtd. via R.Ex. only. Prices shown are subject to change.

111 Liberty St., N.Y. 6, N.Y., Rector 2-6245, Dept. 2PE6

ADVERTISER'S INDEX

ADVERTISER	PAGE NO.
Advance Spectacle Co.	116
Algeradio Electronics Co.	116
Allied Radio Corp.	118
Almo Radio Co.	123
American School	125
Arrow Electronics	124
Barley Technical Schools	115
Burstein-Applebee Co.	122
Canadian Institute of Science	120
Capitol Radio Engineering Institute	21
Century Electronics Co.	121
Chicago Standard Transformer Co.	121
Cisin, Harry G.	131
Cleveland Institute of Radio Electronics	17
Coloradapter	31
Coyne Electrical School	5, 34
DeVry Technical Institute	11
Duraclean Company	120
Dynamu Magnetics Corp.	124
Electronic Instrument Co., Inc. (EICO)	12
Electronic Measurements Corp.	8
Emig School of Electronics	122
Esse Radio Co.	29
G & H Wood Products Co., Inc.	4th Cover
Gratham School of Electronics	114
Greenlee Tool Co.	30
Gyro Electronics Co.	121
Heath Company	102, 103, 104, 105
Hershel Radio Co.	14
Huckert Electronics	120
Indianapolis Electronic School	116
Institute of Mentalphysics, The	111
Instructograph Co.	118
International Correspondence Schools	13
Jamestown Stamp Co.	120
Jensen Manufacturing Co.	114
Johnson, E. F.	119
Jones Box Corp., Jesse	116
Karlson Associates, Inc.	121
Klipsch & Associates	16
Kruger Corporation	126
LMB	118
Lafayette	32
Lectron Specialties	127
Linguaphone Institute	24
McGraw Hill Book Co., Inc.	112
McMorrow, Bernard & Davidson	120
MacFarlane Industries	108, 109
Major Brand Tubes Co.	122
Miller, Gustave	31
Milwaukee School of Engineering	113
Minnesota Mining & Mfg. Co.	2nd Cover
Moss Electronics Distributing Co., Inc.	108, 109
National Radio Institute	25, 99, 100
National Schools	15
O'Brien, Clarence & H. B. Jacobson	114
Orradio Industries	26
Pacific States University	118
Pentron Corporation	24
Perma Power Company	30
Philadelphia Wireless Technical Institute	121
Precision Electronics (Grommes)	16
Precision Electronics (Western Radio)	118
Progressive "Edu-Kits" Inc.	3
RCA Institutes	23
Radio TV Training Association	7
Radio & Television News	115
Raytheon Manufacturing Co.	6
Rex Radio Supply	130
Rider, John F., Publishing Co., Inc.	16
Rinehart Books	28
Rockbar Corporation	20
Science Kits	123
Sherwood Electronic Labs.	18
Shure Brothers	22
Silvo Hardware	21
Simpson Mfg. Co., Mark	30
Smith, Johnson & Co.	125
Solar Electronics	19
Spraxberry Academy of Radio	3rd Cover
Springfield Enterprises	118, 126, 130
Stanley Electronics Corp.	25
TV Sales Company	122
TAB	132
Tech-Master Products Co.	125
Tetrad, Inc.	8
Thoreson Company	114
Transvision, Inc.	130
Tube Mart, The	111
U. S. Air Force	27
Universal Television Schools	131
Upholstery Trade School	122
V.S.I. Television School	120
Walparaiso Technical College	124
Viking of Minneapolis	10
Von Schrader Mfg. Co.	8
Whitehall Pharmacal Co.	130
World Radio Labs	117
YMCA Trade Schools	123

Learn **PRACTICAL RADIO-TV**
with **25 BIG KITS**

of equipment I send you while
you train with me... for valuable
shop bench experience...

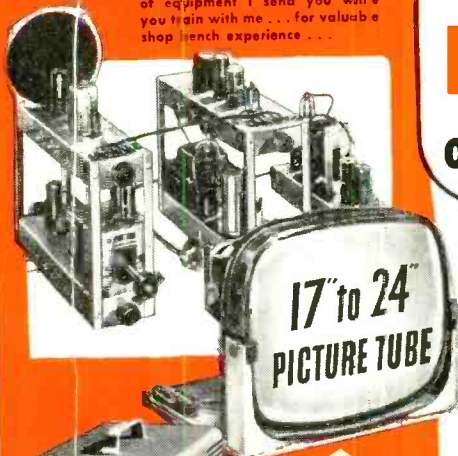

**17" to 24"
PICTURE TUBE**

The new Sprayberry Training Television receiver, built and tested in sections.

I now offer this fine modern oscilloscope.

You build this powerful 2 Band superheter radio receiver.

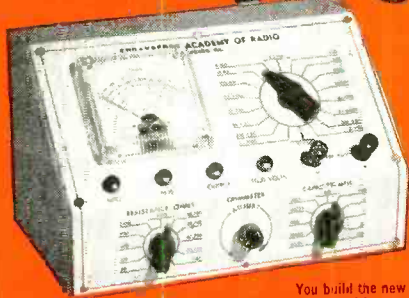

You build the new Sprayberry Tester... 18-range Volt-Ohm-Milliammeter readings.

In addition to modern lesson training, I also give you plenty of home practice on actual Radio Television equipment... you will build and use the units shown here plus many more. All this equipment is yours to keep... keep everything you need to set up your shop.

Prepare for a Good Paying Job — Or Your Own Business

**"I Will Train You at Home in
RADIO-TELEVISION
on Liberal No Obligation Plan!"**

New Equipment! New Lessons! Enlarged Course! The true facts are yours in my big new catalog... **YOURS FREE**...
JUST MAIL COUPON!



Frank L. Sprayberry
President, Sprayberry
Academy of Radio

I can train and prepare you in as little as 10 months to step into the big opportunity Radio-Television service field. Train *without* signing a binding contract... without obligating yourself to pay any regular monthly amounts. You train entirely at home in spare hours... you train as fast or as slowly as you wish. You'll have your choice of **THREE SPRAYBERRY TRAINING PLANS**... planned for both beginners as well as the more experienced man. Get the true facts about the finest most modern Radio-Training available today... just mail the coupon for my big new 56 page fact-filled catalog plus sample lesson—both **FREE**.

Train the Practical Way—with Actual Radio-Television Equipment

My students do better because I train both the mind and the hands. Sprayberry Training is offered in 25 individual training units, each includes a practice giving kit of parts and equipment... all yours to keep. You will gain priceless practical experience building the specially engineered Sprayberry Television Training Receiver, Two-Band Radio Set, Signal Generator, Audio Tester and the new Sprayberry 18 range Multi-Tester, plus other test units. You will have a complete set of Radio-TV test equipment to start your own shop. My lessons are regularly revised and every important new development is covered. My students are completely trained Radio-Television Service Technicians.

NEWEST DEVELOPMENTS
Your training covers UHF, Color Television, F.M., Oscilloscope Servicing, High Fidelity Sound and Transistors.

**See for Yourself... Make Your Own Decision
... Mail Coupon Today!**

The coupon below brings you my big new catalog plus an actual sample Sprayberry Lesson. I invite you to read the facts... to see that I actually illustrate every item I include in my training. With the facts in your hands, you will be able to decide. *No salesman will call on you.* The coupon places you under no obligation. Mail it now, today, and get ready for your place in Radio-Television.

SPRAYBERRY ACADEMY OF RADIO

111 North Canal Street, Dept. 105-H, Chicago 6, Illinois

Mail This Coupon For Free Facts and Sample Lesson



SPRAYBERRY ACADEMY OF RADIO
Dept. 105-H, 111 N. Canal St., Chicago 6, Ill.

Please rush all information on your **ALL-NEW Radio-Television Training Plan**. I understand this does not obligate me and that no salesman will call upon me. Include New Catalog and Sample Lesson **FREE**.

Name _____ Age _____
Address _____
City _____ Zone _____ State _____

CABINART '56 - HI FI CABINET KITS

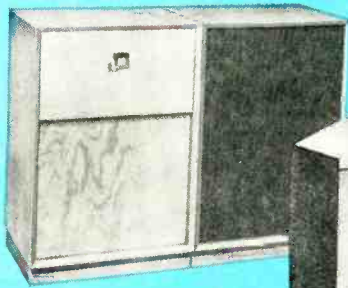

**MODEL 27K
MODEL 28K**
matched equipment
and speaker
cabinets

**Hi Fi
wall storage
units**

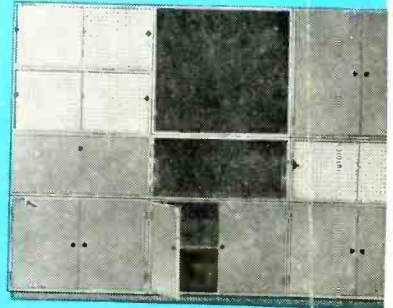

**Model K-3
newest Rebel***
corner folded horn kit



... all you need is a screwdriver!

Machined wood pieces key exactly to each other! Pre-shaped, pre-drilled, pre-engineered and not a scrap of sawdust left over!

THE REBEL K-3

Identical acoustically with the KR-3, first and largest of the Klipsch-designed Rebel series of corner folded horns. Using the mirror images of room walls at a corner, the K-3 extends bass down nearly to 30 cycles! Two companion Rebel kits are more economical but only in price and size.



K-3 . . . \$54.00

Prices slightly higher west and south

THE "ST" SERIES

Wall storage units . . . ten basic Cabinart designs in kitform or assembled, ready to finish. Each is tailored to the needs of hi-fi installations. The Series includes a *nine cubic foot bass reflex cabinet.*

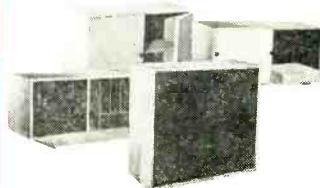

**Prices from
\$21.00 to \$36.00**

FURNITURE KITS

The new 27K and 28K typify Cabinart kit utility and economy. Both point up the unique design functions necessary to the correct hi-fi installation.



**Equipment Cabinet
\$51.00**



**Bass Reflex
\$39.00**

WRITE FOR THE NAME OF YOUR NEAREST DEALER AND MAIL ORDER HOUSE.

kits by **cabinart** ...the pioneers in radio furniture
for high fidelity.

99 NORTH 11th STREET, BROOKLYN 11, NEW YORK

*
Trademark

WRITE

1. Equipment Storage
2. Equipment/Speaker Enclosure Kits
3. The Rebel Speakers
4. Wall Storage Cabinets
5. Accessories By Cabinart

